

AUDIO ENGINEERING

APRIL
1951
35c

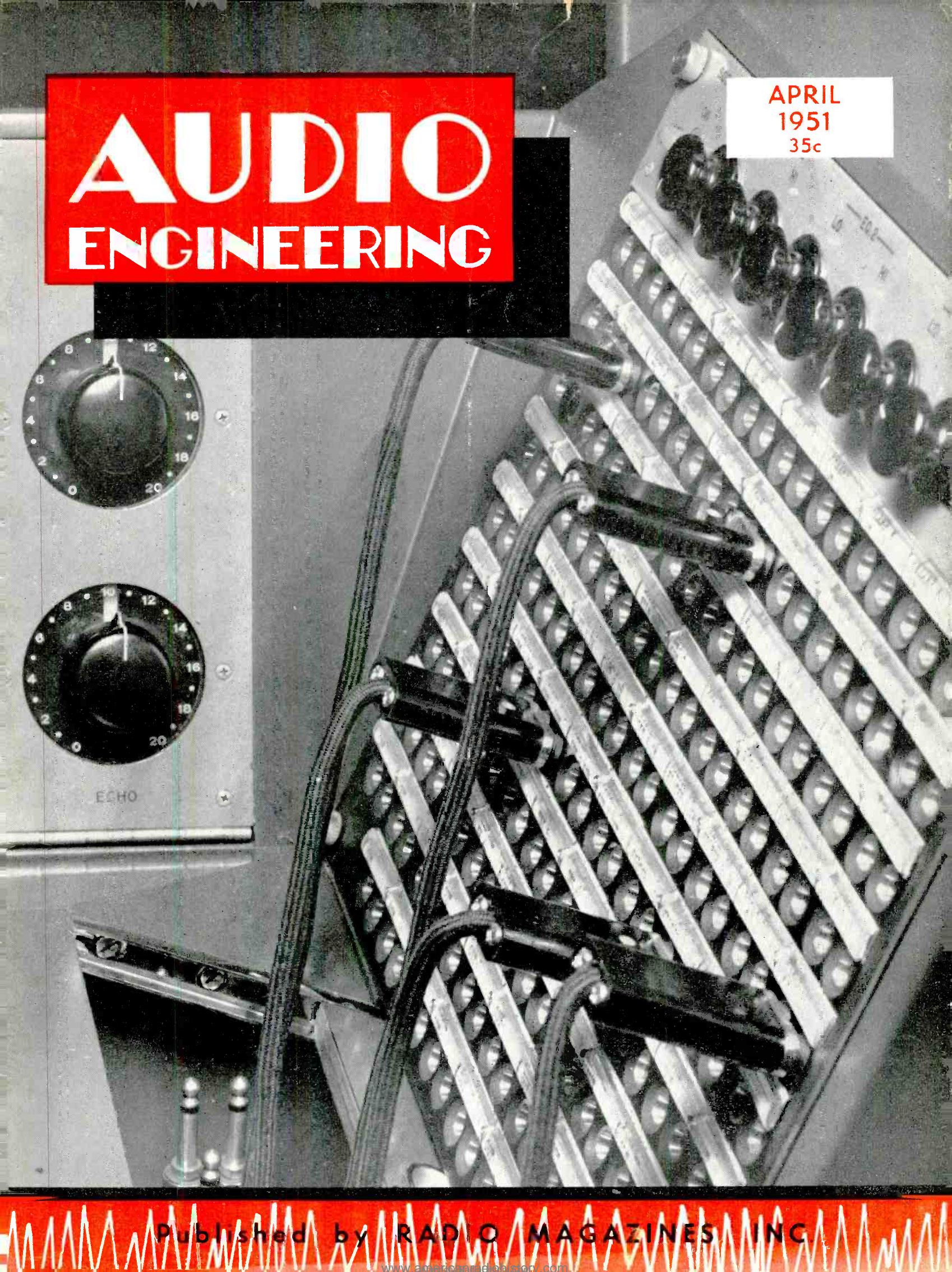

Published by RADIO MAGAZINES, INC.

www.americanradiohistory.com

CONSISTENT UNIFORM QUALITY

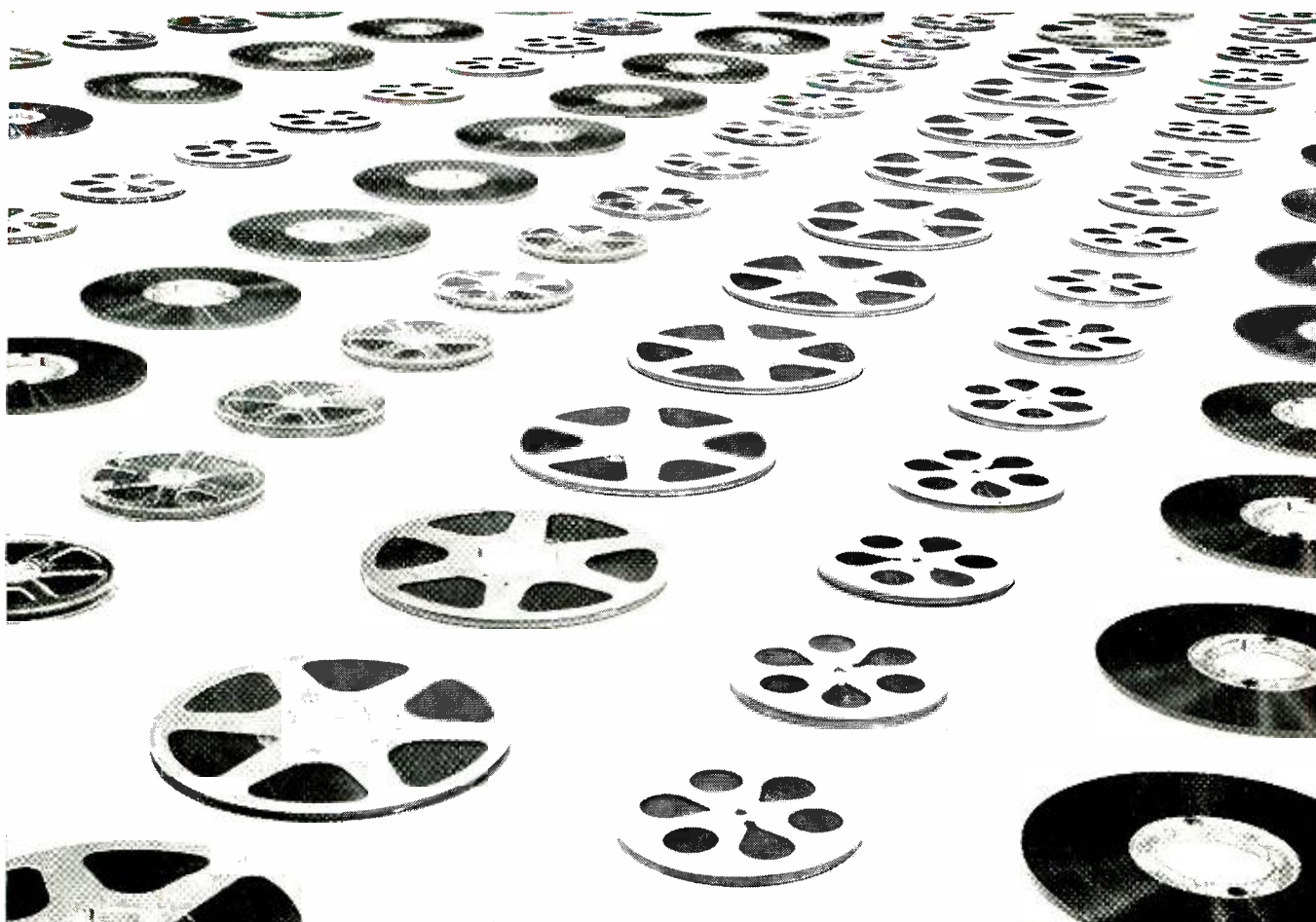

... reel after reel after reel!

That's just one of the EXTRA VALUES that you get in **audiotape*** made by audio engineers, for audio engineers

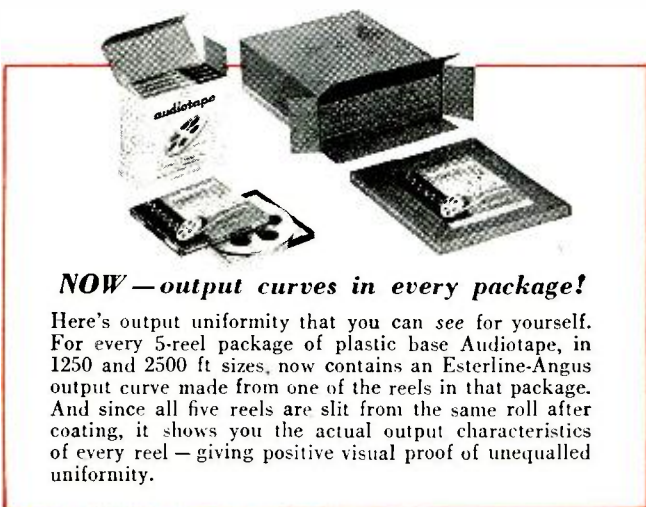

NOW — output curves in every package!

Here's output uniformity that you can see for yourself. For every 5-reel package of plastic base Audiotape, in 1250 and 2500 ft sizes, now contains an Esterline-Angus output curve made from one of the reels in that package. And since all five reels are slit from the same roll after coating, it shows you the actual output characteristics of every reel — giving positive visual proof of unequalled uniformity.

● Yes — when you reach for a reel of Audiotape, you can be *sure* that you will have the finest recording that your equipment can produce. You *know* that the output volume will not vary more than $\pm \frac{1}{4}$ db within every 1250 ft or 2500 ft reel of plastic base Audiotape. That is *guaranteed*. You *know* that these reels are entirely free from splices. That is guaranteed also. But, still more important, you know that you can depend on Audiotape for unequalled over-all performance — with maximum fidelity of reproduction and minimum surface noise and distortion.

In short, Audiotape *always* gives you the same consistent, uniform quality that has characterized Audiodiscs for more than a decade.

Have you heard about our new disc *recoating service*? We are now prepared to recoat your used discs for you — at a substantial saving over the cost of new discs. Your Audiodisc distributor will be glad to give you complete details.

*Trade Mark

AUDIO DEVICES, Inc.

444 MADISON AVE., NEW YORK 22, N. Y.

Export Dept.: 13 East 40th St., New York 16, N. Y., Cables: "ARLAB"

AUDIO ENGINEERING

Successor to **RADIO**

Established 1917



C. G. McProud, Editor

Luci Turner, Production Manager S. L. Cahn, Advertising Director
Luci e Carty, Circulation Manager H. N. Reizes, Advertising Manager

Editorial Advisory Board

Howard A. Chinn
John D. Colvin
C. J. LeBel
J. P. Maxfield
George M. Nixon

Representatives

H. Thorpe Covington, Special Representative
677 N. Michigan Ave., Chicago 11, Ill.
Sanford R. Cowan, Mid-West Sales
67 W. 44th St., New York 18, N. Y.
James C. Galloway, Pacific Coast Sales
816 W. 5th St., Los Angeles 17, Calif.
Technical Book & Magazine Co.
297 Swanston St., Melbourne, C. I.
Victoria, Australia

CONTENTS APRIL, 1951 Vol. 35, No. 4

Audio Patents— <i>Richard H. Dorf</i>	2
Letters	5
Hollywood Letter— <i>C. A. Hisserich</i>	8
Editor's Report	10
Television Studio Acoustics— <i>M. Rettinger</i>	13
A 15-Watt Direct-Coupled Amplifier— <i>William B. Fraser</i>	15
Harmonic Distortion in Iron-Core Transformers— <i>T. Williams and R. H. Eastop</i>	18
New Professional Tape Recorder— <i>W. E. Stewart</i>	21

AUDIO engineering society SECTION

Loudspeaker Damping— <i>Albert Preisman</i>	24
Record Revue— <i>Edward Tatnall Canby</i>	28
Pops— <i>Rudo S. Globus</i>	28
New Products	34
New Literature	35
Employment Register	46
Industry Notes	47
Industry People	47
Advertising Index	48

COVER

Patch panel of one of the five custom-built audio-TV consoles of advanced design which are being completed by the Broadcast Equipment Section of RCA Engineering Products Department for NBC studios 5A, 5B, and 5H, as well as new studios in the Center and Hudson Theatres in New York. A two-section desk arrangement provides for all switching facilities and controls in the desk proper, while a mirror in the separate hood at the rear permits the engineer to view the vertically mounted picture monitors. Signal lights in the hood indicate which cameras are in use.

AUDIO ENGINEERING (title registered U. S. Pat. Off.) is published monthly at 10 McGovern Ave., Lancaster, Pa., by Radio Magazines, Inc., D. S. Potts, President and Publisher; Henry A. Schober, Secretary-Treasurer. Executive and Editorial Offices: 342 Madison Avenue, New York 17, N. Y. Subscription rates—United States, U. S. Possessions and Canada, \$3.00 for 1 year, \$5.00 for 2 years; elsewhere \$4.00 per year. Single copies 35c. Printed in U. S. A. All rights reserved. Entire contents copyright 1950 by Radio Magazines, Inc. Entered as Second Class Matter February 9, 1950 at the Post Office, Lancaster, Pa. under the Act of March 3, 1879.

AUDIO ENGINEERING • APRIL, 1951



JIMMY DURANTE
"Four Star Review," NBC

Microphone of the STARS

RCA's new ribbon-pressure
"STARMAKER"

... a ribbon-pressure microphone that is so slim ... so skillfully styled ... so unobtrusive ... you must look twice to see it.

Despite its slim construction, the STARMAKER meets the exacting quality standards of other RCA professional Broadcast microphones. Pick-up is non-directional. Frequency response is substantially uniform, 50 to 15,000 cps. It is free from wind rumble and air blast ... and virtually impervious to mechanical shock.

The STARMAKER fits any standard microphone stand ... can be used in place of any RCA microphone. *No extra attachments needed.*

For delivery information call your RCA Broadcast Sales Engineer, or write: Department P-7, RCA Engineering Products, Camden, N. J. (In Canada write: RCA Victor Limited, Montreal.)



**RADIO CORPORATION
of AMERICA**

“exciting current test”

Another in a series which demonstrates **PEERLESS** transformer superiority!



PEERLESS S-240-Q



Competitor No. 1

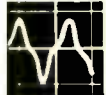

Competitor No. 2



Competitor No. 3



Competitor No. 4

Since the 1949 Audio Fair, comparative square wave tests on transformers shown all over the country have demonstrated Peerless superiority... Now Peerless emphasizes another very important property of transformers as shown by the “exciting current test.”

An output transformer’s ability to deliver plenty of clean, low-frequency power (the goal of every music lover) is inversely proportional to the amplitude and distortion of its exciting current.

PEERLESS superior low-frequency power handling capacity is illustrated in these comparative oscillograms.

Write for complete data.

PEERLESS
Electrical Products



Division

ALTEC
LANSING CORPORATION

161 Sixth Avenue
New York 13, N.Y.

9356 Santa Monica Blvd.
Beverly Hills, Calif.

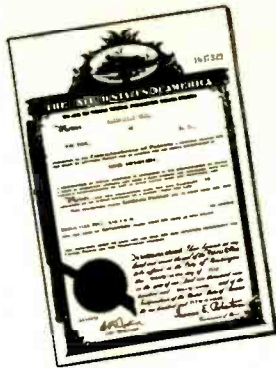

AUDIO PATENTS

RICHARD H. DORF*

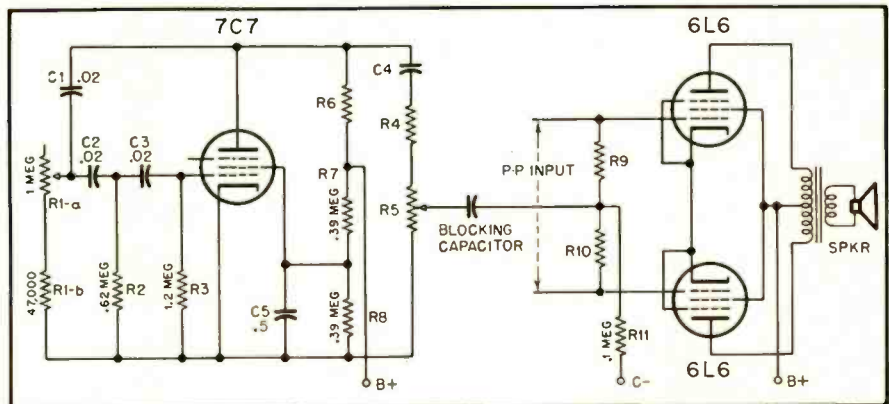

Figure 1

WHETHER THE MUSICALLY ELEGANT among us like the idea or no, quite a few electric guitarists exist. Each one of them requires an audio amplifier to go with his contact microphone and quite a few guitarists—to say nothing of electronic-minded violinists, banjoists, and other producers of music and neo-music—like to have their amplifiers produce the vibrato for them. True vibrato is not particularly easy to produce in an amplifier; this writer, at least, defines vibrato as a periodic variation in frequency at a rate in the 6-cps region.

Tremolo, however, can be added to an amplifier in a number of ways, since it is merely a periodic variation in signal amplitude. Nathan I. Daniel of Long Beach, N. J. presents a very handy method in his Patent No. 2,534,342. The scheme is diagrammed in Fig. 1.

The amplifier itself is entirely normal, using push-pull 6L6's, preferably with fixed bias. As the inventor notes, other tubes probably will work as well, at least in principle. The added attraction is a phase-shift audio oscillator using a 7C7. The phase-shift components are C_1 , C_2 , and C_3 , R_1 , R_2 , and R_3 . An output voltage divider R_4 - R_5 is placed across the plate circuit in series with blocking capacitor C_4 . R_6 is the plate load resistor, and R_7 - R_8 is a d.c. voltage divider for the screen supply. C_5 is, of course, the screen bypass. The frequency of the oscillator is variable between about 3 and 20 cps at a twist of the knob on potentiometer R_{10} . The output level control is R_9 .

Signal from the music source is fed to the push-pull grids in the usual way. The arrangement in the diagram is for a vacuum-tube phase inverter but a transformer is just as good for our purpose, the lead from the arm of R_3 then being connected to its secondary centertap and resistors R_9 and R_{10} being omitted. Bias is

fed to the output stage through isolating resistor R_{11} .

As the oscillator sends out its 3- to 20-cps wave, it effectively varies the bias on both 6L6's. An interesting facet of this circuit is that both tubes are affected in phase by the tremolo-oscillator signal so that the tremolo signal itself can produce no output in the speaker. It does, however, vary the gain of the stage and cause the music signal to vary in amplitude at the tremolo rate. The degree of amplitude swing is controlled by the setting of R_9 and the speed by R_{10} . When large swing is used for a very deep tremolo the arrangement spares the voice coil the work of swinging in and out and probably hashing up the music. Very bad effects—thumps, for instance—can be caused if a type of tremolo which does get to the speaker goes on at the same time a music tone of about the same frequency comes through. This circuit eliminates the hazard.

A tremolo amplifier like this one has one important use we did not mention. If you have designed an electric or electronic organ and can't find any way to add a vibrato—put tremolo in the amplifier.

Electronic Switch

Richard G. Stephenson of Sante Fe, N. M., has come up with a new kind of electronic switch which has some very intriguing possibilities. The patent (No. 2,521,952, assigned to the U. S.) mentions the possibility of viewing several signals simultaneously on an oscilloscope, which is itself an improvement over the ordinary electronic switch, which permits only two signals to appear. But this invention is also (though the inventor didn't use the term) an electronic commutator, which could come in very handy for transmitting several audio signals simultaneously over a single channel—wires or radio. Besides, it's a very “elegant” solution to the problem of sequence switching, which is one reason we like it.

The circuit of Fig. 2 provides for pre-

* Audio Consultant, 255 West 84th Street, New York 24, N. Y.

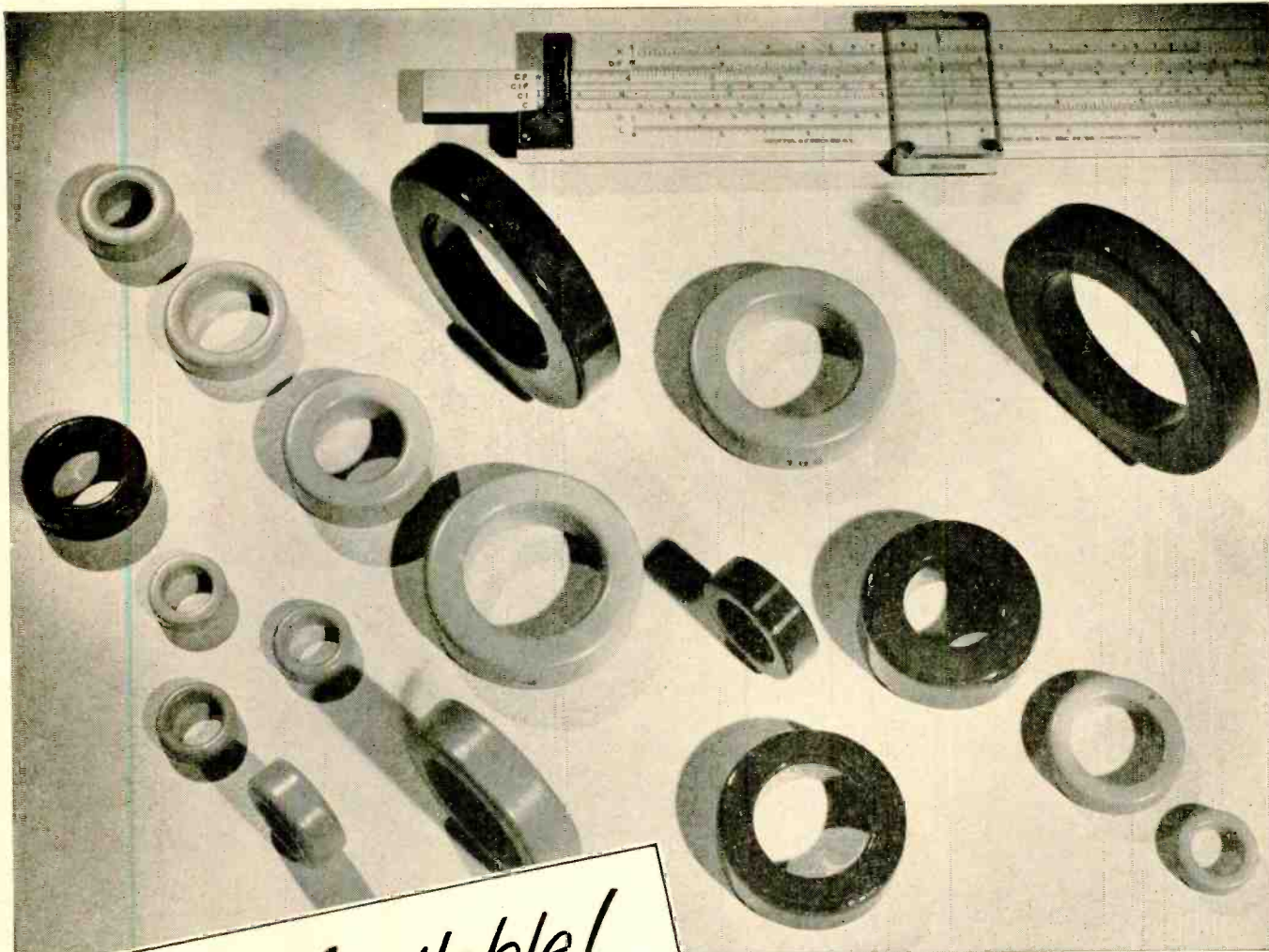

Now Available!
**MOLYBDENUM PERMALLOY
 POWDER CORES***

HIGH Q TOROIDS for use in
**Loading Coils, Filters, Broadband
 Carrier Systems and Networks—**
 for frequencies up to 200 K C

**COMPLETE LINE OF CORES
 TO MEET YOUR NEEDS**

- ★ Furnished in four standard permeabilities—125, 60, 26 and 14.
- ★ Available in a wide range of sizes to obtain nominal inductances as high as 281 mh/1000 turns.
- ★ These toroidal cores are given various types of enamel and varnish finishes, some of which permit winding with heavy Formex insulated wire without supplementary insulation over the core.

For high Q in a small volume, characterized by low eddy current and hysteresis losses, ARNOLD Moly Permalloy Powder Toroidal Cores are commercially available to meet high standards of physical and electrical requirements. They provide constant permeability over a wide range of flux density. The 125 Mu cores are recommended for use up to 15 kc, 60 Mu at 10 to 50 kc, 26 Mu at 30 to 75 kc, and 14 Mu at 50 to 200 kc. Many of these cores may be furnished stabilized to provide constant permeability ($\pm 0.1\%$) over a specific temperature range.

* Manufactured under licensing arrangements with Western Electric Company.

W&O 2930

THE ARNOLD ENGINEERING COMPANY



SUBSIDIARY OF ALLEGHENY LUDLUM STEEL CORPORATION

General Office & Plant: Marengo, Illinois

take a look INSIDE—and see why

CHICAGO

**IS TODAY'S
PREFERRED
TRANSFORMER**

**CHOICE OF ENGINEERS—
CHICAGO'S Sealed-in-Steel
New Equipment Line**

Here's the actual proof that demonstrates why CHICAGO units are ideal for application in new equipment, why they meet the express requirements of today's most-used tubes and circuits. Here are the "inside" facts of CHICAGO "Sealed-in-Steel" design:

1. Drawn steel cases for "steel wall" protection against moisture, for unsurpassed strength and rigidity, for convenient mounting, and for compact, streamlined appearance.
2. Uniformly-wound precise coil structures, for cool operation and superior electrostatic shielding in power units, and minimum leakage with optimum coupling in audio units.
3. Core of high-grade, non-aging silicon steel brought to high efficiency by scientific heat-treating in CHICAGO'S own annealing ovens.
4. Core and coil vacuum-impregnated with varnish; alternating vacuum and pressure, combined with heat, removes all moisture. Final high-temperature baking achieves a perfectly impregnated coil and core locked against vibration.

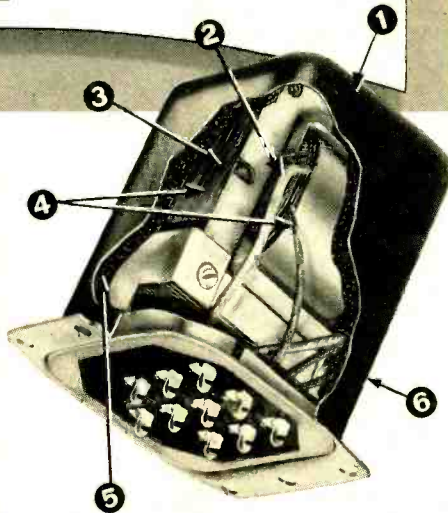

5. Special, moisture-resistant compound fills all internal free space. Compound prevents corrosion and helps maintain cool operation. Heat conduction is faster than in conventional mountings where coil and core are surrounded by air.
6. Units are checked by quality controls throughout manufacture; inspected for materials and workmanship; tested electrically at various stages; rigid concluding tests insure efficient performance and long, dependable operating life.

Available in 4 Constructions to Meet Most Requirements

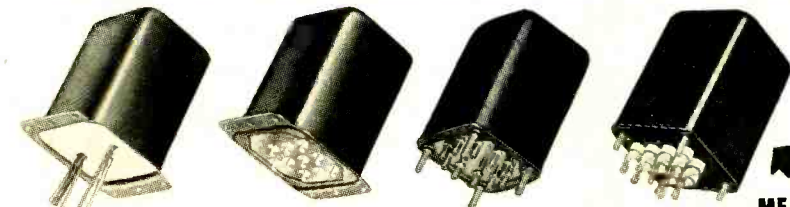

- C-Type.** With 10" color-coded stripped and tinned leads brought out through fibre board base cover. Flange-mounted unit.
- S-Type.** Steel base cover fitted with phenolic terminal board. Convenient numbered solder lug terminals. Flange-mounted unit.
- B-Type.** Steel base cover soldered into case. Phenolic terminal board with solid steel pin terminals. Stud-mounted unit.
- H-Type.** Steel base cover deep-seal soldered into case. Terminals hermetically sealed. Ceramic bushings. Stud-mounted unit.

**MEETS
JAN-T-27
SPECS**



SEND FOR "NEW EQUIPMENT TRANSFORMER" CATALOG

You'll want the full details on CHICAGO'S New Equipment Line. Lists Sealed-in-Steel units for all purposes: Power, Bias, Filament, Filter, Plate, Reactor, Audio (in 3 frequency ranges), JAN-T-27, Modulation, etc. Write for your Free catalog today—or get a copy from your distributor.

CHICAGO TRANSFORMER

DIVISION OF ESSEX WIRE CORPORATION

3501 ADDISON STREET • CHICAGO 18, ILLINOIS



senting four different input signals to a common output in sequence, but many more can be accommodated simply by extending the idea. One of the signals is connected to the grid of each triode and all triodes have a common cathode load resistor, which furnishes the sequential output for the vertical amplifier of the oscilloscope. The plates are connected to the intersections of a delay line or low-pass filter made up of parallel capacitors and series inductors. The output of the filter or delay line is loaded with a resistor of the line's nominal impedance. The output of an audio oscillator is transformer-coupled into the line.

A low-pass filter produces a shift in the phase of an a. c. voltage fed through it—from 0 deg. for d. c. (zero-frequency a. c.) to 180 deg. for the frequency of cutoff. If the frequency and the constants for the filter here are chosen so that each section produces a phase shift of 90 deg., then at

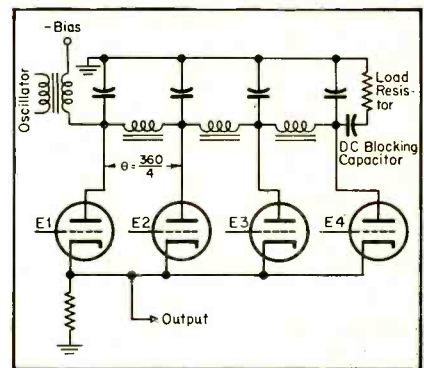

Figure 2

any instant, the positive peak of the sine wave provided by the oscillator will be present at only one tube plate. If then a d. c. negative has just a little less in magnitude than the peak value of the sine waves is applied to the plates through the line, only a single tube will conduct at a time. As the wave passes along the delay line, the positive sine-wave peak will strike each plate in turn. Since the total phase shift in the line is 270 degrees, only one positive peak will be on the line at a time.

As each tube is made to conduct in its turn, its plate current and the audio variations caused in the plate current by the grid signal appear across the cathode resistor and go to the scope. The oscillator may operate at, say, 1,000 cps, giving a switching rate of 1,000 signals per second, and making each of the four signals appear on the c.r. tube 250 times a second. The oscillator signal need not have any particular waveform, though its amplitude must, of course, be high enough to operate the tubes.

The really fascinating possibility with this system, however, not mentioned in the patent but probably feasible, is its use to provide multichannel communication. At the sending end, the circuit would look like Fig. 2. At the receiving end it would be similar with three important exceptions. The oscillator signal would be replaced with signal from the oscillator at the sending end, amplified if necessary. All grids would be commoned and fed from the output of the sending unit. And each cathode would have its own resistor and its own output to separate the signals again. Provided the elements of the delay line were similar at both ends, the four channels would be permanently synchronized.

It should be mentioned that any number of channels can be used by setting frequency and designing the filter so that phase shift in each section is equal to 360 divided by the number of channels.

LETTERS

Remote-Cutoff Tubes

Sir:

Mr. J. M. Diamond suggested, in his letter in the February issue, the use of a remote type of tube as a nominal class A power amplifier to avoid the plate-current cutoff of AB and B with its tendency toward distortion, and yet retaining the low quiescent plate current.

It will be found that this same effect may be obtained with ordinary triodes by using somewhat greater bias than would be normal for the ordinary class A amplifier. In particular, I have been using pp-par 6B4G's for several years in this manner, with excellent results. Using a plate supply of 300 volts (maximum for this tube), the bias is 55 volts and total quiescent plate current is 250 ma. With this arrangement, the power output is 30 watts into the output transformer, with a plate-to-plate impedance of 1450 ohms.

Several things should be said about this mode of operation. First, it represents the maximum that can be gotten out of a given tube in class A (at a given plate voltage), and therefore might be termed Limiting Class A operation. It will be found that not only is there a considerable saving in B-plus current, but that the tubes will be running well below their rated plate dissipation—something that is not usually the case with class A. The efficiency is high; the ratio of power output to d.c. power input is 40 per cent in the case quoted, as contrasted with the 25 per cent usually given for class A.

Second, if the equivalent characteristics of the composite tube are drawn, it will be found that they are almost exactly parallel straight lines. Under this condition, the rule that the load resistance should be double the plate-to-plate tube resistance no longer applies, and the load can be matched to the tubes. If the load line for the composite tube is drawn with this in mind, it will be found that the load line for one tube is curved, and if the proper bias is chosen, one tube will just reach cutoff as the other reaches zero grid voltage. This is, technically, class A operation, although the action is more similar to AB, in that the d.c. plate current varies with signal level. It has been found experimentally that the characteristics for the composite tube are only straight for the one value of bias which gives operation such that one tube just reaches cutoff as the other reaches zero grid voltage—this gives a check as to whether the proper bias have been chosen.

Third, the load line for one tube is not straight since the instantaneous plate resistance of the two output tubes are not constant throughout the operating cycle, as they would be in the normal class A amplifier. With transformer output coupling, the plate resistance of one tube acts in parallel with the load resistance, when viewed from the other tube, and as this plate resistance varies during the cycle, so also will the slope of the load line. A particularly fortunate state of affairs obtains here, since it will be found that the instantaneous load presented to a given tube is at all times equal to its plate resistance at that time; since this is true throughout the cycle, the tube delivers maximum power at all times.

There are at least two disadvantages to this type of operation, as compared with conventional class A. (1) There is a fairly

[Continued on page 6]



HE CHOSE

Magnecorder

THE FIRST CHOICE OF RADIO ENGINEERS

FLEXIBILITY

In rack or console, or in its really portable cases, the Magnecorder will suit every purpose. PT6 Series shown is the most widely used professional tape recorder in the world, and is available with 3 speeds (3 3/4, 7 1/2, 15") if preferred.

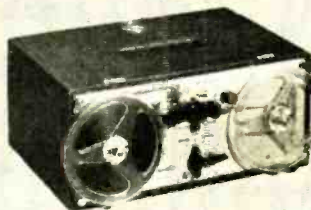

FIDELITY

Lifelike tone quality, low distortion meet N.A.B. standards — and at a moderate price! PT63 Series shown in rack mount also offers three heads to erase, record, and play back to monitor from the tape while recording.



FEATURES

PT7 accommodates 10 1/2" reels and offers 3 heads, positive timing and pushbutton control. PT7 Series shown in complete console model is also available for portable or rack mount. For outstanding recording equipment, see the complete Magnecorder line — PT6, PT63 and PT7.



Magnecord, Inc.

360 NORTH MICHIGAN AVENUE
CHICAGO 1, ILLINOIS

WRITE FOR NEW CATALOG

Magnecord, Inc., Dept. A-4
360 N. Michigan Ave., Chicago 1, Ill.

Send me latest catalog of Magnecord Equipment.

Name.....

Address.....

City..... Zone..... State.....

Here's why
those in the know
demand—

CANNON PLUGS

superior
contact
design

Because the contact is the key to the success of any electric connector, Cannon has always applied the highest order of skill and care to this all-important detail. Cannon pin and socket contacts are all precision machined from solid bar stock. Silver or gold plating maintains high conductivity after years of constant use. Phosphor bronze "napkin ring" of the socket keeps pressure on large areas of heavy metal, preventing current loss. There are no thin metal



tangent contact points in Cannon contacts. (See below). Solder cups are carefully tinned by hand to keep the solder inside the cup. Cannon socket contacts are full floating to assure perfect alignment. You'll find these design features throughout the great variety of precision contacts used in all Cannon connectors. For real value demand Cannon.

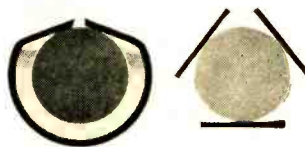
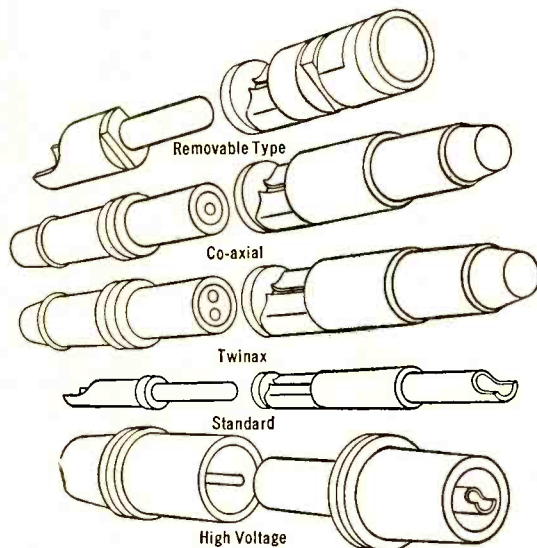

Cannon design (above left) makes contact on large, heavy metal surfaces. Current is not carried through spring section. In Cannon Connectors there are no thin metal tangent contact points, like the design shown at right.

CANNON ELECTRIC

Since 1915
LOS ANGELES 31, CALIFORNIA
REPRESENTATIVES IN
PRINCIPAL CITIES

In Canada & British Empire: Cannon Electric Co., Ltd., Toronto 13, Ontario. World Export (Excepting British Empire): Frazer & Hansen, 301 Clay St San Francisco, California.

large harmonic current component in the power supply, necessitating a supply with lower internal resistance than required for normal class A, but not as low as required for class B. (2) The fact that the plate resistance does vary during the cycle means that we must have a transformer with somewhat closer coupling between halves of the primary than is required for class A, although again our requirements are not as stiff as for class B, and in particular, the ordinary high-class output transformer is satisfactory for this type of operation.

Several amplifiers have been built using these principles. As another example, a single 12AU7 with 250 volts on the plate will deliver 1 watt into the output transformer, and with a single 12AT7 ahead of it makes a high-quality (although low-powered) amplifier.

Frederick C. Billingsley,
2004 Clifton Park Road,
Schenectady 9, N. Y.

"Notch" Distortion

Sir:

Since the recent discussions of "notch" distortion in Class AB and B amplifiers, I have been surprised that elaborate methods only have been suggested for the correction of this fault.

A simple remedy is to connect a high value of resistance from each plate side of the output stage to ground so as to bleed about 1 or 2 ma. through each transformer half section. When either tube is cut off, the residual current remains. The cost of the resistors will be about 15 cents each.

Knowing the trouble and cost of getting a patent, I ask only that others quote the source.

Louis Bourget,
3996 McKinley Blvd.,
Sacramento 16, California

Unknown Speaker

Sir:

Can you or any of *Æ's* readers help me to identify a loudspeaker as to manufacturer? Its characteristics are as follows: 15-in. electrodynamic; field coil stamped 4S6 G56; resistance, 5200 ohms; frame stamped 1-0-1986, K-2810, and 40610; voice coil diam. 1½ in.; horn-shaped cone of stiff material; dome-shaped cover over v.c.; frequency characteristics excellent.

Would like to know name of manufacturer, voice-coil impedance, power rating, and nominal voltage for the field.

W. E. Kuntz,
2111 Hoffman Drive,
Albuquerque, New Mexico

Ear's Transient Response

Sir:

It is well known that transients are capable of being analyzed into their Fourier components, and that most amplifiers can only amplify the component frequencies as such. There seems to be a general idea that the ear functions on transients by breaking up the incoming sound into its component frequencies. A conceivable alternative explanation is that the ear may be capable of responding to the waveform of a transient, as such, rather than to its components.

This raises the further question as to whether microphones respond to the pressure waveform of transients or to their component frequencies. Is there any experimental evidence to settle either or both of these questions?

F. Langford-Smith,
Amalgamated Wireless Valve Co. Pty Ltd.
45-47 York Street,
Sydney, Australia



IT'S UNOBTUSIVE. Umber gray coloring blends it right into the TV picture. Minimum reflection.

In the show . . .
 without stealing the act
 RCA's new ribbon-pressure **"STARMAKER"** *

SO SLIM YOU MUST LOOK sharply to see it . . . so skillfully styled its shape and coloring fade right into the scene . . . this tubular microphone has won the favor of entertainers and announcers wherever it has been shown.

Designed by RCA Laboratories after more than three years of painstaking research, the STARMAKER meets the long need of broadcasting, television, and show business for a high-fidelity microphone that—will not hide the features of performers—is easier to handle—and yet retains all the high-quality features of RCA professional microphones. Pick-up is non-directional. Frequency response is uniform, 50 to 15,000 cps.

Here is a "carry-around" microphone free from wind blast and air rumble. It contains no tubes, no condensers, no high-impedance circuits, no special amplifiers, or power supplies—is virtually impervious to mechanical shock.

The STARMAKER fits any standard microphone stand . . . and can be substituted for any professional high-quality RCA microphone. *No extra attachments needed!*

For price and delivery, call your RCA Broadcast Sales Engineer. Or write Dept. P-7, RCA Engineering Products, Camden, N. J.

**Selected from entries submitted by Broadcast Stations in national contest.*



IT'S COMFORTABLE TO HANDLE . . . weighs only 1 lb.

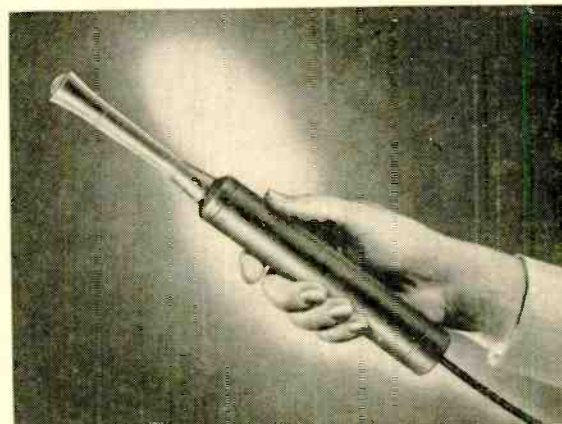

IT'S SMALL. Diameter of body is only 1¼ inches. Diameter of pick-up point is only ⅛ inch!



AUDIO BROADCAST EQUIPMENT
RADIO CORPORATION of AMERICA
ENGINEERING PRODUCTS DEPARTMENT, CAMDEN, N. J.

In Canada: RCA VICTOR Company Limited, Montreal

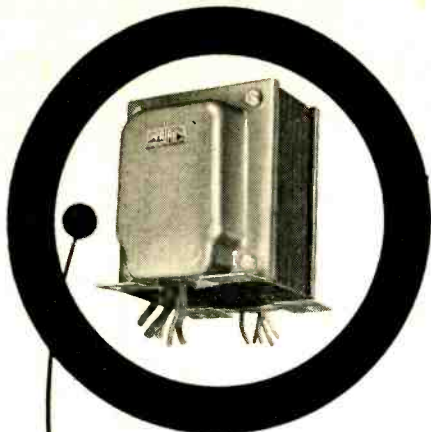

Here is a group of
TRIAD Transformers
 Especially Designed for
REGULATED POWER SUPPLIES

In the design of regulated power supplies, plate voltages, 100 volts or more in excess of those required for normal power supplies, are needed. In addition, the tube filaments are operated at differing potentials, requiring several separate filament windings.

The following new plate and multi-filament transformers, used in connection with standard higher voltage plate transformers and chokes now available, will permit design of a wide range of regulated supplies.

POWER TRANSFORMERS

Type No.	Pri. Volts	Sec. Volts	Fil. No. 1	Fil. No. 2	Fil. No. 3	Fil. No. 4
R-26A	115	880-720V. C.T. @ 200 Ma.	6.3V. C.T. @ 8A.	6.3V. C.T. @ 3A.	6.3V. C.T. @ 1A.	5V. C.T. @ 3A.
R-28A	115	1250V. C.T. @ 300 Ma.	6.3V. C.T. @ 8A.	6.3V. C.T. @ 3A.	6.3V. C.T. @ 3A.	5V. C.T. @ 6A.

FILAMENT TRANSFORMERS

Type No.	Pri. Volts	Fil. No. 1	Fil. No. 2	Fil. No. 3	Fil. No. 4	Fil. No. 5
F-34A	115	6.3V. C.T. @ 1.75A.	6.3V. C.T. @ 1.75A.	6.3V. C.T. @ 1.75A.	6.3V. C.T. @ 1.75A.	
F-36A	115	6.3V. C.T. @ 3.5A.	6.3V. C.T. @ 3.5A.	6.3V. C.T. @ 3.5A.	6.3V. C.T. @ 3.5A.	
F-38A	115	6.3V. C.T. @ 5A.	6.3V. C.T. @ 5A.	6.3V. C.T. @ 1A.	5V. C.T. @ 2A.	5V. C.T. @ 4A.

These and other Triad Transformers are described in



Catalog TR-51, just off the press. Write for your copy today.



C. A. HISSERICH*

THE LATEST DEVELOPMENT in the recording of sound for motion pictures is the so-called "Piggy Back" Motor Drive for the recording machine.

In the early days of motion picture sound recording, two general types of motor drive systems were used: The first and most common type was the "Line Sync" system, in which both the camera and recording machine were driven by separate synchronous motors from a common power line, both machines thus being controlled in absolute speed by the frequency of the power line. In such a system, it is obvious that true synchronism does not exist until running speed is reached or until the motors "lock in" to synchronous speed. This acceleration time, from standstill to synchronous speed, will vary with the individual mechanical load on each motor, and therefore, such a system may not be used when a "starting sync mark" is desired. Such a system must necessarily use a "running sync mark" which is applied after both the camera and recorder have reached "synchronous speed." This "running sync mark" was commonly applied by stepping in front of the camera and snapping together two hinged sticks called "clap sticks," thus audibly making an easily identifiable modulation mark on the sound track which is later matched (with proper projection offset) to the picture frame in which the sticks came together.

Such a system was cumbersome and time consuming in production because (1) both the camera and recorder were started on a signal by their respective operators; (2) the signal that each machine had reached "synchronous speed" had to be given to the "clap-stick" operator; (3) after the "clap-stick" operator put on the "running sync mark," he had to get out of the field of view of the camera before the scene could start; and (4) a power source of good frequency stability had to be provided.

Problems of other than a purely technical nature were encountered with this system also. It was not uncommon when shooting "Horse Operas" or "Westerns," to spend ten or fifteen minutes arranging a number of horses in a grouping that was photographically attractive, then roll the system, call "speed," have the clap stick operator run into the foreground and put on the "running sync" (which sounds something like a .22 cal. shot) and skitter the horses in the general direction of the nearest barn. This problem was so serious that an unwritten rule was observed that when shooting with horses, an "end sync" or sync mark at the end of the scene was used. This, of course, was unpopular with the cutters because it meant that they had to match picture and sound track from the tail end of a scene, a procedure which caused extra work for them.

Western Electric System

A second type of early system was developed by Western Electric which overcame the above difficulties, but which in turn had the disadvantage of being bulky, heavy, and requiring a large amount of power. This system, commonly called the W. E.

Distributor System, used wound rotor or Selsyn type motors as drive units for camera and recorder. The master Selsyn unit, called the distributor, also contained a d.c. drive motor, and an inductor alternator. Electronic speed control was used with this system; the signal (720 cps) from the inductor alternator being passed thru a frequency selective network, rectified, and applied to the control field of the d.c. drive motor in such a way that a speed of 1200 r.p.m. was maintained in the whole system. This system required 110-volt d.c. for the distributor, and 220-volt, 60-cps, three-phase a.c. for the Selsyns.

The W. E. Distributor system had the desirable feature of allowing the camera and recorder to be "interlocked" at standstill and of maintaining this interlock through acceleration of both units to "speed." This feature allowed the use of punched sync marks, which could be prepared between scenes.

A later type of motor drive was developed by Western Electric which was known as the "F" type system. This system was primarily developed for location shooting remote from power lines, but it had the disadvantage of requiring a "running sync mark." Its main advantage was the reduced size and weight compared to the distributor system.

The "F" type system was the first of the "d.c. Interlock" systems and will not be described completely as it has been superseded by an improved system called the "Multiduty" drive system.

In the "Multiduty" system, each motor unit for either a camera or a recorder is identical and contains both 96-volt d.c. drive windings and 220-volt, three-phase a.c. windings. Each unit is adjusted individually by means of its field and armature controls to turn at approximately the "correct" speed with its individual mechanical load. When shooting of synchronized scenes occurs, the a.c. windings of all motors are tied together thus creating an artificial 220-volt, three-phase buss through which they are all "locked" together and through which a "power trade" between units may occur (i.e., a unit tending to run fast feeds power to the buss and vice versa). Thus the absolute rotational speed of the whole system may be varied at any of the individual motor controls. This system will "lock" from start if the motors are prealigned or "indexed" by applying a small amount of d.c. to the sync windings.

The name "Multiduty" was applied to the above system because of the fact that the motors may also be operated as "Line Sync" motors on a 220-volt, three-phase, 60-cps a.c. line.

The "Piggy Back" motor drive system is actually a simplification of the "Multiduty" system. The camera motor is a standard "Multiduty" motor, operated on a 96-volt d.c. supply. This motor supplies 220-volt, three-phase, 60-cps a.c. to the recording machine motor which is a small 40-watt 220-volt, three-phase synchronous motor. Thus the recording machine operates as a "slave" under the control of the camera motor. Actually, in present operation, the on and off switching of the system is done

*954 Hancock Ave., Los Angeles 46, Calif.

[Continued on page 39]



World Wide Distributors

Of

AMPEX

MAGNETIC TAPE RECORDERS

AUDIO-VIDEO OFFERS A COMPLETE ENGINEERING SERVICE TOO . . . Specializing in the design and construction of Custom Audio and Recording Systems. Write or Call our Field Engineering Department.



AUDIO & VIDEO PRODUCTS CORP.
1650 BROADWAY, NEW YORK 19, N. Y. • PLAZA 7-0780

EDITOR'S REPORT

THE 1951 NARTB CONVENTION

COMMENCING with registrations on April 15 and running through Thursday April 19, the 29th Annual NARTB Convention will be held at The Stevens in Chicago in conjunction with the Fifth Annual Broadcast Engineering Conference. The National Association of Radio and Television Broadcasters—the new name for the organization heretofore known as the NAB—has built this meeting around a number of “workshop” sessions which will give broadcasters an opportunity to get down to brass tacks and talk over the problems which confront the entire industry as a result of the current world situation.

The Management Conference will consist of a number of afternoon panel discussions covering Defense Mobilization on Monday, Labor-Management relations and Sports on Tuesday, and Research, Taxation, and Legislation on Wednesday. The morning sessions are devoted to BAB and FM on Tuesday and Wednesday respectively, and the sessions on Thursday are devoted entirely to Television.

Of special interest to engineers will be the four technical sessions with papers covering a wide range of subjects. Among them are: “Trends in Audio Equipment,” by W. E. Stewart, who has an article in this issue; “New Equipment for AM Stations,” by Jack Young; “Engineers and Management,” by Richard P. Doherty; and “Transmitter Maintenance in an Emergency Period,” an important subject at the present time.

The May issue will carry a preliminary report on the convention (in addition to full coverage of the IRE Show which commences just as this issue goes to press) with a more thorough report to follow in the June issue.

FM SURVEYS

A recent report from the FM Department of NARTB tends to discredit the opinions of many who have predicted the death of FM broadcasting. Two separate surveys—one in the South and one in Metropolitan New York—show that FM is slowly increasing in popularity, at least in these two areas.

FM has had practically everything against it from the start—except its inherent advantages. It was just being introduced at the beginning of World War II, when equipment shortages operated to delay wide distribution of receivers. Shortly after the war it went through a frequency-band change, which practically made obsolete all existing receivers, or at least required the use of converters. After this hurdle was cleared, TV began its tremendous surge to popularity, with literally millions of receivers being shoved at the public with audio systems which would have disgraced a \$20 hearing aid. Small wonder that the listening public is turning to a system which is capable of giving the highest possible fidelity.

Specifically, the survey in New York shows that the number of FM homes increased from 18.3 to 26.2 per cent during 1950, an increase of 43 per cent. It is not

important that part of this increase is occasioned by the buying of TV receivers which are equipped with AM, FM, and all-three phonograph equipment. The fact remains that purchasers would not have selected sets with FM unless they had a real desire for better quality.

In many parts of the country, one of the greatest advantages of FM is not appreciated—the static-free reception which is characteristic of this system. Some areas do not have static troubles because of their climatic conditions. But in New York, for example, AM radio becomes unusable over many hours of the summer months, and FM brings the programs through effectively and without objectionable noise. Another great advantage—to the music lover, at least—is that the “good music station” is usually on FM, or even if on AM there is almost always an FM affiliate. And, of course, *any* program actually *sounds* better on a good FM receiver.

It will be remembered that only one manufacturer offered a complete line of phono-radio combinations during the 30's, but today phonograph records are more popular than ever before. Is it too much to hope that a few manufacturers will continue to supply us with good FM equipment and that a few broadcasters will give us something to listen to? We believe it will pay off in the long run, and we sincerely hope we are not alone in this belief.

THE CANBY PROGRAM

As of this date, three stations are carrying the new transcribed Edward Tatnall Canby Program, an *Æ* presentation which was introduced a short time ago. A number of others have expressed interest, but final arrangements have not yet been completed.

The present “*Æ* network” consists of: WDBO, 580 kc, Orlando, Florida; KVOR, 1300 kc, Colorado Springs, Colo.; and WCFM, 99.5 mc, Washington, D.C.

AUDIO AND THE DEFENSE EFFORT

In a recent release from the U. S. Department of Commerce, Defense Production Administrator William H. Harrison is quoted as saying that as far as the defense effort is concerned, there is no more important branch of industry than electronics. That seems obvious, from our experience of the last war, but many audio men have wondered just how they fit into this effort.

Instrumentation is one important field into which the audio engineer can fit without too much readjustment. The basic principles of instrument construction and operation fall quite naturally into lower-frequency categories than most communication and radar systems, and it is in this field that many audio men are finding new opportunities. One such application of audio is in the Loran trainer which employs ultrasonic waves in air to simulate radio waves. The entire system is to be described fully in the next two issues of *Æ*.

PICKERING

diamond stylus pickups

ACKNOWLEDGED BY ENGINEERS
AS THE FINEST AVAILABLE!

- The superiority of diamond styli to styli of other materials has been thoroughly established.
- Exhaustive tests prove resistance to abrasion of diamond styli is many times greater than that of the next hardest material.
- Great resistance to abrasion means a minimum of record wear, longer record life and concert hall quality music all the time.

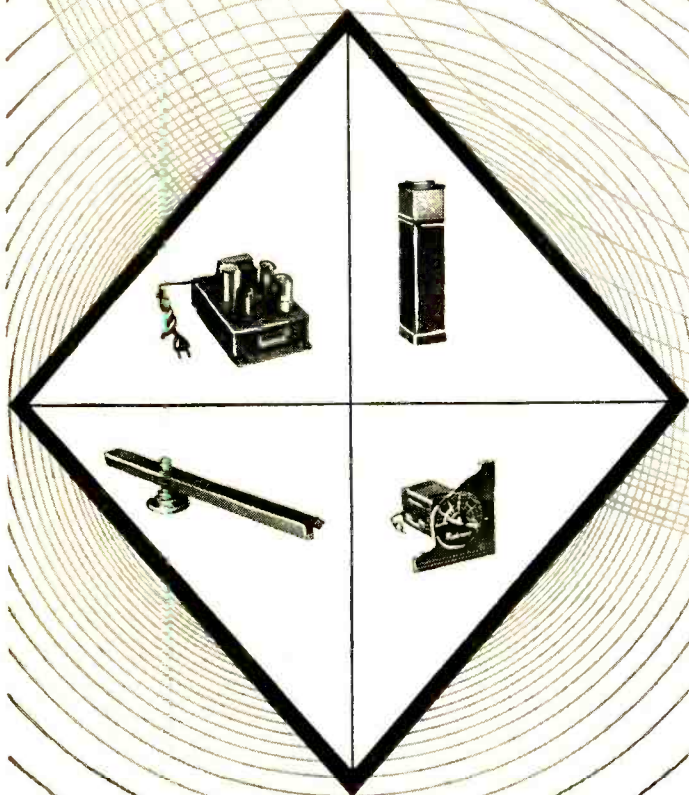
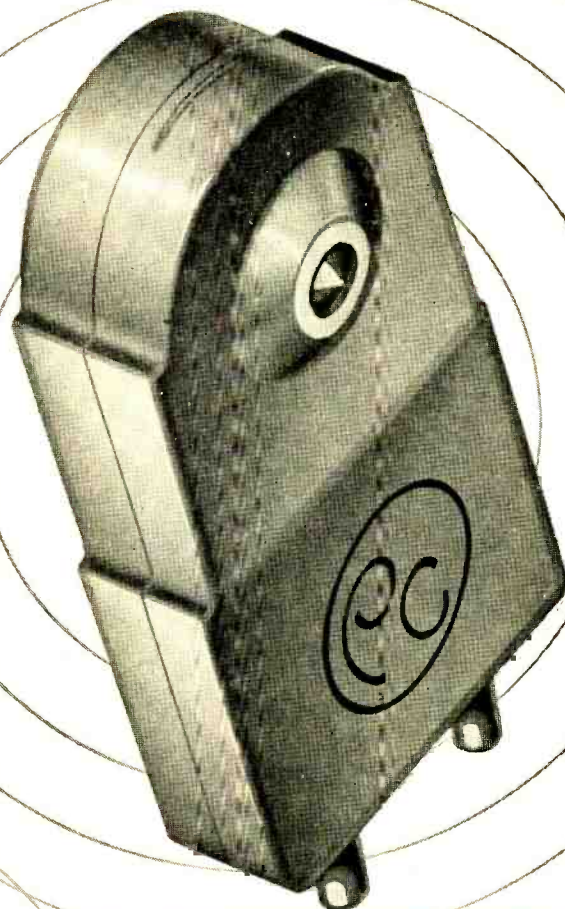
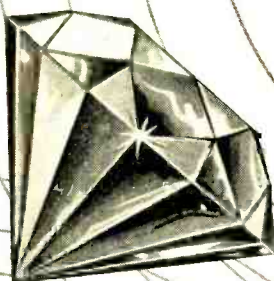

Pickering pickup cartridges, equipped with diamond styli, may cost more than cartridges with other stylus materials but the useful life of a diamond stylus cartridge is so much greater than is represented in the cost differential that from all practical viewpoints—length of service, listening pleasure, and record life—Pickering diamond-stylus cartridges cost less.

The diamonds used in Pickering cartridges are whole diamonds, not splints. They are well cut, gem-polished to high accuracy and precisely mounted to ride free and smooth in the groove walls, recreating all the fine tones and modulations pressed into modern recordings.

The supremacy of Pickering Diamond Cartridges is unchallenged. They meet every exacting requirement of the most critical record playing enthusiast who insists upon the finest musical reproduction; who wants the realism and brilliance of a live performance and who is anxious to maintain the useful life of his record collection.

PICKERING & COMPANY, Inc.
Oceanside, L. I., N. Y.

Address Department A



"Mr. Bell, I heard every word you said - distinctly!" Thus, on March 10, 1876, Alexander Graham Bell (left) learned that his invention had transmitted the first intelligible speech.

75 Years of Tomorrows

Like today's telephone, Alexander Graham Bell's invention was a product of research. For several years Bell had been investigating speech and hearing, and devising methods and apparatus for the electrical communication of intelligence. No one had transmitted speech sounds electrically but Bell saw that it must be possible—given the proper instruments.

One day, while experimenting with his harmonic telegraph, Bell's alert ear caught an unexpected sound in the re-

ceiver. His trained mind told him that here at last was the proof that sound waves could travel as their facsimile in electric waves. Then followed a year of development, and in 1876, as shown above, he transmitted the first intelligible speech by telephone.

During the next three-quarters of a century, the telephone research which Bell started has grown and expanded to serve your telephone system . . . often fruitfully overflowing into other fields of electrical communication. In today's

Bell Telephone Laboratories, promising ideas find the right skills to bring them to life. Through skilled manufacturing by Western Electric Company and skilled operation by the telephone company they are brought to the service of the telephone user.

The high quality of your telephone today, its fine, swift service at reasonable cost, are the products of work in the telephone laboratories in the past. The greater value you may expect in the future is taking form there already.



BELL TELEPHONE LABORATORIES

Exploring and Inventing, Devising and Perfecting, for Continued Improvements and Economies in Telephone Service

Television Studio Acoustics

M. RETTINGER*

Practical pointers in the design and acoustic treatment of studios used in the staging of TV programs to ensure optimum sound quality.

SOUND RECORDING in television studios differs from that in radio studios chiefly by the greater microphone distances which must be employed to keep the pick-up device outside the camera angle. In order to maintain, for maximum intelligibility, a low ratio of reflected to direct sound at the microphone, the reverberation time in television studios must be made considerably shorter. This applies to the television stage proper as well as to any auditorium area, if such exists.

The acoustic treatment of the stage should be highly absorbent as well as durable and fire-proof. Perforated hardboard or asbestos board backed by 2 inches of rock wool constitutes an effective treatment, if large flat surfaces of the board are avoided. A large perforated hardboard panel gives rise to pronounced high-frequency echoes, even when the board is backed by rock wool. For this reason it is desirable to install the material on the stage walls and ceiling in the form of triangular corrugations, none wider than 3 feet, and at least 6 inches deep; or better still, to apply it in the form of cylindrical sections. In this manner the sound becomes dispersed, and the effect of echoes is reduced to a negligible degree. As is well known, the wavefront of a beam of sound reflected from a convex surface is considerably longer than that from an equally large flat surface, provided that the wavelength of the incident sound is small compared to the dimensions of the reflecting surface. *Figure 1* shows this relationship graphically, and it is seen that the wavefront reflected from the convex splay is, for the condition illustrated, several times longer than the sum of the two reflected from

the flat panels. The figure shows also the construction of the wavefronts, analogous to the optical case. The center of the reflected wavefront coming from the curved surface is one-half the radius of the convex splay (assuming the source to be at some distance from the surface).

Figure 2 shows how, in Television Studio E at NBC Hollywood, a convex reflective stage splay is being planned to be converted to a convex absorptive splay employing perforated hardboard for the "facing" and 2 inches of rock wool for the sound absorbent. This studio had previously been used for radio programs only, and was found to be too live for television programs.

Many television programs employ the music of a band for accompaniment or effect. If the orchestra is placed in front of the stage, the intelligibility of the performers' dialogue is sometimes markedly reduced in the auditorium during high music levels. This is so even when the transmitted program has considerable intelligibility, because music and dialogue microphones can be controlled individually, although in small rooms and at moderately high music levels it may become difficult to secure enough acoustic separation between speech and music at the dialogue microphone to obtain an adequate balance.

For this reason an orchestra pit or lateral placement of the band in the room is desirable. The latter means is not too effective, since some scenes may at times have to be laid on the same side of the room as the orchestra. An orchestra pit, on the other hand, may extend partly below the stage, and provides considerable acoustic screening between the individual pick-up units.

It is a frequent complaint of television program attendants that their attention is distracted and their sight to the stage

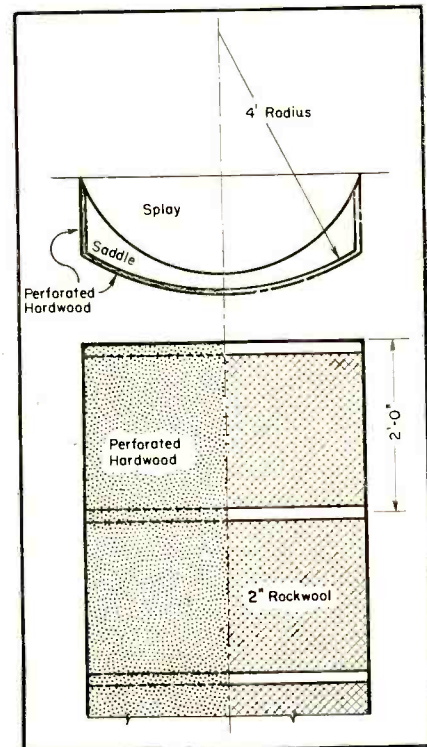

Fig. 2. Method of converting a reflective convex splay to an absorptive convex splay.

obstructed by the various booms and lights and their operators on the stage. For this reason it may be desirable to have a suspended platform along each side of the stage some 10 or 12 feet high on which these devices can be placed, together with the operating personnel. At the KECA Studio in Hollywood, for instance, (previously the "Tom Brennaman Breakfast Studio" and converted by the writer), the sides of the stage are dressing rooms, the roofs of which are strong enough to accommodate lights, booms, and operators.

Television cameras appear far less disturbing, however, and may be assumed to be part of the show. Even so, an auditorium level which is higher than the stage does much to improve observation for the spectators as shown in *Fig. 3*. For this reason, television studios of the future—those intended to accommodate an audience—may have a balcony, even when the studio is not very large.

Auditorium Treatment

No less important than the acoustic treatment of the stage is that of the auditorium proper. Durability of wall

*RCA Victor Division, Radio Corporation of America, Hollywood, California

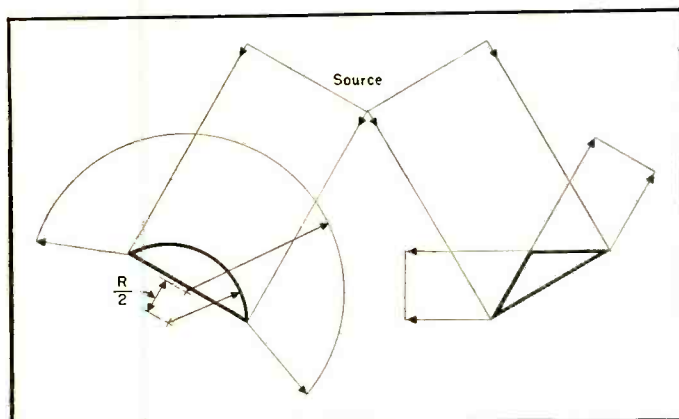

Fig. 1. Graphical representation of reflected waves from convex and triangular splays.

and ceiling treatment appears somewhat less important in this part of the studio, however, while decorativeness or appearance become more significant. For this reason a soft fire-proof tile, which is a good low-frequency absorbent, represents a desirable material. Many such products can be painted without impairing their absorptivity, quite unlike porous ceramic tiles.

Much as in a theatre, the rear wall should carry the most effective treatment. The side-walls as well as the ceiling should be covered with sufficient treatment to secure in the house a reverberation time no longer than two-thirds that accorded to the auditorium were it used for radio shows only. Needless to say, the rear wall should not be made concave, even when it is intended to give it a heavy acoustic treatment, and the side-walls should not be parallel but should be angled and/or splayed.¹

Television stages without audience accommodations should have as low a reverberation time as possible. The reason for this is that, in general, the ratio of (set-) reflected-to-direct sound at the microphone is sufficiently high to provide enough of an impression of reverberation quality so that the pictured scene will have a natural character. If the stage walls are insufficiently absorptive, the added reflections will tend, not only to destroy the illusion of the picture, but also to reduce the intelligibility of the dialogue. It has, therefore, become almost customary to line the stage walls either by nailing a 2 inch rock wool blanket to the wall studs or by packing the space between the studs with rock wool. As a protective measure, muslin and wire mesh are usually applied over the wool. Fiberboard, hair felt, cork, acoustic plaster, etc., are useless for the purpose of treating the stage acoustically. A glance through absorptivity tables of acoustic materials will show that mineral wool, also called rock wool, has by far the highest absorption for the frequencies in the recording spectrum.

Absorptive Materials

Rock wool is made by melting silica and other compounds (notably magnesia, alumina, and lime) and shredding the molten mass into fine fibers by one of many patented processes. Some manufacturers prefer to use glass for the raw material, calling the final product either glass wool or referring to it by a trademarked name (Red Top Insulating Wool, for instance). This type of wool is characterized by a relatively low density (1.5-3 pounds per cubic foot) and a clean, white appearance. Ordinary mineral wool varies in density from three to twelve pounds per cubic foot, the average run being 7.5 pounds per cubic foot. In color, it ranges from a dark gray, almost black, to a white re-

¹ For further details of auditorium design, see "Applied Architectural Acoustics," by M. Rettinger, Chemical Publishing Company, Brooklyn 2, N. Y.

sembling that of glass wool. The density of the material has a considerable bearing on its absorptivity, the light wools being less absorptive than those of higher density.

Regarding its color, it can be said that dark wool indicates the presence of certain elements (phosphorus, sulfur, etc.) or the lack of silica, which may have a bearing on the longevity of the wool. A recently examined installation of dark wool in a motion picture sound stage over twelve years old, showed that a considerable portion of the wool had disintegrated and had settled, in a more or less powdery form, to the lower portions of the structure. However, other portions of the same installation, either because of less contact with a moist atmosphere or because less subject to vibrations, had stood up considerably better.

Regarding the texture of the wool, so-called shot (solid globules of material)

wools, however, muslin and paper are sewed together, approximately every four inches, with a special sewing machine, the stitch running the length of the (usually) four-foot-wide and fifteen-foot-long blanket. The type of paper used varies from forty-pound (per ream) basis Kraft paper to the very strong sixty-pound paper. The muslin is frequently specified as 44-40 count, weighing six ounces per square yard.

If a blanket has been fabricated this way, it can be nailed to the studs with ordinary box nails, although so-called foundry nails (large-headed nails) are sometimes thought to provide greater security. Certainly the use of one-inch diameter washers in conjunction with the nails to give greater security to the installation appears superfluous, judging from the many blankets which have been nailed to the studs with 2½-in. plaster-board nails two feet on center.

The use of a wire mesh over the

Fig. 3. Desirable stage arrangement for TV use. "Balcony" areas offer convenient locations for lights and/or microphone booms.

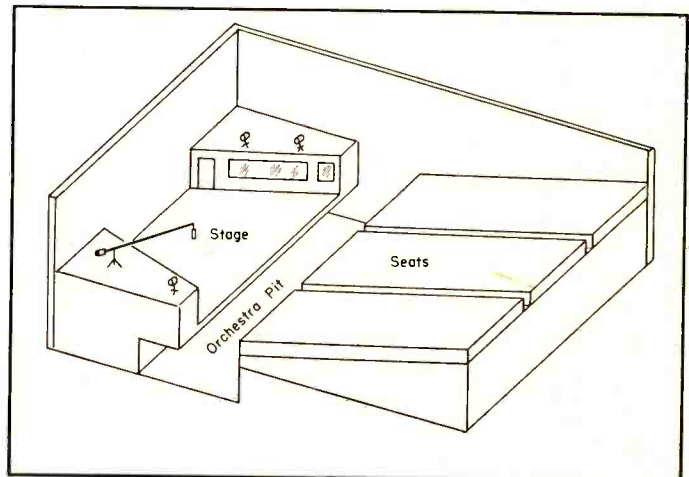

is useless for sound-absorptive purposes. Studio specifications usually exclude wool with shot having a diameter in excess of ⅛ inch. Another shot restriction excludes wool having solids in excess of 30 per cent by weight or 2 per cent by volume.

The preferred method of applying rock wool to stage walls consists in nailing 2-in. blankets directly to the studs of the walls, rather than packing the space between the studs with wool. The latter method is undesirable from a workman's point of view (since the in- and lungs), and also because it provides neither increased absorptivity nor a saving in cost. This is true even in the case where the blanket carries heavy wrapping paper on one side (the one facing the studs) and muslin on the other, instead of muslin on both sides, as did the early and more expensively manufactured mineral wool blankets. The use of the paper in no way detracts from the absorptivity of the product, but even tends to increase it at the low frequencies. Some manufacturers (particularly of low-density wool) glue the paper to the wool, and then merely stretch muslin over the face of the blanket after its application to the studs. For heavier

blanket for protective purposes is recommended. This mesh need not extend from floor to ceiling, but may be applied to a height of approximately 16 feet from the floor. Ordinary 1½-in. chicken-wire is frequently employed for the purpose, although 1-in. hexagonal wire mesh (somewhat more expensive) is used by some studios. A 6-in. baseboard and a 2 x 6 nailer four feet from the floor usually complete the treatment of such a stage wall.

Reverberation

If for any reason the recorded dialogue is to sound reverberant, this can be accomplished by means of a reverberation chamber. The sound is reproduced in this chamber and the output from a microphone in it is mixed with the original. Unlike other methods—electrical or mechanical—of adding a reverberating note to a recording, the chamber method provides both the proper growth characteristic and the decay quality of sound in a live enclosure. Delay networks, magnetic tape recordings, and other devices for achieving synthetic reverberation usually permit only provision for the decay charac-

[Continued on page 46]

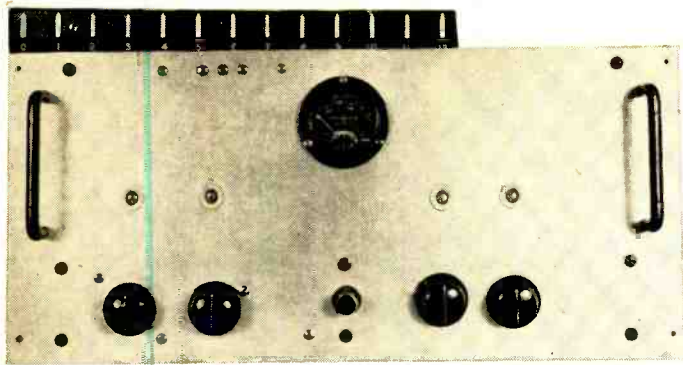

A 15-Watt Direct-Coupled Amplifier

WILLIAM B. FRASER*

Describing a stable, well designed amplifier suitable for high quality music reproduction or for small commercial program distribution systems.

SOME TIME ago the author commenced the design and construction of a high quality audio amplifier for his personal use at home. Complexity of circuit design or difficulty of adjustment were considered unimportant, for it was not intended to publish the circuit. The amplifier was finally completed and gave satisfactory results. Only then did it occur to the author that perhaps others would be interested in the design finally adopted.

The circuit is not complex, though it may appear so because of unconventional circuit arrangements. The unorthodox features include a duplex thermostatically controlled power supply, a unique form of loudness control, direct coupling throughout (except preamplifier), push-pull throughout (except preamplifier), and an input circuit permitting the use of either an unbalanced or push-pull signal. At the least, the design is an interesting study in wire. At most, in the author's opinion, it is an excellent amplifier.

Design specifications are used to define certain objectives. In this case, we wanted an amplifier that sounded as we thought it ought to sound, had no hum or tube noise, and had output power sufficient for home use. How are these requirements expressed in figures? It is difficult to say. Experts argue the problem interminably.

But there must be something more specific to aim at than the generalities just mentioned, so the following specifications were set up:

- Power output: 15 watts maximum
- 10 watts below 1% distortion from 30 to 10,000 cps
- Frequency range: 20-20,000 = 0.5 db
- Hum and noise: inaudible at all volume levels

*Fort Knox, Kentucky

Gain: full output with 0.5 volts or less rms input. A preamplifier permitting the use of magnetic phonograph pickups is to be incorporated.

Circuit Details

The design program commenced with a study of the better known commercial circuits and a number of published diagrams. Most of these designs were more or less conventional. By great refinement, a high degree of excellence had been attained in many of them. Nevertheless, there appeared to be two general ways in which conventional design might be improved somewhat. First, almost all of these circuits employed either transformers or capacitor resistor networks for interstage coupling, and it appeared that a part of the overall distortion of the amplifier originated in these coupling devices. Obviously, then, the elimination of coupling circuits would result in an improvement of the quality of amplification, provided the system used in lieu of conventional coupling was itself distortion free. Secondly, most of the circuits employed single-ended stages for part of the circuit rather than push-pull arrangements. It was thought that a fully push-pull circuit, if feasible, would assist in reducing the second harmonic distortion produced in most equipment.

With these preliminaries in mind, design was commenced. Low- μ triodes were tentatively decided upon for the output stage. 6A5G's were attractive, for they produced the desired power output at small distortion values: they did not require nearly as much driving voltage as the 6AS7G; they had reasonably low plate current and voltage requirements; and they were almost completely hum free.

After design and construction had been completed, it was found that the drivers were capable of providing a peak-to-peak potential of about 210 volts. This is sufficient to drive almost any output tube. Consequently, with ap-

propriate changes, an experimenter may substitute his favorite tube for the 6A5G's shown in the schematic. The author tried 6L6's (tetrode connected), 807's (triode connected), and 6B4G's. 6A5G's seemed to give better results than any of the others, though this is difficult to prove.

Glass enclosed triodes are used for voltage amplifiers. Both 6SN7's and 6SL7's are rugged and non-microphonic. The glass envelopes facilitate trouble shooting. In addition, glass tubes are somewhat less gassy than their metal counterparts. The use of dual triodes cuts down on the total number of tubes required and is also desirable because the two triode sections are more likely to have similar characteristics than separate tubes.

To eliminate conventional coupling devices, direct coupling is used throughout. Direct coupling is inherently free of all forms of distortion. Its principal disadvantages are the high plate supply voltage required, critical balancing, and the possibility of operating tubes at incorrect potentials. Of these problems, maintenance of balance of the circuit was found to be the most difficult to overcome. Balance was finally secured by the use of direct-coupled inverse feedback from the cathodes of the drivers. This arrangement not only corrects for tendencies of the tubes to shift their operating potentials and currents, but also maintains signal balance between the two halves of the push-pull voltage amplifier circuit.

It can be shown that plate supply resistor's common to both tubes of a push-pull arrangement assist in stabilizing the d.c. potentials of a direct coupled circuit. Resistors R_{25} , R_{30} , R_{37} , and R_{38} have such an effect.

This feedback does not, of course, correct distortions which may arise in the output tubes and output transformer. Such distortions are cancelled by inverse feedback from the output transformer secondary tap to which the loud-speaker voice coil is attached. This arrangement

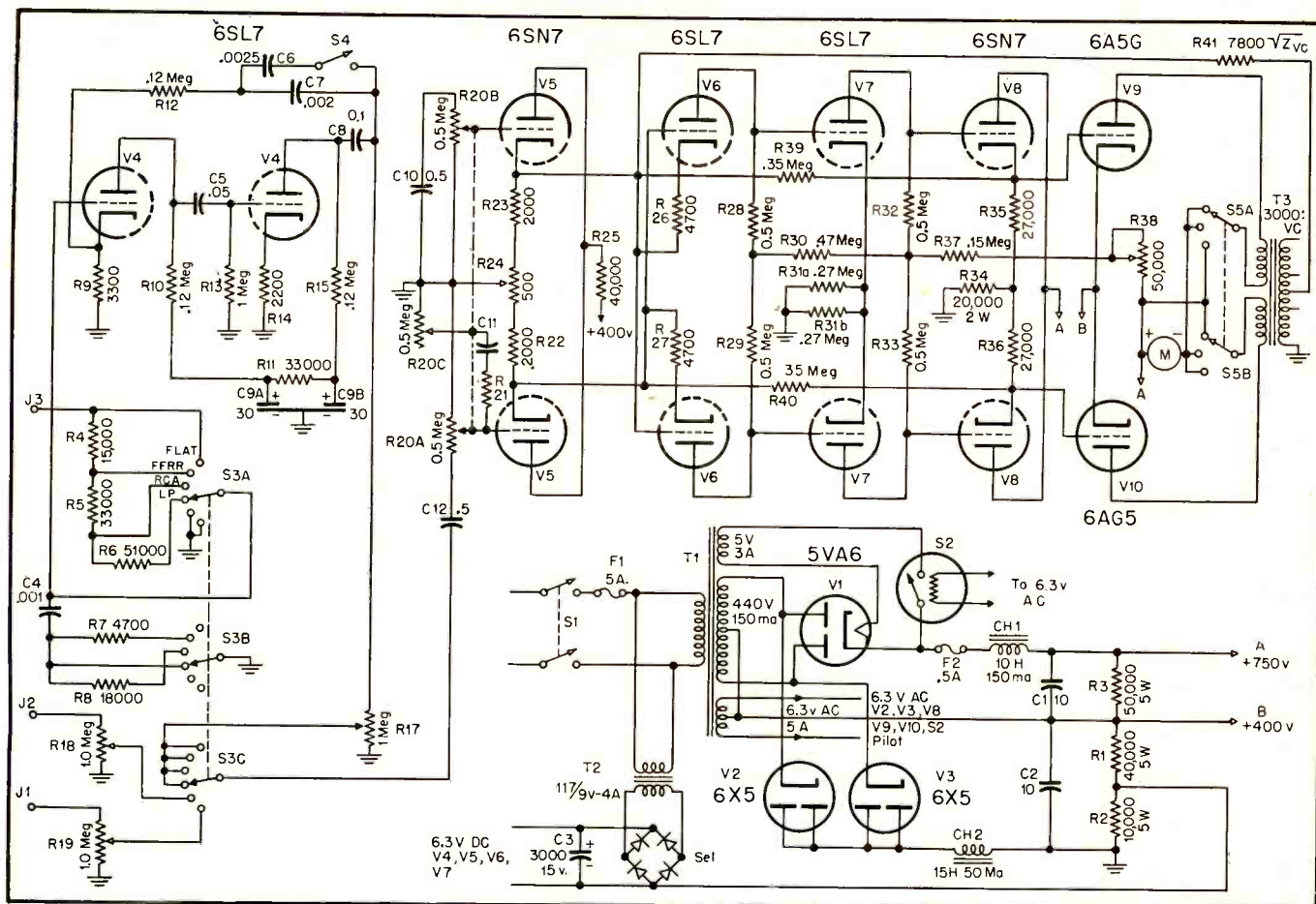

Fig. 2. Over-all schematic of the direct-coupled amplifier.

effectively feeds back an accurate sampling of the voltage supplied to the loudspeaker. The feedback resistor used in this circuit should have a resistance equal to 7800 times the square root of the voice coil impedance.

The values of the feedback resistors were selected after considerable investigation of the effect of feedback on signal waveform. Both sine and square wave inputs were used and the resultant oscilloscope patterns were carefully studied. Because of the small phase shift inherent in this direct coupled circuit, unusually large amounts of feedback can be used. However, feedback in excess of that recommended will result in reduced amplification and may cause high-frequency oscillation.

Signal input can be either single ended or push-pull. Referring to Fig. 2, phase inversion is accomplished by V_5 and V_6 in case a single-ended signal is used. This type of phase inverter has no frequency discrimination and produces a perfectly balanced push-pull signal, provided the corresponding parts of the circuit are matched. The design was adapted from similar circuits which have been published recently. A unique form of loudness control is shown as the three-section ganged potentiometer R_{20} , capacitor C_{11} and resistor R_{21} . It will be observed that the high frequencies fed to the grid of V_5 are automatically attenuated as volume is decreased, thus giving an increased proportion of lower frequencies

at reduced volume levels. The values of R_{21} and C_{11} can be varied to suit the individual. The author used a value of .04 μf for C_{11} and a value of 0 ohms for R_{21} . After values have been established for the components of the loudness control will work with greatest effectiveness for input signals which have the same average strength as the signal for which the loudness control was originally designed. Therefore, individual semi-adjustable volume controls (R_{17} , R_{18} , R_{19}) have been provided for each signal device.

In case a balanced signal is to be used instead of a single ended signal, the signal should be fed to the ungrounded ends of R_{20A} and R_{20B} . C_{10} is then attached to R_{20B} in the same way as C_{12} is attached to R_{20A} . A fourth potentiometer should be ganged to the loudness control and wired similarly to R_{20A} and R_{20B} .

The slightest trace of d.c. appearing on the grid of V_5 will upset the balance of the entire amplifier. Therefore, C_{12} is used to insure that d.c. from the signal sources is eliminated.

It will be noted that V_5 is a cathode follower and hence produces no amplification. V_5 and V_7 amplify in the normal manner. The common cathode resistor of V_7 tends to correct for any signal unbalance which may occur. Finally, the balanced feedback from V_8 to V_5 corrects for any small residual signal unbalance. Oscilloscope tests show that the signals

supplied to the output tubes are balanced under all conditions. This is an important requirement in push-pull circuits.

It will be noted that V_8 has an un-bypassed cathode resistor. The resultant degeneration improves frequency response and stability.

V_8 is a cathode follower driver. Since the 6A5G's are to be operated Class AB₁, and presumably draw no grid current, it may be wondered why V_8 is used. The principal reason for the presence of this tube is that the grids of the 6A5G's do draw current, even though they are not driven positive. This characteristic is typical of many triode-output tubes. V_7 cannot supply current from its plate to the grid of the following tube without suffering serious distortion in its output. However, a cathode follower can supply the small amounts of power required without ill effects, and so this arrangement is used for the driver. An inspection of the circuit diagram will show that R_{35} controls the total plate current of the output tubes and that R_{33} balances the plate current.

A number of excellent preamplifier designs are available. The one shown has been described previously.

Power Supply

At first glance, the power supply may appear to be unusual. Actually, the high voltage secondary of the power transformer merely employs a bridge type

rectifier (V_1 , V_2 , V_3) so arranged that the center tap of the winding is +400 volts. This type of power supply is sometimes referred to as a "duplex" power supply.

The thermostatic delay relay is included to prevent the application of plate voltage to the output tubes before the indirectly heated cathodes of the voltage amplifiers have warmed up sufficiently to provide correct bias.

The 6.3 volt a.c. heater winding is biased at +400 volts. The cathodes of V_2 and V_3 are biased at +400 volts, so the same heater winding that supplies the output tubes can be used for the 6X5 heaters. Also, it will be noted that the cathode of V_1 operates at approximately +327 volts which permits this same source of 6.3-volt a.c. to be used for the heater of V_1 .

A full-wave selenium rectifier and associated transformer are used to provide d.c. heater current for V_1 to V_7 , inclusive. The use of d.c. heaters in these tubes reduces hum disturbances.

Construction

The entire amplifier can be mounted on a 15x19 chassis, but it is recommended that the power supply be mounted on a separate chassis. If only one chassis is used, the parts must be arranged so compactly that a cooling fan is almost a necessity, especially if the amplifier is to be placed in a confined box. If a single chassis is used, the parts should be laid out so that the power supply is at the opposite end of the chassis from the low level stages. Since the circuit is completely push-pull (except for the preamplifier), hum is minimized and shielded wire need not be used. However, the preamplifier must be carefully shielded.

The use of a single ground and grounding bus is recommended to avoid hum which sometimes results from multiple grounds. In this case of the preamplifier, an insulated input jack should be used. The grounded side of this jack should be attached to the grounded end of R_2 . If this precaution is not observed, a high hum level will almost invariably result.

In the interest of good construction, filter capacitors C_1 and C_2 should be oil filled. Because of the push-pull arrangement with its inherent hum cancellation characteristics, no large capacitance electrolytic capacitors are required except in the case of the preamplifier and d.c. heater supply.

It is not absolutely essential to match resistors, capacitors, tubes, etc., of the two halves of the push-pull circuit, because cross-coupling, cathode degeneration, inverse feedback, and balancing potentiometers provide for a reasonably well balanced output, even if exact push-pull symmetry is not maintained. Nevertheless, accurate balance and superior performance of the amplifier can be attained only by electrical and mechanical symmetry. Furthermore, changing line voltage will result in unbalanced operation if parts are not fairly carefully

matched. Therefore, matching of corresponding parts is recommended insofar as possible.

Wiring of those portions of the circuit operating at +400 volts or less should follow conventional procedure. For the higher voltages, wire with fibre glass insulation is recommended.

Potentiometers R_{21} and R_{22} should be so located that they can be reached easily with a screwdriver while the amplifier is in operation.

Transformers and chokes should be of good quality. The output transformer is especially important. The quality of the entire amplifier will depend largely on this item. This circuit was designed, among other things, to eliminate expensive interstage audio transformers, and the money so saved can be invested in the output transformer. A number of excellent makes are available. The author used a UTC linear standard LS55, and found it very satisfactory.

Tubes V_4 , V_5 , and V_6 should be

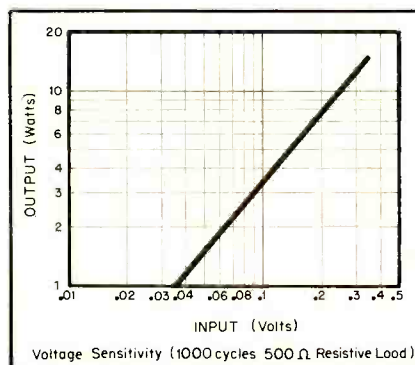

Fig. 3. Curve showing voltage sensitivity of the amplifier when feeding a 500-ohm resistive load.

mounted in non-microphonic tube sockets. Switches S_1 and S_2 should be the shorting type to prevent noisy switching. The feedback loop attached to the secondary of the output transformer should not be finally soldered in place until adjustments of the amplifier are completed.

Adjustment

After completing the construction, insert all tubes heated by d.c. Turn on the amplifier and adjust the heater voltage to 6.3 volts.

Next, insert all tubes heated by a.c. The thermostatic switch should not be inserted until later. Turn on set and measure a.c. heater voltage.

If everything is operating normally, place the thermostatic switch in its socket and turn on the amplifier. Adjust R_{21} and R_{22} to produce correct operating current and voltages for the output tubes. If parts have been well balanced, minimum hum will be obtained when plate currents are balanced. If parts have not been carefully selected, minimum hum may occur when plate currents are slightly unbalanced. Adjust R_{21} for minimum hum.

Finally, attach feedback loop from output transformer secondary to one of

the cathodes of V_5 . If noise increases when feedback loop is attached, the loop has been reversed and should be attached to the other cathode.

A final check of voltages should be made; Table I shows typical values for plate, grid, and cathode potentials referred to ground. If everything is in correct working order, hum and noise will be inaudible when the ear is held more than three or four inches from the speaker. When the preamplifier is switched into the circuit, a small amount of noise will become apparent, though this noise should be so slight as to cause no objection.

In order to maintain balance of the amplifier, potentiometers R_{21} and R_{22} will have to be adjusted periodically as the tubes age. The frequency of these adjustments will decrease after the first few weeks of operation, during which time the tubes' characteristics are changing quite rapidly. Since line voltages will vary throughout the day, it is suggested that balancing be done when the line voltage is at its average value. The amplifier should be adjusted only after it has warmed up at least half an hour.

Performance

Full output of 15 watts is attained with an input voltage of 0.35 volts rms. An output of over 20 watts can be attained, though the amplifier begins to produce appreciable distortion over 15 watts.

Frequency response is flat to approximately 20,000 cps, with a gradual droop above that point. Voltage sensitivity is shown in Fig 3. Hum and noise voltages were so low that they could not be measured with equipment available.

Conclusions

In the past, direct coupled amplifiers have proved unpopular probably because of several problems associated with this type of design. The circuit described herein overcomes all these difficulties by unconventional arrangements, except that periodic adjustment of the current of output tubes will be required.

However, for those who require unusually good performance, and enjoy the work of achieving it, it is believed that this circuit will provide satisfactory results. Its superiority to most typical designs can be shown either by instruments or by listener tests.

[Continued on page 36]

TABLE I

Tube	Plate	Grid	Cathode
V5	170	0	6.5
V6	120	6.5	8
V7	309	120	122.7
V8	750	309	327
V9	745 @ 42 ma	327	400
V10	745 @ 42 ma	327	400

NOTE 1. Actual voltages may vary as much as 15 per cent from figures shown without detrimental effect. However, output tube plate current and voltage should be adjusted as accurately as possible. The exact voltage of output tube grids is unimportant, provided plate current and voltage are correct.

NOTE 2. Voltage measurements should be made with a vacuum tube voltmeter.

Harmonic Distortion in Iron-Core Transformers

T. WILLIAMS*
and
R. H. EASTOP**

A discussion of a simple method of measuring total harmonic distortion with accuracy adequate for routine check purposes.

ONE RESTRICTION upon the design of an audio transformer is that the inherent distortion be confined to insignificant proportions. It is therefore necessary to be able to predict the distortion introduced by a given transformer from data obtained from measurements upon samples of the core material. This information is particularly necessary in connection with large output transformers in which flux density may be quite high at the lowest frequency of the pass band.

Normally a transformer is driven from a circuit containing a thermionic valve and in considering the distortion introduced it is necessary to distinguish between (a) distortion introduced by the valve owing to its own non-linear characteristics and to the fact that it is working into a complex non-linear load; and (b) distortion introduced by the transformer owing to the non-linear characteristic of its core material. Only the latter type of distortion is here considered.

This particular problem has been investigated by N. Partridge¹ and it may be useful to re-state some of his conclusions:

(1) With respect to non-linear distortion in the transformer a circuit consisting of a source (internal resistance r), transformer and load, *Fig. 1* may be replaced by the equivalent circuit of *Fig. 2*. In the case where all circuit elements are linear, this reduces to Thévenin's Theorem.

(2) If no constant polarizing current is present, only odd-number harmonics are produced. Third harmonic predominates and if an accuracy of 5 per cent is acceptable, higher harmonics may be neglected.

(3) The existence of a constant component of magnetizing force results in an asymmetrical hysteresis loop and even as well as odd harmonics appear. If the peak flux density is less than 10,000 gauss (for

silicon-iron laminations) the harmonics above the third can be neglected with less than 5 per cent error.

(4) The percentage harmonic distortion appearing across a transformer in a circuit such as *Fig. 2* is:

$$\frac{V_h}{V_f} = K S \frac{R_1}{f} \left(1 - \frac{R_1}{Z_f} \right)$$

Where K is a numerical constant depending upon the core dimensions

S is a factor depending upon the core material and the peak flux density

R_1 is the value of Z_s and Z_L in parallel

Z_f is the primary open-circuit impedance at the fundamental frequency f .

Methods of Measuring Harmonic Distortion

Methods available for measuring distortion may be classified into three groups:

(1) Wave analyzer methods in which the amplitude (and perhaps the phase, too) of each frequency component in the distorted waveform is measured directly by a selective circuit. These methods give the fullest information but are slow and require expensive and bulky apparatus.

(2) Fundamental suppression methods in which the distorted voltage waveform is fed through a passive high-pass filter which rejects the fundamental but does not attenuate the harmonics. Such filters are not inexpensive and one filter is suitable for measurements at only one frequency.

(3) Fundamental suppression methods in which the distorted voltage waveform is balanced against a pure waveform at the fundamental frequency and the difference is measured. There are several methods of deriving the pure reference waveform by using special transformers or other passive networks, or by using vacuum tube circuits.

Simple Method for Measuring Total Distortion

A simple method for the rapid routine measurement of distortion has been de-

veloped by the authors and does not seem to be widely known. By the use of inexpensive apparatus total core distortion can be measured quickly under conditions strictly comparable with specified operating conditions.

The method falls into category (3) as listed above. *Figure 3* shows a modification of (c) in *Fig. 2* in which a parallel network composed of C_1 , R_1 and r is connected to the same source of e.m.f. and a resistance R_2 is shown across the transformer primary inductance to represent the core losses.

With an indicator connected across A and B this will be recognized as Maxwell's Bridge. By adjustment of C_1 , r , and R the fundamental voltage across AC can be made equal to that across BC. This setting will hold whatever the frequency of E so long as L and R are constant.

The balance conditions are then:

$$L = R R_1 C_1$$

and:

$$R Z = \frac{R R_1}{r}$$

In practice a perfect balance cannot be obtained since the non-sinusoidal magnetizing current through R_1 causes a distorted voltage waveform across R_1 (and L) and this cannot be completely balanced by the sinusoidal voltage across

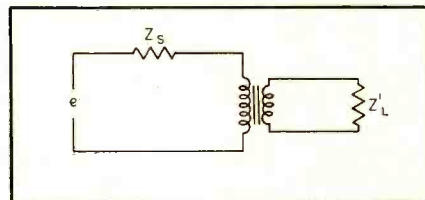

Fig. 1. Circuit of transformer working between impedances of Z_s and Z_1 .

R . The residual voltage across AB when C_1 , r , and R are adjusted for "balance" is the total harmonic distortion appearing across the transformer winding.

* Chief Engineer, Partridge Transformers Ltd., London, England.

** Engineer, Partridge Transformers Ltd., London, England.

¹ N. Partridge, "Harmonic distortion in audio frequency transformers," *Wireless Engineer*, Sept. and Nov., 1942.

The measuring procedure then is as follows:

(1) Set R_1 to the value $Z_S Z_L / (Z_S + Z_L)$

(2) Set E to make the voltage across AC correspond to the desired power in the load Z_L ; i.e., $(V_{AB})^2 = Z_L W_0$

(3) Adjust R and r to make the voltage across AB a minimum. This minimum reading is the harmonic voltage figure required, and if multiplied by $100/V_{AB}$ gives the percentage distortion factor. There is no need to read the values of R and r so that uncalibrated variable resistors may be used for these circuit elements.

Error of the Method

In the foregoing brief description it has been implicitly assumed that (1) the voltage source E is free of harmonics, (2) the voltage source has an internal impedance of zero, and (3) the "balance" indicator has an infinite input impedance and stray capacitances are negligible. Fortunately these conditions can be closely approached and in practice the errors introduced are of small order. Each source of error is examined separately below.

The conditions of balance for the Maxwell bridge contain no frequency

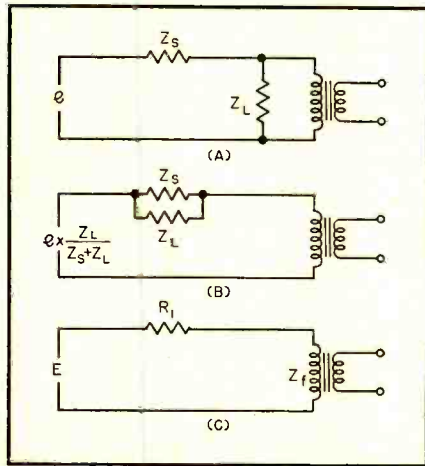

Fig. 2. Equivalent circuit of Fig. 1. (A) represents transposition of transformer impedance ratio; (B) represents transposition using Thévenin's theorem; and (C) represents simplification of (B).

term and so the bridge once balanced for one frequency remains so at all frequencies for which the numerical magnitude of the impedance elements remains unchanged. Unfortunately the inductance of an iron-cored transformer is considerably lower at the third harmonic than it is at fundamental frequency. Thus clearly can it be seen how harmonic frequency components of the source e.m.f. give a false value to the reading.

To examine the order of magnitude of this error let it be supposed that the

bridge is balanced at the fundamental frequency and so the fundamental voltage across AB is zero. Now suppose that the inductance has a magnitude of L at fundamental frequency and $L - \delta L$ at third

harmonic frequency. Let $\frac{n}{100} \times E$ be the

magnitude of this third harmonic frequency present in the source (fundamental magnitude, E). The indicator across AB would give no reading of harmonic from the source if δL were zero. It will be seen therefore that the false reading due to $\frac{n}{100} E$ will be the

difference between the fractions

$$\frac{j\omega(L-\delta L)}{R_1 + j\omega(L-\delta L)}$$

and $\frac{j\omega L}{R_1 + j\omega L}$ of the voltage, $\frac{n}{100} E$;

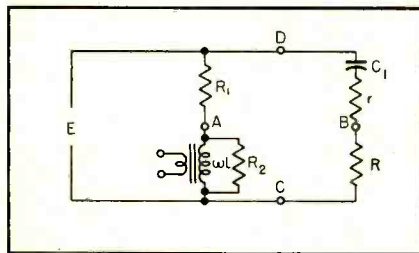

Fig. 3. Modification of (C) in Fig. 2 to permit of measurements of transformer characteristics.

that is

$$\left[\frac{j\omega(L-\delta L)}{R_1 + j\omega(L-\delta L)} - \frac{j\omega L}{R_1 + j\omega L} \right] \frac{n}{100} E$$

Expressed as a percentage of the fundamental across the inductance, this is

$$\frac{\left[\frac{j\omega(L-\delta L)}{R_1 + j\omega(L-\delta L)} - \frac{j\omega L}{R_1 + j\omega L} \right] \frac{n}{100} E}{\frac{j\omega L}{R_1 + j\omega L} E}$$

$\times 100$ per cent which simplifies to

$$n \times \frac{\delta L}{L} \times \sqrt{1 + \frac{\omega^2(L-\delta L)^2}{R_1^2}}$$

By means of this expression the false reading is related to the percentage harmonic, n , in the source and from a knowledge of the factors the value of n can be deduced for a given maximum permissible error reading. $\delta L/L$ is the fractional change of inductance as between fundamental and harmonic when the two are applied simultaneously. Under this condition it has been found experimentally that $\delta L/L$ is a small fraction of the order of a tenth to a fifth, measurements being taken with a fundamental frequency of 50 cps and third harmonic.

The order of magnitude of $1 + \frac{\omega^2(L-\delta L)^2}{R_1^2}$ can be obtained from the

knowledge that at any fundamental frequency in the pass band ωL will be numerically greater than $2R_1$ or at the third harmonic frequency greater than $6R_1$, which makes $\omega(L-\delta L)$ greater than

$5R_1$; so that $\sqrt{1 + \frac{\omega^2(L-\delta L)^2}{R_1^2}}$ becomes

$\sqrt{26}$ which is near enough to 5.

The percentage n in the source gives rise to a false reading of magnitude less than $1/25$ th of n . So if a false reading of less than 0.1 per cent can be tolerated, the source must not contain more than $2\frac{1}{2}$ per cent harmonic.

Error Due to Finite Source Impedance

Let it be supposed that the balanced bridge set-up driven from a pure tone source, of impedance R_S , is indicating an harmonic voltage across AB. The reading across AB can be considered as due to a fictitious generator of harmonics in series with L ; as the source E does not affect the voltage across AB under balanced conditions it is short-circuited, giving the equivalent circuit of A in Fig. 4.

The true reading of distortion appears across AB when $R_S = 0$. How is this reading affected when R_S is not zero?

The complete analysis of this circuit leads into some rather tedious algebra but if the shunting effect of C and R across R_S can be ignored and if $L\omega > 2R_1$ when the equivalent circuit can be greatly simplified as follows:

(1) with respect to a voltage introduced as at e_n the voltage across AB is almost the same as the voltage across AD. This is easily seen by drawing the vector diagram of the various voltages.

(2) The arm CBD can therefore be completely omitted. A of Fig. 4 then reduces to e_n applied to L , R_1 , and R_S in series. The indicated harmonic voltage is the voltage across R_1 . In general, voltage across R_1 is $\frac{R_1}{(R_S + R_1) + j\omega L} \times e_n$

When $R_S = 0$ this becomes $\frac{R_1}{R_1 + j\omega L} \times e_n$, the true reading of harmonic voltage. The ratio of these two voltages is

$\frac{R_1 + j\omega L}{R_S + R_1 + j\omega L}$. To test the magnitude of error introduced by R_S assume as before, $\omega L = 2R_1$ and also $R_S = 0.1R_1$.

The fraction $\frac{R_1 + j\omega L}{R_S + R_1 + j\omega L}$ then reduces to $\frac{(1+j2)}{(1.1+j2)}$. The modulus of this ratio

is $\frac{\sqrt{5}}{\sqrt{5.21}} = 0.98$, i.e., if R_S is 10 per cent

of R_1 the error introduced into the reading is of the order of 2 per cent of the reading.

For many measurements the 60-cps line voltage provides a suitable source

with an internal impedance of a few ohms.

Error Due to Stray Capacitances and Indicator Impedance

There is no difficulty in providing as an indicator a vacuum tube voltmeter of substantially infinite input impedance, and as distortion measurements are of importance only at low frequencies even large "strays" introduce negligible error. For example, $0.01 \mu\text{f}$ at 60 cps is an impedance of 0.27 megohms. However, the choice at grounding point on the bridge does need some consideration. The vacuum-tube voltmeter will probably have one input terminal which must be grounded and the best point for a ground on the bridge is A. The indicator can then be connected across AC, while the voltage V_{AC} is adjusted to give the appropriate flux density in the core, and then switched to AB while R and r are adjusted to give a minimum reading. The bridge must be driven from a floating winding on a transformer and the capacitance of this winding to ground will shunt one or more of the bridge elements.

A vacuum-tube voltmeter with three-terminal input being developed by the authors will give greater freedom in

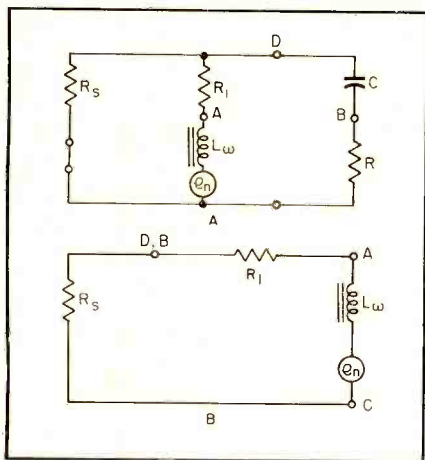

Fig. 4. Bridge of Fig. 3 driven by generator of finite source impedance. (A) actual circuit, and (B) equivalent circuit.

measurements of this kind. Suppose the three input terminals are T_A , T_B , T_C . The terminal T_C is permanently grounded and the input impedance between any two terminals is very high. The indicator reads the voltage between T_A and T_B irrespective of any voltage $T_A - T_C$ or $T_B - T_C$.

Choice of Components

Summing up, the method offers a means of rapid measurement of total distortion using a minimum number of inexpensive components and of sufficient accuracy for most purposes.

The resistance R_1 may be built up from selected composition resistors as the impedance it represents is not known to a high degree of accuracy. A fixed tubular paper capacitor of suitable value is used for C_1 . The resistance R may conveniently be a chain of fixed value composition resistors in series with a composition potentiometer, giving a coarse adjustment and a fine adjustment over a wide range. Another composition potentiometer is suitable for r . For distortion measurements the elements C_1 , r , and R need not be calibrated; they are merely adjusted so that the indicator reading is at a minimum.

Strictly speaking, the indicator itself should give an indication of the r.m.s. value of the complex waveform of distortion voltage appearing across AB. Usually the third harmonic predominates and in this case the mean value, as indicated on a rectifier-type moving-coil instrument, will be close to the r.m.s. value.

If laboratory type decade boxes can be used in the set-up, and a suitable source of variable frequency is available, it may be noted that all the other important parameters of transformer performance can be measured with only a small change of set-up.

(1) *Incremental primary inductance and core loss.*

Use as Maxwell bridge. Frequency as for distortion measurement but voltage reduced.

(2) *Primary leakage inductance and copper loss.*

Short circuit secondary of component on test and increase frequency to middle of pass-band. Use as Maxwell bridge. For this measurement it is more convenient to have C_1 and r in parallel giving the leakage inductance and equivalent series resistance directly as series values.

(3) *Equivalent shunt capacitance.*

Increase frequency well above pass-band. Interchange C and R . Use as simple capacitor bridge.

Measurements can be made with a polarizing direct current through the windings if a source of d.c. is connected

to A and D. Of course, the d.c. path through E should then be blocked with a capacitor and the d.c. supply must be fed through a choke to present a high impedance to E .

Results Obtained

Figure 5 shows two curves taken in the manner described. Curve 1 is the measured distortion characteristic of a typical Partridge High Fidelity output transformer (type PPO/2) employing a high grade silicon-iron core. Curve 2 is the same characteristic taken for the same transformer but with a Radiometal core substituted for the silicon iron. It will be noticed that really low percentages are obtained by the use of the more expensive nickel-iron core material which also greatly increases the band width obtainable with any given degree of primary-secondary intersection. It will be noted, however, that the power handling capacity of the transformer is not increased by the use of the nickel iron core. In both cases the percentage distortion increases rapidly for power levels above 10 watts. This should be expected as both materials saturate at about the same flux density.

Harmonic Distortion and Intermodulation

It is now widely recognized that intermodulation distortion is more important than harmonic distortion as a cause of poor fidelity in audio reproducing systems. In conclusion therefore it may be as well to justify the attention paid to the measurement of harmonic distortion.

It is well-known that harmonic distortion arises from the non-linearity of the magnetic properties of core materials in common use. The production of harmonics is, in itself, not very objectionable since almost all transmitted sounds are rich in harmonics to various degrees; for example, the note of a violin is characterized by the presence of certain harmonic frequencies in proportions which vary for different instruments and for the same instrument played differently. Hence, the propor-

[Continued on page 33]

Fig. 5. Typical distortion curves taken on two transformers with identical windings and different core materials. (1) silicon-iron core, and (2) Radiometal core.

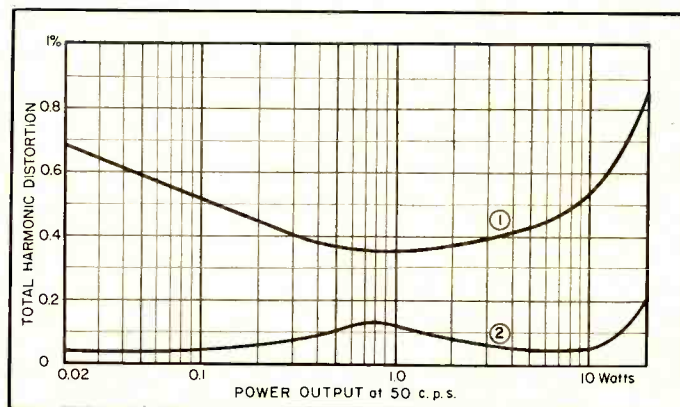

New Professional Tape Recorder

W. E. STEWART*

An engineering description of the latest tape recorder to enter the professional field. Remote-control operation especially suits this machine to broadcast station use.

IN APPROACHING the design of a magnetic tape recorder for broadcast station use, RCA engineers established a set of specifications based on wide experience. It included requirements learned from many broadcasters in stations of all sizes. It met rigid specifications established by a national chain after considerable experience with several makes of recorders. Various recording studios were also consulted. Many points were established by exhaustive laboratory tests.

Such outstanding features as accurate timing, low wow and flutter, plus quick starting with push-button control were considered vitally important. Thus, the resulting machine (RT-11A) described in this paper incorporates all these essential qualities for a truly professional tape recorder.

The basic recorder consists of four major parts: the tape-handling mechanism, the power supply, the recording amplifier, and the reproducing amplifier. The magnetic heads are a part of the tape-handling mechanism. An interconnecting harness is also supplied to simplify installation as much as possible. A number of accessory items can be included such as the Remote Control Unit.

Tape Handling Mechanism

This basic item was designed to mount in a standard cabinet rack. At the same time, care was taken that none of its operations depended on gravity so it could be mounted in any other desired position. In particular, it was expected that some users would prefer a horizontal console type machine.

Considerable study was necessary to determine the best layout of the panel for all operations. It was realized that threading time is of primary interest in a broadcast station. Tests indicated that when the machine was rack mounted, the tape must thread from top to bottom for fastest threading. Both right and left hand threading and various combinations of reel motion were tried. At the same time, experience indicated that when the machine is used in a horizontal position, the tape must move from the left reel to the right reel. Further-

* Manager, Broadcast Audio Engineering Section, Radio Corporation of America, Camden, N. J.

more, the tape must move around the front side of the board to be easily accessible for editing. The tape path shown in Fig. 1 resulted. For those who feel that this might be "left-handed" it is pointed out, that after many years of film projector design, almost every projector on the market threads down the left side of the reels.

In the horizontal position the machine may be used for editing, and it is desirable to draw the tape over the heads and into a basket (without putting it on the takeup reel). This fixes the position of the capstan as *after* the heads. A "pusher" type tape path would make this operation impossible. For editing purposes, it was desirable that the head shields open very wide so the tape could be drawn straight out for marking and cutting. Fig. 2 shows how both the inner and outer covers open widely.

It will be noted that the vertical and horizontal requirements are both answered completely by the final arrange-

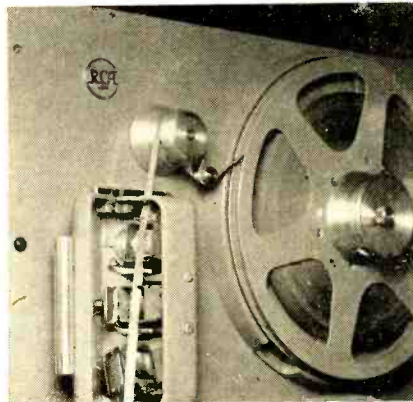

Fig. 2. Opening the main cover over head assembly also opens individual covers over record and reproduce heads. Sapphire guides lift the tape from the heads during rewind.

ment. The utmost convenience and safety in threading and handling the tape is assured. All the controls are recessed so they will not interfere with the tape during the threading operation. Sharp angular projections are avoided throughout.

Full remote control of the machine calls for relay and solenoid operation of all functions, as shown in Fig. 3. It also makes complete interlocking of all func-



Fig. 1. Complete rack-mounted recorder for typical installation in a broadcast station or recording studio.

tions comparatively simple. Since high speed travel of the tape over the heads causes unnecessary wear and damage, a solenoid lifts the tape on sapphire guides whenever it is in high-speed forward or rewind positions. These lifters and guides can be seen in Fig. 2 between the individual heads.

Controls

The control circuits are arranged as follows:

1. **Power Switch**—A toggle switch turns on the a.c. power. This may or may not turn on the amplifiers depending on how the customer desires his installation. The capstan motor is started by this switch and requires about as much time to reach full speed as the tube filaments require for warm up. The control circuits are not energized until this switch is on. A pilot lamp shows when the power is turned on.

2. **Speed Selection**—This toggle switch selects the capstan motor speed for either 7.5 or 15 in./sec. tape speed. It also operates a small relay in each of the amplifiers to adjust compensation for each speed.

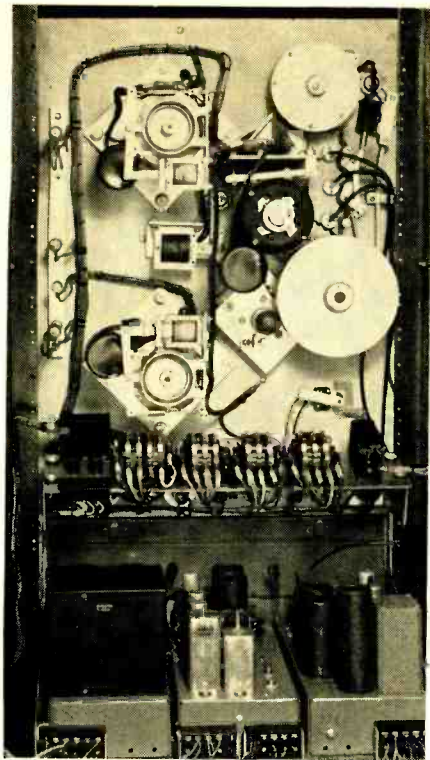

Fig. 3. Rear view of recorder and amplifier to show location of relays and solenoids.

3. **Start**—The **START** button starts the tape moving the heads at the selected speed. It removes the brake load from the reel motor, energizes the reel motors, and pushes the pressure roller against the tape and capstan (moving the tape at capstan speed).

4. **Record**—The **RECORD** button starts the recording function. A lamp indicates that the machine is recording (and erasing what had been on the tape). This button removes the short from the recording head, applies plate potential to the oscillator circuit, and lights the **RECORD** lamp.

This function is electrically interlocked so it cannot be operated until the **START** button has been pushed. If it is desired to start recording immediately upon starting the tape, the **RECORD** button can be held down while the **START** button is pressed.

5. **Fast Reverse**—This button effects rapid rewind of the tape. It releases the **RECORD** functions if they were energized, releases the capstan pressure roller if it was energized, energizes the tape lifter mechanism, and applies heavier torque to the supply reel motor so the tape rewinds.

This circuit overrides any of the other circuits and can be operated without first pressing the **START** button.

6. **Fast Forward**—This button effects rapid forward winding of the tape. Its functions are the same as **REWIND** except for the direction of the tape. **REWIND** overrides **FAST FORWARD** if both buttons are pressed at once. The two may be pushed alternately to obtain exact placement of the tape.

7. **Stop**—This button stops the tape quickly. It deenergizes all the above circuits applying the brakes to the reels, leaving the pressure roller and tape away from the capstan and the tape lifters down. The bias oscillator plate voltage is removed and the recording head shorted.

The follower arm contains a safety switch which will also stop the machine and apply the brakes if the tape should break or come to an end.

The control switches and lamps are located at one end of the panel so the hands do not have to be placed close to the moving parts of the machine. The most used positions are at the left (front when horizontal) and the least used are at the right (or rear). In order, from left to right, they are: **STOP**, **START**, **FAST REVERSE**, **FAST FORWARD**, **RECORD**, **RECORD LAMP**, **POWER**, **POWER LAMP**, and **SPEED SELECTOR**.

The application of remote control is quite simple. The same type of push-buttons are used and can be mounted in any manner the user chooses. A nine wire cable is required from the remote control position to the motor board. A Jones plug-in connector is used for actual connection; one jumper must be clipped when the remote control connection is plugged in.

The above switches are obtainable mounted in a suitable panel on a box as MI-11948. **STOP**, **START**, **FAST REVERSE**, **FAST FORWARD**, **RECORD**, and **RECORD LAMP** may all be extended in this manner. In operation, any function can be performed from either the local or remote position regardless of where the last operation was performed.

As has been mentioned, torque motors have been used for the reels. A brake is applied at the rear end of the shaft. Study of the brake lining resulted in a material that applies the proper torque with comparatively low tension. It is thus possible to use a low-power winding on the solenoid and operate within safe temperature limits even when used continuously.

A standard N.A.B. reel can be placed on the hub, or removed, without removing the hub itself. A flat circular spring

holds the reel in place and no special locating pins are involved. To use the smaller RMA reels, the hub is removed from the shaft, the reel put in place and the hub pushed in against it. A simple finger latch releases the hub. If only N.A.B. reels are to be used, a knurled nut at the center can be used to lock it more tightly. Tens of thousands of off-on cycles with a full reel of tape were used in a life test to check the new hub and the brake design.

Tape Motion

Smooth tape motion is one of the most important requirements in a high-quality recorder. More than twenty motor designs from several companies were tried in arriving at a satisfactory tape drive system.

The simplest drive system, and one giving synchronous capstan operation, is a direct drive in line with the motor shaft. This has several disadvantages, however. If a normal speed motor is used, the capstan becomes quite small and exceedingly rigid limits must be set to avoid flutter from capstan irregularities. Also it is difficult to filter out the motor pulsations without adding a high compliance device that adds a wow or flutter at some objectionable frequency. If a special low-speed motor is used, the hunting in the motor field can add a similar wow. Many systems were tried before discarding the direct drive idea.

The use of a speed reduction device makes a larger capstan possible with more practical manufacturing tolerances resulting. The capstan shaft is supported by a sleeve bearing at the front (or tape) end to give the smoothest possible motion

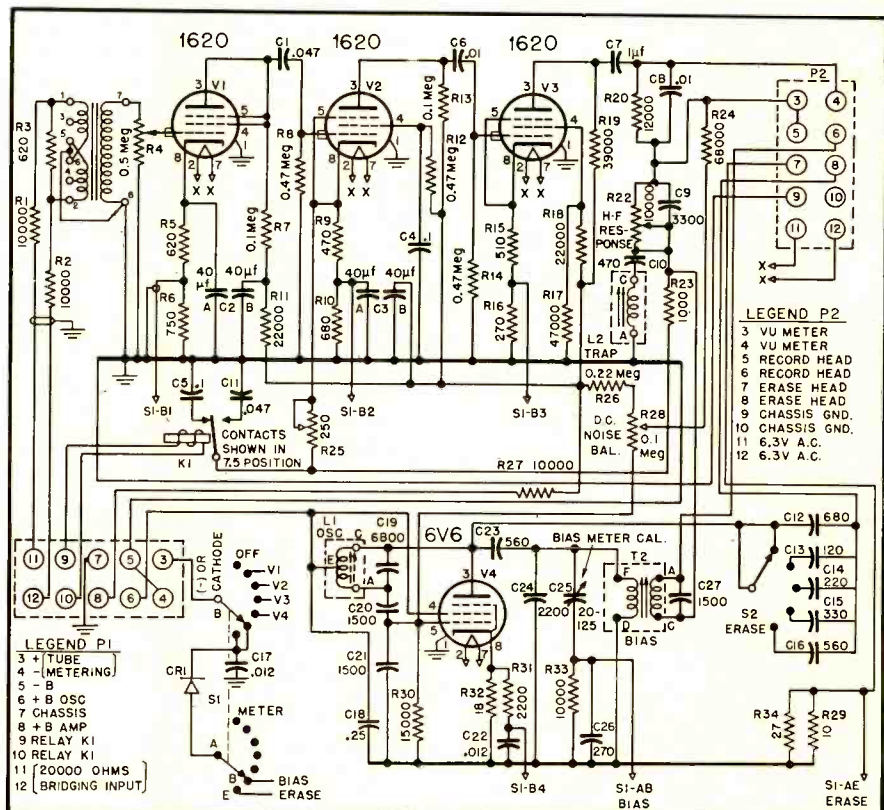

Fig. 5. Overall schematic of recording amplifier.

at the critical end of the shaft. The surface contacting the tape is ground after assembly to assure perfect concentricity. The rear bearing, which must support a heavy flywheel, is a precision ball bearing.

Since accurate timing is an important requirement in broadcast stations, the capstan must be synchronous with the power supply. A timing belt giving a 3 to 1 speed reduction is satisfactory for this purpose. Careful measurements fail to show any significant amount of flutter from the cogs in the belt.

The small flywheel driven by the large one through a rubber idler damps out any tendency to oscillate. In starting, there is a single, small transient lasting approximately one second but no tendency to oscillate or hunt.

Thus, a tape drive system is achieved that is synchronous, and that exhibits very low wow and flutter values in starting and in operation. The small amount of wow and flutter remaining is a complex function, reflecting minute variations in the several rotating parts, tape irregularities, vibration from the floor, etc. This has been carefully evaluated by laboratory tests and is less than 0.1 per cent r.m.s. However, r.m.s. measurements are difficult to make, so a series of peak measurements are used in production to ascertain the peak value and evaluate the frequency range in which the wow and flutter occur. The limit for the combined value is 0.15 per cent peak (0.3 per cent peak-to-peak) while the NAB standard has been set 0.2 per cent (0.4 per cent peak-to-peak).

Experience has shown that a panel mounted machine is often hard to keep properly aligned. The slightest warping of the panel changes the tape path slightly and requires realignment of the heads for good high-frequency response. For this reason, all of the important

Fig. 4. To maintain alignment, critical parts of tape drive mechanism are assembled on a casting which is shock-mounted to the main panel.

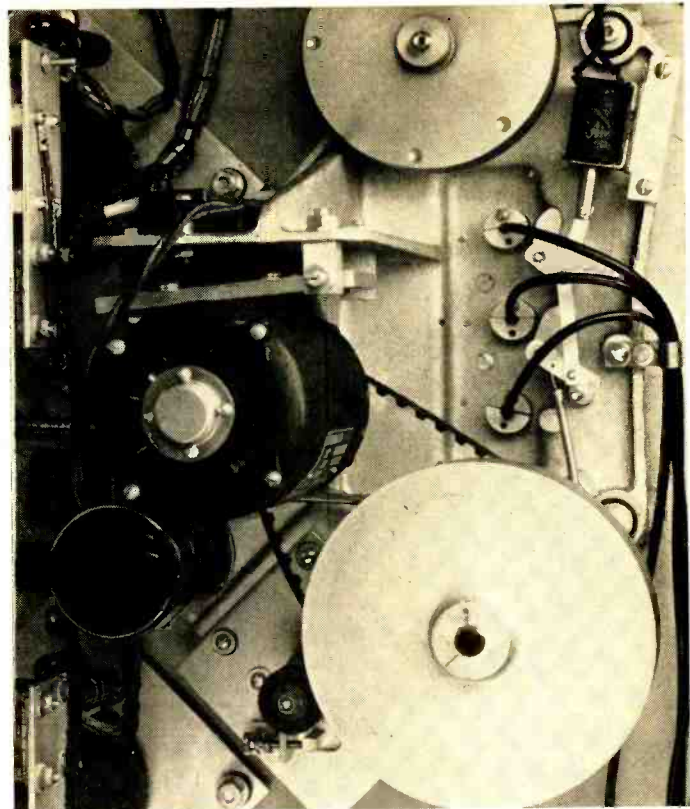

parts of the tape guiding mechanism are mounted on a casting which floats on the panel. The stabilizer, the motor and capstan, the pressure roller and the heads are all mounted on a rigid casting. This casting is mounted in heavy rubber grommets in a three point suspension system. All the above parts that appear on the front of the panel are actually mounted on the casting and have a small clearance between them and the panel. A closeup of the casting and associated parts appear in the photograph of Fig.

4. In addition, the tape is closely guided in and out of the heads by sapphire guides. The sapphires may be rotated and moved slightly from time to time to avoid excessive wear in one spot.

Heads

The design and manufacture of good tape recording heads are so important to the proper functioning of a professional tape recorder that they could be the subject of a complete paper in themselves. They are mentioned only briefly here:

1. **Erase**—The erase head core is made of .002-in. laminations of silicon steel which gives high flux density and increases the effectiveness of the erasure.

A double-gap design is arranged so the tape, in effect, erased twice in a single pass. No pre-erasure is necessary to assure clean, quiet tapes when using this recorder. The head is mounted in a copper shield can to reduce radiation of the 100-kc. erasing frequency.

2. **Record**—The record head must perform an entirely different function than the erase head and consequently has a different structure. An 80 per cent nickel-iron alloy is used for the laminations, and the single gap must have straight, square edges. The losses must be low at high frequencies. To assure no beat between the bias frequency and the higher audio frequencies, 100 kc is used for the bias. This requires extremely thin laminations in the head cores. The head is shielded with a single layer box of nickel-iron alloy. A hinged lid closes tightly on the box, except for entering and exit slots for the tape.

3. **Reproduce**—This head is the most critical of all three. The signal obtained from the tape is very small, being less than that from broadcast microphones. This means that there must be exceptionally good shielding from hum fields. A triple shield is

[Continued on page 36]

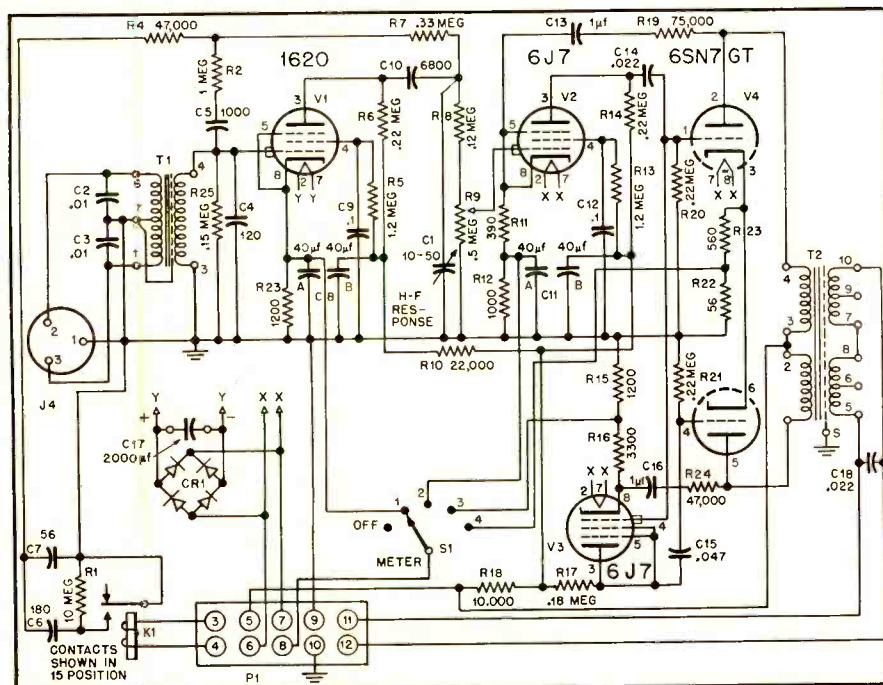

Fig. 6. Overall schematic of reproduce amplifier.



Audio Engineering Society,
Box F, Oceanside, N. Y.

AUDIO engineering society

Containing the Activities and Papers of the Society, and published monthly as a part of AUDIO ENGINEERING Magazine

OFFICERS

John D. Colvin President Bob Hugh Smith Western Vice.-Pres.
C. G. McProud Executive Vice.-Pres. Lawrence Shipley Central Vice.-Pres.
Norman C. Pickering Secretary Ralph A. Schlegel Treasurer

Loudspeaker Damping

ALBERT PREISMAN*

Part 2. A discussion of theoretical considerations of loudspeaker characteristics, together with a practical method of determining the constants of the unit as a preliminary step in obtaining satisfactory performance.

WE NOW COME to the question of damping of the loudspeaker mechanism by the electrical circuit. In Fig 3 is shown the electrical equivalent of a loudspeaker illustrated in Fig. 2, with the addition of an electrical source of internal resistance R_G feeding it. This normally represents the R_p of the output tube or tubes as viewed from the secondary terminals of the output transformer.

The apparent generated voltage as viewed from the secondary terminals is e_G . The transient solution, however, is that current which flows in the network when e_G is zero, and subject to whatever initial conditions we seek to impose.

This circuit has been solved innumerable times; the current flow is oscillatory in nature, and of a frequency and decrement determined by the L , C , and R of the circuit. In particular, if

$$R = \sqrt{L_{me}/C_{me}} \\ = \frac{1}{2\pi f_r C_{me}} \quad (10)$$

where f_r is given by Eq. (8), and R is the resistance paralleling L_{me} and C_{me} , then the circuit is critically damped. This means that the natural frequency is zero, or the circuit is no longer oscillatory; physically the loudspeaker has no hangover effect. Of course R can be less than the value given by Eq. (10); the latter merely gives the maximum permissible value of R .

An inspection of Fig. 3. indicates that R must represent R_{me} paralleled by $(R_{vc} + R_G)$, hence if R_{me} is greater than the value required by Eq. (10),

* Capitol Radio Engineering Institute, Washington, D. C.

Responsibility for the contents of this paper rests upon the author, and statements contained herein are not binding upon the Audio Engineering Society.

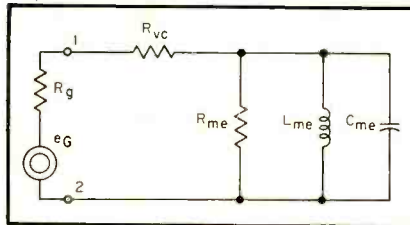

Fig. 3. Circuit of Fig. 2 with addition of generator.

$(R_{vc} + R_G)$ must be a low enough shunt to provide in conjunction with R_{me} the critical damping necessary.

It will be recalled from Eq. (5) that if the mechanical damping $(R_s + R_a)$ is low, R_{me} will be correspondingly high. An example which is to follow will show that usually the mechanical damping $(R_s + R_a)$ is very low, so that it can be expected that R_{me} will be relatively very high; much higher than will provide critical damping.

From this it follows that $(R_{vc} + R_G)$ must be a sufficiently low shunt to satisfy the critical damping condition given by Eq. (10). However, it is possible that the voice coil resistance R_{vc} is itself so high that Eq. (10) cannot be satisfied. In the usual case R_{vc} is not too high, but the maximum value left for R_G to assume can be quite low. In such a case a large amount of inverse voltage feedback may be necessary to reduce the source impedance to the requisite low value.

Numerical Example

The following numerical example will serve to illustrate the above analysis. Suppose we take a 16-inch cone type loudspeaker, whose mass is 40 grams, plus 4 grams for the voice coil. Assume further that the compliance of the suspension is $C_s = 3.2 \times 10^{-7}$ cm/dyne, and that the mechanical resistance is 2400 mechanical ohms.

To the mass of the cone and voice coil must be added that of the mass of the air. In the neighborhood of 25 cps or so, Olson² gives the reactance of the air load as 7500 mechanical ohms. The corresponding mass is

$$M_a = \frac{7500}{2\pi \times 25} = 48 \text{ grams}$$

Hence the total mass is

$$M_t = 40 + 4 + 48 = 92 \text{ grams}$$

The resonant frequency is, by Eq. (8)

$$f_r = \frac{1}{2\pi \cdot 92 \times 3.2 \times 10^{-7}} = 29.3 \text{ cps}$$

which is close to the value of 25 cps initially used to calculate the air mass.

The air also imposes a certain amount of damping in the form of radiation resistance. This is a rapidly varying function of frequency; from Olson's book we find it to be 600 mechanical ohms at 29 cps. Hence the total mechanical damping is

$$R_s + R_a = 2400 + 600 = 3000 \text{ mech. ohms.}$$

Now suppose the flux density B is 10,000 gauss, and the length l of voice coil conductor is 1500 cm. Assume further that the voice coil resistance R_{vc} is 10 ohms.

Then, from Eq. (5), we have

$$R_{me} = \frac{(1500 \times 10^4)^2 \times 10^{-9}}{3000} = 75 \text{ ohms}$$

$$C_{me} = \frac{92}{(1500 \times 10^4)^2 \times 10^{-9}} = 409 \mu f$$

$$L_{me} = (3.2 \times 10^{-7}) (1500 \times 10^4)^2 \times 10^{-9} \\ = 0.072 \text{ henry}$$

Observe how large C_{me} is even though the mass responsible for this capacitive effect is only 92 grams.

For critical damping, the total resist-

² Loc. cit.

[Continued on page 26]

THE NEW TURNER

Aristocrat

**MODEL 50D DYNAMIC
FOR TV - AM - FM
Recording • Broadcast
Public Address**

The crown jewel of dynamic microphones. See it, handle it — use it on highest quality recording, public address or broadcast work. New beauty, new styling, new utility and *new performance* make the Turner *Aristocrat* the finest of the fine. Use it anywhere, indoors or out — in hand, on stand, suspended, or concealed in stage settings. The *Aristocrat* is quickly and easily detached from ball swivel coupler for hand use. Non-directional polar pattern picks up sound from any direction. Equally effective for individual or group pickups with wide range, high fidelity reproduction of voice or music. Its high output dynamic generator requires no closely associated auxiliary equipment for outstanding results. Built of finest materials with flawless workmanship, each unit is laboratory calibrated to insure specification standards. . . . Write for complete details.

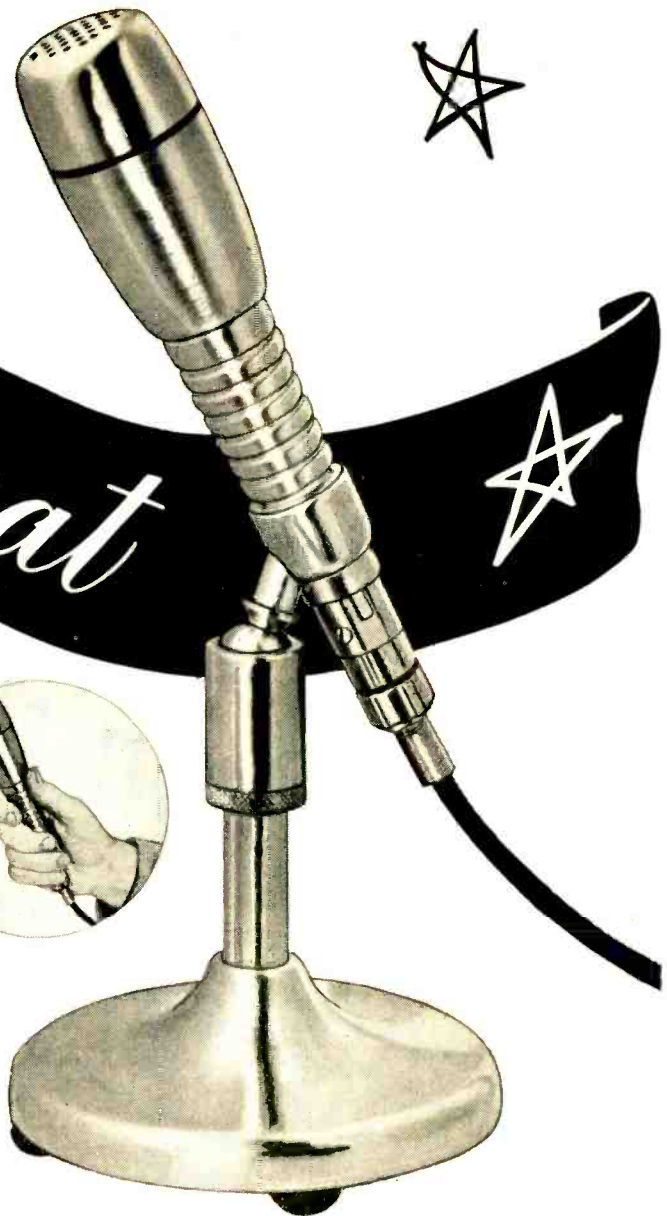

SPECIFICATIONS:

FREQUENCY RESPONSE: 50 to 15,000 c.p.s. flat within $\pm 2\frac{1}{2}$ db.
OUTPUT LEVEL: 56 db below 1 volt/dyne/sq. cm.
IMPEDANCE: 15, 200, 500 ohms or high impedance.
POLAR PATTERN: Essentially non-directional in any position.
MOUNTING: Ball and swivel type, tilts in any direction. Standard $\frac{3}{8}$ " — 27 thread.
CABLE: 20 ft., high quality rubber covered, two conductor shielded cable with Cannon quick-disconnect plug.

THE TURNER COMPANY

929 17th Street N. E., • Cedar Rapids, Iowa
IN CANADA: Canadian Marconi Co., Montreal, P. Q., and Branches
EXPORT: Ad. Auriema, Inc., 89 Broad Street, New York 4, N. Y.



Microphones **BY TURNER**

ance shunting L_{me} and C_{me} must be, by Eq. (10) :

$$R = \sqrt{\frac{.072}{409 \times 10^{-6}}} = 13.3 \text{ ohms}$$

Since R_{me} is one branch in parallel with R_{vc} plus the generator resistance, and this all totals 13.3 ohms, the voice coil branch must be

$$R_o = \frac{R_{me} \times R}{R_{me} - R} = \frac{75 \times 13.3}{75 - 13.3} = 16.18 \text{ ohms}$$

Since the voice coil resistance R_{vc} is 10 ohms, the generator or source resistance, as viewed from the secondary terminals of the output transformer, must be

$$R_G = 16.18 - 10 = 6.18 \text{ ohms.}$$

Although this is a low value, it is by no means prohibitively low. For example, if in the case of a single-ended triode output stage, $R_L = 2R_p$, then at the secondary terminals R_p should reflect as half of the voice coil load, if R_{vc} is 10 ohms, the reflected tube resistance R_G would be $10/2 = 5$ ohms. In short, a triode tube may be expected to act as critical damping in conjunction with the voice coil resistance.

In the case of a pentode tube, R_p is so high that no damping can be expected from it unless inverse voltage feedback is employed to an extent sufficient to lower the apparent source resistance to the required degree.

However, note that all this depends upon how low R_{vc} is compared to the length of wire used, and also how high the flux density B is. If the product (Bl) is low, both R_{me} and R may come out so low that R_{vc} alone may be in excess of that which paralleling R_{me} , will give the required value of R for critical damping. This means that even if the source resistance is zero, R_{vc} is too large and will not permit critical damping to be obtained.

Experimental Determination of Circuit Constants

It is possible to measure the motional impedance by simple electrical means, and from these measurements to determine the critical damping required. Since the measurements are to be made at the very low audio frequencies, ordinary iron vane meters can be used if so desired, and even a d.c. measurement of the voice coil resistance should be sufficient to furnish the value of R_{vc} .

If, however, it is desired to determine this quantity at the resonant frequency of the cone, or at any rate at some a.c. frequency, then the cone should be clamped so that it does not vibrate and generate a c.e.m.f., thereby furnishing a motional impedance value.

To measure the motional impedance, a set-up such as that indicated in Fig. 4 can be used. The audio oscillator wave

shape should be reasonably free of harmonics, and the audio amplifier should be capable of furnishing several watts of power without distorting. The ammeter can be of the iron-vane type, and should read one ampere or less at full scale. The voltmeter is preferably of a high-impedance type. A preliminary run should be made to determine the resonant frequency of the cone and its suspension. This is done by varying the frequency upward in steps starting from say, 20 cps, and noting E and I at each step. Their quotient is the impedance seen looking into the voice coil. This should be done with the field fully energized if it is of the electrodynamic type.

At the mechanical series resonant frequency of the cone, I will drop to a very low value, and E will tend to rise. In short, the quotient will be relatively

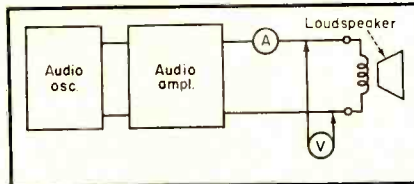

Fig. 4. Circuit arrangement used for making measurement of motional impedance.

large, and will represent $(R_{vc} + R_{me})$. If the value found previously for R_{vc} is subtracted from this reading, R_{me} is obtained. The resonant peak is normally quite sharp for reasons that will be explained further on.

In order to determine the value of critical damping R , it would appear necessary to measure L_{me} and C_{me} . However, R can also be determined by measuring the Q of the circuit; critical damping is obtained if $Q = 1$. To measure Q , ordinarily one merely has to plot the selectivity curve for the device, whether this curve represents transmission, impedance, admittance, or whatever other quantity gives this characteristic.

In the case of the loudspeaker, the resonant Q of the circuit is determined by the impedance as measured across R_{me} , L_{me} , and C_{me} in Fig. 3, with the electrical resistance $(R_{vc} + R_G)$ in parallel with R_{me} . In other words, the condition given by Eq. (10) for critical damping is also the condition for the resonant Q to be unity, where Q_r is in general determined by $\omega_r C_{me}$, and R_{me} and $(R_{vc} + R_G)$ in parallel.

Unfortunately, measurements must be made at terminals 1-2 in Fig. 3, since there are no accessible terminals across Z_{me} . The resulting impedance, Z_t , represents R_{vc} in series with Z_{me} , that is— with R_{me} , C_{me} , and L_{me} all in parallel. To find the above-defined resonant Q therefore requires some preliminary analysis, which will be given below.

Experimentally, however, all one has to do is to measure the impedance Z_t at and around resonance over a range including frequencies at which Z_t drops to $1/\sqrt{2}$ of its value at resonance (where it has the maximum value $R_{vc} + R_{me}$). Then, knowing the two frequencies at which this occurs, as well as the resonant frequency f_r , Q can be calculated. Once Q is known, the necessary value of R can be found, and then the maximum permissible generator resistance R_G .

Let us therefore proceed to evaluate this impedance. The impedance looking to the right into terminals 1-2 of Fig. 3 can be calculated from the circuit elements shown. It is:

$$|Z_t| = \sqrt{\frac{1 + Q_r^2 (1 - \rho^2)^2}{\left(\frac{1}{R_{me} + R_{vc}}\right)^2 + \frac{Q_r^2}{R_{vc}^2} (1 - \rho^2)^2}} \quad (11)$$

where Q_r is the resonant Q of the circuit if terminals 1-2 of Fig. 3 were short-circuited; i.e.,

$$Q_r = \omega_r C_{me} R = R / \omega_r L_{me} \quad (12)$$

in which R represents R_{me} and R_{vc} in parallel, and ω_r is the resonant angular velocity of L_{me} and C_{me} . Furthermore,

$$\rho = f / f_r \quad (13)$$

where f is the frequency at which Z_t is being measured, and f_r is the resonant frequency; in short, ρ represents the fractional deviation from the resonant frequency.

In particular, if $\rho = 1$, ($f = f_r$), Eq. (11) reduces to

$$Z_t = R_{me} + R_{vc} \quad (14)$$

which is correct from an inspection of Fig. 3, since at the resonant frequency L_{me} and C_{me} form a negligibly high shunt impedance across R_{me} , so that Z_t becomes $R_{me} + R_{vc}$, as stated above.

Furthermore, if $\rho = 0$, ($f = 0$), or $\rho = \infty$, ($f = \infty$), Z_t becomes equal to R_{vc} alone, as is also clear from Fig. 3, since L_{me} is a short circuit across R_{me} at $f = 0$, and C_{me} is the short circuit at $f = \infty$.

If Eq. (11) is solved for Q_r in terms of the other variables, there is obtained:

$$Q_r = \frac{1}{(1 - \rho^2)} \sqrt{\frac{\left(1 - \frac{Z_t}{R_{me} + R_{vc}}\right)^2}{(Z_t / R_{vc})^2 - 1}} \quad (15)$$

Now suppose the frequency is varied, which is the same as saying ρ is varied until Z_t drops to $1/\sqrt{2}$ of its maximum value; i.e.,

$$Z_t = \frac{R_{me} + R_{vc}}{\sqrt{2}} \quad (16)$$

If this value is substituted in Eq. (15), together with the corresponding specific

[Continued on page 39]

If you're an AUDIO-PHILE*

*People who enjoy the entertainment provided by fine audio reproduction



You will want this new kind of magazine...

for your listening pleasure: Whatever your interest in radio and recorded music, whether you are a critical listener or a technically-minded hobbyist, you'll say of HIGH-FIDELITY Magazine: "This is just the kind of publication I want. It is edited exactly to suit *me!*"

better reproduction: Helping readers to find the kind of music they want, and to reproduce it the way they want to hear it is one of the basic purposes of HIGH-FIDELITY. You will find information on both modest and expensive installations, each planned according to best audio practice.

custom installations: HIGH-FIDELITY will give you a wealth of ideas on space-saving units for small apartments, built-in designs for private homes, demonstration installations for advertising agencies, speaker systems for residence organs, and plans for home and studio recording.

you can build your own: Looking for instructions on building equipment in your home workshop? Then look to HIGH-FIDELITY for detailed instructions that follow the very latest engineering developments and techniques, modified to suit the facilities you have at your command.

about records, new and old: You'll be amazed and delighted to see the results of research and consultations with music authorities and collectors represented in this department, carefully compiled and classified, covering all types of recordings to meet all tastes and purposes.

if you're a beginner: Maybe, as an Audio-phile, you are now on the outside, looking in. If so, HIGH-FIDELITY has a special department for you with a door-mat that says *Welcome* to all those who want to join the fraternity, and learn the mysteries and delights of fine audio reproduction.

all this, and more: These are only *some* of the features in HIGH-FIDELITY. You will find a fascinating wealth of information, whether your interest is in the music rather than in the equipment which produces it, or if you are a critical listener to whom the technical perfection of your equipment is paramount.

a limited edition: The first issue is necessarily a limited edition. Copies are not available on newsstands, therefore, to be sure of getting the first issue *you must send in your subscription order without delay.*

High-Fidelity

Published by Milton B. Sleeper

Bank Building, Great Barrington, Massachusetts

AUDIO ENGINEERING • APRIL, 1951

IN THE LAST TWO YEARS, there has developed an amazing interest in fine radio and recorded music for home entertainment. Previously the possibilities of high-fidelity reproduction were known only to engineers and a few technically-minded hobbyists.

But suddenly people began to reject the synthetic tone quality of ordinary radio sets and phonographs. For they discovered the totally different kind of music available from the new types of records, improved tape recorders, and static-free FM broadcasting.

And to their surprise, they found that equipment capable of magnificent tone quality is moderate in cost, admirably suited to inconspicuous custom-built installations.

The more people learned about this new kind of musical entertainment, the more they wanted a source of information devoted to their particular interests. HIGH-FIDELITY Magazine has been brought out to meet their specific needs.

It is published by Milton B. Sleeper, also the publisher of RADIO COMMUNICATION, author of many technical books, and a prominent figure in the radio industry for more than thirty years.

HIGH-FIDELITY is a big magazine, 8¾ by 11½ ins., handsomely illustrated, beautifully printed on fine paper. You'll find the contents interesting, readable, authoritative, filled with a wealth of information available from no other source. A year's subscription (4 big quarterly issues) will give you a full 12-months' supply of new ideas, supplemented by a Readers' service always ready to help you. Subscribe now so you will have the first issue, out April 15.

HIGH-FIDELITY MAGAZINE
Bank Building, Great Barrington, Mass.

I want to be a Charter Subscriber to HIGH-FIDELITY Magazine. I enclose my remittance for:

\$3.00 for one year (SAVE \$1.00)

\$6.00 for three years (SAVE \$6.00)

Name:.....

Address:.....

Add 50c per year for Canada, \$1.00 foreign.

RECORD REVUE

EDWARD TATNALL CANBY*

Is Music Distorted?

A REMARKABLE MISCONCEPTION seems still to be going the rounds in recording circles, one that's no new story to this department—except that it keeps cropping up again. One of my informative correspondents in the engineering profession voices high objection to the idea that intermodulation tones are disagreeable, *per se*, as some have maintained, and so constitute a distortion of pleasant musical sound. Let's get rid of IM, says he.

True enough, IM distortion in any man's audio system is the source of a lot of extremely unpleasant listening and should be ostracized. It is definitely unacceptable in polite circles, engineering or otherwise, and I'm all for throwing it out—*provided the IM has been added within the reproducing system*. But please don't ask me as a musician to throw the IM out of music. That I couldn't face. Without IM there wouldn't be any music.

Dissonance

Where did the idea come from that "distortion" (a term I'll have to drop soon, as being entirely inappropriate) isn't proper and desirable in music? "Distortion" of one sort or another, harmonic or non-harmonic, is the very backbone of music itself.

Dissonance, to take a very simple harmonic form (mostly harmonic, anyhow . . .) of it, keeps music alive and in motion. The feeling that tones must move on melodically to other tones, generating tension or seeking rest, is the essence of our music, modern or ancient. Dissonance, to be sure, is a relative thing. It's the dissonance of a tone *in relation to others* in the musical pattern that gives it its musical meaning; not any absolute value. Thus do musical styles and musical language change, as regards dissonance and that's why we can't write a piece in 18th century style mixed with 20th century without creating utter confusion; first we must evolve a new, cross-breed set-up of tonal dissonance-relationships that will be consistent for all the music we write—we must, in effect, lay down unwritten rules of meaning, for our own particular musical language—which, being consistent, will make themselves plain in the actual listening. Otherwise the music would have dissonantal ambiguity,

* 279 W. 4th St., New York 14, N. Y.

to invent a nice term. Its sense would be unclear.

Set dissonance aside for now with a tentative—very tentative—definition; it is at base *the degree of harmonic complexity between two or more sound-groupings*. If that seems cryptic, think a bit and remember that (a), a "single" tone in music is often "single" only by its purely musical sense, since it actually comes from many simultaneous sources, as with some fancy orchestral melody; and (b) dissonance depends not only on the clash of the *fundamentals* of the "single" tones involved, as considered in the formal study of Harmony and Counterpoint, but to an even greater extent it depends on the clashing of the various *overtone sets*—which in music study comes under the formal heading of Instrumentation: how properly to write music to fit the various instrumental tone qualities (i.e. overtone combinations or patterns) available in the orchestra. Hence my cautious phrase, "sound-groupings," which doesn't commit me as to whether a sound is a single tone, a chord, or a noise, or maybe all of them together.

Musical IM

But (with time out for a gasp at the looming complexities of that simple thing, dissonance), look at other "distortions" in music than mere clashing harmonic dissonance. Let us be clear at once that intermodulation—sum tones and difference tones—is riotously present in practically all music other than that for Broken-down Electric Organ with Filter. Intermodulations are the backbone and vertebrae of any highly complex (i.e. normal) musical sound.

Nor are they very often the simple, steady-state generated tones like those pretty things you turn out for IM testing procedures. A very few of the musical instruments, those that do not depend on human breath or fingers for their tone steadiness, can produce fixed-pitch sounds in which interference effects remain more or less fixed too, or at least recurring regularly in recognizable fixed patterns. A dozen or so piano strings sounding off together (if we don't count the initial "head" of percussive tone) produce fairly continuous inter-relationships that stay semi-put

[Continued on page 31]

Pops

RUDO S. GLOBUS*

IN 1940, I was working for a radio station in Providence, Rhode Island as a combination announcer, writer, producer, engineer, musical director, sweep-up man, staff pianist, and a few more things which slip my mind at the moment. The first remote that I worked was a dance, featuring a rising orchestra (or band, if we want to be accurate) led by a scintillating personality who has gone on to bigger and better things. We were fortunately equipped with two mikes that night and in a moment of wild extravagance and dashing experimentation, offered to do something quite untraditional as far as remote dance pickups are concerned . . . namely, use both of them. My classy idea was to suspend one mike from the rear auditorium ceiling and use the other for vocals and between sets talk-talk. Such was not to be the case. Aforementioned scintillating band-leader insisted that if we were going to dignify his performance with two mikes, one be placed "next to the beat boys" and one be left dead center front for his vocal exercises. The night was a horror, what with trying to match front and rear mike, fiddling with the gain controls to achieve some sort of balance and to avoid the impression that a wild herd of Afghanistan tribesmen were invading the vicinity of Naragansett Bay. The piano, bass, and drum virtuosos outdid themselves to justify their rise to audio fame, necessitating the dirty trick of shutting off the gain on their shuddering mike. For the rest of the night, the three wild men went berserk in a glorious attempt to supply the radio audience with a sample of their genius. Until this moment, they have never been aware of the fact that they were playing to a dead mike, and that their efforts were resulting in the usual flatulent percussion sounds of a pick-up dance date.

Years later, the initial experience was recalled by attending a recording session featuring the efforts of a leading dance

[Continued on page 30]

* 15 Palm Lane, Westbury, N. Y.

if

Audax **POLYPHASE** reproducers

have won the acclaim of thousands of users everywhere—in all walks of life. For example, a college president (who, by the way, is a music editor too) states in a recent article:

“... for the pickup there is an obvious choice. The new AUDAX POLYPHASE is indispensable—if it's musical quality you're after”

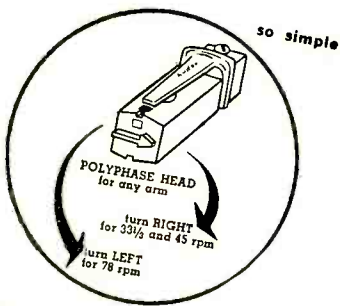

One single magnetic unit plays all home records—Sapphire or diamond styli

Never before such EAR-QUALITY, such FAITHFUL REPRODUCTION but . . . after all the reams are written about kilocycles and other laboratory data—when the chips are down—only you can decide what sounds best and most pleasing to your ears. Therefore . . . SEE and HEAR POLYPHASE and know first-hand the reasons for the spread of POLYPHASE fame—far and wide—within but a few short months.



Available with the new Compass-pivoted Audax Arms and for Record Changers

Write for editorial reprint on POLYPHASE principles

AUDAX COMPANY
500 Fifth Avenue New York 18

“Creators of Fine Electro-Acoustical Apparatus for Over 25 Years”

it's
musical
quality
you're
after...



HOW LEADING NETWORKS USE Carter CONVERTERS

Photo above shows NBC's Tommy Bartlett and Universal Recording Company engineers making transcriptions from STORAGE BATTERY POWER by means of Carter Frequency Controlled Converter.

Wherever 115v. line voltage is not available, or hard to get, Carter Converters supply dependable AC power to make on location recordings. Operates from storage batteries. . . . Used by leading networks, broadcast stations, and program producers.

Recommended by Brush and Magnecord

One model operates both Brush and Magnecord equipment. Delivers clean 60 cycle AC power. Requires no filtering. Frequency control feature compensates for 10% input voltage variation. Available for 6, 12, 24, 28, 32, 64, and 115v. DC input voltage. Size 8 1/4" x 5 3/8" x 7 1/2" high. Weight only 15 3/4 lbs. Performance Guaranteed!



MAIL COUPON FOR FREE CATALOG

New Converter catalog illustrates entire line of Carter Rotary Converters for recording, TV, sound projection and transcription players. SELECTOR CHART included tells model to suit your purpose. Mail Coupon now for your copy and name of nearest Carter distributor.



Carter MOTOR COMPANY

2648 N. MAPLEWOOD AVE., CHICAGO 47

Carter Motor Co.
2648 N. Maplewood Ave.,
Chicago 47, Ill.

Please send catalog #349 with information on Frequency Control Converters, and name of nearest distributor.

Name

Station or Company

Address

band. The broad spaciousness of one of New York's best recording studios was involved in one of the wildest extravaganzas of engineering genius and musical stupidity. The shrieks of the band leader (to the effect that "they can't dance to it unless they can hear the beat") automatically resulted in an exclusive mike arrangement for the percussion section. The solo trumpet complained that the first take muffled his earthy presentation . . . resulting, of course, in his being supplied with an audio-scepter of his own. When everybody had been made happy, the engineers went insane because what resulted was a perverse mess of unbalance that took late into the afternoon to remedy.

Which leads us into the devastating problem of "beat" and percussion effects in pop recording. Some time ago, we pointed out that p.a. systems and records made it possible to hear things which could never be heard in a standard live performance. Unless a p.a. system is set up (and set up with a moderate degree of efficiency), it is impossible to hear the piano-man, and the bass and drums contribute a muffled thump which cannot be described as a carrying beat. Guitars, equipped with their own p.a. systems, can make themselves heard, if they choose to (which they generally don't, except in solo passages). In the case of recordings, those made between 1940 and 1943 demonstrated a superior insight into the percussion demands of the average and above-average dance record. With rare exceptions, most of our recent releases go to one extreme or the other. Percussion is either overemphasized or de-emphasized. The more recent trend in band recording behind a vocalist, for instance, is to fade in and out behind the vocal with piano solos suddenly swelling out of nowhere, drums (obviously picked up by separate mikes) coming in for brief passages and then fading out. Small ensemble recordings try to create an equality of dynamics or de-emphasize the percussion below its natural level.

It has been suggested by some of the more optimistic, rosy-faced and glowing partisans of the "new era" of recordings that the change in percussion balance may be attributed to the refinement of equipment at both ends, recording and play-back. It is their valueless contention that percussion balance hasn't changed; sophisticated equipment is merely clarifying the highs, with the result being that the lows are diminished in relation to the new upper-register brilliance. This is, of course, the most nonsensical bunkum. It is still an almost impossible task to prove to these naive experts that balance is sealed in the record. Hi-fi playback equipment cannot alter defects in balance, nor create defects out of the void. Low-register resonance problems can be created by improper equipment, especially the common case of improperly baffled and enclosed speakers. This has nothing whatsoever to do with percussion balance, as it is controlled acoustically and relationally in the recording studio. If anything, hi-fi equipment demonstrates most exquisitely the neat control demonstrated by pre-war pop recordings. Despite other defects, balance was immaculate and still represents one of the major achievements in the past twenty years of pop recording. For some strange reason, the secret has been lost in the present period and percussion is once again a radical problem. One is tempted to ask . . . "where are the engineers who did the brave work of yore?"

NEW RELEASES

Before rushing headlong into an interesting sampling of new stuff, a repeated word

of caution. Vinylite is going to be heavily curtailed by the middle of the summer. In addition, most of the major companies are in the process of going through their catalogues with a view to cutting down on presently available stuff and limiting their releases to material which promises the greatest sales. Whether you like it or not, a tremendous amount of now available records will disappear shortly thereafter. This is the time to seriously consider what you want in your all-round pop and jazz collection. It may be a long time before major items in the catalogues reappear or are available in quality pressings on quality material. There are only a limited number of LP's that I would urge being placed on an "urgent" list. Included is the Goodman "Carnegie Hall" date, of course. The majority of hasty purchases should include all of the Goodman small combo jobs on the Columbia label, the major Ellington's on Victor, and as many of standard jazz items (Armstrong, et al) still available on 78 r.p.m. For months, I've been promising a basic list, but lack of cooperation from some quarters and uncertainties as to what was still available has held the magic list up. It's just as well, because the emphasis now is being placed on the emergency nature of the situation, and what material I have at the moment is being revamped. Next month, you will definitely get the first installment. . . . Boy Scout's oath!

Popular Collector's Issue Series

Theme Songs

Victor LPT-1

This one features large bands in their famous or infamous theme songs. Included are the Artie Shaw, Benny Goodman, Duke Ellington, Charlie Barnett, Lionel Hampton, and Louis Armstrong bands. The dub job is good. With the exception of Shaw's "Nightmare," all the stuff is worth owning, especially considering the kind of recordings involved. Not Hi-Fi, of course, but neat, rational, well balanced handlings of what has suddenly become a difficult problem for our new engineers.

Artie Shaw

Dance Program

Decca DL 5286

Everything on this LP is danceable, the percussion is good and the recording far above Decca's usual standards. The arrangements are pretty shoddy and are obviously being played by a young pick-up group. But, despite this, a big E for effort to Decca which is demonstrating steady improvement. From the dancing point of view, the beat is sufficiently pervasive so that this would make a good addition to a dance collection. For such purposes, the LP version is to be preferred.

Bobby Hackett

Jazz Session

Columbia CL 6156

Bobby Hackett and crew in a not too inspiring 10-inch LP. It is being reviewed only because of my lasting affection for Mr. Hackett, who is insufficiently well known. I am becoming more and more puzzled at the erratic nature of Columbia's recordings. They have warranted fulsome praise for many of their distinguished discs, but occasionally they slump into a tired product . . . and they require prodding to keep up the good work. On this disc Bobby does some nice things which deserve listening to.

RECORD REVUE

[from page 28]

for several instants. Piano IM is of course immeasurably increased by that diabolically ingenious IM-generating device, tempered tuning—which has all the strings deliberately out of tune with each other (except at the octave) by *so many beats*, that being the way tuners actually tune them. Beats are IM, to you, aren't they? Organ pipes do a still better job on steady-state IM effects, both because the sound is continuous for as long as you want, and because organ sounds have much a stronger and more varied overtone content than piano tones. (Stronger in the higher, "color" area, anyway.) Sometimes, notably with the older and more brilliant organs of the 18th century and earlier, these organ IM effects fairly shake the building and rasp the ears, according to frequency. Yet even with this practically ideal steady-state set-up, the many generated tones, fighting among themselves, unto the *n*th generation, swirling about in the infinite complexity of church acoustics, undoubtedly produce transient peaks that can hardly be called "steady-state"! These are the "distortions" that we are doing our best to reproduce, not to suppress, via audio.

Music is The Voice

And what of IM in the rest of music, where the very sound sources themselves, unlike the organ, are irregular and unfixed? Irregularity is the normal state of musical tone. The organ is freakish, musically. The voice is the prototype of the musical instrument as has often been said. Violins appeal because of their basic emotional similarity of expression to the voice—fingers on strings operating muscularly as the throbbing muscular expression of the voice itself. Irregularity is life for music. (See *Æ*, April, 1949). So with oboes too. The brasses, I'll grant, appeal somewhat more harmonically by their very nature (a very steady pitch with clean, simple overtones, in spite of varying breath supply); but even trumpets and horns tend to give in to the voice-inspired desire for irregularity in tone production. In Germany and the U. S. the "French" horn is blown without wobble; but in France they force it to waver like an opera star. (And need I remind you of the *Vox Humana* on the organ—a stop which wobbles, supposedly like a human voice?)

Tonal Warfare

Thus in most existing music we have a fine picture of IM "distortion." The ordinary IM tones due to clashing fundamentals and their clashing overtones, the percussive transients with their own complex, high-harmonic structures, are made still more complex by the ever-changing poly-pattern of normally irregular tone in shifting conflict with its neighbors. It's tonal warfare, no less.

A year or so ago I got involved in this tonal warfare from another angle, the recording of massed choral voices and the potent transient interferences between the dozens of clashing individual wobbles (also the inability of the usual meter to register them, resulting in false level indications). Suffice it to suggest now that our biggest audio headache still is the problem of reproducing distortion, the enormous "distortions" that occur in music—and at the same time eliminating all *added* distortions generated after the fact, the fact being the music itself. One and the same problem, since if a system won't *reproduce* transients



The Super-Cardioid "Monoplex"

...kills feedback and reduces random noise energy pickup more than any other crystal microphone!

...REDUCES RANDOM NOISE ENERGY PICKUP BY **73%**

THE "MONOPLEX" is the only Super-Cardioid Crystal Microphone made. It employs the same type of acoustic phase-shifting network used in the highest cost Shure Broadcast Microphones. The "Monoplex" permits more volume without feedback—greatly improves sound systems using conventional cardioid microphones.

THE "MONOPLEX" is superior to conventional microphones: gives very satisfactory operation under the most adverse conditions of background noise, where conventional microphones would be practically useless. You are invited to test the "Monoplex" against all other crystal microphones. The results will speak for themselves . . .



"Monoplex"

MODEL 737A

LIST PRICE

\$39⁷⁵

Every "Monoplex" employs the famous Shure "Humi-Seal" moisture-proof element for protection from heat and humidity.

Manufactured Under Shure Patents.
Licensed Under Patents of Brush Development Company.



SHURE BROTHERS, Inc.

Microphones and Acoustic Devices

225 West Huron Street, Chicago 10, Ill. ★ Cable Address: SHUREMICRO

Advance Audio GENERATOR

COVERING
15 c/s to 50,000 c/s
IN THREE RANGES
ACCURACY
 $\pm 1\%$, 1 c/s
DISTORTION
LESS THAN 1% AT 1 kc

SINE AND
SQUARE WAVE OUTPUT



89⁵⁰
NET
F. O. B. N. Y. C.

Imported from England with traditionally fine English craftsmanship plus the advantageous rate of exchange enables Terminal to offer an Audio Generator approaching laboratory standards at a low service instrument price. Besides the extreme accuracy and low distortion, the sine wave output is variable from 200 microvolts to 20 volts, ± 1 db. Square wave output from 800 microvolts to 80 volts peak to peak with rise time less than 3 microseconds to reach 90% of peak value at 10 kc/s. It is furnished complete with American Type tubes, output cable, ready to operate on 110 or 220 volt AC. Weight 14 lbs., size 13 $\frac{1}{4}$ " x 10 $\frac{1}{4}$ " x 8".

NEW! PARTRIDGE audio transformers



Everyone who is familiar with the terrific performance of the WWFB series of Partridge output transformers must raise a speculative eyebrow when we say that the new CFB series is as far ahead of the WWFB as the latter was ahead of ordinary output transformers. For instance, at 16 watts, 50cps, the WWFB has 0.5% core harmonic distortion. The new CFB has 0.05%! The new CFB shows as little as 10 mh series leakage inductance and has therefore more than twice the ratio of Primary Shunt L to leakage series L of the WWFB. This plus the ability to handle up to 60 Watts with less than 1% distortion and a 15 octave bandwidth, even without feedback, a low 88 ohm half-primary resistance but with a primary shunt inductance in excess of 120 Henries, extremely low phase angle at even the highest frequencies and many other features combine to make this the most outstanding output transformer available without regard to price. The secret of its performance lies in the use of a grain oriented, strip wound C core. The extraordinary characteristics made possible by this type of construction permits of a very considerable amount of feedback across several

stages of triodes and it therefore becomes the very finest of output transformers for the Williamson circuit where only perfection of performance and not price, is the consideration.

Hermetically sealed CFB series **35⁰⁰** F. O. B., N. Y. C.
Potted WWFB series **22⁵⁰** F. O. B., N. Y. C.

Terminal Radio Corp.

Distributors of Radio and Electronic Equipment
85 CORTLANDT STREET • NEW YORK 7, NEW YORK • WOrth 4-3311

and IMs, it's automatically going to *introduce* them. Right?

So, designers, don't try to purify our music for us. We want it straight, impurities and all.

MIXED BAG

Mendelssohn, A Midsummer Night's Dream: incidental music.

Berlin Philharmonic, Fricsay. RIAS Choir, solos.

Decca LP:
DL 8516

Vienna Symphony, Clemens Krauss; Chorus, solos, Vienna State Opera.

Vox LP:
PL 6830

A bit of stuffy competition here, somebody scooping someone else—but it's good to have duplications come in such rarities as they do now. This is the complete (more or less) music, including two numbers with women's chorus and two sopranos, sort of nice Gilbert and Sullivan stuff, and several quite unfamiliar orchestral numbers, the best of which is the *Intermezzo*, a really lovely little piece. Also the familiar numbers, including *the Wedding March*, *Scherzo*, etc. For Hi-fi, the Decca version is way out in front. It's first of the forthcoming Deutsche Grammophon reissues, with a sound not unlike *frr* (there's a reason), these, by the sound, probably from disc but of very high quality. Some blast near center; an apparently medium pre-emphasis. The Vox performance is less lush, more tense, driving; I don't like it as much, but it has excellent points. Recording is relatively dead, with so-so high end. (Pantheon originals.)

Brahms, Sixteen Songs (Lieder). Alfred Poell, bass; Victor Graef, piano.

Westminster LP:
WL 5053

Wolf, Fourteen Songs. Alfred Poell; Franz Holletschek, piano.

Westminster LP:
WL 50-48

If you want to hear an astonishingly fine solution of a difficult recording problem, try these (and you'll hear some extremely good singing and playing, too). The piano is problem enough, but the big bass voice is a big problem too—it resonates, intermodulates, distorts, in most recordings. To blend the two properly, with liveness and perspective, is even more troublesome. This is the best recording I've ever heard in these respects. An absolutely steady, rich and full piano tone, the bass voice sharp and clear in diction, round in tone without a trace of distortion, and the piano "enveloping" the voice without getting in its way or receding (as so often) into the liveness background.

Paganini, Caprices.

Michael Rabin, violin solo

Columbia LP:
ML 2168 (10")

Start this on side 1, cut 1 without looking at the album cover and you'll hear an authoritative, top-notch violinist light into the most difficult violin music there is; you'll imagine perhaps a fiery, middle-aged fiddler, bald like Szigeti, or long-haired like Paganini himself. The fiddler here, however, is all of thirteen years old. And the best part of it is that not only does he have fabulous technique, but he plays even these silly things with excellent musical feeling, both for harmony and for rhythm—many a virtuoso fails in these respects. Sonorous, full and wide-range recording of the solo violin.

HARMONIC DISTORTION

[from page 20]

tion of harmonics can be varied within wide limits without destroying the realism of the reproduced sound.

However, the effect upon a compound tone of harmonic distortion in the reproducing system is more objectionable since it is inevitably accompanied by the production of other tones which are not musically related to the fundamental.

These tones are known variously as "intermodulation tones," "combination tones" and "sum-and-difference tones." Possibly the worst result of their presence (in addition to their unmusical character) is the effect on the clarity of reproduction. Individual tones lose distinction and become merged, one with another, due to the wide spectrum of sum-and-difference tones.

It would seem that the best way of specifying the distortion introduced by a circuit element would be to measure the intermodulation distortion. However, it is most desirable to express the distortion by a single number which will offer a direct comparison between equipments; this cannot be done for intermodulation distortion without making some very arbitrary assumptions. To measure intermodulation distortion the procedure is:

(1) Feed in *two* test tones simultaneously, each of known amplitude and frequency (four numbers).

(2) Measure the r.m.s. value of combination tones and harmonics appearing at the output. This is usually expressed as a percentage of the r.m.s. input voltage (one number).

Five numbers are therefore required for the complete specification of intermodulation distortion.

Total harmonic distortion, on the other hand, is completely expressed by three numbers; frequency and amplitude of test tone and r.m.s. value of harmonics appearing in output. The obvious choice of frequency is that of the lower limit of the pass-band, and the amplitude can be that corresponding to maximum rated output; these figures must be stated anyway, and only one more figure is needed to indicate the harmonic distortion.

Since the two types of distortion are so closely related, the magnitude of the harmonic distortion is some indication of the extent of the more objectionable intermodulation, and is more easily measured. Neither figure, of course, is important in itself; the measure of electrical distortion must be correlated to the degree of aural "nuisance value" to which it corresponds.

"A Craftsman Is Only As Good As His Tools!"



—Benjamin Franklin

YOU will find the best in recording apparatus come from the Reeves Soundcraft Laboratories. Magnetic tape with ten distinct features that contribute to its higher efficiency and fidelity; an assortment of recording discs to answer every requirement—all are backed by the greater integrity and experience of the Reeves name, foremost manufacturer of recording and electronics accessories.

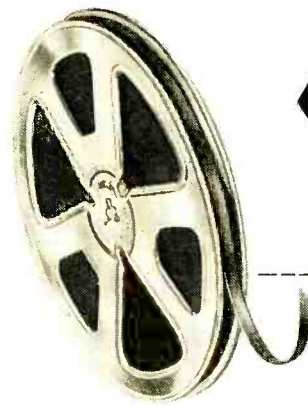

Soundcraft tape is made in all types and lengths to accommodate all tape recorders.



Soundcraft recording discs available in a variety of sizes, single and double face.



REEVES *Soundcraft* CORPORATION

REEVES—"20 YEARS WITH SOUND RECORDING MEDIA"

10 EAST 52nd ST., NEW YORK 22, N. Y. EXPORT—REEVES EQUIPMENT CORP., 10 EAST 52nd STREET, NEW YORK 22, N. Y.

NEW PRODUCTS

● **Mixer-Preamplifier.** A complete remote control system is inherent in the new Rauland-Borg Model 1904 remote mixer-preamplifier, designed to mix four inputs and to feed program material over lines to main amplifying equipment up to several miles distant. Flexible input arrangement permits use of high- or low-impedance microphones, phonograph pickups and tuners in a wide variety of combinations. Other features include master gain control, separate bass and treble tone



controls, and self-contained 24-volt a.c. supply and switch for remote relay control of power amplifiers. Output is approximately 300 milliwatts at 600 ohms. Frequency response is ± 1 db from 40 to 20,000 cps. Model 1904 is finished in green hammerloid and measures $13\frac{1}{2} \times 8 \times 7$ in. Complete details will be supplied upon request by Rauland-Borg Corporation, 3515 Addison St., Chicago 18, Ill.

● **Limiting Amplifier.** The new RCA Type BA-6A limiting amplifier provides an automatic means of limiting audio output to a safe maximum during broadcast transmission or recording. Both the amplifier and its self-contained power supply are built on a plug-in chassis for shelf mounting, and all controls, tubes, and plug-in-type capacitors are accessible from the front. A selector switch permits use of the gain-reduction meter for meas-



uring cathode current of all amplifier tubes, tube balance, and d.c. filament voltage. Gain is 54 db below the verge of limiting and maximum output level is +30 dbm at the verge of limiting. Signal-to-noise ratio is 83 db at verge of limiting, and compression ratio above verge of limiting is 20 db into 2 db. Descriptive literature may be obtained by writing Broadcast Equipment Section, RCA Engineering Products Department, Camden 2, N. J.

● **Probing Tweezers.** Hytron's new probing tweezers, made of molded polystyrene, fill a long-felt need of engineers and servicemen for an effective tool for tracking down intermittents, shorts, opens, noise, feedback. Tweezers provide safety from

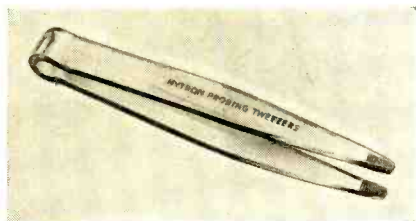

accidental shock, as well as freedom from disturbance in strong magnetic fields. Jaws grip firmly and have fine and coarse serrations for different sizes of wire and components. Available from all Hytron distributors.

● **High-Quality Dynamic Microphone.** Essentially non-directional, with frequency response flat within ± 2.5 db from 50 to 15,000 cps, the new Turner Model 50D

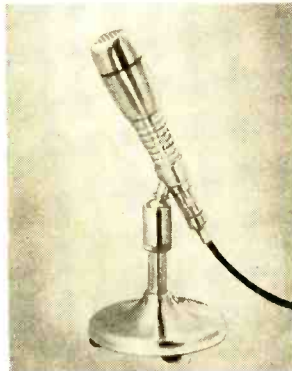

dynamic microphone is well suited for all types of broadcast, recording, and public-address application. Small in size and low in weight, the 50D is easily suspended, or concealed in stage settings. May be quickly and easily detached from ball swivel coupler for hand use. Output level is 56 db below 1 volt/dyne/sq. cm., and impedances are 15, 200, 500 ohms or high impedance. Each unit is laboratory calibrated to insure specification standards. Complete details will be supplied upon request to The Turner Company, 905 17th St. N.E., Cedar Rapids, Iowa.

● **Rotary File.** TV and broadcast stations, as well as other business organizations whose activities require constant reference to large groups of names, companies,



etc., will find many advantages in the new Ferris Rotary File with its capacity of 13,000 cards in just three square feet of floor space. Along with retaining all the features of previous models, the new model illustrated has many advanced improvements which save, simplify, and speed filing operations. For full information inquiries should be addressed to Stanley Dulski, Ferris Business Equipment, Inc., 244 Great Meadows Road, Stratford, Conn.

● **ModulaR Amplifiers.** Block-type construction permits quick and easy assem-

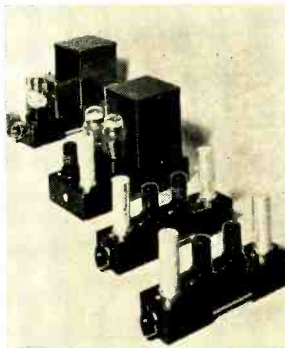

bling of almost any desired amplifier combination with the new line of amplifier components recently announced by ModulaR Audio Corporation, 1546 2nd Ave., New York 28, N. Y. Chassis are standardized in size and tie plates lock units together to form a single structure for rack or cabinet mounting. Connecting terminals on the underside of each component are so placed that the output terminals of one unit are always adjacent to the input terminals of the next one. Power terminals are similarly handled.

● **Magnetic Tape Recorder.** Making its initial entry into the tape-recording field, Webster-Chicago Corporation, pioneer manufacturer of wire-recording equip-



ment, is now introducing a two-speed ($3\frac{3}{4}$ and $7\frac{1}{2}$ in./sec) unit in the low price range. The Web-Cor Model 210 is a double-track recorder including both fast-forward and fast-reverse speeds permitting complete run of a 1200-ft. roll of tape in as little as three minutes. Housed in an attractive burgundy-and-tan leatherette case, Model 210 is supplied complete with microphone, an empty reel, and one 1200-ft. spool of tape with a capacity of two hours of double track recording at low speed. Weight of the equipment is 40 lbs.

● **Ceramic-Element Cartridge.** Duplicating in most respects the performance characteristics of the popular AC series of crystal cartridges, the new Astatic model AC ceramic cartridges are designed for use where exceptionally high temperature and humidity prevail. Although output of the ceramic units is reduced, it is claimed to be adequate for driving the audio amplifiers found in most radio-

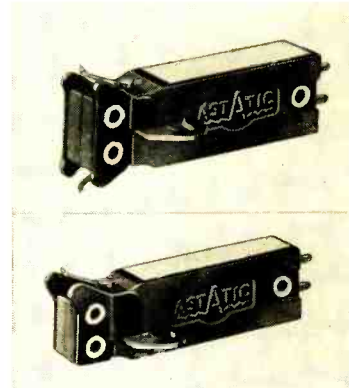

phonographs. Output of the crystal models is one volt at 1000 cps while that of the ceramic counterparts is 0.4 volt. Manufacturer is Astatic Corporation, Conneaut, Ohio.

● **Reflexed Cabinets.** An inexpensive line of reflexed cabinets for 12- and 15-in. speakers has recently been placed on the market by Standard Wood Products Corp., 43-02 38th St., Long Island City 4, N. Y. Designated Model RX, the new cabinets are constructed of $\frac{3}{4}$ -in. plywood and have internal volume of 5.8 cu. ft. Size of port opening is adjustable. Available in mahogany, cordovan mahogany, walnut, ebony and blonde finishes, Model RX cabinets are hand rubbed to a finish in keeping with the most tasteful furnishings.

For those who wish to apply their own finish, unpainted models are available. Dimensions are 36" high, 16" deep, 24" wide. Further information will be supplied by the manufacturer.

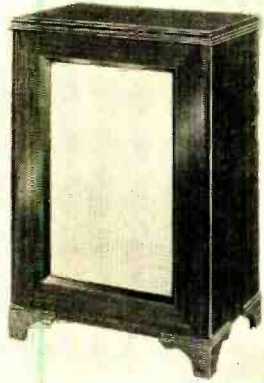

mensions are 36" high, 16" deep, 24" wide. Further information will be supplied by the manufacturer.

NEW LITERATURE

• **Triad Manufacturing Co.**, 2254 Sepulveda Blvd., Los Angeles 61, Calif. announces publication of Catalog TR-51, a complete showing of illustrations and prices of the new Triad line of transformers. Featured are a series of transformers developed especially for regulated power supplies and complete details of the Triad HF-10 hi-fidelity amplifier kit.

• **RCA Engineering Products Department**, Camden 2, N. J. announces publication of a new 20-page illustrated booklet listing RCA's latest professional-type disc recording equipment. Included also is technical information on fine-groove recording techniques and studio recording installations. Copies are available to broadcast engineers and recording technicians upon request on letterhead. When writing ask for Form 2J-6895 and address your request to Department 522.

• **Multicore Sales Corp.**, 164 Duane St., New York 13, N. Y. will supply free on request an article titled "Modern Soft-Soldering Technique", written by R. W. Hallows. Included in the article are discussions covering content of solders of various types together with their uses, joinings required for various metals, and fluxes and their functions. Wide range of subjects covers items of interest to beginners and experts alike.

• **Research Information Service**, 509 Fifth Ave., New York 17, N. Y. is now distributing free of charge Research Bulletin No. 52 titled "Optics and Photography". This is a listing of translations of wartime and post-war patent applications and research reports from the files of leading German manufacturers including I. G. Farben, Telefunken, Leitz, etc. The bulletin is an excellent source of reference material for those interested in optics or related subjects.

• **Richard H. Dorf**, publisher, 225 W. 84th St., New York 24, N. Y. has recently published the 1950 annual issue of **Radiofile**, an index and cross-index by subject of every article of technical interest published during 1950 in 15 American radio magazines and journals. Published since 1946, purpose of the **Radiofile** is to provide engineers with a ready means of locating published material on any desired phase of electronics. Available for 50 cents from the publisher.

• **British Information Services**, 30 Rockefeller Plaza, New York 20, N. Y. announces the availability through British Consulates of advance copies of the B.I.F. catalog, a directory of exhibitors and products which will take part in the British Industries Fair to be held in London and Birmingham from April 30 through May 11. The consulates also will supply introductions to trade and business groups in England.

• **Kay Electric Company**, Pine Brook, N. J. is now distributing a new 64-page catalog covering an extensive variety of specialized electronic instruments for civilian and military application. Included are such devices as sweep oscillators, marker oscillators, analyzers, frequency meters, and reflectometers. Requests should ask for Catalog A51.

The Discriminating Eventually Come to Leonard's!



GARRARD RC-80 RECORD CHANGER

Concert hall quality reproduction for all records—33 1/3, 45, and 78 r.p.m. Extremely simple in operation, the RC-80 is heavily built for long, rugged service. A heavy duty silent motor, plus an extremely sturdy drive shaft completely eliminates all rumble, wows, and wavers. All parts fastidiously machined and finished. Automatic stop at end of any type record.

NET \$39.80

RC-80 WITH SPECIALLY MATCHED PICKERING CARTRIDGES WITH SAPPHIRE STYLII	\$64.70
RC-80 WITH SPECIALLY MATCHED PICKERING CARTRIDGES WITH DIAMOND STYLII	\$100.70
RC-80 WITH AUDAK POLYPHASE HEAD EQUIPPED WITH SAPPHIRE STYLII	\$62.73
RC-80 WITH AUDAK POLYPHASE HEAD EQUIPPED WITH DIAMOND STYLII	\$99.20

BELL CUSTOM HIGH FIDELITY AMPLIFIER MODEL 2145

The Remote Control Unit of this amazing amplifier puts the choice of musical talent right at your fingertips! You select your listening medium, adjust controls, and you hear the world's finest artists present a "command performance" with life-like realism. Adaptable to a wide variety of installations, the 2145 will duplicate programs—whether broadcast or recorded—throughout the complete tonal range—from deep, rich bass to liling treble. Power Rating: 30 watts. Frequency Response: 20 to 30,000 cps. Inputs: 2-Magnetic, 1-Crystal, 1-High Impedance Microphone, 2-Radio. Output Impedance: 4, 8, 16 ohms.

NET \$179.50

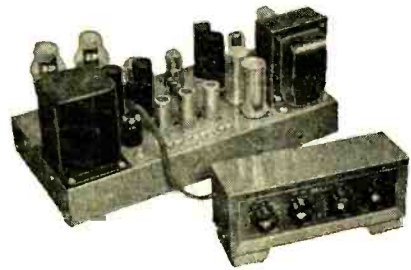

JENSEN HIGH FIDELITY COAXIAL SPEAKER SYSTEM MODEL H-510

Advanced electroacoustic design throughout all engineering details has given this superb 15" 2-way speaker system wide popularity for the most critical applications, including professional sound reproduction, broadcast monitoring, and distinguished home entertainment systems. "Presence" and brilliance of reproduction are maintained essentially constant over the entire room due to a wide-angle ACOUSTIC LENS in conjunction with the Hypex formula h-f horn, with the JENSEN Diaplane l-f radiator contributing an amazing smoothness of response. Built-in frequency dividing systems. Impedance: 16 ohms.

NET \$92.70

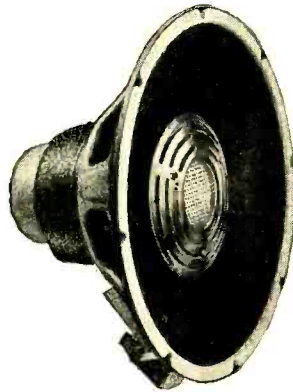

You will want our new catalog. A penny postcard with your name and address will bring it to you.

Leonard
Radio inc.

the house
built on
SERVICE—69 CORTLANDT ST., N. Y. 7, N. Y. COrtlandt 7-0315

DIRECT-COUPLED AMPLIFIER

[from page 17]

PARTS LIST

R ₁	40,000 ohms, 5-watt, wire wound	R ₁₁	33,000 ohms, 1-watt
R ₂	10,000 ohms, 5-watt, wire wound	R ₁₂	0.12 meg, 1/2-watt
R ₃	50,000 ohms, 5-watt, wire wound	R ₁₃	1.0 meg, 1/2-watt
R ₄	15,000 ohms, 1/2-watt	R ₁₄	2200 ohms, 1/2-watt
R ₅	33,000 ohms, 1/2-watt	R ₁₅	75,000 ohms, 1-watt (Not shown, but connects C _{6b} to 400-volt supply at "B")
R ₆	51,000 ohms, 1/2-watt	R ₁₇ , R ₁₈ , R ₁₉	1-meg potentiometer
R ₇	4700 ohms, 1/2-watt	R ₂₀	3-sect. ganged potentiometer, 0.5 meg. each section
R ₈	18,000 ohms, 1/2-watt	R ₂₁	See text
R ₉	3300 ohms, 1/2-watt	R ₂₂ , R ₂₃	2000 ohms, 1-watt
R ₁₀ , R ₁₅	0.12 meg, 1-watt	R ₂₄	500-ohm wire wound potentiometer
		R ₂₅	40,000 ohms, 10-watt, wire wound
		R ₂₆ , R ₂₇	4700 ohms, 1-watt
		R ₂₈ , R ₂₉ , R ₃₂	
		R ₃₃	0.5 meg, 1-watt

R ₃₀	0.47 meg, 1-watt
R ₃₁	0.135 meg (2 0.27-meg 1-watt resistors in parallel)
R ₃₄	20,000 ohms, 2-watt
R ₃₅ , R ₃₆	27,000 ohms, 2-watt
R ₃₇	0.15 meg, 1-watt
R ₃₈	50,000-ohm wirewound potentiometer
R ₃₉ , R ₄₀	0.35 meg, 2-watt
R ₄₁	7800 $\sqrt{V.C.}$ impedance
C ₁ , C ₂	10 μ f, 600-volt, oil filled
C ₃	3000 μ f, 15-volt electrolytic
C ₄	.001 μ f, mica
C ₅	.05 μ f, 600-volt, tubular
C ₆	.0025 μ f, mica
C ₇	.002 μ f, mica
C ₈	0.1 μ f, 600-volt, tubular
C ₉	30-30 μ f, 450-volt, electrolytic
C ₁₀ , C ₁₂	0.5 μ f, 600-volt, oil filled
C ₁₁	See text
V ₁	5V4G
V ₂ , V ₃	6X5
V ₄ , V ₆ , V ₇	6SL7
V ₅ , V ₈	6SN7
V ₉ , V ₁₀	6A5G
S ₁	DPST toggle switch
S ₂	Amperite 20-sec delay relay
S ₃	3-gang, 6-position, shorting type
S ₄	SPST toggle switch
S ₅	2-gang, 3-position, shorting type
T ₁	440-0-440v at 150 ma; 5v at 3a; 6.3v at 5a
T ₂	9v at 4a filament transformer
T ₃	20-watt output transformer, 3000 ohms plate-to-plate
F ₁	5-amp fuse
F ₂	0.5-amp fuse
SEL	15-volt, 4-amp selenium rectifier
M	Milliammeter, 0-100 ma
Ch ₁	10-henry, 150-ma choke
Ch ₂	15-henry, 50-ma choke
J ₁ , J ₂ , J ₃	Input jacks

Presenting

GOODMANS

NEW HIGH FIDELITY - 12" P.M.

TWIN CONE AXIOM 150

\$65. LIST

This 12-in. high fidelity unit has a twin-curvilinear diaphragm (British patent No. 451754). A carefully designed magnet assembly using anisotropic material provides a total flux of 158,000 maxwells on a 1 3/4-in. pole. The back centering device is a dustproof bakelised linen disk with concentric corrugations. The combination of these features gives this precision-built instrument an outstandingly wide coverage from 40 to 15,000 c.p.s. free from bass modulation effects. An ideal high fidelity reproducer for the record enthusiast and the connoisseur of wide range musical reproduction, it gives exceptionally fine transient and frequency response.

U. S. NATIONAL SALES
WILLGOLD ELECTRONICS SALES CORP.
 350 Fifth Avenue, New York, N. Y.

New England Office
 Harold A. Chamberlin
 31 Milk St., Boston 9, Mass.

Pacific Coast Office
 Perlmutth-Colman & Associates, Inc.
 1335 Flower St., Los Angeles, Calif.

Chicago Office
 Harry Halinton Co.
 612 N. Mich. Ave., Chicago 11, Ill.

Canadian Office
 A. C. Simmonds & Sons, Ltd.
 100 Merton St., Toronto 12, Can.

Meet us at the Canadian International Trade Fair,
 Toronto, May 28-June 8, Group #17, Stand #4753.

Manufactured by:

GOODMANS INDUSTRIES LIMITED
 WEMBLEY MIDDLESEX ENGLAND

SPECIFICATION

Frequency Coverage	40/15,000 c.p.s.
Overall Diameter	12 in.-31.3 cms.
Overall Depth	6 in.-17.6 cms.
Fundamental Resonance	55 c.p.s.
Voice Coil Diameter	1 3/4 in.-4.4 cms.
Voice Coil Impedance	15 ohms at 400 c.p.s.
Maximum Power Cap.	15 Watts Peak A.C.
Flux Density	14,000 gauss
Net Weight	12 lbs. 13 ozs. (5810 grs.)
Finish	Grey Rivelling Enamel.

NEW TAPE RECORDER

[from page 23]

used; two layers of nickel-iron alloy with a layer of copper between. A low impedance winding is used to reduce electrostatic pick-up and to allow long leads from head to amplifier when necessary.

Otherwise, the construction of the head is similar to the record head, except that the gap must be built to even more rigid specifications. The tolerances on the dimensions and delineation of the gap are comparable with those called for in optical work. Both machine and hand lapping are used in the manufacturing process, and a microscope inspection is part of the final test.

Azimuth adjustments of the reproduce and the recording heads are available by taking off the outer cover.

The slots in the shields are wide enough to allow the tape to be lifted off

the heads without opening the covers. Remote rewind and fast forward are not practical if the covers must be opened manually for these functions.

Both the outer and inner covers open very wide to allow easy threading and inspection of the heads.

Amplifiers

The amplifier portion of the recorder is divided into three parts. Each occupies 1/3 of a standard BR-2A shelf and is equipped with the standard RCA plug-in arrangement. These three units are the power supply, the recording amplifier and oscillator, and the reproducing amplifier.

The power supply is a simple arrangement consisting of a transformer, a 5Y3G rectifier, and an RC filter. Filament power is also supplied by the transformer. The chassis contains a power switch, fuse, and hum-adjusting potentiometer available at the front end of the chassis.

Recording Amplifier and Oscillator

The recording amplifier is a three-stage amplifier, comparatively conventional in form except for the output. There it is necessary to add the bias frequency and the high-frequency compensation for recording losses. Figure 5 gives the schematic circuit. The compensation is added by C_s and C_u in the inverse feedback circuit. The VU metering position is then bypassed in such a manner that it indicates the response as if it were flat. The VU meter is placed in the circuit so the bias frequency is trapped out. It will be noted that the meter indicates the level at the recording head, assuring the operator against amplifier failure without his knowledge.

A 6V6 on the same chassis supplies the erasing current as well as the bias. The bias frequency is set at approximately 100 kc. This is more than six times the highest audible frequency recorded and precludes the chance that harmonics of the audio frequencies might beat with the bias and cause "birdies".

The input circuit is normally arranged for 20,000 ohms bridging. With this connection, signals of -10 dbm will produce maximum recording level on standard tape. This corresponds to a program level of -20 VU. The input circuit may be reconnected internally, by jumpering the bridging resistors and removing resistor R_s , for 600-ohm matching input, with taps available on the transformer for 150-ohm input. When used in matching position, a -45-dbm (-55 VU) signal will produce maximum recording level on the tape.

The high gain supplied by this amplifier makes auxiliary amplifiers unnecessary in all normal situations. It can be bridged or to distribution busses or matched into mixer circuits or lines.

Reproducing Amplifier

The schematic for Fig. 6 shows the details of this circuit. The low impedance head makes it possible to use comparatively long leads from head to amplifier without electrostatic pickup or loss of

high frequencies. A feedback circuit around the first stage supplies the special frequency response necessary to match the head. The relay K_1 changes the compensation when the tape speed is changed. The filament of the first tube is supplied with d.c. by a rectifier on the chassis; and the input transformer is triple shielded to lower hum to the lowest possible value. Frequency-response compensation is also carefully balanced to bring hum and high-frequency noise to approximately the same residual value. Only by these measures can consistent performance at 60 db signal-to-noise be obtained.

The remainder of the amplifier is comparatively straightforward with a pentode amplifier in the second stage,

phase inverter, and push-pull output. This output level is +24 dbm (+14 VU) ± 2 db for maximum recording level on the tape. The level is sufficient to feed the distribution busses direct with no auxiliary amplifier needed.

Harness

A wiring harness is supplied with the recorders to make installation simpler. The same harness will fit rack and shelf mounting, and console mounting. The plugs are already wired in place and need only mechanical installation. Input, output, power, and metering leads are the only extra connections needed. The plugs are so mounted in the amplifiers and harness that no unit can be plugged into the wrong position.

1951 Edition



Ready!
NOW!

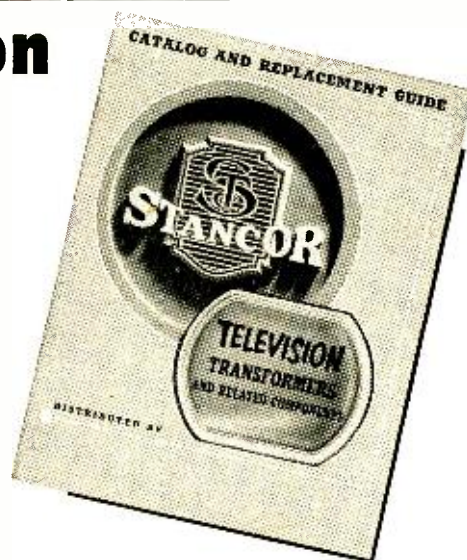

STANCOR'S

New

TV TRANSFORMER CATALOG AND REPLACEMENT GUIDE

Lists:

- Over 900 TV receiver models and chassis made by 71 manufacturers.
- Complete specifications, dimensions and prices of 75 STANCOR transformers and related components for replacement and conversion.

TAKE THE GUESSWORK OUT OF YOUR TV SERVICING! GET YOUR FREE COPY NOW AT YOUR STANCOR DISTRIBUTOR



STANDARD TRANSFORMER CORPORATION

3594 ELSTON AVENUE, CHICAGO 18, ILLINOIS

It's time we got working mad!



As we listen to the latest insults from Moscow, we're likely to get fighting mad.

Instead, we'd better use our heads and get *working* mad.

It is clear by now that Stalin and his gang respect just one thing—strength. Behind the Iron Curtain they've been building a huge fighting machine while we were reducing ours. Now we must rebuild our defenses—*fast*.

As things stand today, there is just *one* way to prevent World War III. That is to re-arm—to become strong—and to stay that way!

This calls for better productivity all along the line. Not just in making guns, tanks and planes, but in turning out civilian goods, too.

Arms must come first. But we must produce arms *at the same time* we produce civilian goods.

We can do this double job if we all work together to turn out more for every hour we work—if we use our ingenuity to step up productivity.

All of us must now make sacrifices for the common good. But we're working for the biggest reward of all—*peace with freedom!*

THE BETTER WE PRODUCE THE STRONGER WE GROW

FOR A FREE COPY OF "THE MIRACLE OF AMERICA"

MAIL THE COUPON to Public Policy Committee, The Advertising Council, Inc., Dept. B.P., 25 West 45th Street, New York 19, N. Y.

Name

Address

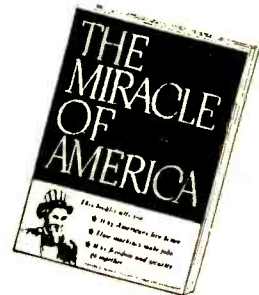

HOLLYWOOD LETTER

[from page 8]

by the assistant cameraman, the recorder remains "on the line" and its operation becomes automatic, and the speed controlling of the system is done by a cableman who operates the field and armature controls of the camera motor. These controls are located in a cable junction box near the camera, and correct speed is determined by means of a vibrating reed tachometer wired across the a.c. windings.

The simpler operation of this system has resulted in a great saving of production time in motion picture sound recording. At present no "clap stick" sync marks are used, but the sync mark is applied through a "Blooping" oscillator automatically operated by the camera slating device. The motors used in this system are supplied by W. R. Turner, of Los Angeles.

LOUDSPEAKER DAMPING

[from page 26]

value of ρ , call it ρ_1 , there is obtained:

$$Q_r = \left(\frac{1}{1 - \rho_1^2} \right) \sqrt{\frac{1}{\left(\frac{R_{me} + R_{vc}}{R_{vc}} \right)^2 - 2}} \quad (17)$$

If $\left(\frac{R_{me} + R_{vc}}{R_{vc}} \right)^2 \gg 2$, say twenty times

two, then Eq. (17) simplifies to

$$Q_r = \left(\frac{1}{1 - \rho_1^2} \right) \left(\frac{R_{vc}}{R_{me} + R_{vc}} \right) \quad (18)$$

If ρ_1 is nearly unity, the difference between the actual frequency f_1 and the resonant frequency f_r is small; that is,

$$\Delta f_1 = f_r - f_1$$

or

$$\Delta f_1 = f_1 - f_r$$

(depending upon whether the excursion is below or above the resonant frequency) is small. This is usually the case, and under such conditions Eq. (18) can be rewritten as

$$Q_r = \left(\frac{f_r}{2\Delta f_1} \right) \left(\frac{R_{vc}}{R_{me} + R_{vc}} \right) \quad (19)$$

which can form the basis of our experimental procedure as well as Eq. (18) can. If we re-write Eq. (19) as follows:

$$\frac{2\Delta f_1}{f_r} = \left(\frac{1}{Q_r} \right) \left(\frac{R_{vc}}{R_{me} + R_{vc}} \right) \quad (20)$$

we recognize the form to be similar to that of the well-known resonance formula, in which the fractional bandwidth ($2\Delta f/f_r$) for the half-power points is the reciprocal of the resonant Q of the circuit. Eq. (20) shows that owing to the point in the circuit at which the measuring instruments are introduced, the fractional bandwidth is reduced by

a factor $R_{vc}/(R_{me} + R_{vc})$, which would not occur if the measurements could be made across the motional impedance component itself.

The significance of Eq. (20) is that even though Q_r for a loudspeaker system may be less than unity, the fractional bandwidth will nevertheless be quite small because of the reducing factor $R_{vc}/(R_{me} + R_{vc})$. This makes the measurements somewhat critical and requires a well-calibrated frequency scale on the audio oscillator.

To see how this all fits together, let us proceed with an experimental run. The first measurement is R_{vc} ; this is found to be 10 ohms. Then the test setup

of Fig. 4 is connected to the loudspeaker and the frequency varied from say 20 to 50 cps.

At 29.3 cps the current is found to dip to a minimum value of 83.2 ma, and the voltmeter reads 7.07 volts. The impedance is resistive, and of a value

$$R_{vc} + R_{me} = 7.07 / .0832 = 85 \text{ ohms.}$$

$$\text{Hence } Z_t = R_{me} = 85 - 10 = 75 \text{ ohms.}$$

Now the frequency is varied above and below 29.3 cps to the point where Z_t drops to $85\sqrt{2} = 60.1$ ohms, as found by taking the ratio of the voltmeter to ammeter readings in exactly the same way as $(R_{vc} + R_{me})$ was calculated.

Suppose the frequency drops from

Still Available at HARVEY'S QUALITY UNITS AT "SOUND" PRICES!

New V-M tri-o-matic 950 3-SPEED AUTOMATIC RECORD CHANGER



Only one control knob for automatic or manual operation. Can handle twelve 10" or ten 12" records at 33 1/3 or 78 rpm; and twelve 7" records at 33 1/3 or 45 rpm . . . with POSITIVE INTERMIX of any TEN 12" and 10" records of the same speed.

Completely automatic operation and automatic shut-off. Tone arm can be held at any time during operation without damage to the mechanism. Positive protection to all records, including slow-speed discs, records being lowered (not dropped) on the spindle shelf, and flat air cushion dropped to the turntable. Incorporates dual needle—reversible cartridge. UL Approved, mechanically and electrically.

Fits all standard cabinets as a replacement unit. Minimum mounting space requirements are 13-3/16" wide x 11 7/8" deep x 7 1/4" high. Base plate is tangent to 12" record on three sides.

950	\$30.22	
955	—Same as the 950, but mounted on an attractive metal base, as a separate and complete changer for playing through any standard radio or amplifier. Six feet of a.c. line cord with four feet of sound cord plus plugs	\$32.26
950GE	—Same as 950 with GE cartridges	\$33.47
955GE	—Same as 955 with GE cartridges	\$35.91

VISIT THE AUDIO- TORIUM

Come in and visit our new sound department . . . all these items and many more on working display at all times.

Telephone:

LUXemburg 2-1500

HARVEY'S
RADIO COMPANY INC.

103 West 43rd St., New York 18, N. Y.

Chances are that we still have that hard-to-get piece of equipment you need. Despite the fact that we are delivering and not "holding back," our stocks have not been seriously depleted. However, we are running low on many items and must announce them as SUBJECT TO PRIOR SALE.

Magnecorder; Jim Lansing Speakers; McIntosh Amplifiers; Revere, Bell, Pentron Tape Recorders; etc. . . .

Availabilities change in a matter of hours . . . so check with HARVEY . . . FIRST!

WILLIAMSON HR-15 AMPLIFIER KIT



The famous Williamson HR-15 amplifier circuit . . . now available with the original Partridge transformers built to Williamson's specifications. Build this kit in 3 hours or less, and enjoy sound of a quality you never heard before. The HR-15 is a 2-Chassis power amplifier for use with tuners or other front ends having own volume and tone controls. All American triodes, 2-6SN7GT, 2-807, or 6BG6G in PP output, 5V4G rectifier. Response $\pm .5$ db, 10-100,000 cycles. Output impedances 1.7 to 109 ohms in 8 steps. Absolute gain 70.8 db. 20 db. of feedback around 4 stages and the output transformers. Kit is complete with Tubes, Punched Chassis, Pre-wired Resistor Board, Sockets, Genuine Partridge Output Transformer, and All Necessary Parts. . . . \$75.00.

PARTRIDGE OUTPUT TRANSFORMER, as used in above Kit, available separately. . . . \$22.50

NOTE: In view of the rapidly changing market conditions, all prices shown are subject to change without notice and are Net, F.O.B., N.Y.C.

Air-Tone HEADQUARTERS FOR Magnecord



WORLD'S MOST WIDELY USED PROFESSIONAL TAPE RECORDER

PT6-JAH Recorder & Amplifier
 Portable rig for superb reproduction of all types of program material. 10-Watts output. Highest Quality, Greatest Value. Complete systems from \$564.00

AIR-TONE SOUND RECORDING TAPE

Broadcast Quality
 TYPE A



SPLICE FREE \$3.50
 IN CANS NET

Air-Tone HIGH FIDELITY SYSTEMS ON DISPLAY AT OUR SHOWROOMS
SOUND & RECORDING COMPANY
 1527 CHESTNUT ST., PHILA. 2, PA. — RI. 6-8388

SEND FOR IT! 1951 **ALLIED CATALOG**
free! 212-Page Buying Guide
 World's Largest Stocks **ELECTRONIC SUPPLIES** for **INDUSTRY** and **BROADCAST STATIONS**

One Complete Dependable Source for Everything in Electronics

Simplify your purchasing—send your consolidated orders to ALLIED—the single, complete source for all Electronic Supplies. Depend on ALLIED for the world's largest stocks of special tubes, parts, test instruments, audio equipment, accessories—complete quality lines of electronic supplies. Our expert Industrial supply service saves you time, effort and money. Send today for your FREE copy of the 1951 ALLIED Catalog—the only complete, up-to-date guide to Electronic Supplies for Industrial and Broadcast use.

ALLIED RADIO CORP.

833 W. Jackson Blvd., Dept. 17-D-1, Chicago 7, Illinois

We Specialize in Electronic Equipment for Research, Development, Maintenance and Production Operations

SEND FOR FREE 1951 ALLIED CATALOG

29.3 to 26.7 cps before $Z_t = 60.1$, and rises to 31.9 cps before this value is reached once more. Then $\Delta f_1 = 29.3 - 26.7 = 2.6$ cps, or $\Delta f_1 = 31.9 - 29.3 = 2.6$ cps, and

$$2\Delta f_1/f_1 = 2 \times 2.6/29.3 = 0.1776.$$

We can now use Eq. (19) to calculate Q_r . Thus

$$Q_r = \left(\frac{1}{0.1776} \right) \left(\frac{10}{85} \right) = 0.663.$$

This is the Q of the loudspeaker circuit if the source impedance R_G were zero. Since Q_r is less than unity, it can be raised to that figure by allowing R_G to be greater than zero. It remains to calculate this value.

We have, for a parallel resonant circuit such as in Fig. 3, that

$$Q = \omega_r C_{me} R \quad (21)$$

where R is the resistance shunting C_{me} and L_{me} (Fig. 3), and is therefore R_{me} in parallel with $(R_{vc} + R_G)$. However, in the measurement and calculation yielding Q_r , R_G is essentially zero, and R represents simply R_{me} and R_{vc} in parallel.

We seek a value R' , such that the Q is equal to unity; i.e.,

$$1 = \omega_r C_{me} R'$$

or

$$R' = 1/\omega_r C_{me} \quad (22)$$

Substituting from Eqs. (21) and (20) in Eq. (22), we obtain

$$R' = \frac{R}{Q_r} = \frac{R_{me} R_{vc}}{R_{me} - R_{vc}} \times \frac{2\Delta f_1}{f_r} \times \frac{R_{me} + R_{vc}}{R_{vc}} = \frac{2\Delta f_1}{f_r} R_{me} \quad (23)$$

This represents R_{me} paralleled by $(R_{vc} + R_G)$, hence

$$R_{vc} + R_G = \frac{R' R_{me}}{R_{me} - R'} \quad (24)$$

and

$$R_G = \frac{R'(R_{me} + R_{vc}) - R_{vc} R_{me}}{R_{me} - R'} \quad (25)$$

Hence let us finish our experimental determination of R_G . From Eq. (23) we can find R' . If we use the last form, we have

$$R' = \frac{2\Delta f_1}{f_r} R_{me} = (0.1776) (75) = 13.31$$

ohms and from Eq. (25) we obtain

$$R_G = \frac{(13.31) (85) - (10) (75)}{(75 - 13.31)} = 6.19 \text{ ohms}$$

which of course checks the previous computation from the values for the mechanical constants, since it is the same loudspeaker that we have under consideration.

An Alternative Viewpoint

It is possible to reflect the electrical

constants into the mechanical side of the circuit, and obtain an alternative viewpoint of the behavior of the system as a whole. The results, so far as the low-frequency resonance is concerned, are the same, as will be shown. There is, however, another advantage of this alternative point of view with regard to the acoustical design; it permits the designer to incorporate the electrical constants into the acoustical design with a corresponding improvement in the performance of the loudspeaker.

First, the design formulas will have to be presented. The electrical impedance of the source and the voice coil appears in the mechanical side of the system as follows:

$$Z_{em} = \frac{(Bl)^2 \times 10^{-9}}{Z_e} \quad (26)$$

where Z_{em} is the mechanical impedance equivalent to the actual electrical impedance Z_e , and B and l have the same significance as before.

The output stage and voice coil in series with it exhibit essentially an inductive and resistive impedance at the higher audio frequencies. The inductance is the leakage inductance of the output transformer, plus that of the voice coil, and the resistance is the apparent source resistance R_G as viewed from the secondary terminals of the output transformer, plus that of the voice coil.

Hence, set

$$Z_e = R_e + j\omega L_e \quad (27)$$

where $R_e = R_{oc} + R_G$ (see Fig. 3), and L_e is the inductance defined above, and which we have not heretofore taken into account. At the lower audio frequencies $j\omega L_e$ can be ignored, whereupon Z_e reduces to R_e .

However, if Eq. (27) be substituted in Eq. (26), and then numerator and denominator divided by $(Bl)^2 \times 10^{-9}$, as before, there is obtained:

$$Z_{em} = \frac{1}{\frac{R_e}{(Bl)^2 \times 10^{-9}} + \frac{j\omega L_e}{(Bl)^2 \times 10^{-9}}} \quad (28)$$

If we consider $R_e/(Bl)^2 \times 10^{-9}$ as a mechanical conductance G_{em} , so that its reciprocal R_{em} , a mechanical resistance, is given

$$R_{em} = 1/G_{em} = 1/[R_e/(Bl)^2 \times 10^{-9}] \quad (29)$$

and if we further consider $L_e/(Bl)^2 \times 10^{-9}$ as a mechanical compliance C_{em} , then we can write Eq. (28) as

$$Z_{em} = \frac{1}{(1/R_{em}) + j\omega C_{em}} \quad (30)$$

MILTON BERLE,
"Texaco Star Theater," NBC



... a ribbon-pressure microphone that is so slim ... so skillfully styled ... so unobtrusive ... you must look twice to see it.

Despite its slim construction, the STARMAKER meets the exacting quality standards of other RCA professional Broadcast microphones. Pick-up is non-directional. Frequency response is substantially uniform, 50 to 15,000 cps. It is free from wind rumble and air blast ...

and virtually impervious to mechanical shock.

The STARMAKER fits any standard microphone stand ... can be used in place of any RCA microphone. No extra attachments needed.

For delivery information call your RCA Broadcast Sales Engineer, or write: Dept. P-7, RCA Engineering Products, Camden, N. J. (In Canada write: RCA VICTOR Limited, Montreal.)



RADIO CORPORATION of AMERICA

PROGRAM FILTER 6517-C

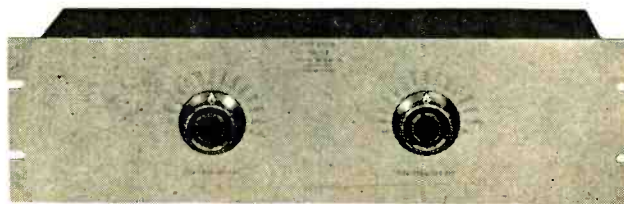

VARIABLE, LOW AND HIGH FREQUENCY WAVE FILTER

An ultimate in sound effects filters. 14 steps from 70 to 10,000 Cycles on each control. (Complete overlap). Cut-off frequencies down 4 db, balance of cut-off at rate of 12 db per octave. Insertion loss is zero. 500/600 Ohms impedance. Passive network, no tubes are required. An excellent engineering tool.

NET PRICE \$350.00

For additional information on this and other filters and equalizers write for Catalog 12E.



CINEMA ENGINEERING COMPANY

1510 WEST VERDUGO AVENUE, BURBANK, CALIFORNIA

Export Agents: Frazer & Hansen, Ltd. • 301 Clay Street • San Francisco, Calif., U. S. A.



Here's the answer to your Tape Duplicating Problems!

Mass Duplication of Magnetic Tape Recordings

by WORLD SOUND *Tape-Scriptions* SERVICE

- ★ Largest tape duplicating capacity in the industry
- ★ Tape Speeds: 15, 7½, or 3¾ inches per second
- ★ NAB Specifications
- ★ Single or Dual Track Duplicates
- ★ Shipped Anywhere within 24 hrs.

We are duplicators of the famous "Quentin Reynolds" Program, sponsored by DuMont dealers and distributors, and service such leading radio stations as: KRPC-Houston, KSD-St. Louis, KYW-Philadelphia, WAMS-Wilmington, WBKA-Nashville, WBNS-Columbus, WEMP-Milwaukee, WFBR-Baltimore, WHEA-Atlanta, WMAQ-Chicago, WMCA-New York City, WMPS-Memphis, WXYZ-Detroit, etc.

Give us your tape duplicating job—and forget it!

Write or Phone MR. BALCH—NOW!
 1440 Broadway, New York 18, N. Y.
 Phone: BRyant 9-1058
 752 S. 2nd St., Philadelphia 47, Pa.
 Phone: WALnut 2-7060
Largest Tape Duplicators in the Industry



audio

anthology

Paper cover . . . \$2.00

Distributors write for quantity discount



The long awaited compilation of reprints from early issues of AUDIO ENGINEERING, most of which are unobtainable.

Contains 37 articles on the following subjects:

- Amplifiers
- Speakers
- Noise Suppressors
- Phonograph Equipment
- Tone and Loudness Controls
- Dividing Networks

These articles have been of great interest to readers of AUDIO ENGINEERING over the past three years. Assembled in one volume, they comprise the most authoritative reference work for the audio hobbyist.

-----CUT OUT—MAIL TODAY-----

Book Division, Dept. A9
 Radio Magazines, Inc.
 342 Madison Ave., New York 17, N. Y.

Sirs: Enclosed is my check money order for _____ copies of the Audio Anthology.

Name (print carefully)
 Address
 City Zone State

or the electrical resistance and inductance in series appear in the mechanical system as a mechanical resistance and compliance in parallel. Hence, the counterpart of Fig. 3 is that shown in Fig. 5: a constant-velocity mechanical generator (counterpart of a constant-voltage electrical generator) feeds the mechanical resistance R_{em} equivalent to the electrical resistance R_e , in parallel with the mechanical compliance C_{em} equivalent to the electrical inductance L_e , and the actual mechanical impedance

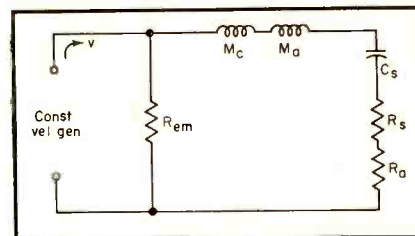

Fig. 5. Counterpart of Fig. 3, in mechanical terminology.

Z_m of the loudspeaker. This circuit has interesting implications both at the low- and at the high-frequency ends of the audio spectrum.

Consider the low-frequency end first. In this range C_{em} can be ignored, and

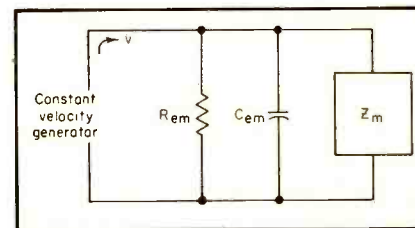

Fig. 6. Equivalent circuit corresponding to Fig. 5, showing damping due to electrical resistance.

Z_m consists, in the case of a direct-radiator cone loudspeaker, of the elements shown in Fig. 1. Hence Fig. 5 becomes circuit shown in Fig. 6. Here it is apparent how the electrical resistance R_e introduces in effect damping into the mechanical circuit by its transformed element R_{em} .

From Fig. 6 it is apparent that for critical damping,

$$(R_{em} + R_s + R_a) = \sqrt{(M_c + M_a)/C_s} \quad (31)$$

or alternatively, that the mechanical Q at resonance is unity:

$$Q_m = \frac{\omega_r(M_c + M_a)}{R_{em} + R_s + R_a} = 1 \quad (32)$$

from which the required electrical resistance must be

$$R_{em} = \omega_r(M_c + M_a) - (R_s + R_a) \quad (33)$$

Once R_{em} is evaluated from Eq. (33), the equivalent electrical resistance R_e

can be found from Eq. (29). Then the voice coil resistance R_{vc} is subtracted from R_e to yield the maximum permissible value of apparent generator resistance R_G .

Let us try out these formulas on the loudspeaker constants given previously. It will be recalled that the total mass (including that of the voice coil) was 92 mechanical ohms. This will be the value used for $(M_e + M_a)$. The resonant frequency was 29.3 cps, so that $\omega_r = 2\pi \cdot 29.3 \text{ rad./sec.}$ Also $(R_e + R_a)$ came out to be 3000 mechanical ohms.

Hence, if the appropriate values be substituted in Eq. (33), there is obtained:

$$R_{em} = (2\pi \cdot 29.3)(92) - (3000) = 16,980 - 3,000 = 13,980 \text{ mech. ohms}$$

Now, from Eq. (29), the equivalent electrical resistance R_e that is required to obtain critical damping is

$$R_e = \frac{(Bl)^2 10^{-9}}{R_{em}} = \frac{(10000 \times 1500)^2}{13980}$$

$= 16.13 \text{ ohms (electrical)}$. Since the voice coil resistance R_{vc} is 10 ohms, the apparent source resistance can be

$$R_G = 16.13 - 10 = 6.13 \text{ ohms}$$

which checks our previous calculations, as it should.

High-Frequency Response

The same equivalence between circuits can be utilized in the analysis of a high-frequency tweeter unit of the horn type. This employs a small diaphragm and voice coil, which feeds the cavity in front of it that leads to an exponential horn. The physical arrangement is shown in cross-section in Fig. 7. Here m_d represents the mass of the diaphragm and associated voice coil; C_a , the compliance of the air chamber in front of the diaphragm, necessary to furnish clearance for the motion of the diaphragm and useful in building out the mechanical circuit; and finally r_h represents the acoustical resistance of the horn throat in the frequency range above its low-frequency cutoff point.

The mechanical circuit has been analyzed many times in the past; it is given in Fig. 8. The resistance r_h is that of the throat of the horn, and is equal to the area of the throat in sq. cm. multiplied by 41.4 mech. ohms, which is the radiation resistance of air per sq. cm. A_d is the area of the diaphragm; in conjunction with A_h it forms a kind of hydraulic press which is the mechanical counterpart of an electrical transformer. The step-down ratio is A_d to A_h ; conversely r_h is reflected to the diaphragm as an equivalent resistance r'_h such that

$$r'_h = (A_d/A_h)^2 \quad (34)$$



MIDGET CONDENSER MICROPHONE

for PRECISION SOUND MEASUREMENTS or HIGH QUALITY SOUND RECORDING

- Rugged Construction
- Exceptional Calibration Stability
- Unaffected by Variations in Humidity

Built to give years of service without adjustments and without change in calibration. Even without dessicators, Kellogg Midget Condenser Microphones show no detectable drift in laboratory service. Proven in use for optimum performance for over 15 years.

This response is flat to within $\pm 3\text{db}$ from 20 to 12,000cps and to within $\pm 3\text{db}$ from 20 to 15,000 cps with the grill removed. The overload level for this model is approximately 130db.

MATERIAL—Diaphragm—.001" ST-17 aluminum alloy. All other major components are brass. External surfaces are bright gold plated and lacquered. **CAPACITY**—Approximately 40mmf. **INSULATION RESISTANCE**—100,000 megohms minimum measured at 250 volts. **POLARIZING VOLTAGE**—150-300 volts. 150-225 volts is the recommended range.

Users include government laboratories, universities, audio development laboratories, sound studios and industrial plants manufacturing sound equipment.

Model B is available either uncalibrated or with free field calibration. Prompt delivery on both models—be sure to specify type desired.

PRINCIPAL CHARACTERISTICS:

RESPONSE—the response for the cavity and coupler sound measurements type Model A is about -58db when referred to 1 volt/dyne/cm². This response is flat to within 1db from 100 to 7000cps and to within 3db from 60 to 10,000cps. The overload on Model A occurs above 140db.

In the free field type Model B the response is about -55db referred to 1 volt/dyne/cm².

Send for full specifications today. Write Dept. 27-D.

KELLOGG

SWITCHBOARD AND SUPPLY COMPANY

MIDGET CONDENSER MICROPHONE

Established 1897

4650 SOUTH CICERO AVENUE • CHICAGO

This May 1951 issue marks

—the Fourth Anniversary of

AUDIO ENGINEERING

To those of you who have watched AE grow during these four years, it is unnecessary to urge you to subscribe . . . you know that each month has brought new and authoritative articles which you had long wanted to read. If you have lost your friends and antagonized your cellmate by borrowing their copies, fill out the coupon below. Remember that most of our back copies are unobtainable.

AUDIO ENGINEERING

342 Madison Avenue, New York 17, N. Y.

Enclosed is my check money order for \$..... for my subscription to AUDIO ENGINEERING FOR 1 yr 2 yrs.

Subscription Price in U. S. A. and Canada and Pan American Union: 1 yr—\$3; 2 yrs—\$5. Add \$1. per year for foreign subscriptions.

Name (please print)

Address

City Zone State

Occupation (give title and department)

Firm name

CLASSIFIED

Rates: 10c per word per insertion for noncommercial advertisements; 25c per word for commercial advertisements. Rates are net, and no discounts will be allowed. Copy must be accompanied by remittance in full, and must reach the New York office by the first of the month preceding the date of issue.

FOR SALE: PT900R1 Presto portable tape recorder used as demonstrator approx. 15-20 hrs. 50-ohm inputs, \$675.00; Brook 10D 30-watt amplifier, \$175.00; Altec 323B amplifier, \$95.00; Altec 604B speaker, dividing network, \$110.00; 605A mahogany Altec cabinet, \$105.00; UTC-3AN equalizer, \$90.00; one Presto L2 playback amplifier-speaker unit, \$197.00; two 6N recording cases, \$20.00 each. All in good condition. Shipping charges COD. MASTERTONE RECORDING COMPANY, Box 1060, Des Moines, Iowa.

FOR SALE: Meissner 9-1091 FM-AM tuner, \$125.00; Thordarson triode expander amplifier, \$50.00. August Zimmerman, 3106 Auchenoroly Terrace, Baltimore 17, Md.

FOR SALE: Bell Model 2145 Hi-Fi amplifier. Brand new, \$155.00, including 50 feet of cable for remote control. Also Pentron tape recorder, \$85.00. Box CA-1, AUDIO ENGINEERING.

PATENTED, can't-be-copied, Barker 150 full-range British speaker. (See advs. E.) Cost \$69 including duty. Three hours use, \$50. Matching Barker-designed corner enclosure with unique horizontal speaker mount and diffusing cone, \$50.00. Quality reproduction. Edward Burks, 222 Cedar Avenue, Washington 12, D. C.

WANTED TO BUY OR SWAP: Used, quality home audio equipment in perfect condition. Amplifiers, tuners, recorders, speakers, 2- or 3-speed changers. J. Colbert, 85-08 168th Place, Jamaica 3, N. Y.

FOR SALE: MAGNECORD amplifier, PT6-J, in carrying case; includes 15-in./sec. equalizer. Used one month, like-new condition. \$210.00. f.o.b. New York. Box CA-2, AUDIO ENGINEERING.

LLEWELLYN Amplifier. New, unique 3-tube 40-watt triode feedbackless amplifier using standard parts. Humfree, ultralow distortion, easily built. Full constructional data, prints, parts list, layout, \$5.00. Data for special high-gain, equalized 4-stage pre-amplifier, accommodates every cartridge, \$3.00. Both \$7.00. No COD's. Llewellyn Keim, 825 Fifth Avenue, New York 21, N. Y.

PROFESSIONAL DIRECTORY

C. J. LeBEL

AUDIO CONSULTANT

Development, Test, Custom Equipment,
Complete Laboratory and Shop Facilities

133 WEST 14TH STREET
NEW YORK 11, N. Y.
CH 3-8082

Custom-Built Equipment

U. S. Recording Co.

1121 Vermont Ave., Washington 5, D. C.
Lincoln 3-2705

RICHARD H. DORF AUDIO CONSULTANT

Sound Systems Recording Installations
Product Design Technical Literature

255 W. 84th Street Phone
New York 24, N. Y. Schuyler 4-1928

The reflected resistance r'_h shunts the air chamber compliance C_a . This is because the lower r'_h is, the more readily can it relieve the pressure built up in the air chamber by the motion of the diaphragm. This is exactly analogous to the reduction in the charge and voltage across a capacitor when it is shunted by a low resistance.

From Fig. 8 the loudspeaker unit is recognized as forming an L-section low-pass filter. For proper transmission up to the cut-off frequency, it is necessary that

$$r'_h = \sqrt{M_d/C_a} \quad (35)$$

The cutoff frequency is given by

$$f_c = \frac{1}{\pi \sqrt{M_d C_a}} \quad (36)$$

If twice the mass ($2M_d$) were employed and another compliance C_a placed at the left end, a π -section filter would be obtained, to which Eqs. (35) and (36) would apply equally well. In short, the same cutoff frequency can be obtained

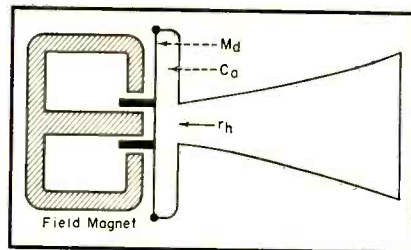

Fig. 7. Physical arrangement of mechanical elements of a high-frequency horn and unit.

for double the mass, if a compliance is placed at the other end of it.

If only the mass is doubled, then the cutoff frequency is reduced to 70.7 per cent of its original value, as is evident by substituting $2M_d$ for M_d in Eq. (36). (The corresponding changes in r'_h are not of importance as they involve merely a change in the ratio of A_d to A_h .)

For a given high-frequency cutoff and power-handling ability of the speaker, the diaphragm mass M_d comes out to be a certain amount. If M_d can be kept the same, and yet a compliance placed at the front end, the high-frequency cutoff can be extended to $\sqrt{2}$ or 1.414 times its original value without altering the speaker's power handling ability. Hence it is of interest to see how this can be done.

At the higher audio frequencies, the output transformer appears at its secondary terminals essentially as a series inductance L_L (its leakage inductance). The power amplifier tubes, as reflected to the secondary of the transformer appear as a resistance R_G in series with L_L . To this must be added the voice coil resistance R_{vc} and its inductance L_{vc} in

series with R_G and L_L . Hence finally the electrical current appears as

$$Z_e = R_e + j\omega L_e$$

where

$$R_e = R_G + R_{vc} \quad (37)$$

and

$$L_e = L_L + L_{vc}$$

Figure 5 and Eq. (30) show how these appear in the mechanical circuit. The mechanical impedance Z_m is in this case illustrated by Fig. 8, so that finally in Fig. 9 is given the complete mechanical circuit including the equivalent electrical circuit parameters.

Here, in accordance with Eq. (29)

$$R_{em} = \frac{1}{R_e/(Bl)^2 \times 10^{-9}} \quad (29)$$

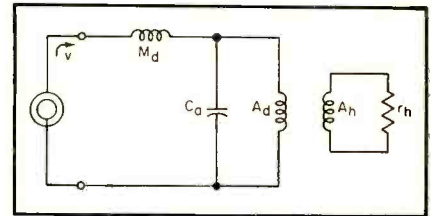

Fig. 8. Mechanical circuit of high-frequency speaker.

and this should match r'_h for maximum power transfer, or

$$R_e = (Bl)^2 \times 10^{-9} / r'_h \quad (38)$$

from which the apparent source impedance should equal

$$R_G = R_e - R_{vc} = \frac{(Bl)^2 \times 10^{-9}}{r'_h} - R_{vc} \quad (39)$$

The apparent mechanical compliance equivalent to the electrical inductance is indicated by Eqs. (28) and (30), namely:

$$C_{em} = L_e / (Bl)^2 \times 10^{-9} \quad (40)$$

However, in order to convert the L-section mechanical low-pass filter of Fig. 8 into the π -section low-pass filter of Fig. 9, it is necessary that

$$C_{em} = C_a = \frac{L_e}{(Bl)^2 \times 10^{-9}} \quad (41)$$

If such coordination in electrical and mechanical design be accomplished, a 41 per cent increase in frequency response may be expected over the case of no electrical inductance at all. Of course, in actual practice the electrical system inherently has inductance and resistance so that the "building-out" of the L-section into a π -section tends to take place; all that it is desired to point out here is that the electrical and mechanical circuit elements can be coordinated so as to improve the performance rather than to have a haphazard relationship to one another, and that furthermore, electrical inductance is not necessarily an undesirable characteristic in the output stage, but can serve a useful purpose.

BENDIX RADIO DIVISION



ELECTRONICS ENGINEERS—At all salary and experience levels.

RESEARCH ON: Antennae, Servo-mechanisms, Microwave ccts. and other phases of communications and navigation equipment.

PRODUCTION DESIGN OF: Military and commercial communications and navigation equipment.

FIELD ENGINEERS — Supervise installation and maintenance of radio and radar equipment. Factory training will be given. Base salaries from \$4200 to \$6900 per year. 25% bonus for time spent overseas. Traveling and living expenses paid by Bendix. Insurance plan.

TEST AND INSPECTION ENGINEERS —Practical knowledge of radio, radar, or TV manufacturing processes. Good knowledge of radio fundamentals essential. Base salaries from \$3900 to \$5880.

TECHNICAL WRITERS — Knowledge of radar fundamentals or radio required. Work closely with engineers to gather material for instruction and maintenance manuals. Base salaries from \$3400 to \$4300.

LABORATORY TECHNICIANS — Require knowledge of radio fundamentals and skill in use of measuring instruments and laboratory equipment. Previous industrial experience essential. Salaries from \$262 to \$321 per month.

BASE SALARIES FOR ALL POSITIONS LISTED ABOVE ARE SUPPLEMENTED BY UP TO 30% FOR REGULARLY SCHEDULED 48 HOUR WEEK.

Housing is no problem in Baltimore.

Excellent group insurance and family hospitalization plan.

Attractive retirement plan for professional personnel.

Write for application:

Engineering Personnel Supervisor
BENDIX RADIO DIVISION of
Bendix Aviation Corporation
Baltimore 4, Maryland
TOWSON 2200

Undoubtedly, in most systems the inductance—particularly that of the voice coil itself—is too high and produces a C_{em} in excess of C_a . Also, R_{em} may be too low compared to r'_h because of excessive electrical resistance $R_G + R_{vo}$. However, this serves to counterbalance an excessive value for C_{em} and therefore tends to smooth out the response.

The interested experimenter can calculate the actual response of the network shown in Fig. 9 on the basis that it is not a truly terminated low-pass filter section, since a resistance such as r'_h is but a nominal match over the pass

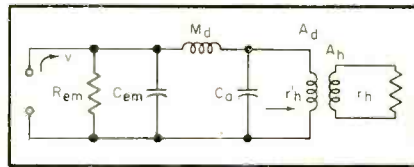

Fig. 9. Conversion of Fig. 8 circuit to pi-section equivalent.

band, and is a considerable mismatch near the cutoff frequency, where the termination should approach zero. He can also calculate the response for his actual speaker and amplifier output stage, in order to see directly the effect of varying, for example, the electrical circuit constants.

Conclusion

A method of coordinating the motional impedance of a loudspeaker with the electrical impedance has been presented here with the object of reducing "hangover" effects and objectionable transients in general at the low-frequency resonance of the speaker.

An experimental method has also been presented to enable the necessary measurements to be made in order that the correct source impedance be obtained for critical damping of the system. The method requires merely an audio oscillator, an a-c voltmeter and an a-c ammeter in order to determine the impedance over a range of frequencies. From the shape of the impedance curve the Q of the system can be determined, and from the value of voice coil and motional impedance at resonance, the requisite source resistance for critical damping can be calculated.

An alternative method based on viewing the electrical constants from the mechanical side was then presented, and it was shown that this method led to the same answers as above. Finally, it was shown by this method how inductance and even resistance in the electrical system could be put to use to obtain a coordinated system in the case of a high-frequency loudspeaker.

REK-O-KUT

Hi-Fi Phonographs and Turntables By Which All Others Are Judged!



REK-O-KUT

Recitalist

Featuring the exclusive Polyphonic Selector.

Equipped with 3-Speed or Continuously Variable Turntable.

Plays Records 6" to 16" and broadcast transcriptions.

Irving Kolodin, Music Editor of the Saturday Review of Literature, says, "... the Recitalist was conceived for schools, businesses, forums, etc., where high grade reproducing equipment is in demand... appeals to a music-lover who wants accurate, undistorted reproduction. The special features are (1) Heavy rim-driven turntable, reliable at all speeds (2) Dual point pickup (3) Excellent amplifier (4) Speaker mounted in detachable cover of carrying case."

RP-43C (with 3-speed turntable) \$229.95

RP-43VC (with continuously variable speed turntable) \$269.95

REK-O-KUT

Continuously Variable Speed Turntable



The BROADCAST QUALITY turntable that plays at any speed from 25 to 100 R.P.M. without "wow". Plays all records from 6" to 16", standard and microgroove. Used by broadcast stations, teachers, musicians, disc jockeys, dance studios, etc. Operates

on 50 to 60 cycles. Plays through any amplifier, phonograph, TV or radio set.

Model CVS-12P (illustrated) in portable case with 16" dual-stylus pickup \$124.95

Model CVS-12, chassis, motor and turntable assembly..... \$ 84.95

Model P-43C—3-Speed, 16" Dual-Stylus Pickup \$ 94.95

REK-O-KUT

Model LP-743 Three-Speed 12" Transcription Turntable



Recommended by leading sound critics. Induction type motor, designed for smooth, quiet, vibration-free operation. Instantaneous speed changes—78, 45, 33 1/3—without stopping turntable or removing disc.

\$54.95 net

Yes, It Costs Less To Buy REK-O-KUT—And Here's Why QUALITY is the word for REK-O-KUT products. They perform better, last longer, provide more "extras" for the money. Your REK-O-KUT machine will serve you faithfully without maintenance day-in and day-out. Write for illustrated catalog of REK-O-KUT line of Hi-Fidelity Recording Instruments. Phonographs, Transcription Tables and Accessories. So—Buy REK-O-KUT, it costs less in the long run.

REK-O-KUT CO.

38-01 Queens Boulevard
Long Island City 1, N. Y.

SAVE

33 1/3%



This is our GROUP SUBSCRIPTION PLAN

You and your friends and co-workers can now save up to \$1.00 on each subscription to AUDIO ENGINEERING. The more men in a Group, the more each saves. If you send 6 or more subscriptions for the U.S.A. and Canada, they will cost each subscriber \$2.00, 1/3 less than the price of a regular 1-year subscription. **Present subscriptions may be renewed or extended as part of a Group.**

AUDIO ENGINEERING is still

- The only publication devoted entirely to Audio—
- Recording
- Broadcasting equipment
- Acoustics
- Home reproduction systems
- PA systems
- Psychoacoustics

(Please print)

Name

Address

Position Company

Name

Address

Position Company

Name

Address

Position Company

Name

Address

Position Company

Name

Address

Position Company

Name

Address

Position Company

Add \$.50 to each Foreign subscription ordered

RADIO MAGAZINES, INC.
342 Madison Ave., N. Y. 17, N. Y.



Employment Register

POSITIONS OPEN and AVAILABLE PERSONNEL may be listed here at no charge to industry or to members of the Society. For insertion in this column, brief announcements should be in the hands of the Secretary, Audio Engineering Society, Box F, Oceanside, N. Y., before the fifth of the month preceding the date of issue.

★ Positions Open • Positions Wanted

★ **Wanted:** Experienced Electronics Engineers and recent university graduates in Electrical Engineering for service, test, and design engineering duties in civilian capacity to work with naval electronics. Salary commensurate with experience. Obtain Federal Civil Service Form 57 at nearest first- or second-class postoffice and send completed form to Employment Superintendent, Code 178, San Francisco Naval Shipyard, San Francisco 24, California.

● **Thirty years** wide radio experience equips this Harvard Graduate to function at top management level to enhance your corporate earnings. Intimate knowledge of industry's production sources and nationwide contacts enable this man to deliver when others falter. Compensation high, (5 figures) but commensurate with demonstrated past performance. Box 401, AUDIO ENGINEERING.

TV STUDIO ACOUSTICS

[from page 14]

teristic; no attempt is made to introduce the growth characteristic since the latter is held less essential in an approach to total reverberation.

The following recommendations for reducing acoustic difficulties on television sets are presented as a guide in design to reduce sound pick-up difficulties often encountered during programs.

1. All alcoves, window recesses, or concave spaces of any type, should be made of cloth to eliminate boominess.
2. Avoid parallel walls in sets such as kitchens, offices, boat interiors, etc., unless opposite walls are made of cloth. When opposite hard walls are angled, the slope should come to 1 foot in 10 feet.
3. Where ceilings are used, they should be made of cloth. It may be noted that dialogue can well be recorded by placing the microphone on the other side of the "ceiling," that is, above the thin cloth representing the ceiling.
4. Whenever possible, the treads of stairways should be covered with soft material and the stairs so constructed as to eliminate squeaks.
5. The use of glass in windows should be kept to a minimum. Wherever possible, black gauze or narrow glass borders should be used. Large plane surfaces reflect a large percentage of the incident sound which reinforces the direct sound, particularly at the low frequencies, causing these frequencies to be over-ac-

BARKER SOUND UNITS TELL THE TRUTH



The ideal loudspeaker is probably one which corrects all preceding defects from studio microphone to final output stage and delivers perfectly re-constituted sound to the listener's ear.

We have not reached that far yet. In fact, we doubt if we ever shall. But we do know that our units get very close indeed to telling the truth about the input they receive. And that is a lot farther than most speakers go, for very good reasons.

Many hundreds of our friends now enjoy the ever fresh joy of hearing favorite music and artists sound NATURAL, and can appreciate clean detail, transients clear cut, full frequency range without break or change of texture. Some of them in your country tell us we have in our dual drive with built-in cross over and our graded compliance cone a combination which beats all, even at many times its price, which is \$60 or \$42, according to magnet size.

Why not write for details now?

BARKER NATURAL SOUND REPRODUCERS
BCM/AADU, LONDON, W.C. 1, ENGLAND

"HAVE YOU HEARD THE SOUND OF QUALITY?"



NEWCOMB SOUND IS BETTER

- Manufacturers of public address, mobile, phonograph, musical instrument and wired music amplifiers • Portable systems • Portable phonographs and radios • Transcription players • Rack and panel equipment.
- Write today! Circle items of interest and indicate whether you are a Dealer, Parts Jobber or Sound Specialist.

NEWCOMB AUDIO PRODUCTS CO.
DEPT. T, 6824 LEXINGTON AVE.
HOLLYWOOD 38, CALIFORNIA

TWIN-TRAX* TAPE RECORDERS

designed... with the **ENGINEER** in mind

A COMPLETE SERIES

... of high-fidelity, dependable tape recorders — from transport mechanisms to highly specialized instruments, including the one YOU want. Write today for catalog 5101. Includes all technical specifications and direct factory prices.

AMPLIFIER CORP of AMERICA
398-4 Broadway New York 13, N. Y.

*Trademark Reg.

WANTED **Engineers**

ELECTRONIC · ELECTRICAL · MECHANICAL

LAB TECHNICIANS: For Design and Development of Magnetic Tape Recorders used for Audio Work and Instrumentation. Creative ability essential.

ALSO: Electrical Draftsmen, Mechanical Draftsmen and Designers.

PERSONNEL for Purchasing, Expediting, and Production Control.

Please send complete information concerning education and experience.

Ampex

ELECTRIC CORPORATION

SAN CARLOS, CALIFORNIA · Telephone LY 6111 3-3128

AUDIO ENGINEERING SCHOOL

Practical engineering training in Audio fundamentals, Disc, Film, Magnetic Recording, and Audio frequency measurements.

Studio training simulates Broadcast, Motion Pictures, Television, and Commercial Recording work.

Approved for Veterans

Hollywood Sound Institute, Inc.
1040-A North Kennore, Hollywood 27, Calif.
Correspondence Courses Available
Specify if Veteran or Non-Veteran

Ready NOW
ULTRASONIC FUNDAMENTALS

By S. YOUNG WHITE

The rapid increase in the use of ultrasonics during the last few years makes it natural that the well-informed sound engineer should want to learn something of the applications and possibilities of this amazing new field. But interest in ultrasonics is not confined to the sound engineer—it is of still greater importance to the industrial engineer for he is the one who will visualize its uses in his own processes.

Elementary in character, **ULTRASONIC FUNDAMENTALS** was written originally as a series of magazine articles just for the purpose of acquainting the novice in this field with the enormous possibilities of a new tool for industry. It serves the double purpose of introducing ultrasonics to both sound and industrial engineers. The list of chapter headings will indicate how it can help you.

CHAPTER HEADLINES

Too Much Audio. Opportunities in Ultrasonics. Elements of Ultrasonics. Experimental Ultrasonics. Coupling Ultrasonic Energy to a Load. Ultrasonics in Liquids. Ultrasonics in Solids. Testing by Ultrasonics. High-Power Ultrasonics. Notes on Using High-Power Ultrasonics. Applications of Ultrasonics to Biology. Economics of Industrial Ultrasonics.

The applications of ultrasonics have already extended to many industries, and as its possibilities are explored they will increase a hundredfold. To keep abreast of its growth, engineers in all fields must know what they may expect from ultrasonics, how it is used, how the energy is generated, and the techniques of applying ultrasonic treatment to many processes.

ULTRASONIC FUNDAMENTALS
By S. YOUNG WHITE

36 pages, 40 ill., 8½ x 11, paper cover \$1.75

Book Division, Dept. A
RADIO MAGAZINES, INC.
342 Madison Avenue New York 17, N. Y.

centuated. Indeed, "boominess" of recorded dialogue is probably the most common acoustic defect experienced on television sets.

6. Noise from footsteps, vehicles, etc., on gravel walks can be reduced through the use of chipped cork in place of gravel, which gives the identical appearance of gravel when televised.

Industry Notes--

Bitel-McCullough, Inc., San Bruno, Calif., recently announced salvage values for two tube types, 3X2500A3 and 3X2500F3. Request information from manufacturer. . . . **National Electronic Mfg. Corp.** moved into new and larger quarters at 4202 Vernon Blvd., Long Island City, N. Y. Company was located in Astoria for many years, and makes a line of antennas and accessories. . . . **The Paris Fair**, an International exhibition of tools, electrical equipment, and other items used throughout the world, is scheduled for exhibition grounds adjacent to Paris from April 28 to May 14.

Pioneer Plastics Corp., 28 Goodhue St., Salem, Mass., announces expansion of facilities for production of full line of industrial laminates in paper and cloth base, as well as GMG glass-melamine which meets Armed Forces specifications.

Plax Corporation, Hartford, Conn., reactivating specialized fabricating services on thermoplastic materials as an aid to manufacturers with military contracts involving polystyrene. . . . **Radiophon Corp.**, located at 55 W. 42nd St., New York 18, N. Y., newly formed to promote sales of European-made electronic parts, tubes, etc. in accordance with the spirit of Marshall plan. . . .

Reeves Soundcraft Corp. announces receipt of authority from NPA to continue the practice of reprocessing used aluminum recording blanks. Company will buy used discs shipped in hundred-pound lots to factory at 204 Walnut St., Allentown, Pa. . . . **Sylvania Electric Products, Inc.** acquires new factory site at Woburn, Mass., for production of electronic tubes and equipment. Work to commence on this, the 19th plant, within two months. . . .

Technology Instrument Corp. moved to Acton, Mass. because of rapidly expanding activities. . . . **World Sound Co., Inc.** 1440 Broadway, N. Y. 18, N. Y. speeding up "Tape-Script" facilities for duplicating magnetic tapes. Shipping process also streamlined for faster service. . . . **The Workshop Associates, Inc.**, 135 Crescent Road, Needham Heights 94, Mass. becomes wholly owned subsidiary of The Gabriel Co., Cleveland, Ohio, without change in policies or procedures of either organization.

Industry People--

R. M. Butler becomes assistant sales manager of merchandise division, International Resistance Co. . . . **Robert F. Field** retires from Engineering Dept. of General Radio Co. after 21 years of service. . . . **John A. Green**, 6815 Oriole Drive, Dallas, Tex. appointed sales rep for Ampere Electronic Corp. in the southwest. . . . **H. Leslie Hoffman**, president of Hoffman Radio Corp., receives plaque in recognition of company's contribution to TV industry and for his outstanding public service. . . .

C. M. "Buck" Lewis named manager of Broadcast and Communications Sales Section of RCA Engrg. Products Dept. . . . **Richard G. Leitner** returns to Packard-Bell as chief research engineer after 18-year absence. **Charles A. Nichols** becomes director of engineering with same company. . . . **Brig. Gen. Russell E. Randall**, USAF Ret, appointed adviser of military activities for Stancil-Hoffman Corp., Hollywood, Calif. . . .

Harold M. Stral becomes advertising manager, Standard Transformer Corp. . . . **William P. Short** appointed chief engineer of General Precision Laboratory, Inc., Pleasantville, N. Y. . . . **W. W. Simons** retires from Altec Service Corp. after 28 years of service. Will join Altec Lansing Corp. in new capacity. . . . **Lewis Allen Weiss** appointed Director of Office of Civilian Requirements in the NPA. Was formerly chairman of the board of Mutual Broadcasting System.

AMPERITE

Studio Microphones at P.A. Prices

Ideal for BROADCASTING RECORDING PUBLIC ADDRESS

"The ultimate in microphone quality," says Evan Rushing, sound engineer of the Hotel New Yorker.

• Shout right into the new Amperite Microphone—or stand 2 feet away—reproduction is always perfect.

• Not affected by any climatic conditions.
• Guaranteed to withstand severe "knocking around."



Models
RBLG—200 ohms
RBHG—Hi-imp.
List \$42.00



"Kontak" Mikes
Model SKH, list \$12.00
Model KKH, list \$18.00

Special Offer: Write for Special Introductory Offer, and 4-page illustrated folder.

AMPERITE Company, Inc.

561 BROADWAY · NEW YORK 12, N. Y.

Canada: Atlas Radio Corp., Ltd., 560 King St. W., Toronto

BETTER SOUND with
37% LESS POWER

New **RACON "Cobra"**
Wide Angle
Horn

COB-11
List Price
\$72.50



The RACON COB-11 delivers greatest useful power by concentrating maximum uniform sound in a horizontal sweep of a full 120°. Vertical angle is only 40°. Especially suited for indoors or outdoors where reverberation, echoes and "hangover" exist. In wide-range systems using 2 or 3 loudspeakers, it's excellent too as a mid- or high-frequency horn.

2 db Higher Efficiency: True exponential flare gives higher sound velocity; no sound-absorbing material on horn mouth; "straight" horn design eliminates attenuation caused by re-entrant members.

Better Response: True exponential flare plus "straight" design produces smoother, more uniform response throughout transmission range.

Crisper Non-"Boomy" Sound: The 250-cycle cut-off eliminates the power-wasting lower frequencies which mar articulate quality.

Sturdier Construction: Consists of heavy 2-piece non-vibratory aluminum casting. Finish is weather-resistant grey hammertone over zinc chromate primer. 17½" h, 22¼" w, 13¾" d. Thread is 1½"-18 for any RACON 25-35 watt driver unit.

WRITE NOW FOR CATALOG A.

In Canada: Dominion Sound Equipments Ltd.
Branches in all principal cities.

ACOUSTICAL EXCELLENCE



Racon Electric Co., inc.
52 East 19th Street, New York 3, N. Y.

**THE IDEA BEHIND THE WORDS
HARTLEY-TURNER**
Quality and Service

This is the first of a series of ads designed to tell you about the inspiration behind Hartley-Turner high fidelity equipment. We have had many letters of congratulation on our sane copywriting and on the accurate and factual technical information we send out. These are not features of a different sort of selling, but an exact reflection of the sort of firm we are.

The products we sell are good products, and they perform well, but the products are but a means to an end—complete confidence between our customers and ourselves. A civilized democracy can only be built up on the idea of mutual co-operation and goodwill, and we have developed our business along those lines.

We are a small firm simply because we like it that way. Also, we have to be small because no large corporation could produce goods of our quality at our price. Our products could not be mass-produced because they have no mass-appeal, and the colossal overheads of a large factory making our quantities would increase the price 50% or more. This is a plain statement of economic facts and nothing else.

We have no competitors, even among the small firms. Simply because we have been at the game so long, we have learned so much, and we just put our acquired knowledge into practice. Our methods of production, with ruthless elimination of non-essential overhead expenses, enable us to charge a lower price for a given standard of performance and service.

We believe that a manufacturer and each of his customers make an individual partnership, the success of which depends on mutual trust and esteem. We share in thousands of these partnerships all over the world, and they last because our customers and we trust and understand each other. And we feel that the partnership should be personal.

A recent order from a man said that it had to be a gamble on his part, for he could not understand how such an allegedly fine speaker had not got national distributorship. We replied that it was nationally distributed, but that we had done the distribution ourselves as a result of the wholehearted support of many U. S. citizens who had taken a chance in the first place—and found there was no gamble. If you send \$48.00 into the blue Atlantic you are showing faith in us. How could we possibly do you down after that? Even if we wanted to.

What we depend on to spread our market is the goodwill of our customers, and the only way to secure that goodwill is to give them more than they might reasonably expect, both in quality and service.

THE SYMBOL OF HARTLEY-TURNER QUALITY AND SERVICE IS IN THE 215 SPEAKER AT \$48.00, said by its owners to surpass any other costing less than \$200.00.

We have a regular mailing of technical data on all aspects of high-fidelity. Already one in ten readers of A.E. are on our list. Send a dollar bill today and make sure of all we have issued so far, and all we shall issue in the future. Many interesting developments are on the drawing-board.

H. A. HARTLEY CO. LTD.,
152 Hammersmith Road
LONDON W. 6, ENGLAND

**ADVERTISING
INDEX**

Air-Tone Sound & Recording Co.	40
Allied Radio Corp.	40
Altec Lansing Corp.	2
Amperite Co., Inc.	47
Ampex Electric Corp.	47, 48
Amplifier Corp. of America	47
Arnold Engineering Co.	3
Audak Co.	29
Audio Devices, Inc.	Cover 2
Audio & Video Products Corp.	9
Barker Natural Sound Reproducers	46
Bell Telephone Laboratories	12
Bendix Radio Division	45
Cannon Electric Div. Co.	6
Carter Motor Co.	30
Chicago Transformer Co.	4
Cinema Engineering Co.	41
Classified Ads	44
Daven Co., The	Cover 3
Dorf, Richard H.	44
Goodman Industries Ltd.	36
Hartley, H. A., Co. Ltd.	48
Harvey Radio Co., Inc.	39
High-Fidelity Magazine	27
Hollywood Sound Institute, Inc.	47
Kellogg Switchboard and Supply Co.	43
LeBel, C. J.	44
Leonard Radio, Inc.	35
Magnecord, Inc.	5
Newcomb Audio Products Co.	46
Partridge Transformers Ltd.	48
Pickering & Co., Inc.	11
Professional Directory	44
Racon Electric Co., Inc.	47
Radio Corp. of America	1, 7, 41
Reeves Soundcraft Corp.	33
Rek-O-Kut Co.	45
Shure Brothers, Inc.	31
Standard Transformer Corp.	37
Terminal Radio Corp.	32
Triad Transformer Mfg. Co.	8
Turner Co.	25
U. S. Recording Co.	44
United Transformer Co.	Cover 4
World Sound Co., Inc.	42

PARTRIDGE

THE AUDIO TRANSFORMERS
that pass ALL tests

Time, no less than test, has proved Partridge Audio Transformers to be the most efficient and reliable in the world.

★ **WILLIAMSON** Output TRANSFORMERS, of which there is no U. S. equivalent (vide "Audio Engineering" Nov. 1949) built to the original specification, comes to you for \$21.00, mail and insurance paid.

★ **PARTRIDGE CFB** 20 Watt output type, accepted as without rival. Series leakage induct. 10 m.H.; primary shunt induct. 130 H, with 'C' core construction and hermetically sealed—to you for \$30.00, mail and insurance paid.

Fulltest data, including square wave tests, distortion curves etc., together with list of U. S. stockists rushed Air Mail to you.

NOTE: We despatch by insured mail per return upon receipt of your ordinary dollar check.

Jobbers are invited to handle the transformer that the States is eager to buy—remember, immediate delivery from large stocks in New York!

PARTRIDGE TRANSFORMERS LTD.
ROEBUCK ROAD, TOLWORTH SURREY, ENGLAND

*no other
tape recorder
like..!*

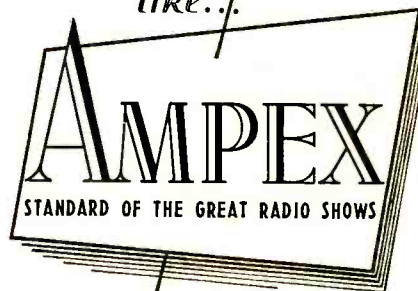

to 40,000 cps at 30 inches
per second tape speed

to 15,000 cps half-track at
7 1/2 inches per second tape
speed

AMPEX ELECTRIC CORPORATION
San Carlos, California

SOLD BY...
BING CROSBY ENTERPRISES, INC., Hollywood
AUDIO-VIDEO PRODUCTS CORP., New York City
GRAYBAR ELECTRIC CO., All Principal Cities
TERMINAL RADIO CORP., New York City
RADIO SHACK CORPORATION, Boston
NEWARK ELECTRIC CO., Chicago
WESTREX CORP. (Export), New York City

AX-34

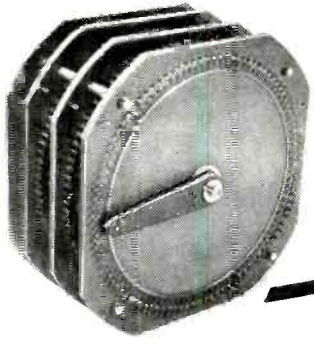

Quick Switches

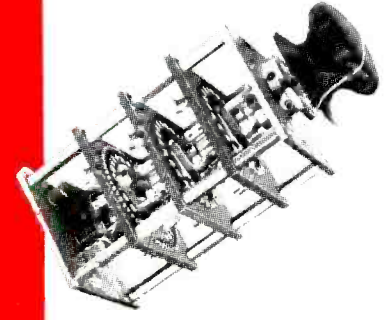
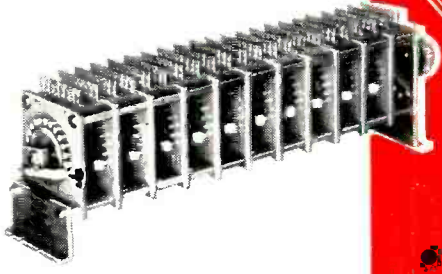

are a

DAVEN SPECIALTY

And the "specialty of the house" is double-barreled... first, choose from hundreds of standard units to satisfy your needs—for quick switch delivery... second, Daven can effect 'quick' switches or changes from standard units to special switches, by using components at hand. Standard parts can be adapted for your switch. That too makes for speed, dependability, economy. Write for more detailed data.

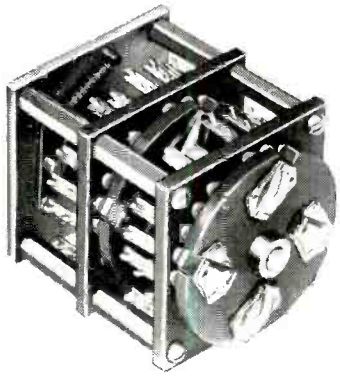
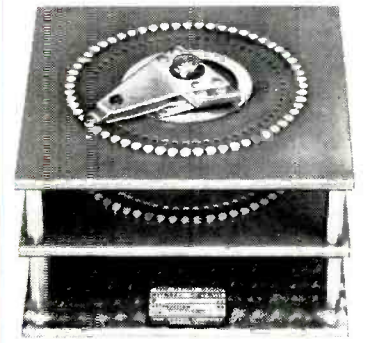

Here's Why Daven Switches Excel

- Low and uniform contact resistance.
- Minimum thermal noise.
- High resistance to leakage.
- Trouble-free operation and long life.
- Roller-type positive detent action.
- Depth of unit not increased by addition of detent.

Standard Daven Switches may be the answer to many of your problems. Therefore, check this list below for many of the popular types that are readily available.

Type	Operation	Maximum No. of Positions (per pole)	Maximum Poles per Deck	Deck
G1A	Make before break	24	1	1 3/8"
C1A	Make before break	31	1	1 3/4"
C2B	Break before make	15	1	1 3/4"
D1A	Make before break	47	1	2 1/4"
D7A	Make before break	14	4	2 1/4"
D8B	Break before make	7	4	2 1/4"
D9A	Make before break	9	5	2 1/4"
E3A	Make before break	47	2	2 3/4"
E8B	Make before break	12	4	2 3/4"
E11A	Make before break	15	6	2 3/4"
F1A	Make before break	60	1	3"



THE DAVEN CO.

185 CENTRAL AVENUE • NEWARK 4, NEW JERSEY

It's Free!

Your copy of Daven's complete, new bulletin on switches. Write for it today.



MINIATURE COMPONENTS FROM STOCK...

SUBOUNCER UNITS

FOR HEARING AIDS...VEST POCKET RADIOS...MIDGET DEVICES

UTC Sub-Ouncer units fulfill an essential requirement for miniaturized components having relatively high efficiency and wide frequency response. Through the use of special nickel iron core materials and winding methods, these miniature units have performance and dependability characteristics far superior to any other comparable items. They are ideal for hearing aids, miniature radios, and other types of miniature electronic equipment. The coils employ automatic layer windings of double Formex wire... in a molded Nylon bobbin. All insulation is of cellulose acetate. Four inch color coded flexible leads are employed, securely anchored mechanically. No mounting facilities are provided, since this would preclude maximum flexibility in location. Units are vacuum impregnated and double (water proof) sealed. The curves below indicate the excellent frequency response available. Alternate curves are shown to indicate operating characteristics in various typical applications.

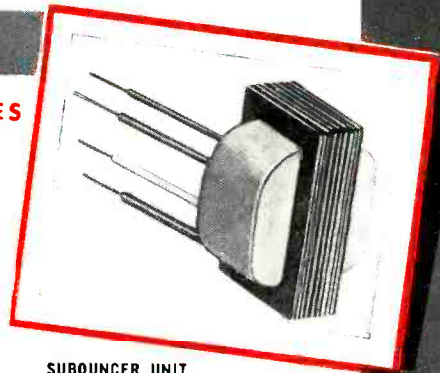

SUBOUNCER UNIT
Dimensions...9/16" x 5/8" x 7/8"
Weight......03 lb.

Type	Application	Level	Pri. Imp.	D.C. in Pri.	Sec. Imp.	Pri. Res.	Sec. Res.	List Price
*S0-1	Input	+ 4 V.U.	200 50	0	250,000 62,500	16	2650	\$ 6.50
S0-2	Interstage/3:1	- 4 V.U.	10,000	0	90,000	225	1850	6.50
*S0-3	Plate to Line	+ 20 V.U.	10,000 25,000	3 mil. 1.5 mil.	200 500	1300	30	6.50
S0-4	Output	- 20 V.U.	30,000	1.0 mil.	50	1800	4.3	6.50
S0-5	Reactor 50 HY at 1 mil D.C.	3000 ohms D.C. Res.						5.50
S0-6	Output	+ 20 V.U.	100,000	.5 mil.	60	3250	3.8	6.50

*Impedance ratio is fixed, 1250:1 for S0-1, 1:50 for S0-3. Any impedance between the values shown may be employed.

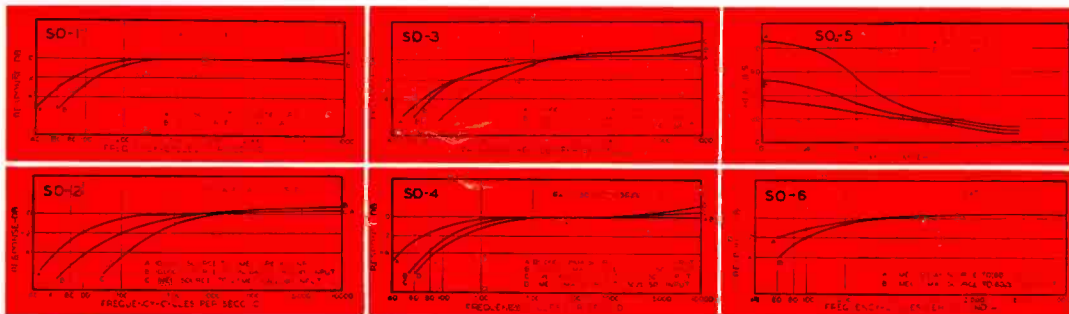

SUB-SUBOUNCER UNITS

FOR HEARING AIDS AND ULTRA-MINIATURE EQUIPMENT

UTC Sub-SubOuncer units have exceptionally high efficiency and frequency range in their ultra-miniature size. This has been effected through the use of specially selected Hiperem-Alloy core material and special winding methods. The constructional details are identical to those of the Sub-Ouncer units described above. The curves below show actual characteristics under typical conditions of application.

Type	Application	Level	Pri. Imp.	D.C. in Pri.	Sec. Imp.	Pri. Res.	Sec. Res.	List Price
*SS0-1	Input	+ 4 V.U.	200 50	0	250,000 62,500	13.5	3700	\$6.50
SS0-2	Interstage/3:1	+ 4 V.U.	10,000	0	90,000	750	3250	6.50
*SS0-3	Plate to Line	+ 20 V.U.	10,000 25,000	3 mil. 1.5 mil.	200 500	2600	35	6.50
SS0-4	Output	+ 20 V.U.	30,000	1.0 mil.	50	2875	4.6	6.50
SS0-5	Reactor 50 HY at 1 mil D.C.	4400 ohms D.C. Res.						5.50
SS0-6	Output	+ 20 V.U.	100,000	.5 mil.	60	4700	3.3	6.50

*Impedance ratio is fixed, 1250:1 for SS0-1, 1:50 for SS0-3. Any impedance between the values shown may be employed.

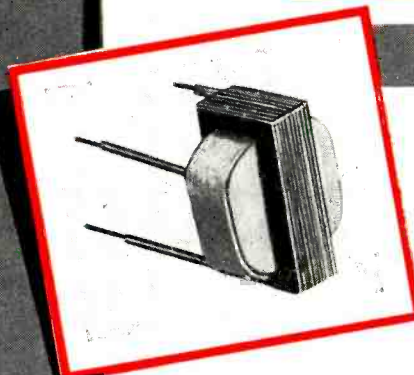
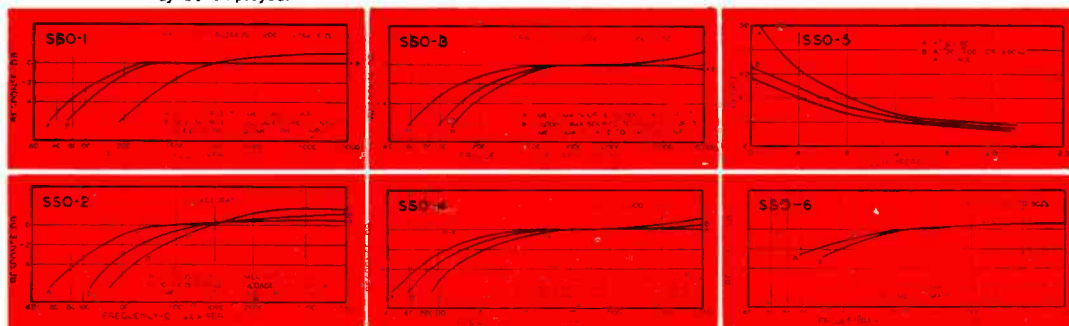

SUB-SUBOUNCER UNIT
Dimensions...7/16" x 3/4" x 5/8"
Weight......02 lb.

United Transformer Co.

150 VARICK STREET NEW YORK 13, N. Y.
EXPORT DIVISION: 13 EAST 40th STREET, NEW YORK 16, N. Y., CABLES: "ARLAB"