

# AUDIO ENGINEERING

JUNE  
1950  
35c

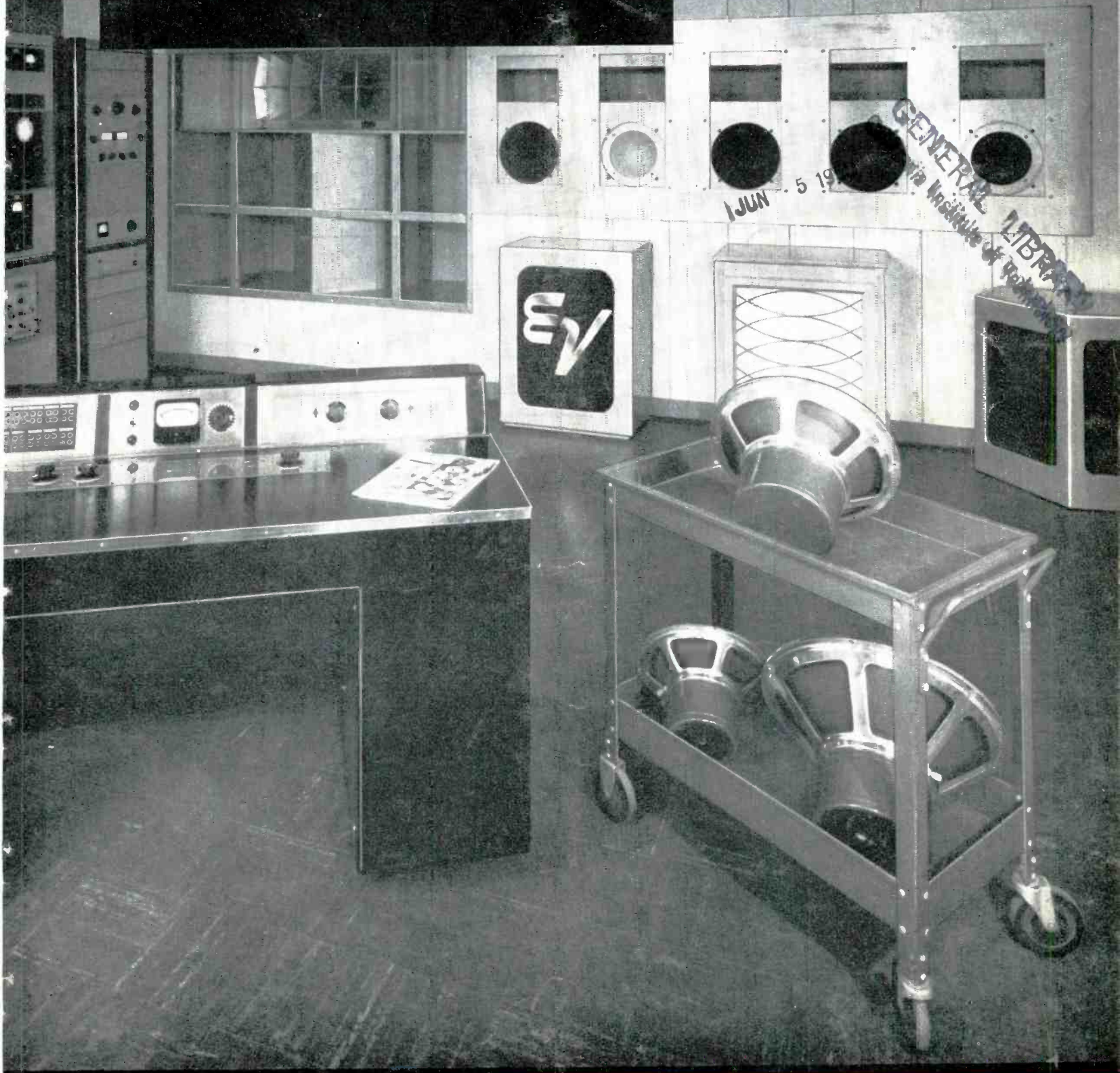

Published by RADIO MAGAZINES, INC.

[www.americanradiohistory.com](http://www.americanradiohistory.com)

Improved Lacquer Formulation gives

# audiodiscs\*

## LOWEST SURFACE NOISE

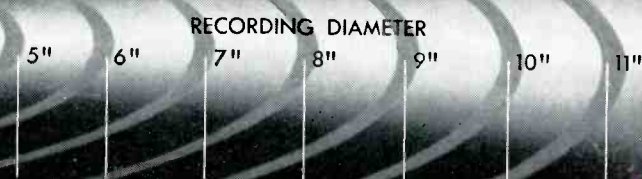
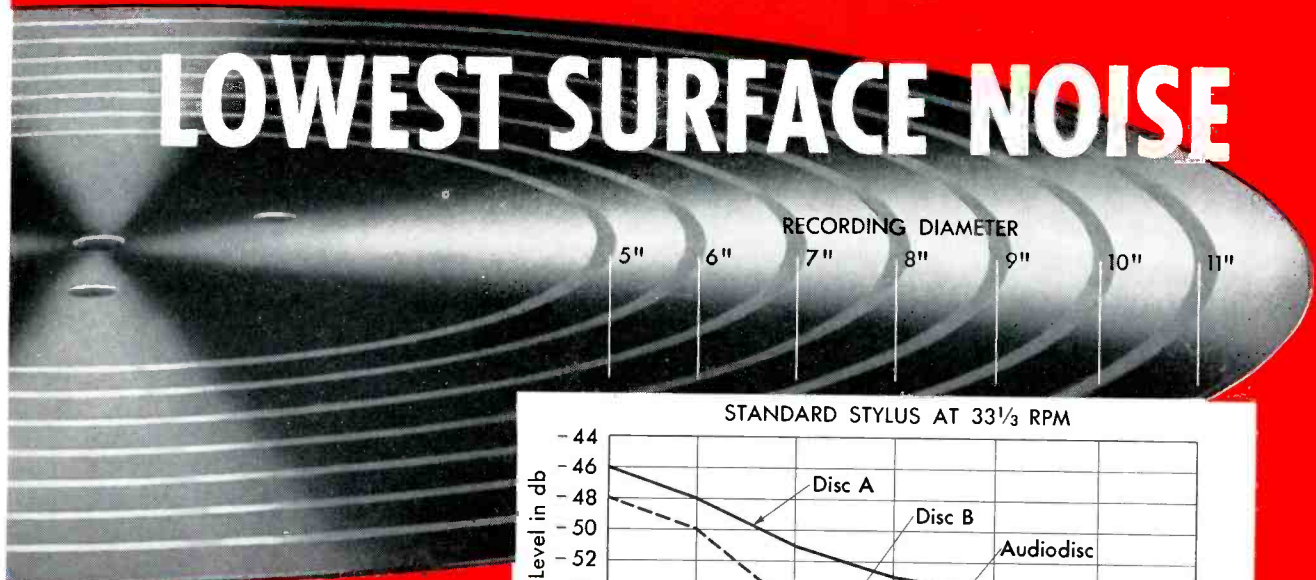

GEORGE M. SUTHEIM, *Audio's Chief Chemist, has developed two major improvements in Audioidisc lacquer*

First was the moisture-resisting lacquer, perfected in 1948. This made all Audioidiscs permanently resistant to humidity—put an end to the "summer troubles" that had plagued the recording industry from the very start. This was followed by his development of the improved, low-surface-noise lacquer—a significant contribution to recording quality.

Mr. Sutheim, a graduate of the Institute of Technology in Vienna, is a chemist of exceptional experience in the field of lacquers and emulsions. He authored "The Introduction to Emulsions" and contributed largely to Dr. J. J. Mattiello's "Protective and Decorative Coating." He has also written many articles on coatings, films, etc., for both French and English periodicals.

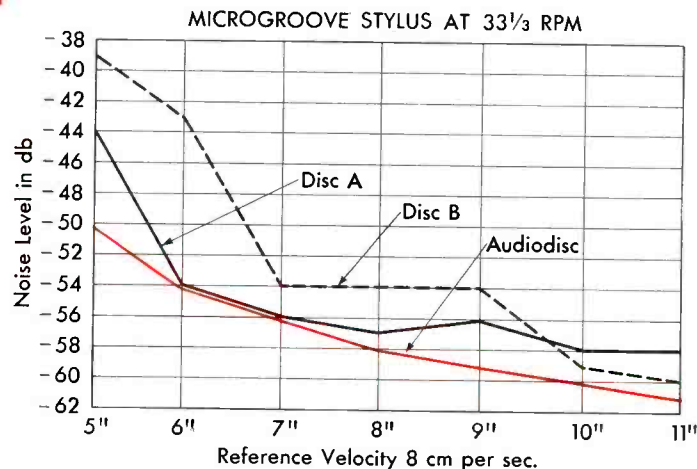
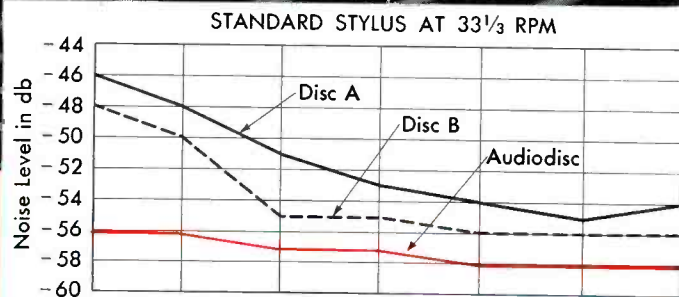

Plotted above are actual surface noise measurements made on an Audioidisc, and on two other makes of discs. Note particularly the *consistently lower noise level* of the Audioidisc.

This drastic reduction in surface noise is the result of an improved lacquer formulation—perfected last Fall, after almost 4 years of research. It has been gradually introduced into production, and since the first of the year, *all* Audioidiscs have been of the improved formulation.

Basically, it contains the same time-tested ingredients that have been used so successfully for the past decade. And it offers the same advantages of recording quality, uniformity, smooth cutting, long life and ease of processing.

The importance of this improvement will be appreciated by all professional recordists.

Audioidiscs are manufactured in the U.S.A. under exclusive license from PYRAL, S.A.R.L., Paris.

### AUDIO DEVICES, INC.

444 MADISON AVE., NEW YORK 22, N. Y.

Export Dept.: ROCKE INTERNATIONAL, 13 East 40th St., New York 16, N. Y.

\*Reg. U.S. Pat. Off.



See also Audio Devices ad on page 43.



# OSCILLATORS GIVE YOU PRECISE TEST VOLTAGES from 1/2 cps to 10 mc!



**-hp- MODEL 200C**

From 1/2 cps to 10 mc, there's an -hp- resistance tuned oscillator engineered to your exact need. Ten precision oscillators in all, including a portable unit that operates from batteries. Each has the familiar -hp- advantages of high stability, constant output, wide frequency range, low distortion and no zero set during operation. -hp- precision oscillators are used by radio stations, manufacturers, research laboratories and scientists throughout the world.

## ANOTHER -hp- SERVICE Person-to-Person Help With Your Measuring Problems

Almost anywhere in America, -hp- field representatives can give you personal help with your measuring problems. They have complete data on -hp- instruments, their performance, servicing and adaptability. Call the nearest -hp- field representative whenever, wherever you need help with a measuring problem.

- ALBUQUERQUE, NEW MEXICO**  
Neely Enterprises  
302 1/2 W. Central Ave., Albuquerque 3-2245
- BOSTON 16, MASSACHUSETTS**  
Burlingame Associates  
270 Commonwealth Ave., KEnmore 6-8100
- CHICAGO 40, ILLINOIS**  
Alfred Crossley & Associates  
4501 Ravenswood Ave., UPtown 8-1141
- CLEVELAND 15, OHIO**  
M. P. Odell Co.  
2536 Euclid Ave., PRospect 1-6171
- DALLAS 5, TEXAS**  
Earl Lipscomb Associates  
4433 Stanford St., LOfan 6-5097
- DAYTON 2, OHIO**  
Alfred Crossley & Associates  
410 W. First St., Michigan 8721
- DENVER 3, COLORADO**  
Ronald G. Bowen  
852 Broadway, AComa 5211
- DETROIT 5, MICHIGAN**  
S. Sterling Company  
13331 Linwood Ave., TOWnsend 8-3130
- FORT MYERS, FLORIDA**  
Arthur Lynch & Associates  
P. O. Box 466, Fort Myers 1269M
- HOUSTON 5, TEXAS**  
Earl Lipscomb Associates  
3919 Riley St., LInden 9303
- HIGH POINT, NORTH CAROLINA**  
Bivins & Caldwell  
Rm. 807, Security Bk. Bldg., High Point 3672
- LOS ANGELES 46, CALIFORNIA**  
Neely Enterprises  
7422 Melrose Ave., WHitney 1147
- NEW YORK 13, NEW YORK**  
Burlingame Associates  
103 Lafayette St., Digby 9-1240
- PHILADELPHIA 44, PENN.**  
Burlingame Associates  
422 Coulter St., TENnessee 9-2006
- SAN FRANCISCO 3, CALIFORNIA**  
Neely Enterprises  
954 Howard St., DOuglas 2-2609
- ST. LOUIS 3, MISSOURI**  
Harris-Hanson Company  
208 North 22nd St., MAIn 5464
- SYRACUSE, NEW YORK**  
Burlingame Associates  
712 State Tower Bldg., SYracuse 2-0194
- TORONTO 2-B, ONTARIO, CANADA**  
Atlas Radio Corporation, Ltd.  
560 King St. West, WAverley 4761
- WASHINGTON 9, D. C.**  
Burlingame Associates  
2017 S Street N. W., DEcatur 8000

### SPECIFICATIONS OF -hp- OSCILLATORS

INSTRUMENT	FREQ. RANGE	OUTPUT	DISTORTION	FREQ. RESPONSE	PRICE
-hp- 200A	35 cps to 35 kc	1 watt/22.5v	Less than 1%	± 1 db to 15 kc	\$120.00
-hp- 200B	20 cps to 20 kc	1 watt/22.5v	Less than 1%	± 1 db to 15 kc	120.00
-hp- 200C	20 cps to 200 kc	100 mw/10v	Less than 1% to 20 kc	± 1 db to 150 kc	150.00
-hp- 200D	7 cps to 70 kc	100 mw/10v	Less than 1% 10 cps to 70 kc	± 1 db throughout range	175.00
-hp- 200H	60 cps to 600 kc	10 mw/1v	Less than 3%	± 1 db, 60 cps to 600 kc	350.00
-hp- 200I	6 cps to 6 kc	100 mw/10v	Less than 1% above 10 cps	± 1 db, 6 to 6000 cps	225.00
-hp- 201B	20 cps to 20 kc	3 w/42.5v	Less than 1/2% (1 watt output)	± 1 db throughout range	250.00
-hp- 202B	1/2 cps to 50 kc	100 mw/10v	Less than 1% 1 to 1000 cps	± 1 db, 10 to 50,000 cps	350.00
-hp- 202D	2 cps to 70 kc	100 mw/10v	Less than 2% 10 cps to 70 kc	± 1 db, 7 cps to 70 kc	275.00
-hp- 204A (Battery Op'd.)	2 cps to 20 kc	2.5 mw/5v	Less than 1%	± 1 db throughout range	175.00
-hp- 650A	10 cps to 10 mc	15 mw/3v	Less than 1% 100 cps to 100 kc	± 1 db throughout range	475.00

For complete details on any -hp- instrument, write direct to factory or contact the -hp- technical representative nearest you.

**HEWLETT-PACKARD CO.**  
1855-C Page Mill Road • Palo Alto, Calif.  
Export Agents: Frazar & Hansen, Ltd.  
301 Clay Street • San Francisco, Calif., U. S. A.



# AMPERITE

## STUDIO MICROPHONES at P.A. PRICES!

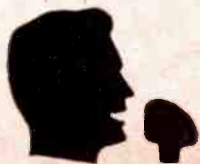

at CLOSE TALKING



and DISTANT PICK-UP

**YOU CAN SHOUT RIGHT INTO IT, or STAND AWAY**  
... In either case, Quality will be perfectly natural. Output change reduced to a minimum by the Automatic Volume Control effect achieved by special construction.

### AMPERITE Ribbon Mike LEADS 7 WAYS

- 1 **BLASTPROOF:** No "boom," or stand 12" away, response is always perfect.
- 2 **LOWEST FEEDBACK:** much less than any diaphragm type mike with equal frequency response.
- 3 **LESS DISTORTION;** 1%.
- 4 **FLAT RESPONSE** without peaks over frequency range of 50-11,000 cps.
- 5 **OUTPUT** (-62 db); automatic volume control effect achieved with special construction.
- 6 **COMPACT** and RUGGED.
- 7 **UNAFFECTED** by CHANGES in climatic conditions, wind, etc.



Models:  
RBLG-200 ohms  
RBHG-Hi-imp.  
List \$42.00



Amperite "Kontak" Mikes  
Model SKH, hi-imp ..... List \$12.00  
Model KKH, with hand volume control ..... List \$18.00

### AMPERITE CARDIOID DYNAMIC MICROPHONE

Models PGH-PGL ..... List \$32.00



**SPECIAL OFFER:**  
Write for Introductory Offer, and 4-page Microphone Folder 53-M

**AMPERITE Company, Inc.**

561 Broadway • New York 12, N. Y.

In Canada: Atlas Radio Corp., Ltd., 560 King St., W., Toronto 2B

## LETTERS

### "Patents" Column

Sir:

I was pleased to see the patent note, in the May issue, on H. L. Daniels' voltage amplifier circuit which I have used on several occasions. Mr. Daniels is currently my associate, and has provided many variations of this circuit for specific applications.

The gain that can be achieved is considerably greater than the "high hundreds"; using a 6SH7 and a 6SF5, a gain of 6000 is readily obtained.

Among other things, the circuit is well adapted for use in negative feedback circuits because of its favorable phase-shift characteristic. It can be changed readily to provide push-pull output and the single phase inversion characteristics may be useful in certain pulse techniques.

John W. Hogan,  
617 E. 24th St.,  
Minneapolis, Minn.

### Identification

Sir:

Don't you suppose that the increase in so-called "unidentified" requests for manufacturers' literature and information comes from the large group of individuals who provide a good portion of the market for radio and allied parts and equipment, while the individuals themselves are not even in the industry? I mean people like myself who take a great deal of pleasure (incidentally spending a sizeable amount of money) in building electronic equipment for self or friends. Naturally, I have no letter-head to use, and postcards are convenient and serve the purpose when I request information. In many instances, information I have received from manufacturers has resulted in the purchase of equipment or parts.

However, there are two outfits which will never get a nickel of my money simply because the first ignored my request for price lists of their components and the second refused to send me the most commonplace information. Of course, I shall not recommend their products to my friends, either.

John Gera,  
6436 S. Hermitage,  
Chicago 36, Ill.

Sir:

In mild disapproval of your May editorial, I assume that your advertisers use  $\text{Æ}$  because they want to reach  $\text{Æ}$ 's readers. In planning advertising expenditures, companies presumably consider that a large section of your readers are interested in audio as individuals, not in a professional way. It would seem reasonable to suggest that those who intend their advertising only for the strictly industrial and professional fields should specifically so state. I have occasionally written in a private capacity for information on products—not in the audio field—required in my professional capacity, merely to avoid the complications involved in going through channels in the rather large company for which I work.

H. Orlo Hoadley,  
324 Hurstbourne Rd.,  
Rochester 9, N. Y.

# AUDIO ENGINEERING

Successor to **RADIO**

Established 1917



**C. G. McProud, Editor**  
Luci Turner, Edit. Prod. Mgr.  
David Saltman, Production Manager  
E. E. Newman, Circulation Manager

**D. S. Potts, Publisher**  
S. L. Cahn, General Manager  
H. N. Reizes, Adv. Mgr.  
Harold Weisner, Asst. Circ. Mgr.

#### Editorial Advisory Board

Howard A. Chinn  
John D. Colvin  
C. J. LeBel  
J. P. Maxfield  
George M. Nixon

#### Representatives

Sanford R. Cowan, Mid-West Sales,  
342 Madison Ave., New York 17, N. Y.  
James C. Galloway, Pacific Coast Sales  
816 W. 5th St., Los Angeles 17, Calif.  
Technical Book & Magazine Co.  
297 Swanston St., Melbourne, C. I.  
Victoria, Australia

## CONTENTS

JUNE, 1950

Vol. 34, No. 6

Letters .....	2
Editor's Report .....	4
Audio Patents— <i>Richard H. Dorf</i> .....	6
The Columbia Hot Stylus Recording Technique— <i>William S. Bachman</i> .....	11
An Adventure in Loudspeaker Design— <i>Howard T. Souther</i> .....	14
Considerations in the Design of Feedback Amplifiers—Part II — <i>Herbert I. Keroes</i> .....	17
Frequency-Controlled Rotary Converters— <i>Robert W. Carter</i> .....	18
The Art of Tape Recording—2— <i>Joel Tall</i> .....	20
Hearing Aid Trends— <i>F. Hardwick</i> .....	23
Audiana—Construction Practice—3— <i>C. G. McProud</i> .....	26
Patent Infringement and the Home Experimenter— <i>Albert E. Hayes, Jr.</i> .....	28
1950 Hearing Show .....	28
Record Revue— <i>Edward Tatnall Canby</i> .....	30
Pops— <i>Rudo S. Globus</i> .....	30
New Products .....	32
New Literature .....	36
Employment Register .....	38
Advertising Index .....	56

#### COVER

Subjective test room used in the development of the new Electro-Voice Radax line of loudspeakers. On the extreme left is a stock theater system used as the ultimate comparison standard. In the five ports are placed alternative comparisons of various makes and designs. The console in the foreground is equipped with level controls for the units under test.

Also in the circuit is a variable high-low equalizer which can shift peak response by actually matching their output audibly and then noting the equalizer settings.

AUDIO ENGINEERING (title registered U. S. Pat. Off.) is published monthly at 10 McGovern Ave., Lancaster Pa., by Radio Magazines, Inc., D. S. Potts, President; Henry A. Schober, Vice-President. Executive and Editorial Offices; 342 Madison Avenue, New York 17, N. Y. Subscription rates—United States, U. S. Possessions and Canada, \$3.00 for 1 year, \$5.00 for 2 years; elsewhere \$4.00 per year. Single copies 35c. Printed in U. S. A. All rights reserved. Entire contents copyright 1950 by Radio Magazines, Inc. Entered as Second Class Matter February 9, 1950 at the Post Office, Lancaster, Pa. under the Act of March 3, 1879.

# DISK Recording WITH TAPE Quality

## Fairchild Thermo-Stylus Kit

- For maximum reduction of surface noise
- For quality recording at innermost diameters

### WHAT IT IS:

A kit of special styli with miniature heating elements, a cutterhead adaptor and a heat control with calibrated meter.

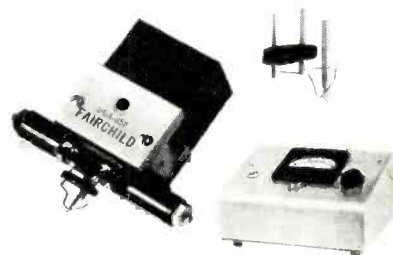

### WHAT IT DOES:

Applies thermoplastic principles to disk recording; eliminates mechanical loading of the cutter by the disk material.

### RESULTS:

- Reduces basic surface noise at least 20 db.
- Minimizes frequency discrimination at innermost diameters.
- Eliminates most difficulties due to production differences in blank disks.

Recordings made with the Fairchild Thermo-Stylus Kit retain the esthetic listening appeal of original sound.

Write for illustrated details—specify your cutterhead.



*Fairchild*

**RECORDING EQUIPMENT  
CORPORATION**

154TH STREET & 7TH AVENUE  
WHITESTONE, NEW YORK FR-112

# EDITOR'S REPORT

## RECORDING CHARACTERISTICS

**M**ANY OF THE more enthusiastic audio hobbyists—always on the search for perfection in their record reproduction systems—search in vain for completely reliable information about the recording characteristics employed in making the various brands of phonograph records. Their letters indicate considerable interest, but in most instances they are completely unanswerable.

This is not altogether the result of our lack of knowledge of what goes on in the recording industry, and it would most certainly be easier to provide each inquirer with a simple printed slip showing the recording characteristic employed by each of the many companies in the field. But, for a number of reasons, this information is not available. In the first place, the characteristics used by a given manufacturer may be changed from time to time, depending upon the opinion of the engineer-in-charge or of those responsible for the over-all sound quality of the product. It also depends upon microphone placement, the studio, or the arrangement of the orchestra in the studio. With any given electrical characteristic, a great variety of "recording characteristics" can be obtained simply by moving the musicians around, or by moving the acoustic "flats," or even by allowing the temperature in the recording studio to rise by as little as ten degrees.

What, then, is the solution for the amplifier builder who wishes to have one switch labeled RCA, Col, frr, LP, and so on, which may be set for any given record with the assurance that it will be played back with optimum quality? It is possible to build such a device which will be infallible? Can the user read the label, set the controls, and just sit back and enjoy his music?

There is a solution to this problem, but it does not come in the form of an answer to the questions proposed. The logical solution, in our opinion, is to provide an amplifier with sufficient flexibility of control that any type of recording characteristic in use can be accommodated readily. Then, the listener can put on the record and adjust the controls so it *sounds* best to him. In the final analysis, this is what he is trying to achieve, but the approach should be based on the ear's satisfaction and not upon the shape of the response curve.

The practical method of doing this—without the necessity of determining the adjustments each time a record is played—is to set up the equalizing controls on a series of tap switches, with the various positions numbered. Then each record can be coded with a set of numbers chosen for best reproduction, and when each is played, settings can be repeated.

Thus it is hoped that a number of inquiries can be answered at once with a method which can eliminate the

need for knowing the presumed recording characteristic.

In all fairness to certain manufacturers—notably Columbia and London frr—it should be stated that many characteristics are adhered to quite closely as far as the *electrical* equalization is concerned. But this does not guarantee that any given record will sound best when played back with the complement of the stated characteristic, and the personal selection by the user of the desired playback curve is certain to be more satisfactory in the long run. In spite of all this, though, it does seem as though record manufacturers would contribute more to standardization if they did publish their characteristic.

Maybe it would be possible for all record manufacturers to use a "standard reproducing system" for their monitoring and checking. If the original recording were then made to sound right on the standard system, it seems certain that the ultimate listener would be assured of hearing the music as the producer intended it to be heard—provided his home system were closely similar to the standard. At least, he would have some place to start.

## SPEAKER CABINETS

On his way through New York to the Parts Show in Chicago, Mr. F. R. Lesser of Goodmans Industries, Ltd., British speaker manufacturers, spent a few hours discussing audio problems in general, loudspeakers in particular. One tangible result was his promise of an article on the theoretical and practical aspects of reflexed cabinet design, to be written by one of his engineers. It is expected that this article will be here in time for the August issue.

## audio anthology

This long discussed, recently promised compilation of early articles from *Æ* has finally gone to press, and mailings will begin on June 15th. It arrived in its final form with 120 pages of text material, comprising over forty separate articles as published in the magazine over the first two years and eight months. The material has been brought up to date in many instances, printing errors have been corrected, the individual articles made to run in complete sequence—no runovers, no advertising.

To the many who have ordered the ANTHOLOGY "sight unseen" we wish to express our appreciation, and we sincerely hope that this compilation of material for the hobbyist will fulfill a demand for articles which we have been unable to furnish in any other form for a long time.

## Outstanding Music and Record Critics Acclaim Pickering Cartridge Reproducers as Unequaled for LP Record Playing

In the February 18th Saturday Review of Literature, E. T. CANBY says: ". . . For pure top-quality sound, Pickering is unbeatable on LP's" . . . and in the January American Record Guide PETER HUGH REED says: ". . . using the Pickering we heard the best of the 45's in a manner which made for the greatest enjoyment of music."

**YES,** Pickering Pickup Cartridges are without equal . . . no other Pickup can equal the performance of Pickering Cartridges on LP's . . . they are widely used by the leading record manufacturers, recording studios, broadcasters and by music enthusiasts who demand the effect of a live performance from their records.

The nearest approach to a live performance is a recording played by a system equipped with Pickering High Quality Audio Components . . . Cartridge, Speaker, Arm, Preamplifier, Record Compensator, etc.

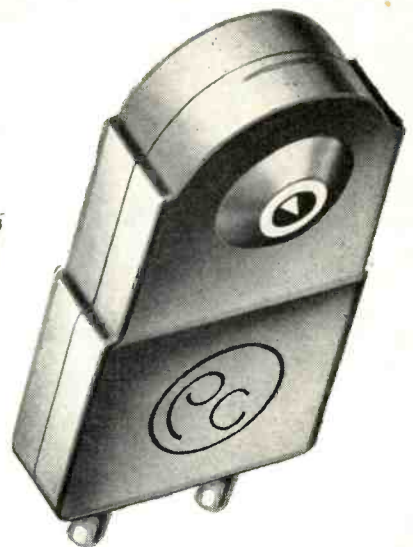

**RECORD  
COMPENSATOR  
MODEL 132E**

This compensator, with 6 positions of equalization, provides the flexibility required to properly equalize for the different recording characteristics used by various record manufacturers . . . it is a most important addition to record playing systems using magnetic pickups.



**LOUDSPEAKER — MODEL 180L**

Designed to satisfy the musical ear. A low-cost high quality loudspeaker with smooth wide-range response (within 5 db, 45 to 12000 cycles) and low distortion . . . the only loudspeaker with acoustically adjustable bass response . . . occupies less floor space than any other high quality loudspeaker — less than one square foot.



**PICKUP ARM — MODEL 190**

The only arm specifically designed for optimum performance on both micro-groove and standard records.

- Magnetic arm rest.
- Plug-in cartridge holder.
- Sensitive tracking force adjustment.
- Statically balanced to eliminate tendency to skip when jarred.
- One-hole mounting — self-contained levelling screws.
- Minimum vertical mass to track any record without imposing extra vertical load on grooves.
- Rugged frictionless bearings.

Cartridges used with this arm require 50% less vertical tracking force than when used in conventional arms.

For the finest audio quality specify Pickering Components

Pickering High Fidelity Components are available through leading jobbers and distributors everywhere . . . detailed literature will be sent upon request.



**PREAMPLIFIER  
MODEL 130H**

This preamplifier represents the most advanced design ever achieved in phonograph preamplifiers.

It equalizes the bass response of records and transcriptions and provides the necessary gain for high quality magnetic pickups . . . its inter-modulation and harmonic distortion is exceptionally low — better than most professional equipment.

**Pickering  
& Company, Inc.  
Oceanside, N. Y.**

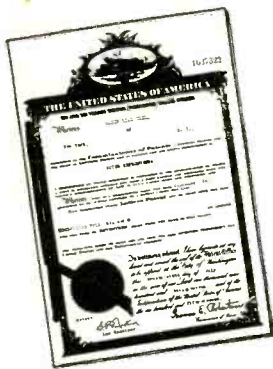

# AUDIO PATENTS

RICHARD H. DORF\*

**T**HE NECESSITY for a loudness control of sorts was recognized long ago by manufacturers of many receivers, who commonly used the tapped-volume-control system. The compensation of that kind of control was extremely sketchy and the results bore little relation to the Fletcher-Munson curves. The subject was revived and given much more thoroughgoing treatment in *AUDIO ENGINEERING* during the last couple of years, with the result that some excellent loudness controls were produced. The drawback (and what probably has prevented their use in commercial amplifiers to date) has been that step-type controls were necessary, with a fair number of resistors and capacitors.

A recent patent by L. J. Bobb (No. 2,491,155, assigned to Philco) discloses

\* *Electronics Consultant, 255 West 84th St., New York, N. Y.*

what the inventor calls a "tone control system" designed to correct the response of an amplifier at low volume levels for the auditory characteristics of the ear. Though Bobb does not associate the device directly with the volume control, there is no reason why an ordinary grid potentiometer cannot be ganged with it.

The circuit appears in *Fig. 1*. The values

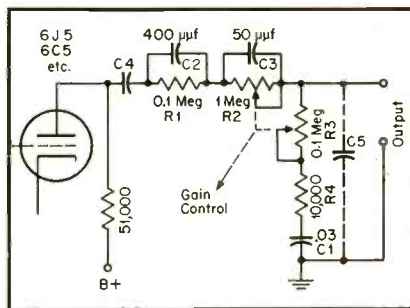

shown are suggested by the inventor for use with a triode voltage amplifier with a plate resistance of about 7,700 ohms. Probably the ordinary 6J5 or 6C5 circuit is entirely suitable.

The output of the triode is applied through coupling capacitor  $C_4$  (large value) to a network with a series and a shunt leg. In this example the ratio of  $R_1 + R_2$  to  $R_3 + R_4$  is 10.  $R_2$  and  $R_3$  are rheostats ganged so that they both reach maximum values together, and they have the same taper. At any point in their rotation, the 10-to-1 relation is maintained so that the mid-frequency transfer of the network is constant.

$C_1$  is chosen so that its reactance in comparison with  $R_5$  at full value is negligible. As  $R_3$  decreases, however, the reactance of  $C_1$  becomes a larger portion of the shunt leg of the network and the low frequencies are boosted. When  $R_3$  is a zero resistance, the boost is about 15 db at 80 cps. (With  $R_3$  at maximum the boost at 80 cps is about 1.25 db.)

The Fletcher-Munson curves also call for a treble boost with lower volume. At the same time wiring capacitances, shown in the diagram as  $C_5$ , reduce highs. The compensation for  $C_5$  is  $C_3$ . As  $R_3$  decreases, the effect of  $C_5$  decreases. Simultaneously,  $C_3$  becomes less effective because  $R_2$  is being reduced. At the same time,  $R_1 - C_2$  becomes a larger portion of the series leg and the increase in highs caused by  $C_2$  is more evident.

The curve of *Fig. 2* gives an idea of what happens to the response with  $R_2$  and  $C_3$  at zero resistance. When they are at

*When seconds count*  
**YOU'RE THERE WITH...**

**SAVES UP TO 500%  
ON HANDLING TIME**

**Handle up to 400 feet of mike cord with short cord ease**

Here's one of the handiest tools ever made for the Radio-Audio Engineer — for either in studio or outside use. Rugged . . . light weight . . . Saves time . . . gets the job done easier . . . faster . . . with less confusion . . . fewer jangled nerves. A must for every special events and remote crew.

**MAKES CORD LAST 5 TIMES AS LONG!**

PORT-O-REEL pays for itself in cord saved. Cord size governs capacity. Some stations and networks use over 400-ft. of 2-wire shielded mike lead, other units equip for 120-volt power transmission. Unwind cord needed . . . set brake.

Reel turns with operator as cord is drawn off. Non-slipping . . . non-tipping. Re-wind 400 ft. of cord in only 40 seconds!

- Weighs only 9-lbs. without cord . . .
- Low, level-wind cord guide prevents kinks and knots.
- Available without cord or equipped with any standard cable and plugs to your specifications.
- Handy screw binding posts permit quick attachment or change of cord on unit.
- Available with receptacle in frame for plug-in of feeder cord or for attachment of feeder cord to screw binding posts.
- Moisture-proof running constant collector ring . . . reel out or wind while broadcasting . . . no audible sound through transmitter.

Patents and Patent Pending

Send for literature, prices and name of nearby distributor.

INDUSTRIAL ELECTRICAL WORKS, 1505 CHICAGO ST., OMAHA 2, NEBR.

**PORT-O-REEL**  
CORD SAVER



**TV Engineers:**  
Ask about the  
3-phase  
Heavy Duty  
POWEREEL



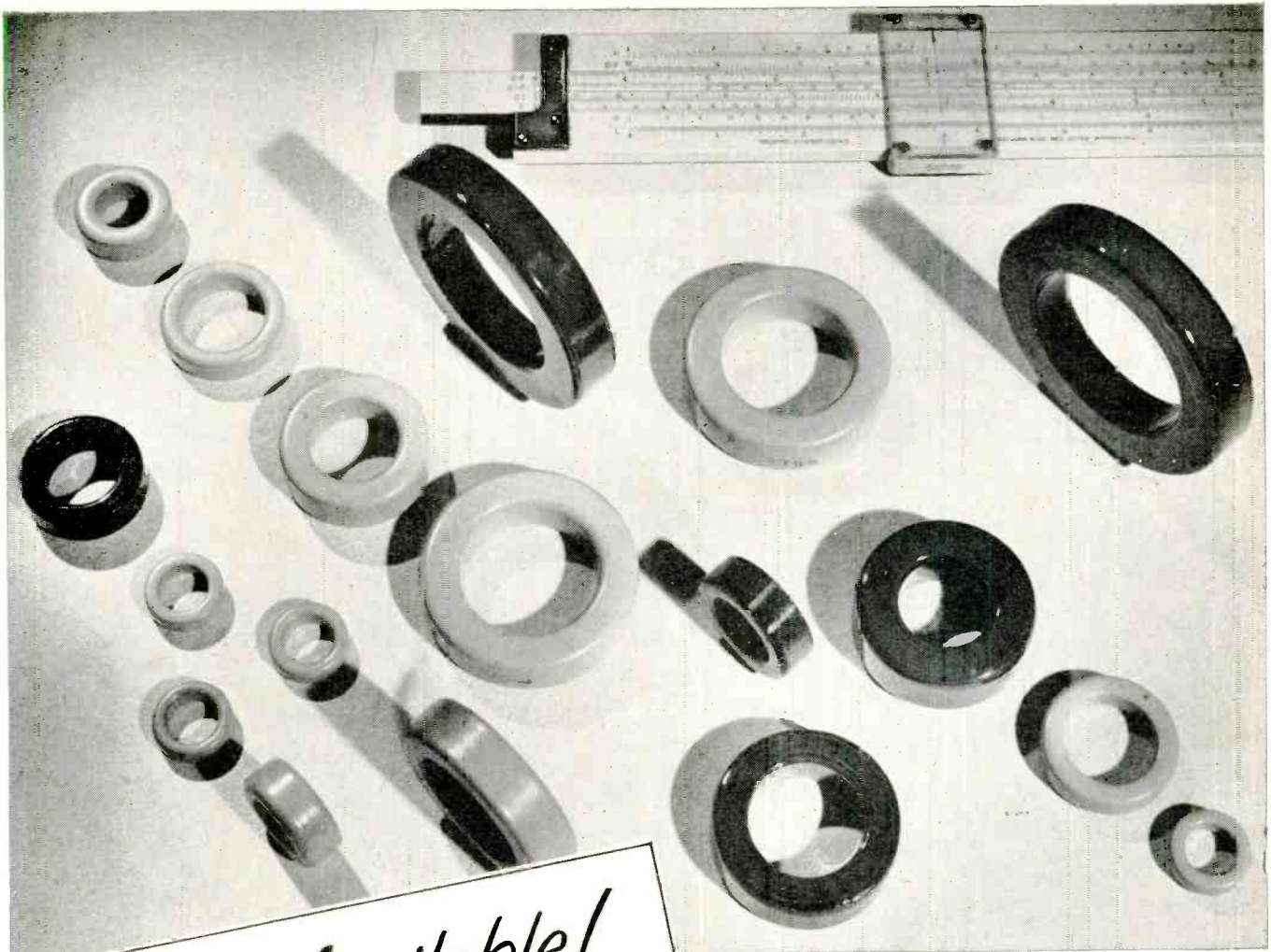

*Now Available!*  
**MOLYBDENUM PERMALLOY  
 POWDER CORES\***

**HIGH Q TOROIDS** for use in  
 Loading Coils, Filters, Broadband  
 Carrier Systems and Networks—  
 for frequencies up to 200 K C

**COMPLETE LINE OF CORES  
 TO MEET YOUR NEEDS**

- ★ Furnished in four standard permeabilities — 125, 60, 26 and 14.
- ★ Available in a wide range of sizes to obtain nominal inductances as high as 281 mh/1000 turns.
- ★ These toroidal cores are given various types of enamel and varnish finishes, some of which permit winding with heavy Formex insulated wire without supplementary insulation over the core.

For high Q in a small volume, characterized by low eddy current and hysteresis losses, ARNOLD Moly Permalloy Powder Toroidal Cores are commercially available to meet high standards of physical and electrical requirements. They provide constant permeability over a wide range of flux density. The 125 Mu cores are recommended for use up to 15 kc, 60 Mu at 10 to 50 kc, 26 Mu at 30 to 75 kc, and 14 Mu at 50 to 200 kc. Many of these cores may be furnished stabilized to provide constant permeability ( $\pm 0.1\%$ ) over a specific temperature range.

*\* Manufactured under licensing arrangements with Western Electric Company.*

W&D 2930

**THE ARNOLD ENGINEERING COMPANY**



SUBSIDIARY OF ALLEGHENY LUDLUM STEEL CORPORATION  
 147 EAST ONTARIO STREET, CHICAGO 11, ILLINOIS

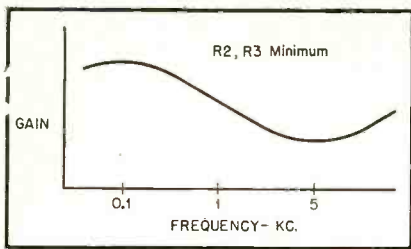

maximum, response is flat except for a 1.25-db rise at 80 cps. To make a continuously variable loudness control, it is only necessary to add a third potentiometer on the same shaft, connected in a grid circuit. A second volume control somewhere else in the amplifier should be preset so that with the new control at maximum, the sound is no louder than the most the owner

desires in the room in which the equipment is installed. A little experiment may be necessary with the value of  $C_3$ . Simply make frequency runs until, with the controls at maximum resistance, a value of  $C_3$  is found which keeps the high end perfectly flat.

#### Interstage Coupling Circuit

Purists who object to the phase shift and falling off of bass caused by interstage coupling capacitors may find a solution in Patent No. 2,494,657, issued to Johan Haantjes of Eindhoven, Netherlands, assigned to Hartford National Bank and Trust Co. The very simple circuit appears in Fig. 3. It is suitable when the plate resistance of the tube is quite low, as with a 6J5-type triode.

The values are selected so that  $R_1 C_1 = R_2 C_2$ . Without going through the many formulas given by the inventor, it is obvious that the impedance ratio of the shunt to the series leg is then the same at all frequencies, as is the phase shift.

The grid-cathode capacitance of the following tube causes a loss in the high-frequency range. To compensate for that, insert  $C_3$  across  $R_1$ . The value of  $C_3$  is  $R_2 C_{gk} / R_1$ . Theoretically,  $C_3$  should be across the entire series leg but if  $C_1$  is reasonably large by comparison (as it will always be in practice) the connection shown is simpler and just as good.

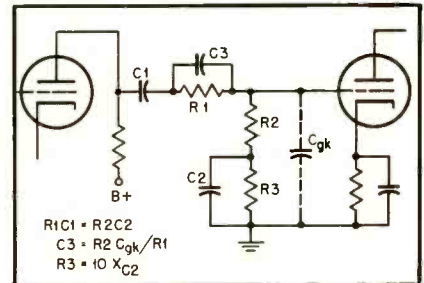

The last step is to provide a grid-leak path for the following tube. That is done with  $R_3$ , whose resistance is large compared to the reactance of  $C_2$  at the lowest desired frequency.  $R_3$  actually upsets the perfection of the network; its effect should be minimized by proportioning components so that  $C_2$  is large enough to permit a practical value for  $R_3$ , yet maintain  $R_3$  at at least ten times  $X_{C_2}$  at the lowest frequency. The network causes a loss of signal level compared to the usual arrangement, but not too much if the components are selected so that the impedance of the shunt leg is several times that of the series leg. The limit there is the necessity of providing for  $R_3$ .

#### Adjusting Binaural Effect

When binaural systems are used with loudspeakers, the realism is governed in large part by the placement of the speakers and the room in which the listeners are sitting. If it differs appreciably from the room in which the sound is being picked up, the binaural effect may be greatly accentuated or reduced.

K. de Boer and R. Vermeulen (both of Eindhoven) help solve the discrepancy

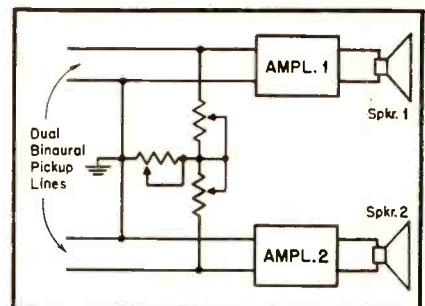

in Patent No. 2,481,911. The binaural effect is greatly accentuated during pickup by making the artificial head with large diameter—increasing the distance between microphones. In the reproducing system, shown in Fig. 4, the two otherwise independent signal lines are joined by what is in effect a variable T-pad. With the pad

[Continued on page 34]

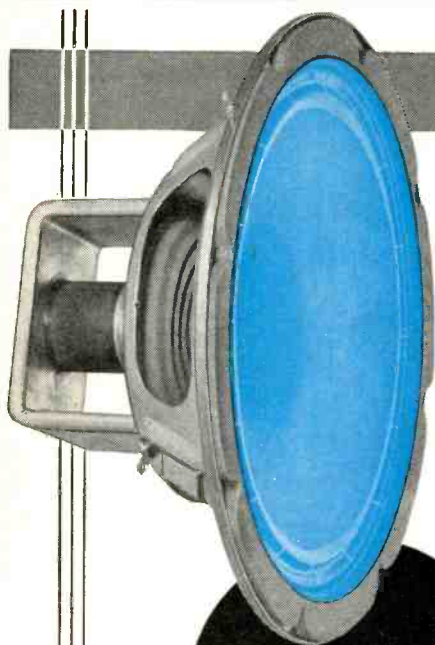

new

## PermoFlux ROYAL EIGHT" compares with any 12" speaker!

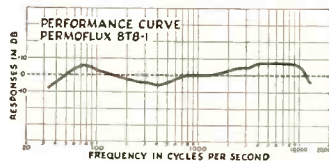

This averaged laboratory response curve of the PermoFlux 8T8-1 proves that it compares with the finest speakers regardless of size or price.

It's Your "Springboard" to Extra Sales with Customers who want 12" performance but don't want to pay a 40% higher price.

PermoFlux  
ROYAL EIGHT"  
with the  
NEW ROYAL BLUE  
CONE

From the resonant boom of jungle drums to the light warble of the flute, this new 8" speaker reproduces sound with superior sensitivity and fidelity. The tonal qualities of this magnificent speaker can only add to the excellence of any audio equipment.

Special processing provides extra-strong cone; allows cone to be soft-suspended from basket and held at coil-end by extra-large spider. Permits more faithful reproduction at lower frequencies. Deeper, curvilinear cone greatly extends high-frequency response.

PermoFlux Royal Eight" (Model 8T8-1) is ruggedly-built, and simple to install. Provides big speaker performance in a small frame—uses smaller, more economical baffle. List Price \$15.00.

Send for Catalog No. J201—Dept. AE

TRADE MARK  
**PERMOFLUX**  
 "SOUND IN DESIGN"  
**PERMOFLUX CORPORATION**  
 4900 W. GRAND AVE., CHICAGO 39, ILL. • 236 S. VERDUGO RD., GLENDALE 5, CALIF.

no matter how you record...



or

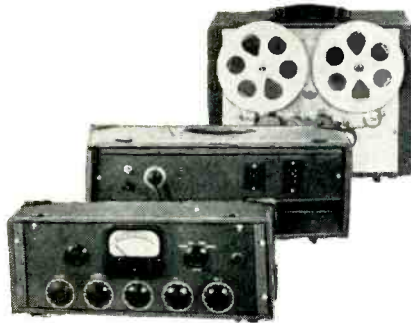

**PRESTO portable tape recorder PT-900**

Packs easily into two portable cases, but sets up into complete broadcast-quality machine. Three heads... erase, record, reproduce. Separate recording and monitoring amplifiers. Available in either 15"/sec & 7 1/2"/sec or 7 1/2"/sec & 3 3/4"/sec. Three microphone input.

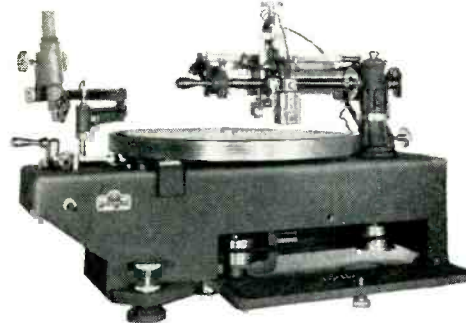

**PRESTO precision disc recorder 8-D**

Designed for extreme accuracy and ease of operation. Available in either rim drive (8-D) or gear drive (8-DG). Frequency response 50 to 10,000 cps. Heavy overhead cantilever cutting mechanism requires no contact with record. Double motor drive on 8-DG. 33 1/3 and 78 rpm.

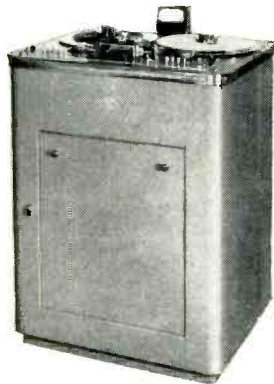

**PRESTO console tape recorder SR-950**

The finest studio-type tape recorder available. Operation by push-button control. Three motors, three heads. Frequency response: 30 to 15,000 cps at 15"/sec. Signal to noise ratio more than 52 db at 1 1/2% distortion. Cabinet designed for rapid maintenance.

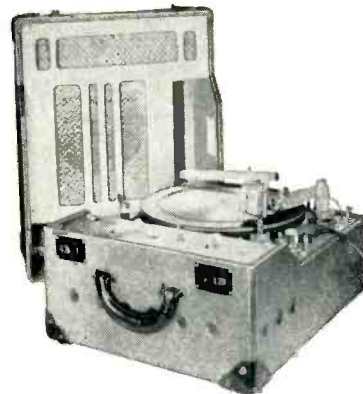

**PRESTO portable disc recorder K-10**

Records and plays microgroove and standard records at 33 1/3 rpm (45 rpm available at slight additional cost). Two interchangeable pickup arms. 12" turntable accommodates 13 1/4" disc. Detachable dynamic speaker, sturdy portable cases. Frequency response: 50-8000 cycles.

**PRESTO** equipment gives **BETTER** results

Well-informed engineers read  
**THE PRESTO RECORDER**  
every month  
Is your name on our free  
distribution list?

 **PRESTO** RECORDING CORPORATION

Paramus, New Jersey

**IN CANADA:** Walter P. Downs, Ltd., Dominion Square Bldg.  
Montreal, Canada  
**OVERSEAS:** M. Simons & Co., Inc., 25 Warren Street  
New York, N. Y.

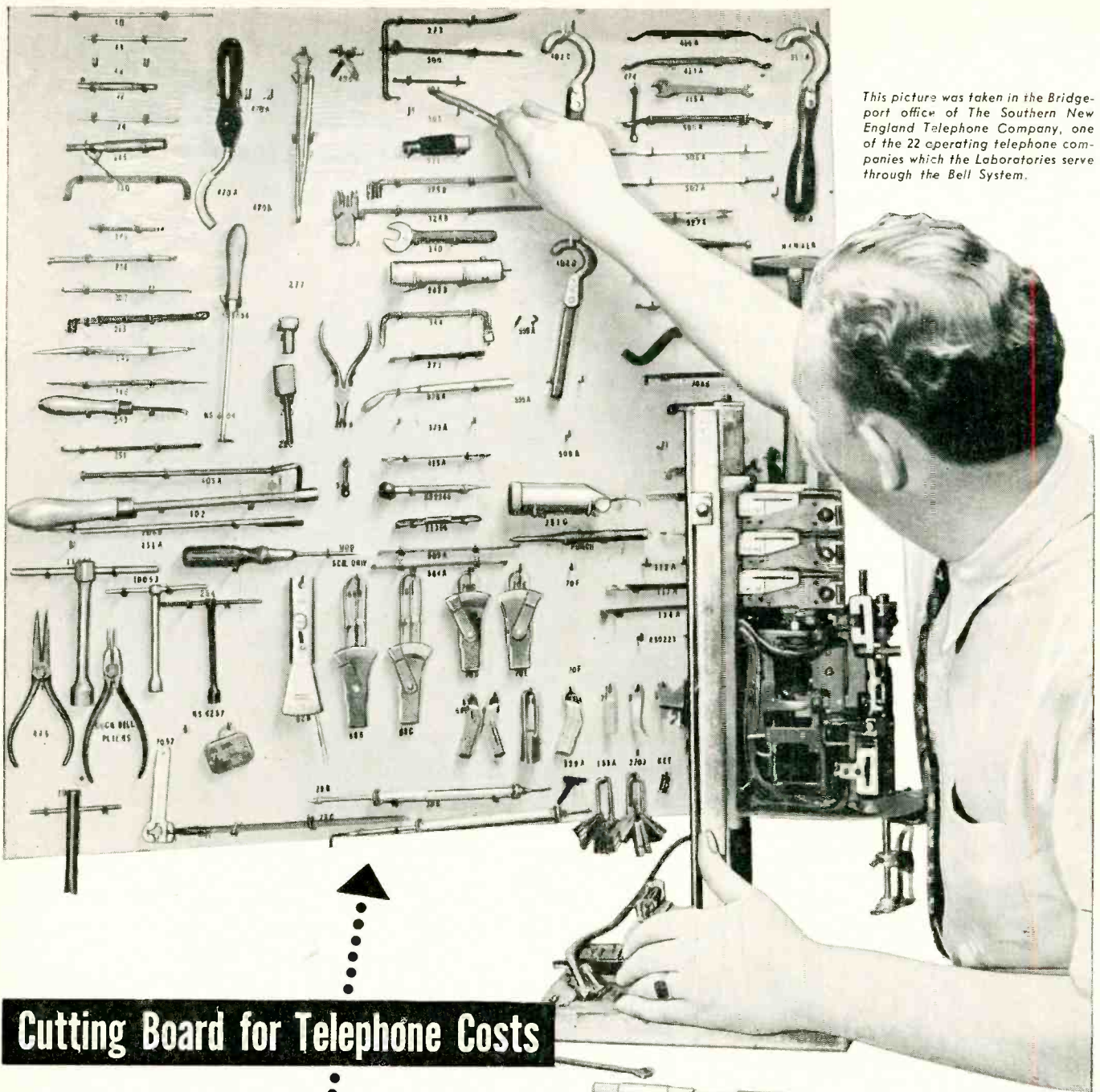

*This picture was taken in the Bridgeport office of The Southern New England Telephone Company, one of the 22 operating telephone companies which the Laboratories serve through the Bell System.*

## Cutting Board for Telephone Costs

Few of these tools have sharp edges. But they are powerful cost cutters. Whenever a telephone craftsman reaches for one, he finds the right tool ready to his hand. There's no time wasted trying to do a complicated job with makeshift equipment.

Most telephone tools are highly specialized. 90% of dial system tools

were designed by Bell Laboratories. Each saves time in maintenance, installation or construction.

There are tools with lights and mirrors to work deep within relay bays; tools to brush, burnish and polish; tools that vacuum clean—even a tool to weld on new contact points without dismantling a relay. There are gauges to

time dial speeds, others to check spring tension. Some look like a dentist's instruments. Some you have never seen.

Keeping the telephone tool kit abreast of improvements is a continuing job for Bell Telephone Laboratories. It's another example of how the Laboratories help keep the value of your telephone service high, the cost low.

# BELL TELEPHONE LABORATORIES

WORKING CONTINUALLY TO KEEP YOUR TELEPHONE SERVICE BIG IN VALUE AND LOW IN COST



# The Columbia Hot Stylus Recording Technique

WILLIAM S. BACHMAN\*

The description of a forward step in the continual drive to increase signal-to-noise ratio.

IN THE CUTTING of disc phonograph records, it has been necessary to strike a compromise between the background noise of the cut and the loss of high-frequency response. The more quiet the cut, the more severe was the high-frequency response loss, the effect being most pronounced at the lower groove velocities which are encountered at the inner diameter of disc records.

It is the purpose of this paper to show that the high frequency loss is largely accounted for by the shape of the cutting edge required to reduce the noise of the cut, and to describe a new technique in which heat is applied to the stylus to obtain a quiet cut. Obtaining adequate quietness of cut in this manner, the cutting stylus may be designed for minimum high-frequency cutting loss.

## Conventional Lacquer Styli

When "instantaneous" lacquer coated recording blanks were introduced, it was noticed that cutting styli of the type used for cutting wax would give a granular noisy cut. For this reason, special cutting styli were developed for use with them. In these special cutting styli, the cutting edge is "dubbed" in a particular way, usually by the provision of one or more burnishing facets on the leading edge of the tool (as illustrated by Fig. 1). Extremely quiet cuts are readily obtained with such styli.

In the playback of records cut on lacquer discs with these styli, it was noted that the high-frequency response dropped off progressively as the groove velocity decreased, the loss becoming quite severe at the inner diameters of  $33\frac{1}{3}$  r.p.m. records. This loss of high frequencies generally was charged to the reproducer—not without reason, for at the time lacquer discs were introduced, most reproducers required bearing forces upon the record of several ounces and had very high needle-point impedances as well. Some reproducing tables were produced having automatic equalizers which increased the high-frequency response as the arm moved toward the center of the record to com-

pensate for this so-called "playback" loss.

This loss of high frequencies was still evident when modern reproducers, having low needle-point impedance and low force upon the record, were substituted for the older types. It was occasionally charged that the size of the reproducer tip was too great to trace the short wavelengths. This would seem to be plausible since reproducer-tip radii of .002" to .0025" were commonly used, and the wavelength of a 10,000-cps tone at  $11\frac{1}{2}$ " diameter and  $33\frac{1}{3}$  r.p.m. is only .002 in. A rigorous examination of the geometry in reproducing disc records<sup>1</sup> shows that below the critical am-

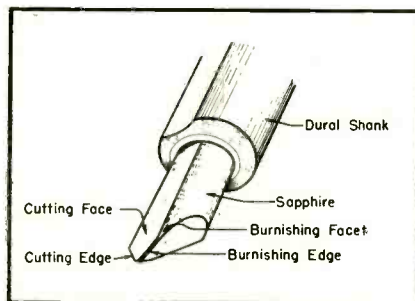

Fig. 1. Perspective view of lacquer cutting stylus.

plitude of the recorded wave, where the radius of curvature of the wave is equal to the reproducer-tip radius, there is no theoretical limit to the frequency which may be traced successfully with a given reproducer-tip radius. It is only necessary that the displacement be limited to values less than the critical amplitude. The critical amplitude varies inversely with the square of the frequency, but even so, quite large values of recorded velocity may be reproduced. For instance, consider the example of the 10,000-cps wave at  $11\frac{1}{2}$ " diameter,  $33\frac{1}{3}$  r.p.m., traced with a .002-in. tip radius. (The effective tip radius at the point of contact with the groove depends upon the included angle of the groove, as may be seen by reference to Fig. 2. If the .002-in. figure above is considered

<sup>1</sup> J. A. Pierce and F. V. Hunt, "On Distortion in Sound Reproduction from Phonograph Records," *J. Acous. Soc. Am.*, July 1938.

as the radius at the point of contact in a 90-deg. groove, the actual physical size of the stylus tip would be .0028 in.). The peak recorded velocity at critical displacement would be 3.2 in./sec. which is far greater than the probable level of 10,000 cps in program material, even with 100-microsecond pre-emphasis.

## Measurement Technique

In a study which was undertaken to separate the possible causes for the observed loss of high frequencies, it was first necessary to settle on the means by which the loss might be measured. The Buchmann-Meyer optical method of measuring the width of the reflected light pattern was considered as a means of indicating the recorded velocity. This has the obvious advantage that possible deformation of the recorded wave due to the reproducer is avoided. While good agreement has been obtained between the light pattern and measurements made with a carefully calibrated reproducer at high groove velocities, of the order of 40 in./sec., considerable disparity is encountered at low groove velocities.

At these low velocities, it is usual for the pattern to show differing widths on opposite sides of the center. The two widths are usually averaged to obtain the apparent velocity. The disparity between the two values which are averaged indicates a rather large area of uncertainty, which throws some doubt on the reliability of the method. It is possible that waveform distortion components may account for some of the

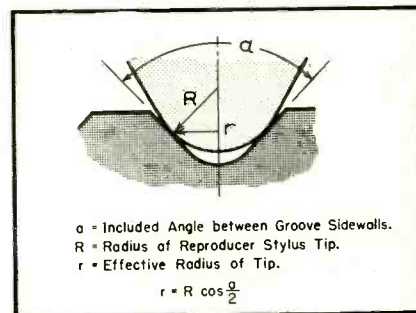

Fig. 2. Cross-sectional view of reproducer stylus in contact with record groove.

\* Columbia Records, Inc., 799 Seventh Ave., New York 19, N. Y.

disparity, or that the "horns," the small ridges which are often thrown up above the plane of the uncut record on both sides of the groove, may affect the pattern. The groove cross section in Fig. 3 shows these horns clearly. Roys, in a paper delivered before the IRE convention in New York in April 1949, pointed



Fig. 3. Photograph of groove cross section showing "horns" thrown up on upper edges of groove.

out that better agreement between the Buchmann-Meyer pattern and other types of measurement were obtained when the light pattern was taken from the matrix which was used to press the record under consideration. This might have some connection with some observations in our laboratory in which the depth of modulation appeared to vary with the size of the reproducer tip used. A "V" type of groove was used, and the observations were made at frequencies and amplitudes chosen so that the tip radius was not more than one fifth of the minimum radius of curvature of the recorded wave.

In view of the foregoing, and on the premise that a record is made more to be played than to be looked at, it was decided to take all of the high-frequency loss data by playback response measurements, using a variable-speed-turntable-calibrated reproducer. This measuring technique is very thoroughly described by Haynes and Roys.<sup>2</sup>

#### High-Frequency Response

In 1946, experimental frequency records were cut with varying input levels, all below the critical amplitude (where the minimum radius of curvature of the recorded wave equals the reproducer-tip radius). The playback response to some of these test records is shown in Fig. 4. It was thereby determined that the playback response was proportional to the input and that the shape of the curve of response vs. frequency was not altered with change in level below this critical value. This indicates also that the effective impedance of the cut groove at the points of contact with the reproducing stylus is either constant, regardless of amplitude level below the critical value, or sufficiently high to be unaf-

ected by the needle-point impedance of the reproducer used in the tests.

Additional test records were cut using a wide range of frequencies over a large number of diameters. Plotting the playback response level from them against the wavelength of the recorded wave showed that the same shape of curve would result for a particular recording stylus and disc material, regardless of the frequency employed, with one important exception. This exception applies to frequencies in the neighborhood of the resonant frequency, or frequencies, of the cutter. At resonance the cutting point impedance reaches its lowest values, and in many cases it gets low enough to be affected by the impedance of the record material being cut. To get good data, therefore, it was necessary to use a cutter having high mechanical impedance or to monitor the motion of the recording stylus by means of an FM calibrator or the equivalent. The wavelength of a constant-frequency tone varies with the diameter at which it is cut, assuming that the rotational speed

is constant. For this reason, the same wavelengths were obtained at several frequency and diameter combinations of the various test records used. The overlapping regions of the playback level vs. wavelength curves coincide when corrections for the various levels used in the several test cuts are made. The resulting curve of response vs. wavelength for a particular stylus and material is a smooth one, having remarkably similar shape to the  $\frac{\sin x}{x}$  curve which describes aperture loss in optical and magnetic recording.

Several response vs. wavelength curves are shown in Fig. 5. Below the curves are additional plots which indicate wavelengths in terms of the frequency and diameter of records turning at 78 and 33 1/3 r.p.m. It is seen from these plots that the "wavelength" loss is more severe with "dubbed" styli and is affected very considerably by the mechanical properties of the material being cut. If a comparison is drawn with the aperture effect mentioned above,

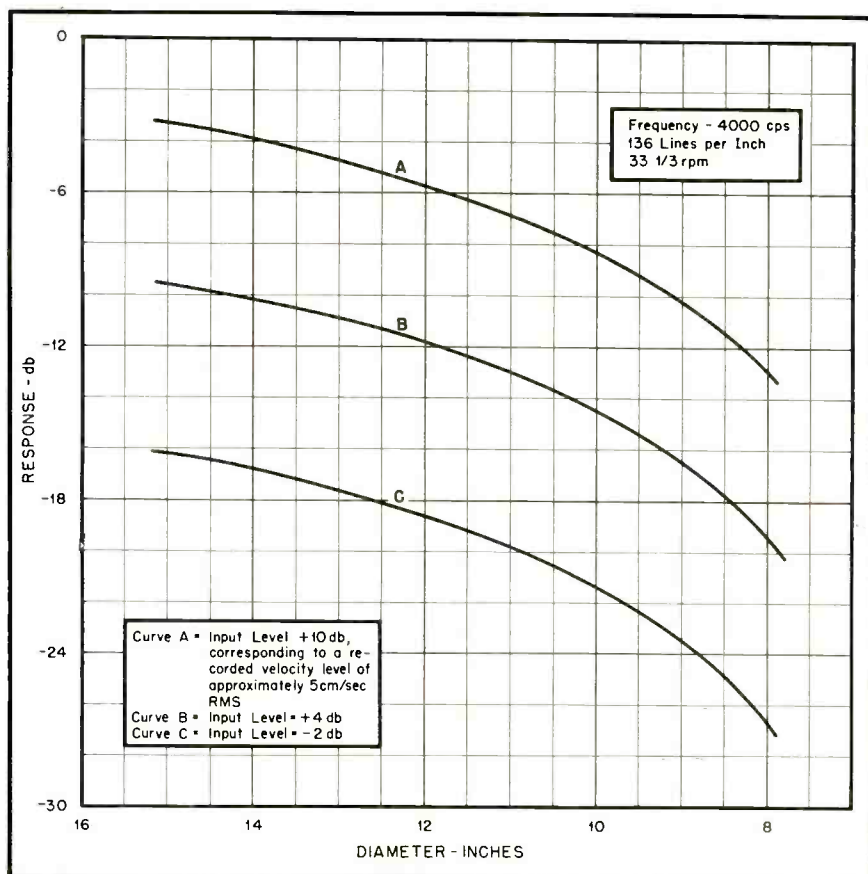

Fig. 4. Curves of playback response of 4000-cps tone vs. diameter for three values of channel input level. The shape of the three curves is similar, and the output is a linear function of input within the probable error of measurement.

<sup>2</sup> "Calibration of Disc Recording Pick-ups," *Proc. I.R.E.*, March 1950, Vol. 38, No. 3.

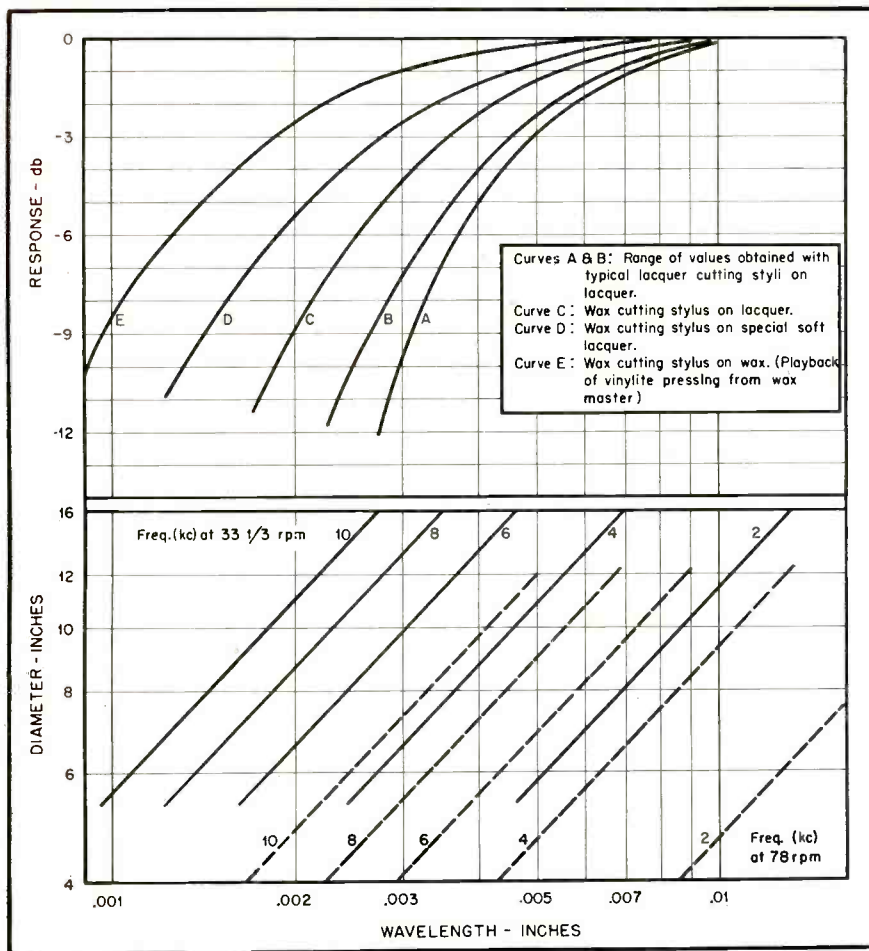

Fig. 5. Playback response vs. wavelength of recorded waves. The lower family of curves relates the wavelength to the frequency and diameter of records turning at 78 and 33 1/3 r.p.m.

the effective gap or aperture appears to be quite large, similar in effect to that obtained when a magnetic tape is being held at a fixed distance away from the pole faces.

#### Heated Stylus Performance

On the theory that the burnishing facets on the recording styli were producing heat through friction to "flow" a smooth surface on the cut groove, it was proposed that the stylus be heated by other means. The first method tried, in early 1948, consisting of winding a small coil of copper wire directly on the sapphire jewel and heating it with a direct current, worked so well that it is still in use, although many other means have been considered. The effect of this heat on the reduction of the groove noise was so pronounced that it immediately became apparent that much smaller, or possibly negligibly small, burnishing facets could be used. This also was found to be true, the styli with smaller facets requiring more heat to

get roughly the same background noise.

Figure 6 is a plot of the noise of a cut made with a sharp edge cutting stylus with varying heating currents applied. The noise was measured on a velocity basis over a band extending from 500 to 8000 cps. The 500-cps limit was chosen to eliminate hum and rumble

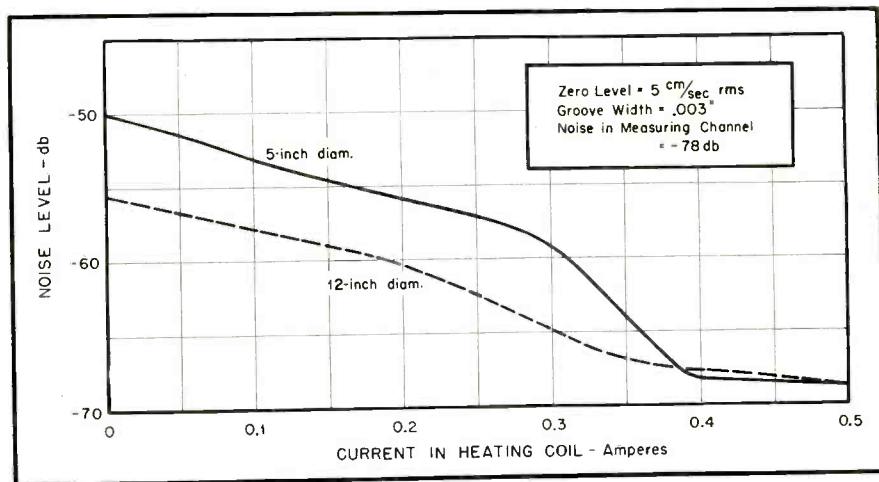

Fig. 6. Curve showing noise level in unmodulated groove vs. current in stylus heating coil. The noise is measured with a playback channel having uniform velocity response over a frequency band extending from 500 to 8000 cps.

vibration from the measurement, and the 8000-cps upper limit was chosen to avoid response in the region where the dynamic mass of the reproducer at the stylus tip might resonate with the compliance of the groove which it engages. Since these measurements were made on a velocity basis, it is evident that a further reduction in the measured noise would be obtained with roll off of the high frequencies, such as that used to equalize for pre-emphasis in recording. Even so, reductions of as much as 18 db in the background noise are readily effected, giving a resulting noise level 68 db below the NAB standard recorded program level.

The actual temperature attained by the stylus was not measured, but, based on the resistance of the coil, the power supplied is in the order of one watt. With values of current in the order of 0.4 to 0.5 amperes, the heat is sufficient to give equivalent results in respect to noise and high-frequency response loss over a wide range of lacquer materials. The high-frequency loss data obtained with heat of this order agrees very closely with curve E of Fig. 5.

#### Conclusion

This development, which was undertaken in the laboratories of Columbia Records Inc., now makes possible the cutting of lacquer discs with very low background noise and a minimum of high-frequency response loss. All of the advantages which formerly were peculiar to wax are realized, without sacrificing the convenience and utility of lacquer discs for direct playback and processing.

attaining truer and more satisfying reproduction. A further advantage lies in the ability of multiple media to reduce further the effects of transient and intermodulation distortion, brought about by the simplified design of the particular driver for a specific restricted range of frequencies.

Measurement is made in almost the same way as it is for intermodulation. The fundamental tone is filtered out and the resultant harmonics generated are read in terms of percentage.

#### The Problem and its Solution

As a result of our tests, we may now draw some conclusions. These conclusions, in turn, should form the crux of our problem.

1. *A two-way system* is a requirement in order to achieve adequate range response. A single cone made of present materials will not respond on extended ranges. Good high-frequency response may be obtained from a cone that is small and light. Over 6 grams, however, even with large magnet powers, response beyond 10,000 cps begins to droop. Good low-frequency response with usable efficiency requires a cone at least 12 in. in diameter. It also must be stiff and therefore, unfortunately, heavy. Listening tests will sometimes indicate wonderfully efficient response in the low end from a light cone, but analysis reveals that the signal is comprised totally of second and third harmonic, devoid of any measureable fundamental whatsoever. Fourteen grams seems to be the least weight we can stand without bass breakup and harmonic distortion. The employment of two distinct driving media is incontrovertibly indicated.
2. *The task of subduing distortions* is made considerably less difficult by utilizing two cones. The cones can be designed for least breakup distortion in the specific ranges they reproduce.

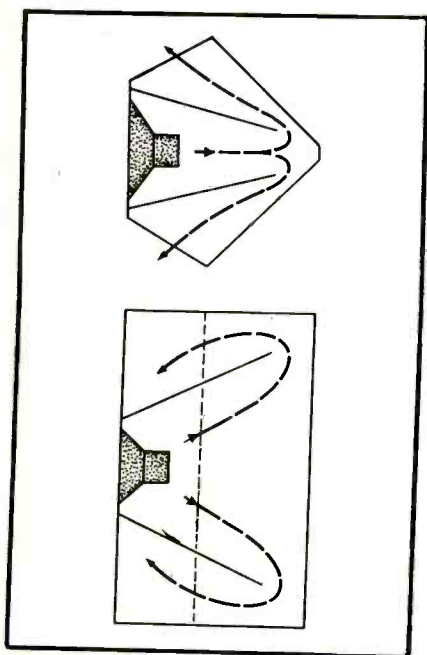

Fig. 4. Diagram of interior arrangement of corner cabinet.

3. *Efficiency* must be reasonably high in order to make economical use of moderate, lower priced, amplifier powers. Every time cone weight is halved, efficiency is increased by a factor of 4, except on extreme bass. Here the mass of the air moved becomes equal to that of the cone or higher and it loads the motor, or voice coil, very heavily. But on highs, power is directly proportional to the mass. We have touched on the importance of cone weight in our first conclusion. Voice coil weight is also very important. If the mass is halved, the power is doubled. Maximum conductor with least weight is obtained by using edge-wise wound aluminum ribbon, resulting in a coil of minimum weight and thickness for the flux gap.
4. *Economy cannot be realized if we must utilize two driving motors for the separate cones.* Magnet material comprises more than half the cost of the speaker. If two efficient and expensive magnet structures must be employed, we are right back where we started.

unit are to be realized, and one especially satisfactory cabinet is shown in Fig. 3.

The Radax high frequency unit requires no baffles. Operating as a true piston, the power is directly proportional to mass and force to all intents and purposes. But not so the bass driver. The velocity at low frequencies is influenced by other factors, the most important of which is sufficient air load on the bass cone. The internal diagram, Fig. 4, shows the loading on the rear of the cone, utilizing the advantages of the familiar corner style design. A 4½-ft. folded path is employed, while allowing front radiation of high frequencies without attenuation.

In closing, the final, conclusive and all-important question must be asked: How does the new Radax Speaker sound?

This, too, is a matter susceptible to

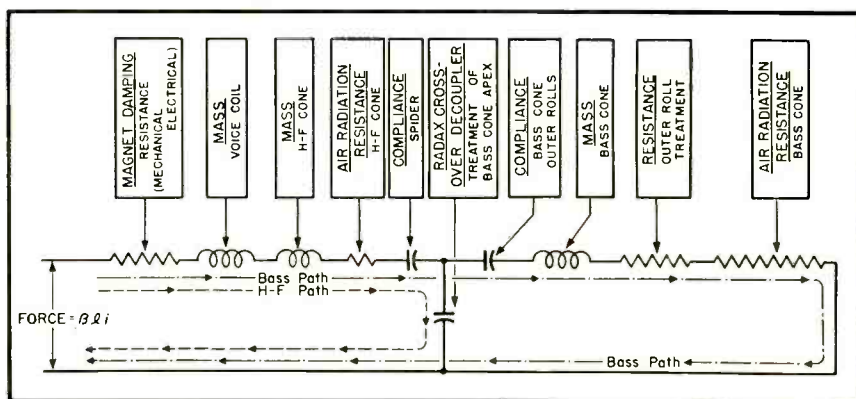

Fig. 5. Equivalent circuit of Radax speakers.

It may be concluded from the foregoing paragraphs that one magnet structure can supply all the energy required for both high and low frequencies—but that a single cone cannot transmit the full range. From the data now compiled we may establish an equivalent electrical circuit.

Figure 5 shows a series circuit with the exception of the capacitive equivalent of the Radax decoupler, or crossover component, paralleling the line. The mass of the HF cone is small compared to the mass of the LF cone. There is also the large resistive component caused by the radiation resistance of the bass cone in air. It will be easily seen that HF generation will be quite small.

But now consider a compliance of the proper characteristics paralleling the line. Two distinct paths, one for high frequencies and one for low frequencies are now offered.

#### An Enclosure for Radax

The design of a good loudspeaker is incomplete without full consideration being given to an enclosure. This is of paramount importance if the low-frequency possibilities of the new driver

clinical test. The requirements for this judgment are several.

1. Surroundings should be comfortable and pleasant. They should simulate acoustically those conditions found in the average living room.
2. The source material should be the best obtainable technically—currently, this means tape recorded directly from a live performance. In addition, the subject matter must be in a category compatible with the judge's personal tastes—no popular music for the "long hair," and vice versa.
3. The ear has a phenomenally short memory. Accordingly, it can evaluate properly only by comparisons made at the same time. Therefore, the judging procedure consists of deciding, first, that this speaker is better than that—and that speaker was better than three others, and so on. Moreover, these decisions are based on instantaneous switching, or A-B tests.

In the final test the Radax Twelve was chosen for listening quality 70 per cent of the time on a direct comparison with the highest priced coaxial speaker commercially available, costing exactly six times as much. The more expensive speaker was 6 db more efficient. The listeners were selected from available, qualified high-fidelity enthusiasts. If the foregoing is a criterion, Radax has accomplished its mission.



# Considerations in the Design of Feedback Amplifiers

HERBERT I. KEROES\*

Part II. A study of the practical application of feedback to both triode and tetrode amplifiers, and of some of the pitfalls which must be avoided.

SO FAR a number of common performance faults in feedback amplifiers have been given which must be overcome to secure optimum results. The means by which they may be overcome are dependent on the skill of the designer and on the merit of the circuit components which he chooses to use. However, it is always consistent with good design principles toward meeting the essential conditions with a minimum of circuit elements.

As far as the system of feedback is concerned, a multiple loop system can be adopted with a main loop to provide a predetermined amount of feedback, and with minor loops or local feedback to correct for undesirable phase and amplitude excursions at the end frequency limits. Moreover, complicated interstage networks may be used to provide the same effects. The simplest and most adaptable system of feedback is based on taking a portion of the load voltage, either across the load winding of the

\* Acro Products Company, 5328-30 Baltimore Ave., Phila., Pa.

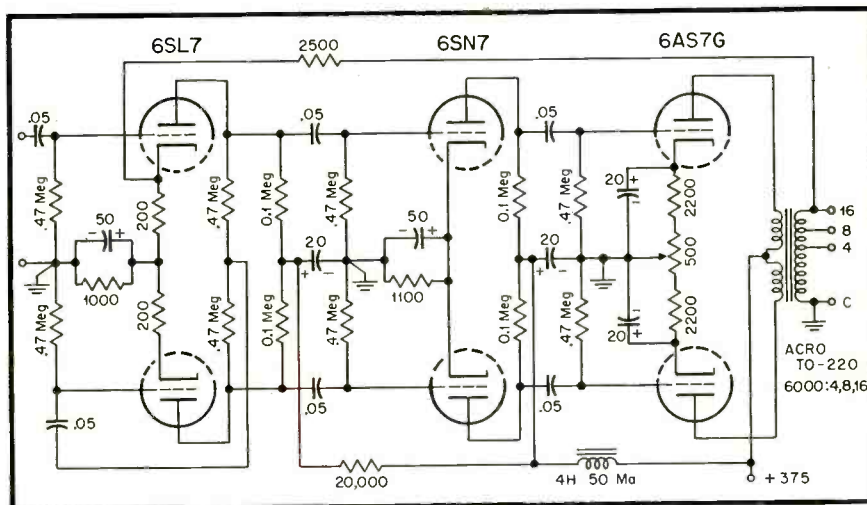

Fig. 3. Conventional 6AS7G output stage with resistance coupled driver and preceding phase inverter.

output transformer or across a tertiary winding included for the purpose, and feeding this back to an earlier single-ended stage. In this manner the feedback voltage is accurately sampled as a

portion of the output of the amplifier as a whole, and is reintroduced where it will have maximum effect at all frequencies.

It is interesting to compare this method with some other systems commonly used to obtain the feedback voltage. Occasionally a circuit is shown in which feedback is taken from one or both output plates into earlier stages. All output transformers contain an inevitable amount of leakage reactance which tends to isolate each of the push-pull output tubes from each other at the higher frequencies. Feedback voltage, so taken, is not representative of the output of the amplifier as a whole, but is only representative of the behavior of the individual output tubes. Moreover, feedback of this type introduces additional phase shift which is not a part of the amount that must be accepted because of the high-frequency gain characteristic of the output stage.

### Output Transformer Characteristics

When the output transformer becomes a part of the feedback loop, the normal phase shift due to the high-frequency loss of gain in the transformer is 90 deg. In order to maintain this as a practical as well as a theoretical value, many

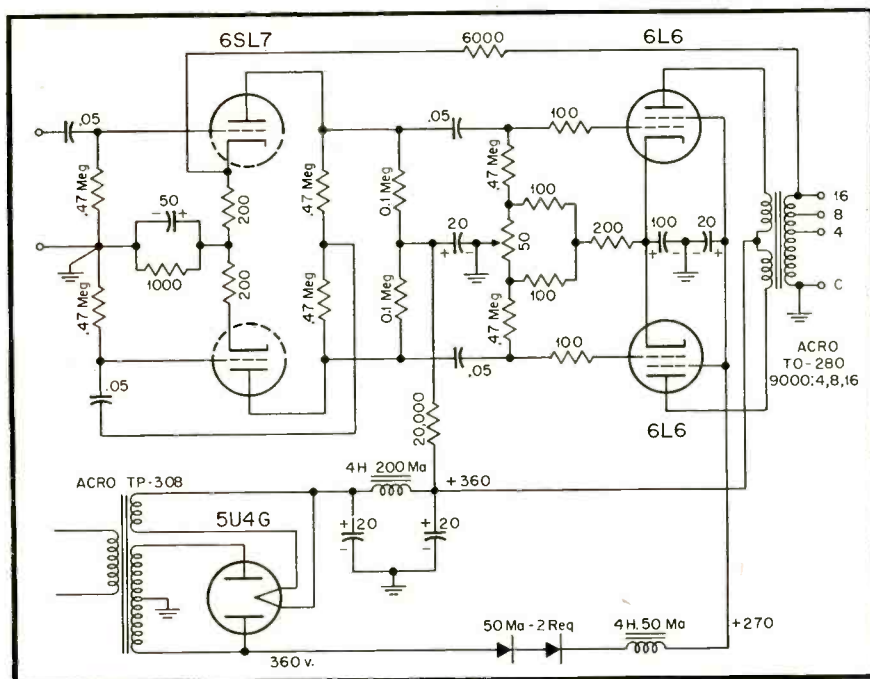

Fig. 2. Two-stage 6L6 amplifier with feedback from secondary of output transformer. Note unique method of obtaining screen voltage for output tubes.

[Continued on page 46]

# Frequency-Controlled Rotary Converters

ROBERT W. CARTER\*

Design and performance of converters used as a portable power supply for broadcast remote wire and tape recordings.

IN RECENT YEARS, development of high-quality portable tape recorders for broadcast use has advanced to the point where they are highly satisfactory for broadcast programming. The problem of a constant a.c. frequency source on mobile operation has dogged broadcast engineers for some time. The Frequency-Controlled Super Converter, shown in Fig. 1, was developed in collaboration with network engineers to provide that source of constant-frequency a.c. power. This type of portable rotary power supply is ideally suited for emergency recordings (for later re-broadcast) of sporting events, floods, interviews, disasters, and many other "on the spot" broadcast requirements.

Wire or tape recorded motors are of synchronous design and therefore must operate at constant 60-cps input, or program timing will be incorrect when the remote recording is broadcast from 60-cps line source at the studio. Even if timing is unimportant, recording frequency must be within  $\pm 1$  cps or voice pitch will, of course, be unnatural. The problem of constant a.c. voltage, however, is of no concern, as most recorder motors and amplifiers operate satisfac-



Fig. 1. Frequency Controlled Super Converter for broadcast service. Note rheostat control and frequency meter.

torily from 100 to 125 volts. Power factor of the recorder load must be considered in the converter design, for inductive loads will increase converter armature speed and frequency. Most wire and tape recorders possess a power factor of 65 to 70 per cent.

#### Primary D.C. Source

While it is possible to operate larger tape recorders from a 6-volt source with

the frequency-controlled converter, the battery drain is usually too high for average broadcast recording requirements. A 12-volt primary source is therefore desirable; where space permits, a 24-volt source from small, light weight aircraft batteries is ideal. The graph shown in Fig. 2 indicates average broadcast tape recorder performance from a standard converter<sup>1</sup> from a 12-volt 135 ampere-hour battery. (Note the 5-cps frequency deviation.) Figure 3 illustrates the performance range of the same converter with frequency control under identical conditions, and it will be noted that the 60-cps output now remains constant. Where light weight and portability are of prime importance, a smaller battery can be used if recording does not exceed one half hour before the battery can be recharged. Figure 4 indicates recording time versus primary voltage drop for a small aircraft-type 24 ampere-hour battery.

#### Frequency Control Principle

The frequency controlled converter is designed to deliver a 60-cps output at full rated load at the highest input volt-

<sup>1</sup> Model B1010 CW4, without frequency control.

\* President, Carter Motor Co.

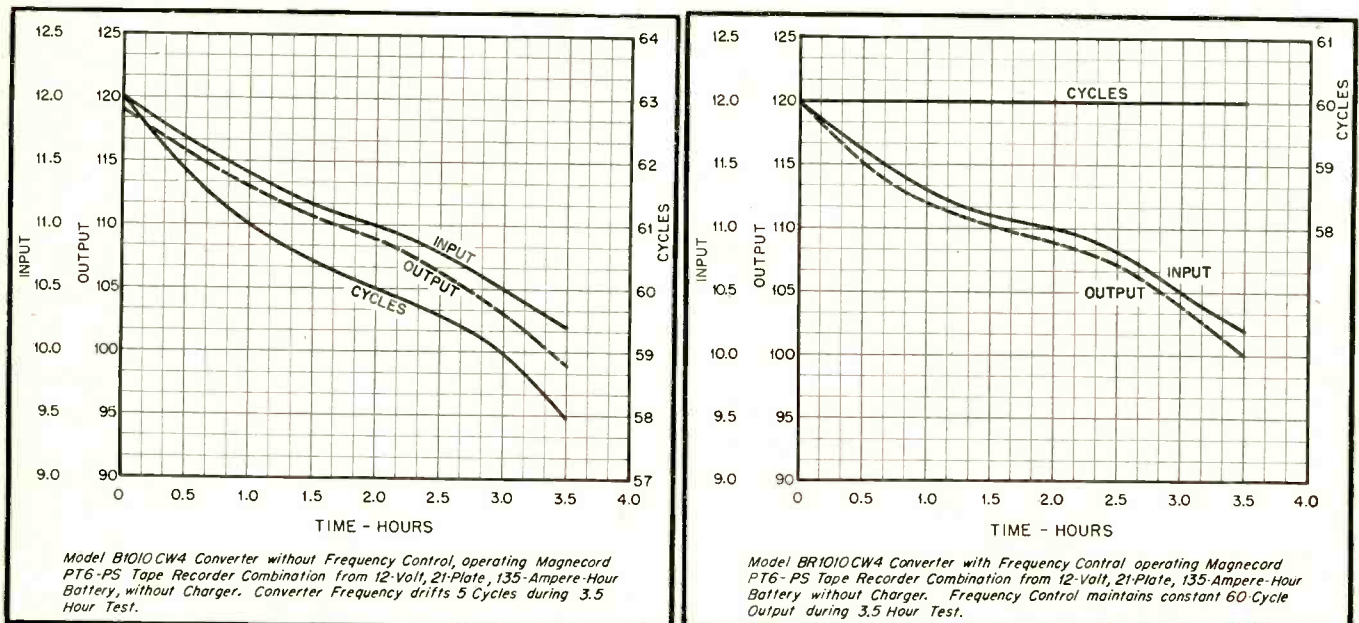

Fig. 2, (left). 12-volt converter performance vs. time (less frequency control). Fig. 3, (right). 12 volt-converter performance vs. time (with frequency control).

age that will be encountered. For example, 6.5 volts or 12.7 volts or 132 volts d.c., depending upon battery or line voltage at the converter. When this d.c. voltage decreases or fluctuates below this highest point, the rheostat control is entered into the circuit and the armature is restored to 60-cps speed. A constant 60-cps converter output can be maintained (providing a.c. load remains fairly stable) with a  $\pm 10$  per cent input-voltage variation. As both d.c. and a.c. windings are wound on a common core in a single d.c. field, the rheostat governs the field strength of the converter, and the output a.c. voltage will vary in proportion to d.c. voltage fluctuation. This a.c. voltage variation does not appreciably affect recorder operation. Because

Fig. 4. 12-volt converter performance vs. time with 24 ampere hour battery.

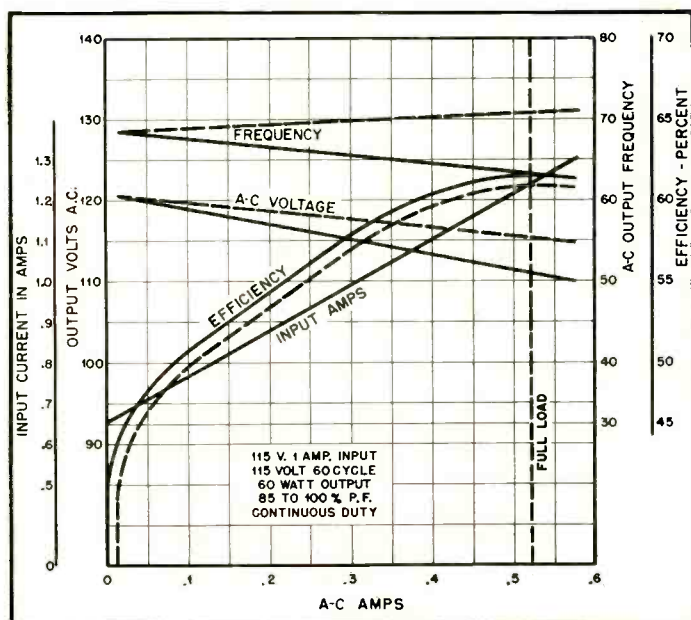
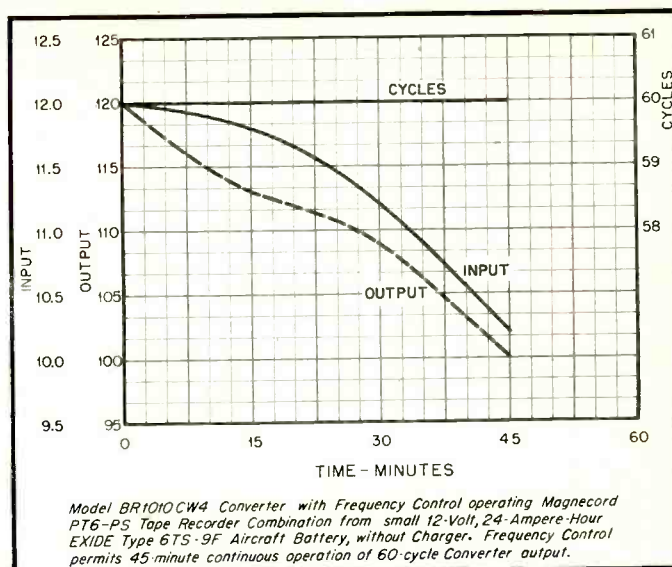

Fig. 5. Converter performance with non-inductive load. Dotted lines indicate effect of 70 per cent power factor load of the same wattage on the same converter.

of course, is undesirable for portable equipment.

### Converter Filtering

Because of the exceptionally clean converter a.c. output wave form shown in Fig. 6, no filtering of any kind is usually necessary for recorders, amplifiers, and other audio circuits. This of course reduces the cost and weight of the converter unit. If the recordings require full microphone volume, it may be advisable to install a 1- $\mu$ f capacitor across the converter output, depending upon the sensitivity of the recorder amplifier. R.f. circuits require a more complete capacitor filter for quiet performance. If the recordings made from 6- or 12-volt automobile battery source are to be played back for checking purposes in the car or remote truck while the engine is running, the microphone plug should be removed on playback, or the shielded cable may pick up ignition noise.

While some frequency controlled converters for broadcast service are custom-designed to individual requirements, many standard models for popular wire and tape recorders are available as packaged units for portable remote recorder operation. Major networks as well as independent stations have found this type of power supply ideal for their portable mobile wire and tape recordings.

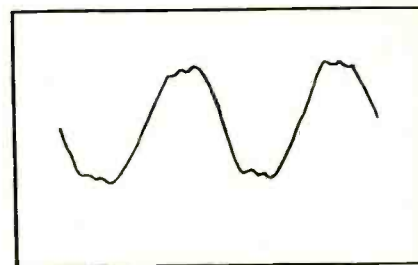

Fig. 6. Output wave form of Super Converter unfiltered. Wave remains unchanged from 0 to full load.

of the flywheel governing effect of the armature, the frequency remains very constant and "well damped" and is not affected by slight input voltage fluctuations or a.c. load changes. Once the frequency has been adjusted to the load conditions and the battery voltage, no further control is usually necessary during the recording. Easy visual monitoring of the converter output is possible with the 58 to 62 cps vibrating reed frequency meter shown in Fig. 1.

### Power Factor

The matter of power factor matching, mentioned previously, is clearly illustrated in Fig. 5. Note the 70 per cent medium power factor wire recorder load (shown in dotted lines) actually raises the converter a.c. output voltage and frequency of a unity power factor converter. Power factor is the ratio of actual watts of the load to the volt-amperes (volt  $\times$  amps) of the load. If the power factor of the recorder is unknown, it easily can be determined by the formula:

$$PF = \frac{W}{EI}$$

Where  $W$  = watts measured  
 $E$  = volts  
 $I$  = amperes

Using the wattmeter, ammeter, wattmeter method:

155 watts a.c. load measured with wattmeter  
 115 volts a.c. } measured with voltmeter  
 1.9 amps a.c. } & ammeter  
 $115 \times 1.9 = 218.5$  volt amps  
 $\frac{155}{218.5} = .71$  or 71% power factor

When a low power factor load is connected to a rotary power supply designed for non-inductive high power factor load, the converter armature will actually increase in speed instead of decreasing slightly as it should, causing a higher output frequency (see Fig. 5). If the power factor of the load is below the converter power factor rating, the kva output will be less than nameplate rating. Converter a.c. voltage regulation is also impaired at a low power factor which,

# The Art of Tape Recording-2

JOEL TALL\*

Continuing the discussion of magnetic recording, with especial attention to the practical aspects of operation under various field conditions.

**Q**UANTITY OF RECORDING depends primarily upon the degree of excellence of the facilities available and secondarily upon the recording engineer's ability. In contrast to other media (film and disc) it is possible for the rankest tyro to get fairly good tape recordings if his recorder is in good condition. But the engineer whose job it is to get consistently excellent results will be interested in finding out exactly how to get them. Top-grade recording on tape requires a fundamental comprehension of the governing factors, whether they be mechanical, electrical, or esthetic in nature.

## Some Causes of Distortion

Overload distortion on tape makes itself evident by the apparent loss of low frequencies and by high-frequency "fringe" noise. A heavily distorted tape will sound "choppy" and harsh. Distortion may be measured by considering the whole recorder as an audio amplifier and proceeding accordingly. Total harmonic distortion at 1000 cps should not exceed 2.0 per cent at maximum output. Distortion arises almost wholly in the magnetic recording process and tends to be more pronounced at the lower end of the recording spectrum. The more iron oxide in the tape coating, the lower the distortion at the low frequencies, provided that the recording level is the same. Distortion above 100 cps should be somewhat less than 2.0 per cent if the bias current has been properly adjusted. For a given amount of distortion there is a definite relation be-

\*Columbia Broadcasting System, New York.

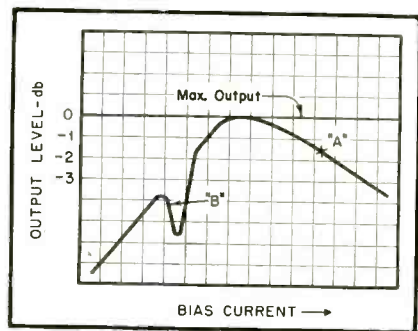

Fig. 1. Curve showing relation between output level and bias current for determination of correct operating point.



Fig. 2. Partially completed dual Magnetophon Unit. (Photograph by Wm. R. Busch, Chief Engineer for RIAS.)

tween the strength of the bias current, the audio level fed into the recording head, and the kind of tape used. Thus, as has been noted, recording at excessive levels results in overload distortion; at too low a level, the signal/noise ratio will suffer. However, it is better to undermodulate than overmodulate.

## Practical Bias-Current Adjustment

One method for adjusting bias current for optimum results is as follows:

1. Record at 1000 cps with an input that normally results in 2.0 per cent total harmonic distortion. This should take place at maximum output.
2. Vary the bias and observe the output level of the tape playback system. When the output level passes maximum and drops between 1 and 2 db, as at "A," the bias is correct for over-all good recording (see Fig. 1).
3. A temporary dip may occur, as at "B" during the bias adjustment operation. Make certain to pass this point to arrive at the correct operating bias point.
4. When minimum distortion at low frequencies is required, the bias may be increased still more than noted in Fig. 1, perhaps by 20 to 30 per cent. The practical effects will be: increased fidelity at low frequencies; loss in tape output voltage; and some loss at high frequencies due to erasure caused by the higher-than-normal bias current.
5. If in doubt, due to lack of measurement facilities, adjust the bias on the high side. Restriction of dynamic range is preferable to distortion.

Most recorders use constant signal current up to about 3 kc (at a speed of 15 in. per second). Above this point the recording signal current is increased in order to overcome, as much as possible, the effects of high-frequency losses in the head and self-demagnetization of the tape. Thus there is pre-emphasis on the

high frequencies and post-emphasis (in playback) on both low and high frequencies, resulting in practically flat reproduction from the recorded tape. It is the best practice to play the tape back on the same machine on which it was recorded or, failing that, on the same make and type of recorder. Follow the manufacturer's advice as to which tape to use and how heavily to modulate it. When you begin to use a new type of tape, noise and distortion tests should be made at several frequencies. It will then be apparent, in line with the foregoing section on bias current adjustment, whether the bias current and audio level are correct. In the output of any tape recorder there will be a certain amount of "tape noise" which should be close to the lower limits of audibility and inaudible at normal listening levels.

## Tape Qualities

The problems attending the manufacture of high quality magnetic coated media are receiving a great deal of attention in the industry. Paper-back tape continues to be used where cost is a factor and a slight increase in noise and lower tensile strength are not deterrents to its use. Homogeneous tape, in which the iron oxide is mixed with the plastics, is not used to any extent in the U. S. Enough iron for good overall response cannot easily be mixed with the plastic; it weakens the tensile strength too much. Homogeneous tape also prints excessively. The tape used in the U. S. is almost wholly the coated type, several kinds of which are easily available. The important characteristics of tape are:

1. Frequency response
2. Signal/noise ratio
3. Sensitivity to recording (Output from the recorded tape)
4. Ability to erase completely easily.

The necessary physical characteristics of tape are:

1. Limpness (for good head contact)
2. Good tensile strength (with no "stretch")
3. Even coating (and non-flaking)
4. Smoothness of backing material

Tape is cut from large sheets or rolls into 1/4-in. strips and then wound on reels of various types. On large tape reels a number of separate strips may be patched together. The conscientious engineer will check the tape splices before

recording. Sometimes these splices are carelessly made and will provide a disconcerting "hole" in the recording. A rapid check may be made by recording tone at low level and monitoring. Another method is to run the tape off at high speed and "feel" for the splices.

The tape speeds encountered in radio broadcasting are 7½, 15, or 30-in. per second. Combinations of 7½ and 15 or 15 and 30-in. speeds may be obtained in most recorders. All three speeds can be had on special order from some manufacturers. It is best to operate at the highest available speed that the budget permits. Fidelity increases with speed up to the point where excessive demagnetization takes place at the high frequencies. The higher the tape speed the easier editing becomes. However, response curves at 15-in. speed are good enough for FM use and where a network standard is needed the 15-in. speed is practical and economical. It should be noted that the 15-in. speed is the primary standard, and that the 7½ and 30 in. speeds are secondary standards.

Overheating of the recorders should be avoided. When operating in hot locations the temperature of the magnetic heads may rise to the point where the tape recording will become distorted. The cure is to devise some method of keeping the head temperatures down. Under normal conditions and with well-designed machines and heads, no cooling is necessary. But, when heads are operated above their normal current carrying capacity or are so mounted as to absorb excessive heat from the motors, a small blower may be used to cool them. Besides the distortion effect, excess heat may soften the tape coating binder and cause it to stick and peel, resulting in eccentric operation. Excess cold, on the other hand, may cause the tape to shat-

•  
**Fig. 3. CBS-NY Studio 30A. Tape engineer Hendrickson at the controls.**  
 •



ter easily, and the bearing grease may possibly congeal.

#### Proper Location for Recorder

Tape recorders should be so located that the mechanical noises they create while operating cannot be picked up by a microphone. The best possible location, obviously, would be in a soundproof room. Recorders for broadcast use should be installed in pairs, with convenient switching, metering and monitoring facilities. Note the partially-completed installation of a dual Magnetophone unit in the studios of RIAS (Radio in American Sector) in Berlin, (Fig. 2). One set of amplifiers is used for two mechanical units, with provisions for switching from one to the other on both record and playback. (Incidentally, the blower mounted at the bottom of the drive motor assembly functions both as

a motor-cooling device and as an air impedance for drive stability.) Recorders used in the U. S. are complete units and may be installed as shown in Fig. 3 where the machines can be used separately or simultaneously for either recording or playback.

The placement of the recording studio with respect to r.f. interference merits consideration. Strong r.f. signals may enter the record or playback amplifier with attendant cross-talk and noise. As a rule of thumb, the closer to earth the recorders are located the less r.f. interference. Test for r.f. pick-up in the feed lines, microphone lines, and in the playback amplifier. Interference may be filtered out with a low-pass filter or tuned out with a band-rejection filter, depending upon circumstances. Recorders used for field work should be well-shielded and should have r.f. by-pass capacitors installed, if necessary, from grid to cathode (or grid to ground) of the first-stage tubes in both record and playback amplifiers. In both studio and field installations avoid ground loops with the concurrent hum and noise increase.

When recording in an automobile or sound-truck, dressing of audio leads and careful grounding should be sufficient to keep out ignition noise. Audio cables should not be placed next to any of the electrical wiring of the car or truck. High- and low-level cables should be grouped separately and the recorder should be well-grounded and placed as far away as possible from the ignition system. Avoid using the car or truck battery as a primary power source for the recorder a.c. supply. No difficulty should be experienced while recording in airplanes since their ignition systems are normally well shielded. Recording in



•  
**Fig. 4. The man-behind-the-mike is Lee Bland, former Director of Special Events for CBS News.**  
 •

motion (except in trains and conveyances offering 115 volts, a.c.) requires the use of either a battery-operated recorder or an a.c. supply system of some sort. Where it is necessary to use a low-wattage a.c. operated recorder, a heavy duty 12-volt storage battery and an inverter supply of the proper size will perform very well. Whether an inverter or a converter is used, make certain its output is well-filtered and its acoustical noise deadened before attempting to record. As an illustration of a hookup using a vibrator supply and a low-wattage (175 watts) recorder in an airplane, the following is typical. The project was to record the conversation between the pilot of a helicopter and one of his passengers during a demonstration flight (see Fig. 4). The recorder was placed in the center of the padded rear seat and securely strapped in place. An inverter, placed on a 2-in. rubber mat, was bolted to the floor on one side of the helicopter cabin with the 12-volt battery on the other side. The mechanical noise of the inverter was then muffled by felt sheets and short ground wires were connected from both the recorder chassis and the vibrator supply to "ground" which, in both cases, was the metal floor of the helicopter cabin. This hookup worked well throughout a thirty minute flight and several landings, including one "dead-motor" landing.

Since this helicopter flight was made, a completely self-contained battery-operated recorder has appeared on the scene.

Figure 5 shows the size and ease of operating the Minitape. It records at either 7½ or 15-in. per second but has no provision for re-winding or playing back. It permits a recording time of 15 minutes at the lower speed and 7½ minutes at the higher. With proper care, very good performance can be expected of this recorder. Another concern has developed and is now marketing a miniature tape-playback amplifier. This is a pocket-sized unit which can be connected quickly and easily to any recorder to permit monitoring the recorded tape while recording. It also can be used, in conjunction with a manual winding mechanism, to check tape for quality while in the field.

Where the machines are used continually in one location for both recording and playback, there are no serious problems of a.c. supply. But when recording in the field with equipment using synchronous motor drives, some method must be found of controlling the frequency of the a.c. supply to the drive motor. One way of doing this is to use a frequency-regulated motor-generator set. Another method, used by John Mullin, recording and editing engineer of the Bing Crosby show, arrives at the proper frequency by triggering a pair of thyristors by a vibrator whose frequency can be varied and measured on a vibrating-reed indicator.

#### Do's and Don'ts of Recording

The normal amount of care should be

expended on getting proper mike placement for the response wanted in the recording. The value of making sample "takes" cannot be overstressed, especially where it is impossible to monitor the tape while recording. With machines that have separate playback systems, it is possible to listen to either the incoming program or the recorded tape and thus make valid quality checks. Incidentally, the human system of hearing is not a "high-fidelity" system but distorts excessively when the "loudness" of sound attacking it is too great. Normal hearing also may "hear" sound where such sound may not exist. The ear will tend to reconstruct some sounds out of harmonies, especially in the low-frequency range. The recording engineer, therefore, should monitor the recorded tape at normal sound level for comparison with the original sound.

The "liveness" of the studio should be adjusted for best results depending on the program to be recorded. Normally a slight amount of reverberation makes for cleaner speech and more sparkling sound. Remember that pre-emphasis in the recording amplifier keeps the highs up; therefore avoid excessive sibilance and paper "rustle". Place mikes to avoid heavy lows, which may overload the tape and also mask the intelligence frequencies. Music should be recorded full range and may be given special treatment in re-recording before playback to air.

If the recording is made with editing in view, the following things should be avoided. It is not possible to remove reverberation from recorded tape; therefore avoid it in recording for editing. It can be put back later in the re-recording process. Keep levels constant, within reason, to permit easy blends in editing. Record several minutes of clear background sound whenever there is a change in the story location or idea. The suggestion of impending change by means of changing background sound patterns is a valuable tool in tape work. Record over again, on the same location, any sequence in conversation that may have been marred by a sudden change in background, a change in position of speakers' voices (unintentional) or by unwanted interjections. Interviewers should, of course, train themselves not to interrupt or trail off into the background with "hm-m." Speakers or "interviewees" must be allowed time in which to settle down to normal voice and pace before recording. Sometimes, obviously, it is better to record a "practice" interview which may prove to be better than the "air" interview.

Always fade into background slowly and fade out the same way; the fades may be needed in editing the show for air. Background sounds, after editing,

[Continued on page 43]



Fig. 5. The author operating a Minitape recorder. There is no level control, only a stop-start switch. The headphones monitor the incoming audio only, not the recorded tape.

# Hearing Aid Trends

F. HARDWICK\*

A discussion of modern hearing aid techniques and requirements, with circuit diagrams and measured performance curves for illustration.

**H**EARING AIDS have improved appreciably in recent years, especially from the standpoint of their flexibility in frequency response, their size, and their weight. This was made possible primarily because of the advent of the miniature electronic receiving vacuum tube. Many hearing aids have several tone control settings, and their size and weight is reduced in some instances to approximately 5.7 cubic inches and five ounces respectively.

In order to appreciate fully the function of a hearing aid, a more than average understanding of the requirements of this type of electronic device is needed.<sup>1</sup> Essentially, a hearing aid should, if possible, raise the intensity of so-called audible sounds, without appreciable distortion, to above the threshold of audibility<sup>2</sup> of a person having impaired hearing (Fig. 2), with amplification continuing at acoustic intensities somewhat below recognized threshold of

\* *Hearing Aid Consultant, 360 Berwick St., Orange, N. J.*

<sup>1</sup> Lewis S. Goodfriend, "Problems in Audio Engineering," *AUDIO ENGINEERING*, May, 1949.

<sup>2</sup> Proposed American Standard Acoustical Terminology. Sponsored by the Acoustical Society of America in cooperation with the Institute of Radio Engineers, Inc. and published by the American Standards Association, Feb. 1949. Definitions 5.030 and 5.035.

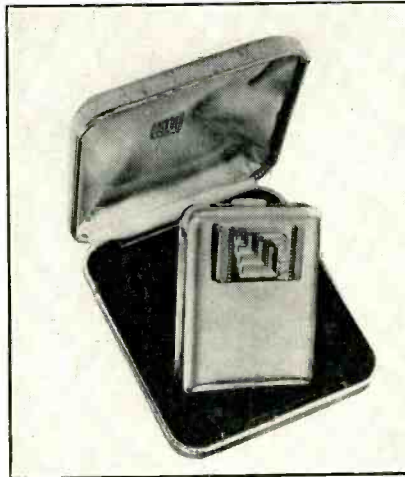

Fig. 1. Recent model hearing aid weighing approximately three ounces with all batteries contained within the case.

(Courtesy Telex, Inc.)

feeling,<sup>3</sup> thus enabling the deafened person to hear the same sounds as the person who has unimpaired hearing, except that the person with impaired hear-

<sup>3</sup> H. Davis, C. V. Hudgins, R. S. Marquis, R. H. Nichols Jr., J. E. Peterson, D. A. Ross and S. S. Stevens on Selection of Hearing Aids. Specifically: the reference to the threshold of feeling of those having unimpaired hearing, as compared to those having impaired hearing. *The Laryngoscope*, March, 1946, p. 106.

ing will hear those sounds at a somewhat altered pressure gradient.

A person who notices that he or she has hearing reduction should ask for an appointment with an otologist, or ear specialist. The ear specialist will investigate the cause of the impaired hearing, and will very likely make an audiometric determination to facilitate his analysis. Impaired hearing is usually either of the *conductive* type (ossicles motion restricted), resulting in reduced air-conduction reception without appreciably affecting bone-conduction sensitivity (as indicated in Fig. 3;<sup>4</sup>) or of the *nerve*

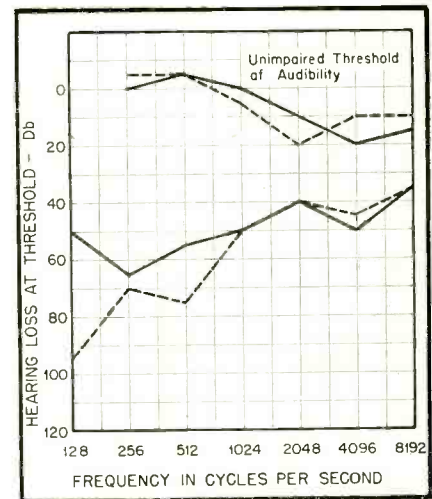

Fig. 3. Hearing loss curves for middle-aged person with conductive deafness of 46.6%. Curves run with Western Electric 6BP Audiometer.

type, usually causing an appreciable decrease in sensitivity towards the higher frequencies of both air- and bone-conduction reception; or third, that of the *conductive and nerve* type, which is indicated by a reduction in sensitivity level and an additional loss at the higher frequencies, as shown in Fig. 4,<sup>4</sup> where the results also indicate probable unsatisfactory contact by bone conduction.

In case, after consultation with an ear specialist the average hearing deficiency of a person's best ear is found to be between 25 db above unimpaired threshold of audibility and approximately 40 db below the threshold of feeling, the

<sup>4</sup> A Western Electric 6BP Audiometer was used to obtain this audiogram.

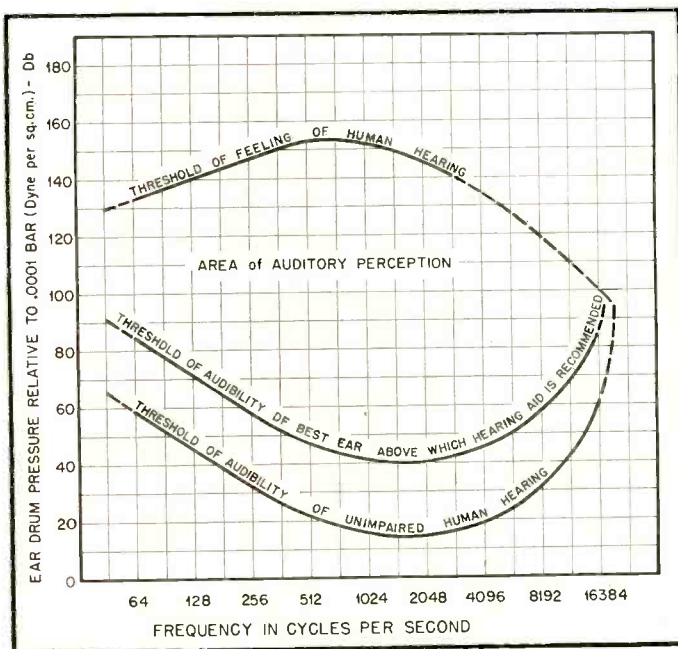

Fig. 2. Threshold of audibility and threshold of feeling considered average for unimpaired hearing.

(Courtesy Harvey Fletcher, "Speech and Hearing," D. Van Nostrand Co.)

use of a hearing aid is usually recommended. Deafness of as little as 25 db gives, according to the tentative standards for evaluating loss in hearing as prepared by the Council of Physical Medicine, a value of  $1.8 + 3.6 + 4.9 + 1.7 = 12.0\%$  binaural loss in hearing or intelligibility.<sup>9</sup> When listening to speech

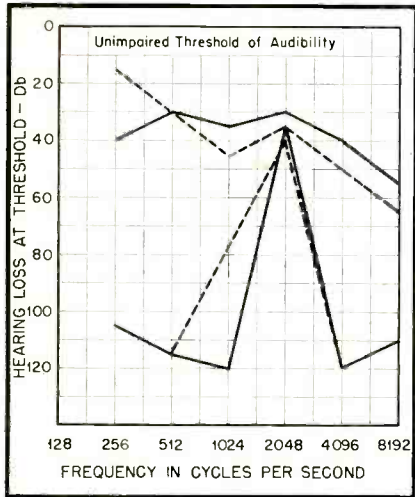

Fig. 4. Hearing loss curves for elderly person with mixed conductive and nerve deafness of 24%.

which cannot easily be repeated, a 12 per cent reduction in intelligibility is noticed.

A hearing aid of the electronic amplifier type includes a microphone, an amplifier circuit with a frequency characteristic depending on the tone control setting, and a small receiver of either the air conduction or bone conduction type.

At present, hearing aid microphones are usually of the crystal type because of the appreciable amplification available as a result of the usage of miniature receiver tubes. In order to prevent pickup of noise due to mechanical vibration, the

Fig. 5, right. Four-tube Microtone hearing aid circuit. Fig. 6, below. Acoustic gain for circuit of Fig. 5 with volume control at maximum. Acoustic termination is a 2-cc coupler.

(Courtesy Microtone Co., St. Paul, Minn.)

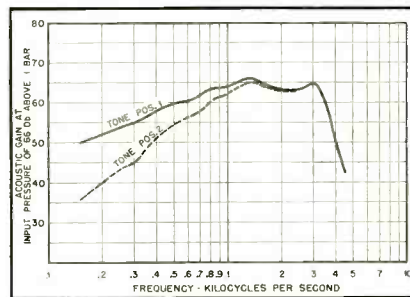
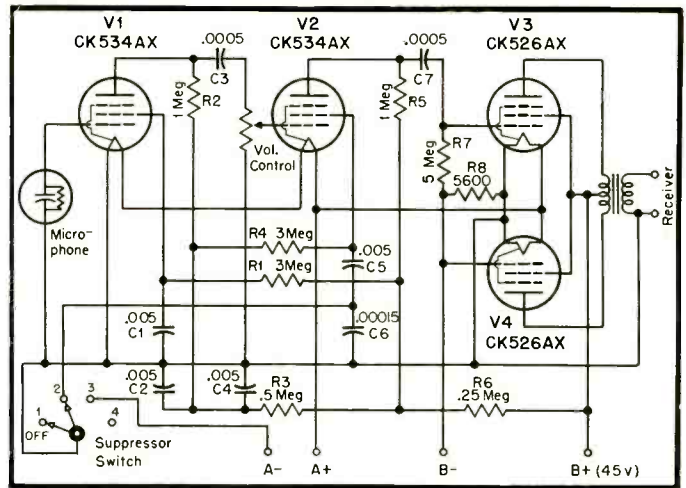

microphone is often mounted in sponge rubber or its equivalent.

#### Commercial Hearing-Aid Circuits

A typical circuit diagram of a recent model hearing aid, making use of three stages of amplification with one stage being push-pull, is shown in Fig. 7. Tone control is obtained by making capacitive changes in the circuit, causing this hear-

<sup>9</sup>J. Amer. Med. Assn. 133-6, 396-397, Feb. 8, 1947. This report on tentative standard procedure for evaluating the percentage loss of hearing in medicolegal cases includes a hearing loss chart with percentage hearing loss, indicated as a function of the db loss in threshold and frequency, as obtained with an audiometer by air conduction, as follows:

Air Conduction Hearing Loss db	Per cent hearing loss at frequency indicated			
	512	1024	2048	4096 (CPS)
0	..	..	..	..
5	..	..	..	..
10	.2	.3	.4	.1
15	.5	.9	1.3	.3
20	1.1	2.1	2.9	.9
25	1.8	3.6	4.9	1.7
30	2.6	5.4	7.3	2.7
35	3.7	7.7	9.8	3.8
40	4.9	10.2	12.9	5.0
45	6.3	13.0	17.3	6.4
50	7.9	15.7	22.4	8.0
55	9.6	19.0	25.7	9.7
60	11.3	21.5	28.0	11.2
65	12.8	23.5	30.2	12.5
70	13.8	25.5	32.2	13.5
75	14.6	27.2	34.0	14.2
80	14.8	28.8	35.8	14.6
85	14.9	29.8	37.5	14.8
90	15.0	29.9	39.2	14.9
95		30.0	40.0	15.0

#### Sample Computation

Per cent hearing loss represented by the audiogram shown in Fig. 4		
Right ear	Freq.	Left ear
2.6%	512	2.6%
7.7	1024	13.0
7.3	2048	9.8
5.0	4096	8.0
22.6%	Total	33.4%

- (A)  $7 \times$  total per cent loss, better ear 158.2
- (B) total per cent loss, worse ear 33.4
- (C) (A) + (B) 191.6
- (D) (C)  $\div 8$  binaural loss 24.0%

<sup>9</sup>Proposed American Standard Acoustical Terminology reprint of Feb. 1949, published by the American Standards Association, Inc. Definition 5.120.

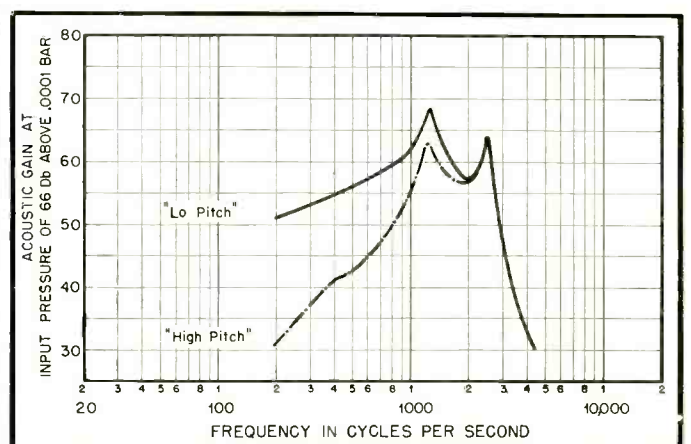
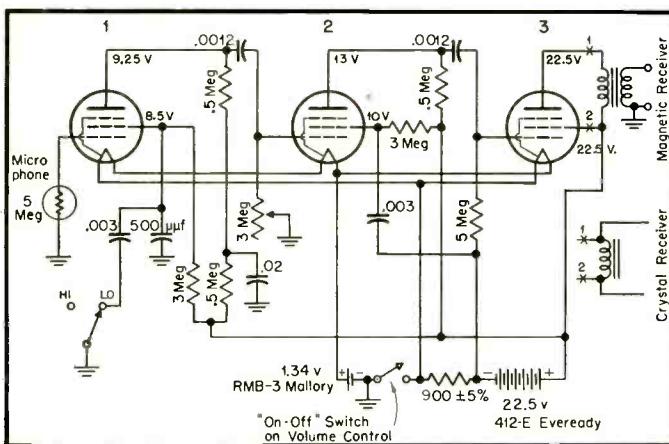

Fig. 7, left. Three-tube hearing aid circuit. Fig. 8, right. Acoustic gain as function of frequency for circuit of Fig. 7. Volume control at maximum; acoustic termination is a simulated earmold into a 2-cc. coupler.

(Courtesy Beltone Hearing Aid Co., Chicago)



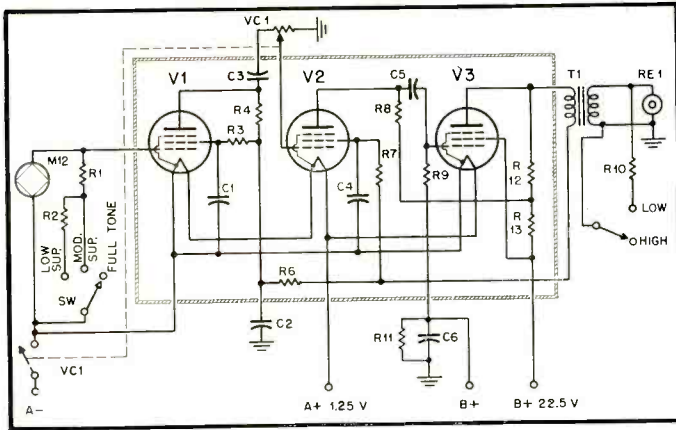

Fig. 9. Three-tube Otariion hearing aid circuit.

(Courtesy Otariion, Inc., Chicago)

ing aid to have frequency-response characteristics of the type shown in Fig. 6, thus indicating that the increase in capacitance in the screen circuit causes an increase in the output of the low-frequency range of this crystal microphone hearing aid.

Another recent three-stage amplifier hearing aid circuit is shown in Fig. 7. In this circuit, the push-pull feature is omitted. Yet it also has tone-control adjustment of the capacitance type, giving rise to frequency characteristics which have between them a maximum of as much as 20 db output level difference, as indicated in Fig. 8.

The circuit diagram of a resistive tone-controlled three-stage amplifier hearing aid is shown in Fig. 9. A printed circuit of similar type is shown in Fig. 11.<sup>7</sup> This printed circuit includes five miniature capacitors of .025 in. thickness, having capacitances ranging from .0005 to .05  $\mu$ f. The conductors consist of a colloidal silver compound deposited on a polystyrene plate. The resistors are made, in this instance, of colloidal graphite. The .025-in. polystyrene plate,  $1\frac{1}{8} \times 2\frac{1}{8}$  in., carries the printed circuit and also supports crossover connections made with highly conductive material and

which are riveted or soldered to the proper terminals. The frequency characteristics obtainable with the hearing aid circuit of Fig. 9 are shown in Fig. 10, where a low-frequency range change is indicated.

The electrical-to-acoustic transformation takes place in small receivers which are either of the air-conduction or bone-conduction type. The air-conduction receivers are usually either of the electromagnetic or crystal type, and are of sturdy construction in order that they be able to stand the usage for which they

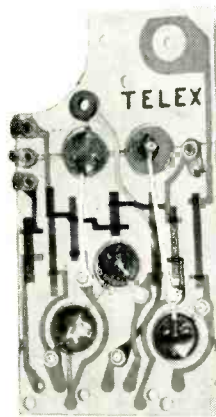

Fig. 11. Printed circuit used in current Telex hearing aid, shown full size. "Chassis" is .025-in. plastic, and all resistors and capacitors are shown in place, being riveted or soldered where required.

(Courtesy Telex Hearing Aid Co., Minneapolis)

are designed. Earpieces appealing most to buyers' aesthetic taste are usually the type that is snapped on to the miniature receiver, or the type completely enclosing the miniature receiver, or the type in which a plastic tubing is connected to a miniature receiver hidden from view somewhere in the wearer's clothing. In many instances, the earpiece may be personally fitted by first taking an imprint

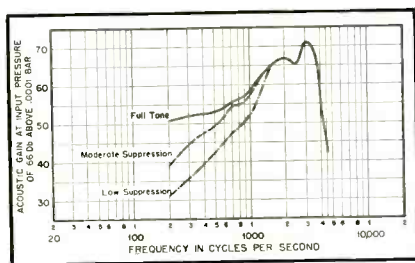

Fig. 10. Acoustic gain as a function of frequency for circuit of Fig. 9, with volume control at half position. Measured with a 2-cc coupler. Distortion products are less than 10%.

(Courtesy Otariion, Inc., Chicago)

of the ear canal with a plaster-like material in powdered form. This powder is mixed with water and the ear canal is filled with the resulting mix, which hardens in a few minutes. Bone-conduction receivers usually consist of a vibrator in a plastic block. Some of these are supported by head bands, while others are designed to adhere directly to the skin. The choice between an air-conduction receiver and a bone-conduction receiver depends on audiometric results, with the air-conduction type being favored unless the bone conduction threshold test results in at least a 20 db increased sensitivity.

#### Miniature Batteries

Dry cells have also been appreciably reduced in size and weight, making it

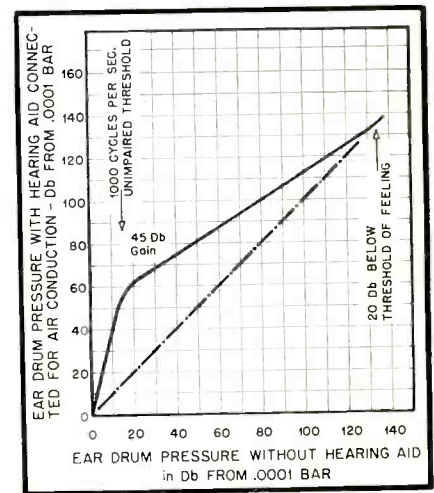

Fig. 12. Desirable acoustic input/output characteristic for air-conduction receiver used by a person with a 45-db hearing loss. Measured at approximately 1000 cps.

possible, for example, to place 1.5-volt "A" and 22.5-volt "B" batteries, having approximately 0.72 and 0.11 ampere hour capacity respectively, in a  $1\frac{1}{2} \times 2 \times \frac{5}{8}$ -in. space, while the combined weight of such dry cells is only two ounces. Dry cell chargers are now available, thus making it possible to increase the span of usefulness of regular "A" as well as "B" batteries several fold. A new "air breathing" filament battery is now being used to good advantage and has, according to claims made, a triple span of usefulness as compared to regular types of batteries in this category.

The trend of hearing aid development is definitely towards smaller sets, thus likely increasing the complex design problems to be solved. Artificial "binaural" hearing aids are likely to become a reality in the not too distant future.

## Construction Practice—3

**G**OOD CONSTRUCTION PRACTICE begins with the selection of good components, a subject which has been discussed in the two previous articles. After the components have been chosen, the problems of chassis, terminal boards, wire, tie points, and most important of all—the analysis of the layout may be considered.

In choosing a chassis for a given unit of audio equipment, there are usually

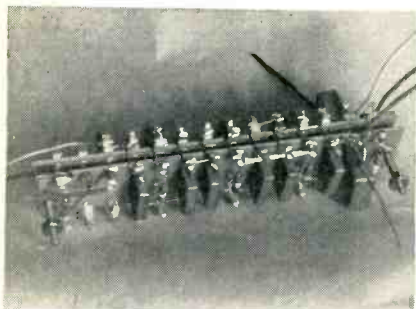

**Fig. 1. Special dual terminal strip made up for an experimental equalizer circuit.**

three conflicting requirements: appearance, available space, and functionality. When the unit must fit into a predetermined space, smaller than the functional optimum, care must be exercised in the layout, and some sacrifice in appearance will usually result. When this condition is encountered, it is best to place the large parts (transformers, chokes, relays, etc.) on the chassis and move them about until tentative positions are found that will still leave enough room for tubes and capacitors. Also the signal level at which the various tubes and transformers are to operate must be kept in mind in order that no low-level components will be placed near a.c. or power output parts. To facilitate layout it is often desirable to cut out small pieces of cardboard having the shapes of the bases of the various parts. These may be shifted about with ease and with no regard to lugs or leads which would otherwise be in the way.

When space is not a limitation, function and appearance should govern layout. When possible, parts should be in rows at right angles to one another merely for the sake of good appearance. However, in no case should quality suf-

fer at the expense of appearance. Slight variations in positioning and alignment of parts may frequently be hidden by careful finishing. An easy way to determine the chassis size is to lay the parts out on a piece of paper which has only two adjacent sides drawn on it. After the parts have been positioned approximately, the commercial chassis size that will be suitable may be selected from a catalog.

The material of which the chassis is made is important in two respects. Where magnetic shielding of sub-chassis components is desirable steel should be used, but if shielding is not required and ease of drilling and punching is desired, aluminum should be selected. Mumetal and stainless steel are not good chassis metals because they are too hard to drill or punch.

### Parts Layout

After the parts are laid out on paper, the chassis may be marked using a good adjustable square and a sharp scribe. Another method that simplifies work is to make a spare chassis drawing to full scale, including the front, back, and side edges. This should be done with a sharp hard pencil. It may then be fastened to the chassis with tape, and all the center punching, drilling, and punching done through the paper. In any case, care must be exercised in making the drawings, laying out the lines on the chassis,

and in centerpunching for drilling. Care here will save many headaches later. After drilling and punching, the holes should be carefully scraped to remove burrs, and the transformers, chokes and other cased parts mounted. It is at this point that the chassis may be painted a uniform color. The three most popular commercially available colors are telephone black, gray, and aluminum. By spraying the entire unit, a very professional appearance may be obtained. Parts to be protected from paint may be covered with masking tape. The choice of the color must take into consideration the temperature ratings of the components.

Physics tells us that black bodies absorb and radiate heat better than light colored ones. Therefore, transformers are usually painted black, capacitors light. If everything is to be painted the same color, then, for light colored units, all parts that get warm should be over-rated, while dark-painted capacitors should have high ratings. Here again care in the selection of components and planning of layout for specific temperature conditions will solve the problems. After the chassis finish has dried, all of the projecting components should be wrapped in heavy brown paper and taped. After this is done, the tube sockets, plugs, switches, and those mechanical sub-assemblies that require wiring may be fastened in place. The brown pa-

**Fig. 2. Example of terminal board construction in a finished professional unit.**

(Courtesy E.R.P. Div'n, Western Electric Co.)

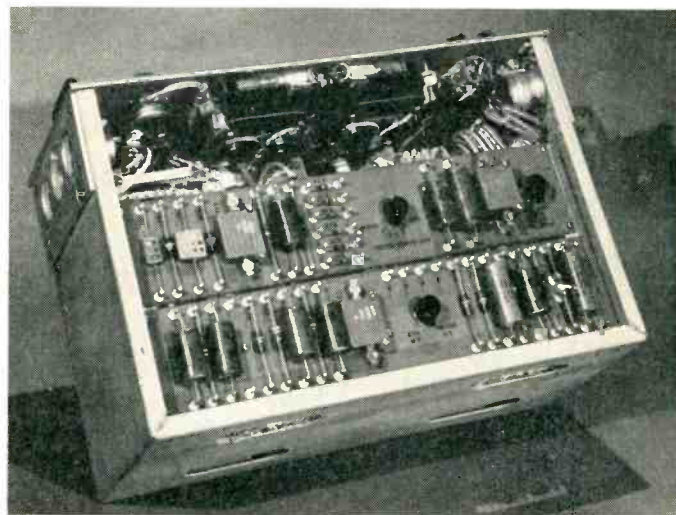

per will protect the finish on the projecting parts while the smaller pieces are being assembled and the wiring is done. Large sub-assemblies that do not require wiring should not be mounted until they are needed for dressing leads around them or fitting to other parts; otherwise they will only serve to the chassis heavier and more unwieldy.

### The Wiring Layout

Before any wiring layout can be made it is necessary to determine the position of the numerous small resistors and capacitors used in audio circuits. Point-to-point wiring is sometimes used, in which case the parts may be laid out directly on the wiring layout and drawn in. However, for ease of construction and servicing and for neatness, terminal boards are recommended. *Figure 1* shows a type of construction used in an experimental equalizer, and *Fig. 2* is a professional example of a completed unit employing the terminal-board form of construction. Terminal boards can be obtained from several manufacturers in made up form, or lugs and terminals having various sizes and shapes may be purchased and mounted on sheets of electrical laminate to meet the builder's own specification. A few of the styles are illustrated

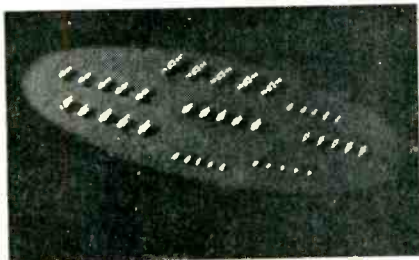

**Fig. 3. Typical terminals for use on mounting strips.**

(Courtesy Cambridge Thermionic Corp.)

in *Fig. 3*. In planning the layout of terminal boards, the parts should be mounted so that they will be reasonably close to the other components with which they must work, and that the wiring and connections on the strip itself permit the majority of the external connections to be brought out along one edge of the strip. This will facilitate assembly of the final units and future maintenance. Where only one or two isolated parts are to be mounted, tie points are quite satisfactory. They should have laminate of sufficient quality and thickness so that they will not warp or change position once they are installed. Tie points are also useful where bias and erase circuits in tape equipment must be built close to the tube socket.

When the chassis layout is being drawn it is a good idea to draw a bottom view also. This drawing can then be used to make the wiring layout. The positions of the wires and the color

**Fig. 4. Example of wiring showing the use of a cabled form or harness.**

(Courtesy E.R.P. Div'n, Western Electric Co.)

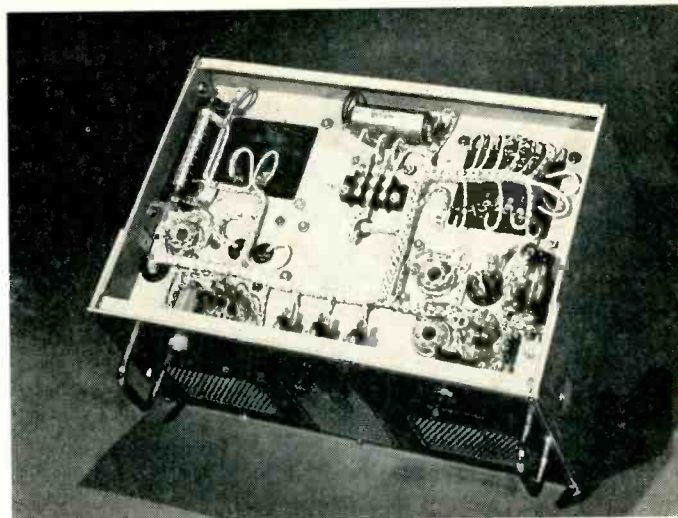

of the insulation can be indicated by drawing them in with colored pencils. In laying out the wiring, long grid or plate leads should be avoided, since they increase the grid-cathode and plate-cathode capacitance. Also the leads within the low-level stages should be as short as possible and all a.c. and power output leads kept as far away from them as possible. D.c. power supply leads may be grouped together and neatly laced after they are soldered in place or laced in harnesses made up to be dropped into place for wiring.

After the parts are mounted and the wiring layout is complete, the wiring may be started. If harnesses are used, they may be made by transferring the bottom view to a sheet of ply wood, placing finishing nails at corners and bends and laying the wires along the paths thus indicated. After the wires are in place the lacing may be done. A typical wiring job using a harness is shown in *Fig. 4*. If harnesses are not used, the heater circuits should be wired first and then the short leads put in, socket to socket, and terminal board to socket, and finally the long leads. By leaving the long leads to last it will be easier to check the major portion of the wiring before they are installed.

### Wire Selection

The choice of wire is determined by circuit considerations and insulation. Acetate coated rayon insulation or wax impregnated cotton are the two commonest types used, although plastic, asbestos, and glass insulation are becoming more popular. All of these types are supplied in a variety of colors, and they should be used in accordance with a standard color coding system such as the RMA color code shown in Table I. With the exception of filament, a.c., power output, and shielded leads, the wire size generally used is #20. For higher current-carrying capacity, #18 or #16 should be used. In case of doubt

consult a wire chart. The big and as yet unanswered question is whether to use solid or stranded wire. This writer has used both with equally good results. For laced harnesses, stranded wire is usually best, but otherwise there is no definite rule. Solid wire makes a neat, well-dressed job, but some engineers feel that stranded wire is less apt to break at the joints. The reader can try both and take his choice.

When the wiring is done, the unit checked and ready to put in the cabinet, it should be equipped with a tightly fitting bottom plate. This will prevent dust, mice, and bugs from getting into the wiring and causing poor operation.

This series of articles on construction practice started with the selection of the components and has arrived at the finished chassis, but no mention of the circuit design has been made. This subject will be covered in a future series of articles.

**TABLE I—RMA COLOR CODES**

Grid circuits	Green
Plate circuits	Blue
B — (maximum)	Red
B — (intermediate)	Orange
Ground	Black*

### Power Transformers

Primary leads, no tap	Black
Primary leads, tapped	
Common	Black
Tap	Black & Yellow
Finish	Black & Red
Rectifier Plates	Red
Center tap	Red & Yellow
Rectifier Filament	Yellow
Center tap	Yellow & Blue
Filament Winding #1	Green
Center tap	Green & Yellow
Filament Winding #2	Brown
Center tap	Brown & Yellow
Filament Winding #3	Slate
Center tap	Slate & Yellow

\* Some manufacturers use Yellow for Ground, Black for Cathode circuits.

# Patent Infringement and the Home Experimenter

ALBERT E. HAYES Jr.\*

**W**HEN WE GET TOGETHER over a late cup of coffee, to discuss the latest in phase inverters and the existence-or-not of sound when that well-known tree crashes to the ground in the Siberian marshes, the conversation often touches upon something new in audio which has appeared in one of the "patent review" sections of the technical press. It is astonishing how often someone remarks on his having built such an item for his own personal use, without considering the fact that he has broken the law of the land. The common belief seems to be that one can build any patented item for one's own use, provided that no cash profit is involved, without violating the law. Nothing could be farther from the truth.

## The Patent Grant

The first sheet of every United States patent includes the following words: "Now therefore these Letters Patent are to grant . . . the exclusive right to make, use, and vend the said invention throughout the United States and the Territories thereof." This wording, as can be seen, does not tie the "making-using" act with the "vending" act, but is a statement of the *three* rights which our government has granted to the inventor, to the exclusion of all others. Thus the construction of an amplifier which incorporates circuits dominated by valid, unexpired U. S. patents—whether for the builder's personal and non-profit use or not—is a definite infringement of the patent, and places the builder in a position to be sued by the owner of the patent. The extent of the monetary damages collectable by the patentee is, in each case, determined by the courts.

## Experimental Use

It has become a doctrine of patent law that a bona fide experimenter may construct *one* of a patented item without running afoul of the law, provided that the construction is for the purpose of making further improvements in the patented item. This license does not, of course, include the right to *use* the patented item, even for one's own entertainment, beyond the use which would come under the heading of *experimental* use.

\* Consulting Radio Physicist; formerly Chief Patent Engineer, Bendix Radio Division.

For example, an audio experimenter may feel free to construct a patented item in order to investigate the shortcomings and relative advantages of the arrangement, but its assembly into a neat cabinet, and its installation in one's living quarters in the form of a record player, would probably be held by the courts to constitute infringement of the patentee's rights.

The line between experimental use and use per se is often rather thinly defined, and the courts are duty bound to determine the question from the circumstances surrounding each particular case. If an audio amplifier containing a patented circuit is the allegedly infringing item, the court involved would seek to learn whether the builder had made it for experimental purposes, or as an entertainment unit for use in his home. In the latter case it is likely that the infringement suit would be decided in favor of the patentee.

The argument of experimental use would obviously be untenable if a sound system containing a patented arrangement were used by its builder for public address service for hire. Although the element of profit appears here, it is not the element of profit itself which underlines the infringement, but its establishment as a *use*, rather than as an experiment.

## From a Practical Standpoint

From a practical standpoint, we've never run into a case where an individual home experimenter has been haled into court by any of the large corporations who own most of the important and frequently-used patents in the electronics field. It is well to remember, however, that the "correct" procedure when a patent owner wishes to recover damages for the infringement of his patent by a number of users, is, customarily, to "get the little man first." Each successful prosecution for infringement of a patent is regarded as a strengthening of the presumed validity of the patent, and therefore a series of successful suits against a number of "little guys" puts the patentee in a better position when he goes to bat against a big corporate infringer than if he had gone after the big one first.

What lesson can we draw from these facts? It is difficult to say. The ethical side of the matter is that an inventor—

the holder of a patent—does, in truth, *own* the inventive material disclosed in a patent, and when we build a device incorporating the teachings of his invention, without paying him for his permission to do so, we are stealing from him. Perhaps the best criteria in these things are:

1) Am I building this because I want to use the device or because I like to build and play with audio gear?

2) Would I buy the device from the inventor if it were on the market or would I build it anyhow?

3) Would I want others to do to me what I am contemplating doing to this inventor?

Let your conscience be your guide, but let's not lose sight of the principles involved.

---

## 1950 Hearing Show

The 1950 Hearing Show, the fortieth anniversary meeting and trade show, sponsored by the New York League for the Hard of Hearing in cooperation with twelve other hearing organizations, was held at the Hotel Roosevelt, New York, on April 19 and 20. The program of the Hearing Show included over twenty movies, papers, and demonstrations which had as their theme advancements being made in the field of aid to the hard of hearing.

Among the exhibitors were two, Paravox and Aurex, who showed photographs of their hearing aids worn as part of the new look coiffure, while the Maico company featured "Hear Rings," which are earrings one of which houses the receiver and uses a small tube to carry the sound into the ear canal. Maico, Telex, and Microtone each featured various types of invisible plastic ear inserts which provide both comfort and improved appearance. Telex displayed a new pen type hearing aid that is worn like a fountain pen, weighing only two and a half ounces. Although not for the hard of hearing, the Aurex "P.A." is like an opera glass, being a personal directive microphone and amplifier to enable the user to hear distant sounds comfortably for short periods. Other exhibitors were the Zenith Corporation, Manufacturers' Battery Company, Audivox (the successor to Western Electric hearing aid division), Dunshaw Inc., Moran Beltone Company, Micronic Company, Olin Industries, Sonotone Corporation, New York Telephone Company, and Radioear of New York, Inc.

new **HORIZONS** in sound reproduction . . .  
new **CONCEPTS** in speaker design . . .

NOW YOURS IN THE



**RADAX Super-Eight.** Coaxial 2-way system in economical 8" speaker. Response to 13,000 c.p.s. Model SP8-B. List . . . . . \$34.00



**RADAX Twelve.** Two cones, including RADAX high-frequency propagator, divide reproduced spectrum. Perfect balance between highs and lows. Model SP12-B. List . . . . . \$36.50



**RADAX Super-Twelve.** Bass diaphragm reproduces lows, RADAX "whizzer" cone reproduces only upper octaves. Response is full, uncompromised from 70 c.p.s. through 13 k.c. Oversized 3 lb. Alnico V magnet. Model SP12. List. \$75.00

**RADAX Super-Fifteen.** Full 15" low frequency driver plus RADAX high frequency cone. Smooth, distortion-free reproduction 50 c.p.s. through 13,000 c.p.s. 5 1/4 lb. Alnico V magnet. Model SP15. List. \$95.00



**Model 12W.** Low-Frequency Driver. Heavy ribbed cone, reduces transient distortion. Outer compliance specially treated to prevent frame reflections from emphasizing or cancelling certain frequencies. List . . . . . \$75.00



**Model 15W.** Low-Frequency Driver. Powerful 5 1/4 lb. Alnico V magnet. Maximum instantaneous power input 20 watts to 30 c.p.s. 300 watts above 100 c.p.s. Sturdy frame. List . . . . . \$95.00

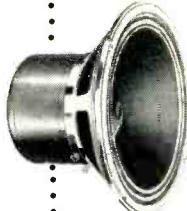

**Model 18W.** Very-Low-Frequency Driver. Bass response to 32 c.p.s. Cone specially treated for moisture and fungus. Outer periphery damped with semi-viscous compound to reduce transient and intermodulation distortion. List. . . . . \$120.00



Each cell of E-V horns is truly exponential permitting full efficiency with spherical wave shape. Horns supplied in 6 models for 800, 600 and 400 cycle cross-overs. From \$30.00 list to \$250.00 list.

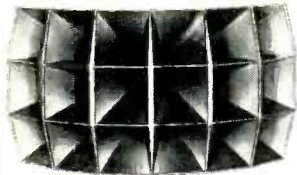

**Model 4-3x6.** Horn. For finest quality theater systems. List . . . . . \$250.00



E-V High-Frequency Drivers for clean, clear reproduction of higher octaves.

**Model T-40.** Input power, 40 watts. Peak, above 400 c.p.s. List . . . . . \$150.00

**Model T-25.** Input power, 25 watts. Peak, above 500 c.p.s. List . . . . . \$75.00

**Model T-10.** Input power, 10 watts. Includes eight-cell horn. List. . . . . \$50.00



All **ELECTRO-VOICE** cross-overs utilize specially wound high Q air cored coils, quality paper condensers. 5 models. 3 db loss points 3500, 800, 600, 400 c.p.s. and combination 3500, 600 and 200 c.p.s. List prices \$10.00 to \$100.00.

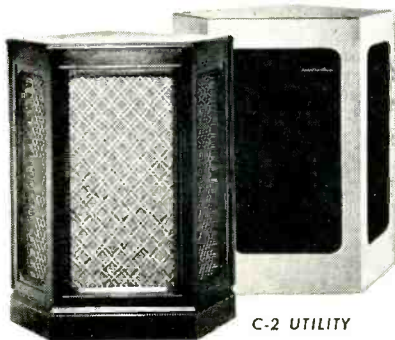

THE REGAL

C-2 UTILITY



THE PERIOD

C-4 UTILITY

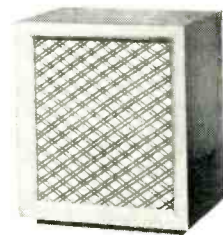

THE CONTEMPORARY

E-V Corner Cabinets are available in three sizes in furniture and utility styling. **PATRICIAN** utilizes separate 4-way reproducing system. **REGAL** (illustrated) employs separate 2-way system. **MARQUIS** is ideally designed for Electro-Voice RADAX coaxial 2-way units.

Conventional bass-phase-inverted-reflex cabinets house wide variety of components. In two models, **PERIOD** and **CONTEMPORARY**. **PERIOD**, designed for separate 3-way or 2-way systems. Mahogany or bleached blonde finish. **ESQUIRE** table cabinet (not shown) . . . for 8 or 12 inch RADAX units.

# NEW

## 2, 3 and 4-WAY HIGH FIDELITY LOUDSPEAKER SYSTEMS

For the first time, separate 3- and 4-way reproducing systems for the home...for the first time, the RADAX Principle of super-efficient high-frequency propagation and dispersion...for the first time, acoustically-correct corner cabinets with authentic furniture styling...these and other E-V exclusives set new standards of high fidelity reproduction.

Electro-Voice loudspeakers include only RADAX coaxial 2-way and separate 2, 3 and 4-way systems, yet prices are surprisingly low and realistic. E-V components offer a wide selection of low-frequency and high-frequency drivers, horns, crossover networks...and cabinets of both bass-phase-inverted-reflex and corner and folded types, in furniture and utility models. Also 40 and 80 watt theater systems.

Investigate this entirely modern loudspeaker line...today! Write for Catalog No. 111 describing E-V loudspeaker systems and components.

FULL, NORMAL TRADE DISCOUNTS PREVAIL

# Electro-Voice INC.

RESEARCH-ENGINEERED MICROPHONES • PHONO PICKUPS • SPEAKER SYSTEMS  
• 400 CARROLL STREET • BUCHANAN, MICHIGAN  
Export: 13 East 40th St., New York 16, N. Y., U.S.A. Cables: Arlab



EDWARD TATNALL CANBY\*

### Boom

**W**HEN THIS DEPARTMENT light-heartedly spoke of the "Fall rush" of records back in the March issue, I had assumed that, come winter, the Christmas-season sort of thing would be over. Rash idea!

Perhaps readers of this column who buy records now and then, as the whim seizes them, may not realize what has been happening these last months. We are "rushing" now in a fashion that to me suggests a sort of 1929-in-records. The LP business in particular, has led to a spectacular effusion of new recorded material. For every new 78-rpm record of a few years back it seems there is at least one LP of similar size—and a lot longer content. Right now, the rush to get in on LP is at what may be its peak, for it is hard to imagine that there can be much more expansion in the way of new items. (Note: I do *not* refer to total sales, but to the number of individual items appearing—which is an altogether different thing.)

The reasons for the present boom, which has practically put this column out of gear, are not too hard to see. First, of course, is the record-war competition, a kind of war which always engenders reckless releases of everything under the sun and don't count the cost. Count, as part of this, the entry of London and RCA, along with big popular outfits, into the LP field and the consequent scramble to build a new segment of catalogue that shall look imposing from the word go. Re-issues and extra new recordings—all swell the total volume. You can count in, too, the counter-revolution whereby London has entered the 45-rpm field, along with various pops outfits. More records.

#### One Speed vs. Three

But what is really most important is the straight economics of the LP record for the small company. The big companies, remember, are committed to the huge expense of two or three speeds. There are signs of agony dimly discernible already. Beneath the benign surface, one is aware

of a frantic desire to get out of this triple-play, triple-edition mess. One notes that numerous LP releases are unaccompanied by 78-rpm counterparts—which are "not available at present." The intervals between "simultaneous" releases at all three speeds become more erratic. Clearly enough, if things go on as at present, the 78-rpm classic is going to follow the heels of the old "AM" automatic sequence and the "M" manual sequence, becoming gradually harder and harder to get, without actually being discontinued in any public way. But this process will take long. Meanwhile, look at the small company! One speed only, no commitments to other speeds. And that one speed fabulously cheap in small quantities, compared to the old 78 (and the new 45).

#### LP Bandwagon

So everyone is now jumping on the LP bandwagon. A new company every day. We've even got to the duplication stage—duplications of works that never would have been recorded at all in the old days. *Three* Beethoven Octets, where there had never been any before in a quarter century of electrical recording. Two Mozart "Coronation" Masses, same story. Three complete Bach choral works arrive in one day's mail, for review hereabouts—and they used to appear once in five years. Two large choral works by Kodaly (contemporary Hungarian) and I had never heard any of his music in this vein before, on records. Anything—everything goes. Ship a couple of tape recorders to Europe and sit in on this or that festival, gather together this or that famous chorus, tape up all the Radio orchestras in central Europe; send 'em home and churn out the LP's. Fantastic! Nothing has ever happened in classical recording remotely like this. It's wonderful. But it can't last. There aren't enough people, enough machines, enough hours (and does this department know all about *that!*) to absorb the flood.

Look closer. The small company has its headaches and LP isn't always easy. Masters, pressings, tapes all go wrong, as al-

[Continued on page 49]

## Pops

RUDO S. GLOBUS\*

**A** CONVERSATION WHICH BEGAN on a street corner at high noon and ended several hours later under the unhealthy glow of record-shop fluorescents has pretty well determined this month's piece. Fellow conversationalist is a leading arranger whose versatility has found outlets into classical and popular channels with outstanding success. Unlike a lot of people in the music business, friend arranger is capable of not only practicing what he preaches, but also talking intelligently on almost every phase of music. We had just finished a hurried indigestible lunch, walked to the corner of 47th Street and Broadway in the city of sin, when friend arranger stopped (not quite as dramatically as I would have it) and spoke:

FRIEND ARRANGER: Did you hear the new Kenton album?

MYSELF: Yeah!

FRIEND ARRANGER: Did you hear Kenton's interview over WNEW (local N. Y. station)?

MYSELF: Yeah!

FRIEND ARRANGER: Well?

MYSELF: You're absolutely right!

From here on, many words leading to another listen over two cigarettes in the dense booth of aforementioned record shop. Along with the Kenton album in LP form and another put out by Discovery of some of George Shearing's klimperings, we went over the month's releases. The upshot is pretty well contained in what follows.

First of all, a word about Capitol records and their relation to the Kenton affair. In a sense, I am full of admiration for any record company that demonstrates its willingness to go along with an experimental situation. Whether or not we can consider Kenton as an experimental situation or not is another question, and is, to all intents and purposes, quite beside the point. We could argue motives all night and never come to any conclusion unless we were either psychoanalysts or in the know. The important

[Continued on page 39]

\* 279 West 4th Street, New York 14, N. Y.

\* 960 Park Ave., New York 28, N. Y.

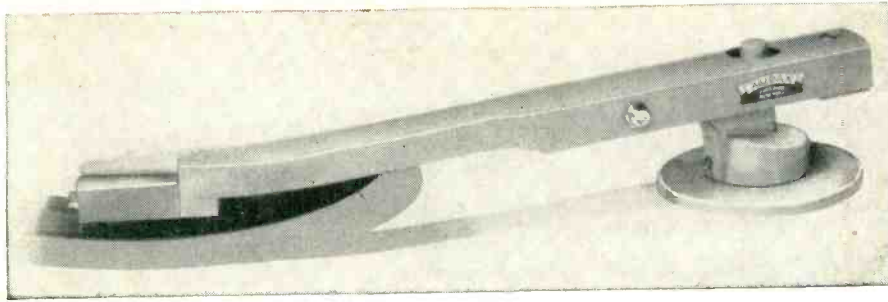

# \* HANGOVER

Writes a POLYPHASE owner:— "Have had your L-6 Polyphase in operation for over three weeks now. I have the needed instruments for testing. Polyphase certainly has the wide range claimed. But I have every other magnetic pick-up available in the market, and some of these also have wide-range. Now, I would like to ask you, what else can there be in this Polyphase that makes it sound SO VASTLY CLEANER, SMOOTHER THAN ANYTHING ELSE I HAVE EVER HEARD" . . .

J. P. Maxfield\*\* writes in AUDIO ENGINEERING, April 1948 . . . "This term (high fidelity) should not be used for 'faithful reproduction' as judged by the ear—since there is considerable evidence indicating that they are different."

\*\* Bell Tel. Lab pioneer and authority on electronic sound recording and reproduction.

As long as ten years ago, Audax stated:— "By now, wide-range has been mastered so thoroughly that today 'most any pick-up can be fixed for wide-range. BUT, wide-range is actually unpleasant if without QUALITY. Thus—of two singers, each capable of reaching high "C", one's voice may be pleasing, the other's just the opposite. To achieve EAR-QUALITY, all other factors must be satisfied. The most important of these is VIBRATORY MOMENTUM. The nearer the vibrating mass approaches the zero ideal, the less the "hangover" and the finer the finished performance."

*The vibrating mass in POLYPHASE is tinier, by far, than in any pick-up hitherto created. VIBRATORY MOMENTUM at last approaches the vanishing point. The result is a facsimile of the original performance.*

Never before such EAR-QUALITY, such FAITHFUL RE-PRODUCTION . . . that is POLYPHASE.

## but...

see it, HEAR it and compare it against any reproducer at any price—then you be the judge.

\* an ugly form of distortion.

## AUDAK COMPANY

500 Fifth Avenue

New York 18, N. Y.

"Creators of Fine Electro-acoustical Apparatus for over 30 years"

so simple

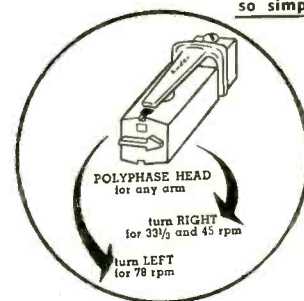

- One single, high quality magnetic unit and same point pressure for all discs, 6-8 grams and costs less than ordinary pickups
- Response 20 to over 10,000
- Sapphire Styli (or diamond) replaceable individually, as simply as you replaced steel needles
- Tracking phenomenal
- Output about 20 m.v.
- High or low impedance
- Needle-talk very low
- Highly sensitized arms
- POLYPHASE available for any arm

*There's an Audax for every purpose . . . Record Changers, Studios, etc. including high output types*

Send for editorial reprint on POLYPHASE principles.

# NEW PRODUCTS

● **Magnetic Recording Tape.** A number of advantages are inherent in the new plastic-base Audiotape recently placed in production by Audio Devices, Inc., 444 Madison Ave., New York 22, N. Y. Available on standard NAB hubs or on complete 10½-in. aluminum reels, the tape is ex-



ceptionally low in cost and is supplied in full 2500-ft rolls. Each roll is guaranteed to be a single strip of tape without splice. Volume variation is guaranteed to be not more than 0.25 db within a single roll, and not to exceed 0.5 db from reel to reel. The new tape is designated Type 2551 and is packed five boxes to a carton. It is available through local Audiotape distributors.

● **Artificial Reverberation Generator.** A new unit which outmodes and makes obsolete the echo chamber in broadcast and recording studios is the Artificial Reverberation Generator, manufactured by Audio Facilities Corp., 133 W. 14th St., New York 11, N. Y. As its name implies, the instrument is designed for adding reverberation, or echo effect, to radio, video and recording sound channels. It accomplishes this function by means of a magnetic-tape delay system combined

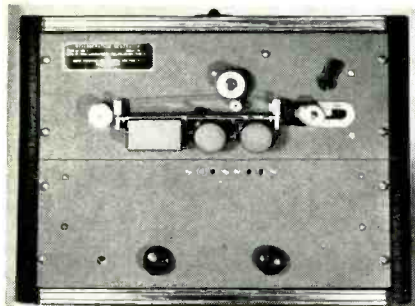

with a reentrant electronic circuit. The basic unit consists of two seven-inch rack panels, and will operate in conjunction with most broadcast-type audio consoles. Both input and output levels are zero VU, and frequency response is suited to wide-range live program material. Literature is available without cost from the manufacturer.

● **Precision Attenuators.** Now available to the audio field is General Radio's Type 829 decade attenuator unit designed for operation at audio and low radio frequencies. It is equally well suited for laboratory use and for incorporation in other equipment. Standard impedance is 600 ohms for both H and T types with other impedances available on special order. Type 1450 decade attenuators are assem-

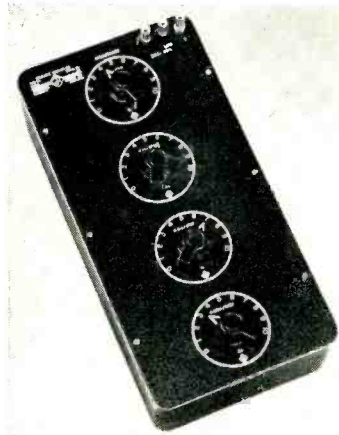

bles of Type 829 decade units in metal cabinets for bench use. Two- and three-dial boxes are available providing up to 110 db maximum attenuation. Complete technical information will be supplied without charge by General Radio Company, Cambridge, Mass.

● **Magazine-Loading Tape Recorder.** Rapid-fire loading is featured in the Tape Riter, recently introduced by Permoflux Corporation, 4900 West Grand, Chicago 39, Ill. Offering both recording and trans-



cribing, the new unit is suitable for all applications where immediate reproduction of recorded material is required. Fast forward and reverse speeds enable the user to locate any particular spot on the tape in a matter of seconds, according to the manufacturer. Accurate indexing is provided. Each magazine load permits 30 minutes of recording. Technical information is available from the manufacturer.

● **Tiny Audio Transformer.** UTC's new Type SSO, introduced recently as the smallest standard audio transformer in

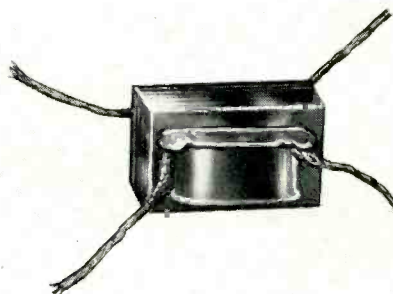

the world, measures .4 × .75 × .56 inches and weighs less than one-third of an ounce. It is especially suited for hearing aids, aircraft radio, and other applications where size and weight are important factors. Five stock models cover input, inter-stage, output, and reactor usages. Additional information may be obtained from United Transformer Company, 150 Varick Street, New York 13, N. Y.

● **Corner Speaker.** In designing the new Stephens Model 418 corner cabinet, appearance and performance were given equal consideration. The result is a speaker with excellent technical characteristics, as well as one which will be at home amid the most tasteful surroundings.



Included in the Model 418 assembly are two 15-in. low-frequency drivers, one high-frequency driver, with a 2 × 4 800-cps horn, and a matching crossover network. Cabinet dimensions are 41 in. wide, 23 in. deep, 36 in. high. Illustrated bulletin with prices will be supplied by Stephens Manufacturing Corp., 8538 Warner Drive, Culver City, Calif.

● **Audio Oscillator.** Although it covers a wide range of frequencies and offers a high degree of precision in operation, the new Radex Model 500 audio oscillator is



both small in size and light in weight. It makes use of an RC tuned circuit with extremely low distortion and noise content. Frequency range is 14.5 to 145,000 cps in four ranges, distortion is one per cent with 2000-ohm load, and hum is 50 db below signal at any output level. Cabinet dimensions are 9 × 5 × 6 in. and weight is only 8 lbs. Manufacturer is Radex Corporation, 2076 Elston Ave., Chicago, Ill.



## A SIMPLE ACOUSTIC CALIBRATOR for Your Sound-Level Meter



THE G-R Type 759-A and -B Sound-Level Meters have built-in calibrators for their electrical circuits; no means are readily available, however, to check the condition and calibration of their associated microphones.

The new Type 1552-A Sound-Level Calibrator is introduced as a simple, convenient and accurate method for calibrating both the microphone and the over-all system. Essentially it consists of a small, stabilized and rugged loud-speaker mounted in an enclosure which fits over the microphone in the sound-level meter. The acoustic coupling between the calibrator and the microphone is fixed and can be repeated accurately. Any audio oscillator with a harmonic content of less than 5%, supplying 2 volts at 400 cycles, can be used to operate the calibrator. A 500-

ohm potentiometer is required as an output control if the oscillator is not equipped with such a control. An accurate vacuum-tube voltmeter is needed to measure the voltage across the calibrator.

The level at which the calibrator is used is such that its operation is not affected by ordinary background noises. This simple device is an ideal means not only for assuring consistency of calibration and locating defective microphones, but also for inter-standardization of several sound level meters.

*The audio oscillator, v-t voltmeter and potentiometer shown in the set-up photograph are standard G-R items. If you need these or if you do not know about the complete line of G-R noise and vibration measuring and analyzing equipment. WRITE FOR THE "NOISE PRIMER".*



The Sound-Level Calibrator was designed for use primarily with the Shure Brothers Type 9898 microphone as used on the G-R Type 759-B Sound-Level Meter. It can be used on other microphones such as the Brush BR2S Sound Cell Microphone and the Western Electric Type 633-A Dynamic Microphone.

TYPE 1552-A Sound-Level Calibrator . . . . . \$45.00



# GENERAL RADIO COMPANY

Cambridge 39,  
Massachusetts

90 West St., New York 6 920 S. Michigan Ave., Chicago 5 1000 N. Seward St., Los Angeles 38



# HARVEY presents

## HR-15 AMPLIFIER KIT

The wondrous Williamson amplifier circuit... now available for the first time with the Original PARTRIDGE transformer built to Williamson's specifications. Order this kit at once, build it in 3 hours or less and enjoy sound like you never heard before. The HR-15 is a 2-chassis power amplifier for use with tuners or other front ends having own volume and tone controls. All triodes, American tubes, 2-6SN7's, 2-807's or 6BG6's in p.p. output, 5V4G rectifier. Frequency response  $\pm .5$  db, 10-100,000 cycles. 5 db rise at 2 cycles, 2 db rise at 250,000 cycles. Harmonic distortion .025% at 10 watts at 400 cycles. Intermodulation distortion at 10 watts output less than 1/2% using frequencies of 60 and 2000 cycles. Phase shift  $20^\circ$ ,  $\pm 10^\circ$ , 20-20,000 cycles. Output impedances 1.7, 6.8, 15.3, 27, 42.5, 61, 83, 109 ohms. Damping factor 50. Absolute gain 70.8 db. 20 db of feedback around 4 stages and the output transformer.

Kit is complete with tubes, punched chassis, prewired resistor board, sockets, genuine Partridge output transformer, and all necessary parts, \$79.50 net.

## MAGNECORD SERIES 6 RECORDERS AND AMPLIFIERS

PT6-JA Recorder and Amplifier...the only combination on the market today that offers such high professional quality at such a low price. Includes PT6-A Recorder plus Amplifier with low impedance microphone and bridging inputs, 10-watt audio amplifier with monitor, speaker and jack for external speaker, 600 ohms balanced line output terminal.



PT6-JA—MagneCORD combination .....	\$499.50
With high speed forward for cueing .....	515.50
PT6-A—Recorder .....	278.00
PT6-AH—Recorder with high speed forward for cueing .....	294.00
PT6-J—Amplifier .....	221.50

## MAGNECORD PT7 PROFESSIONAL TAPE RECORDER 3 Separate Heads

A truly new design for the finest possible reproduction.

### Direct Monitoring During Recording!

Erase head...Record head...Monitor and Playback head. Each designed for maximum performance in its function. Provides greatest flexibility. For portable, rack or console installations.

Place your order now for early delivery.



## PT6-P—PORTABLE AMPLIFIER

A highly versatile, light weight, self-contained unit including a record-playback-remote amplifier and power supply for use with the PT6-A Recorder. 3 low-level, independently mixed mike inputs

plus bridging input. Power supply has monitor amplifier and speaker.

PT6-P—Portable Amplifier .....

WESTERN ELECTRIC SPEAKER 8" — 755-A .....

## ELECTRO-VOICE MIKES

E-V Model 655A, in stock for immediate delivery. Engineered for highest BC and FM standards.....

E-V Model 650.....

E-V Model 645.....

We have a complete stock of Jim Lansing Signature speakers.

WATCH...for the announcement of Harvey's new sound room...opening soon!

Telephone: **3-1rc** LUxemburg 2-1500

All in stock for immediate delivery.



103 West 43rd St., New York 18, N. Y.

NOTE: All prices are Net, F. O. B. N. Y. C. and are subject to change without notice.

● Multi-Cellular Tweeter and Filter. Latest entrant into the high-quality speaker field is the Model HR-2 tweeter and high-pass filter manufactured by Atlas Sound Corporation, 1449 39th St., Brooklyn 18,

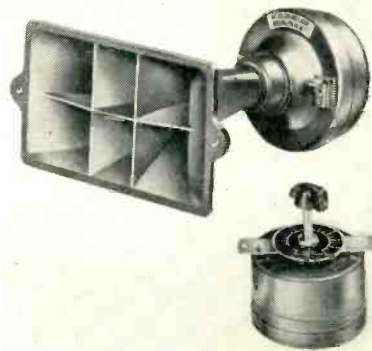

N. Y. The unit will handle 25 watts above 1000 cps, and makes use of a die-cast six-cell horn to achieve wide-angle distribution. Upper frequency limit is 15,000 cps. The assembly is ideally suited for use with any conventional woofer to achieve wide-range reproduction. Technical information will be supplied on request by the manufacturer.

● Wide-band d.c. Amplifier. Produced essentially to increase the sensitivity of cathode-ray oscilloscopes with extended low-frequency response, the new Furst Model 120 d.c. amplifier is also suitable for

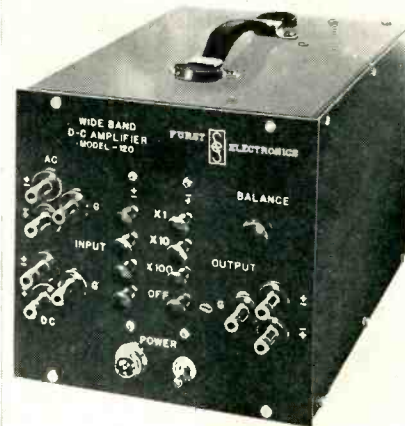

extending the range of vacuum-tube voltmeters, frequency analyzers and other instruments involving unusually low frequencies. Frequency response of Model 120 is d.c. to 100,000 cps  $\pm 1$  db. Maximum gain is  $100 \pm 10$  per cent for balanced or unbalanced inputs and outputs. The unit is supplied in a sheet metal cabinet 7 x 7 x 11 in., finished in black hammertone. Technical sheet will be supplied by Furst Electronics, 12 S. Jefferson Street, Chicago 6, Ill.

## AUDIO PATENTS

[from page 8]

at maximum attenuation, the two channels are separate and maximum binaural effect is obtained. With the pad at zero attenuation, the same signals feed both speakers and the effect is almost monaural. At in-between settings, medium binaural effects, adjustable to the listeners' desires and the room, are possible.

Another patent, No. 2,481,576, by the

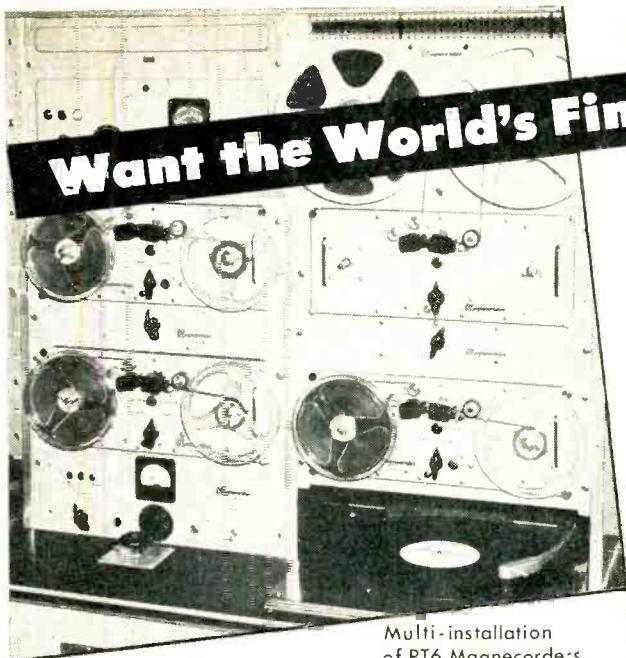

Multi-installation of PT6 Magnecoders

**Want the World's Finest Tape Recordings?**

There's A

# Magnecorder

for every purpose  
... every purse!

*The Talk of the Shows!*

## THE NEW PT-7 SERIES

3 Heads (erase, record, playback for monitoring from tape) in single housing, yet separately alignable, replaceable. New positive drive. 2 speed hysteresis synchronous motor. Push-button controls can be remotely operated. Uses 7" or 10½" N.A.B. reels. 3 channel portable amplifier has high-level mixing.

PORTABLE  
RACK OR  
CONSOLE

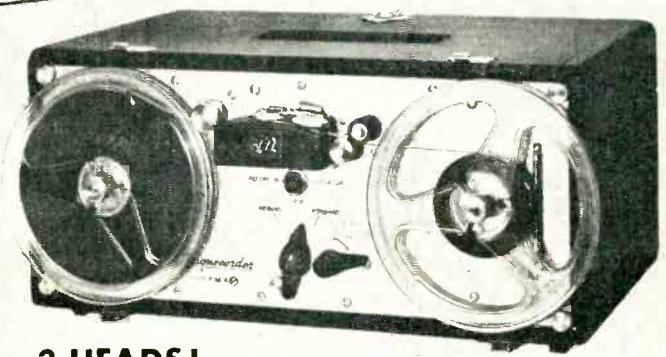
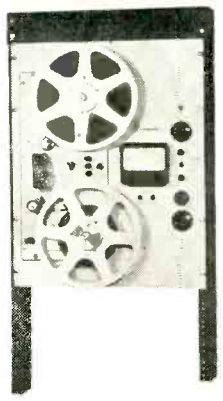
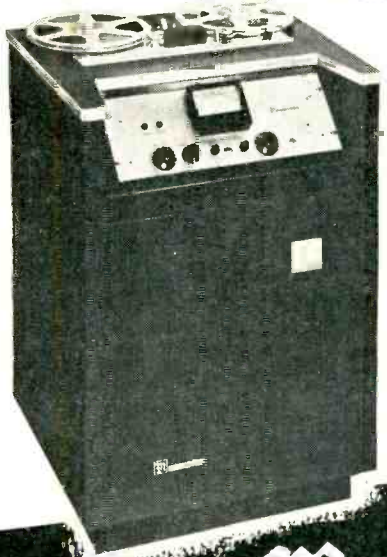
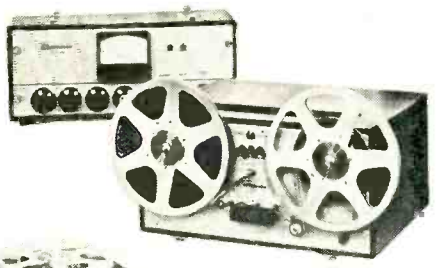

### 3 HEADS!

### PT63-A to MONITOR YOUR MAGNECODINGS

Three separate heads — erase, record, and playback for monitoring from tape — prevent recording errors. Same high fidelity and flexibility as the Magne-corder PT6-A — the world's most widely used professional tape recorder. New PT63-J Amplifier has separate playback and recording amplifiers to monitor from the tape. Includes 10 watt audio amplifier which also will drive external speaker.

### OR CONVERT YOUR PT6-A TO MONITOR

#### KIT 101

Conversion kit includes a three-head unit, monitor amplifier and power supply to modernize your present PT6-A. Head unit plugs into receptacles for present two-head unit.



Write for latest specifications and prices

**Magnecord, INC., CHICAGO 1, ILL.**  
360 NORTH MICHIGAN AVENUE

World's Largest and Oldest Manufacturer of Professional Magnetic Recorders

now....the amazing  
**ALTEC 21B**  
 miniature microphone  
 for lapel use!

actual  
 size



perfect  
 quality  
 hardly  
 visible

The new Altec 28A Lapel Microphone permanently incorporates the Altec 21B. Its small size makes it practically invisible when clipped to the clothing of the user. Here is a development that offers public speakers and professional people a microphone that is invisible, gives them complete freedom of movement and provides them with quality that was never before available. The 28A is held to the clothing by a jewelry clip and is equipped with 6 ft. of cable.

The 154A Matching Unit is used with the 28A and contains the necessary impedance matching tube. The size of a pack of cigarettes, it is easily carried in the pocket. Equipped with 25 ft. of cable.

Write for full information on this and other models of the Altec 21B microphone.



1161 N. VINE ST., HOLLYWOOD 38, CALIFORNIA  
 161 SIXTH AVENUE, NEW YORK 13, NEW YORK

same inventors, suggests that in binaural systems, a second speaker for each channel be placed at the other end of the room, with the listeners in the middle. Each speaker for each channel (four in all) has a separate volume-controlling means available to the operator or operated by control signals recorded on the tape or film being played. When sound effects like rain or crowd noises, which involve a really large spatial distribution of sound, come along, the volume controls are manipulated so that the listeners get that "surrounded" effect. The same system is, of course, usable for "placing" sounds at the front or rear of the listener, as well as to either side of him as in the usual binaural system.

A copy of any patent may be obtained for 25¢ from the Commissioner of Patents, Washington 25, D. C.

### NEW LITERATURE

● **The Turner Company**, Cedar Rapids, Ia. has just issued Bulletin No. 949, a complete listing of all Turner microphones and accessories. The catalog includes illustrations of all items, together with technical specifications and prices. Included also is a brief monograph to aid users in the selection of the proper type of microphone for any specific application.

● **Sylvania Electric Products Inc.**, Electronics Division, announces publication of "40 Uses for Germanium Diodes," an illustrated booklet covering the application of germanium diodes in a diversified variety of electronics equipment. Text and circuit diagrams are grouped in three sections—radio and television receivers; radio transmitters and amplifiers; instruments and supervisory circuit devices. The booklet may be obtained from authorized Sylvania tube distributors, or upon remittance of one dollar to Advertising Department, Sylvania Electric Products Inc., Emporium, Pa.

● **Cannon Electric Development Co.**, 3209 Humboldt St., Los Angeles 31, Calif. is offering a new engineering bulletin covering the entire line of Types K and RK connectors. Containing 48 pages, the new catalog includes complete technical data, incorporating such items as flash-over values, contact amperages, dimensional figures, weights etc. Copies are available from the factory.

● **Allied Radio Corporation**, 833 W. Jackson Blvd., Chicago, Ill. has published "A Dictionary of Electronic Terms" in response to the need for an up-to-date reference source of words commonly used in the electronics field. The 2500 definitions contained in the book range from many words no longer in general use but retained for historic reasons, to the terminology used in color television and the electronics of nuclear physics. Available from Allied for 25 cents to cover costs.

● **Walker-Jimieson, Inc.**, 311 S. Western Ave., Chicago 12, Ill., wholesale distributor, is now in process of circulating Catalog No. 164, a new buying guide for radio, television and electronics parts. Specially planned for quick and easy use by service dealers, the new catalog will be mailed free to those entitled to buy at wholesale prices.

● **Crest Transformer Co.**, 1834 W. North Ave., Chicago 22, Ill. has recently pub-

## ANNOUNCING



### 2 NEW MODELS

#### Of Sun Radio's Famous All-Triode Amplifier

The renowned Sun Amplifier Model CR-10 is now offered in three models, the two new ones featuring the famous Peerless transformers. New models are approved by Consumers' Research, original designers. Here's more good news -- for the first time in many months this much wanted amplifier is available for immediate delivery on all models. And prices are scheduled to go up September 1st, so better buy yours now . . .

CR-10, standard model, as engineered to original design by CONSUMERS' RESEARCH OF WASHINGTON, N. J.

Kit . . . . . \$42.50  
 Lab wired, tested, ready to use . . \$69.50

CR-10-P uses Peerless transformers throughout, including output transformer designed especially for this amplifier. Improved low frequency response adds "presence" to reproduction.

Kit . . . . . \$45.95  
 Lab wired, tested, ready to use . . \$74.50

CR-10-Q using Peerless transformers throughout, features famous Peerless S-240-Q Output Transformer for real presence effect. Note these specs:

Frequency Response  $\pm 1$ db, 20-20,000 cps.  
 Less than 2% Harmonic Distortion at 10W output.

Source impedance at 4 ohm tap is 1.3 ohms -- this provides excellent damping of loudspeakers.

Delivers full power within 1db from 40 to 10,000 cycles.

Output transformer vacuum impregnated, moisture resistant.

Output impedances available for any load 2 ohms to 16 ohms. (500 ohms available on special order at no extra cost).

Transformer has split windings interleaved with secondary, making for extremely high efficiency and low losses.

Kit . . . . . \$54.95  
 Lab wired, tested, ready to use . . \$84.00

Sold Exclusively by Sun Radio, N. Y.



MAIL ORDERS FILLED PROMPTLY

# Here's THE MAGNETIC TAPE YOU asked for!

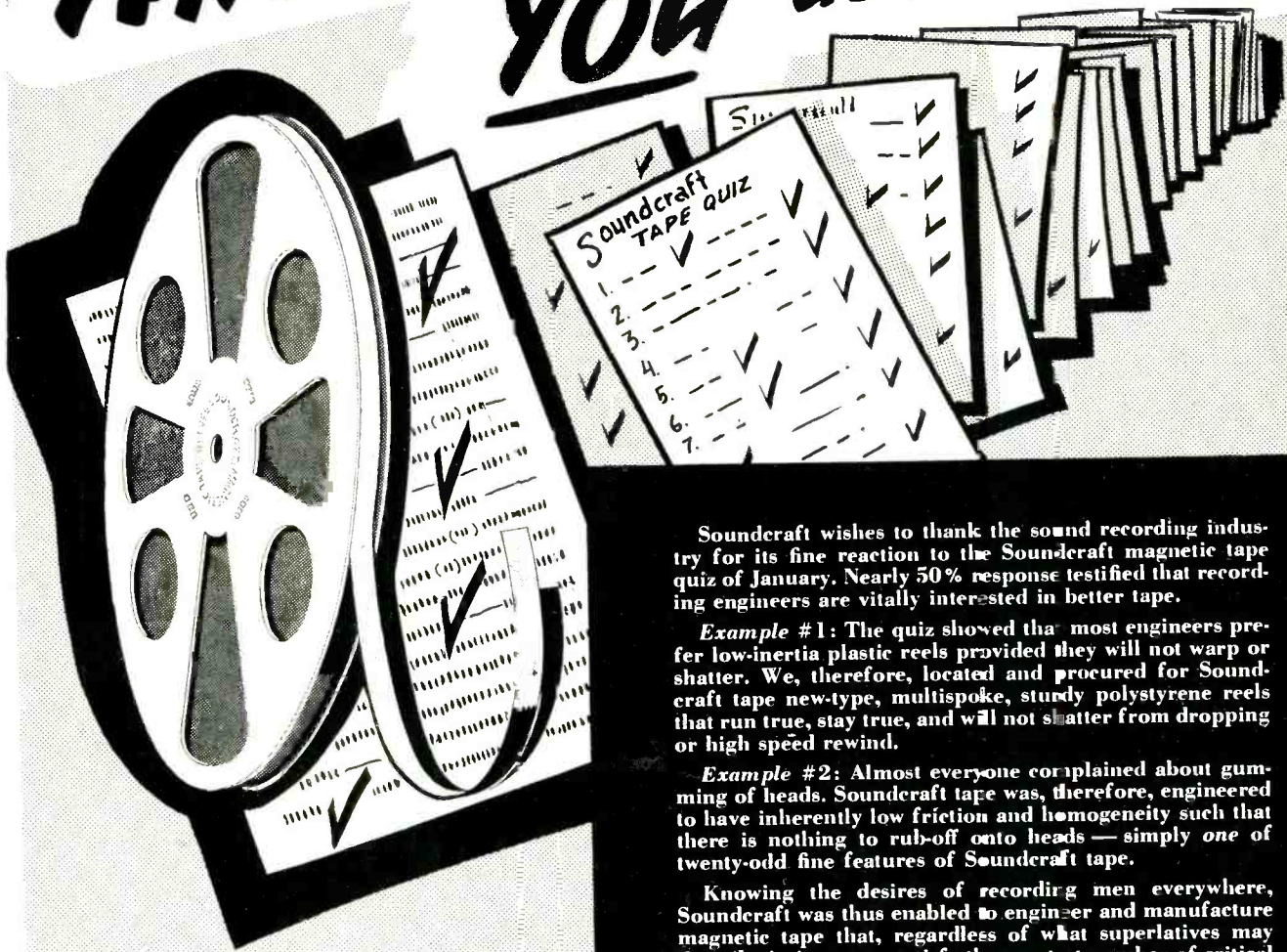

Reeves Soundcraft tape is a new companion product to Reeves Soundcraft discs and styli.  
 "20 years with sound recording media."

Soundcraft wishes to thank the sound recording industry for its fine reaction to the Soundcraft magnetic tape quiz of January. Nearly 50% response testified that recording engineers are vitally interested in better tape.

**Example #1:** The quiz showed that most engineers prefer low-inertia plastic reels provided they will not warp or shatter. We, therefore, located and procured for Soundcraft tape new-type, multispoke, sturdy polystyrene reels that run true, stay true, and will not shatter from dropping or high speed rewind.

**Example #2:** Almost everyone complained about gumming of heads. Soundcraft tape was, therefore, engineered to have inherently low friction and homogeneity such that there is nothing to rub-off onto heads — simply one of twenty-odd fine features of Soundcraft tape.

Knowing the desires of recording men everywhere, Soundcraft was thus enabled to engineer and manufacture magnetic tape that, regardless of what superlatives may describe it, is sure to satisfy the greatest number of critical users.

Gentlemen:

Date: NOW

Please send us OUR free sample of Soundcraft tape (200 ft. on 5" reel). We now use \_\_\_\_\_ brand and type # \_\_\_\_\_.

YOUR NAME \_\_\_\_\_

ADDRESS \_\_\_\_\_

← Mail now to →

**REEVES Soundcraft CORP.**

35-54 36th STREET, LONG ISLAND CITY 6, N. Y.

# Air-Tone HEADQUARTERS FOR MAGNACORD



### McIntosh Amplifiers

Highest quality, efficiency. Full dynamic range. Frequency range—20 to 20,000 plus or minus 2db; 10 to 200,000 plus or minus 2db. Lowest phase shift distortion, lowest noise level.

- 50 W-1 for less than 1% distortion
  - Continuous single frequency rating
  - 50 watts RMS—Peak 100 . . . . . \$249.50 net
- 20 W-2 for less than 1% distortion
  - Continuous single frequency rating
  - 20 watts RMS—Peak 40 . . . . . \$149.50 net

### AIR-TONE HEADQUARTERS FOR MAGNACORD

Air-Tone offers Magnecord recording equipment for all those who desire the ultimate in Magnetic recording. Easy operating. Magnecord provides unusually high fidelity, great flexibility in use, outstanding realism in tone.

#### PT6-JA Recorder & Amplifier

Portable rig for professional, superb reproduction of all types of program material. 10-Watts output. Highest Quality, Greatest Value.

\$499.50



# Air-Tone

SOUND & RECORDING COMPANY

1527 CHESTNUT ST., PHILA. 2, PA. — RI. 6-8388

## New Type 2A TAP SWITCHES HAVE A CONSTANT CONTACT RESISTANCE OF ONLY 1 or 2 MILLIOHMS!

These high quality switches with up to 24 contacts were specifically developed to meet the need for rugged precision instrument switches that have longer operating life and are economical components in competitively priced electronic instruments and military equipment.

Write for Technical Bulletin No. 28.

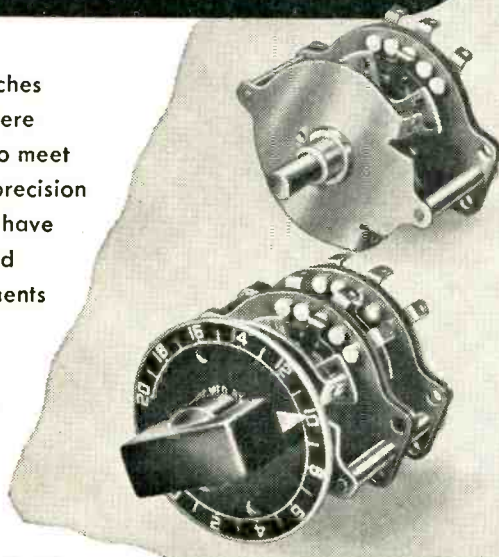

**TECH LABORATORIES** PALISADES PARK  
NEW JERSEY

lished a catalog of television equivalent parts. Comprehensive in every detail, it contains complete listing of equivalent parts for over 200 television sets made by over 50 leading manufacturers. The catalog may be obtained without cost by writing on firm letterhead.

● **Hytron Reference Guide.** The new 4th edition of the reference guide for miniature electron tubes is just off the press, and is available free by writing Hytron Radio & Electronics Corp., Salem, Mass. This guide lists all miniature tubes to date, regardless of make, and includes 132 miniature types involving 41 new tubes and 70 basing diagrams. In addition, the listing indicates similar larger prototypes.

● **Age of a Patent.** A simple little folder has just been published by Patent Reporting Division, Invention Inc., Munsey Bldg., Washington 4, D. C. which indicates the date of issuance of any patent by referring to the number. This useful and interesting folder may be had free by writing on a business letterhead.



## Employment Register

POSITIONS OPEN and AVAILABLE PERSONNEL may be listed here at no charge to industry or to members of the Society. For insertion in this column, brief announcements should be in the hands of the Secretary, Audio Engineering Society, Box F, Oceanside, N. Y., before the fifth of the month preceding the date of issue.

● **Radio Engineer Wanted:** by prominent Chicago electronic mfr. to design and supervise mfg. of full line of comm'l amps. Must have engineering degree or equivalent, and minimum of 2 yrs. design exp. in commercial P.A. systems. Give details including age, education, experience, reference, availability and salary expected. Box 601.

● **Electrical Design Engineer Wanted:** By large, modern, Eastern manufacturing firm for experimental development work in industrial electronics. Applicant must have degree in electrical engineering with communications or electronic option or equivalent in 10-15 years practical experience. Give details, including age, education, experience, references, availability, and salary expected. Box 401.

● **Audio Engineer.** BS in radio from NYU, 26, married. Well versed all phases comm'l disc and tape recd'g. Presently employed large NYC studio, but not happy. A "future position" more desirable than a "present job." 9 yrs audio exp: available immediately, NYC metropolitan area. Box 501.

● **Audio and Electrical Engineer:** MS in physics; MS in EE. 10 yrs research, development, and design experience with magnetic and disc sound recording, acoustic measurements, and transducers. Also experienced in magnetic recording systems for computer applications. In present position for 10 years, but desire change to smaller company or consulting firm. Box 402.

● **Audio Engineer.** BEE from CCNY, 25, married. Superior knowledge of music; some informal experience with magnetic recording. Desire position in audio. Salary and location secondary. Box 301.

# POPS

[from page 30]

factor to be considered is the fact that Capitol did go ahead and record the new Kenton group, especially at a time when the market is turning away from "progressive jazz" and its various offspring and returning to a more conventional thing called "dance music." The Kenton LP may sell like hot cakes and make a lot of money for both Capitol and tall Mr. Kenton. Despite this, it took a lot of faith in the guy and the stuff he is purveying at present to go ahead. As all past readers of this column know, I have nothing but admiration for any record manufacturer who is willing to demonstrate a little liberality in the jazz area and its multitude of fringes.

But, with respect to Mr. Kenton, we are dealing with a horse of another color. I have followed the career of the tall guy with a modicum of interest mixed with a good serving of skepticism. One of the early releases, Tampico, was a neatly recorded, neatly arranged, live job that led to the period of Artistry in Rhythm and various concoctions all stemming from the same fount. A recently released LP, entitled "Stan Kenton's Milestones" and numbered H-190 supplies a quick glimpse into the period in the Kenton story which marked the introduction of such terms as "Progressive Jazz" and the fervent campaigning by Mr. Kenton and various members of his clique for this new approach to music.

We had no particular objection to the period, despite the fact that a listen to the aforementioned LP immediately points to a remarkable redundancy in Mr. Kenton's ideas. The same harmonic progression dominates all the Artistry numbers and appears sporadically in such things as "Concerto to End All Concertos," etc. The redundancy could be forgiven if Mr. Kenton had a legitimately good idea to begin with and demonstrated the ability to do something more with it than rhythmic switches of all shades and varieties. The so-called virtuosity of his band, notwithstanding . . . the capable vocalisms of Miss June Christy notwithstanding . . . our skeptical eyebrows were at their peak. But worse was to come. In the form of a collection of banalities that were excused by the use of such terms as "Twelve Tone System," by such names as Arnold Schoenberg, Alban Berg, and Igor Stravinsky, and by such epithets as "the wave of the future," "modernity in jazz," and a whole bunch of the like, Stan Kenton was exalted to the unprecedented position of "king of the future" (the last by a middle-west disc jockey whose voice quivered with such undeniable enthusiasm during the apotheosis of Monsieur Kenton that I feared the sobs to come). This period was culminated by (and terminated by) a veritable monstrosity called "This is My Theme," a poetry session with background noise. This last thing was recited by Miss June Christy whose talents do not extend to the recitation of poetry, whether good or bad, or the speaking of the English language in a way any more effectual than that of a 12-year-old reciting Gunga Din. The background music, I must admit, was eerie to a degree never before accomplished without the use of Theremin. But the whole world looked bad at this point, and with an ominous feeling that everything was going to pot anyhow, "This is My Theme" seemed to express rightfully the general state of affairs, both musically and otherwise.

Shortly after this, word spread that the Kenton organization had folded. The fold (if that is what one should call it) occurred after several grandiloquent concerts, one

# FIRST

**RESPONSE:**  
40-15,000 C.P.S.  
± 2.5 DB

**POWER RATING: -53**

**OMNIDIRECTIONAL**

**ACOUSTALLOY  
DIAPHRAGM**

**POP-PROOF HEAD**

**CHANGEABLE  
LOW IMPEDANCE**

**REMOVABLE SWIVEL**

**1/2" OR 5/8"-27  
THREAD MOUNTING**

**CANNON XL-3  
CONNECTOR**

**ALL PARTS  
PRECISION GROUND**



Shows TV 655 suspended on a boom. Omnidirectional polar pattern and firm swivel permits easy, diverse use.

# SLIM TRIM DYNAMIC for TV



- New '655' Microphone Provides Ultra-Wide-Range, High Fidelity Response
- More Rugged, More Versatile
- Stops Wind and Breath Blasts
- Individually Laboratory Calibrated

Here, for the first time, you have a slim, trim microphone with all the advantages of dynamic performance and utility! Only because of the ingenious Acoustalloy diaphragm and other E-V developments has it become a reality! Meets the highest standards of TV, FM and AM.

You can use the TV 655 on a stand, in the hand, or on a boom . . . or you can easily conceal it in studio props. No additional closely-associated auxiliary equipment is required! Provides effective individual or group pick-up. Reproduces voice and music with remarkable accuracy.

New E-V Blast Filter makes the 655 pop-proof. Acoustically-treated, strong wire-mesh grille head stops wind and breath blasts. Eliminates wind rumble in outdoor pick-up. Fully field tested and proved! Ideal, too, for recording and high quality sound amplification.

See for yourself! Write today for Bulletin No. 156 and full information on how you can try this amazing new microphone.

Model 655. List Price . . . . . \$200



Shows the popular Patsy Lee with the TV 655. Note how swivel permits aiming at sound source without hiding face.



Shows TV 655 in the hand with swivel removed. Note how convenient it is to handle for announcing or interviewing.

## Electro-Voice INC.

401 CARROLL STREET • BUCHANAN, MICHIGAN

Export: 13 East 40th Street • New York 16, N. Y., U. S. A. • Cables: Arlab

\*Formerly manufactured by Western Electric Co., Inc.

**FIDELITY...**

**PRESENCE...**

**COMPACTNESS**



**757A**—Developed at Bell Telephone Laboratories to reproduce sound over an extended frequency range with arresting presence and fidelity, the 757A Loudspeaker is a complete two-way system combining finest speaker design principles with compactness and adaptability. Its 60-15,000 cps response, 30 watt capacity and wide angle of distribution make the 757A ideal for every service where highest quality sound is required. Input impedance to dividing network is 4 ohms. 757A is 20" high, 30½" wide, 13¾" deep; weighs 82 pounds.

**728B**—The famous 728B Loudspeaker is widely acclaimed by engineer and music lover alike for its fine musical qualities and unusual presence. It is compactly built, with a depth of only 3-25/32". Overall diameter is 12-11/32". Exceptionally smooth frequency response from 60-10,000 cps. Impedance, 4 ohms. Will handle 30 watts continuously.



**755A**—The 755A Loudspeaker gives large speaker performance in a small package only 8" in diameter, 3" deep. 70-13,000 cps response. 8 watt power capacity. Impedance, 4 ohms.



1161 N. VINE STREET, HOLLYWOOD 38, CALIFORNIA  
161 SIXTH AVENUE, NEW YORK 13, NEW YORK

## IN ORDER TO FIND IT— WHY NOT BIND IT?

Your reference library of **AUDIO ENGINEERING** can be up-to-the-minute by keeping your copies in an **AUDIO Binder**.



**APPEARANCE** . . . Your den, workshop . . . or wherever you do your experimentation can be kept in "apple-pie" order when all your copies of **AUDIO ENGINEERING** are within easy reach. The deep, blue cover will harmonize with any color scheme and . . . in addition, the backbone will be gold-stamped with **AUDIO ENGINEERING** and any year you specify.

**CONVENIENCE** . . . No more wondering what happened to last month's issue . . . or the month before . . . Just reach for your Binder and no time is lost finding the information you need . . . **AT ONCE**.

**WORKMANSHIP** . . . DuPont Fabricord . . . stainproof and washable . . . rigid backbone with bound-in metal support . . . center channel to keep magazines securely in position.

**COST** . . . For only \$2.50 you can have this handsome binder for your ready reference.\*

\*(Foreign orders add 50¢ per binder)

**Audio Engineering**  
342 Madison Ave., New York 17, N. Y.

Enclosed find \$ . . . . . for . . . . . Binders

Name . . . . .

Address . . . . .

City . . . . . Zone . . . . . State . . . . .

Year Wanted  1947  1948  1949  1950.

in particular given at Carnegie Hall, New York. We were shocked, to say the least. Despite our musical objections, we had to admit that Mr. Kenton had done a noble job of propagandizing himself and his ideals. A pleasant guy, he made it a point to see every disc jockey he possibly could in the weary treks back and forth across the country. Long evening sessions were spent in talking the cult of the "new music." Whatever else he did, he certainly did one of the most effective jobs of promoting his cause we've ever seen (or heard). Would that Louis Armstrong had done the same thing for Jazz with a capital J.

But the ways of the world are unfathomable, and the Kenton organization came to a dead halt. We kind of figured we'd be hearing from tall Stan again, probably in the form of a more orthodox organization. But never underestimate the power of a trend. Not too long ago, up popped Mr. Kenton with an enormous band replete with strings, bongos, flashy instrumentalists, and the indomitable Miss Christy. Had he retreated? Oh, no! Had he merely held his ground? Oh, no! He's even gone further into the wave of the future and, combining Raymond Scott style titles with complex orchestrations, is dealing in something called "Innovations." A Carnegie Hall recital, a conversation with a disc jockey, and many repeated listenings to "Innovations," Volume 1, have produced the following conclusions.

The argument that I am expressing the typical resentment of the Dixieland reactionary is just so much bosh. I am completely receptive to the patterns of the twentieth century. I am further one of the few people who can call a work such as the Alban Berg "Violin Concerto" a favorite, despite the many groans of disapproval. I am only too willing to give a fair listen to anything, no matter what, which attempts to do something "different" within the confines of the thing called music. But, in the final analysis, the new Kenton group is doing nothing different. The orchestrational tricks employed in the Kenton things are as old as the hills. Further, they are not, in themselves, bad. Friend arranger, mentioned at the beginning of this piece, went to great pains to point out that he himself had used them and so had any number of other arrangers in the business. Further, we agreed that the problem had nothing whatsoever to do with the fact that what Kenton is playing is not jazz, is not swing, is not popular music, but is simple ensemble music with more or less serious implications.

What we object to so strenuously is the utter banality, the sheer vulgarity of the basic material involved. No matter how good the arranger, no matter how good the orchestra, no matter how good the individual soloists, if the basic material is worthless, there is a limit to what you can do with it. This has been the problem with the Kenton menage from the very beginning. We have no fault to find with the group. They have even received the benefit of some of the best recordings in a period of some rather outstanding recording work. From the point that the progressive fixation got going, the basic material has gotten cheaper and cheaper, more banal and more sickeningly second-rate. Take any case you want, think of your pet idea of the most flimsy, worthless music you know and then play around with the idea of tricky arrangements. At first, it may sound a little bit different, slightly out of the ordinary. But after a few listens, you realize that there is no salvation to be found in eccentric arrangements.

We cannot consider Kenton's new music in the normal category of pops. It is deserving, in terms of its pretensions, of a



criticism based on the realization that it is music which calls for specified listening as opposed to dancing, whistling, unconscious recognition, etc. Is it good "serious music?" Arranger friend and I say "definitely not!" Is it good music, period? Arranger friend and I say "definitely not!" Is the performance anything out of the ordinary? No . . . the performances—despite a lot of fortissimo blaring and the like—are wooden, un-free. The old Kenton group at least indicated a degree of familiarity with what they were doing and a degree of freedom within it. There is a tremendous amount of self-consciousness evident in this job.

But to make the case more complete, arranger-friend and I referred to an interview carried on WNEW. Kenton discussed his music in terms of the Schillinger system, and did so rather incompetently for one who theoretically is a student and follower of the Schillinger school, which has to its merit the fact that the founder devised mathematical means of simplifying the rote work in composition and arranging. Certain patterns in music are repetitive to such an extent that there is no reason why they cannot be reduced to formulas and equations and graphs which simplify the job of the modern composer, who after all is not the wide eyed visionary the public thinks he is. A good many of the things that can be said in music have already been said. Both yours truly and friend-arranger have more than a simple familiarity with the Schillinger system, and what Kenton had to say about it was rather strange, to say the least. We can assure you that Schillinger is no more responsible for the inadequacies of the Kenton group than Beethoven for the shortcomings of Irving Berlin. Therefore, friend arranger and I shook our heads sadly and moved on to more congenial fields. Hats off to Capitol for the try! Thumbs down on Kenton, nevertheless.

### NEW RELEASES:

#### De Temps en Temps

Jacqueline Francois et Paul Durant avec son orchestre

#### Polydor 0.803-3ACP

To date, we haven't touched foreign pop releases. Among other reasons, we didn't care to ride the fad bandwagon during the hysterical Edith Piaf period. Further, rather than pan a whole group of releases, thereby giving the impression that European pops aren't any good, we waited until something adequate came along. This month's batch is pretty good, on the whole. The Polydors we've picked out are outstanding for a number of reasons, foremost being technical quality. The international discophile is well aware of the low quality of a majority of pre-war recordings coming out of France. Not only French HMV, but also Polydor shared in the curse of extreme noisiness, low level, etc. Of course there were exceptions, but this isn't the place to discuss them. The passage of time has resulted in some radical improvements as the above job will clearly indicate. Francois is more or less typical in the tradition of the French chantotsie. Smooth, subtle rhythmically, with a gorgeous sense of style and phrasing, she is capable of making the lyric secondary to the implied flavor. Orchestration is standard, extremely smooth, and well calculated to support the vocal. Quality is superb, with the type of balance so rarely found on pop vocals. Surfaces delectful.

#### Sous Le Ciel Bleu de Catari

Teddy Reno avec Boris Sarbeck et son orchestre

#### Polydor 0.813-1 ACP

Another Polydor import deserving of fulsome praise. While this disc is not quite as

# Gray

RESEARCH

FEATURES IDEAL REPRODUCTION

## TRANSCRIPTION ARMS

### NEW VISCOSUS-DAMPED 108-B ARM



For all records — 33 1/3, 45 and 78 r.p.m. Radically new suspension development on the viscous damping principle for perfect tracking of records and elimination of tone arm resonances. Instant cartridge change with automatic correct stylus pressure. Solves all transcription problems. Ideal for LP records. For Pickering, new GE (short), old GE (long) cartridges. Write for bulletin. Price, less cartridges, \$50.70

### MODEL 106-SP ARM

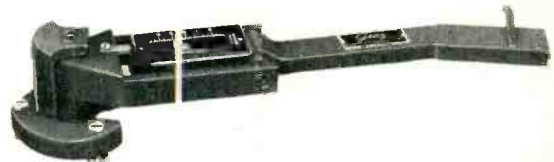

Designed to meet strictest requirements of modern highly compliant pick-up cartridges. 3 cartridge slides furnished enable GE 1-mil, 2 1/2-mil or 3-mil cartridges or Pickering cartridge to be slipped into position in a jiffy. No tools or solder! Superb reproduction of 33 1/3, 45 or 78 r.p.m. records. Low vertical inertia, precisely adjustable stylus pressure. Write for bulletin. Price, less cartridges, \$45.15

## EQUALIZERS

### MODEL 603 EQUALIZER

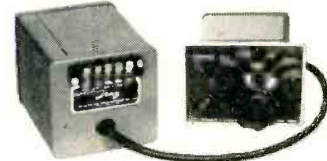

Latest of the universally adopted Gray Equalizers used, with Gray Tone Arms, as standard professional equipment by broadcast stations. High-frequency characteristics obtainable comprise 5 steps — flat, high roll-off, NAB, good records, poor records. For both GE and Pickering cartridges. Price, \$50.70

### MODEL 602 EQUALIZER

Has 4 control positions, highly accurate response curves. Price, \$49.50

Write for bulletins on Gray Equalizers.

**GRAY RESEARCH** and Development Co., Inc.  
18 Arbor St., Hartford 1, Conn.

Division of The GRAY MANUFACTURING COMPANY  
Originators of the Gray Telephone Pay Station and the Gray Audograph



musically satisfying as the Francois, it is nevertheless cleverly made. The orchestration and over-all balance have changed subtly to accommodate a totally different voice (male and baritonish) and a totally different mood. Teddy Reno is a few pegs above the batch of disenchanted French crooners with which the market is flooded at present. A thoroughly pleasant job any way you look at it. A few American manufacturers might look into the production techniques involved in these babies. They reveal a much more comprehensive understanding of the problems involved in recording vocals, especially of the pop variety.

**Latin Rhythms**

Edmundo Ros and His Orchestra  
London LPB 155

As of this moment, London has the edge on the typical Latin American percussive recording. Some months ago we reviewed another Latin Rhythm job with paeons of

praise. This baby is even better, although it belongs in a slightly different musical category. Edmundo Ros is in the process of establishing himself in the U. S. on the basis of a weird, laryngeal voice and the instinct for cuteness in his orchestrations. The Wedding Samba started the whole thing off. Heaven only knows where it will end. But despite some hesitation for blowing my top about the musical genius of Mr. Ros, this job is a happy baby any way you look at it. Psychologically, it is a masterpiece; featuring the percussion section in a balance which is nothing short of inspired, it raises to a prominent level the more appealing elements in Latin-American music and dispenses with the heavy emphasis on melody which has ruined more than one record date. Further, the brass-sax blend is contrasty enough to supply instrumental liveness unbeatable at the moment. Such things as Tico Tico, La Comparsa, Samba Samba, Paraquedista,

Congo, etc., are beautifully done. Every possible type of south of the border rhythmic impulse is on this ten inch LP. Highly recommended for dancing, wiggling, or whistling.

**A Symphonic Portrait of Cole Porter**  
Arranged and Conducted by Guy Luypaerts

Capitol L-159

The blurb on the back of this one mentions the fact that a "fifty piece concert orchestra of some of the world's great musicians" has been assembled for this job. This may very well be; there is occasional evidence, such as woodwind solos, which indicate the possibility that a clinker or two sneaked in. Nevertheless, an interesting job in many respects. Though I don't have any inside information on the recording conditions involved, the LP (I haven't heard the shellac album) sounds very FFRRish. The solo parts come over quite nicely, and unlike several of the recent Capitol LP's, is lacking in brittleness. As far as the orchestration goes, it tends to be moderately over-lush in spots, and extremely smooth elsewhere. Many sections are extremely danceable, but for dancing purposes things have to be arranged in the following way:

1. Because there are long bridges which are not arranged for dancing, a side table should be set up with sandwiches, beverages, and convenient literature for short intermissions.
2. A long couch (not too soft) for pantomime purposes.
3. A metronome with alarm arrangements, making it possible to take advantage of every potential dancing moment.

**Music for Easy Listening**

Paul Weston and his Orchestra

Capitol H 195

We can't help ourselves. We like Weston, his arrangements, his orchestra. Used to be that the finest way of spending the late hours was to lie in bed with the radio tuned to some of the early morning Chicago stations, or filler broadcasts. The bands that played that time of night had the gift of nostalgia. Too few of these groups were recorded, and when they were, a record changer broke the illusion. Weston has the gift like nobody else in the business today, as well as the advantages of LP. Some of the stuff on this disc is not our idea of good listening (Full Moon and Empty Arms, par example), but most of it is. Laura, Moonlight Madonna, Do You Ever Think of Me are cases in point. The arrangement of Laura is delicious. The recording is creditable, although a little mushy in spots.

**Pot Luck:**

I have been besieged by letters and propaganda from record companies that claim to be doing the job on jazz suggested earlier in these columns. Ultimately, none of them are. Their LP's are ranging from poor to foul technically; they are mostly dubs from 10-inchers. It is almost impossible to drum into the heads of some of our small time record impresarios that there is no point in saving pennies through the use of tenth rate recording studios geared to handle amateur musicians and frustrated canaries. Further, small group recording is not as simple as some weird ones would have us believe. The tiny room, the indifferent mike (which is generally shoved at the group with an accompanying "Yuh play into here, see"), the fidgety fingers at the control panel result in monstrosities of such extremes that one is tempted to believe that some engineering genius has finally managed to record the wail of the banshees.

Further, the poor merchandising sense that has gone into these jobs is appalling.

# A PORTFOLIO OF High-Fidelity Installations

**N**OTHING like this has ever been published before . . . A veritable storehouse of new ideas in custom installations of high-fidelity radio-phonograph equipment, some including TV receivers . . . Presented in 27 large photographs taken in private homes.

This portfolio of custom installations has been planned particularly for the benefit of professional audio experts and parts jobbers, so that they can show prospective customers the finest examples of arranging and mounting the latest types of receivers, turntables and pickups, automatic changers, amplifiers, and speakers.

If you are a professional audio expert, this elaborate Portfolio will be worth hundreds of dollars to you in saleable ideas.

It is handsomely printed as a special section of *FM-TV Magazine* for June. A limited number of extra copies of this issue is available for the benefit of those who are not regular subscribers.

You can get a copy of this issue and the Portfolio for 25c in coin or stamps *if you order immediately.*

**YOUR COPY  
WILL BE SENT  
TO YOU BY  
RETURN MAIL**

**FM-TV MAGAZINE**  
Bank Building, Great Barrington, Mass.

Enclosed find 25c for the June issue of FM-TV Magazine, including the Portfolio of Custom Installations.

Name .....

Street .....

City ..... State .....

There is—and the response to my articles only substantiates it further—a large, good demand for respectable jazz well recorded. The Columbia "Dixieland with Dorsey" LP was a step in the right direction. I was, and still am, happy with the technical quality of the job as well as with the group. Nevertheless, the full potentialities of the LP are still neglected and the bands are still 3 minutes in duration. Anyhow, the Dixieland craze is already well on the way out. I have not bothered to review any of the above-mentioned stuff as a matter of common decency. The horrible things I would have to say would make me feel guilty months later. A guy has a right to an honest buck (I think).

## TAPE RECORDING

[from page 22]

assume an importance all out of proportion to their original significance while recording. Consider the plight of a brilliant radio writer who recorded interviews in Europe with the DP's of World War II. The records he obtained were fine examples of recording but, when the tape was edited and the parts he wanted joined together, the effect was anything but homogenous. One sentence contained, in the background of the first part, the roar of an airplane overhead. The airplane sequence then cut abruptly and the second part of the sentence was backstopped by the bawling of an infant. The writer had made the common mistake of trying to compose his script without considering background sound.

Thus it can be readily perceived why, if recording with editing in view, it is so important that background sounds be taken into account. Of course, when recording voices in the open, one does not have full control of any sound that may arise. But it is possible, if in a noisy location, to reduce background sound to a minimum by using uni-directional microphones close to the speakers. Then, after the interview is completed, background noises may be recorded by themselves and utilized in the editing and re-recording process to provide a solid sound background. It is the skillful recording and use of background sound that makes it possible to create outstanding radio shows.

### Acoustic Variation

Just as background and special sounds have a character all their own, room acoustics also vary with weather and the number of occupants. It is preferable to make certain that all recordings made in one location for a given program are made under the same acoustical conditions. There are many shades of acoustical "color" and vibration in the acoustics from one sentence to the next in an edited tape does not make for a good performance. Listeners, even though unconsciously, are affected by reverberation, by deadness, by whispering still-

# NOW

 you can get audiotape\* in 2500-foot rolls!

...with 5 important advantages to all professional users

Plastic base, red oxide Audiotape is now available in professional-size, 2500-foot rolls — on standard NAB aluminum hubs or on complete 10½-inch aluminum reels. This latest addition to the complete Audiotape line offers you these 5 outstanding advantages:

1. *Exceptionally Low Cost*
2. *4% More Tape* than the usual 2400-foot roll
3. *Absolutely No Splices* in the entire roll
4. *Uniform Volume*—guaranteed not to exceed  $\pm 1/4$  db for the full reel, and  $\pm 1/2$  db from reel to reel
5. *A Unique Package* (Pat. Pending), specially designed for easier and safer handling and storage

The folding inner container, shown above and at right, permits the tape to be placed onto the turntable of a machine without danger of its slipping from the hub or becoming unwound. It also permits tape to be transferred from turntable to package with equal ease and safety. What's more, the container is so designed that reel flanges can be attached to the hub quickly and easily, without danger of spilling the tape or dropping the sleeve screws. The package protects the tape in storage, too—prevents flattening of the bottom of the roll or damaging of the edges. This same type of package is also used for 5000-foot rolls of Audiotape.

Ask your dealer to show you the new professional size Audiotape. Or write to us for a free 200-foot sample reel of the tape and a descriptive sheet on the new container.

\*Trade Mark

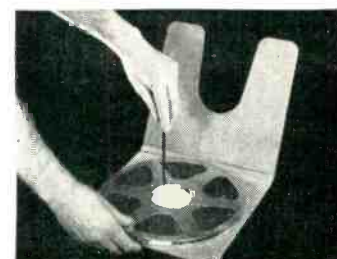
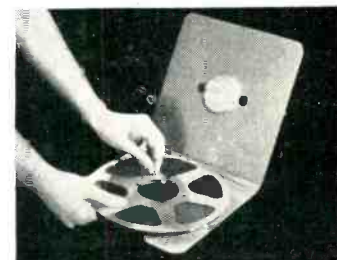
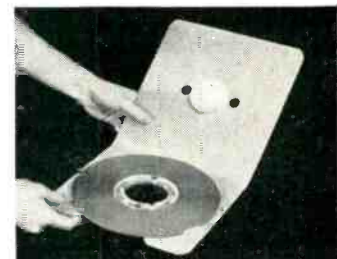

## AUDIO DEVICES, INC.

444 Madison Ave., New York 22, N. Y.

**Western Electric**  
**LIMITING AMPLIFIER**  
 RA-1217A

For film and disk recording, broadcasting studio main amplifiers, and custom built audio systems.

Now available at the low cost of \$350.

**Outstanding Technical Features:**

- **Frequency response**—Flat from 50 to 10,000 cycles
- **Constant gain**—52 db between 600 ohm impedances
- **Adjustable limiting action**—1 db steps from 15 to 25 dbm output level
- **Compression ratio**—10 to 1
- **Recovery time**—Adjustable from 0.03 sec. to 0.6 sec.
- **Special feature**—Built in tube balancing circuits and combined limiting and vacuum tube plate current meter
- **Distortion**—Less than 0.6 per cent below limiting

**Westrex Corporation** 111 Eighth Avenue, New York 11, N. Y.

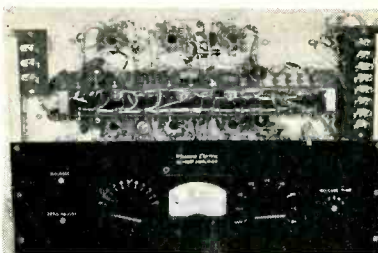

**Advance Orders**  
 now being accepted!

**audio**  
**anthology**

Paper cover . . . \$2.00

Board cover . . . \$3.00

*Distributors write for quantity discount*

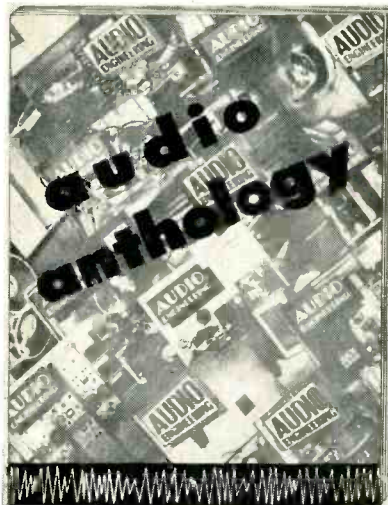

The long awaited compilation of reprints from early issues of AUDIO ENGINEERING, most of which are out of print and unobtainable.

**Contains 37 articles on the following subjects:**

- Amplifiers
- Speakers
- Noise Suppressors
- Phonograph Equipment
- Tone and Loudness Controls
- Dividing Networks

These articles have been of great interest to readers of AUDIO ENGINEERING over the past three years. *Assembled in one volume, they comprise the most authoritative reference work yet available to the audio hobbyist.*

-----CUT OUT-----MAIL TODAY-----

Book Division, Dept. A  
 Radio Magazines, Inc.  
 342 Madison Ave., New York 17, N. Y.

Sirs: Enclosed is my  check  money order for \_\_\_\_\_ copies of the Audio Anthology.

(Please check one)  Paper cover  Board cover

Name (print carefully) .....

Address .....

City ..... Zone ..... State .....

ness, or by blank quiet. The coherence of the acoustical background of a tape show is one of the factors that will gain for it complete credibility, thus creating the wanted illusion of reality.

The human voice with all its variations and moods is a very complex sound. In order to capture this sound completely and reproduce it with no factor of its composition lacking, emphasis should be placed upon the central theme of the subject matter that the "voice" is discussing. To illustrate this, one may use a recording made by Bill Downs of CBS News, who, in addition to being a fine reporter is evidently an artist in the use of atmosphere and background. In the case in point, Bill was recording a sequence in the underground retreat in Berlin where Hitler was presumably killed and later carried out and cremated. Downs and his engineer manoeuvred around in this bunker until the reverberations of his voice carried just enough sepulchral quality to create the correct impression. Even his footsteps going downstairs and coming back up were authentic. Histrionically speaking, his voice *carried* through the recording and placed his audience right in the bunker with him. If he had made the mistake of speaking close to the microphone this atmosphere would have been spoiled or lost entirely.

The tape-recording engineer must keep in mind, during all his recording, the purpose of the recordings. It is not enough just to record at random a multitude of voices and sounds with the hope that out of all that mass there might be enough material to construct a documentary show. If this hit-or-miss method is indulged in, it will generally be found that many necessary ingredients for a good show will have been missed. If he is to turn in a professional job, the engineer must know the purpose for which his recordings are to be used. It would help immeasurably if the engineer were given a resume of the prospective show so that he could become familiar with the dramatic idea. Then, with the help of the director, the engineer could record sequences that would enhance the dramatic appeal of the show by utilizing techniques available and known to him.

Occasionally a sequence is recorded where not enough time is available to make tests and to place microphones. In cases like that of Bill Downs in Berlin, an appropriate background could be dubbed in later to create the proper illusion of "place where" the recording was made. Where enough equipment is available, the voice recording can be played back on one machine, background from another, and both recorded on a third machine utilizing any degree of filtering and reverberation necessary to complete the wanted illusion.

It is advisable when recording voices to choose microphones for good high-frequency response, since a great deal of intelligence is conveyed in the higher voice frequencies (above 1500 cps). It seems also there is more dramatic impact in the high-pitched voice. This may be explained by the fact that hearing is excited more by high sounds, and that low frequencies tend to mask, or obscure, high frequencies in the mechanism of hearing. Another obvious reason is that voices under tension become shrill and listeners' memories react with excitement to an excited, high-pitched voice.

For the last several years point-to-point overseas transmissions have provided a great deal of work for tape recording engineers. There are several reasons why this method of recording news from foreign points is valuable. For one thing, a tape recording may be edited, after it is received, to fit a time-slug in a news program. In common with other means of recording it permits a correspondent to live a more or less normal life (for correspondents!) in that he does not have to get up at unreasonable hours of the morning to appear on a late evening broadcast. Also it provides a fairly cheap method of recording transmissions at the best possible transmission time. Transmissions, or broadcasts, via short wave from foreign countries are generally not crisp enough in quality to bear reproduction without some filtering. Generally speaking, cutting out all frequencies below 150 cps will improve the intelligibility without destroying much voice quality. Very often the communication company can filter this out for you. However, a valuable piece of equipment for any tape recording engineer is a variable-step sound filter, which permits cutting down, by small degrees, any band of sound frequencies. With it, disturbing heterodyne "whistles" can be diminished, modulating hums eliminated etc. It depends upon circumstances whether filtering is to be done before recording or after recording. Ordinarily there is more time available after recording to check the tape, on playing it back through a filter like the one mentioned above. It happens that a recording will be unintelligible as broadcast but completely "readable" when played through the proper filter combination.

It is obviously impossible, in an article of this nature, to include many more specific examples of good engineering. The reader is probably aware of other examples which will serve as guides through the ramifications of tape-recording.

The next part of this series will undertake an explanation of the re-recording or "dubbing" process in tape recording.

*Anyone*  
**Can build a  
HEATHKIT**

*Heathkit*  
**SIGNAL  
TRACER KIT**  
\$19.50

*Heathkit*  
**VACUUM TUBE  
VOLT METER KIT**  
\$24.50

*Heathkit*  
**TUBE CHECKER KIT**  
\$29.50

*Heathkit*  
**BATTERY  
ELIMINATOR KIT**  
\$22.50

*Heathkit*  
**CONDENSER  
CHECKER KIT** \$19.50

*Heathkit*  
**AUDIO GEN.  
KIT . . .** \$34.50

*Heathkit*  
**ELECTRONIC  
SWITCH KIT**  
\$34.50

*Heathkit*  
**IMPEDANCE  
BRIDGE KIT** \$69.50

*Heathkit*  
**5" OSCILLOSCOPE  
KIT**  
\$39.50

*Heathkit*  
**TELEVISION  
GEN. KIT . . .**  
\$39.50

*Heathkit*  
**R. F. SIGNAL  
GEN. KIT . . .**  
\$19.50

*Heathkit*  
**HANDITESTER  
KIT . . .** \$13.50

**HEATH COMPANY**  
BENTON HARBOR 25,  
MICHIGAN

EXPORT DEPT., 13 E. 80th ST., NEW YORK 16, N. Y. • • CABLE ARLAB - N. Y.

Heathkits are beautiful factory engineered quality service instruments supplied unassembled. The builder not only saves the assembly labor cost but learns a great deal about the construction and features of the instrument. This knowledge aids materially in the use and maintenance of the equipment. Heathkits are ideal for and used by leading universities and schools throughout the United States. Each kit is complete with cabinet, 110V 60 cycle transformer (except Handitester), all tubes, coils assembled and calibrated, panel all ready printed, chassis all punched, formed and plated, every part supplied. Each kit is provided with detailed instruction manual for assembly and use. Heathkits provide the perfect solution to the problem of affording complete service equipment on a limited budget. The basic three instruments — an Oscilloscope, Vacuum Tube Voltmeter, and Signal Generator can be purchased in Heathkits for \$83.50, about the cost of a factory-built VTVM alone. Write for complete catalog.



## With the New 3-Speed REK-O-KUT *Recitalist*

- You will hear authentic music reproduction.
- You will hear absolute tonal balance.
- You will hear a pleasing blend of brilliant highs with natural bass.

Whether the Recitalist is played for hundreds in an auditorium (with volume raised) or for you alone, while relaxing in the comfort of your living room (with volume greatly subdued) — you will feel the animated presence of the artists evoked for an enchanting and realistic visit.

Model  
RP-43C  
(Recitalist)  
**\$179<sup>95</sup>**

The Recitalist is a "flexible" instrument. A microphone input enables "mixing" of live music or voice, simultaneously with a recording played on phono . . . or use as a high fidelity public address system. By connecting an FM or AM tuner in the radio input, the Recitalist becomes a superb broadcast receiver.

The **POLYPHONIC SELECTOR**, an engineering feature exclusive with REK-O-KUT, maintains tonal balance and equalization for the particular selection being played on any type of record, whether it be a standard pressing, high fidelity broadcast transcription, or long playing micro-groove — and whether of American or foreign make.

The REK-O-KUT Recitalist is the only full-range, three (3) speed portable phonograph that painstakingly balances the response characteristics of amplifier, speaker and speaker enclosure. By carefully compensating the natural resonances of these three components, undesirable reverberations are avoided.

### FEATURES

**TURNTABLE:** Precision machined aluminum. Three speeds (78, 45 and 33 $\frac{1}{3}$  RPM.) Neoprene idlers. Internal rim drive. Heavy-duty, dynamically balanced motor.

**PICKUP ARM:** 16" with dual stylus cartridge. Plays up to 16" broadcast transcriptions, standard commercial pressings and micro-groove records.

**SPEAKER:** 8" PM type, built to our exacting specifications with 6.8 ounce Alnico V magnet.

**AMPLIFIER:** Frequency response is controlled by Polyphonic Selector.

**Position #1:** Uniform within 1db from 50 to 15,000 cycles.

**Position #2:** Bass up 4db at 100 cycles, treble uniform above 5,000 cycles.

**Position #3:** Bass up 6db at 100 cycles, treble uniform above 5,000 cycles.

**Position #4:** Uniform from 50 to 3,000 cycles, increasingly sharp cut-off, 14db down at 10,000 cycles.

**Power Output** — 10 watts at less than 3% total harmonic distortion.

**Input Channels** — Three. High impedance microphone, radio, crystal phono-pickup.

**Input Gain** — Microphone, 120 db; phono-pickup, 80 db; radio 80 db.

**Output Impedance** — 6 - 8 ohms at speaker jack.

**Noise Level** — More than 50 db below rated output with all controls set at maximum.

**Controls** — Microphone gain; radio-phono fader; Polyphonic Selector.

Write for descriptive literature.

**REK-O-KUT CO., Inc.** 38-01 QUEENS BOULEVARD  
LONG ISLAND CITY 1, N. Y.

## NEW MUSIC LOVERS AMPLIFIER

### the GROMMES CUSTOM

... undisputed best  
"Ears" or Instruments!



**MODEL  
50 PG  
Dealer's Net  
\$4500**

**MODEL  
200 PG  
Dealer's Net  
\$15000**

Exclusive feedback circuits result in effective speaker damping. Equalized inputs for magnetic or crystal pickup, microphone and radio. Extremely flexible tone control with calibrated boost and droop in DB's.

Amplifiers pass all square wave tests — no phase shift or transient oscillations of any kind.

Model 200 PG offers frequency response of  $\pm$  0.1 DB, 10 to 50,000 CPS. Distortion of 20 watts is 0.2%. Write today for free technical bulletin.

**PRECISION ELECTRONICS, INC.**

641-43 MILWAUKEE AVENUE • CHICAGO 22, ILLINOIS

## FEEDBACK AMPLIFIERS

[from page 17]

features must enter into the design of the transformer to minimize and equalize leakage reactances and to eliminate stray capacitive couplings. However, once these procedures have been carried out, the burden of controlling the feedback loop can be placed on the output transformer alone, and the amount of stable feedback that can be obtained may be considered to be one of the properties of the transformer.

To obtain useful values of feedback it is customary to carry the feedback around more than just the output stage alone. Each additional stage in the feedback loop introduces 90 deg. of phase shift which adds to that of the output transformer. Two coupled stages and the output transformer give a total of 180 deg. of phase shift. This is inherently a stable condition, and any amount of feedback can be used since the gain of the amplifier reduces to zero at the 180-deg. point. Greater care must be used in carrying feedback over three coupled stages including the output transformer. The amount of feedback is 270 deg. for this case, but it is still possible to use up to approximately 40 db of feedback before the amplifier will sing. The usual 20 db of stable feedback can easily be realized and this amount will prove sufficient for most purposes.

### Examples

To illustrate the application of the above considerations, two amplifier circuits will be discussed. Each has been designed with 20 db of feedback in a single-loop circuit. These amplifiers have been constructed and subjected to the tests outlined above to determine the extent of their stability. The fact that they excel in this respect is attested by the reports of numerous comparisons with what is considered to be the best grade of commercial equipment. In every instance these amplifiers were rated as equal or better. Most important, the fact that transients are cleanly reproduced has been deduced from the frequent and unsolicited comment that there is no ear fatigue.

The 6L6 circuit, shown in Fig. 2, has been designed for Class AB<sub>1</sub> operation with a maximum output of 24 watts. The 20 db of feedback matches the output of the amplifier to the load. In this connection it is interesting to observe that in some amplifiers, use is made of inverse feedback to reduce the output impedance to a phenomenally small value. It is claimed that speaker damping is improved by this means, and better transient reproduction is obtained. Little im-

provement is actually effected, since the amount of damping in the output circuit is increased only in the ratio of two to one. This follows from a consideration of the total impedance of the load loop for each of the two cases; for a matched load the circuit impedance is twice that of a circuit with zero source impedance.

The procedure of maximizing performance of the amplifier circuit alone has been rigorously carried out. In the 6L6 circuit the power supply is an important part of the circuit and is shown for completeness. A method of deriving the necessary low-impedance source of well regulated voltage for the screens is shown. While voltage regulator tubes have sometimes been used for this purpose, they are not completely satisfactory due to the wide range of current values drawn by the screens between low and high output levels. The circuit shown also has the advantage of requiring a small number of additional parts. The filtering in the main section of the supply is sufficiently adequate to insure plate voltage of low ripple content. While an appreciable amount of ripple may not be audible due to cancellation in the output transformer, it will cross-modulate with the signal voltage and produce distortion. The supply voltage to the phase inverter is isolated from the main supply by an RC decoupling network. This is done to eliminate stray coupling and a spurious feedback path between the output stage and the phase inverter. Since feedback over this path is troublesome mainly at high frequencies, a series choke will in most instances prove equally effective.

A balanced bridge type of phase inverter is used. The circuit is self balancing and permits approximately a 95 per cent balance at all frequencies. The feedback voltage is returned to a cathode resistor in the upper triode and has no effect on balanced operation of the inverter.

Contrary to popular belief, there is little justification for omission of the bypass capacitor across the common cathode bias resistor of a push-pull stage. The purpose of the capacitor is to provide a low-impedance path to ground for the large even-harmonic currents generated in the tubes under conditions of high-level operation. These currents, if permitted to flow in the common cathode resistor, would add together and produce an in-phase harmonic voltage on each grid which, in turn, cross-modulates with the signal voltage and increases the amount of third harmonic and other odd order modulation products<sup>2</sup>.

<sup>2</sup> Preisman: "Graphical Constructions for Vacuum Tube Circuits" Chap V.

## DO YOU NEED *Small* PRECISION RESISTORS ...ACCURATE TO 1% TOLERANCE OR CLOSER?

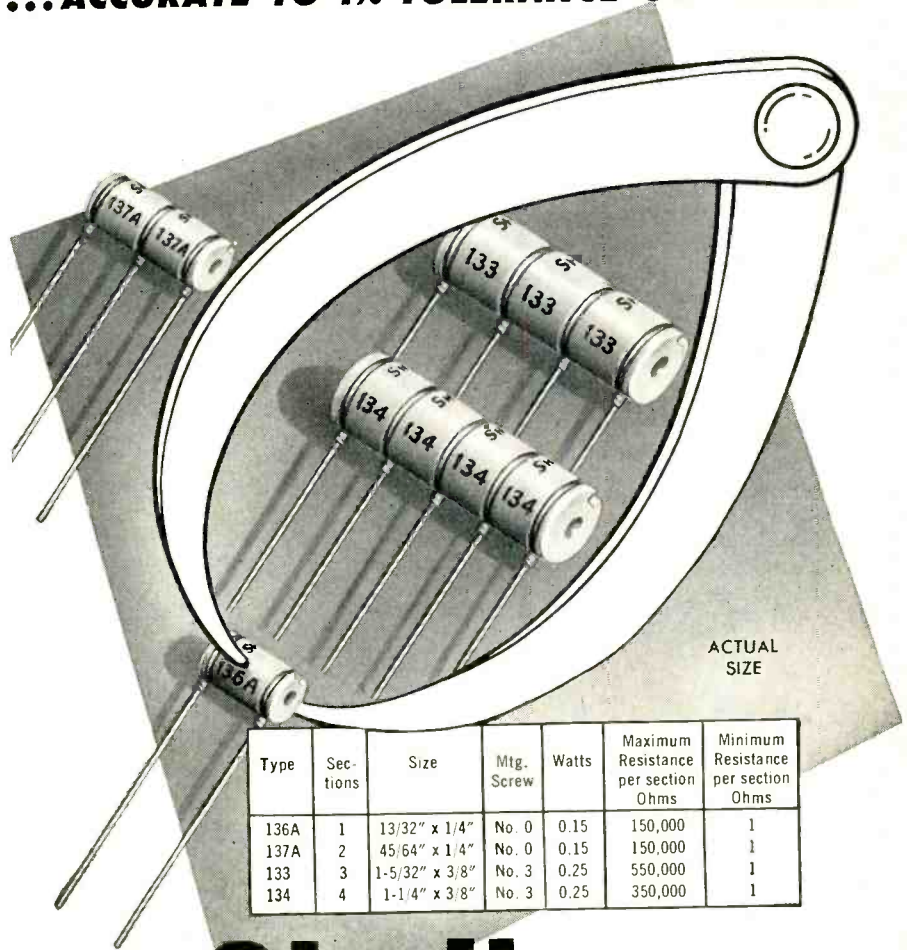

# Shallcross

## Miniature AKRA-OHM Precision Wire-Wound Resistors

There's no substitute for well-made precision wire-wound resistors. They provide close tolerance PLUS the high stability and reliable low temperature coefficient required for dozens of modern electronic circuits! In many cases, however, size limitations of ordinary precision resistors have been a handicap.

Shallcross miniature Akra-Ohm resistors overcome this difficulty. Proved in hundreds of exacting applications, available in types only slightly larger than carbon resistors, they offer unusually high, accurate, and stable resistance values in minimum size and with a suitable variety of leads and mounting arrangements.

### Get this GUIDE to CLOSE TOLERANCE RESISTORS

More than a catalog to the market's largest line of precision wire-wound resistors, Shallcross' new Bulletin R3A contains complete, helpful data for their specification, selection, and use. Sent on request.

**SHALLCROSS MANUFACTURING COMPANY**  
Dept. A-60, Collingdale, Penna.



**peerless**  
20-20 line  
transformers

still best  
by  
square wave  
test

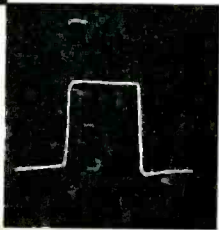

**S**quare wave tests reveal the slightest flaw in audio transformer design and performance. Important elements of frequency, phase and transient characteristics are summarily exposed by this ruthless testing method. Such tests, conducted by impartial engineers at conventions and with jobbers, established the outstanding superiority of Peerless transformers. Throughout the frequency range from 20-20,000 cps, Peerless components were proved to have better frequency-power characteristics, flatter response curves, lower percentages of intermodulation distortion products and lower insertion losses than any other transformer tested! Peerless is justly proud of this record. It still stands—15 months after the tests were first conducted!

So, with Peerless, you can be certain that you have selected the best transformer for the job.

Bring your transformer problems to Peerless. Peerless is equipped to render the finest engineering and manufacturing service obtainable for any transformer need.

**S**end for complete  
Peerless catalogue.



**peerless** division  
electrical  
products



1161 N. VINE ST., HOLLYWOOD 38, CALIF.  
161 SIXTH AVE., NEW YORK 13, NEW YORK

The particular output transformer used allows full rated power to be transmitted at either extremity of the audio band. The frequency characteristic of the transformer alone is down 0.2 db at 20 cps and .03 db at 20 kc. The two sections of the primary winding are tightly coupled to allow balanced push-pull operation at frequencies well above audibility. The leakage reactances between the output winding and the primary halves are balanced, and capacitive couplings have been eliminated. In this manner spurious phase shift of the feedback voltage has been held to a minimum, and large amounts of feedback may be taken without encountering circuit instability.

**6AS7G Amplifier**

The 6AS7G has aroused much interest as an output tube because of its high power capabilities, the use of a low-hum cathode structure, and the advantage of having the two push-pull sections in the same envelope. Because of its low amplification factor, the tube requires a high driving voltage which may best be obtained in a separate resistance coupled driver stage. However, at high output levels the driver operates at its voltage limit and represents an abundant source of distortion. Inverse feedback taken around the driver is particularly helpful in relieving this condition.

In the diagram shown in Fig. 3, inverse feedback is carried around three stages. Choke coil decoupling is used between the power amplifier and the driver to permit the driver to operate at as high a level as the plate-supply voltage will permit. Although 20 db of feedback are used, no compensation will be required for stability reasons either in the feedback loop or across any of the amplifier stages provided the output transformer is of good design.

**Summary**

Some of the considerations basic to the design of feedback amplifiers have been discussed. The application of these ideas into specific design has been found productive in every instance where used. Emphasis has been placed on the fact that skimpy design in the amplifier alone will not be corrected by the addition of feedback. Rather it has been shown that to avoid transient instability, the specifications for the amplifier circuit are considerably more restrictive for an amplifier of the feedback type. In particular, it has been shown how the output transformer can furnish the greatest assistance by making possible the application of large values of stable feedback in a straightforward single-loop circuit.

**CONCERTONE**



**\$295.00**

Net FOB Los Angeles

The magnetic tape recorder that invites competition—for living sound and high fidelity. Compare CONCERTONE quality and performance with any other recorder on the market. **THREE HEADS** for simultaneous monitoring and playback.

**SPECIFICATIONS**

Size: 22" x 14" x 5" mounting depth.  
Recording Speeds: 7.5" and 15" per second.  
Frequency response: 2 db from 50 to 12,500 cycles at 15"/sec.  
2 db from 50 to 7,500 cycles at 7.5"/sec.  
Flutter: Less than 0.1% at 15"/sec.; 0.2% at 7.5"/sec.  
Signal to noise ratio: 55 db for single track recording; 50 db for dual track.  
Total harmonic distortion: Less than 2% at normal maximum signal level.  
Input and output impedance: 0.5 megohm.  
Minimum input signal: 5 millivolts.  
Output signal: 2.0 volt.  
Playing time, single track: 7" reel: 16 min. at 15"/sec.; 32 min. at 7.5"/sec.  
10 1/2" reels: 33 min. at 15"/sec.; 66 min. at 7.5"/sec.  
Double above times for dual track recording.  
Power requirement: 117V. 60 cycle single phase.

Complete descriptive brochure available upon request. For the ultimate in all types of tape and wire recording apparatus, supplies, and service, call, write or wire.

DISTRIBUTED IN THE WEST BY

*Magnetic Recorders Company*  
7120 MELROSE AVENUE  
LOS ANGELES 46, CALIF.  
Telephone Wyoming 9600



**FM**  **NC 108T**  
**TUNER-RECEIVER**

"... the only FM tuner that can accomplish satisfactory separation."

An audio fan, living in Connecticut, wrote us that the National 108T was the only FM tuner he had tried that could separate New York's WQXR and WNYC from two powerful local FM stations—AND at no sacrifice in fidelity (40—15,000 c.p.s., ±2db). The NC-108T can also be used as a complete receiver, with built-in monitoring speaker. Write for details.





## RECORD REVUE

[from page 30]

ways. But even so, the boom is booming, and mainly because the small company, with the one speed, has the large company buffaloed. Forget the 45, forget the 78, *churn out the LP*. And still, the large companies, immersed in their war, are giving aid and comfort right and left. Columbia does a large amount of processing and pressing of LP material, for a slew of small companies. RCA Victor, not to be outdone, will process and press LP's for anyone, in huge lots or little tiny ones, and for prices unbelievably low. MGM does it too. Happy days! You can have yourself as few as 100 copies of a twelve-inch LP record, playing up to an hour, for an average of \$2, often less, covering the entire process from re-recording right through to labels—this, of course, on a strictly private job basis. Regular contracts with small companies in the commercial field run a lot less per disc, probably in the 50 to 80-cent region. If you keep your musical costs low (record solo violin, singer-and-piano, choral music; or take yourself to Europe where you can get a song for a song) and keep your overhead low, you can make your LP records and sell them on a strictly small-business basis, and come out ahead. You still can—but for how long?

Because one of the biggest "protections" the little company has now is the big-company list price on records. Again, forget the 45, forget the 78. The LP list price for a 12-inch is \$4.85. Cheap—but not as cheap, I suspect, as an LP could be if there weren't two other speeds to pay for. Already there are many spots where, need I whisper, records can be had at a whopping discount. The practice is spreading. It was nice of RCA Victor to price their LP's mostly in the \$5 range. That stems the tide a bit, holds the price-plus-discount higher. What will happen? For, remember, the LP price is necessarily tagged to the 78-rpm price. Drop the LP price and you'll have to drop the 78 price too—or 78's will price themselves right off the market. 78's still cost money to make, and as long as they figure as a major operation, LP prices can't fall very far. But, begin to retire the 78 (by gradual withdrawal and/or by pricing it to death) and then, it would seem to me, the LP would be bound to come down a bit officially. And for every cent the price dropped a dozen small companies would fold up. When? . . . Well, maybe I'm just an ole profit—I mean prophet—of doom. *Churn out the LP's*, while the churning's good!

### Quality

From the standpoint of quality we can scarcely complain. Considering the haste with which the present LP boom has boomed, it is quite astonishing how many passable musical performances have been turned out. I would want to think twice before I'd say that the standards of recorded performance have fallen. Indeed, the comparison between now and the past is a bit false, for there were no small companies of importance before the war; we can never expect a small company to pay for the long and detailed rehearsals that can be put into a large-company recording.

Technically, the standards are fabulously high for small-company work, and that thanks to tape, plus the obliging aid of the large companies in processing the results.

## New RACON Sound Equipment for Best Performance and Highest Profits!

### Only the New RACON DRIVER UNIT has all these Exclusives:

- Lowest List Price — \$37.50
- 25 Watts Operating Capacity
- 50 Watts Peak Capacity
- Completely Waterproof and Tropicalized
- Built-in Vacuum Impregnated Line Transformer
- Primary Terminals: 500, 1000, 1500, 2000 Ohms
- Secondary: 15 Ohms
- Alnico V Magnet
- Aluminum Wound Voice Coil for Maximum Efficiency
- Combined Solder Lug and Binding Post Terminals
- Frequency Range 90-6500 Cycles
- Thread Size 1 3/8" — 18



Model PM-708TR \$37.50 List

### Here's Why New RACON COBRA LOUDSPEAKERS SUCCEED when ordinary speakers fail!

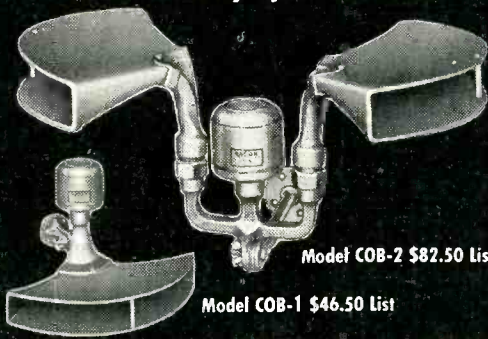

Model COB-2 \$82.50 List

Model COB-1 \$46.50 List

- Widest Sound Pattern (Adjustable from 120-240°)
- Designed for Voice Range: 370-6500 Cycles
- High Conversion Efficiency
- No Re-entrant Members
- 25 Watts Continuous Capacity
- 50 Watts Peak Capacity
- Completely Waterproof
- Tropicalized Driver Unit
- Vertical or Horizontal Adjustable Mounting
- Aluminum and Bronze Castings

### RACON CROSSOVER NETWORKS



Model CON-20, \$22.50 List. Highest quality LC network.

Model CON-15R, \$11.00 List. Efficient RC high-pass filter network.

### RACON TWEETER



Model CHU-2, \$37.50 List.

Wide distribution pattern!  
Clean output to 15,000 cycles!  
When used with crossover network, handles amplifiers of 25-30 watts.

SOUND TECHNICIANS AND SERVICEMEN — For full details on our complete line of Public Address and Wide Range Loudspeakers, see your favorite parts jobber, or write for Catalog A

ALL RACON PRODUCTS ARE GUARANTEED FOR 18 MONTHS

Sound  
Equipment  
Manufacturers

ACOUSTICAL  EXCELLENCE

*Racon Electric Co., inc.*

52 East 19 St.  
New York 3,  
N. Y.

## AN ADAPTER FOR YOUR 9-A EQUIPMENT !!



**No Need to Buy Costly Additional Arms and Equalizers  
Operates through your present 9-A Switch & Filter  
Replace Diamond or Sapphire Points yourself in a few minutes  
Better Fidelity—Less Needle Scratch—Higher Output**

This **G.E. RELUCTANCE HEAD** with **ADAPTER** is interchangeable with any standard **9-A**, which can continue to be used for Vertical or Lateral transcriptions. Impedances are matched.

Available also in **MICROGROOVE** type if desired.

**only \$29.75**

Sapphire point \$2.10 additional—Diamond also available

**BROADCAST SERVICE COMPANY**  
334 ARCADE BLDG. • ST. LOUIS 1, MO.

### Address Changes . . .

Subscribers to **AUDIO ENGINEERING** should notify our Circulation Dept. at least 5 weeks in advance regarding any change in address. The Post Office Dept. does not forward magazines sent to a wrong address unless you pay additional postage. We can not duplicate copies sent to your old residence. Old and new addresses **MUST** be given.

**AUDIO ENGINEERING**  
342 Madison Ave. New York 17, N. Y.

## World-Wide Popularity

Since the inception of **AUDIO ENGINEERING** in May 1947, engineers and audio hobbyists have subscribed in ever-increasing numbers, not only in the 48 states and in all of the major foreign countries but in such places as Tasmania, Transvaal and Trinidad.

Each month **AUDIO ENGINEERING** covers the latest developments and practices in recording, reproduction and instrumentation for the entire audio field.

**Subscribe Now—Don't Miss an Issue! Back numbers are hard to get!**

**AUDIO ENGINEERING**  
342 Madison Avenue, New York 17, N. Y.

Sirs: Here is my  check (or  money order) for \$..... Enter my subscription order to **AUDIO ENGINEERING** for the next ..... issues. Subscription Price: In U.S.A., Canada and Pan American Union—12 issues \$3—24 issues \$5. All others \$4.00 per year. Please check one:  New Subscription  Renewal.

Name (please print) .....

Address .....

City ..... Zone ..... State .....

Occupation (give title and department) .....

Firm Name .....

It is no event at all now when a one-man, one-record sub-microscopic company turns out an LP disc that can match anything on any label—red, blue or ultra-violet. Think back, even to 1946 and 1947; remember the small-company discs of those yesteryears, when people were trying to sell plastic 78's full of man-made static, at \$2.50 for 8 minutes of low-fidelity distortion! The tape-LP revolution is really something.

### Blow Up

What to conclude? All depends on your viewpoint. For the record buyer there has never been such a bonanza. For the hi-fi enthusiast there are more good and pretty-good records than ever before. Enormous areas of the musical world that have lain dormant and impractical until now have been invaded and brought to discs. A lot of enthusiastic activity and gainful (for the moment) employment has been engendered. Things still look bright—except for the dazed reviewers who must stand up to this happy and uninhibited flood.

But my own inescapable conclusion is that, whereas the new small-company LP business is decidedly here to stay, for good, to our great and lasting benefit, the existing state of dynamic expansion is bound to blow up. Next year? Maybe.

Those small companies who plan carefully and wisely, whose business is well organized, whose musical policies are equally well organized, will be in business for a long and profitable future, with the blessing of the large companies—for the pleasing truth is that there is really not much competition between them. They produce complementary material—the small company being now able to turn out specialized repertory on a profitable basis that would never interest the big concerns. As for the fly-by-nights, and the well-meaning, earnest dabblers in LP, they'd better pull in their pile, such as it is, before it's too late. *Churn out the LP's*, now. But look out for the future.

And as for this department, which is getting hopelessly out of gear in its attempts to keep up with new material, the best I can say is that the fact that a record is not mentioned hereabouts does not necessarily condemn it! Probably arrived one mail too late. I'm wondering whether I'd better not substitute a new brand of dehydrated telegraphese for the luxuriously long paragraphs that I have been splurging these last few years, to my own contentment at least. If we allot, say, four lines per record, we might cover everything. Maybe it'd be a good idea to have that blow-up soon. Save a lot of space.

### This Month

Note: The first batch of newly recorded Long Play (33 $\frac{1}{3}$ ) RCA Victor records has just come in, too late to discuss in detail. I've sampled them, compared with competition. The Toscanini-NBC recordings suffer from the same old trouble—dead studio. The Mozart and Haydn symphonies (#101 and #35) are incredible—every chord drops into a spongy vacuum that swallows it instantly. One can't really judge the musical performance under such circumstances—or at least I can't. The orchestra, as a result, sounds strident and flea-sized, without body. Matter of opinion, I suppose—but this is mine. The Toscanini Beethoven "Eroica", symphony #3, is better, though still far too dead for naturalness. The longer, thicker lines in this one help keep the sound rolling; similarly, the Tchaikovsky "Manfred" symphonic poem comes out the best of them, since here, the

music is even heavier and more sustained, there are few chances for that dreadful vacuum to get in its work. This has been going on for 13 years now! Amazing.

Strange, since other new RCA recordings are splendidly live and vibrant. The Boston Symphony with its new conductor, Muench, does a Beethoven 7th Symphony that has the usual fine Boston acoustics, plus adequate highs. Stravinsky's "Orpheus" ballet music (RCA Victor Symphony with Stravinsky) has similarly fine liveness and presence, as have other recordings by this group. You'll find that these Long Plays have the traditional (recent) RCA high turnover point, need bass compensation on most hi-fi machines that do not have turnover adjustment.

**Mormon Tabernacle Choir, vol. ii.**

S. Spencer Cornwall, dir. A. Schreiner, organ.  
Columbia LP: ML 2098

**Mozart, "Coronation" Mass in C, K. 317.**

Salzburg Festival Choir, Orch. & soloists.  
Festival LP: FLP 100

**Kodaly, Te Deum; Theatre Overture.**

Vienna Symphony, Wiener Chor, soloists.  
Westminster LP: W 50-1

**Bach, Cantata #11.**

**Bach, Cantata #67; "Jesu, Joy of Man's Desiring".**

Cantata Singers, Jacques Orch. soloists.  
London LP: LPS 160, 161

One never knows which way the hurricane of present LP expansion will blow next—now, suddenly, there is a rash of fine choral-and-orchestra music, the kind that used to come out sporadically in mammoth heavyweight 78-rpm albums and usually sounded like a mixture of 65% white noise, most of the rest greyish semi-music. Now, with tape and wide-range recording, plus lack of surface noise, the details of these big works come through splendidly and new knowledge of mike placement helps take advantage of the wide-range tone color differentiation. Low price and portability is the final virtue.

The Mormon Tabernacle recordings are a remarkably fine example of how to record huge forces in a huge hall with maximum clarity, perspective, presence. An excellent job. The chorus is enormous, but sounds small and neat. This volume has a number of well known classical items, along with some of the usual schmalzy anthem material. A most enjoyable set, if occasionally a bit corny on the musical side.

Two new companies, characteristically importing tapes made by them in Europe, enter the field with the Mozart and Kodaly recordings, above. The famous Salzburg festival has evidently been taken down complete, in performance, and will come out in slices. The music, performed in the echoful Salzburg cathedral, was a problem in acoustics adequately solved by putting soloists and orchestra very close to mikes, for accentuation. But there's too much solo for my taste in this balance—though perhaps it couldn't have been otherwise. The Westminster Kodaly was a recording-session job and so is better arranged. Both recordings are excellent quality modern tape jobs, well copied onto good LP. Both make excellent listening, and the easier for the fine recording.

London has begun a new series of choral

ANNOUNCING THE SENSATIONAL

# CONCERTONE

## PROFESSIONAL TAPE RECORDER

Plays up to 10½"  
NAB REELS

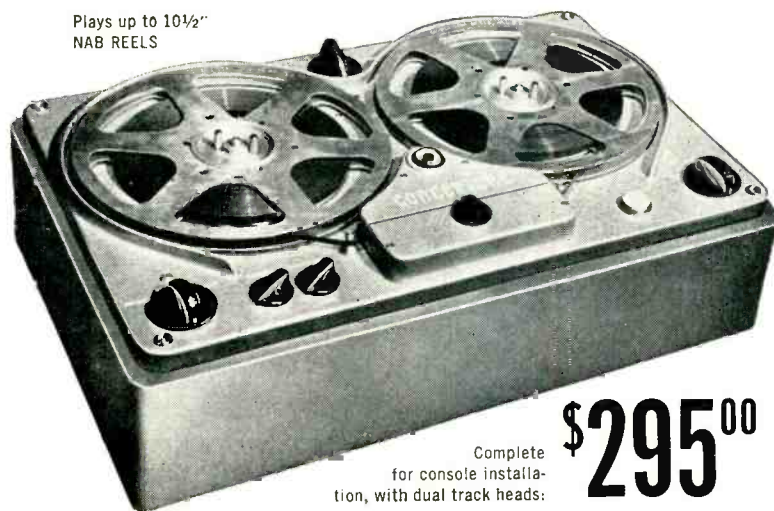

Complete  
for console installation,  
with dual track heads:

**\$295<sup>00</sup>**

■ Never before in the history of tape recording has there been an instrument to equal the CONCERTONE. Its performance and specifications are beyond the \$1000 class, yet its price is little more than that of mass-produced "novelty" recorders. Unbelievable? Yes . . . until you see and hear it. Write us today for a descriptive booklet. After you have read it, we know that like ourselves you will not rest until there is a CONCERTONE in your home or office. The supply is limited. Better not delay.

### Outstanding Features of the CONCERTONE

- Broadcast studio quality; complies with latest NAB standards.
- Plays 5", 7" as well as 10½" NAB reels. (With 10½" reels: 33 min. at 15"/sec., 66 min. at 7½"/sec.)
- Separate heads for erase, record and playback. All heads prealigned and quickly interchangeable for single or dual track.
- Instantaneous choice of 7.5" or 15" tape speeds; automatic equalization for speed selected.
- High speed forward and reverse—2500 feet in 60 seconds.
- Three dynamically balanced motors.
- Flutter: less than 0.1% at 15" and 0.2% at 7.5".
- Frequency range 30-15,000 cycles: (2 db from 40-12,500 cycles at 15"/sec.; 2 db from 40-7500 cycles at 7.5" per second.)
- Signal-to-noise ratio: better than 50 db.
- Total harmonic distortion: less than 2% at normal maximum signal level.
- Recording level indicator.
- Simultaneous monitoring from the tape while recording.
- All controls interlocked to protect tape.
- Available, at additional cost, with base shown, console, or carrying case. Size: 14" x 22" x 7¼" high.

Exclusive Eastern Distributor

FISHER RADIO CORPORATION • 45 E. 47th ST., N. Y.



### TWIN-TRAX\* TAPE RECORDER

Available to you direct from the factory at savings that make TWIN-TRAX the only professional-type recorder in the popular-price field. More than a dozen model variations for portability, long-play, continuous operation, etc. For a better tape recorder that combines professional quality with operating ease and trouble-free construction, it's TWIN-TRAX. Write today for complete literature. \*Trade Mark Registered

**AMPLIFIER CORP. OF AMERICA**  
398-4 Broadway • New York 13, N. Y.

### Carter MANUAL FREQUENCY CONTROLLED SUPER CONVERTER



**RECOMMENDED BY**  
*Brush and Magnecord*  
for "REMOTE" RECORDING

Wherever 115 line voltage is not available, or hard to get, Carter Frequency Controlled Converters supply dependable AC power to make on location recordings from STORAGE BATTERY POWER. Used by leading networks, broadcast stations, and program producers.

#### Handy, Dependable Power

One model operates both Brush and Magnecord equipment. Delivers clean 60 cycle AC power. Requires no filtering. Frequency control feature compensates for input voltage variations. Available for 6, 12, 24, 28, 32, 64, and 115v. DC input voltage. Size 8 1/4" x 5 3/4" x 7 1/2" high. Weight only 15 3/4 lbs. Performance guaranteed.

#### MAIL COUPON for FREE CATALOG

New Converter Catalog No. 349 illustrates entire line of Carter Rotary Converters for recording, TV, sound projection, transcription players etc. SELECTOR CHART included tells which model fits your needs. Mail coupon now for your copy and name of nearest Carter distributor.

## Carter MOTOR CO.

2648 N. Maplewood Ave. Chicago 47, Ill.

Carter Motor Co.  
2648 N. Maplewood Ave.,  
Chicago 47, Ill.

Please send catalog #349 with information on Frequency Control Converters, and name of nearest distributor.

Name .....  
Station or Company .....  
Address .....

works, done in a very British style, with the famous Bach Cantata Singers, the Jacques Orchestra and, among soloists, the well known Kathleen Ferrier, recently a hit in the U. S. Beautiful recording, wonderfully clean highs and an excellent, soft liveness. But (as in the Bloch Sacred Service reviewed last month) the solo voices occasionally sound dead, as though boxed-in, with separate mike. Not a pleasant effect. I wonder why? If you have any yen for Bach you'll enjoy these recordings; even if you don't, the clear, natural sound, the excellent differentiation of complex musical sounds, will please the ear.

- Copland, Billy the Kid (ballet suite)**  
RCA Victor Symphony, Bernstein.  
RCA Victor 45:  
WDM 1333 (3)
- Haydn, Symphony #53 ("Imperial")**  
Leopold Stokowski & His Orchestra.  
WDM 1352 (2)
- Bach, Passacaglia and Fugue in C minor (arr. Respighi)**  
San Francisco Symphony, Monteux.  
WDM 1340 (2)
- Schumann, Fantasiestucke, opus 12**  
Artur Rubinstein, piano.  
WDM 1335 (3)
- Respighi, The Fountains of Rome**  
Symphony Orch. of the Augusteo, Rome; De Sabata.  
WDM 1337 (2)

Just to keep the record straight—these are the 45's (you can have them on 78 if you insist) that continue to keep the 45 system a going business in the classical field, and especially among engineers and hi-fi fans who want recording quality. They make good listening.

The sweet and jazzy Copland suite, *Billy the Kid*, is a delight for anyone who enjoys a bit of the jazz in his orchestra provided it's anchored by good musical construction. Also for those who like the sentiment, in the slow movements, along with a taste of cowboy nostalgia. The Haydn Symphony #53, a hitherto unheard one, is a superb short work, far more "romantic" than the later symphonies, in a really top rank performance by Stokowski—who can be a great musician when he feels like it. The Bach Passacaglia and Fugue tops Stokowski's worst fires of yesteryear (how many times has he recorded his version of this?) and outhowls, outroars him by decibels! The Respighi Bach transcription is a horrendous monument of dreadful taste that makes me shudder in my whole being—except for one little corner of same reserved for the appreciation of effective recording: hence the appearance of the album here. It is good, and if you don't care whether it's Bach or Bop so long as it's loud and wide range and well-miked, then you'll have every right to enjoy this. More power to you! It is a splendid recording job. The last side, the Pastoral from the Christmas Oratorio of Bach, may win out over all the rest for you—a beautifully melodic, swinging piece, alternating strings and oboes. Swings a bit too heartily here (for a pastorelle, remember) . . . but even so . . .

The Rubinstein album is a grand illustration of one way to record a piano. (1) Get a big pianist with a big name, plus an even bigger piano. (2) Put the whole into a hugely resonant hall and back up somewhere (with your mikes) so nothing busts. (3) Attenuate the bass so that nothing is there but those lovely overtones—which, after all, are the important thing. (4) Sell the record. It'll sell, and so will this! Seriously, though there simply is no bass in this

## ATLAS PROFESSIONAL BOOM AND MIKE STANDS

Atlas Microphone Supports are used by leading Radio and Television stations throughout the world.

Atlas can supply microphone stands, and supports for every conceivable application.

All Atlas stands are precision built, are of the finest quality and give complete and lasting satisfaction.

Always be sure its an Atlas Microphone Stand.

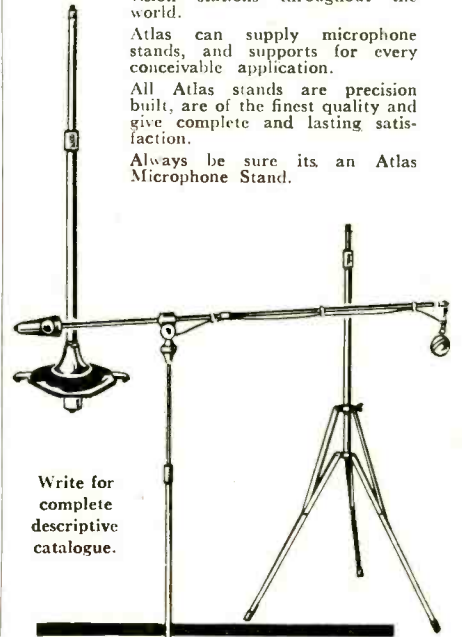

Write for complete descriptive catalogue.

ATLAS SOUND CORPORATION  
1448 39th St.  
Bkn. 18, N. Y.

## The World's STANDARD OF THE GREAT RADIO SHOWS • MOST-LISTENED-TO magnetic tape RECORDER

Experience has proved that expensive radio programming must have the best recording equipment . . . it saves in many ways in the long-run. Ampex Recorders are unequalled for this critical service—they are reliable—equal to operation—maintenance is nil. Ampex has the lowest flutter and wow of any recorder built.

Fully ninety percent of the most-listened-to programs, including "Voice of America", are recorded and played-back on Ampex Magnetic Tape Recorders.



MODEL 300-C  
\$1575 (Lab. San Carlos)  
V. U. Meter \$105 Extra

## AMPEX Magnetic Tape Recorder

Get FREE BOOKLET today!

AMPEX ELECTRIC CORP., San Carlos, California  
Without obligation please send 16-page illustrated booklet containing technical specifications of Ampex Magnetic Tape Recorders.



NAME .....  
ADDRESS .....  
CITY ..... STATE .....

Our need is for:

- Laboratory Research
- Multi-Channel Recording
- Recording-Broadcasting
- Telemetering
- Industrial Recording
- Aerophysical Research

Distributed by . . .

BING CROSBY ENTERPRISES (Hollywood)  
AUDIO & VIDEO PRODUCTS CORP. (New York City)  
GRAYBAR ELECTRIC COMPANY (Everywhere)  
EXPORT: WESTREX (New York City)

that I can find, the sound is a gorgeous one and, if unrealistic, is still preferable to some of the percussively dead close-up wobbles that have been perpetrated recently on 33 $\frac{1}{3}$  in the name of pianism.

The Respighi "Fountains"—his own music this time—is a highly colorful work, glitteringly on-the-surface; it needs good recording and it gets it here in this Italian job. The sound is fully up to the music, though the top highs wouldn't seem to me to be very well represented.

#### Baroque Choral Music.

Dessoff Choirs (unaccompanied),  
Paul Boepple. **Concert Hall LP:  
CHC 44**

This one is a fine example of what happens to Canby when he blunders into a recording job, since I made the tapes my own little self. Done originally as a last-minute bit of experimenting, with one mike and a cheap one at that, the music was good enough to bring out commercially. The job was done at a concert in the Great Armor Hall of the Metropolitan Museum of Art in New York—than which there is no more echoful spot. With multi-mike set-up and lots of rehearsal we might have got a somewhat broader, deeper sound; these records are a bit thin from an ideal standpoint, the diction isn't clear enough (voices too far away from mike—by necessity). Even so, the stuff sounds, and the cathedral-like effect is quite novel and very impressive, once you get used to it. As concrete evidence of last month's remarks concerning the importance of *music* in recording (i.e. the differing results that different music gives, in same situation)—listen to the Bach work here, then the Palestrina. Identical situation, but the Bach sounds confused, muddy unclear, heavy; the Palestrina rings out beautifully clear and transparent. That's because Palestrina (late 16th c.) wrote for just this sort of acoustic situation; Bach (mid-18th c.) wrote for smaller, less live Northern Protestant churches. Also on this record: a strangely chromatic work by experimenter Jacob Handl (late 16th c.), a hearty work by Schein (German 17th c.) and a short British anthem by Henry Purcell (late 17th c.).

(P.S. I'm thoroughly prejudiced—I sang in the chorus; also edited tapes, wrote notes on back of the record album. You may ignore all the above if you wish, therefore! One concrete fact—there is *no* blasting. See **AUDIO ENGINEERING** for May.)

**Great Masters of the Keyboard: "Composers and pianists (1904-11) in their own history-making recorded performances."**

Columbia LP:  
ML 4291/5

If this much-advertised series of piano recordings has fascinated pianists from the interpretive point of view, then engineers and those with a mechanical turn of mind have been equally intrigued by the mechanism involved—a super player piano system, the master-recording machine developed by the Welte people, from which in turn the simpler commercial piano rolls were made for home use. (The funny thing is that thanks to the stigma of the term "player piano" and Columbia's frantic efforts to avoid it—most people still think that these are actual recordings, in the usual sense, and they marvel at the quality of them, as made in the early 1900's!)

To be brief, these special rolls, rescued

with the one player after the war, were played on a piano and recorded on tape in Germany, then processed onto LP here in the usual fashion. The recording was done late in 1948, the early days of tape. The Welte machine worked via carbon rods dipping into mercury, for variable resistance, thereby controlling every key individually as to "touch" and volume. Pedaling, etc. was also "faithfully" recorded—but the question is, how faithfully? How much of what we hear is actually the sound of the great pianists and composers themselves, reproduced? A fascinating question, especially when you detect an indefinable robot-like quality to much of the playing—and can't pin it down. I suspect myself that two things are lacking here—(1) adequate force for the loud passages, which sound "soft," lack punch; and (2) inaccurate or out-of-adjustment pedaling—which can

ruin a masterful interpretation in an instant. This is, of course, pure speculation, from the sound of the records. In any case, much of what is here recorded is actually faithful—tempo, for instance. No reason why it shouldn't be exact, provided the rolls run at constant and predetermined speed.

Robot or not, there's no question that this Welte machine was amazingly ingenious for its day, and it's clear enough to any listener that its ability to bring out details in the playing, (louder inner passages with soft accompaniment, for instance) is astonishing, as was the sheer speed with which it could operate in rapid passages. My only regret is that the recordings, of 1948, weren't better. They rate strictly so-so, even with extenuating circumstances (power fluctuations, etc.) in mind. Not a very good piano sound, as piano recordings go.

# AMPEX

STANDARD OF THE GREAT RADIO SHOWS  
DISTRIBUTED BY

## TERMINAL

RADIO CORPORATION

Almost overnight Ampex Magnetic Tape Recorders revolutionized radio network broadcasting. Ampex succeeded in this most critical service because of simple and dependable operation, plus a tone quality that is unequalled. Ampex is available in several models for a wide range of requirements. Standard units have a dual-speed recording of 7 $\frac{1}{2}$ -15 or 15-30 inches per second.





**SEE and HEAR AMPEX at TERMINAL'S Sound Studio!**

We want you to see for yourself how easy it is to operate the Ampex Magnetic Tape Recorder — and hearing is believing when you listen to an Ampex tape playback! We have studio console and professional portable models on demonstration. If unable to visit us soon, ask us to send you the Ampex Story — a well-illustrated booklet describing Ampex Magnetic Tape Recorders.

**TERMINAL is New York's Leading Distributor OF HIGH QUALITY SOUND EQUIPMENT**



Our Sound Department is famed far and wide for its vast selection of high quality sound equipment. Whether it's a pickup, speaker, amplifier, tuner, turntable, reel of tape, etc. — TERMINAL has what you need! Our big catalog of equipment for true sound reproduction is now ready — 20 pages chock-full of the newest and best available!

*Write for our New Sound Catalog*

# TERMINAL

RADIO CORPORATION

**Distributors of Radio & Electronic Equipment**

**85 CORTLANDT ST., NEW YORK 7, N. Y. • WOrth 4-3311 • Cable: TERMRADIO**

# MERIT NEWS

## MERIT TRANSFORMERS Lead Again for Sound Equipment! with NEW OUTDOOR TYPE

Universal Line Transformers. To couple various line impedances to voice coil. Universal mounting bracket.

Designed specifically for maximum service in the outdoor sound field.

Features: Universal mounting (may be bolted or clamped to speaker bracket); Weather-sealed at moderate cost to withstand outdoor conditions; Encased in one piece drawn metal can; Potted to resist moisture absorption; Terminal board mounted inside can.

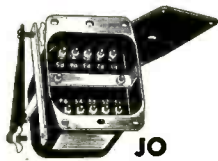

Mounting JO  
Mfg. Center Case  
2 3/4 x 3 3/8  
Dimensions  
H W D  
4 1/4 4-7/16 3-9/16

TYPE NO.	LIST PRICE	OHMS IMPEDANCE PRIMARY	SEC. WATTS
A-4040	\$ 8.75	250-500-1000-1500-2000	4-8-16 8
A-4041	9.75	250-500-1000-1500-2000	4-8-16 12
A-4042	13.75	250-500-1000-1500-2000	4-8-16 25
A-4043	9.75	45-50	4-8 12

### HEAVY DUTY OUTPUT TRANSFORMERS

High Level Type to Couple Line to Speaker  
Sec. Impedances: 4-8-15-250-500 Ohms

TYPE NO.	LIST PRICE	TUBE	PRI. IMPEDANCE	PRI. M.A.	MAX. PER SIDE WATTS
A-3133	\$11.50	P.P. Par. 6L6, P.P. 807	3300 c.t.	240	55
A-3131	7.00	PP6L6, 6Y6, PP2A3, 6A3, 6B4, -15, PP6N7, 46	5000 c.t.	80	30
A-3128	8.00	PP6V6, 6F6	8000 c.t.	50	14

### SEALED-IN MOUNTING H

A-4033	16.50	P.P. Par. 6L6, P.P. 807	3300 c.t.	240	55
A-4030	13.00	P.P. 6L6	6600 c.t.	80	34
A-4028	12.00	PP6V6, 6F6	8000 c.t.	50	14

\*Weatherproofed, potted for outdoor use at 100% over list price.



For information on other transformers see the complete MERIT line in Sam's Red Book or ask for New MERIT Catalog No. 4911



EQUIP WITH MERIT OUTDOOR TYPE TRANSFORMERS TODAY



**MERIT** TRANSFORMER CORP.

4415 NORTH CLARK ST., Chicago 40, Ill.

Ravel, Rhapsodie Espagnole; Debussy, La Mer.

Belgian Nat. Radio Symphony, Brussels Radio Symphony Orch. Franz André.  
Capitol LP: P-8082

Mengelberg Conducting. (Brahms, Tragic Overture; Schubert, Ov. to "Rosamunde"; Beethoven, "Prometheus" music.)

Amsterdam Concertgebouw, Mengelberg.  
Capitol LP: P-8087

Vienna Choir Boys. (Schubert Songs; Austrian Folk Songs).

Capitol LP: P-8085

Here are some highlights from Capitol's latest release of re-recorded European performances. How old these are I cannot say, though the sound suggests disc, not tape, in every case. (There is a subtle difference in sound, incidentally, between disc-made and tape-made originals that is not easy to pin down to the usual matters of distortion or lack thereof. The "tape sound" becomes more and more recognizable as we go along—or so my ear says.) It seems to me that Capitol deserves top honors in perfecting the copying of 78 disc masters to the LP medium. No other company has been able to turn out such consistently good results from 78's dating back, often, a good many years.

The Ravel and Debussy items above—Rhapsodie Espagnole and La Mer—are naturals for wide-range recording, except for one thing, too-frequent low levels. Castanets, cymbals, triangles, whispery strings, trumpets, everything you could want, are here—but the soft passages tend, as always, to disappear in the rising mud. Even so, these two sides of an LP can give you some astonishing sounds. "La Mer" is best known hereabouts in the Koussevitsky-Boston Symphony version, on Victor. On direct comparison, the lack of highs in the Boston version is startling. Yet the Boston set, played by itself, sounds good; a reasonable policy seems to have been followed: namely, that for the ordinary home receiver, fine acoustics and good playing will count more than wide frequency range in getting over the atmosphere of this music. It's a point, alas, rather well taken, whatever we wide-range enthusiasts may have to say. If you want to see how it's done, try almost any Boston Symphony recording prior to 1948. Very effective stuff.

The great Mengelberg made a host of not-too-great recordings for Telefunken in his later years. They are individualistic, powerful, but often fussy, arbitrary, rather hard and unfeeling. The continuing Capitol Mengelberg re-issues are quite unpredictable—some seem to me top-rate, musically; others are punk. The pot-pourri "Mengelberg Conducts" puts together good and bad in just this way. The "Rosamunde" overture is tawdry and sloppily played. The Brahms "Tragic" (perhaps an earlier job) is excellent in playing and very good in recording, and similarly with the very interesting Beethoven music—in which you will hear, to your surprise, one of three earlier versions of the familiar last movement of the "Erioca" Symphony.

The Vienna Choir Boys! All that need be said is that in this unforgettable singing is crammed plenty of two major powerhouse reasons for getting emotional—the

## BRITAIN'S FINEST SPEAKER COMES TO YOU



For the sixth time, we want to talk to you about our BARKER LOUDSPEAKERS. There are now just a few actually in your hands, and a number on the way. So far reports have been excellent, owners being really pleased with the improvement they get in reproduction. Our thanks are due for their very kind appreciation, which we value greatly.

It is true that our name is not yet well known in your land. But ask any real high quality man over here, and he will tell you that the name BARKER means quite a lot in Britain. We are small in size, but make up for that by our unique patented ideas, and pride in turning out a job. Any line on which we develop will never change that fundamental policy of giving the best value and a square deal to all our customers, many of whom are by now also our friends.

May we invite you personally to write to us for details of our dual drive and cone, which combine to form the most perfectly controlled, wide range sound source yet made anywhere. A post card with a 3c stamp will bring our leaflets along.

We are very interested in fixing up a few chosen dealers able to handle high quality gear such as our speakers. If you have a favorite store, get them to write to us. If you prefer to go right ahead, send us your check now.

Two models, both 12 in. frame, 14,000 or 17,500 lines/sq. cm. Prices \$45.00 or \$60.00 by insured post to your home.

BARKER NATURAL SOUND REPRODUCERS  
BCM/AADU, LONDON, W.C.I., ENGLAND.

### FOR THE TAPE RECORDING ENTHUSIAST



Written for the layman, technician and engineer by A. C. Shaney, outstanding author and engineer.

96 pages crammed with facts. Contains circuit diagrams, parts lists, construction hints, as well as elementary and advanced theory and design. Contains data never before in print.

Send dollar bill. No C.O.D.'s.

AMPLIFIER CORP. OF AMERICA  
398-94 Broadway New York 13, N. Y.

### AUDIO ENGINEERING SCHOOL

Practical engineering training in Audio fundamentals, Disc, Film, Magnetic Recording, and Audio frequency measurements.

Studio training simulates Broadcast, Motion Pictures, Television, and Commercial Recording work.

Approved for Veterans

Hollywood Sound Institute, Inc.  
1040-A North Kenmore, Hollywood 27, Calif.

Specify if Veteran or Non-Veteran

Have you ordered your copy of the

## audio anthology?

For details, turn to page 44

## PROFESSIONAL DIRECTORY

### C. J. LEBEL

AUDIO CONSULTANT

Sound Recording • Instrumentation

370 RIVERSIDE DRIVE  
NEW YORK 25, N. Y.

Custom-Built Equipment

### U. S. Recording Co.

1121 Vermont Ave., Washington 5, D. C.

STerling 3626

Consultation • Design • Fabrication

### Audio Facilities Corporation

133 West 14th Street,

New York 11, N. Y.

### HERMAN LEWIS GORDON

Registered Patent Attorney

Patent Investigations and Opinions

Warner Building	100 Normandy Drive
Washington 4, D. C.	Silver Spring, Md.
National 2497	Shepherd 2433

### Albert E. Hayes, Jr.

CONSULTING RADIO PHYSICIST

3 East Sampson St. Bay Park, L.I., N.Y.

RATES FOR  
PROFESSIONAL CARDS  
IN THIS DIRECTORY

\$10 Per Month.  
Orders Are Accepted  
for 12 Insertions Only

sound of well-trained boys' voices, anywhere, and the spirit of Viennese, Austrian singing, as we know it in the Strauss Waltzes. The Schubert songs, including two of those sung by the Robert Shaw group of male voices (reviewed last month), are the very essence of Vienna and Austrian music and these kids seem to feel the music as though Schubert were right there directing them. A remarkable tradition! Like any kids, the folk songs that occupy the other side of the record they do with even more zest. (It's rather hard to tell the folk songs from the Schubert, so closely knit is the Austrian tradition of singing.) Fine recording—but do I note a bit of high-level blasting here and there? The music is just under the permissible maximum level most of the time; could easily have been done at lower levels, I should think.

#### Beethoven, Symphonies #1 and #8.

Amsterdam Concertgebouw, Mengelberg.

Capitol LP:  
P-8079

This one rates separate discussion because the Symphony #1 makes an interesting comparison with the same as done for Columbia by Bruno Walter, rated one of the best LP's of the sort to date. The Walter #1 is separate, on a 10-inch disc both sides; the Mengelberg is squeezed onto one side of a 12—and we have the classic problem in LP, playing time vs. depth of cut. The Walter, with more space, runs at a consistently higher level. Moreover, other interesting comparisons are found here. Columbia's curve is NAB; the Mengelberg apparently has less pre-emphasis. So that in comparing the two one must not only change the over-all level but also readjust the highs, even if a putative difference in turnover point is ignored. Mengelberg, with lower level and weaker highs, tends to be scratchy. Walter is cleaner as to background, and this is of course a clear surface advantage in the NAB curve (the other notable advantage, as I see it, being in the correlation between NAB and the average cheaper crystal cartridge's performance).

Yet with all of this difference, the two are not so far apart. Musically I prefer the Walter LP, especially in the first movement where Mengelberg is very fussy with his tempi. But Mengelberg has a certain leanness of sound, thin and muscular, that makes Walter's orchestra (the New York Philharmonic) seem a bit ponderous in spots. Walter's strings play more accurately and with more natural, better-thought-out phrasing; but Mengelberg boasts some lovely woodwind playing. . . so it goes; this sort of comparison can go on and on, point by point. Is it any wonder that critics hate to say which of two recordings is "better"—as though it were a simple business of black and white?

For some inexplicable reason the Beethoven Eighth, on the reverse, is cut at a higher level than the First, though it would seem to be longer, and with grooves just as close. Both sides of this LP have already broken down in the final loud inner grooves—the usual result of cramming too much music in too little space. Give-away evidence: a double echo of the last two chords (four times) in the following grooves. Most unfortunate, isn't it, that almost every long piece of music ends at its loudest, often begins at its softest. Maybe we should record LP inside-out!

# One Pickup

PLAYS  
ALL DISKS

New Fairchild Turret-Head  
3-Way Transcription Arm  
Plays Standard Laterals, Microgrooves, and Verticals  
Without Plug-ins . . .

#### WHAT IT IS:

A revolutionary new pickup  
with provision for 3 separate  
cartridges—All in ONE arm



#### WHAT IT DOES:

Obsoletes plug-in cartridges.  
Eliminates extra pickups on  
turntable. Performs functions  
of 3 separate pickups.

#### RESULTS:

- Lateral, Vertical, Microgroove in 1 Arm
- Any combination of cartridges in 1 Arm
- Simply turn knob to select cartridge
- Pressure changes automatically
- Optimum performance — separate cartridge for each function
- No arm resonance — new viscous damping
- Fits all transcription turntables.

Write for  
Illustrated Details



154TH STREET AND 7TH AVENUE  
WHITESTONE, N. Y.

FR-113

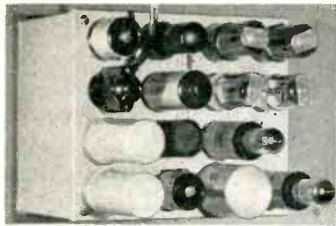

20 W-2 Amplifier \$149.50



AE-2 Equalizer PreAmplifier \$74.50

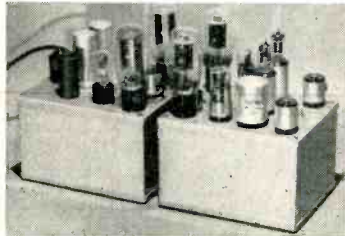

50 W-2 Amplifier \$249.50

# McIntosh

Engineering Laboratory, Inc.  
910 King St. Silver Spring, Md.  
Prices Subject to Change Without Notice.

## ARE YOU A MEMBER OF A HARTLEY-TURNER SPEAKEASY?

We have completed the mailing of our high-fidelity report on American reactions to the 215 speaker. A copy has been sent to every subscriber to "New Notes in Radio", and we hope and believe it will be full of interest to high-fidelity enthusiasts, whether they want a Hartley-Turner speaker or not.

With that report is sent a most unusual document with the title "The Hartley-Turner Speakeasy—a new idea in marketing". This new idea in marketing is a big step forward towards the utopian economy dreamed of by our planners. But unlike the planners' dreams, this is a working proposition which will appeal to you today.

There is no room here to tell you all about it, but we will be glad to send it to you if you are interested. A very large number of A.E. readers think that "New Notes" with its accompanying data sheet service is one of the most interesting publications they have come across, and well worth the dollar we ask for it. If, therefore, you subscribe to "New Notes", which is \$1.00 per lifetime, you will get the Speakeasy scheme and the High-fidelity Report as well.

If you don't want "New Notes" we will still send the other two papers free, but we do think you ought to have "New Notes" too.

Of course this all leads up to the notion that one day you will be the proud owner of a 215 speaker, but don't take our word for it. The information we have mentioned above is solely concerned with giving you factual information on which you can base a reasoned decision, and the decision is yours, and yours only, to make.

When you have made that decision you will be surprised to find at what little cost you can have real high-fidelity reproduction, and real after-sales service.

**H. A. HARTLEY Co. Ltd.,**  
152 Hammersmith Road,  
London, W.6, England.

## ADVERTISING INDEX

Air-Tone Sound & Recording Co. . . . .	38
Altec Lansing Corp. . . . .	36, 40, 48
Amperite Co., Inc. . . . .	2
Ampex Electric Corp. . . . .	52
Amplifier Corp. of America . . . . .	52, 54, 56
Arnold Engineering Company . . . . .	7
Atlas Sound Corp. . . . .	52
Audak Company . . . . .	31
Audio Devices, Inc. . . . .	43, Cover 2
Audio Facilities Corp. . . . .	55
Barker Natural Sound Reproducers . . . . .	54
Bell Telephone Laboratories . . . . .	10
Broadcast Service Company . . . . .	50
Carter Motor Company . . . . .	52
Daven Company, The . . . . .	Cover 3
Electro-Voice, Inc. . . . .	29, 39
Fairchild Recording Equip. Corp. . . . .	3, 55
Fisher Radio Corp. . . . .	51
FM - TV Magazine . . . . .	42
General Radio Company . . . . .	33
Gordon, Herman Lewis . . . . .	55
Gray Research & Dev. Co. . . . .	41
Hartley, H. A. Co., Ltd. . . . .	56
Harvey Radio Company, Inc. . . . .	34
Hayes, Albert E. Jr. . . . .	55
Heath Company . . . . .	45
Hewlett-Packard Co. . . . .	1
Hollywood Sound Institute . . . . .	54
Industrial Electrical Works . . . . .	6
LeBel, C. J. . . . .	55
Magnecord, Inc. . . . .	35
Magnetic Recorders Co. . . . .	48
McIntosh Engineering Lab, Inc. . . . .	56
Merit Transformer Corp. . . . .	54
National Company, Inc. . . . .	48
Partridge Transformers, Ltd. . . . .	56
Permoflux Corporation . . . . .	8
Pickering & Co., Inc. . . . .	5
Precision Electronics, Inc. . . . .	46
Presto Recording Corp. . . . .	9
Professional Directory . . . . .	55
Racon Electric Co., Inc. . . . .	49
Reeves Soundcraft Corp. . . . .	37
Rek-O-Kut Co., Inc. . . . .	46
Shallcross Mfg. Co. . . . .	47
Sun Radio & Electronics Co., Inc. . . . .	36
Tech Laboratories, Inc. . . . .	38
Terminal Radio Corp. . . . .	53
United Transformer Corp. . . . .	Cover 4
U. S. Recording Co. . . . .	55
Westrex Corporation . . . . .	44

## Partridge News

### Individuality tested

#### AUDIO TRANSFORMERS

to the 'WILLIAMSON' Specification

This range of 20 watt push-pull output transformers is intended for use in equipment reproducing the full audio frequency range with the lowest distortion. The design and measured performance is exactly as specified by Williamson in the "Wireless World" August 1949 (see also Audio Engineering November 1948). The transformer is available in a varied range (separate models suitable for KT66, 807 tubes, etc.) Performance assured by comprehensive testing procedure applied to each unit. Close limits set on shunt reactance at 50 cps., series reactance at 5 Kc/sec., d.c. resistances and interwinding insulation resistances at 2 K.V. This is the best possible transformer of its type (weight 14 lbs.) Our new technical data sheet is available and will be rushed to you by airmail upon application. The price of the potted model is . . . . . \$19.50 post free to your door. Immediate from our stocks.

## PARTRIDGE

### TRANSFORMERS LTD

Roebuck Road, Tolworth, Surrey, England

## Announcing

### NEW ELECTRONIC FILTERS\*

and

### TUNED AUDIO AMPLIFIERS\*

Here's great news for engineers in all audio and specialized electronic fields where precise measurements and sensitive controls are of paramount importance—

- Our newly developed Type EF Electronic Filter when added to any commercial oscillator (with 3% distortion) will result in a reduction of distortion to less than 0.031%, about 30 times less than expensive laboratory units!
- When added to a laboratory oscillator, the new Type EF Electronic Filter will reduce distortion to less than 0.01%, which makes it suitable for significant intermodulation or frequency distortion measurements.
- The new Type "A" Tuned Amplifier, when inserted between a bridge balancing network and its indicator or control, will increase sensitivity of measurement or control by a factor of 1000 to 1!

These units are also suitable for a wide variety of super-sensitive phase discriminatory control circuits and have many other valuable applications.

Write for Complete Description and Prices on 12 Different Models  
\*Patent pending

## AMPLIFIER CORP. OF AMERICA

398-4 Broadway, New York 13, N. Y.