

AUDIO ENGINEERING

SEPTEMBER
1948

THE JOURNAL FOR SOUND ENGINEERS

PRICES AND AUDIODISCS

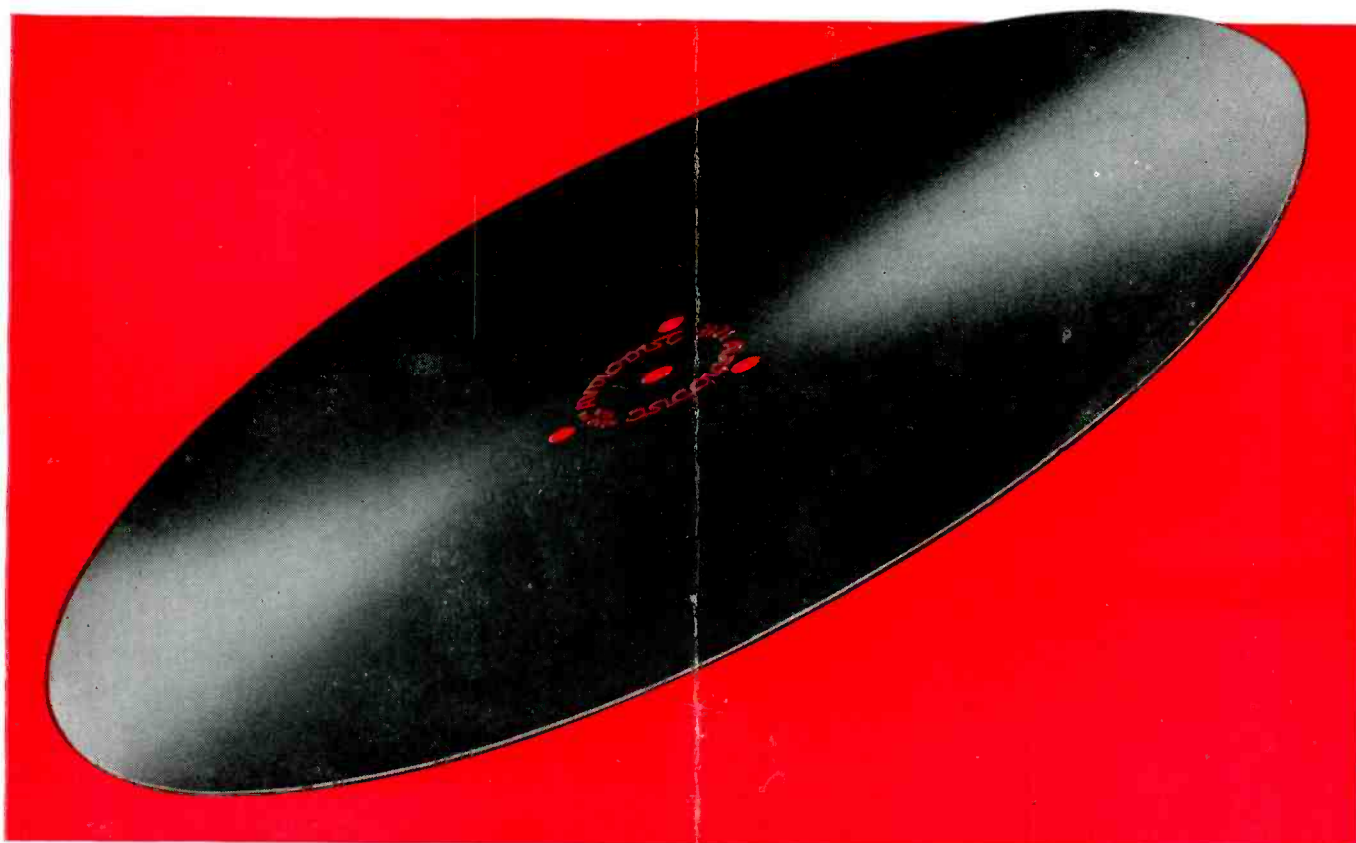

A Statement On Our Price Policy

As of September 1st, aluminum prices are again increased. This means higher cost for the principal raw material used in the manufacture of AUDIODISCS. In fact, the cost of the aluminum base has always been the main item in the cost of production. Thus, any increase in aluminum prices is of major importance.

But beyond the cost of raw materials and labor there is a basic factor which determines the cost of manufacturing professional recording discs. This factor is the extent to which the particular process of manufacture enables the producer to turn out a large proportion of first quality discs. There are several methods of production used. None of these will give anything like a 100% yield. It is, however, obvious that as the percentage of yield increases there is a resulting drop in the average cost of aluminum, lacquer and labor.

Fortunately, our patented, precision-machine process—now used for over a decade and continuously improved—gives a more consistent yield of high quality discs than any method of production now used. And we have tested every other process in use.

So our position with respect to the present increase in aluminum prices is this:

1. We are *not* increasing prices of AUDIODISCS as of September 1st.
2. We shall make every effort to absorb this new aluminum price raise and thus continue our prices at the present level. Our calculations indicate that with some improved efficiency, now under way, and continued large volume production, we shall be successful in this hold-the-price effort.

Audioidiscs are manufactured in the U.S.A. under exclusive license from PYRAL, S.A.R.L., Paris.

Audio Devices, Inc., 444 Madison Ave., N.Y.C.

EXPORT DEPT: ROCKE INTERNATIONAL, 13 EAST 40TH STREET, NEW YORK 16, N. Y.



they speak for themselves **audioidiscs**

Member of Audit Bureau of Circulation

AUDIO ENGINEERING

Successor to **RADIO**

John H. Potts, Editor

C. G. McProud, Managing Editor

Lawrence LeKashman, Asst. Editor

Louisa B. Dresser, Edit. Prod. Mgr.

Sanford R. Cowan, Publisher

S. L. Cahn, Adv. Director

H. N. Reizes, Adv. Mgr.

Jerome S. Harris, Circ. Mgr.

Editorial Advisory Board

Howard A. Chinn

John D. Colvin

Paul A. de Mars

C. J. LeBel

J. P. Maxfield

George M. Nixon

S. Young White

Representatives

James C. Galloway
816 W. 5th St., Los Angeles 13, Calif.

Dale International Publications, Ltd.
105 Bolsover St.
London W. 1, England

Harris & Floyd
297 Swanston St., Melbourne
C. 1, Victoria, Australia

Established 1917

CONTENTS

SEPTEMBER, 1948

Vol. 32, No. 9

Letters	4
Editor's Report	6
Polyethylene Phonograph Records— <i>Otto J. M. Smith</i>	13
Audio Engineering Society News	15
The Problem of Sound Distribution, Part II— <i>O. L. Angevine and R. S. Anderson</i>	16
Technicana: Intermodulation	19
Elements of Residence Radio Systems, Part I— <i>C. G. McProud</i>	22
Design of Amplifying Crystal Units— <i>S. Young White</i>	26
Design of Electronic Organs, Part IV— <i>Winston Wells</i>	28
FM Tuning Indicator— <i>L. B. Keim</i>	32
Record Revue— <i>Edward Tatnall Canby</i>	33
Audio Design Notes: Coaxial Cable Capacity—"Stylus"	34
New Products	36
Professional Directory	36
Advertising Index	18

COVER

This extraordinary photograph of a recording stylus cutting an acetate disc was made by Winston Wells especially for our cover. As shown, it has been enlarged about 12 diameters.

AUDIO ENGINEERING (title registered U. S. Pat. Off.) is published monthly at New York, N.Y., by Radio Magazines, Inc., J. H. Potts, President; S. R. Cowan, Sec'y-Treas. Executive and Editorial Offices at 342 Madison Avenue, New York 17, N. Y. Subscription rates—United States, U. S. Possessions and Canada, \$3.00 for 1 year, \$5.00 for 2 years; elsewhere \$4.00 per year. Single copies 35c. Printed in U. S. A. All rights reserved. Entire contents copyright 1948 by Radio Magazines, Inc. Entered as Second Class Matter July 29, 1918 at the Post Office, New York, N.Y., under the Act of March 3, 1879.

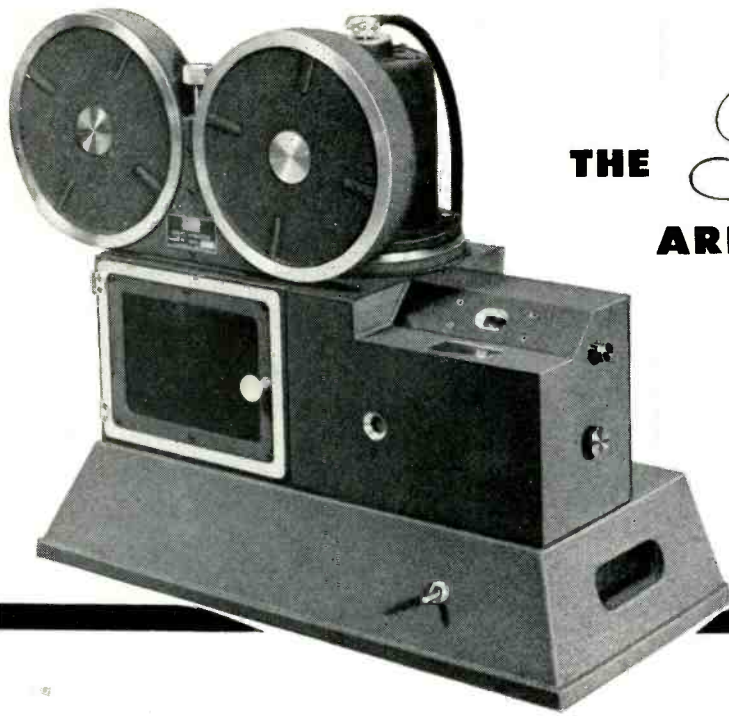

THE *Future*
ARRIVES DAILY

**... and finds Maurer
16-mm equipment ready
to meet its demands**

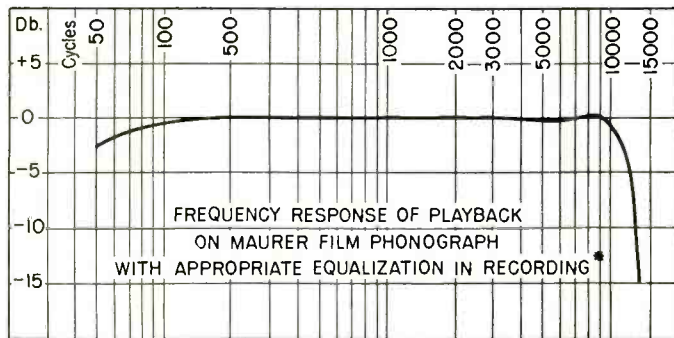
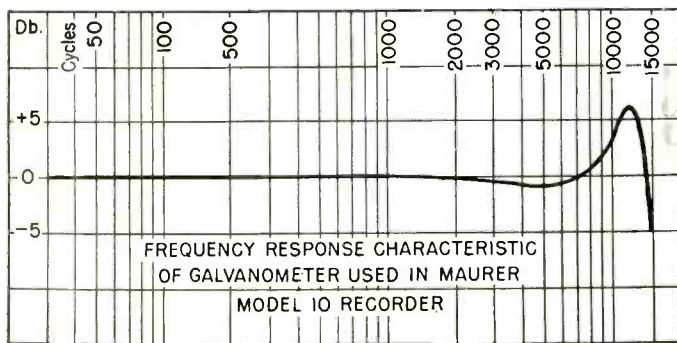

*For those who may have been educated to believe that such a result is not possible with 16-mm film, we shall be glad to demonstrate that it is not only possible, but practical commercially now.

Since 16-mm sound projectors to date have been designed to reproduce only to about 6,000 cycles per second, ordinary sound-on-film recorders have been built to record only that range. But not so with the Maurer!

Anticipating a definite demand for a finer quality of recording including the higher frequencies, the Maurer Recording Optical System was designed to produce an extremely fine line image that makes possible the recording of frequencies well beyond 10,000 cycles, with very low distortion. The galvanometer of the postwar Maurer Model 10 System is tuned to 12,000 cycles. This is the model that has been sold to the trade for two years.

Now television has arrived—and it has brought a demand for high fidelity 16-mm recording. Only Maurer was ready with the equipment to meet this need, proving again the value of the Maurer policy of building, not merely for the present, but for the future.

16mm
maurer

J. A. MAURER, INC.

37-01 31st Street, Long Island City 1, N. Y.

Professional Motion Picture Cameras and
Recording Equipment for the Production of
Industrial, Educational and Training Films



Columbus equipment reaches fires faster sped by 2-way *Motorola* Radio and Sylvania Lock-In Tubes

Those first few minutes are *vital* in fighting a fire!

That's why the Columbus (Ohio) Fire Department counts on Motorola 2-way FM to maintain constant touch between the dispatcher's office and 24 radio-equipped vehicles. Equipment returning to the firehouse can be instantly diverted en route—dispatched to the scene of a new alarm.

And where fires are potentially big enough to call for *additional* equipment to bring them under control, a radio message from the scene to the dispatcher's office has the extra vehicles under way within seconds!

For requirements like this, Motorola counts on Sylvania Lock-In Tubes to help maintain uninterrupted, efficient performance of its mobile units. These tubes stay firmly in place through jolting and jarring. They have few welded joints, no soldered ones. No warping or weaving of elements. Low loss, low leakage. See Sylvania Distributors, or write Radio Tube Division, Emporium, Pa.

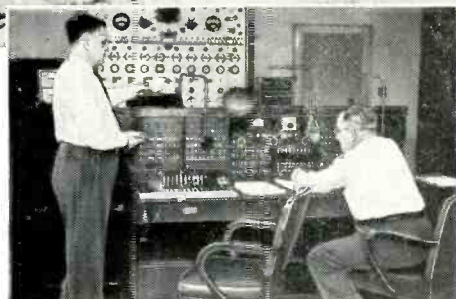

Dispatcher's office is in constant communication with vehicles at all times, directing them to the scene, checking on progress in bringing fire under control.

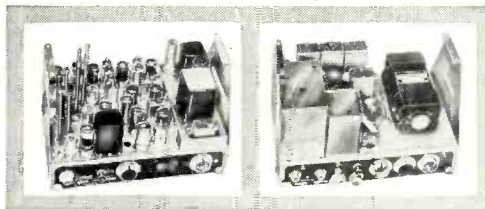

Mobile FM transmitting and receiving units built by Motorola, Inc., Chicago, and used in 24 vehicles of the Columbus Fire Department.

Superior mechanical and electrical features of Sylvania Electric's famous Lock-In Tube make it ideal for equipment on the road, in the air, on the rails—for marine radar, FM and television.



SYLVANIA ELECTRIC

RADIO TUBES; CATHODE RAY TUBES; ELECTRONIC DEVICES; FLUORESCENT LAMPS, FIXTURES, WIRING DEVICES; LIGHT BULBS; PHOTOLAMPS

AUDIO ENGINEERING SEPTEMBER, 1948

Now Available
High Q TOROIDAL COILS

The solution of filter network problems, has been greatly simplified through the use of toroidal coils wound on molybdenum permalloy cores. Design engineers have learned to depend upon them since discovering that only these toroids possess all the necessary qualities of a good high "Q" coil.

Of the 30 different items now being manufactured, the most available types now being supplied are:

TYPE	RANGE
TC-1	Any Ind. up to 10 HYS
TC-2	Any Ind. up to 30 HYS
TC-3	Any Ind. up to 750 MHYS

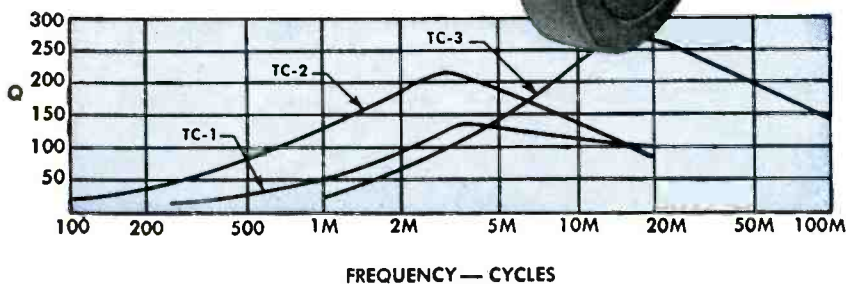

FILTERS

We are producing toroidal coil filters which consistently demonstrate the value of toroidal coils. These filters cannot be matched in stability, accuracy and sharpness by filters made with the usual laminated type of coil.

Orders for samples or production quantities are equally respected. All inquiries will be promptly handled.

Burnell & Co.

DESIGNERS AND MANUFACTURERS
OF ELECTRONIC PRODUCTS

45 WARBURTON AVE. • YONKERS 2, N. Y.

RE TV

Sir:

AUDIO ENGINEERING is by far the most interesting of the six electronic publications to which I subscribe. It is always read from cover to cover and is referred to more frequently than any of the others.

You are doing a fine job.

There is plenty of room for debate on the question of including TV in A.E. I am interested in TV, but to include it in A.E. at the cost of even one word per month on audio, is out.

Should the time come when you could include a "section" on TV, I am for it—provided the issues are put together as two separate sections under one cover.

There should be no mixing of articles, and each section should be complete, including separate index as used in another radio magazine.

I believe most of the objections to TV are probably based on:

- 1) The belief that some Audio material would suffer thru the loss of space, and
- 2) The inconvenience of having to thumb thru a lot of unrelated (and uninteresting for some readers) material to find the various articles on audio.

Strict adherence to the section idea would, no doubt, allow you to increase the scope and circulation of A.E. without drawing any objection from most of the readers who have voted "no" on TV.

If the above idea is practical from a publisher's point of view, and the readers are assured there will be no loss of space devoted to audio articles, I believe the expansion of A.E. would be a good thing and would meet with the wholehearted approval of all concerned.

James F. Redman
5811 32nd St., N.W.
Washington 15, D.C.

This sounds like an excellent idea. What do you think? —Ed.

Hi-Fi?

Sir:

What is wrong with our so-called "high fidelity"? In every high fidelity reproducing system I have ever heard I have noticed a shrill, screechy, and piercing quality that is not present in the original music. This piercing tone of which I am speaking was strikingly demonstrated recently at one of the outdoor Esplanade Concerts in Boston under the direction of Arthur Fiedler.

[Continued on page 8]

MEASURE TOTAL DISTORTION
Between 20 cps and 20 kc



330B DISTORTION ANALYZER

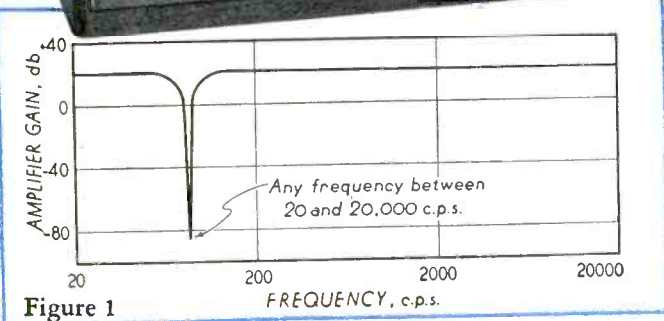

CHECK THESE SEVEN IMPORTANT FUNCTIONS:

1. Measures total audio distortion.
2. Checks distortion of modulated r-f carrier.
3. Determines voltage level, power output.
4. Measures amplifier gain and response.
5. Directly measures audio noise and hum.
6. Determines unknown audio frequencies.
7. Serves as high-gain, wide-band stabilized amplifier.

This fast, versatile *-hp-* 330B Analyzer measures distortion at *any* frequency from 20 cps to 20 kc. Measurements are made by eliminating the fundamental and comparing the ratio of the original wave with the total of remaining harmonic components. This comparison is made with a built-in vacuum tube voltmeter.

The unique *-hp-* resistance-tuned circuit used in this instrument is adapted from the famous *-hp-* 200 series oscillators. It provides almost infinite attenuation at one chosen frequency. All other frequencies are passed at the normal 20 db gain of the amplifier. Figure 1 shows how attenuation of approximately 80 db is achieved at any pre-selected point between 20 cps and 20 kc. Rejection is so sharp that second and higher harmonics are attenuated less than 10%.

Full-Fledged Voltmeter

As a high-impedance, wide-range, high-sensitivity vacuum tube voltmeter, this *-hp-* 330B gives precision response flat at any frequency from 10 cps to 100 kc. Nine full-scale

ranges are provided: .03, .1, .3, 1.0, 3.0, 10, 30, 100 and 300. Calibration from +2 to -12 db is provided, and ranges are related in 10 db steps.

The amplifier of the instrument can be used in cascade with the vacuum tube voltmeter to increase its sensitivity 100 times for noise and hum measurements.

Accuracy throughout is approximately $\pm 3\%$ and is unaffected by changing of tubes or line voltage variations. Output of the voltmeter has terminals for connection to an oscilloscope, to permit visual presentation of wave under measurement.

Measures Direct From R-F Carrier

The *-hp-* 330B incorporates a linear r-f detector to rectify the transmitted carrier, and input circuits are continuously variable from 500 kc to 60 mc in 6 bands.

Ease of operation, universal applicability, great stability and light weight of this unique *-hp-* 330B Analyzer make it ideal for almost any audio measurement in laboratory, broadcast or production line work. Full details are immediately available. Write or wire for them—today Hewlett-Packard Company, 1437L Page Mill Road, Palo Alto, Calif.

hp laboratory instruments
FOR SPEED AND ACCURACY

Noise and Distortion Analyzers	Wave Analyzers	Frequency Meters
Audio Frequency Oscillators	Audio Signal Generators	Vacuum Tube Voltmeters
Amplifiers	Power Supplies	UHF Signal Generators
Square Wave Generators	Frequency Standards	Attenuators
		Electronic Tachometers

EDITOR'S REPORT

AIMS AND MISSES

● ONE of the primary aims of this magazine is, of course, to publish the best technical articles in the audio field. But we want also to present them in most readable fashion. Because we have had the whole-hearted cooperation of a group of enthusiastic and thoroughly competent audio engineers, we have been able to publish a great many articles which are both important technically and also easy to read. As a result, latest surveys show that AUDIO ENGINEERING is now preferred over all other technical magazines by a most discriminating group, the chief engineers of broadcasting stations.

As the magazine grows in influence and prestige, it attracts more and more prominent authors, most of whom have been accustomed to publishing their findings in more academic journals. Thus we are receiving an increasing number of important articles which merit publication, but are written in stereotyped, cut-and-dried form. I often wonder why our engineering schools and colleges train students to write in such a stilted form. Why should an article start off with "INTRODUCTION" as a paragraph head? If you ever find a first paragraph that isn't just that, I'd like to see it. Another thing—and this is much worse—why interrupt the story every few lines with mathematical equations which, no matter how pertinent, make it very difficult to find out just what the writer is trying to say?

When we can catch the author before he has produced one of these academic monstrosities, we shoo him off this form of presentation, and the result is generally an article interesting and easy to read. Often, of course, math is necessary. But even then it can usually be tucked away in an appendix. Those who feel that all important articles should be mathematical are referred to Major Armstrong's classic article on frequency modulation (*Proc. I.R.E.*, May, 1936) which runs to 31 pages and contains but one equation—in arithmetic. Yet most of the academic articles which stem from Armstrong's fundamental disclosure tackle the subject with Bessel's functions, which few can use because they are taught only in graduate courses.

Naturally, the idea of informal presentations can be carried too far. Chatty technical articles are generally pretty awful, as are those with an overdose of humour.

In general, if an author tells his story in the same easy language he would use in explaining it verbally to another engineer, it will be most effective in print.

AES GROWING

● Announcement of the forming of a San Francisco Section of the Audio Engineering Society adds West Coast representation to this rapidly growing organization. Acting Chairman is I. R. Ganic. Other officers are Walter Selsted, acting vice-chairman; Don Lincoln, secretary; Frank Lennert, treasurer. Committee appointments are: J. Alan O'Neil, Harold W. Lindsay, admissions; Ross H. Snyder, meetings; Dick Beck and Jack Hawkins were designated to represent the group for the national nominations committee.

Those in this area who are interested in joining may obtain further information by writing Don E. Lincoln, 325 19th St., Oakland 12, Calif.

It is really too bad that no AES group has yet been formed in the Chicago area. Undoubtedly there are hundreds of audio engineers who live in Chicago and its suburbs who would like to join and if those interested will address their inquiries to this office, we'll try and help them get started.

While we're on the subject, don't forget that there is a chapter of the AES in the Twin Cities area. John Goodell of Minnesota Electronics, 6th and Minnesota Sts., St. Paul, Minn., heads this group.

PIX

● We are very happy about the cover picture and the portion of it that heads the Record Revue this month. Winston Wells did it, proving that a good radio engineer, organist, portrait painter, pianist, and writer, can also do exceptionally fine photographic work.

Incidentally, we are on the lookout for other unusually striking photographs for cover pictures. These should deal with some phase of audio work and should be so composed that our AUDIO ENGINEERING slug can be placed in the upper left-hand section without covering an important part of the picture. If you have something that you think might be suitable, please tell us about it and enclose a small print, if possible. —J.H.P.

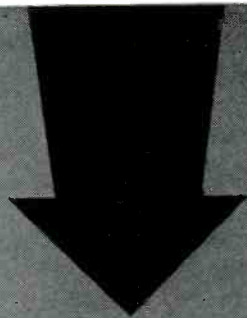

ARNOLD

That's the
name to
remember in
PERMANENT
MAGNETS

There are values in the use of permanent magnets—increased efficiencies and economies—that should be investigated by many a manufacturer of electrical and mechanical equipment. The past decade has seen great strides in the scope and utility of permanent magnets, and this progress is *important* to you.

Equally important are the *extra* values you'll find in Arnold Permanent Magnets—the natural result of specialization and leadership, and of complete quality control in every production step from melting furnace to final test. • Call in an Arnold engineer to help with your design and planning—write direct or to any Allegheny Ludlum office.

W&D 1099

THE ARNOLD ENGINEERING CO.

Subsidiary of

ALLEGHENY LUDLUM STEEL CORPORATION

147 East Ontario Street, Chicago 11, Illinois



*Specialists and Leaders in the Design,
Engineering and Manufacture of PERMANENT MAGNETS*

NEW

SHURE "900MG"

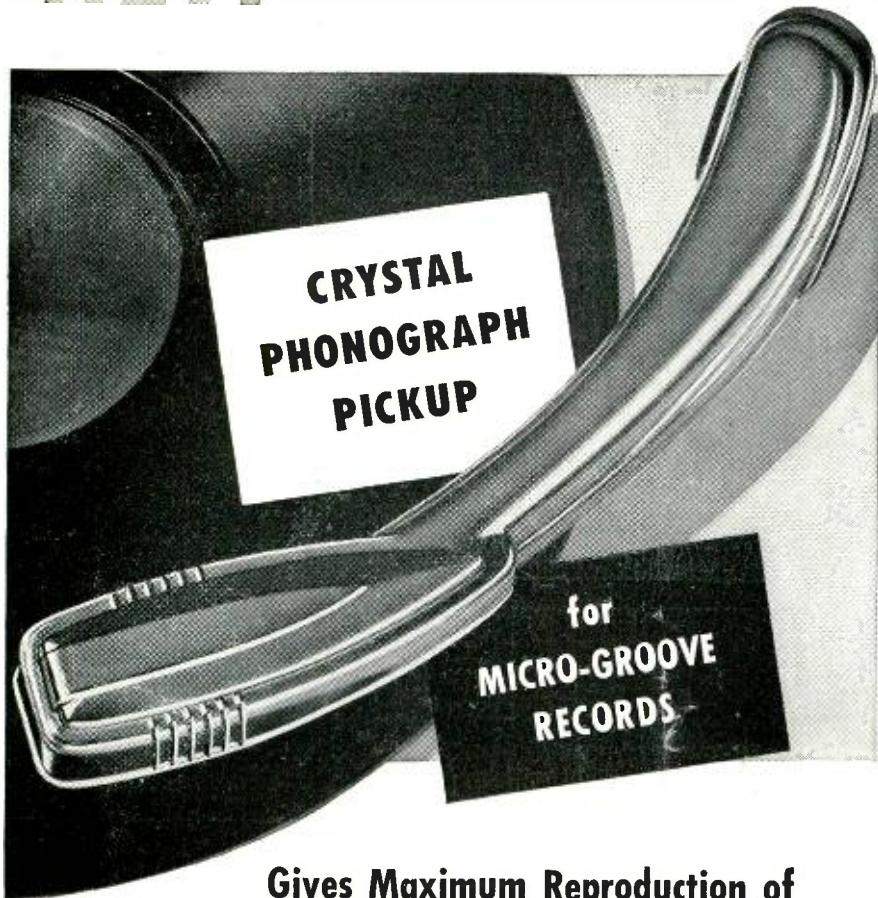

Gives Maximum Reproduction of Micro-Groove Record Fidelity

The Shure "900MG" Pickup is an ideal instrument for tracking on the new micro-groove records. It tracks at 7 grams . . . has a needle force of 9 grams as added safety factor . . . uses a special offset osmium-tipped needle with a point radius of only .001" . . . and has an output of 1 volt! The Shure lever system has been adapted in the development of this new pickup—providing a high needle compliance. Listen to it—you will be thrilled with the results!

Model "900MG" Code: RUZUZ List Price: \$12.50

Shure Patents Issued and Pending. Licensed under the Patents of the Brush Development Co.



SHURE BROTHERS, Inc.

Microphones and Acoustic Devices

225 W. HURON ST., CHICAGO 10, ILL. • CABLE ADDRESS: SHUREMICRO

— Letters —

[from page 4]

On top of the Hatch Memorial Shell is mounted a large multicellular horn loudspeaker used to re-enforce the sound from the orchestra and soloists for the benefit of the listeners sitting a block away. So far as listening quality goes, it would be judged to be among the very fine reproducing systems. By itself, the music coming from the speaker might be called marvelous by some listeners. In fact, sitting sixty rows from the shell, if I had not realized that a solo violin or piano could not carry that far with such volume, I would have sworn that the music was coming direct from the solo instruments and not from a loudspeaker.

It happened one evening when I was sitting in the eighth row that someone accidentally turned the gain control on the amplifier way up so that the re-enforcement system, ordinarily inaudible at that distance, was plainly heard above the orchestra. On loud notes the distortion from the overloaded amplifier and speakers was plainly obvious. However, what was even more disturbing during the soft undistorted passages, was that the violins from the speaker had lost all of their original soft, sweet tone, and acquired a piercing shrillness. The shrillness was enough to spoil the music for those who could hear both the orchestra and the speakers.

I have heard this piercing quality in what are supposed to be the best loudspeakers on the market for home listening. It varies from speaker to speaker, but is always there in one form or another—something wrong in the region between 2,000 and 4,000 cycles. The shrillness does not seem to be generated in amplifiers, since it is possible to pass a signal through several amplifiers and even to record and reproduce from discs without any noticeable difference in quality. That leaves the microphone, the loudspeaker, and the technique of microphone placement; and I think all contribute.

Until we get rid of the shrillness we will not have attained perfectly natural reproduction, even with compensation for hearing loss, stereophonic reproduction, or what have you.

Sincerely yours,

Richard S. Burwen
17 Sheffield Road
Melrose 76, Mass.

The **NEW El-Menco CM15**
MINIATURE CAPACITOR

*Four times
 actual
 size*

ACTUAL SIZE!
 (1/32" x 1/2" x 3/16")

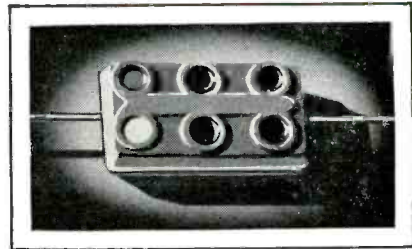

**FOR
 TELEVISION, RADIO
 AND OTHER
 ELECTRONIC APPLICATIONS**

HOW LONG IS HALF AN INCH?

EL-MENCO's answer is illustrated above — the new miniature CM15. That half inch of silver mica capacitor is miles long on performance . . . age-long on endurance . . . 2 to 500 mmf. long on range.

The CM15 is short on delivery time (unlimited production) . . . short on limitations (tolerances: \pm 20% to 1%) . . . short on guess work (6-color coded to Joint Army-Navy Standard Specifications JAN-C-5 for fixed mica dielectric capacitors).

The long and short of it is this: EL-MENCO's new miniature CM15 possesses the value inherent in all EL-MENCO products—

PERFORMANCE • ENDURANCE • RANGE • PRICE • DELIVERY

Write, on firm letterhead, for samples and catalog.
THE ELECTRO MOTIVE MFG. CO., Inc.
 WILLIMANTIC, CONNECTICUT

Foreign Radio and Electronic Manufacturers communicate direct with our Export Department at Willimantic, Conn., for information.

JOBBERS AND DISTRIBUTORS
ARCO ELECTRONICS
 135 Liberty St., New York, N. Y.
 is Sole Agent for El-Menco Products in United States and Canada.

MOLDED MICA **El Menco** **MICA TRIMMER**
CAPACITORS

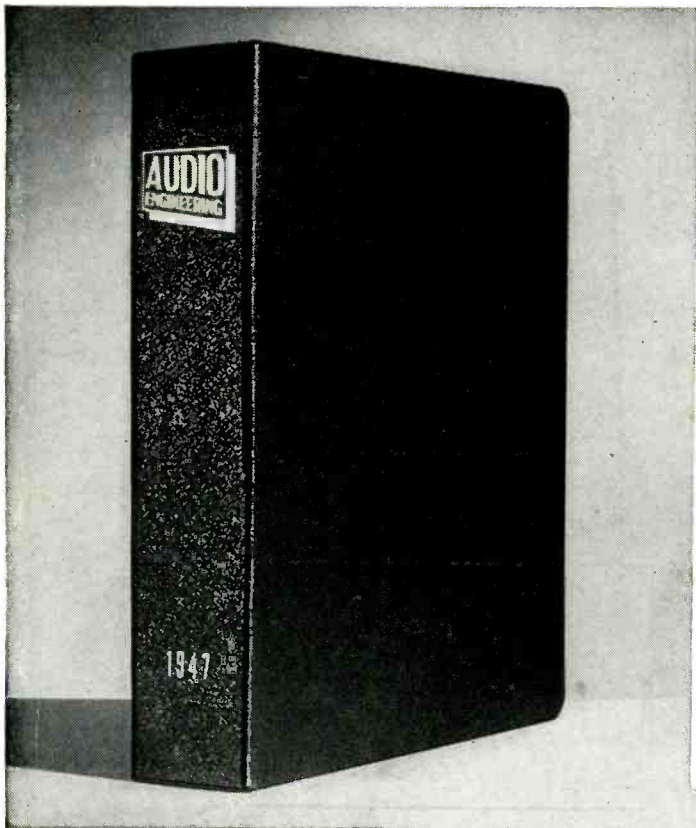

AUDIO ENGINEERING

BINDERS \$2⁵⁰

★ ★ ★ Here at last is a binder using modern postwar materials at prewar prices. Designed to provide instantaneous reference to your monthly copies of Audio Engineering. An unusually fine library finish that will stand up under constant use.

- Rich blue Dupont Fabricord—stainproof and washable.
- Rigid backbone with bound-in metal support.
- Light weight tarnishproof aluminum ends.
- Coil springs built in at each end to securely position spring steel wire holders.
- Backbone gold stamped with Audio Engineering and year.
- Center channel to keep magazines fastened in position.
- Round corners, hinges and backbone fully reinforced.
- \$2.50 postpaid. Foreign orders add 50c.



RADIO MAGAZINES, INC.
342 MADISON AVE.
NEW YORK 17, N. Y.

AUDIO ENGINEERING
BINDERS

1947 1948

Enclosed find \$ for Binders

Name.....

Address.....

City..... State.....

**Jensen
Custommode**

presents four basic units

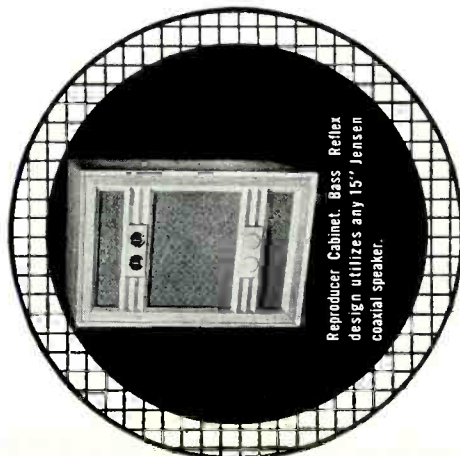

Reproducer Cabinet. Bass Reflex design utilizes any 15" Jensen coaxial speaker.



Medium Utility Cabinet. For large equipment, small television sets, amplifier racks, etc.



Small Utility Cabinet. For tuner, amplifier, recorder, record changer, etc.

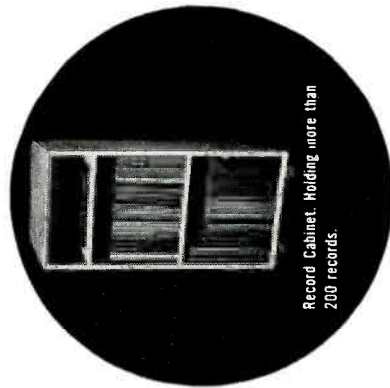

Record Cabinet. Holding more than 200 records.

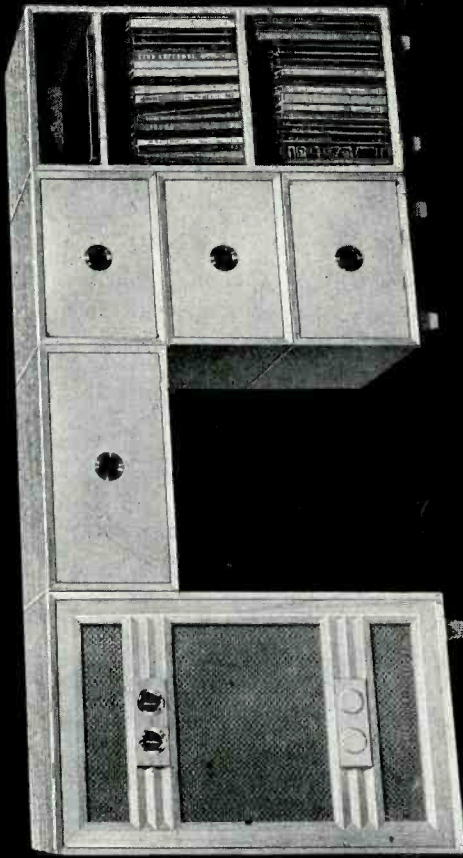

Assemble your own Entertainment Center with distinctive functional decorator-designed Customode

Jensen Customode was created to solve the custom-builder's problem — how to integrate fine sound reproducers and associated audio-video equipment into the space and decorative scheme of the home. Customode's universal "building block" flexibility permits stacking in literally hundreds of different combinations insuring maximum utility for all layout arrangements. In blend or Cordovan mahogany.

Write today for full information and scale cut-up illustrations

Jensen MANUFACTURING COMPANY
6601 S. Laramie Ave. Chicago 38, Illinois

Build quality into your wired music systems ...with these dependable components

AMPLIFIERS



The Western Electric 1140A Amplifier (at left) meets the needs of 85% of subscribers to wired music programs. Operates on a-c or d-c, delivering 10 watts from a-c source; 6 from d-c. Connects directly to telephone wires—needs no separate isolating coils.

For higher power requirements, use the 124H (at right) or the 124J, a-c amplifiers rated at 12-20 watts.



LOUDSPEAKERS



The compact 8-inch 755A direct radiator has 8-watt capacity—ample for most uses. For higher power, use the 20-watt 756A or the 30-watt 728B. All give the same high quality, the same true reproduction.

AUTOTRANSFORMERS



These units are specifically designed for easy matching of multiple loudspeakers in wired program and sound distribution systems. Three power ratings: 25A, 4 watts; 26A, 16 watts; 27A, 64 watts.

MICROPHONES

With a 633A Microphone, subscribers can use their wired music systems for announcements or paging—or can pick up programs originating on their own premises. 639 Type Cardioids also available.



EQUIPMENT FOR THE PROGRAM CENTER, TOO



109 Type Reproducer Groups are complete "packages" for use with transcription turntables. They assure top-quality reproduction of well-cut discs.

Other Western Electric equipment for the program center includes microphones, amplifiers, line coils, associated apparatus.

THE TWO major wired music program studios put the most *into* their discs with Western Electric *recording* equipment. Be sure to get the most *out* of these discs... with Western Electric *reproducing* equipment!

The completeness of Western Electric's line simplifies the planning of a peak-performance system to meet any requirements. You can get full details from your local Graybar Representative—or write Graybar Electric Company, 420 Lexington Avenue, New York 17, N. Y.

—QUALITY COUNTS—



Western Electric

DISTRIBUTORS: IN THE U.S.A.—
Graybar Electric Co. IN CANADA
AND NEWFOUNDLAND—
Northern Electric Company, Ltd.

Polyethylene Phonograph Records

OTTO J. M. SMITH, Ph.D.*

POLYETHYLENE is one of the better new phonograph record materials. It has very little surface noise, is durable, does not collect dust, and does not become disagreeable to listen to as it wears out. This material was chosen after a study of the characteristics of surface noise and the wearing qualities of conventional phonograph records.

A meter was made whose reading correlated well with subjective opinions of the disagreeableness of surface noise. This was used to test a great many records of different labels and experimentally pressed records. The results of these tests indicated that the ideal phonograph record material should have high impact strength, low dielectric constant to prevent the accumulation of dust particles in the grooves, low thermal expansion, low water absorption, and resistance to abrasive wear. A survey of the characteristics of available plastics indicated that polyethylene would be the best material. (Comparative data with other record materials is given in Table I.) Records were pressed from a number of different plastics, and surprisingly enough, the polyethylene records were the best.

*Dept. of Electrical Engineering, University of California, Berkeley, Calif.

●
Describing the many superior features of this plastic as a record material.
●

Scratch Meter

It was discovered that measurements of output voltage from blank record grooves did not correlate at all with subjective opinions of the disagreeableness of the scratch noise. Most of the listeners could tolerate a much greater low frequency scratch voltage than in the 5,000 to 10,000 cycle-per-second range.

The playback unit consisted of an Astatic MLP-1 crystal pick-up in a one-ounce arm, a high-frequency compensating circuit, an Altec-Lansing 74 db amplifier, and an Altec-Lansing dual coaxial speaker in a sound-proof room. The scratch meter was a peak vacuum-tube voltmeter with a 0.3-second mechanical time constant. A two-stage, tunable, high-pass filter was inserted between the speaker and the VTVM, and a series of tests were conducted on records with both low and high frequency scratch. The filter was adjusted until the scratch meter reading correlated with the subjective listening tests. This particular setting

is given in Fig. 1, and the frequency characteristics of the entire scratch meter are shown in Fig. 2. The filter cut-off frequency was 3000 cps, where the response was down 6 db, and at 1000 cps the slope of the cut-off was 12 db per octave.

Surface Noise

The surface noise was measured on new vinylite and shellac records of seven different manufacturers. The noise was measured at three places on the record, the outer edge, the inner edge, and half-way between. Weighted averages of these figures for two or more new records, and in some cases four different records, are shown in Fig. 3. The superiority of vinylite over the usual shellac compositions is quite apparent.

Durability

The popular records were worn out by 100 plays on an automatic machine, using an LP-21 cartridge in a 2-ounce arm. A microscopic comparison of the new and worn records revealed to a certain extent the mechanism of wear. The new records had a smooth high-gloss surface in the groove, due to shellac coating the diatomaceous earth, cotton fibers, and other filler. In a worn record, particles of material were removed, exposing to the needle the rough sides of the filler particles.

Fig. 1 (left). Scratch meter and listening test circuit. The input network is a compensator to achieve linear high-frequency response from the MLP-1 crystal. The output network is a 12 db per octave high-pass filter with a 3000 cps crossover. Fig. 2 (right). Scratch meter response. Curve A is the gain from the amplifier input to the input of the peak vacuum-tube voltmeter. The cut-off is due solely to the high-pass filter. Curve B is the overall response from the crystal output to the meter reading. It includes the effect of the compensator network.

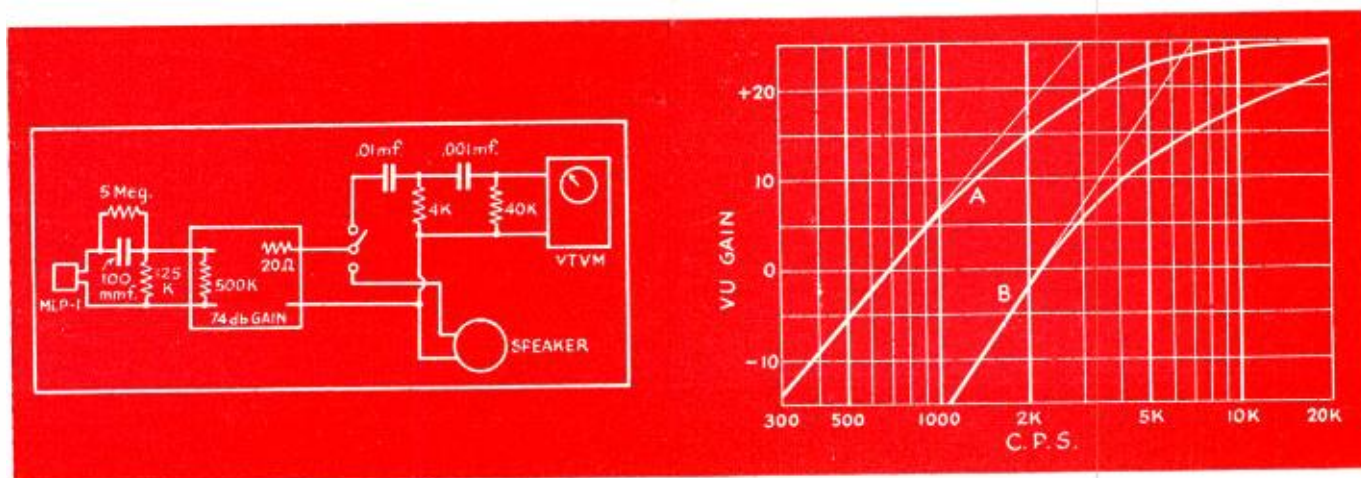

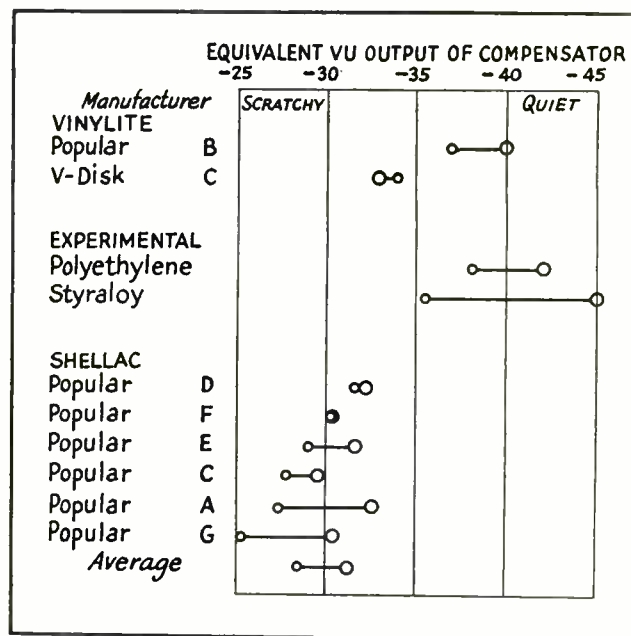
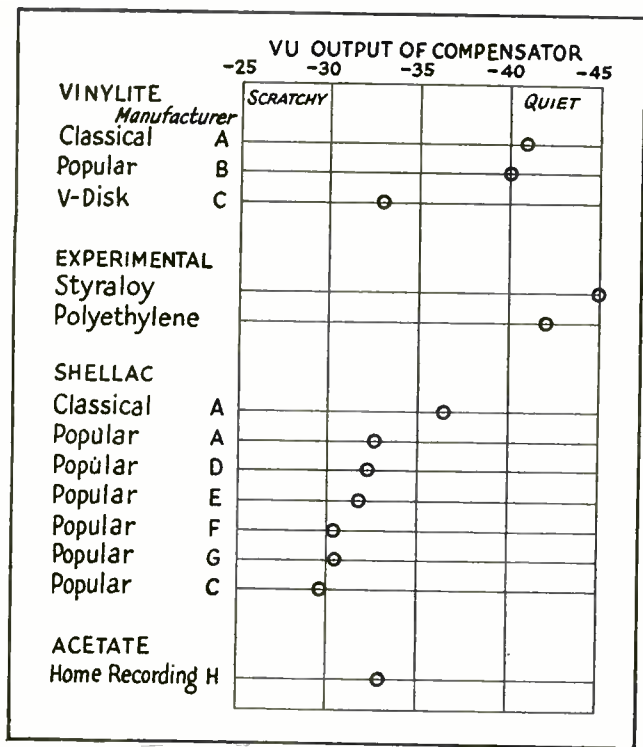

Fig. 3 (left). Surface noise on new records. Fig. 4 (above). Effect of wear on surface noise, 100 plays with a 2-ounce head.

For example, an exposed 5-mil diameter cotton fibre would produce one cycle of a 5600 cps note. The material worn off of a shellac record was angular shaped, while that which accumulated on the vinylite record during wear looked like slivers.

The magnitude of wear and the volume of surface noise was greater in loud musical passages where the needle had high lateral velocities.

Unfortunately, shellac is too brittle to be used without fibrous fillers, though a homogeneous material would probably have less surface noise. Figure 4 shows the results of these tests. Listening tests also indicated that the quality of the music had been changed due to wear. The reason for this was not apparent, but it may be that wear changes the shape of the groove and the wave shape of the reproduced audio signal. This would appear as distortion.

Material Criteria

A satisfactory record material should be a homogeneous plastic, non-brittle, which could be pressed at low temperature. It would not have to be hard to have good resistance to abrasion. In fact, rubber is well known as a flexible, yet very hard-wearing material. Vinylite becomes electrified and collects a considerable amount of room dust, so that even a new record may sound poor after being played and handled in a dusty room. A low dielectric constant is therefore desirable to minimize electrification.

Polyethylene is one of the best materials available in this respect. As

Table I shows, it has half the dielectric constant of vinylite. It is a soft, greasy-like polymerized plastic used for high-frequency insulation and for bottles for corrosive chemicals. In an experimental demonstration, it can be used as a lubricant. It is possible to rub the metal of a noisy sleeve bearing with solid polyethylene and leave enough residue to give an audible im-

provement in the lubricating action. When used for a phonograph record, the polyethylene does not wear off as other record materials do. It only deforms as the record wears out. A good record material should have a low or negative thermal expansion to reproduce accurately the press die. Polyethylene is again one of the best available materials in this respect. It

Hardness	Polyethylene 2.5 kg Rockwell 13	Vinyl Brinell 15-25	Nylon Rockwell L.95-L100	Shellac	Brinell 10 kg 2.5", 8-5 Rockwell, R70-110.
Dielectric Constant 60 cps	2.3	4.7	3.2	3-4	4.9-6.2
Water Absorption %	.005/48 hrs.	.05-.15/168 hrs.	7.6/24 hrs.	0.1/24 hrs.	2.1-6.9/24 hrs.
Strength, Impact ft. lbs./notch in.	(a)	0.2-1.4		2.6-2.9	0.7-4.2
Strength, Flexural, lbs./sq. in.	1700	10,000-13,000	10,000-15,000		5000-16,000
Strength, Tensile, lbs./sq. in.	1600-2000	9000	5000-8500	900-2000	2800-10,000
Thermal Expansion 10 ⁻⁵ /°C	.7-8	6.9	10		14-16
Thermal Conductivity 10 ⁻⁴ Cal. sec. cm ° C	7	4			5.4-8.7
Specific Heat cal/°C gram.	.5-.7	.24	.55		.30-.45
Softening Point °F	220-240 (h) 219 (c)	140.150	450	150	122-205
Operating Temperature °F	122 (d) 140 (e)	130 (top)		150-190	140-180 (continuous)

*Figures from "A Ready Reference for Plastics", 1945 edition, Boonton Molding Co.

(a) Did not break in a 4 ft.-lb. machine.

(b) Boonton Molding Co. data.

(c) "Polythene", by Hahn, Macht, and Fletcher. ASTM D569-43.

(d) Heat-distortion temperature, low-load, ASTM 648-*ibid*.

(e) Yield temperature, duPont M-8, *ibid*.

is also practically impervious to moisture, and is therefore free from warping due to either temperature or high humidity.

Experimental Records

Many different kinds of polyethylene records were pressed. Some were (a) solid polyethylene, (b) polyethylene with carbon black, (c) 3-mil poly sheet over cardboard, (d) 3-mil poly sheet over conventional shellac, and (e) 3-mil poly sheet over floor linoleum. On (d), trouble was experienced with volatile components of the shellac forming minute bubbles under the polyethylene film, which would begin to break through after about 20 plays. On (e), very good records were obtained. Bonding to the linoleum was good, and the time required to cool in the die was quite short.

The importance of this last item is illustrated by Fig. 5, which shows the variation of profit with pressing-cycle time for a small seven-inch record plant with special design for multiple-die presses. The total heat required to press a polyethylene record is twice that for a vinylite record. But since the former has almost twice the thermal conductivity of the latter, and since polyethylene has what appears to be a solidifying point, it can be removed from the presses in less time.

The experimental records were tested in the same manner as the commercial records, and the results are shown in Figs. 3 and 4. The initial surface noise of polyethylene was of the same magnitude as vinylite records made by the A and B companies. The increase

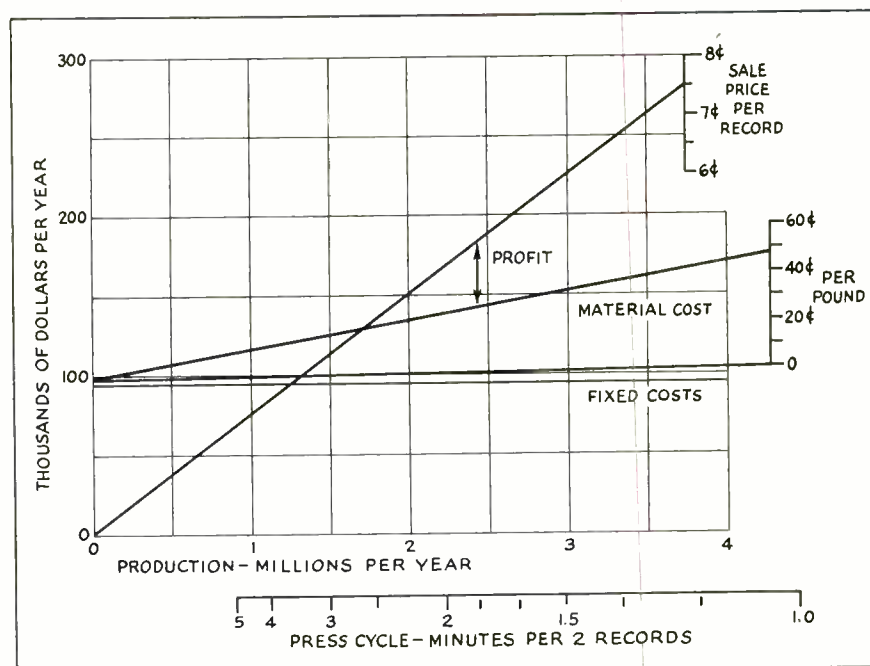

Fig. 5. Change in profit with time for press cycle. The curves are drawn for a 10-press plant, 2-die presses, 2 shifts per day, pure polyethylene record, 0.025-inches thick, 7 inches diameter.

of surface noise with wear was also of the same order of magnitude. On listening tests, the worn polyethylene was superior to the worn vinylite. Polyethylene wore out by losing volume at the high frequencies. The worn record was just as pleasant to listen to as the new record, though the bass was predominant. The material is soft enough to be scratched with a fingernail. A deep scratch with a needle can be heard on playback as a "bump". The smooth contours which polyethy-

lene takes when scratched does not produce the disagreeable noise that a scratch on a shellac record does. The dust which it collected after being left out in the room could be easily blown off.

The increasing use of polyethylene may lower the material cost until it can be considered not only for good quality records, but also for popular and children's records, and perhaps for dictating machines and home recordings.

Audio Engineering Society News

• ALTHOUGH no meetings are being held by the New York section during the summer months, the various committees are carrying on with the necessary business of the Society. The Nominating Committee, composed of George O. Milne, chairman, and George Graveson, Vincent J. Liebler, H. S. Morris, H. I. Reiskind, Berthold Sheffield, and George Stewart has completed its deliberations, and the slate of candidates was announced to the membership during July. Heading the nominees is C. J. LeBel for President, with C. A. Rackey, Norman C. Pickering, and Ralph A. Schlegel following as candidates for Vice-President, Secretary, and Treasurer respectively. The Western Region nominated John T. Mullin for Regional Vice President. Nominees for the six governorships are John K. Hilliard, C. G. McProud,

A. A. Pulley, John D. Colvin, T. W. Lindenberg, and C. R. Sawyer, the latter three for one year. Voting members may propose and nominate candidates for any office, and any eligible candidate proposed by ten members will be entered on the ballots, to be mailed about August 25. The official election date is September 28.

One of the functions of any professional society is to operate an employment register for engineers in its field. Hence, steps are being taken to set up one, within the AES, for audio engineers.

The first edition of the annual Audio Directory will be published shortly after the first of October, and all members of record on that date will be listed therein, with their company affiliations. The Admissions Committee, under John D. Colvin's chairmanship,

is busily engaged in classifying the charter members, as well as handling more recent applicants.

While the various divisions of audio work are encompassed by several different organizations, the Audio Engineering Society is the only professional group covering the entire audio field. The enthusiasm of the New York section is being mirrored by other groups in widely separated cities. The community of interest shared by audio men has resulted in a bond between the local groups and the national organization. Publication of papers—both those presented before the local sections and those from members where no local section exists—is scheduled to begin in the fall, and is expected to strengthen this bond between members and groups, giving them a feeling of alliance with other audio engineers.

The Problem of Sound Distribution

O. L. ANGEVINE, JR.,* and R. S. ANDERSON**

PART II

Valuable data on planning sound installations.

AS WAS INDICATED in the preceding article, the installer will frequently be confronted with a room having higher than optimum reverberation time, and while this has little effect on the audio power requirements, it may seriously impair the articulation of speech, and muffle music.

Likewise, echoes may be a problem. While reverberation is a succession of "echoes" so closely spaced in time as to intermingle, in long corridors or in very large rooms an annoying sharp echo may also be heard. *Figure 7* shows three examples of echo. The 75-foot difference in the length of the

*Chief Sound Equipment Engineer, Stromberg-Carlson Co.

**Acoustical Engineer, Stromberg-Carlson Co., Rochester, N. Y.

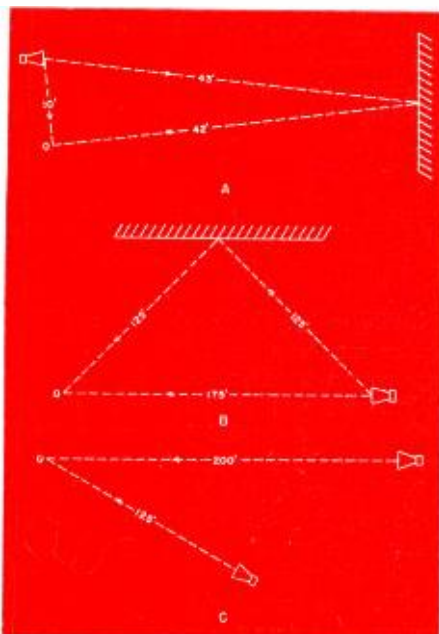

Fig. 7. Echo. O represents the observer. A—the familiar echo from a wall or cliff. B—another version of A. C—echo produced by two speakers. Note that the observer is far enough from the speakers so that the levels are not greatly different. A path-length difference of at least 75 feet is necessary to produce a distinct echo.

In previous articles, the selection of speakers and the determination of audio power requirements were discussed. This article covers room acoustics, the placement of speakers to suit the space to be covered, and the shaping of frequency response for the intended use.

sound paths was selected as representing the distance at which echo becomes apparent. At distances shorter than this, the effect becomes that of reverberation rather than of a sharp, distinct echo.

Other phenomena that will disturb the installer are "dead" spots and "foci". A dead spot is the result of phase cancelling of the sounds reflected from various surfaces in a room, leaving very little resultant sound pressure. Foci are the converse of dead spots in that they are the result of the addition of reflected sounds in phase. As shown in *Fig. 8*, a few seats in an auditorium may be a focal point for sounds originating at a certain point on the stage. This process is reversible, and if the microphone is located at the stage focal point, it will pick up conversation from the seats at the other focal point. This becomes embarrassing if small boys find the focal point. If a speaker happens to be located at a focal point, or so as to produce a dead spot, a relocation will minimize the deleterious effects.

Acoustic Treatment

Acoustic treatment is an important part of solving a problem of bad acoustics, and while a properly installed sound system may go far toward overcoming this problem, it will never be as satisfactory as it would be if

aided by acoustic treatment. Treatment should be used when necessary, although unfortunately the cost may not always permit it. In noisy reverberant rooms, although the sound system may be able to override the noise, acoustic treatment will reduce it and simplify the problem.

While there is not space at this time to touch more than briefly on the method of room treatment, and it is important to get the advice of experts in this field, it may be useful to discuss the main points. With few exceptions, the room needing treatment is too reverberant and requires that absorptive material be added. Note that optimum reverberation time does not mean a "dead" room but rather the acoustic environment that seems most pleasing and natural.

It is possible to calculate the reverberation time of a room with sufficient accuracy by the following simple equation⁷:

$$T = .050 V/A$$

Where

T —reverberation time, in seconds.

V —room volume, in cubic feet.

A —absorption, in sabins.

To compute A at 512 cps, multiply the absorption coefficient found in *Table II* by the area in square feet of that material and sum the values for all areas of the room.

Example—

Small auditorium 40' x 60' x 20'
Seating capacity—370 (6.5 sq. ft. per seat including aisles)
Ceiling—plaster
Walls—brick, painted
Floor—wood
Chairs—metal
 $V=48,000$ cu. ft.
 A =(see below)

Ceiling,	.025 (from Table I)	x 2400 sq. ft.
Walls,	.017 (from Table I)	x 4000 sq. ft.
Floor	.03 (from Table I)	x 2400 sq. ft.
Chairs,	.17 (from Table I)	x 370
Audience,	3.0 (from Table I)	x 370

Total absorption, in sabins=

$$T = .050 \times 48,000 / 263 =$$

$$= .050 \times 48,000 / 1310 =$$

Without Audience	With Audience
60	60
68	68
72	72
63	63
<hr/>	
263	1310

9.1 sec.

1.8 sec.

With a full audience, the reverberation time of this auditorium is nearly the optimum value, but as the size of the audience is reduced, the reverberation becomes very bad.

In order to produce an acceptable reverberation time with a small audience and not have the auditorium too dead when filled to capacity, assume half of the ceiling to be treated with an acoustic material having an absorption coefficient of .50 at 512 cps. The reverberation time then becomes:

A (in sabins) =

Ceiling, untreated half	— .025	x 1200	sq. ft.
treated half	— .50	x 1200	sq. ft.
Walls	— .017	x 4000	sq. ft.
Floor	— .03	x 2400	sq. ft.
Chairs	— .17	x 370	sq. ft.
Audience	— 3.0	x 370	sq. ft.

Total absorption, in sabins

Reverberation time (T) =

The reverberation now is within acceptable limits, regardless of the size of the audience.

A more accurate expression for reverberation time is¹⁰

$$T = \frac{.050 V}{-S \log_e (1 - a_{av})}$$

Where

V = room volume, in cubic feet

S = total area of all surfaces, in sq. ft.

e = base of the natural logarithm = 2.718†

a_{av} = average absorption coefficient = A/S

A = absorption, in sabins

The results obtained with these two equations are nearly equal if the average coefficient is .3 or less. If the latter equation is used in the above example of a full auditorium with ceiling treatment, the reverberation time is 1.12 seconds instead of 1.26 seconds. But as the absorption coefficient increases above .3, the first equation becomes increasingly inaccurate.

In the above example, no consideration has been given to echo, one particularly bad form of which occurs

when the sound bounces between two flat parallel walls. This "flutter echo" is minimized by making the walls non-parallel and irregular, as is done in modern auditoriums designed by acoustically-trained architects. Some of the older architects accomplished the same result accidentally by excessive use of statuary, columns, niches, etc., and therefore, many of the older concert halls, are acoustically better than the newer, more "modern" auditoriums.

	Without Audience	With Audience
	30	30
	600	600
	68	68
	72	72
	63	
		1110
	833	1880
	2.9 sec.	1.3 sec.

Usually the sound installer is confronted with an existing hall whose walls are both flat and parallel. If such is the case, he can reduce flutter echo by distributing the acoustic treatment in patches, attempting to place them in such a manner that no untreated areas are directly opposite each other.

Speaker Placement

Indoors, the placement of loudspeakers resolves itself into two cases. For example, in auditoriums the speakers are located near the stage to create the illusion that all sound originates on the stage (Fig. 9). In wired music systems for restaurants or industrial music and paging systems, it is important that the speakers be distributed and closely spaced to produce a uniform sound field so as to override noise more easily. Likewise, in reverberant rooms, if localization of source is not important, distribution and close spacing of speakers is desirable as it permits keeping the sound level at any one point low enough so that it

is not unduly prolonged by reverberation. Later examples of typical installations will demonstrate these points.

Outdoors, the problem is not generally reverberation but rather loss of energy through dispersion of the sound. Therefore the directional characteristic of horn-type speakers is highly desirable. Echoes are more annoying in that they are not blurred together as reverberation but appear distinctly. Not only will natural echoes be heard from walls and hills, but the delayed sound from a remote speaker will sound like an echo of a nearby speaker. To avoid the latter type of echo, a cluster of high-powered horns at a distance from the audience is often used, for example, in center field of a baseball stadium. Since these horns are located at approximately equal distances from all spectators, the sound level is quite uniform over the audience.

A special case of speaker placement is the stereophonic system which attempts to produce the effect of a three-dimensional, rather than a point source. It is necessary to use a two or three-channel system in which the position of the speaker corresponds to the position of the microphone at the pickup point. This is not a simple problem and while some expensive and complex experiments have been reported^{11,12,13} which indicate the possibilities, there is no indication as yet of how such systems may be simplified and still produce satisfactory stereophonic sound.

Frequency Response

Different frequency band widths are required for various sound system applications. In the case of speech, a comparatively restricted frequency response will give good articulation as well as a balance of highs to lows that sounds normal. As will be shown later, a further reduction of the bass may be

Fig. 8 (left). Focusing (after Knudsen⁶). Building contours focus the sound to produce, in a small area, a sound level nearly equal to the level at the source. The focusing "mirror" need not be a ceiling as walls can produce the same effect. The phenomenon is reversible. Fig. 9 (right). Auditorium speaker location. Speakers located to produce the effect that the sound is coming from the stage.

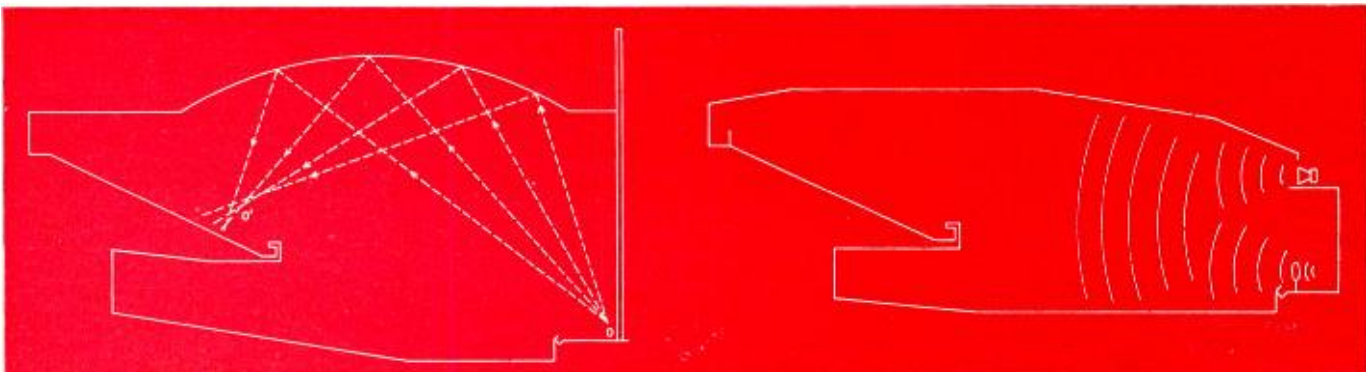

TABLE II

ABSORPTION COEFFICIENTS OF GENERAL BUILDING MATERIALS⁸

Material	Coefficients		
	128 cps	512 cps	2048 cps
Brick wall, painted	.012	.017	.023
Same, unpainted	.024	.03	.049
Carpet, unlined	.09	.20	.27
Same, felt lined	.11	.37	.27
Fabrics, hung straight			
Light, 10 ozs. per sq. yd.	.04	.11	.30
Medium, 14 ozs. per sq. yd.	.06	.13	.40
Heavy, draped, 18 ozs. per sq. yd.	.10	.50	.82
Floors			
Concrete or terrazzo	.01	.015	.02
Wood	.05	.03	.03
Linoleum, asphalt, rubber or cork tile on concrete		.03-.08	
Glass	.035	.027	.02
Marble or Glazed Tile	.01	.01	.015
Openings			
Stage depending on furnishings		.25-.75	
Deep balcony, upholstered seats		.50-1.00	
Grills, ventilating		.15-.50	
Plaster, gypsum or lime, smooth finish on			
Tile or brick	.013	.025	.04
Same, on lath	.02	.03	.04
Plaster, gypsum or lime, rough finish on lath	.039	.06	.054
Wood panelling	.08	.06	.06
Typical Sound Absorbing Materials ^{8,9}	.05 to .67	.25 to .99	.52 to .91

ABSORPTION OF SEATS AND AUDIENCE⁸

	Coefficients		
Audience, seated, units per person, depending on character of seats, etc.	1.0-2.0	3.0-4.3	3.5-6.0
Chairs, metal or wood	.15	.17	.20
Pew Cushions	.75-1.1	1.45-1.90	1.4-1.7
Theatre and Auditorium Chairs			
Wood veneer seat and back		.25	
Upholstered in leatherette		1.6	
Heavily upholstered in plush or mohair		2.6-3.0	
Wood Pews		.40	

made for other reasons without impairing articulation. For music, a much wider band is required, and while the economics of the situation may not permit reproduction of the full range, the balance must be maintained. It has been found that a satisfactory balance is achieved if the product of the high and low frequencies is kept between 500,000 and 600,000. Thus, if the high-frequency cut-off is 8,000 cps, the low-frequency cut-off should be about 70 cps.

Small changes in frequency band width ("fidelity") are not perceptible. For instance with music, if the upper limit is 8,000 cps, it must be increased to 11,000 cps or decreased to 6,400 cps to make a noticeable change¹⁴. A system that is flat and free from distortion from 70 to 8,000 cps gives such excellent response that it is seldom worth the cost to extend the band further. Although the ear can hear frequencies between about 18 and 18,000 cps, it is less sensitive at the extreme ends of the band, and the components

of music which fall at the ends of the band are few. Consequently, only a small change is noticed if the band is increased beyond the example above. Likewise, a system that reproduces only the range between 100 and 5,000 cps is well balanced and may be adequate to reproduce music for some purposes. With speech, as with music, a range of 70 to 8,000 cps will give a very natural response in a quiet location. An even greater change must be made in the band width to be noticeable with speech than was necessary for music. For example, if the upper limit is 7,600 cps, an increase to 15,000 cps or a decrease to 5,300 cps is necessary to make a noticeable change¹⁴.

Fig. 10. The effect of transmission characteristics on the masking of declamatory speech by noise. (Courtesy Jensen Radio Mfg. Co.) A—Flat system frequency response. B—Flat system frequency response with cut-off at 500 cps. C—System frequency response rising 6 db per octave.

French and Steinberg³ have shown that a frequency range of 200 to 6,000 cps will give almost perfect syllable articulation, although this will sound somewhat shrill as it does not provide a proper balance. A telephone system with a restricted band of 200 to 3,000 cps has a high sentence articulation with a good balance. In noisy locations, naturalness and balance may have to be sacrificed for good articulation. When the microphone is located in a noisy area, a reduction of the frequency band will increase the signal-to-noise ratio, as it reduces the noise pickup without seriously affecting the articulation. Close-talking and noise-cancelling microphones will also help in this situation.

Noisy Locations

The more serious problem is the case of the speaker in a noisy location. Here it may be necessary to raise the system frequency response as much as 6 db per octave with increase in frequency.¹⁵ As shown in "A" of Fig. 10 a typical masking level of noise plotted against frequency has a slope very similar to that of a normal speech spectrum. The masking level of noise is the level which any other signal must exceed to be heard over the noise. This figure also shows that considerable energy is contained in the lower frequencies and if an attempt is made to override the noise only by increasing the signal power, there will be a power demand at the low frequencies unwarranted in the light of their small contribution to articulation. Thus the low frequencies may be cut off as shown in "B", with a considerable sav-

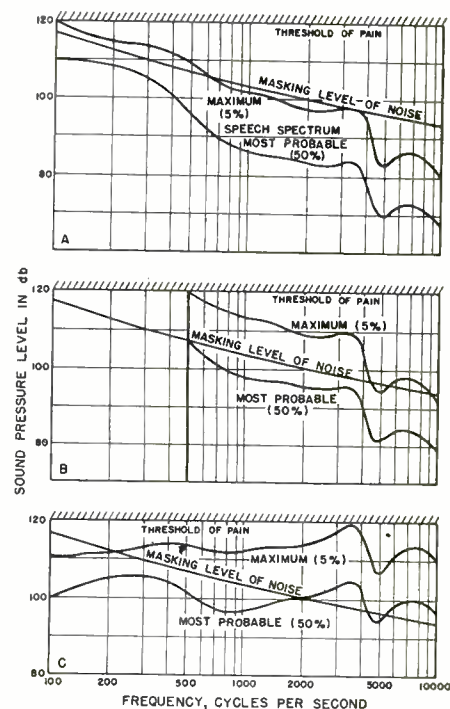

**NEW
LOW
PRICES**

On RCA Top



**RCA 15-watt
DE LUXE AMPLIFIER MI-12295**

**NOW
ONLY
\$87⁵⁰**

List price
complete with tubes

● You've never seen a value like this distinctively styled RCA 15-watt All-Purpose Amplifier. You can't beat it for high quality performance, compactness, beauty, and simplicity of operation under all sorts of operating conditions.

Electronically engineered to give top performance. Frequency response (30 to 15,000 cycles). Two high impedance microphone input channels 116 db. gain (RMA), each with individual volume control. Two hi-impedance phono channels, one for hi-level and one for low-level pickups. Can be used with popu-

lar low output magnetic pickups. Phase inversion and inverse feedback used to obtain low distortion and uniform frequency response for various load conditions. Unique balanced tandem tone control circuit. Choke filtered power supply for minimum hum and uniform regulation. Large functionally designed control knobs. Accessible output terminal board and replaceable cartridge type fuse conveniently located in rear. Set of locking-type 3 pin Cannon plugs and receptacles for each microphone input. Also available with 2 low impedance inputs (250 ohms).

15 watt push-pull Output—
Noise-free electronic mixing—
Switch for high-low power
output requirements — Under-
writers-approved.

Additional Unparalleled
Amplifier Values

RCA 50-watt De Luxe Hi-Impedance Amplifier MI-12293 \$197⁵⁰
Complete with RCA Tubes. Now only

RCA 30-watt De Luxe Hi-Impedance Amplifier MI-12296 \$115⁰⁰
Complete with RCA Tubes. Now only



SOUND PRODUCTS
RADIO CORPORATION of AMERICA
ENGINEERING PRODUCTS DEPARTMENT, CAMDEN, N.J.

In Canada: RCA VICTOR Company Limited, Montreal

Quality Sound Equipment

COMPARE...BE CONVINCED!

More business for you because it's RCA...
More profit because of these new values

RCA SPEAKER

MI-12422

12-inch high efficiency, Alnico V, Cone Type Mechanism. Special cone provides a selected listening characteristic—a result of thousands of listeners' reactions over the past 10 years. 10-watt capacity. 15 ohm voice coil.

\$12⁵⁰

Also available with matched 10-watt multi-tap line transformer as MI-12421.

\$18⁰⁰

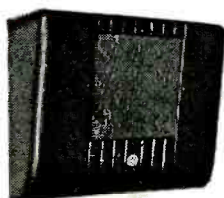

RCA MOLDED SPEAKER BAFFLES

Molded Plasticized Fibre Baffle with attractive gray hammeroid finish and contrasting grille cloth, 12" x 15" x 5½", sloping front, strong, moisture-resistant, and non-warping. Available for 5", 6½" and 8" mechanisms as MI-6378, MI-6379, and MI-6380, respectively.

\$3⁷⁵

Similar baffles for 5", 6½", 8", 10" and 12" mechanisms also available in molded Bakelite and wood.

All prices shown are suggested list prices subject to normal dealer discounts.

RCA VARACOUSTIC MICROPHONE

MI-6204-C

Three microphones in one. Here you have the popular cardioid microphone (uni-directional) *plus* standard velocity microphone (bi-directional) *plus* standard pressure microphone (non-directional) all in one general purpose unit. Variable characteristic obtained by ingenious slider mechanism on rear of housing. Quality and performance found heretofore only in more expensive polydirectional Broadcast Microphones. High sensitivity, shock mounted, high impedance. 30 feet of cable.

\$67⁵⁰

These and many other profitable items of sound equipment are available through your RCA Sound Products Distributor.



NEW BANTAM VELOCITY MICROPHONE

MI-12080-B

Smaller than a pack of cigarettes. First used at all 1948 political conventions. Broadcast quality. Built-in voice-music switch. 15 feet of cable.

\$60⁰⁰



MAIL THIS COUPON FOR FREE CATALOG



BUY THE BEST FOR LESS

84 pages of sound products—microphones, amplifiers, speakers, recorders, intercoms, portable P.A. and numerous other profitable items. Send for your FREE copy today.

RCA SOUND PRODUCTS (Dept. 7-1.)
 Radio Corporation of America
 Camden, N. J.

Please send me free copy of RCA's new Catalog on complete line of matched sound products *and price list*.

Name _____

Company _____

Type of Business _____

Address _____

City _____ State _____

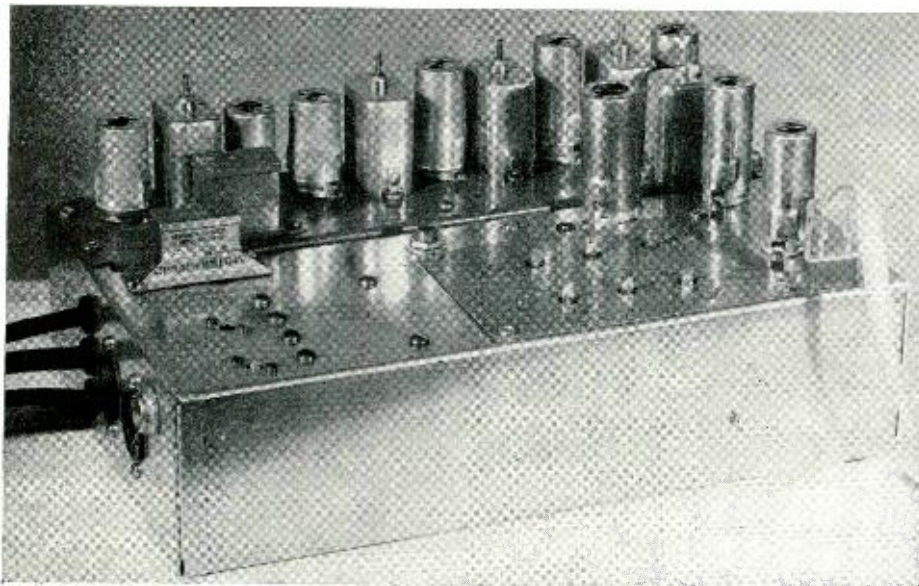

Front view of FM tuner chassis.

Elements of

RESIDENCE RADIO SYSTEMS

C. G. McPROUD*

PART I

A push-button operated, fixed-tune FM receiver serving as a high-fidelity source of signal for home radio systems.

WHILE the audio engineer is interested primarily in amplifiers, speakers, microphones, and other equipment more closely related to the audio spectrum, it cannot be denied that one reason for high-quality amplifiers and speakers is for the reproduction of radio programs. Thus, the audio engineer must also consider the equipment used to provide the source signal, be it AM or FM.

By far the largest percentage of reproducing equipment is used for home entertainment, and there is some evidence to indicate that many listeners are sufficiently interested in good quality to go to the expense of installing an elaborate system as a semi-permanent part of the house. Such installations come under the heading of Residence Radio Systems, and while they include the same elements as is contained in a modern AM-FM-phono combination, the physical construction is usually quite different.

The reasons for this are fairly obvious. It is understood that a good speaker and amplifier are a necessity, and if of excellent quality, they might well be utilized for many years, al-

though changes in the phonograph or in the radio tuners might be made more often. Therefore, in most such installations, the equipment is composed of a number of individual units, each serving a specific purpose, and all tied together by a control system to provide sufficient flexibility.

Typical System

A typical system, therefore, will contain a speaker, a "main" amplifier, a preamplifier—possibly with a scratch suppressor—a record player or changer, one or more radio tuners, depending upon the availability of programs, and a power supply. These sections are basic, and although various sections may be combined physically, all are represented in most instances. In the more elaborate installations, push-button controls may be employed, arranged for remote operation or not, as the owner desires. Some years ago the writer obtained a clock which is capable of completely controlling a radio, turning it on or off, and selecting any of six stations at any desired fifteen-minute interval for a 24-hour period. With such a device, some form of electrical push-button tuning is necessary.

Because programs on either AM or FM may be desired, the switching can become complicated if usual means are employed, so the system to be described has been assembled with the ultimate aim of obtaining good reproduction in the home from FM, AM, or phonograph, with adequate flexibility and with as few controls as possible. The complete system consists of a two-way speaker, a 6AS7G amplifier, a power supply, the preamplifier and scratch suppressor unit, and two tuners, each arranged for push-button station selection. Altogether, this equipment provides a complete home entertainment system; it may be either more or less elaborate than another user might wish. It is offered as an indication of what *can* be done in the way of a home entertainment system.

In the New York area, a total of ten stations appeared to be sufficiently popular to warrant inclusion in the system. Six of these are FM stations; four AM. To simplify switching, it was desired that any push button would select its associated station, whether AM or FM, without any other control operation. The clock made one other feature useful, since it can serve as an alarm clock. However, when set

*Managing Editor, AUDIO ENGINEERING.

to turn off the set after its owner retires for the night—providing a restful lullaby—it would come on in the morning at too low a level to serve as an alarm clock. Therefore, a muting arrangement was included which would reduce the level by about 20 db for the sleeping music, yet, as soon as the clock shut the set off for the night, the system would be restored to normal, and the morning level would be sufficient to serve as an alarm clock.

Thus the problem is stated, and the FM tuning unit is the first to be described. It includes the AM-FM switching relay and the muting circuit, as well as the tuner proper. Relays are used throughout for the various operations, and in spite of the high frequencies involved, the entire unit performs quite satisfactorily.

The Tuning Circuits

The front end of the FM tuner is fairly conventional—electrically. However, the antenna and r-f circuit are tuned with variable air trimmers and left set—the antenna circuit peaked at 101 mc and the r-f circuit at 97 mc. The r-f stage is a 6AG5, with its grid fed with AVC voltage from the first limiter. The converter tube is another 6AG5 operated with the oscillator signal fed to an un-bypassed cathode resistor.

The oscillator circuit is a little unusual, and provides the advantages of automatic frequency control, almost a necessity with a fixed-tune unit. From the schematic *Fig. 1*, it will be seen that the oscillator is of the electron-coupled type, using one-half of a 12AT7 for the oscillator and the other as a reactance tube for the afc circuit. The tuning of the oscillator circuit is accomplished by the use of six variable trimmers, the desired one being

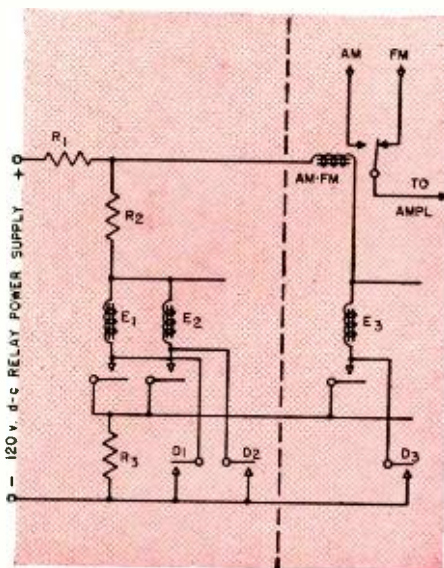

Fig. 2. Basic schematic of self-holding and automatic releasing relay circuits for station selectors.

selected by a relay. This all seems perfectly straightforward but, on account of the frequency range at which it operates, some care is necessary in its construction. Each relay is electrically self-holding, and once a push button is depressed, the associated relay holds in until another button is depressed, at which time the previous one releases.

This circuit is quite simple, yet requires only one lead to the push button, plus one lead common to all. Referring to the portion of *Fig. 2* to the left of the dotted line, the operation may be explained as follows: Suppose push button D_1 is momentarily depressed; current flows through R_1 , R_2 , E_1 , and D_1 , energizing the relay which pulls in its armature and completes the circuit through its contact and R_3 . The relays are all 24-

volt, 300-ohm surplus units, and require about 60 ma to close and 30 ma to hold. Thus the relay is energized, and holds in with less current than is required to operate it. To change the station, another button D_2 is depressed, causing a greater voltage drop across R_1 and R_2 , so E_2 operates (since R_3 is out of its circuit) but E_1 releases. Thus, the operation of any push button causes the associated relay to operate, and releases any other that may have been energized.

When an AM station is to be selected, a button such as D_3 is depressed, and E_3 is operated, releasing E_1 or E_2 . But the current for E_3 flows through the coil of the AM-FM relay, switching the a-f amplifier to the output of the AM tuner unit. Simultaneously, it switches the plate supply on another set of contacts. The operation is reliable, once the correct values are determined for the resist-

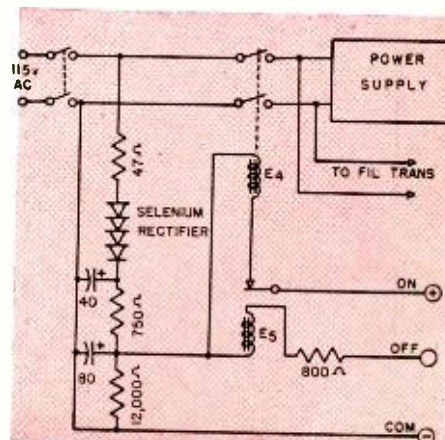

Fig. 3. Power supply for relay circuits, showing main power relay and arrangement for switching on and off.

ors. Although not built into the FM tuner unit, the power supply for the relay circuit is straightforward, and provides the means for turning on or off the entire system. Thus, when the set is off, it requires only the pressing of a station selector button to turn the set on and select the station. The relay power supply, shown in *Fig. 3*, is self-explanatory. The current for operating any of the station selector relays passes through the power relay E_4 to close the primary circuit of the power supply and the filament transformers. To turn off the system, relay E_5 is energized, breaking the holding circuit through its contacts.

Tuner "Front End"

Considerable flexibility is possible in the front end of the FM tuner. In the unit shown, the six tuning capacitors and the associated relays were mounted in a separate small box 3x3x4 inches, with a slot in the bottom to

Under the chassis of the FM tuner. Relay box is at upper right.

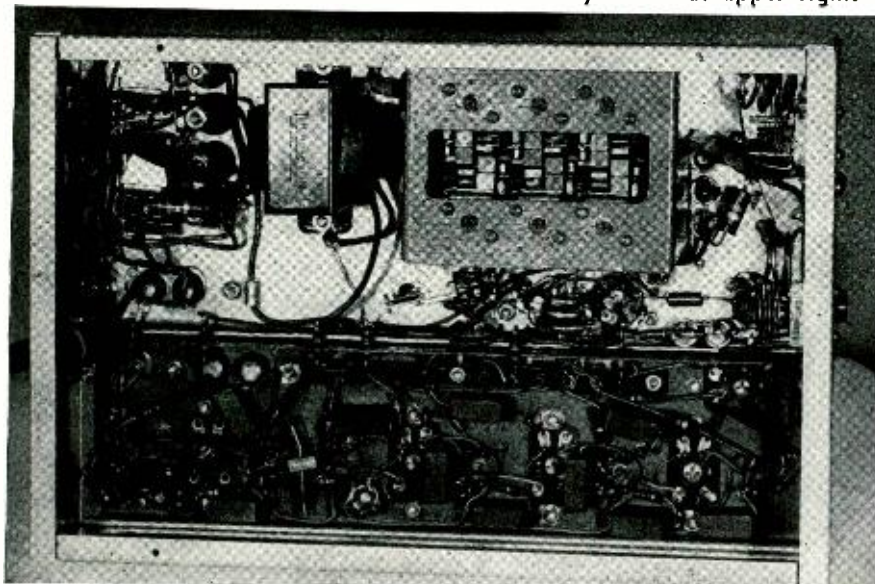

permit the adjustment and cleaning of the relay contacts. The rotors of all the capacitors were connected together, using #16 bus wire, and the stators were connected to the relay contacts. The capacitors were mounted on a piece of linen Bakelite, and the whole enclosed in a sheet metal box, with holes in the top to permit access to the adjusting screws. The capacitance of each trimmer is $25\mu\text{f}$, somewhat greater than necessary to tune the band, so the tuning section was connected across one-half of the coil, the band being fixed by a capacitor across the entire coil. This provides a "band-spread" feature, and makes tuning easier. The three coils are shown in Fig. 4, all of them being wound of #14 bus wire on a $\frac{5}{8}$ " mandrel. The antenna coil has a total of three and a half turns, the ground connection being made at one-half turn from the end. The end and one turn from the end provide the connection for a 300-ohm line, which is effectively balanced to ground by this arrangement. The coil is mounted directly on a crystal socket which serves as an antenna terminal strip. The capacitor coupling to the grid of V_1 is tapped on at one-half turn down from the top.

The r-f coil consists of two full turns, soldered directly to the terminals of the air trimmer, and with the capacitor coupling to the plate of V_1 connected about three-eighths of a turn from the high end. The grid is connected to the stator of the tuning capacitor, with a tip jack provided to facilitate connection to the grid for alignment.

The oscillator coil may take a little more time, but it was found to oscillate perfectly with two turns, with the cathode tap at one turn from the bottom. The tuning capacitors—selected by the relays—are also connected at one turn from ground, as is the capacitor coupling to the converter cathode. The fixed band-setting capacitor connects across the entire coil.

In aligning the oscillator, it will be found necessary to set its frequency on the correct side of the signal, or else the afc circuit will always pull it away from the station. Setting procedure consists of inserting a plug into the afc jack, with leads to a vacuum-tube voltmeter, and adjusting the oscillator to get zero d-c voltage from the discriminator. Then, when the plug is removed, the afc will hold the setting quite accurately. If the oscillator is tuned to the wrong side of the carrier, the afc will always move off the station.

It is preferred to tune the oscillator

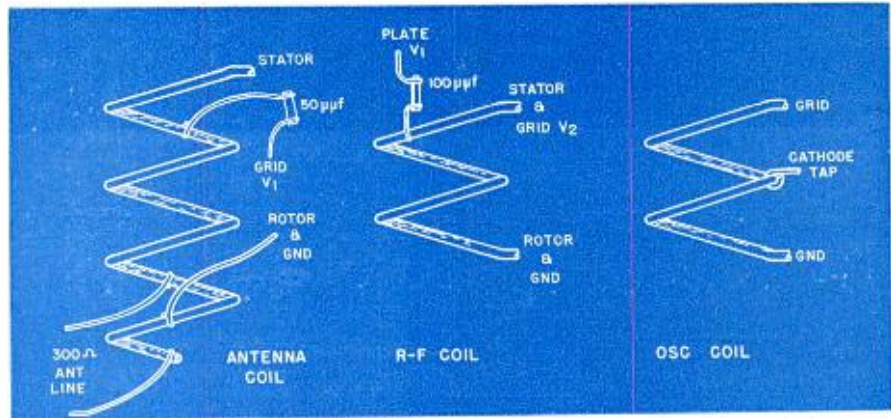

Fig. 4. Coils for front end of the FM tuner. All are wound on $\frac{5}{8}$ " mandrel of No. 14 copper bus wire.

to a frequency lower than the signal, since a reduction of even 20 mc is an appreciable amount to make the oscillator more stable. Once this is determined, the polarity of the afc voltage may be reversed, if necessary, by reversing the leads from the discriminator transformer to the plates of the 6AL5. Reducing the discriminator heater voltage by the use of the 2.7-ohm resistor aids in preventing "hunting" of the afc circuit.

I-F Strip

The i-f amplifier and discriminator for this tuner is built on a separate chassis, three inches wide and ten inches long, which mounts in an opening on the main chassis. This construction was followed for two reasons: it is much simpler and more conven-

circuit for the afc voltage. The transformers are apparently of the low-impedance type, and it will be noted that three i-f stages and two limiters are used. From the photo it will be noted that mica by-pass capacitors were used, surplus items at five cents each, thus cheaper than paper types. This construction is straightforward and fairly easy to align.

I-F Alignment

The alignment of the i-f section must necessarily follow the construction work. Feed a 10.7-mc signal to the grid of V_4 through a .01- μf capacitor, and connect a vtvm to the avc line at "A" on the schematic. Adjust both top and bottom cores of T_4 , T_3 , and T_2 for maximum voltage on the avc bus. Then shift the output of the signal generator to the grid of V_2 , still using the .01- μf capacitor, and adjust the cores of T_1 for maximum. Due to the low impedance of the grid circuit of the converter tube to 10.7 mc, it may be necessary to increase the output of the generator somewhat. However, keep the output to as low a voltage as will cause sufficient deflection of the vtvm.

Then connect the vtvm to a plug and insert into the afc jack, and adjust the top core on T_5 for the maximum voltage, either positive or negative. Adjust the bottom core to obtain zero voltage again. This alignment should be checked several times, because the minimum distortion is obtained only when the adjustments are correct.

If a frequency-modulated signal generator and an oscilloscope are available, the usual procedure is followed for visual alignment except for the discriminator transformer. Connect the vertical input of the 'scope to the output of the tuner, and feed the sig-

[Continued on page 37]

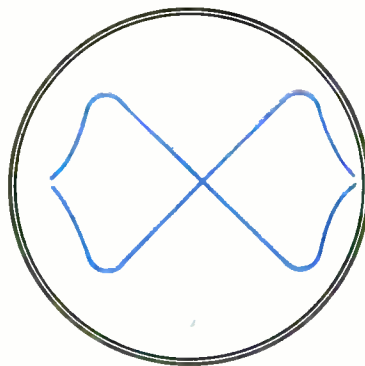
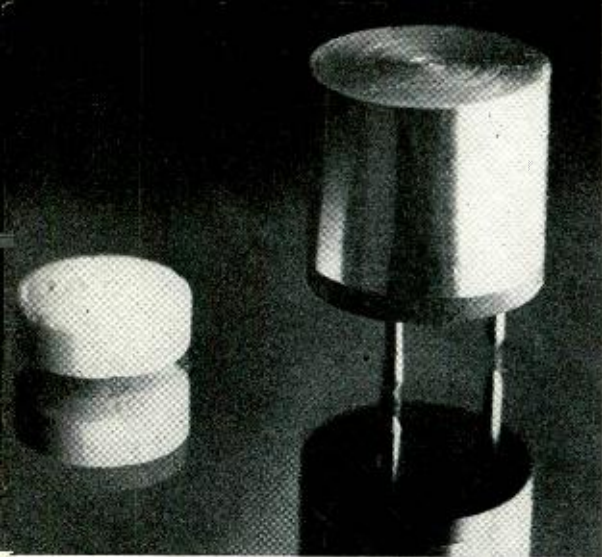

Fig. 5. 'Scope pattern obtained during alignment of i-f amplifier, using 400 kc sweep from frequency-modulated signal generator.

ient to work on, and in case the relay-tuned front end did not work, it could have been removed and used with a more conventional front end. However, since the entire unit functions satisfactorily, there has been no need to change it. The circuit follows the Meissner 9-1091 AM-FM tuner almost exactly, with the addition of a filter



Assembled crystal unit. Aspirin tablet shown for size comparison.

Design of Amplifying Crystal Units

S. YOUNG WHITE*

Practical methods of building crystal amplifier units.

SINCE THE CRYSTAL amplifier is apparently going to be with us for some time, it is interesting to review how crystal units of the rectifier type are made.

Commercial germanium occurs in zinc as a by-product of the mine. It is separated and purified by a rather elaborate process. To produce high-back-voltage units the sources of contamination must be carefully watched.

To make the crystal itself, an induction furnace in vacuum or an inert gas is used, and ingots are formed in a carbon crucible, being roughly two inches in diameter and five inches high. After hours of heat, a selective cooling cycle is used, as the induction coil of the furnace is slowly raised above the crucible, this taking about half an hour. The ingot is then slowly cooled.

This gives an ingot with considerable internal detail. The bottom third is useless on back voltage, the top third also. After the "bark" is removed from the center section, it is ready for slabbing, which is done with a diamond wheel.

At this time it shows grain detail of large size. These boundaries are weak, and are undesirable if they exist on the face of a working crystal, so the operator separates them by breaking them apart. After etching, the backs are plated, the units are soldered to a brass rod, and given a fifteen-minute optical lap. They are then roughed round on a diamond wheel, etched and assembled. This explains the rough edges.

The catwhisker is tungsten, given a conical point by grinding. This point is then dulled or given a ten-thousandth radius by anodizing or reverse plating. It is dipped in tin, coating the end opposite the point for soldering.

*Consulting Engineer, 52-12 Van Horn St., Elmhurst, L.I., N.Y.

The assembly is then put together. The operator looks at the 'scope to see the curve of the point she is finding. When a suitable spot is found, she taps it to shock it into stability, fills the cavity with wax, and the assembly is complete.

The pressure runs about 3 grams with many assemblies, the catwhisker being compressed about two mils. This pressure is about ten thousand pounds per square inch.

Crystal Purity

It is not practical to produce absolutely pure germanium, but impurities are kept to a minimum throughout the process. However, because they do exist, and their nature and amount are unknown, non-uniform operation results.

A reasonably pure crystal has poor conductivity, so impurities are deliberately added. This is called "doping" the crystal. Innumerable materials have been investigated, and some metal is usually used; in this case, tin. A minimum of 0.1 per cent is required; more than that tends to precipitate out of the solution.

There are two types of crystals—the P and the N types. The P type has rather good conductivity in both directions, and cannot operate with a high back voltage. The N type is always used when a high back voltage is to be applied. The naturally occurring P can often be transformed to the desired N by a special heat treatment.

The Crystal Surface

Two processes are necessary in developing high back voltage N crystals—the lap and the etch. Lapping the crystal introduces large flow forces that probably change the all-important surface layer. The function of etching is not too well understood, but it improves the back voltage and seems to be necessary to production.

Amplifying crystals of the N type are usually given a treatment that

changes their surfaces to a P low-resistance type. We shall report on this later.

Note on Theory

The theory of operation is of the utmost complexity. Consider the known factors involved:

- 1) We start with the body of the crystal. It has impurities and also isotopes of unknown amount and distribution.
- 2) We add tin of great purity, but also having isotopes and some impurities.
- 3) The selective cooling gives great variation in observed performance.
- 4) It is mounted with a back contact. This is the simplest step and causes no trouble if the contact is good.
- 5) It is lapped, forming a "work-hardened" surface, as the mechanics say.
- 6) It is etched, or the surface is transformed to P crystal, as we wish.
- 7) We use tungsten contacts.
- 8) We stabilize the performance with 30 volt pulses, for instance.

So we see we have a multiple boundary layer at work. From the solid metal we probably have a layer of occluded gas, into the etched surface which, in turn, merges into the next surface layer and thence into the body of the crystal. From the body into the large area metal contact we seem to have a simple story.

The difficulty with investigating these minute areas and films is that they are so small. Going to radar frequencies gives us a handy tool, as capacity of these small values can be accurately guessed at by indirect effect.

High Back Voltage

The fundamental requirement that makes high back voltage necessary lies in the power relation between input and output circuits.

In general, we have 1 volt at 3 mils in the input. This is three milliwatts and, for amplification, we must obtain much more than that from the output. Therefore, the greater the power generated in the plate circuit, the greater the gain. But because the

RECORD REVUE

I AM back to a somewhat familiar subject again, the H. H. Scott Noise Suppressor system, after several interesting months of intermittent but intimate experience with "all three"—three amplifiers lent me by Messrs. H. H. Scott, Fisher and Goodell, each knowing that I intended to make direct, in-use comparisons with competition. (I am continually astonished at the fair and honest relations among competitors in the engineering field, as compared, shall I suggest, with what goes on in many branches of my own music field!) But the real instigation of this return visit to the Scott system is that, not only do I wish to reaffirm, after this experience, that I find it a valuable supplementary listening gadget, (especially when one must use one's wide-range outfit for musical purposes with those who are not, as most of us are, trained to tune out mentally huge quantities of hiss!)—but, more important, because we can no longer correctly speak of "it" when we evaluate the Dynamic Noise Suppressor. There are different control arrangements on the three amplifiers—so different that one can consider, say, the Fisher and Scott versions of the Noise Suppressor, as in effect different systems, even though the basic dynamic action is of course the same. There is even more confusion due to the coincidence that, though radically different in function, the controls on the three amplifiers look very much alike, and are assumed to be the same by most casual experimenters.

Since there are two sections to this discussion, Section One is entirely descriptive—since I think at the moment my most valuable contribution (even as a non-engineer) may be simply to state the differences, not many engineers having had the time and opportunity to make direct comparisons for themselves. I'll postpone my own personal evaluation for Section Two.

Of the three amplifiers, all using the basic H. H. Scott system, two are basically similar, the Fisher and Goodell; the third, Scott's own current model,

EDWARD TATNALL CANBY*

is decidedly different and represents a contrasting solution of the fundamental problems of how to "organize" the outward controls for best results. (There are still other solution to be found on various built-in models in several lines of complete phonographs.) If there is confusion, perhaps this will indicate why:

Each of the three has two panel control knobs, one principal control, continuously variable, the other secondary control a switch with fixed points, marked "Range". In the Fisher and Goodell models the left-hand (variable) control is Gate Sensitivity; on the Scott the same control takes care of the gates-closed range, continuously variable. The gate sensitivity is factory-fixed, but is also automatically varied in connection with other controls. Moreover, gate sensitivity is in effect varied (to cope with varied input levels) by a screwdriver-operated

input level control at the back. On the Fisher and Goodell models, the right-hand (fixed-position) knob, marked "Range", has the same function, in steps, as the left-hand Scott control (continuous), to adjust the gates-closed frequency limit, leaving the gates-open level the same (10,000) except for one position on the Fisher, which lowers both closed and open frequency limits; three positions on the Goodell also introduce a few db of volume expansion. The Scott right-hand "range" switch, on the other hand, controls the gates-open frequency range, and is a fixed filter when the suppressor is out, with standard positions.

At this point I expect even the hardened engineer to find this quite legible type swimming in circles! Confusion there is bound to be. How to resolve it, so far as existing suppressors are concerned?

Let us look at the outward functions of the suppressor. I will ignore the important action of the low-frequency gates, because in this comparison the

[Continued on page 38]

Operating features of three types of noise suppressors.

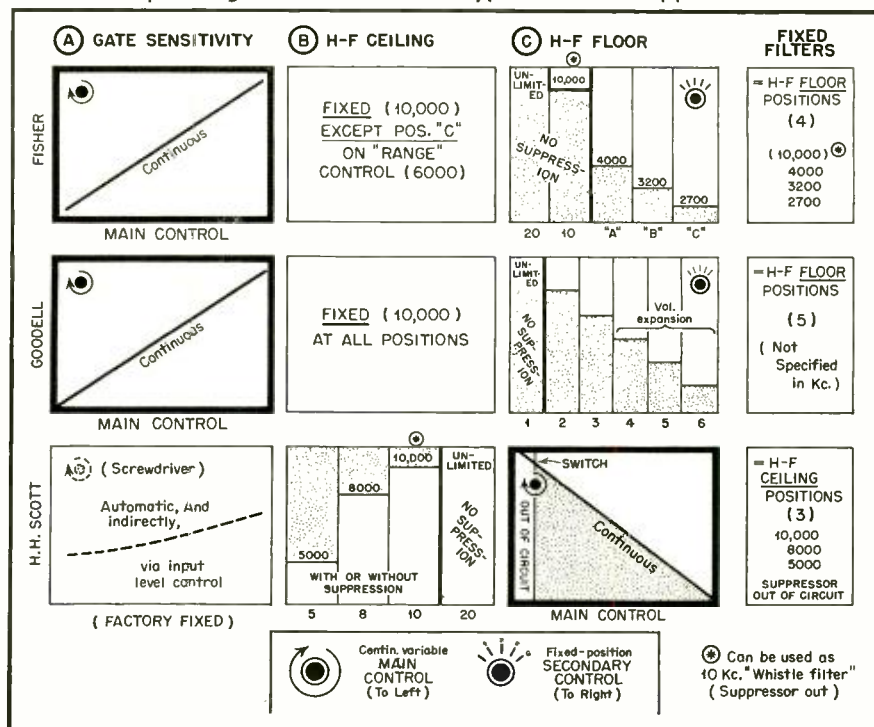

*279 W. 4th St., New York 14, N. Y.

AUDIO DESIGN NOTES

COAXIAL CABLE CAPACITY

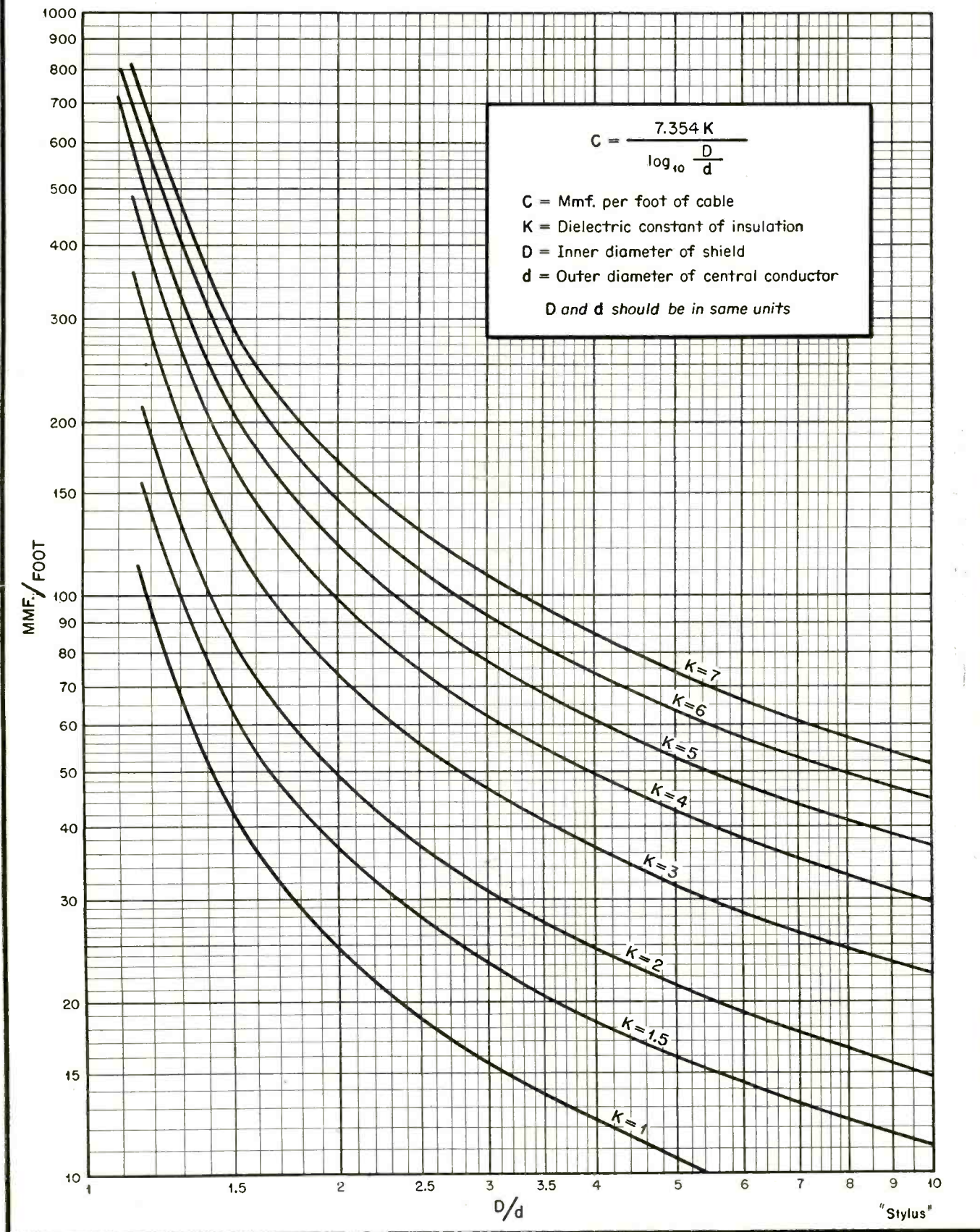

ENGINEERED TO THE HIGHEST FM and AM BROADCAST STANDARDS

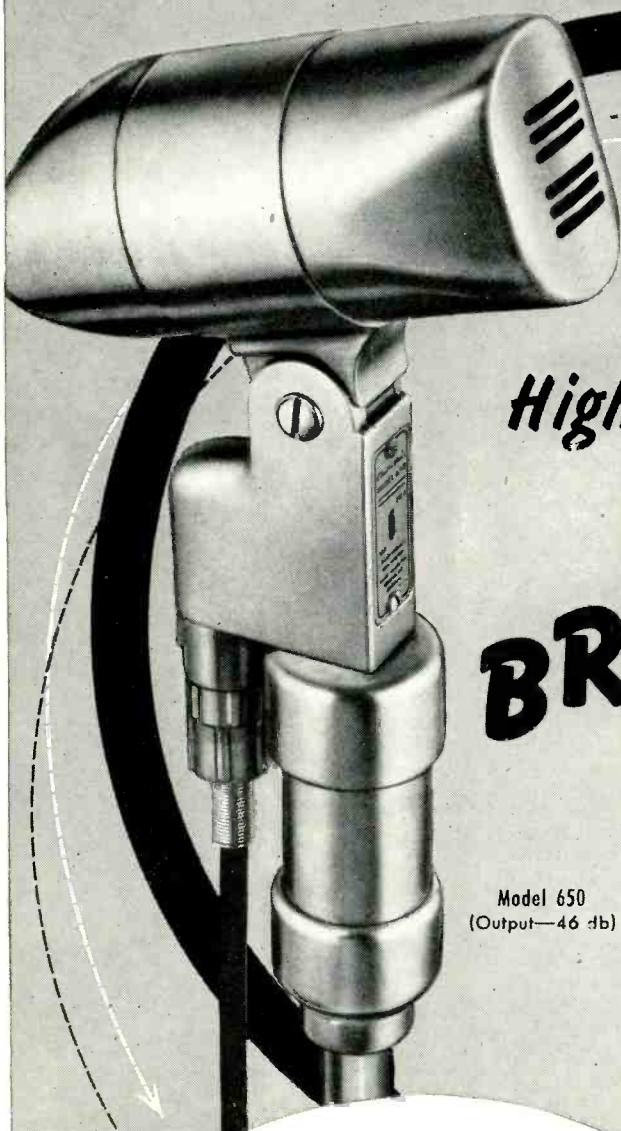

NEW High Fidelity Dynamic BROADCAST Microphones

Model 650
(Output—46 db)

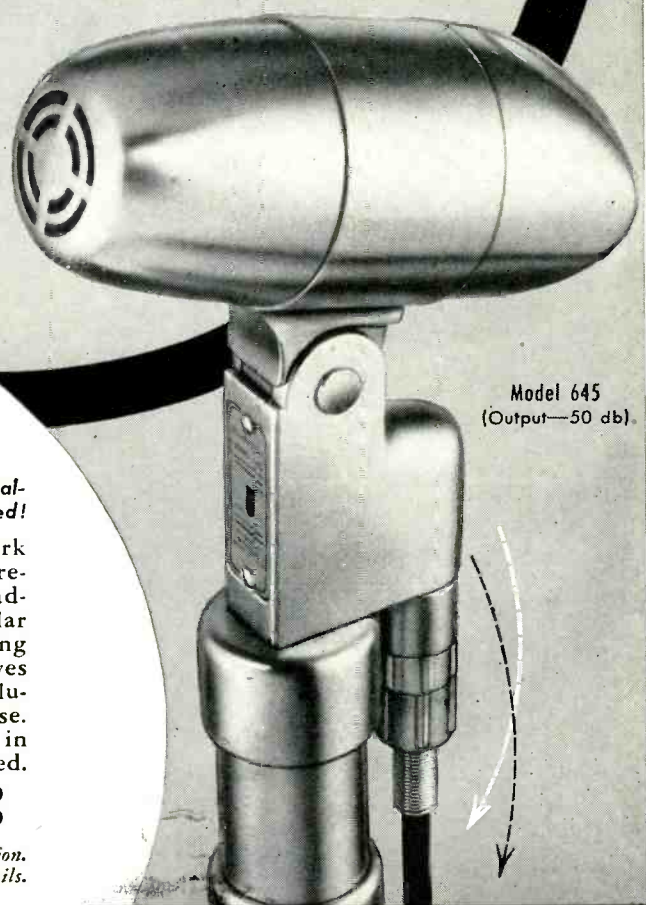

Model 645
(Output—50 db)

**FEATURES LIKE THESE
WIN TOP RATING**
by Station and Network Engineers!

Flat out to 15 kc! Extremely high output! Impedance selector! Dual-type shock-mount! Remarkably rugged! Individually calibrated!

Developed in cooperation with station and network engineers, the new "650" and "645" meet exacting requirements of modern high fidelity FM and AM broadcast service. Proved in studio and remote use. Polar pattern is non-directional at low frequencies, becoming directional at high frequencies. Recessed switch gives instant selection of 50 or 250 ohms impedance. Exclusive Acoustalloy diaphragm withstands toughest use. Many other important features assure the ultimate in broadcast quality. Satin chromium finish. Fully guaranteed.

Model 650. Output level —46 db. List \$150.00
Model 645. Output level —50 db. List \$100.00

Broadcast Engineers: Put the "650" or "645" to the test in your station. Know the thrill of using the newest and finest. Write for full details.

ELECTRO-VOICE, INC. BUCHANAN, MICHIGAN
Export: 13 East 40th St., New York 16, U. S. A. Cables: Arlab

NO FINER CHOICE THAN



NEW PRODUCTS

VTVM

● A new vacuum tube voltmeter 30 times as sensitive as the well-known -hp- 400A voltmeter was announced recently by the Hewlett-Packard Company, 395 Page Mill Road, Palo Alto, Calif.

The new instrument is designated the -hp- 400C Vacuum Tube Voltmeter, and it



provides readings from .1 millivolts to 300 volts, throughout a frequency range of 20 cycles to 2 mc.

A big linear scale reads directly in rms volts or in decibels based on 1 milliwatt into 600 ohms. Generous overlap makes possible more readings at mid-scale or maximum scale, where accuracy is highest. A special output terminal permits use of the new -hp- 400C as a wide-band stabilized amplifier, for increasing gain of oscilloscopes, recorders and measuring devices. Maximum gain is 54 db. In service as a voltmeter, the new instrument may be used for direct hum or noise readings, to determine transmitter and receiver voltages, audio, carrier or supersonic voltages, power gain or network response.

Many of the advantages of the -hp- 400A voltmeter have been incorporated in the new -hp- 400C. The meter is linear and designed for easy reading. The range switch is calibrated in 10-db intervals providing direct readings from minus 70 dbm to plus 52 dbm. Overall accuracy is plus or minus 3% full scale to 100 kilocycles. The high input impedance of 10 megohm means circuits under test are not disturbed. The meter movement itself is built to withstand occasional overload as high as 100 times normal.

Full details of the new instrument are available from manufacturer.

MAGNETAPE RECORDER

● Full-scale production has begun at Amplifier Corp. of America, New York City, on the Twin-Trax Magnetape Recorder, which utilizes two separate recording tracks on standard 1/4 inch wide magnetic tape, and features one full hour of continuous play at the RMA standard tape speed of 7 1/2 inches per second by recording on one track during forward travel and on the other track during reverse travel. An automatic switch and solenoid automatically reverses the direction of tape travel.

Among other special features are a frequency response range of 50 to 9,000 c.p.s. ± 3 db, individual bass and treble equalization controls, DC on the input heaters for low hum level, and simplified tape threading which makes it virtually equivalent to placing a disc record over a turntable spindle. Twin electronic erase heads



provide complete supersonic erasure of each magnetic track whenever desired. Recordings are automatically erased as a new recording is made.

For further information regarding the Twin-Trax Magnetape Recorder, write for technical and descriptive literature to Magnetophone Division, Amplifier Corp. of America, 398-400 Broadway, New York 13, N. Y.

AUDIO-FREQUENCY MICROVOLTER

● The General Radio Company's Audio-Frequency Microvolter has recently been

redesigned to improve its sensitivity, frequency response, and distortion characteristics, and to standardize its impedance level at the now widely used 600 ohms. This microvolter, which consists essentially of a sensitive voltmeter and a precise at-



tenuator, converts any audio oscillator to a standard-signal generator, capable of such measurements as gain or loss, frequency response, overload level and hum level on amplifiers, lines, and other networks. It is useful in measuring the generated voltage of microphones, pickups, and other electro-acoustic transducers.

The output voltage range is 0.1 microvolt to 1.0 volt, open circuit for an input of 2.2 volts across 600 ohms. Accuracy is $\pm (3\% + 0.5 \mu v)$ for output levels above 1 microvolt at frequencies below 20,000 cycles. At frequencies up to 100,000 cycles, the accuracy is $\pm 5\%$. Ratios at a single frequency are accurate to $\pm (2\% + 0.5 \mu v)$. The distortion introduced by the microvolter is about 0.2%.

Measuring 10x7x6 3/8 inches over-all, the Type 546-C Microvolter weighs 6 1/2 pounds.

PICKERING MICRO-GROOVE CARTRIDGE

● The Pickering Model D-140S Cartridge Reproducer is designed expressly for use on the new Microgroove, fine line slow speed, recordings. Its extremely sharp stylus radius is exactly one thousandth of an inch (.001") to track the fine grooves in the new Microgroove recordings. Any coarser radius, besides causing appreciable distortion, would not even follow the grooves and therefore not "track".

Because any wear would destroy the sharp

PROFESSIONAL DIRECTORY

C. J. LEBEL AUDIO CONSULTANT

370 RIVERSIDE DRIVE
NEW YORK 25, N. Y.



PRODUCT DESIGN • INSTRUMENTATION
PSYCHO ACOUSTICS • SOUND RECORDING
ELECTROMEDICAL • SUBMINIATURE AUDIO

Custom-Built Equipment

U. S. Recording Co.

1121 Vermont Ave., Washington 5, D. C.

District 1640

Winston Wells

Designer and Consultant

Acoustical and Electronic Research

307 East 44th St.

MU 4-3487

New York 17, N. Y.

stylus radius, only diamonds are used in the Pickering D-140S. The jewels used are whole diamonds and not splints chipped from larger stones.



The D-140S Cartridge tracks the new Microgroove recordings with a stylus pressure of five (5) grams, or approximately 1/6 of an ounce. The combination of light pressure and high stylus polish assures the absolute minimum of record wear while the life of the stylus is unlimited.

The D-140S Cartridge has the Keystone Clip Mounting, permitting conversion, in a matter of seconds, from the standard cartridge to the Model D-140S for Microgroove, fine line, recordings.

For further data, please write Pickering and Co., Oceanside, L. I., N. Y.

SHURE MICRO-GROOVE PICKUP

• The new Shure "900MG" crystal phonograph pickup for micro-groove records is a special pickup that provides maximum reproduction of micro-groove record fidelity. The "900MG" is an ideal instrument for tracking on the new micro-groove records because: it tracks at 7 grams—has a needle force of 9 grams as an added safety factor—uses a special offset osmium-tipped needle with a point radius of only .001"—and has an output of 1 volt!

The Shure lever system has been adapted in the development of this new pickup—providing a high needle compliance.

For further data, write Shure Bros., Inc., 225 Huron St., Chicago 10, Ill.

RADIO SYSTEMS

[from page 25]

nal to the grid of the converter as before, using a 400-kc sweep at a 60-cps rate. The sweep circuit in the 'scope should be set for a 120-cps linear sweep.

The pattern on the 'scope will resemble Fig. 5. Adjust the top core on the discriminator transformer for maximum amplitude of the peaks of the pattern. Then adjust the lower core for maximum straightness of the two crossed lines. The point of crossover should be in the center of the pattern. These adjustments should be repeated until the peaks are at the maximum, and the lines as straight as it is possible to get them.

Construction Hints

Connections to the i-f strip were made with Kovar bead seals, though any type of terminal strip would suffice. A small shield is mounted between the two limiter sockets, and between the r-f stage and the con-

WHEN you invest in a Racon Horn or Speaker you get all-around super-efficiency—qualities that can not be duplicated by units of conventional type. Such units may resemble Racon units externally but only a Racon has the internal construction features that bring you top performance.

Racon superiority is the result of Advanced Engineering—improvements developed in the Racon Laboratories by Racon Engineers through tireless research and laboratory testing.

For unmatched performance, long life and economy install a Racon.

RACON DOUBLE RE-ENTRANT TRUMPET

(Illustrated above)

An excellent example of Racon scientific engineering. Designed to deliver highly concentrated sound over long ranges with maximum efficiency. Seven models, ranging in length from 6-5/8" to 28". All with aluminum casting inside tone arm and bell of heavy gauge aluminum spinning. Large sizes built with center reflecting section of Racon Acoustic material for preventing resonant effects. Smaller sizes have heavy gauge aluminum spinning for center section.

Strong construction, practically abuse proof. Fitted with swivel mounting ratchet wall bracket. For larger sizes U-bracket mounting will be supplied on request, at no extra cost.

PERMANENT MAGNET HORN UNITS

These units, highly popular in all types of service, embody many improvements. Two groups with Alnico V Magnets and Alnico Blue Dot Magnets. All steel parts plated to prevent corrosion. Also fitted with corrosion proof metal or plastic diaphragms. Voice coil impedance on all units: 15 ohms, except dwarf size—which is 8 ohms. Special ohmages on request.

NOW FURNISHED WITH WATERPROOF CASING

All units, from junior to giant size, may now be had with heavy spun aluminum case, forming a close fitting hermetically sealed, watertight housing for outdoor use. Waterproof type at slight extra cost.

Write for Catalog of complete Racon line.

RACON ELECTRIC CO., INC.

52 E. 19th Street, New York 3, N. Y.

RACON

*Speakers
Horn Units
Horns*



verter tube socket. All resistors are one-half watt types, unless otherwise marked on the schematic. The two chokes—one in the heater circuit of the oscillator and one in the heater circuit of the discriminator—may be made by winding a 1-meg resistor full of #32 enameled wire, soldering the ends of the wire to the resistor leads.

The muting relay is actuated by a separate push button, and when once set, the station selector relays cannot be changed without switching the set off first. In addition to lowering the level by about 20 db, the mute also

changes the frequency characteristic, giving a 3-db/octave boost below 200 cps to compensate for the hearing curve at the lower level. Power connections to the unit are through attached cables, as is the output signal. Separate cables are used for the rectified line voltage for the relay circuits, and for the plate and heater supply voltages. The filament transformer for the tuner is mounted on its chassis, and 115-volts is fed from the power supply, and through to the AM tuner. A nine-terminal socket provides connections for the push buttons, an octal

socket furnishes power to the AM unit, and a microphone-type socket receives the output from the AM tuner.

No trouble should be encountered in this construction. It is desirable to employ a steel plug in the miniature sockets when wiring to them to avoid misaligning the contacts, with the possibility of damage to the tube when it is later inserted. However, make sure the plug is removed before applying power. This information is offered as the result of experience, which necessitated replacing the 6AL5 heater choke.

Proved in Millions of Applications!



**RELAYS
RESISTORS
RHEOSTATS**

**Vast Variety of Stock Units
ANSWERS EVERYDAY NEEDS ECONOMICALLY**

Relays are available from stock in general-purpose, industrial, and radio amateur types for continuous or intermittent duty.

Vitrohm wire-wound Fixed Resistors are available in 8 stock sizes from 5 to 200 watts. Adjustohms in 7 stock sizes from 10 to 200 watts. Plaque Resistors in 3 sizes from 20 to 125 watts. Discohms in 18 watts. Stripohm in 5 stock sizes from 30 watts to 75 watts. Ring-type close control Rheostats in 4 stock sizes from 25 to 150 watts. (Plate Type Rheostats recommended for larger sizes.) Wide variety of Resistance Values.

**AUTHORIZED DISTRIBUTORS EVERYWHERE
WARD LEONARD ELECTRIC COMPANY**

Radio & Electronic Distributor Division
55-- West Jackson Blvd., Chicago 4, U. S. A.

SEND FOR HELPFUL CATALOGS
Catalog D-30 gives complete data and listings on stock units available in Resistors, Rheostats and Radio Amateur Relays. Catalog D-20 lists Industrial and General-Purpose Relays. Write for them today!

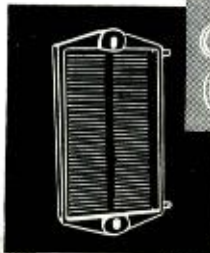
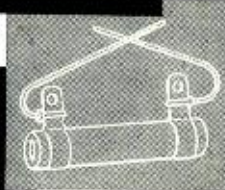
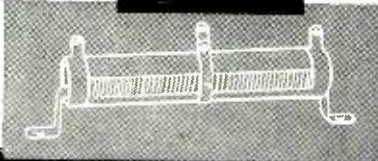
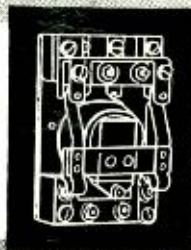

WARD LEONARD
Basic 3R's in Current Control

RECORD REVUE

[from page 33]

differences are not nearly as important nor as confusing as those between the various high-frequency controls. There are three basic kinds of control to be applied, outwardly speaking, and every system must incorporate them in the controls it uses and (*important*) in the wording by which it designates its control knobs. Considering, again, only the high-frequency end for the present, we have:

(A) *Gate sensitivity control.* (The two gates, dual high and single low, are not given separate outward controls, though their action may be distinct.) This determines the relative volume in the music at which the gates begin to open. Naturally, a change in input level will affect this function and since inputs are bound to differ, some manual control is necessary, over and above any fixed or automatic control.

(B) *Control of the h-f gates-open limit:* usually, as I get it, simply a filter system to cut down over-all top range. It can be arranged to act when the suppressor is out, as a straight fixed filter system. I suggest for present purposes that this be called *h-f ceiling*.

(C) *Control of the h-f gates-closed limit,* the lower limit of suppressor action when gates are all the way closed. I suggest this be called the *h-f floor*.

How these functions are to be juggled in the controls to solve the world-formula

*optimum operation =
most flexible control system
simplest, least confusing controls*

is the great and variously answered question.

More specifically,

- 1) Which of these three shall be the "main" control, if any?
- 2) Which of the three shall be available

on the front panel, and which shall be continuously variable, which in fixed positions?

- 3) If fixed positions, how many, what values?
- 4) Shall there be dual functions controlled by one knob? If so, which ones?
- 5) Shall extra functions be incorporated—volume expansion, etc.?

The answers to these questions determine the usefulness in actual operation of the suppressor, as distinct from its internal electrical design, heretofore the chief interest among engineers. And since the whole thing is more a matter of human psychology and of musical characteristics than of straight engineering, its not at all surprising that there have been several sets of answers, based on listening expectations. There is disagreement on every question above, and the designers have been able to put forth some very persuasive arguments in favor of their various positions so much so that the whole business of suppressor design has become both a thorny problem and a highly interesting one. The gentlemen agree only on one point—that the controls should consist, on the front panel, of one "main" control, continuously variable "main" control, and one secondary control, with several fixed positions, marked "Frequency Range". This is enough to give the impression that all three are alike! But here the similarity ends.

The Fisher and Goodell amplifiers, differing in detail, are basically alike in that the fundamental decision, the answer to (1) above, is the same; to make *Gate Sensitivity* the "main", continuously variable control, and therefore to fix the user's mind primarily upon the volume level at which the gates are adjusted to operate. To increase awareness of this function, eye indicator tubes give visual pictures of the gates in actual operation, and the principal adjustment to be made is to match this action, *by ear*, to the sound of the music.

H. H. Scott answers question (1) differently in his current models. (Some earlier ones used the above principle.) His "main", continuously variable control, situated in the same position as the other two, has nothing to do with gate sensitivity at all; instead, he makes a *variable h-f floor* (c) the basic adjustment, and thus the listener's interest is centered on what might be called the depth of maximum suppression rather than on the volume level at which suppression occurs—a very important and fundamental difference in approach. The difference in outlook represented by these two differing answers to question (1) may

Shallcross

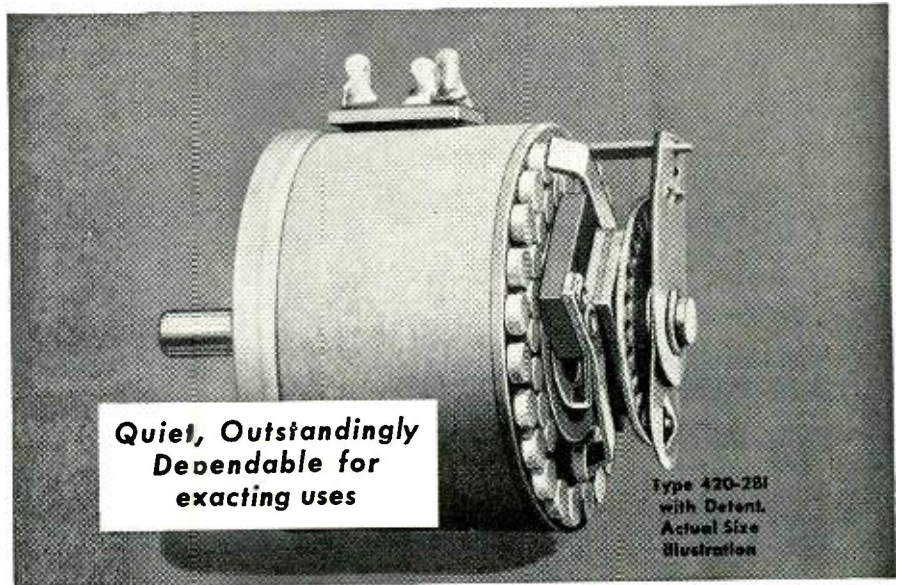

announces the 420-OBO series of bridged "T" ATTENUATORS

CHECK THESE IMPORTANT SPECIFICATIONS

ELECTRICAL CHARACTERISTICS —
 Circuit — Bridged T
 Attenuation — 1, 2, 3 db/step (odd values available on special order)
 Number of steps — 20
 Attenuation Characteristic — Available in linear, linear with off position or tapered on last 5 steps to off.
 Impedance — 30, 60, 150, 200, 250, 500, 600 ohms, in or out. Other values on special order.
 Insertion loss — Zero.
 Resistors — All wound with low temperature coefficient wire.

MECHANICAL CHARACTERISTICS —
 Diameter — 2 1/8"
 Back of panel depth — 2" (with detent 2 5/16")
 Mounting — Two 6-32 or 8-32 screws on 1 1/2" centers
 Shaft Length — 15/16"
 Contact Spacing — 15°

Good things continue to come in small packages! If you're looking for a small attenuator of highest quality—if you want all the quality features normally found in large units but still must save space—Shallcross has the answer.

Measuring only 2 1/8" in diameter, the new 420-OBO Series Bridged T Attenuators are destined to satisfy many important requirements for speech input engineers. The various characteristics available make these new units ideal for use as mixer or master gain controls. In addition to compact construction and the wide variation of ranges and tapers available to your specifications, consider these typical Shallcross quality features:

1. Attenuation characteristic essentially flat from 30 to 15,000 cycles.
2. Attenuation in "off" position 100 db or better.
3. All resistors non-inductively wound and sealed against moisture and shock.

A New Shallcross Cueing Attenuator

Any standard Shallcross ladder, bridged T, or straight T attenuator may be equipped for cueing action without any increase in the diameter of the unit. With it, the operator can listen for cue and transfer a program from cueing amplifier to the transmitter smoothly and efficiently merely by turning up the volume instead of reaching for a separate switch. Write for complete details.

Write for Attenuator Quotation Specification Sheet

SHALLCROSS MANUFACTURING COMPANY
 Dept. A-98 Collingdale, Pa.

be nicely gauged by the fact that whereas Scott gives a continuously variable floor over a very wide range as his principal control, Fisher provides three fixed steps only, on the secondary, fixed-position control ("4,000, 3,200, 2,700"). All other differences in the three amplifiers relate themselves to this fundamental difference in viewpoint as to the principal control.

The secondary (right hand) fixed-position knob in all three amplifiers is labelled "Range". The designation is decidedly misleading, if technically correct. In the Fisher and Goodell controls this switch is actually a *floor* control (c) with a fixed ceiling for all positions (except the lowest in Fisher). H. H. Scott's "Range" control, on the other hand, is a *ceiling* control (b) with no effect on the floor at all—that being in the other (variable) control.

A further confusion to clear up about this right-hand "Range" knob is that in all three suppressors the fixed positions here may be used, at will, as fixed filters without dynamic action—simple, *except* that in the case of the H. H. Scott, the suppressor being entirely removed from the circuit, the *ceiling* range applies to the standard positions "5, 8, 10, 20 kc", whereas in Goodell and Fisher models it is the

floor range that applies, with the gates fully closed; in Fisher, "4000, 3200, 2700". Again, a rather fundamental difference that has a great deal to do with the operation of each amplifier in actual practice, since fixed filter positions are bound to be important. (It should be added that all three have the now standard continuously variable boost-attenuate controls for bass and treble, differing functionally only in that the positions on the panels are dissimilar. I suggest, as a standard for the industry in future, that "bass" should always be leftward of "treble"—as any musician would expect, and as the piano keyboard itself is constructed. The bass and treble controls are counted upon heavily as additional factors in noise suppression, particularly by Mr. Goodell, who has no ceiling control, but prefers to use the treble attenuator.)

Other differences between the three amplifiers are relatively simple to understand. Goodell adds some slight volume expansion as an extra in his lowest three floor positions (questions 4 & 5), a factor not directly related to the suppressor action (though the relation between vertical and horizontal suppression, as Mr. Scott often points out, is an interesting one); the lowest step in the Fisher "Range" knob, which

cuts down both floor and ceiling as a dual-function position, is for very poor records only and is, hence, not particularly significant.

Let me put this information in generalized diagrammatic form, without attempting to be microscopically accurate. I am still ignoring the low-frequency gate function as relatively unimportant in this comparison; and I take it as understood that all "range" figures refer to the upper portion of a curve of response.

Recent Recordings

Saint-Saens, *Symphony #3 in C Minor, op. 78.* Columbia MM 747 (4)
New York Philharmonic, Muench. E. Niesberger, organ.

Here is the latest "ideal" test recording, if you want good, solid, heavyweight, romantic music: not only a full-sized orchestra, as big as they come, but with the very important (technically) addition of a large organ, with powerful pedal notes, that give you low-frequency powerhouse tones such as seldom occur on records and practically never in conjunction with the sharp highs of an orchestra. (The highs of the organ are musically of little importance since the tone color of the instrument comes largely from the lower harmonics, the top highs giving merely a non-essential metallic edge.) This is big, bombastic music, full of tremendous dynamic contrasts, with plenty of technically useful sounds such as triangles, cymbals, drums, etc. The re-

It's Tops!

Surveys show that AUDIO ENGINEERING is preferred over all other technical magazines read by the best informed in the sound field—the broadcast engineers. Each issue brings you outstanding articles on five or more of the following subjects:

- Broadcasting
- Sound on Film
- Recording
- Phono Reproduction
- Public Address
- Industrial Sound equipment and applications.
- Acoustic treatment of studios, rooms, auditoriums etc.

In addition, each month Audio Engineering presents latest improvements in sound reproducing equipment design, test methods, and technical news from here and abroad. The editorial staff includes top authorities in the sound field.

Subscribe NOW! Don't miss an issue!

Sorry, back numbers of practically all issues are unobtainable because of the terrific demand.

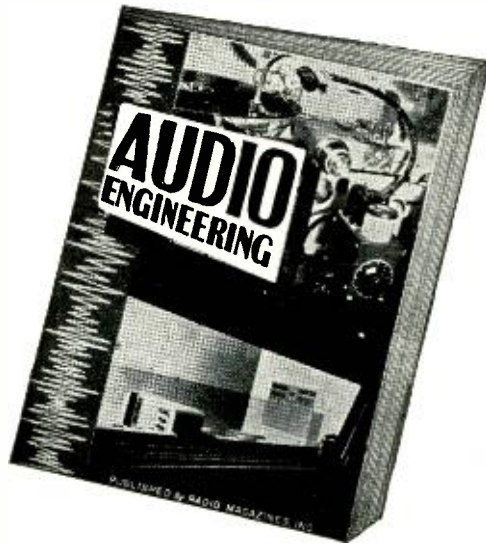

AUDIO ENGINEERING
RADIO MAGAZINES, INC.
342 Madison Avenue, New York 17, N. Y.

Sirs: Here is my check (or money order) for \$..... Enter my subscription order to AUDIO ENGINEERING for the next..... issues. Subscription Price: In U. S. A. and Canada—12 issues \$3—24 issues \$5. Foreign subscriptions are \$4 annually. Please check one: New Subscription Renewal

Name (please print).....

Address..... City..... State.....

Occupation (give title and department).....

Firm Name.....

Recording is stunning as to liveness, with none of the occasional over-dry deadness of some Columbias. Everything is sharp, but everything floats beautifully in a big-hall liveness that perfectly suits the music.

Try side 7 as a sample. Powerful low organ notes, solo, alternate with sharp, steely violin swipes and huge cymbal crashes.

No doubt about it, Saint-S. was the sound man's dream composer, even if his music is, in the long run, just a bit dull.

Sibelius, *Symphony #2 in D Major, op. 43.*
The Philadelphia Orchestra, Ormandy.

Columbia MM 759 (5)

Technically, this is a job quite similar to the above Saint-Saens—but the listening results are quite different. It is a splendid recording; but Sibelius (contrary to what one might expect) does not oblige quite as fully as Saint-S. Big orchestra, yes, and plenty of schmaltz in this familiar, once-modern (anything but, now!) piece of music. But it is too atmospheric for best recording. Too many very low-level passages, meant to be ominous, but in recording merely ineffective. Lots of big bursts of energy, but without the sharpness that makes for best technical work in recording. Still—if you are a Sibelius fan this will loom far ahead of earlier recordings of the same as played on your up-to-date equipment.

Berg, *Lyric Suite (1926)*
Galimir String Quartet.

Vox 181 (4)

Technically an interesting example of the present technique of rehabilitating older recordings. This was made in France well before the war (1936, I think) and issued on very poor surfaces. An American Deca re-pressing was even worse. Now Vox, with the original masters to work with, via assorted vinylite copies (I think dubbed with added level, etc.), has reissued the set in enormously improved form. Still no highs, of course—they can't be made out of nothing; but the level is adequate and the background noise is tremendously reduced. A good job.

Musically, this one will baffle the uninitiated—it is perhaps the most difficult contemporary work of first importance to be issued on records since the war. Partly in 12-tone technique, entirely dissonant, highly emotional, very involved, it may sound at first like a bunch of angry cats. But, take it from me, this is listenable music, if listened to long enough, and expressive, too. (For flounders, a lengthy explanation by Canby will be found in the album liner. This is *not* a plug!)

Debussy, *String Quartet in G Minor, op. 10.*
Paganini Quartet.

RCA Victor DV 17 (4 plastic)

A first-rate performance of an early Debussy work that is decidedly easy listening today, though back a half-century it had musicians generally treed. The Paganini Quartet gets all the French delicacy and atmosphere into this that makes it so different from the German-Austrian quartets of Mozart, Beethoven, Brahms, etc.

Technically it is a disappointment, at least on my copy. Excellent, big liveness, but the tonal range seems to be abnormally restricted—I can't find much of anything over 5 or 6 thousand. On plastic this is

most lamentable, especially since the vinylite is tops here. (Try your standard "5-8-10-20" kc switch: scarcely any change above the first step. Try the same on the above Columbias: even the 10-20 step will yield some musical difference, hiss aside.) There also seems to be considerable fuzziness and distortion in the loud passages, on my copy, but this seems to decrease towards the end. (My imagination, or is there pressing difficulty here?)

Ibert, *Divertissement.*
Boston "Pops" Orchestra, Fiedler.

RCA Victor DM 1199 (2)

I first reviewed this under the impression it was a new recording; it seems it is a re-issue of the quite old Victor job that was formerly coupled with a white elephant al-

bum mate, a work by MacDowell. This is one of those brilliant, live "Pops" recordings that, without great tonal range, gives an excellent impression of it. It stands up very well to the latest "Pops" recordings and might as well be a brand new one. (Somewhat more loud-passage distortion than current jobs.)

The music is a hilariously melodic take-off of everything and anything, from an Offenbach Can-can to a Sousa march, with some very sour jazz (a la 1920) mixed in. Good fun.

Buxtehude, *Organ Music.*

Carl Weinrich, "Praetorius" Organ.

Musicraft 40 (4)

Another Musicraft re-issue of this pre-war series of musically excellent organ re-



"Professional Junior"
**COLLAPSIBLE
DOLLY for**
TV Camera Work

**Now being used by RCA--NBC
CBS & DuMont Video Stations**

Sturdily supports TV camera on tripod, also cameraman. Assembles quickly without tools. Collapses into carrying case 1' sq. by 6' long. Ideal for Studio & Location TV work.

This Dolly made by specialists in custom-built TV and motion picture equipment.

Representatives for Houston Developing Machines; Auricon SS camera & recording equipment; Bardwell & McAlister lighting equipment; Moviola and Micro Engineering editing equipment.

Rentals, Sales & Repairs of all types 16mm and 35mm cameras, and editing equipment.

FRANK C. ZUCKER
CAMERA EQUIPMENT CO.
1600 BROADWAY NEW YORK CITY

Complete staff of trained technicians
available for consultation.

4 CONTINUOUS HOURS of PLAY
with the **MAGNETAPE**
TWIN-TRAX
RECORDER
\$495 including microphone



NO OTHER RECORDER OFFERS THESE SPECIAL FEATURES

4 hours continuous play . . . Frequency response 40 to 10,000 cycles \pm 2 db . . . Individual bass and treble controls . . . Simplified tape threading . . . Heavy-duty non-overheating motor . . . No tape winding necessary . . . Phono pickup and turntable facilities available . . . Low hum level (DC on heaters) . . . Automatic tape reversal at end of reel . . . Sockets for VU meter and foot switch . . . Major components easily accessible . . . No mechanical noises . . . Instantaneous reverse control — without unthreading . . . Instantaneous stop — rapid start . . . High speed forward and reverse without unthreading . . . No tape spillage possible during high speed shuttle . . . Plays single track recordings made on other recorders . . . Separate recording and playback amplifiers on single chassis . . . Rubber-rimmed drive cannot develop flats . . . Complete elimination of capstan tape slippage . . . 3.2 and 500/600 ohm balanced line outputs . . . Jack for external speaker or earphone monitoring . . . Twin electronic erase heads . . . Flutter and wow \pm 0.1% . . . No belts to loosen or pulleys to slip . . . Dimensions 20 1/2" x 17" x 15 1/2". Wt 55 lbs.

Complete symphonies and operas — or any musical or variety program up to 4 hours in duration can now be recorded and played back on a single 13 1/2 inch reel of magnetic tape with the newly-developed Model 910-B Magnetape Twin-Trax Recorder. Incorporating new mechanical design features and the finest magnetic recording amplifier ever constructed, this exceptional instrument is the only answer to prolonged, uninterrupted high-fidelity recording of music or voice. Built-in reverse control and instantaneous stop feature makes this recorder ideal, also, for dictation and conference recording. Tape costs are actually cut in half through the revolutionary use of two independent and isolated sound tracks on standard 1/4 inch reels of tape. The cabinet, ingeniously designed for compactness and beauty, covers and protects the reels during operation of the recorder. Its many exclusive features make this recorder unmistakably the perfect unit for the home, laboratory, industry, recording studio, and broadcast station. Also available is Model 810-B Twin-Trax Recorder, which plays for one hour at high fidelity on standard 1/2-hour reels of magnetic tape. Priced at \$285.00, less microphone.



Unit operates with cover and sides closed.

If not available at your dealer, order direct

*Trademark

AMPLIFIER CORP. OF AMERICA

398-4 Broadway

New York 13, N. Y.

cordings. No perceptible change in quality except for somewhat more uniform surfaces (and we hope more durable), but this is like others in group. An excellent illustration of the unimportance of highs in organ tone color; (see Saint-Saens, above). Great variety of chortling tone colors here are entirely under 5,000 cycles.

Acoustically, the "Praetorius" recordings are totally dead, a serious disadvantage in any organ music. But for some reason it is far less objectionable here in this pre-Bach Buxtehude music than in the Bach Albums made at the same time. Buxtehude, incidentally, was a leading predecessor of Bach, writes very different music, more informal, often very humorous, full of changing colors and changing rhythms.

Schubert, Symphony #5.
Boston Symphony, Koussevitsky.

RCA Victor DM 1215 (3)

A very satisfactory recording, technically, of a favorite short symphony of Schubert. A bit over-live (some blurriness of detail), but there is a definitely satisfying tonal range here—plenty between 8 and 10 thousand, clean and smooth; best, the loud passages are quite free of the many unpleasant buzzy overloading I seem to find on many earlier Victor's. This isn't a technical man's show-piece—not that kind of music. But even so, if you want a sample of Victor's unassuming best, try this out.

Musically it is lighter, somewhat more romantic than the earlier (and standard) Beecham version. I prefer it, Beecham plods whenever he gets a chance, even though his detail work is to be praised above Koussevitsky's.

Cousin Emmy: Kentucky Mountain Ballads.
Cousin Emmy, acct. of banjo, guitar, harmonica, etc.

Decca 574 (4 10") Booklet

Cousin E. is a rip-snorting professional radio hill-billy singer who nevertheless can dish out the real Kentucky stuff without Broadwayizing. She accompanies herself miraculously here, with some anonymous assistance. Recording is popular type, rather coarse, but with more tonal range than might be expected. Powerful stuff, this.

Liszt, Hungarian Rhapsodies.
Shura Cherkassky, pianist.

Vox 175 (4 10")

Brahms, Variations on a Theme of Paganini.
Jacob Gimpel, pianist.

Vox 209 (2)

Smetana, Polkas for piano.
Erno Balough, pianist.

Vox 179 (3 10")

Three samples of the excellent Vox piano recording—excellent, that is, as to acoustics, naturalness of tone. This company, as of Dec. 1947, was producing about the best piano recordings in this country. Other technical aspects get in the way, though. There are often volume peaks too loud for perfect reproduction. The Brahms records above are very long, several sides over 4 1/2 minutes; loud passages near the ends of these sides are hopelessly fuzzy. Even so, in their better sections these rate tops in the field.

The Liszt album is heavy lightweight entertainment. Much bombast and plenty of fancy pianistic whipped cream, as only Liszt can dish it out. Pseudo-Gypsy-Hungarian flavor. The Brahms is a more solid work, super-brilliant pianism as in the earliest Brahms piano works. (His later works



Radio Engineers! Hams!

If you are interested in amateur radio, you'll want "CQ" every month. Subscribe now. Use the handy coupon below. Attach your remittance and mail today.

CUT OUT—MAIL TODAY

CQ-RADIO MAGAZINES, INC. Call.....
342 MADISON AVE., NEW YORK 17, N. Y.

Sirs: Here is my check (or money order) for \$..... Send me..... issues of CQ. 12 issues \$2.50—24 issues \$4. (Foreign subscriptions are \$1.00 higher per year.)

Please indicate: NEW RENEWAL

Subscriber's Name (print carefully)

Address

City..... Zone..... State.....

are heavier, less fancy for the fingers.) The theme is the familiar Caprice, also used for Rachmaninoff's Variations for piano and orchestra.

The Smetana polkas are delightful new discoveries, almost never heard—why Heaven alone knows. These are polkas for listening, not dancing, tuneful, graceful, often like Chopin but more good humored.

Debussy, Reverie; Ravel, Pavane for a Dead Princess.

E. Robert Schmitz, pianist.

RCA Victor 12-0066 (1)

A fine contrast to the above—this is languid, dreamy, impressionistic music, inward-turning, with soulful piano melodies. Well recorded, in view of great difficulties presented by such low-level music. Suffers from some percussive peaks here and there. An authoritative and easy-to-listen-to interpretation.

AMPLIFYING CRYSTAL UNITS

[from page 27]

A jeweler's saw with #6-0 blade was used to slot the tops of the copper pins. They were then inserted and rotated to the proper angle and height. A dummy crystal of .073" diameter brass was made up, and a prick punch used to put a small hole in the face of the dummy crystal. The catwhiskers were lined up in this hole and the copper slot crimped shut. After checking operation on an actual crystal, the whole top of the pin was soldered.

Circumference Mount

Fig. 3 shows two pieces of tungsten sheet held down by brass heads on the pins. They are adjusted to a .003 gap by a feeler gauge, and the crystal presented to them so that it bears on the gap with its edge. This is mechanically very easy to adjust, as the crystal assembly is simply swung past the gap, and it falls in very nicely.

There are several undesirable features about this assembly,—first, it is very difficult to drill tungsten, especially when it must stay flat—it must be drilled between steel sheets in a large sheet, and then trimmed to size. The second point is that it is inoperative unless the edge of the crystal is lapped, which, so far, we have been unable to do. Remember our previous requirement of a lapped and etched surface, and realize as the crystals come out of a 1N34 the edge is not lapped, only rough-ground to size. However, this makes a very nice double diode, at least for low-level signals. It tends to have great uniformity of performance of the two contacts, perhaps because they are so close together.

Shoulder-gap Mount

Fig. 4. shows a very promising arrangement of entirely different per-

CINEMA'S NEW SWITCHBOARD KEYS

This series of keys is designed especially for audio switching and control circuits where the requirements call for long, dependable service with no maintenance. The type 1041 is ideally suited for microphone input circuits.



Type 1041
Rotary Cam-Operated

The springs are constructed of heavy nickel silver and exceptionally large, pure silver contacts are used to provide low and constant contact resistance for noise-free operation.



Type 1042
Rotary Cam-Operated

The keys mount on the panel through a half inch hole. The panel may be of any thickness up to one half inch. The following spring combinations are available on the keys:—two makes, two breaks, two make-breaks or two make-before-break.



Type 1043
Push-Button (Non-Locking)

Prices upon request.

CINEMA

ENGINEERING COMPANY

1510 W. Verdugo Ave. Burbank, Calif.
Cable Address: CINENG BURBANK

AMPERITE

Studio Microphones

at P.A. Prices

Ideal for BROADCASTING

- RECORDING
- PUBLIC ADDRESS

"The ultimate in microphone quality," says Evan Rushing, sound engineer of the Hotel New Yorker.

- Shout right into the new Amperite Microphone—or stand 2 feet away—reproduction is always perfect.
- The only type microphone that is not affected by any climatic conditions.
- Guaranteed to withstand more "knocking around" than any other type mike.

Special Offer: Write for Special Introductory Offer, and 4-page illustrated folder.

Models
RBLG—200 ohms
RBHG—Hi-imp.
List \$42.00

"Kontak" Mikes
Model SKH, list \$12.00
Model KKH, list \$18.00

AMPERITE Company, Inc.

561 BROADWAY • NEW YORK 12, N. Y.

In Canada: Atlas Radio Corp., Ltd., 560 King St. W., Toronto

ARROW ELECTRONICS INDUSTRIAL SALES DEPT.

Specializing in
**ALL ELECTRONIC COMPONENTS,
PARTS, TEST EQUIPMENT AND**

Catering Especially
TO THE NEEDS OF
MANUFACTURERS • LABORATORIES
RESEARCH DEPTS. • ENGINEERS
SCHOOLS • PURCHASING AGENTS

CALL • WRITE • WIRE

FOR

SPECIAL PRICES • QUOTATIONS • DELIVERY SCHEDULES

Jack Kirschbaum, mgr.

Digby 9-4714

ARROW ELECTRONICS

I N C O R P O R A T E D

82 CORTLANDT STREET, NEW YORK 7, N.Y.

Announcing— **TELEVISION INTERFERENCE** **Its Causes and Cures**

A new Handbook by Radio Magazines, Inc., covering in detail the important facts of TVI. The TVI Handbook is edited to fill the pressing requirements of amateurs and other technicians confronted with the problems of TV interference, or otherwise unsatisfactory television reception. Included in its thorough treatment of causes and cures are a comprehensive set of TV screen photos depicting all types of reception, many case histories, preventative design data, and other equally pertinent facts. It is a vital publication for radiomen wherever TV is on, or about to go on the air.

Price 50c postpaid, or order from your local dealer.

CQ—Radio Magazines, Inc.
342 MADISON AVE., New York 17, N. Y.

Enclosed find \$..... for..... copies TVI Handbook

Name

Address

City..... Zone..... State.....

formance and theory. The crystal is so presented to the gap that its top lays on one side, and the side lays on the other side of the gap. The side is invariably the grid.

The geometry of this gap offered an interesting problem. If the end of a true cylinder is presented to a gap having straight parallel sides, the top of the cylinder will bear on a line contact which is a chord. In this arrangement we desire the cylindrical end to fall into the gap a distance of about 1½ mils. That distance in from the edge, the chord or potential line of contact is about 18 mils long. This we do not want, as parts of the line will be about 9 mils away from the grid, which is in the center line.

So the tungsten is given a slight radius, and thus the line contact is turned into a point, as a circle tangent to a plane gives a point of contact. Despite the uneven geometry of the edge of the 1N34 crystal, it is fairly easy to line up, or rather choose a point on the rim that is quite operative.

This type construction also introduces a new mode of operation. The art shows that the plate must have high back voltage, and consequently a polished and etched surface. The grid, however, being always 1 volt positive, needs no such surface. So here we have two surfaces of different characteristics, the polished for the plate and unpolished for the grid, very closely adjacent.

The tungsten must be polished and burrs removed, and it is well to reverse-plate it for a few minutes in sodium hydroxide (ordinary kitchen lye) with a single dry cell and a nail for the other electrode. Make the tungsten positive, and stop when it is gray all over the immersed portion.

The method illustrated for holding down the tungsten works very well. The copper pins are accurately bent at more than 90 degrees, and forced into the bakelite base. The ends force down the tungsten sheets with plenty of reserve power for anchoring them firmly. A light press to start allows sliding the tungsten around so as to locate the gap accurately under the crystal, which is spring-mounted. While statistically it means nothing, the first point tried on the crystal gave a current of 7 ma at 35 volts, and the 1 volt grid potential increased it to 8.5 ma. It seemed stable but needed quite a bit of pressure on the face of the crystal, but only moderate pressure on the grid (side) contact. So the spring piece holding the crystal had to be reinforced with additional pressure.

Suggestions for Test

Since we must find a spot that will take 5 to 10 ma at 30 to 40 volts, we need a setup to check for this quite rapidly. One is shown in Fig. 5. A high

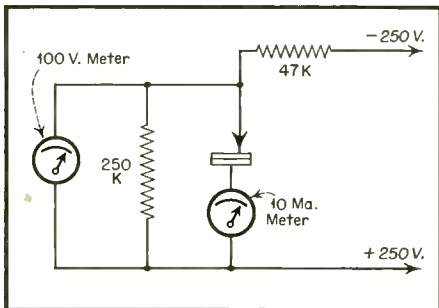

Constant current method of locating points of correct back voltage.

voltage of 250 volts is used with a bleeder of 47,000 ohms and .25 megohms in series. The crystal is connected through a ten ma meter to the junction, and a d-c vtm is connected across the crystal.

To prevent shocking the crystal, the plate supply is turned off each time, so the rectifier heating time allows a gradual voltage buildup across the point.

The high series resistance produces constant-current operation, so the voltmeter gives the drop at 5 ma across the crystal. Maximum applied voltage should not exceed 70 volts; minimum, 15 volts.

This emphasizes one point of quality control of the crystal in production. Since we wish about 5 ma at 40 volts for all crystals, it means that point B on the curve of Fig. 1 must be carefully held so that all crystals will work on a single plate supply. Operation at C will give marvelous performance, with the risk of gradual creep up to the trigger point, and operation at A to B means poor transconductance or power gain.

Present production 1N34s have a tremendous variation in current at minus 40 volts, being from 20 to 400 μ a since they are designed to be used as rectifiers, not as amplifiers.

[In our next issue, details of a complete three-stage, crystal amplifier will be presented. —Ed.]

SOUND DISTRIBUTION

[from page 19]

be noticed as an attenuation of the high frequencies as shown in Table III. This attenuation is related in a complex manner to the humidity, temperature, and the amount of dust, smoke, rain, snow, or fog in the air. The main effect indoors is to reduce

AN 8" DIA-CONE SPEAKER WITH THE HIGHEST EFFICIENCY NOW AVAILABLE TO INDUSTRY

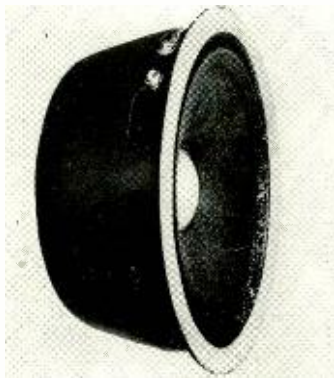

The acknowledged design leadership of Altec Lansing in the field of high quality sound reproduction has now produced an 8" speaker of extreme high efficiency, light weight, and quality performance. It incorporates the famous Dia-cone principle of high frequency reproduction from a separate metal diaphragm. It is particularly applicable for portable sound reproduction uses, such as 16 MM sound projectors, wire recorders, and announcing and music systems in mobile units, such as airplanes and buses. It is ideally suited for television, and table model FM receivers where quality reproduction is essential and space occupied by the speaker is important.

Inquiries from manufacturers concerned with economy in quantity production are invited. An illustrated brochure, fully describing the entire 1948 Altec Lansing line of speakers, containing frequency response curves for each speaker, will be sent on request. Write to address nearest you.

SPECIFICATIONS:

Power Rating	12 watts
Voice Coil Impedance	8 ohms
Required Amplifier Output Impedance	4-8 ohms
Voice Coil Diameter	1 3/4"
Speaker Diameter	8 3/4"
Speaker Depth	3 3/4"
Weight	4 lbs.



161 Sixth Avenue
New York 13, N. Y.
1161 N. Vine Street
Hollywood 38, Calif.

**AN IMPORTANT
TECH LAB
DEVELOPMENT**

**New Type 1250
R. F. SWITCH**

High r. f. current carrying capacity
50 amps. max. intermittent load; 30
amps. steady load. Low loss factor.
Sturdy mechanical design . . .
Mycalex insulation.
Furnished in any
number of
decks.

Write for Bulletin No. 472

Manufacturers of Precision Electrical Resistance Instruments

337 CENTRAL AVE. • JERSEY CITY, N. J.

NOW AVAILABLE!

INDIVIDUAL COMPONENTS

of the

WIDELY ACCLAIMED

KLIPSCH SPEAKER SYSTEM

by



YOU CAN NOW BUY THE SEPARATE PARTS
THAT MAKE UP THIS

"CORNER" SPEAKER

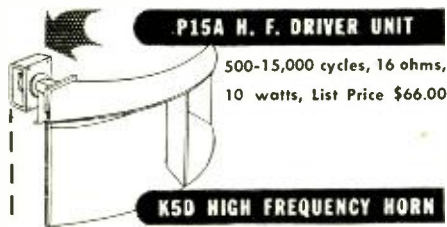

P15A H. F. DRIVER UNIT

500-15,000 cycles, 16 ohms,
10 watts, List Price \$66.00

K5D HIGH FREQUENCY HORN

Acoustical cut-off 330 cycles. Dispersion angle: horizontal 90°, vertical 60°. Non-resonant laminated plastic assembly. Adaptors available for use with all commercially available driver units. Dimensions with standard adaptor for P15A driver: 25" wide x 9" high x 20" deep. List Price \$122.00



K16 500-Cycle DIVIDING NETWORK

Constant-resistance type. 12 db per octave. Air-core inductors. Zero distortion. Includes continuously adjustable L-pad in H.F. channel. 16 ohms, 10 watts. (Power capacity up to 50 watts with heavier L-pad available at extra cost.) In non-metallic box. Dimensions: 6 1/2" wide x 3 1/2" high x 14 1/4" long. List Price \$66.00

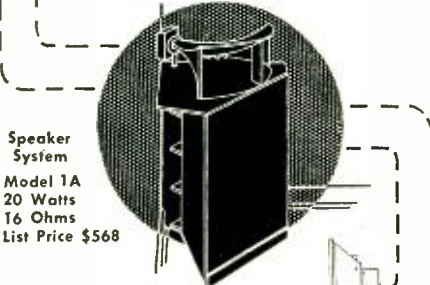

Speaker System

Model 1A
20 Watts
16 Ohms
List Price \$568

L15 SPEAKER

For use in K3B horn. Highly efficient driver with characteristics to produce optimum response. Very compliant suspension. 15-inch cone. 2-inch voice coil. 3.2 lb. Alnico V magnet. 9 ohms impedance. List Price \$66.00

K3B LOW FREQUENCY HORN

30-500 cycles with 15-inch l.f. driver. Heart of the Brociner-Klipsch Speaker System. Exponential horn with 40-cycle l.f. cut-off, providing excellent fundamentals down to 30 cycles with negligible distortion. Rigid plywood construction. Finished in cream lacquer to match color of the companion K5D h.f. horn. Dimensions: 31" across front panel x 39" high x 28" deep. List Price \$198.00 not incl. driver.

★ Write for data on our NEW Pre-Amplifier for Variable Reluctance Pickups. Dept. S.

BROCINER ELECTRONICS LABORATORY

1546 Second Avenue, New York 28 • REgent 7-6794

the reverberation time at high frequencies. Outdoors, a further attenuation of the high frequencies is caused by absorption by trees, shrubbery, fallen snow, etc.

Thus, it may be necessary to boost the low-frequency response of the system to make up for a lack of propagation, and the high-frequency response to make up for a loss due to absorption in air.

The final section of this article will give examples of sound systems planned according to the data presented in this and the preceding section.

REFERENCES

- V. O. Knudsen, "Architectural Acoustics," John Wiley and Sons, Inc., New York, 1932, p. 354.
- W. C. Sabine, "Collected Papers in Acoustics," Harvard University Press, Cambridge, Mass., 1923.
- Acoustic Materials Association, Bulletin IX, 205 West Monroe Street, Chicago, Illinois, 1947.
- National Bureau of Standards, Letter Circular LC870, Washington, D.C., 1947.
- C. F. Eyring, "Reverberation Time in 'Dead' Rooms," *Journal of the Acoustical Society of America*, Vol. I, No. 2, p. 217, January, 1930.
- A symposium of six papers on "Auditory Perspective," *Electrical Engineering*, Vol. LIII, No. 4, p. 239, April, 1934.
- H. Fletcher, "Transmission and Reproduction of Speech and Music in Auditory Perspective," *Journal of the Society of Motion Picture Engineers*, Vol. 22, No. 5, p. 314, May, 1934.
- A symposium of five papers on "Auditory Perspective," *Journal of the Society of Motion Picture Engineers*, Vol. 13, No. 2, p. 89, October, 1941.
- D. K. Gannett and I. Kerney, "The Discernibility of Changes in Program Band-Width," *Bell System Technical Journal*, Vol. 23, No. 1, p. 1, January, 1944.
- Jensen Technical Monograph No. 4, "The Effective Reproduction of Speech," Jensen Radio Manufacturing Company, Chicago, Illinois, 1946, p. 8.
- V. O. Knudsen, "The Propagation of Sound in the Atmosphere—Attenuation and Fluctuations," *Journal of the Acoustical Society of America*, Vol. 18, No. 1, p. 90, July, 1946.

FM TUNING INDICATOR

[from page 32]

this tube is a translucent screen, of two vertical columns. The lower half of both columns is connected to the limiter circuit, so that as the a-v-c voltage increases, this will cause a shortening of the beam. This actioning network across the a-v-c line, ever, the upper left-half of the beam remains at ground potential at all times, as a reference point to which

the upper right beam is adjusted for zero direct current voltage occurring across the discriminator loading resistors. Consequently, to obtain perfect tuning of the set, the lower half of the beam should rise as far as possible while the line across the upper segment should be a horizontal line. Tuning through a few stations will soon familiarize the user with the action of the eye.

It may happen, in those locations where signals are strong, that there will be so much limiter current flowing as to practically extinguish the beam on the tube. This can be corrected easily by using a voltage-dividing network across the a-v-c line, comprising two 2-megohm, 1/2-watt resistors in series, with the deflection electrode connected at the midpoint of the resistor network. Such a load will in no matter interfere with the a-v-c action of the receiver.

The installation of this new indicator will well repay the effort and cost involved, as it assures the perfect tuning of your fm tuner.

While some users may well prefer to install expensive meters for tuning, the device described serves equally as well.

Introducing
Cellular Grand
by **RACON**

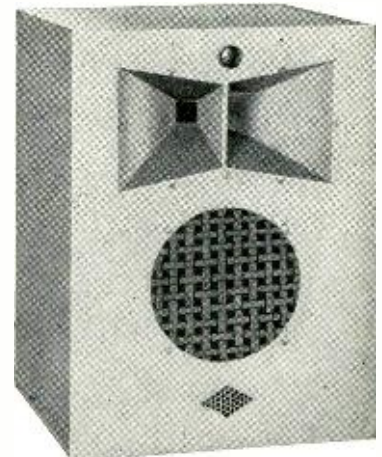

A HIGH FIDELITY reproducer that sets a new standard of efficiency in electro-acoustical conversion. Size 11"x11"x15" small enough to fit into the home console. Sound output ample for studio and industrial requirements. Has 120° horizontal sound angle. Special type cone speaker for low reproduction, and cellular speaker for wide angle coverage and high frequency response, and many other exclusive features. Frequency range 50 to 12,000 cps.

Write for free catalog

RACON ELECTRIC CO., INC.

52 E. 19th St.

N. Y. 3, N. Y.



We illustrate the units below for the information they bring to engineers of "What can be done." A large part of UTC production, however, is on catalogued and special material of more standard nature. UTC quality has world-wide recognition on ALL types of transformer components.

FOR FILTERS

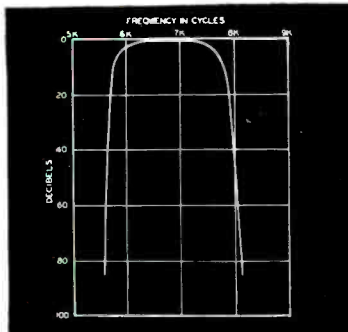

**BROAD BAND
SHARP CUTOFF
FILTER**

**NARROW BAND
SHARP CUTOFF
FILTER**

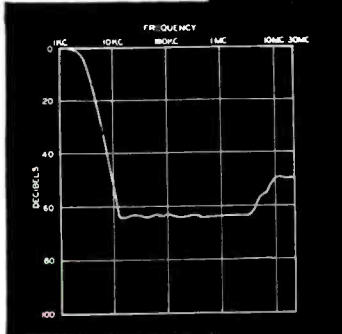
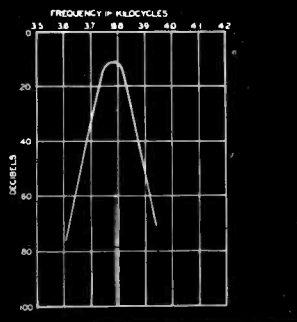

**ATTENUATES
10KC TO 30
MEGACYCLES**

**LOW FREQUENCY
— LOW PASS
FILTER**

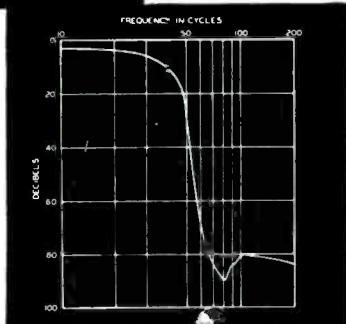

FOR TRANSFORMERS



This high gain transformer is used in a 60 cycle chopper circuit for measuring small DC voltages—primary inductance 10 Hys. Ratio 250:1 — 100 DB of shielding.



This unit weighs but 1.3 oz. The rectifier in which it is employed delivers 2000 V DC with vibrator-battery input.



This input transformer was the perfect answer for an amplifier with a difficult hum problem. The locking universal joint mounting permits orientation to point of minimum hum level.



This pulse transformer has tight requirements. Frequency response is ± 3 DB from 80 KC to 4 MC.

Write for our Catalog PS-408

United Transformer Co.

150 VARICK STREET

NEW YORK 13, N. Y.

EXPORT DIVISION: 13 EAST 40th STREET, NEW YORK 16, N. Y.,

CABLES: "ARLAB"

RCA
Remote Amplifier
Type BN2A

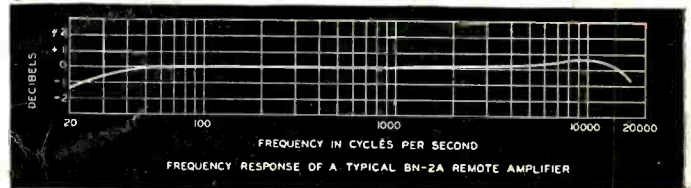

High-Fidelity Remotes

-30 to 15,000 cps!



HERE IS ONE of the finest high-quality amplifiers yet designed for remote services. Distortion is less than 1 per cent over the complete frequency range of the instrument. High-level mixing reduces general noise level by at least 15 to 20 db. Stabilized feedback holds program quality steady over a wide range of operating conditions. Each of the three amplifier channels provides an over-all gain of 92.5 db—enough to help high-quality microphones through nearly any situation.

The BN2A is plenty flexible, too. You can feed the program to the output channel and the public address system *simultaneously*. You can isolate the remote amplifier and feed the cue circuit into the PA *direct*. You can monitor both circuits. You can switch in as many as four microphones—through the four microphone inputs provided

(inputs 3 and 4 are switchable to mixer 3). And you can run the BN2A from a battery simply by removing the power line connector—and plugging in the battery cord.

Weighing only 29 pounds, and completely self-contained for a-c operation, this sturdy remote amplifier carries as lightly as a brief case. More about the BN2A from your RCA Broadcast Sales Engineer. Or drop us a card. Dept. 7-I.

SPECIFICATIONS

Mixing Channels.....	Three	Power Source.....	105-125 v. a. c. (or battery)
Microphone Input Combinations.....	Four	Size.....	14½"L., 9½"D., 10"H.
Freq. Response (±1.0 db).....	30-15000 cycles	Weight.....	29 lbs. (complete with a-c cable and spare tubes)
Noise Level.....	-70 db below +18 dbm	Cabine.....	Deep umber-gray metalustre wrinkle. Removable aluminum front cover.
Distortion.....	Less than 1% rms		
Rated Output Level.....	+18 dbm		

The One Source for Everything in **Broadcasting**—is RCA



BROADCAST EQUIPMENT
RADIO CORPORATION of AMERICA
ENGINEERING PRODUCTS DEPARTMENT, CAMDEN, N.J.

In Canada: RCA VICTOR Company Limited, Montreal

AUDIO ENGINEERING

JUNE
1948

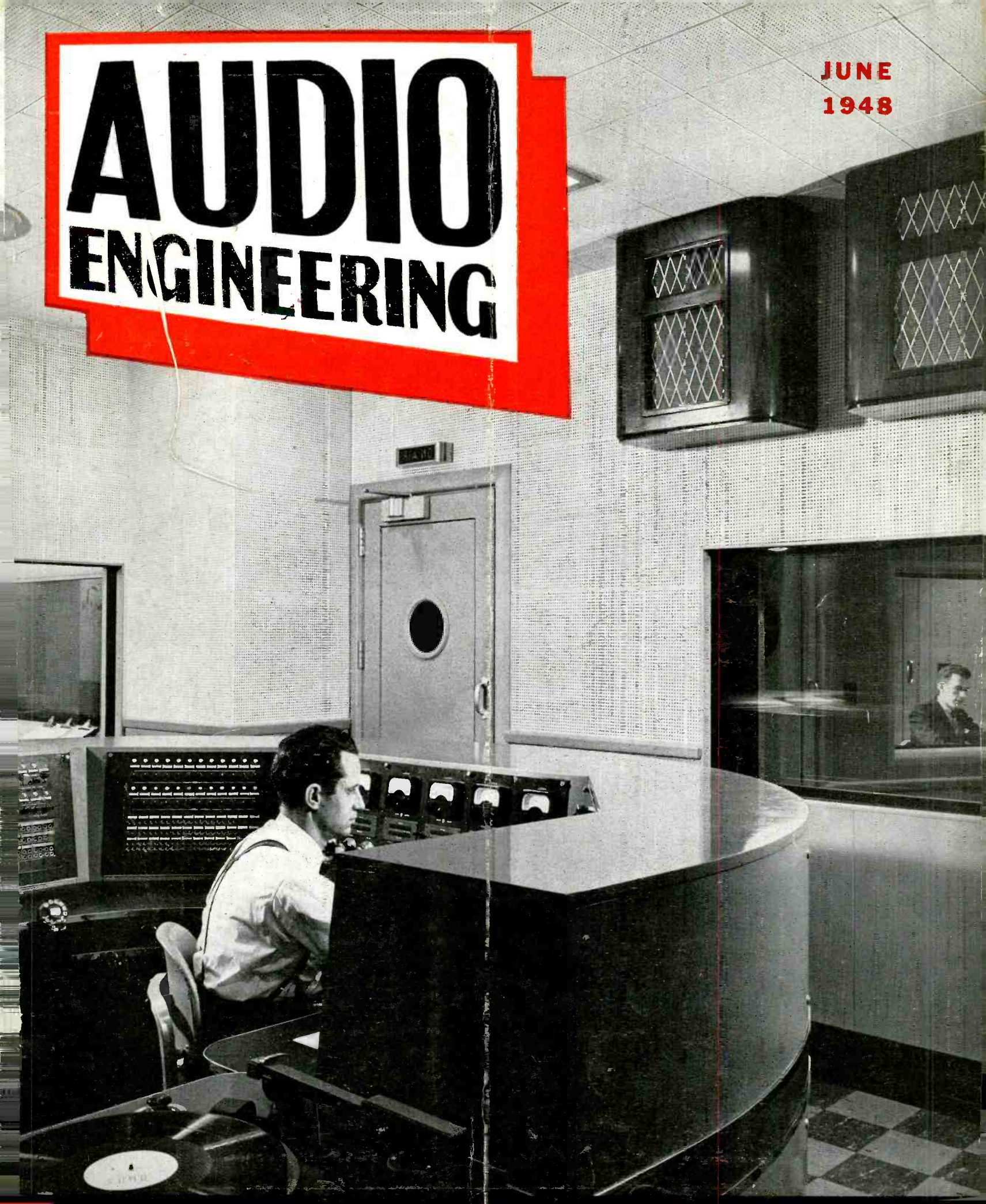

THE JOURNAL FOR SOUND ENGINEERS

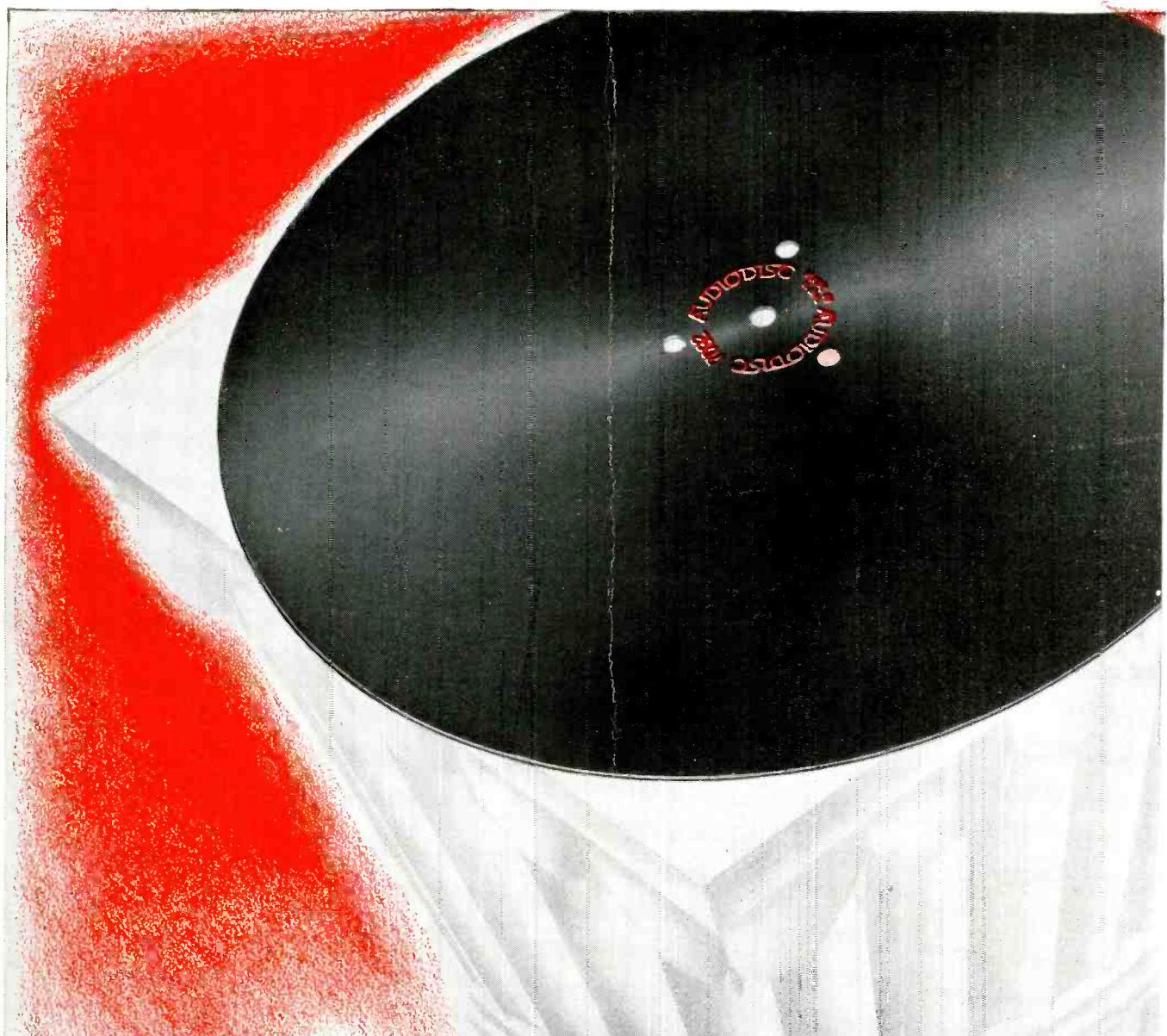

TEN YEARS OF LEADERSHIP

Ten years ago the first AUDIODISC was manufactured . . . manufactured by a patented precision-machine process, which produced the finest recording disc known.

During this decade AUDIODISCS have been rated first in every field of sound recording . . . radio broadcasting, commercial recording studios, the phonograph record industry, motion picture studios, educational institutions, home recording, research laboratories and governmental agencies. In every country throughout the world, AUDIODISCS are regarded as the true standard of recording quality.

At first the output of AUDIODISCS was measured in tens of thousands, then in hundreds of thousands and later in millions per year. Today this highest rate of production is being maintained and the quality is the finest yet achieved.

AUDIO DEVICES, INC., 444 Madison Avenue, New York 22, N.Y.

Export Department: Roche International Corp., 13 E. 40th Street, New York 16, N. Y.

AudiDiscs are manufactured in the U.S.A. under exclusive license from PYRAL, S.A.R.L., Paris



they speak for themselves **audiDiscs**

AS NEW AS THE FUTURE!

... the only transformer
line of its kind

*Advanced, practical
engineering
gives you*

THESE OUTSTANDING FEATURES



CHICAGO TRANSFORMERS

Sealed in Steel

Have Complete Details On Hand For Your New Equipment Planning

WRITE TODAY FOR CATALOG

CHICAGO TRANSFORMER Division, Essex Wire Corporation

3501 ADDISON STREET, CHICAGO 18, ILLINOIS

1 SEALED IN STEEL CONSTRUCTION

Chicago Transformer's drawn steel cases provide convenient, compact mountings; seamless steel-wall protection against atmospheric moisture and corrosion; unsurpassed strength and rigidity to withstand shock and vibration; clean, streamlined appearance that adds eye-appeal to any equipment.

2 CHOICE OF CONNECTORS

Solder lugs or wire leads. Most units are available with identical ratings in two base styles to fit your price and/or wiring preference.

3 CHARACTERISTICS KEYED TO MODERN TUBES

Voltage, current, and output ratings have been designed for one purpose only—to fill the requirements of the receiving, transmitting, and industrial electronic tubes currently most in demand. No listings wasted on obsolete circuit needs. Result—a condensed, yet comprehensive, line that's right in step with today's new circuit designs.

4 EXACT MATCHING OF REACTORS

with power transformers. Current ratings of plate and filament supply transformers and of the high voltage plate transformers are matched by choke capacities specially designed for the purpose. Mountings match, as well, for uniform, "tailored" good looks.

5 TRUE HIGH FIDELITY THROUGHOUT 3 RANGES

Frequency response within $\pm 1/2$ db; distortion exceedingly low, even at low frequencies. These are the characteristics of the input and output transformers. Driver and modulation transformers provide response within ± 1 db. All audio units are designed for frequency ranges that fit three classes of up-to-date audio application. Full Frequency Range: 30-15,000 cycles (good up to 20,000 cycles, where required). Public Address Range: 50-10,000 cycles. Communications Range (voice): 200-3,500 cycles.

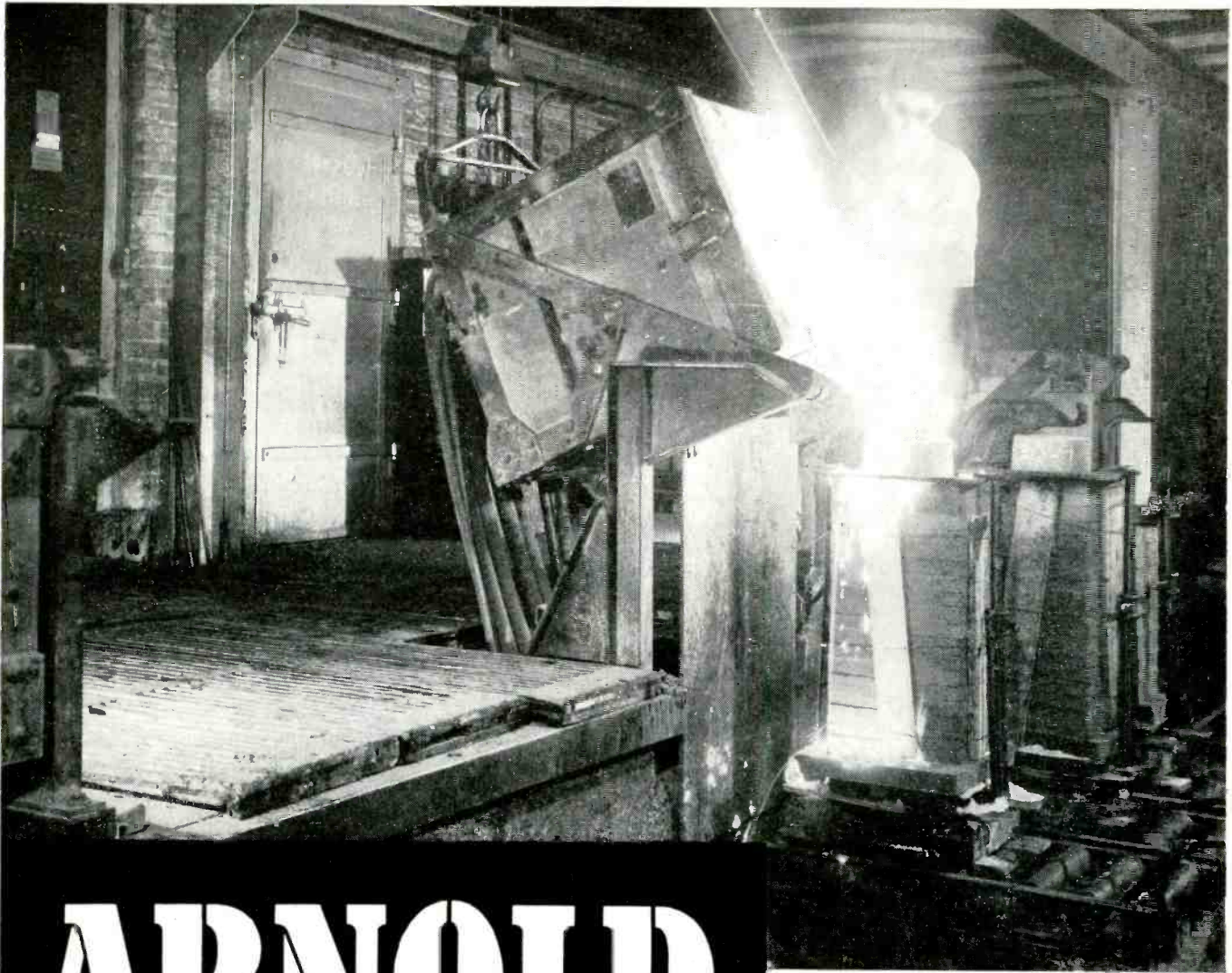

ARNOLD

PERMANENT MAGNETS

*100% quality-controlled
at every step from
the design board
to final assembly*

The increased efficiency and economy you'll realize in the use of Arnold Permanent Magnets are *constant* factors. The thousandth unit is exactly like the first—because they're produced under controlled conditions at every step of manufacture, to bring you complete uniformity in every magnetic and physical characteristic. Count on Arnold Products to do your magnet job *best*—and they're available in any grade of material, size, shape, or degree of finish you require. Write us direct, or check with any Allegheny Ludlum field representative.

THE ARNOLD ENGINEERING CO.

Subsidiary of
ALLEGHENY LUDLUM STEEL CORPORATION

147 East Ontario Street, Chicago 11, Illinois

Specialists and Leaders in the Design, Engineering and Manufacture of
PERMANENT MAGNETS



W&D 1297