

MAY  
1944

# AUDIO ENGINEERING

HUEBNER



THE JOURNAL FOR SOUND ENGINEERS



**ALREADY  
PROVED—**

**IN  
1001 NEW  
APPLICATIONS**

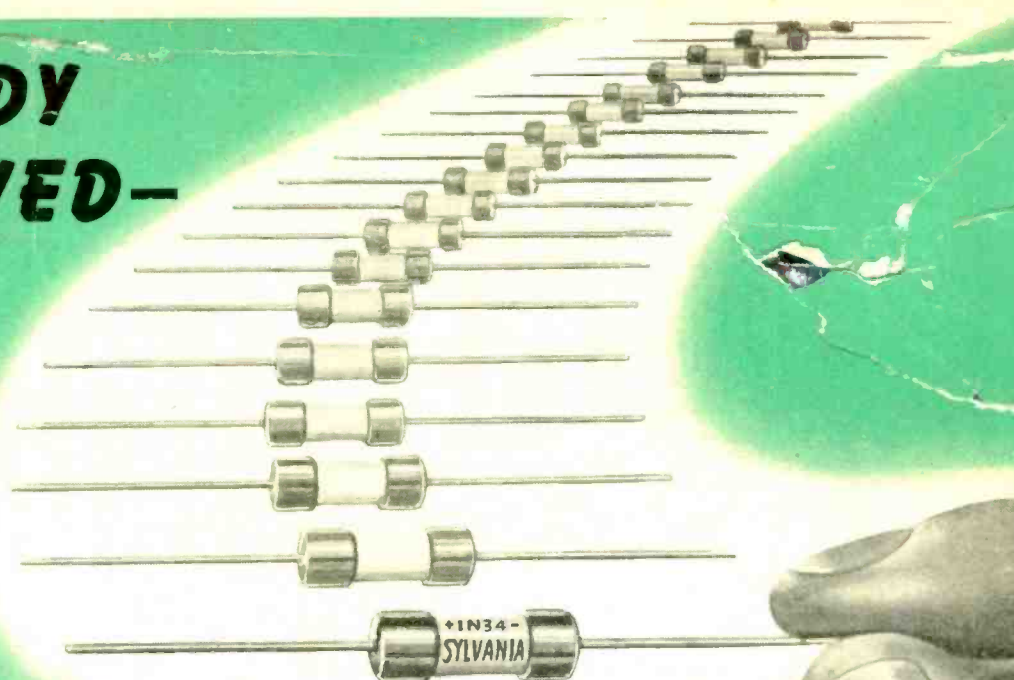

**THE SYLVANIA 1N34  
GERMANIUM CRYSTAL DIODE**

Introduced only a short time ago, the 1N34 Crystal Diode has already established its value in a long list of applications calling for a circuit element with non-linear characteristics.

Advantages of the 1N34 which have led to its widespread acceptance are: small size; pigtail construction, permitting soldering into place; low forward resistance value; low shunt capacitance; increased frequency range.

A typical application of the 1N34 in the field of audio engineering is in the design of automatic volume expansion and compression equipment for use in phonograph recording and playback, circuit for which is shown at the right. Note particularly the use of four 1N34 units in the bridge rectifier. Here use of the 1N34 results in much lower conducting resistance, reducing the charging time of the filter condenser following the bridge, and giving more rapid action of the circuit.

*Sylvania Electric Products Inc., Electronics Division, 500 Fifth Avenue, New York 18, N. Y.*

**SCHEMATIC DIAGRAM OF VOLUME EXPANDER AND COMPRESSOR**

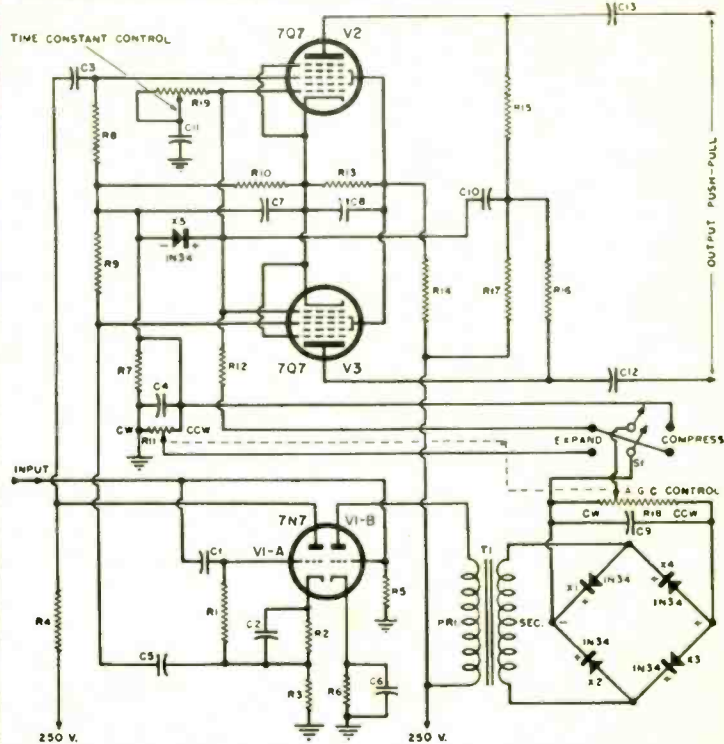

- |  |   |
|--|---|
| $R_1, R_6, R_8, R_9$ —750,000 ohm, ½ w. res.     | $C_1, C_5$ —.1 $\mu$ fd., 400 v. cond.                                      |
| $R_2$ —1000 ohm, ½ w. res.                       | $C_2, C_7$ —25 $\mu$ fd., 25 v. elec. cond.                                 |
| $R_3, R_4, R_7$ —10,000 ohm, ½ w. res.           | $C_3, C_{12}, C_{13}$ —.1 $\mu$ fd., 600 v. cond.                           |
| $R_5$ —2000 ohm, ½ w. res.                       | $C_4$ —8 $\mu$ fd., 250 v. elec. cond.                                      |
| $R_{10}$ —620 ohm, ½ w. res.                     | $C_6$ —10 $\mu$ fd., 25 v. elec. cond.                                      |
| $R_{11}, R_{18}$ —Dual 250,000 ohm pot.          | $C_8$ —8 $\mu$ fd., 350 v. elec. cond.                                      |
| $R_{12}$ —250,000 ohm, ½ w. res.                 | $C_9$ —.02 $\mu$ fd., 400 v. cond.  |
| $R_{13}$ —51,000 ohm, ½ w. res.                  | $C_{10}$ —.01 $\mu$ fd., 600 v. cond.                                       |
| $R_{14}, R_{15}, R_{16}$ —100,000 ohm, ½ w. res. | $C_{11}$ —1 $\mu$ fd., 200 v. cond.   |
| $R_{17}$ —75,000 ohm, ½ w. res.                  | $T_1$ —Audio trans. 1/3.5 ratio   |
| $R_{19}$ —500,000 ohm carbon pot.                | $X_1, X_2, X_3, X_4, X_5$ —1N34 crystal diodes<br>(polarities as indicated) |

**SYLVANIA  ELECTRIC**  
MAKERS OF ELECTRONIC DEVICES; RADIO TUBES; CATHODE RAY TUBES; FLUORESCENT LAMPS, FIXTURES, WIRING DEVICES; ELECTRIC LIGHT BULBS

31 No. 3

Member of Audit Bureau of Circulation



Successor to RADIO

John H. Potts, Editor

C. G. McProud, Managing Editor
S. L. Cahn, Adv. Director
L. B. Dresser, Edit. Prod. Mgr.

Sanford R. Cowan, Publisher

O. P. Ferrell, Asst. Ed.
H. N. Reizes, Adv. Mgr.
J. M. Wheeler, Circl. Mgr.

Editorial Advisory Board

Howard A. Chinn
John D. Colvin
C. J. LeBel
J. P. Maxfield
George M. Nixon

Representatives

James C. Galloway
816 W. 5th St., Los Angeles 13,
Calif., MUtual 8335

Harris & Floyd
297 Swanston St., Melbourne,
C. 1, Victoria, Australia

Established 1917

CONTENTS MAY, 1947

Vol. 31, No. 3

Table listing articles such as Transients, Magnetic Tape Recorders in Broadcasting, Audio Systems for FM Broadcasting, etc., with page numbers.

TECHNICANA

Table listing technical articles such as Reducing Distortion—Liveness in Broadcasting, Graphical Characteristics of Cathode-Coupled Triode Amplifiers, etc.

COVER ILLUSTRATION

Norman Pickering testing his new pickup and (lower photo) Western Electric control consoles in operation at WOR.

AUDIO ENGINEERING (title registered U. S. Pat. Off.) is published monthly at Boston Post Road, Orange, Connecticut, by Radio Magazines, Inc. J. H. Potts, President; S. R. Cowan, Sec'y-Treas. Executive and Editorial Offices at 342 Madison Avenue, New York 17, N. Y.



# NOW—quick, simplified

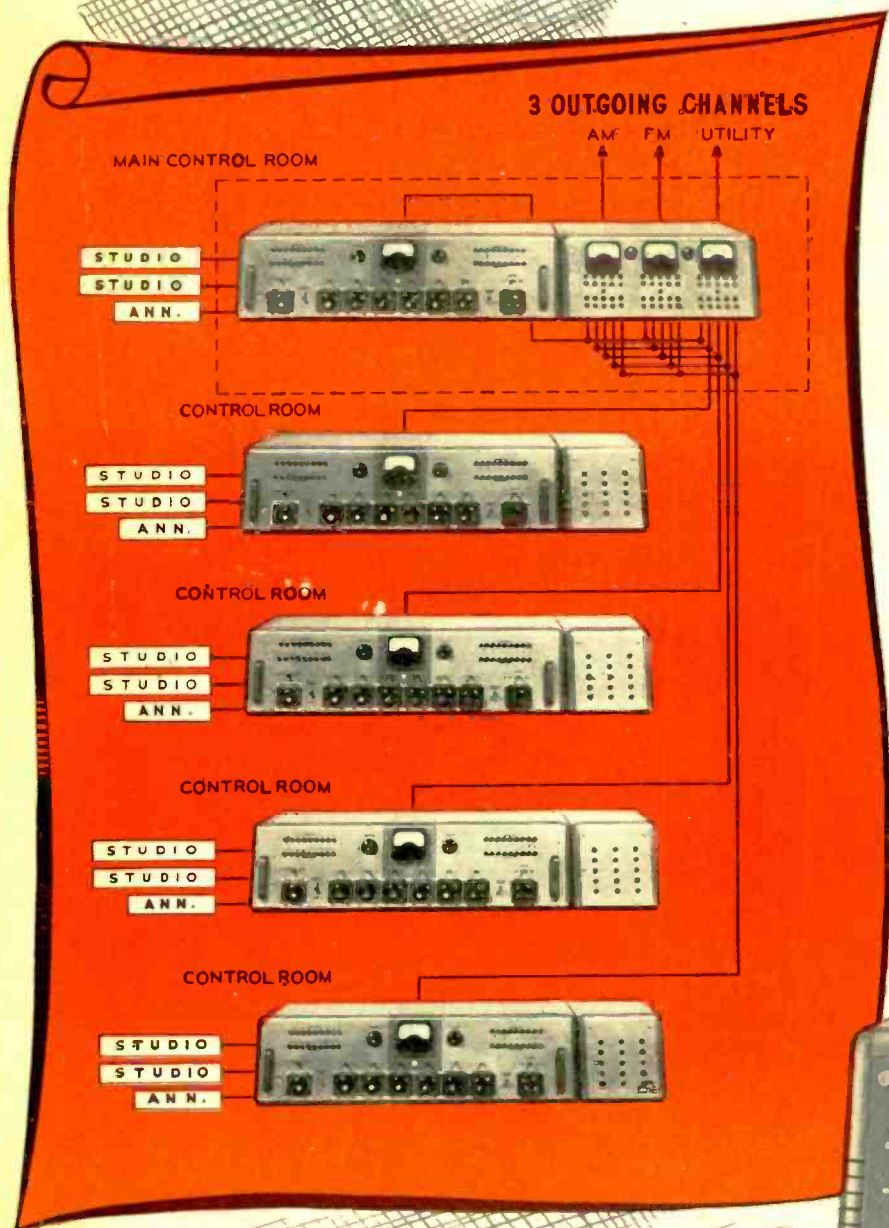

## Type BCS-1A Master Switching System

This system consists of one Master Switching Console (above, right—shown with an RCA 76-B4 Console) and one or more sub-control units (below). It contains all the relays needed for any combination of switching functions.

Up to five sub-control rooms can be used with the master console, each of which can handle from one to three studios.

Status lights give accurate picture of "On Air," "In Use," "Ready," and "On-Off" conditions in all control rooms for each outgoing line. Unique design features prevent feeding more than one program to any one line, although supporting program material can be handled as remotes from the originating studio. Sub-control units act as relay control stations between studios and master control unit.





# switching for AM-FM Programming

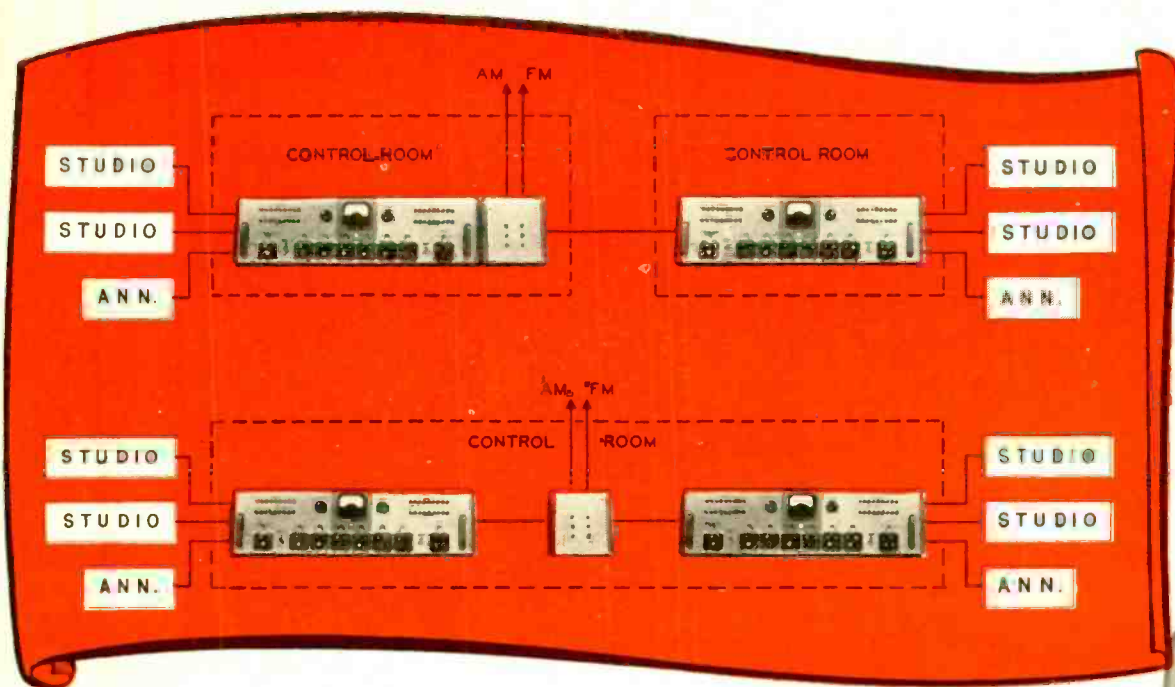

## Type BCS-2A Switching System

Two studio inputs may be switched independently to either of two outgoing lines. Mechanical interlocking prevents feeding two inputs to same line. Handles up to four studios and two announce booths. Two examples of the layouts possible are shown at left.



## These new RCA consolette switching systems co-ordinate all studio-station functions

Here's another example of RCA's program of providing "packaged" broadcast equipments having the flexibility and performance of custom-built jobs.

The two Switching Consoles shown, in connection with standard RCA Consolettes of identical styling, give you sufficient latitude to perform intricate AM, FM and network programming operations—easily, precisely and quickly. Choice of model depends upon the complexity of your station's operating requirements.

The BCS-1A Console is designed for

the more elaborate station . . . switching the outputs of as many as five control consolettes to three outgoing lines. Many combinations are practicable. Inputs from studios, network, recording rooms or frequent remotes can be monitored and switched to transmitters or network lines. Electrically interlocking controls have reduced the possibility of switching error to the vanishing point.

Managers of stations requiring only two consolettes will find the RCA Type BCS-2A Console the ideal switching sys-

tem. Used with two RCA 76-B4 Consolettes, program material from up to four studios and two announce booths is routed to desired outgoing lines (AM and FM, or either transmitter and a network line).

Both types of RCA Switching Systems are designed for long-range station planning. They have sufficient flexibility to take care of future expansion. Complete details may be obtained from Engineering Products Dept., Section 115-E, Radio Corporation of America, Camden, N. J.



**BROADCAST EQUIPMENT**  
**RADIO CORPORATION of AMERICA**  
**ENGINEERING PRODUCTS DEPARTMENT, CAMDEN, N. J.**

In Canada: RCA VICTOR Company Limited, Montreal]

# Transients

---

## INTRODUCING "AUDIO ENGINEERING"

★ As announced in the February-March issue of Radio, we have decided to devote the editorial content of this magazine to the sadly neglected audio engineering field, and we want to take this opportunity to welcome the thousands of new readers who have joined our group. This is *your* magazine, and we invite your comments and recommendations. Our editorial advisory board is composed of top-flight experts in the sound engineering field. If you have problems which they can help you solve, they shall be glad to be of service.

AUDIO ENGINEERING will present articles, charts, and news concerning developments in sound engineering as it relates to commercial broadcasting, transmitter and receiver manufacturing, sound-on-film equipment, recording (disc, wire, and tape), public address, industrial sound, and acoustics. We are concentrating on thoroughly practical articles, avoiding highly mathematical presentations unless they are of vital importance and indispensable to the discussion.

Because so little attention has been devoted to recording, we are placing particular editorial emphasis on this subject. No comprehensive engineering treatise on this subject has been published in the past thirty years, and very little text has appeared in any engineering journal. This branch of the industry is in sad need of standardization; different makes of records do not have the same cross-over frequencies, the degree of pre-emphasis at the higher frequencies varies, groove depth is not always the same, and there are still other factors which affect reproduction upon which no standards have been selected. Therefore, even the best reproducing equipment cannot give equally satisfactory results with all makes of records. By offering this magazine as a forum for the interchange of ideas, we hope to be able to contribute in some measure to eventual standardization of these varying techniques.

Another feature, unique in a technical magazine, is the page on which records are reviewed. The author, Mr. Canby, also reviews records for the *Saturday Review of Literature*, but as you will note, he approaches his topic from a more technical viewpoint in

his presentations here. Because so many of our readers are record fans after hours, and because those who are professionally engaged in broadcasting may find the recommendations helpful, we feel that this special monthly feature will be of considerable interest.

## HIGH FIDELITY

★ No discussion of audio engineering gets very far before the matter of fidelity is brought up. Because this point is so highly controversial, a number of articles on this subject are scheduled for early publication. These will include results of listener preference tests conducted in England, as well as in this country. Perhaps we may be jumping the gun, and perhaps some members of our editorial board will not agree with the writer, but we do believe that some of the tests which indicate that listeners prefer a medium band to a wide frequency range merely show that there is something wrong with the reproducing equipment or measuring technique.

It seems inconceivable that those who listen to and enjoy "live" orchestral presentations should prefer to hear reproduced music in which some of the frequencies present in the original are suppressed. It is claimed that the binaural effect present in live music may be one reason; this may be so. But there is no adequate proof. On the contrary, at one recent demonstration of binaural reproduction, we understand that the presentation went on for eleven minutes before it was discovered that one of the two sound tracks was not operating, due to a defective exciter lamp.

One interesting listener preference test conducted in England showed initially that the majority preferred a medium frequency range rather than the full range. But when these comparison tests were repeated many times with the same group of listeners, eventually they grew to prefer the wider frequency range.

In any event, it is apparent that this is no subject on which snap judgments can be made. And, further, that there is a very great need for a thorough and impartial investigation of the entire question.

—J.H.P.



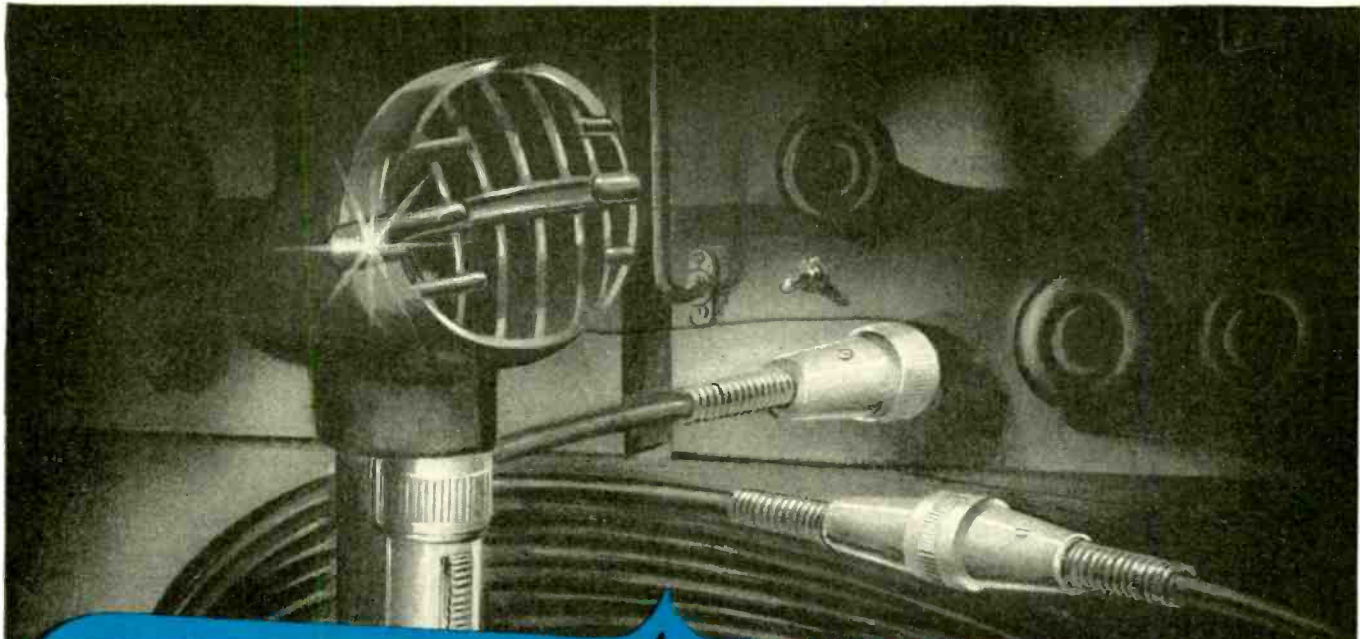

## LOWEST LOSS from Microphone to Chassis with Amphenol Connectors and Cables

Rated high in dielectric value, and with an improved power factor, Amphenol low-loss Microphone Connectors and Cables insure maximum efficiency in sound equipment. Dependable and easy to install, they are widely used by leading manufacturers of sound equipment apparatus, photo electric devices, home recorders and a complete range of similar items.

The Amphenol line is precision-built, compact, lightweight and complete. Microphone plugs, mating connectors and receptacles have unbreakable, chromium-plated brass shells and low-loss bakelite inserts. Cord protectors or cable clamps relieve strain on contacts. Threaded coupling rings screw onto mating coupling threads to provide "yank-proof" connections that are free from noise, leaks or shorts. Accidental disconnects are impossible. Multi-contact connectors are polarized.

**AMPHENOL MICROPHONE CABLES** are unusually low in capacitance for their small diameters.\* Light in weight, their durable plastic jackets remain flexible down to  $-40^{\circ}$  F. May be used with standard connectors and cord protectors.

Cables are available in either of two plastic jackets: Vinyl for heavy auditorium and outdoor use where cables are long and the trampling of crowds is a factor; polyethylene for home and cocktail lounge applications.

Write today for new booklet describing Amphenol Microphone Connectors and Cables.

\*Capacitance per foot ranges from 20 mmf. for Amphenol No. 21-120 (.242" diam.) to 35 mmf. for 21-156 (.155" diam.).

**AMERICAN PHENOLIC CORPORATION**  
1830 South 54th Avenue • Chicago 50, Illinois



Amphenol Connectors are available in straight and right angle styles in three types:

**SERIES 91:** Three and four contact microphone style, used on all types of portable apparatus. Since 1934, the standard of the sound industry.

**SERIES 80:** For standard single and two wire shielded cables such as: coaxial and microphone cables, twisted pairs, concentric lines, photo cell leads, etc.

**SERIES 75:** For standard single conductor shielded cable. Widely used in amplifiers, transmitters, photo electric devices, home recorders and similar equipment.



# BIGGEST NEWS IN AM!

It's Federal's New Triodes for 50 KW Transmitters —  
with **THORIATED TUNGSTEN FILAMENTS!**

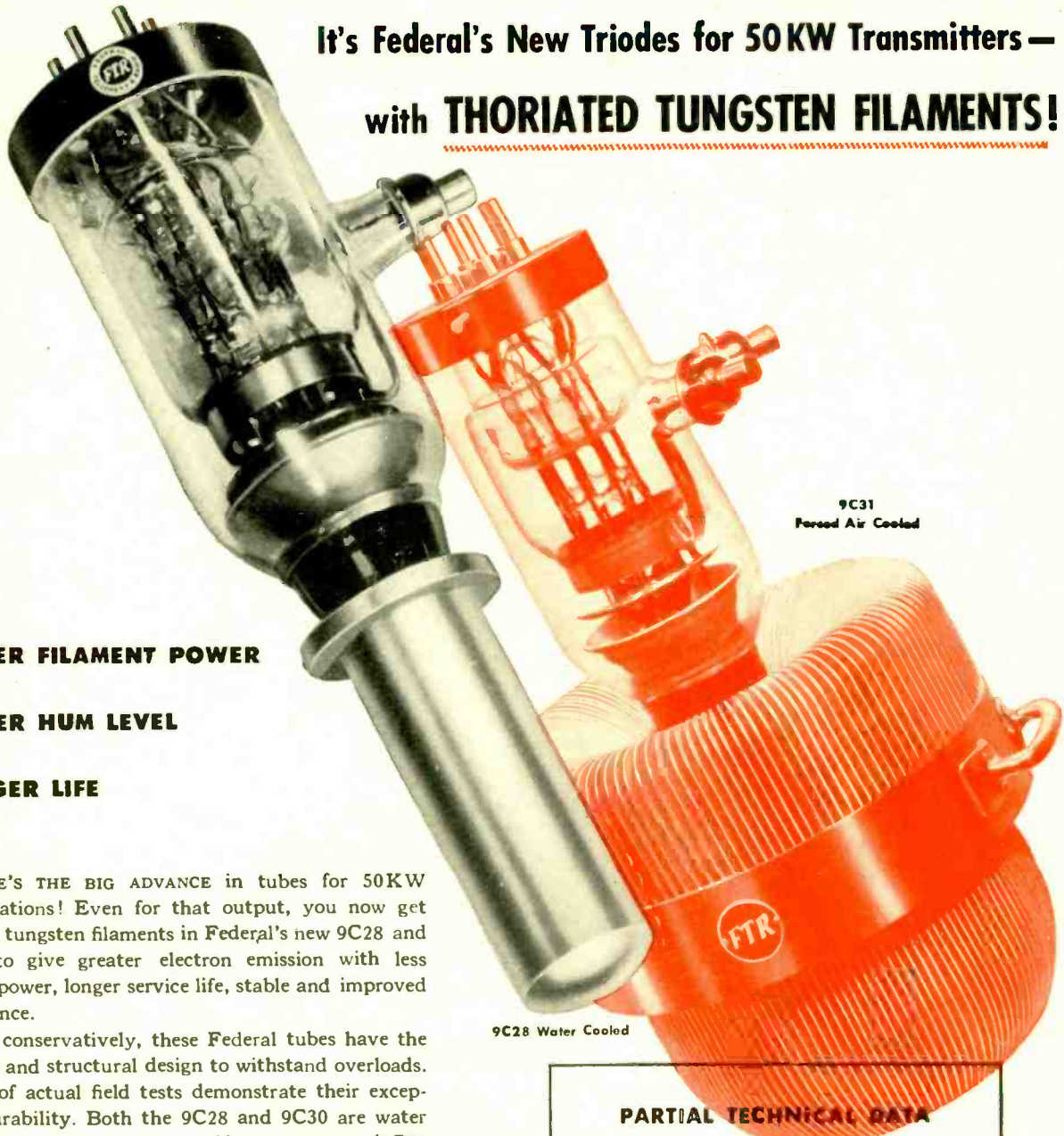

- LOWER FILAMENT POWER
- LOWER HUM LEVEL
- LONGER LIFE

**H**ERE'S THE BIG ADVANCE in tubes for 50KW stations! Even for that output, you now get thoriated tungsten filaments in Federal's new 9C28 and 9C30 — to give greater electron emission with less filament power, longer service life, stable and improved performance.

Rated conservatively, these Federal tubes have the electrical and structural design to withstand overloads. Months of actual field tests demonstrate their exceptional durability. Both the 9C28 and 9C30 are water cooled for maximum output. Alternate types (9C29 and 9C31), with air cooling, are also available. In a pair of either type you'll find new operating economy and low tube costs.

Federal's 38 years of tube engineering and manufacture show up once more in this latest "first". No wonder Federal tubes have consistently set the standards for performance in AM broadcast service. We'll be glad to send you more data on these tubes. Write department K 480.

#### PARTIAL TECHNICAL DATA

|                           | 9C28      | 9C30      |
|---------------------------|-----------|-----------|
| Filament voltage . . .    | 15 v.     | 15 v.     |
| Filament current . . .    | 135 amp.  | 135 amp.  |
| <i>Maximum Ratings</i>    |           |           |
| Plate Voltage . . . . .   | 12,000 v. | 15,000 v. |
| Plate Current . . . . .   | 10 amp.   | 8 amp.    |
| Plate Input . . . . .     | 100 kw.   | 120 kw.   |
| Plate Dissipation . . . . | 40 kw.    | 40 kw.    |

## Federal Telephone and Radio Corporation

In Canada: — Federal Electric Manufacturing Company, Ltd., Montreal.  
Export Distributors: — International Standard Electric Corp. 67 Broad St., N. Y.



100 Kingsland Road,  
Clifton, New Jersey



# Magnetic Tape Recorders in Broadcasting

HOWARD A. CHINN\*

**D**URING THE WAR, many of the members of the broadcasting industry who were with the Armed Services, had an opportunity to familiarize themselves with the potentialities and the limitations of magnetic wire recorders. Since the war, wire recorders have become (or are about to become) generally available for various applications. These include combination radio-recorders for the home, office dictation machines, recorded music for reproduction in trains, and both fixed and portable equipment intended for broadcast applications.

Although magnetic wire recorders are very satisfactory for many uses, they have limitations when it comes to meticulous, professional applications. For example, unless the wire is contained in plug-in type magazines, annoying (and sometimes disastrous) wire snarls are likely to be encountered, as anyone who has ever handled a wire recorded is well aware. Even if one has the patience—and good luck—to be able to disentangle one of these “bird nests,” it will be found that the wire has been weakened where bent too sharply and before long a break occurs, together with another wire (and personal) snarl.

The problem of flutter, caused by spurious speed variations of the driving mechanism, can be readily overcome in wire recorders. On the other hand, absolute speed accuracy is not simple to achieve. For broadcasting

●  
**The value of magnetic recorders in broadcasting is not generally appreciated. In this article, the author describes many of the more useful applications of this equipment in this type of service.**  
●

applications, it is generally considered desirable to be able to achieve an absolute speed that does not deviate from correct timing by more than 0.25%. That is, a recording exactly one-half hour in length should play back within 5 seconds of the time of the original performance. Accuracies

of this order are quite likely to be difficult, if not impossible, to achieve with the usual types of wire driving mechanisms.

Magnetic wire recording, from a home application viewpoint at least, has another serious limitation. The cost of the raw material itself—the magnetic wire—is much too high to encourage very many persons to keep on hand a large supply of reels containing favorite recordings. Present-day prices are in the vicinity of \$10.00 for sufficient wire for an hour's recording (at a speed that provides a medium tonal range), and the most optimistic have not forecast a decrease in this price of more than 50%.

Finally (and perhaps most important from a professional application viewpoint) when it comes to editing record-

\*Chief Audio Engineer, Columbia Broadcasting System.

The Rangertone tape recorder, currently in the development stage, is intended for professional recording applications. It is planned to use 14-inch diameter reels accommodating enough magnetic tape for one-half hour of recording at a tape speed of 30 inches per second. The erase, record and playback heads are contained in a plug-in assembly that facilitates maintenance and replacement. Push-button control provides for record, rewind, playback and stop functions. The white dial in the center of the top panel is a running time indicator (footage counter) that is of considerable value in “cueing” recordings.







Magnetic tape, having a paper or a plastic base, can be readily edited by taking out or adding lengths of tape as desired. A butt-joint splice is made by joining the two ends (Fig. 1A, left) and placing a small

piece of clear scotch tape on the back (uncoated side) of the magnetic tape (Fig. 1B). The excess Scotch tape is then trimmed with a scissors (Fig. 1C, right) so that it is no wider than the original magnetic tape. A

splice made in this manner will not add any spurious noise to the reproduction. For professional applications a modified 8mm film splicer makes it possible to undertake the operation more expeditiously.

ed material, the draw-backs of magnetic wire are just about as serious as for disc recordings. There just isn't any simple way to do it.

### Magnetic Tape

Recorders making use of a paper— or plastic-base magnetic material, are inherently capable of overcoming practically all of the shortcomings of wire recorders. Magnetic tape recorders, employing a steel tape at first and later both paper and plastic tapes coated with magnetic material, were first placed in regular broadcasting service in Europe. Prior to the war,

steel tape recorders were used rather extensively both in Great Britain and on the Continent. Although some machines employing steel tape were manufactured in this country, they were never used to any extent except possibly for voice-training purposes. The drawbacks of the steel tape are similar to those of magnetic wire except there is no twisting of the tape, of course, and high-quality recording is practical.

Although a paper-base magnetic tape was available in Germany during the war, an independent development program was undertaken in this country under an NDRC (National Defense Research Committee) contract. The objective, and the final result, was the development of a paper-base magnetic material, having magnetic properties equal to or better than the best available steel tape. This development was successfully completed just about the time the war ended.

### Advantages

As contrasted to other forms of magnetic recording material, a paper or plastic-base tape has many advantages. From a broadcasting viewpoint, perhaps the most important of these is the ability to cut and splice the tape. This provides an unexcelled opportunity to broadcast material otherwise unacceptable. For example during the 1946 New York State political conventions, CBS recorded the entire day- and night-long proceedings. Upon the completion of a day's recording, the material was reviewed and the highlights of the meeting spliced together into one interesting fast-moving program. This material, with just enough of the atmosphere (but without the interminable delays, roll-calls and other extraneous proceedings of any large meeting) was then broadcast locally. Within the space of single program periods, the radio audience was thus enabled to hear all the important speeches and transactions of the day. The recording, the editing, and the broadcasting were on the scene with portable equipment. This seems to be the most feasible method of bringing this interesting program material to the broadcast listener. A number of potential similar applications will immediately suggest themselves to every broadcaster.

In the simplest form, slicing of magnetic tape can be accomplished with a pair of scissors and a roll of scotch tape, Fig. 1. For more speedy splices, a modified 8-mm film splicer is a great assistance. Of no small importance, in connection with splicing magnetic tape, is the fact that it is practically free of handling difficulties. A reel can be dropped to the floor or otherwise mishandled without fear of hopeless tangles of tape.

The ease with which tape may be handled also lends itself to rapid rewind. For example, in a relatively simple type of recorder intended for home use, a rewind speed of approximately 60 to 1 has been achieved. That is, a one-half hour recording can be rewound in about 30 seconds.



Fig. 2. The Brush BK-401 Soundmirror is a magnetic tape recorder having the general size and appearance of a conventional table-model phonograph. It is a complete recorder and reproducer and is capable of one-half hour of continuous operation. Recordings can be made from the microphone provided with the unit, from a radio receiver or any other source of audio signals. Convenient controls are provided to perform the various operations. The reels, which are 7 inches in diameter accommodate 1250 feet of 1/4 inch wide, paper-base magnetic tape.



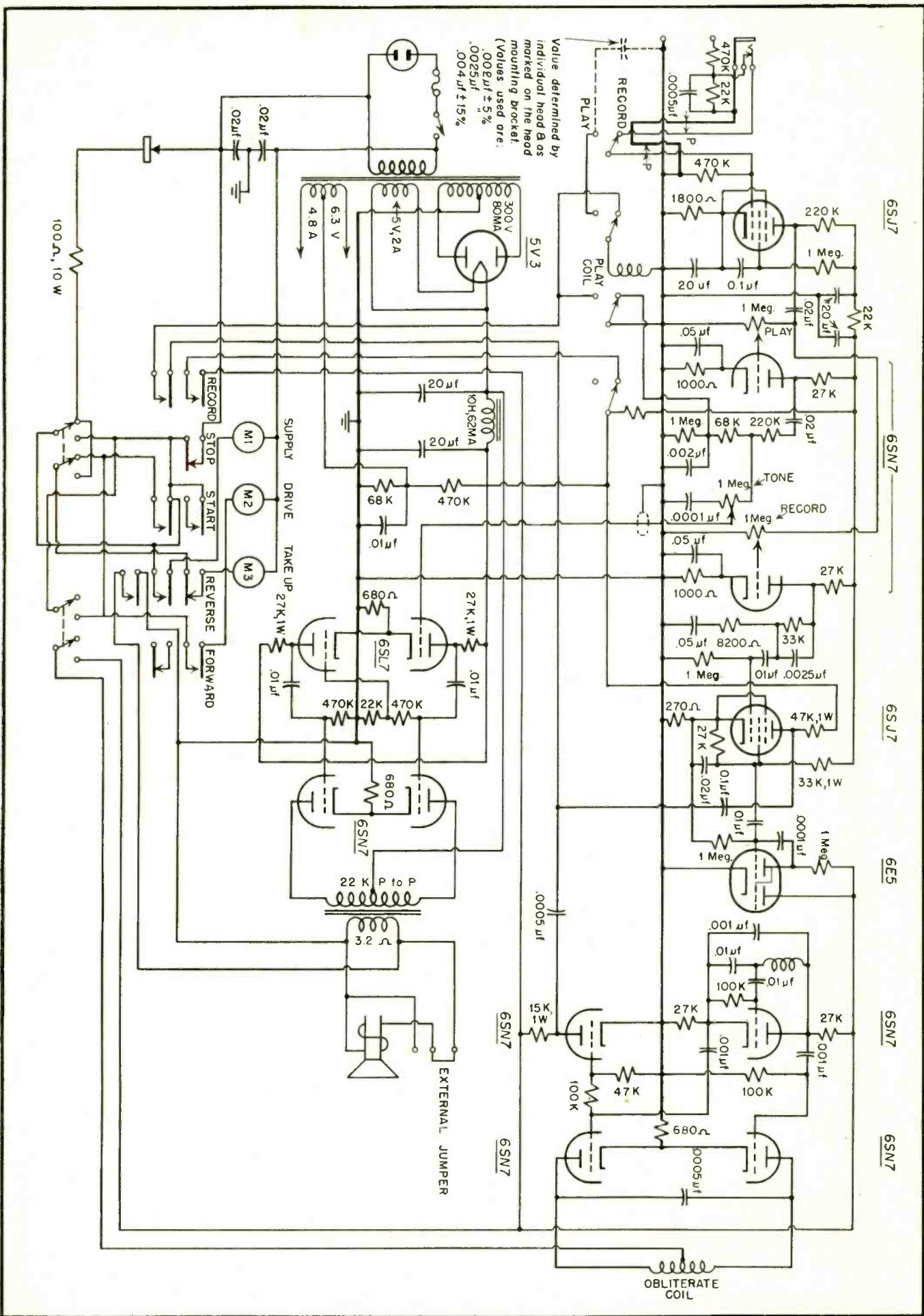

Fig. 3. From this detailed circuit diagram of the Brush BK-401 Soundmirror it is seen that except for the input amplifier stage, completely separate channels are provided for recording and reproducing. By avoiding the need for performing dual functions optimum tube and circuit arrangements can be used for each operation. Two input circuits are provided, one for high impedance microphones (J-1) or other low-level audio source and the other (E-1) for somewhat higher-level sources.



electronic and mechanical possibilities immediately suggest themselves for tape recording machines. For example, with plastic-base tape, consideration may be given to the use of perforations, as used for 8 mm movies. A sprocket drive employing conventional arrangements can provide exact synchronism, of course. These and other systems not requiring perforations lend themselves to accurate absolute speed operation.

Just as with magnetic wire, tape may be used over and over again. As a matter of fact, it is for applications where a permanent record is not required that magnetic recording is at its best from the economic viewpoint. On the other hand, the cost of paper-base tape promises to be sufficiently low so that it can be given consideration for those applications where a recording is to be retained for a considerable length of time. Even though machines have not yet become available on a widespread basis for utilizing paper tape, the cost for the material is already down to about one-fifth of magnetic wire costs—the comparison being made on the basis of a tape and a wire speed that results in comparable quality. There is every reason to believe that even lower costs can be expected for the paper tape.

Cost considerations (together with others) will determine whether a paper or a plastic base should be used for a given application. One of the great advantages of a magnetic material is the ability to erase the recording, after it has served its purpose, and to re-use the recording medium. Temporary recordings of this type (particularly if they are likely to be subject to considerable editing by splicing) can perhaps be made most economically on a paper-base tape. As a matter of fact, even recordings that are to be kept for several years may well be made on a paper tape in order to keep the investment in tape at a minimum.

On the other hand, for applications where the recordings are of a documentary nature and are to be preserved for an exceedingly long time, it may be advantageous to make use of a plastic-base tape. The cost of such tape will be greater than for a paper-base tape and the needs of the application in hand must justify the additional expense.

Among the other factors that must be considered in selecting the type of tape is the matter of tape elongation or stretch. If no special means (timing marks, sprocket holes, etc.) are employed for obtaining high absolute-speed accuracy, then the tape whose length is most stable with changes in temperature, humidity and time, will provide the best absolute-speed accuracy, all other factors being equal.

## Magnetic "Echoes"

One type of plastic tape was developed in Germany that, at first glance, seems to have many advantages. It consists of a plastic in which the magnetic material is impregnated—that is, uniformly distributed throughout the material. With a tape of this type, the magnetic material is held with a better bond than when simply coated upon the surface of a carrier or base.

It has been found, however, that tape of this type is subject to magnetic "leakage" from layer to layer. This phenomenon is most readily detectable when a fully modulated signal is recorded on this type of tape, with un-recorded tape immediately before and immediately after the recording. Upon spooling the tape in the usual manner, the recorded signal impresses a magnetic image of itself upon the layers of tape immediately above and immediately below the layer containing the signal. Measurements have indicated that in the

background noise of the adjacent layers. The second layer away from the original recording contained no evidence whatsoever of an echo.

## Magnetic Tape Recorder

At the present time is only one magnetic tape recorder being manufactured in this country although plans are being made by several companies to enter the field. The unit that is available, Fig. 2, was designed in its entirety after V-J day and, in spite of material procurement problems, is already in production. Although this recorder was primarily intended for the home-recorder market, it is of considerable interest to the broadcasting industry as a demonstration of the features of magnetic tape recording. Its performance capabilities are such that it may be used to advantage for many broadcast applications until professional-model recorders become available.

The unit contains all the mechanical and electrical components necessary to

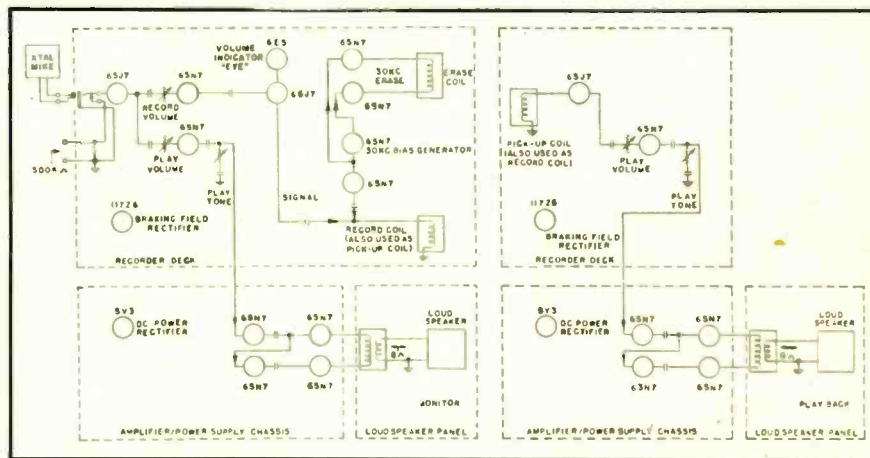

Fig. 4. This simplified functional diagram shows the general alignment of the circuits during recording (Fig. 4A) and during reproducing (Fig. 4B, right). In recording both low- and high-frequency pre-emphasis is introduced in the VT-2(A) and the VT-3 stages. Also, the reproducing channel acts as a monitoring loudspeaker channel and is provided with its own volume control. During playback, the plate voltage is removed from the supersonic bias generator and amplifiers and from the VT-3 amplifier stage. In addition, the recording coil is reconnected to serve as the pickup coil. The reproducing tone control provides an adjustable high-frequency roll-off, while low-frequency post-emphasis is introduced in the VT-2(B) stage.

layer immediately above and the one immediately below the original recording the "echo" is down only about 20 db in intensity as compared with the original signal. Four layers away, in both directions, the signal is just discernible in the noise background, but is too low in intensity to be measured by ordinary means.<sup>1</sup> A similar test made with a coated paper-base tape of American manufacture did not result in any measurable echo, even on the immediately adjacent layer although a weak signal was discernible in the

make and reproduce recordings. These include amplifiers, drive, take-up and rewind motors, supersonic bias and erase generator, erase and combination record-playback head, operating controls and a playback and monitoring loudspeaker. The size and external appearance of the unit is similar to a conventional table-model phonograph.

The various operations of recording, rewinding and playback are controlled by push-buttons. In order to guard against accidental erasing of recorded material, two particular push-buttons must be depressed simultaneously before a new recording can be made (the erasing head immediately proceeds the recording head and is energized only when the controls are in the position).

<sup>1</sup>The author is indebted to Colonel Richard H. Ranger, of Rangertone, Inc., for calling this phenomenon to his attention and to Mr. George Graham, of the National Broadcasting Company, for the measurements on the German tape.



# AUDIO SYSTEMS FOR FM BROADCASTING

J. D. COLVIN\*

**W**ITH THE COMING of hundreds of new FM broadcasting stations will be the construction of an almost equal number of new studio layouts. A number of these installations will be made by individual owners or organizations that have had long experience in the broadcast business, while a great many will be made by those to whom broadcasting is a new venture. It is for the possible assistance to the newcomers in the field that this article is being prepared.

Designing an audio system for FM broadcasting is an individual problem with each broadcast station that can be solved in its entirety only by the management and the engineering staff of the individual stations. Although many items of the system design are common to all stations, an almost equal number are found to be different from station to station. This variance is due to dif-

\*Audio Facilities Engineer, American Broadcasting Co.

●

**While the design of audio systems for FM broadcasting is an individual problem for each station, the author describes many basic circuit arrangements which are applicable to most cases. These may usually be adapted to the situation at hand with little modification.**

●

ferences found in programming, in policy, in local conditions, size and number of studios, and the past experience of the chief engineer. It is impossible to lay out in a single article a design of an audio system that will fit all the conditions of all the new layouts. However, the basic consideration and circuits of audio systems found to be applicable to the most cases will be presented. These can be applied with the necessary modifications to fit the

functional requirements of the individual station.

While the actual audio equipment employed in an FM system must receive careful attention, it in itself is not the most important part of the system and it is not the part of the design which is hardest to solve. Reliable manufacturers of broadcast equipment now have time-proven equipment and components that will meet FM requirements with regard to performance when properly assembled. However, the most carefully laid out system of the best components, meeting all functional requirements of operation, having the flattest frequency response, the lowest possible distortion and the least amount of hum and noise will fall absolutely flat on FM performance if the acoustical design of the studio is not correct. Although it is not the intent of this article to go into studio design, it is felt that a mention of its importance should be made before going into audio circuits. Studios must be quiet, must have a cer-

All audio and transmitter controls are centralized on the center control console of the CBS-KNX plant shown.

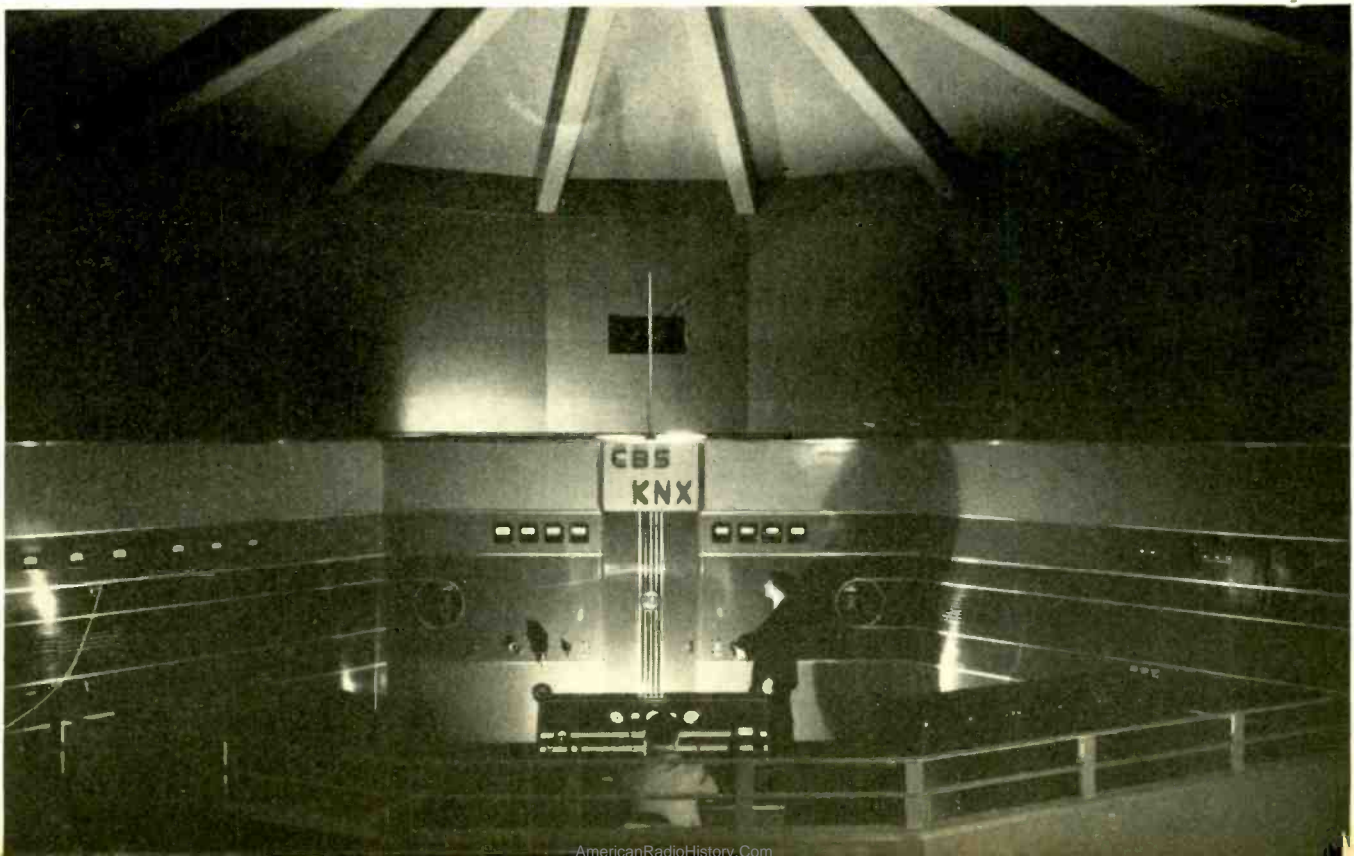



tain reverberation time and frequency response, must have certain dimensional ratios, and must have minimum volume per performer, and there are other important factors.

### Studio Design

For the actual design of the studios one should enlist the services of an acoustical consulting engineer who has had experience in the design of FM studios. Ideas on the arrangement of studio control rooms can be obtained from several of the manufacturers of broadcast equipment and by visiting other broadcasters who have up-to-date studios. The architect employed to make up the plans for the studios should work closely with the acoustical engineer. Too much stress cannot be laid upon the importance of arriving at the right design before construction work is started and the importance of attention to every detail during the building of the studios. Every dollar spent in properly designing the studios will be a good investment.

Starting at the assumed condition that the new station has decided rather completely upon the number and size of studios that will be required for its programming, that the studio site has been selected and that adequate design for the studios is being prepared, an outline of circuits and equipment will

be discussed. It is also quite safe to assume that the bulk of the new FM stations will decide on three studios as being sufficient for their operation; about three-fourths of the remainder will have five studios and the balance will run between eight and ten studios.

A distinct difference exists between the equipment required for a single control room—three studio layout, the five, and the eight-to-ten studio plant. For the three studio—single control room it would be well for economic reasons for the new station to consider the purchase of completely assembled consoles that are available from several manufacturers. These consoles have been thoughtfully designed and improved over the past five years and are capable of handling practically all of the requirements of the small three studio station. Four to six microphone inputs are usually available on these consoles, and an additional mike circuit for the announce booth is obtainable by a switching arrangement. Facilities for turntables, remote programs, auditions, cueing, signal lights and talk-back are available. Arrangements for emergency operation in case of main amplifier and power supply failures are provided in most cases. The fact that such units are built in quantities on production lines makes their cost run about one-half to one-third the cost of a cus-

tom-built equipment that would do the same job.

A word of caution should be injected concerning the use of these consoles. As built, they will give satisfactory performance in all functions for which they were designed. As is often the case, a broadcaster comes across an unusual condition of operation that cannot be met with the circuits available, but observes from the wiring diagram that if a certain change is made, the desired result can be obtained. Making changes in the console circuit may lead to trouble, such as an oscillation condition or a rise in hum level. Great care was exerted and much rearranging of cables was necessary in the design models to obtain stable operating conditions in consoles. Disturbing these cables should be avoided, if possible.

### Three-Studio Layout

In most cases, the small three-studio layout will not require any output switching nor additional line amplifier other than that supplied in the console. However, a bridging type of amplifier capable of delivering about a plus 24 dbm output and having approximately 40 to 50 db gain will find many uses around the station; such as, feeding programs to a network, bridging the program line for a feed to a recording amplifier, or as a booster for a long re-

Fig. 1. Diagram of three-studio layout employing two factory-built consoles for control equipment.

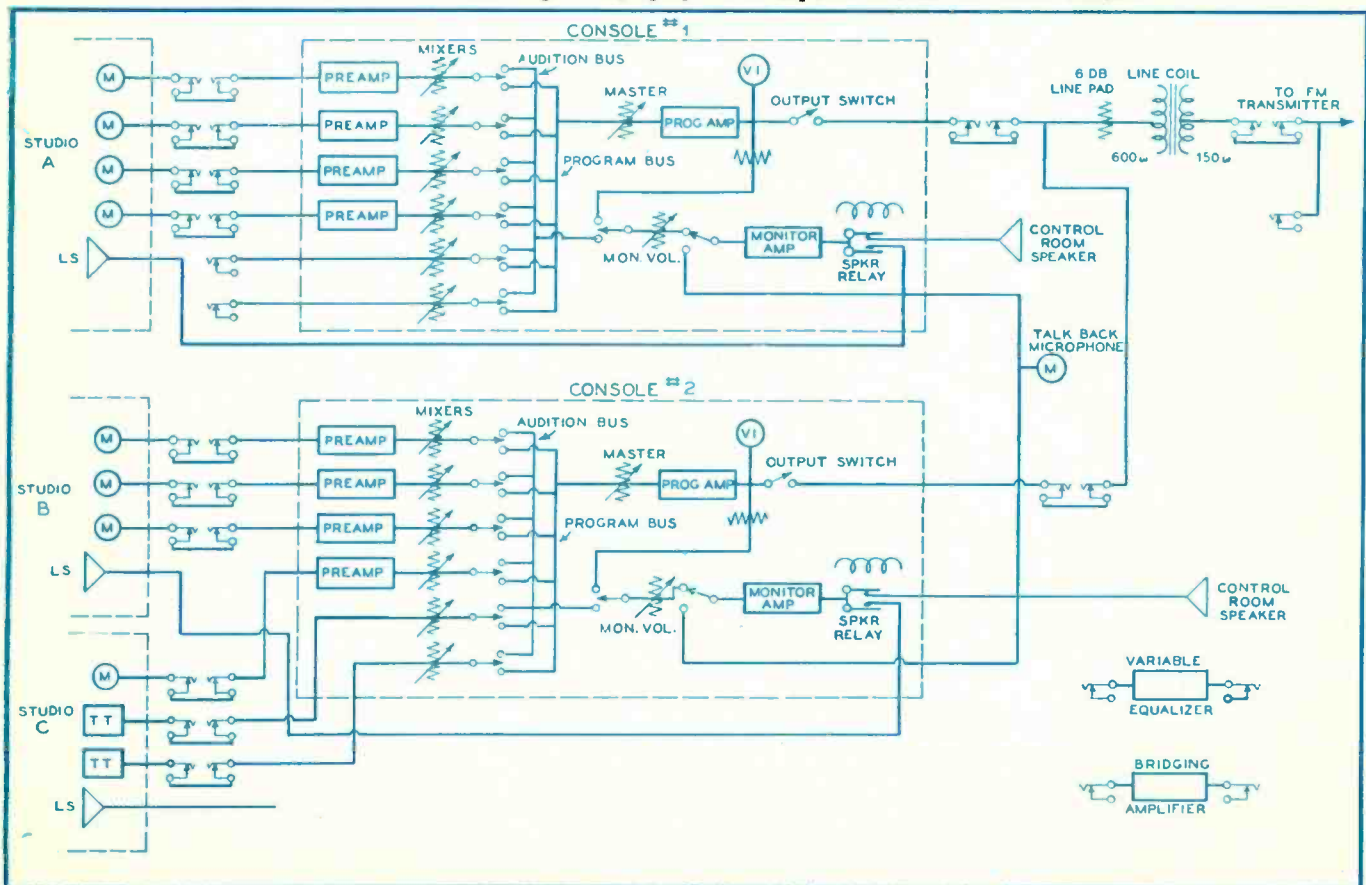



remote line that has required considerable equalization. Another useful external addition to such equipment is a strip of jacks through which are normalled all of the inputs to the console. This will allow a greater flexibility in setups. A variable line equalizer should be employed for compensation of remote lines. This equalizer as well as the bridging amplifier should also appear on the jack strip. Care should be taken when connecting the input and output of this amplifier to the jack strip so as to allow as much separation as possible from the microphone circuits.

Figure 1 shows in block diagram form a three-studio layout employing two factory-built consoles for control equipment. This diagram shows the basic circuits of these units that are common to the several manufacturers and include several of the added features mentioned.

Going on to the five-studio and the eight-to-ten studio layouts, the basic difference in these two size groups lies in the output switching and added refinements as the number of studios is increased. The control consoles for each group are comparable, the only variation being in the number of microphone inputs. The usual trend is toward custom-built consoles that have only the required operational functions rather than the factory-built consoles that

would have more than necessary of some features and not enough of others. Reference is being made here to the remote line and remote cueing facilities found in these consoles, which are unnecessary to the extent provided for a single studio control that operates into a master control. Also, these consoles are usually limited to five microphone inputs, while twice this number is often required for a large studio.

### Console Sizes

In general, three sizes of consoles will be required for either the larger size group of studios—one to care for the auditorium type of studio, one for the small and medium-size studio, and one for the announcers' and turntable studio. As a rule, a five-studio layout will have one auditorium studio, two medium studios, one small studio, and one announcers' and turntable studio. A ten-studio layout will have two auditorium studios, four medium studios, two small studios, and two of the announcer type studios. One of the latter of these might be permanently assigned to news while the other is used for announcements and transcriptions.

Figure 2 shows in block form a suggested layout for the auditorium type of studio. Eight microphone inputs are provided. It will be noted that three of the microphone faders feed through a

submaster gain control. The purpose of this agreement is to permit the individual settings of the three microphones to be made to suit the conditions of pickup of an orchestra which, during the course of the program, must be faded in and out rapidly to accommodate sketches or announcements. This fade out and in can be accomplished by the use of one control knob and with the assurance that, when faded in, that proper balance still exists. The remaining five inputs are straightforward. In addition to the eight microphone inputs, one input without a preamplifier is used to handle a remote input. The source of this remote input might be that portion of a divider program in which a speaker talks from a distant point, or it might be a sound effect patched through from the transcription studio. A conventional talkback and monitoring system is shown. Equipment necessary for one echo chamber is shown separate from the circuit of the console with the exception of the echo chamber volume control which would be part of the console. Thus the same echo chamber equipment could be used with any studio equipped with an echo control fader by patching in through trunk circuits. The input and output of the echo chamber circuit is connected by patch cords to the desired microphone

FIG. 2. Diagram of suggested layout for the auditorium type of studio.

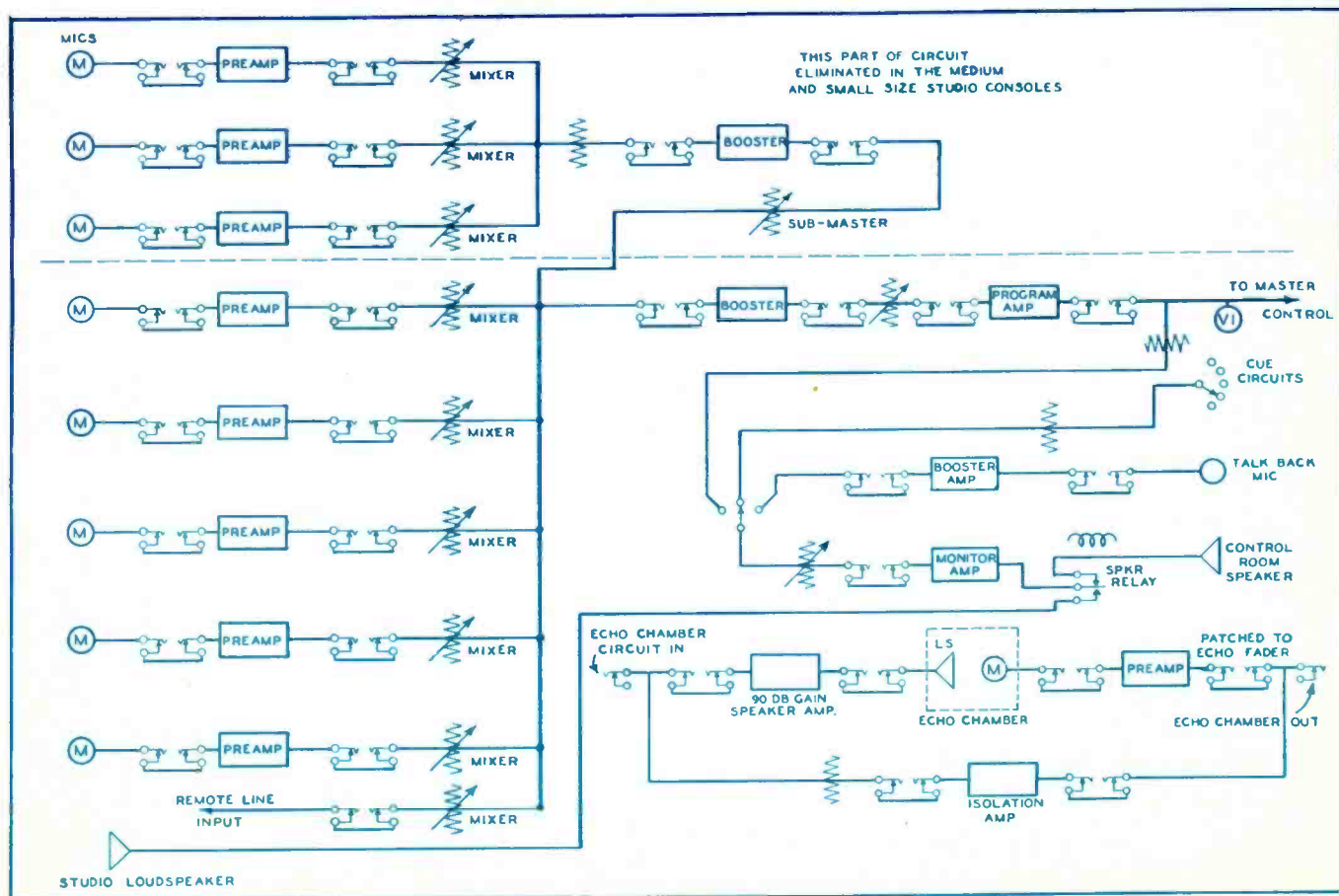



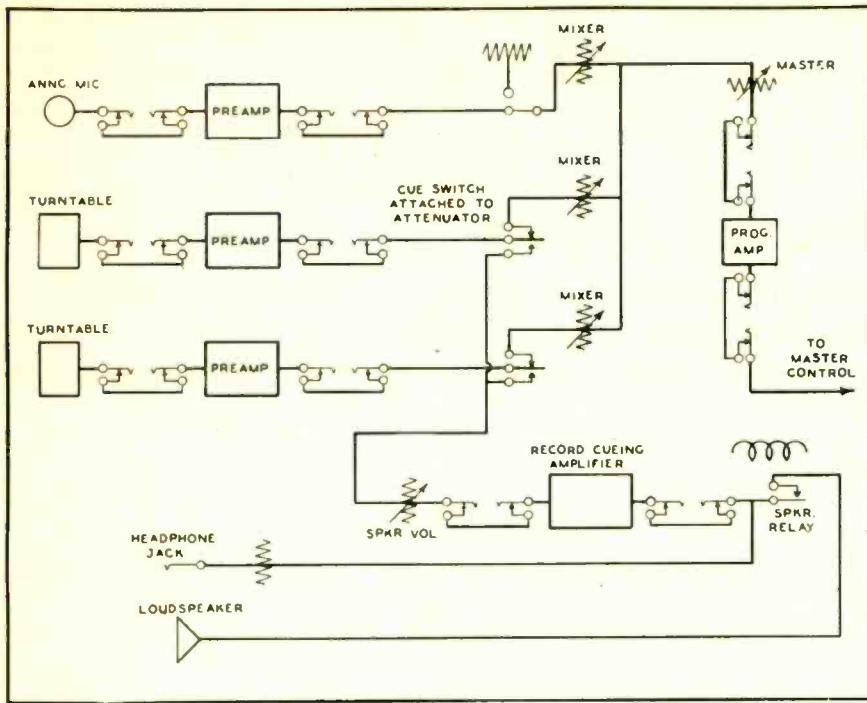
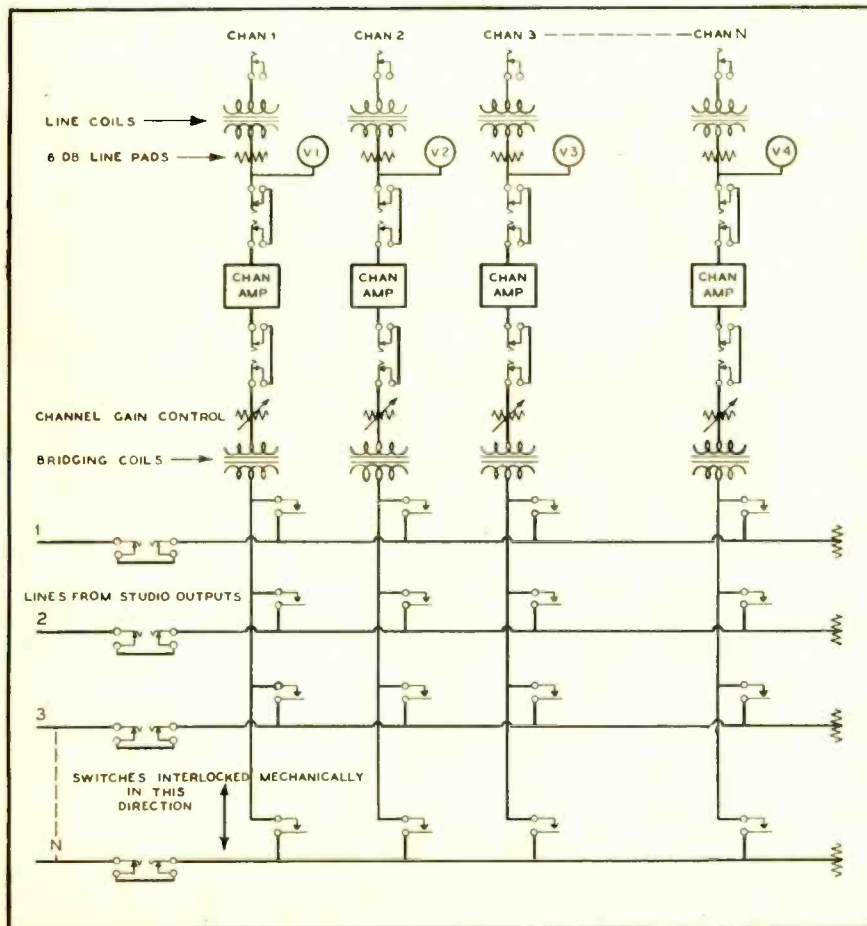

Fig. 3. Suggested arrangement for handling transcribed programs.

circuit at the jacks following the pre-amplifier for that microphone. For echo on the over-all program, the input and output of the echo chamber would be picked up by patch cords at the

jacks following the booster amplifier preceding the master gain control. The amount of echo is determined by the setting of the echo fader mounted on the console.

Fig. 4. Diagram of master switching circuits for manual or preset relay operated systems.



The circuit for the medium and small type of studio would be exactly the same as that shown in Fig. 2, with the elimination of the three microphone circuits feeding into the submaster control. This leaves a total of five microphone inputs and a remote line input. All other features would be the same.

### Transcribed Programs

Figure 3 shows an arrangement for an announcer and transcription studio and is intended primarily for the handling of transcribed programs. The transcriptions can be announced by the same person who operates the turntable or can be announced by another individual in an adjoining studio connected with a viewing window. Two turntable inputs and one microphone input are shown. The usual method of operation of the turntable faders is wide open when playing and closed when off. This makes for easier operation when a quick shift is to be made from one machine to another in that the operator need not be conscious of the necessity to open the fader on the coming-in machine to a definite part-way setting, but instead simply to turn the knob until the fader hits the stop. Proper level is obtained with the master gain control. Provisions are made for headphone or loudspeaker cueing of a transcription. When announcing is done in the same room with the transcription machine, an interlock between the announce microphone key and the loudspeaker should be provided. Turntable starting keys should be located on the console so as to confine the operator's motions to as limited space as possible during time of rapid operations.

### Balanced Circuits

Concerning the actual type of circuits used in the consoles, it has been the writer's experience that the least amount of trouble will be had from any tendency toward oscillation, cross-talk between circuits, and failure of faders to completely cut off at all audio frequencies if balanced circuits are used throughout. Such a statement is subject to much argument pro and con; but of the twenty or more studio layouts designed by the writer during the past five years, the only ones that gave any trouble and required "fussing with" were three that used unbalanced circuits.

Another feature in console design that is subject to some discussion pro and con is whether all amplifiers and components associated with the console should be contained in the console turret and desk, or if only the operating controls should be contained in the

[Continued on page 49]



# A Comparative Vacuum-Tube Decibel Meter

J. H. GRIEVESON\* and A. M. WIGGINS\*\*

**M**ANY METHODS are used to obtain the free field† response curves of microphones and electro-acoustical devices. If extreme accuracy is desired the reciprocity method has proven to be of considerable value, especially when no calibrated microphone or speaker is available. A commonly used method, when extreme accuracy is not demanded, is by first calibrating a speaker with a calibrated microphone, then by taking the response curve with the unknown microphone and calibrated speaker, the response of the microphone may be obtained. This necessitates subtracting the response curve of the speaker from the response curve of the microphone and speaker combination. The response curves of even the most expensive speakers are none too smooth, which contributes to the inaccuracy of the measurements.

Attempts have been made to control the amplifier output to compensate for the irregularity of the speaker response curve. If the variation in response of the speaker is not too great, electrical filters may be used with some measure of success. If the response varies widely over small increments of frequency more drastic measures must be taken, such as the use of cams operated from the frequency control shaft of the oscillator and shaped to give the required compensation in the amplifier output.

## A Method of Obtaining Response Curves

A method of obtaining the response curves of microphones without the time-

**The unique instrument which the authors have developed is essentially a linear scale, direct-reading, decibel meter, which may be adjusted to indicate the difference in db level between a standard and any other similar device under test. It has been found particularly suitable for testing microphones, audio transformers and amplifiers, loudspeakers, and phonograph pick-ups.**

consuming activity of subtracting curves has been developed which has proven very useful in both laboratory and production control work, and is without the inaccuracies associated with other methods. This method employs an instrument that gives a direct reading (in decibels) of the difference between the output of a reference microphone and the microphone under test. Thus a comparative response curve may be made in one operation, eliminating the need of taking two measurements, and then calculating the results. Although loudspeakers generally available cannot be used as a standard sound source, due to the irregularities in their response, there are microphones which have very flat re-

Testing microphones with the comparative decibel meter (ElectroVoice Corp.)



\*Product Engineer, ElectroVoice Corp.

\*\*Chief Engineer, ElectroVoice Corp.

†Measurements of electro-acoustical devices, such as microphones and loudspeakers, are usually undertaken in an environment that simulates free-space conditions; that is, away from any surfaces or objects from which sound waves would be reflected. In practice, this is achieved (a) by making measurements out-of-doors, (b) by using an acoustical test chamber whose walls absorb sound waves as completely as possible or (c) by employing a pulse technique—Ed.



sponse curves. The Western Electric 640A is an example of a microphone whose response is very flat if the axis of the microphone is oriented at 90 degrees to the sound source. The ratio of the output voltage of an unknown microphone to that of a standard microphone having a uniform response is the response of the unknown microphone. By taking the logarithm of this ratio and multiplying by 20 the response in decibels is obtained. Since the two microphones in the sound field must necessarily be separated by a small distance, the output voltages must be rectified before mixing as there will be a difference in phase between their outputs.

The logarithm of the ratio of the two output voltages may be obtained by subtracting the logarithms of the output voltages from the two microphones. If  $E_1$  is the rectified output of one microphone and  $E_2$  the rectified output of the other then:

$$\text{Log} \frac{E_1}{E_2} = \text{log } E_1 - \text{log } E_2$$

If  $E_2$  is the output of a flat microphone and  $E_1$  the output of the microphone under test, then  $E_2$  becomes the reference level and the meter reads  $\text{log } E_1$ , and may therefore be calibrated to indicate the output in decibels of the microphone under test.

Co-author Wiggins at work in an unusual acoustically treated room in the Electro-Voice lab.



### The Comparative Decibel Meter

A schematic diagram of the amplifiers and comparative decibel meter is shown in *Fig. 1*. The two microphones are fed into the conventional amplifiers *A* and *B*, whose outputs are rectified. The rectifiers are connected through high resistances (5 megohms) to the diodes in the 6H6 of the instrument. Voltages which are proportional to the logarithm of the input voltages are developed across the diodes. This is amplified by the 6F8 d-c amplifier. The two triodes in the 6F8 are connected in opposition as shown. The bias resistor  $R_1$  is of a value to compensate approximately for the contact potential in the tubes. The meter for measuring the logarithm of the two voltage ratios has a 200 microampere range and is connected from plate to plate of the 6F8. The instrument is calibrated first by setting the microammeter to the midpoint of the scale by means of the potentiometer  $P_2$  whose midpoint is connected to B+. The full scale deflection is set by applying a difference in voltage between points *C* and *D* of the desired range. If a range of 20 db from midpoint to full scale is desired a voltage difference of ten to one is applied. Then, by adjusting potentiometer  $P_1$  the meter may be set to read full scale. The setting may be checked by applying the ten to one voltage ratio to the opposite tubes causing the meter to read 20 db in the opposite direction which would be the zero reading. The gain of the two amplifiers may be set to the same amount by feeding the output of one microphone into both amplifiers and adjusting the output of each amplifier to the same value. The instrument may also be used as a straight logarithmic voltmeter by putting a d-c voltage into one side of the 6H6 instead of the rectified output of a standard microphone making this d-c voltage the reference level.

### Applications

The instrument has been used at considerable advantage in the laboratory for design work on microphones. By being able to read the absolute response of the microphone on a meter much time is saved, as it is not necessary to take a complete curve of the microphone and compare this curve with the speaker curve. An automatic curve tracer can be used in connection with the instrument which gives the absolute response curve of the microphone without further work.

Valuable use of the instrument can also be obtained in a production control department. A large box treated with fiberglas wedges is used for rapid production checking of microphones as they come off the assembly line. A microphone of the particular model to be checked is first laboratory checked and



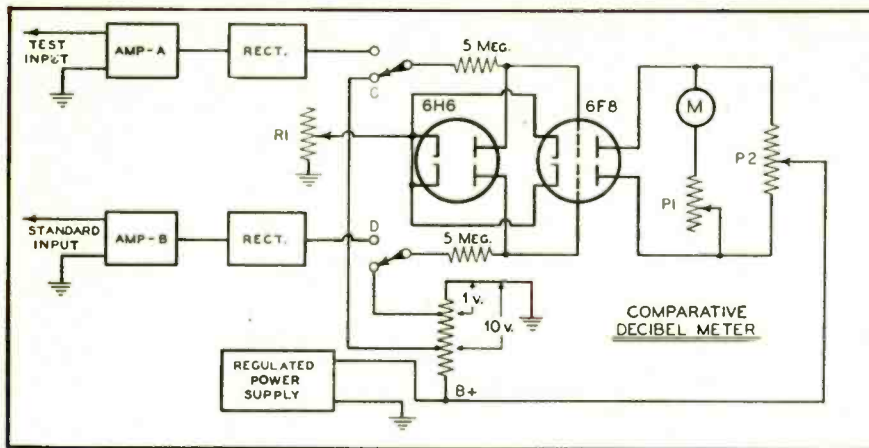

Fig. 1. Schematic diagram of the comparative decibel meter.

used as a standard microphone. By placing the standard microphone in the sound box alongside a microphone to be checked, the deviation from the standard is noted over the complete audio spectrum. A photograph of the instrument as used in production control is shown in Fig. 2. An oscillator is fitted into the lower part of the case below the comparative decibel meter.

#### Other Uses

The instrument has many more uses besides that of comparing microphone response. Some other applications to which the instrument may be applied are listed below.

Comparing amounts of noise generated by industrial machinery.

Testing photocells by the use of a standard photocell.

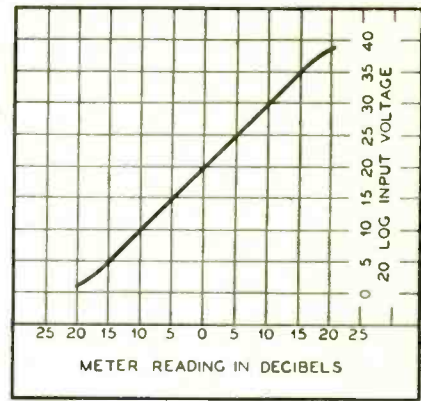

Fig. 2. Graph showing linear db scale of the comparative decibel meter.

Comparing colors with photocells eliminating variation due to light fluctuations.

Testing loud speakers.

Testing audio transformers and amplifiers.

Testing sensitivity and response of radio receivers.

Production checking of phonograph pickups.

## Ringling a Bell at its Fundamental Mode

S. Y. WHITE, Consulting Engineer

IT IS NOT GENERALLY REALIZED that there is no way to ring a bell at its fundamental mode of oscillation. This can be better realized when we look at Fig. 1. The view of the bell from the bottom, which is always a perfect circle, is shown in Fig. 1A. If we could squeeze the bell into the perfect oval of Fig. 1B and instantly release it, it would oscillate between the oval of Fig. 1C and back to Fig. 1B, and so on until the energy died out. Since this is very difficult to do, we actually hit the bell with a hammer and form a local dimple, as in Fig. 1D, and from there on anything can happen in the way of extremely complex coupled oscillations.

Since many of us have some condensers around that are capable of high discharge rates we can set up the circuit of Fig. 2, where the big filter condenser  $C_1$  is 20 to 100 microfarads, charged from a source of 400 volts or more through a limiting resistor  $R_1$  of 10,000 ohms or so. The inductance  $L_1$  is 50 or 100 turns of number 24 wire on a three-inch form, or just wound in a bunch and taped together. Nothing is

critical. The switch  $Sw_1$  had better be a mercury switch, otherwise it will weld together. If you want, you can just touch two wires together to close the discharge path.

Now we take a telephone bell, or a dime store bell of any kind, and place it in the field of the coil as shown in Fig. 3. On closing the circuit the bell will ring, and by careful attention you will probably think you are listening to

at least a fifteen-pound bell, with a very deep, pure tone.

The surge of current through the coil induces a tremendous current in the side of the bell facing us, as shown by the arrows. There is an equal current with a similar path on the opposite side of the bell. These two current loops mechanically repel each other, and the bell is forced into the oval form of Fig. 1C. The current then disappears, and the bell oscillates at its fundamental.

If you want to make a set of chimes this way, you must use thyratrons or at least mercury switches to control the high current, as any ordinary switch contacts will simply weld together.

If the bell sounds weak, try about 5 or 10 ohms in series with the discharge path, as the circuit might be oscillating. The series resistance insures that the circuit is at least critically damped so you can get a single surge instead of oscillations.

All sorts of metal shapes will "ring" when placed in the coil, but the real fun is to take a very tinkly telephone bell and have it sound like a monster.

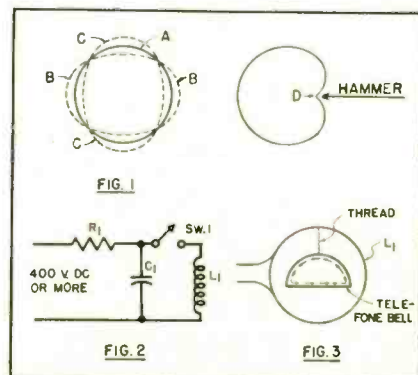

Figures 1, 2, and 3.



# FM CALIBRATOR FOR DISC RECORDING HEADS

## PART I

RALPH A. SCHLEGEL  
WOR Recording Studios

**This is the first of two articles describing the design and construction of a successful FM calibrator.**

ONE HUNDRED AND TEN YEARS have passed since the Frenchman, Leon Scott, made the first mechanical recording of sound upon a moving paper tape coated with lampblack, the sound track being engraved by a pig's bristle attached to a thin, stretched sheepskin diaphragm. Forty years later Thomas A. Edison recorded sound upon a sheet of tinfoil wrapped around a revolving cylinder. Some ten years later, Emile Berliner devised a method of recording sound upon a revolving disc.

Since the beginning of recording, the engineer has been faced with the necessity of adjusting, measuring, and calibrating the vibrating system of the recording head. For many years this was accomplished by mounting the recording head under a microscope and measuring the amplitude of stylus vibration in air

at various frequencies. It was assumed that the load presented to the recording stylus by the recording material during the engraving was low relative to the mechanical impedance of the cutter. However, it is difficult to obtain accurate results with this method, especially when the amplitude of vibration is extremely small. Some workers have substituted a photocell for the human eye, thus greatly improving the accuracy.

Another method of evaluating the recording head was to record various frequencies upon a disc and, by means of a calibrated microscope, to measure the groove amplitude. The most commonly used method of calibration makes use of the reflected light pattern.<sup>1,2,3</sup> This is accomplished by recording different frequencies on a disc and, with the aid of a light source, measuring the width of a reflected light pattern. This is fairly accurate under the proper conditions<sup>2</sup> and may be taken as a true indication of frequency response of the recording head.

Fig. 6. The FM calibrator: ready for operation with a Scully Recorder

The aforementioned methods of measurement are laborious and time-consuming, and do not provide a means of measuring the distortion of the recording head nor do they permit the making of measurements while cutting a record.

### FM Reproducer

Several years ago Messrs. Beers and Sinnett<sup>4</sup> developed a record reproducer wherein the reproducing stylus varied the capacitance of an FM oscillator-discriminator tube. The radio-frequency output of the tube was rectified and filtered, and the remaining audio component of the signal was used for reproduction purposes. Since recording and reproducing are inversely related, it was not long before Badmaieff and Roys<sup>5,6</sup> made use of the FM reproducer system, adapting it to the measurement of vibrating systems.

Frequency-modulation circuits in which the oscillator and the discriminator are combined in one tube can be used to convert mechanical vibrations to electrical voltage variations and can



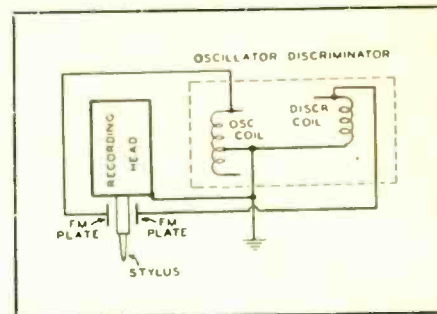
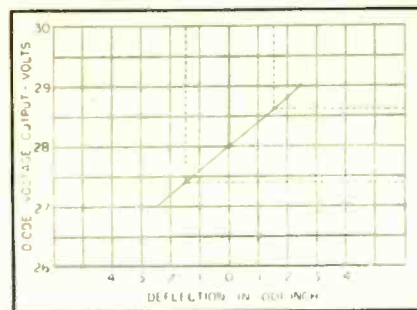
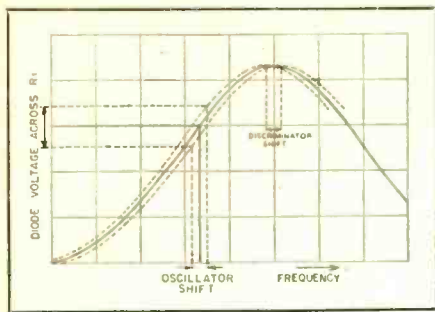

Fig. 1 (left). Graph of combined oscillator discriminator modulations in push-pull FM system. Fig. 2 (center). Linearity of push-pull FM system. (Courtesy Journal of the SMPE). Fig. 3 (right). Arrangement of FM capacitor plates.

be applied to measuring devices, reproducers, etc. Early work was confined to single-ended FM circuits where a very small capacitor plate acted as the frequency-controlling element. However, a non-linear relation existed between capacitor plate spacing and the frequency controlled by the capacitor, resulting in even-harmonic distortion. This distortion can be cancelled, although it is not easy to attain and can only be satisfied when the *change* in capacitor plate spacing is kept small in comparison with the *average* spacing. To accomplish this, and to produce the frequency shift necessary to obtain reasonable output voltage, relatively large plates must be used. In a single-ended FM circuit only one side of the movable plate is active, since only one fixed plate is used, while in a push-pull arrangement both sides of the movable plate are active as each side forms one plate of two capacitors, because two fixed plates are used. This reduces the required size of the movable plate to one-half that needed in a single-ended circuit. Further reduction in size is obtained by movement in a small space, thus producing sufficient frequency shift to obtain a reasonable output voltage.

In single-ended FM circuits, either the oscillator or discriminator circuit may be modulated, the output voltage being identical in either case. In the push-pull circuit, both oscillator and discriminator are modulated 180 degrees out of phase so that the oscillator frequency shifts in the opposite direction to the discriminator resonant frequency, resulting in a doubling of output voltage for the same amount of capacitance change. This is graphically illustrated in Fig. 1.

Frequency modulation of the oscillator and discriminator coils is achieved through the use of a small capacitor which can be considered as a balanced split-stator unit with rotor plates so arranged that the capacitance of one section is increased while a corresponding decrease in capacitance is obtained in the other section. One section of the capacitor is connected across the oscillator coil and the other across the discriminator coil. The center plate is at ground potential. If the rotor or

grounded plate is moved in either direction, the frequency changes of the oscillator and discriminator circuits will be in opposite directions, resulting in push-pull action. This push-pull action is applicable only to the capacitor. Distortion is not cancelled due to the non-linearity of the discriminator curve. To achieve the full benefits of push-pull action to reduce distortion, it is necessary that both parts of the system be closely balanced with each other. The inductances must be identical, the construction of both sides of the push-pull capacitor must be able to provide equal capacitance, equally varied in opposite directions. The linearity of the push-pull FM system was measured by Badmaieff<sup>5</sup> and is given in Fig. 2. It is seen that throughout most of its length the curve is practically linear. The total harmonic content represented by the curvature amounts to less than one per cent. The discriminator will contribute negligible distortion if the modulation is restricted to 80 kc on a 40 mc carrier frequency. The range actually used in the FM calibrator covers 30 kc in each push-pull section, thus covering 60 kc of the discriminator curve. See Fig. 2.

#### Circuit Design

The development of the push-pull FM circuit provides a solution to the problem of measuring a recording head

under actual operating conditions. Here is a device that can be attached to the recorder without interfering in any way with the action of the recording stylus. As shown in Fig. 3, two small plates on either side of the stylus shank and insulated from each other and from the cutter are spaced several thousandths of an inch from the stylus. Nothing has been added to the vibrating system so that no change in its action can occur. Flexible leads from the plates and cutter are connected to the oscillator-discriminator unit mounted on the cutter carriage. Variation of capacitance caused by the vibration of the stylus between the plates shifts the oscillator frequency in one direction and the discriminator tuning in the opposite direction as described earlier. The audio output from the diode section of the oscillator-discriminator unit is fed to an audio amplifier through a short length of coaxial cable. The output of the audio amplifier may be measured with a suitable vacuum tube voltmeter or may be further amplified for monitoring purposes provided suitable equalization is

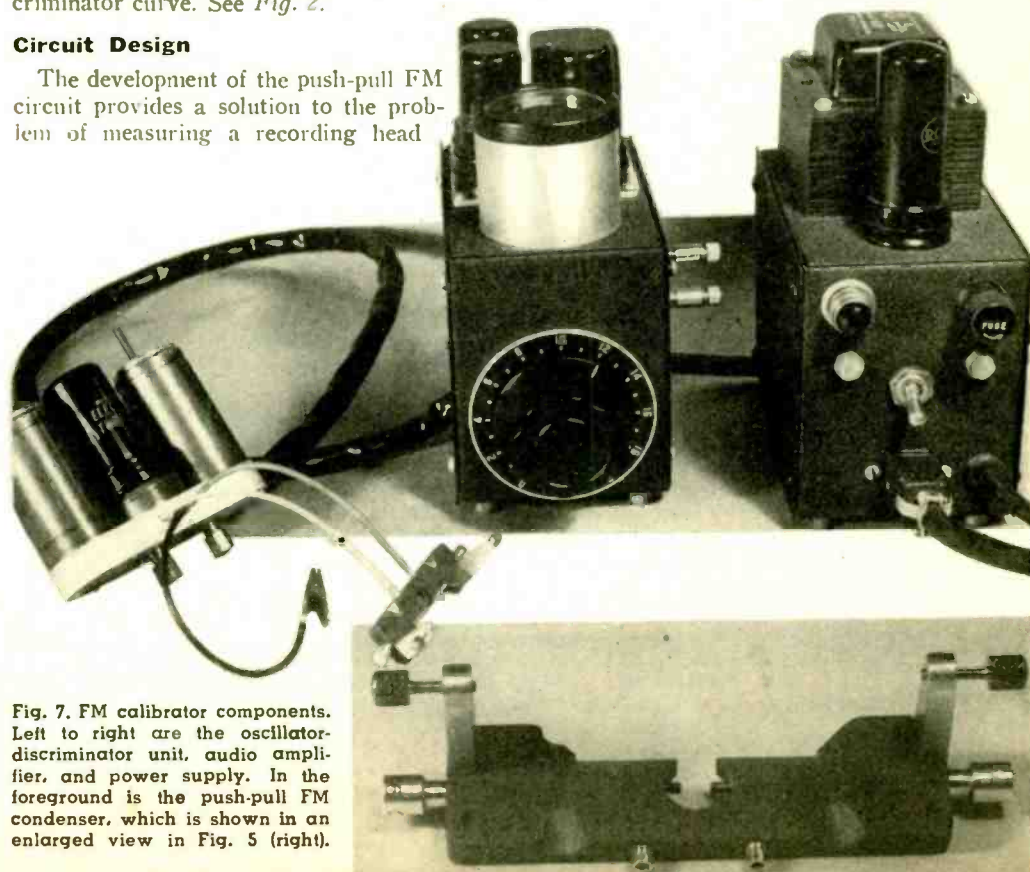

Fig. 7. FM calibrator components. Left to right are the oscillator-discriminator unit, audio amplifier, and power supply. In the foreground is the push-pull FM condenser, which is shown in an enlarged view in Fig. 5 (right).



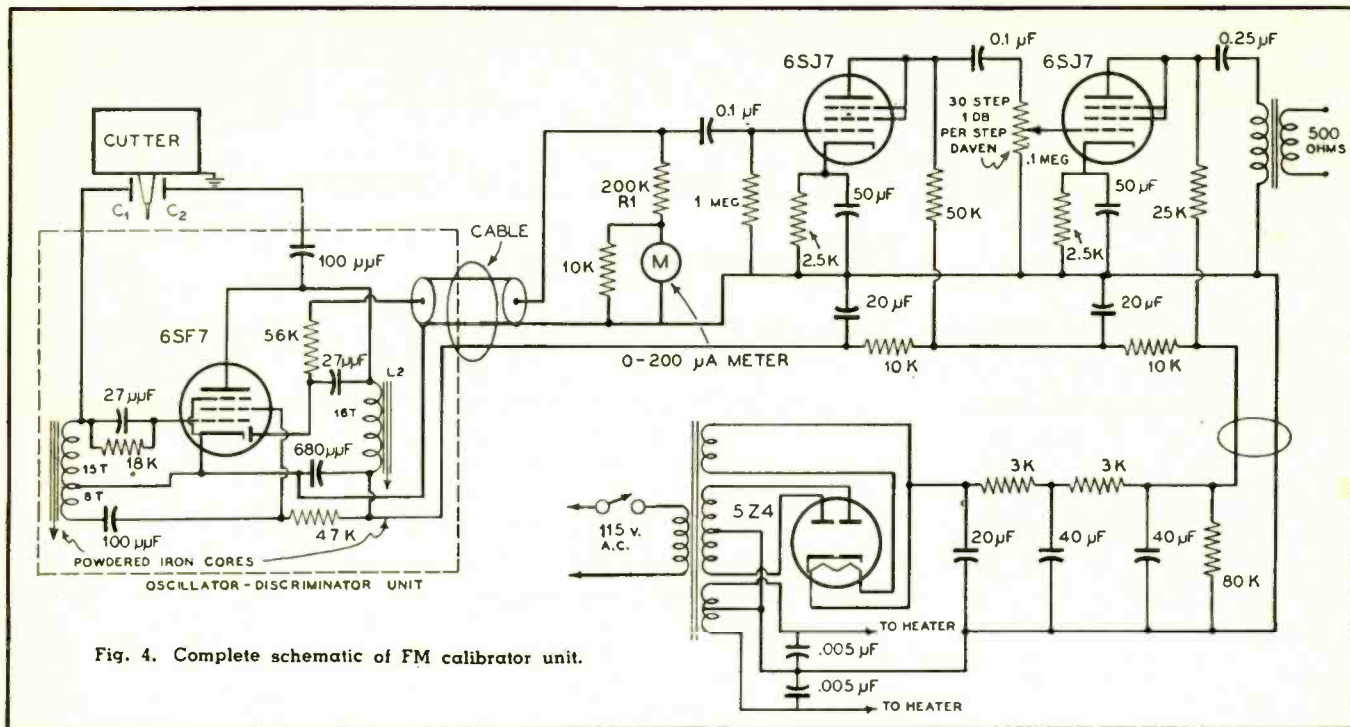

Fig. 4. Complete schematic of FM calibrator unit.

used. The complete schematic is shown in Fig. 4.

In the circuit of Fig. 4,  $L_1$ , one-half ( $C_1$ ) of the push-pull capacitor, the 6SF7 grid, cathode and screen combine to form the oscillator portion.  $L_2$ , the other half ( $C_2$ ) of the push-pull capacitor and the 6SF7 plate form the discriminator circuit. The two circuits are electron-coupled<sup>7</sup> and shielded from each other in the tube by the 6SF7 suppressor grid, which is at ground potential. The output is rectified and filtered by the diode section of the 6SF7. A 0-200 microammeter is placed in the diode circuit so that the oscillator may be tuned to the same frequency in relation to the optimum operating point of the discriminator. This is accomplished by tuning the oscillator circuit for maximum diode current and then backing down on the oscillator tuning to 70 per cent of the maximum current. If the oscillator is tuned to the wrong side of the discriminator peak, unstable operation will result. To determine the correct side of the discriminator curve, introduce some body capacitance by touching one of the leads from the FM capacitor plates and note the action of the diode meter. If the correct side of the slope has been chosen, the current will dip slightly. Should the diode current dip sharply to zero and possibly stay at zero although the body capacity has been removed indicates the oscillator is tuned to the wrong side of the discriminator peak.

The push-pull FM plates are mounted on the cutter so that the stylus is centered between them. Figure 5 shows the push-pull FM capacitor unit consisting of a  $\frac{1}{8}$ " thick Bakelite bracket in

which are mounted two 0-80 machine screws which serve as the capacitor plates. The micrometer knobs with which the plate spacing may be adjusted are shown at each end of the Bakelite bracket and are insulated from the capacitor plate screws by small polystyrene rods. Contact is made from the capacitor-plate bushing to pin jacks mounted in the side of the bracket, flexible leads of 4-mil steel wires, covered with vinyl tubing and mounted on lucite spacers from the pin jacks to the oscillator-discriminator section which is supported above the cutter by a bracket clamped to the recorder carriage.

#### Oscillator-Discriminator

The oscillator-discriminator unit must be built as rigidly as possible to provide stability of operation. The chassis is milled out of a block of dural, while the coil shields are  $\frac{1}{8}$  in. wall brass tubing. The iron-core adjusting screws are accessible from the top of the coil shields. Connection is made to the audio amplifier through a short flexible length of cambric tubing which carries the co-axial line and the necessary plate and filament voltages. The power supply has been built on a separate chassis to avoid hum pickup in the audio system. Figure 6 shows the complete unit set up for operation. It might be mentioned at this point that a frequency run and distortion check can be made almost as quickly as the operator can change the audio oscillator and read the calibrator output.

The FM calibrator was designed originally as a laboratory instrument for the calibration and adjustment of recording heads. The model illustrated was

designed primarily as a maintenance tool for making periodic frequency and distortion checks on the recording heads in the studios. The FM calibrator also lends itself admirably to the making of test frequency records.

Construction details of the push-pull FM capacitor assembly, the oscillator-discriminator unit, and the associated mounting brackets as well as applications of the FM calibrator will follow in subsequent issues.

The writer wishes to acknowledge the helpful suggestions and technical information supplied by H. E. Roys of RCA, and for the mechanical construction assistance of Vincent Broyles of the Vibromaster Co.

#### References

- <sup>1</sup>G. Buchman and E. Meyer, "A New Optical Method of Measurement for Phonograph Records," *E.N.T.*, 7, 147 (1930). A translation of this article appeared in *J. Acous. Soc. Am.*, 12, 303 (1940).
- <sup>2</sup>B. B. Bauer, "Measurement of Recording Characteristics by Means of Light Patterns," *J. Acous. Soc. Am.*, Vol. 18, No. 2, 387 (1946).
- <sup>3</sup>D. G. Fink, "Electronics Engineering Manual," McGraw-Hill (New York), p. 240.
- <sup>4</sup>G. L. Beers and C. M. Sinnott, "Some Recent Developments in Record Reproducing Systems," *J. Soc. Mot. Pict. Eng.*, XL, 4 (Apr. 1943), p. 222.
- <sup>5</sup>H. E. Roys, "Experience with an FM Calibrator for Disk Recording Heads," *J. Soc. Mot. Pict. Eng.*, 44, 6 (June, 1945), p. 461.
- <sup>6</sup>A. Badmaieff, "Push-Pull Frequency Modulated Circuit and its Application to Vibratory Systems," *J. Soc. Mot. Pict. Eng.*, 46, 1 (Jan. 1946), p. 37.
- <sup>7</sup>F. E. Terman, "Radio Engineering," McGraw-Hill (New York), 1937, p. 360; J. B. Dow, "A Recent Development in Vacuum Tube Oscillator Circuits," *Proc. I.R.E.*, 19 (Dec. 1931), p. 2095.



# Simplified Intermodulation Measurement

C. G. McPROUD\*

The author shows how to use the oscilloscope as a means for portraying intermodulation distortion, with a method especially suitable for amplifier development work.

IT HAS BEEN FAIRLY WELL ESTABLISHED that intermodulation distortion is a serious deterrent to high quality reproduction of speech or music. The measurement of this type of distortion has been discussed frequently in the literature over the past few years, but the principal drawback to its use is the relatively high cost of the equipment necessary for determining the percentage of distortion.

## Test Method

To review, momentarily, the principles underlying the measurement of intermodulation, it may be stated simply that two frequencies, widely spaced and not harmonically related, are passed through an amplifier. The output signal is passed through a filter to remove the

lower of the two frequencies, and the amount of modulation of the higher frequency by the lower is measured as a function of the amplitude of the higher frequency. In commercial instruments for the measurement of intermodulation distortion, the low frequency usually employed is 60 or 100 cps, while the higher frequency may be 1000, 2000, 4000, 6000, or any other high frequency which is within the pass band of the amplifier. Both of these frequencies are fed into the input of the amplifier, often being combined so that the lower frequency has an amplitude of four times (12 db above) that of the higher. Thus the test signal may be considered to have an appearance similar to that of Fig. 1.

Increasing the signal amplitude will cause the grid swings to exceed the lin-

ear range of the system, resulting in the "clipping" of the high-frequency fringe of the test signal at the peak swings of the lower frequency, as shown in Fig. 2 in which the dotted lines represent the maximum signal level that can be passed through the amplifier without distortion by the non-linearity of the tube characteristics above that level. Figure 2 represents the output of an amplifier stage which is operated at the optimum grid-bias point, with both positive and negative grid swings becoming overloaded at the same signal amplitude.

If the output signal is then passed through a high-pass filter to remove the low-frequency component of the combined signal, the notches placed in the high-frequency carrier still remain as a modulation of that carrier, as shown at (A) in Fig. 3. This signal

\*Managing Editor, AUDIO ENGINEERING.

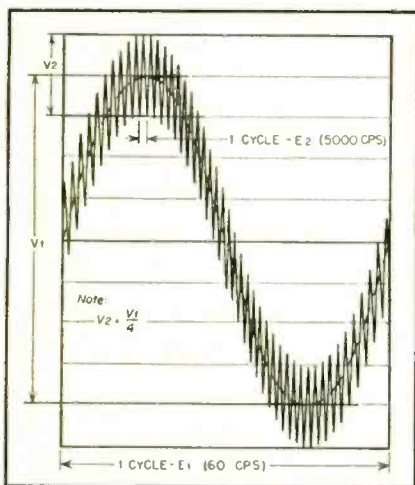

Fig. 1. Oscilloscope pattern of a test signal composed of a low frequency upon which is superimposed a high frequency 12 db lower in amplitude.

Measurement of intermodulation distortion is of considerable importance in evaluating amplifier performance. While this method does not give quantitative results, it does provide a tool whereby the presence of intermodulation can be detected and minimized.

Sound engineering laboratories which are now using this set-up have found it reliable and a great time-saver. Ed.

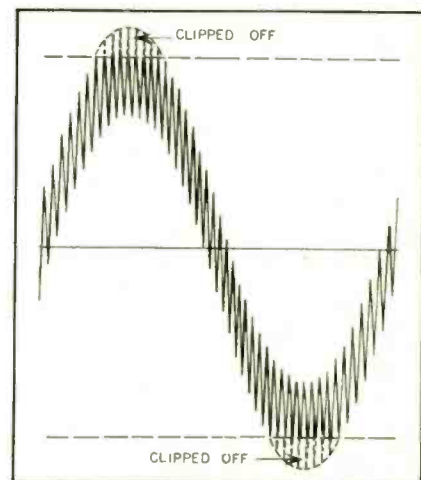

Fig. 2. Test signal after passing through amplifier, with fringe of high frequency signal clipped on peaks of low-frequency wave.



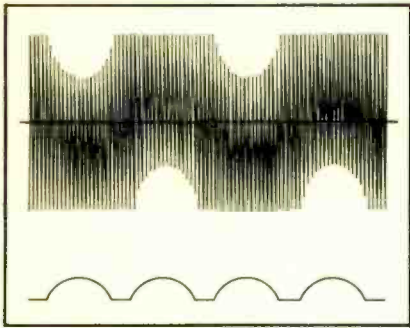

Fig. 3. (A) Output signal after low frequency is filtered out, leaving higher frequency modulated by the lower frequency. (B), below, A-C component of rectified h-f signal.

may now be rectified, and the a-c component, shown at (B), measured as a percentage of the amplitude of the carrier. This is a brief statement of the method employed in intermodulation analyzers.

### Proposed Method

Since the commercial intermodulation analyzer may not be available to the engineer who desires to make occasional measurements of this type, it is quite possible to substitute an oscilloscope and a high-pass filter for it, and obtain results which will give an indication of the amount of intermodulation, although not an accurate quantitative measurement. The method proposed here is capable of providing certain information, and it requires no equipment which is not generally available. Furthermore, the method goes further than the measurement method in that it indicates to some extent the cause of the intermodulation, thus giving the engineer a clue as to where to look for the trouble. As an advantage over the customary harmonic measurement method which consists of a number of separate observations, the pattern on

the oscilloscope may be viewed continuously while making changes in the component values to give improved performance.

Basically, the proposed method consists of the application of a standard intermodulation test signal to the input of an amplifier. The output is terminated with its normal impedance, across which is bridged a high-pass filter and an oscilloscope. The method of obtaining the test signal and of filtering the output will be described later in this article. To aid in making the observations, the screen of the oscilloscope is marked with two limit lines, which are the calibrating points for the carrier, and two additional lines which are one-fourth of the distance from the limit lines to the axis as shown in Fig. 4. The use of these latter lines is explained below.

To analyze the results obtained from this method refer to Figs. 5 and 6. In Fig. 5(A) is shown the test signal applied to the grid of a single-tube amplifier stage operating at an insufficient grid bias. As the amplitude of the test signal is increased, the positive swings of the plate current are flattened out ahead of the negative swings, and the high-frequency fringe of the test signal is clipped at certain points. When the filtered carrier is viewed on the oscilloscope, the effect of the clipping is shown by notches in one side of the pattern. Thus the presence of two notches on one side of the pattern is an indication of an incorrect bias condition in a single-tube stage. Note that the sweep circuit of the oscilloscope is adjusted so that it shows two complete cycles of the low-frequency signal.

In (B) of Fig. 5, the test signal is shown applied to a tube which is operating at the correct grid bias, but the amplitude of the signal is greater than the linear portion of the  $E_p I_p$  curve of

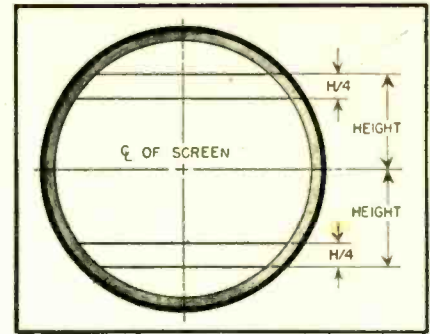

Fig. 4. Screen of C-R oscilloscope tube marked to indicate limits of high-frequency signal and depth of 25 per cent notches.

the tube can handle. Therefore, the fringe is clipped on both peaks of the low-frequency wave, with a resulting four-notch pattern.

When making tests of push-pull stages, the patterns obtained from insufficient grid bias conditions are shown in Fig. 6(A) which shows the effect of the test signal applied to two push-pull tubes. The positive peak of the wave is clipped by one tube, while the negative peak (which is the positive peak to the opposite tube) is also clipped. The plate-current curves of the two tubes are shown, both having the tops clipped. However, due to the push-pull connection, one of these curves is inverted, so that four notches appear in the pattern, resembling that of Fig. 5(B). When a push-pull stage is operated beyond its maximum permissible grid swing, the pattern will exhibit eight notches, four on each side as in Fig. 6(B).

### Pattern Analysis

Analyzing the patterns, then, will give a clue to the trouble, as well as to the preferred manner of using the oscilloscope method. Each individual stage should be checked independently, feeding the signal to the grid and observing the output at the plate. By connecting an a-f voltmeter across the output, the operating level of the amplifier is known at all times. As the input is increased gradually, the pattern on the oscilloscope should be maintained at the reference limits, and adjustments of both signal level and oscilloscope gain made simultaneously to maintain the notches at a given percentage (e.g. 25%) of the signal amplitude. The optimum operating point is reached when the output voltage is at its maximum value for the desired type of notching.

While no quantitative measurement is offered by this method, it may be stated that for a signal composed of 60 and 5,000 cps, with a 12-db difference between the two, many laboratory measurements of various amplifier types have shown that the recommended notch of 25% of the carrier amplitude corre-

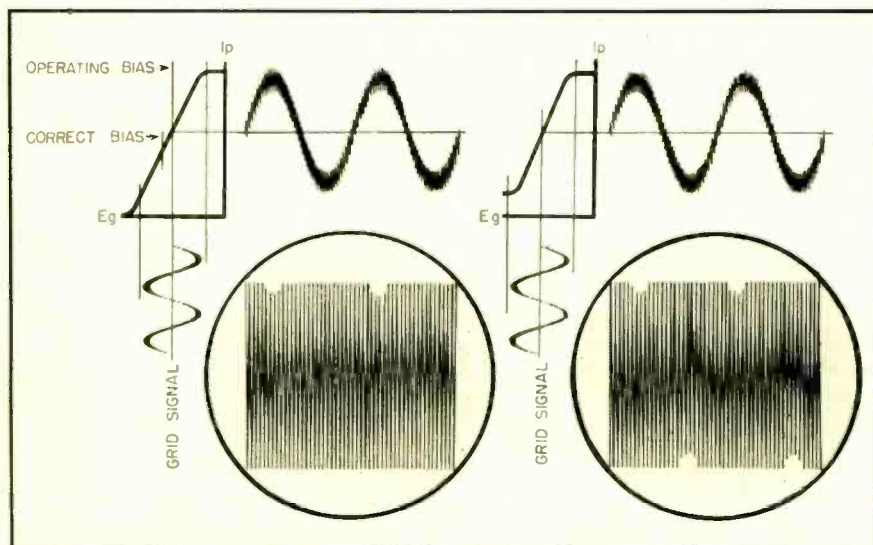

Fig. 5.  $I_p E_g$  curves, and type of indications resulting from single-tube amplifier stage with (A) insufficient bias, and (B), right, excessive input signal.



sponds roughly to the point at which 1% harmonic distortion is obtained. This would seem to indicate a relationship between harmonic distortion and intermodulation distortion, but since many other quantitative measurements have shown that no such relationship necessarily exists, it should not be inferred that this is so. The 25-per-cent point is selected as a purely arbitrary reference which is sufficiently observable even on a 2-inch oscilloscope tube to be readily usable.

### Test Signal Generator

For most rapid and convenient operation, it is suggested that a small oscillator unit be provided with sufficient flexibility to permit the mixing of the two frequencies. For preliminary testing of the method, however, it should be sufficient to place a series resistor in the output circuit of an oscillator, applying a 60-cps voltage across this resistor. Any method used for mixing the test frequencies should be checked carefully to ensure that no intermodulation takes place in the generator circuits. Figure 7 shows a suitable method for combining the two frequencies, with the meter switching being arranged for indication of relative levels. When the switch is set at "CAL HIGH," the output of the oscillator is adjusted to a reference indication on the meter. The switch is then thrown to the "CAL LOW" position which also introduces a resistor in series with the meter so that 0 db on the scale indicates a +12 db level, and the low-frequency level is then adjusted to the same setting. The instrument is ready to use when the switch is thrown to the "USE" position.

The block schematic for this method of measurement is shown in Fig. 8. The high-pass filter may be any standard filter capable of removing the low frequency, or, since the input of the 'scope is high, a parallel-T null circuit may be employed with excellent results, since the frequency to be measured is well removed from the low-frequency carrier. With a 60-cps low-frequency signal, the oscilloscope may be synchronized easily at a sweep frequency of 30 per second, giving the desired pattern which will include two full cycles of the carrier frequency. A refinement in

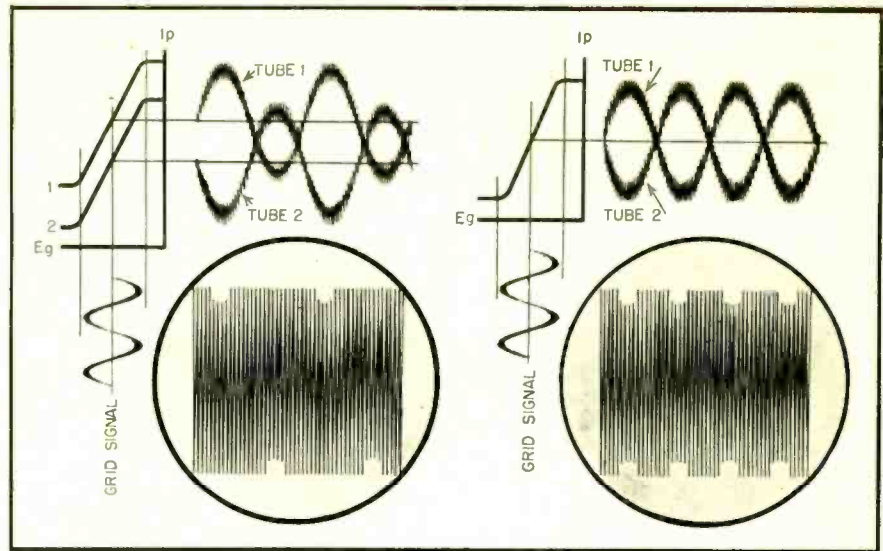

Fig. 6.  $I_p E_g$  curves, and type of indications resulting from push-pull amplifier stage with (A) insufficient bias, and (B), right, excessive input signal.

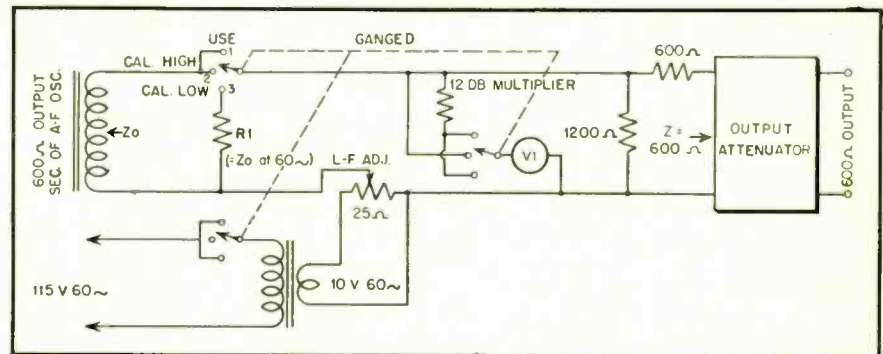

Fig. 7. Diagram of connections in mixer unit to supply intermodulation test signal for amplifier testing. Adjustment of high-frequency output is made with oscillator output control.

the generator would include a dual potentiometer so arranged that the output of the amplifier being measured is passed through the second unit before being applied to the oscilloscope — thus as the input to the amplifier is increased, the output fed to the 'scope is decreased by the same amount, making it unnecessary to vary the vertical amplitude control when making a series of measurements. If a dual potentiometer is so used, care must be taken to ensure that the two circuits are sufficiently isolated to avoid feedback. However, this entire method is submitted because it is simple to use with existing equipment, and such refinements are not necessary.

In the development of amplifiers and other equipment, this system has proven to be a convenient aid in determining the exact values of components for optimum performance. For example, if a number of variable resistors are placed in a circuit, adjustments can be made to the values while observing the pattern on the screen, and after obtaining the desired results, the variable elements can be replaced by fixed values. In this manner, a complete amplifier may be assembled with the assurance that each stage is working under the best possible conditions, yet without the necessity of making a large number of laborious harmonic distortion measurements.

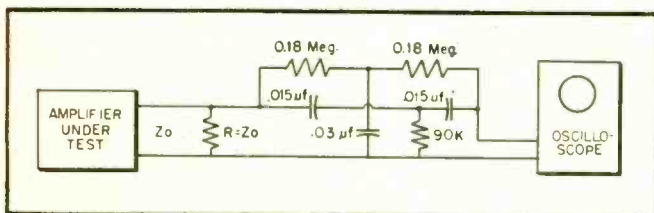

Fig. 8. Block diagram of connections of intermodulation test signal generator, amplifier, high-pass filter, and oscilloscope for testing by proposed method.

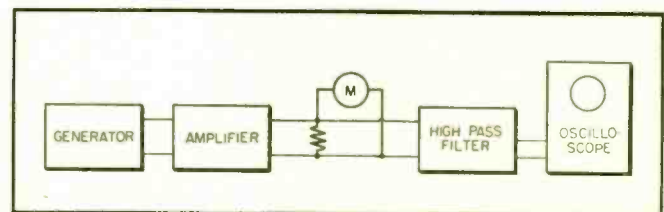

Fig. 9. Parallel-T network suitable for filtering out low-frequency (60-cps) signal before applying output of amplifier to vertical input of oscilloscope.



# EMBOSSSED HIGH- FIDELITY RECORDING

**ROBERT WAGNER**

Wagner Recorder Mfg. Co.



Fig. 1. The complete recorder unit is shown at the right. A 15-minute recording can be made on the small plastic discs shown. The arm and spring pressing on disc assure good contact between disc and tracking point following groove cut on back of blank.

**This article describes a new type of home recorder with many extraordinary features.**

**F**OR ALMOST TWENTY YEARS the search has continued for some means of recording which would be readily and successfully usable by the novice, but which would be free from the limitations generally inherent in non-professional equipment. These limitations involve the following: cost — both initial and operating — which must be kept to a minimum for such a device to have a wide popular appeal; the quality of reproduction, which should be at least reasonably comparable to commercial records; the playing time, which should be upward of five minutes per disc, with a desired maximum of fifteen minutes; and the ease of operation, to ensure that satisfactory results can be obtained by the non-professional user.

In addition to serving its principal function as a home recorder, there is an enormous field for an extremely portable instrument for the "borderline" uses, where the degree of perfection required in professional equipment is not an absolute necessity. The most important of

these uses is on-the-spot recording for delayed broadcasting, and very compact equipment is of considerable advantage, provided the quality can be acceptable.

The Wagner-Nichols Recorder is the result of these years of development, with the actual recording unit shown in Fig. 1. This unit comprises the heart of the equipment, with only a driving motor, amplifier, microphone, and speaker being necessary to provide a complete system. The recording unit is 7 inches long and 5½ inches high, with an overall depth of 2½ inches, exclusive of the motor. Recordings produced on this machine were considered extraordinary by those who heard the demonstrations at the recent IRE Convention in New York; a vinylite disc 3¾ inches in diameter and .01-inch thick records for 15 minutes with fidelity comparable to that of commercial equipment.

The principal objectives of the recorder—compactness, fidelity, simplicity, and low cost—dictate the trend which the design must follow. Cutting acetate

discs requires the use of accurately ground styli, which have a comparatively short life. Constant replacement or resharpening is expensive, besides being a bother to the home recording fan, and after the novelty wears off, he is likely to consider it too much trouble to keep on using the device.

## **Embossed Recordings**

On the other hand, embossing does not wear the recording stylus appreciably, so with a suitable record base, the life of the stylus may be considered indefinite. The main disadvantage of previous embossing processes was the necessity for providing a sound groove of sufficient depth to permit adequate stylus tracking for playback. The depth required precluded the possibility of obtaining high fidelity, and limited the number of lines per inch to a maximum of about 200.

To record a full fifteen-minute program on a disc of small diameter requires a very large number of lines per



inch. On a  $3\frac{3}{4}$ -inch disc, the maximum usable diameter is about  $3\frac{1}{8}$  inches; recording to a minimum diameter of  $1\frac{1}{2}$  inches leaves a recording area only  $1\frac{1}{16}$  inches wide. At a recording speed of  $33\frac{1}{3}$  rpm, this requires that the grooves be spaced to a minimum of 470 lines per inch. To allow a little leeway over the fifteen minutes for starting and finishing off, the recording is actually done at 515 lines per inch.

This figure may sound fantastic, especially so when it is remembered that this is a lateral cut, but a brief consideration of the relative dimensions may clear up an apparent discrepancy. To begin with, 515 lines per inch means that the line spacing is just under 2 mils, and if a normal groove-land ratio of 60-40 is maintained, the groove itself is just under 1.2 mils.

### Stylus Characteristics

This small dimension necessitates the use of a much sharper stylus point than is used for acetate recording. A conical sapphire having a tip radius of 0.5 mil is used, with an inclined angle of 70 deg., resulting in a groove depth of 0.82 mils. The relative dimensions are shown in Fig. 2, where (A) represents the stylus of this recorder and the resulting groove, and (B) represents the conventional stylus used for acetate recording. Since no material is removed, the embossing process deforms the surface of the disc to some extent, as in-

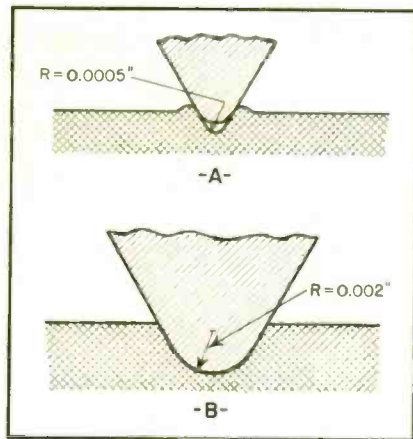

Fig. 2. Relative dimensions of embossed groove (A) and conventional acetate groove (B), together with recording styli used for both types.

dicated in (A). This has the advantage of aiding in the tracking, since the stylus has no inclination to climb up over the banks of the adjacent groove as the disc rotates. Also, since no material is removed, the original surface of the disc is not disturbed appreciably — that is, the bottom of the groove retains the high polish which is inherent to the normal surface of the disc before recording.

When one considers that standard recording is feasible at 160 lines per inch using a stylus with a 2.0-mil radius, a reduction in radius to one-fourth of this value should permit the embossing of a groove having equivalent dimen-

sions at four times 160, or 640 lines per inch. Add to this advantage the fact that the same stylus is used for recording and reproduction, so that the playback stylus follows the groove much more closely than a conventional reproducing stylus follows a cut groove. Therefore, in spite of the seeming impossibility of such close spacing, satisfactory results are obtained at 515 lines per inch.

The embossing process has one other advantage over the cutting process in that it produces no shavings which must be removed. This eliminates the need for brushing up the shavings as they are made, or for the more elaborate vacuum system which would be prohibitive for home use. The remaining problem is that of eliminating the expense and precision required for the conventional lead screw for moving the carriage across the disc as recording progresses.

This has been solved by pre-grooving the opposite side of the disc; thus the disc itself becomes its own lead screw. A small, chisel-shaped, carbide point engages the pre-grooved bottom of the disc at a point opposite the recording stylus. A small spring, mounted on an arm which is an integral part of the carriage, presses down on top of the disc and ensures sufficient pressure for good tracking. Thus, each record is equipped with its own feed screw, and any groove spacing can be accommo-

Fig. 3. Top view and (right) underside of recorder unit shown in Fig. 1. Carriage rides on rollers and mounts tracking point, combination recording and playback head, tracking pressure spring, and indicator.

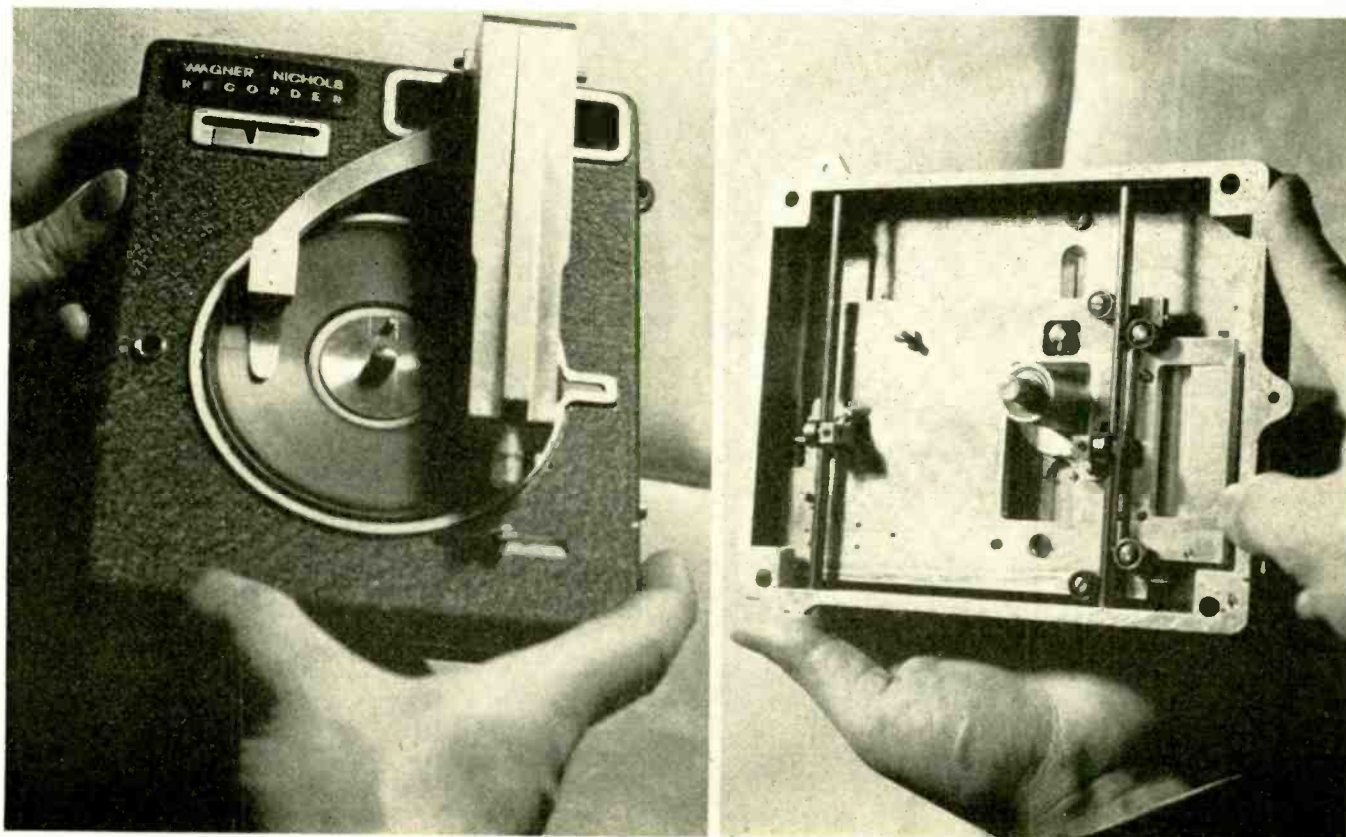



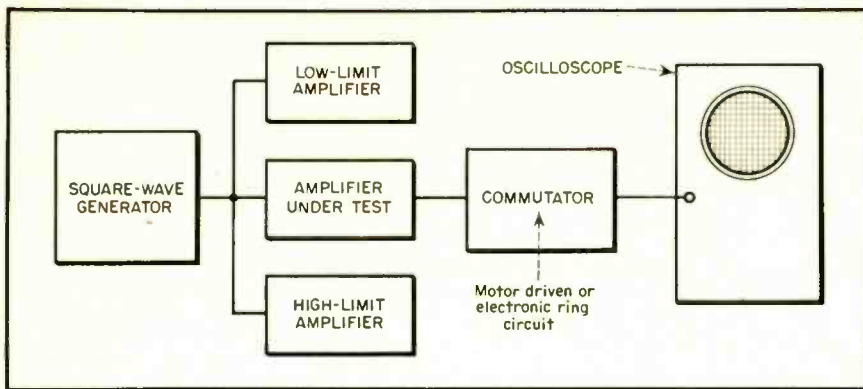

Fig. 2. Method of using square-wave test in amplifier production testing. Response of amplifier under test is compared with those representing upper and lower limits.

1B, relative frequency response information may be readily gained.\*

If many amplifiers of the same type are to be tested for frequency response characteristics carrying broad tolerances, the square-wave method becomes even more attractive. Limits may be established on the oscilloscope screen in several ways. One approach is to provide a transparent screen for the cathode-ray tube on which lines are scribed to represent the responses of two amplifiers tested by steady-state methods and known to be within the desired tolerance by the possible error in observation of the display.

An extension of this method is illustrated in Fig. 2. Here the square wave is applied simultaneously to the input terminals of three amplifiers. Two of these have characteristics representing the upper and lower acceptance limits and the third is the device being tested. The outputs of these amplifiers are applied in sequence to the oscilloscope "Y" axis. Both this commutation rate and the "X" axis deflection are in synchronism with the square-wave generator output.

### Phase Distortion

Phase distortion, or the departure from linearity of the phase-frequency characteristic of an amplifier or coupling network, is fortunately of little importance in audio-frequency work. However, in the design of feedback amplifiers, the frequencies at which the amplifier output voltage has shifted in phase by  $180^\circ$  from that at the point at which it is fed back are very important. From a knowledge of these frequencies and of the amplifier gain (without feedback) at these frequencies, the maximum amount of negative feedback that can be used with reasonable stability can be determined.\* However, this phase information is much more readily obtained by using a sine wave audio frequency

\*Swift, "Amplifier Testing by Means of Square Waves" *Communications*, Vol. 19, Feb. 1939.

generator and an oscilloscope. Admittedly, the square wave output of an amplifier is a very sensitive indication of departure from linearity of the phase vs. frequency characteristic. For example,\*\* a phase error of  $2^\circ$  at the fundamental frequency of the square wave produces a 10 per cent slope in the waveform (see Fig. 3). This type of information is of incalculable value in the testing of a video-frequency amplifier, but is of doubtful worth in connection with audio-frequency amplifiers.

However, this phase vs. frequency characteristic is important in an indirect way. It is well known that the transient response of an amplifier may be completely specified by the gain vs. frequency and the phase vs. frequency characteristics. The calculation of this transient response is laborious if performed analytically, and inaccurate if performed graphically. In general, sharp discontinuities in the frequency response curve of an amplifier foster the production of transient oscillations which blur or mask what should have been discrete, staccato sounds.

In Fig. 4 are shown the steady-state frequency and phase response curves of a typical amplifier. The response of this amplifier to a 5 kc square wave is shown in Fig. 5. Note the tendency for a slight transient oscillation to occur at the leading edge of the pulse. In Fig. 4, are shown the response curves of the same amplifier with approximately 17% of inverse voltage feedback. The steady state characteristics are seen to

\*\*Radio Engineer's Handbook, F. E. Terman.

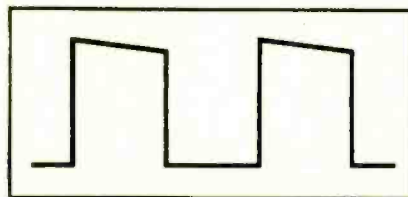

Fig. 3. A phase error of  $2^\circ$  at the fundamental frequency produces a 10 per cent slope in the square wave form.

be somewhat improved by the addition of the inverse feedback. However, the response of the amplifier to a 5 kc square wave (Fig. 5) shows that the transient oscillation noted before now has a longer decay time. The frequency of the damped wave train is approximately 40 kc which indicates that at that frequency the product of the no-feedback gain and the fraction of the output voltage fed back is less than unity, since the oscillation is damped. Also, the fact that the addition of feedback lessens the damping indicates that at the frequency of the oscillation, the overall phase shift has exceeded  $180^\circ$ . Thus it is seen that the square wave approach to audio amplifier testing is of great value whenever direct information of the transient response is desired.

Now to apply the second major design consideration, that of output level and impedance, to audio-frequency amplifiers which ultimately supply sound power to human ears. Here also, the output power must be measured in terms of sinusoidal power to be readily compared with the findings of other workers. A rough idea of output power may be obtained by discarding the output due to all but one of the frequency components in the square wave. This is hardly a practical approach, and is mentioned for any possible academic value. If it desired to measure the peak power output capabilities of an amplifier, a short duration, rectangular pulse may be used to drive the amplifier. The repetition frequency of this pulse is chosen low enough so that the average power capabilities of the system are not exceeded. The amplitude of the output pulse may be measured with a calibrated oscilloscope or an adequate peak reading voltmeter.

The third major design consideration, that of input impedance and level, may be disposed of insofar as the square wave approach is concerned by mentioning that a rough idea of the input-level-handling capabilities of the unit may be obtained by observing the changes in output waveform as the input level is increased from zero. Any useful information, in a quantitative sense, concerning input level maxima for given distortion percentages must be acquired with steady state techniques.

The fourth and last design consideration, that of signal-to-noise power ratios, is important since the ear recognizes and objects to these disturbances long before it notices the effects of non-linear and frequency distortion. Again, the square wave analysis produces no useful information on this subject.

The foregoing discussion has been confined to amplifiers in the audio spectrum which will drive an electro-acoustic transducer and thence drive



the human ears. We have pointed out that non-linear distortion is the most severe problem in this case and that the square wave is not a suitable test waveform for obtaining information on the behavior of the amplifier in this regard. In checking the frequency response within broad limits, the square wave provides quick results. As for determining the behavior under shock from a steep wave front signal, the square wave method gives a direct and quantitative answer.

It is also possible to estimate the overall bandwidth of an amplifier from the transition time. The transition time is defined as the time required for the output pulse to increase from 0.1 to 0.9 of full amplitude. This measurement must be made with a square wave generator and oscilloscope which together have a transition time small compared to that of the amplifier under test. The following equation relates bandwidth from the 65 per cent point to zero frequency, to transition time.

$$\tau = \frac{1}{2f_0}$$

transition time in seconds =  $\tau$   
frequency for 65% response =  $f_0$

However, it is to be noted that the above definitions do not hold if the transition is oscillatory.\*

### Testing Requirements

The testing requirements for amplifiers used in measuring instruments are more stringent than those to be used for listening purposes. Oscilloscope amplifiers must possess amplitude vs. frequency and phase vs. frequency characteristics which depart from linearity by a very small amount. It is desirable to check these amplifiers for frequency response with the usual steady state techniques. The square wave can then be applied and the output waveforms considered in the light of the known frequency characteristic, thus yielding information on the linearity of the phase vs. frequency characteristic. Thus, before the steady state phase data are taken, adjustments are made for a transient output with the fastest transition time consistent with negligible overshoot. This is done at a repetition rate of approximately 0.1 of the maximum frequency that it is desired to transmit with negligible distortion. Then, adjustments are made with a slow repetition rate of square wave for maximum parallelism of the wave tops. Following these adjustments, a steady state phase vs. frequency characteristic may be taken and should show little departure from linearity within the passband.

Again, examination of the amplifier for poorly damped transient oscillations,

\*Eaglesfield, "Transition Time and Pass Band" *Proc. I.R.E.* Feb. 1947.

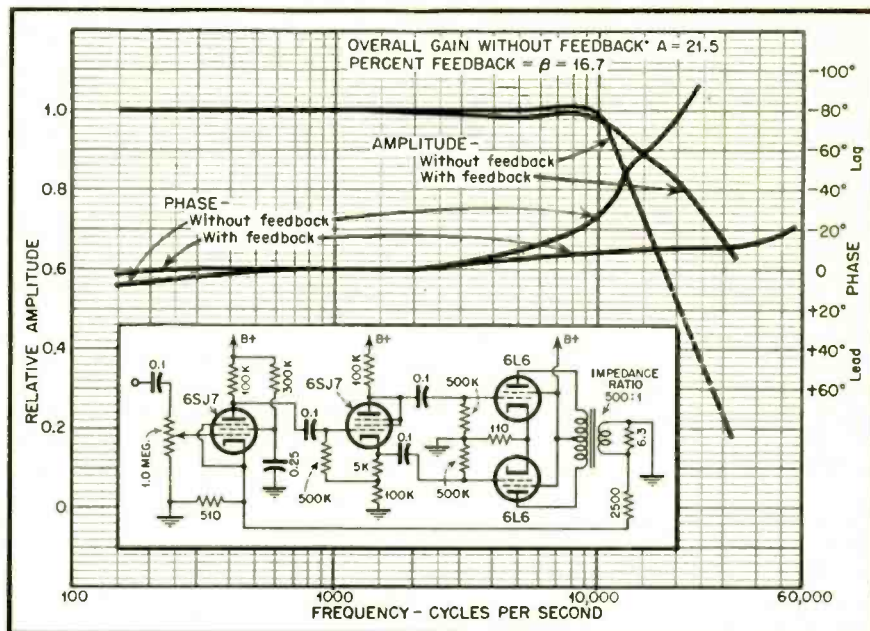

Fig. 4. Steady state frequency and phase response curves of a typical amplifier, with and without feedback.

regeneration, and parasitic oscillations may be undertaken simultaneously with the suggested phase data.

The third general type of amplifier mentioned was that variety used in control service. Often, the non-linear distortion requirements are very lax. Mere capability of handling the range of input voltages to be encountered with 10 to 20 per cent departure from linearity is often adequate. The frequency-response characteristic may have great importance, and inflections and maxima or minima must be located accurately in frequency. The square wave may be employed to check the approximate location of these critical points before final adjustments are made. See Fig. 5.

### Fourier Analysis

Through application of the Fourier series method of analysis, it is possible to deduce the steady state amplitude and

phase characteristics which were responsible for the shape of the observed output of the square-wave-driven amplifier. This method requires a method of accurately measuring distances along the oscilloscope time axis and also the corresponding ordinates. Then follows a lengthy graphical integration which becomes more laborious the more varied the outline of the output pulse. This all seems a very laborious method of obtaining steady-state data which can be obtained by direct measurement.

The trend in present-day engineering is to confine the use of transient techniques to devices such as video amplifiers and pulse amplifiers, the ultimate aim of which is to amplify or shape a transient phenomenon properly. In the case of the audio-frequency amplifier, steady-state amplification is of foremost interest and hence steady state techniques give, in general, the most informative results with a given effort. Mention has been made of several well-known examples of correlation between steady-state and transient response data because much attention has been drawn to them recently by the television problem. In every case, confining the frequency range under discussion to the audio region so simplifies the taking of direct steady-state or transient response data that it seems foolish to resort to laborious calculations to deduce one set of information from the other.

The greatest simplification provided by limiting the response requirements of an amplifier to the usual audio-frequency signals is that perfectly satisfactory transmission is obtained if the frequency components that go to make up a complex waveform are not shifted in phase

[Continued on page 57]

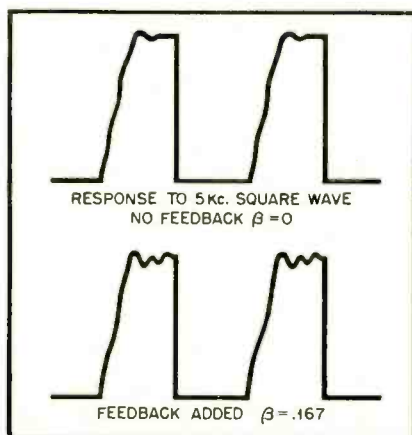

Fig. 5. Square wave response of amplifier shown in Fig. 4, with and without feedback.



# Multiple Speaker Matching

JOHN WINSLOW

IN PUBLIC ADDRESS systems using a number of loudspeakers, it is considered good practice to regulate the amount of power delivered to each speaker in the system in accordance with its requirements. There are a number of ways in which this can be accomplished, but the simplest is by proper choice of impedance for the transformers matching the speaker to the line. With this method, no power is lost in resistance attenuators, and at high power levels every watt of power must be utilized most efficiently.

For most systems, the usual connection of the output lines puts the various loads in parallel across the output transformer. This simplifies the wiring, since all distribution lines branch out from the amplifier, and one pair of wires feeds each speaker or each line of speakers. When the speakers are arranged in a long loop, however, it may sometimes be more economical to feed them from a series circuit, so that a single lead can be used for the wiring. These two methods are shown in Fig. 1 and Fig. 2, together with the formulas

for calculating the required primary impedances. In these formulas,  $P_t$  represents the total available power, with  $P_1, P_2, P_3, \dots, P_n$  representing the power delivered to each speaker; and  $Z_s$  represents the source impedance — which is the output impedance into which the amplifier is to feed — with  $Z_1, Z_2, Z_3, \dots, Z_n$  representing the reflected primary impedance of the individual speaker transformers.

## Slide Rule Method

Although the calculations for either type of connection are quite simple once they are reduced to these formulas, a recent attempt to simplify the problem even more by means of a chart indicated a slide-rule method for determining the correct impedances.

For the case where the parallel connection is to be used, let us consider the following example: The system in a small auditorium is capable of putting out a maximum of 15 watts at an impedance of 600 ohms; the stage speaker line requires 12 watts, a speaker in the lounge requires 2 watts, and a speaker in the manager's office requires 1 watt. What is the required primary impedance of each of the speaker matching transformers?

For the solution, each circuit is handled separately, using a slide rule for each computation. Opposite 15 on the "D" scale, representing the total available power, set 12 on the "C" scale, representing the power required for the stage speaker. Under 500 on the "C" scale, representing the output impedance of the amplifier, appears 625 on the "D" scale, which is the impedance of the primary of the speaker matching transformer, the secondary value being matched to the speaker itself. Similarly, for the lounge speaker, an impedance of 3,750 ohms is indicated; and for the manager's office, an impedance of 7,500 ohms is indicated. All three of these primary impedances are connected in parallel across the output circuit of the amplifier, and the resulting impedance

[Continued on page 52]

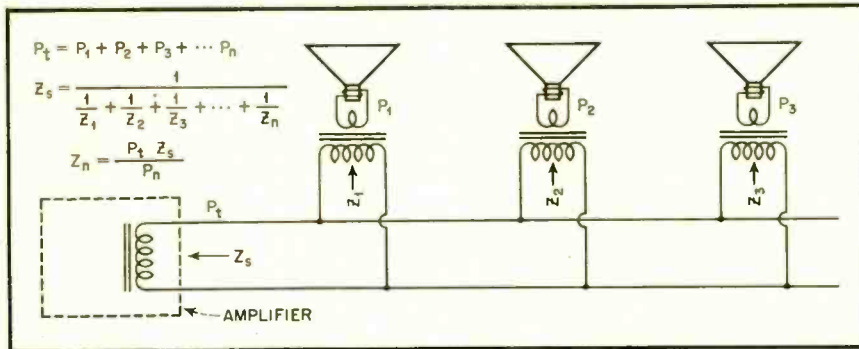
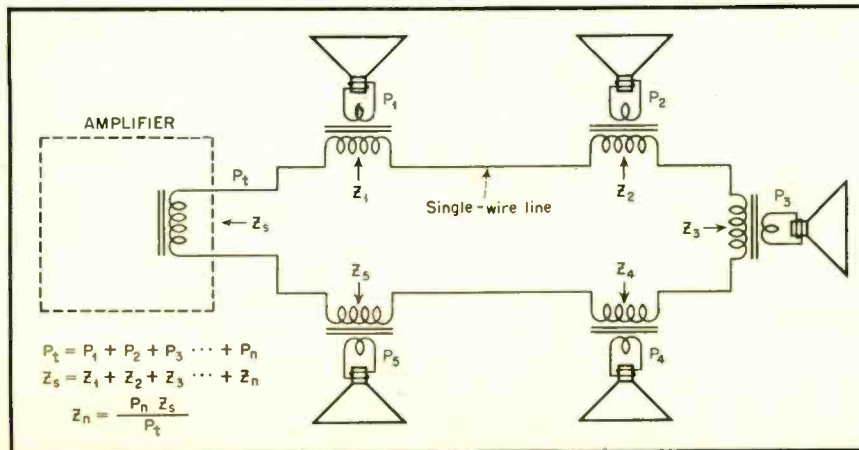

Fig. 1. Typical distribution system for number of speakers fed in parallel from the output of an amplifier. By adjusting the primary impedance of the transformers, the percentage of the total power fed to any individual speaker can be regulated.

Fig. 2. Alternate method of feeding speakers by means of a series circuit. The use of a single line proves economical where the speakers are distributed in a loop, such as around a race track.





# TOO MUCH AUDIO

S. YOUNG WHITE

**A description of hitherto unknown effects of extremely high audio power on the human system.**

FOR MANY YEARS the writer has attempted to generate real amounts of ultrasonic power. Being a radio engineer, he has tried the usual sources—crystals, magnetostriction, and Hartmann whistles. Maximum obtainable power is a hundred watts or so, which is too low for many applications, and attempts to raise it to a few kw seemed hopeless.

Some effects noted in airplane turbojet units showed that improper design allowed "turbulence" to develop, and sometimes this seemed to take the form of resonant oscillations. A study of the theory led to the design of the generator shown in the photographs. This was designed for maximum efficiency at 24,000 cycles, but by slowing it down it took on some similarity to a siren.

The power drawn by this relatively tiny unit is a maximum of 19.6 kw of compressed air. The unit itself weighs two pounds, and the rotor only seven

ounces. The percentage of modulation of the airstream is about 93%, so the efficiency is quite high. The unit is shown without the impedance-matching nozzle, so the construction can be better seen.

Before describing the theory, we might mention the effect produced when this amount of power is released in an ordinary-sized laboratory at about 800 cycles. We might remind the reader that a high-fidelity speaker fed with 20 watts deliver about 1 watt to the air.

When some power is fed to the head and then the driving motor is varied in rpm from zero up, the writer always gets "stuck" at about 800 cycles. The sound intensity is too much for the ear, so the ear effect is not at all unpleasant. The ear seems to say—"There cannot be a sound that loud, so overlook it". Evidently bone slippage is rather complete, so the ear is protecting itself rather well.

The eye can be used as an indicator, however, as it begins to apparently change shape and go out of focus at a mere 3 kw.

Between 5 and 8 kw there is a complete loss of muscular control and memory. When operating the device at full power it is necessary to have someone with ear plugs some distance away to shut off the power on the air compressor, as the operator does not have enough mental control left to shut it off or vary the speed. (Incidentally, you need a 40 shaft h-p compressor to run the generator at full rating.)

The only other effect noted was that several people thought their scalps had lifted up about a half inch. All expression is gone from the face, and the jaw drops down and hangs on its muscles.

The suggestion was made that this value of sound energy might prove useful in shock therapy.

[Continued on page 52]

Fig. 1 (left). Over-all view of the turbo generator. Fig. 2. View looking at the shaft of the generator with rotors used for different frequencies.

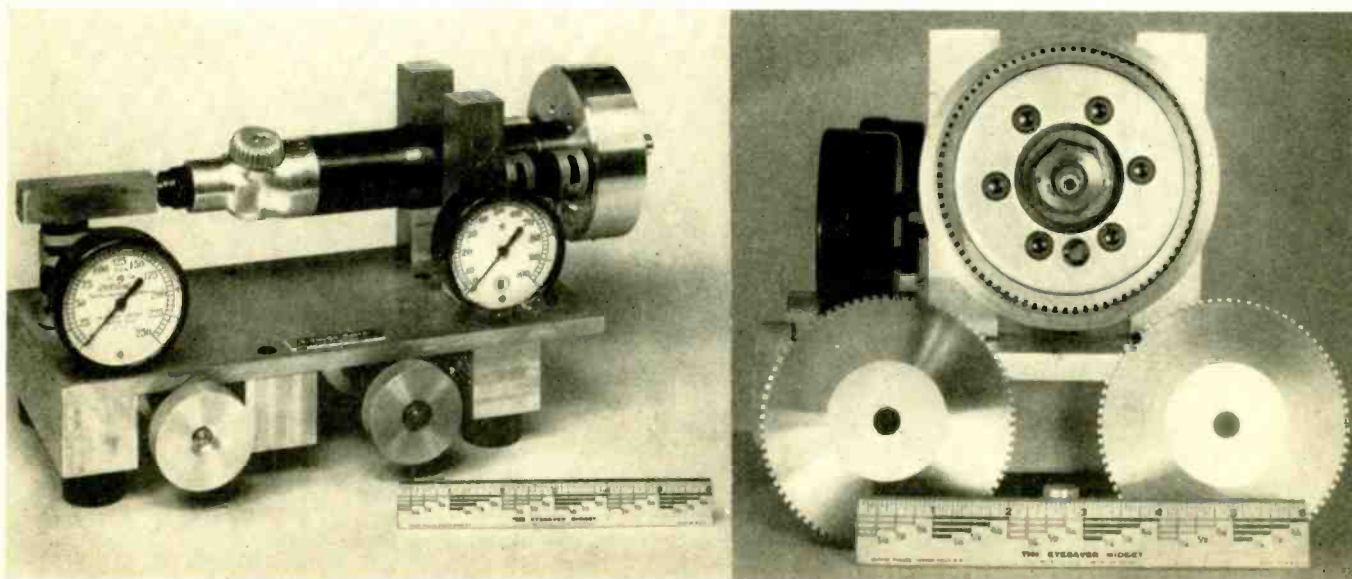



# RECORD

# REVUE



In this department the author, who is a very well-known record critic, will review monthly record releases of outstanding technical, as well as musical, quality.

## EDWARD TATNALL CANBY

THE RECORDS LISTED BELOW are not necessarily *the* finest recordings, technically speaking, of recent months; nor for that matter do they all have the same sort of technical virtues. Some are best because of superior microphoning and/or acoustical conditions at the time and place of recording; others are good because of fine work in the later stages — a suitable recording characteristic, good clean highs, relatively low distortion, good bass, and — perhaps most important — a quiet surface that reproduces high tones well. Though there is not space to describe each one of these records — and there are plenty of others — the list at least offers the engineer in search of good material for his audio layout a group of better-than-average records, all post-war, all featuring clearly extended audio range as compared to pre-war standards.

It is quite possible that for really high-fidelity equipment, the plastic record is the only answer. But the fact remains that very great improvements in reproduction from shellac-type records have been made since the war. Many record buyers, with inferior playing equipment, are not yet aware of this. The best new shellacs have a great deal more on them than most home phonographs can handle, and they give plenty in the way of highs for the high-fidelity enthusiast.

Scratch on shellac is a difficult problem. But it has been simplified greatly by the more uniform surfaces now available, because a smooth, even scratch

is far less objectionable than an irregular, fluttering one. Moreover, though it is true that on the better pickups, "wide open" — especially those with narrow (2-mil) points, and with a vertical component sensitivity — shellac records are unpleasantly noisy unless filtered. On the other hand, some new pickups with wider-radius points, and without the sensitivity to the vertical, can give a remarkably noiseless performance from shellac, with at least some reproduction of highs up to 10,000 cps. This is, of course, far better than most cheap machines with ordinary pickups can do, and in fact is near enough to a reproduction of "all" the music to satisfy most listeners who are fidelity conscious. The listed shellacs will give greatly superior results to even the best shellac records issued before the war.

Good recent albums — both musically and technically — in shellac include:

- Khachaturian—Gayne ballet suite, New York Philharmonic, Kurz, *cond.* ..... CM 664
- Violin Recital, Zino Francescatti ..... CM 660
- Sabicas, Flamenco recital (guitar) ..... Keynote K 134
- Mozart—Operatic Arias, Ezio Pinza, Met. Opera Orch., Bruno Walter, *cond.* ... CM 643
- Copland—A Lincoln Portrait, Boston Symphony Orch., Melvin Douglas ..... VM 1088
- Franck—Symphony in D Minor, Philadelphia Orch., Ormandy, *cond.* ..... CM 608

- Excerpts from Hamlet, Maurice Evans .... CM 651
  - Britten—Serenade for tenor, horn, and strings—Peter Pears, Dennis Brain, Boyd Neel String Orch., Britten, *cond.* ..... Decca London EDA 7
  - Delibes—Sylvia Ballet—BBC Theatre Orch., Robinson, *cond.* ..... Decca London EDA 2
  - Dvorak—Cello Concerto — Piatigorsky; Phila. Orch., Ormandy, *cond.* ..... CM 658
  - Schubert—Die Schöne Müllerin Lotte Lehnan ..... CM 615
  - Copland—Appalachian Spring—Boston Symphony Orch., Koussevitsky, *cond.* ..... VM 1046
- In plastic records, the following are exceptional for their respective types of subject matter:
- Prokofieff—String Quartet No. 2 Gordon String Quartet.... Concert Hall Society Album 106
  - Bach—Cantata No. 106 Harvard Glee Club, Radcliffe Choral Soc. Chamber Orch. (Boston Symphony players) G. Wallace Woodworth, *cond.* .... Technichord T-6
  - Purcell—Eight Harpsichord Suites Sylvia Marlowe ..... Gramophone Shop GSC 2
  - Haydn—"Toy" Symphony ..... Young People's Record Club
  - Prokofieff—Overture on Hebrew Themes.... Disc 4020
  - Historical Recordings—FDR, Churchill, Eisenhower, Montgomery, Truman, etc.... Historical Recordings, HR 100



# HIGH FIDELITY LOUDSPEAKER OF UNIQUE DESIGN

**JOHN K. HILLIARD**

Chief Engineer, Altec-Lansing Corp.

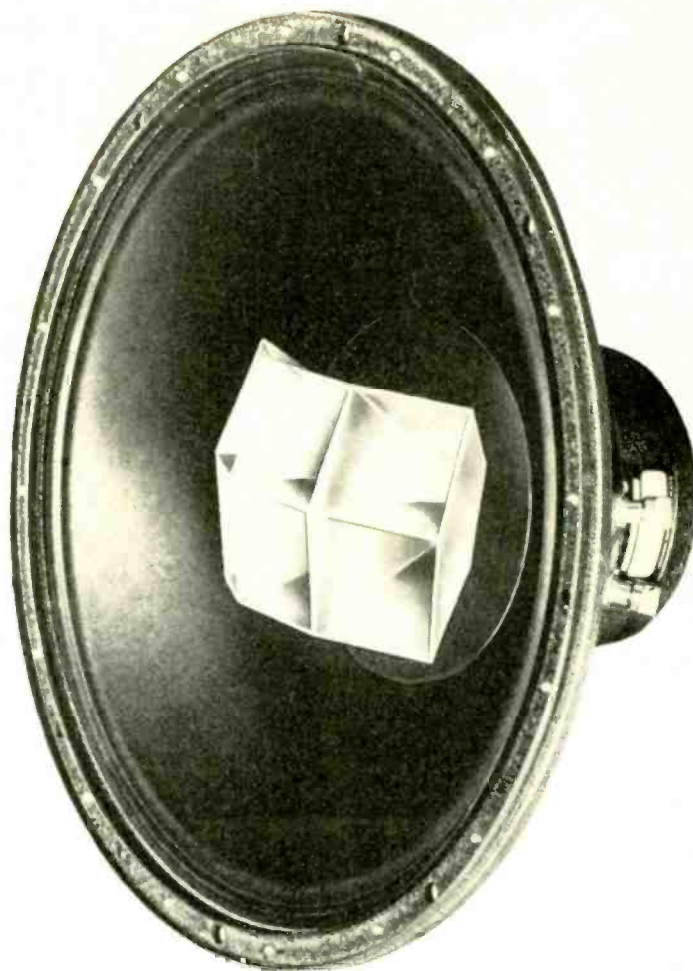

**Describing in detail the characteristics of a new type of loudspeaker, shown in Fig. 1 at the right.**

**A** MAJOR HANDICAP to true high-quality sound reproduction has been the electro-acoustic converter at the end of the reproducing system — the loudspeaker — which has all the limitations that go with mechanical systems.

The advent of better records and the promise that full range FM broadcasting will shortly become a country-wide reality has accelerated the demand for loudspeakers having both a wider frequency response and freedom from intermodulation distortion. Several such loudspeakers are available which meet these requirements, but unfortunately their high manufacturing cost has resulted in their being priced beyond the reach of most users.

## **Dia-cone Principle**

In an attempt to provide a lower-priced unit which retains most of the good features of the finest loudspeakers, the design now known as the Dia-cone was developed. The principles involved are relatively new to the loudspeaker field, and the results obtained have made this particular design one which should be considered for applications in which high quality is desired, yet where the cost of the more elaborate models prohibits their use.

The name Dia-cone is derived from "diaphragm" and "cone" and applies to a loudspeaker having both a high-frequency diaphragm and a low-frequency cone driven through a mechanical network by a single large voice coil. The combination thus gives many of the advantages of a true two-way loudspeaker without the accompanying high costs of double magnets, double voice coils, crossover networks, and the additional costs necessitated by a complicated mechanical construction.

The Model 603 (Altec Lansing) Multicell Dia-cone speaker has an over-all diameter of 15-3/16 in. and a depth of 6 5/8 in., being sufficiently compact, as shown in Fig. 1, to enable its use in standard cabinets when desired. No additional equipment is required for its connection to the output of any good standard amplifier having output impedances designed to match its rated voice-coil impedance of 10 ohms.

Acoustic energy is radiated from two diaphragms which are attached to a single 3-inch voice coil. Since it is recognized that a single large diameter cone-type diaphragm is not capable of providing the necessary uniformity of response over the entire frequency range, the dia-cone type of construction

has been employed. At frequencies above 2,000 cps, the mass of the outside cone is large, and, as a consequence, its ability to radiate uniform energy above 2,000 cps decreases rapidly as the frequency range is increased. Attached directly to the voice coil ring is a domed metal diaphragm of the same diameter as the voice coil. This diaphragm has a high stiffness-mass ratio and so is able to operate as a piston even though the large cone on the outside of the voice coil fails to provide the proper excursion. The voice coil and the metal diaphragm vibrate independently of the outer diaphragm at high frequencies because of the compliance in the area immediately outside and adjacent to the voice coil. The vibrating area of the metal dome is small in comparison with the wave lengths of the frequencies being radiated, and for this reason the distribution is efficient up to 8,000 cps. The amplitude of diaphragm excursion for uniform radiation of acoustic power decreases with an increase in frequency, so that considerable acoustic power can be radiated from a 3-inch diaphragm with a comparatively small amount of excursion. At low frequencies, the metal diaphragm moves as a unit with the



large cone, thus providing the maximum possible vibrating area. The efficiency of this speaker is such that it will deliver a level of 89 db (reference level = 0.0002 dynes per sq. cm.) on its axis at a distance of five feet with an input of only 0.1 watt (500-1,000 cps). The electrical power rating is 25 watts.

In order to enhance the distribution pattern over the high-frequency range, a molded bakelite six-cell multicellular horn is mounted directly in front of the metal dome, as shown in Fig. 2. Sufficient clearance is provided so there is no possibility of the metal diaphragm striking the throat of the high-frequency horn even at rated maximum power. The horn is held in position by means of two studs which are threaded into the top plate surrounding the voice coil structure and pole piece, and clearance holes are provided in the outside cone for the studs. In addition to improving the angular distribution, the multicellular horn also reduces irregularities in response.

#### Cone Design

The cone itself, of seamless molded construction, has an effective radiating area of 123 square inches, and is treated to resist moisture. The domed diaphragm is cemented directly onto the voice coil structure, which is edgewise-wound with aluminum ribbon. This permits an increase in the space factor by 27 per cent over round wire, and since more conductor material can be placed in the air gap, the efficiency is raised and the operating temperature — with higher power — is reduced. The large voice coil permits a decreased cone depth with an increase in effective stiffness to the driving force, so that the

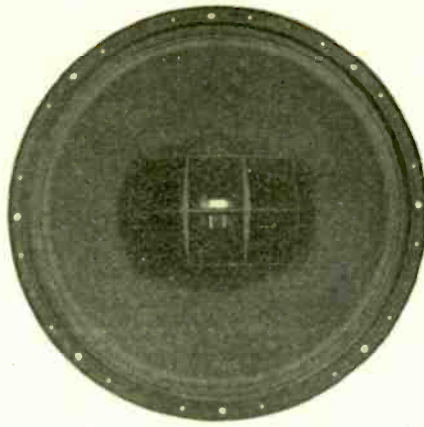

Fig. 2. Front view of the Dia-cone speaker described in this article.

cone acts more nearly as a piston at low frequencies. The spider is of the accordion type so as to permit large low-frequency excursions, and is attached to the magnet structure outside the voice coil. The resonance frequency of the cone and voice-coil assembly is approximately 45 cps in free air.

Field excitation is provided by an Alnico V permanent magnet, with the magnetic circuit being so designed that there is very little stray field. This is an advantage when the speaker may be used in proximity to cathode-ray tubes, as in television-radio cabinets.

When using this speaker with amplifiers having negative feedback embracing the output stage, the maximum true bass response can be obtained when the internal output impedance of the amplifier is approximately 10 ohms. It is not sufficient alone that the amplifier be rated for a 10-ohm load, since the use of a large amount of feedback may produce

output impedances much lower than the rated load impedance of the amplifier. An output impedance several times lower than the speaker impedance should be used only in connection with loudspeaker cabinets which are of improper design and tend to give boomy reproduction.

Cabinets of the tuned-port type are recommended where the maximum bass response is required in a limited space. Enclosures having a volume of four cubic feet will give efficient response down to 90 cps, where cutoff begins. Low-frequency response is improved with increase in size, with efficient response down to 55 cps being obtainable from a seven cubic-foot cabinet. In any such type of cabinet, the speaker should be mounted as high in the cabinet as possible so the direct radiation will not be obstructed by furniture, and to minimize floor reflection. Port tuning may be resorted to for adjustment of optimum performance.

#### Cabinet Types

Figures 3 and 4 show two different types of cabinets used with the Dia-cone speaker as available units. The furniture cabinet, Fig. 3, has a volume of seven cubic feet, with the port resonated for maximum response down to 55 cps. The utility cabinet, Fig. 4, has a volume of approximately six cubic feet, with the port tuned to 60 cps. Both of these cabinets are lined with fiberglass panels, 2 inches thick.

The Dia-cone speaker was designed to supply a superior quality of reproduction for those applications where the added high-frequency response of a duplex speaker may not be necessary, and where the extra cost is not warranted by the use to which the speaker is to be put.

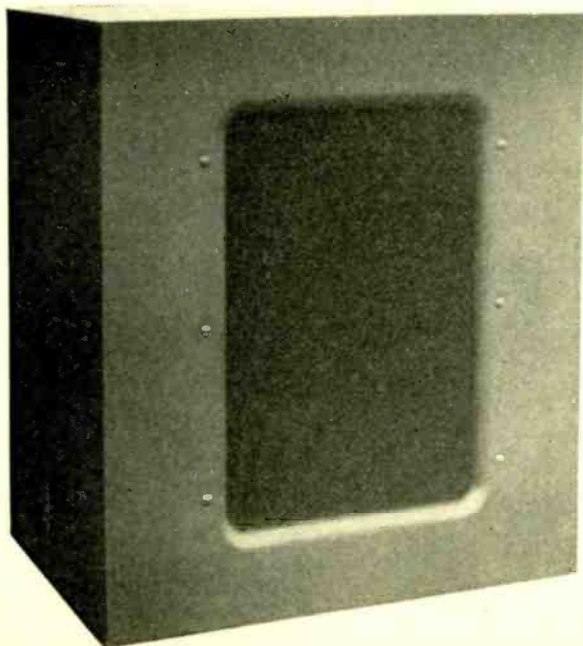

Fig. 3 (right). The loudspeaker is shown installed in the furniture type cabinet.

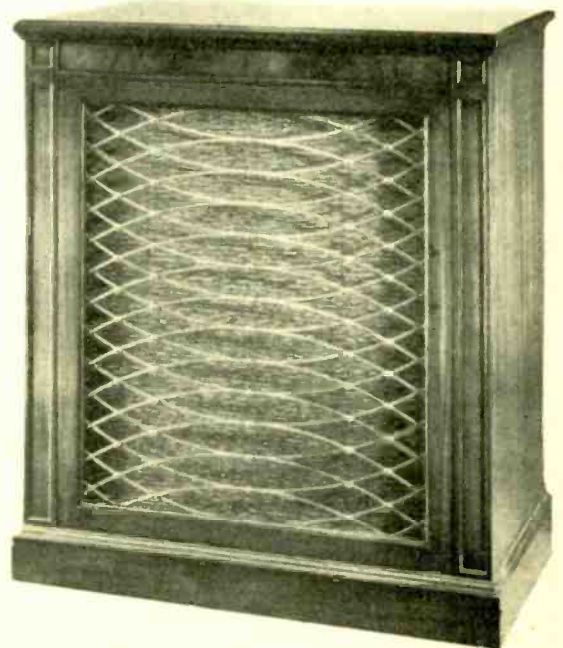

Fig. 4 (left). Speaker installed in utility cabinet.



# AUDIO DESIGN NOTES

## NEGATIVE FEEDBACK CIRCUITS

• Non-linear distortion is reduced by application of negative feedback, and other circuit disturbances may be minimized in many cases. In any event, signal output is reduced by the amount indicated in Fig. 1. As a result, a sufficient margin of gain must be provided to realize the desired output level when the feedback mesh is connected into the circuit. This margin of gain is likewise indicated in the chart.

The amount by which non-linear distortion is reduced for a given amount of feedback may be stated as

$$D_f = D/(1 - AB)$$

where

$D_f$  is the distortion remaining with use of feedback

$D$  is the distortion present without feedback

$A$  is the gain of the amplifier

$B$  is fraction of output voltage fed back

Because of the many desirable features of negative feedback, it has come to be regarded in some circles as a panacea for all amplifier shortcomings. This, of course, is not quite true and may be particularly untrue in the case of hum.\* With a transformer-coupled load, feedback voltage should not be

\*RADIO, June 1946, p. 22

taken from the plate, as the hum level will rise rather than diminish. Instead, the feedback connection should be made on the output side. When using pentodes or tetrodes, additional filtering of the screen supply will be found highly desirable to minimize hum.

In a typical case, it was found that when feeding back from the voice coil without auxiliary screen filtering, the hum was 16 per cent of the source hum voltage, but was reduced to 1 per cent with auxiliary screen filtering. Without feedback, these values were found to be 180 per cent and 2 per cent respectively. A conventional pentode with transformer output was used.

Properties of negative feedback amplifiers are dependent upon whether current or voltage circuits are used. Voltage feedback causes a tube to operate as if it had a lower plate resistance

$$R_{p1} = R_p/(1+B\mu)$$

where

$R_{p1}$  is the apparent plate resistance

$R_p$  is the plate resistance of the tube

$B$  is the fraction of output voltage fed back

$\mu$  is the amplification factor of the tube

Thus voltage feedback frequently aids in obtaining desired speaker damping.

Current feedback, on the other hand,

causes the tube to assume an apparent plate resistance

$$R_{p1} = R_p + R_k(1+\mu)$$

where  $R_k$  is the value of the unby-passed cathode resistance.

The cathode follower is a special case of current feedback in which  $B = 1$ . Another special case includes half the load resistance in the cathode circuit and half in the plate circuit, forming the useful phase-splitter inverter.

When feeding back over more than one stage, there is the possibility that phase shifts in the coupling networks and other circuit reactances will cause positive feedback to occur at some frequency, with resulting oscillation. This oscillation frequency may be outside the frequency range of immediate interest, and hence the complete response characteristic of the amplifier should be taken into consideration when analyzing oscillation conditions.

Nyquist<sup>1</sup> has established the analytical requirement for non-oscillation. The term  $AB$  is separated into real and quadrature components, and plotted upon Cartesian coordinates over a complete range of frequency. The curve

[Continued on page 52]

<sup>1</sup>Bell System Tech. Journal, Jan., 1932, p. 126

Fig. 1. Gain required to restore original output when negative feedback is used.

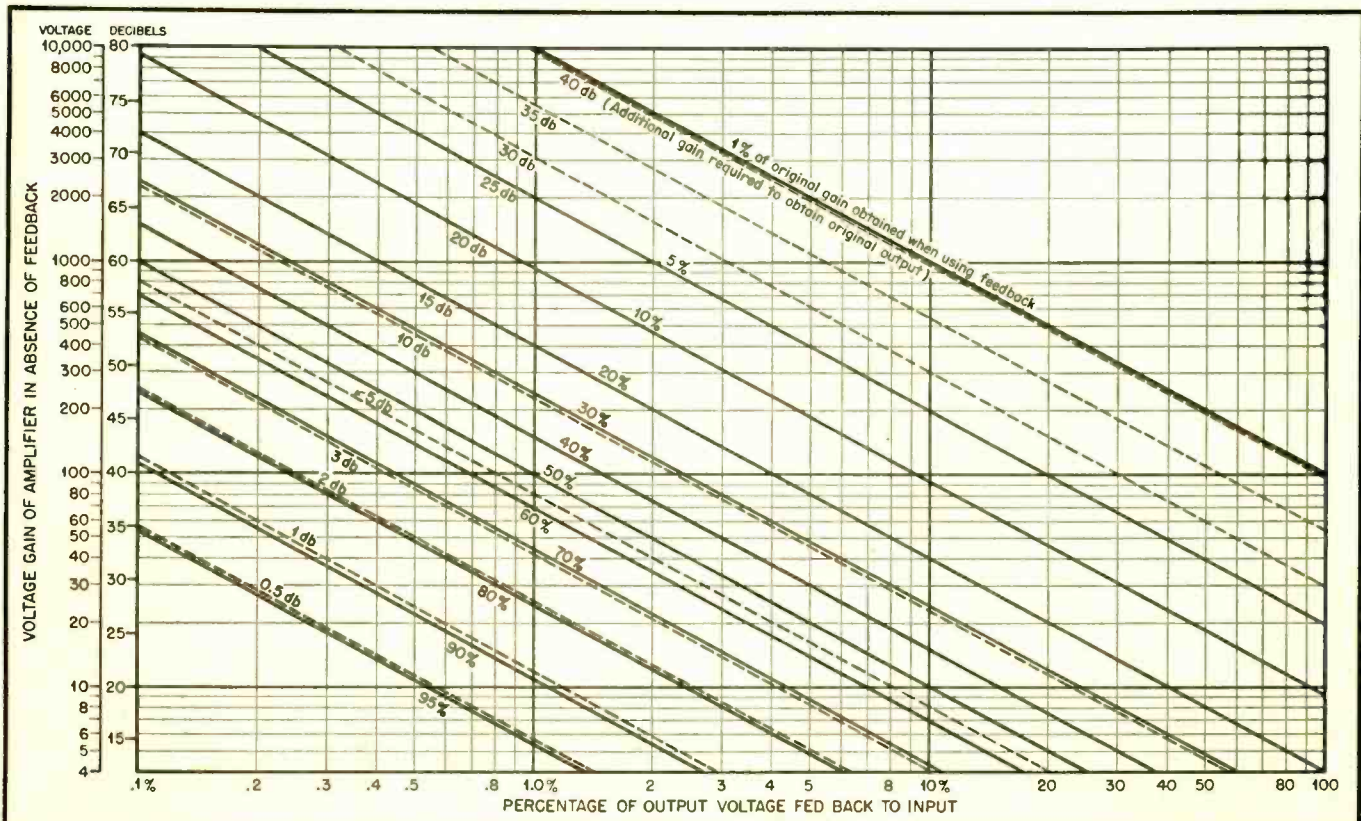





# USED... PROVED... OK'D...



## TODAY'S MOST Complete Line

ANSWERS EVERY  
MICROPHONE NEED

- Only *ELECTRO-VOICE* brings you *all* these types and *all* their features! Proved in critical service, they are widely used today by leading manufacturers and sound engineers.
- In the complete E-V line, there is a microphone for every application . . . for every budget. With such a *wide* choice, you can make a *better* choice—for *your* requirements.
- Outstanding developments by E-V engineers assure you *finer* performance, *superior* quality, *greater* value than ever!

**THE CARDYNE** — True cardioid unidirectional dynamic microphone, with exclusive E-V Mechanophase® principle, Acoustalloy diaphragm, smooth, wide range response, and high output.

**THE CARDAX** — The only high level cardioid crystal microphone with Dual Frequency response for high fidelity voice and music, or rising characteristic for extra crispness of speech.

\*Patent Pending.  
Crystal Microphones Licensed under Brush Patents

Visit  
Booth No. 15  
Radio Parts  
Show  
Stevens Hotel  
Chicago  
May 13-16

|   |  |  |
|---|--|--|
|  <p><b>Hand-Held<br/>Differential†</b><br/>Model 205-S Carbon</p> <p>Close-talking, noise-cancelling—for maximum intelligibility under intense noise. Blastproof, waterproof, shock-resistant. Used in police, aircraft, marine and high noise industrial applications. Fits comfortably in the hand. Substantially flat response. High output. Weighs only 8 oz. Press-to-talk switch.</p> <p>†Patent No. 2,350,010</p> |  <p><b>Rugged Hand-Held</b><br/>Model 600-D Dynamic<br/>Model 210-S Carbon<br/>Model 602 Differential†</p> <p>Widely used for clear speech transmission. High impact phenolic case. Press-to-talk switch. Model 600-D Dynamic gives higher articulation—easy on the listener. Model 210-S is similar, but in single-button carbon. Model 602 Differential Dynamic is close-talking, noise cancelling.</p> |  <p><b>Noise-Cancelling<br/>Differential†</b><br/>Model 606 Dynamic</p> <p>Effectively used in airport control towers, police dispatching, special events broadcasting, close-talking p.a., and high noise industrial applications—indoors and outdoors. Transmitted speech gets through clearly and completely. Has E-V Acoustalloy diaphragm. 22° fixed tilt. Satin chromium finish. High and low impedances.</p> |
|---|--|--|



by Sound Engineers EVERYWHERE!



Modern, Low-Cost  
Model 610 Dynamic  
Model 910 Crystal

Adds smartness to economical public address, paging systems, ham rigs. Smooth response 50-8000 c.p.s. Fine reproduction of speech and music. 15° fixed tilt. Satin chromium finish. Built-in cable connector. Dynamic has Acoustalloy diaphragm. Output -53 db. High and low impedances. Crystal model has high capacity moisture sealed crystal. Output -48 db.



High Fidelity  
High Output  
Model 630 Dynamic

Exceptionally smooth response from 40-9000 c.p.s., for voice and music. Output -53 db. Compact, rugged. Has Acoustalloy diaphragm. Withstands severe service indoors and outdoors. Head tilts through 90° for aiming at sound source. "On-Off" switch. Built-in cable connector. Satin chromium finish. Available in high and low impedances.



Bi-Directional  
High Fidelity  
Velocity

Proved E-V design gives superb voice and music reproduction, for indoor public address, broadcasting, recording. Equal front and back pick-up. Zero pick-up at sides, top and bottom. Reflection-free housing. Internal shock-absorber. Locking cradle mounting. "On-Off" switch. Available in Models V-1, V-2, V-3.



General Utility  
Model 605 Dynamic  
Model 905 Crystal

Durable, efficient, low-cost models for public address, paging systems, dispatching, recording, and amateur radio. Excellent response from 50-7500 c.p.s. Satin Chromium finish. 22° fixed tilt. Built-in cable connector. Dynamic has Acoustalloy diaphragm. High and low impedances. Crystal model has high capacity moisture-sealed crystal.



High Quality  
General-Purpose  
Model 640 Dynamic

Response substantially flat 35-10,000 c.p.s. High output (-53 db). Gives accurate reproduction of voice and music. Has exclusive E-V Acoustalloy diaphragm. Very rugged for outdoor and indoor use. Cradle mounting, with built-in cable connector, permits 135° tilt. Satin chromium finish. Available in high and low impedances.



Comet  
Microphone and Stand  
902 Crystal  
601 Dynamic

Perfectly balanced in one unit—at low cost. Non-breakable plastic. Easy to use as hand mike or on desk. Smooth response 70-7000 c.p.s., for home recording, p.a., paging, and amateur communications. Dynamic model has Acoustalloy diaphragm. Output -53 db. High and low impedances. Crystal model has -47 db output.

NO FINER CHOICE THAN

**Electro-Voice**

ELECTRO-VOICE, INC., BUCHANAN, MICH.

Export Division: 13 East 40th Street, New York 16, N. Y. Cables: Arlab

Send for  
Catalog 101

Gives valuable data and information on E-V Microphones. Includes handy selection guide.





# TECHNICANA

## REDUCING DISTORTION

• In audio amplification the input impedance of a conventional triode is almost infinite with the exception of when the input voltage peaks exceed the normal grid bias. With the intermittent flow of grid current the distortion due to the varying input impedances results in audio oscillations or *ringing* in the driver stages which is often very difficult to cure. A possible method of reducing this distortion, particularly in audio amplifiers of large outputs, is described in *Wireless Engineer* for Jan., 1947.

It is suggested, that in class B amplifiers the output stage may be a grounded-grid amplifier. With this form of cathode coupling the input impedance may be made very low and the

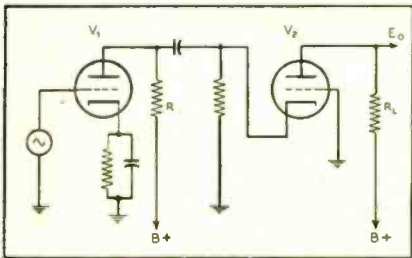
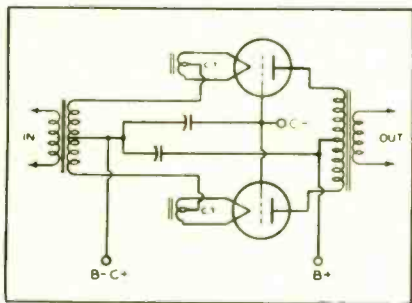

Fig. 1. above, Fig. 2. below.



additional parallel load from the grid current flow is then made comparatively small. The basic circuit illustrating the cathode coupled stage and its driver is shown in Fig. 1. Generally, the problem of matching the impedance of \$V\_1\$ and the final load impedance \$R\_L\$ can only be solved with a matching transformer whose primary reactance at the lowest audio frequency is at least ten times the a-c plate resistance of \$V\_1\$.

A practical class B amplifier circuit is shown in Fig. 2. It is necessary to maintain excellent plate voltage regu-

lation. Any of the various systems of negative feedback may be employed, although voltage feedback is to be preferred.

## LIVENESS IN BROADCASTING

• Most outstanding article on the subject of microphone placement published within several years is entitled "Liveness in Broadcasting," by J. P. Maxfield, of Bell Telephone Laboratories, in January issue of *Western Electric Oscillator*.

Locating microphones so as to provide the studio engineer with a means of supplying the necessary accentuation lost by the failure of the listener's binocular sense, and with means for making full use of the distinction between nearby and distant sounds, and to eliminate the undesired accentuation of the apparent liveness. One important advantage is a gain of as much as 6 db in average program level with the same facilities.

Liveness is a characteristic which creates an effect of adding the studio space behind the loudspeaker plane without any intervening wall, thus eliminating the unpleasant effect of the sound coming from a "hole in a box." The technique consists of the use of a microphone situated some distance from the performers to pick up the general blend of sound, and one or more accentuation microphones for accenting soloists or desired portions of the orchestra.

Positioning of microphones is definitely related to size and reverberation time of the studio, and to the desired liveness constant for the type of program, all of which is thoroughly covered in the article. (Another article by the same author, covering this subject in greater detail, will appear in *AUDIO Engineering*. Ed.)

## FEEDBACK AMPLIFIERS

• An excellent discussion by A. B. Hillan on the design and performance of amplifiers employing negative feedback through a parallel-T bridge has appeared in the *Journal of the Institution of Electrical Engineers*, Part III, January, 1947. The parallel-T bridge makes it possible to construct a frequency selective amplifier without the use of inductive reactance circuits.

The parallel-T bridge is derived

from the characteristics of the T- $\pi$  transformation circuit theorem, where the impedances between a T type network and a  $\pi$  type network become indistinguishable. It is possible, therefore, to apply this to a negative feedback circuit in such a fashion that the bridge characteristic is dependent upon frequency having only one balance point of peak amplification. This is apparent since from the two types of networks we have

$$Z_A = \frac{Z_1 Z_2 + Z_2 Z_3 + Z_3 Z_1}{Z_2}$$

$$Z_B = \frac{Z_1 Z_2 + Z_2 Z_3 + Z_3 Z_1}{Z_3}$$

$$Z_C = \frac{Z_1 Z_2 + Z_2 Z_3 + Z_3 Z_1}{Z_1}$$

Combining and summarizing, we have from the arrangement in Fig. 3A and

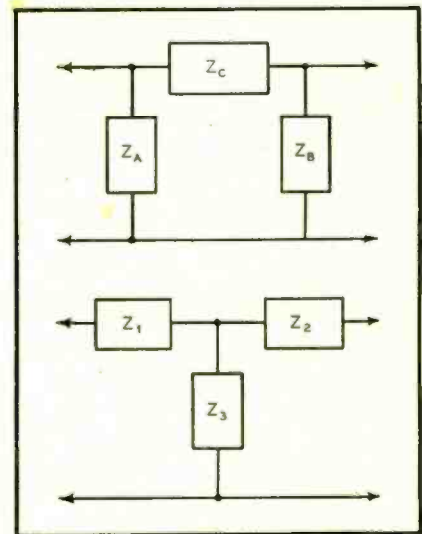

Fig. 3A-3B. above, Fig. 4A-4B. below.

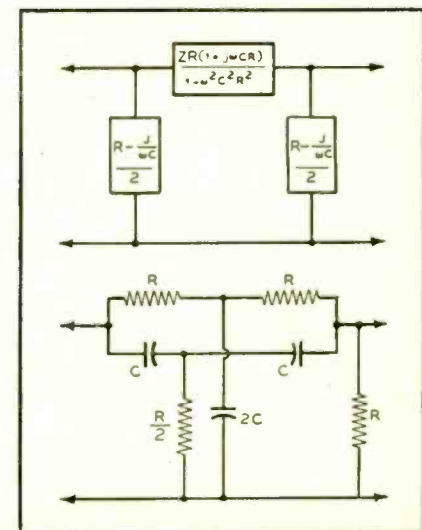
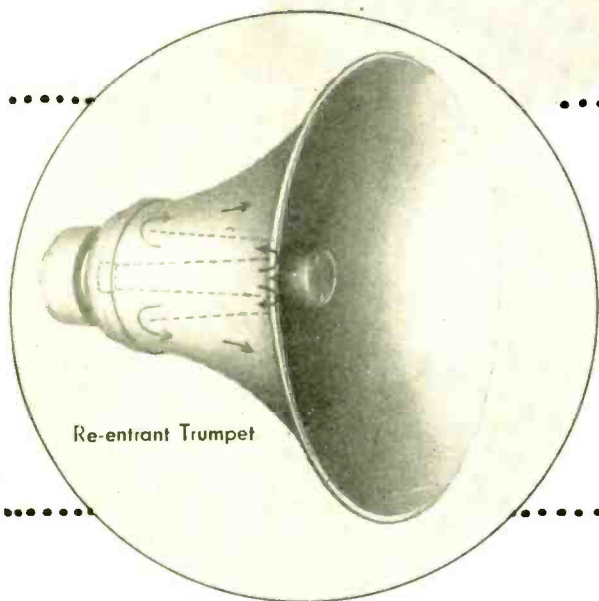

Fig. 3B an equivalent circuit shown in Fig. 4A or the schematic in Fig. 4B.

For a zero transmission characteristic through this bridge we have at balance [Continued on page 46]

# AUDIO ENGINEERING SUPREMACY

is built into every RACON Sound Reproducer



Re-entrant Trumpet

## ACOUSTIC & STORMPROOF MATERIAL

Only RACON makes speakers with Racon Acoustic Cloth which is processed by a patented method which gives a non-vibratory wall, thereby increasing the output of the horn without loss due to wall vibration. Supplied for indoor use (DeLuxe type) and for outdoor use (Stormproof type)—guaranteed for life in all kinds of weather and temperature, regardless of climatic conditions.

## ADVANCED ENGINEERING & DESIGN

RACON'S leadership in sound reproducer engineering has been recognized for almost three decades. RACON driver units have a rated output for peak and continuous performance far in excess of any other brands — continuous operating capacity 30 watts, peak capacity 60 watts. RACON speakers and driving units require less energy input yet they deliver more efficient sound reproduction output.

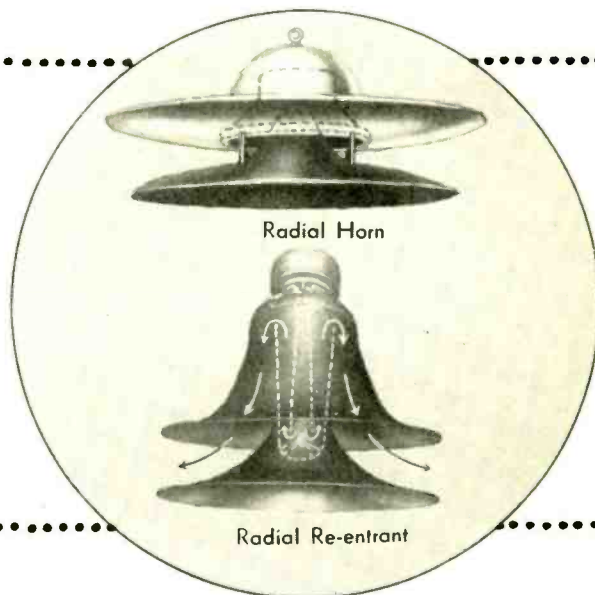

Radial Horn

Radial Re-entrant

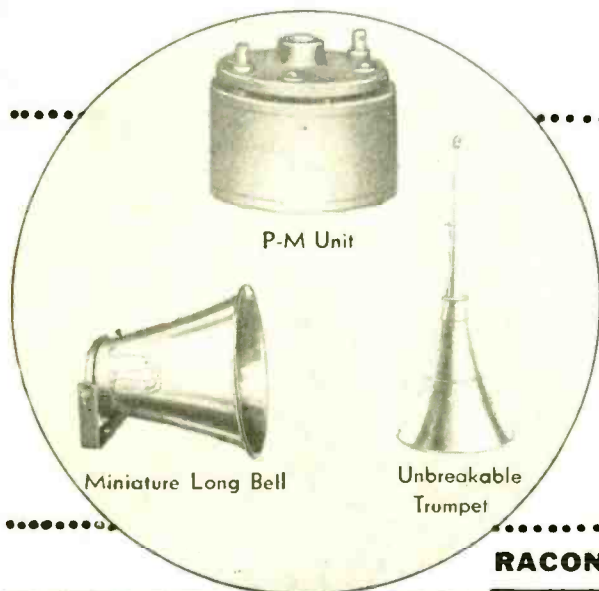

P-M Unit

Miniature Long Bell

Unbreakable Trumpet

## COMPLETE LINE TO CHOOSE FROM

There is a RACON driving unit, trumpet or speaker for every conceivable sound application — also the accessories (brackets and housings) that may be required for special purposes. Soundmen know that it pays to choose and use a speaker line that is complete. Yes — RACON makes every kind of sound reproducer from the giant 7 foot length auditorium horn down to the small 4 inch intercom cone speaker — from the super giant P.M. driving unit to the tiny driver for paging horns.

SEND FOR FREE CATALOG

**RACON ELEC. CO., INC., 52 E. 19 ST., NEW YORK, N. Y.**

# RACON

Racon Elec. Co., Inc.  
52 E. 19th St., New York 3, N. Y.  
Gentlemen: Please send me a copy of your new free catalog.  
Name .....  
Address .....  
City & State .....



# Graphical Characteristics of Cathode-Coupled Triode Amplifiers

The author shows how the characteristics of cathode-coupled amplifiers may be rapidly determined from equivalent triode analysis, using two simple charts to replace the usual laborious computations.

**C. J. LeBEL**

Consulting Audio Engineer

**T**HE CATHODE-COUPLED AMPLIFIER has received increased attention lately, but its use has been hampered by the computations necessary to judge its characteristics. It is the purpose of this article to discuss graphs which make it almost as easy to use as a single triode.

Although a combination of two old elements—a cathode output (cathode follower) stage feeding a cathode input stage (grounded grid) by way of the common cathode impedance—it has been regarded with increasing interest only in the last few years.<sup>1,2</sup>

## Uses

The chief attention has been in connection with wide-band amplifiers, where the alternative would be a heavily compensated, high-transconductance pentode stage. However, the cathode-coupled triode has better signal to noise ratio, less intermodulation, and requires less compensation (often none) than a pentode. A suitable twin triode tube costs less than a high transconductance pentode.

Since the input section is a cathode follower, we have the expected many-fold increase in tube input impedance, which combines well with useful gain, and low enough output-impedance to minimize the effect of stray capacity in the load circuit.

Finally, it does not cause phase reversal, i.e., input and output are in

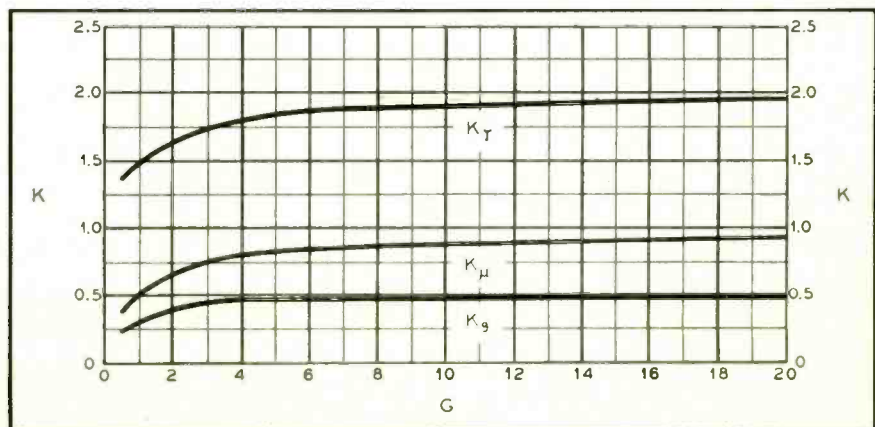
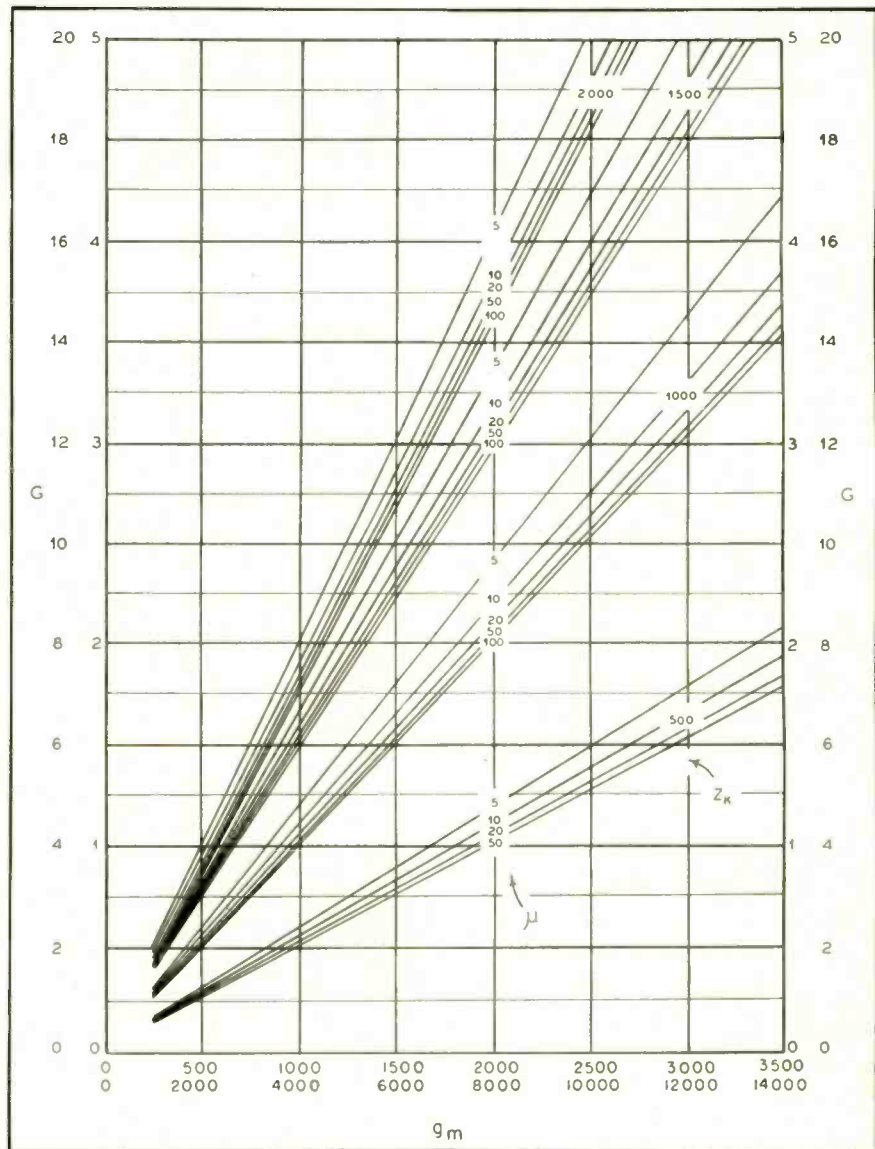

Fig. 1 (top). This chart is used to find the value,  $G$ , which in turn is employed with Fig. 2 (bottom) to find the factors necessary to determine the equivalent triode characteristics.

phase. There are occasions when this is very useful.

### Derivation

The graphs are based on a recent study<sup>2</sup> which shows how a cathode-coupled amplifier may be directly replaced by an equivalent triode. Mutual conductance, plate impedance and amplification factor are simply related to the constants of the amplifier tubes. The two individual amplifier triodes are assumed identical, as is usually the case.

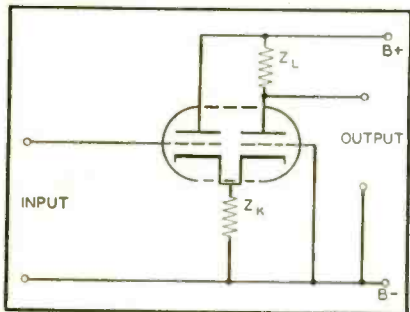

Fig. 3. Schematic of cathode-coupled amplifier, as analyzed in this article.

### Use

Use Fig. 1, which is a graphic solution of the equation where

$$G = Z_k g_m \left( 1 + \frac{1}{\mu} \right)$$

$Z_k$  = cathode coupling impedance  
 $g_m$  = mutual conductance of individual triodes  
 $\mu$  = amplification factor of individual triodes

Take this value of  $G$  to Fig. 2 and read off  $K_p$ ,  $K_r$ , and  $K_\mu$  directly.

Now the equivalent triode constants  $g_m'$ ,  $r'$ , and  $\mu'$  are found from the individual triode constants  $g_m$ ,  $r$  and  $\mu$  by mere multiplication

$$\begin{aligned} g_m' &= gK_p \\ r' &= rK_r \\ \mu' &= \mu K_\mu \end{aligned}$$

### Example

Take a popular triode with the following constants:

$$\begin{aligned} g_m &= 2500 \text{ } \mu\text{mhos} & r &= 8000 \text{ ohms} \\ \mu &= 20 & Z_k &= 1000 \text{ ohms} \end{aligned}$$

From Fig. 1,  $G = 2.62$ . From Fig. 2, then:

$$\begin{aligned} K_r &= 1.73 \\ K_\mu &= .73 \\ K_p &= .42 \end{aligned}$$

and hence the equivalent triode will be:

$$\begin{aligned} g_m' &= 2500 \times .42 = -1050 \text{ } \mu\text{mhos} \\ r' &= 8000 \times 1.73 = 13800 \text{ ohms} \\ \mu' &= 20 \times .73 = -14.6 \end{aligned}$$

### References

1. Cathode-Coupled Wide-Band Amplifiers, G. C. Sziklai & A. C. Schroeder, *Proc. I.R.E.*, Vol. 33, No. 10, pp. 701-709. Oct. 1945.
2. Cathode-Coupled Triode Amplifiers, N. I. Korman, *Proc. I.R.E.*, Vol. 35, No. 1, p. 48, Jan. 1947.

AVAILABLE IMMEDIATELY



# PARA-FLUX REPRODUCERS

for realistic reproduction of transcriptions



Universal Reproducer



Lateral Only Reproducer



Vertical Only Reproducer

PARA-FLUX REPRODUCERS set a new standard of performance for true color tone from record transcriptions. Sound Engineers who demand quality of reproduction, dependable service and more flexibility are specifying and using PARA-FLUX REPRODUCERS, more and more. Evidence of this broad recognition is their use by an ever-increasing number of leading Transcription Console manufacturers. And more than 1,000 PARA-FLUX REPRODUCERS are now on the air over FM-AM stations.

For FM operation, where quality production is essential, PARA-FLUX Vertical Only and Lateral Only Magnetic Reproducers assure absolute pick-up accuracy. And on AM, PARA-FLUX Universal Reproducers give superior performance where both Lateral and Vertical reproduction is required from the same unit, and likewise for quick cueing operations. FM quality can be assured through the use of any Reproducer illustrated opposite. All three types are interchangeable with our Model A-16 Arm and Model EL-1 Equalizer.

*Bulletin PR4 describes and illustrates the complete assembly, lists engineering data, shows graphs illustrating the effect of the Equalizer in its various positions, and other pertinent information . . . yours for the asking.*

Available through authorized Jobbers

**RADIO-MUSIC CORP.**  
**EAST PORT CHESTER • CONNECTICUT 5**



# New Products

## LOW-COST MIKE

A new Model 905 Crystal Microphone is announced by Electro-Voice, Inc., Buchanan, Michigan. It offers a combination of durability, attractive appearance and smooth reproduction of voice and music. Frequency response is rated substantially flat from 50-7500 c.p.s. Output



level is -50 db. Makes a quality microphone available at low cost for general sound work, recording and communications. Recommended for schools, churches, hotels, theaters, auditoriums, amateur radio communications, call and dispatching systems, business and industrial paging systems, home recording and semi-professional recording service. Polar pattern is non-directional at low frequencies becoming directional at higher frequencies. Employs high capacity, moisture-sealed crystal. High impedance. Case design is similar to the popular E-V Model 605 Dynamic. Made of the highest purity (99.-99%) pressure-cast metal, finished in satin chromium. Head at fixed tilt of 20°. Built-in cable connector. Standard  $\frac{5}{8}$ "-27 thread for stand mounting. Equipped with 8 ft. or 20 ft. well-shielded cable.

E-V Catalog No. 101 gives detailed information. Simply write to Electro-Voice, Inc., Buchanan, Michigan.

## NEW P. A. AMPLIFIERS

The Thordarson Electric Manufacturing Division of Maguire Industries, Inc., has recently announced a new line of audio amplifiers for public address systems. Included are 8, 25, 50 watt amplifiers, a pre-amplifier and a booster.

The 8 watt amplifier, whose dimensions are only 10"x6"x7½" and which weighs only 14¾ pounds, provides two input circuits; one a high impedance microphone channel giving 115 db gain and the other a high impedance phono-channel with 72 db gain (both values based on 100,000-ohm input impedance). The tone control of the high-frequency attenuator type, will satisfactorily eliminate needle scratch or objectional highs—at maximum position it will give 22 db attenuation at 10,000 cycles. In normal operation the frequency

response is rated flat within 1 db from 50 to 10,000 cycles.

The 25-watt amplifier provides three input circuits, all of which may be electronically mixed to feed the output circuit. Individual treble and bass tone controls make possible the elimination of unwanted highs in recordings or lows which would tend to interfere with crisp speech output. With tone controls in the normal positions characteristic "True-Fidelity" output, with frequency response flat within 1 db from 30 to 15,000 cycles is obtainable. The hum level is 65 db below rated output. An all-steel streamlined cabinet provides fully enclosed construction with the three input circuit controls as well as the base and treble tone control knobs protected by a conveniently recessed, sloping front panel.

The 50-watt model is designed for large stadia and roller skating rinks. This rating is conservative since the unit is capable of 65 watts peak output. The five input channels (three microphone and two phono) are equipped with individual controls. The Thordarson dual tone controls permit nine extreme response curves.

## INTERCOM SYSTEM

RCA's first postwar intercommunication system, newly designed and engineered, with compact speaker stations as small as an ordinary desk clock, has been announced by the RCA Sound Equipment Section.

A "two-station" intercom, the system is designed with amplifier and speaker station in separate units, permitting off-the-desk location of the amplifier at any out-of-the-way point and reducing speaker station size to a minimum. Speaker stations are newly styled and housed in streamlined black plastic cabinets with satin-chrome speaker grills.

Conversation may be carried on over the new intercom at normal voice level



with a flick of the two-position switch. Releasing the switch returns it to "listen" position. A three-inch speaker is used in the speaker station, which feature design and circuit refinements to eliminate hiss and hum.

Especially designed for such two-sta-

tion use as communication between executive and secretary, theatre box-office and manager's office, or doctor and receptionist, the system consists of two speaker stations, separate amplifier, and 100 feet of interconnecting wire. It is easily installed and plugs into any 110-volt AC or RC outlet. If desired, additional stations up to five can be connected to the amplifier.

The new intercom, which is immediately available, will be distributed through RAC Sound Equipment distributors.

## VOLTAGE REGULATORS

A new catalog, describing the principles of operation and technical specifications of electronically-controlled voltage regulators and Nobatrons, has just been issued by Sorensen & Co., Inc., 375 Fairfield Avenue, Stamford, Connecticut.

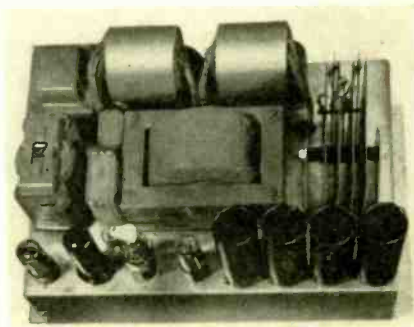

Containing complete information on the entire Sorensen line of electronic apparatus, the catalog is illustrated with performance curves and pictures of the various models available. The catalog is letter size for easy filing and reference. Copies can be had by writing to the manufacturer.

## NEW ILLUMINATED METERS

The important but troublesome problem of how to illuminate the dials of panel meters and similar instruments has finally been solved to the complete satisfaction of the Simpson Electric Company, Chicago, Ill., manufacturers of electrical measuring instruments.

"We believe that this Simpson patented method of illumination is the answer the industry has long looked for," says Ray Simpson, President of the company. "It does away with translucent dials and that, we consider, is an outstanding advancement."

Simpson claims that the new illuminated meter floods every fraction of the dial face with an even radiance, doing away completely with shadow spots.

An ingeniously shaped Lucite cone carries the light from a recessed bulb in the back of the instrument through the front edge of the cone which entirely surrounds the dial face. This makes possible the use of the standard Simpson metal dial. Thus, the tendency of translucent dials to fade, discolor or buckle from age and heat is

# Join An Outstanding Group!

**Subscribe NOW to  
AUDIO ENGINEERING—  
the ONLY Journal for  
Sound Engineers**

**Each issue covers 5 or  
more of these subjects**

- 1—Broadcasting
- 2—Transmitter and receiver  
manufacturing
- 3—Sound-on-film equipment
- 4—Recording (disc, wire and tape)
- 5—Public address
- 6—Industrial sound equipment  
and applications
- 7—Acoustic treatment of studios,  
rooms, auditoriums, etc.



Our editorial policy has aroused tremendous interest and acclaim among engineers prominent in the industry. We are proud to announce that co-operating with the editors of AUDIO ENGINEERING are such outstanding authorities as:

**HOWARD A. CHINN**  
Chief audio engineer for the  
Columbia Broadcasting System

**J. P. MAXFIELD**  
Authority on sound engineering,  
Bell Telephone Labs.

**JOHN P. COLVIN**  
Audio Facilities Engineer,  
American Broadcasting Company

**GEORGE M. NIXON**  
Ass't Director of Technical  
Development  
National Broadcasting Company

who are members of the editorial  
advisory board.

**Because of the acute paper shortage we are compelled to limit the number of subscriptions we can accept. If you are not already a subscriber, we recommend that you fill out and mail NOW the subscription form on this page. AUDIO ENGINEERING is available only to subscribers. Make certain you get your copy every month.**

AUDIO ENGINEERING  
RADIO MAGAZINES, INC.  
342 Madison Avenue, New York 17, N. Y.

Sirs: Here is my  check (or  money order) for \$..... Enter my subscription order to AUDIO ENGINEERING for the next ..... issues.

Subscription Price: In U. S. A. and Canada—12 issues \$3—24 issues \$5. Foreign subscriptions are \$4 annually.  
Please check one:  New subscriber  Old "Radio" subscriber

Name (please print) .....

Address ..... City ..... State .....

Occupation .....

Firm Name .....



done away with, according to Simpson. Pointers cannot stick or readings be distorted.

The new Simpson Illuminated Meters are available in 2" and 3" sizes, in both rectangular and round cases.

### NEW DYNAMIC MICROPHONE

Through the use of the new Acoustalloy diaphragm developed by E-V engineers, the Electric-Voice Model 630 dynamic microphone now provides high fidelity pick-up and reproduction of voice and music. Suitable for a great variety of applications. Frequency response is substantially flat, 40,900 c.p.s. Output level is 53 db below 1 volt/dync/cm<sup>2</sup>, open circuit. Voltage developed by normal speech (10 dynes/cm<sup>2</sup>) is .0224 volt. The new Acoustalloy diaphragm withstands high humidity, extremes of temperature, corrosive effects of salt air, and severe mechanical shocks. This makes the Model

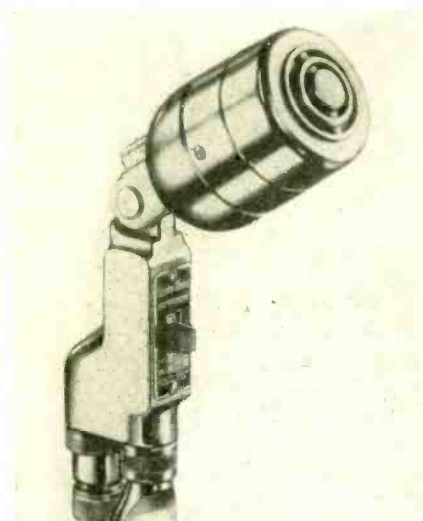

630 Microphone especially rugged for indoor and outdoor use. Alnico V and Armco magnetic iron ore are also utilized in a non-welded magnetic circuit.

Built in cable connector permits vertical tilting of microphone head in a 90° arc—for directional or non-directional pick-up—without moving cable. Built in "On-Off" switch gives instant control—easily accessible for reconnecting as a relay control. Standard 5/8"-27 thread for stand mounting. Compact, convenient to use. Finished in satin chromium. Equipped with 20 ft. shielded cable.

For complete information, Catalog No. 101 write to Electro-Voice, Inc., Buchanan, Michigan.

### WIRE RECORDER PRODUCTION

The transition of wire recorder production from model shop production to precision mass production is announced by Ralph C. Powell, president of R. C. Powell & Co., Inc., New York, sales representatives for The WiRecorder Corporation of Detroit, Mich.

First of five models employing the WiRecorder unit which will go into production will be the Model B Recorder illustrated. This recorder is designed for general commercial use by recording studios, radio stations, schools, theatres, industrial plants, and other companies



operating public address and recording systems.

Mechanical features of the Model B wire recorder include: a capstan drive which keeps wire speed constant, preventing flutter and changes in pitch; magnetic clutches which keep wire tension constant during recording; a cam-operated recording head which winds the wire in even layers on the take-up spool; and safety switches which stop the motor when a spool is almost entirely unwound, thereby eliminating re-threading.

### HIGH FREQUENCY TWEETER

This loudspeaker, with integral dividing network, is made specifically for efficient high frequency reproduction and wide angle distribution. Any good quality cone speaker in a suitable baffle may be used as a companion "woofer" by connecting it to cross-over terminals provided.

The dividing network is designed to eliminate phase distortion in the cross-over region and a volume control is incorporated to adjust the level of the "tweeter" to balance that of the particular "woofer" chosen. A transfer switch is also provided to cut out the "tweeter" and network for relatively narrow band AM radio reception, reproduction from scratchy records, or other average quality signals having excessive noise or noticeable distortion.

An entirely new principle has been utilized to give wide angle, uniform dis-

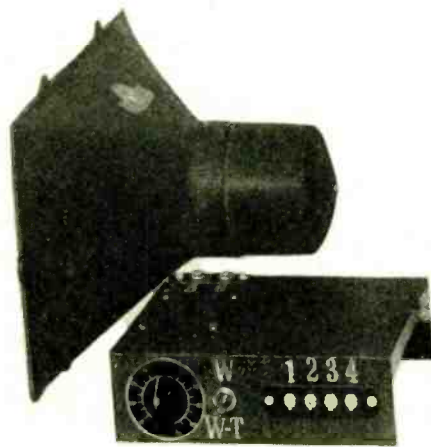

tribution of the full range of frequencies produced by this "tweeter" starting at approximately 1200 cycles.

For further information write the Atlas Sound Corp. 1450 39th St., Brooklyn 18, N. Y.

### MAGNETIC CUTTERHEAD

Fairchild Camera and Instrument Corporation has announced an improved magnetic cutterhead, the Unit 541A, with standard mounting plate for any current model sound recorder. It is designed to meet the highest quality standards of both AM and FM broadcasting and professional recording.

The new magnetic cutterhead guarantees a frequency response of plus or minus 2 db over the 30- to 8,000-cycle range, at a high recording level, with low distortion content (less than one per cent at 400 cycles). This guaranteed frequency response is being exceeded in present production models, which have a flat response within plus or minus 2 db to 9,000 cycles or better. Before being shipped, all cutterheads are checked by the so-called light method, and a photograph of the light pattern is supplied each user.

Exclusive features of the Fairchild cutterhead include a damping device, with unusually long cushion blocks and a positive means of adjusting and maintaining the armature in correct alignment

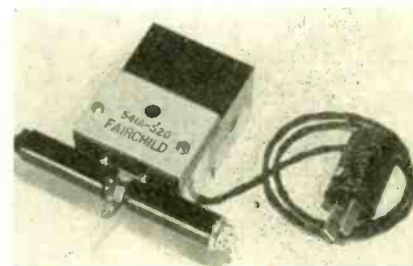

without disassembling the cutterhead; and a viewing window which permits instant check of the armature alignment.

When installed on any past or present model Fairchild portable recorder, an adapter provides a swivel-mounted sapphire ball for ready adjustment of in-out or out-in cutting, and a micrometer-threaded control for depth of cut and provisions for adjusting the angle of the cutting stylus. Both can be adjusted while recording is in progress.

Being exceptionally free from harmonic distortion, clean-cut recordings may be made at a level to give high signal-to-noise ratio.

#### Response Data of Fairchild Unit 541A Magnetic Cutterhead:

(The distortion measurements given here are based on the averaged performance of 10 cutterheads selected at random. A recording of a 400-cycle note made at a recording level of plus 20 decibels—reference .006 watt—to produce a stylus velocity of 2.5 inches per second. Playback was made with a Fairchild dynamic pickup. The overall distortion, including cutterhead, amplifiers, pickup and acetate record, was 1.7 per cent.)

Frequency response . . . plus or minus 2 decibels, 30 to 8,000 cycles  
Distortion . . . . . less than 1 per cent, 400 cycles  
Impedance . . . . . 500 ohms  
Audio power required . . . . . 0.6 watt (plus 20 db)  
Size stylus accommodated . . . . 5/8" long, .062" diameter

[Continued on page 55]



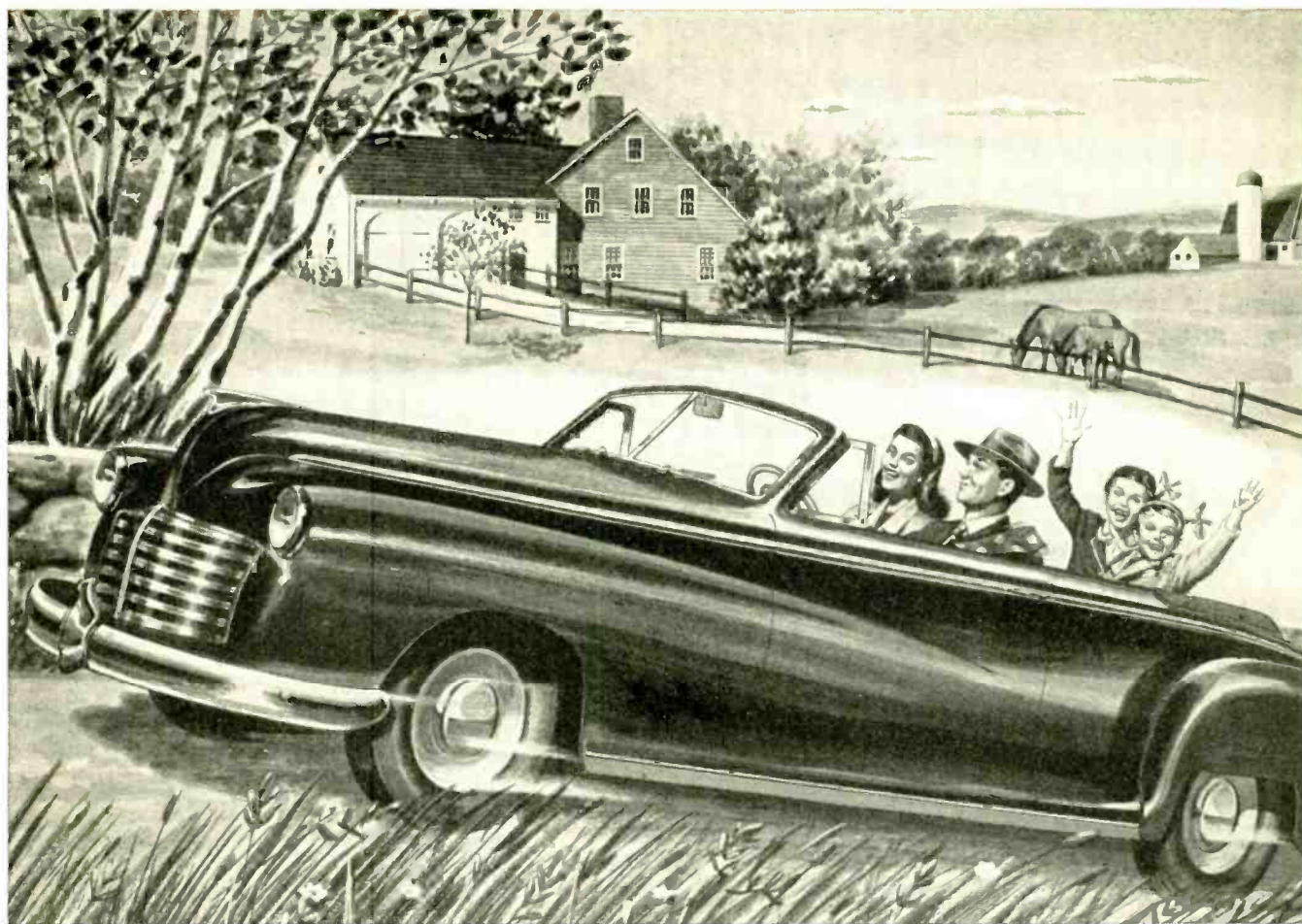

## This car is running with an "EMPTY" gas tank!



Even after the gas gauge says "empty" a modern car can keep going for a good many miles. Here's why.

Automobile manufacturers know human nature. They figure that, sooner or later, we'll get careless, or misjudge how far we have to go. So the gas gauge is set to show "empty," while there are still a couple of gallons left in the tank.

**This reserve supply** is a swell idea that has kept many a family from getting stuck.

It's an even better idea for a family's budget!

*A reserve supply of dollars* is a lifesaver in case of financial emergency. It will keep your family going if sudden illness strikes, or unexpected expenses show up.

And one of the easiest ways to build just such a cash re-

serve is buying *U. S. Savings Bonds on the Payroll Savings Plan!*

**Millions of Americans** have discovered that *automatic Bond buying* is the quickest, surest way of piling up an emergency fund. And of saving money for other things, too —important things like college for the kids, or a home in the country, or a cash income for later in life.

What's more, the money you save in Bonds buckles right down and starts *making more money*—in just 10 years you get back \$100 for every \$75 you put in today.

**So keep on buying Bonds** on the Payroll Plan. Buy all the extra Bonds you can, at any bank or post office. And remember, you're helping your country as well as yourself —for every Bond you buy plays a part in keeping the U. S. strong and economically sound!

## Save the easy way..buy your bonds through payroll savings

Contributed by this magazine  
in co-operation with the Magazine Publishers of America as a public service.





# MATCH UP

with

# TRIPLETT Meters

**5 BASIC  
MOVEMENTS  
IN SIZES FOR EVERY NEED**

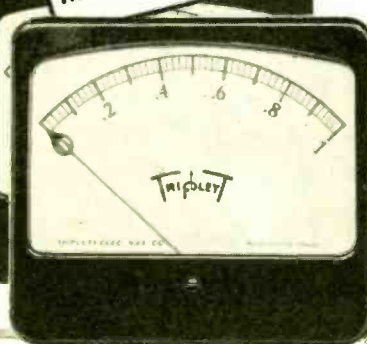

## METER HIGHLIGHTS

- **FIVE BASIC MOVEMENTS**—Electrodynamometer, moving iron, moving coil, thermocouple and rectifier types.
- **RANGES**—All standard ranges for every major instrument need.
- **SIZES**—2", 3", 4", 5", 6" and 7".
- **STYLES AND FINISHES**—Round, rectangular, square and fan; wide flange, narrow flange, flush, projection or portable. Available in molded or metal case.
- **SPECIAL FEATURES TO ORDER**—Rear illumination, special dials and other features available on most models.

# Triplet

**ELECTRICAL INSTRUMENT CO.**  
BLUFFTON, OHIO

## Technicana

(from page 38)

the relationship

$$\frac{2R(1+j\omega CR)}{1-\omega_o^2 C^2 R^2} = \infty$$

where  $\omega_o$  is taken as the value of  $\omega$  at balance. However, since  $\omega_o$  is also equal to  $2\pi f_o$ , the equation becomes at balance

$$f_o = \frac{1}{2\pi CR}$$

A test amplifier especially constructed to demonstrate the effectiveness and the selectivity of the parallel-T feedback circuit was designed using the circuit

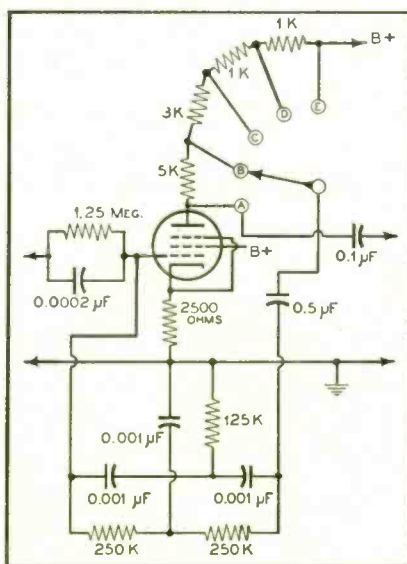

Figure 5

in Fig. 5. The gain was measured to be 25.5 db. The switch in the plate load resistance is an effective means of varying the feedback component and hence the selectivity. For the part values shown, the balance frequency should be equal to

$$f_o = \frac{1}{2\pi CR} = \frac{1}{(2\pi)(10^{-9})(250)(10^3)}$$

or 637 cycles per second.

The measured variation in selectivity with the corresponding switch positions shown in schematic Fig. 5 are illustrated in the graph Fig. 6. Hillan points out that with the basic circuit the maximum selectivity depends upon the maximum amplifier gain possible. Although a two stage amplifier increases the gain it is then necessary to place the bridge circuit in the cathode circuit of the first stage to obtain the correct phase relationship. With three stages of amplification it is particularly necessary to consider the effects of the highest and the lowest frequencies the amplifier will pass in relation to the phase shift. In

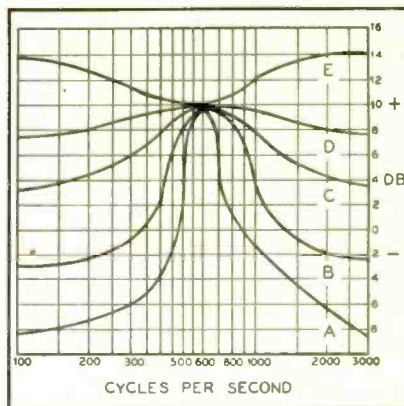

Figure 6

all cases, it appears necessary to pay attention to the stability of the part values and circuit components.

## MAGNETIC SOUND TRACK

● The advantages and disadvantages of magnetic sound recording for motion picture films are discussed by Marvin Camras of the Armour Research Foundation in the *Journal of the Society of Motion Picture Engineers* for January 1947. The author concludes that the technique is both economical as well as convenient. Without the picture frames it is possible to accommodate four sound channels on one strip of 35-mm sound film as shown in Fig. 7.

Advantages of magnetic recording are enumerated as: simplicity, low cost, possibility of immediate monitoring, no processing requirements, ease of erasure with the possibility of dubbing in new sounds, and no serious distortion on overmodulation peaks. The disadvantages listed are: possibility of wear from the contact of the reproducing

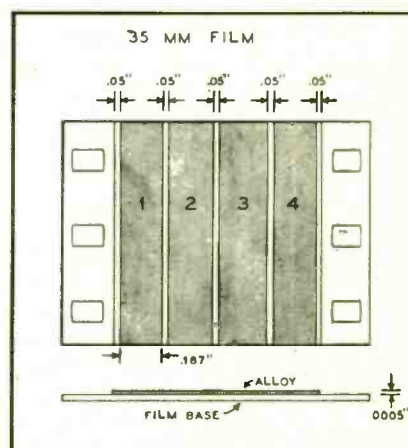

Figure 7

head and somewhat lower fidelity than the best optical tracks, although the magnetic recording should give a greater dynamic range without resorting to artificial noise reduction schemes.

Since four simultaneous tracks are possible, it is practical to use four

different microphone setups and select the best one afterward. Also, a track may be reversed, thus eliminating the necessity of rewindings. Similarly, a pair of sound tracks may be used for binaural recording with another track utilized for control purposes.

The base material used for the magnetic film recording was cellulose acetate with a coating of magnetic alloy. A frequency range of 50 to 12,000 cycles within  $\pm 3$  db was obtained. The maximum signal-to-noise ratio is about 45 db.

### RAPID DUBBING

• To facilitate the rapid dubbing of films of the training type in which a narrator carries the main theme of the story but with a music or sound effects background, a unique method is employed by Walt Disney Productions as outlined in the *S.M.P.E. Journal* for December 1946 by C. O. Slyfield, Sound Director.

The main problem is to bring up the background during pauses in the narration, and to drop the background down when the narrator resumes. When the intervals are short and come in rapid succession, proper dubbing necessitates the constant and tiresome watching of a footage counter to ensure realistic re-

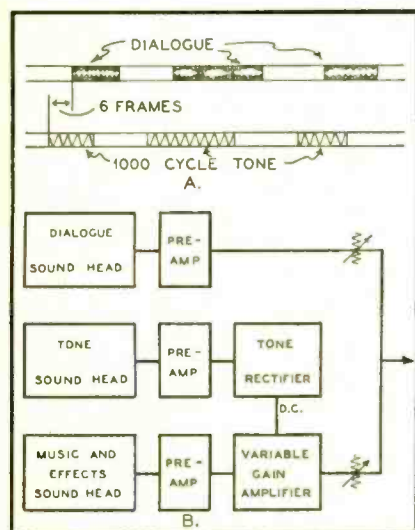

Figure 1

sults. By assembling a 1000-cps tone track in synchronism with the dialog and then while running the two tracks simultaneously with the music and effects track, the output from the tone track can be fed to a rectifier, with the d-c output fed to the grid returns of a variable gain amplifier stage using two 6K7 tubes. Time constants are arranged so that the fades take place in fifteen frames, with the increase in background level requiring thirty frames.

The tone track is advanced six frames ahead of the dialog track so that the

fades and increases take place in the most natural manner, avoiding unwanted quiet spots or quick changes in background level. The method of film assembling and a block diagram of the entire system are shown in Fig. 1.

### ULTRASONIC HI-Z PRE-AMPLIFIER

• That small capacitor-microphones may find as successful application in ultrasonic applications as crystal microphones is pointed out by Theodore H. Bonn, in the final 1946 quarterly issue of the *Journal of the American Acoustical Society*. In his article, "An Ultrasonic Condenser Microphone," a cath-

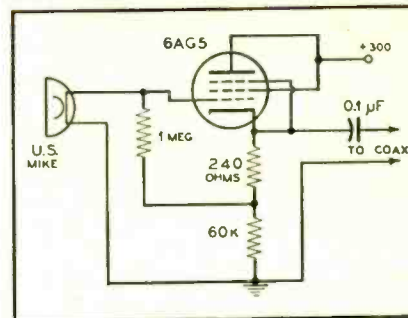

Figure 2

ode-follower type of pre-amplifier is recommended to energize the coaxial cable to the utilization circuits.

[Continued on page 48]



### Precision Adapter for Drill Presses Perfects Alignment—Prevents Drift!

The new Aetna Adapter, of aluminum alloy, fits the columns of most small drill presses—assures accurate milling and accurate deep hole drilling—without a drill jig. It firmly and accurately holds interchangeable drill bushings close to work.

Precision alignment is accomplished through an eccentric aligning bushing, which once set needs no further adjustment. Filler bushings cover the entire bushing range up to 1/2". Stops to locate the piece to be drilled, are attached to the press table or directly to the adapter. Milling chatter is avoided. Chip interference is eliminated. Overlapping holes can be drilled without punch marks, or indication of run-out, with drills as small as 1/32" diameter. 1/4" holes can be drilled more than 6" deep with as little as .006" drift.

Accuracy in work is achieved best by alert workers. That's why many plant owners make chewing gum available to all. The chewing action helps relieve monotony—helps keep workers alert, aiding them to do a better job with more ease and safety. And they can chew Wrigley's Spearmint Gum right on the job—even when hands are busy.

You can get complete information from Aetna Mfg. Co., 250 Chicago Ave., Oak Park, Ill.

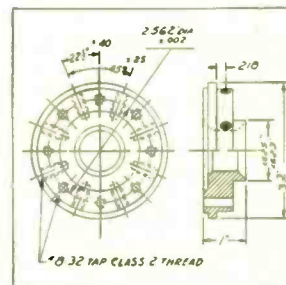

Example of piece drilled with Aetna Adapter



AB-59



The cathode-follower pre-amp offers a very low effective input capacitance and high input resistance, factors of considerable importance when using small capacitor-microphones. The circuit, shown in Fig. 2, obtains plate-supply voltage from a regulated power supply.

Frequency response of the pre-amp was found satisfactory from 1000-32,000 cps.

#### NEW SQUARE WAVE GENERATOR

A new square wave signal generator has just been announced by the Sterling



Electronic Laboratories, 151 E. 70th Street, New York City. This generator is designed for testing high quality audio apparatus,

phase shift measurements, and checking network designs. In general testing, it can be used to locate paper rattles and peaks in loudspeakers and other vibratory systems. When used to modulate an r-f signal generator, the response of r-f and i-f amplifiers to a square-wave modulated signal can be checked.

The Sterling Square Wave Generator has a frequency range of 20-20,000 cycles, in 3 steps. The rise time is 1.5 microseconds and the output is 2.5 volts across 3000 ohms.

For further information, please write the manufacturer.

## Tape Recorders

[from page 10]

A playback tone control is provided, together with separate volume controls for recording and for playback. A "tuning" eye-indicator tube is centrally located on the control panel and functions as a volume-level indicator when recordings are being made.

A detailed circuit of the recorder is shown in Fig. 3 and a simplified functional diagram in Fig. 4. The circuit elements employed during recording are shown in Fig. 4A and those for playback in Fig. 4B. The input circuit is seen to be of high impedance

with one-side grounded and is intended to work from the crystal microphone which is provided with the recorder. This input may also be bridged across any other source of program material if the level is within the range that can be handled and provided the one-side grounded circuit is not detrimental to the circuit being bridged.

For broadcast applications, however, it is often desirable to be able to bridge the recorder across the standard 150 ohm: 600-ohm circuit carrying program material at a level in the neighborhood of +10 vu. This can be readily accomplished by the addition of a suitable bridging coil (20,000 ohms to grid).

The output of the playback and monitoring amplifier normally feeds the self-contained loudspeaker. Again, in broadcast service it is generally desirable to be able to feed a 150-ohm: 600-ohm line at a level around +10 vu. Provisions for doing this can be made by installing a suitable impedance matching coil (8 to 600/150 ohms) and the usual line pad.

The motor features of the recorder are well planned. There are three separate motors, one for the capstan-type tape drive, another for the take-up reel and a third for rewinding. The drive and the take-up motors are employed in the same manner both when recording and when reproducing. The drive motor operates through a rubber, rim-drive pulley to turn, at constant speed, a fly-wheel stabilized, cork-surfaced drive capstan. The take-up motor operates to maintain tape tension ahead of the capstan and runs at whatever speed the diameter of the tape on the take-up reel permits. Back tension is supplied by the drag in the magnetic heads and by light mechanical braking on the "rewind" motors which suffices to provide a smooth tape flow. For rewinding, only one motor is used and it rewinds the tape at the highest speed it is capable of reaching with the load placed upon it. As the end of the tape leaves the reel from which it is being rewound, braking voltage is automatically and immediately applied to the motor that is doing the rewinding. If, on the other hand, the "stop" button is operated during rewind (before all the tape is rewound), the braking voltage is applied to the take-up motor from which reel the tape is being rewound.

This machine makes use of reels that are the same size as standard 400-foot, 8 mm motion-picture reels—in fact, such reels can be used on the machine without alteration (although they are not as convenient to use as the standard ones designed by the manufacturer of the recorder). The reels are 7 inches in diameter and hold sufficient tape for one-half hour of recording. The tape

# new

## CONCORD Radio Catalog

**RADIO PARTS • RADIO SETS  
RECORD CHANGERS • PLAYERS  
HAM GEAR • AMPLIFIERS • TESTERS**

It's here—the new 1947 Concord Catalog—a vast, complete selection of everything in Radio and Electronics. See these value-packed pages showing thousands of items available for IMMEDIATE SHIPMENT—hundreds of them now available for the first time—featuring new, latest 1947 prices. See new LOWER prices on finest-quality RADIO SETS, PHONO-RADIOS, RECORD CHANGERS, RECORD PLAYERS, PORTABLES, AMPLIFIERS, COMPLETE SOUND SYSTEMS, TESTERS. See latest listings of well-known, standard, dependable lines of radio parts and equipment—tubes, condensers, transformers, relays—available for IMMEDIATE SHIPMENT from huge stocks in CHICAGO and ATLANTA. Mail coupon NOW!

# free

**Mail COUPON TODAY!**

Concord Radio Corporation, Dept. F-57  
901 W. Jackson Blvd., Chicago 7, Ill.

Yes, rush FREE COPY of the comprehensive new Concord Radio Catalog.

Name.....  
Address.....  
City..... State.....

## CONCORD

**RADIO CORPORATION**  
LAFAYETTE RADIO CORPORATION  
CHICAGO 7, ILL.      ATLANTA 3, GA.  
301 W. Jackson Blvd.      265 Peachtree St.

speed is approximately  $7\frac{1}{2}$  inches per second, so that a total of 1250 feet is required for a full half-hour's recording (plus a few minutes extra for possible run-overs).

The performance of the magnetic tape recorder that has been described, insofar as response-frequency characteristic, harmonic distortion and signal-to-noise are concerned, is not limited by the magnetic tape but rather by economic considerations. In order to reach the home market many of the refinements that are desirable in a professional recorder have had to be omitted. In spite of this, the overall performance is remarkably good. It can be most concisely summarized by stating that it is just about equivalent to the performance obtained on long Class A network circuits.

#### Conclusion

Magnetic tape recording and reproducing systems seem to be inherently capable of the highest fidelity required for any audio application. Consequently, when professional-model portable and fixed machines become available, they will undoubtedly find widespread application in the broadcasting field. However, considerable design and development work will be required to achieve *all* the objectives desirable in the "ultimate" magnetic tape recorder. Meanwhile, the machine that has been described represents a very good start and, until such time as a better unit becomes available, it will be of considerable usefulness to the broadcaster.

The scope of this article does not permit a discussion of the relative merits of magnetic tape and of disc recording. Suffice it to say, however, that each has its fundamental advantages. Consequently, it seems logical to conclude that each medium will find its own field and neither one is likely to predominate to the exclusion of the other.

## High-Fidelity Recording

(from page 26)

terial can be recorded on one pound of these discs to play over 80 hours continuously. If used for no other purpose than to record desired musical selections from radio broadcasts, for example, a library corresponding to slightly over five hundred 12-inch records could be carried in a 4x4 inch box only two inches deep.

Thus another step in the continually advancing art of recording has been made which bids fair to become a popular instrument for home use, and as a valuable adjunct to commercial equipment where extreme compactness is an important consideration.

## Audio Systems

(from page 14)

console turret and the balance of the amplifying equipment and other components be mounted in a separate cabinet rack. An argument in favor of the completely self-contained unit is that installation costs are lower. Against the self-contained unit is the argument that it is harder to maintain and service. Arguments for and against mounting the amplifiers and non-operated components in a separate cabinet rack are the exact opposite. From experience, the writer prefers the

separate cabinet rack for mounting of the amplifiers and jack strips. Installation is a first cost, but maintenance must go on for the life of the equipment.

While on the subject of consoles, it is suggested that utmost simplicity in circuits be uppermost in the mind of the designer. The less involved the system is of lights, switches, tricky interlocks, and devices that do not add to the functional operation of the equipment, the simpler and more straightforward becomes the cabling in the console. This will reduce possibilities of key clicks, noise and cross-talk, the absence of which is essential for good



## See You in CHICAGO!

We have our sights on the Big Show because, in Chicago, we will give you a preview of our 1947 plans—show you products we're proud to offer under the Eastern Amplifier banner! . . . To complete the new units in our line, in which you'll be vitally interested, we have established and expanded

engineering forces with know-how, background and outstandingly successful experience. From here in—watch EASTERN for new and unusual sound equipment! . . . Eastern Amplifier Corporation, 794 East 140th Street, New York.

**SEE YOU IN CHICAGO — BOOTH 34**

**Stevens Hotel**

**Leon Alpert**

**William Lorenz  
W. E. Macdonald**

**Gerson Lewis  
S. K. Lackoff**

**EASTERN AMPLIFIERS**



FM operation. Microphone circuits can be closed by turning faders to the "off" position: a key is not necessary. It is easier for an operator to know that all that is necessary to open a microphone circuit is to bring up the fader. He need not concern himself as to whether or not a key is thrown. An output key on the console is another hazard and is definitely not required when switching of studios is done by a master control. The studio operator is concerned with the starting of the program and with his hands full of mixer controls might very easily forget to throw the output key. Master, on the other hand, is concerned only with the pickup of studios and the distribution of the program. Functional design should consider the placement of operational responsibilities in the proper places.

As was mentioned previously, the basic differences between the five and eight-to-ten studio layouts lie in the type of master control switching employed and added features that become necessary with the increase in the number of studios and increase in the volume of programs to be handled. For five studios it is felt that a manually operated type of mechanically interlocked push keys will suffice for master switching. With a possible maximum

of three studios involving air time accuracy in switching and feeding a possible maximum of three outgoing circuits, an operator who is familiar with the equipment will not find it difficult to perform the operation with manual switching. Normally, fewer combinations of studios and outgoing circuits would be in use.

However, when eight to ten studios become involved and the number of outgoing circuits increases, it becomes imperative that an electrical interlocked preset relay system be employed. The increase in possible switching combinations that must be performed simultaneously become great enough that the operator could not accurately handle the operation in the time permitted. Using a preset relay system, the switching combinations can be set up prior to switch time and the entire setup combination put instantaneously into effect by the operation of one switch. Such a preset system could be used in the five studio layout, but would result in higher costs and more wiring complication for a feature that is not functionally required.

Figure 4 shows in block form the circuit arrangement of master switching that will serve for either the manual operated or the preset relay operated systems; the only difference

being that relays would replace the switches shown in the latter case. In addition to the relays there would be an equal number of keys or an equivalent number of rotary switches to perform the presetting operation. Lights should also be employed to leave a pattern of the switching combinations set up in order that the operator may have a means of checking his work before the actual electrical switching is done.

Some of the features that become necessary with larger installations and that require thought are the number of outgoing channels that should be incorporated in the original design, and the method employed to handle program monitoring throughout the studio plant.

In the three-studio layout the opinion was expressed that one available bridging amplifier would suffice to handle an occasional outgoing feed in addition to the normal line to the transmitter. The five-and-larger studio layouts will undoubtedly be called upon regularly to make extra feeds. Many such stations probably will still have an AM transmitter to feed in addition to their FM transmitter. There are also local and national networks to consider and those special occasions in which stations feed regional interest programs back and forth. It is imperative that regularly assigned and installed equipment be available through the master switching to handle such work.

The five-studio station should have at least three outgoing channels with the fourth not representing an excessive investment. Channel 1 would normally be assigned to the FM transmitter line; channel 2 would be used to feed network; channel 3 is very convenient for feeding programs to the recording room; channel 4 would be held as a spare in case of failure of any of the other three, and as a reserve to take care of the unpredictable situations that arise. At least one spare input to the master switching system should be provided in addition to the five studio inputs.

The eight-to-ten studio plant will require a minimum of five outgoing channels and would not be over-equipped with six. Of the five, one would be assigned to the FM transmitter, two for network feeds (local and national), two for recording, and the sixth as a spare. Two or three spare inputs should be provided to the master switching system.

#### Monitoring

Regarding monitoring, it has generally been found that the multiple cable to all monitoring points is the most economical and completely satisfactory

**New . . . Improved**  
**ATTENUATORS**  
 by **TECH LABS**



Type 800

Type 900

"New Times—New Modes", says old proverb. These new attenuators were born to meet new war-created demands. They represent a new medium frame size: Type 800 (2 1/4" dia.) and a larger size: Type 900 (3" dia.). The Type 800 is supplied as potentiometer, rheostat, ladder and T-pad up to 20 steps. The larger size Type 900 is similarly furnished with up to 45 steps. Write for new bulletin.

TECH

Manufacturers of Precision Electrical Resistance Instruments  
 337 CENTRAL AVE. • JERSEY CITY 7, N. J.



When our air valve is just cracked it allows a kw or so through.

The effect was very unexpected and pleasant. At full power our ears that had been calibrated at low intensity to "hear" 14 kc, could only hear up to 12 kc. We checked all the way to 24 kc, and there were no odd phenomena at all. When we came down again we again picked up at 12 kc. There was no nausea, or other pressure phenomena. While we did not check, it was obvious that if we were far enough removed or had enough sound isolation so the db level was a watt or two we would note the "4-watt nausea".

### Generator Design

Figure 1 shows the side view of the generator. The black cylinder on top is an eccentric vane air motor rated 0.7 hp and 18,000 rpm-(300 rps). By the valve and gauge we can control the speed and thus the frequency. The frequency is checked against an audio-frequency standard, using a crystal for a microphone. A Strobotac is good for approximate frequency determination.

On the right hand end of the motor is the head unit. This is a "turbulent turbine", and is fed through the valve and gauged in a manner similar to the motor, so we have independent power and frequency control over the output.

Figure 2 shows a view looking at the shaft of the generator proper. The rotor is removed and several rotors are shown.

There are 80 jets on the stator, each about one-sixteenth inch square. They are equivalent to a single perfect orifice just under 5/8 inch diameter which at 90 pounds of air takes about 58 hp.

The rotor is very nice fitting, clearing the housing by one mil all around, and also having about 1 1/2 mil clearance from the stator. This clearance is leakage, so we minimize it.

When the vanes on the rotor are lined up with the jets, we lose about 7% in leakage. When they clear the jets, we emit 80 slugs of air simultaneously. In one revolution of the rotor we release 3600 slugs, and at rated 300 rps we release 1,920,000 slugs per second, the frequency being 24,000. Each slug weighs about two-tenths micro-pound.

At low frequencies it is a simple siren taking up to 200 cfm at 60 lb. pressure. At 24 kc, however, it is much more complex, so we must accelerate the slugs to sonic velocity in about 5 micro-seconds, and that cannot be done with pressure alone. As we increase pressure the gas density increases also, we rapidly reach a limit in acceleration. So we use resonant chambers in the stator to build up a starting pressure about 3 times the static gas pressure.

At full power the gas in the resonant chambers is accelerated over 25,000

miles per second per second, or 8,800,000 G (times its own weight).

For any specific load the vanes of the rotor can be cut at an angle to give a reaction turbine effect and it will run itself, so the head alone can be used. This unit can be built in almost any size, and further development should allow operation on steam.

In any such device, however, a motor should be provided to bring it to speed above sonic range as, while it is starting up, in about 3/5th of a second you will be quite unpopular for some blocks around.

The power density is about 40 kw to the square inch, and the rotor shows no erosion in about 50 hours test even though the air filter was removed to allow dust to enter.

For low-frequency operation a crude impedance-matching horn was used, and no actual data taken on the sound level in the room. The wave shape at 800 cycles was between sine and triangular. At 12 kc it was pretty good sine, and at 24 kc was very complex, as there are

many factors affecting the wave shape.

For daily experimental work, a stator with a single jet should be used, as the power density and acceleration are the same, and only about a half h-p compressor is needed. When higher powers are required, a stator with any number of holes can be used up to the full amount.

Some darn fool (the writer) put his left hand in the full field at 24 kc for a few seconds. The effect was that of having little scintillating hot and cold spots, rapidly alternating, over the area of skin in the field. The hand has not dropped off yet. The calculated percentage of reflection of sound energy from the flesh is about 99.98%, so apparently we do not have a death ray. Also, 24 kc is attenuated through air 6 db in 180 feet, so it does not travel too far.

This little head puts out over half the audio power of the big siren installed on top of the RCA building in New York City for air-raid warning, which delivered about 36 kw. The effect is rather pronounced in a small room.



*Musical Distinction*  
WITH  
**ABSOLUTE FIDELITY  
AMPLIFICATION**  
DESIGNED BY A. C. SHANEY

A new amplifier development now enables you to clearly identify all the instruments in a full orchestra! After 20 years of audio research and development, we can now place in your hands a new means to make the most fascinating, uplifting, and enjoyable journey into the realm of perfect sound reproduction—through the medium of the most satisfying musical amplifier the world has ever known.

If you are one of those discriminating persons for whom anything less than the best is a disappointment, you are one for whom the ACA-100DC Amplifier was designed. Send for literature.

**AMPLIFIER CORP. of AMERICA**

396-1 Broadway, New York 13, N. Y.  
Send 3¢ stamp for A. C. Shaney's new booklet "20 steps to Perfect Amplification"  
A. C. Shaney's FM-AM AMPLIFIER MANUAL is still available at 25¢



## NEW! SQUARE WAVE GENERATOR

20 CYCLES TO 20,000 CYCLES  
FOR CHECKING RESPONSE OF YOUR AUDIO PRODUCTS. RESONANT PEAKS IN SPEAKERS. PHASE SHIFT IN AUDIO AMPLIFIERS AND NETWORKS. SQUARE WAVE MODULATION OF YOUR R.F. SIGNAL GENERATOR TO CHECK SQUARE WAVE RESPONSE OF MODERN R.F. CIRCUITS. IN SOLID WALNUT CABINET 5" x 5" x 9" SATIN FINISH ALUMINUM PANEL

Sold exclusively by **\$75<sup>net</sup>**  
**STERLING ELECTRONIC LABORATORIES**  
151 EAST 70th ST., NEW YORK 21, N. Y.



# HOPP Plastic RADIO DIALS

DIAL WINDOWS, NAME PLATES, GAUGES, CALCULATORS, SCALES, CHARTS, ETC.



PLASTIC RADIO DIALS have endless possibilities in design, size, shape and color combination. Attractive and durable, our radio dials, windows and scales are preferred by many leading Radio manufacturers.

Not only for dials, but for numerous other electronic and electrical applications, Laminated Plastics are preferable.

Consult with our artists and engineers regarding applications for your particular purpose. Or... send us your blue prints or samples for quotation.

**THE HOPP PRESS, INC.**  
460 W. 34th STREET, NEW YORK 1, N. Y.  
ESTABLISHED 1893

## BOOKS FOR THE ENGINEER

### UNDERSTANDING MICROWAVES

(Chapter Heads)

The Ultra High Frequency Concept Stationary Charge and its Field • Magnetostatics • Alternating Current and Lumped Constants • Transmission Lines Poynting's Vector and Maxwell's Equations • Waveguides • Resonant Cavities • Antennas • Microwave Oscillators • Radar and Communication • Section Two is devoted to descriptions of Microwave Terms, Ideas and Theorems. Index.

400 PAGES PRICE \$6.00

### A-C CALCULATION CHARTS

Student engineers will find this book invaluable. Simplifies and speeds work. Covers all AC calculations from 10 cycles to 1000 megacycles.

160 PAGES PRICE \$7.50

**JOHN F. RIDER, Publisher, Inc.**

404 FOURTH AVENUE, NEW YORK 16, N. Y.  
EXPORT DIV. ROCKE-INTERNATIONAL ELEC. CORP.  
13 E. 40TH STREET, NEW YORK CITY CABLE ARLAB

## THIS MONTH

### E. N. WENDELL HONORED

E. N. Wendell, vice president in charge of Federal Telephone and Radio Corp., manufacturing associate of the International Telephone and Telegraph Corp., and newly elected Fellow of the Institute of Radio Engineers who was formally pre-



sent with his citation at the Institute's annual convention held March 3-6. Mr. Wendell's honor was bestowed for his "contribution to the development and production of radio systems for navigating and landing airplanes by instrument."

### E.A.C. APPOINTMENTS

Eastern Amplifier Corporation announces that, effective immediately, S. K. Lackoff has joined its organization as Chief Engineer and Gerson Lewis as Executive Assistant to Leon Alpert, who is Vice President and General Manager.

This is in line with the announced policy of Mr. Alpert to expand the scope of the company as to its products and sales market.

K. Streuber, who was recently placed in charge of export sales for Eastern Amplifier, announces that Walter B. LaChicotte is now associated with him in Eastern Amplifier export activities.

### JOHNSON BUYS GOTHARD

The E. F. Johnson Co., Waseca, Minn. has announced purchase from the Gothard Manufacturing Co., Springfield, Ill. of the Gothard line of indicator lights.

Current Gothard catalogs remain in effect and users are assured that present quality standards will be maintained and improved. All dies, tools, inventories and rights have been transferred to the new owner.

The Gothard line is now being manufactured at the Johnson plant in Waseca. Johnson will provide a complete engineering service for those seeking special indicator light assemblies for industrial machinery, panel boards, instruments, and electrical appliances.

### RESTORING DRY CELLS

Small dry-cell batteries that have been exposed to excessively low temperatures may be restored to service within a few

minutes by being heated internally with an alternating current according to a war-time research report now on sale by the Office of Technical Services, Department of Commerce.

The report was prepared by John P. Schrodt, D. Norman Craig and George W. Vinal of the National Bureau of Standards. During the war the report was classified as "confidential" and distributed by the National Defense Research Committee to military agencies only.

To restore a battery, alternating current is applied directly to the terminals. A paper condenser connected in series with the battery prevents the battery from discharging its current. The report suggests the substitution of a counter electromotive force supplied by an auxiliary dry cell, should the condenser required be inconveniently large.

The alternating current heats the electrodes of the battery and thereby raises its internal temperature. As a result, the internal resistance drops enabling the battery to furnish an adequate flow of direct current for practical use. The time required to restore the battery to usefulness depends on the initial temperature of the battery and the characteristics of the alternating current available.

The report also describes a method for keeping small batteries in active condition when the temperature falls as low as 78 degrees below zero (Fahrenheit). A comparatively small alternating current is fed continuously to the terminals of a battery. A condenser or a counter-electromotive force stops the battery current from entering the alternating current circuit.

The alternating current does not interfere with the chemical action within the battery. Consequently, the battery can generate direct current, even though its electrodes continuously receive alternating current.

Orders for the report (PB-50853; *The Performance of Small Dry Batteries*; photostat, \$2; microfilm, \$1; 28 pages including graphs and tables) should be addressed to the Office of Technical Services, Department of Commerce, Washington 25, D. C., and should be accompanied by check or money order, payable to the Treasurer of the United States.

### CONNECTOR BOOKLET

A 76-page illustrated book on "Cannon Plugs for the Electric Circuits of Industry" has been issued by the Cannon Electric Development Company. Subtitled the "Quick Disconnect," the book is a digest of ideas for assembly, servicing, maintenance and portability of electric equipment through the use of connectors.

Industries covered include communications, power, railroads, medicine, aviation, textiles, television, welding, mining, motion pictures, sound, public utilities, automotive, commercial radio, process industries, marine, petroleum, and electric motive power.

Copies will be sent free and without obligation to those using this magazine reply card, or on company stationery only. Address Catalog Director, Cannon Electric Development Co., 3209 Humboldt Street, Los Angeles 13, California.



## New Products

[from page 44]

### NEW MINIATURE TERMINAL LUG

Designed to meet the special requirements of manufacturers of small radios, hearing aids, microphones, meters and test equipment, a new terminal lug has just been placed on the market. Said to be the smallest machined terminal lug in existence, the "Mini-Lug" has a 3/32" base diameter, and projects 3/32" above the mounting board.

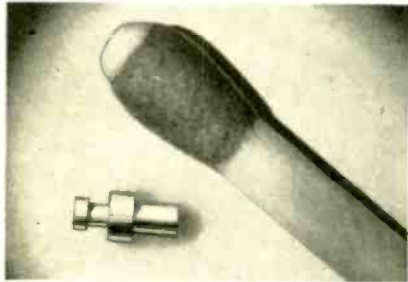

The mounting shank is .025" long for fastening to a 1/64" board. A shank of .045" is available for a 1/32" mounting board. The material is silverplated brass. Chief uses are for wiring miniature carbon resistors and ceramic capacitors in extremely small units. Manufacturer: *Cambridge Thermionic Corporation, Dept. 12, 415 Concord Ave., Cambridge, Mass.*

### POCKET-SIZED OHMMETER

An attractive, compact, inexpensive pocket-sized ohmmeter for spot checking radio and electronic circuit components, automobile horns, relays, generators, starters, electric clocks and other electrical equipment has been announced by the Radio Tube Division of Sylvania Electric Products Inc., 500 Fifth Avenue, New York 18, N. Y.

The instrument has been designed particularly for use by servicemen as a pocket indicator for preliminary isolation of electrical faults for prompt estimates of service charges, time required for repairs and other information essential to efficient customer service.



In radio set servicing the miniature ohmmeter will indicate transient or other faults in difficult replacements including i-f transformers, tuning units and audio sections; approximate values of individual resistors; and open or shorted conditions in other circuit components.

Direct readings between 0 and 10,000 ohms are given on a 1.5 milliamper full scale sensitivity Weston meter in series with a 1000 ohm molded carbon resistor

and a standard penlight dry cell. Test electrodes include a stainless steel prod built into the meter case and one secured to the tip of a 17 inch test cord.

### NEEDLE-POINT IRON

Drake Electric Works, Inc., Chicago, announces a new needle-point model #350 nidget iron.

A high quality mica-wound continuous-duty 35 watt iron has recently been developed after analysis of the meter and hearing aid industries, etc. The need for a small continuous-duty industrial iron has now been filled. The iron will work from 110 volt AC or DC. It is provided with two tips—one standard 1/8" straight tip, and one special 45 angle tip. The iron measures 7" long and is so constructed that no stand is required.

Production is planned for late May or June.

### HIGH FIDELITY RECORDER

A high-fidelity wire recorder which incorporates the principles developed in recent years by the Armour Research Foundation of the Illinois Institute of Technology was announced recently by Magnecord, Inc.

Designed for professional users, the Magnecorder Model SD-1 has a frequency response rated flat within 2 db from 50 to 12,000 cps with a signal-to-noise ratio of well over 45 db.

The recording media for this custom-produced unit is stainless steel wire .004 inch in diameter. However, the unit

utilizes a capstan drive system to drive this wire across the heads at four feet per second. This design assists greatly in the elimination of wow and flutter and produces constant wire speed.

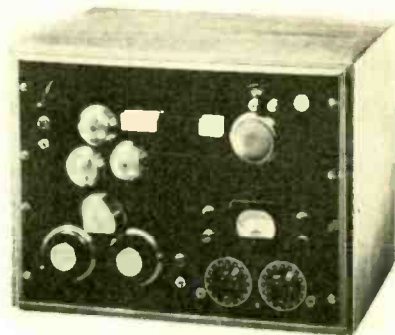

Using standard size spools, the Magnecorder is capable of recording and playing back continuously for a half hour.

The unit performs a wide variety of services in the average radio station, is capable of synchronization for motion picture production use, and is suitable for laboratory use.

### AUTOMATIC TURNTABLE

Arnold B. Hartley, Program Director of WOV, and Hillis W. Holt, WOV Manager of Technical Operations, have received U. S. Patent No. 2416583, issued to them on their mutual invention, the Hartley-Holt Automatic Turntable. The purpose of the device, invented during the recent war, is to permit the playing of either 78 rpm or

## HIGH QUALITY AUDIO AND ACCESSORY EQUIPMENT

### JACKS



STANDARD 218A type broadcast jacks with tip, normal, and sleeve connections. Self-cleaning contacts. Special discounts for quantities over 500.

Our type 104B

47c.  
each

### JACK STRIPS



SINGLE and double row jack strips for rack mounting, complete with designation strips. Supplied mounted with 24 jacks per row.

Single Row Strips — Type 114B

19.50

Double Row Strips — Type 124B

32.50

### AUDIO DEVELOPMENT COMPANY

Shielded patch cords with heavy overall braid. Six inch reinforcement on both ends.

|              |               |
|--------------|---------------|
| 1 ft. — 6.90 | 4 ft. — 7.50  |
| 2 ft. — 7.02 | 5 ft. — 7.80  |
| 3 ft. — 7.20 | 10 ft. — 8.88 |

### PATCH CORDS



Send for AC catalog listing new line of quality transformers.

## AUDIO EQUIPMENT SALES

923 EIGHTH AVENUE

NEW YORK 19, N. Y.

TELEPHONE CIRCLE 5-7798



33 1/3 rpm records without the necessity of changing turntable speed.

The Hartley-Holt table consists of a 12-inch inner table rotating at 78 rpm, surrounded by a 2-inch outer ring, slightly raised above the inner table and rotating at 33 1/3 rpm. 16-inch discs therefore automatically are turned at the slow speed, and discs 12-inches or less in diameter turn at the fast speed. More than 95% of all existing discs can thus be played without manipulation of any kind to set or change speed.

Production, to date, has been on a custom basis, with the first models turned out going to Station WOV, New York, and Station KDKA, Pittsburgh. The patentees are now assembling production equipment necessary to manufacture the tables.



### G-E LIMITING AMPLIFIER

General Electric is building this new limiting amplifier (Type BA-5-A) at its electronics plant in Syracuse, N. Y. Photos show D. E. Maxwell of the CBS General Engineering Department with the unit, and (left to right) E. E. Schroeder of CBS Station WBBM, Chicago, and Mr. Maxwell. Mr. Schroeder developed the basic circuit.

According to G. E., tests have been made which show that effectively instantaneous control action is obtained with very low transient waveform distortion, and with complete freedom from audible thumps in the program. Use of the amplifier permits higher average modulation without danger of overmodulation on program peaks. Company officials explain that adjacent channel interference, and transmitter outages caused by overmodulation, are prevented by use of this unit.

Both amplifier and power supply sections have hinged front panels, a construction feature of G. E.'s line of broadcast audio equipment.

### CALLMASTER INTERCOM

The new '47 Callmaster Intercommunicator features attractive new high luster mahogany plastic cabinets, improved sensitivity, and power output. The model CM-10 shown is a master and sub combination and fills a great need for an economical, dependable, and instantaneous means for two people, remotely located, to talk back and forth.



These intercommunicators are sold as a packaged unit and are easily installed by the user.

Callmasters are priced to produce attractive results for both dealers and wholesalers. Write the Lyman Electronic Corp., 12 Cass St., Springfield, Mass., for full details.

### WIRE RECORDER DATA

An 18-page Tech Manual describing the P.E. magnetic wire recorder model 20B-2 is available from the Office of Technical Services, Department of Commerce for \$2.00. This publication is known as PB 48394. The G.E. portable recorder is designed for 28 volt d-c operation from a bank of twenty-four type BA35 dry cells. Although designed primarily as a recorder, the speech amplifier may also be utilized as a two-station interphone. The unit consists of the recording mechanism, an audio amplifier using a 28D7 tube, a 30-kc erasing oscillator using another 28D7, a driving motor and accessories, which include two microphones, recording wire and spools. Photographs and a schematic are included.

### ADVERTISING INDEX

|  |               |
|--|---------------|
| American Phenolic Corp. . . . .            | 5             |
| Amplifier Corp. of America . . . . .       | 53            |
| Audio Equipment Sales . . . . .            | 55            |
| Concord Radio Corp. . . . .                | 48            |
| Eastern Amplifier Corp. . . . .            | 49            |
| Electro-Voice, Inc. . . . .                | 36, 37        |
| Federal Sapphire Products Co. . . . .      | 56            |
| Federal Telephone & Radio Corp. . . . .    | 6             |
| Hopp Press, Inc. . . . .                   | 54            |
| Maguire Industries, Inc. Cover 3           |               |
| Miles Reproducer Co., Inc. . . . .         | 56            |
| Northwest Procurement & Sales . . . . .    | 56            |
| Offenbach & Reimus Co. . . . .             | 56            |
| Racon Electric Co., Inc. . . . .           | 39            |
| Radio Corporation of America . . . . .     | 2, 3, Cover 4 |
| Radio Music Corporation . . . . .          | 41            |
| Reeves Soundcraft Corp. . . . .            | 52            |
| Rider, John F. Publisher Inc. . . . .      | 54            |
| Sterling Electronic Laboratories . . . . . | 53            |
| Sylvania Electric Products Inc. . . . .    | Cover 2       |
| Tech Laboratories . . . . .                | 50            |
| Triplet Electrical Instrument Co. . . . .  | 46            |
| Wrigley, William Jr. Co. . . . .           | 47            |

● 2000 WATT MODULATION XFMR  
NEW—SURPLUS. Chicago Trans. Co. Pri. 12000 ohms, Sec. 4000 ohms. Made for Collins (#667S610). **\$68**

● 2500 WATT MODULATION XFMR  
NEW—SURPLUS—KENYON #10765. Pri. 12000 ohms. Sec. 5000 and 7500 ohms. Response 5000 cycles plus or minus 1db. **\$75**

● 10.4-KVA, 17,600 - AC XFMR  
NEW—SURPLUS. Pri. 115 AC. 25-Kv test. Same as in RA-38 Rectifier Unit. **\$78**

● Federal Tel. BC-447 XMTR. \$475.  
NEW—SURPLUS—2-13.4 mc. Dual Channel. 110-220 v single phase. Remote keying.

... Write For List Of Other Surplus ...

**OFFENBACH & REIMUS CO.**  
372 Ellis St., San Francisco 2, Calif.  
Phone: ORdway 8551

**HERE'S A TIP . . .**  
**Sapphire Tip, That Is!**  
The FEDERAL EUPHONIC SAPPHIRE TIPT PHONO NEEDLE permits more faithful reproduction of your records with less record wear because.

**IT IS**

- Diamond lapped
- Micro Polished
- Virtually Friction Free
- Manufactured to precision tolerances

Distributors — Wanted for some territories  
**FEDERAL SAPPHIRE PRODUCTS CO.**  
Elmhurst, N. Y.

**ATTENTION — SERVICE MEN!**  
**STATIC SUPPRESSORS — AUTOMOTIVE TYPE**  
10-Ohms — Angle types — 1 C.A. #349 B — .08 ea.  
Min. order \$5.00  
Mail orders filled postpaid anywhere in the U.S.A. — while they last. Send money order for prompt shipment. Regular billing vs. P.O. to rated accounts.  
**NORTHWEST PROCUREMENT & SALES**  
107 N. W. Couch St. Portland 9, Oregon

**FILMGRAPH PAT'D**  
**Conference Recorders**

UNINTERRUPTED  
Longtime (up to 12 hours) Conference & Telephone Recordings on Safety Film Models for Dictation "TALKIES"

ECONOMICAL  
PERMANENT  
INSTANTANEOUS  
PLAY-BACK

MILES REPRODUCER CO., INC. 812 BROADWAY, N.Y. 3 Dept. AE



# 2 NEW THORDARSON Hi-Fidelity AMPLIFIERS

## THORDARSON 10 WATT PHONO-AMPLIFIER

Unique in design and far ahead of its field, this new Hi-Fidelity Phono-Amplifier incorporates both microphone and phono input into an amplifier specially adapted for use with the Meissner High Fidelity AM-FM Tuner . . . or with tuners of comparable performance. As the speech amplifier in an amateur transmitter, or as the amplifier section in recording units, this new Phono-Amplifier leaves nothing to be desired in naturalness or brilliance of tone. Separate bass and treble controls with both accentuation and attenuation action assures complete adoption of the output to all acoustical conditions . . . plus the pleasure of listening to music the way it should be heard. Production costs have been materially lowered by mounting this unit on a simple chassis (inasmuch as amplifier is usually installed in cabinet, no cover is required). Complete specifications on request.

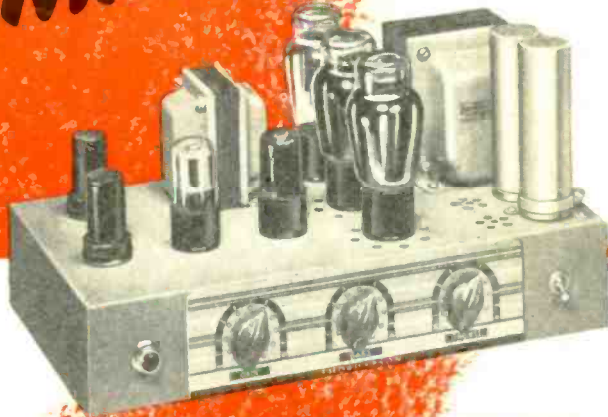

MODEL T31W10A

## THORDARSON 20 WATT MOBILE AMPLIFIER

A new, conservatively-rated universal mobile amplifier designed to furnish sufficient undistorted power for sound trucks, picnics, carnivals and similar installations, wherever the versatility of 6 volts DC or 115 volts AC operation is required. A truly versatile amplifier, shock-mounted for smooth operation over rough terrain. Electric turntable and pick-up mounted on top of amplifier operates in any position. Treble attenuation tone compensation allows correction to acoustical conditions and provides for record scratch reduction. Mixing procedure controlled with the coupled phono and microphone input channels. All connections on back of chassis vastly simplifies hook-up procedure and leaves front panel trim and unhampered. Complete specifications on request.



MODEL T31W20A

**ELECTRONIC DISTRIBUTOR AND  
INDUSTRIAL SALES DEPARTMENT**

# THORDARSON

A DIVISION OF

## MAGUIRE INDUSTRIES, INC.

936 N. MICHIGAN AVENUE  
CHICAGO 11, ILLINOIS

EXPORT ADDRESS

### SCHEEL INTERNATIONAL

4237 N. LINCOLN AVE., CHICAGO 18, ILL.  
CABLE — HARSHEEL



# ANNOUNCING... RCA blue-sensitive Gas Phototubes



RCA 5582



RCA 5583



RCA 1P37



RCA 5581



RCA 5584

## TABLE OF COMPARABLE TYPES

| NEW TYPES<br>S-4 RESPONSE | INTERCHANGEABILITY            | OLDER TYPES<br>S-1 RESPONSE |
|---------------------------|-------------------------------|-----------------------------|
| 5581 . . . . .            |                               | 930                         |
| 5582 . . . . .            | The new RCA types are inter-  | 921                         |
| 5583 . . . . .            | changeable with these earlier | 927                         |
| 5584 . . . . .            | types. In some cases, minor   | 920                         |
| 1P37 . . . . .            | circuit changes are necessary | 868,918                     |

**Feature high sensitivity to blue radiation, no response to infrared, and high signal-to-noise ratio**

These five new phototubes represent another important tube development initiated by RCA with the introduction of the 1P37. They have the advantage of combining the S-4 response with gas amplification. Thus, the tubes offer exceptional sensitivity to blue radiation, no response to infrared, and a high signal-to-noise ratio.

The five types illustrated are especially valuable in sound reproduction from a dye-image sound track because of the total absence of masking of the modulation by infrared transmission. They are equally attractive for industrial applications involving measurement and color control where infrared radiation might mask the desired signal.

RCA 1P37, 5581, 5582, 5583, and 5584 Gas Phototubes have a maximum response at a wavelength of 4000 Angstroms and a maximum gas amplification factor of 5.5.

Each of the five new types has comparable luminous sensitivity, anode characteristics, and structure to the older type having S-1 response. They may therefore be used interchangeably with the earlier types with minor circuit changes.

RCA Tube Application Engineers will be pleased to offer their services toward the use of these or other RCA tube types in your equipment. Meanwhile, send for the new Bulletin CRPS-102 covering the technical data on the complete line of RCA Cathode Ray, Phototube, and Special Types. Address all inquiries to Commercial Engineering, Section R-65E, Harrison, N. J.



RCA Laboratories,  
Princeton, N. J.

THE FOUNTAINHEAD OF MODERN TUBE DEVELOPMENT IS RCA



TUBE DEPARTMENT

**RADIO CORPORATION of AMERICA**

HARRISON, N. J.