

Stereo

FOR BEGINNERS

by B. J. Webb



A MILES HENSLOW PUBLICATION

hifi
BOOKS

SEVEN & SIXPENCE

STEREO FOR BEGINNERS

By
B. J. WEBB



PUBLISHED BY MILES HENSLow YEAR BOOKS LTD.
99 MORTIMER STREET, LONDON, W.1

*PRINTED FOR THEM BY PORTIA PRESS LTD.,
WHITCHURCH, HANTS, ENGLAND*



CONTENTS

	<i>Page</i>
<i>INTRODUCTION</i>	5
Chapter One—<i>WHAT IS STEREO?</i>	9
A brief look back. Two channels needed. Directional hearing. A simple experiment. Stereo works.	
Chapter Two—<i>IS STEREO WORTHWHILE?</i>	17
The menace of gimmicks. Mono too confined. Dodging the point source. Need for diffusion. Catching the “ambience”. The lateral dimension.	
Chapter Three—<i>STEREO RECORDING</i>	23
A science and art. Types of microphone. Microphone techniques. Many variations.	
Chapter Four—<i>THE BASIC REQUIREMENTS</i>	27
A popular heresy. Amplifier arrangements. Essential facilities. Speakers and personal taste. Types of speaker. Direct and reflected sound. What to listen for.	
Chapter Five—<i>STEREO FROM DISCS</i>	43
How the grooves are cut. Pickup requirements. Matching pickups. Crystal types. Magnetic types. Pickup arms. Tracking weight. Turntables. Disc imperfections. Record care.	
Chapter Six—<i>STEREO FROM TAPE</i>	65
The basic essentials. Various tape machines. Specifications. Tracks and speeds. Home recording. Types of tape. Copyright law.	
Chapter Seven—<i>STEREO FROM RADIO</i>	77
BBC experiments. Various methods. An ideal system.	

Chapter Eight — <i>CONVERTING TO STEREO</i>	81
Not possible with a cheap player. Using differing amplifiers. Pairing unmatched speakers. Tape conversions.	
Chapter Nine — <i>PURCHASE, INSTALLATION, MAINTENANCE</i>	85
Planning an installation. Wall mounting. Types of cabinet. Fitting pickups and motors. Connecting up and earthing. Keeping things running.	
Chapter Ten — <i>LISTENING TO STEREO</i>	97
How do we listen? Listening fatigue. The music room. Speaker positioning. Speaker phasing. Relaxing to listen.	
Chapter Eleven — <i>QUESTIONS AND ANSWERS</i>	103
<i>SHORT GLOSSARY OF HI-FI AND STEREO TERMS</i>	109
<i>INDEX</i>	115

STEREO FOR BEGINNERS

INTRODUCTION

Of the innumerable scientific and technological advances made in this century, the perfection of the gramophone has been entirely to the advantage of mankind, with practically no attendant, malignant applications. Many millions of people have been acquainted with the art of music through its medium, and the concert halls and opera houses of the world have become—as it were by proxy—the common property of all who can afford record playing apparatus. But the gramophone has, through technical limitations, remained a second best. Anyone who has been fortunate enough to live near a concert hall, and willing to accept someone else's choice of programme, has known that the "atmosphere" associated with the real thing cannot be found in the home.

Advances there have certainly been and, in the years since the second world war, the techniques of recording and reproduction have improved almost beyond measure. Yet there remained a seemingly unbridgable gap—that "atmosphere" would still not come into the home, no matter how loud or near the reproduced sound was made. But now a bridge is being built, in the form of stereophonic sound. At last it is possible to reproduce something of the breadth, warmth, spaciousness and clarity of real music, together with that indefinable "feel" of the concert hall or operatic stage.

Stereo is still widely misunderstood and frequently misused, largely because it is often presented as a gimmick rather than an aid to musical enjoyment. In many respects the gap between reality and illusion is still wide, but it is nevertheless narrower than ever before, and as techniques further improve the superiority of the concert hall will become social rather than musical.

The best stereo reproduction is already a revelation to music lovers who have previously been intolerant of "canned" music, and in time it will

become essential for all to whom the *sound* of music is more important than a mere succession of notes in a score. This book is written for the many who will come to want stereo in their homes, with the object of guiding them in a reasonably non-technical manner towards the best quality of stereo sound obtainable for the outlay they can afford.

If we merely wish to reproduce in our homes a wide range of sounds with that "flat response from DC to infinity", towards which some listeners stretch out like children seeking to touch a rainbow; if we wish merely to pluck the chords of memory; if we happen to belong to that fortunate company of musicians who can listen at any time to an ideal performance by reading a score, then *stereo* has little to offer us which a single channel will not provide just as well. If we wish, in the words of equipment advertisements to "*Bring the orchestra into the living room*" the same is true. But for those who seek beyond these limited though perhaps unattainable ends—for something more and something different; and for those who may not even have a very clear idea of what is being sought, but who find any and every piece of *mono* (*single channel*) reproduction in some strange way inadequate, unsatisfying and incomplete, *stereo* may well be the talisman opening the way to an adventure with remarkable possibilities, to an experience distinct from any previously offered by reproduced sound, leading to revaluations and new assessments of quality.

Mono versus stereo

To see why this should be so, let us look briefly at the two systems. It has long been established that a good *mono* recording, made in a rather "dead" studio and well reproduced, can effectively place an artist in the position of the loudspeaker in a room. This technique, applied to solo singers and instrumentalists, produces almost completely convincing and satisfactory results—so much so that there has been a tendency to think that we needed only to refine our methods and equipment a little further for reality to lie within the hollow of our loudspeaker cones. But in fact the success of the procedure depended on a careful selection of sound sources of comparable size to the speaker. the avoidance of multiplication of these sources, and the recording of a minimum of "ambience" or reverberation involving close microphones and



Mono is like coins in a pile—stereo spreads them out.

acoustically dead studios. It was necessary for recording conditions to be artificial in order that reproduction might be natural!

The very success of mono in this restricted field served to emphasize its limitations in the ears of some forward looking people. Because we were working in one channel only, as soon as the sound sources were multiplied, however many microphones might be in use, the effect was rather like building a pile of coins, one on top of the other: the faces are hidden; only the edges are visible; and the smaller ones are submerged by the larger, unless they are deliberately brought forward. The only dimension it is possible to transmit by *mono* is *backward and forward*, since any movement other than forward is away from the microphone. If this is counterbalanced by the use of other microphones, there is no apparent movement, and a performer needs only to play more loudly to appear to move forward.

It follows that maximum clarity in the recording of large sound sources, such as orchestras, was to be obtained by the use of several microphones, spaced across the laterally spread sound source; and, provided that the listener would accept an apparent position on the conductor's rostrum when the recording was reproduced, the method worked quite well. However, we were not all prepared to do this, our objection being that we did not normally occupy this position at concerts, and any attempt to use the volume control as it should be used, as a distance control, produced infallibly the impossible effect of listening close to an orchestra from a distance away!

The Second Channel

The use of a *second* channel, however, spreads out the coins before us, each in its proper place, all the faces equally visible, the smaller in due proportion to the larger—nothing obscured or pushed forward. Correct relationships are now preserved; the physical separation of the performers is conveyed with its consequent clarity, and no longer is it necessary to suppress ambience, which now seems to be recorded separately from the music, much as a frame is separate from a picture, yet forms with it a single entity.

A sound generated at the left or right of centre emerges, apparently, from that position in reproduction, as if one wall of the room had disappeared, making an opening into the auditorium where the performance is taking place. In point of fact directional properties do not matter much, except in operatic works: what does matter is that the sound should not seem to come from a loudspeaker, and that we should receive something more than just sounds.

High fidelity in *mono* form puts impulses of excellent quality (if often incomplete) into loudspeakers. We now seek to take sound out of loudspeakers and put it into space *with its ambience*. *Stereo* with its two channels gives us the means to do this. Some of our apparatus may be approaching finality in its development, and while research must and will continue, we already have equipment enabling us to enjoy a completely new standard of reproduced music. We have only to use this equipment in the right way, and to insist on

the sort of records, tapes and (later) radio transmissions which will give us the results we desire. In this field, we are all beginners.

When we attend a concert, we are conscious of the atmosphere—of the environment of which we are a part—even if we close our eyes. With *stereo* it is possible to record and reproduce not only sounds, but an “environment”, so that we become a part of it in the same way, and this is what we should seek to do. Anything less is a failure, to a greater or lesser extent, in using the full possibilities of the medium. This amounts, in effect, to our transportation to the scene of the original performance: the very reverse of the old theme of “bringing the orchestra into the living room”. We do not wish the mountain to come to Mohamet; Mohamet must go to the mountain. This involves recording the whole complexity of the waveforms in their correct relationships, and regenerating those waveforms apparently in the space between the loudspeakers—something which can be accomplished only by the use of two separate channels—by *stereo*.

It is an accepted fact that sound makes physical, nervous, mental and spiritual impacts on all of us. The nature and extent of these impacts has been, and continues to be, a subject of study in some hospitals and medical research centres. Without doubt, the form of sound most stimulating to the imagination is musical sound. It is no exaggeration to say that people can leave a concert feeling better for having attended it. “Every performance” said Artur Schnabel “is an occasion”; and it is the simulation of that experience which is the criterion of *stereo* quality—not its frequency range or the positioning of individual sound sources. It will at once be obvious, however, that a simulation of this order, which amounts to a replica or facsimile of the original, and therefore the creation of similar sound pressures at the ears of the listeners, requires (1) very low distortion levels, (2) adequate power in the amplifiers, and (3) proper arrangement of the speakers; and these essentials cannot yet be provided by one-piece reproducers.

I have felt it necessary to write this somewhat lengthy introduction because it has been brought home to me that with the same quantity of bricks of equal quality one can build a mansion or a mausoleum: a place for the living or one for the dead; and the greater part of this book is concerned with the assembly of the right sort of bricks. I believe that sound reproduction is not only a living, growing art and science, but also a living, growing force with potentialities as yet unrealised, remarkable as its present actualities are. *Stereo* represents the art's highest manifestation so far, and to write about the means of producing this without first giving an indication of what we should be trying to do, would be an evasion. *Stereo is not simply an extension of high fidelity*. It is something essentially different aesthetically and psychologically, an experience of a different order, and it should be approached with that knowledge.

I record my very sincere thanks to all those who have helped and encouraged me to write this approach to stereo, especially to Mr F. H. Brittain and Mr C. E. Watts who have spent much time in the attempt to enlighten an obtuse and argumentative mind.

CHAPTER. ONE

WHAT IS STEREO?

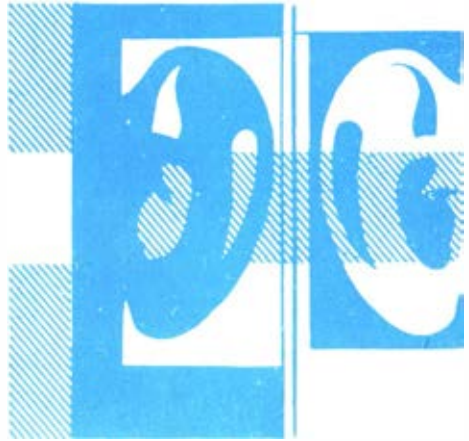

The word “stereo” is an abbreviation of stereoscopic, stereophonic, or the mongrel word “stereosonic”. It comes, directly from the Greek word *stereos*, meaning solid or stiff, and in the world of sound reproduction stereo can be used to describe any system which employs two or more independent, separate and distinct channels between the sound source and the listener, whether these channels are carried by radio, tape, disc, film or any other medium. A single channel system is commonly known as *mono*, an abbreviation of monophonic.

Paris—1881

The first public demonstration of stereo took place at the Paris Opera House in 1881, by means of a telephone system, and it was apparently successful; but the time was not yet ripe for it, and the experiment was of no practical value. Towards the end of the first world war, some government work on stereo was undertaken for sound location purposes, but the fundamental research which has made stereo recording and reproduction a practical proposition was done in England by one genius, the late A. D. Blumlein, working in the laboratories of the British Columbia Graphophone Company, between 1929 and 1931. (British Patent No. 394,325. Applied for 1931. Completed 1933)—and in America, some time later, by a group of engineers at the Bell Telephone Laboratories.

Although the first stereo recordings available to the public were made on tape (EMI issued “Stereosonic” tapes in this country in April 1955), Blumlein’s work was done many years before the discovery of this material. The first stereo records were made on wax under his direction around 1933/34,

STEREO FOR BEGINNERS

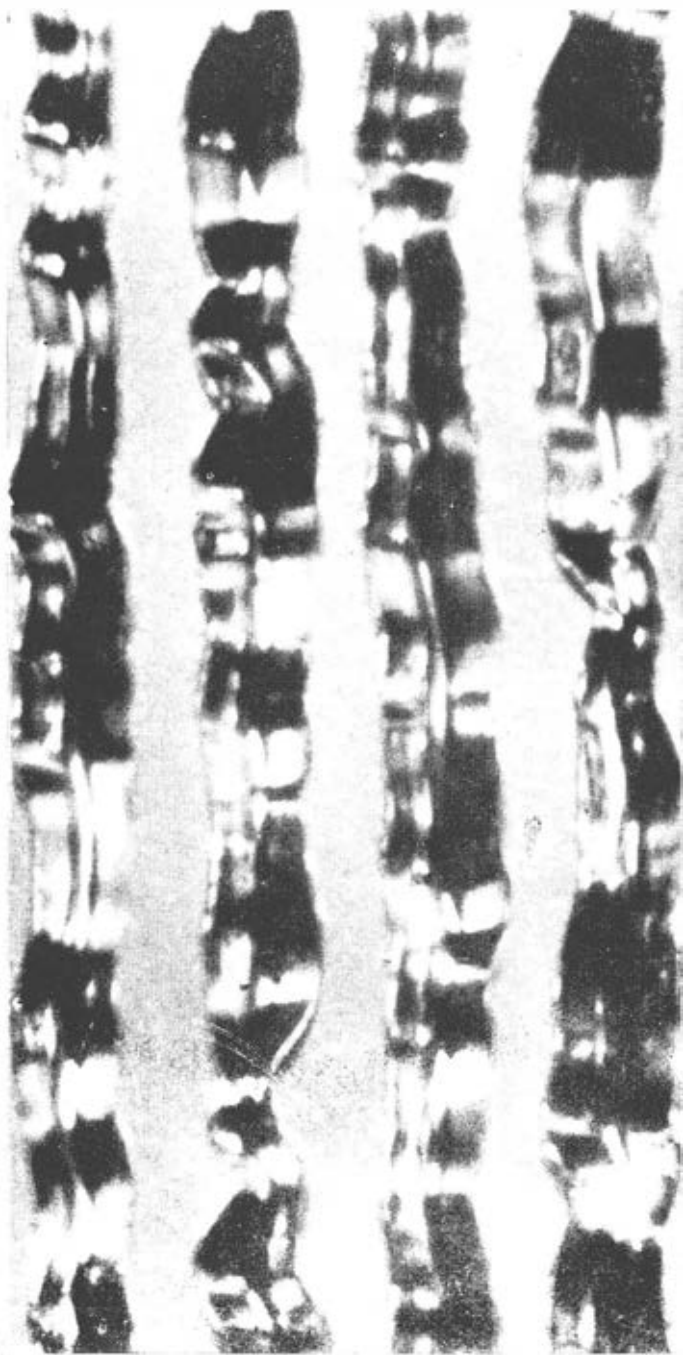

This was one of the first pictures ever taken of stereo record grooves (1957). Grooves were cut by Arnold Sagden of Commsieur and photographed by Cecil Watts. The "information" on the two groove walls can, in theory, be completely different though usually on musical material there is some "in-phase" signal which causes the two walls to follow similar patterns.

and from these recordings shellac pressings were produced. But, as Dr Dutton tells us, "*The reproduction quality in these early days was limited by the surface noise of the shellac pressings, and by the tracing distortion due to the large reproducing stylus. The frequency range was limited both by the cutter and reproducer heads, and it was very soon found that reproduction quality could not be sacrificed in noise, distortion or frequency range in order to obtain a stereo system. In other words, stereo reproduction can only be fully effective if each channel is operating under very high quality conditions. The stereo disc was therefore shelved pending the development and improvement of gramophone technique.*"

The American experiments tended to show that, particularly in larger spaces, there was something to be gained from the use of *more* than two independent channels for stereo recording and reproduction. At this stage film was the only medium available for such a system although, as we shall see, it has subsequently been applied to tape. The possibilities of such a system for public entertainment in cinemas (where cost and complexity were not matters of prime importance) were soon realised, and led directly to the sort of sound reproduction which we hear today in "*Cinerama*" and other film presentations.

Seventeen years after the first demonstration of stereo in 1881, a Dane by name of Poulsen patented a device for recording magnetically on steel tape or wire; and during the Second World War German scientists developed this device along new lines by producing a tape coated with iron oxide. This, together with improvements which had been made previously to Poulsen's device by other scientists (Blattner and Stille), made tape recording a useful and practical system.

Wax Out—Tape In

After the war, the victors took this invention from the Germans, and it was rapidly developed and improved still further. From about 1950, tape recording replaced wax blanks as the material and method by which the record companies made their originals. With the arrival of the half-track tape recording system, which doubled the playing time, and with the introduction of a new method of copying tapes—by means of a master machine controlling a large number of "slaves"—the marketing of musical performances on tape instead of on discs became practicable. So the door was wide open for stereo recording and reproduction. No new apparatus was required: it was merely a matter of "doubling up", for the twin tracks were recorded or reproduced at the same time via separate amplifiers and loudspeakers.

At one time it looked as if the future of stereo lay with tape. Impressive demonstrations of the high quality and vastly increased realism obtainable were given in London by James Moir (then of BTH) and F. H. Brittain of GEC, using their own tapes and recording methods. EMI dug out Blumlein's work and made recordings by his methods. They duplicated these tapes at a slower speed (7½ in. per sec) for sale to the public and gave a number of

demonstrations, the best of all taking place in the Abbey Road Studios before an invited audience, prior to the first release of their “*Stereosonic*” tapes.

However, there were those who believed that general acceptance and use of domestic stereo reproduction depended on the disc—and perhaps ultimately on radio. The pioneers of stereo disc records had not been idle. Emory Cook in America had issued stereo discs in 1952—twin groove records, needing dual pickups for replay, and giving only half the normal playing time per side. More promising were the efforts of Arnold Sugden (of *Connoisseur* motor fame) in England during 1956/58, when he successfully demonstrated single groove disc stereo recordings at exhibitions of the British Sound Recording Association in London. These were recordings that he had made himself, and he replayed them with a pickup of his own design and manufacture. Others, too, were working quietly on similar lines.

The “development and improvement of gramophone technique” which Dr Dutton mentions as an essential for the production of stereo discs had now taken place. We had better cutters and pickups, which had given us “*ffrr*” (full frequency range recording) and much improved reproduction. The LP disc had come successfully through its inevitable teething troubles. Pressed from an unfilled vinyl plastic material, which reduced surface noise to vanishing point, these discs were played with a 0.001-inch radius stylus tip—about one third of the size of that used for 78’s. These developments, and the introduction of the feedback cutter head, now made it possible to consider going on from where Blumlein had left off some twenty years earlier.

Decca Developments

Mr Arthur Haddy, Chief Engineer of the Decca Record Co., and one of the most distinguished members of his profession, set himself the task of developing a practical stereo disc system of equivalent quality to Decca’s *ffrr* long players. Mr Haddy is among the more reticent of a reticent profession, but he was persuaded to give some account of his activities for the benefit of the company assembled at the March LP Conference at Blackpool in 1960. He told us that C. J. Francis (then with the Parlophone Co.) was working on the problems of stereo sound in 1938, and how his contacts with Francis had stimulated the stereo project within the Decca Company. Three workable systems were evolved—one by *Decca*; one by Decca’s German associates, *Teldec*, with whom close contact was maintained; and one in America by *Westrex*, about which we shall have more to say in the chapter on “Stereo from Discs”.

International agreement was reached for the adoption of the “*Westrex 45-45*” system as standard, and in 1957 the road was clear, though much work remained to be done. Decca had been preparing for stereo discs since 1954, by making original tapes in stereo as well as mono, so that when a decision was made to proceed with the issue of stereo discs, a repertoire was available. Much more than this was required, however, for suitable apparatus had to be designed and manufactured for the reproduction of the new records.

WHAT IS STEREO?

However, while all this preparatory work was still going on, someone else let off the rocket! In April 1958, immediately before the London Audio Fair, Pye Records Ltd., gave a demonstration to an invited audience in London, and announced their first release of stereo discs.

Many people have since expressed the opinion that it would have been far better for stereo if all manufacturers had agreed to, and adhered to, a date for the first release of stereo discs, so that a reasonable term of notice could have been given to both the public and the equipment manufacturers. As it turned out, disc stereo got off to a bad start, amid general confusion. Apparatus of good quality to play the new records was not available in useful quantity. Makers of records and equipment felt themselves pushed, and during the next few months many people wasted much money on gear that was inadequate for its purpose. This situation did much harm to the cause of high quality sound reproduction in general, and to stereo sound in particular.

Twin-Channel Stereo

So much for a brief historical survey: now let us take a closer look at the general nature of the stereo reproduction which all of us can enjoy in our homes today. This should properly be designated "*twin-channel stereo*", because we know that stereo is not tied to the employment of two channels *only*. We can add further channels and improve results, but each additional channel gives a smaller improvement in return for the added complexity and cost. Domestic stereo is likely to remain twin channel for a long time, and all future references to stereo in this book will mean *twin-channel stereo* unless a specific qualification is used. Twin channel stereo, like every other form of sound reproduction, is a compromise, but it does provide the essential basic minimum requirements—something which no system employing only one channel can accomplish.

In attempts to explain why this is so, an analogy has been drawn with stereoscopic vision. This is useful if it is not carried too far or applied too literally. We are all aware of the fact that complete stereoscopic vision is achieved by the use of our two eyes, and cannot be achieved with one only;

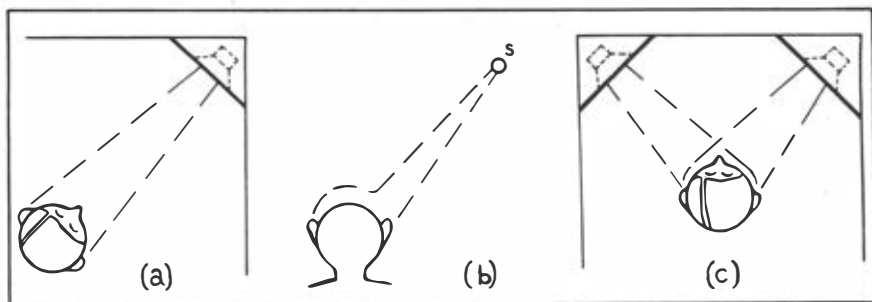
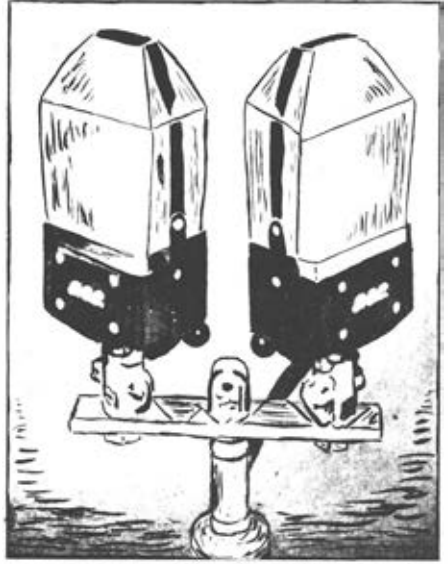

Fig. 1:1. At (a) there are identical signals at each ear. If the listener turns away from the source *S* as at (b), the signal to one ear is delayed and attenuated. At (c) the delays and attenuations at both ears from two speakers create an illusion of sounds in-between.



Early stereo experiments by B.T.H. employed a tailor's dummy with microphones mounted in its ears (left). G.E.C. used two ribbon microphones mounted side by side with their axes at right-angles.

and that perfectly effective stereoscopic reproduction is possible from a "stereo pair" of pictures taken with a camera having its lenses set the same distance apart as human eyes. When these pictures are set up in a suitable viewer which causes them to merge into one picture; they apparently possess three-dimensional, solid characteristics. Because each eye sees the picture from a slightly different angle, the brain is able to assess relative size and distance by using the difference between the two sets of information presented to it, and by registering the extent to which the eyes have to be converged to produce one central image.

Our ears don't work in the same way, of course; they are not directional organs, and we can't move them independently of each other or of the head which keeps them apart, but we can turn that thick head until a balance is reached; when this has been done, we are facing the direction of the sound source. When a sound originates to the right or left of the direction in which we are facing, it arrives at one ear a little sooner than at the other, and is heard by that other ear at a lower intensity (above 1 kc/s) and with slight differences due to the obstruction presented by the head and the longer path length which the sound has to take. The brain compares four images, two at each ear, and by this means locates the position of the source, more or less accurately according to the circumstances (**fig. 1:1**, page 13).

Recent work by Dr D. M. Leakey of the GEC Research Laboratories at Wembley seems to establish that the differences in sound level and arrival time at the ears are the governing factors in sound location, and that they are interdependent in their effect on the brain. Nevertheless, a great deal of

argument, which is outside the scope of this book, persists about the exact mechanism, the factors involved, and their relative importance.

Our faculty of aural location is less precise than our power of visual location, as a few honest experiments in concert halls, with eyes closed, will clearly show. Sound originating in enclosed spaces, such as these, does not all reach the ears directly: much of it arrives by reflection from walls, ceiling and other surfaces, and so tends to confuse rather than clarify. The same thing happens when the sound is reproduced, which is why a rather "dead" room is best for stereo reproduction; but in spite of these facts we still retain the ability to "place" sounds, and stereo gives us the opportunity to exercise this ability (which we employ unconsciously and continuously in our daily aural experiences) when listening to reproduced sound. It is possible to do this only by recording a minimum of two different signals, such as might be received by a person present at the performance, *and by keeping these two signals entirely separate* until they are reproduced simultaneously to be reconstituted by the brain (fig. 1:2).

Synthetic Stereo

If signals are mixed into a single channel, the differences between them which make stereo possible are lost, and can never be restored. It is possible to provide two different channels in reproduction of a single channel source—for example, by means of a frequency dividing network which puts the treble on the left and the bass on the right with a generous overlap. A time delay can be introduced between the two speakers. Although such devices as these will give results different from, and in some cases perhaps better than, ordinary mono or "double mono" reproduction (i.e. a single channel reproduced through two separated loudspeakers), the results will *not* be stereo because the differences between the signals will not simulate those which would have been presented to the ears at the performance. In true stereo these signals are merely interrupted on their way to the ears. Once they have been mixed in a single channel they cannot be sorted out again in reproduction, and it must be emphasised that no instrument purporting to give stereo effects from a mono source can, in fact, give stereo reproduction.

If you have a tape recorder, you can prove this for yourself by means

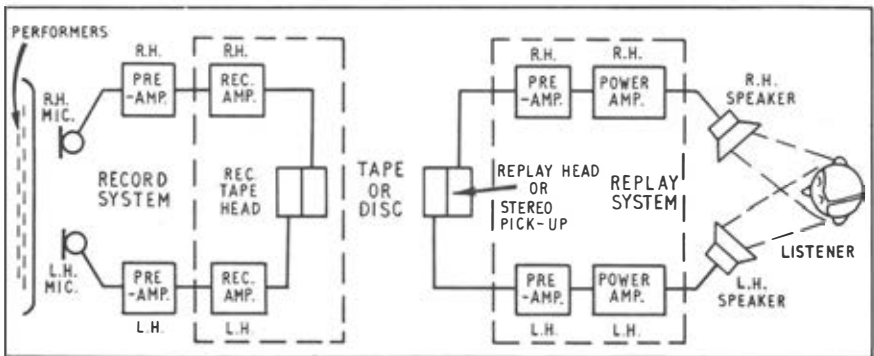

Fig. 1:2. This represents a complete stereo system from performers to listener.

of a simple experiment. Get two people to stand close together and recite different nursery rhymes; you will find it very difficult to follow either to the exclusion of the other. If now you get your subjects to stand 10 feet or so apart and say their pieces together again, you will find that you can follow either at will. Now record the sound on your tape in each case by means of a single microphone, and on playing back your recordings you will find it just as difficult to separate the speakers in the second case as in the first, whether you use one loudspeaker or two, and however you "doctor" the output. The result will be exactly the same if you use two separate microphones, however positioned, and combine their outputs on the tape.

To carry the experiment to its logical conclusion, a stereo recorder and a little experience in its use would be required; but then it would be found that, on playback through similarly placed external loudspeakers, your ability to follow either person at will when they are separated by 10 feet or so would be restored. We shall have occasion to refer to this experiment again in a subsequent chapter. At this stage we will observe only that it serves admirably to illustrate: (*a*) that microphones and other electronic recording and reproducing equipment do not possess the faculty of the human hearing system to analyse the sounds they receive, and (*b*) that two completely separate channels are *essential* for stereo recording and reproduction.

Stereo works. Although our understanding of exactly how and why it works may be incomplete or inexact, and the explanation offered here even more so, one properly arranged demonstration will convince anyone. The author has on many occasions found it both interesting and entertaining to watch the facial expressions of sceptical and prejudiced people change during the course of half an hour's listening, and has been delighted to see them depart "converted". Quite recently, after an hour of stereo, a visitor got up and said sadly: "Well, I must go home now—tell my wife I'm going over to stereo—and then take evasive action as quickly as possible!"

Generally speaking, this should not be necessary, as we shall see when we come to consider suitable apparatus; but first, though we may be convinced that stereo works, we must look at what it can offer us in comparison with mono reproduction, and then decide whether it is worthwhile.



CHAPTER TWO

IS STEREO WORTHWHILE?



As Mr Peter Walker has pointed out, there are two classes of people who listen to reproduced sound: those who put up with the loudspeakers in order to listen to the music, and those who put up with the music in order to listen to the loudspeakers. Whereas a few years ago High Fidelity was giving some people high blood pressure, for the good reason that it had become a thing of penetrating menace in the hands of Mr Walker's second category of listeners, a couple of years ago these same sound addicts had succumbed to a new disease which may be described as "hystereosis". Trains and racing cars roared their way through these people's homes with shattering frequency, interspersed by the arrival and recession of hordes of pipers. One wall of their rooms melted away to give access at will to a swimming bath or the Tower of London, and when the tumult and the shouting died, life, which might be just one big bowl of cherries, became instead one interminable game of ping-pong.

All the above, whilst proving indubitably that stereo works (as we said in the last chapter), did little good to us and none at all to the cause of sound reproduction. I have come across people actively engaged in disposing of perfectly good mono equipment of high quality, and excellent records of various kinds for a mere song—recorded in stereo, of course. So, lest we be carried away in the boat of ignorance by the wind of enthusiasm, or delay too long and be left stranded by the rising tide, let us look soberly at what stereo has to offer to those of us whose interest in the means of sound reproduction is governed entirely by our desire for the end: the ability to transport ourselves and our guests at will to the scene of a musical or dramatic performance.

Until the advent of stereo, sound reproducing systems (even of the highest attainable quality) employed one channel only between performers and

audience. Several microphones might be used in the recording, but their outputs were invariably mixed and applied ultimately to one pair of terminals at the input to the recording amplifier. Over the years all the links in the chain, from microphone to loudspeaker, have been steadily improved until, today, a single channel reproducer can have an almost perfect *measured* performance. Indeed, five or six years ago some of us were pretty pleased with our mono reproducers; we were thrilled with the increased faithfulness of the sounds they made when we played a good record and handled the controls properly. Frequency range had been extended almost to the limits of our ears; distortion had been reduced to the point at which it was no longer a serious distraction, and improved transient response gave crispness to the sound, but a few awkward people rightly refused to be satisfied.

Electronics—plus “something”

An almost perfect electrical performance does *not* ensure almost perfect reproduction. The picture is somehow incomplete. We did not know, and still do not, all the things we ought to be measuring, or we have not found out how to measure them; so in the end we are forced to depend on our ears. If those ears are trained and practised in the appreciation of live sounds, they will miss very little when assessing reproduction, even though their assessments may, like their owners, differ; and it may be difficult or impossible to express these judgements in measurable terms.

One fact is beyond dispute: at the time we are writing about, it was perfectly possible, under carefully controlled conditions, to deceive experienced listeners by a direct comparison between certain kinds of live and recorded sound. Many readers may have experienced this. Mr Cecil Watts's amazing private recordings of the harpsichord, made around 1950, were not considered satisfactory until a trained and experienced musician, sitting three or four yards away in the room where the recordings were made, was as often wrong as right when trying to decide whether the sound was “live” or recorded.

Nevertheless, with many kinds of musical sound, reproduction could not (and still cannot) bear comparison in quality with the real thing, and if our measuring instruments tell us something different, or lead us to expect something different from this fact, then either they are lying or “the fault, dear Brutus, lies not in our instruments but in ourselves that we are underlings”, because we do not know how to measure all the things which are important.

Single Speaker Limitations

We suffer from a shortage of words, or a shortage of knowledge of how to use them to describe accurately the differences in quality between a live performance and a first class reproduction of it; but, listening to a single loudspeaker, one thing stands out a mile: a sort of compression, a squeezing together of the sound once we go beyond solo instruments and voices; a lack of spread, of size, in the source; a concentration of the higher frequencies so that they “squirt” at a listener facing the speaker. Under these conditions, if we stopped to think, it was obvious that we were listening to sound coming

from a hole in a box; from a very small hole in a very large box, if we thought a little more: just as if we were shut up in a sound-proof room in a concert hall, facing a circular aperture ten or twelve inches in diameter cut in one wall.

It was this realisation which had led that great engineer Paul Voigt to design his famous *Corner Horn*, twenty years ahead of its time, and which later produced the *Wharfedale Corner Reflex*, the *Acoustical Corner Ribbon*, the *Watts "Folly"* and subsequently that masterpiece the *Watts "Spheri-sonic"* which among other virtues gave omnidirectional radiation at all frequencies, but which never reached the commercial market because, like a fine piano, it had to be hand made throughout by craftsmen.

Experiments with Speakers

Listening to these loudspeakers led the present author, who could not afford to buy them, and a number of people in the same boat, to experiment with loudspeakers laid on their backs, facing into corners (like Mr Ralph West's admirable *Decca Corner Horn*, still the best design of its type), or placed on one side of room dividers with the listeners on the other, and to advocate publicly the trial of these ideas. We were all trying to dodge the "point source", to disguise the too obvious origin, by diffusion--and, better still, by hiding or disguising the speaker as well.

The result in almost every case was some loss in measured quality, but a considerable gain in realism, due to a more natural listening angle and the avoidance of loudspeaker consciousness. The next logical step was to use two loudspeakers, spaced apart and fed in parallel, which often broke up the room resonances quite nicely (another of the nuisances with which we have to contend), and apparently transferred the source of sound to a point between the speakers, thus tending to take our attention from them. This was the limit of progress along these lines from a single channel source, and

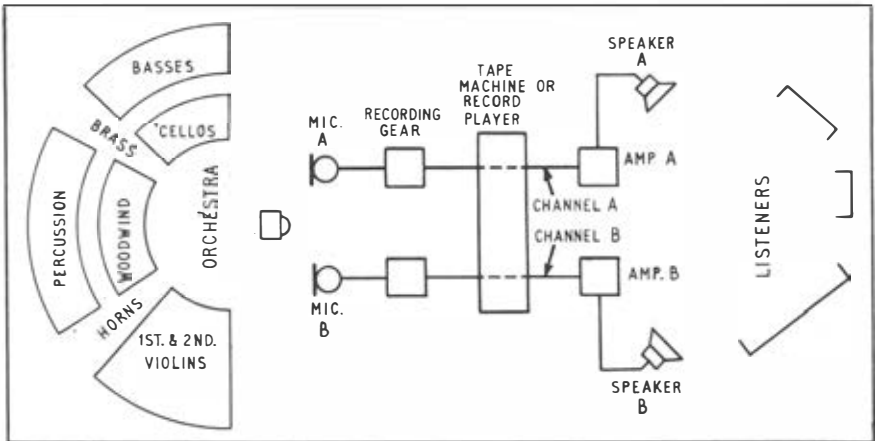

Fig. 2:1. Stereo enables one to hear the orchestra in proper perspective, without strain

it is from this point that stereo takes over. Is it worthwhile? What has it to offer which we cannot get from the application of intelligence and art in the use of the improved apparatus available for the reproduction of a single channel?

For our application, which I am taking to be chiefly the reproduction and appreciation of music, the differences between mono and stereo reproduction of equivalent standards are not of the staggering or shattering kind. They have nothing in common with the differences in the visual field between black-and-white cinema and "glorious technicolour"; rather are they of the order of the differences between first class colour films and *Cinemascope* or wide-screen projection.

The first and greatest advantage of stereo sound is that it gives an indication of the size of the original source. A loudspeaker cannot change its size in accordance with changes in the size of the source of the recording which it is called upon to reproduce, but speakers reproducing a stereo signal appear to do this, because the sound seems to be taken out of the loudspeakers and to occupy a greater or lesser extent of the space between them. Hence we get not merely the possibility of lateral location, but something much more important—a more natural listening angle for the various types of programme material (**fig. 2:1**).

Home versus Concert Hall

To a listener in a good seat, an orchestra of normal size in a concert hall subtends an angle of about 50 to 70 degrees. A loudspeaker at home provides a listening angle of about 5 or 6 degrees to a listener facing it from a distance of 8 to 10 ft—the equivalent of a seat so far from the orchestra that binoculars and a public address system would be required to see and hear it as anything more than a distant blur!

But the advantages of stereo are not confined to orchestras. As we all know from experience, the performers in a theatre are not static. They come and go and move about the stage with (in the case of an opera) an orchestra remaining spread out in front of them. All the sound does not emanate from the same spot or the same area of space from start to finish. Now, if in a single channel recording made with a single microphone a performer moves away from that microphone in *any* direction, the result is always the same when the recording is reproduced: the performer seems to have moved *backwards*. In order to avoid this undesirable effect, several microphones are used, their outputs are mixed and, in reproduction, all the sound seems to come from one point, which does not coincide with our experience of the real thing. Stereo gives us a much more natural result.

One of the major advantages of listening to a real orchestra in a decent hall is the clarity and separation of the groups and individual instruments. The degree of separation differs, of course, depending on the hall and, in most cases, on the seat occupied by the listener: one has only to attend a "Prom" at the Albert Hall one evening and a concert at the Festival Hall the next to realise this. Nevertheless this separation is always there, largely

as a result of the physical separation of the players, and the sounds which they produce reach our ears from different directions. These effects are necessarily lost in a mono recording, as we saw from the experiment with the tape recorder suggested in *Chapter One*, even if the signal is the combined outputs of several microphones, or is reproduced through multiple loudspeakers.

Some improvement can be secured by the employment of close microphone technique and recording in acoustically "dead" surroundings, but as the effect in reproduction is to bring the performers into the listening room, the applications for natural results are limited to soloists and small groups of players such as quartets. The performers suffer some inconvenience from sitting as close together as is physically possible in order to produce the effect of sound proceeding from one integrated source, and not from four separate players.

When close microphone technique is applied to larger groups such as orchestras, the result is not pleasing: first, because no one in his senses wishes to simulate the effect of an orchestra in his living room; second, because if he seeks to take the orchestra further away by decreasing the volume, the result is one quite impossible in nature of listening to "close up" sounds from a long way off; and third, because the acoustically "dry" effect, with little recorded ambience (which a friend of mine once described as "like listening on the front row of the Festival Hall with the rest of the building stuffed with cotton wool") is quite unreal, and to most ears rather unpleasant under domestic conditions.

Recorded "Ambience"

The problem of the amount of ambience which should be recorded—that is, the acoustic atmosphere or coloration of the original performance—is not an easy one to solve. Too little leaves us very thirsty, and too much drowns us, and all the fine details of the music as well. We want just enough to give us the illusion of presence—not the presence of the artists in our rooms, because generally speaking our rooms are not large enough to accept them comfortably, or the sounds which they produce—but of *our* presence in whatever surroundings the performance took place. Here, stereo scores heavily. An increased amount of ambience can be recorded without loss of clarity and separation because the ambience itself seems to be separated from the direct sound. As James Moir so clearly puts it, "A stereo reproducer transmits the acoustic characteristics of the original scene. A single-channel system degrades them"

The final characteristic of stereo reproduction which we shall consider here is, for most ordinary listeners to music, the least important and the most variable: the ability which it confers (to a greater or lesser extent) on the listener to "pin-point" the position of a given sound source, relative to himself and other sound sources in the space between the loudspeakers. This characteristic depends, more than any of the others, on the recording methods employed, the reproducer used, and the position of the listeners relative to the loudspeakers; and it is the least important because it is also

the most variable of the characteristics of a live performance, and it contributes less than the others to our enjoyment of it. To quote Dr Leakey: ". . . it must never be forgotten that it is the subjective impression that finally counts in the assessment of a practical sound system.

Unfortunately, the subjective improvement resulting from the use of multi-channel sound systems does not appear to be based on the ability to localise spatially the various sound images. Indeed, with many systems the reverse appears to be the case. Further, systems in which definite location is virtually impossible often appear to be preferred". My only personal doubt about that statement concerns the use of the word "unfortunately".

We ought to be quite clear in our minds about what stereo can do in this respect. In some quarters, stereo has acquired the tag "3.D." or "*three dimensional sound*", which is unfortunate because it is inaccurate and misleading. Worse still, on one amplifier which was widely sold, the switch position giving mono reproduction through two loudspeakers was marked "3.D.", so that stereo presumably was by inference 4 or 5 D! Now, if we are listening in a concert hall, and if the horns or any other group of instruments play loudly, they appear to be nearer to us than when they play softly; this is a state of affairs perfectly well appreciated by composers, and perfectly well conveyed by a mono reproducer, which will also convey accurately the difference in *quality* of sound caused by an actual movement of the instrument to another environment—e.g. playing off stage, or the difference between an instrument played softly *close* to a microphone, and *loudly* further away from it. So we can say that a mono system is "one-dimensional".

A stereo system adds one more dimension—the lateral dimension. Movement to the sides, away from the centre, is combined with the apparent shift backwards or forwards that is conveyed by mono. The fundamental importance of this (as was pointed out on page 7) is that a performer can move or be placed to the side without seeming to have moved backwards, and he will keep this relative position in reproduction, instead of being brought back to the centre by the use of another microphone—or allowed to seem as if he had moved backwards, as would be the case with mono recording and reproduction. Stereo does not, and cannot, convey any information about the third or vertical dimension, and while it would be theoretically possible to extend the system to do this, there would be little point in it.

On the basis of what has been said, we may justifiably conclude: (a) that a stereo reproducing system is one which transmits from a stereo recording some indications of the size and spatial distribution of the original sound source, and (b) that such a system of recording and reproduction is very definitely worthwhile because, by increasing the naturalness of the sound reproduced in the ways which have been indicated, it brings an immediately appreciable increase in the pleasure of listening.

Stéreo is here to stay. Therefore anyone who is now considering the purchase or improvement of sound reproducing equipment would be most unwise to leave stereo out of account, for sooner or later—and probably sooner—he will want it.

CHAPTER THREE

STEREO RECORDING



At present (1963) the only way to enjoy stereo sound regularly at home is by means of recordings. All stereo records are made on tape in the first place, and subsequently transferred to discs or other tapes for domestic use. The recordings from British studios are made to internationally agreed recording characteristics, known as RIAA for discs and CCIR for tapes, with a view to securing the best possible compromise between distortion, frequency response and signal-to-noise ratio when the records are replayed through amplifiers fitted with standard compensation devices.

Although it owes so much to modern scientific advances, recording (in mono or stereo) remains, and is likely to remain, an art as well as a science; this is the first thing we learn if we try our hand at it by means of a tape recorder, or if we are fortunate enough to be able to attend a recording session. There are few, if any, fixed rules, and assuming the high standards of equipment and processing which are today almost universal, perhaps the most important single factor which affects the quality of the results that we get from a record is the placing of the microphones.

Microphone Types

Microphones may be classified according to the shape of their sound pick-up pattern. There are three types: *omni-directional* (picking up sound from all round), *figure-of-eight* (picking up front and back, but not at the sides) and *cardioid* (picking up at front and sides, but not at the back). These different types are often used together, and it will be clear from a glance at the patterns of the pick-up fields (**Fig. 3: 1**) that even if only the minimum two microphones are used in making a stereo recording, which nowadays

A SELECTION OF STEREO MICROPHONES

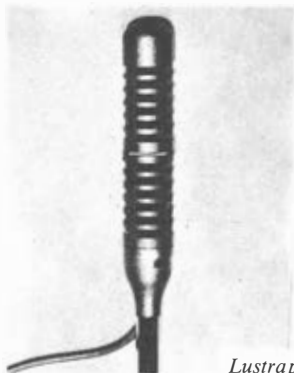

Lustraphone VR/65NS

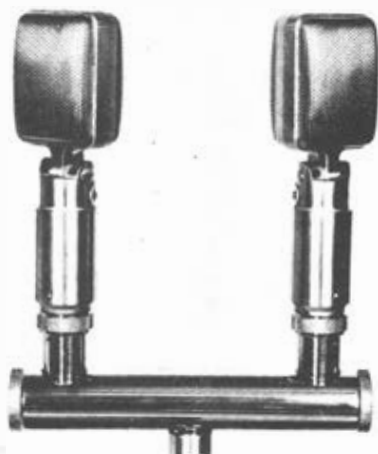

A pair of Reslo RBT/L

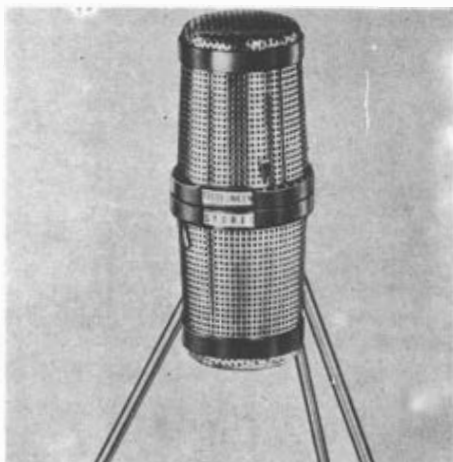

Telefunken



Acos Mic. 44



B and O SM5



AKG D88

is unusual, by choice of types and arrangement the pick-up pattern is almost infinitely variable.

Blumlein used two *figure-of-eight* pattern microphones, mounted one above the other with their axes at right angles. EMI "Stereosonic" tapes are still recorded by using this method, and they provide some of the best stereo available. F. H. Brittain of GEC used a similar method, but with the microphones side by side on the same level, their rear pick-up being suppressed by sound absorbing material. Results are excellent.

Other methods using the microphones close together have been tried, *omnidirectional* microphones being mounted at either side of an artificial head in the position of human ears, on either side of a separating or "shadowing" disc (failing to take account of the fact that *both* ears receive signals from *both* channels), and similar instruments placed horizontally from one to two feet apart facing the performers. Techniques using microphones close together are popular in this country, but they must not be described as, or confused with *close microphone* techniques, because this expression refers to the proximity of the microphones to the performers, not to each other. Rather, the expression *coincident microphones* should be used.

Wide Microphone Spacing

In America, methods of stereo recording with the microphones spaced much further apart have been more extensively used, based on what has been called "Classical" stereo recording—in which early practice the distance between the microphones in recording was intended to correspond to the distance apart of the loudspeakers to be used in reproduction. The distances varied from about 6 ft to as much as 30 ft. Recordings made with widely spaced microphones tend to produce an exaggerated "left and right" effect, without a solid central image, sometimes called "tink and tonk" stereo, but nowadays recordings made in this way almost invariably include a third, central channel which is mixed into the other two for twin channel reproduction, with improved results (fig. 3:2).

Mention must be made of the German M/S (Mitte-Seite, Middle-Side) system, which has been much used in Europe, including England. It employs a special *Neumann* microphone, Type SM 2, which is really a pair of condenser

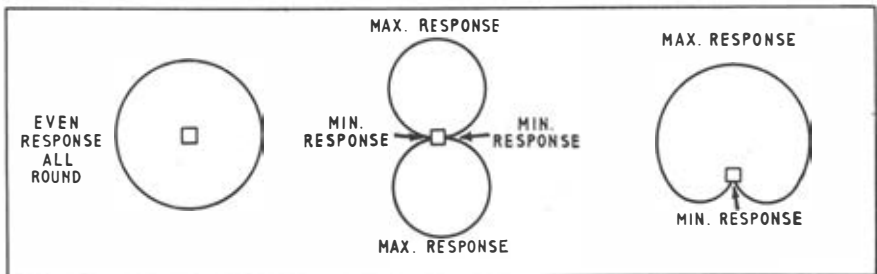

Fig. 3:1. Microphone responses may be omni-directional, figure-of-eight or cardioid each has its uses.

microphones in one case. Their pick-up patterns can be varied. One is given a *figure-of-eight* characteristic, but sideways on to the performers, and the other a *cardioid* characteristic facing directly towards them. The signals from these instruments are mixed in special output transformers, contained within the microphone, in such a way that one channel carries information from left plus centre, and the other from right plus centre, as in the three channel system mentioned above.

Some recording companies occasionally give a general indication of the method which was used for making a record. The information is of interest, but it is unlikely that the practice will become general. Ways of recording are being combined, changed, and varied from day to day, according to circumstances. Recording does not take place under constant conditions; the type and size of the sound source changes over a very wide range; the number of variables is almost infinite, and the engineer has constantly to exercise his art, since an arrangement which works well in one case may very well not produce the best results in another.

The apparatus and environment most likely to be found in reproduction of the recordings has also to be considered. Brittain and Leakey state that "The aim of a perfect stereophonic sound reproducing system is to create for the listeners a similar sound picture in correct aural perspective to that which they would have if transported to an ideal position from which to hear the original sounds". If we accept this statement, as I think we must, and if we have had experience of records of similar sounds made by different **methods**—then, in general, we may well agree with Dr Leakey that "Perhaps the most successful system is one employing pressure-gradient microphones directed outwards at 90 degrees and spaced at a short distance apart . . .". But this does not mean that satisfactory, fully acceptable, and pleasing results cannot be obtained by other methods. We know from experience that this can be so, and that it is achieved regularly.

Recording is outside our control, unless we have a stereo tape recorder and can do our own; and this will quickly teach respect for recording engineers. Therefore, while it is interesting and useful to know something about recording methods, the most important thing for us, as listeners, is so to choose and use our stereo reproducers that we can get the best results from the wide range of records available on disc and tape.

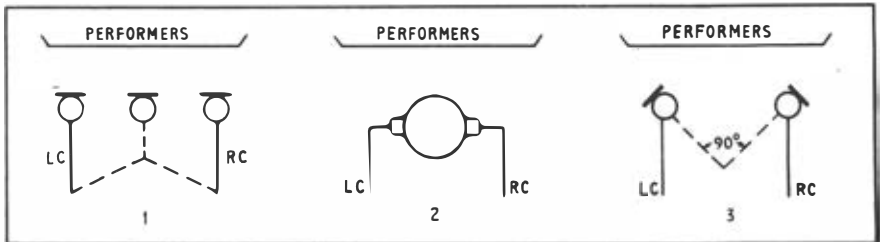
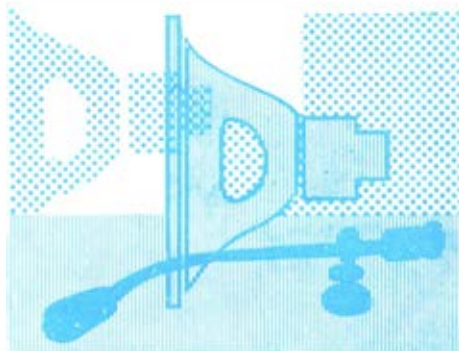

Fig. 3:2. Left and right microphones may be augmented by a third (1), used on a dummy head (2), or angled as a "coincident pair" (3).

CHAPTER FOUR

THE BASIC REQUIREMENTS



The positive and immediate gain in listening pleasure from stereo reproduction, as compared with mono of equivalent standard, has of course to be paid for in both cash and space: but fortunately those who live in small rooms, and who thus have to make the greatest sacrifices to install stereo equipment, need not fear that they will not reap the full benefit. First class stereo in a small room is difficult, but first class mono is almost impossible. It would be absurd to suggest that going over to stereo solves all the problems, but if the equipment is carefully chosen (which ideally involves listening to it in the room in which it will be used—see *Chapter Eight*) the improvement is almost spectacular.

There is a popular heresy, conceived by salesmen and born at demonstrations, that high quality reproduction must be of shattering volume in order to make its full impact, so that the impact is almost physical! The idea is now dying, but too slowly. There are still people who believe, honestly and sincerely but quite wrongly, that the dual amplifiers and speakers required for stereo will necessarily make more noise than one of each, just as there are people who would not consider a 20 watt amplifier because they think it would make twice as much noise as a 10 watt model, whereas in fact an amplifier of about 100 watts rating would be required to do this. In stereo, because the apparent sound source is spread, and because the use of a second speaker tends to break up room resonances, a given sound output seems less loud. It is the ordinary person who wishes to listen to music in a room of ordinary size who will benefit most of all from installing stereo.

Before going further, an emphatic word of warning must be given, lest anyone may think that there is some magic about stereo, and is tempted to sell good mono apparatus cheaply because he quails at the thought, and

A SELECTION OF AMPLIFIERS



Armstrong A20 power amp.



Radford SC2 control unit



Derritron 306 integrated



Clarke & Smith Model 655

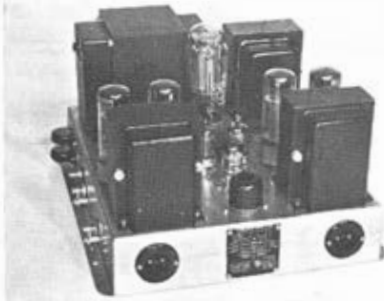

Lowther LL15S amplifier



Rogers RD Cadet II control unit



Leak Varislope control unit

the cost, of duplicating it. In *Chapter Nine* we shall consider the problems of converting existing equipment for stereo reproduction, but here and now it must be made clear that the advantages and increased listening pleasures which stereo brings will *not* be better than mono from one channel of high quality unless the second channel is of equal excellence. If you are buying new equipment for stereo, it must be at least as good as, and preferably better than, the mono equipment which it replaces; if you install a second channel for stereo, it must measure up in quality to the existing one.

The basic essentials for stereo reproduction are two amplifiers and two loudspeakers (preferably, but not essentially, identical), to which will be added a stereo disc player, a tape machine with stereo playback facilities, or a complete stereo recorder, or both, according to individual requirements. These items will be discussed in the chapters on *Stereo from Disc* and *Stereo from Tape* respectively. Eventually, we shall be able to add a stereo radio unit instead of, or in addition to, stereo disc and tape playing equipment, but in this chapter we are concerned only with the indispensable items in any stereo set-up—the amplifiers and the loudspeakers.

Stereo Amplifiers

The amplifier lies in the centre of the reproducing chain, and during the past twenty years it has attained a greater degree of perfection than any other component, so that today there are probably about thirty models of these instruments available, made in this country, which will handle uniformly a range of sounds, in the form of electrical impulses, and which introduce no more than a few parts in a thousand of distortion in the process of building up the tiny signals from pickup, tape or radio to a level at which they will drive loudspeakers.

In every amplifier useful for stereo there are two sections: the pre-amplifier or control unit and the main, or power amplifier. Sometimes these are put together on one chassis; more usually the two sections are separate. There are three possible stereo amplifier arrangements:—

- (a) Two completely separate amplifiers and control units. This is inconvenient, and not usually recommended, though it may save money in some instances. See *Chapter Nine*, “*Converting to Stereo*”.
- (b) A stereo control unit and two separate main amplifiers—3 chassis.
- (c) A stereo control unit and stereo main amplifier. This usually shows some saving in cost over (b), as only one power supply section is required. 1 or 2 chassis.

A stereo control unit or pre-amplifier is actually two units mounted together in each case. Sometimes separate controls for each channel are employed in the pre-amplifier; more often the controls are ganged. Whatever the arrangement, it does not affect the quality obtainable, given good design, and the choice is purely one of personal preference.

For a normal living room of about 1,800 to 2,000 cu ft, and with speakers of average efficiency, a stereo amplifier in any of the above forms, providing an output of 5 watts per channel will prove adequate. Less, in a room of this

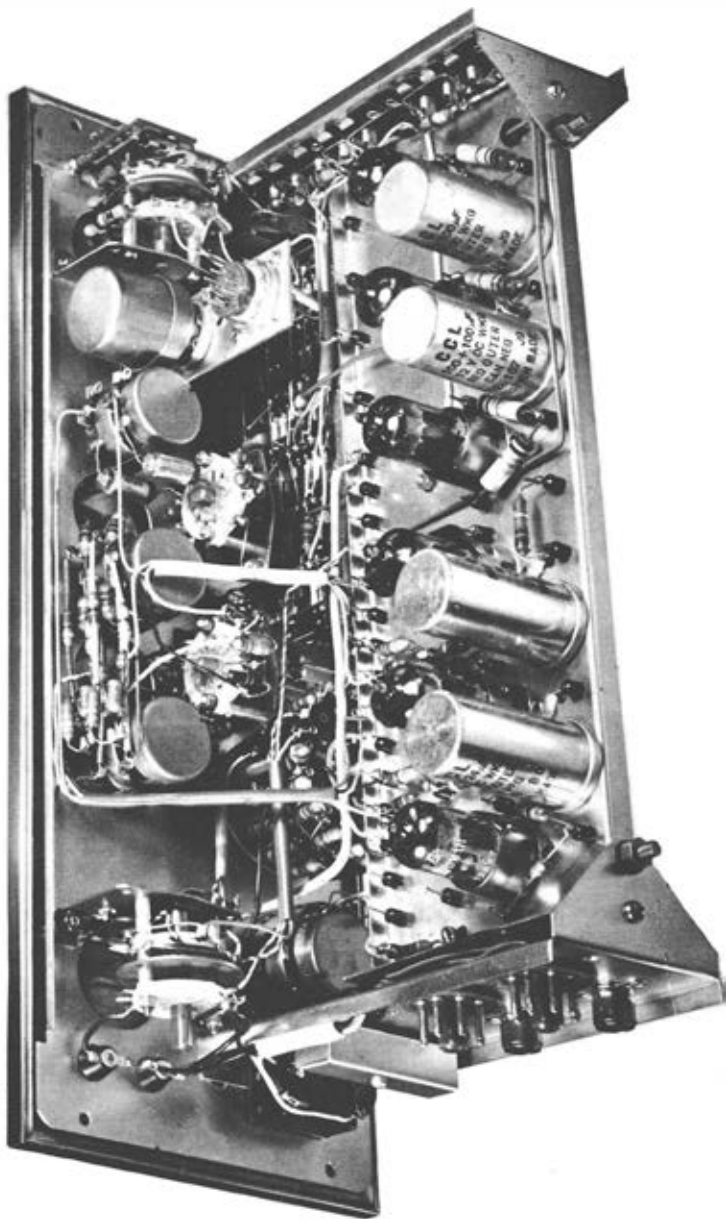

Rogers Master Stereo Control Unit with cover removed

size, is sailing rather near the wind, especially if the owner is fond of realistic organ reproduction, or such works as Walton's *Balshazzar's Feast*, Verdi's *Requiem*, Wagner's *Ring*, or other music on an heroic scale. In larger rooms, 10 watts per channel should be regarded as the minimum, and 15 watts per channel may be desirable.

All reliable manufacturers publish performance specifications of their amplifiers. The following should be regarded as essential *minimum* requirements: Frequency response, 40 c s to 15 Kc s, plus or minus 2 dB. Total distortion, not exceeding 0.2%, at 1 Kc s. Hum and noise, at least 60 dB down on full output. The universal application of negative feedback has made the attainment of such standards a simple matter.

It should look good, too

See whether the maker has anything to say in his specification about distortion below 100 c s. Have a good organ recording played at full volume, and listen carefully for any nasty noises. Satisfy yourself that the amplifier is more than just sufficiently sensitive to give full output from a tape pre-amplifier or the low level output from a recorder; see that these, as well as the pickup, will match the amplifier inputs in level and impedance. Don't be afraid to ask questions, unless you know exactly what you are looking for, and don't allow yourself to be put off by evasive answers. See that the layout inside and out is neat and clean, especially the wiring, and that the finish is good. Look particularly at the output transformers; they should not be much smaller than large oranges.

Versatility is important. The control unit should have stereo inputs for gramophone pickup, tape, and radio, and also tape output sockets for future stereo recording from radio. The following controls are desirable: *Selector switch* (or push buttons) for different inputs; *volume* and *balance* controls, mono/stereo switch, separate and independent *bass* and *treble* controls giving both lift and cut, *rumble filter*, either permanently operative or switchable, and a *low-pass filter* operating at two or three different frequencies.

Filters

The question of filters is important. Because a stereo pickup is sensitive to vertical as well as lateral vibrations, motor rumble is a more serious menace to stereo than to mono reproduction, especially if the speakers to be used have a good bass response. A very steep cutting high-pass filter, known as a rumble filter, should be regarded as essential in a stereo amplifier, for no loudspeaker can reproduce good, clean, hard bass and rumble at the same time, even though the rumble may be overlaid by the music.

The function of the variable *low-pass* filter is to allow the *bass* and *treble* controls to be used for their proper purpose: to compensate for differences in loudspeakers and listening rooms, and to permit a fairly permanent setting of these controls for correct musical balance. Distortion in any of the sound sources which the amplifier will be called upon to deal with is likely to be

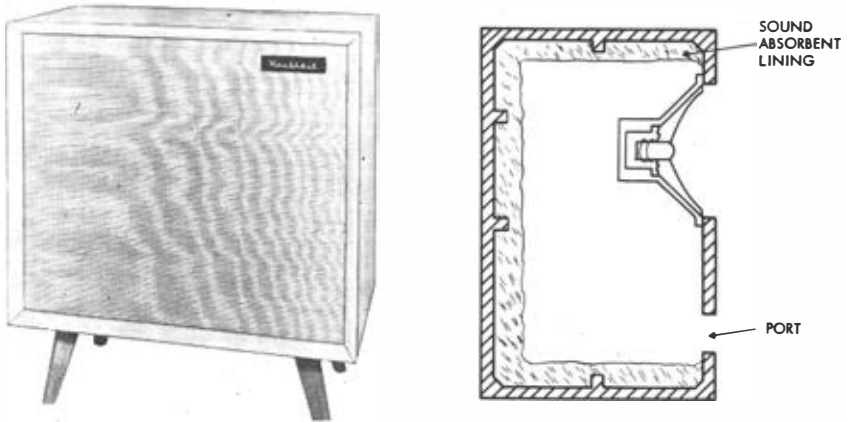

Fig. 4:1 (left) shows the Heathkit Cotswold speaker. On the right (fig. 4:2) is a cross-section of a reflex enclosure.

most prevalent and most unpleasant at high frequencies; and when it is present it is likely to increase rapidly with an upward extension of the range.

The variable low-pass filter enables the extreme treble response to be reduced, or "rolled off", thus reducing or eliminating irritating distortion with minimum effect on the actual musical range. If the treble control has to be used for this purpose, not only is its proper function disturbed, but the cut starts too low in the scale, is not sharp enough, and before it can be reasonably effective in removing any distortion which may be present, all the life has been taken from the music. The same remark applies, with even greater emphasis, to the use of the *bass* control for the curtailment of motor rumble. The *balance* control should provide a maximum of not less than 6 dB difference in level between the channels.

The fact that versatility and flexibility are essential in a good stereo control unit does not mean that it need be large, or possess a front panel resembling the cockpit of an aeroplane. Don't fall too easily for the unit with the largest array of knobs. The less you play with the controls when listening, the more pleasure you are likely to get; the greater the number of knobs the greater will be the temptation to twiddle them. In particular, once bass and treble controls have been adjusted to suit your room and loudspeakers, it should seldom be necessary to touch them except to provide additional compensation for occasional over-brilliant or bass-less recordings.

Finally, choose an amplifier produced by a maker of established reputation. If you are uncertain, seek unbiased and responsible advice from an experienced friend or the technical advice service of one of the journals devoted to sound reproduction.

Loudspeakers are very personal things. It is possible to state, scientifically, a specification for a tape machine, amplifier, pickup or motor with certainty that any instrument which fulfils that specification will produce results satisfactory to anyone. No such thing is yet possible with a loudspeaker. We can discover and even measure the faults in a speaker; we can specify the

desirable qualities. Our difficulty lies in estimating—for we cannot measure—their relative importance: like a child who can recognise numbers but not evaluate them. All loudspeakers add to, and subtract from the signals which they receive, not merely in quantitative terms, but so that the character of the resulting sound is changed: further, the extent to which they do this is dependent not only on the units themselves, but also on the way they are mounted, the room in which they are used and their position in that room. No two pairs of human ears are alike, and no two different loudspeakers sound alike to the same person. The matter is complex, and the necessity to use two loudspeakers for stereo does nothing to simplify the problems, even though it improves the final result.

You choose a loudspeaker for yourself, and often one man's meat is another man's poison in this respect. It might be supposed that, since all loudspeakers add some colouration of their own to the sounds which they reproduce, the loudspeaker which adds the least—which is itself nearly colourless—would be the best: and some of us think that this is in fact true, other things being equal. But if, for example, an electrostatic speaker has been chosen as the ideal, and some people complain that the result is "cold", who shall say that they are wrong? The most anyone can say is that he does not agree, or perhaps that he does not like hot music! In the final analysis, every listener is left with the verdict of his own ears, but comparing one loudspeaker with another is a risky practice which should not be carried too far. Every loudspeaker should be compared, as far as memory permits, with live sound in the concert hall or the home; and memory should be kept as fresh as possible by regular experience.

At this point it is perhaps as well to make clear that the word "loudspeaker" is loosely used to cover everything from an apple-sized "tweeter" for the

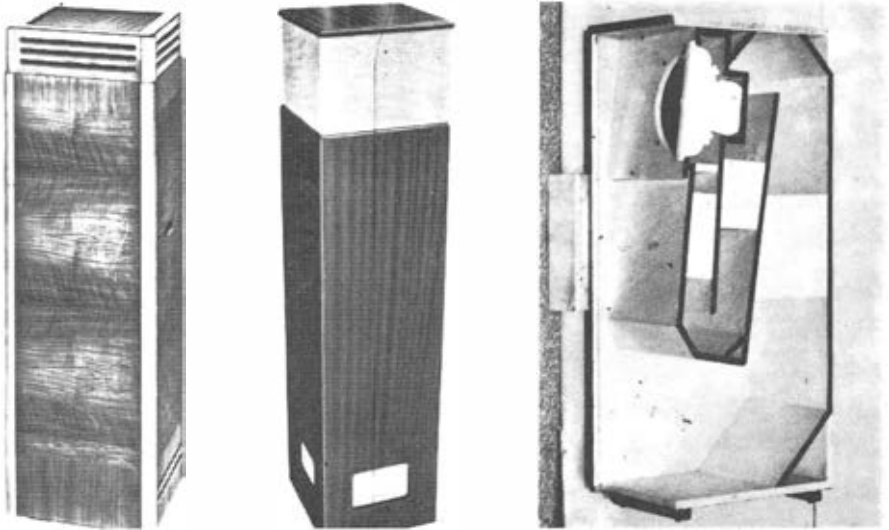
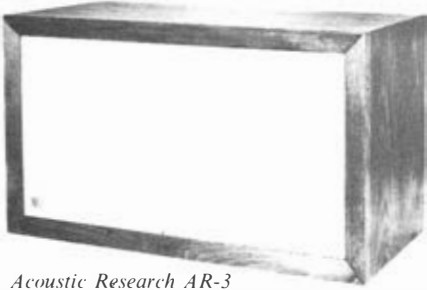
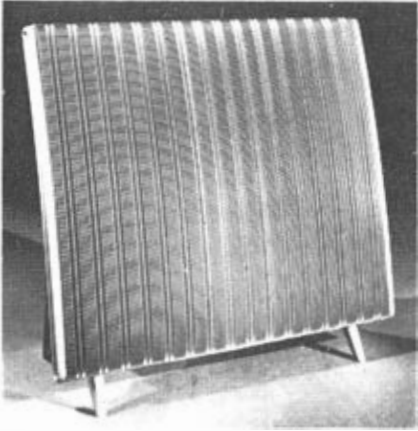

Fig. 4:3 (left) shows typical column speakers. Fig. 4:4 (right) is cutaway version of Lowther Acousta.

A SELECTION OF SPEAKERS



Acoustic Research AR-3



Quad Electrostatic.

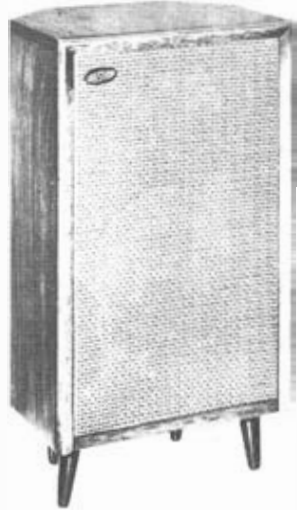

Rola Celestion Colaudio 11

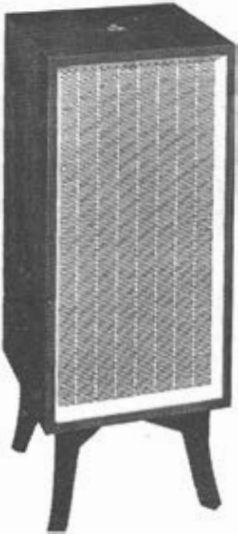

Clarke & Smith 519 infinite baffle.

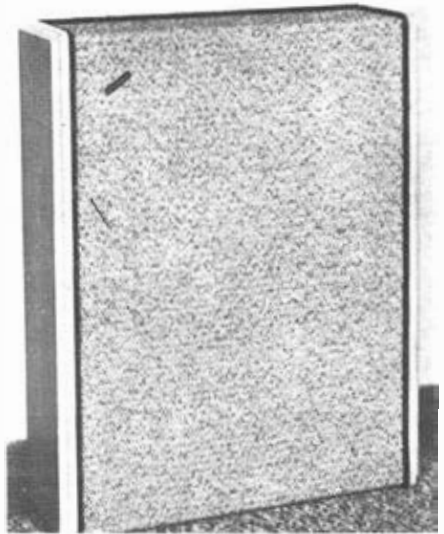

Wharfedale Slimline 2

higher frequencies only to a large cabinet containing a "woofers" or bass unit the size of a dinner plate, one or more "tweeters" and a unit for the middle range as well. Since no loudspeaker can function properly without some form of mounting (box, baffle or horn), the word should properly be used only for the complete article, and it will therefore be so used in this book, and the actual generators will be referred to as speaker or loudspeaker "units".

One last point before we begin to discuss the various types and arrangements of loudspeakers available for stereo reproduction. Where tape machines, motors, pickups or amplifiers are concerned, increased price nearly always indicates a generally accepted improvement in quality. This is by no means true of loudspeakers, once the realm of the obviously "cheap and nasty" has been left behind. Nevertheless, it would be stupid to suppose that the range and general level of quality of speakers costing £20 each is as high as that of speakers costing, say, £50 each.

Speaker Space

Stereo has solved some problems in domestic sound reproduction, but it has also created some; and, leaving financial considerations aside for the moment, the chief of these problems created by the introduction of stereo into our homes is the problem of space for loudspeakers. A stereo tape machine or playing desk takes up no more room than a mono one; a stereo amplifier requires very little more; but two loudspeakers take up a good deal more room than one!

In stereo recording, considerable care is taken to keep the two channels as nearly identical as possible, in all respects other than the actual information which they carry, and it is therefore clearly desirable, (though we do not pretend that it is essential) that the reproducing channels should also be as nearly alike as possible, so that, *ideally*, our stereo loudspeakers should be a pair, thus taking up just twice as much of our valuable room space as a single one. This has led to a perfectly understandable demand for small speakers, and also to another demand, equally understandable but less easy to meet, that these small speakers shall produce the same effects as much larger ones.

Speaker Boxes

All readers will, I hope, appreciate that speaker units have to be mounted in some way—not just to make them more presentable to the eye, but also to the ear, to avoid cancellation of the sound waves in the bass. At the treble end, the physical size of the speaker unit itself would be sufficient to accomplish this, but at the low end of the scale help is unfortunately needed—unfortunate because the baffles, boxes and horns which we have to employ for this purpose cost money, and they vitiate rather than improve the inherent quality of the resulting sound. However, necessity being the mother of invention, some extremely ingenious methods of mounting have been devised, and recent improvements in speaker unit design have made it possible to produce results from small cabinets which would have been impossible a few years ago. However, it is still as true in the world of loudspeakers as it is in the boxing

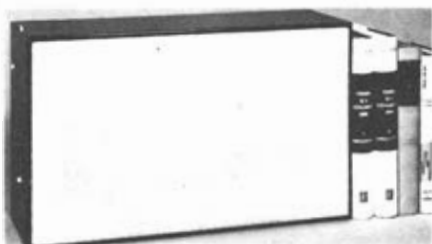

KEF Celeste

A SELECTION OF SPEAKERS



Delius 12 Reflex

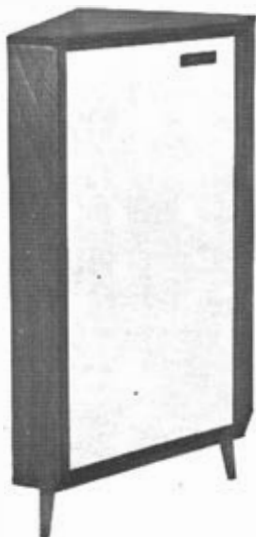

Tannoy Chatsworth 11



Lowther Audiovector

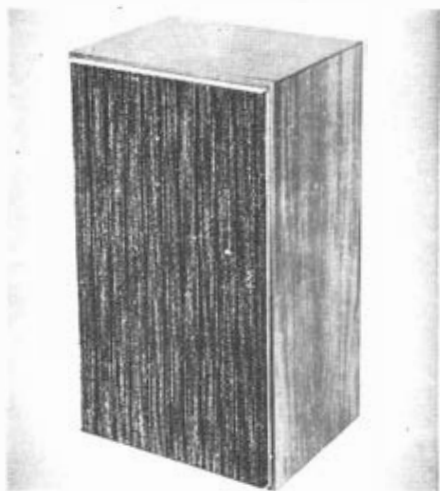

Leak Sandwich.

ring (and likely to remain so) that “a good big ‘un will always beat a good little ‘un”, so, *if you have the space in your room*, you will almost invariably improve your results by using larger loudspeakers. Notice that I say “loudspeakers” *not* loudspeaker units.

One thing to avoid is the attempt to get a heavy deep bass response in a small room, even in stereo, though the effect is worse in mono reproduction. The lowest note which can be properly reproduced in any enclosed space is one which has a wavelength not exceeding twice the longest dimension of the room, and if the response of the equipment is maintained at a high level below this point, all that will result is an unpleasant muddled booming noise, as a result of the resonances of the space itself being strongly excited; so in small rooms it is best to allow the bass to fade away gently below 50–70 c/s. Fortunately this means that, in general, small loudspeakers are the best for small rooms.

Classifications

Loudspeakers are often described or classified according to the methods of loading or mounting employed: *horn loaded*, *reflex* or *vented* cabinet, *labyrinth*, *baffle* or *doublet*, and *infinite baffle* are the usual type names employed. The drive units are either cone type or electrostatic; of the latter only three models are on the British market at present (1962): the *Quad* full range model and the *Audistatic* and *Woollet* tweeters; all of these are doublets and each is excellent within its respective field, with certain provisos which will be mentioned later.

Detailed discussion of the differences in design and construction of the various types of mounting is outside the scope of this book. Interested readers are referred to our forthcoming book, “*Speakers for Beginners*”, and to Mr G. A. Briggs’s books “*Loudspeakers*” and “*Cabinet Construction*”, where full information will be found, together with a selection of suitable designs for those who wish to construct their own cabinets at a considerable saving in cost. Most of the leading speaker unit makers, including *Goodmans Industries Ltd.*, *Axiom Works*, *Wembley*, *Middlesex*, and *Wharfedale Wireless Works*, *Bradford Road*, *Idle*, *Bradford*, *Yorkshire*, will supply constructional drawings free of charge for various types of cabinets suitable for their units, and readers who have the skill and the urge to “do it themselves” are advised, if they have decided on speaker units, to stick to the cabinet designs given by the makers of those units. If they have decided on a cabinet design they should also use only the speaker units specified for it, otherwise results can easily be disappointing.

Decreasing Cabinet Size

A couple of years ago, reflex cabinets were easily the most popular form of speaker housing; they are still probably the most popular but not by nearly so great a margin, because cabinets of small size are in ever-increasing demand, and with the development of special drive units, the “*infinite baffle*” (which is simply a totally enclosed box without a vent, with the

interior suitably damped with sound absorbing material) is being increasingly used. Speakers of this type, properly designed, give very satisfactory results; better results, in fact, when restricted to cabinets of 2 cu ft or under, than can be obtained by any other form of loading. One of the best examples of this type, in a rather larger box, at a very reasonable price, is the *Heathkit "Cotswold"* (Fig. 4:1).

Reflex cabinets are inexpensive, simple to construct and efficient, provided that in the smaller sizes up to about 5 cu ft with which we are mainly concerned they match the speaker units to be used in them. Under these conditions, given the necessary room dimensions, they provide rather better and more extended bass per £1 cost of speaker unit plus cabinet than any other type (Fig. 4:2).

A special form of vented cabinet, becoming increasingly popular because it occupies only about 1 sq ft of floor space is the column (Fig. 4:3). These speakers need careful design, with special attention paid to damping, in order to avoid unpleasant resonances in reproduction; and since the speaker unit is mounted horizontally, facing upwards, a diffuser is necessary to prevent the high frequencies being squirted up at the ceiling. The best results from these enclosures are secured from 8 in. or 10 in. drive units, especially those designed to be used in a horizontal position, such as the *Wharfedale "Column 8"*. They are particularly good in smaller rooms, where the volume level does not need to be very high, providing a general sense of spaciousness at the cost of some loss of accuracy of location in stereo.

Horn loaded speakers are very efficient, but neither easy nor cheap to make. Loudspeakers of this type work best with drive units designed specially

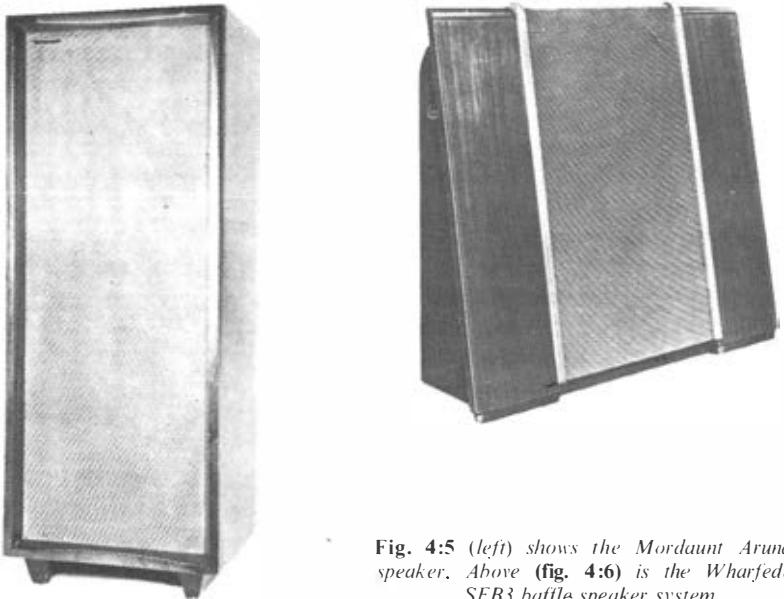

Fig. 4:5 (left) shows the *Mordaunt Arundel* speaker. Above (fig. 4:6) is the *Wharfedale SFB3* baffle speaker system.

for them, and when the horn loading is applied to the front of the cone, generally need the addition of some other method of loading, such as a vented chamber at the rear, to provide good bass response. This is because the length of horn required cannot possibly be accommodated in a cabinet of reasonable size, however it is folded—and the folding of horns itself introduces problems if the quality of reproduction is not to be impaired. Speakers of this type are usually designed to occupy a corner position, utilising the walls to extend the horn, and taking advantage of the fact that such a position improves bass response. The first example (and some people still think the best) was the famous *Voigt Domestic Corner Horn*. Voigt's work has been continued by Mr D. M. Chave of the Lowther Manufacturing Company, at Bromley, who has introduced units of remarkable efficiency housed in smaller cabinets of modern design (**Fig. 4:4**).

The "Spherisomic"

Some designers have applied horn loading to the rear of the cone instead of the front. The Watts "*Spherisomic*" was of this type; so was the *Decca Corner Horn*. The "Spherisomic" radiated in all directions, as the name suggests, the units being mounted horizontally. The Decca faced into, not out of, a corner, sound being reflected from the walls into the room. Unfortunately, neither of these speakers is now in production, but drawings and instructions for building the corner horn have appeared in "*Hi-Fi News*" (March 1959 p. 724, January 1961 p. 570).

In other famous loudspeakers such as the G.R. Fountain "*Autograph*" and the Lowther "*T.P.I.*", horn loading is applied to both front *and* rear of the cone; in yet others, the *Westrex*, the *Acoustical Corner Ribbon* (no longer available) and the Mordaunt "*Arundel*"—a most elegant modern example—(**Fig. 4:5**) separate units have been combined in one enclosure, using horn loading for treble and reflex loading for bass. The *Klipshorn* uses separate units with a folded double channel horn for bass and a separate horn for the treble unit. Horn loading for the higher frequencies has much to commend it; a better "tweeter" than the *Kelly Ribbon* would indeed be hard to find, and when horn loaded treble is combined with carefully designed reflex loading for bass, one is getting near to having the best of both worlds.

The labyrinth is a type of enclosure in which the speaker unit is loaded by a long pipe (a quarter of the wavelength of the resonant frequency of the speaker) lined with sound absorbing material. Cabinets of this type give good performance-to-size ratio, but are not as economical in material and cost as the reflex, nor so easy to make. The labyrinth needs careful calculation and construction, or response will not be even through the range. For these reasons, comparatively few labyrinth loudspeakers are available.

Fundamental Resonance

All loudspeaker units have a fundamental resonance in free air. Enclosing them, totally or partially, in any way, alters this resonance (which is often an excellent thing) and also introduces other resonances—of the enclosed air

and sometimes of the box itself. This is not so good, but it is the price which we have to pay for good bass response.

The only way to avoid these resonances is to have no box to contain resonating air, or to resonate itself; this can be accomplished by mounting the speaker units on a flat board known as a baffle. We have already noted that, under such conditions, there will be a rapid fall in bass response below a frequency determined by the size of the baffle board. For full radiation down to 50 c/s, baffles approximately 11 ft square would be required; rather larger than most people can house with comfort!

The Infinite Baffle

It should be noted in passing that the best form of baffle mounting is the true infinite baffle, obtained by fixing the speaker units in holes cut in the walls of a room. Apart from those specially designed for horn loading, any speaker unit will give its best when treated in this way, at the cost of about half its power, since all the radiation from the rear of the cone is lost. Even if we are prepared to accept this loss, the method has certain other obvious disadvantages, especially for stereo when we may wish to alter the spacing and angle of the speakers; also, the rear radiation will make its presence fully felt in the adjoining rooms, which can be a nuisance in mono, and positively disconcerting in stereo when such radiation will consist of one channel only in each room!

Practical finite baffle speakers have been designed, and are obtainable, using two or three units on one baffle. The *Wharfedale SFB 3* is the leading example (Fig. 4:6). Speakers of this type are very sensitive to position in the listening room, and should not be placed close to walls, although a corner position will excite maximum room resonances with apparent increase in bass response. If they are kept away from walls—taking up more room space—these speakers, which operate as “doublets” (that is radiating backwards and forwards equally, but not radiating edgeways) excite a minimum of room resonance. The electrostatic speakers at present available are special examples of this type. In general they are not at their best in stereo in ordinary rooms since it is very difficult to keep them far enough away from reflecting surfaces (3–4 ft) to avoid confusion from the reflected sound or, as an alternative if this cannot be done, to arrange heavy sound absorbing drapery over these reflectors.

Electrostatic speakers have desirable qualities not possessed in the same degree by cone driven models, and we may look with the greatest possible interest towards the day when we shall have available a full-range electrostatic speaker suitably loaded at the rear of the diaphragm, and so shaped as to occupy less floor space and present a more suitable polar characteristic for stereo reproduction, so that the fullest advantage may be taken of its inherent qualities of low distortion and superb transient response.

A few general observations on the characteristics of amplifiers and loudspeakers have been offered in this chapter with a view to providing some

guidance in the whole field of choice through which intending purchasers are now invited to walk. It remains to add that questions of positioning and arrangement will be dealt with in *Chapter Eight*—"Buying and Installing Stereo Equipment"—and to make it abundantly clear that the "snags" in all types of loudspeakers are fully appreciated by their designers. These experts have bent their best efforts towards overcoming them, so that no purchaser need fear that he will not get satisfactory results from any of the types detailed above, provided that he understands its individual qualities, and that he has satisfied himself that the kind of reproduction which it provides is the kind which he wants.

Pontifical pronouncements are occasionally made about loudspeakers for stereo: they must be directional, or they must not: they must be arranged in certain specified positions relative to the listeners and each other, etc. It is respectfully suggested that any such statements be disregarded. Experience has convinced the writer that there are no definite rules of this kind, and that all which may safely be said by way of guidance is that, under normal domestic conditions, speakers should be from 6 to 12 ft apart, that the maximum stereo information will be received by a listener at a similar distance from each speaker, and that directional speakers provide more precise sound source location. Readers will find some discussion of possible speaker arrangements in *Chapter Ten*, "Listening to Stereo".

"There ain't no sich animal" (as the old lady said on being shown a rhinoceros for the first time) as the "best" speaker for stereo, or for mono either. The choice of a loudspeaker to live with for a number of years has never been an easy matter, and is inextricably bound up with the tastes, ears, environment and pocket of the listener. The best loudspeakers for you are those which make the easiest compromise with these conflicting demands.

Three-Speaker Systems

So far, we have been thinking in terms of pairs of loudspeakers, but as we shall see in *Chapter Eight*, "Converting to Stereo", it is not *essential* to use identical speakers, although it is desirable to do so; and since most of the directional information in stereo comes from the higher frequencies, a three-speaker system employing a common bass unit and two separate treble speakers, one on either side, handling the separate channels above about 400 c/s is sometimes used.

Perhaps the most important decision to be made about loudspeakers for stereo is whether they shall be direct radiators, or reflectors of the sound, like columns. The only satisfactory way to make this decision is to listen, preferably in your own room, to a pair of each type reproducing a variety of sounds. Many good dealers are prepared to arrange this sort of trial, or you may be able to borrow speakers from friends—or, as a second best, listen to pairs of each type in their homes. If all else fails, you will have to rely on a showroom demonstration, to which we shall refer in *Chapter Eight*.

The reflecting type of speaker provides very easy, untiring listening, together with a sort of open air, ethereal quality, a sense of spaciousness,

which many people find very attractive. Stereo coverage is good, but location is less precise than with direct radiators. In many cases, direct radiators can be positioned to work as reflectors if the user prefers the effect, but one of the advantages of columns is that the higher frequencies are projected into the room from the walls at a height well above the level of absorbing furniture, which is not always the case with other designs.

Directional speakers give an effect of greater immediacy, better location over a rather more restricted field, and a more forward effect, as from a seat rather nearer to the performers, at the same volume level.

Use Speech for Guidance

When choosing speakers, listen to speech, using a direct microphone transmission of the voice of someone you know, or the BBC VHF service, or such a record as Col. 33SX 1043 (Gerald Moore) or Caedmon TCE 103 (Beatrice Lilley, Cyril Ritchard and Stanley Holloway). Speech, especially male speech, quickly shows up coloration of the lower middle register, and it also reveals any tendency for the speaker to boom, together with excessive sibilance; but it must always be remembered that this latter defect is to some extent controlled by the position of the person who is talking, in relation to the microphone. If he is too close, any speaker worth having will produce excessive sibilance, especially with amplifier controls set for flat response, as they should be when making loudspeaker tests.

Live with them if possible

When music is reproduced, let it be music; and if possible let it be from records on tape or disc, which you know well, and don't be carried away by excessive "brilliance", or what may be described as "impressive" sound; it soon becomes tiring, even in stereo, which causes less listening fatigue than mono. Hence the importance of having speakers in your home for an extended period of listening. Listen for balance throughout the range. Deep bass, middle and high top should all be there in proper proportion, but don't blame the loudspeaker for not reproducing bass or treble properly if there is little or none of one or the other in the score at that particular point. That is one reason why it is important to listen to music which you know. If you notice bass or treble without consciously listening for it, there is almost certainly too much of it. Listen for clarity and crispness, for separation of groups and individual instruments; above all listen for what seems to you to be a *natural* quality of sound. Try the effect of standing up, sitting down and moving around while the speakers are in operation, and bear in mind that, while your friends may want to listen to your new loudspeakers, you will not want to do so, at least after the first week or two. You will want to listen only to the music.

CHAPTER FIVE

STEREO FROM DISCS

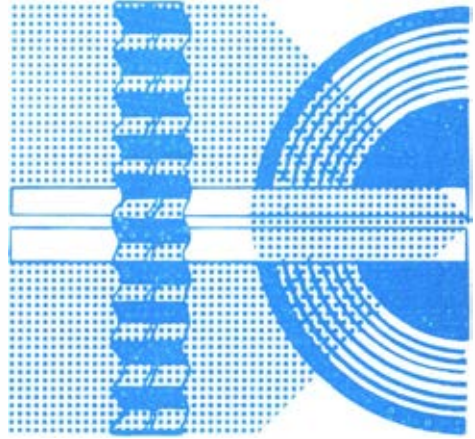

Gramophone records are the simplest and least expensive source of a wide range of stereo sound of high quality, and this position is unlikely to change until the advent of a full service of stereophonic radio transmissions. In this chapter, we shall consider how a stereo disc "works", and the particular pieces of equipment that are needed to reproduce sound from it, in addition to the basic apparatus for the reproduction of any stereo sound source which was discussed in the last chapter. We shall also have something to say about the care of discs, which applies equally to mono records.

Rather more than eighty years ago Thomas Edison made his earliest recordings on wax cylinders using "hill and dale" cut which, as the name implies, required the reproducing point to respond in a vertical plane. A few years later, Berliner made disc records using a lateral cut, which required a sideways movement from the reproducing stylus. The evolution of the stereo disc was made possible by the combination of these two different cuts in one instrument (known as the cutter head) and their tracing by a single reproducing stylus in a suitable pickup, an idea which seems first to have occurred to V. H. Emerson in America in 1921, and to have been first applied by another American, W. Bartlett Jones, to recording for binaural listening by means of headphones. Peter Ford, perhaps our foremost authority on the history of sound reproduction, tells us that "Jones was the first to propose complex cut discs in which the vertical and lateral modulation of the groove is carried out by a single cutter and reproduced by a single pickup (US Patents Nos. 1,855,149 and 1,855,150)". This work was brought to fruition by the creation of a complete and practical system of stereo recording and reproduction, using discs and loudspeakers with a cutter head and pickup of his own design, by A. D. Blümlein, as noted in our first chapter.

For an account of the more recent history of stereo discs we are indebted to Arthur Haddy of The Decca Record Co., Ltd., who tells us that, after the

1939 45 war, Decca produced a system of stereo recording using for the second channel a "carrier" of very high frequency (beyond the range of our hearing), superimposed on the ordinary recorded signal. The apparatus required was complex, but the system worked very well. So far as we are concerned, perhaps its greatest value in practice was that it required a cutter head (designed by Mr Haddy) which would record up to 30 kc/s, and a pickup of similar range. He further explains that Decca's associate company in Germany, *Teldec*, had, with the aid of feed-back applied to the cutter head, produced a workable system combining *hill-and-dale* and *lateral* cuts in one groove. Sir Edward Lewis, Chairman of Decca, decided that in the public interest future developments must be along these lines rather than along those of the carrier system; so Decca's subsequent experiments were carried out in this way.

Forty-five/forty-five

At about this time Arthur Haddy became aware that the Westrex Company in America were working on a system known by the awkward name of "forty-five/forty-five" (written 45/45). In *hill-and-dale/lateral* cutting, each signal is at an angle of ninety degrees to the other, one in the plane of the record surface, the other at ninety degrees to it. In the 45/45 system, each signal remains at ninety degrees to the other, but at forty-five degrees to the record surface, so that each signal is cut on *one wall* of the groove.

Mr Haddy and his colleagues feared chaos in the record industry, with British stereo discs unplayable in America, and vice versa; so Sir Edward

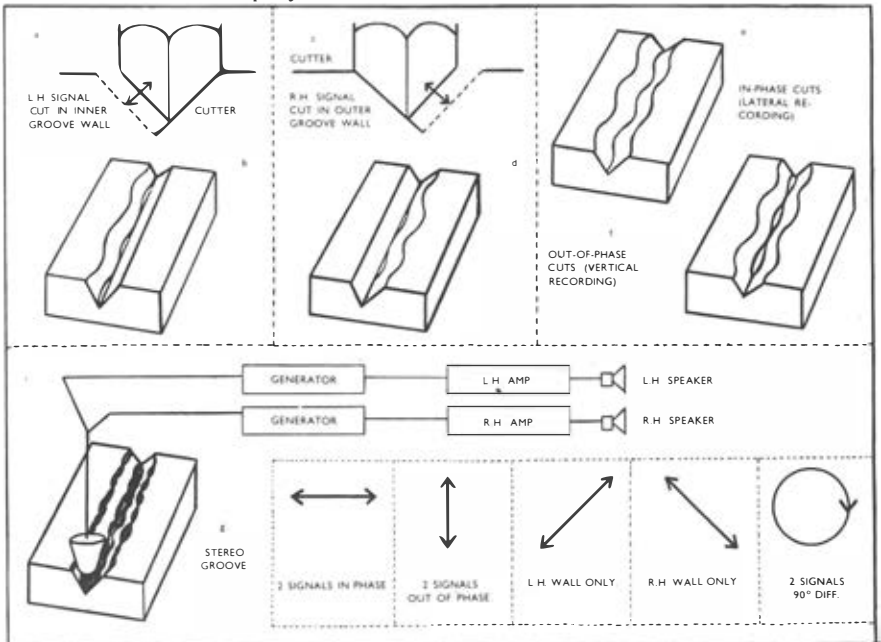

Fig. 5:1. The relationships between the two signals and modulations on the groove walls is depicted here.

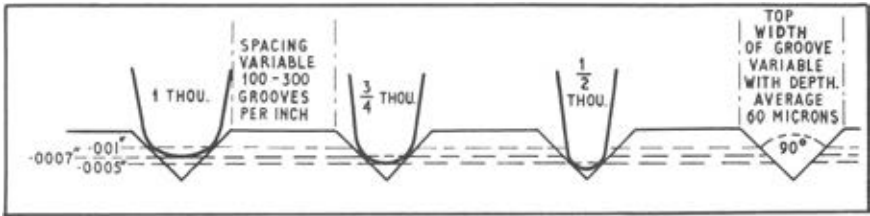

Fig. 5:2. This shows how various size stylus tips sit in the record groove. The $\frac{1}{2}$ -thou radius is best for stereo, but it may "bottom" in some badly shaped grooves.

Lewis decided that they should visit America and discuss matters with Westrex. This was done. Decca explained their fears, and each side demonstrated its system to the other with success, though the Decca pickup proved to be much better than American models. Subsequently, meetings of the leading gramophone companies were called in Europe and America, and to the surprise of many people it was learned that Decca were quite prepared to go over to the 45/45 system. Whatever the reasons, the results must speak for themselves, and today "45/45" is the international standard to which all stereo discs are made. So the thing which still looks to many people like a miracle (and, what is more important, *sounds* like one) was accomplished, and the leading question: "How can you get two separate signals from one groove with one stylus?" was answered practically. A study of fig. 5:1 will explain graphically how this is done.

All that is required to reproduce sound from a stereo disc, in addition to the amplifiers and loudspeakers, is a stereo record playing desk, which consists of a motor, turntable and stereo pickup. A "record player" is not needed. This term is used for a complete, portable piece of equipment, stereo or mono, consisting of motor, pickup, amplifier, control unit and speaker units all housed in one box. This is useful for certain limited applications, particularly for mono records, but cannot in the nature of things provide really high quality reproduction. In stereo such instruments often produce results which are a mere travesty of the effect which stereo discs should yield.

Cutters and Pickups

The makers of stereo discs found that the cutter head was the most troublesome item to perfect. When replaying discs the counterpart of the cutter head is the pickup, and so there is obviously a very definite link between the manufacturer's cutter problems and the problems that the disc buyer may discover. Normal mono L.P. discs were designed to be played by a stylus of 0.001 in. tip radius, shown resting in a groove in the diagram fig. 5:2. The complexity of a stereo groove makes it necessary to use a smaller stylus, the correct size being 0.0005 in. tip radius. The tip *area* is therefore a quarter of that of the mono stylus, and the equivalent pressure on the disc is thus four times as great.

From this it can be seen immediately that a reduction in playing weight is called for, as well as the provision of vertical compliance and an additional element for the reproduction of the second channel. But unfortunately,

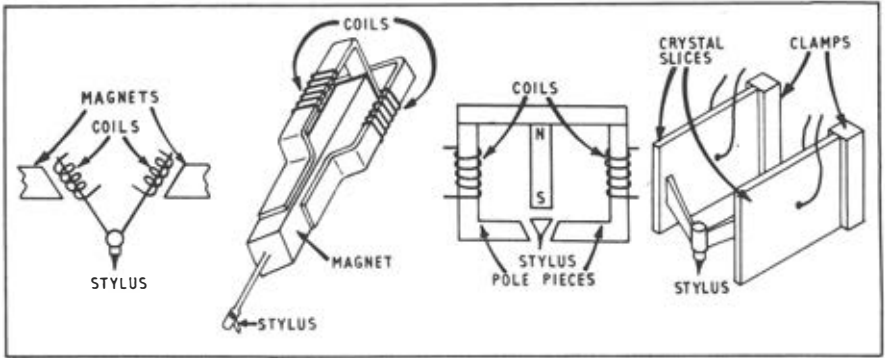

The four basic types of pickup are (left to right) moving coil, moving magnet, moving iron and crystal ceramic. The first is rare, the middle two fairly common and the last very common.

because of differing cutter heads, not all stereo grooves have been of the correct size and shape, and difficulties have been encountered in the use of the 0.0005 in. stylus. This fact, and the desire for a *compatible* stylus—one which would enable both mono and stereo discs to be played with the same pickup—led to the adoption by some pickup makers (in the USA by almost all of them) of a compromise stylus—one of a size between the correct sizes for mono and stereo—namely, 0.0007 in. radius. Such a point gives improved results from discs in which the groove shape is incorrect, and gives excellent reproduction of new mono records, but when using good stereo records on wide range equipment the loss of top response and the increased distortion due to the larger stylus are immediately noticeable, and the 0.0005 in. stylus is clearly superior. Fortunately, almost all British records now have grooves of the proper size and shape, which yield their best when reproduced with a “half thou” (0.0005 in.) point. It is mandatory that the stereo stylus, whatever its size, should be a diamond of high quality if records are to be preserved in good playing condition indefinitely.

The Factors of Perfection

A perfect pickup, mono or stereo, has yet to be produced; probably such an instrument will never be made. To qualify for consideration in such a category, a stereo pickup would need to possess the following qualities:

1. Response 20 to 20,000 c/s, plus or minus 1 dB. Tip mass $\frac{1}{2}$ mg maximum.
2. No resonances within the above range, and no undamped resonances within the range 10 to 25,000 c/s in head or arm.
3. Harmonic and intermodulation distortion less than 1%.
4. Channel balance within 1 dB throughout the frequency range.
5. Channel separation (“crosstalk”) not less than 20 dB over the range.
6. No deterioration in performance with continued use, apart from stylus wear.
7. Minimum output 1.5 mv/cm/sec per channel.
8. Sufficient stability and mechanical strength to permit use by unskilled hands without risk of damage.
9. Complete shielding against hum induction.
10. Immunity to temperature change and climatic conditions.
11. Track all discs perfectly

at under 2 grams pressure, on its own arm. **12.** Incorporate mechanism to *drive* the head across the disc (as distinct from being dragged across by the record groove) exactly at a tangent to the groove at all points. (Parallel tracking). **13.** Be immune to external vibrations. **14.** Incorporate its own raising and lowering device.

Realistic factors

The person who designed such an instrument to sell at £25 to £30 would make a fortune, and would richly deserve to do so! However, we must return from the ideal to the real, and before considering the characteristics of the available types of pickups, three points must be emphasised: (a) The achievements of pickup designers and manufacturers during the past two or three years are remarkable, and there are a number of stereo pickups of very high quality available. (b) The modern stereo pickup is a miniaturised precision instrument, and for this reason high quality and low price do not, and cannot be expected to go hand in hand. (c) Where economy is necessary in the planning and purchase of equipment for reproduction of stereo discs, *the worst possible place to economise is on the pickup*. Around £20 is a reasonable price for a head and arm of good, but not the highest possible, quality. The pickup is the Alpha and if it is bad, the Omega, the beginning and the ending, of disc stereo. It is the only part of the equipment in direct contact with the disc—the sound source—and unless it is right nothing else will be right. It will mean good stereo or bad stereo, or even no stereo; records perfect after 100 playings or ruined long before double figures have been reached. Economise if you must—we shall have something to say on this subject later—but buy a rather better pickup than you can afford!

Stereo pickups can be divided broadly into two types: (1) crystal (including ceramics); (2) magnetic (including variable reluctance, moving magnet, and moving coil). In general, it may be said that the magnetics cost rather more

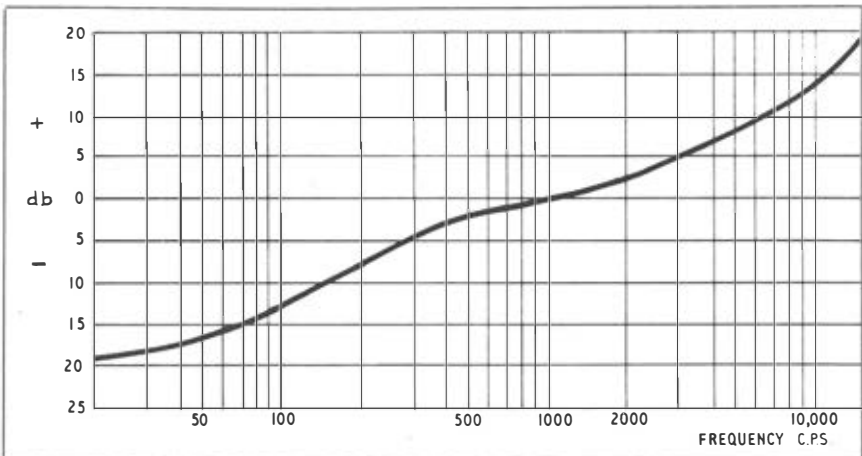

Fig. 5:3. The RIAA recording characteristic in universal use. The reproducer must follow the inverse of this.

than the crystals and give less output, and that the best magnetic types are superior to the best crystals; but a pickup must always be thought of in association with the amplifier into which it will work. As mentioned in an earlier chapter, all stereo discs are made to the RIAA characteristic, with a deliberate fall away in the bass and a rise in the treble (see **fig. 5:3**) and this characteristic has to be corrected when playing back in order to provide as nearly as possible an even response over the audible range. This correction can be done either in the amplifier or in the pickup itself.

Most crystal pickups are self-compensating when working into a high impedance—stated by the pickup maker, and usually of the order of 1 to 2 megohms. Magnetic pickups always require the compensation to be arranged in the amplifier. Most of the better stereo amplifiers provide alternative inputs for crystal and magnetic pickups, often designated High Impedance and Low Impedance, or “High Z and Low Z”. The instruction book will always indicate the actual impedance imposed on the pickup in each case. Most magnetic models are happy when working into about 50,000 ohms.

Makers always state an output figure for their pickups—usually the level to be expected from an average recording. It is important that the pickup input sensitivity voltage quoted by the manufacturer of the amplifier should not be higher than this figure, but it does not matter if it is lower. For example, the output of the *Tannoy* Vari-Twin Mk II pickup cartridge is quoted by the makers as 7 mV per channel. It is useless to connect this pickup to an amplifier with a pickup input sensitivity of 50 mV, since there would be insufficient volume of reproduction; but it is perfectly in order to connect it to an amplifier with a pickup sensitivity of, say, 4 mV.

Pickup matching

The Formula:

$$\frac{1}{R} = \frac{1}{R_1} + \frac{1}{R_2} + \frac{1}{R_3}, \text{ etc.}$$

For example, a pickup requiring a load of 50 K working into a pre-set control of value 100 K should have an additional resistor of 100 K placed across the leads (if possible inside the pre-amplifier case), since:

$$\frac{1}{R} = \frac{1}{100} + \frac{1}{100} \quad \therefore R = \frac{100}{2} = 50 \text{ K.} \quad \text{and the Example}$$

This business of suiting pickup and amplifier to each other, in voltage and impedance, is known as matching, and it is of the greatest importance if the best results are to be obtained. Some amplifiers provide matching units or plugs which adapt the input circuits to any pickup; others, especially in the medium price range, provide a fairly high sensitivity and a pre-set control (usually a potentiometer of about 100 K) to enable the output of a pickup to be reduced to avoid overloading and enable normal settings of the volume control to be

used. Where the value of the pre-set control is too high to suit the chosen pickup, an additional resistor should be placed across the pickup leads to give the correct impedance. This, of course, is an example of using resistances in parallel, and for those who have forgotten the formula for working out the required value, it is given, with an example, on page 48.

Correction Circuits

Where it is desired to use a crystal pickup with an amplifier whose input circuitry is designed for magnetic types—i.e. one which provides only a low impedance input of from 50–100 K—this can be done by the use of a correction circuit (usually shown in the instructions accompanying the pickup, but otherwise obtainable from the makers on request) which converts the crystal pickup to a “velocity characteristic”. That is to say, it neutralises the built-in compensation for the recording characteristic, and causes the pickup to behave like one of a magnetic type; at the same time it reduces the output to a suitable level if necessary.

Comparisons of one make of pickup with another, and detailed observations of the performance of different makes are outside the scope of this book; they will be found in the review columns of “*Hi-Fi News*” and other similar journals. But we can usefully indicate the general characteristics of the different types, with the addition of a few basic essentials which should be common, and the reader can then decide for himself which particular model will suit him best, taking into consideration the amplifier he will use and the money he has to spend. If possible, make no final decision without careful listening tests using known records.

Crystal and Ceramic Types: General Characteristics

High output: usually between 100 and 200 mV per channel at average modulation. Moving mass and compliance moderate. Playing weight required, 4 to 8 grams. Response range, average, 30 to 15,000 c/s. Not generally “flat”. Channel balance: Generally good. Crosstalk (channel separation) variable, but generally adequate. Stylus size: Usually 0.0007 in. Where tracking pressures exceeding 5 grammes are required, some record wear is likely. Self compensating for the recording characteristic when playing into the correct impedance. Minimum generally 1 megohm. Lower input impedance than that specified reduces bass response. Amplifier sensitivity required, from 100 to 250 mV. Separate stereo cartridges or heads generally give better results than mono/stereo turnover types.

Crystal cartridges are comparatively inexpensive and robust, and are available either with or without their own arms. They have standard $\frac{1}{2}$ in. fixing centres as a rule, enabling them to be used in almost any pickup arm. Nevertheless, a pickup should ideally be designed, produced and used with its own arm, as one integral unit.

The design of crystal pickups has by no means reached finality, and mention must be made of two special, high quality examples which have recently

A SELECTION
OF PICKUPS AND
CARTRIDGES



Pickering 380A.

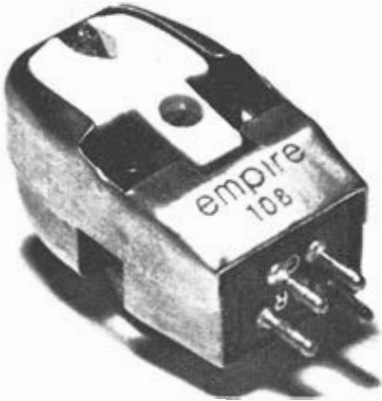

Empire 108.

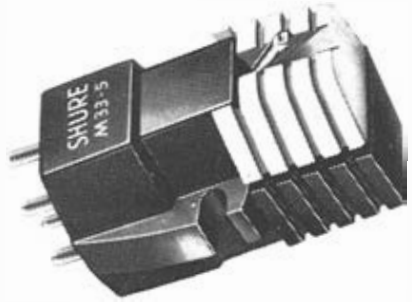

Shure M33-5 cartridge.



Decca Professional arm and head.



EMI EPU 100 arm and head

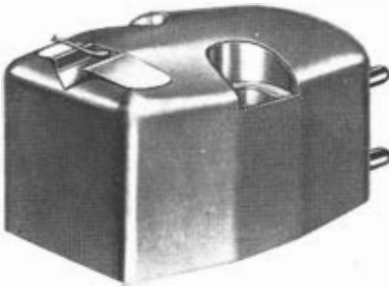

ADC Professional cartridge.



Ortofon SMG 212 arm.

appeared, the *Acos* "Hi-Light" and the *Decca* "Deram". The *Acos* is available only as a complete unit, comprising a special arm of very high quality and separate mono and stereo heads (0.0005 in. stylus). The heads have very high compliances, and the arm has exceptionally low inertia and side thrust, among other features. This combination of qualities enables stereo discs to be tracked at around 2 gms pressure. Output is low for a crystal. Thirty mV per channel for the stereo head is quoted by the makers. An amplifier sensitivity of 50 mV is, however, quite adequate given the correct input impedance of 2 meg. This pickup was the first really high quality crystal to appear on the British market, and is a pointer to the future possibilities of crystals.

The *Decca* Deram can be used in any standard pickup arm, whereas the *Acos* heads are suitable only for the "Hi-Light" arm. A special arm for the "Deram" is now available. The "Deram" has very similar qualities to those of the "Hi-Light" stereo head. Output again is low, in comparison with ordinary crystals (50 mV per channel) and, as with the *Acos*, an input impedance of 2 megohms is required in the associated amplifier.

A point must be made here regarding the connection of these two pickups to amplifiers in the popular price range. Many of these have an input impedance of $\frac{1}{2}$ megohm, and an input sensitivity of from 100 to 250 mV. They are, in fact, designed to accept the normal crystal cartridge output. If such a cartridge demands a higher input impedance, this is easily arranged by the insertion of a series resistor, and although this will reduce the output of the cartridge, there will usually be more than enough left to provide adequate volume. If the same procedure is adopted with the "Hi-Light" and the "Deram", with a 1.5 megohm resistor put in series the output will not be sufficient to load these amplifiers. Intending users should bear this in mind, and should seek an amplifier of higher sensitivity or higher input impedance.

Magnetic Types

Response range 25 18,000 c/s average. Wider and smoother than crystals. Output: low, from 5 to 10 mV per channel. Tip mass: low, around 1 milligram. Compliance, high. Tracking pressures $2\frac{1}{2}$ to 4 grams. Stylus size: 0.0005 in., 0.0006 in. or 0.0007 in. Channel balance, satisfactory in general. Crosstalk variable, but adequately low as a rule. Correction for recording characteristic required in the amplifier. Amplifier sensitivity: 5 to 7 mV, minimum. Amplifier impedance at pickup input, 50 K approx.: 100 K maximum. Lower input impedance cuts top response. Impedance higher than specified will emphasise any treble peak.

Magnetic pickups are relatively expensive, but worth the extra cost to those who can afford one. Moving coil types have very low impedance and output, and require input transformers (which can be built into the head as in the *Ortofon* Type SPU/GT) or a transistor head amplifier such as the *Heathkit* or *Stereo Wal-Gain*.

Some magnetic cartridges are suitable for use only with their own arms, but an increasing number of heads now available have standard $\frac{1}{2}$ in. fixing

centres, enabling them to be used in a wide range of arms. Unless the user can afford one of the specialised high precision arms, such as the *SME* (which will be discussed in the following paragraphs) the maker's own arm should always be used where possible.

Due to the combination of low tip mass and high compliance which, with a good arm, enables low tracking pressures to be employed, record wear with a good magnetic pickup will be less than with crystals, apart from those special types already mentioned. Magnetic pickups are more prone to the induction of hum (as distinct from motor rumble, to which we shall refer later) than crystals.

Pickup Arms

A gramophone record consists of a continuous spiral groove from outside to inside. When a record is played, the pickup stylus must follow this groove, and it has to be moved across the disc by the groove itself. This latter fact is unfortunate, and it is not impossible that something may be done about it before very long. The function of all existing pickup arms is to permit the pickup head to be moved across the disc by the groove with as little effort as possible. It therefore follows that the movements of the arm itself must be as free as possible, and that it is highly desirable to use an arm specially designed and balanced to perform with minimum side pressure and at the lowest attainable tracking weight for the cartridge in use.

Tracking error exists because a pivoted arm tracks in an arc, and the records which it has to track were originally cut by a head which moved across the disc surface in a straight line, and always at ninety degrees to the groove. This error must be kept at a minimum, especially over the last inch of the disc, or there will be avoidable distortion. Comparatively few arms fulfil these requirements. Some of the better ones (like the *Acos* "Hi-Light", the *EMI* "EPU.100", and the *Shure* "M.212") are designed to work only with the makers' special heads supplied with them; in other words, the head and arm have been designed as one unit—the complete pickup—which is as it should be. At the same time, if a maker is prepared to go far enough, it is possible to produce a pickup arm so good that any head or cartridge used with



This pickup arm by SME has every refinement demanded by the most delicate cartridges.

it will give the finest performance it is capable of giving. This fact has been clearly demonstrated by SME Ltd., with the Types 3009 and 3012 pickup arms.

The essential requirements in an arm may be summarised as follows: (1) Minimum bearing friction, horizontal and vertical. (2) Resonances outside the recorded range, of small amplitude, and damped. (3) Accurate lateral and vertical balance, adjustable to conditions and pickup head in use. (4) Length, offset and flexibility such that, with any cartridge, maximum tracking error can be made less than two degrees, with zero error over the last $\frac{1}{2}$ in. of playing surface. (5) Compensation for the tendency of a pickup to move towards the centre of a revolving disc, due to the offset angle of the head incorporated to reduce tracking error.

The *SME* arms, with bias adjuster, fulfil all these requirements; and while £25 is a great deal of money for an arm, for those who can afford it the investment is eminently sound. Other arms of similar calibre are in course of development—at lower price levels, and consequently rather less refined. There are also the “*All-Balance*” and the *Shure* M.232 and M.236 arms. However, the safe alternative to such special products is the selection of a good pickup head, and the decision to use it in the maker’s own arm at his recommended tracking pressure.

Optimum Playing Pressure

The question of optimum playing pressure is a somewhat vexed one. The plastic material from which records are made is soft, and because of the pressure of the stylus and the heat generated by friction as the groove passes under it, the material is deformed. If the pressure is excessive, this deformation is permanent: but it has been found that if discs can be tracked at pressures not exceeding $1\frac{1}{2}$ grms (which calls for a perfectly balanced arm, a head of high compliance, and stylus of low tip mass), the groove merely flexes under the stylus like elastic, and returns to its original form. This is what is meant by “tracking within the elastic limit of the material”.

Pickup manufacturers give fairly precise information about the tracking pressures at which their heads should be used. The stated pressures are usually, and properly, on the safe side; that is to say under favourable con-



All Balanced pickup arm

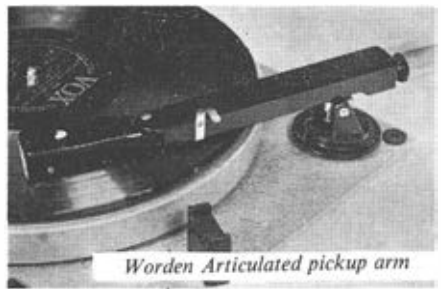

Worden Articulated pickup arm

All-balance pickup arm and Shure M232 arm (left) Worden articulated arm above.

ditions, with the best available arms, some reduction may be possible. However, it must be remembered that it is vital for good results and for minimum record wear that the stylus shall maintain *continuous* contact with the record groove. Further, with some pickups of the "sum-and-difference" type—the Decca ffss is an example—a certain minimum weight, which may vary slightly from head to head, is required to maintain the armature in a central position, and any reduction below this point will seriously degrade the performance.

When a maker produces a pickup, complete with its own arm, and states a definite tracking weight without providing facilities or instructions for adjustment, the user will be most unwise to attempt any alteration—even where an adjustment is provided—unless he has some technical knowledge and is an experienced listener. A decrease of from $\frac{1}{2}$ to 1 grm in tracking pressure from the recommended weight is as far as one should go. Though it is most desirable to track within the elastic limits of the record material, because there is absolutely no wear on discs under these conditions provided that they are kept clean, there are very few combinations of head and arm which will accomplish it. Against this, however, quite a number of the better magnetic heads will perform beautifully at about $2\frac{1}{2}$ grams when properly set up in a good arm; and when discs are well cared for, the additional $\frac{1}{2}$ gram or so is barely significant from the point of view of performance. Further, it is very likely that with such a pickup and arm, record wear will be at the lowest attainable level at $2\frac{1}{2}$ grams pressure.

Summary

Consider the pickup and amplifier together, and choose a pair which will work together; or, if you already have the amplifier, choose a pickup to suit it. And do not expect the cheapest pickup to give you the best results. If you intend to play only stereo discs, choose if possible a pickup fitted with a "half thou" point. It is perfectly practical to play both mono and stereo records, with good results, with one stereo pickup; if you must do this on grounds of economy, the 0.0007 in. stylus is probably the best for you. Do not, please do not ever attempt to play a stereo disc with a mono pickup. You will just ruin the disc if you do. For preference, use a mono head for mono discs (0.001 in. stylus) and a stereo head for stereo discs, especially if you already have a collection of mono records played with a standard mono stylus. Incidentally, if you have not yet tried it, you will be surprised and delighted with the results from these records when they are played through a stereo set-up, using both loudspeakers.

If your chosen stereo pickup has a 0.0007 in. stylus your maximum tracking pressure should *not* exceed 5 grams. If it has 0.0005 in. stylus $3\frac{1}{2}$ grams should be the maximum. Unless you can afford a special "transcription" arm, use the maker's arm. Follow his guidance regarding tracking weight, but if he suggests anything in excess of 5 grams, look for another pickup.

The minimum frequency range should be from 40 to 14,000 c/s, plus or minus 3 dB. Crosstalk not worse than minus 20 dB at 1 Kc/s (Crosstalk is the inverse of channel separation). Channel balance is not usually specified

and should not be a serious problem. Amplifiers and speakers also affect the final balance, and your amplifier will have a balance control.

Gramophone Turntables

The last but not the least important of the essential pieces of equipment which must be considered for the reproduction of a stereo disc is the turntable unit. Gramophone records are still available for four different playing speeds—unfortunately! Two would be quite sufficient, and it seems likely that stereo discs will continue, as at present, to be issued in two speeds only ($33\frac{1}{3}$ and 45 rpm). The four available speeds are $16\frac{2}{3}$, $33\frac{1}{3}$, 45 and 78 rpm, but the first and last of these have not been used for stereo. The 45 rpm speed is used only for 7-inch discs, though full sized discs for playing at this speed have recently (1962) been introduced in the USA.

Nothing has shown up the defects of gramophone turntables so clearly as the advent of stereo records. Only the transcription types, with really solid base plates and heavy turntables of full 12 in. diameter are useful in a stereo installation, and around £20 is the lower limit of cost of a good unit. Even at this cost (and higher), there is often room for improvement, and with some pickups, if the speakers have good bass response and if there is no "rumble filter" in the amplifier, hum and rumble can completely spoil results. Even if they are not obtrusive, it is well to remember that no loudspeaker can reproduce both these noises and good clean bass at the same time.

The chief faults to be found in gramophone motor-turntable units are: (1) *Wow*. A slow variation in speed, causing a rise and fall in pitch of the reproduced sound, especially noticeable on sustained notes. (2) *Flutter*. A rapid speed variation, causing rapid pitch variation in reproduction. (3) *Vibration*. Transmitted to the pickup through the motor board and arm, or through the turntable, and reproduced as a rumble of very low pitch by the loudspeakers. (4) *Stray fields*, inducing hum into some magnetic pickups which is reproduced by the loudspeakers.



Garrard 301 (left) and Connoisseur Craftsman III turntable units are among the best available.

The first two of the above faults are no longer prevalent in "transcription" type units; the last two remain a problem in many cases. In *Chapter Nine*, under the heading of "Installation", we shall suggest mounting methods which minimise the induction of hum and the transmission of vibrations to the pickup, but intending buyers of a motor unit will be wise to seek the advice of a specialist dealer or consult the technical department of one of the leading journals concerning its suitability for use with a particular pickup; or, better still, to arrange to listen to the pair working together. If trouble does arise, the matter should first be investigated by a careful check of the installation. It is not possible to "shield" some pickups from hum.

Certain transcription units are sold complete with a pickup arm mounted on the base plate. They are generally of quite good quality, and their use can simplify installation; but they may raise problems later, if it is decided to change to another pickup, and therefore a unit as a separate item is to be preferred. In this case, too, some care should be taken, or advice sought, before deciding on a particular combination of motor and pickup arm, especially if the motor is mounted on a large oblong metal base plate. For example, it is not possible to use the *SME 3009* arm with the *Connoisseur* Type B 3-speed motor without some little trouble, because the mounting plate of the arm lies partly on and partly off the thick metal motor plate.

Planning before Mounting

Available space must also be thought of, taking into account the amount of "overhang" at the back of the chosen arm. It is usually possible to get round these difficulties, but time and temper can be saved by a knowledge of their existence and a thoughtful approach. Such motors as the *Connoisseur* "Craftsman" 2-speed, mounted on a banjo plate, or the *Garrard 301* with its cut-away corners raise few problems when mounting any arm, and no doubt we shall see others of similar outline in the future.

The object of a heavy turntable is to reduce vibration and contribute to even rotation by flywheel action; but beware of motors with ferrous turntables, sometimes used to provide both weight and a screening effect from the motor field. It is possible to use crystal or moving magnet pickups satisfactorily with such turntables, because in the first of these there is no magnet in the head, and in the second the magnet is very tiny. But with other kinds of pickup the magnet may be quite large, comparatively, and quite close to the record, and it may radiate a considerable magnetic field of its own which can be distorted by a ferrous turntable; also, the magnetic pull between the two will add considerably to the tracking weight, which will not be easy to adjust accurately under these conditions, assuming that an adjustment is provided.

Turntable rumble may be negligible or extremely annoying. Every unit produces some rumble, but people who like their reproduction rather light in the bass, or who listen at low levels, or who use small loudspeakers in small rooms, are often untroubled by it. In some units the amount of rumble produced is quite small, and it would be a mistake to blame the turntable bearings automatically for any rumble which we hear. The records may be

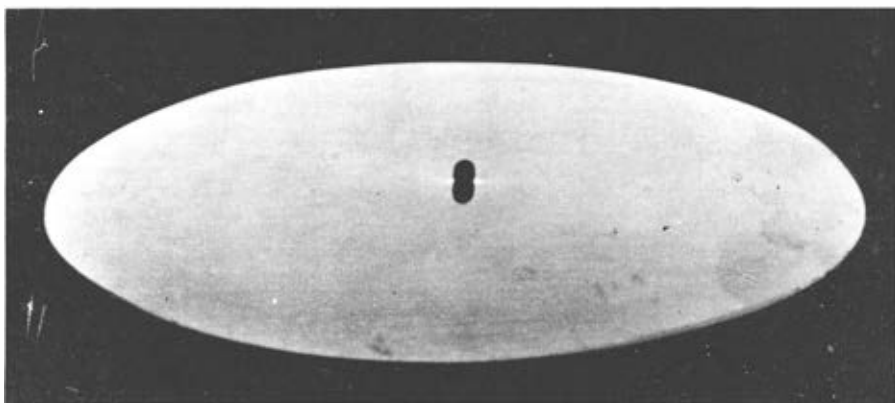

Fig. 5:4. Using a special optical technique evolved by Cecil Watts, this shows the reflection from a perfectly flat disc of Perspex.

responsible. There is such a thing as recorded rumble, and a record which is not flat—and there are many, as we shall see later—can produce rumble in reproduction. If rumble only troubles you on some discs, and is absent on the silent grooves between one band and the next, don't blame your motor; but if you get it all the time, the motor should go back to the maker.

It is necessary to distinguish between hum and rumble. Hum is a steady sound; around 50 c/s (main frequency) or double it (100 c/s). Rumble is much lower in pitch and less steady—below 40 c/s as a rule. Some amplifiers are fitted with a *rumble filter*. This device varies in usefulness according to the frequency at which it operates and the sharpness of the cut it imposes. Generally speaking, the use of the rumble filter removes some of the audible bass from the reproduction, which is undesirable, but may sometimes be forced upon us. The most satisfactory rumble filters are those which cannot be switched out, and which give a very sharp cut starting below 30 c/s, as for instance in the *Quad* amplifier.

When testing or choosing a motor unit, if it makes a noise which is audible when your head is a couple of feet away, or if you can feel vibration when the tips of your fingers are placed anywhere on the motor board, the instrument is unsatisfactory and should be rejected. If you are blessed—or cursed—with the sense of absolute pitch, you should choose a model which allows some variation from the switched speeds. The speed of gramophone motors is usually checked by means of a stroboscope. This is a circle of some suitable material with a centre hole to fit over the turntable spindle, marked in bands with numbers of lines for the different speeds. These are so arranged that when viewed by AC lighting of a specific frequency, and with the turntable revolving, the band relating to the speed in use appears to be stationary if the speed is correct.

Some turntables have stroboscopic markings engraved on their edges; others have a stroboscope fixed to the underside, viewed by means of an inbuilt mirror and a small bulb which lights up when the motor is switched on.

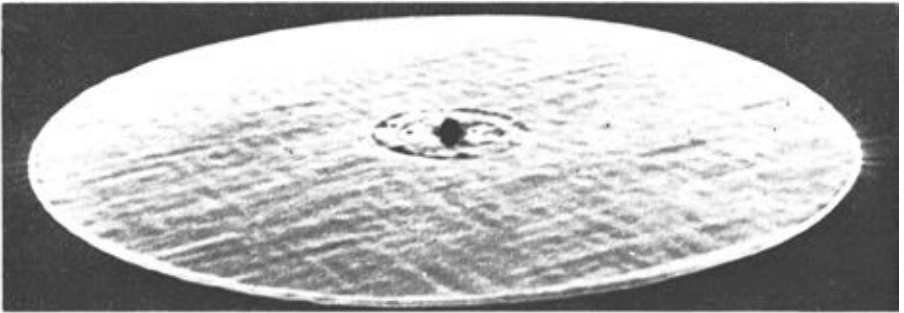

Fig. 5:5. A recording blank photographed under the same conditions as in Fig. 5:4. Note the slight irregularities.

The device is a very convenient one, but it depends upon mains frequency for its accuracy. One method (independent of artificial lighting or its frequency) is to buy a tuning fork and to have it ground till its vibrating frequency matches one of the bands on a frequency test record—say 500 c/s. The motor speed can then be checked by ear at any time; but since frequency test discs are only made at the $33\frac{1}{3}$ rpm speed, this method is restricted in its application, and it is also expensive.

Stereo Discs and their Care

A study of the photo micrographs which illustrate this chapter will make it clear that the modern stereo disc is a miracle of precision plastic moulding. Inevitably, in spite of careful control and inspection, faulty copies do sometimes reach the customer, but the day has passed when distortion was always attributed to a bad disc! For **example**, that awful distortion which often used to harass our ears during the last half inch of a disc is now very unlikely to be the fault of the record. In nine cases out of ten it results from a pickup which has not been set up properly. Some observations on this subject will be found in *Chapter Ten*. Again, thanks to precision machines installed by the recording companies, "swingers"—i.e. records in which the hole is not truly central in relation to the spiral groove—are much less common than they used to be. If such a record is purchased, it should be returned to the dealer or maker, when it will be replaced free of charge. The same remark applies to any disc found to be warped or "dished" when received. This again is a much less frequent occurrence now than a year or two ago, due to research into and careful control of the "mix"—the material from which the record is pressed.

The leading manufacturers are quite sincere in their desire that every record they make shall give full satisfaction to the user, and are quite extraordinarily co-operative whenever a disc is returned to them with a genuine complaint. Those readers who have been interested in discs for a number of years will remember how, in the early days of LP records, we were often plagued by

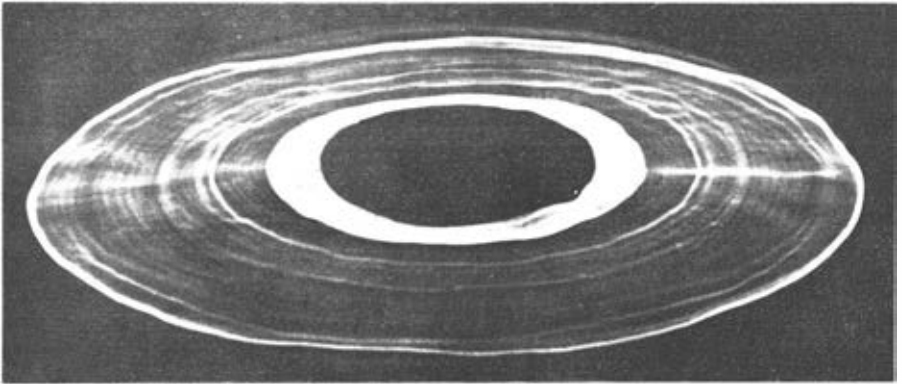

Fig. 5:6. *This shows the considerable surface undulations often found on commercial pressings, noisy surfaces and by clicks, pops and bangs in the grooves; they will not need to be reminded of the improvement which has taken place in this direction. Nowadays, if a record is properly cared for, one of the most enjoyable things about it, paradoxically, is its silence!*

The most common fault in modern gramophone records is one of a more subtle nature—a deviation from flatness which is not perceptible on normal inspection. Using an optical system devised by Mr Cecil Watts to magnify surface irregularities, these deviations from a plane surface can readily be perceived. **Fig. 5:4** shows the reflection from a disc of Perspex $\frac{1}{16}$ inch thick, which is virtually optically flat. **Fig. 5:5** shows a good disc, and **figs. 5:6** and **5:7** are examples of faulty pressings.

Mr Watts writes: "The faults, (if we can call them such) are introduced during different stages of manufacture, and take forms which can easily be identified separately. In combination, however, they can be very confusing to the user of the final pressing, when an endeavour is made to ascertain the cause of a rumble, hum or thump—as to whether it originates in the repro-

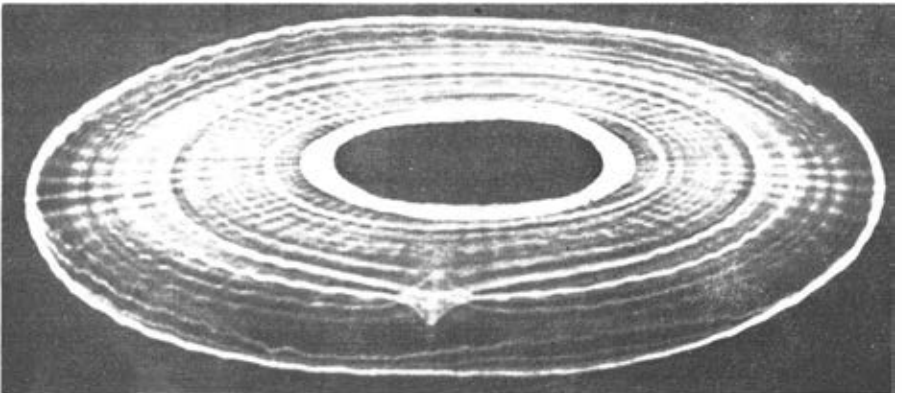

Fig. 5:7. *A further example of poor pressing, this time with a steady ripple which would probably be heard as "rumble"*

ducer, or from the record, or as is most often the case from a combination of both. It will be seen from these photographs that there can be, (and often is) a vast difference in quality between any two outwardly well-produced discs. We have come a long way since the days of the individually embossed hill-and-dale cylinders of Edison, but we have still a long way to go before the quantity-produced L.P. reaches the standard of perfection that will satisfy both users and manufacturers alike”.

Fig. 5:8. *In the absence of proper attention to record cleanliness, dust can gather on and around the stylus and tend to lift it away from the groove. On the left is the stylus of a Decca pickup after playing an uncleaned record, while on the right is the same stylus after playing a cleaned disc.*



I am greatly indebted to Mr Watts for these photographs and observations. The manufacturers are conscious of the existence of these defects, and they are doing everything possible to eliminate them. Whether they arise from faults in the original blank, from internal stresses in the pressing, or from manipulation at some stage of the processing, they are outside the control of the user. He is concerned only with their effects, which range from audible rumble in the 30 to 50 cycle region to intermodulation of the recorded waveforms by sub-audible frequencies and difficulties in tracking, all of which inhibit good stereo.

It was easier with mono

In mono, when every effort was made to avoid any generation of output by vertical movements of the pickup stylus, deviations from flatness in the record surface had much less significance, and this is one of the reasons why we continue to prefer a mono pickup head for playing mono records. It must always be remembered that stereo pickups generate a signal *from any vertical excursion of the stylus*, and this means that undulations of the record surface which are not components of the recorded signal, *whether at audio frequencies or not*, will produce noise and distortion. However, when the two outputs of a stereo pickup are paralleled for playing a mono disc the output due to any *purely* vertical motion of the stylus is cancelled.

The average set-up of good quality stereo disc playing equipment costs about the same amount of money as 60 or 70 stereo discs, so most of us should soon be able to say that our discs are worth more than our apparatus. But this statement will be true only if our records are still as good, after we

have had them and played them for two or three years or more, as they were when we bought them. Whether this is the case or not will depend partly on our equipment and partly on our observation of a number of points of detail in handling and storing our discs.

I have already written about the necessity for a lightweight, highly compliant pickup, with a diamond stylus, for stereo reproduction; but, whatever pickup is used, if it is habitually raised and lowered by hand, and at places other than the run-in and run-out grooves, sooner or later, (and probably sooner) clicks and bangs will appear because of groove damage. So, unless the pickup arm is equipped with its own integral raising and lowering device, such an accessory as the *Microlift*, the *Hi-Jack* or the *Auriol* pickup control will be a wise investment. When ordering, specify the pickup arm in use.

The Enemies of Discs

Records are subject to attack from five main enemies: bad pickups, worn styli, dust, poor storage, and careless human fingers. We have said what is necessary about the first of these, and stated that a diamond stylus is mandatory for stereo. Most of the irritating and distracting faults which arise in record reproduction are traceable to defective pickups or worn styli. A diamond should be inspected by an expert, using a proper microscope, after about 2,000 sides have been played, and subsequently at 1,000 side intervals. Most of the better dealers now have special microscopes for this purpose. It is no use inspecting the point with a magnifying glass. Do not wait until distortion is heard before having the stylus checked; by that time your records will have been irretrievably damaged.

Dust is always with us; brand new records come from the factory into our hands laden with it, and unless they are thoroughly cleaned before they are first played, and *during* each playing afterwards, this fine dust will collect round the stylus, impeding its movements and making accurate groove tracing impossible (Fig. 5:8). The finer particles between the stylus and the groove walls will form a most efficient abrasive, so that in effect, however highly polished the stylus and however perfect the finish of the grooves themselves, we might just as well trace them with a piece of glasspaper. The

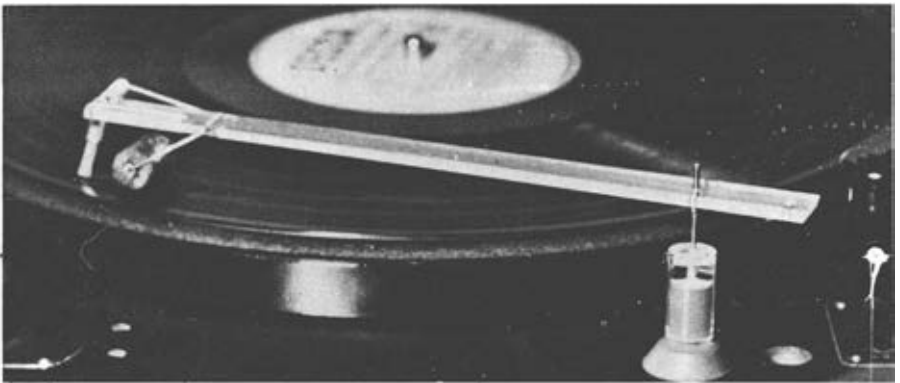

Fig. 5:9. *The Dust Bug*, invention of Cecil Watts, "plays" the record to remove dust continuously.



Pickup lifting and lowering devices are very useful. The *Auriol Control* and *Decca Microlift* are shown here.

difficulty is two-fold. In the first place, wiping the record surface is no use, apart from removing obvious debris, because it cannot remove anything from the actual groove. Secondly, the record material is highly electrostatic—even the act of pulling a disc from its polythene bag is sufficient to charge it—and so dust is very difficult to remove; and even if this is accomplished, more dust is immediately attracted to the surface from the atmosphere.

Experiments have been going on for some time with a view to adding something to the “mix” which will render the record more or less static-free, but it is not yet with us, and so it is clearly necessary: (a) to remove the dust from the grooves themselves before the disc is played, and (b) to make the record antistatic in order to ensure maximum record life, minimum surface noise and the best possible reproduction. Fortunately, it is possible for these things to be done quickly and easily, thanks to Mr Watts, who first proved conclusively the necessity for these things to be done, and then devised the means in the shape of the *Dust Bug*, *Parastat* and then the *Domestic Parastat*, and more recently the *Preener* (See **figs. 5:9** to **5:11**).

The Parastat

A *Parastat* should be in every record dealer’s shop. Many of the better dealers now have them, and will treat all records free of charge when purchased, if requested to do so by the customer. The specially shaped nylon bristles of the brushes penetrate to the bottom of the grooves, cleaning them thoroughly. The dust is collected on the pads, and, at the same time a molecular film is deposited in the groove edges, so that the record remains antistatic for an indefinite period afterwards, since this lubricant film will not evaporate and cannot be rubbed off. The pads and brushes of the machine should be kept clean, but not all users maintain their machines in this condition.

If your dealer’s *Parastat* looks as if it had received a coat of black shoe polish on the pads and bristles, don’t let him put your record through it, because it will merely deposit on your disc the dirt removed from others. A *Domestic Parastat*, which is a universal disc cleaner and applicator, is a wise investment for anyone who really values his discs. It enables the user to

clean and treat all his records, new or not so new, on his own turntable, taking about a minute for each one. The principle is exactly the same as that of the original *Parastat*, and it is perfectly easy for the owner to keep his brush and pad clean. After *Parastat* treatment, domestic or regular, the *Dust Bug* can do its work of removing the dust which will inevitably reach the record between one playing and the next, far more easily and efficiently, and since this operation is performed a fraction of a second before the stylus traces the groove, its track is always clean, and the improvement in quality of sound, background noise and record life is remarkable, leading to an experience of music on a different plane.

There are, of course, record cleaning cloths, sponges, sprays and liquids available in variety. Some of them are quite useful and others positively dangerous. Decca, E.M.I. and Philips of the record makers offer impregnated anti-static cloths which are effective within their limits. The same companies, in common with almost all the others, inform users that discs may be cleaned with a damp cloth. Water, of course, is an excellent anti-static while it lasts, and enables surface dust to be removed.

Damp Cloths and Background Noise

The great limitation of any cloth is that it cannot penetrate into the grooves, and ideas of dampness vary very considerably. In the course of a lecture delivered at the Institute of Recorded Sound on January 18th 1961, Mr Watts observed: "I often receive specimens of records which are claimed to have been cleaned only with a barely damp cloth—on which there are large areas of dried mud. Of course the background noise will be high! The free moisture has spread into the groove, especially where it has been wiped straight across, and has left a gritty residue in the path of the stylus. *Any free fluid applied to a record is usually harmful*".

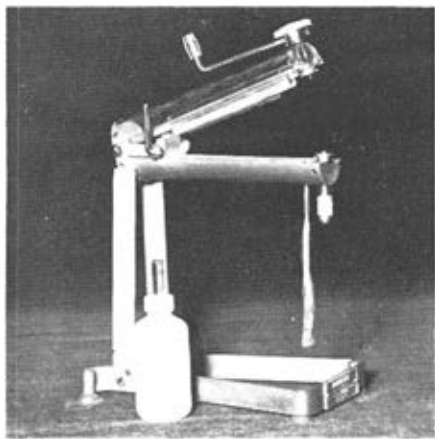

Fig. 5:10 (left) shows the *Domestic Parastat*, useful for thorough disc maintenance, while on the right (fig. 5:11) is the *Watts Preener* for removing superficial dirt.

However clean your hands, do not touch the playing surfaces of records with your fingers. If you do, you will leave behind finger marks, and these are in fact slightly greasy, acid deposits which it is almost impossible to remove without damage to the grooves. So handle discs by their edges, and if you find the technique of withdrawing a record from its bag with your thumb on the edge and middle finger on the label difficult to master, keep a piece of soft cloth, preferably silk, for use in this process. These suggestions may sound like somewhat fussy counsels of perfection, but in fact they very quickly become automatic, and as already suggested, the pleasure we get from records is in direct proportion to the care we are prepared to take in using them.

Store Discs Vertically

The storage of discs can be covered in comparatively few words. Store them vertically, on edge, 7 in., 10 in. and 12 in. separately, filling in any spaces in the cabinet with books, or squares of cardboard used in record packing, so that the records are not only kept from leaning or falling sideways, but are closely, though not tightly, packed together. Do *not* store them in piles one on top of the other. Keep them in as even a temperature as possible, and away from damp. Different types of storage boxes are available, many of them made on the "add-on" principle, which has much to commend it. Discs should be placed in the cabinet with the open ends of the covers to the back. Open record racks, made of plastic coated metal or similar material are not to be recommended.

Perhaps the greatest attraction of discs as a source of stereo sound is the enormous repertoire available, and the ease with which it can be stored and located. It is also true that, given a careful choice and intelligent arrangement of apparatus, the quality of experience provided by disc reproduction is at least as high as that provided by any other medium at present available under domestic conditions, when the records themselves are of the best quality and properly cared for. A careless, or merely casual approach to music, whether live or reproduced, seldom yields any results worthwhile, and the introduction of the stereo disc has done nothing to alter this position; nor could it be expected to do so, because we are now asking, and getting, more from gramophone records than ever before.



STEREO FROM TAPE

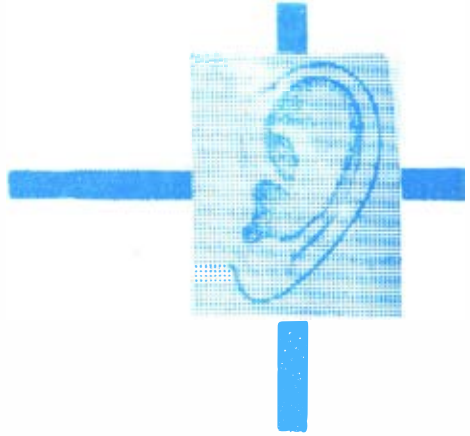

Commercially recorded tapes are for some strange reason often referred to as “pre-recorded tapes”. I have never been able to understand the term. Surely a tape is either recorded or not: it cannot be *pre*-recorded. However, the term will probably stick, and these tapes are the only other source of a repertoire of stereo sound of high quality available at present, apart from disc records. Recorded tapes have certain advantages and disadvantages compared with discs, which may be summarised as follows:

Advantages: Less liable to wear. Less liable to mechanical damage. Less crosstalk. Even quality and frequency response from beginning to end. Negligible distortion inherent in the *reproducing* process. Reproducing equipment can usually be used also for recording.

Disadvantages: Less convenient to handle. More expensive because of the time taken to duplicate them and the higher cost of materials. Reproducing equipment of equivalent quality costs more. Frequency range less wide and more wow and flutter is usually present, except at very high tape speeds; but such speeds are not used for commercially recorded tapes. Greater losses and more distortion introduced in duplication. A smaller choice of recordings—at present. Liability to accidental erasure.

In respect of background noise, dynamic range and liability to suffer from careless storage, the two media are about equal. In order to reproduce stereo tapes you will need, in addition to the basic amplifiers and loudspeakers, one of the following units—according to the way you decide to set about your installation, the standard of quality at which you are aiming, and the facilities you desire: (1) A complete tape recorder, twin or four track stereo model, with facility for twin track stereo replay. (2) A tape “deck” as above, with pre-amplifier only, for connection to external amplifiers and speakers. (3) A tape deck as above only.

A tape deck consists of a plate on which are mounted the tape transport mechanism and heads, without correction circuits, pre-amplifiers, or electronics

of any kind. *You cannot record with a tape deck only*, in mono or stereo. Under certain conditions, you may be able to *replay* directly from a deck. In order to do this, you require a pre-amplifier having a very high sensitivity at the tape input socket, with built-in correction for the characteristic of the tapes you wish to replay. All British commercially recorded tapes are made to the C.C.I.R. characteristic. American tapes are recorded to the N.A.R.T.B. characteristic, needing an additional top cut of about 5dB at 10 Kc/s (**Fig. 6:1**). If you intend to work this way, it is advisable to check with the makers (or with a reliable dealer who specialises in tape) that the output of the head on the deck you propose to use is suitable for your amplifier, or vice versa. This is the cheapest way of reproducing stereo tapes, but it is not the best, and in fact it cannot be seriously recommended to those in search of first class quality.

Undoubtedly the best way to get a really high standard of tape reproduction is to buy a good deck and pre-amplifier, and to feed the output from this into the *uncorrected* tape input sockets of a good stereo amplifier. Unless you are an expert in these matters, you will be wise to use a tape pre-amplifier made by the makers of the tape deck, unless you are prepared to restrict your field of choice and use a tape unit such as the *Shirley, Cape, Tele-Radio Masterlink, or Heathkit*. These units give excellent results with a specified range of tape heads, but they are not cheap to buy. Enquire about their suitability for a particular tape head before purchase. The makers are always willing to help.

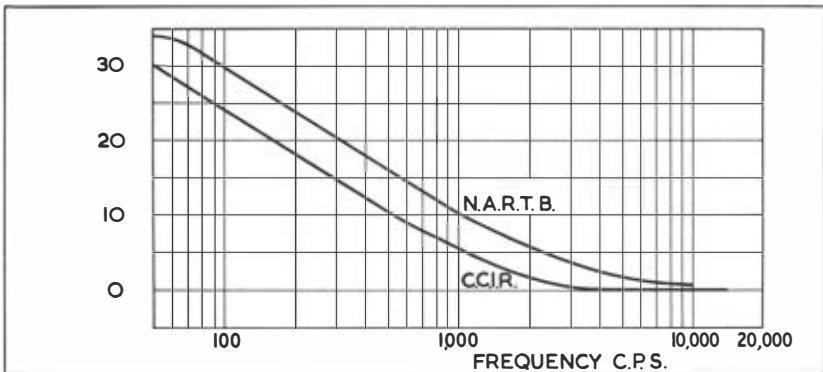

Fig. 6:1. Standard playback curves used for tape. C.C.I.R. (European) has a time constant of 100 μ Sec, and the N.A.R.T.B. (USA) uses 50 μ Sec. Recently a compromise 70 μ Sec has been suggested.

Almost all the manufacturers of tape decks who market their product separately, also produce a pre-amplifier as well as selling complete recorders. Such pre-amplifiers are specially designed for the heads fitted to their decks and, when necessary, it is not a difficult matter to "doctor" the output from them slightly in order to match the amplifier input. The makers will either do this themselves, or give the necessary instructions on request. Such pre-amplifiers always provide recording facilities, and they should almost invariably be used with their own power pack. It follows that if the deck, pre-amplifier and power pack, with suitable microphones, are housed in a

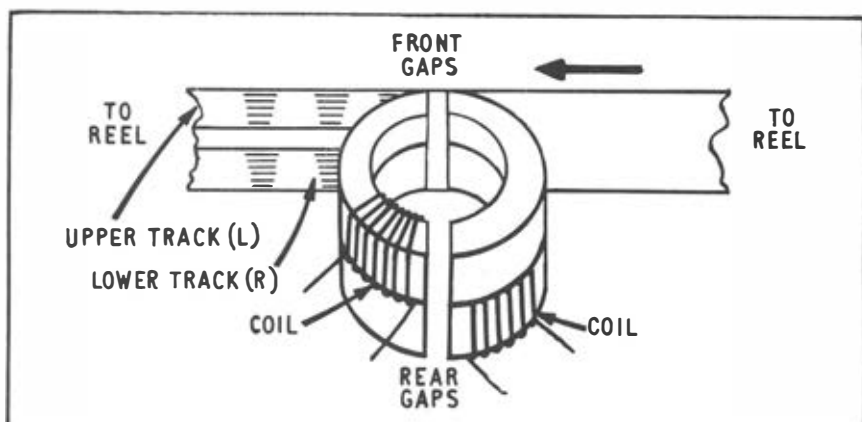

Fig. 6:2. Viewed from the coated side, the tape moves from right to left (left to right from the front of most recorders). The left track is at the top and right at the bottom.

separate case (which can be constructed or bought ready made) portable recording facilities are available to the user, but he will not be able to play back his results "on the spot". To do this, a complete recorder is required.

It is unfortunately true that it costs quite a lot of money to realise the full potentialities of stereo tapes. About 25% to 50% more needs to be spent on equipment. In spite of recent advances in tape quality and improvements in the design and manufacture of heads, it is still true to say that connecting an average stereo tape recorder of "domestic" quality to high-grade stereo reproducing gear is exactly the equivalent of using a portable stereo disc player with the same equipment. In either case, if the record is good, the result will be better than if the portable instrument is used alone—and it will have some entertainment value; but it will *not* provide the sort of result outlined and aimed for in the introduction to this book.

Good Tape Electronics are Essential

Those who wish their reproduction from stereo tapes to be of the same high standards as those from other stereo sound sources, available now or in the future, *must* use good tape electronics, and these electronics are not cheap. The makers of tape machines are well aware of these facts, and many of the better recorders are designed to be used with external electronic apparatus. For this purpose they are provided with a take-off point at suitable impedance and level, so that the output stage of the portable instrument can be by-passed. Thus a signal of good quality is available to be fed directly into high fidelity amplifiers.

Complete recorders may be divided into two classes: "*professional*" and "*general purpose*". The first category is outside the scope of this book, and also outside the scope of the pockets of most of its readers, so we shall not consider it. The second category may again be divided into two: the purely domestic portable, and the semi-professional, or general-purpose machine—

A SELECTION OF
TAPE RECORDERS
AND DECKS



Magnavox (Collaro) Studio.



Truvox PD86

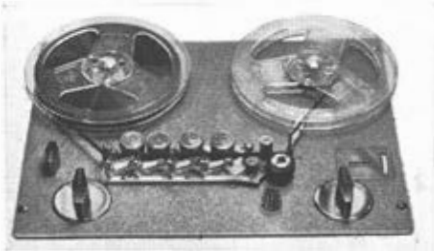

Brenell Mark 5



Reflectograph Model S

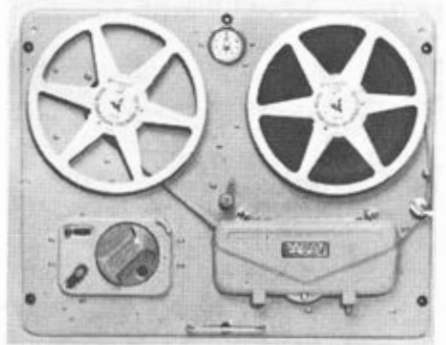

Wearite 5A



Tandberg Series 6

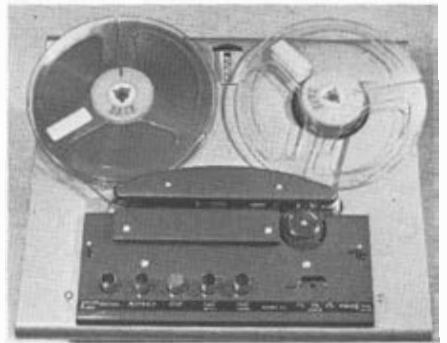

Planet U1

properly so called. There are few stereo machines in the domestic class as yet, but once stereo radio transmissions become a regular feature they will appear in great numbers.

The general-purpose machine is the kind most suitable in the home, with facilities for making stereo recordings of reasonable quality. Do not expect to be able to buy a new machine in this class for appreciably less than £100. Some models provide for stereo playback, but only mono recording. The point to remember here is that if in the future you wish to make *stereo* recordings—from radio or any other source—conversion will cost more money, and unless the machine is specially designed with this possibility in view, the process may be expensive and not completely satisfactory.

Tape Machine Specifications

Some people find "specifications" puzzling. This is not surprising for it is easily possible to find domestic portable machines which cost less than £100 with "specifications" that read better than those of professional equipment at two or three times the price; and this is particularly common with frequency response claims. If this were really true, there would, of course, be no professional machines, for the makers would have gone out of business in this field long ago!

The mystery is not difficult to explain. The specification of a professional machine is a *minimum* standard, to which every machine will conform. Buyers have the facilities to check it, and any machine not up to standard will be rejected; further, that specification must be maintained, day in and day out, with continuous use. And, of course, there are more important considerations in recorder design than the widest possible frequency range, which may well worsen the signal-to-noise ratio.

Some "Specifications" are meaningless

For example, what is the point of seeking a machine with a flat response to, say 16 or 18 Kc/s? Again, the mere statement—(and I quote from an actual specification)—"Frequency Response $3\frac{3}{4}$ i/s, 50–15,000 c/s" means virtually nothing. It might be 10 to 15 dB down at either, or both extremes. What then should we look for in a specification? The following would indicate a machine of good standard if stated by a reliable and well established maker:

Frequency Response (F.R.) $7\frac{1}{2}$ i/s, 50–12,000 c/s, plus or minus 3 dB. $3\frac{3}{4}$ i/s, 60–8,000 c/s, plus or minus 3 dB. *Hum and Noise* (H & N), Minus 45 dB. *Wow and Flutter* (W & F) Less than 0.25% at $7\frac{1}{2}$ i/s. *Replay to C.C.I.R characteristic*. (This is essential if you wish to use commercially recorded tapes or replay tapes recorded on machines other than your own.)

These figures should only be regarded as an indication that you may expect a reasonable standard from the machine. As with other audio apparatus, the *performance* of tape equipment cannot be conveyed merely by figures: the way it behaves and sounds is something to be judged by hands and ears.

There is an apparent simplicity about the process of stereo recording and reproduction from tape: two tracks, one above the other; two heads

arranged in the same way, serving, usually, both for recording and reproduction. None of the complications of transfer from one medium to another, or of tracing two tracks with a single instrument, as with discs.

Reduced to its essentials, a tape head is a magnet carrying coils of wire. It behaves in accordance with the well known law which states that, under such conditions, if an electric current is generated in the coils, the magnetic flux in the gap of the head will vary according to variations in the current. Conversely, if the magnetic flux is made to vary, a similarity varying current will flow in the coils.

How it works

Tape is a plastic material coated with finely divided magnetic material, (iron oxide—a refined form of ordinary rust). In the recording process a varying current from the sound source is fed to the coils as the tape is pulled past the magnet, and a magnetic pattern is impressed on the tape in accordance with another scientific fact—namely, that magnetic materials are magnetised when they are stroked with a magnet.

In replay, the above process is reversed. The magnetised tape is drawn past the head and so induces a current in the coils. To go into the details (and snags) of this delightfully simple arrangement would involve another book, larger than this one. So for simplicity we can accept what is everyday fact—that it is possible to record one, two, three or four separate tracks on standard tape, which is $\frac{1}{4}$ in. wide. For stereo, these tracks must be recorded in pairs; so stereo recorders are either “*twin track*” or “*four track*”. So far, British

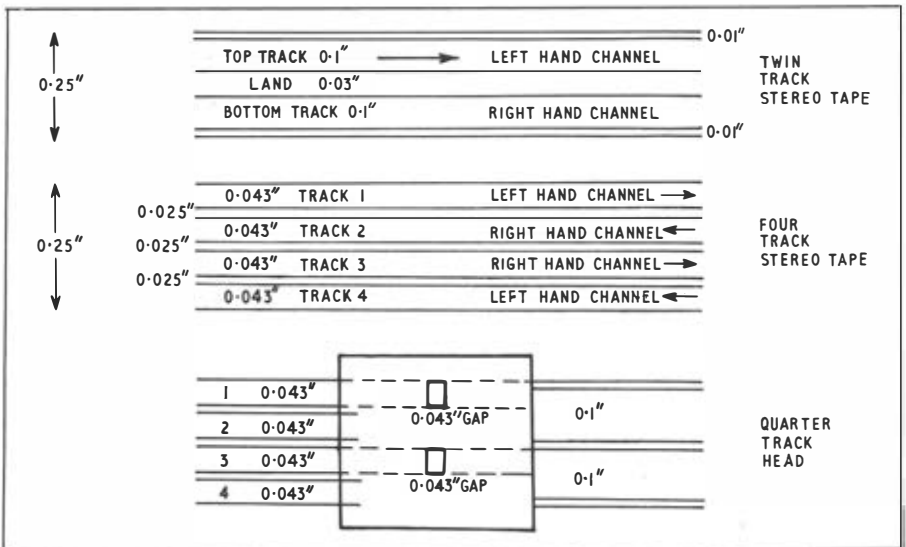

Fig. 6:3. The arrangement of tracks on a four-track machine can be quite confusing at first sight. This diagram gives all the essential information.

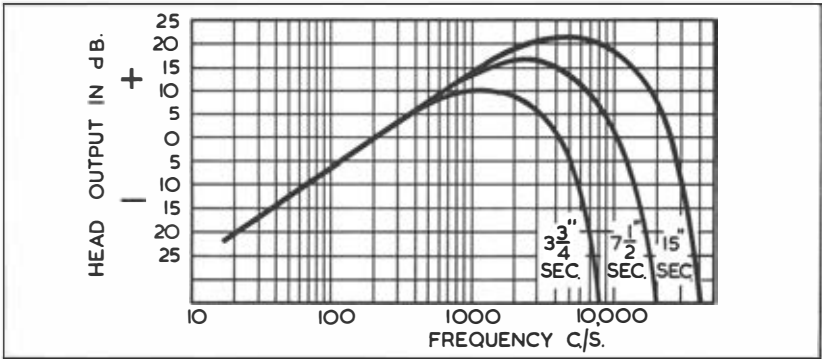

Fig. 6:4. Practical tape heads have a finite gap width, and this determines the upper cut-off frequency. The higher the tape speed, the more extended the range.

commercially recorded tapes are twin track only, and it is therefore essential, if you wish to use these tapes, that your machine, whether it is two or four track, shall have facilities for replaying twin track stereo tapes, at a speed of $7\frac{1}{2}$ i/s.

Four track recording is one of the recent developments mentioned earlier in this chapter. At one time, all tape records occupied the full width of the tape (known as "full track" recording). Then came twin-track recording, with a doubling of playing time at the same speed, and now we have the process repeated (and the playing time again doubled) with the coming of four tracks means that we can get as much playing time in stereo as we could formerly get in mono from a given length of tape at the same speed. Alas! All is not pure gain—everything has to be paid for.

The position at the moment is that we pay for this increased playing time by some loss of quality, but this may not always be the case. For a time we suffered loss of quality through the introduction of twin track recording, but improvements in tape and tape machines redressed the balance.

Twin track tapes are made to agreed standards of track width, track spacing, and direction of recording (**Fig. 6:2**). There are as yet no agreed standards for four track recording, but in this country the system shown in **fig. 6:3** is used.

Tape Speeds

A similar state of affairs exists with tape speeds and compensation for replay. Six or seven years ago a tape speed of 15 inches per second was regarded as the lowest practicable speed for high quality results, and indeed disc recording companies were then still making their original tapes at a speed of 30 i/s. Today, a recorder with a really good head and well designed electronics can produce at least as good quality from tape running at only $3\frac{3}{4}$ i/s, as was then possible at twice that tape speed, which again means economy in tape. Because tape speed affects frequency response, a standard has been agreed for

compensation, or correction, at 15 and $7\frac{1}{2}$ i/s speeds. There is not yet any agreed correction for the slower tape speeds, but tape amplifiers provide compensation in accordance with head performance at these speeds (Fig. 6:4).

In order to simplify the loading and handling of tapes, *cassettes* have been introduced. These enable a tape to be dropped on to a machine, or removed from it, as easily as handling a disc on a turntable. This in turn has led to the introduction of simplified tape decks, working at one speed only ($3\frac{3}{4}$ i/s, in Britain) which will accommodate these cassettes, but not ordinary reels of tape. So far no stereo deck or machine of this kind has been produced here, but in America two or three different types of cassette carrying stereo recordings on two or four tracks at speeds as low as $1\frac{7}{8}$ i/s have been tried. A far greater variety of recorded material is available on tape in the USA than in this country, although at least three concerns (*EMI*, *World Record Club* and *Saga*) are trying to make up some of the deficiency.

The Present day Tape Position

The world of tape at present is far from being clean and tidy, and future developments (which may be just round the corner) are inclined to be problematical. However, it may be useful to try to summarise the position as it appears from the user's standpoint, adding a word or two more of advice to people who may be hesitating:

1. Tape is a very good medium for stereo reproduction, but it is likely to be a long time before it can offer anything like the same choice of recorded material that is available on disc. Its greatest advantage applies only to those who wish to be doers, and not hearers only—to use the facility for making stereo recordings; but it must be remembered that this facility costs extra money, requires much patient experiment (one cannot become a good recording engineer overnight, and one must learn by trial and error—mainly by error!). Also the recordings so produced will not normally be of the same calibre, either in performance or technical quality, as those made professionally.

Twin track at $7\frac{1}{2}$ i/s

2. If you wish to be able to take full advantage of the limited repertoire of stereo tapes at present available here, it is essential that your equipment can reproduce *twin-track* tapes at $7\frac{1}{2}$ i/s. This apart, the choice between two and four track at present boils down to a choice between quality and economy. If you want the best possible quality, stick to two tracks. If you are prepared to sacrifice a little quality for the sake of economy, choose four track equipment. Unfortunately, there are at present no international standards for four track recording, but if your main interest in stereo tapes is likely to be the recording of future stereo radio transmissions, the best four track machines will meet your needs.

3. Of the tape speeds at present in use, $3\frac{3}{4}$ and $7\frac{1}{2}$ i/s are the two useful ones. American experiments by Dr Peter Goldmark and his colleagues of Columbia and Minnesota Mining and Manufacturing Co., (who, two years ago, demonstrated a new type of cassette containing special tape) seem to

The Garrard Magazine Deck. Introduced in August 1959, this deck was the first to use a tape cassette. It plays at $3\frac{3}{4}$ i/s and is supplied with 2 or 4-track head systems.



indicate that there is a future possibility of good quality at $1\frac{7}{8}$ i/s, but in Britain, using best quality tape on reels with the latest small gap heads, $3\frac{3}{4}$ i/s is the slowest speed which will provide an adequate frequency range with sufficiently low wow and flutter levels. The $7\frac{1}{2}$ i/s speed is better, but for our purposes there is no further need to consider recording and reproduction at 15 i/s.

The only defence for four tracks and slow speeds is economy, which is eminently reasonable, but it must be remembered that good quality under these circumstances demands greater accuracy in tape transport, because the signal now occupies only half the area; it also worsens the signal-to-noise ratio since the output is correspondingly reduced. Freedom from minor speed variations, better heads with narrower gaps, (*which must be kept really clean*) better tape and more intimate contact between tape and head are also essential. In other words, greater precision is called for, and this means a higher cost of equipment.

There is a parallel here with disc reproducing equipment, where the introduction of long playing records, operating at slower speeds, demanded better material for the discs themselves, and a greater precision in reproducing equipment. These were challenges which were triumphantly overcome once standards were agreed. Given a similar agreement, there seems to be no fundamental reasons why tape should not meet the challenge with equal success; indeed a few British and foreign machines already point the way.

Recording on Tape

This book is primarily concerned with high quality reproduction of stereo sound sources. *Recording* on tape, especially stereo recording, demands a volume to itself. There are several in existence, and I understand that another book in this family, "*Tape for Beginners*", is now being written by my fellow author, Alec Tutchings. So I will not discuss the subject here, except to remark in passing that, if you are seriously considering stereo recording as a hobby, it would be well to bear the following points in mind:

1. *Live Recording*: Good microphones are absolutely necessary. However high the standard of the rest of your equipment may be, the "mike" stands in

the same relationship to it as the pickup does in the reproduction of a gramophone record. The most generally useful type for stereo recording is the ribbon, which is fairly expensive, rather delicate (do not blow into it!) and of low impedance, requiring a matching transformer, which may be built in. You will need a pair, and the best way to get them (unless you are technically skilled and wish to experiment) is to buy a stereo ribbon, which consists of two matched ribbons mounted one above the other with their axes at right angles. (See *Chapter Three, Stereo Recording*).

Recording from Radio and Disc

2. *Recording from Radio*: At the moment (1962) this is virtually hypothetical, as there are only experimental stereo transmissions. However, we hope that more may come soon. If and when they do, you will probably require an FM tuner unit with provision for the attachment of another small "box of tricks" to enable you to receive the second channel. You can use an FM Tuner now, and enjoy incomparable quality from single channel broadcasts. Connecting the additional unit when it becomes necessary may merely be a matter of plugging in.

3. *Recording from Discs*: There is little justification for this operation, save in exceptional circumstances, since with any modern disc there will be an easily perceptible loss of quality, and the process is a flagrant breach of the Copyright Act 1956. (See Section 12.) However, you may temporarily have access to a record not issued in this country, or no longer obtainable anywhere, in which case you need only to play it with a suitable pickup head and feed the signal through your pre-amplifier into your recorder. Some experiment is indicated before recording, in order to find the best control settings of pre-amplifier and recorder.

Dubbing

4. *Recording from other tapes*: There is little difference between this procedure and recording a disc. The output from the recorder playing the tape should be taken from the high impedance take-off point and fed to the recording machine, via the pre-amplifier. The two machines need not operate at the same speed, but you are unlikely to wish to record at a higher speed than that of the original, since to do so would bring no benefit and would use more tape. As when recording a disc, experiments can be done before the final recording is made, and the results checked by playing back.

5. *Choice and care of tape*: There are innumerable brands of tape to choose from, in three thicknesses: *Standard*, *Long Play*, and *Double Play*. Unless you are technically informed and wish to experiment, wisdom dictates that you should use the brand or type of tape specified or recommended by the makers of your tape machine when making your own recordings, because the machine will have been designed and constructed to give consistent results of the highest quality within its capabilities with this particular type of

material. In the case of commercially recorded tapes, you have no choice, but this is of no significance, as you are only replaying the tape, not recording on it.

All tapes are liable to suffer from "print through", which is akin to the almost conquered trouble of "pre-echo" on discs. It is the transfer, or superimposition, of a very weak and distorted signal from one piece of tape to the piece adjacent to it on the spool. There are several factors involved, but liability to the trouble is in inverse proportion to the thickness of the tape used. Tape thickness also affects mechanical strength, playing time and price: the thinner the tape, the greater the cost per foot, and the greater the playing time from a reel of given size. See table, **fig. 6:5**. The standard and long play tapes are suggested for normal use; double play tape where it is necessary to get maximum playing time from a spool of given size.

Tape storage is not a difficult matter. A bookshelf is excellent for the purpose. Tape should be evenly spooled for storage, and kept in dry conditions away from heat: that is, at normal room temperatures, as even as may be, not in immediate proximity to fires or radiators, and, if kept in stock for long periods without replaying, should be re-spooled occasionally. The tape spools can conveniently be kept in the boxes in which they are purchased, or in the neat plastic cases now available.

Playing times for Twin Track Stereo Tape

Note. The length of tape on a spool of given size varies. The playing times quoted are therefore approximate, but are those usually obtained.

Spool size.	3"	3"	5"	5"	5 $\frac{3}{4}$ "	5 $\frac{3}{4}$ "	7"	7"
Speed. ips.	3 $\frac{3}{4}$	7 $\frac{1}{2}$	3 $\frac{3}{4}$	7 $\frac{1}{2}$	3 $\frac{3}{4}$	7 $\frac{1}{2}$	3 $\frac{3}{4}$	7 $\frac{1}{2}$
Standard.	9 $\frac{1}{4}$ mts.	4 $\frac{3}{4}$ mts.	32	16	45 $\frac{1}{4}$	22 $\frac{3}{4}$	1 h 4	32
Long Play.	13 $\frac{1}{4}$	6 $\frac{3}{4}$	45 $\frac{1}{4}$	22 $\frac{3}{4}$	1 h 4	32	1 h 36	48
Double Play.	16	8	1 h 4	32	1 h 36	48	2 h 8	1 h 4

Fig. 6:5 For four track recording, multiply all playing times by 2.

Tape Recording and the Copyright Law

The new copyright Act of 1956 was intended to remove some of the anomalies of the 1911 Act, but the law of Copyright still remains somewhat confused and confusing. The purpose of both Acts was to protect authors and composers from exploitation by people using their works without payment; in other words, to enable them to earn some sort of living from their creative efforts.

One or two points in the 1956 act may usefully be summarised for the guidance of tape recorder owners. It is not only the originators of a work who are protected, but also those to whom they have sold the right to make use of their productions. If at any time you make a recording of a broadcast, you infringe the broadcasting company's Copyright; and in certain cases other people's Copyright as well. For instance, the Copyright of the recording company in the case of a gramophone record. If you use the record you have made by playing it in public, that is another infringement of the law; and if

you had made such a record with the intention of using it to make a profit, that would be a third offence. An action for damages could be brought against you, and you could be fined. However, up to now, while everyone knows that these things are done, so long as you confine yourself to the first offence, the actual making of the record, in the sense that you do not sell it, or sell a copy of it to anyone, and do not play it in public, using it only in your own home, for your own entertainment and that of your family and friends, no one will proceed against you.

Watch the Copyright Act

The dubbing of gramophone records on to tape is a much less easily justifiable business. It should be shunned on purely ethical grounds, except under special circumstances, such as those suggested in a previous paragraph. Since the transfer of a disc to tape cannot possibly improve the quality, the only possible reason for doing it with an available record is to make a profit, either by selling the original or the copy, or to profit indirectly by making a copy of a borrowed disc, thus obtaining the performance for no more than the cost of the tape used. In either case, the bread is being taken from someone's mouth.

In the case of live performances in theatres or concert halls, the permission of the management must be obtained, and also the permission of the appropriate Union if professional performers are involved, *and* of the author or composer or his agent (unless the Copyright has expired) before any attempt is made to record. Much will depend upon whether you wish to record the whole performance or just an excerpt or two.

Finally, it should be noted that gramophone records or commercially recorded tapes must not be played in public without permission from the Performing Rights Society, who will charge a small fee, according to the records to be played and the duration of the programme.



STEREO FROM RADIO

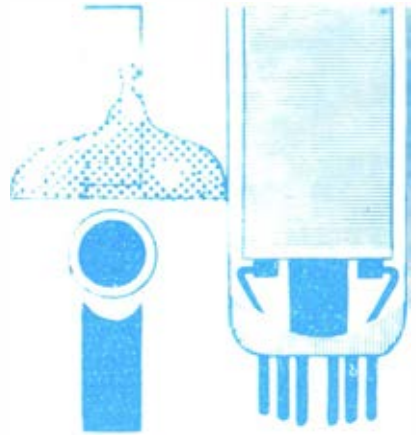

This must of necessity be a tentative chapter since apart from the BBC's experimental transmissions people in this country have no experience of the subject, which is a pity. Stereo reproduction has not "caught on" with the general public as quickly or as widely as was hoped. There are various reasons for this, some of which have already been mentioned in passing—the high cost of stereo tapes and reproducing equipment—the release of stereo discs without proper preparation—the absence of modestly priced stereo pickups with reasonably high output and minimum record wear—but the chief reason is without doubt the fact that there is (1963) no regular stereo radio service.

The BBC has long been well aware of interest in stereo transmissions, and the response to the experimental Saturday morning broadcasts, which ended in the Summer of 1962, to be replaced by the first series of experimental FM multiplex transmissions, was keen and critical. Upwards of 100 letters and reports were received by the engineering division after each one. Though some of us may think it a somewhat tardy body, we are fortunate that the future of stereo by radio lies in the hands of the BBC, for its standards are high, its integrity is a byword throughout the world, and it is uninfluenced by commercial considerations. Of necessity the BBC must tend towards conservatism in the inauguration of a new system. Even though its earliest experiments in the stereo field date back to 1933, considerable sums of money will be involved when a regular service is started, based upon that experience. This must be public money, and the Corporation would not readily be forgiven if these sums were ill spent. Nevertheless, the experimental multiplex transmissions have shown that things are at last moving in this field. Europe, as a whole, has virtually decided to adopt the General Electric *Zenith* system of multiplex stereo, and it is most probable that Britain will also decide to use it.

The system used for the recently terminated series of experiments (which continued, with some short breaks, since October 1958) provided much

valuable information. But that system could not be used for the provision of a regular, more extended experiment—from which much more, and more valuable information might be expected—because it employed two transmitters, one of which was the television transmitter, which was required for its proper purpose during the afternoons and evenings. It is astonishing that the system yielded such satisfactory results when we remember the widely different characteristics of the amplifiers and loudspeakers generally used for the right hand (*Television*) and left hand (*Network Three*) stereo channels.

A comparatively small number of people possessed a TV sound receiver (apart from the TV set itself) with the facility to feed the right and left hand signals through identical amplifiers to matching external speakers, and many listeners whose apparatus was not movable had to suffer their stereo in reverse. The solution (which keen listeners were able to hear in the Summer and Autumn of 1962) is to broadcast both channels on one frequency, just as the solution to disc stereo was to record and reproduce both channels from one groove. This is known as multiplexing, and the system was pioneered by G. H. Armstrong and his colleagues in the United States.

AM and FM

Readers will know that radio programmes are transmitted by means of a carrier—continuous waves of a certain length—which is modulated by the signals according to Amplitude or Frequency, so that we get *AM* and *FM* transmissions which require different types of receivers. In multiplexing, a supersonic sub-carrier is used, itself modulated by one part of the stereo signal, and this modulated sub-carrier is then imposed on the main carrier which bears the other part.

There are obviously many possible variations of this basic system for stereo transmissions, according to the way in which the signal is divided between the main and sub carriers, the frequency and method of modulation employed. In North America, some systems have used two *AM* carriers, others two *FM* carriers. The system finally selected by the Federal Communications Commission for use in stereo broadcasting in the USA (as from June 1st

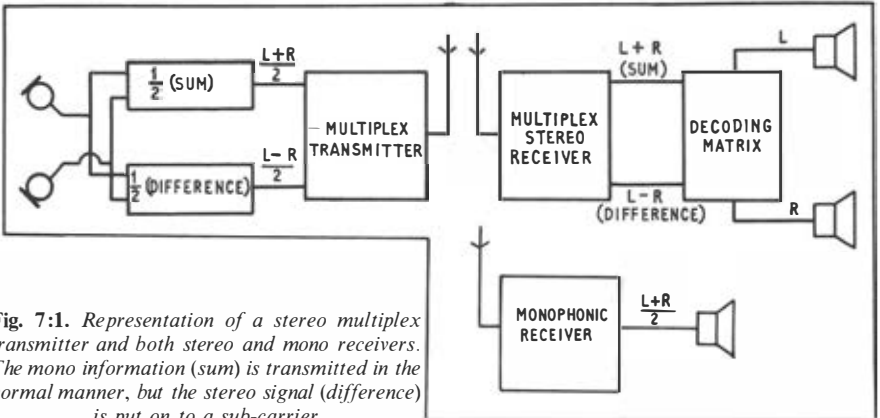

Fig. 7:1. Representation of a stereo multiplex transmitter and both stereo and mono receivers. The mono information (sum) is transmitted in the normal manner, but the stereo signal (difference) is put on to a sub-carrier.

1961) employs *FM* main carrier and *AM* sub-carrier. In some systems each carrier bears one channel; in others the main carrier transmits the *sum* of the two channels and the sub-carrier the *difference*; the sub-carrier may be used for a "steering signal" and so on. The object in every case is to produce a stereo sound source from one transmitter which will also be "compatible"—that is, receivable as a mono signal of good quality without the need to modify existing mono tuners or receivers.

Any stereo sound source consists of two signals, one from each microphone, which are usually denoted as L and R (for left and right) or A and B. It is generally accepted that the sum of these two signals forms a satisfactory representation in mono of a stereo source. Therefore, this L+R signal in a stereo broadcast must be available for mono receivers; and these of course will not detect whatever information is transmitted by means of the sub-carrier. If this information is the difference signal, L-R, a stereo receiver can recover the original signals by a process of addition and subtraction: $(L + R) + (L - R) = 2L$. $(L + R) - (L - R) = 2R$. (See **fig. 7:1**).

The Mullard and Percival Systems

Two British systems were submitted and demonstrated to the BBC, prior to the 1962 decision to try out the American Zenith system. They were the EMI or *Percival* system, due to W. S. Percival, and the *Mullard* system due to G. D. Browne. The *Percival* system transmits one compatible audio signal, (L + R) and a directional or steering signal on a sub-carrier. Experiments by Mr Percival indicated that it is the onset, the initial transients of sounds which are most important in determination of their direction, and that once this impression of direction has been established, it will persist for a short time, irrespective of the ratio of the outputs of the speakers. The sub-carrier is therefore used to indicate the ratio between the strength of the L and R signals.

At the receiver end, the sum signal goes to both speakers, but their relative volume is controlled by the guiding signal, and stereo information depends on the "precedence effect" mentioned above. It will be seen that not very much directional information is transmitted, and the system can operate successfully on a narrower bandwidth than many others.

Time Multiplexing

The Mullard system, on the other hand, transmits a maximum of directional information, L and R signals being handled quite separately and combined in a mono receiver to produce the sum, (L + R) for compatibility. To quote G. D. Browne "The process is known as *time multiplexing*. The technique is based on the fact that if a sound is interrupted regularly and sufficiently rapidly, a receiver will disregard the interruptions and translate it as an unbroken output". This is similar to the effect of a cinema film, in which the eye interprets a regularly and rapidly interrupted series of separate pictures as one continuous moving scene ignoring the interruptions. To quote Mr Browne again "The transmitter sends alternate pulses of L and R informa-

tion. In the stereo receiver, a synchronised electronic switch routes alternate sample pulses to their relevant channels and loudspeakers, thus re-creating the original L and R signals".

Readers who wish to obtain detailed technical descriptions of these systems are referred to the BBC Engineering Division Monograph No 29. "*A Summary of the Present Position of Stereophonic Broadcasting*" by D. E. L. Shorter and G. J. Phillips.

As mentioned above, the Federal Communications Commission has recently given permission for stereo broadcasting to begin in America using the GEC *Zenith* system, which employs FM main carrier bearing (L + R) signal and AM sub-carrier bearing (L - R) signal. It is claimed that this system provides a nearly perfect mono signal, with a worsening of signal-to-noise ratio of only 1 dB, a separation between stereo channels of 30 dB from 50 to 15,000 c/s, and that in the simplest form a one valve adaptor can handle the conversion of existing tuners for stereo reception. The BBC kept itself fully informed about this *Zenith* system and, as mentioned earlier, made the first tests and experimental transmissions with it in 1962 in order to find out whether it was suitable for use in this country.

The Ideal System

An ideal system of stereo broadcasting would provide: (1) Transmission on one frequency channel without increase in bandwidth or reduction in service area (2) Reception of stereo programmes on mono receivers with the addition of a simple and inexpensive adaptor. (3) Reproduction comparable with good disc or tape. (4) Compatibility i.e. capability of reception as a mono signal on mono receivers such that the only limitation is that imposed by the nature of the programme. (5) Ability to operate with any pair of stereo signals, however derived.

"It will no doubt be impossible", say Shorter and Phillips "in practice, to fill all these requirements simultaneously". Nevertheless, a stage has been reached when it is clearly possible, from an engineering point of view, to provide a stereo service very nearly approaching this ideal, and the BBC provides what is generally considered to be the best broadcasting service in the world. It was early in the stereo field, some limited experiments being carried out before the last war. Its standards are extremely high, and whatever system it eventually decides to adopt will, we may be sure, bring us the very best that current techniques permit.



CONVERTING TO STEREO

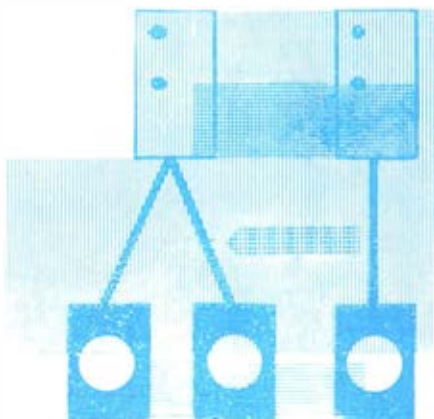

Many of the readers of this book who are interested in stereo reproduction will already possess mono equipment of some kind, and will naturally wish to consider the possibility of converting this gear for stereo. Whether or not this will be worthwhile from the conjoined points of view of quality, economy and convenience, will depend largely on the type of apparatus in use. It is *possible* to convert almost any mono equipment, from a portable record player or tape recorder, to the most ambitious high fidelity set-up; whether it is wise to do so is another matter, and there is usually more than one way of doing it. Every proposition of this kind really requires individual consideration, and in this chapter only general indications can be provided for that reason. If, after reading this section, you consider that in your case conversion may well “pay off”, seek out a reliable dealer specialising in high quality sound equipment and discuss the matter fully with him.

Not all Conversion is Worthwhile

The conversion of a record player or ordinary one-piece radiogram to stereo is just not worthwhile. If you have an instrument of this kind in good condition, and you wish to go over to stereo, by far the best thing you can do is to sell it, give it to someone for a wedding present or, if it is quite modern and has been well kept externally as well as being electronically sound, trade it in when getting new equipment. Assuming that there is already a good quality mono set-up in use, consisting of a playing desk, amplifier and separate speaker, with a tape machine in addition to—or instead of—the playing desk, there are several different procedures which may be adopted. Let us consider discs first.

The simplest, though not the best nor the least expensive method is to select a suitable stereo pickup, and then duplicate the speaker, amplifier and pre-amplifier. Assuming that the motor is a transcription model, and as nearly as possible rumble-free, this will give good results. But greater convenience in use and a saving in space will come from the installation of a

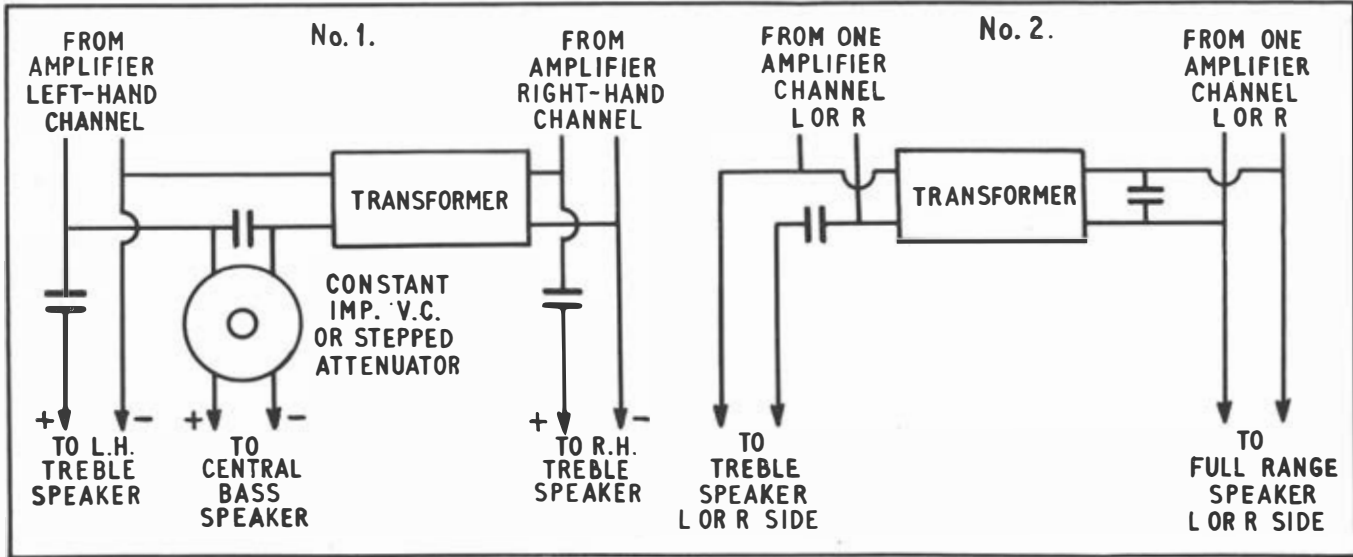
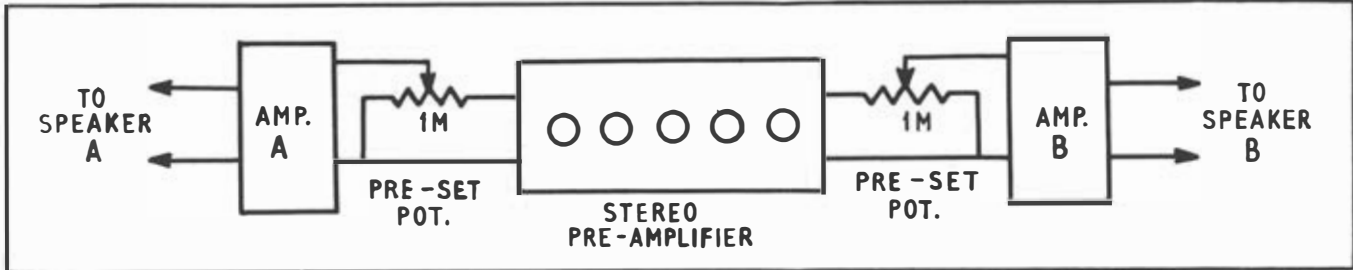

Fig. 8:1 (top) shows a method of coping with differing power amplifiers, while fig. 8:2 (bottom) outlines two types of speaker economy.

stereo pre-amplifier, the mono pre-amp being "scrapped" or traded-in according to age and circumstances, and the main amplifier and speaker duplicated.

Identical Pairs Not Essential

This is a good time to make it clear that, while identical equipment in each channel of a stereo reproducer is the most desirable arrangement leading to the best results with the least trouble in operation and installation, it is *not essential* for satisfactory stereo. *Provided that it is of similar sensitivity and input impedance*, a second amplifier (either complete or a power amplifier only) of not less than half the output power of the one already in operation may be used for the second channel, with some saving in cost. If two different main amplifiers are fed from a stereo pre-amp and have different sensitivities: (e.g. if one produces 15 watts out for 1.5 V in, and the other 10 watts out for 1.4 V input) a pair of pre-set controls can be placed across the inputs to equalize things. A pair of 1 megohm potentiometers are generally useful for this purpose, but the input sensitivities of the amplifiers should be roughly similar, and power supplies for the pre-amp need to be checked; voltage dropping and additional smoothing may be required. My earliest stereo equipment utilised 12 and 25 watt main amplifiers in this way quite satisfactorily, the pre-set controls being adjusted, with the pre-amp balance control centralised, until mono speech—from the BBC—appeared to emanate from mid-way between the speakers (**fig. 8:1**).

It is obviously desirable that there should not be wide differences in frequency response and distortion levels, but with modern amplifiers this is not usually a serious problem. It has already been pointed out (in the chapter on *Stereo from Disc*) that the pickup must be carefully chosen to match the pre-amplifier. If a stereo pickup is to be used with a dissimilar couple of pre-amplifiers, a double check is necessary.

Speaker Variations

There are numerous possibilities with loudspeakers. If you already have one 9 cu ft brick reflex enclosure, you may not have room for another, even if you do not quail at the thought of building it, and if your wife does not mind. If you like your existing speaker, match it if you can, but if you cannot, good stereo is not out of reach. In the earlier part of this book it was explained that most of what may be called "the stereo effect" comes from the higher frequencies, and where it is necessary we can make use of this fact by employing only one bass speaker with a treble unit disposed on either side. See **fig. 8:2**.

Crossover Units

Connection of the two channels is made via a transformer, such as the Wharfedale Type SM1, or a special crossover unit such as Goodmans Type S23. It is also possible, though less satisfactory, to use the arrangement shown in **fig. 8:2**, with the full range speaker at one side and a treble unit at the other—a smaller full range speaker may be used on one side with an existing larger one at the other. They should be roughly equal in range and power handling capacity, and of comparable efficiency. This usually implies that they

should be similar in type, though it is perfectly reasonable and practicable to use a column or an "infinite baffle" type, with a reflex mounted speaker in the other channel; but it is not a good idea to try to "pair up" a horn-loaded speaker or a full range electrostatic with a speaker of a different kind.

The conversion of a single channel tape deck to *play* stereo tapes is, in most cases, a practical proposition, and the cost is not prohibitive. An extra head (*stacked stereo replay*) is needed, and the governing factor in the conversion is finding room for it. Many decks provide for this possibility in the design. If you have a stereo pre-amp which will accept signals direct from a tape head and provide C.C.I.R. equalisation—and if you are prepared to use this method—nothing else will be required except a switch (or shorted plug) to cut out the single channel replay head when you are using stereo tapes; but if you replay via a tape pre-amp—the better method—it will be necessary to substitute a stereo model.

Stereo Recording

The same procedure can be adopted with a complete mono recorder, playing back directly from the stereo head; but the conversion of a deck or a complete machine to *record* stereo tapes as well as to play them back is not worthwhile in any case, and is often impossible. If this is what you want, dispose of the machine and start again with a properly designed stereo recorder.

Before starting, or giving any instructions for the conversion of tape equipment for stereo playback, it is a good idea to address an enquiry to the makers. They are always ready to help where it is possible, and can often save you time, trouble and money.



PURCHASE, INSTALLATION, MAINTENANCE



You may possibly have hoped to find in this book clear, precise and specific advice on what to buy and how to buy it. If so, I am sorry to disappoint you. There are so many possible combinations of equipment at different price levels, and so many variables in the purchasers themselves (their pockets and their environment) about which no author can know anything at all, that such a task is obviously impossible. Some guidance has been given in the sections dealing with *Basic Requirements*, *Stereo from Discs* and *Stereo from Tape* on the things to look for when making a choice, but in the end this is something which you have to do for yourself, which is as it should be, for the specification of an ideal set of equipment should begin with a specification of the listener—his mind, his ears, his musical tastes, his home and its furnishings.

Consult a Good Dealer

In the matter of buying equipment, people are in widely different situations. The best way, undoubtedly, is to visit a specialist dealer, having made an appointment beforehand, giving him some indication of the things which interest you. Such a dealer will almost certainly be equipped with some form of “comparator”, which will enable quick switches to be made from one set-up to another. A session in such a demonstration room should narrow the field of choice considerably, and it should then be possible to arrange for a further session to take place at home before final decisions are made.

This is all very well if one lives within striking distance of a town or city where such a dealer is to be found. If not, it is worthwhile to make a pilgrimage. If this is impossible, perhaps you know someone whose equipment satisfies you completely, in which case you can duplicate it. Failing this, study the reviews in the technical press; do not rely on one man’s tests and opinions. Consider only apparatus made by firms of established reputation, and buy it from a specialist dealer who is accustomed to long distance trading and who will guarantee safe delivery and satisfaction. Having made a provisional

choice, write to the technical advice department of one of the journals, stating your intentions and asking for an opinion, together with advice about any items on which you feel doubtful. These people are quite unprejudiced, and will do their best to help.

Installation

This section should be read in conjunction with the following one, “*Listening to Stereo*”, because some of the problems of installation are problems of arrangement—for convenience and for best results acoustically. Together, these create the listening environment which (if the potentialities of stereo are to be realised in the way indicated in the *Introduction*) must not obtrude upon, clash with, or obstruct the environment of the performance. It therefore seemed best to deal with this part of the subject, particularly with respect to the actual loudspeakers, under the heading of “*Listening to Stereo*”. The present chapter will consequently be largely, though not entirely, devoted to connecting up and keeping things working smoothly.

The installation of equipment will often be carried out by the dealer from whom it is purchased. Do not let his engineer run away too quickly; make sure that the apparatus really *is* working to your satisfaction on all inputs before he goes, or you may have to fetch him back again next day, to your annoyance and his. When everything is going properly, there will still be something left for you to do, as will be seen later; but let us begin at the beginning.

Assuming that you have chosen the equipment you wish to use, the next step is to *plan* the installation before it arrives—indeed, before you even order it. This means considering its position in your room, and ways of housing it. In the last analysis these are personal matters, but there are a few general principles which should be observed. In the first place, the less noticeable the equipment is the better, no matter how proud you may be of it. “Lose” it in the room as far as you can; you will not be able to do so completely, of course. The commonsense place for the playing desk, tape machine and controls is adjacent to your favourite chair, and at such a height that you can operate it without getting up. The loudspeakers should be as far from the listeners as the room will allow, but leave their actual positions as flexible as possible; we shall return to this subject later.

Place the Items Securely

Whether the gear is housed in one or more cabinets, or placed on shelves or tables, these things need to be solid, heavy and supported on a good firm floor where there is as little “spring” in it as possible. This is in order to avoid acoustic feedback, or the transmission of vibrations to the playing desk from the movements of people in the room. One excellent scheme, capable of extended application, was outlined by the editor of *Hi-Fi News* in the October 1961 issue, illustrated by a photograph of his own equipment, which is reproduced in **fig. 9:1** and which, to quote Mr Henslow, “shows the system in



Fig. 9:1. *One way of avoiding transmission of vibrations to the turntable is to mount it on the wall. A main structural wall should be used rather than a partition.*

its most primitive form". There is no doubt that wall mounting is ideal for a playing desk. To quote Mr Henslow again "You could . . . walk an elephant across the floor without causing the stylus to jump a groove".

It is equally true that there is no reason why the lower part of the motor cannot be enclosed in a suitable box, and a lid fitted to open in whichever direction is most convenient, if the user feels (as I do) that the thing would be both better looking and less obtrusive if this were done. There need be little or no restriction of the freedom of movement for handling discs. The tape machine is admirably placed, and pulls out for use. The whole idea of wall mounting is capable of an infinity of variations according to conditions, and merits very serious consideration.

Plinths versus Legs

Where a single cabinet or a "Build up" of units is used to contain all the equipment other than the loudspeakers, avoid elegant slender legs; in handling dozens of cabinets fitted with them, I have so far not come across one which had the solidity and stability needed, and I think it unlikely that I shall do so in the future. If you *must* have legs on the cabinet, the shorter and thicker the better; but I prefer the type which goes down to the floor or stands on a shallow plinth. Incidentally, if the cabinet has to be moved sometimes, Shepherd *Minicasters* fitted to the bottom, or to the plinth, will be found very suitable.

Horizontal extension—i.e. a long, low cabinet—is preferable to vertical extension, in spite of the additional floor space occupied, both on grounds of convenience and sound "engineering". This is because the worst possible place for the pickup is immediately above the main amplifiers, from the point

of view of hum induction. Also, unless the cabinet is quite inconveniently tall and the back is left completely open, a pre-amplifier and radio unit mounted between the main amplifiers and the playing desk or tape recorder, stands an excellent chance of being "fried", and this shortens the life of components. A horizontal cabinet allows a much better distribution of units, if it is well designed, with the playing desk to the side of the lower amplifiers. Whatever the method adopted, there *must* be good ventilation and free circulation of air round the main amplifiers.

Under difficult conditions, special methods may have to be adopted. **Fig. 9:2** shows a system devised and proved in practice by Mr R. E. Cooke (lately of *Wharfedale*, now of *K.E.F. Electronics*) for isolating the pickup from floor vibrations. It can easily be adapted to suit a horizontal cabinet by the use of an extra slab and pair of damping blocks. I do not suggest that you should start like this, but domestic conditions do exist in which this has proved the only cure for trouble, and even concrete slabs and damping blocks can be disguised! Arrange, if you can, for the motor board or tape deck to be flush with the top edges of the cabinet; digging about in a shallow pit is inconvenient, especially from an armchair position.

So much, then, for cabinets and playing desks. What about putting the

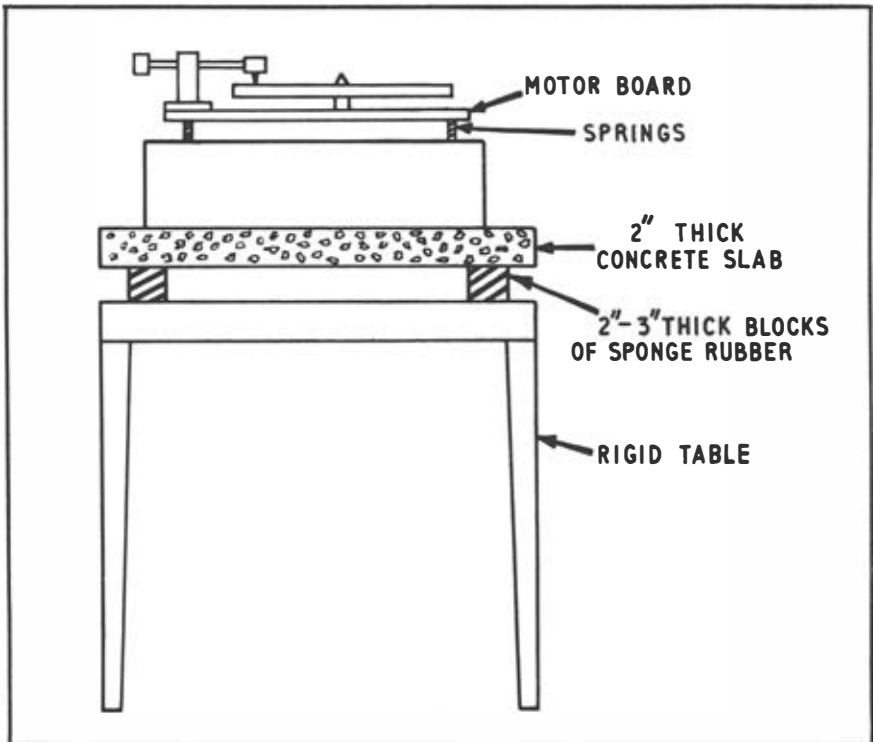

Fig. 9:2. In extreme cases, where vibrations are being transmitted through the house structure, the turntable may be "decoupled" by means of the inertia of a concrete slab.

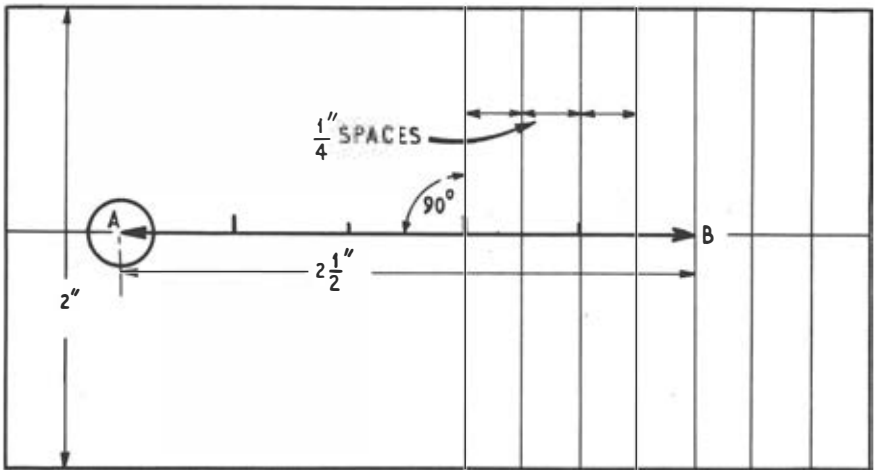

Fig. 9:3. This cardboard template makes pickup alignment easy. With the turntable spindle at A and the stylus tip at B, the pickup shell or cartridge should line-up with the parallel lines.

components into them, if, as may well happen for a variety of reasons, you do it yourself? A good thick (minimum $\frac{1}{2}$ in. preferably $\frac{5}{8}$ in. or $\frac{3}{4}$ in.) motor board is essential. It is worthwhile checking this point when buying a ready-made cabinet. If you are saddled with a thinner one, and cannot match the timber finish with a thicker one, get a piece of plywood properly glued and screwed to the underside before getting the cut-out done.

Springs not Recommended

Spring mounting of motor plates tends to increase rather than decrease the incidence of motor rumble; so if springs are provided for mounting the motor on to the board, do not use them. Instead, use rubber grommets on the mounting bolts above and below the board, so that the motor plate is just clear of the board, not touching it anywhere, and so that the nuts below are screwed up on to a rubber grommet or washer from below.

When drilling the bolt holes, make them larger than necessary so that the bolts will go through easily, clear of the holes, and bush the holes with felt or valve rubber. Make the motor board slightly smaller—about $\frac{1}{16}$ in. all round—than the aperture, so that there is no contact between board and cabinet sides. Strips of foam rubber—not the soft plastic foam used for draught exclusion—or felt should be placed on the bearers before the board is put in position. Do not screw it down. Its weight and the grip of the rubber will keep it in position nicely, and there will be no direct contact between motor plate and board or between board and cabinet. Do not mount the pickup on the motor plate itself if you can help it; it is better on the board, screwed down evenly—not viciously—with small rubber washers between base and board.

In general, the templates supplied by manufacturers for mounting their pickups are accurate, and they should be carefully used according to instructions. Accuracy in mounting a pickup is of the greatest importance for avoiding

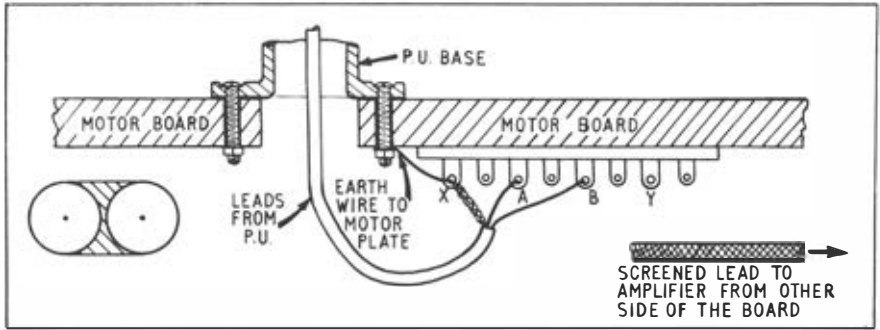

Fig. 9:4. The hole in the motorboard should be elongated for easy adjustment by drilling two holes and filing. Pickup leads should be looped to avoid drag.

distortion due to tracking error. If inaccuracy creeps in, it is much more likely to be the user than the template which is at fault. After positioning, a simple check can be made with a little device made with a piece of card, as shown in **fig. 9:3**. It is a good idea to make the centre hole for the pickup base in the form of a slot by drilling two holes as close as possible together, one behind the other, removing the surplus wood between them with a chisel. Such a slot allows any small movement forward or backward to be made easily; and if at any future time a different pickup head is used, making it necessary to reposition the arm base, it can be quickly done with a minimum of trouble. (See **fig. 9:4**).

Set the motor board level. A small circular spirit level is an excellent investment. Tilting the motor board to secure dynamic levelling has now, fortunately, been abandoned. This tilting in order to counteract the forces which tend to pull the pickup inwards towards the centre of the disc and which give unequal pressure on the groove walls, is bad practice. Simple devices are available for attaining this desirable end which, for stereo, is most necessary. These accessories are obtainable for use with the *S.M.E.* and some other pickups, and a method which has appeared in various slightly different forms was outlined in the April 1961 issue of *Hi-Fi News* by Mr D. A. Wratten, and is reproduced in **fig. 9:5**.

When deciding where to put a pickup in relation to the motor—where the makers have left you a choice in the matter—good guiding principles are to arrange for the pickup to lie easily under the hand, and for both base and the head in its passage across the disc to be as far from the actual motor as possible. Again as an example, using the *Garrard 301* motor, the arrangement shown in **fig. 9:6** gives good results, particularly with magnetic pickups sensitive to hum induction. The “301” with its “cut-away shoulders” allows freedom of choice in pickup mounting position, as does the *Connoisseur Craftsman 2-speed* on its banjo plate and the new *Connoisseur Craftsman 3-speed*.

Even when using a thick motor board such as described, it is a good idea to screw a couple of lumps of metal, lead, brass or iron to the underside of the motor board to make it as heavy as possible—the heavier piece on the side

Fig. 9:5. Side-thrust may be compensated by applying an anti-clockwise moment to the pickup arm, using a weight pulling on a thread. By adjusting the weight and angle θ the pickup will remain stationary at any point on a rotating blank disc

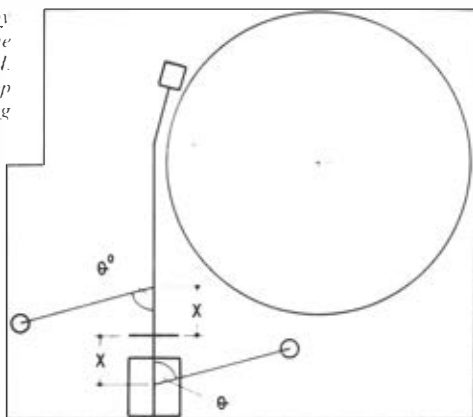
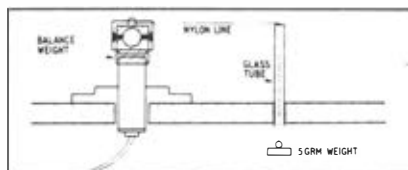

opposite to the motor unit itself to counter-balance its weight. The heavier the board, the less easily it will vibrate. Possible positions for these weights are shown by dotted lines in **fig. 9:6**. If necessary, check and adjust the angle of the stylus relative to the groove, see **fig. 9:7**, and the playing weight with a *Garrard* or *Acos* pickup gauge.

Unless your amplifier is of the integrated type (in which case it will presumably stand on a shelf or table) the main or power units are best out of the way, down near the floor, whether in the bottom of a cabinet or on a shelf. Pre-amplifiers can be placed wherever you like; they are fully screened as a rule and do not carry transformers or chokes likely to cause hum troubles. Do not alter the length of the cables connecting them to the main amplifiers, because these cables act as capacitors of a known value, and altering them can affect the frequency response of the equipment; they are usually longer than you will find necessary, so take care not to let the surplus rest on top of the main amplifier's power valves!

The installation of a tape deck offers few problems; none if it is a complete recorder or "Hi-Fi Unit" in its own case. If the deck and tape pre-amplifier are separate units, the same remarks apply as in the case of motor units and pre-amplifiers, but the deck needs only to be screwed down firmly to a good solid board in an approximately level position.

Connecting Up

Connecting up is an important operation, which *can*—(though *not* if reasonable care is exercised)—culminate in a blinding blue flash, the cessation of the electricity supply, a noise like a gargantuan beehive, or a fizz and a wisp of smoke from the loudspeaker cabinet, indicating that the unit has been connected to the mains! Connecting up is largely a matter of putting the correct plugs into the proper sockets, according to the instructions supplied with the units, but there are usually some plugs to be wired before connections can be made, and also some earthing to be attended to.

Fig. 9:8 shows the proper way to connect wires to mains plugs, **fig. 9:9** to phonoplugs, and **fig. 9:10** to standard co-axial plugs. The only tools you will

need are a soldering iron, a small screwdriver, a pair of wire-cutting pliers and a wire stripper, together with a small supply of fluxcored solder. You can probably borrow a soldering iron if you haven't one; in extremity you *can* cut the wire with scissors, though preferably not those used for dressmaking; you *can* strip the wire with your pocket knife, but the result will probably be a cut thumb or a reduced number of conductors in the flex, or both!

Earthing

Earthing is very important. Your amplifier will be provided with an earth point, or will be fed by a standard 3-wire lead. If the former is the case, then all the rest of the gear must be earthed *once* to the amplifier *and nowhere else*, and the amplifier earth point itself must be connected to your main "earth" point—the third pin on the mains plug, if the house wiring is modern and satisfactory, providing a proper earth. If the latter is the case, then all other units plugged into it by co-axial cables will automatically be "earthed" as well—except perhaps the pick-up arm and the base-plate of the turntable and motor, and a single wire may be used to connect these to the mains "earth" via the large, "earth" pin on the plug.

We are now in a position to look at the interconnection of the various units, beginning with the pickup. More pickups are now being made with plug-and-socket connections at the base of the arm, which is an excellent thing. If your pickup is made like this, there is really nothing more to be said about connecting it. The wiring will have been done correctly by the maker. Simply follow his instructions. In this case it will be best to earth the motor separately, as mentioned above, either by means on a wire from the tag provided on the underside of the motor plate directly to the amplifier earth point, or to the 3-pin plug. Unless the instruction leaflet tells you something different, the arm will be earthed automatically, through the plug and socket connections.

Screened Pickup Leads

If your pickup is supplied simply with screened leads protruding from the arm base, cut them off about 6 in. below the base. Get a small 4-tag board and screw it to the underside of the motor board, immediately adjacent to the central hole for the pickup base. Leaving a loop as shown in **fig. 9:4**, connect the leads to the tags. From the other ends of the tags, continue the wiring to the control unit, using screened leads, and connecting screens to screens and live to live, as on the pickup side of the board. Connect the earth tag on the motor plate to the pickup arm by means of a tag on one of the bolts, and continue the wire to one of the "screen" tags on the board. Motor and arm are then earthed when the pickup leads are connected to the control unit.

Alternatively, and perhaps better, join earth tags on motor and pickup arm together as described, and take this separate lead directly to the amplifier earthing point. If your pickup has a common earth connection—i.e. three wires,

2 live and 1 screen, instead of four— proceed in the same way, using only three tags instead of four, but in this case use twin screened lead (2 insulated wires within one screen) on the amplifier side. *Shure Electronics*, 84 Blackfriars Road, London SE1, produce a most useful set of leads, No. A30C for 3-wire stereo installation which can be used with advantage in practically every case, and includes a separate wire for motor and pickup arm earthing.

By this procedure we are trying to avoid earth “loops” which cause hum and so spoil the reproduction. We have therefore to be careful that everything is earthed once only. There are other causes of hum, of course, but installation along the lines suggested will take care of them. Earth loops are the most common cause of hum trouble.

Interconnections and loops

If your amplifier is of the integrated type, or if your control unit and amplifier come from the same maker, connecting them together will present no problems; but if they are by different makers, it is possible that the leads between them may form a loop. The control unit is usually earthed via the H.T. negative lead, and if there is a separate, screened “audio” lead from it as well, the screen will have to be disconnected at *one* end in order to eliminate a loop. The same remarks apply to radio tuners. If a self-powered tuner is used, do *not* wire it to the mains by means of a three-pin connection. Cut back and tape up the *green* lead, and connect the red and black only to the plug. Do not earth the tuner; this will be done automatically by the screen of the audio lead.

A separate tape machine should be treated as such—earthed separately only when, and if, it is used independently. Use a 2-pin connection to the mains and, when you are recording in the church hall or elsewhere, take along a length of five or six yards of wire with a crocodile clip at one end, so that you can earth to a radiator or other suitable point, and join the other end to the green wire on the recorder lead by means of a phono plug and socket. When the machine is used in conjunction with the equipment at home, and when the *tape in* and *tape out* sockets are both connected semi-permanently

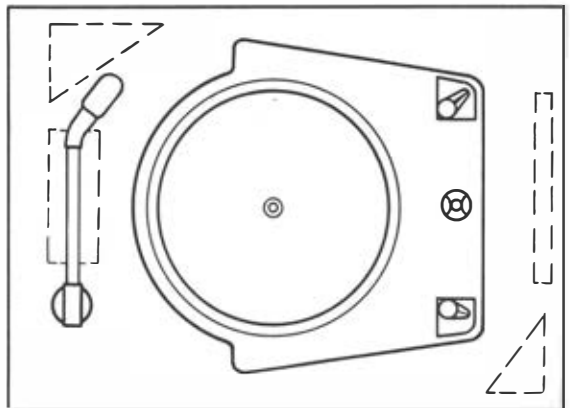

Fig. 9:6. *In troublesome cases it may be necessary to fix pieces of brass to the baseboard underside to minimise transmission of vibrations to the pick-up arm via its base.*

to the pre-amplifier, a 2-pin connection should be made to the mains, and the screen of *one* of the leads to the control unit should be disconnected at one end.

When installing your equipment, the best way is to make the external earth connection to the amplifier first, and then add the other items of equipment, one at a time, checking that each one is earthed to the amplifier, *but earthed only once*. Keep the leads from the pickup to the control unit as short as you conveniently can, and as far away as possible from mains carrying components. If hum is present on test, try moving the pickup leads (without switching off) until a position of minimum hum is found, and then anchor them. In some cases, a movement of three inches will clear hum completely. The installation of loudspeakers will be discussed in the following chapter; there is, of course, no need to use screened leads for connecting them to the amplifiers. In domestic conditions, ordinary twin flex is perfectly satisfactory, though in halls, where the speakers are a long way from the amplifying equipment, heavier flex should be used.

Two final words on the subject of installation, a *do* and a *do not*. *Do* sit down with each piece of equipment in front of you, and read the maker's instruction book slowly and carefully *before* you go to work. *Do not* switch on the mains before you have checked that the voltage selector on *each item* connected to the electricity supply is correctly set to the voltage stated on your meter or distribution board, and not before you have re-checked every connection which you have made.

Maintenance

It must be made clear at once that this section of the book will not (and is not intended to) turn you into a service engineer in one easy lesson, or enable you to dispense with the instruments, skill, and experience of these busy and invaluable people: exactly the reverse in fact. Some people treat their sound reproducing equipment as they do their watches: take them for granted until they give trouble. "This has been a marvellous set, you know, old man. I've had it for five years now and never spent a penny on it. Never even changed a valve"!

Such a remark is, of course, a testimonial to the reliability of the particular maker's products, but the operative words are "has been". It certainly is not a marvellous set now, though the owner may still be content with the noise it makes. Deterioration takes place so slowly that it is often imperceptible unless we hear another set of equipment and notice the difference. This does not mean that we must be forever tinkering with our gear—so anxious about

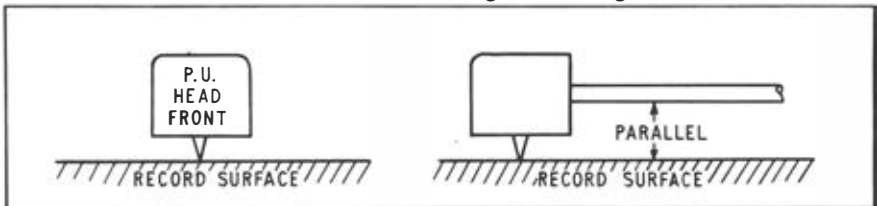

Fig. 9:7. The pick-up should be set-up so that its underside is parallel to the record surface, especially when viewed from the front.

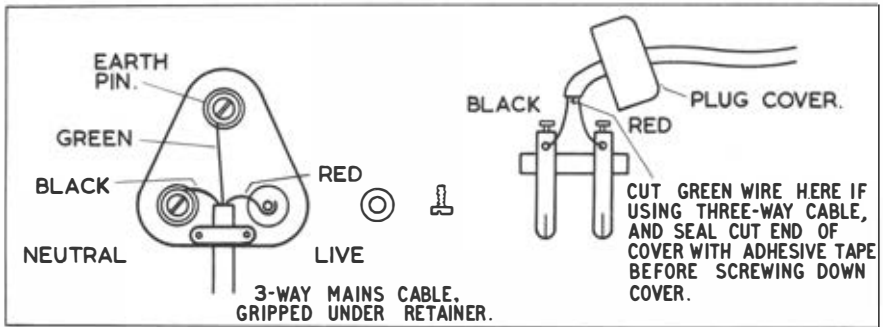

Fig. 9:8. This shows the correct way to wire-up 2-pin and 3-pin mains plugs.

it that we become obsessed with the means at the expense of the end; we need to steer a middle course.

In general, it is a sound principle to leave apparatus alone so long as it gives satisfaction but, with average use, a year is about as long as it can be expected to go without some falling off in quality. An annual overhaul is not an expensive luxury, and it will pay good dividends in the maintenance of quality and the avoidance of both listening fatigue and breakdown at inconvenient moments. A good time for this annual service is while you are away on holiday. Service engineers are busy people, and their attention cannot always be secured within an hour or two; if you give them time to breathe by letting them have your equipment for a week or so while you are away rather than rushing them to get the work done quickly, they will appreciate it and will be able to give more detailed attention to your apparatus.

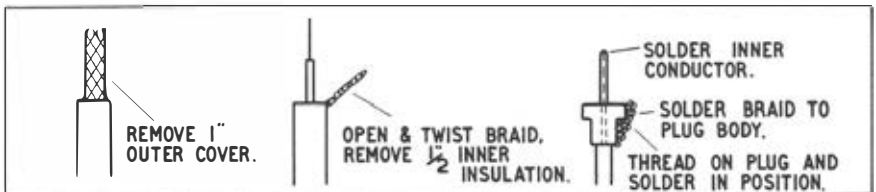

Fig. 9:9. This shows the correct procedure for connecting small metal phono plugs to co-axial cable.

The things which you can do for yourself to keep gear running sweetly are three in number: reasonable care in handling, cleaning, and oiling. Keep all instruction books together in a safe place for easy reference. They will give you invaluable information on the little jobs of maintenance we are discussing: how to remove the turntable from your motor, where and how often to oil it, etc. When carrying out this essential operation, do not bath the motor in oil, and be very careful to see that none gets on the driving pulley, rubber idler wheel or the inside edge of the turntable, which should all be cleaned with a dry, lint-free cloth.

After each playing session, dust the pickup stylus carefully with a camel hair brush—the type sold in a small case for cleaning camera lenses is excellent

for this purpose—using it in a backward and forward, not sideways, direction. When playing a new record which has not received *Parastat* treatment, this needs to be done after each side. If your pickup arm is of the transcription type, with adjustable balance, re-check it from time to time. After a couple of years of average use, return the pickup head to the makers for examination and stylus check: this, of course, assumes a diamond stylus, fortunately now almost universal.

Dirt and oil in the wrong places are the chief enemies of tape recorders—as harmful as they are to discs and their playing equipment. On tape machines, tiny particles of the oxide tape coating and dust from the atmosphere build up on the heads. Every month or so, the cover should be removed and the faces of the heads dusted with the camel hair brush, or a soft cloth. The capstan and pinch wheel should be carefully cleaned with a lintless rag, such as a well-worn old handkerchief moistened with carbon tetrachloride.

Do not use oil on the machines at all, except in accordance with the instruction manual. After a time, the heads will become magnetised, and if they are allowed to remain in this state they will cause an increase in background noise. If you take the machine to your dealer, he will de-magnetise them on the spot at a very small charge, but the best procedure is to buy a “de-fluxer” for about 50s. and do the job yourself about once a month—every time you have the cover off for cleaning. Avoid bent or warped tape spools: they can cause wow.

This is no place to go into the business of fault finding and correction. Unless you are well informed and practised technically, you will be well advised to leave this to the professionals, who have the proper instruments for the job. One point needs making here: amplifiers and recorders are usually fitted with fuses, so be sure that you always have one or two spares of the right type and rating in the house. If the equipment suddenly goes dead, or if there is no sign of life when you switch on, one of these fuses has probably blown. *Switch off*, unplug, check with another piece of apparatus (such as a fire or iron or lamp) to see whether there is current at the mains plug, replace the fuse, plug in and switch on. If the fuse immediately blows again, there is something amiss. You should switch off, and send for the service engineer.

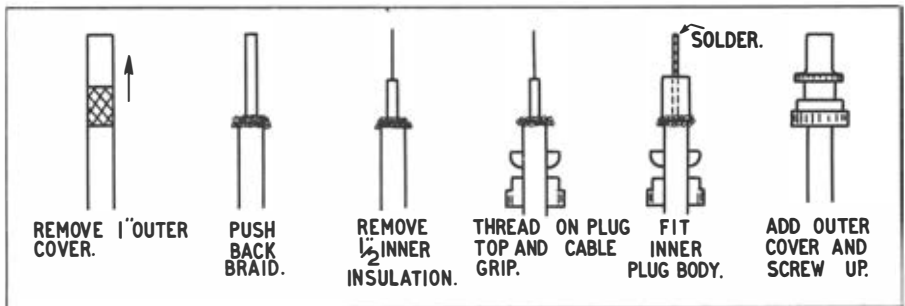

Fig. 9:10. Co-axial plugs are a little more *difficult* to fit than phono plugs, but they make a thoroughly screened connection.

LISTENING TO STEREO



Readers who have followed me so far will have gathered that I do not believe it possible to get worthwhile stereo reproduction by a “slap-happy” approach. This may be considered a nuisance, but stereo reproduction is an art and is therefore itself dependent on the proper use of well made and designed tools, so we cannot dodge the elements of thought and care, even if we would. Stereo equipment is an investment which we choose like any other. In previous chapters some of the factors which may influence our choice have been discussed; our records, on disc or tape, are the subjects of regular advice from **experts**—but how we handle these things when we have them, and consequently the degree of pleasure and permanence which our investments provide is, to a very large extent, under our personal control. And in this connection, Shakespeare’s famous words, *Neither a borrower nor a lender be . . .* are very applicable to precious discs and equipment.

Listen to the music—not the Equipment!

Next, having spent a not inconsiderable sum on stereo equipment, it will pay to take the little extra trouble needed to create an environment for it—and for those who are to listen to it—in which sound reproduction can, and does regularly, become sound re-creation. Few people want to listen to a reproducer of any kind; they want to listen to a performance, and in this chapter it is proposed to discuss the factors other than the actual choice of the equipment which help to make this experience possible.

Listening is a concentrated activity of the mind, not merely a function of the ear. In the case of listening to music, it can be an exhausting activity, especially for those relatively unpractised. Indeed some people seem to find it impossible. We all know the sort of visitor who suggests some music, and then breaks into animated speech immediately it begins, pausing now and again to sing, hum or whistle an inaccurate version of the main tune, a bar

or so behind the performers, thus showing how much he is enjoying what he would call listening!

Why do we listen to music at all? Surely because it gives us pleasure, which on analysis we find to be partly intellectual but mainly emotional. All art, ultimately, affects our feelings; if it does not we find no pleasure in it, and commonly express the fact in the phrase "It leaves me cold". But, as we gain experience, our feelings are controlled to a greater degree by our judgment, which is an intellectual quality, a function of the mind. We seldom begin by liking the best things. Taste develops slowly. This taste may well differ from our neighbour's, but in any subject of which we have more than superficial knowledge we are well aware of the increase in enjoyment which comes with the exercise of discrimination. In the sphere of music this is as true of the actual quality of the sound itself as of the musical ideas which it expresses, although these ideas are more important; and this is equally true of reproduced as of live sound.

Check the live and the reproduction

However great the work that is being performed, our pleasure is marred if the strings of the orchestra play with faulty intonation, or if the oboes are sour, or if the singer is obviously suffering from a cold. Equally, our pleasure is marred if our reproducer makes a distorted noise, or if the music sounds "canned". With these things in mind, it is a good thing to check our reproduction against experience of the real thing as often as possible, if we are not to be the victims of more subtle irritations. We have said that listening can be exhausting, but listening fatigue is much more common with reproduced sound, and more so with mono than with stereo.

The development of listening fatigue is subconscious, and is the result of our ears and mind being overworked in the effort to supply deficiencies, or to

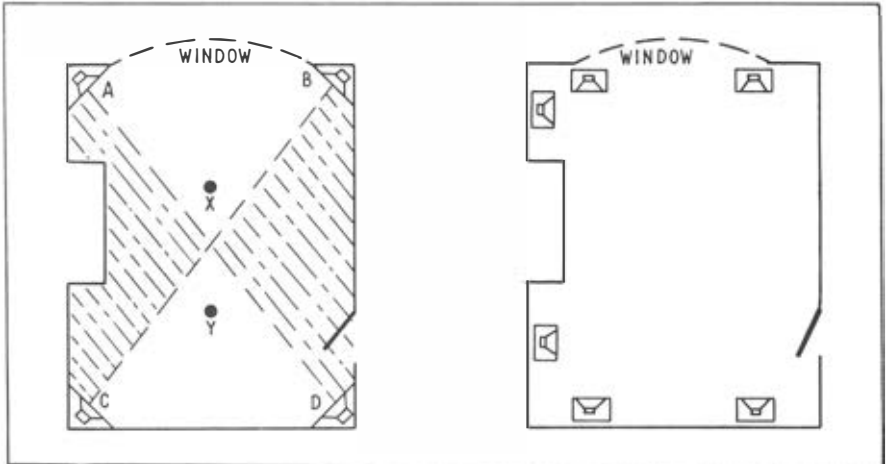

Fig. 10:1. Free-standing speakers may be placed at any position shown on the right, but corner enclosures are confined to A, B, C and D. With speakers at AB or CD there should be good stereo behind X and Y respectively, but when using AC or BD good listening may be confined to space between and behind XY.

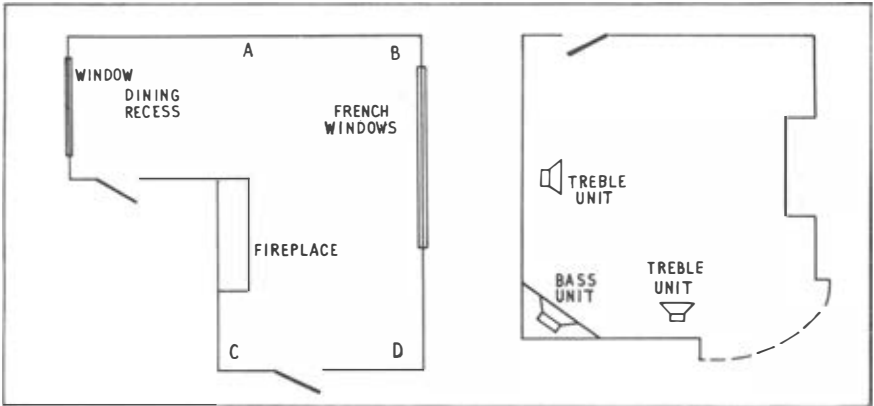

Fig. 10:2. *In an L-shaped room positions AB or CD would be suitable for speakers, while a "satellite" system could be as on the right.*

eliminate additions in the sounds they receive. They strive constantly for clarity and balance, and good stereo makes a notable contribution to the elimination of listening fatigue. This is due to its increased clarity, separation and ambience—and, consequently, its more natural perspective—and it can be aided by the proper use of our equipment.

If you can, choose the largest room in your house for your stereo, unless it happens to be noisy—for example by reason of close proximity to a main road. If the choice must lie between size and quietness, choose quietness. If the room is an "odd" shape, so much the better, acoustically, as a rule. If you have a piano, put it in another room if possible. The strings are easily set vibrating by the loudspeakers, producing an unpleasant humming effect. Make the listening room rather "dead" if you can, by the use of a thick carpet, heavy curtains and well upholstered furniture. Avoid ticking clocks, squeaking chairs and lights which glare into the eyes. Do not place table lamps, vases, or other small objects on or near the loudspeakers unless you stand them on rubber mats, because the volume level at which such things will buzz is surprisingly low.

Speaker Positions

Of the many points which need to be thought about in the setting up and arrangement of stereo equipment for optimum results—by which we mean the attainment of the greatest and most lasting pleasure for the owner and his family and friends—perhaps the most crucial is the positioning of the loudspeakers. If stereo is to take its proper place, naturally, as it should in our homes, it must be accepted and arranged in a natural manner, without continuous disturbance or regimentation of the listeners as a result of striving for maximum "effect".

The listening room and its furnishings constitute the frame within which stereo must be fitted, and some compromise is almost inevitable. The posi-

tioning of loudspeakers is a matter for patient experiment. Results cannot be assessed in ten minutes, nor can we expect to be able to put the speakers down in what seem the obvious places and assume that all will be well. The best positions cannot be found immediately, or by guess-work, but only by careful listening to a variety of reproduced sounds. As a starting point for your own adventures in stereo it may be useful to remember the following points:

(a) That a corner position will strengthen bass response. If your chosen loudspeakers have been specially designed for use in corner positions they must be used in that way.

(b) That within the confines of an ordinary living room the further the listeners are from the speakers, the better the results are likely to be. For the greatest possible enjoyment of stereo, the apparatus should be self-effacing. It should not obtrude itself between you and the music. If you notice bass or treble particularly in reproduction, you almost certainly have too much, and it needs controlling. One cannot easily hide a couple of 9 cu ft brick reflex cabinets under chairs, but even if your speakers are large they can be merged into the room by suitable finishing, and there is usually no need to sit a couple of yards away, looking at one or other of them. It is almost impossible to get good reproduction if you do—even with stereo.

A Basic Guide

Figures 10:1 to 10:3 show basic speaker arrangements for stereo which have been found satisfactory. "You pays your money, and you takes your choice!" If you are using corner speakers, the distance apart will be decided for you by the length or width of your room; otherwise this distance is variable, according to conditions, from about 8 to 12 ft—the further the better, so long as there is no "hole in the middle". This effect is more often due to the use of widely spaced microphones in recording than to excessive distance between the speakers in reproduction, and causes them to sound like two separate units instead of the creators of a homogeneous sound pattern between them.

Whenever possible, listeners should be at least as far from the speakers as the speakers are from each other. Maximum stereo effect will always be received by a listener on the centre line between the speakers, but with proper orientation good stereo should be obtainable across the whole space between them. The most precise location of sound sources will be obtained from directional speakers properly positioned and angled, but columns and other omnidirectional types will provide a good "spread", with less trouble in positioning. Where a room has two walls longer than the others, best results are usually produced by spacing the speakers across one of the shorter walls. Too many highly reflecting surfaces can muddle and spoil stereo, and direct obstructions in the sound paths from the speakers should be avoided; for this reason, units radiating the higher frequencies should preferably be at a minimum height of 3 ft from the floor. When buying speakers, the room in which they will be used and the furnishings with which they will have to "live"

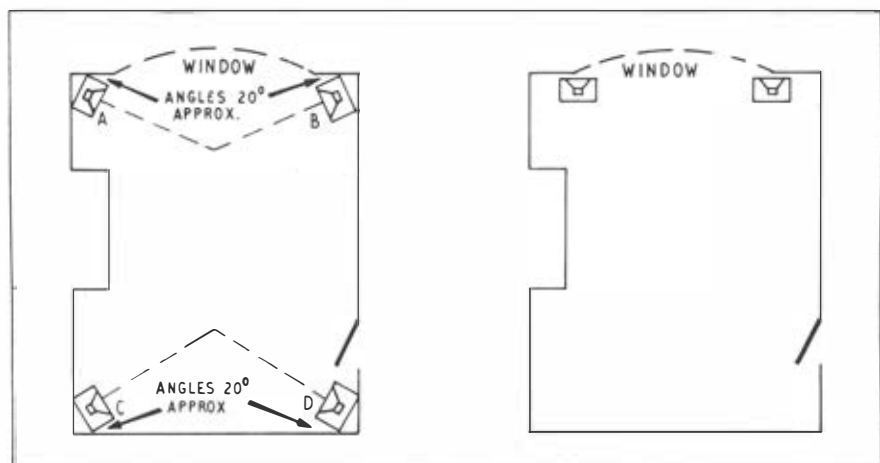

Fig. 10:3. Excellent results are often obtained with speakers facing back towards the walls, as on the right. With forward-facing units better stereo is sometimes obtained if the speakers are faced in towards each other at a quite steep angle.

must not be forgotten. A home trial when buying one loudspeaker is highly desirable; when buying a pair for stereo it is almost essential.

Before any attempt can be made to position the speakers, their phasing must be checked. The easiest way to do this is to place the speakers *close together* and play a test disc or tape, or one containing well sustained deep bass notes. Having done this, reverse the connections to *one* of the speakers, and repeat. You will notice a marked difference; in one case the bass will be louder, firmer and more solid than in the other. When this is the case, the speakers are correctly phased. If your amplifier has a phase reverse switch, use this instead of changing the connections round, but do not confuse this switch with *stereo reverse*, which merely changes over right and left *channels*, and which has nothing to do with speaker phasing.

Your object in positioning the speakers will be to produce the best sound quality and balance obtainable in the room, combined with the widest stereo spread and a normal arrangement of furniture. Do not be in a hurry to finalise the positions. When using speakers which radiate directly forward, some soft furnishings or curtains on the opposite walls can be helpful in reducing reflections.

Balancing

Having phased the speakers and positioned them tentatively, they must be balanced by the use of a test disc or tape which includes a centralizing signal—such as a single person speaking or a metronome ticking. Standing or sitting on the centre line between the speakers, and as far or further from them than they are from each other, listen to this signal while someone else adjusts the balance control on the amplifier until the sound is exactly centralised between the two loudspeakers. This done, you can move around and note the extent

of the apparent deviation of the signal from the centre position between the speakers while someone else makes small adjustments to their angle. Testing can then continue with music, the crucial test being the effect which you receive when you are sitting in your normal position in the room.

If one or both of the speakers are moved, in order to try the effect of another position, the centralizing process will have to be repeated; and once the speakers have been correctly phased, see to it that the wires and connectors are clearly marked, so that if they need to be disconnected there will be no need to repeat the phase check. All this may sound very laborious, but in the end we are likely to get out of our stereo just about as much as we put into it at the beginning—that is, during the first few weeks. When comparing results after moving speakers, it is essential to use not only the same records, but the same volume and control settings. Varying more than one thing at a time will completely confuse the issue.

Once your speakers have been positioned to your satisfaction, and civilized arrangement of the furnishings of the room have been made in relation to them, do not disturb it on theoretical grounds by arranging chairs in the shape of a triangle, or in rows facing the speakers. Such a procedure is not merely unnecessary, it is positively idiotic, despite any illustrations you may see in books, magazines or leaflets. You will have established the framework within which your sound will manifest itself, and a satisfactory position for yourself within it. Let people sit where they like within that framework. If your stereo is worth having, they will find satisfaction wherever they choose to position themselves. Given a good source, you will find that wherever you or your friends sit, enjoyment of the music is more natural, less fatiguing, more complete than before. After all, one does not usually refuse to attend a concert because one cannot have the centre seat in the front row of the balcony.

Do not use the “Gimmick” discs

May I suggest that you avoid buying stereo “sampler” or demonstration records, apart from the one necessary for setting up your equipment? They are full of “gimmicks” which will encourage you to listen to stereo in the wrong way, concentrating first on one channel and then on the other, listening to left and right instead of to the whole.

The purpose of the various controls provided on the pre-amplifier is to make the equipment versatile and flexible, to enable it to be adjusted to suit the record, the loudspeakers, the environment and the listeners. The one which will perhaps affect your enjoyment more than any other is the “*volume*”, or as it should properly be thought of, the “*distance*” control. As was mentioned in the introduction, much used to be made of the ability of “*Hi-Fi*” to “bring the players right into the room” and one can still come across equipment used in this way, rather than as a means of transporting the listeners to the place where the recording was made. The kind of reproduction you like is closely related to the seat you choose in a concert hall, assuming that you frequent these places. If you do not, it is difficult to know by what standards you judge the realism of reproduced sound

QUESTIONS AND ANSWERS



Q.1. *Can I use a stereo pickup to play mono records?*

A.1. Yes, certainly, but if the mono records have already been well played with a mono pickup you may have trouble because of the 0.0005" stylus "bottoming" the groove, causing distortion. If you intend to use the same pickup for both mono and stereo discs you will probably be wise to choose one fitted with 0.0007" or " $\frac{3}{4}$ thou" stylus. Stereo pickups respond to vertical as well as lateral vibrations, which will make motor rumble more troublesome, if you have any. It is a good idea to have a switch fitted to connect the pickup channels in parallel, unless there is already a switch on your pre-amplifier for this purpose.

* * *

Q.2. *I have to buy my stereo equipment gradually, because I cannot afford the outlay to get it all at once. I have bought a stereo pickup which matches my mono pre-amp and I intend to get a stereo pre-amp and another main amplifier by the same maker in due course, and then another speaker. How should I connect the stereo pickup to my mono pre-amplifier? Shall I be able to use the stereo pre-amp for mono until I complete the set-up? and can I buy stereo records now and play them with my stereo pickup through my mono gear?*

A.2. The answer to all your questions is "Yes". You should connect the two channels of your stereo pickup in parallel, and then feed into your mono pre-amplifier. If you use your stereo pre-amplifier temporarily with one main amplifier, have a "dummy load"—a resistor of correct value and rating—fitted across the output of one channel. This can be removed in a matter of seconds when you get the second main amplifier. If you are going over to stereo fairly soon, it is quite a sound idea to buy stereo discs now, and play them through your mono gear; but, if it is likely to be a year or two before you complete the installation, I would stick to mono discs for the present, unless your stereo pickup is one of the very best types, tracking at 3 grammes or under, so that you may be certain that your stereo discs are in perfect condition when you are ready to take full advantage of them.

Q.3. *I would like to use a third speaker in between my stereo pair, as advocated by the designer of the Klipshorn, Paul Klipsch, in the United States. Do you think this is a good idea, and how ought I to go about it?*

A.3. People vary considerably in their reactions to the use of a third speaker. I have been present at demonstrations where more than half the audience considered that reproduction showed an improvement when a third speaker, centrally placed, was introduced; although, unknown to them, it was deliberately left unconnected! Under domestic conditions, I have never found any necessity to use a third speaker for two channel stereo, nor any improvement from its use, sometimes the reverse: while those who have thought that an improvement was made have not considered it sufficient to justify the extra expense. In such cases, it has usually been possible to effect a similar improvement by adjusting the existing apparatus, giving careful attention to the placing and angling of the speakers. However, if you intend to pursue the idea, the third speaker (if you intend to connect it!) should have similar characteristics and efficiency to the existing pair, be positioned mid-way between, and fed with reduced power via a mixing transformer such as the *Wharfedale SMT1*.

* * *

Q.4. *I have a good mono moving coil pickup. Do you advise me to continue to use this for mono discs, or use my stereo pickup for both, with or without a separate mono head?*

A.4. If you have enough room on your motor board for another pickup, and your mono pickup is giving you satisfaction without record wear, keep it and fit the stereo pickup in addition. By and large, I prefer a mono pickup or head for mono discs, and there is little to choose between the best of the mono pickups, and the mono heads now available for the better stereo pickups. Any marginal advantage lies with the latter, which tend to lighter tracking pressures, higher vertical compliance and in some cases rather better response.

* * *

Q.5. *I can afford to spend just about £100 on equipment, having got rid of my old radiogram. Can I get a good quality stereo set-up for this sum, or do you advise me to stick to mono for the time being, and to change over to stereo in a year or two when I can spend some more money?*

A.5. If you can (and are prepared to) "do it yourself", you can assemble a good quality disc stereo reproducer for rather less than £100, and for very little over you can have radio as well, which you will presumably want, since you have disposed of your radiogram. If you have not the time or the inclination to build your own equipment, you will probably be wiser to keep to mono for the moment, until you can spend another £30 or £40 on a good stereo pickup and second speaker or power amplifier, but in any case I would get a stereo pre-amplifier now.

* * *

Q.6. *I do not understand the specifications which makers give of the goods they offer. These specifications nearly all say something like this:*

Pickup. *Output 5 mV. Range 20-15,000 cps. S.P. 5 grams. Rec. load 47 K ohms.*

Amplifier. *Output 10 watts per channel. Response 30-30,000 c/s, plus or minus 2dB. Distortion 1%. Filter 6 Kc/s and 9 Kc/s. H. & N. Minus 55dB. Output impedance 4, 8 and 16 ohms. Sensitivity: P.U. 5 mV and 60 mV. Radio 100 mV. Tape 100 mV. Mic. 3 mV. Will you please explain?*

A.6. It is not possible here to go fully into all the factors affecting a specification and its statement; an elementary knowledge of electronics and methods of measurement is required in order to appreciate them fully. However, here are some pointers of simple guidance which should be sufficient for your purpose. Take the pickup first.

The output of the pickup and the sensitivity of the amplifier are stated in the same terms, so that you may know whether the one will provide enough drive for the other. Generally speaking, these figures should agree, or match, within a few mV (millivolts) but if the output of the pickup is *greater* than the sensitivity of the amplifier, that does not matter, because it is easy to reduce it; but one cannot feed a pickup with an output of 5 mV directly into an amplifier with a sensitivity of 20 mV with satisfactory results. The recommended load on the pickup (47,000 ohms in this case) should correspond as nearly as possible to the input impedance of the amplifier if the stated performance of the pickup is to be maintained. In this case, amplifier input impedance is not stated, and it would be necessary to ask the dealer or maker about it.

The figures for frequency range stated in this instance do not mean very much (except that the pickup will respond to some extent to all frequencies within those limits) because the degree of variation of response is not stated. It ought to be within plus or minus 3 dB (decibel), in which case the range would be satisfactory.

S.P. stands for stylus pressure, or playing weight. The figure quoted by the makers is usually "safe", using their own arm if they produce one. It should seldom be necessary to increase this playing weight, but it may be possible, under good conditions (such as the use of a better pickup arm) to reduce it by a gramme or so, always bearing in mind that too little can be as bad as too much.

With regard to the amplifier, some guidance will be found in the chapter on *Amplifiers and Loudspeakers*. The quoted output power of 10 watts per channel will be adequate for all but very large rooms, and the response is perfectly adequate. 2 dB is about the smallest variation in intensity which the human ear can detect and, with this amplifier, the maximum possible variation, if the specification is maintained, is 4 dB over almost the whole audible range. The fact that the response falls away below 30 c/s is no bad thing; very few rooms will allow lower frequencies to be generated since, for this to be possible, the maximum dimension of the room must be not less than half the wavelength of the frequency required. Further, motor rumble can be a nuisance below 30 c/s. This amplifier may incorporate a built-in rumble filter which cannot be switched out; we are not told.

The information about distortion is adequate so far as it goes, but it does not go far! It has almost certainly been measured at 1,000 c/s, probably at

full rated output of 10 watts, and under such conditions it is as low as one could wish. What we would like to know, however, is the distortion level at the same power at 40 and 4,000 c/s, and this we are not told. Unfortunately, few amplifier makers give us this information, or even tell us whether their amplifier will provide their rated output at these frequencies.

With any sound source, distortion tends to increase and to become more irritating as the treble range is extended. This amplifier is equipped with a variable filter allowing the treble to be "rolled off" above 6 or 9 Kc/s, so that any distortion in the sound source can be reduced with a minimum of effect on the actual music, and allowing the bass and treble controls to be used for their proper purpose—compensation for the room and loudspeakers. The hum and noise level is satisfactory; anything below minus 60 dB is very good.

The output impedances refer to loudspeaker matching. Most speakers are 15 ohms, and would be connected to the 16 ohm tapping, but if two 15 ohm speakers were used in parallel, the impedance would be $7\frac{1}{2}$ ohms, and loudspeakers with 3 or 4 ohms impedance are occasionally met.

Pickup sensitivity has already been dealt with. The 100 mV radio sensitivity is perfectly adequate for all radio tuners. The tape input will accept the output from a tape pre-amplifier, the monitor or even the external speaker output from a recorder, and the Mic sensitivity of 3 mV is high enough for most microphones. The same remarks about matching of output and input, and impedances, apply here as in the case of pickups. The second pickup input of 60 mV is intended to cater for crystal types, which have a higher output and require a higher input impedance.

* * *

Q.7. *I have a disturbing hum which I cannot cure. All my leads are screened. I have tried changing them round with no effect. There is no hum when I switch to Radio, Tape, or Aux. If I disconnect the p.u. leads, the hum disappears.*

A.7. Unfortunately, it is impossible to pin-point the cause of hum in a given case without personal investigation, as there are so many possibilities. Here are one or two pointers towards some likely causes. First, read carefully the remarks about earthing in the chapter on *Installation and Maintenance*. Second, it is possible that your pickup may be collecting hum from the motor. A good test is to move the pickup across the record surface, with the motor running, as close as possible without touching the disc, and see if the hum "comes up" or varies when this is done. If so, see whether it is possible to re-position the pickup relative to the motor, or it may be necessary to return the motor to the makers with a full statement of your complaint. The pickup head should be as far as possible from power amplifier transformers and chokes. Moving pickup leads a mere two or three inches will sometimes clear hum completely. Turning the amplifiers through 90 or 180 degrees can make a great difference. So can reversing one or more of the mains plugs. Remember that if you have two mains plugs, they can be connected four different ways round. It is possible to confuse hum with rumble, to which all stereo pickups are more prone than mono types. Similarly, crystals are more

so than magnetics. Rumble will be transmitted only when the pickup is in contact with the disc. If this proves to be your trouble, the motor needs servicing.

* * *

Q.8. *I would like to feed the sound from my TV set into my stereo pre-amp as the set is positioned midway between my stereo speakers. In this way I think I should be able to get the illusion of high quality sound issuing from the TV set. However, I understand that this can be dangerous. Will you please advise me?*

A.8. The idea is excellent, and the illusion which you seek can readily be obtained, but the procedure is indeed dangerous—in fact possibly lethal—unless proper precautions are taken. Any connection from the TV set must be *completely isolated* from the mains before removing the back of the set. You will require a 1:1 isolating transformer which any dealer can supply to order, and it should be connected by a qualified engineer. The dealer can do this for you at a very small charge.

* * *

Q.9. *Will you please tell me the maximum length of lead which I can use between the pickup and pre-amplifier without effect on quality or frequency response, and also the maximum length of ordinary lighting flex which I can use for leads to the speakers from the amplifier?*

A.9. The maximum length of lead from pickup to pre-amplifier depends on a number of factors: the impedance of the pickup—in general, the lower the longer; the type of cable used for connection—light-weight co-ax or microphone cable terminated by proper plugs and sockets is recommended; and the position of the connecting leads relative to other components, especially mains transformers and chokes. There are three good general rules: (1) Do not alter the length of connecting leads supplied with the pickup unless you are forced to do so. (2) Keep leads as short as possible. (3) If the pickup requires an input transformer or head amplifier, and if you are obliged to extend the leads, do so on the pickup side only, keeping the transformer or head amplifier as close as possible to the pre-amplifier. The restricting factor on the length of lead from amplifier to speakers is the resistance of the wire. Ordinary lighting flex is quite all right for leads up to 30 ft. in length. Over this distance, use heavier flex, 23/0-0076.

Fig. 11:1. *The problem here is to obtain satisfactory stereo without moving away from the fire. Speakers in the corners either side of the window with the listener at A would be one answer.*

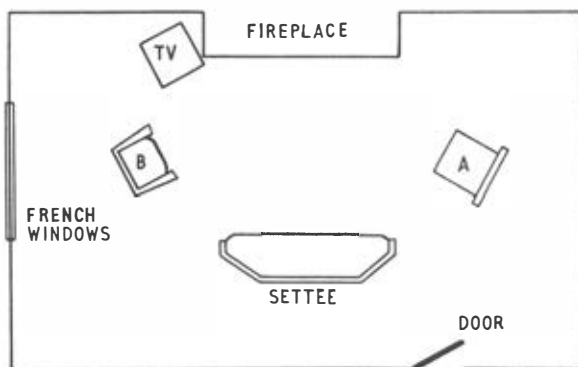

Q.10. *My amplifier has inputs for radio marked LO.Z and HI.Z. What does this mean? The manual tells me that the sensitivity of the inputs is LO.Z. 100 mV into 100 K and HI.Z. 250 mV into 250 K. My tuner has a maximum output of 1 V and impedance of 12,000 ohms. How should I connect it, and how should the volume controls be set?*

A.10. HI.Z and LO.Z stand for high impedance and low impedance. You should connect your tuner into the LO.Z socket, set the volume control of the amplifier at, or slightly below, the half way position, and turn up the volume control on the tuner until you get sufficient output. After this it should not be necessary to touch the tuner volume control again.

* * *

Q.11. *I live in a house typical of many. A sketch of my room is given here (Fig. 11:1). In the winter I like to sit opposite the fire, look at television and enjoy stereo. How do I place my speakers so that I can be warm, have the music in front of me, and no "hole in the middle"?*

A.11. The best place for the speakers would probably be in the corners on either side of the French window. If you then occupy chair A, your requirements would be met, though you would not face the fire. The settee could be moved round to accommodate other listeners and viewers. Alternatively, the TV set could be moved into the corner, and the speakers placed on either side of the fireplace. They might have to be brought out from the rear walls level with the line of the fireplace.

* * *

Q.12. *My listening room is 24½ ft long by 14 ft wide, decreasing after 14 ft to 9½ ft wide. I would like to wall mount my two Axiom speakers in alcoves on either side of the fireplace, which is situated in the centre of the wider end of the room. Can you please suggest height from the floor and best spacing between the speakers?*

A.12. Permanent stereo installations are always difficult, and personally I am against them because one never knows exactly what the effect will be until it is too late to alter it, and quite small differences in speaker placing and angling can make very big differences to results. However, if there is some reason why you *must* adopt this method, I would install the speakers not less than 3 ft 6 in. from the floor, angled towards the diagonally opposite corners of the room, and about 12 ft apart.

* * *

Q.13. *Occasionally I like to listen to stereo when the rest of the household has gone to bed. Are there any headphones suitable for this purpose, and how should I connect them to my amplifier?*

A.13. Good quality headphones for stereo listening are made by Messrs. S. G. Brown Ltd. and A.K.G. Ltd., costing about £7 to £8 per pair. You will need the low impedance type, so that you can connect them into the speaker sockets of your stereo amplifier or recorder. They are so wired that you can get them in phase, and also connect both earpieces in series for mono listening. The left earpiece is connected to the left stereo channel, and the right earpiece to the right stereo channel. A 15 ohm resistor of 3 to 5 watts rating should be connected across the leads of each channel to absorb the extra power.

A SHORT GLOSSARY OF HI-FI AND STEREO TERMS

A-B. These are letters used to designate two stereo channels, or equipment for their transmission. A usually denotes the left, and B the right hand. $A+B$ and $A-B$ therefore represent the sum and difference signals of the two channels. The letters L and R are sometimes used instead of A and B. I wish this were universal.

A.M. Amplitude modulation. Type of transmission used for broadcasting on medium and long wave bands. Refers to modulation of the carrier wave by the signal.

Ambience. Acoustic atmosphere of auditorium in which performance takes place.

Arrival time. When a listener is facing in any direction, a sound originating to his left reaches his left ear before his right. The difference in arrival time is of the order of fractions of a millisecond, and is used by the brain in helping to determine the direction from which the sound comes.

Audio. Connected with the ear. Audio frequencies (often abbreviated A.F.) are those frequencies of vibration detectable as sound by human ears.

Balance Control. Device permitting adjustment of channel levels relative to each other, total volume being unaltered.

Bias. A steady AC or DC voltage applied to any part of a circuit to ensure proper operation.

Binaural. "Two-eared". Stereo headphone system.

B.S.R.A. British Sound Recording Association (Hon. Sec. Greenways, 40 Fairfield Way, Ewell, Surrey). Arranges lectures and meetings in London and provinces. Quarterly journal available to non-members.

Cardioid. Heart shaped. Refers to directional properties of a microphone. See chapter "*Stereo Recording*".

Cartridge. Term often used to denote a pickup head.

Cassette. See Magazine.

C.C.I.R. Comité Consultatif International des Radiocommunications. International body which recommends standards for all aspects of radio

and allied subjects. Its specification for tape recording characteristics is at present used for most non-American commercially recorded tapes for re-sale to the public, often known as "pre-recorded tapes". Tape machines conforming to C.C.I.R. standards will give satisfactory reproduction of tapes recorded on any other machine constructed to the same standards.

Channel Balance. Degree of identity of response and output between two channels in any piece of stereo reproducing equipment, or the overall system. Reverse is often called "imbalance".

Compliance. Degree of freedom of movement. Particular reference to pickup armatures and loudspeaker suspensions, indicating ease of movement of stylus or cone.

Crossover unit. Network of coils (chokes) and capacitors (condensers) dividing signal according to frequency into two or three bands, enabling separate speaker units, specially adapted to reproduce these frequency bands, to be used and combined in a single loudspeaker.

Crosstalk. Unwanted overlap of signal from one channel to the other. Occurs in disc cutters, pickups, record grooves and stereo tapes.

Crystal. Slice of Rochelle salt or barium titanate (ceramic) generating a difference of potential between its faces when bent or twisted. Used, on account of this property, in pickups and microphones.

c/s. Cycles per second. Frequency of vibration of sound generator. The more rapid the vibrations, the higher the pitch. Vibrations are transmitted by wave motion, and each complete wave is called a cycle. The lowest note on a piano has a frequency of 27.5 cycles per second, middle "C" is 261.6 c/s. "A" (to which an orchestra tunes) is 440 c/s, and the top note of the piano is 4186 c/s.

Decibel (dB). Unit used to express the logarithmic ratio between sound levels. Human ears cannot detect a change in level less than one decibel, and only experienced ears will notice a change less than 3dB, which requires a doubling of *power*.

Decay Time. See Reverberation.

Difference Signal. Combination of left and right channels out of phase, often denoted by (L-R) or (A-B).

Directionality. Of stereo system. Ability conferred on listener to pinpoint origin of sound-source in space between speakers. Ability of listener to do this depends on differences in arrival time (q.v.) intensity, phase, waveform and ratio of direct to reflected sound at each ear.

Distortion. Any difference between the original sound and its reproduction is distortion. It is obvious that this can exist in many different forms, but the most irritating are harmonic distortion—the imposition of spurious harmonics on the signal—and intermodulation distortion—the disturbance of one part of the signal by another. The distortion figures quoted for amplifiers usually refer to the harmonic distortion at 1,000 c/s, expressed as a percentage difference between the input and output at this frequency at a certain power level.

Electromagnet. Usually a piece of metal which acts as a magnet when an electric current is passed through a coil of wire wrapped round it. Tape heads are electromagnets.

Feedback. Acoustic feedback takes place when the vibrations from a loudspeaker are transmitted either directly or through floor and furnishings to a microphone or pickup, and thence back again via the amplifier to the speaker, building up into an appalling noise. Negative feedback is a circuit arrangement for reducing distortion. Part of the output is fed back into an earlier part of the circuit 180 degrees out of phase.

FFSS. Trademark of the Decca Recording Company, standing for Full Frequency Stereophonic Sound.

F.M. Radio transmission in which carrier is frequency modulated instead of amplitude modulated. Our VHF (very high frequency) radio transmissions are FM. Medium and long wave transmissions are AM.

45/45. International standard method of stereo disc recording. Each signal is recorded at 45 degrees to the disc surface, and at right angles to the other signal.

Four Track. Refers to tape machines or tapes recording or reproducing four tracks on standard $\frac{1}{4}$ " tape. See "*Stereo from Tape*". Also used for mono. Advantages are tape economy and reduced crosstalk, at the expense of some loss of quality overall. Sometimes described as Quarter Track.

Gain. Ratio between input and output of an amplifier or one of its steps or stages.

Gap. Separation of pole-pieces of ring electromagnet in tape head. "Narrow gap" heads are coming into general use, and have advantages for recording.

Head. Portion of pickup containing transducing elements, often interchangeable to allow optimum results from stereo or mono records. In tape machines, the electro-magnet which erases, records or plays back as tape is pulled across it. A separate head is always used for erasure, but recording and playback functions are commonly combined in one head in domestic machines.

Hi-Fi. Short for High Fidelity, a term for sound equipment of the highest quality, capable of a faithful reproduction of the original sound.

Hole-in-the-middle. Apparent gap in sound spread between speakers in stereo reproduction, causing them to sound as two separate radiators. May be due to microphones too widely spaced in recording, speakers too widely separated, or speakers connected out of phase.

H.T. High tension. Power supply to anodes of valves in amplifier circuits, usually between 300 and 450 volts in domestic audio amplifiers.

Imbalance. See Channel Balance.

Impedance. Opposition to flow of alternating electric current. Measured in ohms, is a combination of resistance, capacitance and inductance. Varies with frequency. Two pieces of equipment connected together should have similar impedance if both are to operate properly. In particular, a higher impedance should not work into a lower one, where a mis-match is inevitable.

Integrated Amplifier. One in which control unit or pre-amplifier is combined with power amplifiers on one chassis.

Jack plug. Large plug used for temporary connection of equipment (for example, tape machines) on which there are spring loaded jack sockets. The normal pattern for this purpose is known as the standard telephone jack, from its use in telephone exchanges.

Lateral. Sideways, i.e. parallel to disc surface. Mono LP discs have laterally cut grooves. Stereo discs have grooves which require lateral and vertical movement of stylus in reproduction.

Loudness Control. Deprecated control which boosts low frequencies as volume is reduced. Considered by most amplifier designers in this country to be unnecessary and technically unsound.

LP Record Library (LPRL). Provides special stereo service, also special service to Gramophone Societies. Issues annual Stereo Record Guide, valuable in choosing discs. Enquiries to: Ivan March, Squires Gate Station Approach, Blackpool, Lancs.

LT. Low tension. Heater supply to valves in amplifiers. Normally 6.3 volts.

Magazine. (Tape) Container holding tape and spools for insertion in special tape machine without threading.

Magic Eye. Visual signal level indicator, used in many domestic tape machines rather than the preferred micro-ammeter (meter) level indicator, to save cost. The object of these indicators is to enable the volume control to be so adjusted that maximum recorded level will not cause distortion.

Mixer. Tape recorder accessory, enabling varying number of different signals from radio, microphones and pickups to be controlled and combined into one signal at the level required.

Monaural. “One-eared”. Mono is not an abbreviation of this word. Unless the listener is deaf in one ear, there is no such thing as monaural reproduction or listening.

Monitor. Check on signal as it is transmitted or recorded. Some tape machines provide this facility; others do not. Signal may be monitored by headphones or loudspeaker either immediately before or after recording.

Monophonic. Audio equipment using one channel only. Several inputs may be mixed into this one channel. See Mixer.

NFGS. National Federation of Gramophone Societies (Hon Sec W. L. Dixon, 4 Beulah Hill, London SE19). Issues quarterly “Bulletin” containing occasional critical reviews of equipment, provides reduced performing right fees to member societies and use of a free library of mono and stereo discs.

Phase. When sound waves rise and fall in step with each other, they are said to be in phase. When one leads the other, they are said to be so many degrees out of phase, and this difference between them is the phase angle. When exactly in phase, sound waves add together, and cancel each other out when completely out of phase or “in opposite phase”. Loudspeakers are said to be in phase when a signal fed to them at the same time causes their cones to move inwards and outwards together. If one cone moves inwards as the other moves outwards, the speakers are out of phase, there will be loss of bass response, and stereo effect will be spoilt.

Polyester Base. Tape base used for long playing tape, because it is stronger and stretches less than cellulose acetate.

Pre-recorded Tape. The tape equivalent of the disc record. Commercially recorded tapes marketed by some record manufacturing companies.

Print Through. Transfer of part of recorded signal to next layer of tape.

Pseudo Stereo (Quasi-Stereo). Terms applied to attempts, using various methods and devices, to obtain stereo effect from a single channel source. The best known and most popular in Britain is perhaps Dr Hermann Scherchen’s “Stereophoner”. It must be emphasised that, while these devices produce results which some people find more pleasing than ordinary mono reproduction, they do *not* provide stereo, for which two separate channels are essential.

PVC. Polyvinyl Chloride. Base for tape.

Resistance. Opposition to flow of current, causing energy to be dissipated as heat.

Reverberation. Persistence of sound after generation in room or hall. Depends upon acoustic properties of building. In recording studios, reverberation is controlled. Optimum reverberation time varies according to the music being performed. Decay time is the time taken for sound to die away to inaudibility.

RF. Radio Frequency. High frequency currents in radio receivers.

RIAA. Radio Industries Association of America. Standard recording characteristic, internationally accepted, for mono and stereo discs.

Screened lead. Connecting wire in which insulated conductor is enclosed in metal braid which is connected to earth, screening conductor from interference. Co axial cable is one kind of screened lead.

Signal-to-Noise Ratio. Unwanted noise is always present to some degree in recording and reproduction. Recording characteristics are chosen so as to minimise the proportion of this noise present in reproduction. The ratio between this noise and the wanted signal is the signal-to-noise ratio. In amplifiers and tape machines it is usually quoted in dB down on full output power as rated.

Stacked heads. Magnetic tape recording/reproducing heads arranged one above the other, in line. Standard system for stereo.

Static. Electrical charge induced by friction on surface of certain materials, especially vinyl plastic of which gramophone discs are made, causing them to attract dust. Can be countered by deposit of molecular film, providing a leakage path, in the edges of the grooves by means of the Parastat machine.

Stereosonic. Name given to tapes commercially recorded and issued by EMI Ltd. These tapes are made using Blumlein's method.

Stylus. The reproducing point mounted in a gramophone pickup. Jewel, occasionally sapphire, now more usually diamond.

Sum Signal. Combination of the signals from two microphones in phase, denoted by (A + B) or (L + R).

Test Disc. Fulfills the same function as a test tape, but for use on disc reproducing equipment. There is no fully satisfactory stereo test disc at present, but DGG 220497 (7 in.) is useful for setting up apparatus.

Test Tape. Tape bearing test signals to enable a recorder to be checked.

Vertical Signal. In stereo disc, sound arriving simultaneously at each microphone 180 degrees out of phase, causing vertical movement of recording stylus, and of pickup stylus in reproduction.

INDEX

	<i>page</i>
<i>Ambience</i>	6, 7, 21
<i>Amplifiers</i>	29, 31
<i>Arms for pickups</i>	52
<i>Arm requirements</i>	53
<i>Audio Fair</i>	13
<i>Balance Control</i>	32
<i>Balancing the speakers</i>	101, 102
<i>Bartlett Jones, W.</i>	43
<i>Bell Telephone Laboratories</i>	9
<i>Berliner</i>	43
<i>Blattner</i>	11
<i>Blumlein, A. D.</i>	9, 12, 25, 43
<i>Booming bass</i>	37
<i>British Sound Recording Association</i>	12
<i>Brittain, F. H.</i>	11, 25, 26
<i>Cabinet requirements</i>	87, 88
<i>Cardioid microphones</i>	23, 25, 26
<i>Centralizing the signal</i>	101, 102
<i>Choice of speakers</i>	32, 33, 35
<i>Cinemas</i>	11
<i>Coaxial plugs</i>	91, 96
<i>Columbia Graphophone Company</i>	9
<i>Column speakers</i>	38
<i>Compatible stylus</i>	46
<i>Concert hall</i>	5
<i>Connecting up</i>	91, 92, 93
<i>Control units</i>	29, 31
<i>Cook, E.</i>	12
<i>Copyright law</i>	75, 76
<i>Crystal and ceramic pickups</i>	47, 48, 49, 51
<i>Dead studios and rooms</i>	6, 7, 15, 21, 99
<i>Decca Record Co.</i>	12, 43, 44, 45
<i>Definition of stereo</i>	9
<i>Directional properties</i>	7, 20
<i>Disc storage</i>	64
<i>Domestic requirements</i>	100, 101, 102
<i>Double mono</i>	15
<i>Dubbing</i>	74
<i>Dust</i>	61, 62
<i>Dutton, Dr.</i>	11, 12

INDEX—continued

	page
<i>Earthing</i>	92, 93
<i>Economical stereo</i> 104
<i>Edison, T.</i> 43
<i>Electrostatic speakers</i> 40
<i>Emerson, V. H.</i> 43
<i>E.M.I.</i>	11, 25
<i>Experimental stereo broadcasts</i>	77, 78
<i>Fault finding</i> 96
<i>Figure-of-Eight microphones</i> 23
<i>Filters</i> 31
<i>Flutter</i> 55
<i>FM and AM</i>	78, 79
<i>Ford, P.</i> 43
<i>Francis, C. J.</i> 12
<i>Full frequency range recording</i> 12
<i>GEC</i>	11, 14, 25
<i>Gimmicks</i>	5, 102
<i>Grooves</i>	10, 44
<i>Haddy, A.</i>	12, 43, 44
<i>Harpichord recordings</i> 18
<i>Headphones for stereo</i> 108
<i>High and low impedance</i> 108
<i>High-pass filter</i> 31
<i>Hill and dale records</i>	43, 44
<i>Hole in the middle</i> 100
<i>Horn speakers</i>	38, 39
<i>Hum</i>	57, 93, 94, 106
<i>Infinite baffle</i>	37, 40
<i>Installing equipment</i> 86
<i>Instrumental separation</i> 20
<i>Lateral location</i>	20, 22
<i>Leakey, D. M.</i>	14, 22, 26
<i>Listening angle</i> 20
<i>Listening fatigue</i> 98
<i>Loops</i>	93, 94
<i>Loudspeaker mountings</i>	35, 37
<i>Low-pass filter</i>	31, 32
<i>Magnetic pickups</i>	47, 48, 51
<i>Magnetic turntables</i> 56
<i>Mains plugs</i>	91, 93, 95

INDEX—continued

	<i>page</i>
<i>Matching different amplifiers</i>	83
<i>Microphones</i>	7, 14, 21, 23
<i>Mitte-Seite</i>	25
<i>Moir, J.</i>	11, 21
<i>Moving-coil pickups</i>	51
<i>Mullard stereo system</i>	79
<i>Multiplex</i>	78
<i>Musical sound</i>	8
<i>Neumann</i>	25
<i>Omni-directional microphones</i>	23
<i>Output power and matching</i>	105, 106
<i>Paris Opera House</i>	9
<i>Percival stereo system</i>	79
<i>Phonoplugs</i>	91, 95
<i>Pickup connections</i>	92, 93
<i>Pickup impedance</i>	48, 49
<i>Pickup matching</i>	48, 49
<i>Pickup mounting</i>	89, 90, 91, 94
<i>Pickup requirements</i>	46
<i>Pickup output</i>	48
<i>Playing weight</i>	53, 54
<i>Point-source</i>	19
<i>Poulsen</i>	11
<i>Power requirements</i>	29, 31
<i>Print-through</i>	75
<i>Pye Records Ltd.</i>	13
<i>Record cleaning</i>	62, 63, 64
<i>Record deformation</i>	53
<i>Record speeds</i>	55
<i>Recorder specifications</i>	69
<i>Recording characteristics</i>	23, 47, 48, 66
<i>Recording on tape</i>	73
<i>Reducing reflections</i> 101
<i>Reflex cabinets</i>	37, 38
<i>Rigid mounting</i>	86, 87
<i>Room arrangement</i>	98, 99, 100, 101
<i>Room resonances</i>	19
<i>Rumble</i>	31, 56, 57
<i>Short pickup leads</i>	107
<i>Side-thrust in pickups</i>	90
<i>Small rooms</i>	27

INDEX—continued

	<i>page</i>
Speaker matching	83, 84
Speaker phasing	101
Speaker positioning	99, 100, 108
Specifications	104, 105
Speech reproduction	42
Stereoscopic vision	13
Stereosonic tapes	9, 12, 25
Stereo pickup for mono	103
Stille	11
Stylus size	12, 45, 46, 54
Sugden, A.	12
Tape copying	11
Tape limitations	71
Tape pros and cons	65
Tape recorder types	67
Tape speeds	71, 72, 73
Tape storage	75
Taping radio and disc	74
Teledec	12, 44
Television sound	107
Third speaker	104
Three dimensions	22
Tink and tonk stereo	25
Tip mass	46
Tracks on tape	70, 73
Turntable and pickup mounting	88, 89, 93
Turntables	55, 56, 57, 88, 89
Tweeters	33, 35
Twin-channel stereo	13
Understanding specifications	104, 105
Unequal amplifiers	83
Vinyl plastic	12
Voigt, P.A.G.H.	19, 39
Volume control	102
Walker, P.	17
Watts, C.	18, 19, 59, 63
West, R.	19
Westrex	12, 44, 45
Woofers	35
Wow	55
Zenith G.E. system	77, 79, 80

An important magazine
for the new age.

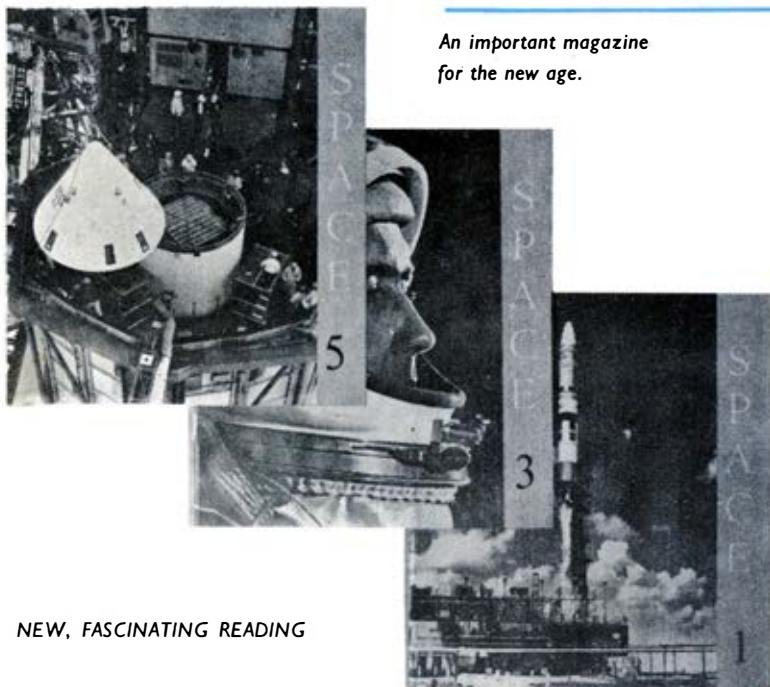

NEW, FASCINATING READING

● When Sputnik 1 appeared in the night sky on 4th October 1957 a new age of exploration began. The Russians launched 2 craft that year. The Americans put 5 into orbit in the next 12 months. By the end of 1959 the USSR and the USA had between them launched more than 40 satellites and probes. In the next 3 years there were 160 more. The total passed the 1,500 mark in 1965. The pace is quickening. The planets are within range of television cameras. Men are training for Moon landings.

● *SPACE*, a compact 48-page magazine was launched in April 1965 to document and keep abreast with all this fascinating progress. A complete record of the early years exists in its first few numbers. There, also, are illustrated stories of the Mariner flights to Venus and Mars. There are regular articles on space age astronomy, and each number carries many photos and drawings.

● *SPACE*, please note, is **only** available by subscription, and **only** from the address below. The price is £2 for 12 numbers (USA \$6.00). All back numbers are available. An illustrated brochure will be sent, free, on request.

SPACE

99 MORTIMER ST
LONDON W.I.