

Adrian Hope

# The Hi-Fi Handbook

A complete  
guide to sound  
investment

The Hi-Fi Handbook

Adrian Hope



EBURY  
PRESS

Adrian Hope tells you how to be sure you get value for money when you decide to buy hi-fi equipment. He takes the mystique out of the subject and writes for the layman who may have been put off by all the technical terms which make most hi-fi publications read like a foreign language.

Here you will find answers to all those questions that bother the music lover who has no technical knowledge. For instance:

- \* How do I choose the best equipment for my particular requirements ?
- \* How can I stagger the cost sensibly ?
- \* What are the pros and cons of buying a music centre ?
- \* How powerful an amplifier do I need ?
- \* Is it worth going in for quadraphonics ?
- \* How can I be sure that I don't spend more than I can really afford and still be disappointed with the result ?

Not only does he show you how to set up and use what you've bought, when you've finally made your choice, but also, when something goes wrong, how to diagnose the fault and put it right.

£3.50 net.

# The Hi-fi Handbook



# The Hi-fi Handbook

*ADRIAN HOPE*



EBURY PRESS *London*

**First published 1976 by  
Ebury Press, Chestergate House,  
Vauxhall Bridge Road,  
London SW1V 1HF**

**© Adrian Hope 1976**

**All rights reserved. No part of this publication may be reproduced, stored in a retrieval system, or transmitted in any form or by any means, electronic, mechanical, photocopying, recording or otherwise, without the prior permission of the copyright owner.**

**ISBN 0 85223 059 1**

**Cover design by M. Carney  
Diagrams by Chris Evans**

**Printed in Great Britain by  
Bristol Typesetting Co. Ltd,  
Barton Manor, St Philips, Bristol  
and bound by  
Mansell (Book binders) Ltd,  
Witham, Essex**

To my wife who tolerates all the wires and my children who at least try not to trip over them – but not, I am afraid, to the family pet rabbit which has taken to biting through them.

---

# Acknowledgments

---

The author would like to thank the following firms for their valuable assistance in providing material for picture reference :

Acoustical Manufacturing Co Ltd

Armstrong Audio Ltd

BIB Hi-fi Accessories Ltd

Dolby Laboratories Ltd, in particular for permission to reproduce their leaflet on pages 62 and 63

Eagle

KPR

Rank Audio Products Ltd

Rank Audio Visual

Rank Leak Wharfedale Ltd

Tape Recorder Spares and Audio Packs

Trio



---

# Contents

---

FOREWORD	<i>page</i> 8
INTRODUCTION	9
1 Basic Facts of Audio Life	11
2 A Necessary Digression	19
3 The Amplifier – the Heart of any Hi-fi Set-up	27
4 Adding a Record Player	35
5 Tape in General	44
6 Cassette Tape in Particular	56
7 Tuning in to Radio in Hi-fi	67
8 All about Loudspeakers	80
9 Setting up and Using What You've Bought	91
10 Gilding the Lily	105
11 Hi-fi Shopper's Check list	115
12 Bodger's Law	118
GLOSSARY	123
INDEX	135

---

# Foreword

---

When I was told that this book was in gestation, my immediate riposte was 'Oh! not another primer on hi-fi'. So the author, although a friend, had to surmount a hurdle right at the start, so far as I was concerned. Were his efforts really necessary?

Having now studied this text carefully, I'm happy to say that his labours were not in vain. For many newcomers to the fascinating world of hi-fi, the advice given in these pages on the purchase of the right audio system for particular requirements and pockets, and how best to install it, will save the enthusiast money and headaches.

Adrian Hope is one of a new breed of investigative journalists, specialising in superior sound reproduction. His writing style is down to earth, and he's learnt the subject the hard practical way – do it and see. This is a valuable addition to the literature.

DONALD ALDOUS

Technical Editor

*Hi-fi News and Record Review*

---

# Introduction

---

A hi-fi manufacturer in the USA now uses the slogan, IF GOD HAD WANTED US TO GO TO CONCERTS, HE WOULD HAVE GIVEN US TICKETS. The slogan is used with tongue in cheek, but it neatly sums up the current situation. Until the gramophone was invented by Thomas Alva Edison in 1877, the only way to hear music played or an artist perform was to go out and attend a 'live' performance. Now it would be quite impossible for all music lovers to listen to music 'live'. An orchestral concert conducted by Leonard Bernstein, an operatic performance by Joan Sutherland, or a pop concert featuring anyone of the legendary calibre of Frank Sinatra, the Beatles or the Rolling Stones will be a sell-out within hours of the box office opening. The only way we can listen to most top artists now is to watch them on television, hear them on the radio, or listen to them on record. And even though a live appearance by a famous performer should always have a magic of its own, it is hard for an audience to feel too enthusiastic after queuing all night for a ticket entitling them to a seat with a poor view and sound piped over an often inadequate sound system. An evening at home, listening to the artist in the comfort of an armchair and through a high quality sound system is, to many people, a substitute that betters the original. Small wonder that records now sell in greater numbers than ever before, and more and more people decide to equip their homes with hi-fi sound reproduction equipment.

## **Ignorance is not bliss**

Unfortunately most people are ignorant of hi-fi, and only find out what they need to know about it when it is too late; that is, when they have already bought expensive equipment.

Hi-fi is simply an abbreviation for high fidelity, and that phrase is itself simply the abbreviation of a concept. This is to reproduce a recorded or transmitted sound with the highest possible fidelity to the original sound. The prize achievement in hi-fi is often regarded as the ability to reproduce sounds so accurately that even a trained ear cannot distinguish them in a direct comparison with the originals.

The ultimate in hi-fi is therefore perfection, and there is no such thing as perfection. There are now, however, some very near misses. Not surprisingly, top quality equipment is expensive. Indeed, after the purchase of a house and a car, an impressive hi-fi rig may well be the next most expensive item ever bought by a householder. Few people buy a house without a surveyor, or a car without a road test and much careful thought. But a surprising number of people today spend many hundreds of pounds on a hi-fi rig simply because it looks nice, sports a multitude of fancy knobs to twiddle and has been recommended to them by the friend of a man they once met in a pub. As a result, far too many people buy either well-packaged junk or good equipment that is utterly unsuitable for the job in hand. After all, who buys a flashy sports car for family touring, or an old Austin Seven for racing?

### **Money down the drain**

At this very moment, someone somewhere is throwing good money down the drain after bad hi-fi equipment. Why is this? Quite simply, although we have all grown up with houses and cars, this is not true of hi-fi. Anyone thirsty for audio information and advice will very probably not find any of his friends or relations a useful source. Although there are numerous audio textbooks and magazines, many of which are excellent, most of them do assume a basic technical and mathematical expertise on the part of the reader. Unfortunately this is a dangerous assumption which the present book seeks to avoid. Wherever possible, hi-fi equipment and techniques are described in non-technical language.

### **Technicalities**

Where technical terms have to be used, or where it will help the reader to know the correct technical term for an item of equipment or commonplace hi-fi situation, that term is explained both at the time of use and again for reference in the glossary. Also included is a list of suggested further reading for anyone whose appetite for more audio knowledge is whetted.

---

# 1 / Basic Facts of Audio Life

---

If it were a perfect world, the would-be hi-fi buyer could walk straight into any hi-fi shop and say, 'I have £500 to spend on hi-fi: tell me what best suits my needs for that money.' Unfortunately it is not a perfect world.

## **The price to pay**

When resale price maintenance was abolished, a price cutting war broke out in the hi-fi market place. Some shops cut their prices so drastically that (before they went broke or revised their policy) they were forced to employ the cheapest and therefore the most ignorant staff. Often they were quite incapable of doing anything other than sell a sealed box at cut price. As far as the salesman was concerned, the box might as well have contained apples as an amplifier. So the customer could expect neither technical advice nor service from the shop. Older established dealers continued to employ trained and responsible staff and ran a properly equipped repair workshop. But not surprisingly such shops were forced to charge a full price for everything. After a while it became clear that customers were going to a responsible dealer for advice and demonstrations and then moving off down the road to a cut price shop to buy the goods of their choice. Clearly this situation had to end, which it did. Today the market has semi-stabilised into a division between shops which concentrate on selling low and medium price range equipment at relatively low prices with relatively little technical advice or back-up (other than basic guarantees under the consumer laws) and shops that concentrate on selling medium and upper range equipment at fuller prices and with skilled advice and know-how. Some manufacturers try to supply only shops which guarantee to sell their goods at full price. But of course the situation is in practice fluid and flexible. For instance some hi-fi chain stores have some branches competing in the cut price market and others in the full price or so-called 'carriage trade'. At least one chain has experimented with a telephone advice bureau which enables a potential customer to sort out his problems and

make his decisions before he even visits one of their shops.

### **The decision to make**

What all this means, to the man who wants to come in off the street and buy hi-fi, is that he must first of all decide which end of the market he is going to buy from. If he is prepared to spend the extra and buy 'carriage trade' equipment at full price, then he can afford also to remain relatively ignorant. If, on the other hand, the decision is to buy as cheap as possible, then ignorance may prove to be a very expensive luxury.

### **How to decide**

But how is the man in the street to know which shop is offering sales and service and which is offering mainly sales? The answer is really only commonsense and it is usually possible to 'feel' from a shop the kind of service you are likely to get. Suppose, for instance, the shop showroom has a dozen or more large loudspeakers mounted in rows down one wall and a range of amplifiers, turntables and tape decks racked along another wall. There is also a comparator (usually a push-button switch panel) so that the output of any one of several turntables or decks can be fed through any one of several amplifiers to any one of several pairs of speakers. Clearly the chances are that you have found yourself a dealer who is sufficiently interested in customer satisfaction to offer guidance and demonstrate equipment before selling it. The fact that the shop only has a relatively limited number of different makes of equipment on display is more likely to mean that the owner has pre-selected the wheat from the chaff, than that he can't be bothered to stock many lines. On the other hand, suppose the shop has a window full of a thousand and one glossy items, many of them at bargain offer prices. Inside you are confronted with a warehouse-like counter, an endless supply of cardboard boxes and half-a-dozen items of equipment bleating ineffectually in competition with the sound of cash registers. Equally clearly the chances are that you should regard the shop simply as somewhere to buy cheaply whatever it is you have already decided to buy.

It is obvious that if you choose to patronise the latter type of shop (and there is absolutely no reason why you should not), you will need to have most of your decisions made in advance. But, rather less obvious, even if you patronise a dealer with an encyclopaedic knowledge of hi-fi and take advantage of his experience, you will need to have some *opinions* of your own.

### **A break from tradition?**

For example, until very recently, it was traditional to build up a collection of recorded music on records. But there is one big snag in this. If you buy records over the years and play them on inferior equipment (for instance as an impoverished student or in a bachelor flat), you will inevitably damage those discs. However carefully you may treat them, the simple act of playing them on inferior equipment will degrade them. But you will not notice this until the great hi-fi call comes and you try and play them on top quality equipment. Then they will suddenly sound terrible. And most of the recordings will by this time have long since been deleted from the record company catalogues and thus be irreplaceable. There is nothing whatsoever that you can do to prevent this situation occurring with disc records, short of never playing anything until you are old and rich enough to own top quality equipment. And that is not what being a music lover is all about.

There is now, however, an alternative approach. You can buy cassettes rather than discs. A cassette is simply a small plastics pack which contains a length of recording tape. It was developed by Philips and is correctly called either a Philips or Compact Cassette. Cassettes are sold both as blanks, to enable the user to record his own material, and as pre-recorded Musicassettes. Many of the record companies now offer parallel cassette issues of many disc recordings. Thus, when a new LP disc is released, it is frequently simultaneously released as a Musicassette. Although Musicassettes cost rather more than discs and *may* sometimes be of slightly inferior audio quality, they do benefit from the one, glorious advantage that they are very difficult to damage. Most important of all, it is very hard, if not virtually impossible, to degrade a Musicassette simply by playing it. Thus a collection of Musicassettes built up over the years and played on budget equipment will still sound as good as new when finally played on top quality equipment, even if this is not until a decade after their original purchase.

So, anyone with limited funds who is starting out to build an audio set-up and a collection of recordings, should consider basing that collection on Musicassette rather than disc – or at least cassette as well as disc. This will be regarded as a heretical view by many who favour the disc and suspect the cassette. I can only suggest that they rout out a treasured record that they played day in, day out as a student some twenty years ago, and see how it sounds today on a modern hi-fi record player.

### **Integration or 'building block' approach?**

The heart of *any* hi-fi set-up is an amplifier, which provides the power to drive the loudspeakers, but ideally does not produce any characteristic sound of its own. It is possible now to buy amplifiers which are integrated or combined with radio tuners (which receive radio programmes) and record and cassette tape decks (to play discs and cassette tapes). 'Music centres' (also known as audio centres) of this type have one basic advantage and one equally basic disadvantage. Although a music centre, with all its combined gadgetry, has the very real advantage of being extremely easy to set up and use, it has the very real disadvantage of being inflexible in the future. You cannot improve any one part (such as the record or cassette deck) independently of the others. If you wish to up-grade a music centre, you can only throw it out and replace it with a better one. Far more flexible an approach is to build up a hi-fi set-up, in building block fashion, around a high quality amplifier. But although it is, in practice, inflexible to integrate a record player and cassette deck with an amplifier, it is now regarded as sound practice to integrate a radio tuner with an amplifier. Many manufacturers produce both amplifiers and tuners, and it makes both electronic and economic sense for them to build the two into one and the same cabinet. Apart from anything else, it saves a fair amount of duplicated circuitry.

### **Basic starting point**

As will be explained in chapter 2, sound can be reproduced from a single source (mono) or a number of sources (stereo or 'surround sound'). No one now buys or uses mono (single channel) amplifiers, so this leaves us with the solid preferred starting point of a *stereo tuner-amp* (fig 1). This, coupled with a pair of loudspeakers, and fed by an aerial, will reproduce stereo radio. The amplifier will have a range of sockets on the rear (fig 1a) to feed loudspeakers and receive connections (fig 1b) from an aerial, a record deck, a reel-to-reel tape deck or a cassette tape deck. If you can afford all three decks to begin with, then all well and good. But if funds are short, then it is far better to buy a good record or tape deck, rather than a mediocre one of each.

Again, we are back to flexibility. If you buy mediocre equipment in the beginning, you can only up-grade by throwing it away and replacing it. So, far better to decide on which source of pre-recorded material interests you most – disc or cassette – and spend all your available money on a good piece of equipment to handle that source. And of



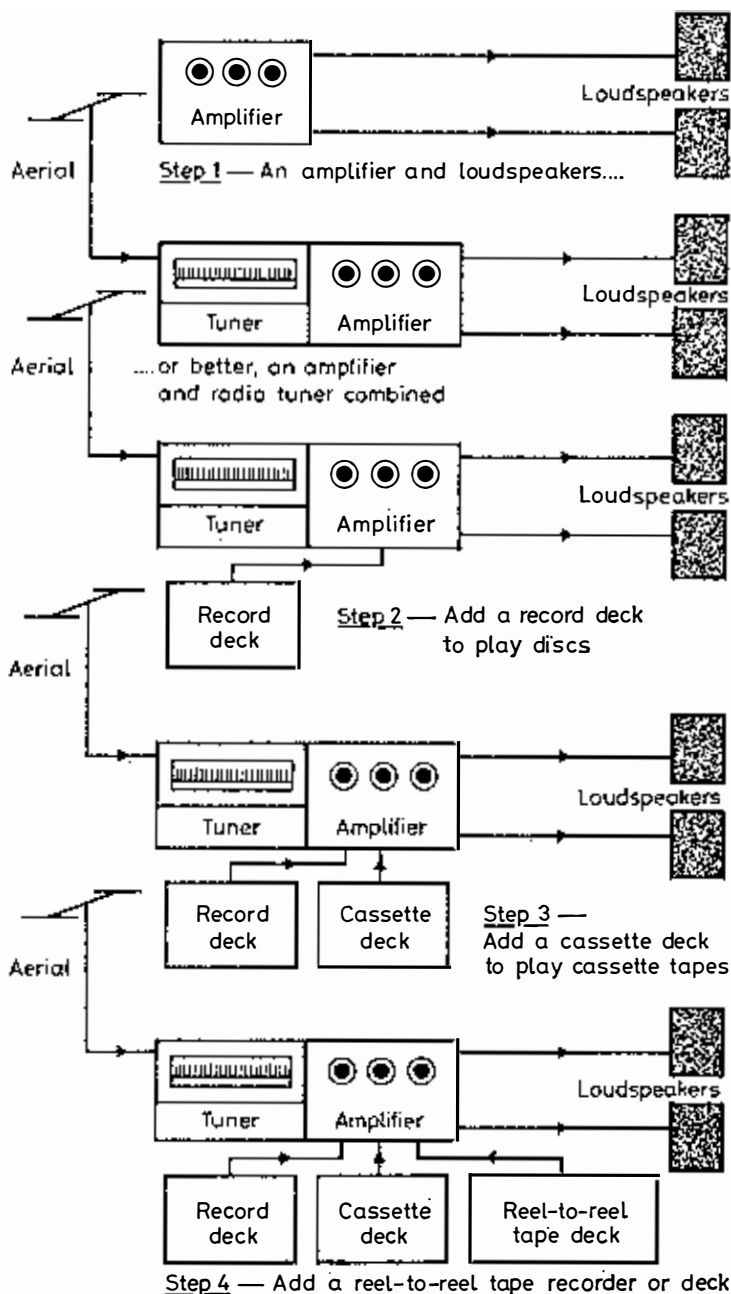

**Fig 1** The building block approach to hi-fi.

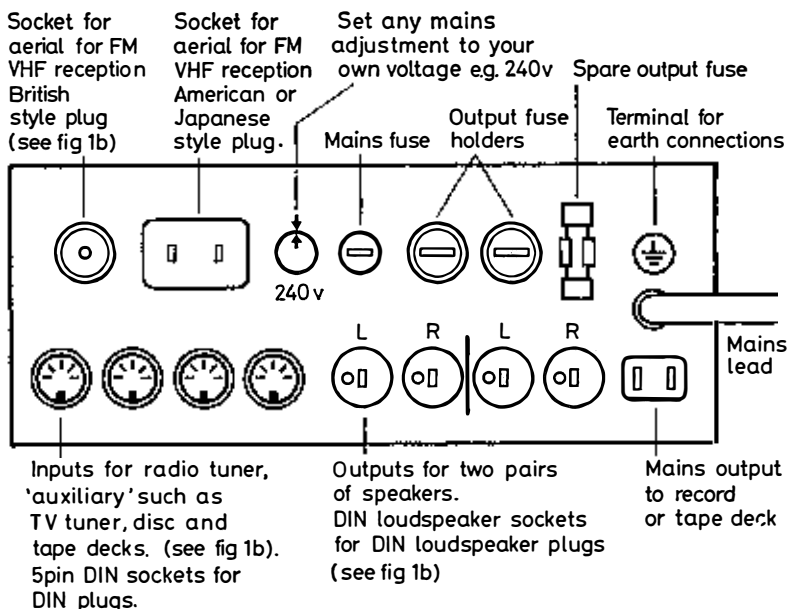

Fig 1a What the rear of the tuner-amplifier (or 'receiver') will look like – but different makes vary in style, of course.

course, as explained above, there is now good reason to at least consider starting off with cassette rather than disc.

### Thinking ahead

If it is important to buy a good quality record or cassette deck in the first place, then it is doubly important to buy a good quality amplifier. As this is the heart of the system, all your programme sources will be playing through it and out to the loudspeakers. Thus it is essential to buy an amplifier (or tuner-amp) that is likely to keep you satisfied for many years to come. When you buy your amplifier or tuner-amp, perhaps along with a record or cassette deck, you will need also to buy loudspeakers for the amplifier to power. (Without loudspeakers there will of course be nothing to hear.) But unless you are a millionaire or happen to have someone else's blank cheque to hand, you will probably be forced to compromise on loudspeakers. The pitfall is to buy loudspeakers that are rather better than junk but not as good as you would

really like. It may be another heretical view but I suggest it is far better to buy relatively cheap speakers and, with cold-blooded calculation, reckon on giving or throwing them away when you can afford what you really want. But some expensive loudspeakers require a considerable amount of amplifier output power to drive them properly. So don't fall into the trap of buying a low power amplifier which will quite happily drive cheap loudspeakers but will fall hopelessly short of driving the more expensive and less efficient speakers that you intend saving up for. When you buy your amplifier, seek dealer advice (or educate your-

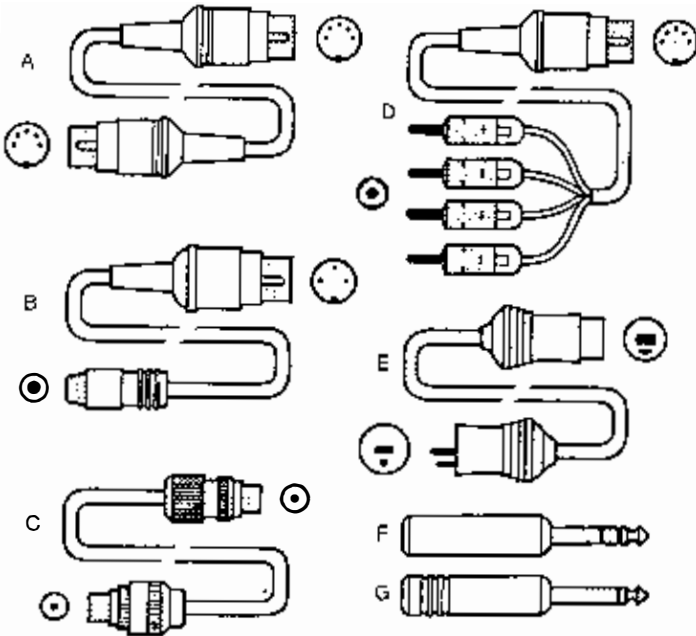

Fig 1b Some commonly encountered connecting leads and plugs – almost limitless combinations are possible to cope with virtually any connection requirement.

A 5 pin DIN plug to 5 pin DIN plug (eg for amplifier input sockets, see Fig 1a); B 3 pin DIN plug to phono socket (or sockets); C British style coaxial aerial plugs (eg for amplifier aerial input, see Fig 1a); D 5 pin DIN plug to phono plugs – common alternative to A; E DIN loudspeaker socket to DIN loudspeaker plug (eg for amplifier loudspeaker outputs, see Fig 1a); F Stereo and G mono jack plugs – used now mainly for connecting microphones and headphones.

self from later chapters) on what amplifier power ratings you are likely to need. To make matters even more complicated, the size of a room, the location in which you intend placing your speakers and the type of furnishings you have, all affect the same issue.

**Pitfalls ahead**

Hopefully, by now some of the basic essentials of buying audio will have come across, together with sufficient of the pitfalls awaiting the innocent, the ignorant and the ill-advised, to stimulate an interest in the closer look at each individual link of the hi-fi chain that follows. It should now also be clear why no one should buy hi-fi without first having arrived at a few informed opinions for himself or herself.

---

## 2/A Necessary Digression

---

### **What is the difference between hi-fi, stereo and mono?**

Whenever people talk about hi-fi they usually also talk in the same breath about 'stereo', often confusing the two and using one term wrongly instead of the other, and so on. As we have already seen, the aim of hi-fi, abbreviation for 'high fidelity', is to reproduce a recorded or transmitted sound with the highest possible fidelity in the original sound. But what is stereo?

Stereo is another abbreviation, this time for the word 'stereophonic'. This is derived from the Greek word meaning 'solid', and 'phonic', which has to do with sound. 'Stereophonic' thus means solid, or three-dimensional, sound, just as 'stereoscopic' means solid, or three-dimensional, vision. Stereophonic sound can only be produced artificially *ie*, reproduced, with a minimum of two separate channels of sound. But stereo sound is not necessarily *two*-channel sound, although the word stereo is now almost universally used to define a two-channel system. Mono, a shortening from 'monophonic' or 'monaural' (which, strictly, means one-eared), does however really mean what we intend it to mean – a one-channel system. From now onwards, even though it is semantically not strictly correct, references in this book to stereo are intended to mean a two-channel system, and references to mono a one-channel system.

Bear in mind, incidentally, that simply playing a single channel of sound (for instance from a simple transistor portable radio) through two loudspeakers, does not create stereo from mono, because there can never be two distinct, discrete or different channels of sound. Every now and then an enterprising businessman falls foul of the British consumer laws by deliberately or accidentally failing to understand this.

But why can two channels produce a three-dimensional or solid sound, whereas a single sound channel fails miserably in this respect?

### **How we hear**

We hear with two ears, and are able to use them to pin-point the location

of sounds very accurately. Close your eyes, listen to everyday sounds, and you will know what I mean. All kinds of theories abound on how that most sophisticated of all computers, the human brain, decodes what it hears through our two ears, to pin-point the direction of a sound; but the honest truth is that no one really knows. One possible answer is direction-finding by repeated head movements to beam both ears by relative loudness onto the sound source; after all, our ears are shaped to receive more sound from the front than the rear.

But this theory does not explain how someone with his head remaining still, for instance in bed or in an armchair, can still accurately locate a sound source. Probably the most important clues here for the brain are the differences in the same sound heard at our two ears. One's solid head serves as a soundproof baffle and enables the brain to detect both loudness and phase relationships and tiny time delays between the same sound as heard in each ear. It is also an odd fact that the ear and brain are better able to locate the source of high-pitched sounds than low-pitched rumbles. Try pin-pointing the source of a chirping bird on the one hand and a roll of thunder on the other, and you will see what I mean.

### **Early recognition**

It was recognised very early on that the only way to reproduce sound accurately was to use at least two sound sources. Early experiments centred on the use of a dummy human head with a microphone in each ear for recording, and playback via a pair of headphones to feed only left-ear sound to the left ear and only right-ear sound to the right ear (figs 2 and 3). The experiments with this technique date back at least to the 1920s, and every few years people freshly discover for themselves how surprisingly good the results are. They then herald dummy head stereo as a sensational new invention.

Because different sounds are fed to each ear, in the headphone playback of a dummy head recording, two *separate* channels of sound are needed. Two separate channels of sound are also needed for the much more social way of listening to reproduced music – on loudspeakers – because the sound fed to one loudspeaker again differs from that fed to the other. But the approach has to be different. Simply feeding dummy head recordings into loudspeakers is unsuccessful. The whole point of dummy head recording is that the sound picked up by the microphone in the dummy's left ear is subsequently fed only to the left ear of the listener, and the sound picked up at the dummy's right ear is fed only

A Necessary Digression

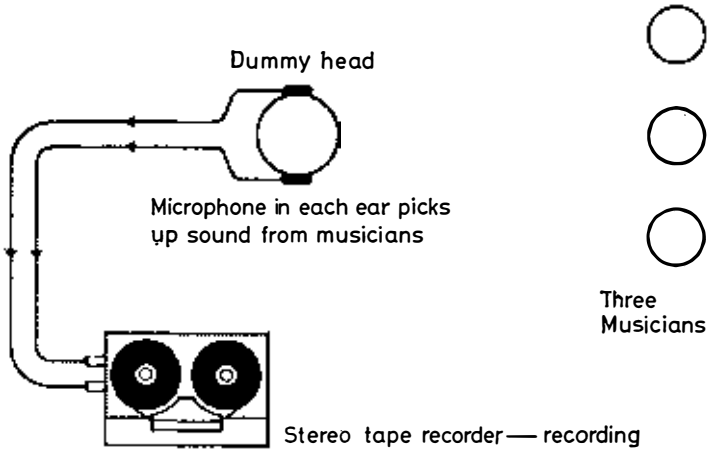

Fig 2 Making a dummy head, or binaural, recording.

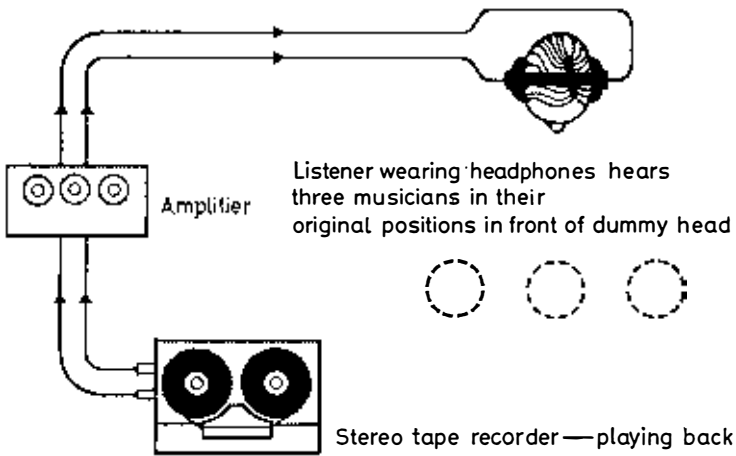

Fig 3 Playing back a dummy head recording.

to the right ear of the listener. Blasting these sounds out of a pair of loudspeakers so that they mix and fill a room is a fruitless exercise. The resultant sound is a very poor replica of the original, because each of the listener's ears simultaneously hears a mixture of the sounds intended only for each ear individually. In other words the listener's left ear hears

not only sounds intended for that ear but also sounds intended for his right ear, and so on. Not surprisingly, the brain ends up totally confused.

### **A different technique for loudspeaker playback**

So the reproduction of two-channel sound via loudspeakers requires a different recording technique. In the simplest case two or more microphones are used, often arranged as a V in front of, and pointing at, the band, actors or orchestra to be recorded (fig 4). Essentially the left-hand microphone points towards the left-hand side of the sound stage being recorded, and picks up mainly the left-hand sound, but also some from the centre and even a little from the right-hand side as well. Likewise the right-hand microphone, pointing towards the right-hand side of the sound stage, picks up predominantly the right-hand sound but also some from the centre and even a little from the left. The sound from the two microphones is kept separate, in two stereo channels, and is subsequently amplified and reproduced by a pair of loudspeakers spaced several feet apart and pointing together at a listener in his favourite position (the so called 'stereo seat') in the room (fig 5). All other things being equal, (*ie*, the recording, the equipment and the set-up being correct) the left-hand loudspeaker reproduces mainly left-hand sound, some centre sound and a very little of the right; simultaneously, the right-hand speaker reproduces right-hand sound, some from the centre and a very little from the left. The listener's ears and brain hear the result not as two separate loudspeakers spouting separate sound but as a wide spread of sound. Ideally this matches the original sound stage that was recorded, with left-hand sound coming from the left, right-hand sound from the right, and the centre sound coming equally loud from both loudspeakers and appearing as if from a central source. Indeed, a good stereo system will give an even spread of sound and stereo 'image' of the original, with the existence of the loudspeakers being totally unnoticed by the listener's ears.

### **Two separate channels always needed for stereo**

This, then, is why discs, tapes and radio broadcasts need to carry two separate channels of sound at the same time for simultaneous playback in stereo. On a tape recorder this is the easiest thing in the world to achieve; the width of tape is simply divided up into separate bands or tracks and a separate channel recorded in each. On a disc, one channel is cut in each wall of the spiral groove on the record surface. In a stereo



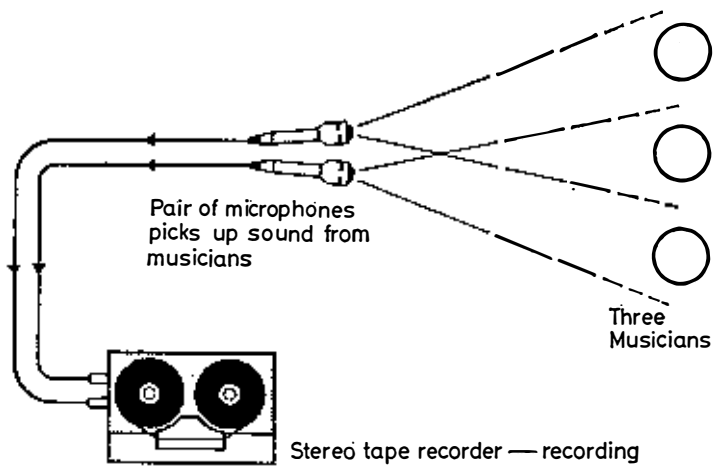

*Fig 4 Making a stereo recording for loudspeaker playback.*

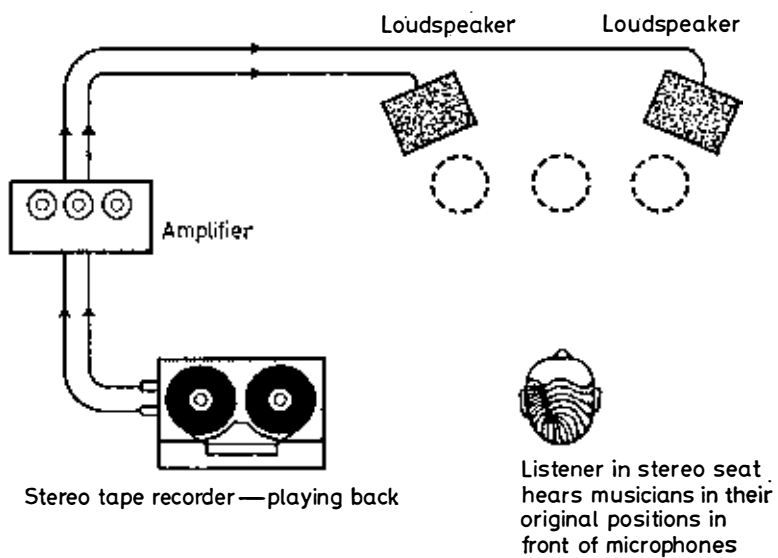

*Fig 5 Playing back the stereo recording on loudspeakers.*

radio transmission the two channels are carried by the same transmission wavelength but by different modulations of that wavelength.

### **Multi-channel sound**

Although more difficult to carry, three channels may be an improvement over two, as are four, or even more. The idea of multi-channel sound (*ie*, more than two channels) is to make the finished result even more solid and three dimensional. This is what quadraphonics is all about, the idea being to use four (or more) channels of sound to surround the listener. But the law of diminishing returns applies here, and there is more to be gained from using a few separate or discrete channels of sound sensibly than employing a lorryload with reckless abandon and no real understanding of the object in view.

In fact, few people would argue that the whole concept of surround, multi-channel or quadraphonic sound (the words *don't* mean the same thing, but they convey the same message) has more to do with making money than enhancing reproduction of sound. Certainly the difference in terms of reproduced reality is far more dramatic when mono is up-graded to stereo than when stereo is up-graded further. But, as we shall see later on, the latter can be rewarding, at least insofar as it may provide aural excitement, and it would be churlish to ignore the possibility.

### **The deficiencies of mono**

The reason why up-grading from mono to stereo is so impressive is that in a mono system all the sound from the whole sound stage is gathered together, either by one microphone or several, and bundled into a single sound channel (figs 6 and 7). When this sound channel is reproduced via a loudspeaker, every sound made by the whole orchestra, band or group of actors must be reproduced from that one, single loudspeaker source. So the listener's ear and brain just cannot be fooled into thinking that the reproduced sound is coming from a wide sound stage. In a good mono system, the loudspeaker will sound larger than it really is, but it is still a single, muzzy source. The use of two or more loudspeakers, fed in parallel from the same mono source, will spread the sound out somewhat but it will still be diffuse. It can never be a simulated sound stage, because every loudspeaker will be producing the same sound, and the ear will merely be fooled into thinking that every instrument and voice reproduced is several feet wide. Few musicians, actors and singers actually are.

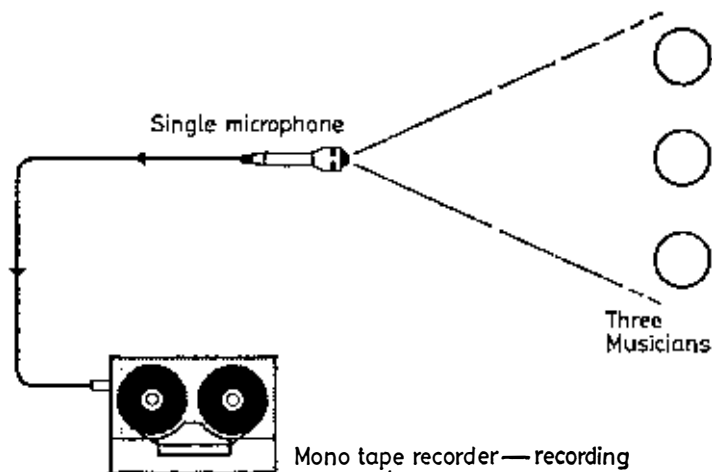

Fig 6 Making a mono recording.

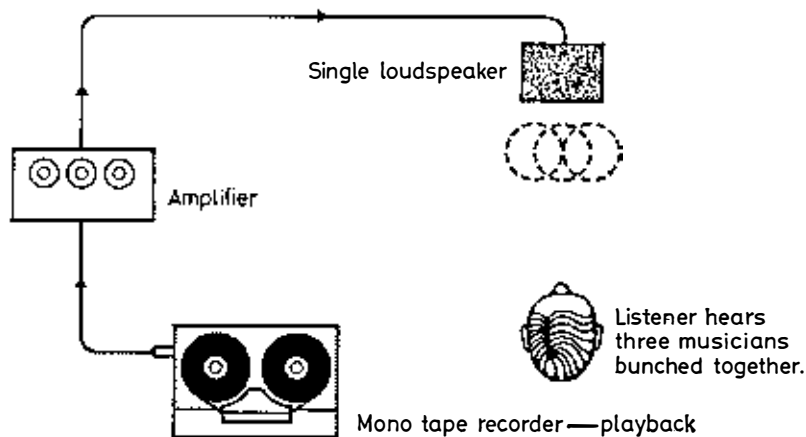

Fig 7 Playing back a mono recording.

There is thus a great deal to be said for buying a stereo rather than a mono set-up. Nowadays this view is so widely accepted that it is almost impossible to buy an expensive mono hi-fi rig, and only cheap or budget equipment or small portable radios can produce mono sound only. Of course, no equipment can produce stereo from a mono source. For instance, no radio can produce true stereo from a mono transmission

and no reproducer can create a stereo concert from a mono disc or tape. Far more important, no mono equipment can produce stereo results from whatever source, be it mono or stereo.

### **But mono never dies**

However widespread stereo equipment may now be, there are still literally millions of mono record players, radios and tape recorders in homes all over the world. Also, mono portable radios and budget recorders and record players will continue to be marketed for many, many years, if not for ever.

Apart from all other considerations, the two loudspeakers of a piece of stereo equipment must be spaced well apart to produce a worthwhile stereo image. It is obviously physically impossible to space speakers wide apart in a cabinet that is deliberately made small or easily portable. Thus it is essential that a stereo broadcast or recording should reproduce as mono on mono equipment. This is what 'mono compatibility' is all about. You will see the words written on records and tapes and hear it referred to in discussions on broadcast technology.

To be mono-compatible, a stereo broadcast must produce stereo sound on stereo radio equipment but an accurate sum of the two channels on mono equipment. Likewise a mono-compatible stereo disc must produce true stereo on stereo equipment but the sum of both channels on mono equipment. Ideally, stereo tapes should function likewise, but here there is a difference between recordings made on tape wound on open spools and those made on narrower tape stored in cassettes. There are various recording standards for tape on open reels and not all of them are truly mono-compatible. In plain terms a stereo tape may not produce the sum of both channels when played on a mono recorder. But stereo cassettes do conform to a mono-compatible standard and a stereo cassette will produce the sum of both channels when played on a mono cassette machine.

Incidentally, the business of tape width is somewhat confusing if examined too closely! The British and metric measurements do not exactly equate but for the purposes of this book the measurement 6.3 mm ( $\frac{1}{4}$  in) will be used to denote open reel tape and the measurement 3.81 mm (0.15 in or just over  $\frac{1}{8}$  in) will be used to denote cassette tape. These are the figures used by BASF, who invented tape.

---

## 3/The Amplifier - the Heart of any Hi-fi Set-up

---

### **Hot and heavy – but good**

Once upon a time, not very long ago, an amplifier was a fairly sizeable and heavy object. A gang of valves was powered by a mains transformer and fed a loudspeaker via an output transformer. All these components produced a considerable amount of heat; indeed anyone leaving an LP record on top of a valve amplifier very soon saw it droop and start to melt away. But even if valve amplifiers were bulky, hot and expensive on electricity to run, they could produce remarkable audio quality.

Indeed, when the craze for transistorising everything got under way, in the 1960s, very few true hi-fi enthusiasts would touch a transistor amplifier with a barge pole. They just didn't sound right. Even now, some purists say they prefer the sound of a valve amplifier, and although it is hard to put into words what one means by the sound of an amplifier (because its task is to amplify signals and not to produce any characteristic sound of its own), there is no doubt that a good valve amplifier is still worth a dozen second-rate transistor models.

Fortunately there are now fewer and fewer second-rate transistor amplifiers on the market, and it is a safe bet that whatever amplifier or combined tuner and amplifier (usually called a 'receiver', in hi-fi parlance) you buy, it will be transistorised and none the worse for it.

Some of the advantages of transistors are obvious. They run cooler, consume less electricity and are far less likely to give trouble than valves. They usually don't break if you are clumsy enough to drop whatever piece of equipment contains them. Also they are cheap. A less obvious advantage is that they do not need to drive loudspeakers via an output transformer, and omitting the latter from a circuit makes it cheaper, lighter in weight and less likely to distort the sound. But all audio is a swings-and-roundabouts affair, and the advantages gained by using transistors and no output transformer can easily be wiped out by some risks of damage that rear their ugly heads.

A transistorised amplifier has heavy duty power output transistors to

drive the loudspeakers. If these are short-circuited, they very quickly disappear in a puff of expensive smoke. And it is only too easy to short-circuit the output of an amplifier, for instance by briefly touching together the bare ends of the wires feeding a loudspeaker. So make sure that any amplifier or receiver you buy has output protection. What this means is that if you are clumsy with the loudspeaker output wires, a fuse will blow or an automatic switch will trigger before any internal damage is done.

### **What power and watts power**

One problem that faces everyone buying an amplifier or receiver is what power rating to look for. Don't be confused by the term 'power rating'. This is nothing to do with the watts of mains power which the equipment uses up continually while it is switched on, but refers to the maximum power available for feeding to loudspeakers. Output power is also measured in watts, but unfortunately watts can be evaluated in any one of several different ways.

Without becoming too technical, the watt is a unit of power defined as the product of amps multiplied by volts. This is fine for direct current but not so fine for alternating current, because its voltage is continually changing. The RMS (or root mean square) of an AC voltage is less than its peak, and is best described as an electronic average. Thus a wattage rating based on RMS is a sensible measurement and the one most often used by manufacturers. References to average output power and continuous sine-wave power usually mean much the same thing. Fortunately most reputable amplifier manufacturers have now standardised on their methods of measurement, and the power rating of an amplifier as quoted in one advertisement can be directly compared with another.

The ratings to watch out for, because they are misleading, are those involving maximum, instantaneous, peak or music power. They can all end up as around twice the continuous, average or RMS power value and may thus trap the unwary purchaser into buying an amplifier that is half as powerful as he thinks.

### **Factors affecting choice of amplifier**

Although it is obvious that someone who wants to play music loud in a large room will need a more powerful amplifier than someone who lives in a small bedsitter and likes only background music, there is a massive grey area in between which will cover most domestic situ-

ations. There are all manner of factors that interact. A large room will contain more air, and thus the loudspeakers will need to produce more power to move the air to produce sound. If the room is heavily soft-furnished, for instance with carpets, curtains and wall rugs, then these soft furnishings will soak up a lot of the sound from the loudspeakers (converting it into minute quantities of heat incidentally) and thus there will be a need for a more powerful amplifier to serve the room. Also, as a room fills up, all the extra human flesh and clothing soaks up sound. How many times have you been to a party and heard a small portable gramophone cope fairly reasonably, early in the evening, but end up sounding hopelessly ineffectual by the time the room has filled up? Added to this, people create background noise, and an amplifier must work harder to produce enough sound to overcome any background noise. Perhaps most important of all, some loudspeakers are much more efficient at converting the electrical power output of an amplifier into sound than others. Finally, the kind of music you intend to play must govern the type of amplifier you buy. If your taste is light orchestral, then you are highly unlikely to want to play it as loud as hard rock or big band jazz.

### **A useful formula**

One manufacturer of both loudspeakers and amplifiers suggests that you can get a good idea of what amplifier power is needed for a room by finding the volume of the room in cubic metres (multiply the length by the width by the height) and then dividing the result by four. This, they suggest, is the minimum amplifier power in average, continuous or RMS watts required for average listening under average conditions. If either you or your room is not average, then you should add half as much power again.

Let's see how this simple formula works with a fairly average room; say 5 metres long by 4 metres wide by 3 metres high. That's 60 cubic metres. Now divide by 4, to give a figure of 15 – and yes, that's a fairly reasonable minimum wattage rating per channel for a stereo amplifier.

But assume that the room is heavily carpeted and you like rock music. Around 20 or 25 watts per channel now becomes a safer bet. To be even on the safer side, perhaps because you may later need to use your amplifier in a larger room or with less efficient speakers than at present, it might be worth while buying an amplifier with 30 watts power per channel. Although it is ridiculous to buy an amplifier with hundreds

of watts per channel (they are available) for a domestic situation, it is easy to overlook the fact that no amplifier should ever be run with the volume control turned full up. An ideal setting is at about 3, 4 or at the most 5 on a scale of 10. This not only leaves the amplifier free to handle loud peaks in the programme, for instance sudden crescendoes, without distorting, but also leaves you with plenty of power in hand if you do give a party and everyone you ask turns up with a friend to soak up your booze and sound. Also, due to an odd phenomenon akin to that whereby enthusiasts with a keen ear can talk sensibly about transistor and valve 'sounds', a piece of equipment run leisurely at a low volume setting always seems to sound more satisfying than another run on the verge of being flat-out.

### **Inaudible snags at the output**

Some amplifiers boast that because they are transistorised, they have no output transformer and can have what is called 'direct coupling'. What this means is that the audio signals fed out to the loudspeaker extend not just in the audible range (20 Hertz to 20,000 Hertz), but right down to zero Hertz or direct current. (Hertz or Hz is the term now used as a measure of frequency, in place of cycles-per-second.) No one has yet told me satisfactorily why it should be necessary to feed inaudible sounds to a loudspeaker, and there are very real reasons for *not* doing so.

Think for a while about what can happen when you drop a record sleeve onto a table on which a very sensitive gramophone turntable is playing. The gramophone pick-up, which is designed to sense vibrations at all frequencies, responds to the low-frequency thud of the falling object by producing a very low-frequency signal. If conditions are right (or, more accurately, wrong), that low-frequency thud may end up being amplified and direct-coupled to the loudspeakers, to produce a heavy current surge that is of such low frequency that it is only partly audible, but powerful enough to distort audible sounds or even damage the loudspeaker.

Exactly the same problem can arise if the amplifier feeds very high frequencies through to the loudspeaker. You won't be able to hear them, but they can quite easily burn out the coils of the high frequency units in the loudspeaker. And it is again only too easy to feed high-pitched signals through an amplifier to the loudspeakers without realising it. All you have to do is rewind a tape fast on some types of tape.



recorder with the amplifier volume control turned up. Any recording on the tape will flash past the playback head so fast that it will produce just those very high frequencies that will burn out a loudspeaker coil. So if you are buying a high power amplifier choose one that has at least the option of filtering off unwanted low (and ideally high) frequencies from its loudspeaker outputs. Also, it is a good idea always to remember to turn down the volume control of an amplifier when you are rewinding tape.

### **Into the inputs – the need to match correctly**

Having looked at what an amplifier should produce at its outputs, we now need to look at what it should take in at its inputs. In fact, to be more accurate, we need to consider not only what it can take, but what it demands. This is because an amplifier or receiver will only perform properly if fed with the right input signals. Unfortunately, it is only too easy to overload, underload or otherwise mis-match the inputs of an amplifier, and so produce quite atrocious results at the output. This is the main pitfall to be avoided when buying separate items of hi-fi equipment to link up together as a building block system. If you follow the recommendations of a reputable dealer or manufacturer, you have a good chance of ending up with a well-matched system. If you cross your fingers and hope for the best, you can spend a great deal of money and be rewarded by some awful sounds. The other possibility is to learn enough about matching to make the right decisions for yourself.

The main inputs to any amplifier are at least one for a record deck or gramophone (often labelled ‘phono’), at least one for a tape recorder (labelled ‘tape’) and usually at least one for some other auxiliary source (not surprisingly usually labelled ‘auxiliary’).

### **Phono**

A few years ago there were two types of phono input, one for a so-called crystal or ceramic gramophone cartridge and another for a magnetic cartridge. Nowadays ceramic or crystal inputs are seldom encountered which, as we shall see later, may be a cause of regret to some people. The old ceramic or crystal inputs were designed to receive a fairly high level signal (a large fraction of a volt) but magnetic cartridges produce far less signal than this, so magnetic phono inputs are designed to receive much lower signals (in the order of a few thousandths of a volt). Typical input sensitivities will be between 2.5 millivolts and 10 millivolts.

Ideally, and in theory, the best results are obtained when the rated signal output of a gramophone cartridge exactly matches the rated input sensitivity of a phono input. But in practice most amplifiers have such a good overload capability that if there is only one magnetic phono input and no provision for switching it between two different sensitivities, almost any magnetic cartridge will work well into that input. If more than one phono input is provided, or there is a switch built in which changes that input between high and low sensitivity, the answer is to switch it and see. You can do no damage by plugging a cartridge into the wrong input or switching to the wrong sensitivity, and a few minutes' trial and error should tell you which position gives the best result in terms of least distortion and most reasonable setting for the main volume control.

To help them give an overall cleaner sound, gramophone records are recorded with a doctoring of the frequency response (according to the so-called RIAA curve), which needs correcting in the amplifier if a magnetic cartridge is used. This is of no concern to the user because it is all done automatically. But it does mean that a tape recorder or some other piece of auxiliary equipment (such as an external radio or TV tuner) cannot be fed into a magnetic phono input because the signals from such equipment are 'flat' (*ie*, undoctored) and do not require any frequency correction. Also, incidentally, they are much higher in level and would heavily overload the very sensitive magnetic phono input. For exactly the same reasons a ceramic or crystal cartridge (which has a high level 'flat' output) should not be plugged into a magnetic input.

### **Tape and auxiliary**

Provided that you stick to the general rule of plugging tape or auxiliary equipment only into the tape or auxiliary sockets of an amplifier, then there is unlikely to be any over- or under-load problem. Difficulties may arise with some Continental equipment, but usually the instruction book accompanying such equipment will explain how to match it to more standard equipment.

### **Plug types**

The physical connection between a record or tape deck and the inputs of an amplifier may be via so-called phono or RCA plugs. An alternative method of connection is the so-called DIN plug and socket (the letters standing for Deutscher Industrie Normen, the German equivalent for

British Standards). A DIN tape socket can not only take in a signal from a tape deck but also put out a signal which can be used for tape recording a radio or gramophone programme being fed through the amplifier. Thus a single DIN plug, lead and socket connection can provide two-way connection between a tape deck and amplifier.

There is now commercially available a very wide range of ready made-up leads with plugs and sockets at their ends, which will cover just about every connection problem likely to be encountered by the human race. Take my tip and buy ready-made leads like this. Quite apart from the fact that ready-made leads are almost as cheap as leads made up from separately bought plugs and wire, it is a tricky, time-consuming and infuriating exercise to make them up yourself. A useful tip, however, is to bear in mind that some shops always seem to be out of stock of the most popular leads. Thus, when a shop sells you expensive equipment, insist that it also sells you all the necessary connecting leads at the same time. (See back to figs 1, 1a and 1b in chapter 1.)

### **Aerial connection**

A tuner/amplifier or receiver will of course also have aerial input sockets for FM radio reception in stereo or mono. The FM sockets provided will be of two kinds; a coaxial socket for British use and a twin-feed or terminal connection for USA use, which can be ignored. The aerial necessary for AM reception on the medium or long waves is often provided by a ferrite rod inside the receiver or hinged to a rear panel. Alternatively a simple terminal connection may be provided for a straightforward wire aerial.

### **With knobs on**

Having now dealt with the mysterious business of what inputs an amplifier should have out of sight at its rear, we need only to look briefly at the question of what knobs it should have on the front. Obviously there will be an on/off switch, a volume control, tuning gear for the radio circuitry, and tone controls for cutting and boosting the treble (high) frequencies and the bass (low) frequencies. There may also be a so-called 'presence' control, which controls the mid-range frequencies in between the bass and treble, and there will be a knob for switching between the record, tape and auxiliary inputs.

Well worth watching out for is an amplifier which enables as many inputs as possible to be switched one from the other. The most infuriat-

ing thing in the world is to have to grovel around the rear of an amplifier, plugging leads in and out. Apart from **anything** else, leads tend to develop faults if they are not left alone. It is a joy to be able to switch at the front between one record or phono source and another and one tape source and another while they all remain plugged into the rear. Ideally, if the amplifier has inputs for two tape recorders, there should be a facility for dubbing from one to the other: in other words, using one recorder on playback and recording its output on another.

Other worthwhile features to watch for are switchable filters which trim the bass or treble end of the amplifier's performance, in addition to the trimming provided by the tone controls. These can help get rid of the hiss from old, scratched records or poor tape recordings.

As manufacturers become more and more desperate to sell new models, they think of ever-impressive new knobs to provide for twiddling. You can even dim the light on the radio tuning dial of some receivers. The main advantage of such controls is that they put last year's model out of date, and so knock pounds off its retail price, thereby making it an ideal bargain for the level-headed shopper.

---

## 4/Adding a Record Player

---

### **An idea that shouldn't have worked**

Super-big and super-small are seldom super-good. The same can usually be said of super-new. As often as not, the trusted and tried old approach turns out in the long run to be as good as, or better than, innovations made for their own sake. So technology has a fascinating habit of chasing its own tail. Think, for a moment, about how the most expensive and the most modern typewriters use a golf-ball head with the typeface dotted over its surface. As the ball is brought hard against the paper it is spun round to expose the selected letter. That of course is exactly how many of the old, original typewriters worked.

But just as technology chases its tail, so it does something else, equally odd. It enables man to make a success of almost any project, provided he works hard enough at it. Technicolour films are printed, not photographically, but mechanically by running blank film several times past other strips of film that are soaked with dye. Years of research and development have made this apparently unworkable idea work so well that the picture, even on a vast cinema screen, is clear and crisp. Likewise, the Hovercraft, the whole American space programme, the internal combustion engine, Xerographic copying machines and even that original golf-ball typewriter must have all seemed pretty hopeless ideas until somebody persevered with them long enough to make them work. The gramophone record is another hopeless idea that should never have worked. But of course it does. And gramophone technology also tends to chase its tail.

### **Eureka!**

It was that extraordinary inventor, Thomas Alva Edison, who invented the gramophone – or phonograph, as he christened it – and rushed details to the American Patent Office on Christmas Eve 1877. Previously, other engineers had given up all hope of recording the human voice or the sound of music, because they knew that such sounds were built up from massively complicated mixtures of mechanical vibrations,

and it seemed quite out of the question to capture those vibrations mechanically. But Edison cut a spiral groove in a hard cylinder and covered it with soft metal foil or wax. He rotated the cylinder and moved it sideways past a sharp stylus, which was attached to a diaphragm. Sound falling on the diaphragm vibrated the stylus as it cut into the soft material. Edison made his diaphragm vibrate by speaking the words, 'Mary had a little lamb.' He then repeated exactly the same operation but with a smaller stylus and lighter diaphragm. His own words came back at him from the diaphragm, and the gramophone record was born.

### **Birth of the disc**

Soon after, workers such as Bell, Tainter and Berliner used flat discs instead of hollow cylinders as a record medium, but of course the principle was the same: the vibrating diaphragm moved a needle which made an undulating cut in the record surface as it was moved past the needle.

There were two types of record undulation: varying depth indentations, which were known as 'hill-and-dale' cuts, and side-to-side or 'lateral' cut grooves. The words explain everything. In the hill-and-dale cut, the needle vibrated up and down, and in the lateral cut it vibrated from side to side. Eventually, hill-and-dale cuts fell out of favour, and lateral cut became standard. In fact any mono recording (be it 78, 45 or 33 $\frac{1}{3}$  rpm) has a simple, lateral-cut groove; so a gramophone stylus playing back a mono record simply moves from side to side.

When the stylus plays back a stereo record, however, it moves both side to side and up and down. This is because stereo records have one channel of sound cut in one groove wall and the other channel sound cut in the other wall. This requires the stylus to move (or have so-called 'compliance') in all directions, and is one reason why it will damage a stereo record to play it on an old mono gramophone. Another reason for damage is that an old mono gramophone will probably have a very heavy pick-up and bear down far too hard on the record groove for its well-being and long life.

### **The first thoughts of stereo recording**

Incidentally, although stereo records were not widely available until the late 1950s and early 1960s, and mono did not really die away until the end of the latter decade, it was recognised as far back as the 1920s

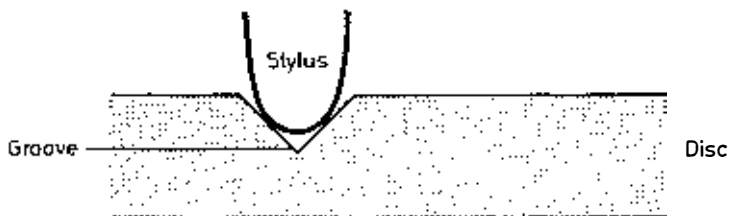
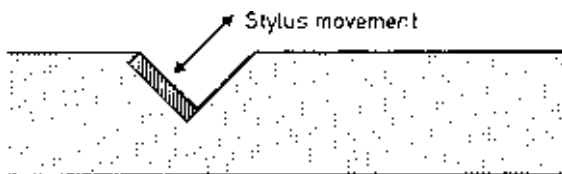

*Fig 8* The pick-up stylus 'tracks' a spiral groove cut in the disc surface. In a stereo record separate left and right channel signals are cut in the opposite walls of the same groove.

that at least two separate recorded channels are needed for good sound reproduction – witness those early dummy head experiments. And in case you think that the *method* of storing those two channels in a single groove of a disc is a recent invention, it wasn't. The original idea of tracing one channel of sound on one wall of the groove and the other channel on the other wall dates back to an early 1930s invention by the late Alan Dower Blumlein.

The way in which a modern stereo disc is cut, and plays back, is well worth considering in a little more detail.

As the sketches show, a gramophone stylus tracks the spiral groove cut in the surface of the disc and if the walls of the disc are completely smooth (fig 8) then there is no sound at all. If, however (fig 9), the cutting stylus vibrates in the direction of the arrow, to cut undulations in one wall of the groove, then when the record is played the gramophone stylus will move in a similar manner and produce sound in one channel only. On the other hand if (as shown in fig 10) the cutting stylus moves in the opposite direction, it will cut signal undulations only in the opposite wall of the groove, and on playback a replica signal will be produced in the other channel only. If (as shown in fig 11) the cutting stylus is fed with signals from two channels, it will move in both directions, not at



*Fig 9* Signal cut in one wall of the groove and reproduced in one channel only.

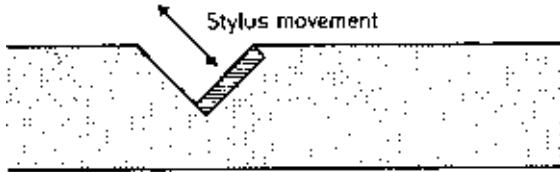

*Fig 10* Signal cut in the opposite wall of the same groove and reproduced in one channel only.

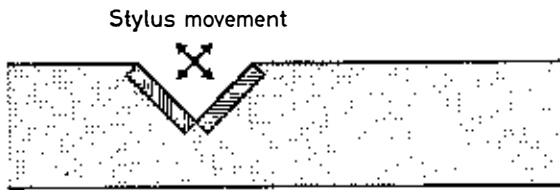

*Fig 11* Signals cut in both walls and thus reproduced in both channels.

the same time of course, but in a complex wave form, to cut undulations in both groove walls. On playback this will produce signals in both channels.

The cutting engineer will try very hard to ensure that where the same signal is cut in both walls they will move together in snake-like fashion (fig 12) rather than in opposite directions (as shown in fig 13). This is because in the former (in-phase) case, the stylus will move only side to side, to produce an equal and in-step signal in each channel, but in the latter (out-of-phase) case the stylus will move up and down, to produce



*Fig 12* The same signal 'in phase' in each channel produces a groove that looks like this from above.



*Fig 13* The same signal 'out-of-phase' in each channel produces a groove that looks like this from above.



equal but opposite and out-of-step signals in each channel. This detracts from the stereo sound heard from the loudspeakers.

### Old and new again

When Edison first recorded sound on a cylinder, the cutting stylus was mounted on an arm which moved lengthways along the cylinder transverse to its central axis. The playback stylus moved in the same way. When discs replaced cylinders, the spiral groove on the disc flat surface was cut by a stylus mounted on an arm that moved straight in from the edge to the centre, so that (just as with the original cylinders) the arm carrying the cutting stylus was always tangential to the grooves (fig 14). This is usually called parallel tracking, and it seems obvious to have the disc *playback* cartridge parallel-track in the same way. Unfortunately, it's a difficult object to achieve, and the compromise reached was an arm pivoted to a fixed point alongside the disc (fig 15). This is the so-called 'fixed pivot arm' which is seen on all but a very few gramophones today. It is a compromise, because the stylus is only truly tangential to the groove over some of its swing, but it's a compromise that represents the triumph of prolonged perseverance.

Records are still *cut* with a parallel or tangential tracking arm, just as they always were and – surprise, surprise – technology is going round in circles yet again to bring parallel tracker gramophones onto the con-

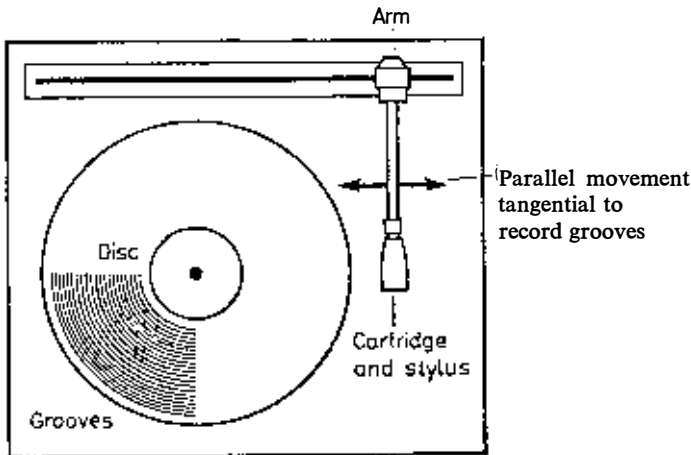

Fig 14 A parallel or tangential tracking pick-up arm.

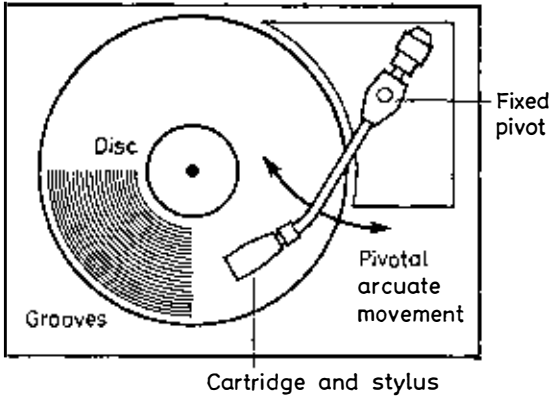

Fig 15 A fixed pivot arm.

sumer market. But these are expensive, because they must incorporate complicated servo-control mechanism to help the arm move slowly over any record, be it warped, eccentric or otherwise abnormal.

All in all, unless money is no object, you are better off buying a turntable with a conventional, fixed pivot arm. Also, because of the complicated geometry needed to ensure that the pick-up stylus as nearly matches the movement of the cutting stylus as possible, it is safer for most people to buy a record deck or turntable with a fitted arm. Hi-fi purists will match and fit what they regard as the best arm to the best turntable, and some dealers will do this matching for you; but otherwise go for a turntable and arm combined.

### The magnetic cartridge

The pick-up arm carries the pick-up cartridge at its free end and in the cartridge the stylus (or needle as it used to be known) is mounted on the tip of a very tiny, very light – and very fragile! – rod or ‘cantilever arm’. This vibrates with the stylus as it tracks the record groove. In a magnetic cartridge, the vibrating rod moves a tiny member such as a piece of metal or a magnet in a magnetic field, to generate tiny electrical currents in a series of coils. The coils are so wound that when the stylus and cantilever are vibrated by undulations cut in one groove wall they produce a signal in one coil and channel only, and when they are vibrated by undulations cut in the other groove wall they produce signals

in that coil and channel only. Undulations cut on both groove walls produce signals in both coils and channels, to build up a normal stereo signal with sound in both channels.

As we have already seen, where an equal in-phase sound is to be produced in both channels, the groove walls will each be cut in the same way and the stylus will move only from side to side – in exactly the same manner as the groove of a mono record groove. As we have also already seen, equal sound in both channels produces a centre front – or mono – sound from a stereo set-up (provided that it is in phase or in step). This is why a mono record played on correctly set up stereo equipment produces a centre-front sound.

### **Other types of cartridge**

But not all pick-up cartridges are of magnetic type. Capacitor cartridges are appearing on the market but are so far fairly expensive. The previously mentioned crystal or ceramic type has been available now for many years and in these the cantilever arm is moved by the stylus to press on a tiny piezo-electric element of crystal or ceramic (artificial crystal) which produces minute electrical currents as it is physically deformed. Only very cheap gramophones now have crystal pick-ups or cartridges, because although they produce a fair amount of electricity (remember what was said previously about the various phono inputs on an amplifier) and are thus easier to use with cheap amplifiers, they suffer from many disadvantages. They tend for instance to produce a rather 'spiky' sound, which makes them unsuitable for true hi-fi use. But that is not to say that all piezo-electric cartridges are low-fi. There still exist fair quality, low cost cartridges of ceramic or artificial crystal type.

### **Stylus cost**

The advantage of a cartridge of ceramic type is that stylus replacement tends to be cheap, whereas stylus replacement for a magnetic cartridge tends to be expensive. It will cost only a pound or so to replace a stylus for a ceramic cartridge, but £10 or even £20 to replace a stylus for a good magnetic unit. All modern stylus tips are made of diamond, and are far more likely to need replacement through clumsy handling than through natural wear and tear. So when you buy a cartridge, do ask how much a replacement stylus is. You may be surprised.

### Matching again

But don't buy a ceramic cartridge simply because stylus replacement is cheap unless you are sure that your amplifier has an input that can be correctly matched to it. A ceramic cartridge mis-matched to a magnetic input will very probably produce an awful sound.

Cartridges vary widely in price and most pick-up arms will physically accept most cartridges. But there is absolutely no point in putting an expensive cartridge into a cheap arm and there is very little point in putting a cheap cartridge in an expensive arm. For the advantages of an expensive pick-up cartridge to make themselves felt – or, more to the point, heard – the cartridge must be able to track the record at very low weight. But if the arm is poorly made, with too much mass, friction and inertia, it will not enable any cartridge to track at low weight.

Some firms specialise in making arms and others in cartridges, and the use of one with the other as an ideal pair is usually acknowledged and recommended by the firms themselves. Follow these recommendations unless you know what you are doing to the contrary.

Other firms, however, steadfastly maintain that the cartridges they produce perform best with their arms (and turntables), and have deliberately made them difficult or impossible to combine with equipment from other manufacturers. There is sound sense in both approaches. On the one hand it can be argued that it is enough for a manufacturer to concentrate on producing the best possible arm, cartridge or turntable; on the other hand it can be argued that the manufacturer is in the best position to match a cartridge to an arm to a turntable. You pay your money and you take your choice. My personal tip is that all but the most dedicated enthusiast is far better off buying a cartridge/arm/turntable combination that has been put together as a complete record deck by a reputable manufacturer or an informed and reliable dealer.

### The turntable

So far we have tended to concentrate on arms and cartridges and mentioned turntables only in passing. There is good reason to leave turntables until last. It is after all not unduly difficult to make a flat, metal disc or platter run smoothly and quietly round at a constant speed of  $33\frac{1}{3}$  or 45 rpm. Of course it gets more difficult to make sure that the speed is *absolutely* constant, and that the bearings on which the moving parts move are absolutely silent, so that the cartridge cannot pick up any mechanical vibrations from those bearings while tracking a record

and produce so-called 'rumble' noise from the loudspeakers. But then again many records have so much noise already built in, either from the studio air conditioning, or the sound of traffic passing outside the studio building, or the bearings of the disc-cutting equipment, that zero rumble is something of a pointless panacea. Moreover, provided that the disc is rotated at unvarying speed (to avoid so-called 'wow' and 'flutter' in the reproduced sound) is it really so important to anyone but a musician that the disc is playing at exactly 33.33333 rpm? Before answering that question for yourself think for a moment on whether you have ever noticed that cinema sound films shown on television are projected at 25 frames per second rather than 24 fps as intended !

### **Extra gadgetry**

It is also fairly easy for a mechanical engineer to design a mechanical system for helping the pick-up arm and cartridge on and off the record, and for doing any one of the hundred-and-one other tasks which some people seem to expect of their gramophones. Really, this is all up to the purchaser. If you want gadgetry like automatic lift-off, you must simply be prepared to pay for it, and look for yourself at how smoothly it performs.

There is only one real problem facing someone who is in turn facing a row of different record decks at different prices. Some will have belt drive, some will have idler drive working on the turntable rim, and others will have direct drive. The latter (direct drive) is a fairly recent development in gramophone technology, and all it means is that the flat metal turntable or platter that turns round carrying the disc is formed actually as a part of a slow-running electric motor. In a belt drive turntable, a fast-running motor transmits its power to the platter via a belt, and in an idler wheel or rim drive design the motor drives a sequence of idlers of which one bears directly on the inside or outside rim of the turntable platter. Direct drive turntables tend to cost more than other types, but the other types have more parts to wear out and start causing uneven performance. As in most things you get what you pay for and belt drive tends to be quieter, and more expensive, than rim drive, but cheaper than direct drive.

---

## 5/Tape in General

---

### **An old idea**

Although magnetic tape recording only became a household concept in the Fifties, the basic idea of recording magnetically dates back to the end of the nineteenth century. The theory is really very simple. You take a strip of magnetisable material and move it past a coil into which electrical signals are fed. The electrical signals passing through the coil create a magnetic field which imprints magnetic patterns onto the material as it passes. So the result is a strip of material with a train of magnetic patterns along its length (fig 16). If this is now moved past a fixed coil (it may even be the same coil as was used to magnetise in the first place), the magnetic patterns will create a changing magnetic field in the coil and this will in turn produce a tiny electrical current. The coils are generally embedded in a so-called 'magnetic head', and if attention is paid to a thousand-and-one small details (such as using a suitable material and keeping the speed of the strip constant and equal on playback and record), the electrical signals produced by the playback head will be an exact replica of those originally fed into the record head (fig 17).

Within reason, it doesn't matter whether the strip is played back five minutes or five years after it was recorded because, provided that some other strong magnetic field does not wipe out or 'erase' the recorded patterns, the strip will hold those patterns for ever in a sort of electronic deep freeze. And even running them backwards and forwards past a playback head over and over again will not seriously alter them. But to replace them with fresh patterns, you simply deliberately erase the originals by applying a strong magnetic field and then re-use the strip.

The early workers, including Edison's assistant, Tainter, and the Danish inventor Poulsen, tried all kinds of magnetic material as the magnetic strip, including metal drums, and discs and thin steel strip or wire. Nowadays, of course, magnetic tape is almost invariably used, but discs with a magnetic coating are used in computers and TV recorders. Tape was once made of coated paper, but, of course, it broke too easily.

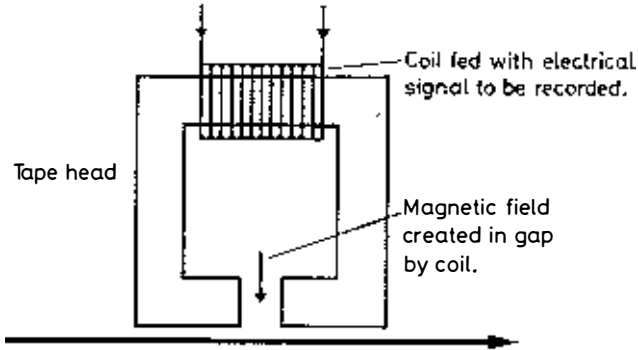

Magnetisable strip moves past gap in record head.

*Fig 16* How a magnetic, eg tape, recording is made.

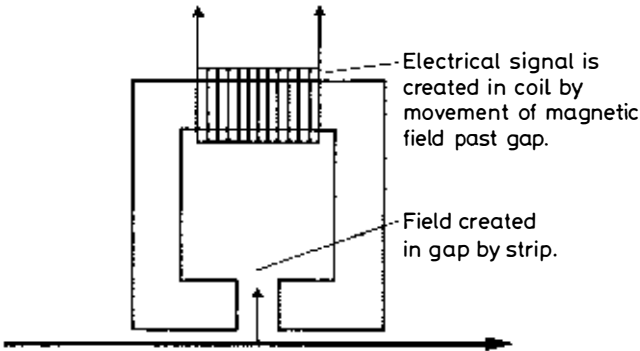

Magnetised strip is moved past the gap in playback head.

*Fig 17* How the magnetic recording is played back.

Now the tape you buy for domestic use all has a plastic base with a thin coating of magnetic material on one side. Every tape manufacturer has his own secret recipe for his own particular type of coating, but all these recipes have in common one basic, essential ingredient; namely tiny magnetic metal oxide particles that pick up and store the magnetic pattern as the tape is moved past the record-head.

### Two types of tape recorder

There are now two major types of tape recorder on the hi-fi market: the 'open reel', or 'reel-to-reel' type, and the 'cassette' type. It makes

sense to hold over discussion of the cassette type until the next chapter, because the difference between these and open reel machines is one of practical detail, rather than scientific theory.

### **The open reel or reel-to-reel machine**

As the words imply, on an open reel or reel-to-reel tape recorder, the magnetic tape is stored on a simple open reel or spool, rather like a large typewriter ribbon spool, and is fed past the record and playback heads onto another, similar open reel. Conventionally, the loaded reel is referred to as the 'take-off' reel, and the empty reel that gradually fills up as tape is run through the machine is referred to as the 'take-up' reel.

The playback and record heads have their coils secured inside them, and each has a polished metal surface over which the tape must be guided smoothly and closely. Tiny gaps, only just visible to the naked eye, are formed in the polished metal head surfaces. These gaps serve to focus the magnetic field onto or from the working electronics of the heads. By and large, the smaller the head gaps the better the tape recorder will be, and it is essential that these gaps be kept clean.

Because magnetic tape is an abrasive medium (it would function very well as fine sandpaper if sold in large enough sheets) its passage over the heads keeps them clean and polished but also tends to wear them out. The tape also sheds tiny particles of metal oxide as it travels, and these tend to clog up the head gaps. The heads on a good audio tape recorder used with good tape will last for many years before they are worn away sufficiently to need replacing, but they do need frequent cleaning to keep the gaps unclogged. You would be surprised how many very expensive tape recorders are at this moment producing quite abysmal audio quality, simply because their owners haven't bothered to clean the tape heads since purchase. The symptoms of a clogged gap are low output volume, and a generally muffled sound, caused by the loss of high frequencies.

### **How to clean by hand**

Unfortunately it is very easy to damage a tape head by cleaning it clumsily. Never ever use any kind of metal tool, such as a pin, needle or nail file end. This will not only scratch the highly polished surface but may permanently magnetise the head itself, which will then imprint unwanted hiss on any tapes you use for playback or recording in future. Also, be very careful about what cleaning solvents you use on the heads



of a tape recorder. It is only too easy to dissolve away the plastics which holds the coils. Don't, for instance, ever use carbon tetrachloride on a tape recorder head. In fact don't ever use CTC for any hi-fi equipment, because you will find, to your misery, that it goes through plastics like a wire through butter. Isopropyl alcohol or vodka (no kidding!) or, at a pinch, methylated or surgical spirits are the best commercial solvents to use. And you will be surprised how much you can clean with a tiny drop of saliva.

There are now coming onto the market a whole range of Aerosol sprays of solvent liquids, some intended especially for cleaning tape recorder heads, and these are also a safe bet. But do always read the instructions on the can before use, and if in doubt about whether or not it is safe to use any solvent near the plastics of your own particular tape recorder, put a small test amount of the material onto the underside of the case or some other, out-of-the-way area, and see what happens.

Although metal tools of all types are taboo, you will often find the need to budge a persistent piece of dirt from a tape head surface with some kind of pointed instrument. The safest thing to use here is a small piece of plastic, which can't possibly scratch or magnetise the polished metal. Just as there are various Aerosol sprays now available on the market for cleaning tape heads, so there are fancy kits of cleaning utensils, such as a little plastic stick with a cotton bud on each end of exactly the same type that is sold in chemists' shops for cleaning children's ears. But invariably these cotton buds cost far less in a chemist's shop than in a hi-fi cleaning kit.

### **Automatic tape head cleaners**

There are also various tapes on the market which are supposed to clean the record and playback heads of a tape recorder automatically when the tape is run through the machine a couple of times. Personally, I have never found these cleaning tapes too successful, as they tend only to get rid of that dirt which is most easily got rid of otherwise. The really hard-core residue that causes the trouble always needs shifting with a bit of delicate elbow grease.

### **Beware of cheap tape**

Do be wary over buying cheap recording tape from unknown makers or obviously dubious sources. The household tape names (Agfa, BASF, Zonal, TDK, Sony and so on) may cost rather more than a similar length

of nondescript tape, but buying the cheap version can be very false economy. Cheap tape is often far more abrasive than full-price tape, and can cause rapid wear of the record and playback heads. Cheap tape also suffers from 'drop-out' (gaps in the recorded sound due to bald patches in the magnetic coating mix) and may also be slit to slightly over or under the standard 6.3 mm ( $\frac{1}{4}$  in) width. Some machines will cope happily with tape that is slightly too wide or too narrow, but others will simply refuse to play it. It may also just not make a good recording! All this can be very annoying if you have bought a bargain lot of ten reels from a mail order firm at a PO Box number several hundred miles away.

### **A video aside**

Although we shall be looking briefly at video or television picture tape recorders later on, I would hate to think that anyone took the advice given above and went off now and cleaned the heads on a video recorder before reading any further. The heads on a video machine do not stay stationary like the heads on an audio tape recorder. Instead they whizz round on a drum at around 32 kilometres (20 miles) an hour and are not only very, very fragile but also very expensive to replace. So never try to clean the heads on a video recorder without first reading the instruction book which will tell you what parts of the heads you can clean and what other parts will immediately be ruined if you so much as lay a finger on them.

### **Why your voice sounds odd on a tape recorder**

Nowadays most people have either owned or used a tape recorder at some stage. Gone, thank goodness, are the days when it was thought exciting to hear the sound of your own voice. 'Is that really me?' was the stock question that was always asked when people heard their own voices on tape for the first time. Incidentally, the reason why a recording of one's voice sounds odd is that one hears one's own voice 'live' mainly through bone conduction, the sound travelling from the mouth to the ears via the bones in the head rather than through the air. Try blocking your ears and talking to yourself (in private, or passers-by will think you are mad) and you will see what I mean. This means that if you want to try the ultimate test on your own or someone else's hi-fi you will need someone else as an accomplice. And now is as good a time as any to explain that ultimate test.

### **The ultimate hi-fi test**

What you do, to check out a hi-fi system for overall quality, is set up a microphone in the open air (to make sure that there are no echoes, however imperceptible) and record the voice of an accomplice speaking at normal level into the microphone. You then move inside and play the tape back through the hi-fi system under test, so that the recorded voice comes out of one or both loudspeakers. The accomplice then stands next to the loudspeaker and speaks the same words that are on the recording immediately after it has been played.

The human ear is remarkably adept at spotting even subtle errors in the reproduction of a recorded human voice. This isn't really too surprising. When we all lived in caves, we had to recognise the difference between other people's voices in the dark, because that was the only way of knowing whether the shadow across the cave was a friend or foe. Natural selection soon weeded out those who were unable to distinguish between friend or foe, because they were very soon killed by their foes and didn't have a chance to procreate. (On the other hand, our ancestors seldom had occasion to compare the sound of two similar symphony orchestras, string quartets or rock groups.) So it isn't really so surprising that our ears are uncommonly good at spotting any difference between the recorded sound of a voice and the live original. Indeed, a sure-fire way to sap any hi-fi enthusiast of all his confidence is to run the ultimate test on his gear. There are very, very few domestic set-ups that will fool a blindfolded listener, and leave him unable to tell which voice is live and which is recorded.

### **What else to listen for**

If you are setting out to buy a tape recorder and you have a chance of taking it on trial loan, then the voice test is worth trying. But do remember that almost always the faults that show up will be due to the loudspeaker colouring the sound that it reproduces. In other words, don't condemn a tape recorder simply because it fails the live versus recorded voice test. But certainly condemn it if the voice shows any sign of wavering, either slowly (this is called 'wow') or more rapidly (this is called 'flutter'). Actually wow and flutter will show up most on piano recordings. In fact, piano, along with the human voice, is one of the most difficult sounds to record accurately. Voice and piano together is a truly vicious test.

Usually, middle-of-the-road price range tape recorder purchases

won't be available on a trial basis. You will need to make your decisions on the strength of published technical specifications, reviewers' comments and the words of a salesman you hope you can trust. I am not a great believer in studying the published technical specifications of tape recorders, or for that matter any other hi-fi gear. It may look impressive on paper when the makers talk about this percentage of wow and flutter, that percentage of distortion and so many dB less of unwanted noise (dB is the abbreviation for decibel). But to interpret the true meaning of figures like these you do really have to know a great deal about the subject. This is one area where a little knowledge can be very dangerous because it leaves you wide open to being conned. For one thing, there are different ways of taking different measurements, to produce different results. For another thing, most equipment is mass produced, and there is no doubt that not everything coming off a production line lives up to its quoted specification.

### **Judging equipment**

What matters is how a piece of equipment *handles* and what it *sounds* like. As no ordinary household hi-fi enthusiast will have test equipment to check whether a piece of equipment meets its published specification or not, the final judgement on audio quality must always be made by ear. I have known people listen, blissfully happy, to the most awful equipment, simply because a piece of paper full of technical jargon had convinced them that it should sound like a million dollars. Far better to short list a few pieces of equipment that have just the facilities and features that you need and cost the right amount of money, and then read a few reviewers' reports in the hi-fi press on how the review samples checked out. If the reviewers' reports seem hopeful, go along to a dealer and ask to handle and hear a model of each for yourself. Then choose.

### **Features to look for**

But what features should you look for in a tape recorder? Well, first of all, there is no point in having a domestic machine that will only take 13 cm (5 in) spools, because these will not give you enough tape length to make long recordings without changing tapes. An 18 cm (7 in) spool capability is ideal, but several machines will take 26.5 cm (10½ in) spools. This is fine, provided that the mechanics of the tape recorder really are gutsy enough to handle weighty 26.5 cm (10½ in) spools full of tape without overheating or developing wow or flutter. But generally, a

cheap machine loaded with large spools will be more trouble than it is worth.

Of course the length of recording available from a fixed length of tape depends on the speed at which it is run through the machine. In general, the faster the tape runs through the machine the better will be the recording quality, and the less risk there will be of tape drop-outs producing irritating audible effects. Obviously a tiny fault in the oxide coating will go past the record and playback heads far more rapidly at a high tape speed than a low tape speed, and will be far less noticeable, because it will be of much shorter duration.

It is far easier, too, to edit tape that has been recorded at fast speed, because the recording is stretched out rather than compressed, and the gaps between words will be physically longer. Speed is measured in centimetres per second (cm/s), previously inches per second (ips). Broadcasters use a tape speed of 19 cm/s ( $7\frac{1}{2}$  ips) or 38 cm/s (15 ips) and some professional recording machines use 76 cm/s (30 ips). For domestic use, 19 cm/s ( $7\frac{1}{2}$  ips) is ideal, but a good modern machine will produce excellent results at 9.5 cm/s ( $3\frac{3}{4}$  ips). On an open-reel machine, the speed 4.75 cm/s ( $1\frac{7}{8}$  ips) is really only suitable for recording speech. Thus the best bet for a domestic reel-to-reel machine is usually one that will run at either 9.5 cm/s or 19 cm/s ( $3\frac{3}{4}$  or  $7\frac{1}{2}$  ips) or preferably both.

Most cheap tape machines have only two heads, one for record and playback and one for erase. Better machines have three heads, one for record, one for playback and one for erase. The provision of separate heads for record and playback has two advantages. The heads may each be optimised for their own particular task and thus can produce better audio quality. Also a triple-head machine can be used in conjunction with an amplifier having a 'monitor' facility to enable a recording to be played back (monitored) while it is actually being made. The playback head simply replays what the record head has just recorded. This will show up immediately any faults in the recording and enable you to correct them. On a mono machine each head is a single track head – on a stereo machine each head is actually a stereo pair of heads.

### **Mono, stereo, half and quarter track**

There is little point in buying a mono-recorder – unless you intend using it only for speech or interviews, in which case you may do better to buy a cassette rather than an open reel machine. Stereo open reel machines

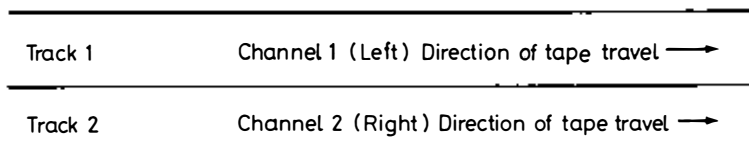

Fig 18 Half track stereo recording.

come in two formats, the half track and the quarter track type. On a half track machine one stereo channel covers half the tape width and the other channel covers the other half width (fig 18). On a quarter track machine the tape width is divided into quarters rather than halves and there is thus room for two quite independent stereo recordings on the same tape (fig 19). Conventionally one stereo pair is recorded with the tape running in one direction and another pair with the tape running in the opposite direction. Thus any given length of tape will store twice as much recorded stereo in the quarter track format as in the half track format. This is an obvious economy.

Tape, however, is not particularly expensive and there are snags to the quarter track format. For instance it is impossible to edit one recording on a quarter track tape without ruining the other. And because less tape width is used the audio quality of a quarter track tape will be poorer than of a half track tape running at the same speed. Furthermore, because of the curious convention adopted for the spacing of the tracks across the tape width, quarter and half track recordings are not always compatible, *ie*, a recording made in one format will not always produce usable results when played back on a machine of different track format.

Thus a half track stereo machine is probably the best all round bet for anyone more interested in good audio quality and ease of editing than in cramming as much recorded material onto the shortest possible length of tape.

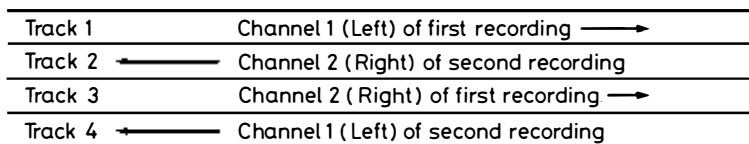

Fig 19 Quarter track stereo recording.

### **Level control**

For serious use, the recording level must be manually controllable. Automatic level control is useful for recording interviews, where the last thing the interviewer wants to do is keep fiddling with the knobs on his recorder, but it is hopeless for recording music; all the low volume musical passages will be boosted up in level, and all the high level passages will be damped down. Early domestic tape machines used 'magic eye' level controls which had to be adjusted so that one half of a glowing light did not overlap the other half. A more scientific approach is the type of dial meter now found on most good machines.

There are two types of dial meter – VU (volume unit) and PPM (peak programme meter). The VU, which averages out the sound being recorded, is most common on middle-of-the-range domestic machines, and the PPM, which senses every musical peak, is favoured for some professional work and broadcasting. Neither meter suffers fools gladly, and to get good recording results, you need to find out by trial and experience how the meters on your machine react to different types of sound material. So don't reject a machine simply because it has VUs and not PPMs or *vice versa*. You can do well or badly with either. Most meters have a black area and a red area on the dial and the pointer should be kept out of the red at all times to avoid distortion on the recording.

### **Weight, a useful tell-tale**

There is one very useful rule of thumb for anyone buying a recorder. A really good machine will have three electric motors, one to drive the take-off spool, one to drive the capstan which guides the tape past the heads at constant speed, and one to drive the take-up spool. These motors should be powerful, especially if the machine handles large spools of tape, and powerful motors are inevitably heavy. It follows that any expensive tape recorder worth its salt will be pretty heavy. So however beautiful a machine on bargain offer may look, if you can pick it up easily with the finger of one hand then put it down again quickly and buy something else.

### **Recorder or deck – what's the difference?**

Although it is customary to talk about tape 'recorders', most people adding a tape machine to a hi-fi set-up will go for a 'tape deck' rather than a 'recorder', and there is a deal of important difference between a recorder and a deck.

A tape recorder has all the necessary electronic circuitry built in to enable it to record sounds and then play them back again, either through a built-in loudspeaker or through an external speaker. So a tape recorder will have its own power amplifier as well as all the mechanics and electronics necessary for recording onto tape. If you are using a domestic hi-fi set-up with a power amplifier as its heart, then the power amplifier in the tape recorder won't be used because the connection from the tape recorder to the main amplifier will be via what is called a 'line out socket'. This latter feeds out a signal to the tape, or auxiliary, input socket of the main amplifier, which is of fairly low level (a few millivolts). The main amplifier then treats this signal in exactly the same way as any other signal it receives, for instance from a radio tuner. Although it is perfectly satisfactory to use the line out or output socket of the tape recorder to feed the tape or auxiliary input of the main amplifier in this way, it is wasteful in these days of expensive equipment and electricity to have a whole power amplifier running pointlessly in the recorder. So it makes sense to build a tape recorder without a power amplifier. This is a tape deck.

A tape deck thus has all the electronics and mechanics necessary for making and replaying tape recordings, but it needs the help of an external power amplifier for playback at audible levels. Thus whatever tape recorder or deck you buy should have a line output socket (usually of the DIN, phono or jack plug type; see Glossary) for connection via a lead to matching sockets on the amplifier. It should also have a line input socket of similar type for connection to matching line out sockets on the amplifier. This will enable the recorder not only to play back through the amplifier but to record whatever signal the amplifier is carrying. For instance, if the amplifier is reproducing a record or radio signal, this can be recorded as it is played through the loudspeakers.

As previously mentioned, it is usual for the line in and out connections between an amplifier and tape machine to be combined together, so that a single connecting cable, with a DIN plug on each end, makes the two-way connection.

### **Live recording**

Of course when you record from the amplifier via a line connection, the recording is being made directly, and purely electrically. Although virtually every tape recorder or deck will have an input socket for a microphone, it is quite hopeless to try and record by placing the microphone



in front of a loudspeaker. Not only is there a massive loss in signal quality, but you would have to move around the room like a mouse to avoid putting extra noise on tape.

With the direct electrical line connection between amplifier and recorder, you can tape record whilst making as much noise in the room as you like. Also usually the amplifier volume controls will not affect the level of signal passing through the line connection to the recorder. This means that the volume of the amplifier can be turned right down, so that little, if anything, is coming through the loudspeakers, while there is still the necessary signal being pumped out to the recorder. This means for instance, that a tape recording of a broadcast can be made without the need actually to listen to that broadcast at the time, the equipment simply being tuned in to the necessary station, the level set, and then the volume turned down.

---

## 6/Cassette Tape in Particular

---

### **Tape threading problems**

Over the years engineers have had no illusions over the extent to which we, the general public, are both idle and incompetent. If there is a wrong way of doing something, then sooner or later someone will do it the wrong way. The task of lacing up tape in a recorder from the take-off to the take-up spool via the heads is hardly a skilled task, but nevertheless one that invites mistakes. It really is quite easy to twist the tape without realising it, and so end up with the glossy plastics backing, rather than the magnetic coating, running over the tape heads. This doesn't do any damage, but it makes it impossible for the record head to record or the playback head to play back. And this can quite easily throw the user into confusion and convince him that either the tape is dud or the machine needs servicing or repair.

It is also a relatively time-consuming job to take expended reels of tape off a machine, replace them with fresh reels and lace up. If you have had an open reel of tape run out halfway through an important occasion that you are trying to record you will know what I mean. In real time, the 60 seconds it takes to change tape reels may not be much, but it is a very large chunk out of a recorded speech. A comparable situation exists with standard 8 mm home movie film on open reels. It is simple to thread, but only when you are not in a hurry. More haste, less speed, sums up both situations.

### **Film and tape in cassettes**

Just as home movie firms have devised various automatic camera and projector loading systems over the years, so tape manufacturers have tried hard to make tape threading easier and easier. The real breakthrough in home movie film came when Kodak launched the Super-8 cassette system that is almost idiot-proof. A 15.25 metre (50 ft) roll of film inside a cassette can be slapped into a camera in virtually no time at all, and requires no threading. The Philips compact audio tape cassette is equally simple to use, and the extraordinary thing is that

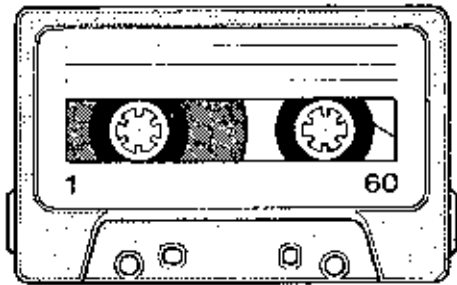

*Fig 20* A Philips type tape cassette – often called a Compact cassette. When sold with music already recorded, it is called a Musicassette.

although it is now an accepted hi-fi medium, it was originally launched in the Sixties as the heart of a dictating system (fig 20).

### **The Philips or compact cassette**

The tape is only 3.81 mm (0.15 in) wide, which is half as wide as normal domestic recording tape. Moreover it runs through the record and playback machines at only 4.75 cm/s ( $1\frac{7}{8}$  ips) which is half the speed that is normally regarded as the absolute minimum for domestic tape recorders. But astonishingly cassettes can now produce audio quality directly comparable with the best reel-to-reel machines or discs. It is another of those cases where an apparently limited area of technology has been pushed towards, and way beyond, what seemed to be its natural boundaries.

Philips filed the patents on the cassette system, and although they allow any other manufacturer a free licence to produce cassettes and cassette recorders, they attach very tight reins to every licensee. The idea of giving away free licences right from the beginning was, of course, to ensure that no other manufacturer would be discouraged from backing the system, and Philips have been rewarded by seeing their compact cassette become a standard of the audio world. But those tight reins are needed to ensure that every cassette made, in whatever part of the world, matches other cassettes from everywhere else. Even a few fractions of a millimetre too much on the length or breadth of the cassette, or a slight discrepancy on the spacing of the spindles, will mean that the cassette is unusable on a standard machine. As it is, only very occasionally do cheap and shoddy cassettes creep into the shops, and their makers are

very soon sat on by Philips. There is, however, little or nothing to stop a manufacturer from putting cheap tape into his cassettes, so bear in mind the points made in the last chapter about the pitfalls of buying cheap tape. They apply just as much to cassettes as to open reel machines, if not more so.

### **Standard and compatible**

Thanks to the Philips' standardisation, cassettes can be labelled in time rather than in physical length. It would, of course, be pointless to refer to the playing time of a length of open reel tape, because playing time depends on the speed at which it is played and open reel tape is used at a variety of speeds: 9.5, 19, 38 cm/s ( $3\frac{3}{4}$ ;  $7\frac{1}{2}$ ; 15 ips). But cassettes are always recorded and played back at the same speed, so a given length of cassette tape will always run for a given length of time. Thus a C-60 cassette runs for a total of 60 minutes, a C-90 for a total of 90 minutes, and a C-120 for a total of two hours. The reference to 'total time' is important. Every cassette is a mirror image of itself. So the tape can be run from one side to the other, then the cassette lifted out of the machine, turned over, and replaced, so that the tape in the cassette simply runs back again.

The tiny 3.81 mm (0.15 in) wide tape can carry four separate audio tracks alongside each other, which is of course sufficient for two separate stereo pairs. Like a stereo reel-to-reel machine, a stereo cassette machine has stereo pairs of heads. When the tape is running one way through the cassette one stereo pair of tracks is read; then, when the cassette is turned over and the tape run back through the cassette in the opposite direction, the same pair of heads will read the other pair of tracks.

In this way a cassette can be used to make and replay two quite separate stereo recordings each of half the total rated time of the cassette, *ie*, a C-60 cassette will hold two quite separate half-hour stereo recordings which can be played one directly after the other and without the need for any rewinding of the tape (or 'dead time'). This is comparable with the reel-to-reel situation for quarter track stereo.

However, here the similarity ends because the two channels of each stereo pair are recorded on adjacent cassette tracks (fig 20a). Thus a single mono head will simply read from both stereo tracks at the same time, add the signals together and produce a mono signal. This is why cassettes are said to be 'mono-stereo compatible'; they play in stereo on

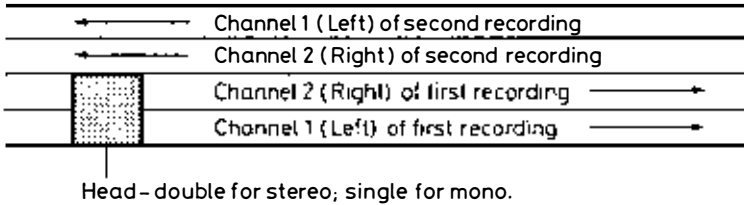

Fig 20a Cassette tape recording format.

a stereo machine and in mono on a mono machine. At first sight, this would seem to be the obvious way of doing things, but as previously mentioned it isn't the way that reel-to-reel tape recordings are made. In the latter case the four tracks are spread across the 6.3 mm ( $\frac{1}{4}$  in) tape width with the left and right channels of each stereo pair arranged alternately. The unhappy result is that recordings made on some reel-to-reel stereo machines cannot be played back on some mono machines. The head will sense one half of one track running one way and the other half of the other track running the other and this produces garbled confusion and backwards sounds from the loudspeakers. So, full marks to the cassette for compatibility! (See figs 18, 19 again.)

### Special cassette recording problems

Apart from this, cassette tape recording is intrinsically the same as reel-to-reel recording, except that everything is of course smaller and slower for cassettes than for reel-to-reel machines. This smallness and slowness enables everything to do with cassettes to be very compact; indeed '*Compact Cassette*' is a Philips' trade name. (The name '*Musicassette*' refers to a 'compact cassette' with programme material already recorded on the tape.) But it also produces technical problems.

The slower tape runs, the harder it becomes to record loud sounds and high frequencies. So cassette tape recording is prone to hiss and distortion. Hiss is the electronic noise made by the tape particles themselves as they pass the playback head. The smaller the particles, the less the hiss. But there is a limit to how small you can make a tape particle. In reel-to-reel machines, by the way, hiss is only a problem with quarter track recordings made at low speeds, because at high speeds the particles move past the heads so fast that the noise frequency they produce is too high to be a nuisance. And the wider the recorded track, the easier it becomes to cram enough undistorted signal onto the

tape to stand head and shoulders above the basic and ever-present background hiss. Hence there is less hiss on half track.

On stereo cassette playback, separate heads are reading along only very narrow widths of cassette tape – whereas in mono a double width head is reading from double the width of tape. It follows that the mono playback of a cassette is less prone to hiss than stereo playback. In the early days of the cassette they produced very hissy results, but newer tapes have tinier and more efficient magnetic particles and various systems have been devised for cutting down on hiss while leaving the music untouched. Most common of these is the *Dolby* noise reduction system, which has probably done more to bring the cassette up into the hi-fi bracket than any other single technical advance.

### **The Dolby system**

Briefly, the Dolby system works as follows. When the programme signal is recorded onto tape, electronic circuitry senses when it has only a fairly low level of high frequency (high-pitched) sound – for instance when only violins are playing softly. These low-level, high-frequency sounds are then boosted, so that they are recorded onto tape at somewhat abnormally high level. On playback the same circuitry senses in the same way, but in mirror image fashion cuts down the level of just those signals that were boosted on recording. Thus the recorded violins end up being reproduced at exactly their original level. But the reduction of level on playback not only brings the sound of the violins back down to their normal level, it also brings down the level of the unwanted hiss that would otherwise have enveloped the violins. Thus there is reduction of unwanted hiss noise without any degradation of the wanted signal.

Most middle and upper price range cassette recorders now incorporate the Dolby system, and enable the user either to make a Dolby recording or replay one. Indeed, most of the time the Dolby system will be switched in and never touched. It will be boosting during record and de-boosting on playback, to cut down hiss. It is now fairly standard practice for commercially produced pre-recorded cassettes (*Musicassettes*) to be recorded using the Dolby system. Anyone buying a *Musicassette* and seeing the Dolby trademark on a *Musicassette* knows he has to switch in the Dolby circuit on his machine.

But of course not everyone has a cassette machine with Dolby facility, and it would be quite unthinkable for the *Musicassette* manufacturers

to record using Dolby system if that meant that the cassettes could only be played on Dolby machines. Fortunately, the Dolby system is compatible, in that a Dolbyised cassette played on a non-Dolby cassette recorder sounds perfectly acceptable. Indeed it may even sound better than a non-Dolby cassette. This is because the Dolby system boosts just those high notes that are usually rather poorly served by cheap cassette machines. And if a Dolbyised cassette sounds rather too 'bright' (*ie*, has rather too many high frequencies) when played on a non-Dolby machine, then it is only necessary to turn back the treble tone control of the machine or amplifier slightly to provide a reasonable compromise compensation for this. (See fig 21 overleaf for Dolby Laboratories' own, more detailed explanation of the system.)

### **Other systems for reducing hiss**

There are other noise reduction systems which – like Dolby – are operative both on record and playback, notably the ANRS (Automatic Noise Reduction System) and dbx system. In some respects ANRS from Japan and dbx from the USA are similar to Dolby; indeed, an ANRS cassette can be played on a Dolby machine, or *vice versa*, with very few people being any the wiser.

Another type of noise reduction system is operative on playback only. The Philips DNL (Dynamic Noise Limiter) is the most commonly occurring example of this. Because DNL is a playback system only, it does not require the sound to be treated on recording. The DNL system 'listens' to the tape it is playing and senses when there are loud and quiet passages.

When there is a loud passage the DNL does absolutely nothing. This is because whatever hiss there is on the tape will be masked by whatever loud music or other sounds are being played back, it being a characteristic of the human ear not to notice the presence of a quiet sound amongst a wide range of other loud sounds.

When the tape is producing only a quiet signal, however, the DNL automatically brings in a filter which quietly trims off some of the high frequency hiss. The problem is that circuitry of this type, although pretty remarkable, is quite unable to tell the difference between quiet high frequency sounds that aren't wanted (hiss) and quiet high frequency sounds that are wanted (violins played softly). There is also a problem that the listener's ear may be able to detect a 'breathing' sound of the hiss coming and going as the filter moves in and out of operation.

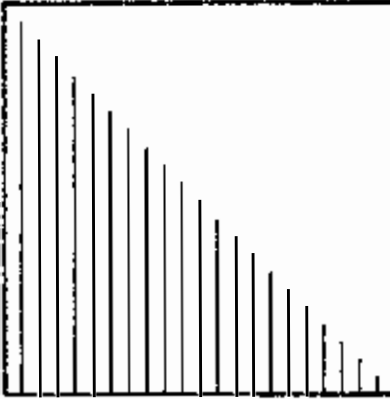

Music consists of sounds of different pitch and loudness, separated by intervals of silence. Loud and soft sounds are shown here as long and short lines. The 'music' represented in the diagram at left starts very loud and gradually becomes very quiet.

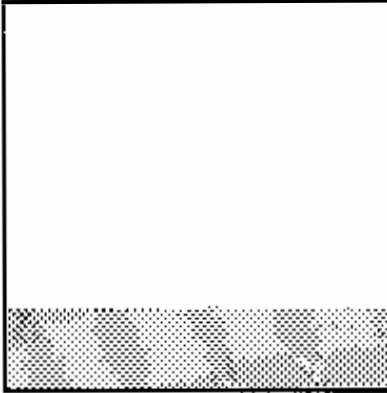

Even the best recording tape makes a constant hissing sound when it is played, whether or not any music has been recorded on it. The best professional tape recordings contain this noise, just as home cassette recordings do. However, the problem is much more serious with cassettes because of the slow speed of the tape and the narrow width of the recording track. These cause tape noise to be even more annoying, because of the drastically reduced level of music which can be recorded on the tape.

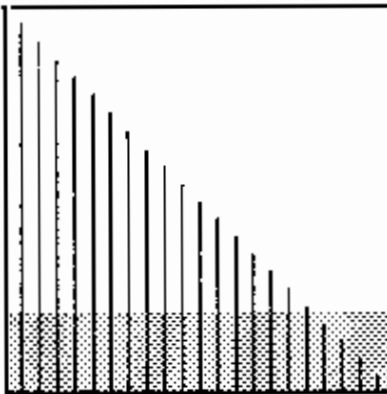

When a tape recording is played, the noise of the tape obliterates silent passages, conceals the quietest musical sounds, and interferes with many sounds, even some louder than the noise itself. Bass tones need to be extremely loud for tape noise not to be heard during the music.

Fig 21 Dolby Laboratories explain their n



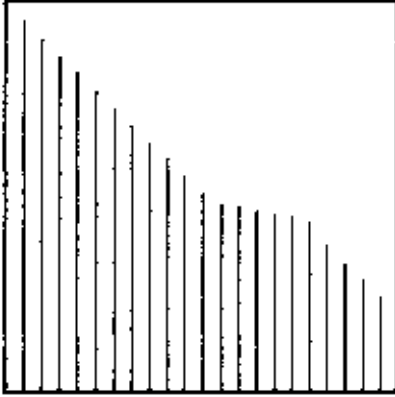

Before a recording is made, the Dolby system 'listens' to the music to find the places where tape noise might later be heard when the tape is played. This happens mainly during the quietest parts of the music. When it finds such a place, the system automatically increases the volume so that the music is recorded at a higher level than normal. An important feature which enables the Dolby system to do this effectively is its ability to distinguish sounds of different pitch as well as sounds of different loudness.

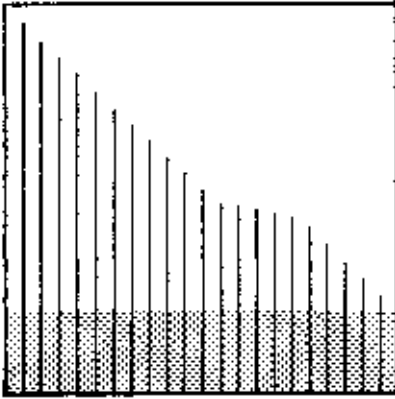

In a Dolbyised recording, those parts of the music which have been made louder stand out clearly from the noise. This is what makes Dolbyised recordings sound unusually brilliant even when played without the special Dolby circuit. Listeners without Dolby equipment use Dolbyised cassettes, for example, just like any other cassettes.

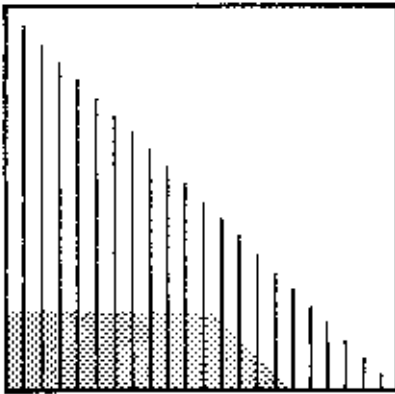

When Dolbyised recordings are played back on a recorder equipped with the Dolby circuit, the volume is automatically reduced in all of the places where it was increased during recording. This makes the music sound exactly right, because the loudness of every note is just the same as it was at the start. At the same time the noise of the tape, which is now mixed with the music, is reduced in all of the same places – just the places where the noise would otherwise have been heard.

In practice the snags with systems like DNL are not half as evident as you would think, and although the Dolby system (or the similar, ANRS and dbx systems for that matter) is ideal for those situations when it is possible to treat or 'encode' the original recording, DNL is ideal for the numerous situations when the original recording has not been encoded. Some machines now incorporate both Dolby and DNL, and this gives the user the best of both worlds.

### **Level meters**

Cassette recorders, just like reel-to-reel machines, are provided with record level meters, but these are almost always of the VU rather than PPM type. Cassette tape is very sensitive to overload on recording, so it is usually important to ensure that the meters on the dials never go into the red during record. Incidentally an overload signal will be recorded loud, but irrevocably distorted; reducing the volume on *play-back* will not cure distortion once it has been recorded on tape. But it is important, in avoiding the pitfall of overload, not to fall into the trap of putting too little signal onto tape at the record stage and thereby ending up with a very quiet recording that is knee-deep in cassette tape hiss.

### **The need for care**

Of all hi-fi media, the cassette is the one which suffers foolishness or lack of care least gladly. The tape head gaps are so tiny that even a small amount of dirt will clog them badly to trim the top frequency response and make reproduction sound woolly and dead. Cassette heads should be cleaned in exactly the same way as open-reel machine heads, and with exactly the same care and materials. I would put my shirt on a bet that at least half the cassette machines installed in cars and homes around the country are producing unnecessarily sub-standard results, simply because their tape heads have never been cleaned.

### **Cassette tape types**

New types of cassette tapes seem to be launched and advertised to the hi-fi market almost daily. I am generally very resistant to change for the sake of change, but have to admit that there is all the difference in the world between the performance of cassette tapes as sold a few years ago and those sold now and containing low noise, high performance tape.

Every machine has its favourite tape, sometimes recommended by the instruction book. The machine usually works better with that tape

than any other, and there are good scientific reasons for this. Most important of all, the ideal recording bias (bias is a high frequency signal that jogs the tape particles around to help them take up the necessary pattern on recording) varies from one tape to another. Thus a top quality machine may have the bias set all wrong for one top quality tape but all right for another. So find out (by reading the instruction book and trying out a few different cassette types) which tape suits your machine best and then stick to it – at least until something even better is put on the market.

A few years ago, chrome oxide tape was heralded as a significant advance in cassettes. This is true, up to a point, but chrome tape needs not only a special bias characteristic but also a different equalisation characteristic. (Equalisation, by the way, is simply a deliberate distortion of the signal as it is recorded, and a mirror image correction on playback, intended to compensate for the deficiencies inherent in all types of tape.) If chrome tape is played on a cassette machine that has its bias and equalisation correctly set for such tape, then it can produce remarkably good results, especially if the Dolby system is used as well. But if chrome tape is played on an ordinary cassette machine, with its bias and equalisation set for ordinary (iron oxide) magnetic tape, then the overall result will be no improvement over ordinary iron tape. Chrome tape costs more than iron tape, so it is quite pointless to use it unless your machine has a chrome ( $\text{CrO}_2$ ) setting. Likewise it is pointless to use a double layer tape – one of chrome, one of iron – on a machine without the correct setting.

### **Trends**

Cassette machines are getting both cheaper and more expensive. It is now possible to buy a small portable mono recorder for the price of a good meal or a semi-professional stereo deck, with a third head for monitoring off tape, Dolby facility and switched settings for a whole range of tapes including chrome and double layer, for as much as a lavish holiday abroad. The tape transport mechanism (the motor and pulleys that drive the tape past the record and playback heads) will be extremely tinny on the cheaper machines, but nevertheless can produce remarkably good results.

If you want to start out with a cheap means of playing pre-recorded music and of recording original sounds for yourself you should look no further than a cheap, mono cassette recorder. Pre-recorded Musi-

cassettes are increasingly widely available, many recordings being issued simultaneously on disc and on cassette. Although the cassette version of an issue usually costs rather more than its disc counterpart, it bears repeating that a cassette will be far more resistant to hard use than a disc and will not suffer from playing on cheap equipment. Also, a cheap cassette recorder can produce remarkably clean recordings of original sound, for instance baby's first words, a small daughter's first efforts on the piano or dad's amateur theatricals. Add to this the fact that blank cassettes are cheap, easy to use and easy to store and you begin to understand why many people argue that reel-to-reel tape and the disc have had their day for domestic use.

---

## 7/Tuning in to Radio in Hi-fi

---

### **Buying a tuner**

Eventually, substantially the whole of the UK will be able to receive stereo radio. All the commercial local radio stations overseen by the IBA broadcast in stereo and the BBC continues to transmit an increasing number of its national programmes to an increasing number of areas in stereo. But it is doubtful if the time will ever come when the BBC transmits everything in stereo from all its transmitters. It would thus seem logical for anyone buying a radio tuner to check with the BBC and IBA Engineering and Information Departments before spending hard cash on full stereo facilities. Actually, however, such a check would be somewhat pointless. For one thing, very few mono only tuners are now made, so if you are buying a new tuner it will almost certainly have stereo capability.

It is also worth bearing in mind that the use of a good tuner and good aerial will often enable you to pick up radio transmissions from well outside their intended area of coverage. For instance some people can listen to Continental transmissions. Thus there is a good chance that you would be able to receive some stereo radio even if all the transmitters designed to cover your area of the country were broadcasting in mono only. Indeed, if your local transmitters are not yet functioning in stereo, that is all the more reason to buy a good stereo tuner which, with a good aerial, will pull in distant British and Continental broadcasts and reproduce them in acceptable stereo.

But immediately we are into the problem of what is a 'good' aerial and what is a 'good' tuner. Nothing infuriates me more than reading an advert which advises me that some product or other is available 'at all good shops'. So I solemnly promise to try to explain what I mean by 'good' as applied to tuners and aerials during the course of this chapter.

First of all, however, it is worthwhile trying to sort out some of the confusion that exists over the different types of radio transmission that are available for reception. This confusion closely parallels that mentioned earlier which centres on the difference between 'hi-fi' and 'stereo'.

## **Two types of radio transmission – AM**

There are two ways in which radio programmes are transmitted domestically. Amplitude modulation (AM) transmissions are put out on the long, medium and some short wave bands. In an AM transmission a signal of fixed frequency and wavelength is made to vary in amplitude or volume. These variations in amplitude are detected by the receiver circuitry and used to produce small audio signals of exactly the same type as are produced by a record or tape deck. They are then amplified and reproduced through loudspeakers, again like tape or record signals. Unfortunately AM transmissions are very prone to interference and distortion. Because it is fairly easy to transmit them over fairly long distances there is inevitably a great deal of interference between different stations using the same wavelength. Anyone who has tried to listen to a music programme on the medium or long wave and heard the Latvian weather forecast loud and clear in the background will know what I mean.

All in all, it is virtually impossible to get anything resembling true hi-fi from a modern AM transmission, on whatever wavelength. Thus, although AM long wave and medium wave reception will always be useful, and ideal for portable radios, it can never provide hi-fi satisfaction. Some hi-fi tuners provide for AM reception, and I suppose this can be a godsend once in a blue moon. But a more realistic and cheaper approach is to have a portable radio for AM reception and use an FM only radio tuner for hi-fi.

## **FM**

FM is an abbreviation for frequency modulation, and in this type of transmission a signal of only nominally fixed frequency and wavelength is varied slightly in frequency. The variations in frequency are detected in the tuner or receiver, to produce an audio signal which is exactly similar to that produced by a record or tape deck or AM detector. So again it is amplified and fed to loudspeakers. But the signal is of far higher quality than AM. Also it is far less prone to interference because it is not affected by the tiny sparks which are inevitable in many domestic appliances and cars and which produce crackling on an AM receiver.

## **Interference**

An FM receiver is also far less prone to interference from distant stations, because the signals do not normally travel over great distances. Inciden-

tally this failure to travel over long distances is nothing to do with the fact that the signal is FM rather than AM. Instead it is a result of the fact that FM radio transmissions are put out in the VHF (very high frequency) bands, and signals in these bands travel more or less in straight lines. On the other hand signals in the medium and long wavebands can follow the curvature of the earth and this is why they travel longer distances.

To receive a VHF FM signal one ideally needs the receiving aerial to be in direct line of sight with the transmitting aerial, but in practice there is rather more latitude. What this means is that if you go on your roof to erect a VHF aerial for your FM radio and you can see the transmitting aerial, then you are virtually certain to get perfect reproduction if you point one at the other. If the aerial is above the horizon but you cannot see it because it is too far away, you will still get virtually perfect reproduction. If the transmitter is invisible only because it is screened by buildings, small hills or is just below the horizon you may still get good reception if you are lucky. But if the transmitter is so far away that it is well below the horizon, you will need a more sensitive receiver, (to make the most of what little signal is available) and an aerial on a very high mast (to help effectively lower the horizon). You may also need a directional aerial that will pick up signals very efficiently from the direction in which it is pointed but very inefficiently from all other directions.

### **How is stereo radio transmitted?**

So far we have said nothing about stereo. A common misconception is that stereo radio can only be transmitted on VHF FM, but this is not so. There are various techniques for transmitting stereo radio in AM on the medium and long wavebands, and perhaps some of these will be adopted in the future in this country or elsewhere in the world. There are however very positive technical stumbling blocks. It is hard to transmit a high quality, full frequency range signal in AM on the medium and long wavebands, and for technical reasons this makes it impossible to transmit MW and LW stereo in the manner used for VHF FM (where a much wider frequency range is available). Also, any system of stereo transmission adopted must provide mono-compatibility; in other words it must enable all those millions of existing mono sets to go on receiving just as before, while enabling those few people who have bought stereo sets to hear the transmissions in stereo.

Of the various mono-compatible systems proposed for transmitting stereo in FM on the VHF bands, the one finally adopted after the Second World War was the so-called multiplex system. At the transmitter the left and right channels of the stereo pair are added together to produce a sum signal, and this is used to frequency-modulate the transmission wavelength in conventional manner. Thus anyone with an ordinary mono FM receiver simply receives the sum of the left and right channels which is, of course, mono. Anyone with a stereo receiver is, however, able to receive something else. The difference between the left and right channels (the one minus the other) is used to modulate the same basic transmission wavelength in a different manner, and a stereo receiver 'extracts' this so-called 'difference signal'. Schoolboy algebra will show how it is possible to recover the left channel alone and the right channel alone from the sum and difference signals which the stereo receiver extracts from the transmission :

$$(L + R) + (L - R) = 2L$$

$$(L + R) - (L - R) = 2R$$

The electrical circuitry of a stereo tuner automatically performs this 'decoding' function, to reproduce the original stereo pair of signals transmitted.

### **Always a snag!**

Nothing in this world is for free, and the problem with this otherwise apparently perfect solution to stereo transmission is that a stereo receiver needs much more signal from its aerial than a mono receiver, if the two stereo channels reproduced are to be of clean quality and sound free from hiss. Although an expensive tuner with good 'sensitivity' will be able to produce a satisfactory stereo signal from a relatively weak signal, no tuner in the world can produce a good stereo signal from a really inadequate aerial signal. It always surprises me how some hi-fi enthusiasts will spend literally hundreds of pounds on a tuner with every gadget imaginable and then hook it up to an aerial which is really no better than a damp piece of string. They then complain that they are getting poor results for their money! Actually you will probably get better results from a reasonable tuner and a good aerial than a good tuner and a damp piece of string – and it will be cheaper, too.



### **Points to watch out for on a tuner**

Before looking briefly at aerials and how they should be fitted, let's digress for a moment on the main points to look for on a tuner. Perhaps the most critical of all is sensitivity. As should by now have become clear this is a gauge of how efficient the tuner will be at decoding a good stereo signal from what it picks up at its aerial socket. All kinds of figures abound which purport to show how one tuner is more sensitive than another, and it is very easy to take no notice of any of the figures and assume that they are just another part of the world-wide plot to confuse the hi-fi man in the street. But actually, whatever the motives behind the figures published, they really do mean something.

When a stereo tuner tries to detect and decode a signal, its circuitry must work very hard (at full 'gain') to produce anything worthwhile from a weak aerial signal. Unfortunately, when electronic circuitry works hard at full gain it tends to produce its own noise. This noise is in the form of hiss. So when a stereo tuner is faced with only a weak input signal from an aerial, it produces very loud background hiss as it desperately tries to make the best of that signal. Thus, although VHF FM radio reception is in theory far less susceptible to background noise and interference than AM reception, in practice, if the received signal is weak, there will be just as much (if not more) background noise than with a cheap AM receiver. If a tuner is very sensitive, it will produce less hiss and noise when handling a weak signal than a less sensitive receiver.

### **An example of sensitivity**

That this all really does matter in practice was brought home to me very forcefully a few years ago. I was using a relatively old stereo tuner, on an aerial which was badly sited (more of which later), and I had become virtually accustomed to an irritating background hiss that enveloped some stations. I then borrowed a couple of other tuners, both relatively cheap, but incorporating more up-to-date circuitry. Immediately I found that they could both reproduce stereo radio with virtually none of the hiss that I had encountered with the older tuner. When the two new tuners that I'd had on loan went back to their owners, I had to return to my old set-up, and was really quite staggered by how bad it sounded in comparison. I had its circuitry checked out by the makers to establish whether or not it was up to its original, intended design specification. Sure enough it did prove to be 'up to spec'. In other words, it had no faults and was working exactly as had been intended, but nowhere

near as efficiently as a similarly priced tuner of more modern design.

There are really only two ways in which a would-be purchaser can judge a tuner's sensitivity (other than taking the salesman's word for it without question). Firstly, he can take it home and try it on approval; secondly, he can find out something about sensitivity ratings as included in the specification given for a tuner. As it is really not reasonable to ask a shop for a low or medium priced tuner on approval, we really do need to look briefly at how sensitivity is measured.

The usual figure given is the number of microvolts ( $\mu\text{v}$ ) (millionths of a volt) which the tuner needs at its aerial input to produce a hiss level which is so low that it is not really noticeable. To be reasonably unnoticeable, a hiss level should be at least 30 dB (thirty decibels) quieter than the programme material and on the old tuner which I found hissy with an inadequate aerial, the sensitivity for stereo was listed as 5  $\mu\text{v}$  for the necessary 30 dB 'quieting'. One of the newer tuners that I used was rated as 1.25  $\mu\text{v}$  for 30 dB quieting and the other was 2.5  $\mu\text{v}$  for 30 dB quieting. So although the difference between 5  $\mu\text{v}$  on the old tuner and 2.5 and 1.5 on the newer tuners may appear insignificant in print, it makes a considerable difference in practice.

### **The trouble with numbers**

In practice many figures given for amplifier, turntable, tape recorder and tuner performance matter very little to the man in the street, because a big change in the numbers means a little change to the ear. But here is one instance where a very small change in the numbers means a big change to the ear and is thus worth understanding. The only consolation I can offer to anyone who really does not want to be involved in any figures at all, is that, if you are prepared to go to the trouble of erecting an aerial that is halfway to reasonable, you should be able to receive all the stations *that you are intended to receive* in your area in good, hiss-free stereo, with any reasonably modern stereo tuner made by a reputable firm.

### **And now to the aerial**

It should not be too difficult for anyone to sort out for themselves whether a tuner falls into the category of 'reasonably modern' and 'made by a reputable firm'. But it is far, far more difficult for anyone to sort out what is and what is not a reasonable aerial. And sadly it is not always safe to leave this problem in the hands of an aerial contractor.

Although there are many firms who, for a fee, will risk life and limb on your roof to install an aerial correctly, there are plenty more firms who will take your money for doing the job rather badly.

Anyone with a good head for heights can claim to be an aerial contractor and clamber on your roof where, for a hefty fee, he does a bodged job. Because the poor householder never has occasion to wander over his own roof and so see the job done, he will only know he has been swindled when he realises, often months later, that the aerial system just isn't performing as well as it should. Thus, even if you intend leaving aerial installation to a contractor, you should know at least something about aerials and their performance. Also, when looking for an aerial contractor, it is well worth looking first through personal recommendation, for instance from a reputable dealer who has sold you the tuner in the first place.

### **The historical background**

It was in 1900 that Guglielmo Marconi finally devised a way of transmitting radiations over large distances without any connecting wires and with one transmitter able to communicate with only selected receivers, rather than any receiver in the area of the aerial. If you turn that achievement round you have the birth of modern radio, where receivers are able to tune in only to selected transmitters, to the exclusion of any other transmitter in the area. Marconi had been working on the idea of 'wireless' transmissions for several years, and had been granted a patent on a primitive spark gap transmitter in 1896. His breakthrough in 1900 was to *tune* the transmitter to the receiver, and *vice versa*. If Marconi's patent claims at that time are to be believed, he was already transmitting over distances of around 300 kilometres (nearly 200 miles).

In the early days of radio, very long aerials were used, and Marconi described plans for 30 metres (100 ft) of wire suspended from a balloon. Although a long length of wire will serve as an aerial for a medium or long wave transmitter or receiver, it will be useless as an aerial for VHF FM transmission and reception. The reason is that, to be efficient for transmission or reception, an aerial must have its length directly related to the wavelength of the signal being handled. Of course medium and long wave signals have wavelengths which are several hundred or even thousand metres long. (It is worth bearing in mind that although in theory it makes sense to install a very long wire as an aerial for a medium or long wave domestic receiver, in practice such an aerial is

more trouble than it's worth, because it pulls in far too much interference. So actually a much shorter length of wire is far more effective.)

### A simple calculation

A VHF FM radio signal will have a frequency of around 100 MHz (a hundred million cycles per second), which gives it a wavelength of just over 3 metres. Conventionally, for FM radio (and TV as well, incidentally) the aerial is tuned to the signal by forming it as a straight rod in two equal lengths (to make it a so-called 'dipole'), each length being one quarter of the wavelength long. This gives a total length of half the wavelength being received. Of course each VHF station being received has a slightly different wavelength, but it is obviously impractical to have a separate aerial for each station. Thus a degree of compromise is necessary with one aerial of average length being used to cover the whole VHF band. As the average wavelength for the VHF FM radio band is about 3 metres, an FM radio aerial dipole takes the form of a straight rod formed in two equal lengths which are each around  $\frac{3}{4}$  metre (75 cm) long, to make a total length of about  $1\frac{1}{2}$  metres. Dipoles of this type can be bought cheaply.

### DIY aerial for FM

Alternatively two metal rods (or wires) of quarter wavelength can be lined up to make a simple DIY dipole aerial (fig 22), the aerial being connected to the tuner via a length of aerial cable of the standard

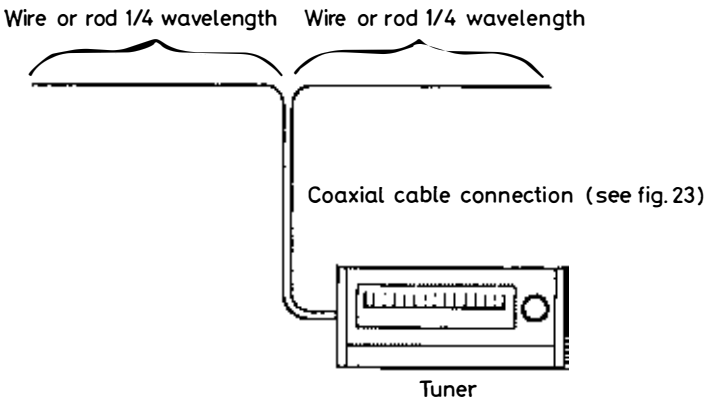

Fig 22 The simplest form of FM aerial.

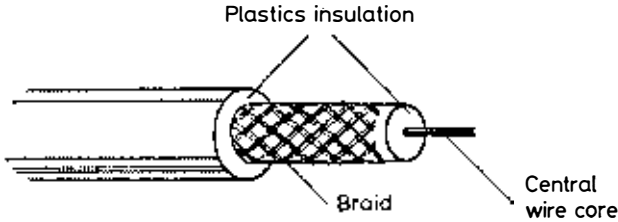

Fig 23 Coaxial aerial cable.

coaxial type that has a central wire core surrounded by plastics insulation and a metal braid (fig 23). One of the two rods is connected to the central core of the lead and this connects to the central pin of the aerial socket on the back of the tuner; the other rod goes to the braid which makes contact with the earthed outer casing of the aerial socket.

A simple dipole of this type (either bought or home-made) can give very respectable FM reception, provided that it is properly positioned. Indeed, in certain circumstances, replacing it with something more elaborate may make matters worse. The key to success is remembering that although virtually any piece of wire, wherever it is laid, will pick up useful medium and long wave radio signals, the shorter wave VHF signals which the dipole is to receive do not circulate round a room to 'find' an aerial. Instead, the aerial needs to find the signal.

Since VHF signals tend to move in straight lines along a line of sight, it will often be necessary to locate the aerial in an attic or on an open roof to achieve something resembling line of sight siting, in other words, pointing the aerial in the direction of the transmitter as judged by eye. Because the BBC transmit their radio signals with what is called horizontal polarisation, the dipole should be mounted horizontally, rather than vertically in the manner of a car whip aerial. The commercial IBA transmitters use circular polarisation, which enables their signals to be received by either horizontally or vertically arranged aerials. Thus the IBA transmissions can be received equally well in cars on whip aerials and by roof or attic aerials arranged horizontally to receive the BBC. The dipole should always be at right angles, or broadside on, to the direction of the transmitter – *not* pointing towards it in spear-like fashion.

### Science confounded – but only sometimes

Although the textbooks will all prove mathematically that a simple

dipole mounted in a roof or attic in the manner described is the absolute minimum for reasonable FM stereo radio reception, good fortune may sometimes confound science by taking the side of an idle person who cannot be bothered to do anything more than hang up a home-made dipole casually in the corner of a room. If he has a sensitive tuner and the programme is originating from a local transmitter, the results may turn out to be satisfactory. But it is highly unwise to rely on this kind of good fortune. You are more likely to end up with a very hissy sound through the loudspeakers.

### Trying for something better

Although under most practical circumstances of use that simple dipole on the roof or attic will (if correctly sited) pull in all the local and national stations that you are *intended* to receive, many people will, very understandably, wish to improve reception or receive more stations, by using a more elaborate aerial.

One way of making an aerial more elaborate is to make it more directional. A 'reflector' element is arranged behind the dipole (fig 24) and as an additional refinement one or more 'director' elements are arranged in front (fig 25). The director and reflector elements are not electrically connected but serve to make the aerial pick up signals only from the direction in which it is pointing. In this respect the extra elements do

Fig 24 A more sophisticated FM aerial.

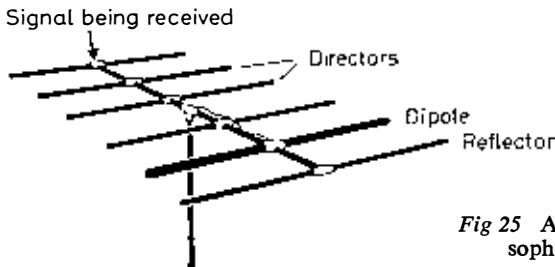
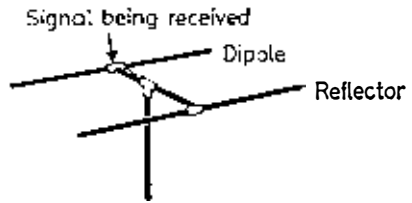

Fig 25 And still more sophisticated.

exactly what their names suggests – the directors help direct the signal in and onto the dipole and the reflector helps reflect the signal back onto it. In practice, the dipole itself will probably be made from a double length rod ‘folded’ over into a ‘folded dipole’.

Although a good ‘multi-element’ aerial of this type will pull in a strong signal in an otherwise weak signal area, it does need much more careful positioning than a simple dipole. Quite obviously, if it is directional it must be pointed accurately at what it is intended to receive – if it is inaccurately located, it will exclude exactly what it was bought to pull in! This is one reason why using an elaborate aerial may make matters worse rather than better. Also, there is the problem that (for reasons political, technical and bureaucratic) the IBA and the BBC do not transmit their radio stations from the same transmitters. Thus a very directional aerial, carefully sited on a BBC radio transmitter may well exclude the majority of the signals being transmitted from the IBA radio transmitter intended to serve the same area.

The extent to which this problem concerns individual listeners will depend entirely on their location with respect to the IBA and BBC transmitters in their area and the angle which their aerial makes with both. The sketch map shows how this can work out in practice, taking the London area as an example, and how, where a directional aerial is used, a compromise must be reached in which it is pointed between the two transmitters and not accurately directed at either (fig 26).

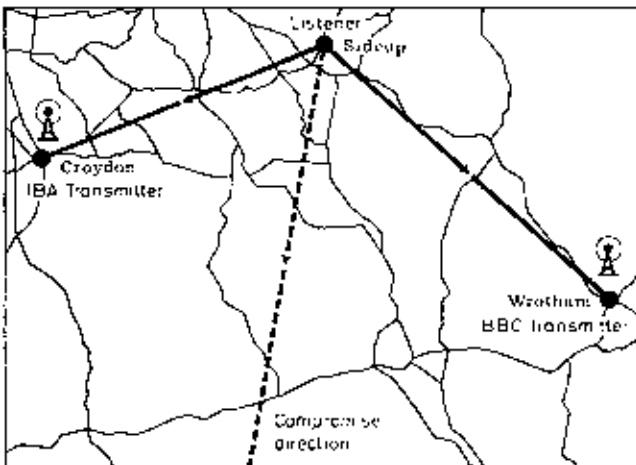

Fig 26 Bad luck may put you out of line with both the BBC and IBA transmitters.

Although, as we have seen, it can in certain circumstances be an advantage to use a simple and cheap dipole which is not particularly directional, if you are interested in receiving distant stations you will need the higher 'gain' of a multi-element aerial to pull them in with sufficient strength. To enable a directional aerial to cover a whole range of stations dotted round all points of the compass, gadgets are available which enable a roof aerial to be rotated through 360° under the control of a knob mounted down below and alongside the tuner.

### **How to spot an incompetent contractor**

The risk of inadvertently finding yourself an incompetent aerial contractor was mentioned above. If the chap on the roof does not know what he is doing, he can cause all manner of problems with even the most expensive aerial. If he does not understand about sighting and siting a directional aerial correctly, he may beam it in the wrong direction, perhaps simply following the direction of the aerial on the roof next door. In one London street, virtually every aerial was pointed in the wrong direction, because the first rigger to work in the street had got it wrong, and everyone else had followed him like sheep. A good fitter uses a gadget called a signal strength meter to enable him to adjust the aerial position while looking at a pointer on a dial which gives a reading of the signal strength obtained in each position. If anyone tries to fit an aerial for you without using a signal strength meter, then you should immediately become suspicious. Incompetent fitters have even been known to fit a multi-element aerial back to front, so that the reflector points towards the transmitter and shields the dipole from all the signal it is intended to receive. They have also been known to mount aerials the wrong way up, for instance vertically rather than horizontal to the ground. And if an aerial is mounted vertically, it will pick up virtually no BBC signals whatsoever.

### **More on installation**

One final point bears making on installation. As explained, the aerial should be connected to the set via coaxial aerial cable. All is straightforward in this respect where there is a direct connection between aerial, cable and set. The pitfalls start arising when both a TV and a radio aerial on the roof are, for convenience and economy, to have their signals 'combined' into a single coaxial lead down the side of the house and 'split' again in the living-room between TV set and radio tuner. The pit-



falls get even more plentiful if sockets for more than one radio set or TV tuner are to be provided, either for simultaneous or alternative use. It is just not possible to connect up several aerials, cables and sockets in the manner of torch bulbs connected to a battery. An attempt to wire up several aerials or sockets, or both, in parallel or series will produce disastrous results, in the form of ghosted TV pictures and nasty noises on the radio. There are precise electronic rules governing how different aerial signals can be combined and split again, and there are stock junction boxes commercially available for the job. Either buy these junctions or leave all this type of work to an aerial fitter who is worth his salt.

### **Aerials for AM**

Previous references to AM medium and long wave reception were somewhat disparaging, and intended to dissuade anyone from spending too much money on a tuner with this facility, because it can never produce reasonable audio quality. But where your tuner does have the facility, you might as well use it, and as often as not there will be no need to provide an external aerial. Although a socket or terminal may be provided for a medium and long wave aerial, there will probably also be a ferrite rod aerial, either inside the chassis of the tuner or on the back plate. In 99 times out of 100, such a ferrite rod will function as a perfectly satisfactory aerial. On some sets connection of the external braiding for the FM aerial may affect medium and long wave reception so don't be misled into thinking that your set has developed a fault if its performance on the medium and long waves alters when the VHF FM aerial is unplugged.

Finally, don't blame your set if it makes a harsh, rasping noise when tuned to the long and medium wavebands. The modern craze for thyristor controlled dimmer switches to control domestic lighting is virtually killing AM reception on the medium and long wavebands. These switches create terrible AM interference, even though they are often claimed to be 'interference suppressed'.

---

## 8/All about Loudspeakers

---

### **The traditional chain**

One of the traditional and most accurate analogies is that which draws a parallel between hi-fi and a chain. If you hang increasingly heavy weights from a chain, it will break just as soon as the strength of the weakest link is overtaxed. It won't matter at all that all the remaining links are ten times stronger. Exactly the same thing is true of hi-fi. No matter how much money you spend on the individual items of a hi-fi chain, if one single unit is faulty, mis-matched or just plain inadequate, then the overall sound will be no better than the rogue component. And at least nine times out of ten, and more probably 99 times out of 100, it will be the loudspeakers that are not doing the rest of the hi-fi set-up justice.

To generalise and over-simplify, it is now possible to design (and therefore buy) a deck that will reproduce the signals stored on a disc or tape so accurately that there is virtually no audible difference between the recorded and reproduced signal. The same goes for amplifiers, transistor technology now having reached the stage at which a good power amplifier will boost the tiny signal reproduced from a tape or disc so accurately that the process of boosting introduces virtually no audible changes or distortions. But even if it were possible to produce a loudspeaker that would convert amplified electrical signals into sound waves so accurately that the conversion introduced no audible distortion at quiet and loud levels alike (which it isn't), that loudspeaker might well not do justice to the rest of the audio chain under some circumstances of use.

### **A great deal depends on environment**

The problem, which is really very obvious when you think about it, is that although there is no earthly reason why a record or tape deck and amplifier should not function equally well in a variety of environments, there is every reason in the world why a loudspeaker will function very differently according to where it is used. The loudspeaker must do some-

thing which no other link in the hi-fi chain need do: co-operate with the very individual acoustics of your own, particular home and listening room. From here it is a short step to realising that, to be perfect, a loudspeaker must inevitably be designed with a particular listening environment in mind; indeed a loudspeaker should ideally be tailor-made to the room in which it is to be used or *vice versa*. Don't laugh, some hi-fi enthusiasts do virtually design their houses and loudspeakers around each other, constructing vast, concrete horns as an integral part of the building.

Happily for lesser mortals (myself included) extremes of this nature are not necessary, and very acceptable results can now be obtained from many of the cabinet loudspeakers available on the commercial market. But less happily, it is still possible to buy an attractive looking cabinet loudspeaker that produces sounds which will prove quite unacceptable to all but the least discerning listener, especially after a few weeks or months of listening have shown up its inadequacies.

### **In the shops**

There are now relatively few really bad loudspeakers in the shops (other than the obviously cheap and nasty variety). This is largely because the loudspeaker market is very competitive and the public has over recent years become more discerning. Also a good dealer will either not stock, or will deter customers from buying, second-best ranges. But even so there will always be a need for the hi-fi customer to know something about loudspeakers if he is not to be disappointed with his purchase.

Disappointment most often follows from the customer's wrongly assuming that a loudspeaker that sounds good in a demonstration room will sound equally good with different equipment and in a different environment. But it is not unduly difficult deliberately to make a loudspeaker sound rather more effective than it really is by demonstrating it under rather abnormal conditions; for instance the use of a very high powered amplifier will cover up a speaker's inefficiency or the amplifier bass boost control may be turned up to compensate for the loudspeaker's own inadequate bass response. There is, of course, no rule to say that all loudspeakers should be demonstrated with low powered amplifiers and all the tone controls set at 'flat' (neither boosting nor cutting treble or bass). But it is only fair on the customer that the demonstrator should let him in on any such secret.

### Understanding before choice

Before choosing a loudspeaker, you really need to know something about the problems involved in their design and manufacture. Let's first of all consider why it is so difficult to design a good loudspeaker.

An ordinary 'raw' or chassis loudspeaker of the moving coil and cone type (as used in virtually all cheap audio equipment) will produce quite terrible sound if it is simply connected to an amplifier while lying in its naked state on a table top. The reason for this is very basic. A moving coil loudspeaker produces audible sound waves as its paper or plastics cone is moved backwards and forwards like a piston. This movement is due to the motor effect of the amplified audio signals passing through the coil and magnet arrangement that is an integral part of the speaker.

The snag is that the cone, like everything else, has two sides – a front and a back. Thus it shifts air both at the front and at the rear. All the sound waves from the rear of the cone move round and mix with those at the front, and *vice versa* (fig 27). Because the front surface of the cone is pushing forward while the rear surface of the cone is pulling back and the front surface of the cone is pulling back when the rear surface is pushing forwards, the notes from the front and rear of the cone are out of step or of exactly opposite 'phase'. In other words, a single movement of the cone will compress the air in front of the cone and rarefy it at the rear, and then rarefy the air at the front and compress it at the rear.

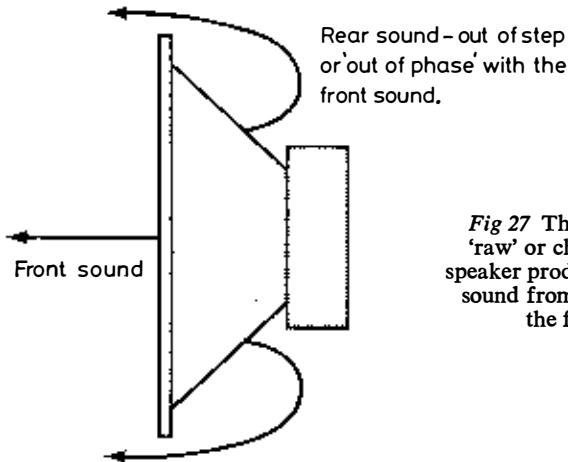

Fig 27 The cone of a 'raw' or chassis loudspeaker produces as much sound from the rear as the front.

### **Bass mix**

When the sounds produced by the cone are relatively low or bass in frequency, their wavelength will be long and the distance round the edge of the cone which the waves must travel to mix will be relatively small in comparison. Therefore, when bass waves from the rear mix with those at the front, they will still be almost entirely out-of-step or phase with the waves coming from the front of the cone. And they will cancel out, just as two tug-o'-war teams cancel out each other's efforts.

### **Treble mix**

Where the sounds produced by the cone are relatively high or treble pitched, their wavelength will be relatively short compared to the distance they must travel round the edge of the cone to get from rear to front. In this case the mixture will produce random results and no serious cancellation.

What all this adds up to in practice is that a naked or raw chassis loudspeaker on a table top will produce virtually only mid and top frequency notes, and no bass at all, because the latter will all be cancelled out by rear-to-front sound leakage.

### **The solutions to good bass performance**

It follows, then, that to produce good bass sounds from a loudspeaker, it is necessary to prevent the sound waves from the cone rear ever getting round to the front to mix with the waves beamed out towards a listener. There are various ways of tackling this problem; all work well in some respects, but all suffer from particular disadvantages.

In the bass reflex type of cabinet, the sound from the rear of the cone has its phase inverted by channelling it through a port in the cabinet (fig 28). In this way it adds to, and reinforces, the sound from the front of the cone rather than cancelling it out. This makes for good, healthy bass, but it is difficult to avoid some notes sounding 'coloured' or louder than others. In the transmission line or labyrinth type of loudspeaker, sound from the rear of the cone is disposed of simply by losing it in a long column filled with air and sound damping material. In the infinite baffle or sealed cabinet (fig 29), the loudspeaker is mounted, as the second of its names suggests, in a very small, completely sealed cabinet. The speaker cone is effectively suspended by the air trapped in the cabinet and virtually all the sound from the rear of the loudspeaker is trapped inside the box.

The other name for a sealed cabinet, 'infinite baffle', comes from another possibility – mounting the loudspeaker in a hole in a very large wall or baffle board so that sound has to travel a very long distance round the baffle to get to the front and either reverses its phase or loses most of its power on the way. Some hi-fi enthusiasts have even been known to mount loudspeakers in windows of their houses, with the cone

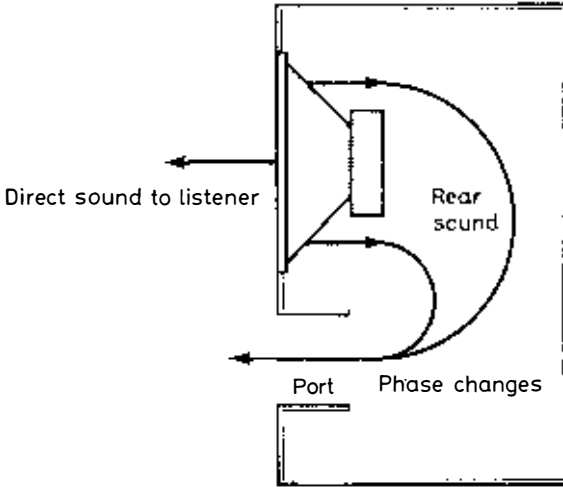

Fig 28 In a bass reflex cabinet the rear sound has its phase changed to 'help' the front sound.

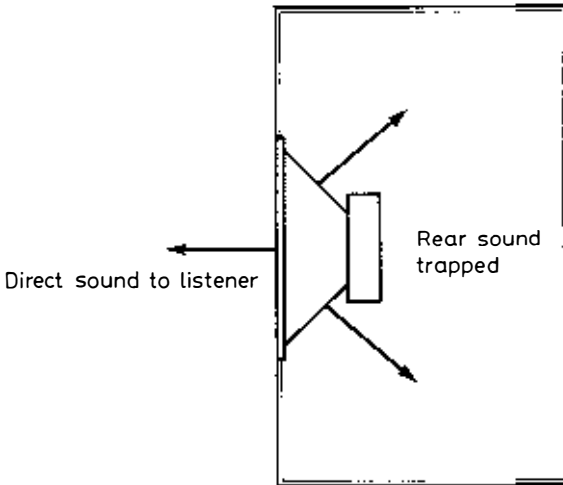

Fig 29 In a sealed or infinite baffle cabinet the rear sound is not allowed to escape.

front pointing in and the cone rear pointing out into the garden or street. This can produce good sounds, but makes for unhappy neighbours, because this technique relies on losing most of the sound from the rear of the cone into the open air.

### **Efficiency**

The small infinite baffle, sealed cabinet, type of loudspeaker is now very popular and can produce very good results (without any such neighbour problems!). But it has the disadvantage of being relatively inefficient, in that only a small proportion of the sound produced is actually heard, most of it being lost and converted into tiny amounts of heat inside the cabinet. Indeed, it is a sobering fact that the efficiency of most domestic loudspeakers (a measure of the amount of sound they produce for a given electrical input) is around 1 per cent or less!

Of course some loudspeakers are more efficient than others, but it is very much a swings-and-roundabouts situation, the tendency being for an efficient speaker to be rather inadequate in other respects. For instance it may colour or emphasise some sounds above others. The important point to bear always in mind is that a small loudspeaker that sounds gutsy, uncoloured and satisfying in the showroom may only be sounding that way because it is being driven hard by a very high powered amplifier, perhaps up to 100 watts per channel. It may sound very different indeed when you get it home and drive it only with 10 watts per channel. The difference will show up not so much as failure to generate sheer volume of sound, but as failure to keep the sound clean when the gain or volume is high. It is for this reason that you should never buy a pair of loudspeakers without first considering, and better still discussing, the power rating of your amplifier. Likewise, you should never buy an amplifier without first giving a thought to what loudspeakers you may eventually wish it to drive.

### **Nasties**

Some nasty sounds that loudspeakers produce are only too easy to hear. Clipping due to overloading (but not to a sufficient extent to burn out the loudspeaker coils) is perhaps the most common; the speaker just sounds as if it can no longer handle all the power being supplied to it, especially during brief peaks and crescendoes. Amplifiers also clip, especially when driving inefficient loudspeakers, and the sound is similar. The only cure for a domestic set-up that produces clipping sounds

(short of replacing the amplifier or loudspeakers or both), is to turn down the volume.

Other nasty sounds are less noticeable but equally annoying, especially in the long run. Colouration has been previously mentioned and is perhaps the main bugbear of loudspeakers. To a certain extent all loudspeakers colour the sound they produce in some way or another. The phrase means exactly what you would expect it to mean. The loudspeaker simply handles some sounds more efficiently than others and therefore colours or boosts them artificially.

The classic example of loudspeaker colouration is to be heard in any juke box; indeed the phrase 'juke box sound' is in the vocabulary of every loudspeaker designer. If you blow air over the top of an empty bottle it will resonate at a fixed frequency. An undamped loudspeaker cabinet will behave in exactly the same way, but at a lower frequency, and a juke box is usually an undamped cabinet. Thus it 'honks' or produces inordinately loud sounds at a few bass frequencies. Because juke boxes are designed for use in crowded, noisy pubs and cafés, it is an advantage to have the bass notes throbbing away in this manner; but to live with a juke box in an ordinary, domestic environment would prove very fatiguing indeed after a very short time. Most good domestic loudspeakers are far less coloured than a juke box, but even slight colouration may start to nag the discerning listener in the long run and create a general feeling of listening fatigue.

### **Crossing over**

Early loudspeaker designs tried to use a single moving coil and cone unit to handle all the frequencies, from the very low bass (30 Hz) right through the mid-range and up to the highest frequencies audible to man (15 KHz to 20 KHz – 15 to 20,000 Hertz – depending on age). This practice fell out of favour, because it is obviously difficult to have one loudspeaker cone handle such a wide range of frequencies. Soon it became common practice to use a bass speaker or 'woofer' to handle the bass frequencies, a mid-range unit (occasionally called a 'squawker') to handle the middle frequency sounds and a high frequency speaker, or 'tweeter', to handle the top end (figs 30 and 30a). Sometimes now a 'super tweeter' is used to handle the very highest frequencies. Although the use of several, separate units to handle the separate frequency ranges solves some problems, it brings many more down on the designer's head. Most difficult of all, it involves the need to feed only bass notes to the



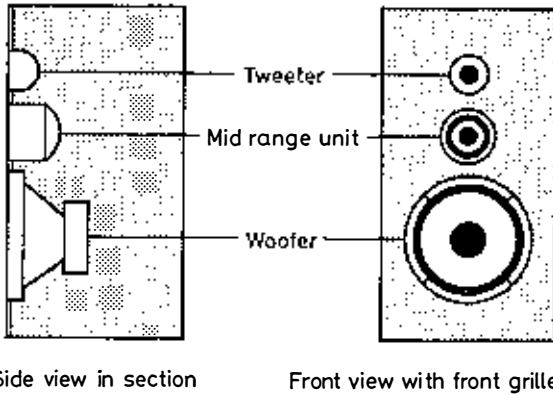

Fig 30 (left) A loudspeaker cabinet as seen 'sliced' in half; and fig 30a (right) the same cabinet from the front with front grille removed.

bass speaker, only mid notes to the mid-range unit and only high notes to the tweeter. To feed bass notes to a tweeter would immediately burn it out; high notes fed to a woofer will just not reproduce; and a mid-range unit will distort on bass and high frequencies.

### What approach to take?

Although an electronics engineer can fairly easily devise a 'crossover' unit (fig 31), to filter the electrical sound signals so that the correct ranges of frequency are only fed to the intended speaker units, the problem arises of how and where to make the crossover points. Should the designer overlap the performance of the units, so that the woofer handles some of the mid-range and the mid-range unit handles some of the bass

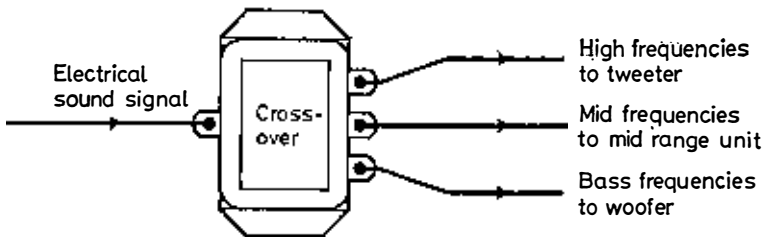

Fig 31 An electronic cross-over for loudspeakers.

notes? Or should he try for a rigid cut-off between units? A rigid cut-off will sound very odd, with some sounds jumping from unit to unit as their pitch changes; but too much overlap will produce anomalous effects due to reinforcement of the sound from one unit by the sound from another and so on. Also, it is hard to divide up signals without altering their phase, and as we have seen phase can be very important.

The problems are virtually endless, and every designer has his own pet solutions. Some solutions work well only for low level listening, while other solutions work best at high level. It is for this reason that someone who is interested only in listening to rock music at high level is well advised to buy a loudspeaker which has a reputation for just such use. On the other hand, another listener who hates rock music and listens by choice only to classical music would be far better advised to buy a speaker that has a reputation for the clean, uncoloured reproduction of music at relatively low levels. I doubt that there is any successful and respected loudspeaker designer in the world who would innocently put hand on heart and claim that any one of his designs was equally well suited to both extremes of reproduction.

### **Other types**

Although we have so far considered only moving coil-moving cone loudspeakers, there are other types of 'transducer' on the market which convert electrical energy into sound in different ways. Over the years there have been some quite bizarre proposals, some even involving the modulation of a sustained electric spark as found in an arc lamp. There are even tales of theatrical carbon arc lamps being used not only to illuminate the stage but also to generate sound. For the record, this type of arc modulation can produce interesting sounds, but suffers from the disadvantage that it also produces ozone, which in large quantities can constitute a health risk.

Not all alternatives to the moving cone loudspeaker are as exotic as this. Some manufacturers are now manufacturing their loudspeaker diaphragms in the form of a flat, plastic sheet, carrying a metal wire over the surface and suspended between magnets. The electrical sound signal is passed through the wire, and the magnetic fields that are created cause the sheet to flap between the magnets. This system can produce remarkably satisfying sounds, as can the related ribbon and air motion transformer systems.

## **Electrostatics**

But the most effective alternative (so far) to the moving coil is the electrostatic loudspeaker. In this case, a large, flat diaphragm is spaced between electrodes, and an electrostatic field created by a permanent supply voltage. When the electrical sound signals are applied to this charged unit, the diaphragm moves to create sound waves.

A good electrostatic speaker can produce the cleanest and most uncoloured sounds in the world (cleaner probably than the most carefully designed moving coil unit) but, as always, there are snags. For one thing, although it is easy to theorise over electrostatic loudspeakers, it is quite another thing to design one that works reliably over a period of years. Some firms have licked the problem – others have not. Also, if the loudspeaker is to be in any way sensitive to small audio signals, and thus able to reproduce quiet sounds accurately, it will be incapable of handling large volumes of sound. Thus, although electrostatic loudspeakers are ideal for the reproduction of low volume classical music, for instance string quartets, they are usually unsuitable for heavy duty jazz, rock or even some loud orchestral use.

## **Hear it at home or at least think hard before buying**

It is often said that no one should buy a loudspeaker without first hearing it in his own home. Even the position in which a loudspeaker is placed in a room can affect the results quite considerably. Certainly, if you are spending several hundreds of pounds on a pair of loudspeakers (this kind of expenditure is inevitable if the results are to be really worthwhile), you should leave your options open by at least negotiating a deal whereby you can try another, quite different pair, of loudspeakers if the first proves to be a disappointment when you listen to them at home. But this cannot apply for cheaper purchases and there is no reason why the basic characteristics of a loudspeaker, such as its ability to handle loud sounds or its efficiency, should not be established in the shop or showroom, long before you think of buying anything and taking it home.

Without doubt, if you buy a loudspeaker without at least hearing it in a showroom, demonstrated under good conditions and playing music of the type that interests you, you deserve all the disappointment you will inevitably get. But if, for reasons which I frankly can't imagine, you are ever in the position of having to buy a loudspeaker unheard (and heaven help you if you do), there is one rule of thumb which you

should certainly observe: steer clear of a light-weight model. Because a good loudspeaker unit must have a strong and heavy magnet, and because a good cabinet should be built of solid, vibration-free material, and because the inside of a good cabinet should include at least some kind of damping material, a cabinet loudspeaker which is light to lift will almost certainly be a waste of money.

---

## 9/Setting up and Using What You've Bought

---

### **Trendy but ignorant**

While the hi-fi boom was at its first great height, one of the bank credit card schemes ran a full-page picture advert in a colour supplement magazine. The message was that there was no point in waiting for hi-fi if it could be bought now, on credit. The picture showed a trendy young man in his trendy new home, with some pretty expensive and very worthwhile hi-fi equipment. He was sitting with a blissful gloat on his face, supposedly listening to some beautiful sounds, but he was in just about the one position in the room where he couldn't possibly have been hearing anything worthwhile. For me, this summed up what the early hi-fi boom really meant. It meant that neither the photographer, nor the advertising agency, nor the credit account executives knew the first thing about hi-fi. But I'll bet that every single one of them had reasonable equipment in his own home – probably equally badly set up.

### **Market research**

At around the same time, an ad-man, who this time *did* know something about hi-fi, told me how his firm's market research showed that hi-fi is now on the 'essential household luxury' list for many families. Once the modern 'necessities' of life, like a roof over your head, a house full of furniture, a car perhaps, and a cooker and fridge have been bought, there is a fairly well-defined pattern showing how any extra money is spent. Colour TV, a washing machine, a second car and a holiday in a far-off, sunny land have for some time now rated as virtually standard luxury expenditure. Hi-fi has now been added to that list for many families. Unfortunately, and as that full-page colour advert neatly showed, it may be easy to buy hi-fi, but it is rather less easy than you would think to use it properly.

### **The set-up and the stereo seat**

The best stereo image from a pair of loudspeakers will be heard by

someone in the so-called 'stereo seat'. This is the name for that area of a room in which the listener receives just that sound from the loudspeakers that he is intended to hear, and (all other things being equal) in correct balance. To find the stereo seat in your room, or more realistically to locate the stereo seat so that it is in a reasonable position for everyday listening, place your two cabinet loudspeakers around 2 metres (about 6 ft) apart (more in a large room, less in a small room) and angle them with their front grilles pointing slightly inwards. Now draw an imaginary line from each loudspeaker grille into the centre of the room, and where the imaginary lines cross is the most likely area of the stereo seat (fig 32). Again with all other things being equal, you will hear in that area a stereo spread of sound between the two loudspeakers, rather than left channel sound from the left loudspeaker and right channel sound from the right speaker. (See figs 33-36 for some set-ups to avoid.)

Some loudspeakers will create a much more tightly defined stereo seat than others, and this can, for obvious reasons, be something of a

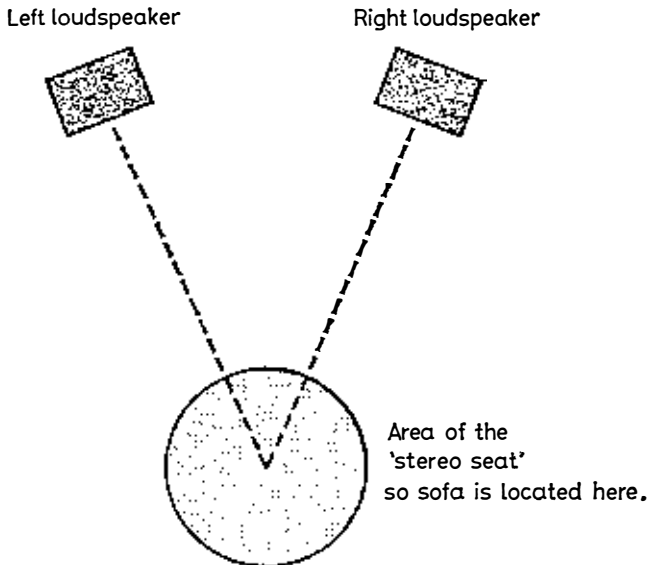
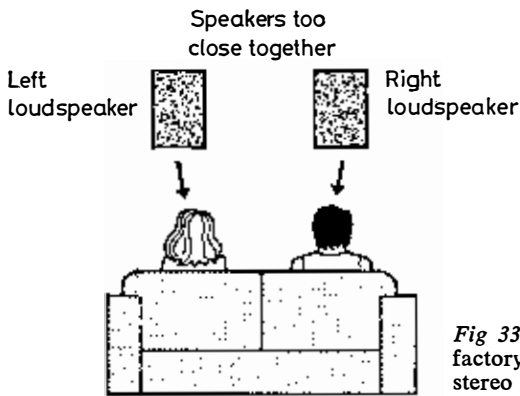
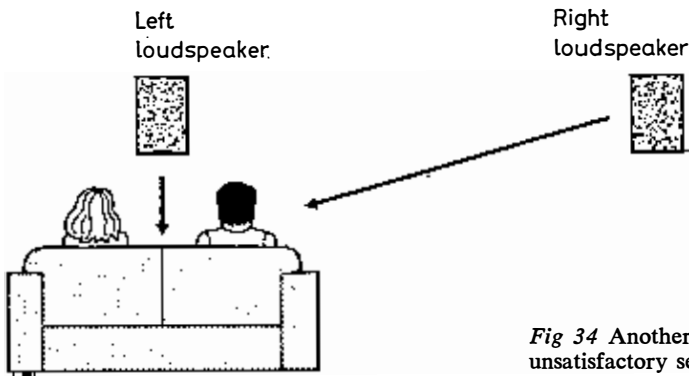

Fig 32 The basis of a good stereo set-up – shown schematically from above.



*Fig 33* An unsatisfactory way to use stereo domestically.



*Fig 34* Another unsatisfactory set-up.

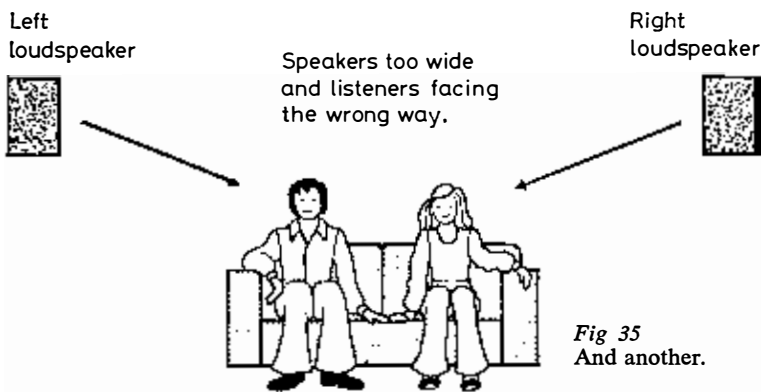

*Fig 35*  
And another.

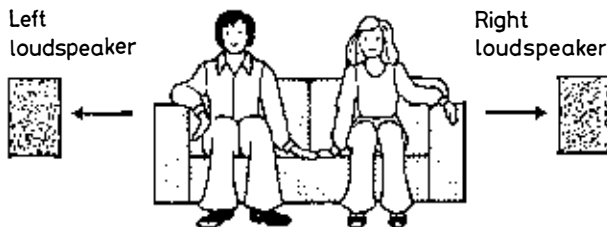

Sofa between speakers and listeners again facing the wrong way.

*Fig 36 And another!*

disadvantage. On the other hand, attempts to spread or banish the stereo seat altogether, for instance by using so-called 'omni-directional' speakers which beam their sound all round rather than in a fairly tightly defined front direction, may succeed in greatly widening the area in which a listener can sit, but may also fail ever to provide a really firm stereo image.

There is a great deal of controversy between, on the one hand, those who back directional speakers and, on the other hand, those who would stake their life on an 'omni'. In practice, this really is another area where compromise is necessary. If you want a really firm stereo image, then you should look to conventional, directional speakers (most rectangular box cabinets are directional) and be prepared to listen from whatever position produces that firm image. If, on the other hand, you like to wander as you listen and abhor the idea of sitting down in a fairly positively defined position, then you would do well to try a pair of omnis.

### **Positioning the rest of the set-up**

It really doesn't matter where you put the rest of your equipment, provided that two guiding principles are borne in mind.

Firstly, keep all connecting leads between the amplifier and tape or record deck as short as possible. The longer the connecting lead the more likely it is that difficulties will arise. A long lead may roll off the top frequencies or high notes (due to capacitance effects short circuiting the high frequencies) and cut down overall sound level (due to its resistance). It is also more likely to introduce hum due to 50 Hz mains radiation being picked up. The leads between the loudspeaker and



amplifier can be as long as you like (within reason) and can be of ordinary electric flex. However, it is advisable to make the flex as thick and heavy-duty as possible. Thin wire, such as bell wire, introduces more electrical resistance and this will, among other things, cut down the amount of sound produced by the loudspeaker.

The second point to watch is that of acoustic feedback. Any vibration in the room, whether produced by footsteps or the sound of the loudspeakers themselves, may, if it finds its way to the record deck, be converted by the gramophone cartridge into electrical signals which are amplified and fed to the speakers. Alternatively the stylus may bounce in the record groove that it is tracking. The symptoms of groove bouncing are obvious; the recording being played just skips a few musical bars here and there. The result of vibrations finding their way into the pick-up cartridge and from there to the speakers and then back to the cartridge again, is a vicious circle of 'feedback' which usually sounds like a low bass roar from the loudspeakers. Not only does this kind of feedback make loud listening impossible, it may also damage the loudspeakers.

The answer to both these problems is to mount the record deck on a really solid surface, for instance a heavy sideboard or, better still, a wall shelf. It is highly unlikely that there will ever be any similar feedback problem with tape decks and amplifiers, so far less care is needed about where to mount these.

### **Getting it right (and left)**

I have used the phrase 'other things being equal' earlier in the context of a good stereo image, so this now needs explaining. Even if you are not foolishly trying to listen to hi-fi from halfway along a straight line drawn between the sides of two loudspeakers (as was the trendy young man in the silly advert), you can still suffer some very disappointing results. First of all, it is absolutely essential to ensure that the left-hand channel sound really does come from the left-hand speaker, in all functions of use. It may sound ridiculous to suggest that this may not always be the case, but it is astonishing how many hi-fi rigs are set up with the right-hand loudspeaker over to the left of the room from the listening position and *vice versa*. Many people are still convinced that in stereo the high notes come from one speaker and the low notes from another, and anyone with this kind of misunderstanding is unlikely to bother too much about which loudspeaker goes to which side of his listening pos-

ition. But we have already seen, in chapter 2, how a stereo recording is made and should be reproduced and this will make it easy to understand why, if the left and right wire connections are crossed, the intended stereo image will be confused by mirror inversion.

It is, I suppose, something of a pity that such a mirror of sounds can provide quite reasonable listening for anyone who has no idea what a correct stereo image should sound like. It would almost be better if routing the left channel through the right loudspeaker and *vice versa* produced no sound at all! But unfortunately it doesn't, and the listener who has no idea how good stereo should sound must look to other ways of ensuring that he is not suffering from an undiagnosed case of left/right inversion.

### **Diagnosis**

The obvious and first way, of course, is to check that the leads of the left speaker really are going to the left-hand speaker output socket on the amplifier and so on. But some amplifiers identify their channels as A and B, and in such a case it will be necessary to go back to the instruction book and keep a clear head while checking all the connections. Remember that every external piece of equipment, such as a record or tape deck, will have its own connection to the amplifier, and any one of these can have left/right inversion. Some connections are made with simple phono plugs, and others with DIN plugs. It is only too easy to push the phono plug for the right-hand channel of the tape recorder output into the left-hand input of the amplifier, and although it is not possible to push a DIN plug in the wrong way round, it is possible that the plug has been incorrectly wired at one end in the first place. So although you may very diligently have ensured that the left-hand loudspeaker output socket is feeding the loudspeaker to the left of your listening position, any one or more of the input connections may still be incorrect.

### **Using test material**

Checking every single connection to make sure that you have all correct (see fig 37) is a time-consuming, irritating business and it is all too easy to become confused halfway through and perhaps end up reversing two connections; this will then put the system effectively back where it was in the first place! So take my tip and check left/right connections in the only positive way possible. Buy or borrow (some record libraries will

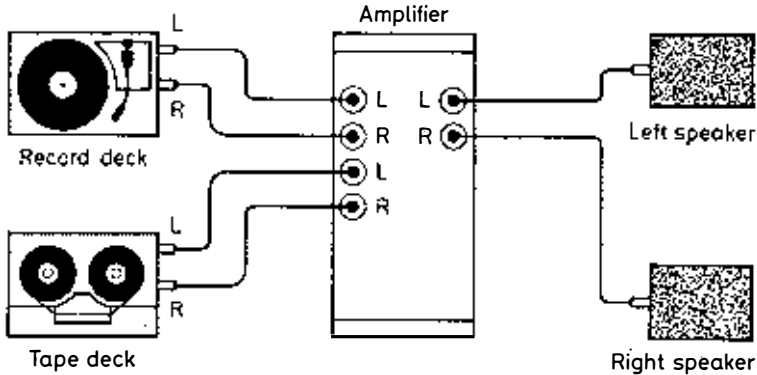

Fig 37 Correct Left-Right connections.

have them) a test disc and a test cassette which carry positive identification of which is the left and the right channel. Play the disc on your turntable and check that when the recorded voice says, 'I am on the left,' it really does come from your left loudspeaker. Then do the same with the test cassette and ensure that the recorded voices again emerge from where they say they should be. Next, record the disc onto a blank cassette and check the playback. Finally check again that the left-hand loudspeaker output socket on your amplifier really is feeding the left-hand speaker. If it isn't, but you are getting *correct* results, you've got both the inputs and the outputs round the wrong way and you should change them round. This is essential, because otherwise a radio tuner integrated in the amplifier (which of course will be permanently correctly connected internally) will be wrong.

### What's needed

Although at the time of writing it is easy to obtain a test cassette and disc, it is not so easy to obtain a test tape for reel-to-reel recording. At first sight it would seem easy to make up your own test tape, by dubbing onto blank tape from a test disc, to identify left and right channels. Unfortunately there is a basic fallacy in this. If the recording connection between the amplifier and tape recorder is reversed, then the recording put onto tape will be likewise reversed (fig 38). If the tape output to the amplifier is also reversed the set-up will produce a final *correct* left/right situation from the loudspeakers. This will be fine while you are playing

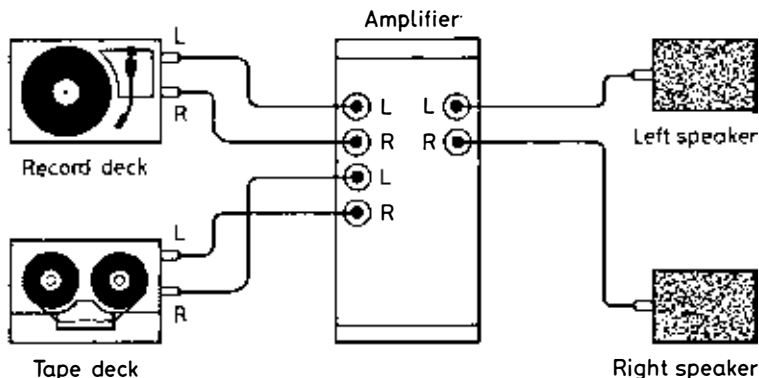

Fig 38 An incorrect connection on one function (the tape deck).

tapes that you have made yourself – but as soon as you try and play someone else's tapes (that have been recorded on a correctly connected machine) the pre-recorded left channel will start coming out of the right speaker and *vice versa*. It is only too easy for a listener to fail to identify this kind of problem, because his own tests will have made him falsely confident that everything is correctly connected. So there will always be a crying audio need for a reasonably priced package deal containing a short test disc, test cassette and reel-to-reel tape, all with left and right channel identification.

### More checks – balance first

Any such test material should also include a balance test and a phasing test. These are usually included in the test discs and cassettes already on the market, and are just as important as left/right tests. To take the first test first, a balance test is really very straightforward. If you are sitting in the 'stereo seat' at an equal distance from each loudspeaker, a correct stereo image will only be produced when equal volume sounds arrive from both loudspeakers. Owing to a peculiar psycho-acoustic phenomenon, if one loudspeaker sounds louder than the other the stereo image will tend to swing over and hug that speaker. Likewise, if you are sitting closer to one speaker than the other, even if they are both producing the same level of sound, the stereo image will tend to hug the closest speaker. It can be very useful to play one phenomenon off against the other.

If you find it really necessary to listen at home from a position somewhat to one side of the stereo seat, you can often compensate for this simply by altering the balance control on your amplifier so as to put more volume through one loudspeaker than the other. Pre-recorded balance tests (as found on test discs and cassettes) usually produce a similar level sound through each channel and the suggested instruction is that the listener should alter the balance control on his amplifier until the combined sound appears to be coming from exactly halfway between the two loudspeakers, or at least from neither one in particular.

Incidentally, don't be alarmed if you need to set the balance control on your amplifier slightly to one side or the other of its central position when conducting a test like this. Not only are the markings on many amplifier controls slightly wrong (so that true dead centre is slightly to one side of the dead centre marking), but also room acoustics and slight left-right inequality somewhere along your hi-fi chain can quite easily cause either a real or an apparently higher level of sound to be produced by one loudspeaker or the other.

### **Now phasing**

The other test mentioned above was 'phasing'. We have come across this word already in connection with loudspeaker design, and seen how the low frequency sounds from the rear of a loudspeaker cone will cancel out the similar sounds from the front if the two are allowed to mix out of phase. When the loudspeakers in a pair of separate cabinets are correctly phased, they push and pull together, to work together and increase the total amount of bass that the listener hears. But when they are wrongly phased, one is pushing while the other is pulling, and the net result is an almost total cancellation of all low notes being reproduced – just like the cancellation which results from low notes straying round from the rear of a cone to the front of the same cone.

The effect of wrong phasing at middle frequencies, for instance on speech, is to confuse the listener's ears over the direction of the sound's origin. Thus whereas two correctly phased loudspeakers producing the same sound will seem to be producing that sound from halfway between them, if the loudspeakers are incorrectly phased the sound will appear to be coming from somewhere to one side of one loudspeaker, or from nowhere in particular.

Test discs and cassettes use this phenomenon to help the listener check phasing. Two exactly similar sounds are played through each channel

of the test disc, both recorded exactly in phase. If the two loudspeakers are correctly phased, then the sound heard will have a healthy, meaty bass content and will appear to come from halfway between the speakers. If the speakers are out of phase, then the sound heard will be lacking in bass and diffuse in its point of origin. Some test discs deliberately follow the in-phase test example with an out-of-phase test example, advising the listener that if the second example sounds better than the first, his speakers are out of phase.

### **How to correct a phase error**

To reverse the phase of a pair of loudspeakers, it is only necessary to reverse the polarity or positive-negative connection to *one* of those speakers. (In other words, take the leads to one loudspeaker and put the negative lead to the positive terminal and *vice versa*.) If the positive-negative connections to *both* are reversed, then of course the situation will be back where it was in the first place, with each speaker still out of phase one with respect to the other.

### **Don't be too sure**

As a final point, in case you should think you can't possibly have your loudspeakers out of phase, I can only quote one example that I personally encountered. I was transported at considerable expense to the new factory of a manufacturer with an exciting new range of hi-fi products. The wonderful equipment was demonstrated to me, and it sounded terrible. The reason was that the loudspeakers used for the demonstration had been connected out of phase. If a manufacturer of equipment can make a mistake like that without realising it, then so most certainly can someone buying hi-fi for the first time.

### **At last – using hi-fi**

Once a hi-fi set-up has been set up, then all that remains is to use it. And that, for most people, is the object of the whole exercise. No one needs any advice, from me or anyone else, on how to enjoy listening to their favourite recordings. The only advice worth offering is on how to keep on getting the best out of those recordings.

It is remarkably easy to make several hundred pounds' worth of hi-fi equipment sound shoddy, simply by covering the gramophone stylus with fluff and letting the tape head gaps clog with tape particles and dirt. If left to their own devices, both the stylus and tape heads will do

this with remarkable efficiency, in a relatively short period of time. So it really is necessary to do something to keep your gramophone stylus and tape heads clean.

### **De-magnetising a tape head**

Nothing more need be said on how to clean tape heads (see chapter 5), but it's worth mentioning the desirability of occasionally de-magnetising a tape head. After months of use, the tape record and playback heads may tend to become permanently magnetised themselves, and this will in turn permanently imprint a background hiss on any tape that passes over them. Once imprinted, this hiss can never be removed, and the remedy is to de-magnetise the heads every few months. Commercial de-magnetisers are available, and these consist simply of a large mains electromagnet. The electromagnet is held close to the head and pulled away slowly whilst it is still switched on. In this way the head is gradually magnetised by a decreasing amount, so that it ends up with no magnetism whatsoever. Some such gadgets, incidentally, can also be used to bulk-erase reels of tape in exactly the same manner.

### **Cleaning a gramophone stylus**

There are various proprietary gadgets available for cleaning a gramophone stylus. Some are in the form of a brush and others are similar to a small piece of velvet. The very fact that so many different gadgets are available suggests that it is not too critical what material is used. However, what does matter, very much, is that the gramophone stylus should be cleaned *gently*. Using a light brush or piece of velvet, it should be gently stroked *along the length* of the tiny cantilever arm that carries the (usually diamond) tip. Any attempt at brushing from side to side will almost certainly break the tiny cantilever. Unfortunately the gentle approach will not shift all dirt deposits, and it will often be necessary to use a solvent. Much of what was said about tape head cleaning applies equally well to styli. Thus sometimes that cheapest of all solvents, a dab of saliva, will be sufficient to loosen dirt deposited round and over the stylus. But other times a commercial solvent will be needed. The best again is isopropyl alcohol, because it has the happy knack of removing unwanted dirt but leaving unaffected most, if not all, plastics and similar materials from which hi-fi equipment is constructed. It also leaves no residue when it evaporates. All the talk about it being 'available from any good chemist' is eyewash, and I have never yet found a chemist with

isopropyl alcohol on his shop shelf. But I have found some that will obtain a pint bottle on special order.

As before, another useful cleaning material is vodka (still no kidding), but this is even more expensive than isopropyl alcohol. And the further alternatives, still usable at a pinch, are surgical spirits and methylated spirits. To re-iterate the previous warning, *never use carbon tetrachloride* (CTC), which may remove dirt but also dissolves plastics and just about every material from which hi-fi equipment is made. Various proprietary aerosol sprays are now also available for cleaning styli, and the golden rule here is to read the instructions on the can before buying and using. As always, if still in any doubt you must spray initially in very small amounts, preferably on an expendable piece of material, for instance on an area of the equipment which is well out of sight.

### **How to tell a dud or dirty stylus**

The obvious question arises of how one knows when a gramophone stylus needs cleaning or replacing. A very dirty stylus will look dirty to the naked eye; but most dirt will need a magnifying glass (around  $\times 10$ ) to reveal it. Stylus damage will either not show up at all or be very hard to detect under such low magnification and will require a small microscope. The problem here is that few people know what a stylus *should* look like in pristine condition, so can hardly be expected to judge whether or not it is damaged. However, some shops now offer a microscope inspection service and many stylus manufacturers run a similar service through the mail. So buy yourself a small magnifying glass or watchmaker's eyeglass to check whether your stylus is clean or dirty, and leave more detailed inspection, once every year or so, to those who know what they are doing.

### **Time scales**

Although cheap, poor quality tape tends to clog the tape heads more quickly than tape of better quality, there is really no way of preventing heads from clogging in the long term – the remedy is to clean them occasionally. But we are talking here on a time scale of weeks or months. With a gramophone stylus, however, the time scale is much shorter. Just *one* playing of a dirty record will completely clog a stylus, and even playing the cleanest records will gradually dirty a stylus, due mainly to airborne dust settling in the grooves.



### **Chief chore**

It follows that perhaps the most important, and difficult, hi-fi chore of all is keeping records clean. It is no fun whatsoever to have to keep de-fluffing a stylus after every record play, and of course repeatedly cleaning something as fragile as a stylus will inevitably shorten its life. Clean records mean less stylus cleaning, and the only real answer to keeping records clean is to never let them get dirty.

### **Why records get dirty**

The unfortunate fact is that most, if not all, gramophone records are made of a plastics material which picks up an electrostatic charge when it is wiped clean. A record even charges up as it revolves through the air and is played with a stylus. An electrostatic charge on a piece of plastics attracts dust (in fact in some laboratories the air is kept clear of dust by attracting it electrostatically), so the whole business of record cleaning is a terrible vicious circle. Once a new record has become dirty it must be wiped clean, and this generates an electrostatic charge.

### **How to prevent it**

The charge created on the record by cleaning it can be dispelled by various gadgetry, such as an ioniser. But if the record is then played on a turntable open to the atmosphere dust will fall on it due to gravity and because the charge starts to build up again as it revolves. So more gadgetry must be used to keep the record clean while it revolves, and this in turn may help produce a greater electric charge.

There are numerous record-cleaning gadgets on the market, all of which promise something and many of which work as claimed. By all means buy whatever gadgetry takes your fancy, and use it, but never lose sight of the prime need to prevent records from getting too dirty in the first place. Always keep records in their inner sleeves inside the main sleeve, and with the opening of the inner sleeve turned sideways in the outer sleeve, so that no portion of the record itself is ever exposed direct to the atmosphere. Handle them carefully, using only the extreme edges and the central land in the middle where the label is secured. Also, if your record player has a lid which can be closed while the record is playing, then close it. In this way the only dust that can reach the record is that small amount which is trapped inside the very small volume of the record player. Think about this when choosing a record player in the first place.

### **Live recording**

So far we have considered only reproducing other people's pre-recorded efforts. But a tape recorder (either reel-to-reel or cassette) will almost certainly have provision for original recording using either a microphone or pair of microphones. The instruction book will advise on which microphone type is best suited for the machine in question, and this is advice you should take.

There are numerous microphone types (crystal, dynamic, ribbon and condenser), all of different cost and quality and characteristic. To produce good results a microphone must match the input of the machine into which it is plugged, and a mis-match will mean poor results, however much the individual components may have cost. Many cassette machines come ready equipped with matching microphones, and very often these will produce the best results obtainable from the machine in question. Really it is best to start recording in *mono* until you have gained experience. Recording in *stereo*, with microphones located without thought and a full understanding of at least the basic principles explained in the earlier chapters will produce disappointing results.

The recording hobby tends to bite like a bug. Some people never use their equipment for any other purpose than reproducing commercially recorded material – then one day they find out what fun it can be to create original recordings of their own, perhaps editing and overdubbing to produce creative results. It then becomes a whole new hobby of its own.

---

# 10/Gilding the Lily

---

## **The risk**

There is a risk with hi-fi, as with all hobbies, that it may simply become an excuse to spend money. Enthusiasm for hi-fi itself is replaced by enthusiasm for acquiring new items of equipment, and indeed it is quite easy to spend so much on pointless additions, accessories and add-on electronic gadgetry that all one's time is spent fiddling with the extras, and there is no money left to buy tapes or records. On the other hand, there are various hi-fi accessories and additions that are well worth buying if funds permit.

## **The essentials and 'in-car' entertainment**

Of course, absolutely essential are the basic necessities for cleaning records and tape heads, described in chapters 5 and 9. Also, car owners may well wish to install in-car entertainment, and this, if used sensibly, can be of benefit to anyone who needs to travel long distances alone or regularly sit miserably in traffic jams. But although in-car entertainment will relieve the boredom of a long, lone journey and calm the nerves of a jammed city motorist, it can also be distracting if played at too high a level and could therefore well cause an accident. The whole subject of in-car entertainment really needs a book of its own, so suffice it here to say that no one now uses discs in a car. Several years ago there were attempts to devise record-playing systems which accepted discs through a letterbox slot, played them and then disgorged them again through the slot. But the upsurge of interest in tape cassettes and cartridges inevitably killed interest in these systems stone dead, and now anyone listening to sounds in a car does so either via a built-in radio tuner, a cassette player or a cartridge player. Radio and cassette systems should need no further basic explanation to anyone who has read this book so far, although anyone who tries to fit one in a car on an amateur basis will find that there are all manner of problems (such as interference from the engine) in practice. But a few explanatory words ought to be offered on cartridges.

### **Tape cartridges**

For a start, don't confuse a tape cartridge with a gramophone cartridge. Only the words are the same. A tape cartridge is rather larger than a Philips compact cassette and has in common with a cassette the fact that it requires no tape threading; it is simply slapped into a matching slot to be played. But whereas a cassette uses 3.81 mm (about  $\frac{1}{8}$  in) wide tape, a cartridge uses 6.3 mm ( $\frac{1}{4}$  in) wide tape, and whereas cassette tape runs from one spool to the other inside the cassette and then back again when turned over, the tape inside a cartridge is in a continuous loop. This means that, once started, a cartridge goes on playing for ever until stopped.

To enable a relatively short length of cartridge tape to carry a relatively long spell of recorded sound, the tape width is divided up into eight separate tracks, which are used as four separate stereo pairs. Hence the generic term '8-track cartridge' and hence also goodbye to the illusion that a cartridge must be able to produce better quality sound than a cassette because it has wider tape. The four tracks, on 3.81 mm ( $\frac{1}{8}$  in) wide cassette tape are virtually the same width as the eight tracks on 6.3 mm ( $\frac{1}{4}$  in) tape – simple mathematics proves the point. But there is a theoretical, if not practical, gain in quality because 8-track tape runs twice as fast as cassette tape. Although the 8-track cartridge contains four separate stereo recordings running alongside each other on the continuous loop of tape, it is clear that only one of these must be played at any one time. Thus manual and automatic switching is provided to move the playback heads slightly across the tape. Normally this occurs every time the loop has made a full tour. The movement is just sufficient to ensure that the heads line up on a different stereo recording at the end of each tour, so that as the tape loop runs continually the four stereo recordings that it contains are played in their entirety, one after the other.

On the fifth tour of the tape, the heads start on the same movements all over again. This means that a single loop of tape can contain four times its basic length of recording, and because it is a continuous loop it will go on playing all its recordings until switched off. This makes it ideal for in-car entertainment, but rather less than ideal for domestic use, especially as the programme material should be carefully pre-planned to ensure that no single musical item overlaps the start and the finish of the loop, so that it is interrupted by a change of head position.

### **Cartridge versus cassette**

In the USA some 8-track cartridge machines are used domestically, but in this country they are almost exclusively used in cars. Really the only reason for a hi-fi enthusiast to buy mains-powered, 8-track equipment for domestic use is to make up his own cartridges for use on an 8-track player mounted in a car. Otherwise it is best to stick to disc and cassette equipment in the home. Moreover if you have cassette equipment in your home it makes good sense to have cassette equipment in your car as well. After all, a C-120 cassette runs for one hour before it needs turning over, and player manufacturers are now making it more and more easy for a driver to turn over a cassette in his in-car player without taking his eyes off the road. Some players have 'auto-reverse' which does the job for you by playing the tape backwards. I also happen to believe it is fallacious to assume that anyone with an 8-track player leaves the same cartridge playing endlessly. Thus, they too, must attend to their cartridge machine at least as frequently as a driver using cassettes attends to his player.

### **Gadgets and yet more gadgets**

There are countless gadgets on the market which help the user cut and join tape, fast wind cassettes by hand, check stylus tracking weight, prevent, clean or remove this, that or the other, and generally do virtually anything conceivable to the hi-fi mind. Many of them just make useful Christmas presents for someone you don't know too well. But it is often the case that some specific gadget will do exactly the job that you really need to be done. And that is the crunch. The reason to buy gadgets is because you need them, not because you want to buy a gadget.

### **Manual lift**

I remember once going into a very highly respected hi-fi shop to try and buy an add-on gadget to lift the pick-up arm on and off the record. Many record decks have these lifts built in, but mine did not. 'God has given you the best pick-up lifting gadget that money can buy – your hand,' said the dealer. 'Why don't you use it?' I took his advice, left the shop without buying the lift, and for several weeks continued to use my fingers to lift the arm on and off.

Before long I fumbled, dropped the pick-up arm onto the side of the turntable and in so doing wrecked the stylus, which cost me the price of

five long-playing records to replace. I then decided that I really did need a pick-up lift, and went off and insisted that the dealer sell me one. I have recommended that dealer to friends ever since, because although he inadvertently cost me the price of a new stylus, he had the right idea about gadgets – they should be needed, not just wanted.

### **Auxiliary equipment**

Most amplifiers have an ‘auxiliary’ socket at the rear into which some auxiliary unit can be plugged. This can be an extra tape deck, but it can also be an external tuner, and the tuner may be a TV sound tuner rather than a straightforward radio tuner. There are also gadgets which extract sound signals from a TV set for feeding into the auxiliary socket of a hi-fi amplifier. Both types of TV unit serve the same purpose: they feed into your hi-fi system the sound which accompanies whatever TV programme is being transmitted. Traditionally, domestic TV sets have very poor sound systems, and this irritates many hi-fi enthusiasts. It is for this reason that they buy the gadgetry necessary to route the sound through their hi-fi systems. But, as often as not, the result, although perhaps aurally satisfying, proves to be more trouble than it is worth. I have had various TV link-ups over the years, and only occasionally used them.

### **Safety first**

In this connection, do please bear in mind one warning that is often given, but equally often ignored. It really is **very dangerous indeed** to try to make a direct amateur connection between a domestic TV set and a hi-fi rig. Many TV sets are of the AC/DC variety, and as a result have mains voltages lurking, ready to kill, in many parts of the circuit. Also TV screen tubes require tens of thousands of volts to drive them, and this can easily leak or jump across onto stray wiring. So, if your TV set does not have any kind of output socket specifically intended for external connection, **use only a commercially available unit to feed TV sound to your hi-fi.**

### **‘Simulcasts’**

All TV sound is in mono and it will be many years before TV sound is transmitted in stereo, along with the picture. Probably, it will not happen in the lifetime of any existing TV set or hi-fi rig. So nothing you currently own or now buy is likely to become obsolete in this respect.

However, TV transmissions are sometimes linked with stereo radio transmissions in so-called 'simulcasts'. For a simulcast the television station transmits the picture and ordinary mono sound, in completely conventional manner, but the radio station transmits the same sound in stereo. This means that anyone with an ordinary TV set and an ordinary hi-fi rig with stereo radio facility can use the two together, to watch the picture on TV and listen to the sound in stereo on radio.

This simulcast system works well, but it does require the viewer to arrange his room so that the TV set is sensibly placed with respect to the stereo pair of loudspeakers – ideally the set should be halfway between the two. This is worth bearing in mind if you are freshly laying out a room or rearranging your furniture. If you can position your TV set normally between your two stereo speakers, then when a simulcast is transmitted it will be simply a question of switching on both the TV and radio and turning down the TV sound, to listen and view to best advantage. Another alternative is to listen to the stereo sound from your hi-fi on headphones, while watching the TV screen.

### Headphone listening

Now seems a good time to make brief mention of the use of headphones (fig 39). Over recent years more and more high quality stereo headphones have come onto the market at more and more reasonable prices.

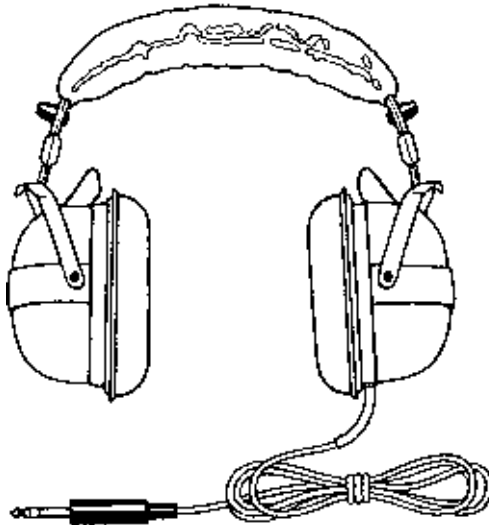

*Fig 39* A pair of stereo headphones.

Gone are the days when a pair of headphones could produce only telephone-type sound quality. Today the sound produced from a pair of headphones can be as good as, or better than, that produced by loudspeakers. But wearing headphones is anti-social and can be fatiguing, not only because of the physical weight or feel of the phones but also because of the slightly unnatural sound they produce. Anyone listening to stereo sound over headphones for the first time, and especially a dummy head recording, will be astounded at the feeling of all-round presence and realism that they can generate. But this feeling can be a little wearing over a period of time. Thus, although headphones are almost a necessity for anyone who likes to listen to their music loud and late at night (because what is loud in the ears of a listener is virtually inaudible a few feet away) they should never be regarded as a long-term replacement for loudspeakers.

### **Surround sound**

A dummy head recording replayed on headphones can produce virtually surround sound, the listener swearing that he is hearing some sounds from the rear, some from the sides and some from the front as well as above and below. It is much more difficult to achieve this sensation with loudspeakers, and this is what quadraphonics and surround-sound is all about. Rightly or wrongly, several of the big-name manufacturers of hi-fi hardware and software decided several years ago that what we all needed was surround sound. They also decided that the best way of providing this was to use four, instead of two, loudspeakers as sound sources (hence the word 'quadraphonics') fed by four separate channels.

It became conventional to have one loudspeaker at the listener's front left (as normal for stereo) and one at his front right (also as normal for stereo) but with the addition of one at the rear left and one at the rear right as well. Because all modern domestic equipment is geared to two-channel reproduction, numerous methods were devised of 'encoding' four (or more) channels of sound into the two stereo channels available, and then 'decoding' them on playback. Unfortunately, because the big names all researched and developed different systems, utter confusion soon resulted.

### **Compromise**

If you would like to experiment for yourself with four-channel, quad-



raphonic or surround sound you can easily do so, for the price of a pair of extra loudspeakers and a few yards of loudspeaker connecting wire. It was an American, David Hafler, who almost in passing gave the clue as to how this could be done. Hafler had for many years been involved in proposals for deriving the sound for more than two loudspeakers from a stereo system, and he observed that if the 'difference' in the signals being fed to the two loudspeakers of an ordinary stereo set-up was fed to one or more extra loudspeakers, placed at the rear of the listener, the result was quite surprising.

### Difference signal

To derive the 'difference' signal, all that is necessary is to leave your existing hi-fi set-up exactly as it is, but add one extra wire to the positive output terminal of the amplifier feeding the left-hand loudspeaker and one extra wire to the positive terminal feeding the right-hand loudspeaker. Rather in the manner of a pair of kitchen scales, the electrical difference signal (the difference between what one channel is producing with respect to the other) is developed across these two extra wires. If

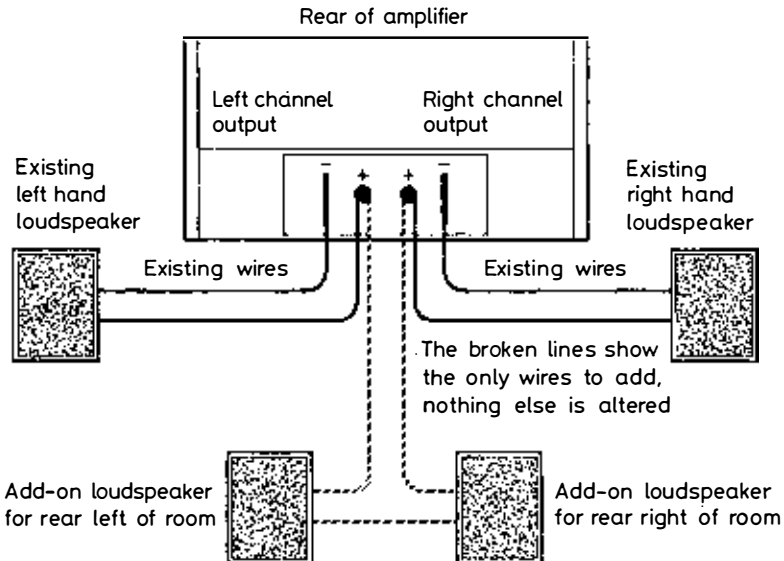

*Fig 40* The so-called Hafler method of connecting a extra pair of loudspeakers to give a degree of surround sound from stereo.

the wires are connected to one or more extra loudspeakers arranged in series or parallel, as shown in fig 40, the electrical difference signal is reproduced as sound.

### **Ambience and exotics**

Quite often a major part of the difference between channels is the so-called 'ambience' or faint, echoey sound which makes a large room or concert hall sound as it does, but which is mainly lost from an ordinary stereo recording played in two-channel stereo. Also, some exotic recording effects on pop records produce signals on the two stereo channels which are out of phase with each other, and as a result produce a substantial difference signal. Both ambience and exotic sounds are produced from the extra loudspeakers, and with the latter placed at the rear of the room, some interesting effects can be obtained. In practice, the effects are most marked where the recordings have been made in a fairly large and ambient room or hall and where the producer has a penchant for special effects. Also many four-channel or quadraphonic discs sound impressive when reproduced in this way. Several junction box gadgets are available to make the connection of extra speakers easier, on a plug-in basis; but essentially they all rely on the basic, very simple 'difference' connections suggested by David Hafler.

### **TV and the future of hi-fi**

TV has been mentioned briefly in both this and a previous chapter, and it seems fitting to end with another brief comment, because TV technology may well aid audio to an increasing extent in the future. Over recent years, manufacturers have poured a vast amount of time and money into researching and developing different and better methods of recording TV signals domestically. Already there are several videotape recorders and players which, for not much more than the price of a top quality sound tape recorder, will record TV pictures in colour, along with their sound. There are also video disc systems which will enable anyone with a special, but again relatively cheap, record player to reproduce TV pictures in colour and sound from a pre-recorded disc via one's own domestic TV. So every day the line between hi-fi and TV is becoming more fuzzy. Sooner or later the time must come when a domestic entertainment centre will contain both video and audio reproduction equipment, side by side. Indeed, there are signs that already this is happening in some homes.

### **Video – an expensive hobby**

But no one should blunder into buying video without at least taking reliable advice. The clumsy purchase of hi-fi can prove to be an expensive mistake, but is unlikely to be as expensive as the clumsy purchase of video. Also, there are various rival video tape and disc systems (just as there are rival quadraphonic sound systems) and no one yet knows which system will win out in the long run. Probably some form of the Philips video cassette system (VCR) will become as much of a domestic standard in Europe as the Philips audio cassette, with some form of the Japanese Sony video cassette system finding most support in the USA and the East and in some professional, semi-professional and business fields throughout the world.

Although video recorders may appear relatively cheap for the technological miracle that they achieve, video can still be a very expensive hobby. An hour's video recording time will probably always cost far more in cassette tape than the equivalent tape recording time for audio. As previously mentioned, the recording heads on a domestic video machine are moving round at a speed approaching 32 kilometres an hour, and not only wear out through natural causes far more quickly than those of an audio tape recorder head but also cost far more to replace. Also, although the user can clean his own audio head gaps, he will almost certainly destroy a video head if he so much as touches it. Problems like these will doubtless be alleviated, as domestic video technology becomes more advanced, but the basic warnings must stand good for many years to come.

### **Audio-video**

Perhaps the most exciting thing about video is its audio applications. To record a colour TV signal on tape, disc or any other medium is about as easy (or rather as difficult) as to record several dozen audio channels all at the same time. Video engineers have now succeeded in recording colour TV signals, so there is absolutely no reason why they should not apply the fruits of their video labours to audio. Thus inevitably there will be changes in the future of audio, and new recording media will be developed which will provide higher fidelity, longer playing time and greater resistance to degradation than anything so far used. But all this will happen only very slowly, and no one need have any fear that what they already own or what perhaps this book has encouraged them to buy will suddenly become obsolete. Common sense holds the answer. It

is hardly likely that any record, tape or hi-fi hardware manufacturer will suddenly say to the public, 'As from now I am going to stop producing what all of you have proved yourselves happy to buy from me, and am instead going to devote all my future energies to manufacturing and selling something completely different, that is totally incompatible with everything else on the market, and will make everything that you already own totally obsolete.'

Not a bit of it. Any new developments in audio will inevitably be as an addition to what we already have, not as a replacement. So feel free to equip yourself with the best of modern audio equipment that you can afford, and enjoy it. But buy wisely, not blindly. In a nutshell; if in doubt, find out. Details of some books for suggested further reading are given at the end of the Glossary.

---

## 11/ Hi-fi Shopper's Check List

---

When buying hi-fi, think particularly about these points before taking the plunge.

### **Amplifiers**

Must be stereo unless you have some very special reason for wanting mono. Buy quadraphonic or four-channel equipment only if you are sure that you really do want four-channel or quadraphonic sound.

Check that the amplifier has enough power for the room and furnishings in which it is going to be used and the speakers with which it is going to be used. Use the standard formula (chapter 3) for this check but bear in mind that it is hard to envisage any amplifier of less than 10 watts per channel offering true hi-fi at anything but fairly low levels of sound.

Decide whether you will want to receive stereo radio, and if you do, think seriously about buying a combined tuner and amplifier ('tuner-amp' or 'receiver').

By all means buy something that looks nice, but don't be blinded by beauty that is only skin deep. Also, don't be blinded by a surfeit of gimmickry and knobs to control it. Your money might well be better spent on a more powerful piece of equipment with fewer gimmicks. But all amplifiers must have some knobs, and it can be instructive to check the way they feel. If they are light and made of flimsy plastic, the chances are they will crack over the years, and there is a good chance that an exact, matching replacement may not by then be available. Also, cheap external construction may well mean similar skimping elsewhere and out of sight. Good, solid knobs and switches will probably never need replacing and may well imply sound construction throughout.

Look also at the way that the amplifier or tuner-amp is decorated and marked with scales. Simple light transfers may wipe off over the years. Good, solid paintwork, or engraving will not.

### **Radio tuner**

Unless you have good reasons for having a separate tuner, buy one already built into an amplifier. Don't bother with mono – buy stereo. Check that it has a reasonable sensitivity (see chapter 7). All the comments on gimmickry, knobs, skin-deep beauty and lettering made in connection with amplifiers apply also to tuners.

It is a good idea, while buying a tuner or tuner-amp, to check with the dealer about whether he knows of a good aerial fitter if you need one.

### **Record deck**

Look for solid but careful construction, especially for the platter or turntable on which the records will rest. But don't necessarily be put off by flimsy-looking construction for the pick-up arm; some of the best arms in the world look as if they were dreamed up by Heath Robinson on a bad night. However if you intend giving your record deck a fairly hard working life (perhaps even letting your wife/husband and kids use it as well), be prepared to sacrifice a little audio quality for a sturdier arm.

Try if at all possible to buy a model with a lid that closes while a record is playing as this will minimise problems due to dusty discs.

Most record decks now run at only two speeds ( $33\frac{1}{3}$  and 45 rpm), so don't be put off by the absence of 78 rpm or  $16\frac{2}{3}$  rpm, both of which are obsolete speeds. (If you are a collector of historic 78s, though, a few turntables are still obtainable with this speed.) If you are a musician, consider buying a deck with a fine speed adjustment; this way you can correct any slightly off-pitch recordings (and there are plenty around).

### **Tape deck**

By and large, reel-to-reel tape is best for live recording and editing. So if you are going to make and edit live recordings, go for a reel-to-reel machine first. If, on the other hand, you are going to concentrate mostly on recording music off the radio or off discs (often illegal under the copyright laws, but frankly few people take any notice when replayed within the home circle), then cassettes are most convenient.

Buy a good mains-powered, stereo cassette machine for hi-fi use at home and a cheap, mono, battery portable machine for dictation or business use. Don't try to buy one machine to cope with both uses – you will end up falling between the two stools. The simple portable

machine need have no frills, but the hi-fi machine should at least have Dolby noise reduction facility.

### **Loudspeakers**

The proof of the pudding is in the hearing. If they sound good after careful listening, then they almost almost certainly are good. But check that they will handle enough power for your domestic situation and can be driven satisfactorily by the amplifier you are going to use with them.

Remember the rule of thumb that no light and flimsy loudspeaker can produce clean, meaty sounds. Also, another fact of audio and acoustic life is that you are more likely to get plenty of good, solid, meaty bass sounds out of a large box than a small box.

Try for a home trial or exchange deal if possible, in case you don't like the way they sound in your home.

### **General points to watch**

If you are buying equipment from an odd source, for instance a friend who has been living abroad, do make sure it has the correct mains rating. British mains voltage is fairly standard now, at 240 volts, 50 Hz, but elsewhere in the world it can be 110 volts and 60 Hz. Most equipment has an adjustable voltage tapping on the transformer, to enable it to be used on either voltage. But some equipment is for one voltage only, and using it on the wrong voltage will either destroy it or produce hopeless results. Also, tape and record decks designed for American 60 Hz operation will probably run too slow when plugged without modification into British 50 Hz mains; and modification may be difficult.

Finally, when buying equipment, do try to buy all the *necessary* accessories at the same time. You can't use hi-fi equipment without the correct connecting leads and plugs, so these are very definitely necessary. Sometimes it may prove easiest to buy them while you are spending several hundred pounds on equipment. The reasons are obvious. If a particularly popular lead or plug is in short supply (this does often happen) a shop may be faced with the choice of selling its last one either to a customer spending several hundred pounds or to another spending only a couple of pounds. There are no prizes for guessing who has the best chance of getting what he wants.

---

## 12/Bodger's Law

---

Bodger's Law, for the uninitiated, is the same as Limey's Law, Murphy's Law, or any other ethnic law. It lays down what was suggested in an earlier chapter – if there is a wrong way of doing something, someone will sooner or later hit on it.

The Law of Cussedness is a closely related law – that is the one that ensures that the record you are looking for is always at the bottom of the pile and the book you need is always the one that you have lent to a friend. The latter law also says that if you have bodged a connection, you will check every perfect joint before finding the bodge.

What follows is intended to confound both laws.

### **Symptom**

*Nothing works.*

**ACTION** Check first that the mains power point is working and switched on. The best way of doing this is to plug in a table light or something similar that you know is all in order, and see if it works. If the table light test shows the mains socket to be OK but the hi-fi gear still refuses to show any signs of life, it could be a fuse in the mains plug. Most hi-fi gear also has its own built-in mains fuse so check that as well. But beware – if any fuse blows more than a couple of times, there must be a fault on the equipment. Fuses are intended as a safeguard, and it is downright stupid, as well as dangerous, to replace a blown fuse with another of too-high rating. You will only end up blowing out something far more expensive than a fuse. Check the instruction book for the equipment for the correct fuse rating.

**MORAL** Never throw away the instruction book for any piece of equipment you own.

### **Symptom**

*The equipment shows signs of life (dial or indicator lights go on), but there is no sound.*



**ACTION** Switch between various inputs to check whether tape works, although disc does not, or *vice versa*. If your amplifier has a built-in radio tuner, then switch to radio, and if you get normal radio sound then the fault is very probably external. If everything is silent, including the tuner, then listen for faint hiss or hum at the loudspeakers. If they are 100 per cent silent, check that they are connected. Many amplifiers now have a loudspeaker muting switch, so check its position – it may be 'off'. Finally, check the safety fuses for the amplifier output stages (you'll need the instruction book again here), because if you have even briefly short-circuited the loudspeaker connections you can easily have blown an output fuse or both if there are two.

### Symptom

*One external source only (eg, the record player) won't work.*

**ACTION** Be logical. Don't rush at anything; think it through. If everything works except one function, then it is either a fault in the switching inside the amplifier (unlikely) or (much more likely) a fault with the external piece of equipment that is silent. As often as not, the fault won't actually be on the equipment, but on its connection. Try pulling out every plug and pushing it back in again – but remember to pull by the plug casing, not the wire itself, or you will simply succeed in creating a fresh connection fault which will make the original fault even harder to find. If all this fails, try replacing the connecting lead.

**MORAL** Keep a few spare leads around for checking and for use when you buy or borrow a new piece of equipment and all the shops are closed or have sold out of what you want.

### Symptom

*Unreliable switching between functions (sometimes your amplifier control switches between tape, disc and radio, sometimes it doesn't). Or there are crackles and odd noises or jumps in sound level when you set a volume or tone control.*

**ACTION** A little controlled brute force without ignorance is the answer here. Switch the switch or turn the control briskly and firmly from one extreme setting to the other and back again, half a dozen times. You will be surprised how many times this cleans dirt or condensation from the switch contacts and cures the fault, at least temporarily. If

the fault keeps returning after a while, then the switch contacts are probably worn or wearing out.

### Symptom

*An intermittent fault – sometimes something works, sometimes it doesn't.*

**ACTION** Again think logically and again don't rush things. Isolate in your mind where the fault is most likely to be, and then gently feel your way along all the relevant connecting plugs and leads, fingering the leads and wagging each plug. If there is an intermittent fault, this will probably cause it to appear and disappear; you can then replace the lead.

### Symptom

*Everything works well, except there is an irritating low-frequency hum from the loudspeakers.*

**ACTION** The cause is almost certainly either a faulty screened lead or a so-called 'hum loop'. All leads for connecting low level audio signals (as opposed to mains power leads or loudspeaker connection cables) should be screened. The central conductors are surrounded by a metal sheath which is earthed and prevents them from picking up low frequency (50Hz) radiations from the house mains supply. If the earth connections break away, then hum will result; if they come loose, the hum will come and go intermittently. However, hum can also occur when all screening connections are secure and correct but where several pieces of equipment are all joined together and earthed at various points, *eg* through various earth terminals, tags and three-pin mains plugs. This causes a loop around which currents flow to create hum.

Hum due to faulty leads can be traced because it is eradicated by replacing a bad lead with a good one. So replace them one by one to help identification of the rogue. Hum loops can sometimes be cured by simply re-routing audio and main cables, so that they are not so physically close, or by cutting down on the number of earth connections. But beware here – *if equipment is supposed to have an earth connection it may be dangerous to disconnect it.* The safest approach is to keep all connections as physically short as possible and run as many of them to the same common earth point as possible.

Where a piece of equipment has only a two-pin (unearthed) lead,

try reversing the plug in its socket or the leads in the plug – quite often this will produce a magical cure for hum.

**MORAL** Same as before – try and keep some spare leads handy.

### **Symptom**

*Everything works, but discs or tapes, or both, sound less good than usual.*

**ACTION** Almost certainly your pick-up stylus or tape heads, or both, are dirty. Clean them, but gently and, as explained earlier, remember that both tape heads and gramophone styli can look clean but actually be dirty or damaged. Always brush along stylus, not across it. Check your gramophone stylus initially under a magnifying glass. If in doubt take it to a shop with a microscope examination service, or return it to the maker (many stylus firms offer an inspection service for a nominal charge).

### **Symptom**

*You have checked everything out and it all seems to be right, but somehow nothing sounds quite as good as you feel it should.*

**ACTION** Check that the left channel really is coming out of the left-hand speaker on all functions – in other words, that the left channel on disc, tape and radio is always being routed to the left loudspeaker. Check also that the loudspeakers are in phase on all functions, in other words check that phasing is correct for disc, tape and radio. It is only too easy to set up a system with a test *disc* and never know that a faulty connection is routing the left-hand channel from a *tape* deck out of the right loudspeaker, or putting it out-of-phase.

**MORAL** At some time buy or borrow both a test disc and cassette to check left/right routing and phasing (and balance as well).

### **Symptom**

*One piece of equipment is obviously not right. It isn't the connecting leads, nothing is dirty, but it still sounds wrong.*

**ACTION** Check that the 'faulty' piece of equipment is correctly matched to whatever input on the amplifier it is feeding. Re-read the instruction book and try switching and varying any sensitivity controls that are provided. But, of course, if the fault appears to have developed in use, then it is likely that it really is a fault rather than a mis-match. If it

affects only one function of use (eg, disc reproduction) then the fault is far more likely to be on the external piece of equipment (in this case the disc player) than on the amplifier, which is behaving normally on other functions (tape and radio). Of course, it's possible that one of the components associated with that particular input to the amplifier has gone faulty, but it's highly unlikely. Another possibility worth bearing in mind is that as you listen to your equipment more and more, and perhaps listen to higher quality equipment elsewhere, you may start noticing faults that have always existed.

But, assuming none of this holds good, and one of your pieces of gear really has developed a fault, there is only one thing to do. Take it or send it back for repair. *And this raises what I reckon to be the most important lesson of all:*

**MORAL** If humanly practicable, keep the original packing for every piece of equipment you own. If one day you have to return it for repair, you will find that the safest, easiest and quickest way of packaging it will be in the tailor-made box in which it originally came.

---

# A Layman's Hi-Fi Glossary

---

What follows is not intended to be a scientific glossary because plenty already exist. Instead, it is a simple explanation in a nutshell of the terms most likely to be first encountered by anyone buying, using or reading about hi-fi.

**AERIAL** Anything, from a piece of wire to a highly sophisticated arrangement of metal rods, ideally mounted in an attic or on a roof. Receives radio (or TV) signals and conveys them via a connecting lead to a tuner or tuner-amplifier.

**AMBIENCE** Acoustic 'warmth' (due to reverberation) in a listening room or concert hall. The term is currently popular, and sometimes misused, to describe certain aspects of four-loudspeaker reproduction.

**AMBIOPHONY** Commonly refers to the addition of one or two extra loudspeakers located at the sides or back of the listening room, and wired to the stereo sound system, *eg*, to reproduce the difference signals of the two stereo channels, in which case it is sometimes known as the Hafler technique, after its originator, David Hafler.

**AMBISONIC** System, due to a British team including Professor Peter Fellgett (Department of Engineering and Cybernetics, University of Reading) and Michael Gerzon (Mathematical Institute, Oxford), which aims at reproducing true ambient sound from all around the listener. Due to financial backing this is known as the NRDC Ambisonic system, and is an alternative to 'quadraphonic' surround systems. The listeners experience directionality and reverberance approximating these characteristics of the original sounds.

**AM** Amplitude Modulation, the way in which radio waves are used to carry sound signals in the medium and long wavebands.

**AMPLIFIER** Popular term for integrated amplifier (combined PRE-AMP and POWER AMP).

**BALANCE TESTING** Feed equal level identical signals to both channels (for instance from a mono radio transmission or from a test tape or disc) and adjust the amplifier balance control until the sound appears to come from halfway between the two loudspeakers.

**BASS** Low frequency sound. (Pronounced 'base'.)

**BIAS** A signal automatically fed to the tape of a tape recorder in the 'record' mode which jogs the magnetic particles at high frequency, to help them take up the audio recording being made. Bias adjustment on most machines is fixed at the factory.

**BINAURAL** Two-channel sound, in which each recorded channel is heard only through one ear. Thus the listener must wear headphones. (Also called **DUMMY HEAD** stereo – compare with **STEREO**).

**CAPACITANCE EFFECT** Some audio components, especially long coaxial leads of poor quality, behave as capacitors and short-circuit high frequencies, thereby acting undesirably as a treble cut tone control.

**CARTRIDGE** There are two forms of cartridge, one which is mounted at the business end of a gramophone pick-up arm and includes a stylus to track the record groove, and another which contains 8-track tape, usually for in-car entertainment. Refer to the first as a gramophone or pick-up cartridge and the second as a tape cartridge and you won't be sold the wrong one by mistake.

**CASSETTE DECK** A specific form of tape deck, which handles only tape 3.81 mm (about  $\frac{1}{8}$  in) wide in cassettes.

**CD-4** Four channel multiplex disc technique, developed by JVC in Japan. Known as **QUADRADISC** by RCA.

**CM/s** Centimetres per second (cm/s). A measure of speed, usually for recording tape running past a recording or playback head.

**COAXIAL LEAD OR CABLE** Intended generally to mean a fairly thick screened lead, for use in connecting aerials to tuners or microphones to tape recorders. In fact virtually all screened lead is coaxial and *vice versa*, but different types must be used for different purposes. It is safest always to buy any lead by specifying the use for which it is intended. See **SCREENED LEAD OR CABLE**.

**COAXIAL PLUG** Generally the term is used to describe a plug somewhat

similar to a phono plug, that is intended to connect an aerial lead to a tuner.

**COLOURATION** In a sound, the unnatural emphasis of some frequencies. Produces boomy or screechy effect depending on the frequency involved.

**COMPATIBLE** Usable in more than one format, *eg* a stereo recording or broadcast which produces mono on mono equipment is 'mono-compatible'.

**COMPLIANCE** Term used to describe pick-up cartridge performance. The opposite of 'stiffness'. Inadequate compliance limits cartridge performance.

**CONTINUOUS SINE WAVE POWER** See **RMS POWER**.

**CONTROL UNIT** See **PRE-AMP**.

**dB** See **DECIBEL**.

**DECIBEL** (or **dB**) A numerical expression (actually a logarithmic unit) of acoustical or electrical ratios, indicating the relative intensity of a sound or the relative strength of a signal. One decibel is about the smallest sound change perceptible to the average ear.

**DECODE** To de-process an encoded signal, so as to revert it to its original form. For instance, to produce two channels of stereo radio from a single wavelength transmission; or four channels of sound from a stereo record or transmission; or to return a **DOLBY**-encoded or 'Dolbyised' signal to its original form.

**DIN PLUGS** **DIN** stands for Deutscher Industrie Normen, which is roughly the German equivalent of British Standards. One **DIN** Standard relates to plugs, and **DIN** type audio plugs are now commonly used throughout Europe. There are different types of audio **DIN** plug intended for different purposes, but two types are most likely to be encountered by hi-fi enthusiasts. Two-pin plugs with one small, round pin for the positive lead and one larger, flat pin for the negative lead are used for loudspeaker connections; three- and five-pin audio plugs are used at the end of screened leads. As with leads, it is safest to buy **DIN** plugs by specifying the intended use.

**DIPOLE** An aerial, usually for **VHF FM**, comprising a long straight rod formed from two equal lengths.

**DIRECT COUPLING** An amplifier output stage which feeds loudspeakers without the use of an output transformer is direct-coupled to them.

**DIRECT DRIVE** Term usually applied to turntables, where the moving members including the platter are all part of one, large, slow-running motor.

**DISCRETE SYSTEM** A term generally (but usually incorrectly) used to describe a type of quadraphonic, four-channel or surround sound system, in which four channels of sound are combined into two by a system similar to that used for the conventional transmission of stereo radio on a single wavelength.

**DISTORTION** Any alteration of the original signal, usually producing nasty-sounding, or 'unclean' results.

**DOLBY SYSTEM** One form of noise reduction system, now very widely used with cassettes to reduce hiss.

**DROPOUT** Audible gaps in a recording (or visible gaps in a video recording) caused by physical damage to the tape coating.

**DUMMY HEAD** A recording technique whereby a dummy human head has a microphone in each ear. Playback is via headphones worn by the listener.

**ENCODE** To process signals, before recording or transmission, for instance as in stereo radio transmission; or as in quadraphonic, four-channel or surround sound recording and transmission; or as in a noise reduction system such as DOLBY.

**EQUALISATION** Any fixed value electronic frequency boost or cut of a signal to produce a desired result. Usually some frequencies are automatically boosted by a fixed amount on recording with corresponding de-boost on playback (to overcome deficiencies inherent in the recording medium). See RIAA, which defines the equalisation used for modern disc recording.

**FLAT SIGNALS** Signals or sounds with no unnatural boost or cut and thus, undoctored frequency response, are said to be flat.

**FLUTTER** Irregularities in running speed of a tape or disc which make the reproduced sound fluttery. See also wow; flutter variations are faster than wow variations.



**FM** Frequency Modulation. The way in which radio waves are used to carry mono and stereo sound signals in the VHF bands.

**FOUR-CHANNEL SOUND** Virtually the same as quadraphonics, and often used (wrongly) as synonymous with surround sound.

**FREQUENCY** A measure of Hertz (Hz), or cycles-per-second. High frequencies of sound are high pitched, low frequencies are low.

**HERTZ (Hz)** The term now used, instead of cycles-per-second, as a measure of frequency. Thus 50 Hz is the same as 50 cycles-per-second (as for British mains electricity). The figure k before Hz denotes a thousand Hz or cycles-per-second, and the figure M before Hz denotes a million Hz or cycles-per-second. Thus 2 kHz is 2,000 Hertz, Hz or cycles-per-second, and 2 MHz is 2,000,000 Hertz, Hz or cycles-per-second. (k is short for kilo- and M for Mega-.) See **FREQUENCY**.

**HUM** The sound of 50 Hz mains encroaching on the wanted signal. Caused by the pick-up of radiation from a nearby mains cable.

**Hz** See **HERTZ**.

**IDLER DRIVE** Used in turntables to connect mechanically a fast running drive motor to the rim of the platter.

**INFINITE Baffle (or Sealed Cabinet)** A form of loudspeaker mounting wherein a loudspeaker drive unit is mounted in an opening to an otherwise totally enclosed cabinet.

**INPUT** Any socket or connection that is intended to receive a signal from an **OUTPUT**; or the signal received.

**INTEGRATED AMPLIFIER** Power amp and pre-amp (for definition see separate entries) combined into a single casing.

**IPS** Inches per second (ips). A measure of speed, usually for recording tape, used as an alternative to centimetres per second.

**JACK PLUG** A long established plug (mono or stereo), available in different sizes and used to make firm push fit connections. A single pin has several separate connection rings along its length.

**LABYRINTH LOUDSPEAKER** A loudspeaker unit mounted in a cabinet with a tortuous or labyrinthine internal path to 'lose' the sound originating from the rear of the speaker cone.

**LINE CONNECTION** A low level (rather than high or amplified level) audio connection, made with screened leads, *eg* between tape deck and amplifier.

**LOUDSPEAKER** The word can mean one of two things. In one sense it is a raw, or chassis, loudspeaker unit which, on its own, is no use whatsoever for sound reproduction. In the other sense it means a cabinet or enclosure of some kind with one or more raw units correctly mounted inside.

**LOUDSPEAKER LEADS** There is no need to use special or screened leads for connecting loudspeakers to an amplifier. Ordinary electrical flex wire will do, but try and use the thickest available (rather than thin bell wire), to avoid losses due to resistance.

**MATRIX SYSTEM** Generally used to describe one generic type of quadrasonic, four-channel or surround sound system, in which more than two sound channels are mixed together into two channels (a stereo pair) for recording or transmission, and then (partly) unmixed again for reproduction.

**MICROVOLT** Term represents one-millionth of a volt ( $\mu\text{V}$ ).

**MILLIVOLT** Term represents one-thousandth of a volt (mV).

**MONO** Short for Monophonic or Monaural, and meaning single-channel sound.

**MONO COMPATIBILITY** The ability of any signal other than mono (*eg* stereo or quadrasonic or surround sound) to sound acceptable in mono.

**MULTI-CHANNEL SOUND** Something of a meaningless term, because anything other than mono is strictly speaking multi-channel! Used commonly as a misnomer for quadrasonic, or surround sound.

**MULTIPLEX** A system, used in radio transmission (and recording) for carrying extra information on a high frequency carrier wave.

**NOISE** Any sound you don't want to hear. Usually hiss in hi-fi, but can also be hum or crackle.

**NOISE REDUCTION SYSTEM** A means of suppressing unwanted noise (mainly the hiss inherent in cassettes).

**OMNI-DIRECTIONAL SPEAKERS** Any loudspeaker that produces sound in all (or most) directions, rather than in a fairly well defined beam.

**OPEN-REEL TAPE DECK** See REEL-TO-REEL TAPE DECK.

**OUTPUT** Any socket or connection that delivers a signal for use or for feeding to an INPUT; or the signal delivered.

**PHASE** Signals that are 'in phase' move together in-step and signals that are 'out of phase' move out-of-step with each other.

**PHONO PLUG** Sometimes called RCA plug. A long-established alternative to DIN plugs, the phono plug has a single central pin surrounded by a metal casing. They are used at the end of screened leads to connect a tape or record deck to an amplifier.

**PICK-UP (ARM)** Sometimes called tone arm, from the days of acoustic gramophones. The arm which moves across a gramophone record with a cartridge and stylus at its free end to track the record grooves.

**PLATTER** Flat disc which, as part of a record deck or record player, revolves to carry the disc record being played.

**POWER AMP(-LIFIER)** Electronic circuitry, usually in decorative case, which receives electrical sound signals from a PRE-AMP or control unit and boosts them to a sufficient level to drive a loudspeaker.

**POWER HANDLING** A measure of the ability of a loudspeaker to handle power fed to it from an amplifier, without distortion or its electric coils disappearing in a puff of expensive smoke. Most loudspeakers will handle high levels of power for *short* periods of time, *eg* musical peaks. Thus, unless you want a discothèque in your front room, there is usually no need to equate loudspeaker power handling with the total power available from an amplifier.

**POWER OUTPUT** A measure (in watts) of the useful or undistorted power which is available from the loudspeaker output terminals of an amplifier. Use the formula given in chapter 3 to work out the minimum power for your own situation and certainly think more than twice about any amplifier giving less than 10 watts rms per channel.

**POWER RATING** Usually a measure of the power output from an amplifier which a loudspeaker can handle without distortion or damage. The power rating of a loudspeaker can in practice be less than the POWER

**OUTPUT** of your amplifier – unless you intend using the system at full power for long periods of time.

**PRE-AMP(-LIFIER)** Also called a control unit. Electronic circuitry, usually in a decorative case and with external controls, which slightly boosts and also controls the characteristics of low level electrical signals from a tape deck, record deck or radio tuner. Feeds a power amp.

**QUAD** Popular shortening for Quadraphonic. Actually the registered trade mark for electrostatic loudspeakers, tuners and amplifiers made by The Acoustical Manufacturing Co. of Huntingdon.

**QUADRAPHONIC SOUND** The word commonly used (albeit sometimes incorrectly) to describe the reproduction of four channels of sound from four loudspeakers to provide **SURROUND SOUND**.

**QS** A matrixing technique for encoding four-channel sound into two (stereo) channels. Due to Sansui.

**RCA PLUG** See **PHONO PLUG**.

**RECEIVER** Most accurately a combined amplifier and radio tuner, but also sometimes used to mean a tuner alone.

**RECORD** As a noun, the common British term for a disc recording, and as a verb, the act of making a recording.

**RECORD DECK** A complete record playing unit (but without amplifier or loudspeakers), comprising a motor-driven turntable mounted on a plinth along with a pick-up arm and sometimes with a removable or hinged lid. Although record decks are conventionally sold complete with a pick-up arm, the quoted price for a deck may not always include a pick-up cartridge.

**RECORD PLAYER** A record deck complete with built-in amplifier and loudspeaker(s) – not usually regarded as hi-fi.

**REEL-TO-REEL TAPE DECK** Also called an open-reel deck. Handles only open reels of 6.3 mm ( $\frac{1}{4}$  in) wide tape, the tape running from one reel to the other.

**RIAA** Abbreviation of Record Industry Association of America. Commonly refers to gramophone record equalisation characteristic.

**RM** Regular matrix; a Japanese matrix technique on which **QS** is based. See **MATRIX SYSTEM**.

**RMS POWER** In practice virtually equivalent to Average Output Power and Continuous Sine Wave Power. Strictly, power calculated using the Root Mean Square of an AC voltage, but most realistically regarded as the effective average power in an AC supply (which, by virtue of its sine wave character, continually varies between a maximum, which is above the rms value, and zero). The most useful, and now most common, audio power measurement.

**RUMBLE** Very low frequency unwanted sounds, usually from a record deck, and caused usually by mechanical vibrations in the deck motor or bearings reaching the pick-up cartridge. Zero or no rumble at all, is hard to achieve by design, but a very low frequency filter (a rumble filter) is often provided on an amplifier to cut out what remains.

**SCREENED LEAD OR CABLE** A special type of electrical connecting wire used to carry low level electrical sound signals with low loss and freedom from interference caused by outside sources (such as the mains wiring of a house). At least one central metal core is surrounded, first by an insulating layer and then by a metal braid. The braid is earthed by connection to the outer metal casing of a plug or socket, while the, or each, central core connects with a central pin of the plug or socket. See also COAXIAL LEAD OR CABLE.

**SEALED CABINET** See INFINITE BAFFLE.

**SENSITIVITY** Measure of signal strength required to actuate amplifier, tuner, etc, for a specified output. The lower the input, the higher the sensitivity of the equipment will need to be.

**SIMULCAST** Technique for providing television with stereo sound; a TV station joins forces with an FM stereo radio station to broadcast simultaneously vision and stereo sound.

**SOLID-STATE** Circuit or equipment employing transistors and integrated circuits (ICs) instead of the old thermionic valve.

**SQ** Another matrixing technique, developed by CBS in America. Used by EMI and CBS in UK.

**SQUAWKER** Term little now used to denote a middle range loudspeaker unit.

**STEREO** Short for Stereophonic, meaning literally 'solid sound', but in practice generally used to mean two-channel sound.

**SURROUND SOUND** The term used to describe a reproduction system

(inevitably with more than two loudspeakers) that surrounds the listener with sound. Not truly synonymous with quadraphonics, or four-channel sound, but often incorrectly used in that way.

**TAPE** Plastic tape with a magnetic coating, on which recordings are made. Stored either on open reels or in cassettes or in cartridges.

**TAPE DECK** Comparable to a record deck, in that it includes all the mechanics and electronics necessary to record and play back tapes when connected to an amplifier and loudspeakers.

**TAPE RECORDER** A tape deck complete with **AMPLIFIER** and **LOUD-SPEAKER(S)**. More likely to be hi-fi than a record player, but the incorporation of an amplifier and speaker(s) tends to be a waste of money if the recorder is always to be used in conjunction with a hi-fi amplifier and loudspeakers and with its own built-in amplifier and loudspeaker(s) switched off.

**TRANSDUCER** Any piece of equipment which converts sound into electrical energy or *vice versa*, commonly used to denote a loudspeaker unit or pick-up cartridge.

**TREBLE** High frequency sound.

**TUNER** An electronic circuit, usually in a decorative case with external controls, which converts radio signals received via an aerial into electrical sound signals for amplification.

**TUNER-AMPLIFIER** Sometimes called a **RECEIVER**. A combined radio tuner and amplifier.

**TURNTABLE** A motor and a circular, heavy metal platter, on which a gramophone record is rotated by the motor. Sometimes mounted on a plinth and sometimes with a lid, but usually without a pick-up arm. See **RECORD DECK**.

**TWEETER** Small loudspeaker unit which handles only high frequencies.

**UD-4** A special **MATRIX** and **MULTIPLEX** combination, due to Duane Cooper, University of Illinois, and Nippon-Columbia in Japan. In some respects similar to the **AMBISONIC** system.

**VCR** Video Cassette Recorder, which records both sound and vision on tape in a cassette, for reproduction via a television set. In Europe,

used domestically, the term VCR is most likely to mean a machine of the type designed by Philips.

**WATT** Technically, a unit of power obtained by multiplying the amps of current flowing in a circuit by the voltage driving them. The most important hi-fi usage is in defining the power output of an amplifier and the power handling capability of a loudspeaker. Because amplifiers and loudspeakers handle alternating current (AC), rather than direct current (DC), it is necessary to average out the power to get a meaningful figure. The most commonly encountered (and most realistic) averaging technique is rms (root mean square) but 'average output power' and 'continuous sine wave power' mean more or less the same thing. Distrust wattage rating expressed as 'maximum', 'instantaneous', 'peak' or 'music power'.

**WOOFER** Loudspeaker unit that handles only bass frequencies.

**WOW** See also FLUTTER. Audible effect of slow changes in running speed of a record or tape deck. Wow variations are slower than flutter variations.

### Further reading

For anyone who would like to know more about hi-fi, the following books will be of interest :

John Borwick, *Living with Hi-Fi* (General Gramophone Publications, 1972, 80p)

Herman Burstein, *Questions and Answers about Tape Recording* (Foulsham, 1975, £2.05)

John Crabbe, *Hi-Fi in the Home* (Blandford Press, 1972, £2.00)

John Earl, *Tuners and Amplifiers; Improving your Hi-Fi; Pickups and Loudspeakers* (Fountain Press, 1970, £2.00; 1973, £3.00 and 1971, £3.00 respectively)

H.W. Hellyer, *Tape Recorders* (Fountain Press, 1970, £3.00)

### Test records

*The Enjoyment of Stereo*, EMI (SEOM 6)

*Hi-Fi Sound Stereo Test Record* (HFS 75) Haymarket Press Group

*An Audio Obstacle Course* (Shure TTR 101) Shure Electronics

### Test cassette

BIB Hi-fi Stereo Test Cassette (recorded for BIB sales by the Decca Record Co. Ltd)





---

# Index

*(Bold numerals indicate definition in Glossary)*

---

- Accessories, 105, 117  
Acoustic(s), 81, 99, 117; feedback, 95  
Adjustable voltage tapping, 117  
Adjustment, mains, 16; speed, 116  
Advice, skilled, 11  
Aerial, 14, 15, 16, 33, 67, 70, 71, 72-79, **123**; cable, coaxial, 75, 78; connection, 33; contractor, 72-73, 78; dipole, 74; directional, 69, 77, 78; elaborate, 76-77; external, 79; ferrite rod, 79; fitter, 116; FM, 74, 76, 79; for AM, 79; input, 33, 72; installation, 73, 78-79; multi-element, 77, 78; plug, coaxial, 17; position, 78; radio, 78; receiving, 69; signals, 79; socket, 33, 71, 75; transmitting, 69; TV, 78; VHF, 69; whip, 75  
Agfa, 47  
Alcohol, isopropyl, 47, 101, 102  
Alternating current, 28  
AM, 68, 69, 71, 79, **123**; aerials for, 79; detector, 68; interference, 79; receiver, 68; reception, 33  
Ambience, 112, **123**  
Ambiophony, **123**  
Ambisonic, **123**  
Amplifier, 11, 12, 14, 15, 16, 18, 21, 23, 25, 27-34, 41, 42, 51, 54, 55, 61, 72, 80, 81, 82, 85, 86, 94, 95, 96, 97, 98, 99, 108, 111, 115, 116, 117, 119, 121, 122, **123**; choice of, 28-29; combined tuner and, 15, 27; external power, 54; input sockets, 17; integrated, **127**; low power, 17, power, 54, **129**; power rating, 18; pre-, **130**; transistor, 27; tuner-, 14, 16, 27, 33, 115, 116, **132**; valve, 27  
Amplitude modulation (AM), 68, 69, 71, 79, **123**  
Arm, cantilever, 40, 41, 101; fitted, 40; fixed pivot, 39, 40; parallel tracking, 39; pick-up, 40, 42, 43, 107, 116, **129**; tangential tracking, 39; tone, *see* Pick-up arm, **129**  
Audio, cable, 120; centre, 14; chain, 80; channel, 113; equipment, 82, 112, 114; information and advice, 10; quality, 13, 46, 50, 51, 52, 57, 79, 116; signals, 30, 68, 82, 89, 120; tape recorder, 48; text books and magazines, 10; -video, 113  
Audible range, 30  
Automatic level control, 53; Noise Reduction System (ANRS), 61, 64; switch, 28; tape cleaners, 47  
Auto-reverse, 107  
Auxiliary equipment, 32, 108; input, 33, 54; socket, 54, 108; source, 31, 32  
Average output power, 28, *see* RMS power, **130-131**  
Baffle, infinite, 83, 84, 85, **127**  
Balance, 92, 121; control, 99; test, 98, 99; testing, **124**  
Bands, wave, 68, 69, 79, 123; VHF, 70, 127  
BASF, 47  
Bass, 33, 34, 81, 83, 86, 100, 117, **124**; boost control, 81; mix, 83; reflex cabinet, 83, 84; roar, 95; rumbles, 20; speaker, 86  
BBC, 67, 75, 77, 78; and IBA Engineering & Information Departments, 67  
Belt drive, 43  
Bias, 65, **124**  
Binaural, **124**; recording, 21  
Boost, 33, 60, 61, 80, 86, 126, 129, **130**; control, bass, 81  
Box, juke, 86; junction, 79, 112  
'Breathing' sound, 61  
Broadcast, radio, 22; stereo, 26; technology, 26  
British mains voltage, 117; standards, 33, 125  
'Building block', 14, 15, 31  
Cabinet, bass reflex, 83, 84; loudspeaker, 26, 81, 86, 87, 90; sealed, 83, 84, 85, *see* Infinite baffle, **127**  
Cable, audio, 120; coaxial, **124**; coaxial aerial, 75, 78; loudspeaker connection, 120; main, 120, 127; screened, **131**

## Index

- Cantilever arm, 40, 41, 101  
Capability, stereo, 67  
Capacitance effect, 94, **124**  
Capacitor cartridge, 41  
Capstan, 53  
Carbon tetrachloride, 47, 102  
Cartridge, 43, 105, **124**; capacitor, 41; ceramic, 31, 41, 42; crystal, 31, 41; gramophone, 31, 32, 95, 106; magnetic, 31, 32, 40, 41; pick-up, 40, 41, 42; player, 105; tape, 106; 8-track, 106, 107  
Cassette, 13, 14, 16, 26, 52, 56-66, 104, 107, 116; Compact, 13, 56, 57, 59, 106; deck, 14, 15, 16, **124**; Dolbyised, 61; machine, 26, 58, 61, 105, 116; Musi-, 13, 57, 59, 60, 66; Philips, 13, 56, 57, 106, 113; pre-recorded, 60; recorder, 46, 57, 61, 64, 66, 104; recorder, video (VCR), **132**; system, 56, 57, 113; tape, 14, 15, 46, 56, 64, 113; test, 97, 98, 99, 121  
CD-4, **124**  
Centimetres per second (cm/s), 51, 58, **124**  
Central conductors, 120  
Centre-front sound, 41  
Ceramic cartridge, 31, 41, 42; inputs, 31  
Chain, audio, 80; Hi-fi, 99  
Channel(s), audio, 113; discrete, 24; four-, 110, 112, 115; identification, 98; multi-, 24; single sound, 24; stereo, 22, 112; three, 24; two-, 22, 24, 110  
Charge, electrostatic, 103  
Chassis loudspeaker, 82, 83  
Cheap equipment, 51, 57, 58, 61, 66  
Choice of amplifier, 28-29  
Chrome oxide tape, 65  
Circuit, short-, 28  
Circuitry, electronic, 54, 60, 70, 71, 129, 130; radio, 33; receiver, 68  
Circuits, integrated (ICS), 131  
Cleaning gadgets, record, 103; kit, hi-fi, 47; solvent, 46; stylus, 102; tape, 47  
Clipping, 85  
Cm/s, 51, 58, **124**  
Coaxial aerial cable, 75, 78; plug, 17; lead or cable, **124**; plug, **124**; socket, 33  
Coil, and cone unit, moving, 86; electric, 129; loudspeaker, 31, 85; unit, moving, 89  
Colouration, **125**  
Combined tuner and amplifier, 15, 27  
Compact cassette, 13, 56, 57, 59, 106  
Comparator, 12  
Compatibility, mono-, 26, 58, 69, 70, **128**  
Compatible, **125**  
Compliance, 36, **125**  
Condenser microphone, 104  
Conductors, central, 120  
Cone, loudspeaker, 82, 83, 84, 85, 99; unit, moving coil and, 86  
Connecting leads and plugs, 17, 94, 117, 119, 120, 121  
Connection, aerial, 33; cables, loudspeaker, 120; earth, 16, 120; fault, 119, 121; left-right, 97; line, 54, 55, **128**; positive-negative, 100; screening, 120; terminal, 33  
Consumer laws, 11  
Contacts, switch, 120  
Continental equipment, 32; transmission, 67  
Continuous sine-wave power, 28, *see* RMS power, **130-131**  
Control, amplifier volume, 30, 55; automatic level, 53; balance, 99; bass boost, 81; level, 53; 'Magic Eye' level, 53; 'presence', 33; sensitivity, 121; tone, 33, 34, 61, 81, 119, 124; unit, *see* Pre-amp (-lifier), **130**; volume, 31, 33, 119  
Copyright laws, 116  
Correct fuse rating, 118  
Correction, frequency, 32  
Coupling, direct, 30, **126**  
'Crossover' unit, 87  
Crystal cartridge, 31, 41; inputs, 31; microphone, 104; pick-up, 41  
CTC, 47, 102  
Current, alternating, 28; direct, 28, 30; surge, 30  
Cutting stylus, 37, 39, 40  
Cycles-per-second, 30  
Cylinder, 36, 39  
Damage, internal, 28; stylus, 102  
dbx system, 61, 64  
'Dead' time, 58  
Decibel (dB), 50, 72, **125**  
Deck, cassette, 14, 15, 16, 124; Open-reel tape, *see* Reel-to-reel tape deck, **130**; record, 14, 15, 16, 31, 32, 40, 42, 43, 68, 80, 94, 95, 96, 97, 98, 107, 116, 117, **130**; reel-to-reel tape, 15, **130**; tape, 12, 16, 32, 33, 53, 54, 68, 80, 94, 95, 96, 97, 98, 108, 116, 117, 121, **132**

- Decode, **125**  
 Decoding function, 70, 110  
 De-magnetising, 101  
 Departments, BBC and IBA Engineering & Information, 67  
 Detector, AM, 68  
 Deutscher Industrie Normen (DIN), 32, **125**  
 Dial meter, 53; radio tuning, 34  
 Diamond, 41, 101  
 Diaphragm, loudspeaker, 36, 88, 89  
 Difference signal, 111, 112  
 Dimmer switches, thyristor controlled, 79  
 DIN plug, 16, 17, 32, 33, 54, 96, **125**; socket, 16, 17, 33  
 Dipole, 74, 75, 76, 77, 78, **125**  
 Direct, coupling, 30, **125**; current, 28, 30; drive, 43, **126**  
 Directional aerial, 69, 77, 78; speakers, 94  
 Directors, 76, 77  
 Dirty, records, 103; stylus, 102  
 Disc, 13, 14, 15, 16, 22, 36, 37, 39, 42, 43, 44, 57, 66, 80, 107, 113, 116, 119, 121, 126; four-channel, 112; pre-recorded, 112; quadraphonic, 112; reproduction, 122; system, video, 112, test, 97, 98, 99, 100, 121, 124  
 Discrete system, **126**  
 Distortion, 50, 59, 64, 68, 80, **126**  
 DNL, 64; Philips, 61  
 Dolby, 60, 62-63, 65, 117; system, 60, 61, 62-63, 64, 65, **126**  
 Domestic machines, 50, 51, 53, 54, 57  
 Double head, 59  
 Drive, belt, 43; direct, 43, **126**; idler, 43, **127**; rim, 43  
 Dropout, 48, 51, **126**  
 Dummy head, 20, 21, 37, 110, **126**  
 Dynamic microphone, 104; noise limiter, Philips, 61  
  
 Earth connections, 16, 120; terminals, 120  
 Echo, 49  
 Edison, Thomas Alva, 9, 35, 39, 44  
 Editing, 104, 116  
 Effect, capacitance, 94, **124**  
 Efficiency, loudspeaker, 85  
 Elaborate aerial, 76-77  
 Electrical circuitry, 70; energy, 88; input, 85; power output, 29; resistance, 95; signals, 44, 45, 87, 88, 89, 95  
 Electronic circuitry, 54, 60, 71, 129, 130; gadgetry, 105; noise, 59  
  
 Electrostatic charge, 103; loudspeaker, 89  
 Element, director, 76; piezo-electric, 41; reflector, 76  
 Encode, 64, 110, **126**  
 Energy, electrical, 88  
 Engine interference, 105  
 Enthusiasts, Hi-fi, 70, 81, 84, 108, 125  
 Equalisation, 65, **126**  
 Equipment, audio, 82, 112, 114; auxiliary, 32, 108; budget, 13, 25; cheap, 51, 57, 58, 61, 66; continental, 32; expensive, 9, 10, 53, 54; Hi-fi, 9, 10, 47, 100, 101, 117; judging, 50; video reproduction, 112  
 Erase head, 51  
 Examination service, microscope, 102, 121  
 Exotic sounds, 112  
 Expensive equipment, 9, 10, 53, 54  
 External aerial, 79; power amplifier, 54; source, 119; tuner, 108  
  
 Facility, Dolby, 65, 117; Stereo radio, 109  
 Fault, connection, 119, 121; intermittent, 120; screened lead, 120  
 Feedback, acoustic, 95  
 Ferrite rod, 33, 79  
 Filter, 34, 61  
 Fitted arm, 40  
 Fitter, aerial, 116  
 Fixed pivot arm, 39, 40  
 Flat signals, **126**  
 Flutter, 43, 49, 50, **126**  
 FM, 16, 68, 69, 70, 71, 73, 74, 76, **127**; aerial, 74, 76, 79; radio, 33, 69, 74; receiver, 68, 70; socket, 33  
 Four-channel, 110, 115; discs, 112; sound, 127  
 Frequency, 30, 33, 46, 59, 60, 61, 65, 68, 74, 83, 86, 87, 94, **127**; correction, 32; modulation (FM), 16, 68, 69, 70, 71, 73, 74, 76, **127**; radiations, 120; response, 32, 64; very high (VHF), 16, 69, 71, 73, 74, 75, 79  
 Friction, 42  
 Function, decoding, 70  
 Fuse, 28, 118; mains, 16; rating, correct, 118; safety, 119  
 Future of hi-fi, 112  
  
 Gadgets, 107, 108; electronic, 105; record cleaning, 103  
 Grading, Up-, 24

## Index

- Gramophone, 9, 31, 35, 39, 41, 43; acoustic, 129; cartridge, 31, 32, 95, 106; parallel tracker, 40; pick-up, 30; records, 32, 35, 36; stylus, 100, 101, 121; technology, 35, 43; turntable, 30
- Grooves, 36, 37, 38, 40, 41, 95
- Guarantees, 11
- Haffer, David, 111, 112, 125
- Half track, 51, 52
- Handling, power, **129**
- Head, double, 59; dummy, 37, 110, **125**; erase, 51; magnetic, 44; phone, 17, 20, 109, 110, 124, 126; playback, 31, 44, 45, 46, 47, 48, 51, 56, 59, 65, 106, 124; record, 44, 45, 46, 47, 48, 51, 56, 65, 113, 124; single, 59; tape, 45, 46, 47, 56, 64, 100, 101, 105, 121
- Hertz (Hz), 30, 86, 94, 117, 120, **127**
- Hi-fi boom, 91; chain, 80, 99; chore, 103; cleaning kit, 47; enthusiasts, 27, 70, 81, 84, 107, 108, 125; equipment, 9, 10, 47, 100, 101, 102, 117; future of, 112; market, 45; mono, 19, 25; purists, 40; rig, 108, 109; set-up, 14, 53, 54; test, ultimate, 49
- High frequency, unwanted, 31; signal, 65; units, 30; VHF, 16, 69, 71, 73, 74, 75, 79
- High performance tape, low noise, 64; pitched sound, 20, 60; speeds, 59
- Hiss, 34, 46, 59, 60, 61, 64, 70, 71, 72, 76, 101, 119, 128
- Hum, 94, 119, 120, **127**; loop, 120
- Hz, 30, 86, 94, 117, 120, **127**
- IBA, 67, 75, 77
- ICS, 131
- Identification channel, 98
- Idler drive, 43, **127**
- Image, stereo, 22, 26, 91, 94, 95, 98
- In-car entertainment, 105, 106
- Inches per second, 51; *see* IPS
- Infinite baffle, 83, 84, 85, **127**
- Information Departments, BBC and IBA Engineering and, 67
- In phase, 38, 41, 121
- Input, 31, 42, 119, 121, 122, **127**; aerial, 72; amplifier, 17; auxiliary, 33, 54; ceramic, 31; crystal, 31; electrical, 85; magnetic, 31, 42; phono, 31, 32, 41; record, 33; sensitivity, 31, 32; signals, 31; socket, 17, 33, 54; tape, 33
- Inspection service, microscope, 102, 121
- Installation, aerial, 73, 78-79
- Instruction book, 64, 65, 96, 104, 118, 119, 121
- Integrated amplifier, **127**; circuits (ICS), 131
- Interference, 68, 74, 131; AM, 79; engine, 105; suppressed, 79
- Intermittent fault, 120
- Internal damage, 28
- Inversion (of speakers), left/right, 96
- Ioniser, 103
- Ips, 51, 58, **127**
- Iron oxide magnetic tape, 65
- Isopropyl alcohol, 47, 101, 102
- Jack plug, 17, 54, **127**
- Judging equipment, 50
- Juke box, 86
- Junction box, 79, 112
- KHz, 86
- Labyrinth loudspeaker, 83, **127**
- Law, copyright, 116
- Leads and plugs, connecting, 94, 117, 119, 120, 121; coaxial, **124**; faulty screened, 120; loudspeaker, **128**; mains power, 120; screened, **131**; unearthed, 120
- Left-right connections, 97; inversion (of speakers), 96; routing, 121
- Level control, automatic, 53; 'Magic Eye', 53; meter, record, 64; recording, 53; sound, 94, 119
- Lift, manual, 107; pick-up, 108
- Line connection, 54, 55, **128**
- Line output socket, 54
- Link-up, TV, 108
- Live recording, 104, 116
- Loop, hum, 120
- Loudspeaker(s), 12, 14, 15, 16, 17, 18, 19, 20, 21, 22, 23, 24, 26, 27, 28, 29, 30, 38, 43, 49, 54, 55, 59, 68, 76, 80-90, 91, 92, 93, 94, 95, 97, 98, 99, 100, 109, 110, 111, 112, 117, 119, 120, **128**; cabinet, 81, 86, 87, 90; chassis, 82, 83; coil, 31, 85; cone, 99; connection cables, 120; diaphragm, 88, 89; efficiency, 85; electrostatic, 89; labyrinth, 83, **127**; leads, **128**; moving coil, 82; muting switch, 119; output, 28, 31; playback, 22, 23; plug, DIN, 17; 'raw', 82, 83; socket, DIN, 17; source, 24; transmission line, 83

- Low-fi, 41  
 Low frequency, unwanted, 31; noise, high performance tape, 64; speeds, 59
- Machine, cassette, 26, 58, 61, 116; cheap, 51, 61; domestic, 50, 51, 53, 54, 57; open reel, 51, 52, 58; play-back, 57; record, 57; reel-to-reel, 51, 57, 58, 64; triple head, 51
- 'Magic Eye' level control, 53
- Magnetic cartridge, 31, 32, 40, 41; head, 44; input, 31, 42; strip, 44; tape, 44, 46, 65
- Mains adjustment, 16; cable, 120, 127; fuse, 16; plug, 120; power, 28; power leads, 120; point, 118; rating, 117; voltages, 108, 117
- Manual lift, 107
- Marconi, Guglielmo, 73
- Market, hi-fi, 45; research, 91
- Material, test, 96, 98
- Matrix, Regular (RM), **130**; system, **128**
- Mechanism, Servo-control, 40; tape transport, 65
- Meter, dial, 53; peak programme (PPM), 53, 64; record level, 64; signal strength, 78
- Methylated spirits, 47, 102
- Microphone, 17, 20, 21, 22, 23, 24, 25, 49, 54, 104, 124; condenser, 104; crystal, 104; dynamic, 104; ribbon, 104
- Microscope inspection service, 102, 121
- Microvolt, **72, 128**
- Mid-range frequencies, 33; unit, 86, 87
- Millivolt, 31, 54
- Mix, bass, 83; treble, 83
- Modulation, amplitude (AM), 68, 69, 71, 79, **123**; frequency (FM), 16, 68, 69, 70, 71, 73, 74, 76, **127**
- Monaural, 19, *see* Mono, **128**
- Monitor, 51
- Mono, 14, 17, 19, 24, 33, 51, 104, 108, 115, 116, **128**; compatibility, 26, 58, 69, 70, **128**; deficiencies of, 24; FM receiver, 70; head, 58; hi-fi, 19, 25; -phonic, 19, *see* Mono, **128**; recorder, 51, 65; recording, 25, 36; signal, 58; sound, 25, 26; system, 24, 25, 26; transmission, 26
- Motor, 53, 65
- Moving coil loudspeaker, 82; and cone unit, 86, 88, 89
- Muffled sound, 46
- Multi-channel sound, 24, **128**
- Multi-element aerial, 77, 78
- Multiplex, 70, **128**
- Musicassette, 13, 57, 59, 60, 66
- Music centre, 14; recording, 116
- Muting switch, loudspeaker, 119
- Necessary accessories, 117
- Needle, 36, 40
- Noise, **128**; electronic, 59; frequency, 59; Limiter, Philips Dynamic, 61; reduction system, 60, 61, 62-63, 117, **128**
- Off-pitch recording, 116
- Omni-directional speakers, 94, **128**
- One-channel system, 19
- On/off switch, 33
- Open reel, 56; machine, 51, 52, 58; tape, 58; tape deck, *see* Reel-to-reel; tape deck, **130**; tape recorder, 45
- Open spool, 26
- Out-of-phase, 38, 82, 83, 121
- Output, 12, 14, 28, 34, **129**; loud-speaker, 16, 31, 96, 97; power, 28, 29, **129**; power, amplifier, 17; power, average, 28, *see* RMS power, **130-131**; protection, 28; signal, 32; socket, 16, 54, 96, 97, 108; terminal, 111; transformer, 27, 30; volume, 46; wires, loudspeaker, 28
- Overdubbing, 104
- Overload, 31, 32, 64, 85
- Parallel-track, 39, 40
- Particle, tape, 59, 65
- Patent, Marconi's, 73
- Peak programme meter (PPM), 53, 64
- Performance, 72
- Phase, 88, **129**; In-, 38, 41, 121; Out-of-, 38, 82, 83, 121
- Phasing test, 98, 99
- Philips, 13, 57, 58, 59, 133; Cassette, 13, 56, 57, 106, 113; DNL (Dynamic Noise Limiter), 61; video cassette system, 113
- Phonograph, 35
- Phono input, 31, 32, 41; plug, 17, 32, 54, 96, **129**; socket, 17; source, 34
- Pick-up arm, 40, 42, 43, 107, 116, **129**; cartridge, 40, 41, 42; crystal, 41; gramophone, 30; lift, 108; stylus, 37, 40, 121
- Picture tape recorder, television, 48
- Piezo-electric element, 41
- Pivot arm, fixed, 39, 40

## Index

- Platter, 42, 116, **129**
- Playback, 20, 22, 34, 37, 38, 44, 46, 54, 60, 61, 64, 65, 97, 110, 126; head, 31, 44, 45, 46, 47, 48, 51, 56, 59, 65, 106, 124; loudspeaker, 22, 23; machine, 57; stylus, 39; system, 61
- Player, cartridge, 105; cassette, 105; disc, 122; record, 35, 103, 112, 119, **130**; videotape, 112
- Playing time, 58
- Plugs and leads, connecting, 117, 120, 121; coaxial, **124**; coaxial aerial, 17; DIN, 16, 17, 32, 33, 54, 96; Jack, 17, 54, **127**; mains, 120; phono, 17, 32, 54, 96, **129**; RCA, 32, *see* Phono plug, **129**
- Point, mains power, 118
- Polarisation, 75
- Position, aerial, 78
- Positive-negative connections, 100; output terminal, 111
- Power, 14, 16, 28, 30; amplifier, 54, **129**; average output, 28, *see* RMS power, **130-131**; Continuous sine-wave, 28, *see* RMS power, **130-131**; handling, **129**; mains, 28, 120; output, 27, 28, 29, **129**; point, mains, 118; rating, 18, 28, 85, **129**; RMS, **130-131**; watts, 28
- PPM (peak programme meter), 53, 64
- Pre-amp (-lifier), **130**
- Pre-recorded cassette, 60; disc, 112; material, 14
- Presence control, 33
- Problems, 11, 59, 118-122
- Programme, gramophone, 33; signal, 60; source, 16
- Protection, output, 28
- Pulleys, 65
- Purists, hi-fi, 40
- Quad, **130**; speakers, 89
- Quadradiac, 124
- Quadraphonic, 24, 110, 111, 115; disc, 112; sound, 113, **130**
- Quality, audio, 13, 46, 50, 51, 52, 57, 79, 116; recording, 51; signal, 55
- Quarter track, 51, 52
- Quiet signal, 61
- qs, **130**
- Radiations, low frequency, 120
- Radio, 9, 19, 25, 26, 67-79, 116, 119, 121, 122; aerial, 78; broadcast, 22; circuitry, 33; facility, stereo, 109; FM, 33, 69, 74; set, 79; signal, 74, 75, 123; stereo, 24, 67, 69, 109, 115; transmission, 24, 67, 68, 69, 109, 124; tuner, 14, 15, 16, 32, 54, 67, 78, 97, 105, 108, 116, 119; waves, 127
- Range, audible, 30
- Rating, correct fuse, 118; mains, 117; power, 28, 85, **129**; wattage, 28, 29
- 'Raw' loudspeaker, 82, 83
- RCA plug, 32, *see* Phono plug, **129**
- Receiver, 16, 27, 28, 31, 33, 34, 68, 69, 70, 71, 73, 115, **130**
- Receiving aerial, 69
- Reception, 16, 33, 67, 68, 69, 73, 75, 76, 79
- Record, 9, 13, 32, 34, 35, 36, 37, 40, 43, 44, 60, 61, 102, 103, 105, 107, 108, 114, 116, 118, **130**; cleaning gadgets, 103; deck, 14, 15, 16, 31, 32, 40, 42, 43, 68, 80, 94, 95, 96, 97, 98, 107, 116, 117, **130**; dirty, 103; groove, 36, 40, 41, 95; head, 44, 45, 46, 47, 48, 51, 56, 65; Industry Association of America (RIAA), **130**; input, 33; level meter, 64; player, 14, 26, 35, 103, 112, 119, **130**; signals, 68; playing systems, 105; source, 34; turntable, 54; undulation, 36
- Recorded voice, 48, 49
- Recorder, 26, 53, 55; cassette, 46, 57, 61, 64, 66, 104; mono, 51, 65; open reel tape, 46; reel-to-reel tape, 14, 15, 46, 104; tape, 21, 22, 23, 25, 26, 30, 31, 32, 34, 45-54, 56, 57, 72, 96, 97, 104, 112, **132**; television picture tape, 48; tv, 44; video cassette (vcr), **132**; videotape, 48, 112, 113
- Recording, 20, 22, 25, 36, 46, 128; binaural, 21; Dolby, 60; dummy head, 21; heads, 113, 124; level, 53; live, 104, 116; music, 116; off-pitch, 116; quality, 51; reel-to-reel, 97; standard, 26; stereo, 23, 95; tape, 13, 34, 44, 45; technique, 22; time, 113
- Reel, open, 56; take-off, 46; take-up, 46
- Reel-to-reel machine, 51, 57, 58, 64, 104; recording, 97; tape, 59, 66, 98, 116; tape deck, 15, **130**; tape recorder, 14, 15, 46
- Reflector, 76, 77, 78
- Regular matrix (RM), **130**
- Repair, 11, 56, 122
- Replacement, stylus, 41, 42
- Reproduction, 22, 24, 64, 122; equipment, audio, 112; video, 112

- Research, market, 91  
 Resistance, electrical, 95  
 Response, frequency, 32, 64  
 Results, sub-standard, 64, 118-122  
 Reverse, Auto-, 107  
 RIAA, 32, **130**  
 Ribbon microphone, 104  
 Rig, hi-fi, 108, 109  
 Right/left inversion (of speakers), 96  
 Rim drive, 43; turntable, 43  
 RM, **130**  
 RMS, 28, 29; power, **130-131**  
 Roar, bass, 95  
 Rod, ferrite, 33, 40  
 Root mean square (RMS), 28, **130-131**  
 Routing, left/right, 121  
 Rules, electronic, 79  
 Rumble, 20, 43, **131**; zero, 43
- Safety fuse, 119  
 Screened lead or cable, **131**; faulty, 120  
 Screening connection, 120  
 Sealed cabinet, 83, 84, 85, *see* Infinite baffle, **127**  
 Seat, stereo, 92, 98  
 Sensitive receiver, 69  
 Sensitivity, 32, 70, 71, 72, 116, **131**; control, 121; Input, 31, 32  
 Service, 12, 56; microscope inspection, 102, 121  
 Servo-control mechanism, 40  
 Set, radio, 79; tv, 78, 108, 109  
 Set-up, hi-fi, 53, 54; mono, 25; stereo, 25, 92-94  
 Short-circuit, 28  
 Signal, 38, 54, 55, 65, 69, 70, 73, 76, 77, 80, 87, 88, 111, 112; aerial, 79; audio, 30, 68, 82, 89, 120; difference, 111, 112; electrical, 44, 45, 88, 89, 95; flat, **126**; in-phase, 38; input, 31; mono, 58; out-of-phase, 38; output, 32; overload, 64; quiet, 61; radio, 74, 75, 123; record, 68; sound, 108; stereo, 41, 71; strength meter, 78; tape, 68; tv, 113, 123; undistorted, 59; undulation, 37  
 Simulcast, 108, 109, **131**  
 Sine-wave power, continuous, 28, *see* RMS power, **130-131**  
 Single head, 59  
 Single sound channel, 24  
 Skilled advice, 11  
 Socket(s), 14, 16, 79, 121; aerial, 33, 71, 75; amplifier input, 17; auxiliary, 54, 108; coaxial, 33; DIN, 16, 17, 33; FM, 33; output, 16, 54, 96, 97, 108; phono, 17; plugs and, 33; tape input, 54  
 Solid-state, **131**  
 Solvent, cleaning, 46; commercial, 47, 101  
 Sony, 47; video cassette system, 113  
 Sound(s), 'breathing', 61; centre-front, 41; channel, 20, 24; exotic, 112; four-channel, **127**; high-pitched, 20, 60; in-phase, 41; level, 94, 119; muffled, 46; multi-channel, 24, **128**; quadraphonic, 113, **130**; signal, electrical, 87, 88, 89; source, 20; stereo, 110; surround, 14, 24, 110, 111, **131**; transistor, 30; tuner, tv, 108; two-channel, 22; valve, 30; waves, 80, 82, 83, 89  
 Source, auxiliary, 31; external, 119; loudspeaker, 24; mono, 26; phono, 34; programme, 16; record, 34; sound, 20; tape, 34  
 Spark gap transmitter, 73  
 Speaker(s), 17, 18, 115, 121; bass, 86; cone, 82, 83, 84, 85; directional, 94; electrical sound, 87; high-frequency, 86; Omni-directional, 94, **128**; output socket, 16, 96, 97; quad, 89  
 Specifications, technical, 50  
 Speed, adjustment, 116; tape, 51  
 Spindle, 57  
 Spool, 46, 50, 51; open, 26; take-off, 53, 56; take-up, 53, 56  
 SQ, **131**  
 Squawker, 86, **131**  
 Standard, recording, 26  
 Standards, British, 33, 125  
 Stereo, 14, 19, 24, 26, 33, 51, 72, 95, 104, 108, 115, 116, **131**; broadcast, 26; capability, 67; cassette, 26, 58; channels, 22; deck, 65; dummy head, 20; heads, 58; image, 22, 26, 91, 94, 95, 96, 98; radio, 67, 69, 115; receiver, 70; record, 37; recording, 23, 36, 95; reel-to-reel machine, 58; seat, 22, 92, 98, 99; set-up, 25, 92-94; signal, 41, 71; sound, 110; system, 22, 111; tracks, 58; transmission, 24, 69, 70, 109; true, 26; tuner, 70, tuner-amp, 14; two-channel, 112  
 Strip, magnetic, 44  
 Stylus, 36, 38, 40, 41, 95, 100, 101, 102, 103, 107, 108, 121; cleaning, 101; cost, 41; cutting, 37, 39, 40; damage, 102; dirty, 102; pick-up, 37, 40, 121; playback, 39; replacement, 41, 42

## Index

- Sub-standard results, 64, 118-122  
Super-8 cassette system, 56  
Super tweeter, 86  
Suppressed, interference, 79  
Surge, current, 30  
Surgical spirits, 47, 102  
Surround sound, 14, 24, 110, 111, **131**  
Switch, automatic, 28; contacts, 20;  
loudspeaker muting, 119; on/off,  
33; thyristor controlled dimmer, 79  
System, ANRS, 61, 64; Automatic Noise  
Reduction (ANRS), 61, 64; building  
block, 31; cassette, 57; dbx, 61, 64;  
discrete, **126**; DNL, 64, Dolby, 60,  
61, 62-63, 64, 65, **126**; matrix, **128**;  
mono, 24; mono-compatible, 70;  
multiplex, 70; noise reduction, 60,  
61, 64, **128**; one-channel, 19; Philips  
video cassette, 113; playback, 61;  
quadraphonic sound, 113; record  
playing, 105; Sony video cassette,  
113; stereo, 22, 111; Super-8 cassette,  
56; transformer, 88; two-channel,  
19; video disc, 112  
  
Tainter, 36, 44  
Take-off reel, 46; spool, 53, 56  
Take-up reel, 46; spool, 53, 56  
Tangential tracking arm, 39  
Tape(s), 22, 31, 32, 44-55, 58, 59, 60,  
61, 64, 65, 80, 102, 105, 113, 114,  
119, 121, 122, **132**; cartridge, 106;  
cassette, 15, 56, 64, 113; cheap, 47,  
48, 58; chrome oxide, 65; cleaners,  
47; deck, 12, 16, 32, 33, 53, 54, 68,  
80, 94, 95, 96, 97, 98, 108, 116, 117,  
121, **132**; deck, open reel, *see* Reel-  
to-reel tape deck, **130**; Reel-to-reel,  
15, **130**; drop-out, 51; head, 45, 46,  
47, 56, 64, 100, 101, 102, 105, 121;  
input, 33, 54; iron, 65; iron oxide,  
65; machine, 51, 53; magnetic, 46,  
65; open reel, 58; particle, 59, 65;  
recorder, 21, 22, 23, 25, 26, 30, 31,  
34, 45-54, 56, 57, 72, 96, 97, 104,  
112, **132**; recordings, 34, 44, 45;  
reel-to-reel, 59, 66, 98, 116; signals,  
68; socket, DIN, 33; source, 34;  
speed, 51; test, 97, 124; transport  
mechanism, 65  
Tapping, adjustable voltage, 117  
TDK, 47  
Technical advance, 60; advice, 11;  
expertise, 10; problems, 59; speci-  
fications, 50; terms, 10  
Technique, Hafler, 123; recording, 22  
Technology, 35, 39, 57; broadcast, 26;  
gramophone, 35, 43; tv, 112; video,  
113  
Telephone advice bureau, 11  
Television picture tape recorder, 48  
Terminal, connections, 33; earth, 120;  
positive output, 111  
Test, balance, 98, 99; cassette, 97, 98,  
99, 121; disc, 97, 98, 99, 100, 121,  
124; material, 96, 98; phasing, 98,  
99; tape, 97, 124; ultimate hi-fi, 49;  
voice, 49  
Testing, balance, **124**  
Tetrachloride, carbon, 47, 102  
Thermionic valve, 131  
Thyristor controlled dimmer switches,  
79  
Time, 'Dead', 58; playing, 58; record-  
ing, 113; 'total', 58  
Tip, diamond, 101  
Tone arm, *see* Pick-up arm, **129**; con-  
trol, 33, 34, 61, 81, 119, 124  
'Total' time, 58  
Track, cassette, 58; half, 51, 52; par-  
allel, 39; quarter, 51, 52; stereo, 58  
Tracking arm, parallel, 39; tangential,  
39  
Transducer, 88, **132**  
Transformer, 27, 117, 126; output, 27,  
30; systems, 88  
Transistor, 27, 131; amplifier, 27;  
power output, 27; sounds, 30  
Transmission, 73, 128; Continental,  
67; FM radio, 69; line loudspeaker,  
83; mono, 26; radio, 24, 67, 68, 69,  
109, 124; stereo, 24, 69, 70, 109; tv,  
109; wavelength, 24; 'wireless', 73  
Transmitter, 67, 69, 70, 73, 75, 76, 77,  
78; Spark gap, 73  
Transmitting aerial, 69  
Transport mechanism, tape, 65  
Treble, 33, 34, 81, **132**; mix, 83  
Triple head machine, 51  
True stereo, 26  
Tuner, 15, 67-72, 74, 75, 76, 78, 79,  
**132**; -amp(-lifier), 16, 27, 33, 115,  
116, **132**; external, 108; radio, 14,  
15, 16, 32, 54, 67, 78, 97, 105, 108,  
116, 119; stereo, 70; tv, 16, 32, 79,  
108  
Tuning dial, Radio, 34  
Turntable, 12, 40, 42, 72, 97, 103, 107,  
116, **132**; gramophone, 30; record,  
54; rim, 43  
tv, 74, 112, aerial, 78; link-up, 108;  
recorder, 44; set, 78, 108, 109;  
signal, 113, 123; technology, 112;  
transmission, 109; tuner, 16, 32, 79



- Tweeter, 86, 87, **132**; 'super', 86  
 Two-channel reproduction, 110;  
   sound, 22; stereo, 112; system, 19,  
   22, 24, 110  
 Ultimate hi-fi test, 49  
 Underload, 31, 32  
 Undistorted signal, 59  
 Undulations, 40; record, 36; signal, 37  
 Unearthed lead, 120  
 Unit, control, *see* Pre-amp(-lifier),  
   **130**, crossover, 87; mid-range, 86,  
   87; moving-coil, 89; moving coil  
   and cone, 86; high frequency, 30;  
   volume (vU), 53, 64  
 Up-grading, 24  
 Valve, 27; amplifier, 27; 'sounds', 30;  
   thermionic, 131  
 vcr, 113, **132**  
 vhf (very high frequency), 16, 69, 71,  
   73, 74, 75, 79; aerial, 69; bands, 70,  
   127; station, 74  
 Vibrations, 42, 95  
 Video, 48, 113; audio-, 113; cassette  
   recorder (vcr), 113, **132**; cassette  
   system, Philips, 113; Sony, 113; disc  
   system, 112; recorders, 113; repro-  
   duction equipment, 112; tape re-  
   corders, 48, 112; technology, 113  
 Vodka, 47, 102  
 Voice, recorded, 48, 49; test, 49  
 Volt, 28, 31; micro-, 72, **128**; milli-,  
   31, 54, **128**  
 Voltage, 16, 28; mains, 108, 117; tap-  
   ping, adjustable, 117  
 Volume, 68, 85, 86, 98, 99; control,  
   31, 33, 119; amplifier, 30, 55; out-  
   put, 46; unit (vU), 53, 64  
 Watt, 28, 29, 85, **133**  
 Wattage rating, 28, 29  
 Watts power, 28  
 Wavebands, 68, 69, 79, 123  
 Wavelength, 24, 33, 68, 70, 73, 74, 75,  
   83; transmission, 24  
 Waves, radio, 127; sound, 80, 82, 83,  
   89  
 Whip aerial, 75  
 'Wireless' transmission, 73  
 Wires, loudspeaker output, 28  
 Woofer, 86, 87, **133**  
 Wow, 43, 49, 50, **133**  
 Zonal, 47  
 Zero rumble, 43

## ABOUT THE AUTHOR

Adrian Hope writes for most of the hi-fi publications on the British market. He is also a regular contributor to *The Times*, *The Times Educational Supplement*, *New Scientist* and various specialist electronics magazines. Along with his passion for audio and video is an insatiable curiosity about scientific developments and inventions, both past and present; his articles on everything from making use of solar energy to choosing a pocket calculator are a popular feature of *She* magazine. Adrian Hope has also written *Why Didn't I Think of it First?*, a pot-pourri of crazy inventions patented over the last few hundred years.