

*Thrilling New Sounds—*

# HI GH FI DELITY

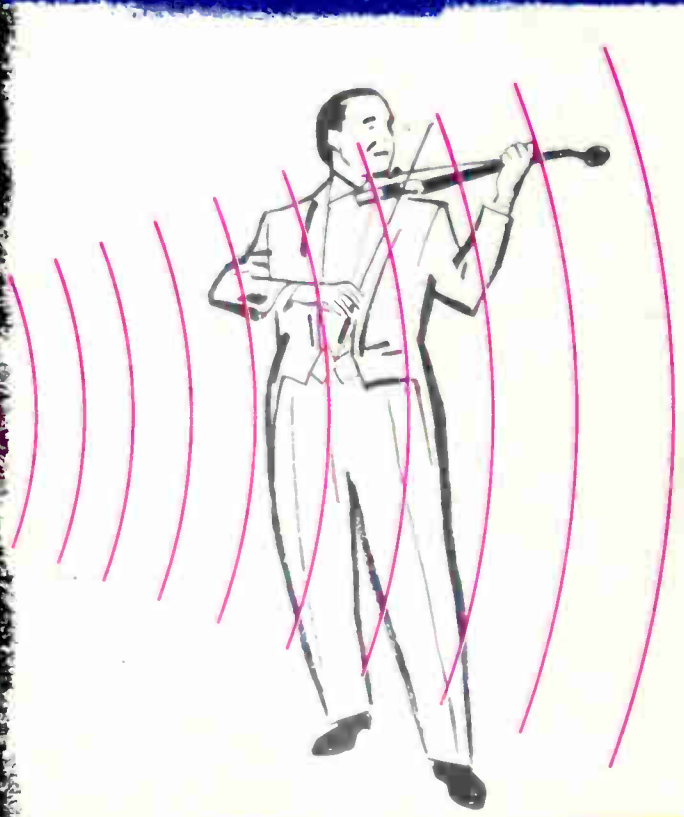

**What Is Hi-Fi?**  
**Installation Tricks**  
**Make Your Set for \$150**  
**Maintenance Instructions**

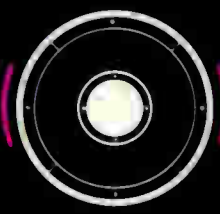
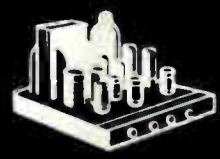
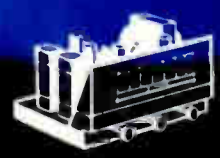

*Bring Musicians Into Your Home With Hi-Fi*



Music is made to come alive—with true-to-life sound reproduction at low cost. Now for the first time, here is an authoritative guide to truly inexpensive HIGH FIDELITY home music systems. In this book you will find a practical approach to the sound thrill of a lifetime. With the priceless combination of matched electronic components you have custom installed at home, HIGH FIDELITY will provide magnificent living music for your leisure hours of relaxation.

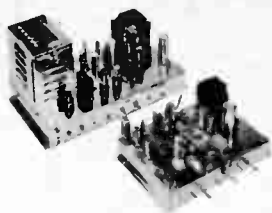

# HI GH FI DELITY

A new Trend Book showing you how to enjoy the ultimate in music at lowest cost.

Containing a brilliant foreword by famed orchestra leader Les Brown, this great new manual has 128 pages of informative, non-technical features.

Plus valuable information on maintaining tape recorders, connecting extension speakers, and building a collection of the finest recorded music.

With a few easy-to-use tools you can install a Hi Fi set equal to the best. Or build it yourself from the fine kits available by mail. No matter what your interests, this is your book of HIGH FIDELITY . . . The Thrilling New Sounds.

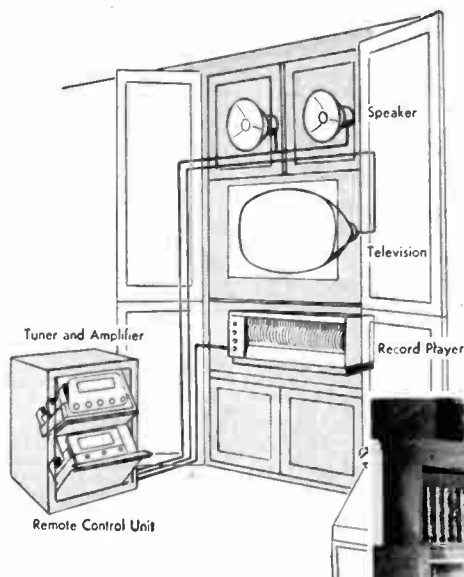

Dozens of clean drawings and beautiful installations, plus detailed descriptions of enclosures and cabinets could reduce the cost of your home music system. Here is the story on what to buy and how to use it.

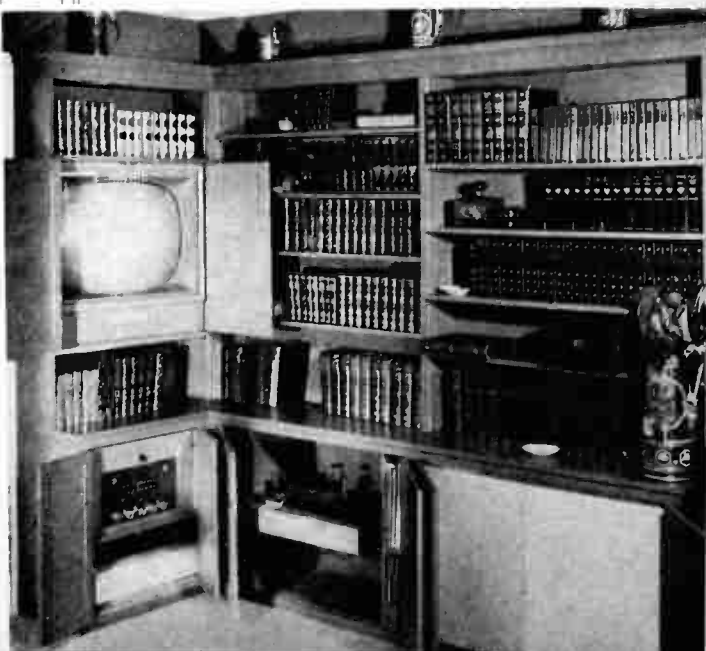



Music is made to come alive—with true-to-life sound reproduction at low cost. Now for the first time, here is an authoritative guide to truly inexpensive **HIGH FIDELITY** home music systems. In this book you will find a practical approach to the sound thrill of a lifetime. With the priceless combination of matched electronic components you have custom installed at home, **HIGH FIDELITY** will provide magnificent living music for your leisure hours of relaxation.

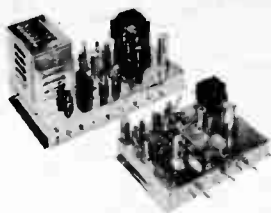

# HIGH FIDELITY

A new Trend Book showing you how to enjoy the ultimate in music at lowest cost. Containing a brilliant foreword by famed orchestra leader Les Brown, this great new manual has 128 pages of informative, non-technical features.

Plus valuable information on maintaining tape recorders, connecting extension speakers, and building a collection of the finest recorded music.

With a few easy-to-use tools you can install a Hi Fi set equal to the best. Or build it yourself from the fine kits available by mail. No matter what your interests, this is your book of HIGH FIDELITY . . . The Thrilling New Sounds.

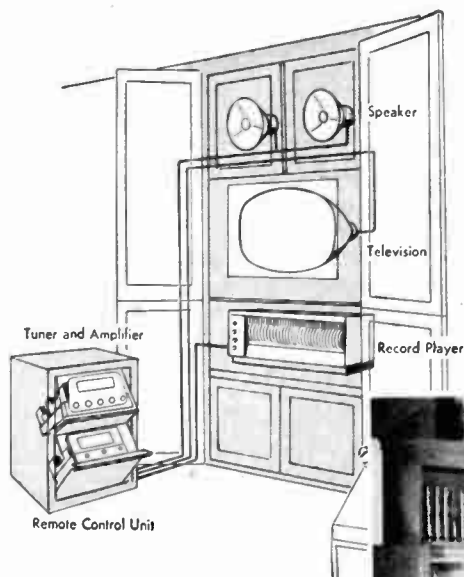

Dozens of clean drawings and beautiful installations, plus detailed descriptions of enclosures and cabinets could reduce the cost of your home music system. Here is the story on what to buy and how to use it.

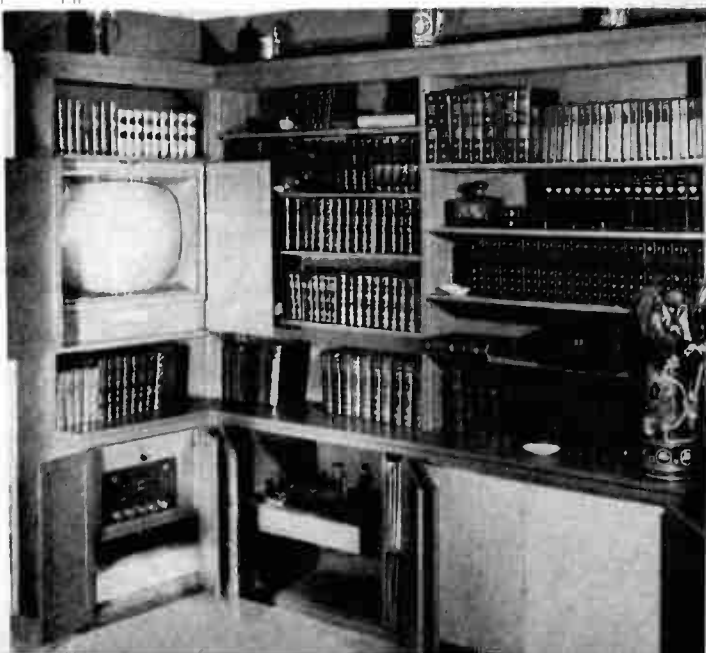

# "HIGH FIDELITY

*is my favorite hobby,"*

*says musician*

**LES BROWN**

"Do you fellows really like music?" is a question I hear at least once every day.

The only way I can answer it is to say, "We not only make our living from music, but High Fidelity music is our favorite hobby." My bandsmen may compete among themselves for the best flowers, or occasionally get together for a group project and combine efforts to add extra rooms for their growing families. But when the chips are down, music is their first love and will no doubt be their last.

The band producing my music has had a wonderful way of living for the past seven years. For nine months each year we spend most of our time in California, playing the Bob Hope radio and television shows. Along with Bob, many days are spent recording or transcribing, together with movie studio calls and other television appearances. The boys are also kept busy with our dance engagements at colleges, service camps and ball-rooms. An average of six airplane trips are taken each year so the band can visit other parts of the country. These trips usually are no longer than six days in order to get home for the scheduled radio or television shows. All air trips are taken in "our home away from home," a Douglas DC-3, which has flown the band many thousands of miles. Along with Armed Forces shows in Korea and Europe, these side trips have given the men more flying hours than any other band in the history of music business.

Our last jaunt with Bob Hope was to Korea. The troupe traveled 25,000 miles to en-



ertain over 500,000 service men in the Orient and adjacent areas. Bob has often referred to the Korean trip as a "Sentimental Journey," which you may remember as the title of our theme song. When this song was written, I certainly had no idea that places with far-away sounding names would eventually be musical memories. My boys know Guam, Saipan, Seoul, Taegu, Pyongyang, Tokyo, Paris, Berlin, Wiesbaden and Frankfurt almost as well as they know their own Hollywood Boulevard.

In Hollywood, a band leader is always apt to lose some of his very best men to the motion picture studios, and once we lost a bass player to the Pittsburgh Symphony Orchestra. Replacing such men has been my only real problem during a period when many band leaders have had a tough time just to keep going.

Many music lovers wonder about the selection of band musicians. All I can explain is to speak about personal preferences. In our band we have extremely well-schooled musicians, but believe me, tone is my prime requisite in hiring a new man. By tone I mean that big, warm, round tone that gives our band a sound unlike that of any other. Musical technique, as such, is not too important. We like a musician who is fast and accurate at sight reading, but a good rehearsal always seems to take care of any tricky or technical passages. Other things





ALL PHOTOGRAPHS BY  
DAVE PELL

which are important to me (in addition to musicianship) are personality and a neat appearance at all times.

The making of records is perhaps the most interesting (next to television) of our many projects. The routine of record production is somewhat like this: After the music has been selected and a recording date decided, men of the band begin arranging the music. This means that each one of the simple popular songs we record is rewritten to suit the ability and instrument of every man in the band. Each musician has his own separate copy of the music from which to play. After this come hours of rehearsal to perfect the composer's musical thoughts; altering them as little as possible to suit our style of music.

Finally, the recording day arrives. Several hours ahead of time everyone is in their place. This is that important last minute rehearsal. Engineers are in and out of our hair, arranging microphones, moving bandmen around to achieve the best sound effects, and in general doing everything possible to make our life miserable—and produce the very best record. Finally everything seems set, and we run through a number for the benefit of recording engineers. This first tape is played back. We all listen to the piece and pick up bloopers that might have occurred. Again the music is recorded and played back. Sometimes a second try doesn't

quite sound good enough. A third recording, even a fourth, and we keep working until every member of the band is satisfied that the played-back tape represents our very best efforts. Only then is the selection considered satisfactory. The record company handles all details of production and release of the disc to you.

For us it is a never-ending search for better music that can be enjoyed by everyone. It is pleasant we can earn a living by doing something we all enjoy so much. Music, to a good musician, will always be more than just a method of making money. It is a medium of self-expression and a way of life. With it you create, you bring joy and happiness to music lovers everywhere. And you always have that warm feeling of accomplishment so important to any artist.

Use of recordings in the home makes it possible for millions of people to enjoy the world's greatest musical compositions. Speaking as a musician, I can assure you that every phonograph record you buy represents more in the way of artistic expression than any other popular art medium available to the public today.

As a music lover, I wish that you could visit my home and enjoy the thousands of records of my collection, look at the hundreds of original musical scores, and meet the talented musicians living in nearby Southern California cities. ■



## *your record collection*

*Alfred Leonard*

THE GATES to a fabulous wonderland swing open the moment you become the owner of a High Fidelity sound system. Inside, you will be welcomed by the greatest artists of the past and present. They have been brought together from all over the world to sing and play for you the music you want to hear. Here is truly one of the miracles of our times. You name the music and the artists. At your command they begin playing, just for you, right in your home!

No matter how much money you are going to spend on your first record purchase, and how much you plan to invest in future additions, there are a few questions which should be settled right from the start.

What kind of a record collection are you going to build? Shall it be a well-rounded library, with records to suit every occasion, or are you planning to limit it to some special interest in music or artists of a particular type? Are you going to feature mainly recordings of music which you already know and have found to your liking, or do you want to take advantage of your chances to become better acquainted with new artists and unfamiliar musical selections?

For most of us the answer to these questions will be in the form of a compromise. Especially in the beginning, while our collection is still small, we want as much variety as possible. At this stage, it is of the greatest importance that we pick recordings which we want to hear time and again. Therefore, we should leave for a later date those items which we may enjoy hearing once in a while, but which are not suitable as a steady listening diet. In other words, before we buy caviar or some exotic spices, we will do well to stock our musical larder with those daily staples which offer solid and satisfying musical nourishment. As our collection grows, we may decide to develop some specialty such as piano concertos, chamber music, Dixieland jazz, or the recordings of a particular artist. Generally, it may prove far more satisfactory to take first things first. Start with a well-balanced cross-section through the great music of all times, adding now and then a less familiar selection which satisfies our desires for novelty and musical adventure.

After we decide on the musical selection we have two other questions to answer before deciding on one particular recording. We want to be sure that we are selecting the best performance and also the most perfect (technically) recording. How can



*Vertical storage and control section.*

you tell? The reviews which you may read in magazines and newspapers, or the suggestions of good sales-people in record shops, can be helpful, provided that you don't follow them blindly. Their advice will save you time in narrowing down the field to a group of two or three topnotchers. However, the final choice should be yours, and yours alone! After all, you are spending hard-earned dollars and you will do the listening. Judge each record on its own merits and don't take anything for granted. Toscanini may be the greatest conductor, Harry James your favorite trumpet player; still, is it not possible that another famous conductor, or even a yet unknown one, turned in a performance which was better, or more to your personal taste? Perhaps a newcomer might play the trumpet still more brilliantly than Harry James. Of course, it is possible; and selection of records based merely on names of artists is just as dangerous as any other form of bias.



You cannot possibly hope to own the best recording if you try to make your selection in a hurry, or, still worse, by ordering it "sight unheard." When you shop for records, take enough time to listen carefully, to compare different recordings, and you will save yourself a lot of money and disappointment. If at all possible, go to a record store which carries a good selection. Of course, if there is no such store where you live, you will have to send away for your records. You will find that better record stores in different parts of the country handle mail orders on a "personal" basis. They will tell you impartially which recordings are worth considering, and some of them allow customers to exchange a record should it fail to come up to expectations.

One final suggestion. Among your friends are several who enjoy the same type of music which you like best. Why not get together with them and work out a master plan to avoid duplications of purchases? Few people can afford to buy all the records which they would like to hear regularly. With a little forethought a small group can easily work out some scheme of lending records to each other, thus gaining access to a library many times the size of their own.

No record will afford you lasting pleasure unless you protect and treat it well. Records are rather delicate, but if you observe a few simple rules, they will stay in the pink (or

black) of condition for a long, long time.

1. The most important point is the point of your needle! You can wreck any record the first time you play it with a worn or improper size needle. There are no "permanent" needles. And even a diamond point will wear out eventually. However, a diamond will last at least twenty to thirty times as long as a sapphire tip, yet costs only what you would pay for seven or eight sapphire needles. In the long run a diamond needle is not only the best, but the most economical needle to use.

2. The plastic unbreakable material of which most records are made today has a tendency to attract and to hold dust. It is very important that the record be clean when you play it, because the dust will act as an abrasive in the delicate grooves. Don't brush the record, but wipe it carefully with a just barely damp, lint-free cloth or chamouis as shown on pages 96 to 99.

3. Don't touch the playing surface with your fingers, but hold the records at the edges. Fingermarks deposit a film of grease, and the records resent it!

4. Never stack records on top of each other without some protective separation, or the surfaces will scrape and mar.

5. Store your records in protective, dust-proof covers or albums, in a cool and dry place. Make sure that they stand upright and not on a slant, or they may warp. ■

*Books and fine music belong together.* PHOTOGRAPHS FROM GATEWAY TO MUSIC, LOS ANGELES 5



## *making records*

*Capitol Records, Inc.,  
Hollywood, Calif.*



FROM THE MOMENT famous recording artists, such as Les Paul and Mary Ford, create the first audible image of a new tune, the record business is a maze of skill and art for use in your home.

Nearly all new recorded music is taped. The artist can listen to the music immediately after it has been recorded without any loss of quality. Once approved, this master tape is sent to the record production line. Music is transferred from the tape (via a cutting lathe) to a master disc. On this disc is coated a fine layer of metal, which, when stripped from the master, is used to produce a stamping disc. A stamping disc is a metallic reproduction (in reverse) of the phonograph record you will buy. Used somewhat like a waffle iron, two of these heated masters press a slab of vinylite plastic between them. This piece of plastic picks up every tiny tonal indentation. When trimmed and packed, it is the inexpensive carrier of fine music into your home. ■

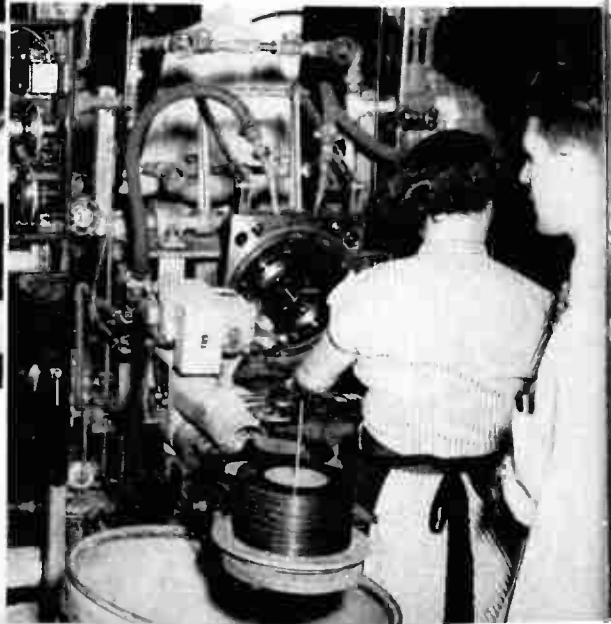

## junior disc jockeys

*The Children's Record Guild, N.Y. 13, N.Y.*

TODAY'S BOYS AND GIRLS, from tots to teens, have a wonderful world to grow up in, even when compared to the generation just preceding them. We're talking, of course, of that fabulous recorded world of nursery rhymes, fairy tales and folk songs.

We're not for a minute belittlin' the soothing effects of a mother's lullaby at bed time. But let us face it. Mother may sometimes hit a sour note, or sing off-key. And when it comes to "Please tell me just one more story—please," Mother or Dad might quite possibly decide that drowning the offspring is a safe and sane solution!

But no more—there's a children's record on the market to meet most situations. And in addition to keeping the kids entertained, most of these records are calculated to even teach them a little something at the same time — without their knowing it.

Proof that parents have recognized the importance of these records, and that the kids are clamoring for them, is the fact that the children's record industry is now called the "Billion-Dollar Baby-Sitter!"

One proud father said, "I never knew my boy was interested in ships till we played a record called 'Ship Ahoy.' But he wanted to know all about the running of a ship. Other parents are learning that the kids respect other people's property when they own and operate their own record players.

*A ride-'em cowboy record is the inspiration for these bappy children's rural shenanigans.*

These junior disc jockeys are now hosting their own parties and, needless to say, get a great big bang out of it. Their guests also think it's great fun. They're having a wonderful time acting out animal sounds and "ride-'em cowboy" records.

There are "story" records for the child who is sick and must remain inactive. There are records with different color labels for the tot who cannot yet read, which enable him to make his selections.

All the wonderful, golden stories and music of the centuries are enacted and recorded by the great artists of our time for the lucky kids of today. And while the youngsters probably won't enter into a discussion of the relative merits of Hi Fi with you, we'll bet they want to be counted in when you plan an entertainment center. ■

*Here's a slick trick. Slipping and sliding just like real live seals, with music for fun!*



*No organ grinder, but a catchy monkey song makes these little "monkeys" take off.*



## *fidelity and illusion*



*by Charles Fowler,  
Editor of HIGH FIDELITY MAGAZINE;  
courtesy Capitol Records Inc.,  
Hollywood, California*

ALTEC LANSING PHOTO

**H**IGH FIDELITY is a qualitative expression, and because there is no precise measure of it, it has many definitions. They can be summarized, however, in one statement: the purpose of high fidelity reproduction of music is to recreate as perfectly as possible, for the individual listener in his home, the illusion of the most carefully staged live performance.

We use the word illusion intentionally. With certain types of musical sound it is both possible and desirable to reproduce the original with such accuracy that even the most sensitive ear finds it practically impossible to distinguish the original from its re-creation. With other types, it is technically possible, despite difficulties, to reproduce the original, but to do so is often considered undesirable.

Let us consider some examples of live music. In an average-size living room, a violin is unqualifiedly pleasant to listen to. Even in a small room, it would never be played with such volume as to become unpleasant. But with a piano we must impose qualifications. A concert grand in a small living room, played by a forceful pianist, could easily become too loud for comfort. If, finally, we imagine the extreme case of a symphony orchestra concentrated, somehow, into one corner of a living room, it is obvious that even the fragmented sound of the musicians tuning their instruments would be shattering in its impact.

This is why we use the word illusion. To create the illusion of the orchestra is the purpose of High Fidelity. It must also create the illusion of a violinist playing in the

room, and sometimes the violinist and the orchestra must appear together.

The problems encountered in the achievement of this goal fall into two areas: the recording process and the reproducing process. To obtain the best illusion in the home, we must understand both.

If the engineers were concerned only with the physical or electrical problems of recording, their life would be easy. As we have said, it is technically possible, though difficult, to record and reproduce any type of music with perfect fidelity.

But let us examine again the problem of the grand piano. If we put it into a small living room, say twelve by fifteen feet, the loudness is almost unbearable. The sound of every note bounces around within the room until an arpeggio becomes a blurred din of confusing sound.

If we transfer our concert grand to another living room, one with dimensions of approximately thirty by fifty feet, we can establish a whole series of listening conditions, each of which will flavor the sound of the piano—slightly, perhaps, but discernibly. For example, our imaginary living room might be sparsely furnished, with the piano in one corner and a pair of chairs for us to sit on far off in an opposite corner. The sound will be brilliant, hard, highly reverberant, and sometimes too loud.

Now suppose we have an interior decorator move in upholstered furniture, fill empty bookcases, hang pictures and draperies along the walls and over windows, and arrange enough folding chairs to accommodate forty or fifty people. Before the people

arrive, if we go back to our chairs in the corner and listen, the piano will probably sound almost perfect.

Finally, we invite in all our friends to fill those folding chairs. To recapture the gorgeous sound we heard before we crowded the room with an audience, it is likely we shall have to move from our far corner to about one-third of the distance from the front to the back row of chairs. Filling the room with people will have changed the sound to an obvious degree.

It is quite possible for recording engineers to capture the sound exactly as it would be heard under each of the conditions described above. It is also possible to set up loudspeakers and amplifiers and reproduce the sound so that the difference between original and reproduction would be barely, if at all, perceptible.

But if we were to record under one set of conditions and reproduce under a different set, the sound from the loudspeakers would be noticeably peculiar and false.

So the recording company has the very great problem of guessing the conditions under which a particular record will be played back. It must guess the size of the room, its shape, its furnishings, the number of people listening, and even the personal preferences of those listeners insofar as sound quality is concerned.

The recording company must also guess what kind of equipment will be used to reproduce its record. This is the greatest single variable it faces. A record may be played on anything from a portable table-model phonograph of unknown vintage to an elaborate custom installation involving multiple speakers and the finest of electronic equipment. Given these two extremes, it is certain that what sounds listenable on one type of playback equipment—what creates as nearly as possible the illusion of live performance—will sound unpleasant and unreal on the other. And between these two extremes of reproduction lie an infinite number of variations and mutations.

Therefore the recording company must first create, in its mind, a typical listening room fitted with typical playback equipment, and then tailor the original sound to suit those conditions. Thus, in making a record the company says, in essence: "This is sound adapted, we think, for listening conditions like yours, so that the illusion of the original will be created as perfectly as is technically possible."

It is here that we see most clearly the unusual nature of the test record album. It differs from other records because it has been prepared for a critical audience, an audience which possesses playback equipment of especially high quality. This improvement in the prevailing listening conditions permits the record manufacturer to adapt his product to high standards.

The process of moulding sound to fit a specific set of listening conditions would not be too difficult if only one musical instrument, or one standard group of instruments, were involved. But test records contain a number of excerpts from a variety of types of music, both popular and classical. Thus it demonstrates the ability to capture different kinds of sounds and to tailor each to its best advantage. For each must receive different treatment. It is not advisable to modify the sound of an orchestra and then employ the same modifications on a solo piano. We do not expect, for example, the dynamic range of a piano to be the same as that of an orchestra. Nor do we expect the piano to sound the same by itself as when it is being played as a solo instrument in a concerto.

Furthermore, we expect variations in quality of sound from one type of music to another. Popular music has its own qualities, often varying with its orchestras and musicians. Even classical music has its differences, especially where modern composers are concerned. Compare, for instance, Art Tatum with Les Brown, or a Mozart Serenade with a Shostakovich Symphony.

We should not expect all sound, just because it is recorded, to have the same quality or tonality. And we must take into consideration the illusion which the recording company, in conjunction with the musicians, conductors, and composers, wished to convey. Was the sound intended to give the effect of having been originated in a small room? In a large, crowded concert hall? Are we supposed to be listening from the first row or the fifteenth? These are questions to be borne in mind when listening to a record such as this, which contains many excerpts from varying types of music.

So far we have been discussing almost exclusively the recording link in the chain. The reproducing link is equally important. If it is a strong link, it can elicit all the beauty of the original sound. If it is weak or inadequate, no amount of doctoring of the sound at the recording end can overcome

the handicap and create the lifelike illusion we seek in home musical entertainment.

As high fidelity enthusiasts know only too well, there are several essential elements to be considered in the reproducing equipment. Principal among them are the pickup and its stylus, the loudspeaker and its enclosure, the amplifier, and finally, room acoustics of your home.

It is quite true that room acoustics are seldom thought of as part of the high fidelity system itself. Nevertheless, they are as important to correct sound reproduction as they are to correct sound production. If we substitute a loudspeaker system for the concert grand piano we were moving around several paragraphs ago, we shall find that the characteristics of the room have just as much effect on the speaker's sound quality as they did on the piano's. But changing room acoustics is, to say the least, a rather costly process, since it may require building a new and larger house. Therefore the reproducing system should be able to alter the quality of the sound to compensate for peculiarities in individual listening conditions. The recording company's concept of our living room—which is, after all, an approximation—can thus be electrically adjusted to the actual situation.

Unlike room acoustics, there is a great deal that can be done about the other components in the high fidelity system. Many, many factors enter into the decision as to whether or not a particular component should be changed or can be improved. They are beyond the realm of this discussion, and books have been written on them. We can only state some generalities, an understanding of which should be helpful in the use of this record.

Certain technical characteristics of the components in a sound reproducing system help to define its quality. One of these is frequency range. An engineer says that every pure sound has a frequency, stated in cycles per second; a musician says that every sound has a fundamental pitch. The range of frequencies which the normal human ear can hear is from 20 cycles per second to 15,000 or more. The frequency range of a particular component can be tested scientifically; it can also be checked aurally by musical selections like those on test records. The tinkle of a triangle is at the high end, as are the harmonics of many string instruments; low-pitch sounds of the double bass,

organ pedal notes, and the bottom notes on a piano, are representative of the deep end of the frequency spectrum to test your equipment.

Contrary to widely accepted opinion, there is no particular technical difficulty in the reproduction of high frequency sounds. However, the low end of the range is a different matter. It is here that cabinets resonate, tending to produce what is known as "juke box bass," and speakers lose efficiency, tending to produce no bass. True, such distortions of the original sound are most clearly apparent when tested technically with pure tones, but such a test alone may not be sufficient. It is lifelike reproduction of music we are after. The accurate re-creation of the "growl" of a string bass is more important than the perfection with which a system passes pure sound at 60 cycles per second, for the sound from the string bass is made up of pure sound plus many harmonics, or overtones. Hence, for a final test, musical sound must be used in conjunction with the pure sound generated in a laboratory. The value of various sections of test records for such tests is pointed out in the commentary accompanying the listing of individual selections on the recording.

It cannot be too strongly emphasized that the ability to reproduce high frequency sounds—at sometimes searing strength—is not in itself an indication of High Fidelity. The word "fidelity" applies to the entire range of sound. Reproduction must be faithful to the original not only at 10,000 cycles, but also at 100, and the balance between the two must be the same as in the live version of the sound.

This faithfulness to the original throughout the frequency range is what is meant by "flatness of frequency response." The "juke box bass" mentioned above is an indication of lack of fidelity, since it overemphasizes one portion of the sound spectrum in comparison with others. Flat frequency response of the high fidelity system can be judged by listening to an orchestral selection and determining, as carefully as possible, if the balance between instruments is approximately the same as that which existed when the live music was recorded. Any unnatural dominance of a single instrument not intended by the composer or the performers may indicate a system susceptible to improvement.

*On the opposite page is the first section of a critique from FULL DIMENSIONAL SOUND, a Capitol Records album created for listeners finding special delight in fine music.*

Distortion is another ailment of sound reproducing systems. It takes many forms since, by definition, distortion is any variation from the original. Two types of distortion can be heard fairly distinctly with musical material. One is the production of new frequencies or sounds by the system itself. Such distortion can introduce dissonance which the recorded material does not contain, thereby blurring ensemble sound or altering the distinctive quality of an instrument playing a solo passage.

A second type of distortion is caused by the system's inability to reproduce certain tones. It occurs at loud volume levels and

can be heard particularly in the low frequency region, becoming most apparent if the controls are adjusted to give maximum emphasis to the bass. A very low note may, for instance, actually appear to change in pitch if greater volume amplifies an overtone more than the fundamental tone.

There is little that is more gratifying to the music listener than a really good recording played over a fine high fidelity system. It is the goal of the high fidelity enthusiast, of the recording company, and of the high fidelity equipment manufacturer to help more music listeners achieve this ultimate satisfaction.

# high fidelity critique

Two important aspects of recording techniques should be mentioned here, since they apply to all the selections which follow. In general, popular music is recorded with the microphones placed very near the orchestra. In this way, brilliance and a feeling of proximity are achieved. Microphone placement varies, in the recording of classical music, with the type of music and the sought-for illusion of listening position. Thus, the Bloch, on the classical side of the disk, has been recorded to give the impression of listening from fairly far back in the audience, whereas the Tchaikovsky selection is "heard" from row A. All the popular tracks on this record use the close microphone technique.

Microphone placement in "pop" recording is further used to accentuate a particular instrument or group of instruments. Many popular organizations rely on microphones for their effects, the best known examples being singers who, without electrical amplification of their voices, would be without a job. In recording classical music, such effects are not attempted. In concert, a separate microphone may be placed near the solo instrument and used to keep the instrument from dropping out completely, but this must be done with extreme care because it is contrary to what happens in the concert hall. Unless one is sitting directly in front of the violinist, for instance, the sound of the violin is going to be drowned out from time to time by the orchestra. Holding the violin sound, in spite of the orchestra, would produce an unnatural effect. In popular music recording, however, such treatment is frequently desired.

The different effects which can be achieved by these techniques of microphone placement and balance are brought out clearly by the varied excerpts on this record.

## SIDE 1: POPULAR SELECTIONS

### TRACK 1: RAY ANTHONY AND HIS ORCHESTRA *The Continental*

This is a good example of the close microphone technique. Note how various groups in the orchestra are pulled out and emphasized, even though the overall balance is well maintained. A phonograph system possessing "juke box bass" is likely to place the rhythm section out of balance; it may make the beat sound as though only one note were being played, whereas in actuality it changes pitch and is subdued, though nearly always present and audible, in comparison with the rest of the orchestra. For this selection the Anthony band includes four trombones, four trumpets, five saxes, and four rhythm.

### TRACK 2: HAL REES *Studies in Percussion (Part 1)*

This is a special selection performed by Hal Rees, chief percussionist for Twentieth Century-Fox Films, to demonstrate the sound of various percussion instruments. They are, in order of their appearance: glockenspiel, gong, vibraphone, xylophone, cymbal, marimba, chimes, temple blocks, cow bells, klaxon, triangle, castanets, tambourine, tom-toms, field drum, bass drum and cymbal.

As with the percussion track on the reverse side of this record, these constitute some of the finest musical test material available. If the

reproducing system is deficient in highs or lows, or if there are spurious resonances in cabinets or enclosures, such defects are almost certain to show up. Listening to certain instruments first on one system and then another will show up tone and quality differences vividly. The effect of tone and equalization controls on various instruments can also be studied. In the case of the vibraphone and the marimba, for example, either instrument will show up resonances in cabinetry or speaker enclosure, which come, in the original, hard to reproduce since it is characterized by tones which come, in the original, perilously close to the noise made by the vibraphone.

There should be no mistaking one instrument for another: their tonal qualities are completely different. Compare the glockenspiel with the triangle, the vibraphone with the tambourine. The chimes are a fine test for turntable "wow," which would produce a slow change in pitch. Note the long "overhang" of the cymbal into the marimba, the metallic sound of the cow bells, and the soft loose-sounding "whump" of the bass drum at the end of the track.

### TRACK 3: DICK STABLE AND HIS ORCHESTRA *Foghorn Boogie*

Since the Stable group in this selection uses no brass—only six saxes and four rhythm—it provides a good test of middle and high frequency reproduction. There should be no brassy sound, yet the bass sax should growl, not grumble. The slightly reedy flavor of the high sax notes should also be apparent.

### TRACK 4: JUNE HUTTON WITH AXEL STORDAHL AND HIS ORCHESTRA *Sung From Moulin Rouge*

This is a perfect example of how microphone placement is used in popular recordings. In real life, so to speak, Stordahl's orchestra (nine strings, four saxes, one horn, one harp, and four rhythm) would drown out June Hutton's voice, yet on this track her voice dominates the orchestra throughout. The opening string sweeps, heavily emphasizing the waltz rhythm, are aided by microphone placement and utilization. It would be virtually impossible to create this sound in a live performance without using microphones and electrical equipment.

### TRACK 5: LES PAUL *Meet Mister Callaghan*

Les Paul is, of course, famous for his utilization of advanced electronic techniques to secure his unique effects. This is not just a matter of microphone placement, but of echo chambers and multiple recordings. Soundwise, balance between highs and lows is well demonstrated. The "plucky" quality of the guitar should be evident, and the variations in the tonal qualities of the strings should stand out clearly on reproduction. The sound should never be sticky, but should be well-defined, with the same recorded detail that reveals Les Paul's "finger-squeak" as he moves along the strings.

### TRACK 6: LES BAXTER AND HIS ORCHESTRA *Quiet Village*

This is a good bass test track. In spite of the sweeping effect to the beating rhythm, the piano enters and still the overall level for the dynamic range is not broad. The orchestra sounds much larger than it is. There are only nine strings—exotically colored by muted bass, harp, piano, and two percussion.

# IT'S NOT EXPENSIVE

Jerry Franke

WHAT'S the cheapest High Fidelity I can buy?" seems to be today's most important question. A better approach to the problem might be "How much High Fidelity for the money I want to spend?"

No two "experts" seem to agree on any single system. Nor will two similar Hi Fi sets sound the same to your ears. There are so many links in the sound chain, including psychological factors, that no two people hear or "perceive" music to the same degree. The ultimate test is by your own ears, be they "golden" or base metal.

Rack-assembly of High Fidelity units is one of the fastest growing hobbies there is today. Buying the individual components, and watching your system grow, opens a new world of fun. Racks are just that . . . an open framework with adjustable bars on which any variety and type of equipment can be mounted with quick accessibility and interchangeability of parts. For the Sunday tinkerer or radio amateur, here is a most productive and satisfying hobby.

High Fidelity at low cost is available to everyone. \$150 will buy a good record changer, AM-FM radio with built-in 10 watt amplifier, triple play magnetic cartridge, and a 12-inch extended range speaker. Many initial installations are begun by purchasing just one piece of equipment at a time. First the record changer, then an amplifier, a good speaker, and finally the speaker enclosure. Usually the electronic equipment is installed in a closet or cabinet already used in the home for storing unwanted articles.

A high quality "self-assembly" kit on the market for \$275 consists of an AM-FM tuner, 10 watt amplifier, automatic changer with magnetic pickup, 12 inch coaxial speaker, mounting board, complete wiring, and suggested installation diagrams. Many suppliers provide a complete service in which the connecting cables are color coded. Even the most difficult connections are simplified by matching the color of a cable to a socket.

You can start with Hi Fi at low cost, by "improving" your present radio-phono combination (if the cabinet is worth your trouble). Replacing the present single speed changer with a three speed automatic unit would be the logical first, and easiest step. Complete instructions are given in Section XI, pages 112 to 115. Here you should make your first big decision that will decide the future of High Fidelity in your home: "How good a unit should I buy?"

Is this to be a make-shift improvement to what you have, or will this new changer be the first link in your future chain of music components?

You can install an inexpensive changer, with crystal pickup, which will be more than adequate with the usual phonograph amplifier and speaker. This provides the equipment to play all sizes and speeds of records. You'll be limited to the middle range of tones (about 150 to 8,000 cycles per second) at a cost of around \$40 plus your labor of making the installation.

An automatic changer, with a better motor, and ceramic pickup with a range of 50-12,500 cycles, would cost from \$50 to \$60. A better quality changer with a four-pole motor, better tone arm, interchangeable heads and weighted turntable, is in the \$70-\$125 price class.

In the purchase of most changers there is also the problem of required additional parts. The changer, itself, may cost from \$46.50 to \$93.75; plus \$3.95 for an interchangeable 45 rpm spindle to play 45 rpm records, about \$2 for a simple plywood mounting board, or \$7.50 for a complete base. Then there is a wide choice of various cartridges and styli ranging from \$9.90 to \$37.50 each. Add your choice of components and check the family budget carefully. Should you plan further additions to your music system, it will be well worth while to buy the best record player available. It will never need replacing in the future and provides a practical foundation for home music.

*Bass reflex speaker enclosure kit is available for about \$22, while rack for all components costs only a few dollars.*

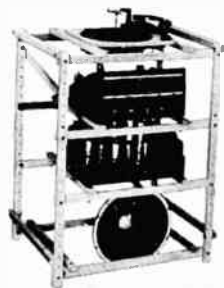



## Typical Installation showing interconnecting cables

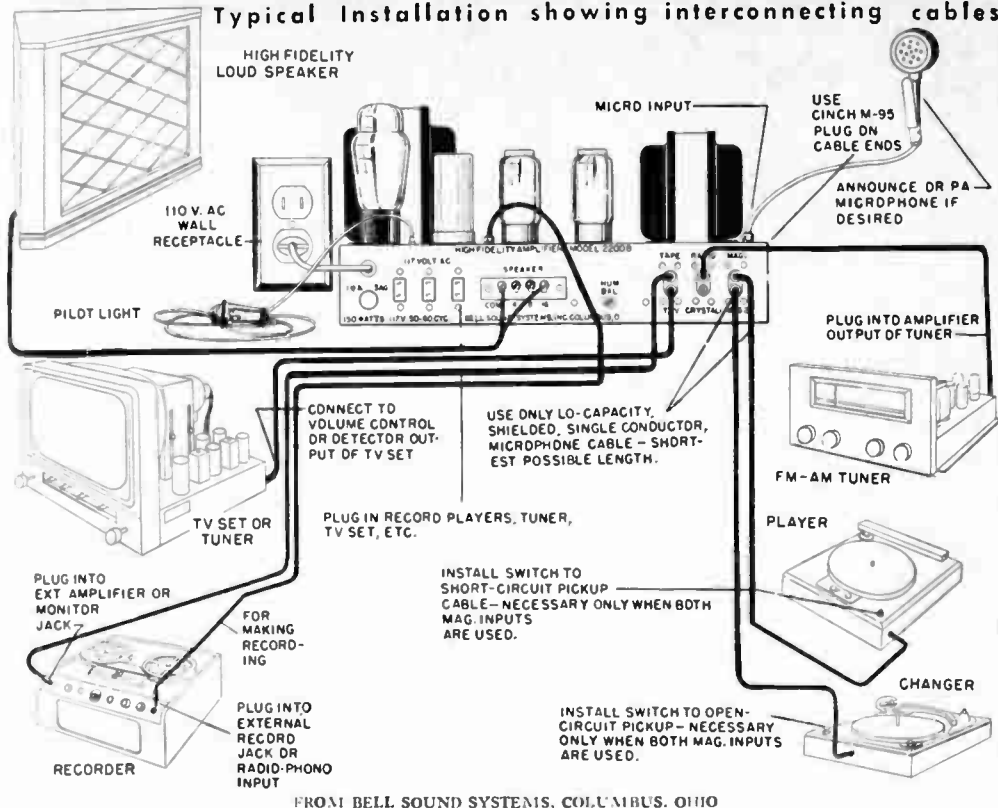

FROM BELL SOUND SYSTEMS, COLUMBUS, OHIO

This new player can be added to your present console with a few hours' labor, including minor cabinet saving or alteration. Having completed this improvement, your fate is sealed. You can now pick up the full range of music from your record with the newly installed Hi Fi changer. But your present amplifier still is limited in tone range, as is the old speaker system. New 10 watt amplifiers are available at about \$40. It's simple to connect one into the present sound system ahead of the volume control.

Sit back and relax? Not yet. The old speaker rattles, rumbles and may even tear its cone from the increased power of your new amplifier. Good replacement speakers start at \$24.95 for a 12-inch coaxial, with a cross-over network to separate the high and low tones being reproduced.

Don't put a new speaker into the old cabinet; you need a minimum of four cubic feet enclosed behind a 12-inch speaker. The speaker section (pages 48 to 61) contains plans for enclosures. Home construction kits are priced from \$18. So, "go shopping"; read all the catalogs, and meet self-appointed Hi Fi experts working for your local radio parts stores. They'll do their best to

sell you on the biggest enclosure in the place. Failing in that, they usually push some type of home construction kit. Building an enclosure at home is a good way to learn the theory of sound. If theory is not important you might be better off to buy an assembled utility cabinet and add finishing touches after you mount the speaker. Your room acoustics, glass areas, walls, etc., will have a lot to do with the type of enclosures that will produce the best sound (in that particular room). Actually, the wall mounting of a speaker, so that it exhausts into another room or closet, is an ideal means of installation for any size speaker.

Rack, shelf, or bookcase mountings are growing in popularity. Many Hi Fi addicts (the audiophiles) have learned that music tastes may change. They soon begin trading some of their earlier equipment in on higher quality rigs. You might wait until you are satisfied with your home music system before beginning to think about installation of the cabinet or building into a wall.

By all means plan on eventually buying a tape recorder for your system. And when you run television sound through a Hi Fi system, you're in for a real surprise. ■



Changers and amplifiers cost as little as \$40 and small Hi Fi speakers about \$20.



\$1250 Home entertainment center by Zenith.

## ready made Hi Fi

Jerry Franke

Today there are a number of moderately priced table model High Fidelity record players as low as \$129.50, which reproduce a full range of tone with amazing clarity.

The familiar old-fashioned pre-war radio-phonograph combination was vastly different. It was produced with the emphasis on furniture styling and low price as prime concerns. As a result these units usually had drawbacks which ruined any hope of hearing full fidelity music. The lack of adequate space for a speaker precluded any possibility of properly enclosing and baffling the sound. Little was usually heard except the middle range of music—and needle noise.

The old record changers rumbled, ran at varying speeds with a resulting lack of pitch, and the crystal pickup was usually limited to a 150-8,000 cycle range. This was a sacrifice of at least six octaves of tone from your music. The radio often had a simple production line chassis with a small record player amplifier incorporated into the set. Its limit was about 5 watts of badly distorted power. Tone control was sagely added to muffle this distortion and the usual needle scratch. When set on "bass" the tone control gave a booming "juke-box" bass so familiar to music fans. Broadcast music was also of poor quality because the usual AM (standard) radio transmission is only around 5,000 cycles per second. Network program quality was also cut off near this figure by telephone feeder lines. Later when FM (frequency modulation) radio was added to the phono-combination, the amplifier and speaker system proved itself inadequate to reproduce FM's full range of music.

Great credit should be given to Dr. Peter Goldmark, who produced the Columbia 360 table model phonograph. Released to the public in early 1953, it was the first unit through which the listener could hear High Fidelity at a price that anyone could afford. With this unit Dr. Goldmark finally broke through the "sound barrier" into a field that had been only for the select musical connoisseurs, audiophiles, and sound engineers. The 360's quick acceptance by the general public forced other manufacturers to get on the "High Fidelity" bandwagon.

However, in designing the Columbia 360 with its twin speakers on each side of the case, Dr. Goldmark began an opportunist's cycle. The number of speakers, rather than quality of speakers, has become the new criterion of mass production inexpensive radio-phonographs. It should be pointed out that use of more than one speaker does not make a Hi Fi set of portable phonographs.

Many professional full fidelity music systems divorce the speaker enclosure from the electronic equipment. It is often placed into wall-baffles or corner enclosures matching the decorative scheme. The speaker itself is usually the type known as *coaxial*. This consists of two speakers on one frame with a dividing network that permits only the emission of low tones from the large bass cone and high tones from the separate smaller tweeter cone of the coaxial speaker.

Logically enough, price tends to affect the amount and type of music fidelity that your money can buy. Modern factories are now producing excellent radio-phonographs which are especially desirable for apartment or small room installations in the home.

In the \$150-\$200 price range you can find a multitude of table models. Many use the new ceramic pickups, a two-pole motor, and offer 5 to 8 watt amplification with two or three speakers. The speakers are usually two 6-inch "woofers" and a 3-inch "tweeter." These are seldom in an acoustically designed enclosure, due to space limitations. Or, you may find the newer models which use an 8-inch extended range speaker in a rather adequate baffle, sometimes with the tweeter added for the final touch of high fidelity sound reproduction.

Few magnetic pickups are found in small sets, since their output is low. Magnetic



*Medium price Kelton Hi Fi phonograph.*

pickups necessitate an expensive preamplifier to increase the pickup output before it can go into the regular amplifier. A good preamp should have separate bass and treble controls; plus some form of record equalization to hide recording deficiencies.

In the \$200-\$300 price class, phono-only consolettes reign. Often they are enlarged table models with built-in speaker enclosures on wooden or wrought iron legs. Here magnetic pickups are used, often with adequate front-end controls and record compensators for playback control.

The 8- and 12-inch speakers are out in force and emphasis is on better furniture styling. Unfortunately, quite a few standard and unbaffled 12-inch speaker assemblies are creeping into this field with unwarranted claims of High Fidelity sound reproduction.

In the \$800-\$1,200 price class are the factory's best attempts at professional full fidelity music systems. However, too often the cabinets are oversized pieces of furniture constructed to house adequate enclosures for the two-way speaker systems. The changers are better, with four-pole steady running motors. Magnetic pickups with interchangeable heads are used with sincere attention paid to high quality. The AM-FM tuners with equalization controls and separate powerful amplifiers are equal to the best components available.

See and hear them all, preferably in a store that handles both factory assembled radio-phonographs and High Fidelity components. In the final analysis there are only two judges of High Fidelity sound (your ears), in spite of all the advertising claims that you may read. Buy what sounds best —when playing in your home. ■

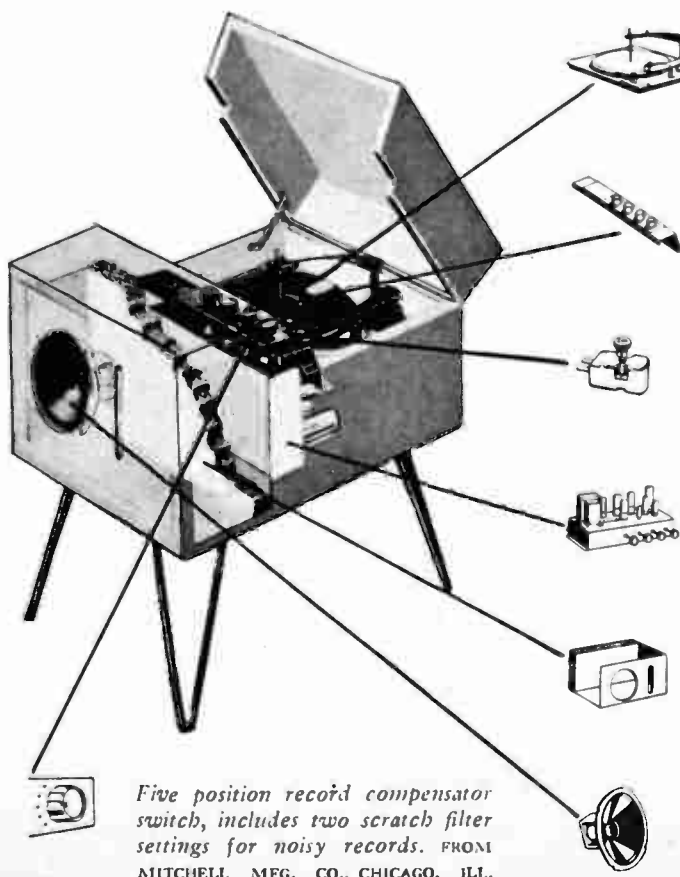

*3-Speed fully automatic changer provides 4 hours continuous play. Plays 7", 10" or 12" records at 33 $\frac{1}{3}$ , 45 or 78 rpm speeds.*

*Simple operation — an "on-off" switch with volume control; separate bass and treble controls; and individual record compensator.*

*Variable - reluctance cartridge. Baton-type design with dual sapphire-tipped styli for either micro-groove or standard record play.*

*Amplifier has preamplifier for variable reluctance cartridge, with 10 watt peak, and less than 1/2% harmonic distortion at 6 watts.*

*Speaker baffle features a tuned acoustical slot to reinforce the rich bass and clear treble frequencies of modern Hi Fi recordings.*

*The oversize, specially matched direct-radiator extended range loudspeaker is equal to the task of handling all volume levels.*

*Five position record compensator switch, includes two scratch filter settings for noisy records. FROM MITCHELL MFG. CO., CHICAGO, ILL.*



# HOW HI FI WORKS

Jon F. Byk

**I**N order to understand the reproduction of sound, we should first read a little on the behavior of sound waves.

Sound is something that most people take for granted. If we stood on a busy street corner we would be aware of overwhelming sound. This type of sound is noise, which lacks rhythm. Music, on the other hand, has rhythm as well as harmony.

Sound waves generated in air are somewhat the same as waves formed by dropping a stone in water. If a small stone is dropped into a pool of still water, waves will travel in all directions away from the point of impact. If, instead of a small stone, a large rock were dropped into the water, the waves would be higher. The up-and-down movement of the water represents the *amplitude* or strength of the waves. Sound particles of disturbed air, moving up, down, and across somewhat as the waves moved, literally bump one another as they travel outward through space in every direction from the source of the sound.

As you may remember, the difference between middle C and high C on the piano is that middle C is lower than high C. This is known as a difference in *pitch*. This variation of pitch is caused by differing amounts of sound waves passing a fixed point during a fixed time. It is described as *frequency* or number of *cycles* per second. The top of the wave is the *crest*, while the bottom is referred to as the *trough*. One complete cycle (wave) begins at a still point, builds to a crest, passes down through the still point to the trough and rises to the still point again.

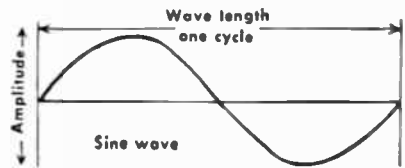

Thus far we have been describing pure sound waves of a specific frequency. These are simple *sine* waves and are illustrated graphically above. We rarely encounter this type of sound in nature. Sine waves or pure sound of a specific frequency can be produced by striking a tuning fork.

Because sound is generated by mechanically causing air particles to vibrate, the frequency (musical pitch) is determined by speed (cycles per second) of the vibrations. If we double the speed of vibrations (frequency) we raise the pitch one octave.

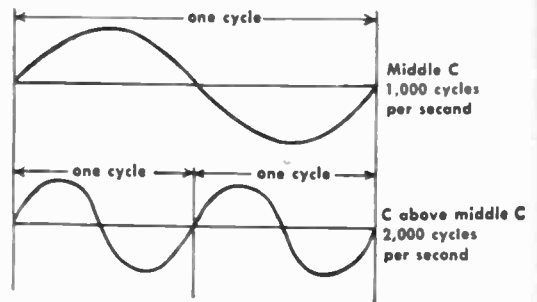

Loudness is relative to the strength (amplitude) of sound. The amount of change which causes a discernible difference in loudness to the human ear is called a *decibel*.

If we heard two tones of the same pitch, one from a flute and the other from a violin, we could readily tell them apart. The difference between the two, which enables us to separate them, is a difference of *wave-form*. Most music consists of a pure sound (sine) wave modified by secondary vibrations which create the distinctive waveform. It is these secondary vibrations that create *timbre* and make it possible for us to distinguish identical tones played on various musical instruments.

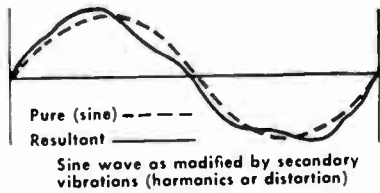

The usual beginning of reproduced sound is the microphone, a mechanical device which changes sound vibrations into electrical impulses. Microphones employ a sensitive metal diaphragm, or ribbon, which vibrates from sound pressure traveling through air. When the diaphragm or ribbon vibrates, small electric currents are developed. The electrical impulses generated by a microphone must be amplified for broadcast, recording or instantaneous use in a public address system. The principle to remember is that the pattern of electrical wave impulses leaving the microphone is exactly the same as the sound wave pattern that vibrated the diaphragm or ribbon. We have only changed sound vibrations into electrical impulses capable of amplification.

We begin with "live" sound and translate it into duplicate electrical impulses with a microphone. If these electrical impulses are to be useful, we must make them powerful enough to do work without changing their form. An amplifier is an electronic device that increases the strength of a weak, sound-created, electrical impulse, such as comes from a microphone, tuner, or phonograph pickup. The increase in power an amplifier can give tiny signals, without changing or distorting the reproduced sound, is a measure of the amplifier quality. The simplest amplifier is an electron tube called a *triode* (three element) tube. In this tube are elements known as the *cathode*, *plate*, and *grid*. When heat is applied to the cathode (most cathodes are indirectly heated by a separate filament) a powerful stream of electrons is released. The cathode is generally coated with a compound which emits electrons more rapidly than bare metal. Within the airless electron tube the plate, which carries a positive electrical charge, is offering a powerful attraction to the invisible cloud of negatively charged electrons emitted by the heated cathode. Thus electrons fly from heated cathode to positively

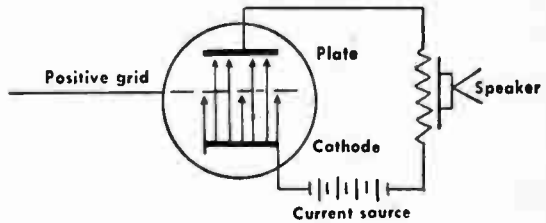

charged plate. In order to control this strong electrical impulse we add the third element known as a grid.

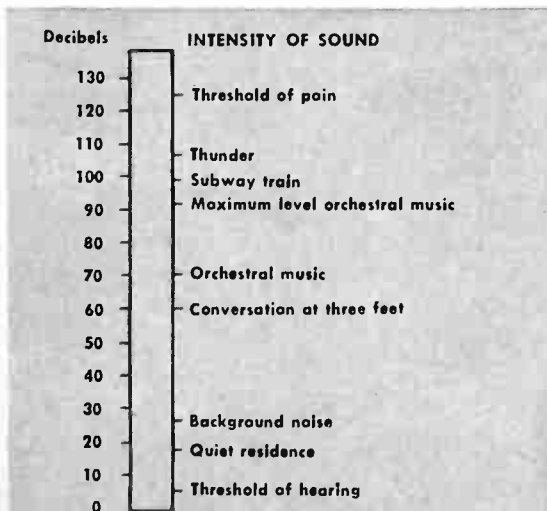

Common sounds range widely when placed on the decibel scale used to measure high fidelity units.

The grid is placed between cathode and plate in the triode tube. The purpose of the grid is to vary the number of electrons flying from heated cathode to positive plate. When a weak electrical voltage to the grid is negative, it repels the electrons before they reach the plate. Consequently, the plate does not receive any electrons and the outgoing plate current is reduced. When the grid voltage is made positive, the grid passes many electrons to the plate, and outgoing plate current (to speaker, etc.) greatly increases. Therefore, when a weak signal (from microphone or record) passes to the grid, the grid is negative (repels electrons) or positive (attracts electrons) in proportion to the weakness or strength of the incoming electrical impulse. A weak incoming signal (voltage) applied in varying strengths to the grid, is able to control a large amount of outgoing plate current. Because this strong plate current is a powerful duplicate (controlled by the grid) of the original incoming signal, the tube is called an amplifier.

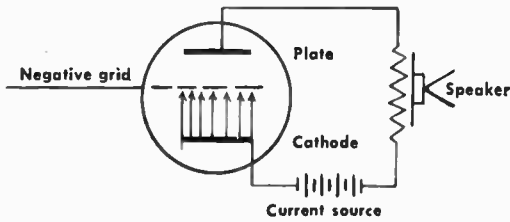

Radio waves are caused by electrical vibration, whereas sound waves are air particles set in motion by physical action. Both travel in all directions. Radio waves move at the speed of light or 186,000 miles per second. Sound travels at the rate of 1090 feet per second through the air.

Radio stations generate electrical vibrations on their assigned frequency (640 kc, etc.). These oscillations are broadcast into space from the station antenna. The radio signal received by your antenna is of the order of a few microvolts (millionths of a volt) and must be amplified through several stages to be useful. In standard AM broadcasting (amplitude modulation) the strength (amplitude) of the carrier wave is varied, but the frequency of the wave always remains the same for each station.

**Standard AM broadcast waves**



Unmodulated radio frequency (RF) carrier



Audio frequency (AF) modulating wave from microphone

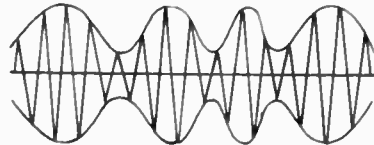

Amplitude modulated (AM) RF wave as broadcast

In FM (frequency modulation) the frequency of the carrier wave is varied, and the strength (amplitude) remains the same. The advantages of frequency modulation are a wider range of tone reception (notably at the high end of the sound spectrum). The dynamic range is greater (the difference in volume between loud and soft passages is nearly identical to the original), and there is no compression effect or loss of extremely high or low notes.

**FM broadcast waves**

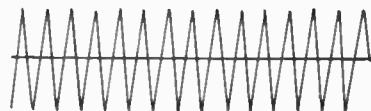

Unmodulated radio frequency (RF) carrier



Audio frequency (AF) modulating wave from microphone

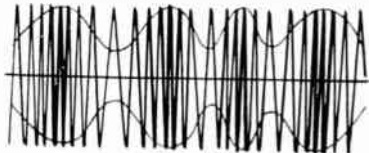

Frequency modulated (FM) RF wave as broadcast



*Although musical instruments produce only a narrow range of tone, their overtones and harmonics create the timbre and presence we associate with a fine composition.*

ZENITH RADIO, CHICAGO

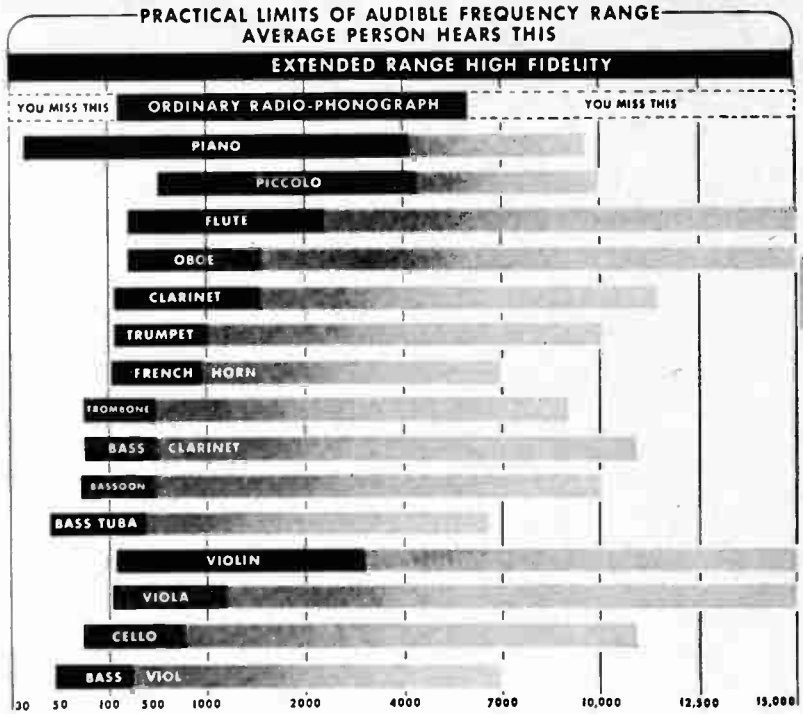

Record making could begin when a person talks into a microphone. Sound waves pass the lips to enter a microphone, where they are duplicated in electrical impulses. These extremely small electrical impulses from the microphone pass through an amplifier from where they are transmitted to a cutting head. Action of a cutting head is similar to action of a microphone in reverse. Instead of vibrations being translated into electrical impulses, electrical impulses are translated into vibrations of a cutting *stylus* (needle) on the blank record. As the record revolves under the stylus, the stylus vibrates from side to side and cuts the blank in accordance with the original sound signal which has just entered the microphone. In this way a master recording is made.

A phonograph consists of a revolving turntable, an arm and phonograph pickup. The pickup with needle (cartridge) follows grooves in the record and acts as an electro-mechanical reproducer of wavy variations in the grooves. As the needle rides in the groove it vibrates from side to side. This vibrating needle is mechanically

coupled to a crystal element, or movable coil suspended within a magnetic field. In either unit, vibrations of the needle create small electric impulses. The audio signal (electrical impulses) from any cartridge is an exact reproduction of the original signal which moved the stylus cutting into the record. The low level audio signal from the phonograph pickup is fed into an amplifier, then to a loudspeaker.

A speaker translates the powerful electrical impulses from an amplifier into sound. It consists of a frame, cone, and a voice coil which is suspended within a strong magnetic field. As the audio signal passes through the voice coil a new magnetic field is set up around the voice coil. This in turn reacts with permanent magnets contained in the speaker, causing the voice coil to move the center of the cone in and out, like a piston. These piston-like movements of the cone set the surrounding air in vibration. The result is reproduction of the original sound vibrations which started far back in the electronic chain of a home music system. ■

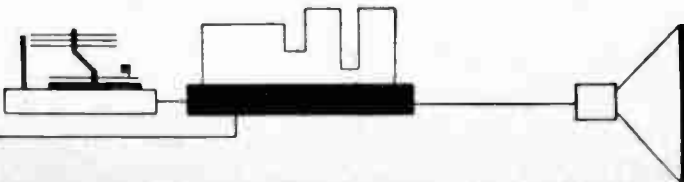

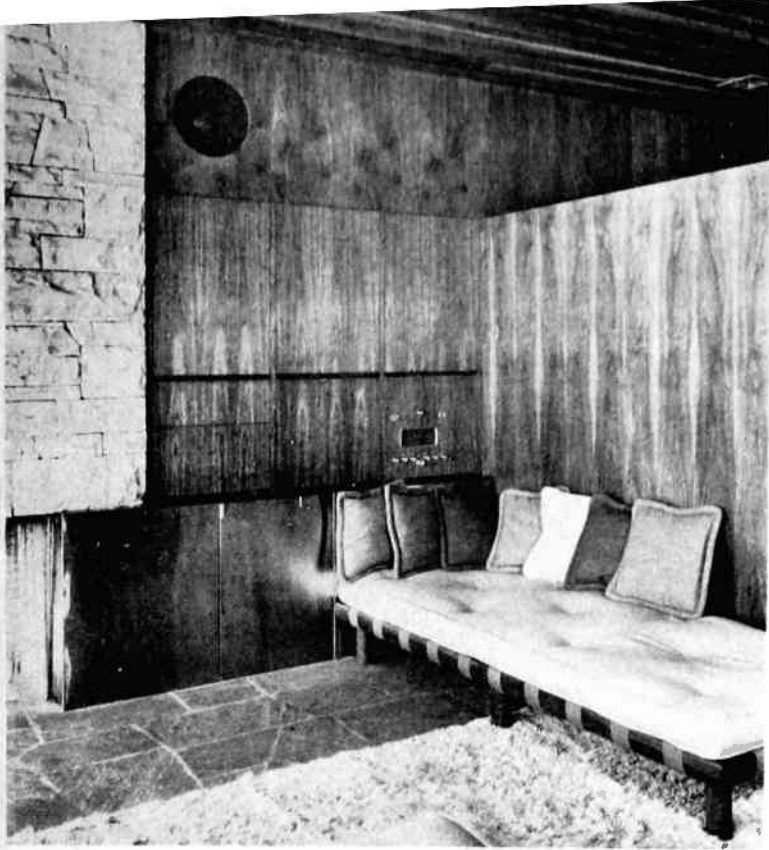

Weingarten Electronics, Los Angeles 46

### *contemporary modern*

**A**N UNUSUAL and attractive Hi Fi installation in the contemporary mood. The tuner and amplifier controls are within easy reach for a reclining listener, while the brass-finished knobs offer an accent note to the naturally finished tropical hardwood panels. The three panels above and to the left of the control panel swing open to lots of record, or what-have-you, storage space. A small gap between upper and lower panels supplies convenient hand grips to open the upper or lower invisibly hinged doors.

A record player is located to the extreme left of the wall, next to the stone fireplace, and behind the lower split door. This makes it simple to change a stack of discs only one or two steps from the couch. Or, if you're across the room, it's not necessary to climb across the couch to reset the player.

Here's another installation with the high speaker location that's becoming so popular. In this case, the large extended-range speaker supplies a decorative balance for the control panel in the corner.

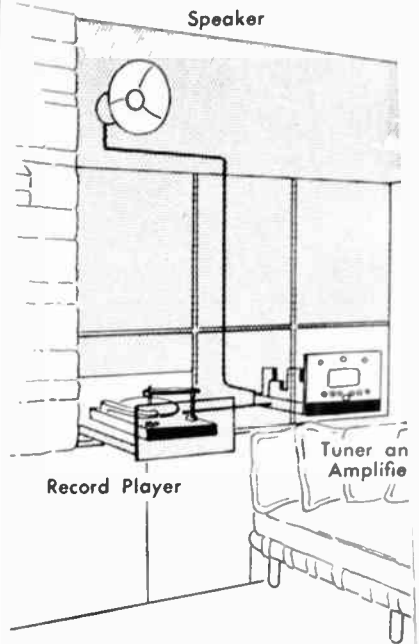

# HOME MUSIC

Even more important in this installation is the need to spread music throughout the most lived-in area of the house. The board and batten ceiling should diffuse sound sufficiently to avoid any "hot spots." A low partition between room areas permits sound to flow into other sections, bringing pleasure wherever you may be. Serious consideration of this corner, other than just as a Hi Fi installation, discloses some often overlooked decorative principles important to contemporary architecture and furnishings. Utilizing three basic art expressions (form, color, and texture) the architect and decorator have created a rare example of the three-way harmonious combination.

Smooth stone flooring is tempered by a rough-textured rug, while mellow-toned wood panels furnish color and texture. The rough fireplace stone contrasts with both the floor and lovely natural copper wood-box doors. Rectangular forms are broken by a well-chosen location of the speaker circle, plus the conversation producing pattern of Hi Fi controls. This is truly modern living at its best . . . living that is completed by perfect reproduction of perfect music. ■



## apartment wall

IN THIS APARTMENT, where space was at a premium, the entire wall area has been utilized with a "building-in" technique. Here the High Fidelity home entertainment center provides room for music and entertainment without crowding. Immediately above the television set are extended-range, high-quality speakers which flood the room with perfect musical tones from either record, radio or television programs.

The television set may be slid forward on concealed tracks for servicing or removal. An unusual automatic phonograph operates by remote control, and will play up to 200 selections with one loading. It, too, moves forward on concealed rollers for servicing, lubrication, or necessary adjustments. The use of louvers both above and below this

installation assures an adequate flow of cool air for ventilation, a factor which should not be ignored in the installation of your unit. When the two louvered doors are closed, the entire unit is concealed from view. In turn, it should be pointed out that the upper portion may be opened for television viewing without disturbing or exposing the record player.

To the left of the couch, in a dark table-high cabinet, is the tuning mechanism for both television set and record player. Both of these may be turned on with touch-plate switches, reducing the effort of providing home entertainment to a bare minimum. The upper portion of this control cabinet uses an AM-FM tuner with preamplifier section incorporating the basic volume, tone, record compensation, and input controls. Through the use of connecting cables, this control cabinet may be placed anywhere in the room. ■

IV

# INSTALLATIONS

*Mintborne Music Co., Los Angeles 6, Calif.*

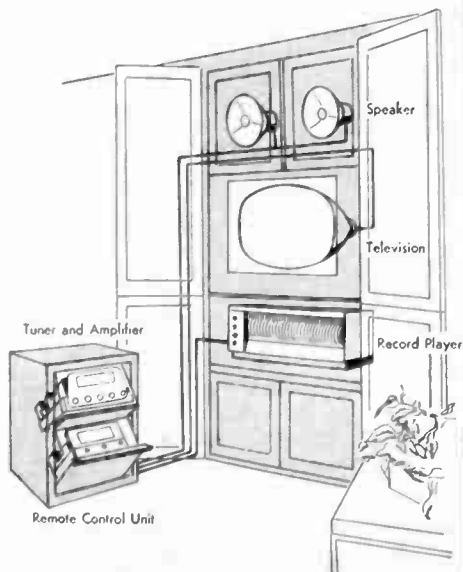

## hidden amplifier

MANY HOME decorative treatments do not provide room for either speaker or amplifier installation. Yet, the true Hi Fi fan finds it desirable to maintain the quality of his music. In this home the speaker is located behind the center grill of the bookcase at floor level. The amplifier has been mounted under the floor of the house and is accessible through the basement. Adequate ventilation is supplied by currents of cool air beneath the floor.

The control system for this unique home music center is located in the top of the shelf in front of the right hand bookcase. Radio, tuner, amplifier and record player may be all controlled from this one central position. With careful planning, this home music system has provided the ultimate in entertainment, while in no way detracting from the charming decorative scheme. ■

*Stephens Tru-Sonic, Culver City, Calif.*

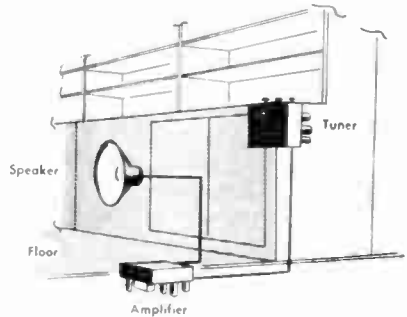

## decorator styled

ORIENTAL touches provide a modern background to an evening of relaxation for young career women in this bedroom decorated by Eleanor Lee, American Institute of Decorators. A corner panel not only contains the obvious television set, but also has a player and amplifier. The speaker for

this interesting home music installation is behind a grill cloth located immediately above the television set. The black statue in front of the speaker in no way destroys the sound quality. Grill cloth is the same color as the walls, and creates an impression of solidity not often found in such installations. An interesting feature is that the television set is at eye level when viewers are seated on the couch. ■

*Metropolitan Living—1954; Eleanor Lee, A.I.D.*

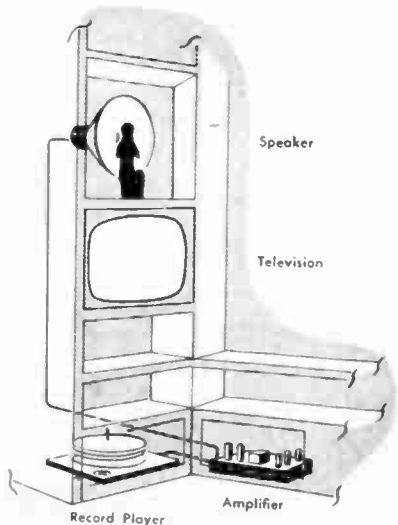

## *practical tv*

WITH AN AMAZING variety of interesting programs being offered on television today, the viewer can be kept busy of a quiet evening running back and forth from a favorite chair to the dial. This unit provides a practical, and yet within reach, answer for those who enjoy their well-earned, end-of-the-day comfort. Remote control television units are skyrocketing saleswise every day. By this same token, unit prices are gradually being reduced to within a few dollars of standard receivers!

Today remote control viewing has become common in many new homes. This installation is one of the most original and clever disguising methods for what is normally a big slab of cold glass. Placing the business end of the television set in a closet or in the next room with sufficient camouflage, is not only decorative, but practical; and certainly a natural for remote control installations.

Utilizing a series of handsome black and white photographs previously mounted by the home owner on an otherwise uninteresting wall, the designer shuffled pictures about to place the largest directly over the best screen location. Mounting this picture on a plywood backing and hinging it to the wall solves the "cold glass" look for this viewing area. The plywood backing panel is held in place by a magnetic latch when the set is not in use.



*American Music Co., Los Angeles 13, Calif.*

A large speaker is mounted in an attractive contemporary cabinet just below the hinged picture. Although the grill cloth presents a good-looking frontal appearance to the speaker cabinet, perforated composition board doors have been added to complete the appearance of the "package."

All necessary controls for television are contained in a novel and unobtrusive natural finish wooden unit at the finger tips of the viewer. An arrangement such as this might easily include a remote control unit for a Hi Fi amplifier. This would provide the audiophile and videophile with what's best known as "easy living!" ■





## *a man's room*

HERE'S A ROOM that typifies good living with a masculine touch. It's for the man who appreciates life for the sheer pleasure of living with fine things: such as good music, good food, fine art . . . the mellow bookish scent of antique leather and the lines on every page between.

Appreciating all these things, but ignoring them for the present, let's examine the music system. It's difficult to imagine anyone who would not be satisfied with these components just as they are arranged here: a remotely controlled television set, an AM-FM tuner and amplifier, two record changers, and a large speaker enclosure.

The television set is connected through the tuner and amplifier to produce the best fidelity possible, but here we encounter a shortcoming. As the television set uses the music system's speaker, there will be a great

deal of separation between sight and sound. However, some persons are not as susceptible to this lack of direct audio-video relationship as others, and it may not be a major fault to the listener.

The tuner and amplifier are placed in a practical, if not too convenient, location for the lady of the house. But, as so many housewives perform their daily chores to a pleasant background of FM music, there is little need for set or station adjustment more than once or twice a day.

A touch of efficiency in the record player arrangement should provoke some thought. Although a three-speed automatic changer is installed in the lower cabinet, a 45 rpm changer in the same compartment permits alternate playing of varied speed records. One is not continually changing the center mounting post of the three-speed unit between the thick 45 rpm post and the slender LP or 78 rpm post. With such excellent 45 automatic changers available at very low prices, it might pay to duplicate this arrangement if you have a large collection of records at all three standard speeds.

All components of the system are covered by swinging cupboard-type doors when not in active use, presenting a neat, attractive, and conservative front to the non-musically minded guest or inquisitive child who might enjoy turning pretty knobs. ■

*American Music Co., Los Angeles 13, Calif.*

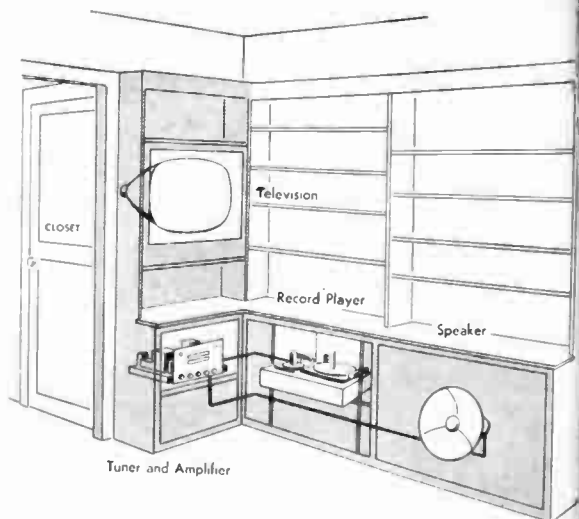

## *movable wall*

THIS RELAXED living room atmosphere features decorative grouping for tele-viewing, listening to music, and friendly conversation. With all of these desirable features, this apartment is conducive to the finest in American living, superior in many ways to so-called well-decorated homes. It is of interest that the entertainment wall is not a part of the permanent structure, but has been built in without alteration to the apartment building.

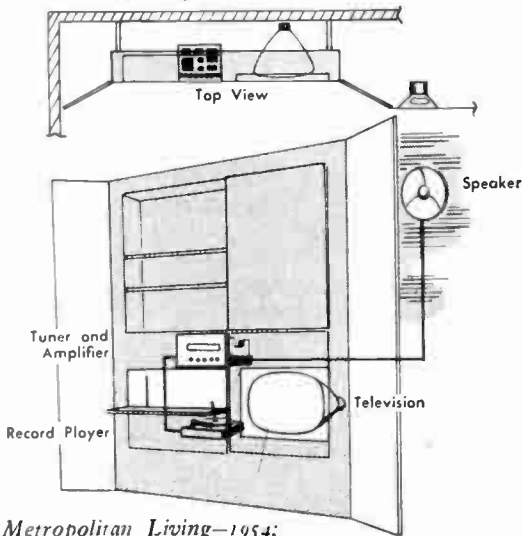

*Metropolitan Living—1954;  
Schneider-Garnier, A.I.D.*

Standing as it does free from a permanent wall, the back of this unit has supporting braces for the remotely controlled television set. However, in other installations this could very easily be a standard table model television with the controls projecting through to the panel. The record player sits below the level of its concealing door. When this door is dropped (to expose the player) it also serves as a writing desk, or convenient place to lay records in the process of loading the changer. Above the record player has been installed the AM-FM tuner and matching amplifier controls. The power amplifier is to the left of the tuner behind a non-opening false door.

Immediately above are shelves for records and decorative art objects, all of which may be covered or exposed, depending on the evening's mood. The false wall behind the table lamp on the right is only a bamboo curtain hanging from a bracket near the ceiling. Behind this curtain, and separately mounted in an unfinished wooden cabinet, is the high quality extended range speaker. The bamboo screen serves to disperse the sound and create an illusion of space.

This design of a movable wall, and its many magnificent features, is applicable to the most modest apartment or home. It should be given serious consideration if you pay rent. Additionally, for the non-music enthusiast, the same wall could support book shelves, or dark room equipment. ■



## colonial beauty

A TWO-WAY installation, television and record player, that re-creates memories of Colonial elegance. Using a hard-to-decorate short wall between the fireplace mantel and a hall door, the owner set a good example of what to do with this odd space.

The butterfly-type shutters fold back to expose a large screen television set mounted somewhat higher than average, an automatic record player, amplifier controls, and an obvious low-mounted speaker.

Before you criticize this installation consider the many problems. There was a very small amount of lateral space available, so the arrangement had to be vertical. This presented another problem—what should go where? The television set was placed at the top of the panel as upward viewing, within reason, is not objectionable. If you think it might be elsewhere, take a closer look at the location of the television set in your favorite pub or friend's home.

There was little dispute over the record player location as far as convenience of operation was concerned. It went into the center section of the panel.

This left the bottom third for the speaker installation, which is another speaker location that fools the eye. Although appearing to be extremely close to the floor, the distance between the speaker center and the floor is only slightly less than the same

speaker would be in a floor-standing enclosure. The amplifier controls were placed between the speaker and record player.

Television sound is routed through the amplifier and speaker; another reason for speaker location. When incorporating an existing television set into a Hi Fi sound system, never forget the possibility of an unhappy placing of the speaker so as to completely disassociate sight and sound.

A speaker above or below the television set offers little chance of sight-to-sound disturbances, as the ear has only very slight sensitivity to vertical displacement of sound, but a great amount of sensitivity to any lateral displacement. To balance this unit decoratively, an identical shutter on the opposite side of the fireplace conceals a small service bar.



American Music Co., Los Angeles, Calif.

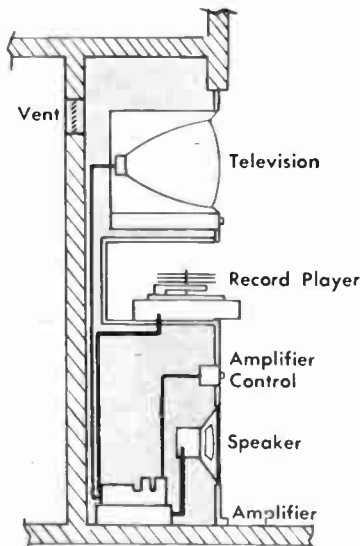

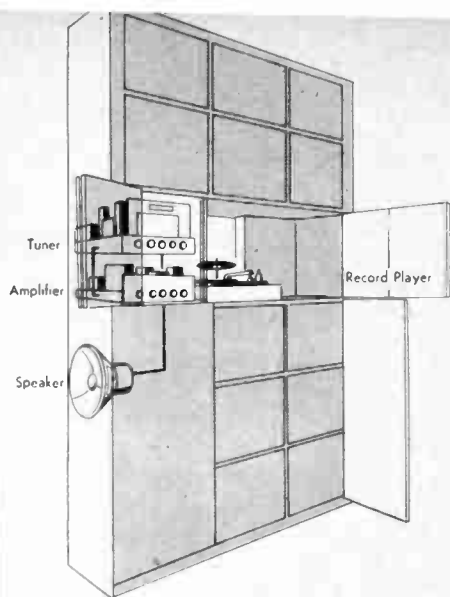

American Music Co., Los Angeles, Calif.

IV

### *bookcase remodeled*

ANOTHER OUTSTANDING example of the remodeled bookcase treatment in a delightfully furnished and designed home.

The two top shelves and their vertical dividers have been left untouched with the exception of some additional horizontal bracing under this area. The same holds true for the three lower shelves and their vertical dividers. But let's see what's been done to the equipment shelf and why.

Both the AM-FM tuner and amplifier have separate controls, the tuner being mounted above the amplifier unit at the outer edge of the cabinet. This puts all controls up at an easy handling level for the average person (and viewing, too, when one is station-seeking).

The record changer and player location is equally convenient. Give this some thought when planning your unit. Many Hi Fi installations are beautifully planned, constructed and deliver top performance. But some changer-player arrangements leave a lot to be desired. Low positioning of the player is inconvenient for a person of average height and should be avoided, unless physical properties of the cabinet prevent use of another location. Besides, the most gracious host or hostess is not usually at best advantage while bent over or squatting.

Two very special, but simple, touches turn the record player into something out of the ordinary. A small light brightly illuminates the turntable area, and a pull-out



board below the changer shelf furnishes a temporary resting place for records being stacked on or removed from the player. Often-played selections are stored to the side of the player, while albums and books of single records are stored above and below the "music shelf" of Hi Fi components.

The speaker is located at what appears to be an unusually high position. Actually, the floor to speaker distance is nearly identical to a standard floor cabinet. A permanent (screw-mounted) "door" covers the speaker enclosure, while butterfly doors before the equipment shelf prevent interesting language from the casual stroller. A note of caution—watch out for those double doors when they are wide open! ■

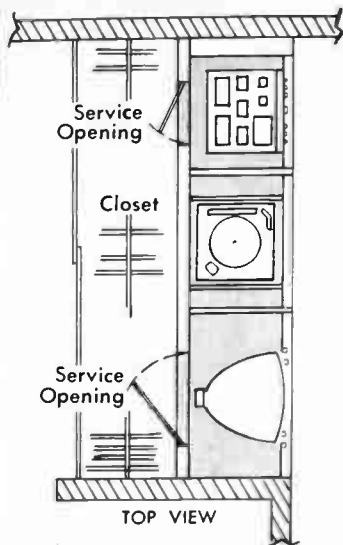

## *new sound and old wood*

THIS IS a perfect example of the "new sound" in home music adapted to the "old look" in interiors. Whether your home is Early American or Western Ranch Style, this installation will blend magnificently; another unit that may be built in when you plan your new home, or just as easily installed in an existing knotty pine wall. Utilizing a complete home entertainment system, AM-FM tuner, record player, and television, this music wall will bring hours of pleasure to its owner.

Each component is a part of the whole, yet may be played separately with the remaining units out-of-the-way behind closed doors. The record changer may be loaded with favorites, the volume control set, and ignoring individual record compensation for purists, you have an automatic concert without distraction from shining dials or spinning turntables. A wealth of storage for records or what-have-you is available under the equipment section of the wall.

*Weingarten Electronics, Los Angeles 46*

The speaker is located above the record player compartment. This high position is becoming more and more popular in installations where floor or cabinet space is at a premium. However, it is close to the television screen so there will be as little disassociation of sound and picture as possible. Disassociation can be very confusing and annoying when viewing television as most programs will appear to be "dubbed"—lip movement and voice will not reach your eyes and ears at the same time. So, if you are no longer using the original television sound system, place the new speaker near to the video screen, if possible.

Although the record changer appears to have adequate access space, this could be considerably improved by removing the vertical partitions on either side of the changer.

An example of good planning is the location of the tuner and amplifier controls. If it is necessary to leave any of the three compartments open, this is the most logical one. It has been so placed as to be the least obvious or disturbing to occupants of the room.

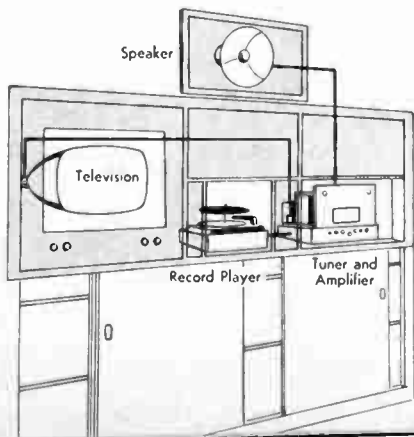



## *if it's rented*

OFTEN a rented home will have adequate shelving for books and knickknacks, which could be easily converted to hold a high fidelity system. All of this conversion can be done at minimum expense and without making structural alterations. Although not obvious in the drawing, there is a television set and tuner hidden in this lovely informal living room wall.

The speaker (immediately below the upper left book shelf) is mounted in an infinite baffle chamber. This chamber is unique in that a portion of it extends up and behind the books. Such an L-shaped enclosure pro-

vides the maximum of baffling space, without calling for alterations of the shelving. Below the speaker are matching doors behind which is a table model television set. This set has been slid into position, and could easily be removed at any time.

The counter top has not been disturbed by the installation of an AM-FM tuner, complete with preamplifier controls. A small drop-front cover at the left of the counter, and beneath the first shelf, hides the tuner when operating controls are not in use. Because the basic power amplifier is remotely controlled, it has been placed at the back of one of the lower storage cabinets, leaving the entire forward area for its designed purpose of household hideaway space. ■

IV



*Altec Lansing Corp., Beverly Hills, Calif.*

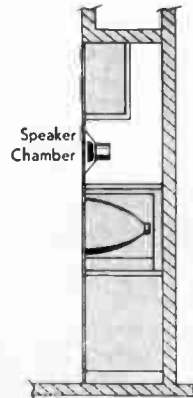
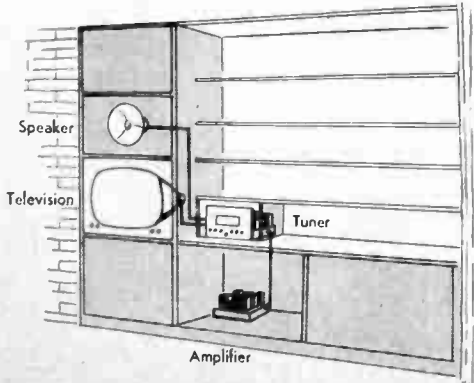



Weingarten Electronics, Los Angeles 46

## for an older home

IN THE OLDER, and quite typical, American home of the middle Twenties, installation of Hi Fi components can become somewhat of a problem. The degree of wood craftsmanship in older homes far exceeded today's average. Extreme care should be taken when any major remodeling is necessary. Many pieces of fine cabinet work are interdependent. One part may be completely ruined by the careless removal of another.

This installation has skillfully avoided any complicated or difficult rework of an old style "built-in." A large storage closet behind the bookcase provided natural access area for the television set as well as adequate ventilation. The tuner and amplifier are also accessible through the closet. As these last two components usually require the least amount of maintenance, they are located to the rear of the closet. If this maintenance factor is disregarded, the location is equally justified from a decorative standpoint—their control panel balances the large solid wood area presented by closed doors of the television set. This effect is brought to the absolute by the let-down door of a record changer, plus the deep mounting board for the changer mechanism. A practical touch to the open television doors is their ability to slide into the wall. This eliminates a dangerous obstruction and provides a clear view for those seated at a slight angle.

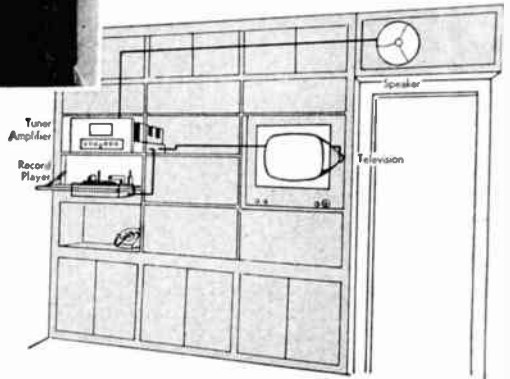
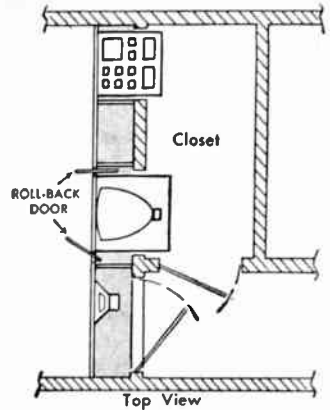

Whether by accident, or a stroke of sheer genius, the telephone location is perfect. It takes little more to drive a music listener into nervous collapse than to rush from room to room, twisting knobs when the telephone rings. With this installation, you merely walk towards the phone, reach up, turn the volume down, and pick up the phone. This item merits some thought in your own layout.

The speaker was placed high over the door, waste space for every day use, but valuable in this case. As all sound, including television, emanates from this speaker, it was necessary to avoid any possible disassociation of sight and sound. The proximity of the speaker to the ceiling has little or no effect on distortion or annoying echoes, and in some cases this location may prove advantageous by diffusing sound down to ear level.

Whether in an open or closed position, the unit is attractive, accessible, offers a large amount of handy storage space for record albums, and is far from complicated for the home craftsman. ■

## and for the new

AS MANY MODERN, popular-priced homes seem to be designed by architects who go overboard on hanging cabinets, this installation is an excellent answer to the question "What'll we do with it?" This music unit is simple, compact, attractive, and eliminates much head cracking on the part of smaller fry.

The sideboard type of cabinet may be included in original house plans, or added to an existing room with little or no difficulty. When the doors are closed, the unit becomes a good-looking storage cupboard and gives no clue as to the "goodies" it contains. It is particularly suitable to period or transitional furnishings where its uncluttered shape requires only finish to contrast or blend with the room.

If the cabinet is built in an existing room, this example points up two important details: one functional, one decorative. Almost perfect usage has been made of nearly useless space under hanging shelves, where a chair would be less than practical. From a decorative standpoint, the cabinet is beautifully integrated by usage of the room's door molding for a cabinet baseboard. A tiny detail, but well worth it.

The extended-range speaker installation is practical and attractive, utilizing existing space to best advantage. Mounted at average ear level, this unit should provide satisfactory performance for the most discriminating music lover.

The interior installation of tuner, amplifier, and record changer is as mechanically simple as the exterior design. All components are easily accessible by removal of the face panels and favorite records are always within reach.

For the home with a long wall intersecting a short window wall, it may pay to give a second thought to this installation, even without a ready-made hanging cabinet. This is tailor-made for the "do-it-yourself" Hi Fi fan who wants an attractive installation, but has neither the time nor inclination to cut more than one hole in a wall. ■

Weingarten Electronics, Los Angeles 46

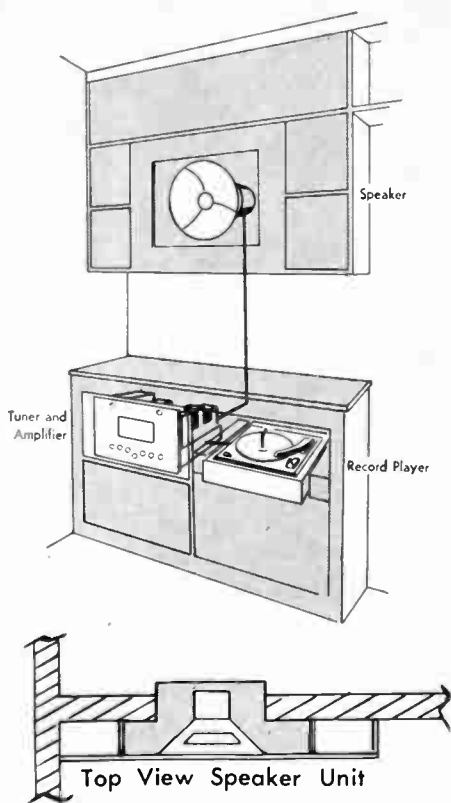

## early american tv

EARLY AMERICAN blends with "Late American" in this remote control television installation. Even the strong light of the photographer's flash fails to spoil the effect of comfort this room presents to a casual observer. Nor does the very large screen TV set destroy the homey "Priscilla and John" period of American decorating.

The television screen has been framed in antique finish, minimizing its size and playing down the "cold glass" effect to a minimum. Planters on surrounding knickknack shelves further push the screen into reasonable obscurity when not in use. The speaker is placed under the set and behind shutter-type doors.

This elegant arrangement should offer some suggestions for your own installation, as many homes have just such a space on one or both sides of a fireplace.

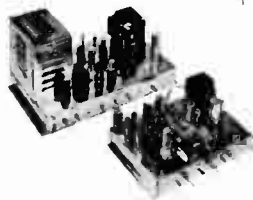
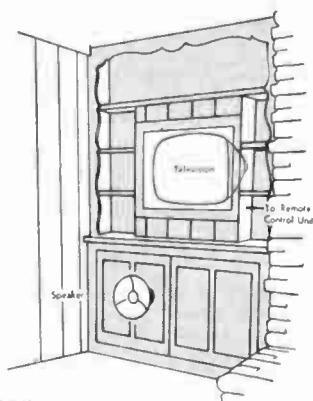

Such an area is usually quite a decorative problem . . . with this arrangement as one answer, providing the rear of the set doesn't project into your neighbor's living room.

Treatment of the "cold glass" look could be carried even further in this installation by placing an appropriate print or lithograph of the period on a hinged plywood panel covering the tube face when not in use. An example of this idea, using a framed photograph, is presented elsewhere in this section of the book.

A remote control unit for the television set can be provided in any decorative form. It may be contained in an attractive box on an occasional table, or, as in this case, built into an end table, completely out of view when not being used.

New models of remote control television are within the price range of most people. Remember, although manufacturers of the remote-type sets will furnish deluxe cabinets upon request, most of their sales are bare chassis, without cabinet, for custom installation. So, in spite of the remote units being available, usually in 21- to 27-inch tube sizes, savings on cabinets bring the sets down to a price competitive with ordinary sets possessing a 21- to 27-inch tube in an expensive cabinet. ■

Douglas Roesch Inc., Los Angeles 7, Calif.



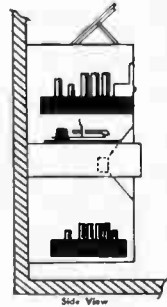
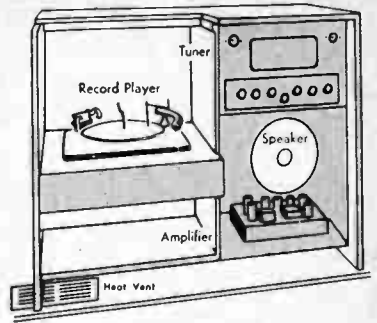
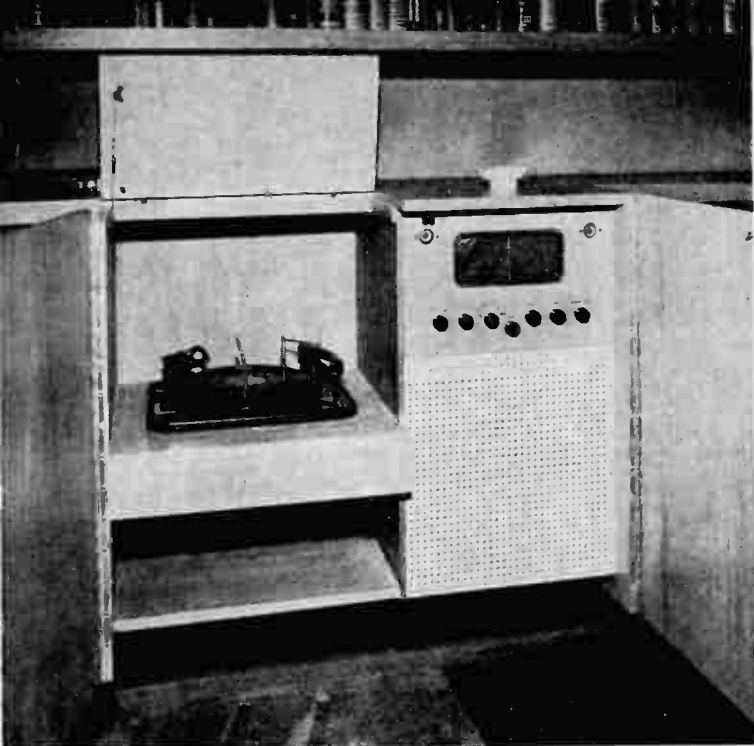

IV

## home craftsman design

A REMARKABLY handsome Hi Fi installation which is both unobtrusive to the eye and accessible to the hand. This unit may easily be built in existing bookcases or planned in the original blueprint stage for "from-the-ground-up" construction.

Beautifully grained hardwood forms the neutrally designed double door panel, as well as the side panels which are visible from the room. In keeping with the idea of unobtrusiveness, even door pulls have been eliminated—a simple procedure with the many new types of cabinet hardware available from builders' supply stores.

While on the subject of hardware, the home craftsman has a tendency to overlook the diversified styles of hinges the local hardware store has in stock. These doors are perfectly mounted with full-length piano hinges for two reasons. In the first place, this is one of the most attractive hinge types from a decorative standpoint; it never distracts the eye from the cabinet to which it is fitted. In the second place, it offers strongest support for open doors in the event some thoughtless person decides to lean on them!

The tuner and amplifier are neatly mounted in the right-hand side of the cabinet, just above the speaker. The record player offers maximum accessibility from both top and sides. Never forget this need for proper clearance around a record player. Many otherwise excellent installations have been made impractical by the discovery that there was insufficient vertical or horizontal clearance to allow stacking of 12-inch discs on some changer models. Ample record storage space is provided in shelves on either side of the unit. A word of caution is necessary if duplication of this installation is attempted under identical room conditions. As the cabinet is mounted just above a room heating vent, incoming warm air will have a tendency to dry out the wood with slight warpage resulting. This may be avoided if seasoned woods are used in construction. The absence of door pulls do a great deal to eliminate curious but tiny hands from the control panel. ■

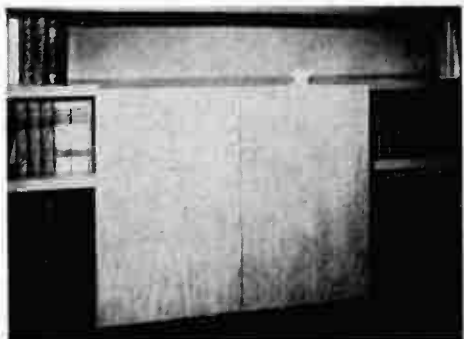

## *the cost was \$18.82*

*By Stan Gordon, courtesy of  
Magnecord Inc., Chicago 10, Ill.*

IF YOU'RE LIVING in the gramophone age, you can do something about it. Take it from a guy who knows nothing about High Fidelity. I know as much about electronics as a new-born aborigine knows of differential calculus, but I built the installation pictured here all alone, without help, advice, example, suggestion, or experience.

The materials (excluding the electronic components) cost \$18.82, which included the wood, hardware and finish. My tools? Just what you'll find in any household.

We had a monstrosity of an old-fashioned, synthetic fireplace replete with mantel, bookcases, etc. It was a useless gas-log affair that was a decorating headache. We never used it either so out it came!

My architectural plans were strictly from the seat of my pants. If you're one who likes a bedtime snack, you can understand my progress. The darnedest sandwiches are invented at bedtime. You just take what

comes natural. I'm not particularly recommending this procedure—merely confessing it as a source of inspiration.

The two pieces of bread for my "Dagwood" home entertainment center were the two bookcases at either end of the mantel. The filling eventually comprised a television set, AM, FM and short-wave radio, a three-speed record changer, a speaker, a Magne-corder, and a panel-control switchboard to govern the alternate or simultaneous interplay of these units.

My solution was panelling. I chose the new combed plywood. It comes in 4x8 foot sheets, of which two were required for my job. I found ¼-inch thickness just what I wanted. For the framework around the cut out panels I used "back-bend." It is cheap and ideal, being machine cut with an inset groove to let you bend it.

For accurate cutting and fitting of corners, a miter-box is a must. If you don't have one, make it. Just nail two 1x3-inch pieces to the sides of a 2x4.

Other purchases will be for brass round-head screws for surfaces that show, assorted



plain flat-head wood screws, brads, nails, hinges. You may latch the doors any way you choose, but I used a magnetic catch consisting of a flat steel strike plate and a magnetized cube with adjustable screw slots. It keeps the panel snug-fitting and rattle-proof, plus easy to open.

For the record changer, you can get a pair of metal motor-board slide-outs, plain for \$1.18, or heavier ball bearing units for \$4.60. The motor-board itself can also be bought ready-cut in either wood or metal. I made my own from a piece of 3/4-inch plywood found in the garage.

For the racks and supports behind the panels and platforms, I used lumber which had also been cluttering my garage for years. For the main platforms, I used slats of 1x3-inch hardwood, spacing them an inch apart for ventilation since the various units generate considerable heat.

The metal grill and grass cloth masking can be purchased in radio parts stores. A piece of metal grill 12x12 cost \$1.76 and a 12x18 piece of grass cloth only 29 cents. —And there you have it.

*Stan Gordon*



IV

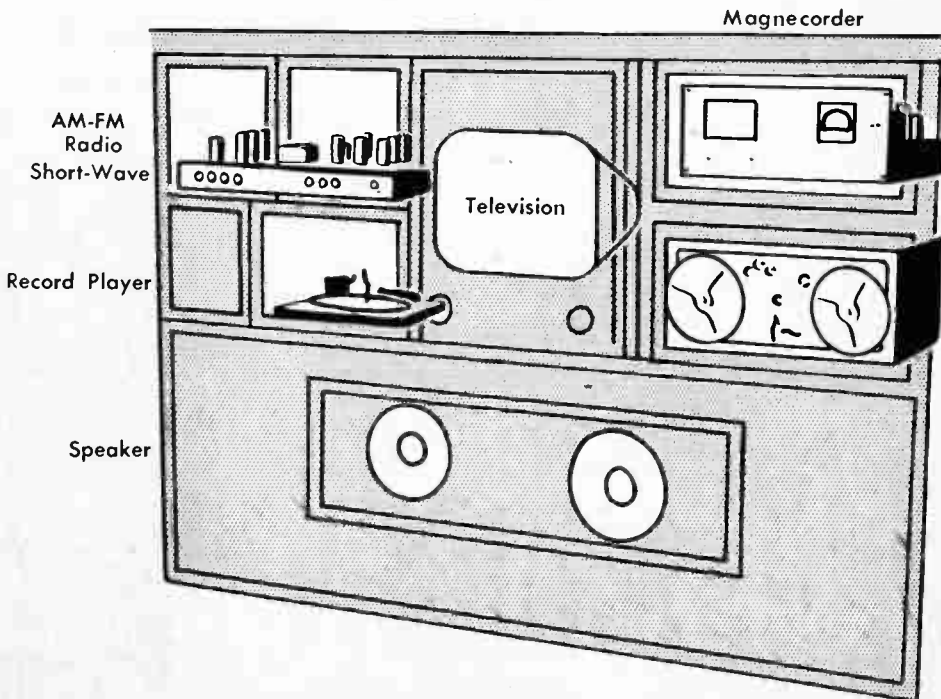



## *module modern*

A MODERN TREND of interior design is the use of module furniture. Basically such furniture is of the same general pattern, design, and shape so that it may be stacked or arranged in any fashion suitable for the decorative scheme of your home.

Now High Fidelity has taken a leaf from the decorator's book, and is using such ensembles in the installation of home music and entertainment systems. The basic units illustrated in this section are a small cabinet, 15 inches high, 40 inches long and 20 inches deep. A larger cabinet is 25 inches high, 40 inches long and 20 inches deep. The only exception to these dimensions is that cabinet housing the television set, which is slightly deeper. Through the use of legs of differing lengths (which screw into prepared sockets) the cabinets may be adjusted to any height, matching that of already owned furnishings in the room.

The cabinet containing a tape recorder and microphone is equipped with tambour doors. This protects the equipment and does away with projecting leaves associated with folding doors. The portable tape recorder is placed on a shelf which pulls forward on sliding rails. By this means, the tape recorder is always in the clear for loading and adjusting, but is thoroughly protected when pushed back into the cabinet. A small cubby-hole to the left holds the microphone, or extra tape and reels for the recorder.

Below the tape recorder is a larger size cabinet containing an automatic record player, AM-FM tuner, and a preamplifier, with the basic power amplifier hidden behind a grill on the right. The automatic record changer base pulls forward on concealed rails for loading and adjustment. The AM-FM tuner and all interconnected apparatus is controlled by the preamplifier section in the base. Dials on the face include controls for volume, treble, input sources (AM-FM, TV and phonograph), bass, tuner, dynamic level, record turn-over, noise suppression, audio range, and record compensation.

A second-type installation has been created by using one large and one small module cabinet. In the smaller cabinet is placed an automatic record changer, an AM-FM tuner and associated preamplifier connected directly to the power amplifier. In the larger cabinet below is an extended range speaker contained in a mammoth infinite baffle enclosure. This combination is ideal for the small apartment, and represents a minimum investment home music system.

Television is often greatly improved by the addition of a suitable high quality speaker. In one of the module assemblies the large television cabinet supports a small speaker assembly of exceptionally high quality. With the speaker immediately above the video screen, there is no disassociation of sight and sound as might occur if the speaker were some distance away. The television set pictured uses a remote control which may be placed anywhere in the room.



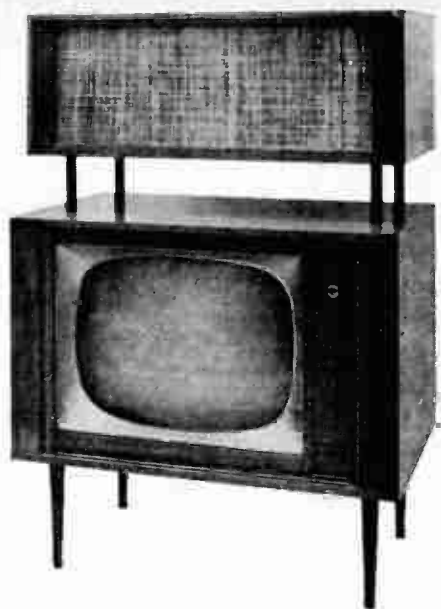

IV

The smaller cabinet may also be adapted (with partitions) to the storage of records or tape reels. Different length legs can be placed under the cabinet adjusting its height for the utmost of convenience or effect. ■

*Gateway to Music, Los Angeles 5, California*

### *a hidden speaker*

CONCEALMENT of the speaker when wall-mounted is frequently a decorating problem of great importance. A more than satisfactory solution is the use of a bric-a-brac shelf already keyed to the decorations.

In this installation a Hi Fi speaker was wall-mounted, with the rear portion of the cone extending into a hall closet. Protective framework already on the speaker eliminated the necessity for protective framing. In addition, the generous-size closet provided an adequately large infinite baffle, giving splendid bass response. On the visible side of the speaker a grill-cloth panel, the exact size of the bric-a-brac shelf and of a color harmonious with the wall, was installed over the speaker. This hid the cone from view without creating any sound distortion. Next, the shelves were mounted solidly in place, over and around the cloth panel. With the addition of decorative ceramic objects and a small planter, the unit became an interesting addition to the home. Here, indeed, is an interesting solution to a problem not easily solved. ■

*Altec Lansing, Beverly Hills, California*

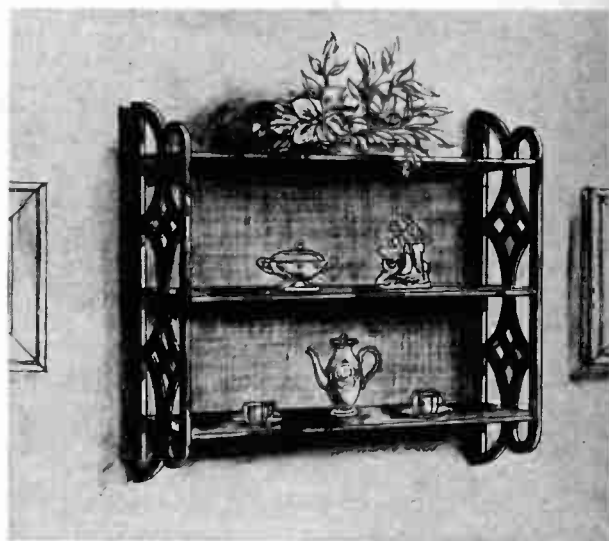

Speaker

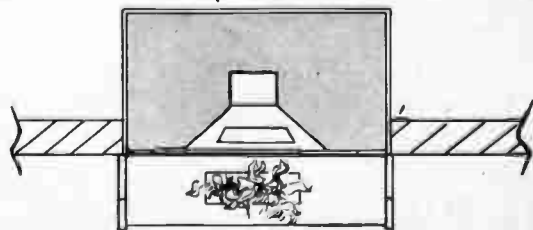

TOP VIEW

## apartment size

PLUSH INSTALLATIONS for apartment dwellers often include every basic component for reproducing sound. In this magnificent example of fine cabinet work, there has been installed an AM-FM tuner (with pre-amplifier), a record player, extended range speaker system, professional tape recorder, with storage space for both records and tape.

The tuner and amplifier installations swing forward on a hinged front plate. This arrangement of controls is easily operated from a standing position, and does away with the necessity of either stooping or sitting. When closed, the tuner is completely covered, and there is no possibility of idle fingers changing the accurate settings, or damaging equipment.

The tape recorder has been mounted in a drawer-like cabinet. This slides forward on ball bearing rails so that maximum usage may be made of the equipment. By closing the drawer when the tape recorder is operating, all miscellaneous machinery sounds are contained within the cabinet. The speaker then introduces into the room only harmonious sounds from the tape recorder, radio tuner or record player. The microphone is for production of home-recorded tape programs. ■



*Magnetic Recorders, Los Angeles 46, Calif.*

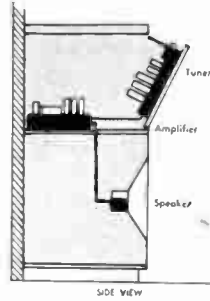

## for the large home

WALL TO WALL book shelves are ideal for the installation of automatic record playing units. In this lovely home a player has been installed in shelves immediately beneath the book shelves. The amplifier unit is mounted behind the record player which pulls forward on concealed rails.

A feature of this particular installation is the numerous remote speakers. Each room of the house has its own speaker, complete with volume control. In addition, the pool area and tennis court have outdoor speaker installations. Such a grouping of speakers in the large home could be used for calling members of the family by using the amplifier as an inter-com system. ■

*Mintborne Music Co., Los Angeles 6, Calif.*



## *bass reflex wall*

A NEW UNIT, in the unfinished state, with several interesting details including magnetic latches for upper and lower doors.

The outstanding feature is a bass reflex speaker mounted above the changer compartment. This is used only as a monitoring speaker for tuning, etc.; the actual playback speaker being in another room. However, bass characteristics of the monitoring speaker should be nothing short of fantastic! The air column extends from the top of the speaker enclosure, behind the storage and player compartment, amplifier and tuner panel, finally venting through four slots just above the floor.

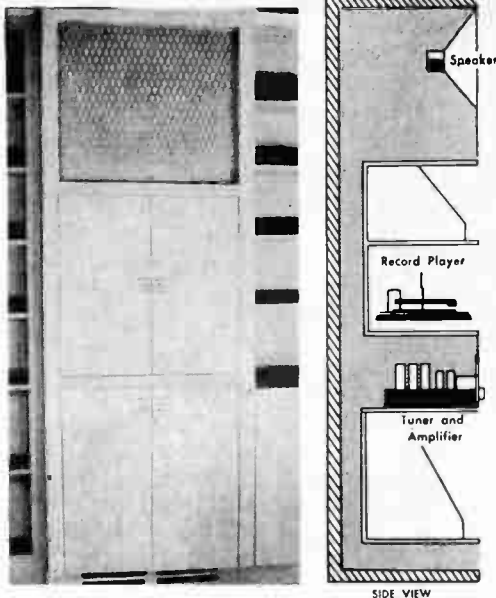

IV

*T & W Electronics, Inglewood, California*

Plenty of record storage area is provided above, below, and on the sides if necessary. Another Hi Fi trend becoming quite widespread is the usage of a record player compartment rather than a sliding-type drawer. One obvious advantage is the amount of working room available around the player, plus eliminating the chances of someone pulling out the drawer while a record is playing. This saves wear and tear on valuable records.

For the Hi Fi fan who enjoys extended sessions of FM music or drama, and revels equally in large stacks of long-playing records, the monitoring speaker is a great asset. If a monitor setup is considered in original planning of a home music system, it's often convenient to place the entire assembly in some out-of-the-way location. In this manner it's possible to establish a program you would like to hear, or records you want to play, without twisting dials and annoying yourself or guests with the noisy tumult that usually results.

By using a monitor speaker, the entire unit may be kept in a closet, eliminating much expensive cabinet work, lost floor space, etc. It's a matter of personal opinion as to which you would rather have, convenience or the "wired music" effect. ■

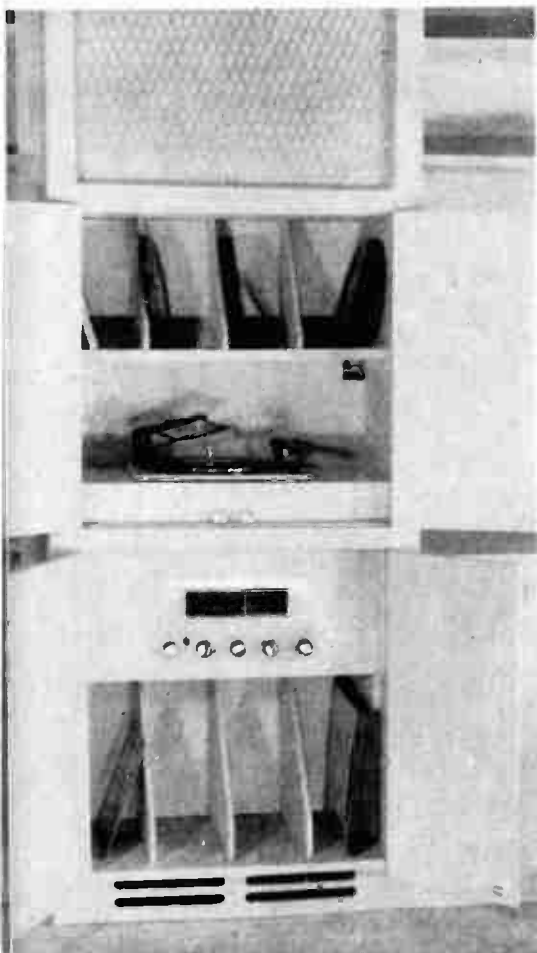



California Sound Products, Hollywood 46

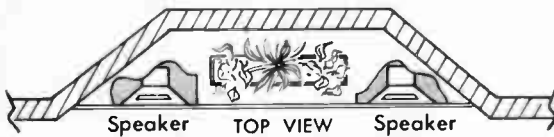

## heirloom remodeled

OFTEN a fine home is graced by a priceless heirloom, such as this commodious buffet, which is no longer usable for the purpose it was designed to serve. Without altering the exterior and destroying the magnificent lines, such a unit can be converted to serve as the basis for a high fidelity home music system. None of the charm of period design is lost, and the numerous shelves and doors admirably serve the purpose of concealing electronic components.

This installation has a single extended range speaker behind louvers in the central upper portion of the cabinet. The sound is deflected downward by wooden slats, and is not thrown throughout the room. The two small doors in the central portion of the cabinet conceal an AM-FM tuner, the amplifier and its attendant controls, plus an automatic record changer which slides forward on concealed ball bearing rails. This entire assembly of audio components is at eye level for a person of medium height. The two larger doors in the central section of the cabinet are for storage of records and other material used with this high fidelity system. The remaining doors and shelves are catch-alls for the necessary adjuncts of modern living. ■

Atec Lansing, Beverly Hills, California

## bay window beauty

MANY an older home has a decorating problem in the once-favored bay window. No matter what furniture is selected, modern decorative schemes seem to do little for such an odd-shaped space.

One possible solution is that shown here. A remote control television set has been mounted behind a charming wooden frame. To each side of the television set are high fidelity speakers providing a broad area of sound. The entire top of the cabinet is decked over with beautiful hardwood, and a matching wooden planter.

Control of this unit is from the opposite side of the room where comfortable chairs have been placed to enjoy television viewing at its best. It may be of interest to consider the same design possibilities as applied to standard table model television sets. There would be few problems in creating a charming cabinet, leaving the front control knobs for manual operation. ■

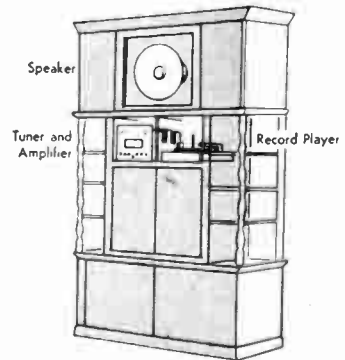

## home entertainment—plus

PERHAPS YOU ARE the person who listens best with low flames from a brick hearth reflecting on highly polished, mellow-toned wood. If so, this cabinet is for you. The atmosphere created by music is often spoiled by disturbing elements in the room's furnishings, but this installation seems to complement fine reproduction of good music in a comfortable home.

If this cabinet were to be constructed by an expert cabinet maker, its cost would be rather high, but a highly skilled home craftsman will consider it a challenge. It is well within the realm of ability for the serious amateur woodworker.

There are probably many readers who will look closely at this unit and wonder why they ever sold (or otherwise eliminated) an identical family heirloom! In the not-too-distant past, this type of cabinet took many forms—bookcases, desks, sideboards, etc.—before losing its popularity. But, if you are among the lucky few who have preserved the valued heirloom with loving care, and wonder where to put your modern Hi Fi equipment in a traditionally furnished room, dust it off, clean it out, and go to work.

The entire inside shelving has been removed and carefully redesigned to accommodate new components. The horizontal divider below the TV set and bass reflex speaker, was reinforced to support the heavy TV unit (which extends into the far room),

*American Music Co., Los Angeles 13, Calif.*

a detail to remember when custom-mounting a television chassis.

All original vertical partitions were removed and new ones constructed where necessary. The speaker is close to the TV screen. Cabinet width of the table model television forced installation of changer, tuner, and amplifier at the next lower level. Below these is reasonable storage space for record albums. On either side of the main cabinet, original bookcases have been retained for their designed use.

The double doors merit some mention. Due to the extreme width of the restyled center case, dutch-type, butterfly doors were the obvious answer to avoid large, unwieldy and difficult-to-support panels.

So—if you lean rather heavily to traditional furnishings, dig out that old catch-all and go to work. ■

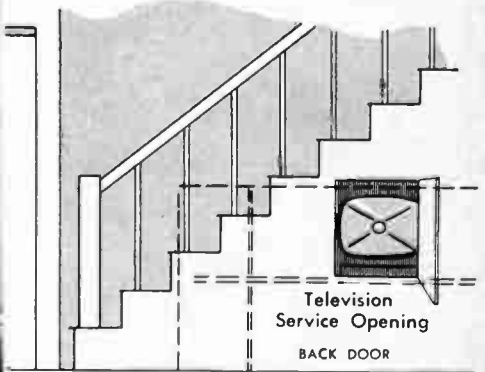

## *a room divider*

AS HAS BEEN shown by the illustrations in this section, a home music set-up lends itself to any type of home. Yet, it seems to become peculiarly well situated in the contemporary surroundings so popular with young builders of new homes.

This installation, in a modern home, has several outstanding answers to installation problems. The tuner, amplifier, and record player are artfully concealed by a natural-finish wood panel built into the end of an always practical storage wall. The access door to the Hi Fi components is located well out of the reach of small children. Even if a child could open the door, the tuning controls are still out of their reach. (Please don't misunderstand the editors and think that because we mention the importance of keeping things out of their reach, we hate all little people. Remember small hands are busy and curious . . . as damaging to themselves as they might be to delicate equipment!) A considerable amount of storage for favorite records is available below the changer base, and abundant open area surrounds the installation.

A large-screen television set is installed on the opposite side of the step-down entry. The set does not use the tuner as a part

of its sound system, but retains the manufacturer's original system. This installation appears to have another less obvious advantage for home entertainment. The television set has been installed to swivel 180 degrees to the rear when the lower living area is occupied and a favorite program is on the screen. It's not as complicated as it may seem, and should give you an idea or two if you have an unusual wall or low partition in your home.

As has been pointed out previously on these pages, medium height room dividers or low partitions offer wonderful opportunities for filling your home with music. This was an important acoustic consideration when placing the large speaker in a hall closet with its wall outlet facing two rooms and a 15 cubic foot enclosure backing it up! An installation, unique in its simplicity, superb in its performance. ■

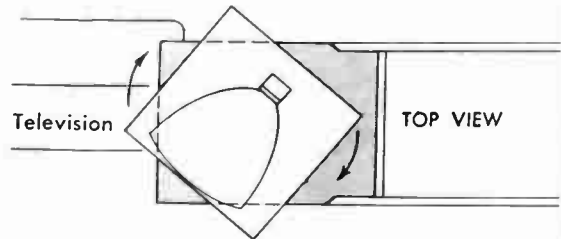

*T & W Electronics, Inglewood, California*



American Music Co.,  
Los Angeles 13, Calif.

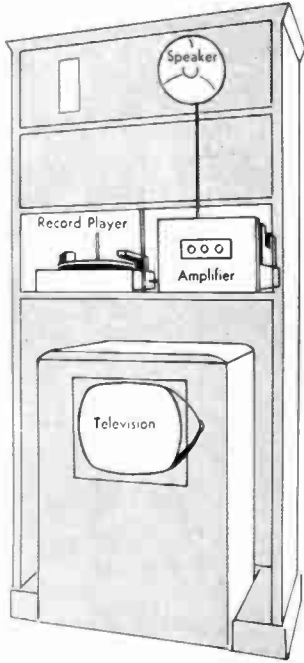

IV

## *simply good*

LEAST EXPENSIVE of the many installations photographed for this book, is this unit which makes use of a normally unfortunate corner in an older house. Clever design and attention to detail has created a simple audio-visual entertainment center which is more than satisfactory to the home owner and music fan.

About \$35 was spent to build and finish the cabinet work. Attention to detail included wooden molding which exactly matched that already in the house. In the upper portion of the cabinet a heavy plywood panel was cut to hold an 8-inch extended range speaker, and slotted to create a bass reflex enclosure. The small size speakers sell for around \$15. The next shelf was prepared for record storage, and the one below for player and amplifier. An inexpensive amplifier was installed, with all controls mounted on the front of a solid panel.

The 3-speed record changer has been placed in a deep drawer with open sides. Sliding forward on concealed rails, this unit is at working height for all adults. Mounted as it is, the fine records and delicate player are safe from childish investigation. The standard console television set is scheduled for replacement at a later date. Therefore, adequate space was left to insert a larger unit for color reception.

In this installation the television set uses its own speaker so there is little disassociation of sight and sound. The record player and amplifier make use of the high fidelity speaker in the upper portion of the cabinet. The heating grill at the base of the right hand wall will not create any problems with the electronic components or the records, as it is adequately separated by the right side of the cabinet.

Here is a unit which emphasizes our point . . . that High Fidelity need not be expensive if imagination is the main ingredient of your design. ■

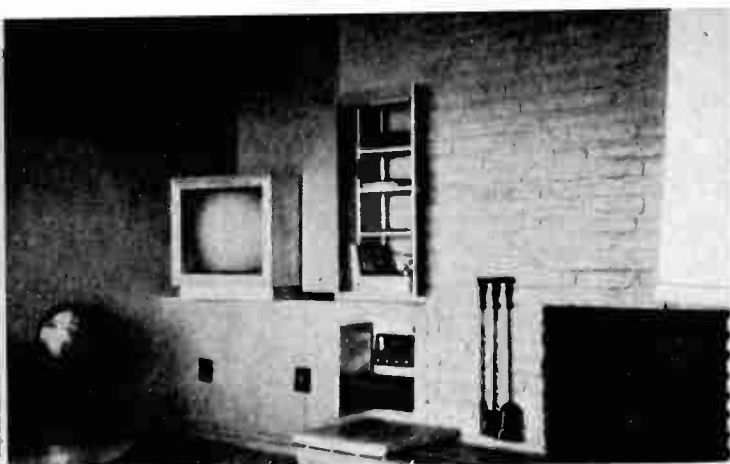

*T & W Electronics, Inglewood, California*

## *fireplace with music*

CONTEMPORARY HOMES, with their magnificent slumpstone fireplaces, are splendid opportunities for modern design in the installation of a High Fidelity home music system. Successfully illustrating the possibilities of today's modern home, we find a remote control television set mounted on a swivel platform which permits its being turned to face the maximum audience.

To the right of the television set, in a wall cabinet, is an automatic record changer, above which are shelves for record storage and changer accessories. The panel door for this cabinet opens, and then slides inward so that it does not project into the room. At the top of this cabinet is mounted an extended range speaker, projecting sound into the room through a grill which matches

## *bedroom television*

ONE END of this unique bedroom features a liquor cabinet with facilities for television, AM-FM radio, a High Fidelity record player, bar, and book shelves.

In this unusual installation, several small speakers have been mounted behind a narrow grill below the television screen. Although this screen is somewhat lower than eye level, it is not uncomfortable to view over long periods of time. To the right of the television screen is a closed cabinet behind which are the radio, tuner, record player and amplifier installations. In this type of home music system, either television or records may be used independently of each other, or completely closed off from view. An excellent coaxial High Fidelity speaker installation is behind the light-colored drapes. They are of a loosely woven material which

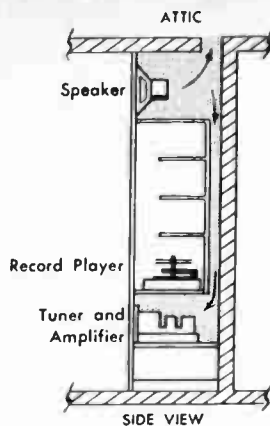

the interior color scheme. A unique feature of this speaker installation is a rear opening into the attic. Inasmuch as the attic is lined with rock wool (for heat insulation) it also is a non-sound-reflecting chamber. Such an enclosed chamber is known as an infinite baffle, and being of attic size produces the optimum backloading effect. The result is nearly perfect sound reproduction by making use of a basic home construction feature.

Beneath the record player, mounted into a wall cabinet, is an AM-FM tuner and preamplifier control section. A power amplifier has been placed behind the tuner through which it is controlled. Ventilation for the power amplifier is provided by a false back in the record changer cabinet area. The false back vents into the attic providing an adequate flow of cool air which increases the life of electronic tubes. ■



*Metropolitan Living 1954,  
Miriam Whelan, A.I.D.*

does not absorb sound waves, yet conceals the speaker from view. Here again we find an apartment decorative scheme which makes excellent use of the possibilities of a harmoniously installed music system. ■



## closet music system

SOMETIMES it is impractical to build the home music system into bookshelves, walls or furniture. In these cases a closet door can be used. A very heavy door is the best to hold a home music system. This door can be used solely for the loudspeaker, or for the entire system.

In the illustration the loudspeaker is hidden behind a cloth covering the top panel of the door. A hinged panel in the center provides access to the radio tuner and pre-amplifier controls, while the record player is supported on brackets below. The amplifier is placed in a corner of the closet. ■

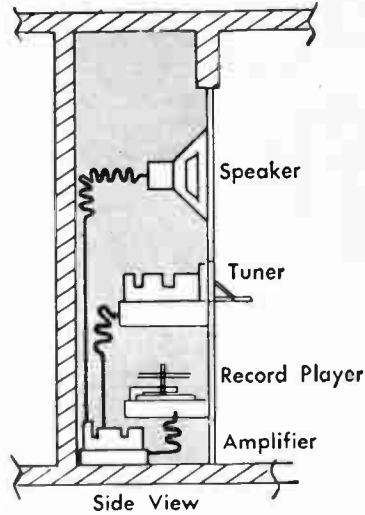
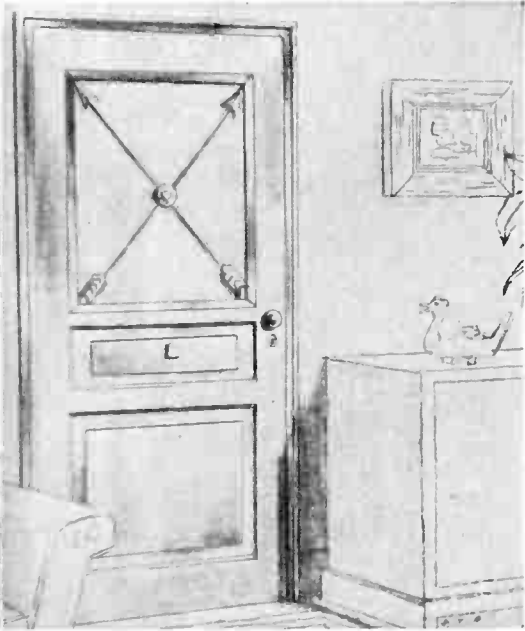

*Atec Lansing, Beverly Hills, California*

## speaker and storage

SPEAKER LOCATION is the most difficult problem facing an installer of a home music system. Quality of sound is controlled as much by quality of the speaker as it is by the speaker's location. A satisfactory solution may be found through enclosing the speaker in existing cabinet work. In this installation the speaker has been mounted behind the left-hand door of a bookcase cabinet. The right-hand door is still usable for storage, while providing adequate baffling space behind the speaker. In this particular installation, the amplifier, record player, and control unit are located at some distance from the speaker. ■

*American Music Co., Los Angeles 13, Calif.*

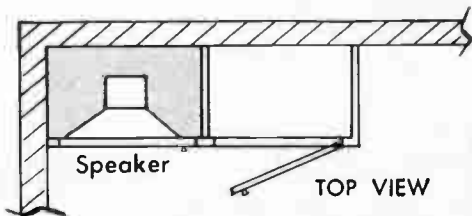

# THE LOUDSPEAKER SYSTEM



*Patrician speaker system is made by  
Electro-Voice in Buchanan, Michigan, and sells  
at a net price of \$727.50 f.o.b. factory.*

**A WELL-DESIGNED CABINET** (loudspeaker enclosure) is one of the most important items in a High Fidelity system. Reproduction of the full high fidelity range of music can only be obtained through wide range loudspeakers that are contained in cabinets large enough to satisfy the severe acoustical requirements of a quality audio system. This so-called "baffle" is just as important to a loudspeaker as the sounding board is to a grand piano. If it were too small there would be no deep resonance and the piano would sound "tinny." The same is true of "pint-sized" loudspeaker enclosures that, because of insufficient size, are incapable of clean reproduction of the important bass notes (low frequencies) without distortion. These low tones sound muffled and become irritating to the listener.

There are three basic types of enclosures. Each has its own characteristics and each will sound different (even with identical loudspeakers). The finest loudspeaker will, in the wrong enclosure, sound worse than many inferior loudspeakers in the proper enclosure. Leading manufacturers of high fidelity speakers have recognized the importance of designing the enclosure to meet the requirements of a particular loudspeaker. They have been literally forced into the cabinet business—just to make sure that the reproducing system would be capable of providing distortion-free high fidelity sound at wide dynamic range from their own loudspeakers.

V

*350 reflex speaker system by Permoflux (Chicago 39) uses three separate speakers.*

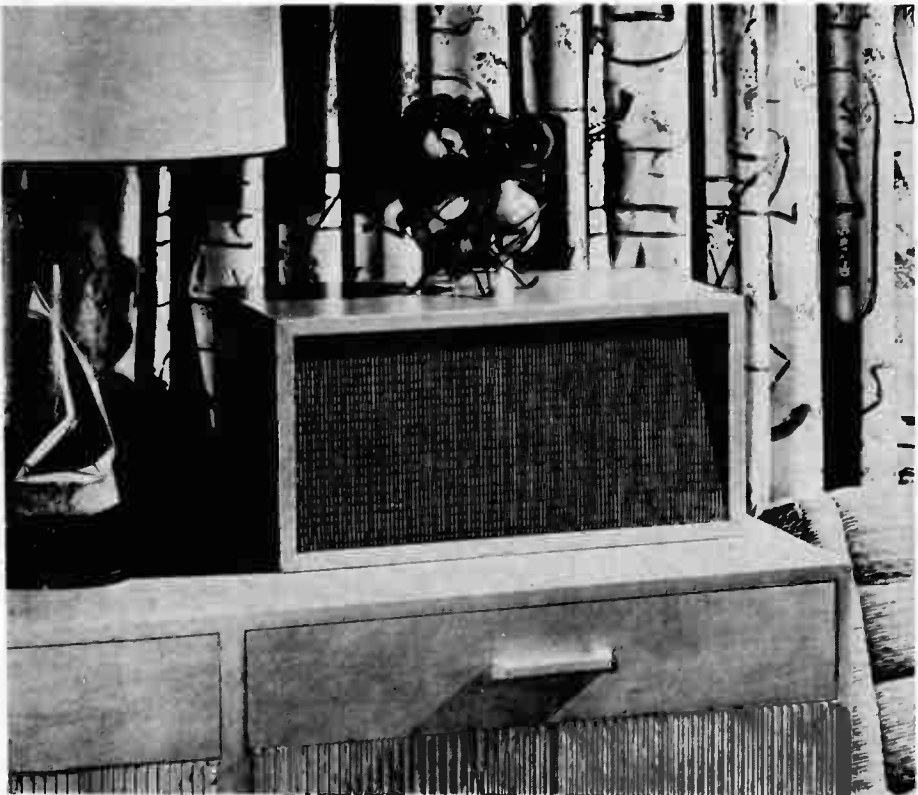

Many audiophiles are satisfied with a good 15-inch coaxial loudspeaker. Others prefer a two-way woofer-tweeter combination. A great many now enjoy the benefits of the fine three-way systems comprising woofer, mid-range horns and high frequency tweeters contained in the same enclosure.

Choosing the right enclosure for a loudspeaker is no easy task and too often the choice of enclosure is made on cabinet shape or appearance alone without carefully considering the all important acoustical properties of the cabinet and its effect on the performance of a Hi Fi loudspeaker system. Too often results are poor simply because a good loudspeaker is installed in the wrong type of enclosure. What do we mean by types of enclosures for loudspeakers?

There are three basic types of "baffling" or enclosures. They are:

1. The folded horn.
2. The infinite baffle.
3. The bass reflex.

The "folded horn" provides an effective loading to the cone of the loudspeaker diaphragm (Fig. 1) and is capable of providing better bass at higher efficiency than other types. It gives a close coupling to the air, reduces distortion and eliminates or minimizes the resonant effects of the loudspeaker. Because of the horn-loading effect, the loudspeaker cone moves but a fraction of the distance (in piston-like fashion) that it otherwise would.

The "infinite baffle" is considered by many authorities to be the best of methods for mounting loudspeakers. A cabinet (Fig. 2) providing such characteristics is generally a completely enclosed box (enclosure) carefully braced to prevent vibrations and padded to prevent bouncing around of

sounds within the enclosure. This type of enclosure (baffle) requires a minimum inside space (air volume) of at least 10 cubic feet for 15-inch loudspeakers. It is capable of good performance with many single or coaxial speakers of Hi Fi quality.

The "bass reflex" type of enclosure (Fig. 3) has been popular for many years and is considered as the least expensive type giving satisfactory performance. The enclosure employs a port (opening) which is placed below and close to the loudspeaker cone. The area of this port must be exactly re-

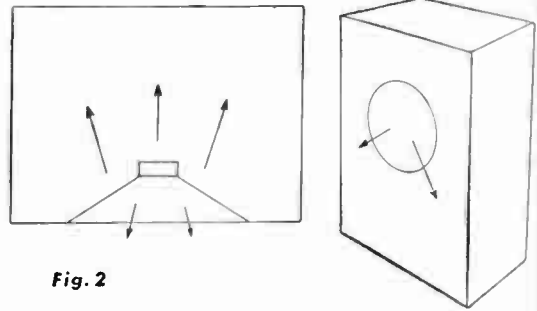

Fig. 2

lated to the inside volume of the enclosure and the resonance of the loudspeaker cone. Unfortunately, commercial reflex cabinets are made with the reflex port dimensions determined (by acoustical measurements), fixed, and designed for a specific loudspeaker, which may be unlike yours.

Which enclosure is best depends on many things—the size of the room in which it is to be placed, the acoustical behavior of the

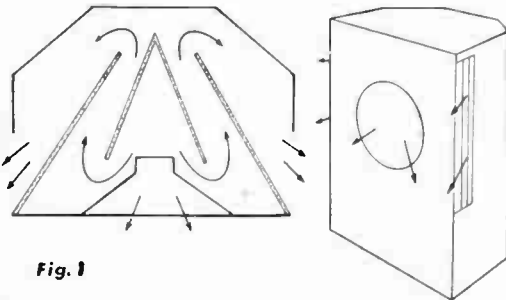

Fig. 1

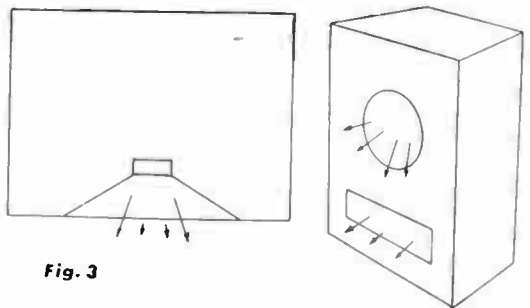

Fig. 3

room, the particular loudspeaker or multiple speakers chosen, the location in the room and the personal tastes of the audiophile. Any one of the three types of enclosures can, if well constructed and properly designed for a specific loudspeaker, give good performance. That's the reason for the maze of cabinets one encounters when visiting a high fidelity demonstration room. It is here the prospective user listens to these enclosures hoping the one selected will appear handsome in the living room and give superb reproduction as well.

There is one all-purpose loudspeaker enclosure which is called the "Fold-a-flex." It can be used as a folded horn, an infinite baffle or as a bass reflex, as shown in Fig. 4 on the right.

**Folded Horn**—Two hinged doors or ports, A and B, are completely sealed by gaskets against passage of air, in either of two open positions. Pushed inward, ports A and B become extensions of inner horn structure, forming the mouths of the folded horn.

**Infinite Baffle**—Closing ports A, B and C makes the enclosure an air tight infinite baffle, trapping approximately 10 cubic feet of air which is sufficient to damp properly 12- or 15-inch speakers.

**Bass Reflex**—Position of slide D (Fig. 4) is easily adjusted by loosening two knobs. Instructions for accurate settings are furnished with each cabinet.

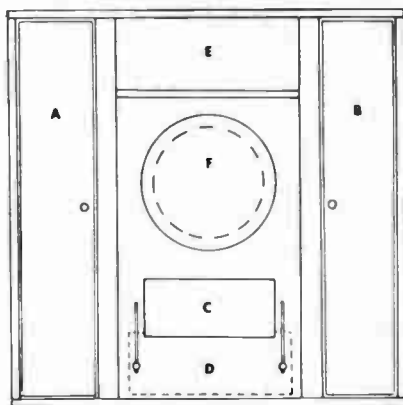
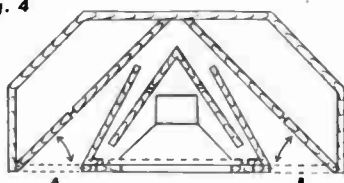
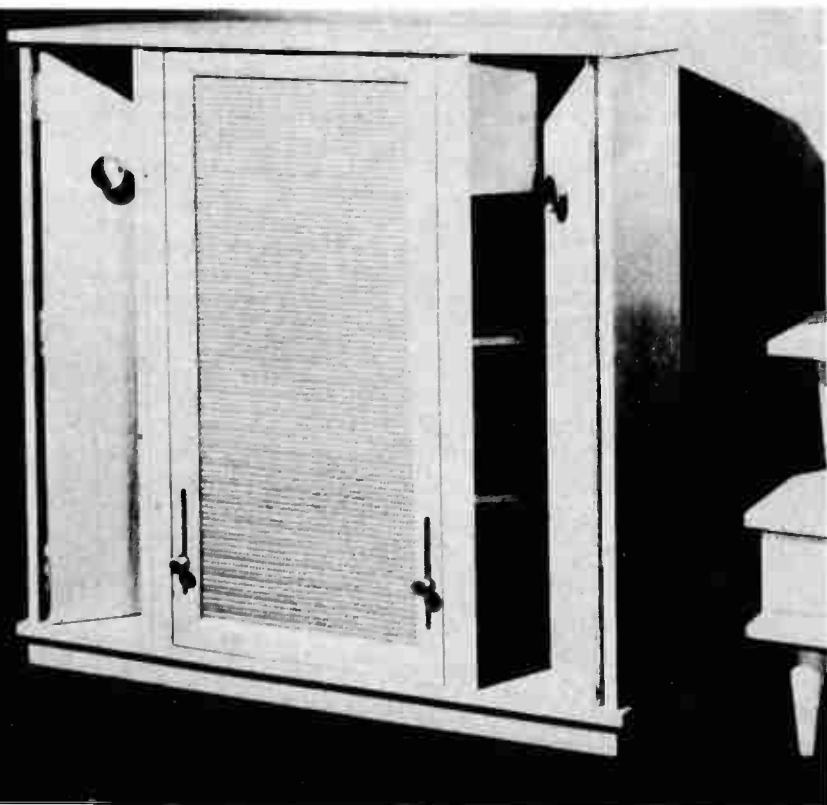

Fig. 4



It is an acoustical invention of Oliver Read, Editor and Assistant Publisher of *Radio & Television News* magazine, and author of the best selling audio book, *The Recording and Reproduction of Sound*. It is a brand new development in sound reproducers and was first introduced at the 1953 Audio Fair, in New York City, by the inventor and his associates.

V



Completed "Fold-a-flex" speaker cabinet with doors open for folded horn speaker loading.

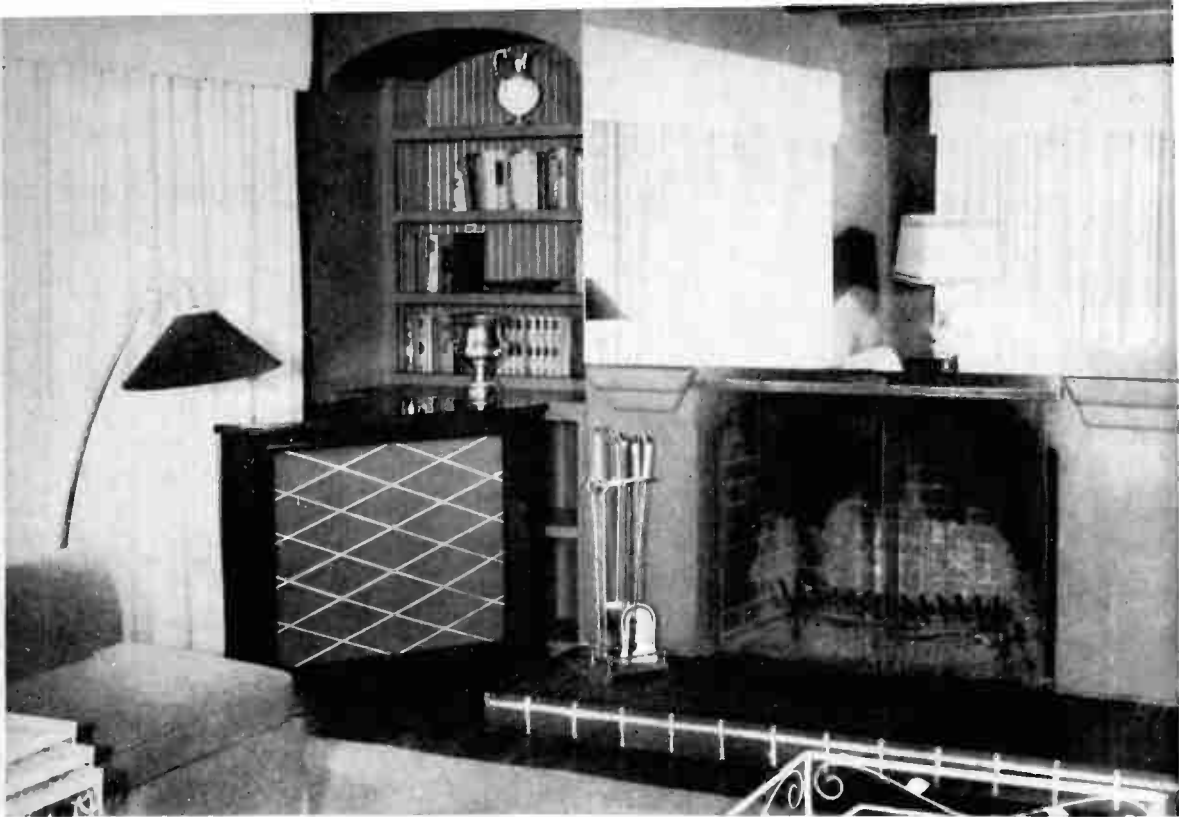

*Corner speaker enclosure is by Stephens, Culver City, California.*

The "Fold-a-flex" design consists of three adjustable acoustical ports and a built-in folded horn and sound chamber. Above the sound chamber is an acoustically isolated compartment designed to contain a mid-range horn, a high frequency tweeter, or both. Space is also provided to mount crossover networks in two or three-way systems in the top compartment. The "Fold-a-flex" cabinet permits a wide choice of mounting arrangements so that you may use a single 12- or 15-inch loudspeaker. Later you can add one of the excellent tweeters and enjoy a two-way system. If you so desire, a third (mid-range) horn may be added. Thus, depending upon the amount you can invest in loudspeakers, various components can be added later if you choose. Because it is necessary to invest between 50% and 75% of the total cost of a true High Fidelity system in purchasing cabinet and loudspeakers, the selection of these components should be made with great care. Fortunately, there are many fine loudspeakers, amplifiers, preamplifier-equalizers and tuners from which to choose. The same is true of record players and phono pickups.

The "Fold-a-flex" has a *variable* reflex port

that can be easily adjusted to resonate with any make of loudspeaker. This is most important as seldom do different loudspeakers have the same cone resonance. Cone fatigue (limbering) lowers a cone's resonance with use. The "Fold-a-flex" easily compensates for any resonance change and is tuneable to all loudspeakers.

A small flashlight battery and the help of someone in the family are all that are needed in order to properly adjust the reflex port. Simply connect two wires to the 12- or 15-inch loudspeaker terminals, or the crossover filter that feeds the main speaker. Fasten one of the wires to one terminal of the battery. Have someone hold the remaining wire in one hand and then make and break contact to the battery which will cause a series of sharp clicks to be heard from the loudspeaker. The port is adjusted, by the listener, until the clicks are clearly defined as clicks—not thuds or distorted clicks. Note the positions of the two knobs by referring to the scales adjacent to the knobs. Record the reading for the make and model of loudspeaker tested. A good idea is to pencil the information on the back side of the cabinet.

## RECTANGULAR ENCLOSURES

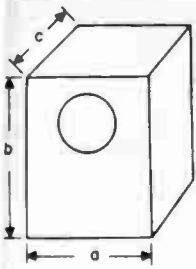

FIG. 1

Choose dimensions to fit available space and to provide 6 or 10 cu. ft. enclosed volume, as desired.

$a = \text{at least } 1/2 b$

$c = 12'' \text{ min. inside, (approx. } 16'' \text{ to } 18'' \text{ preferred).}$

Use drilling plan, figure 3, for 6 cu. ft., or figure 4 for 10 cu. ft.

from General Electric, High Fidelity Division, Electronics Park, Syracuse, New York.

For those who are installing a "built-in" High Fidelity system, dimensions and specifications for constructing "distributed port" enclosures are shown in Fig. 1 through 4. Drilling plans for the "distributed port" are shown for a volume of 6 cu. ft. (Fig. 3) and 10 cu. ft. (Fig. 4).

If a grille cloth is required for styling purposes, the material used must not impair the transmission of high frequencies. Suitable materials are woven plastic or fabric, having a light porous weave. The grille cloth should be mounted in a manner which will not allow vibration of the cloth against the cabinet. When grille cloth is used, the speaker is attached to the rear surface of the speaker mounting board.

Use plywood at least  $1/2$ -inch thick for 6 cu. ft. size and  $3/8$ -inch for 10 cu. ft. size. Line three inside surfaces (non-parallel) with 1-inch Fiberglas or similar soft acoustic material. Glue all joints. Make front or back removable, if speaker is to be mounted on the inside surface of the mounting board.

The use of a 10 cu. ft. enclosure extends the low frequency response to about 34 cycles and improves the power handling ability at low frequencies. The shape and proportions of the enclosure are not extremely critical, but the inside depth should be at least 12 inches. Ratio of length to width should not exceed 2 to 1. The long dimension may be either vertical or horizontal. ■

Plans for simple bass-reflex enclosure are from River Edge Industries, River Edge, N.J.

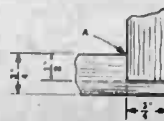
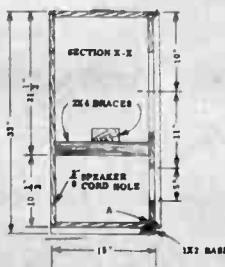
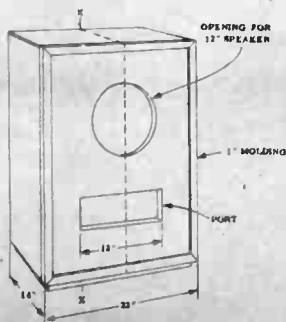

## CORNER ENCLOSURES

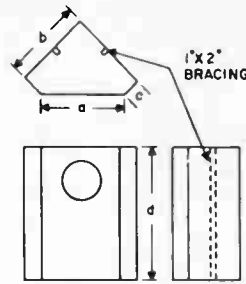

FIG. 2

Outside Dimension	6 cu. ft.
a	24"
b	25 1/2"
c	8 1/2"
d	25 1/2"
	10 cu. ft.
a	24"
b	25 1/2"
c	8 1/2"
d	40"

Use drilling plan, figure 3, for 6 cu. ft., or figure 4 for 10 cu. ft.

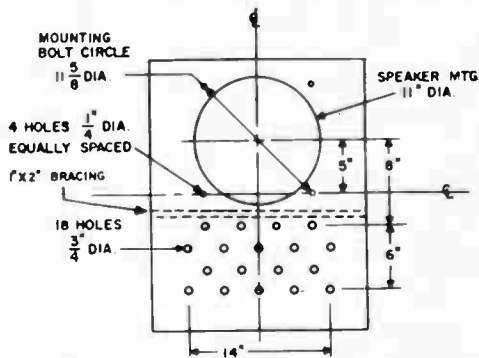

FIG. 3. DRILLING PLAN, 6 CU. FT. ENCLOSURE

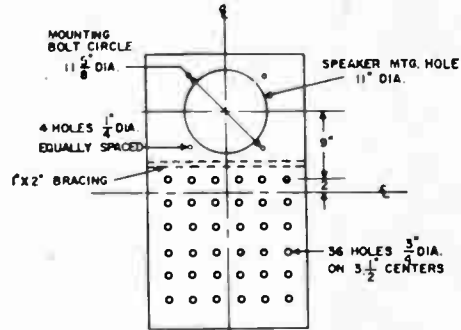
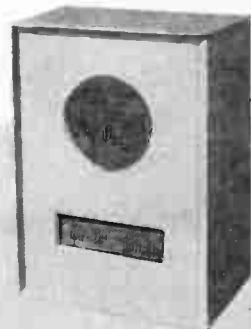

FIG. 4. DRILLING PLAN, 10 CU. FT. ENCLOSURE



THE SIX-FOOT HORN part of this rear-loaded, wide-mouth, true exponential horn adds at least an octave of clean, flat bass. All joints must be precision fitted and glued, with horn sides fastened by wood screws (2-inch centers) to the rear divider.

Three-quarter inch plywood is used throughout. Well glued lock-miter or spline-miter joints are preferred from the standpoint of appearance. Rabbed or butt joints may be used, but should be reinforced with glue-blocks and wood screws from the inside. Integrity of joints is a very important acoustical factor. Back panel may be demountable, edges mitered, fastened with screws every four inches.

1. Cut sides, top, and bottom of enclosure. Cut joints and fit parts perfectly.

2. Lay out horn pattern on inside of sides. Screw and glue blocks on sides to support baffles. Curved sections may be carved from solid blocks of wood.

3. Assemble enclosure. Cut baffles. Horizontal dimensions are not given in drawing. Due to variations in the thickness of plywood used in the sides, it is best to determine width from inside dimensions of assembled enclosure.

4. Cut seals for inside of front opening. Mount bottom seal in position.

5. Make a cardboard pattern for inside bottom curve of enclosure. Transfer the

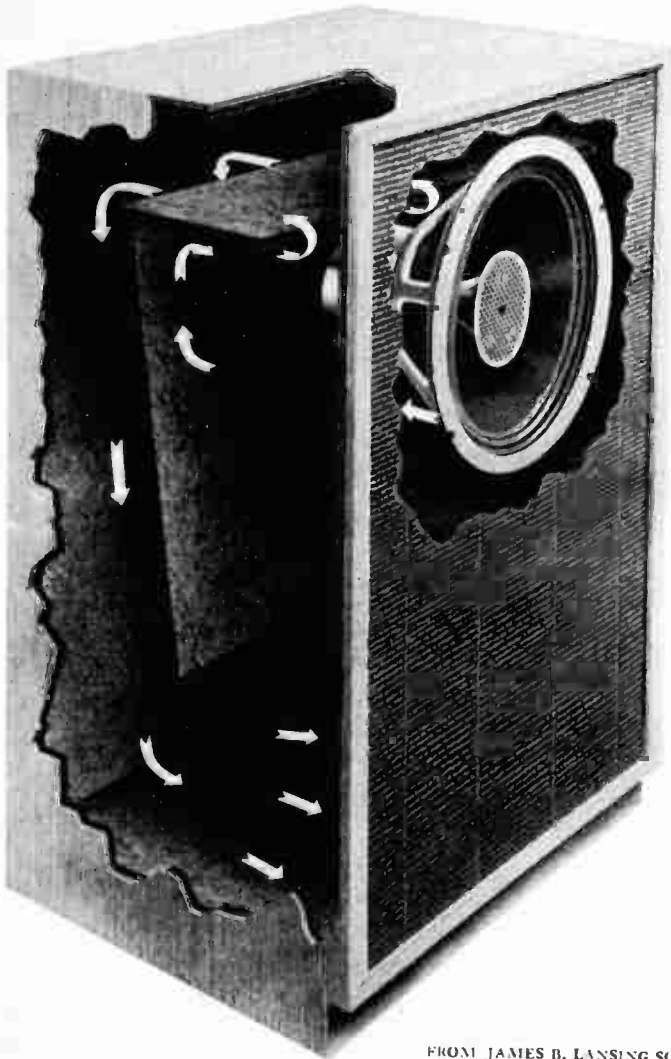

*Cut-away drawing of Stromberg-Carlson rear-loaded horn shows attention to interior reflection of sound waves from back of high fidelity speaker cone.*



*Completed Lansing speaker enclosure could be finished with any number of fine veneers.*

FROM JAMES B. LANSING SOUND, LOS ANGELES 39, CALIFORNIA



pattern to 1/4-inch plywood and cut. Force into place and screw it down to semi-circular vertical supports. Repeat this step so that bottom curve consists of two layers of 1/4-inch plywood one on top of the other completely glued together over entire area.

6. Glue and clamp remaining three scabs to opening.

7. Mount speakers solidly on front baffle. Screw baffle to glue-blocks. Mount dividing network to blocks on back panel. Wire speakers to crossover network. Staple lead wires in place.

8. Install grille cloth. The cabinet may be finished as described on page 111 of this book on High Fidelity. ■

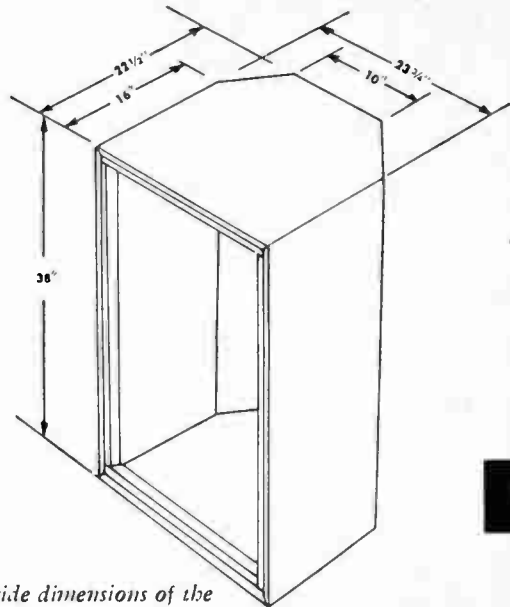

*Outside dimensions of the finished cabinet will not overwhelm the proportions of other furniture.*

**To mount grille cloth:**

Cut cloth to width and a few inches longer than needed. Staple top and bottom of cloth to battens. Screw top batten to top of enclosure. Roll grille cloth on bottom batten until it is about 1/2" shorter than opening. Through holes drilled in bottom of enclosure run long wood screws into batten and tighten.

Enclosure may be set on legs or toe-kick to suit your taste. Toe-kick can be made from 3/4"x1 1/8" plywood set back 1 3/8" from front and sides.

Scabs of 3/4"x1 1/2" plywood to mask edge of grille cloth are shown in place. Front edge may be covered with veneer, molding, or lacquer.

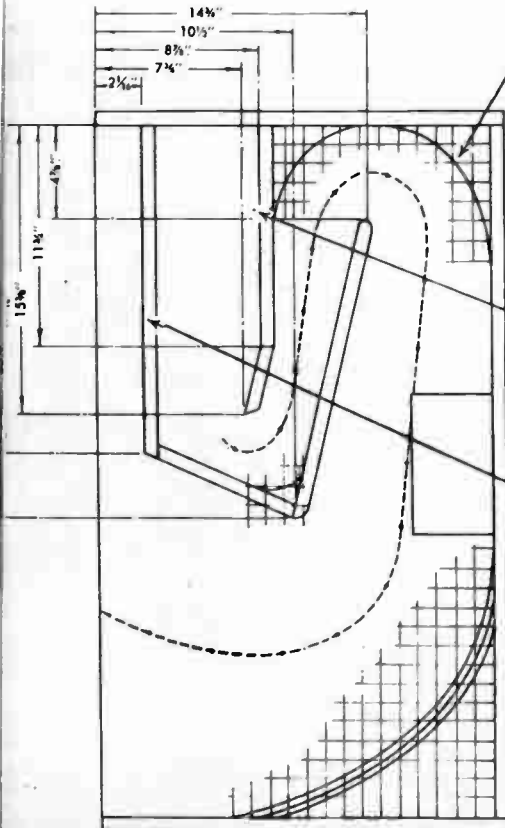

Each square on drawing equals 1" in finished cabinet. By laying out 1" squares and approximating curves you will be able to make full-scale pattern for cutting internal contours.

Padding 1" thick is fastened to front of this baffle. Cut 4 3/4" hole in baffle and contour block on same center used on mounting baffle to accommodate Lansing Koustical Lens. Line hole with felt 1/4"x1 1/2". Force driver into hole.

This is the speaker mounting baffle in place. The glue blocks to which it is fastened are not shown. Especial care should be taken to mount this baffle true and secure.

A hole 4-5/32"x5-7/16" may be cut in the back panel here for crossover network. The network can be mounted on the inside of enclosure on two blocks 4 3/8"x7 1/2"x3/4".

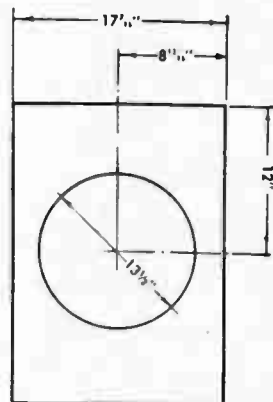

### SIDEWALL POSITION

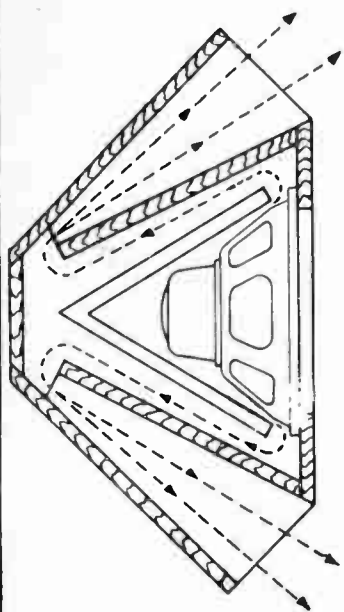

### CORNER POSITION

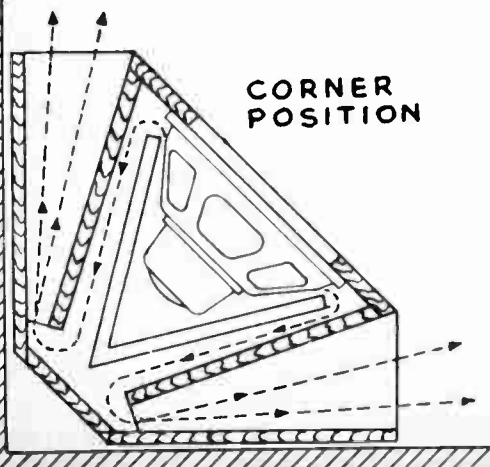

Home construction kit (above) of  $\frac{1}{2}$ -inch thick white pine costs \$19.95 for a 12-inch speaker, or \$23.95 for a 15-inch speaker. Folded horn enclosure contains an insulating blanket to reduce echoes. G & H Wood Products, Brooklyn 11, N.Y.

Drawings by River Edge Industries, River Edge, N.J.; Radio Craftsmen, Chicago 40.

CORNER ENCLOSURES are becoming increasingly popular with Hi Fi fans. While somewhat difficult to construct, they definitely improve sound quality. The secret of their success lies in the designed use of the house walls as a part of the sound pattern. You may notice that when the speaker is placed in the corner position, tones emanating from the back of the horn are passed from the enclosure along the wall. This disperses the sound and creates an audio impression of increased sound source area. When such a corner enclosure is placed in a sidewall position it operates with efficiency, but the low notes lack the reinforcement of the corner walls. Many of these fine enclosures are available as kits for home construction. ■

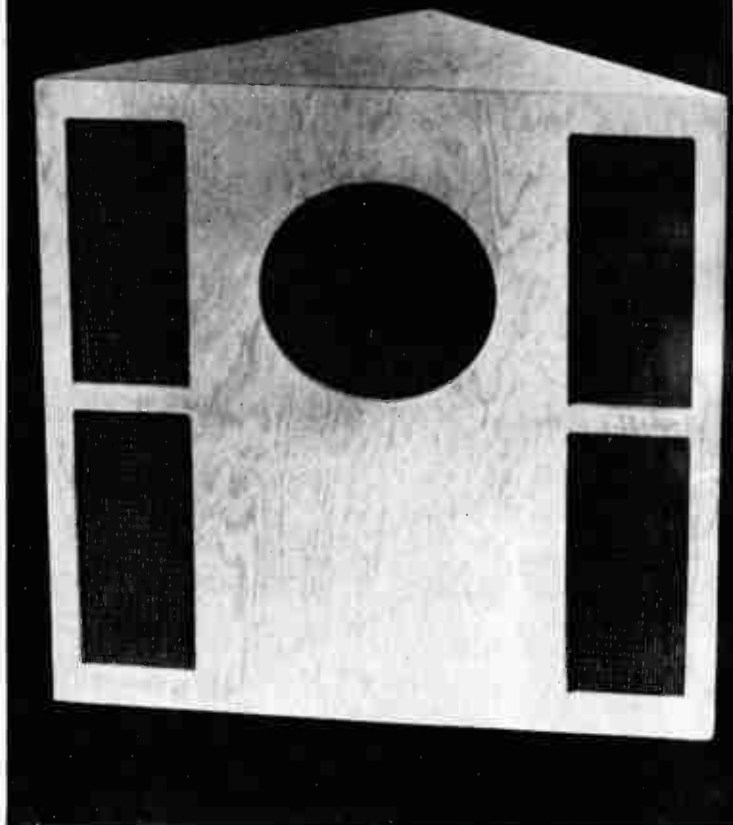

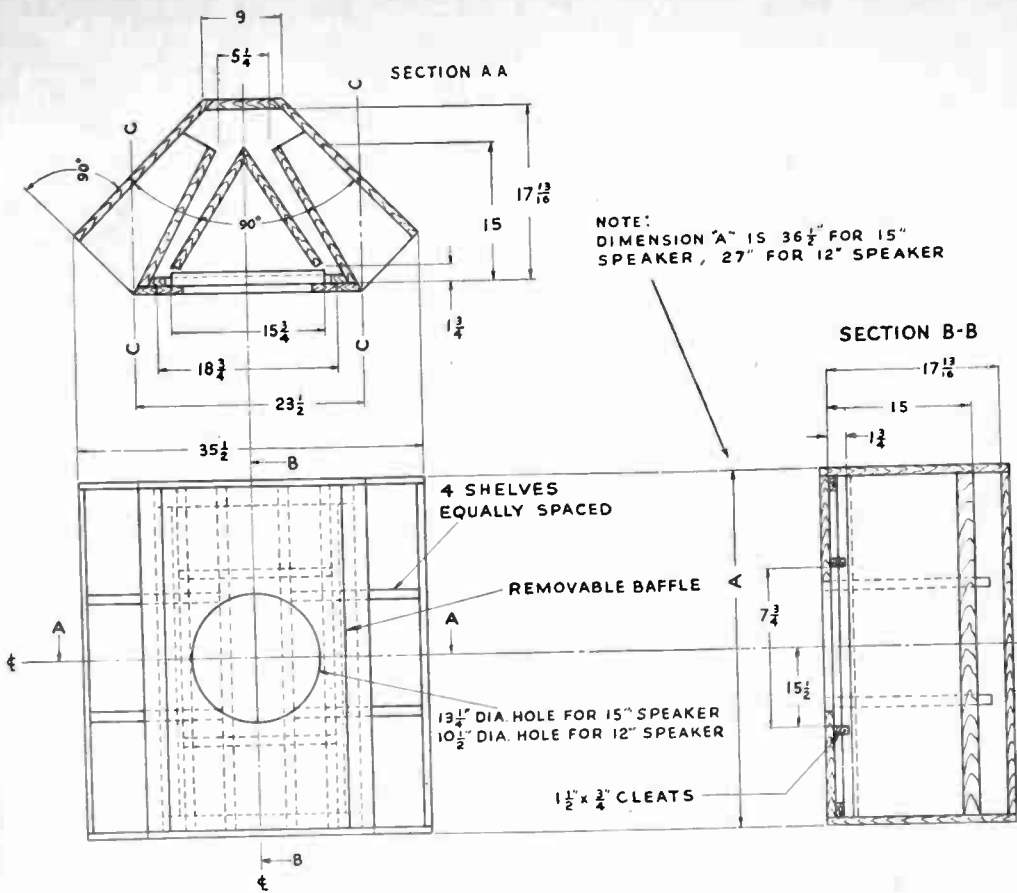

*Custom built corner horn was designed to support table model TV set which is heard through the Hi Fi speaker enclosure. T & W Electronics, Inglewood, California.*

## speakers

From David Bogen Co., Inc., N.Y. 14

THE LOUDSPEAKER is to radio what the receiver is to the telephone, as the principle involved is nearly identical. The same sound could enter both systems and be changed to strong electrical impulses by an amplifier. Then the sound would be translated into music or words by the voice coil and pass from the radio loudspeaker on the one hand, or a telephone receiver on the other.

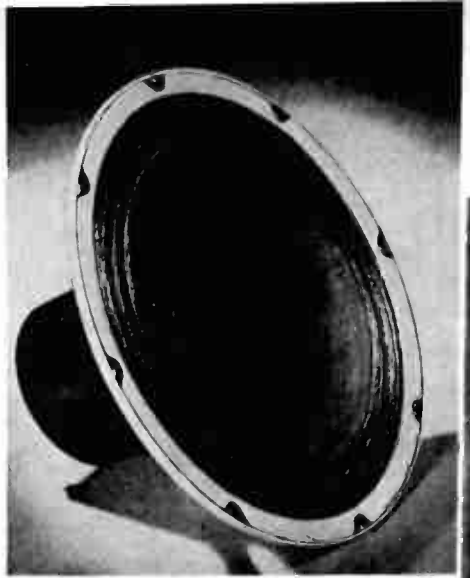

Hi Fi speaker by Stromberg-Carlson

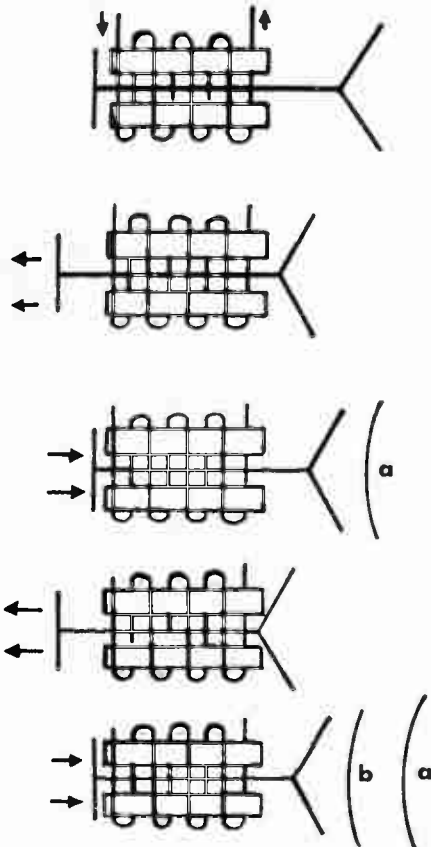

Sound in a telephone receiver is caused by amplified electrical impulses flowing through a coil of wire to produce a varying magnetic field. This field of varying strength reacts against a second magnetic field from a permanent magnet which is a part of all speakers. Because of the rapidly changing relationship of these two fields, a flexibly suspended rod hung between them moves back and forth. Let us now assume the current flowing through the coil of wire (voice coil) is the electrical impulse caused by a musical note, and that the suspended rod is attached to a diaphragm. The motions of the rod will cause the diaphragm to vibrate back and forth. These movements will set the surrounding air in motion, thus producing sound waves corresponding to electrical impulses first created by the original musical note. The loudspeaker is a simple device for converting electrical energy into mechanical energy, which reaches our ears as pure sound or musical tones.

The coil of wire which is connected to the amplifier and receives from it the electrical impulses to be converted to sound waves, is known as the voice coil.

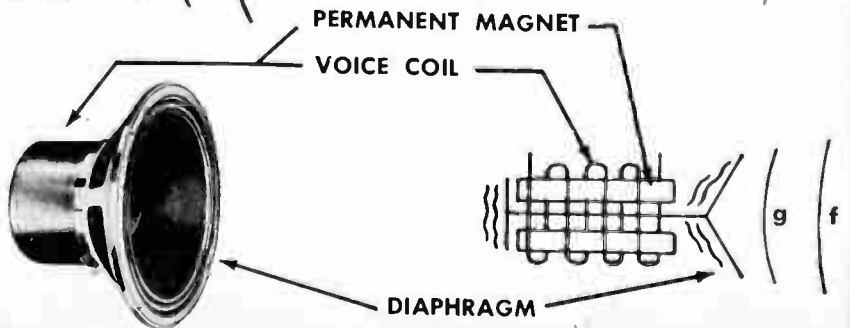

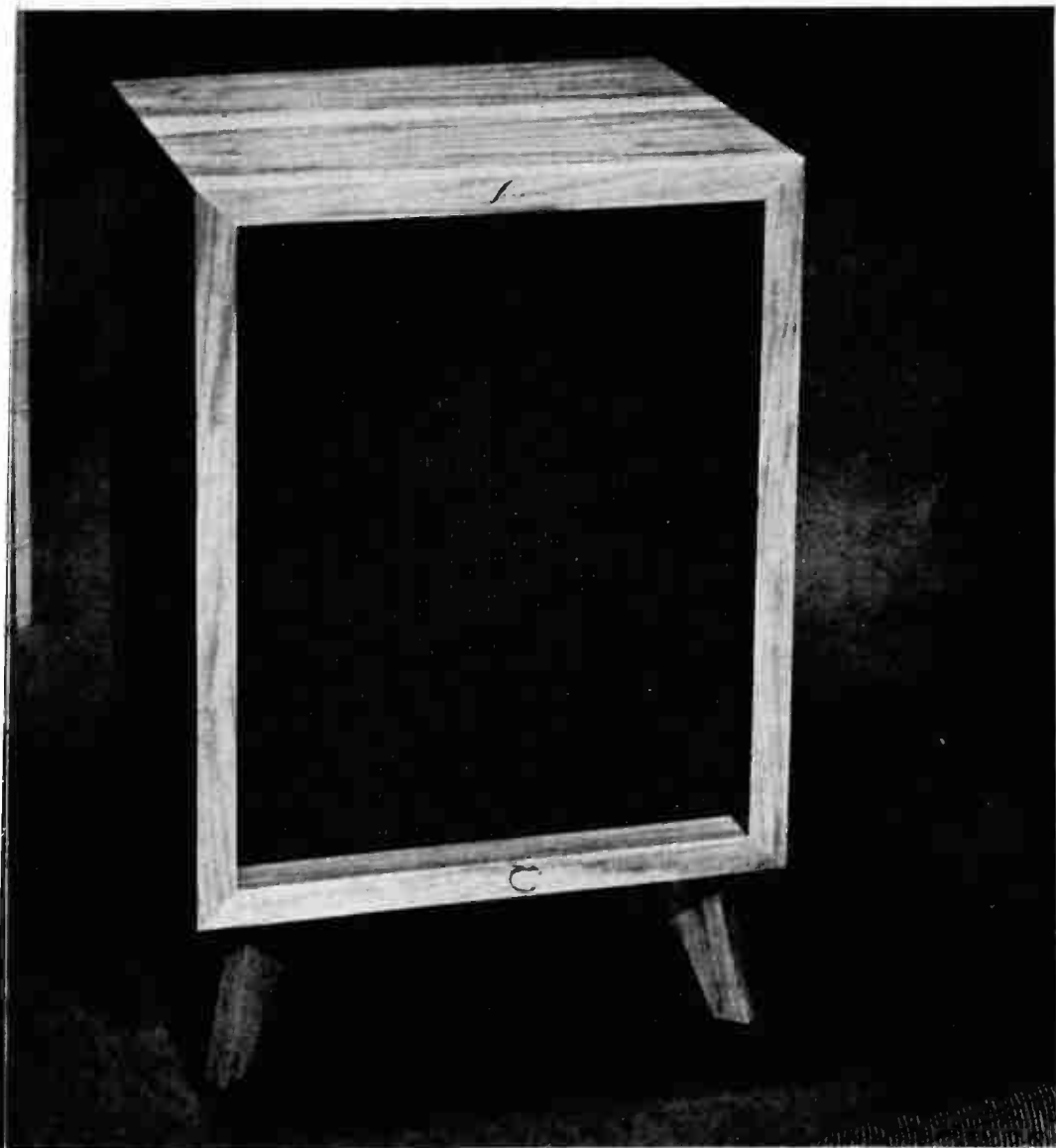

V

*Small, minimum volume, reflex enclosure is for inexpensive 8-inch James Lansing speaker.*

The permanent magnetic field, which works with the rapidly changing field of the voice coil, is produced by the speaker's permanent magnet. This magnet is made of a special steel alloy containing aluminum, nickel, and cobalt, known as Alnico. The speaker diaphragm, operated by the voice coil, is usually a cone of specially treated paper designed to be light but tough.

Quality is of paramount importance in the selection of a loudspeaker for your

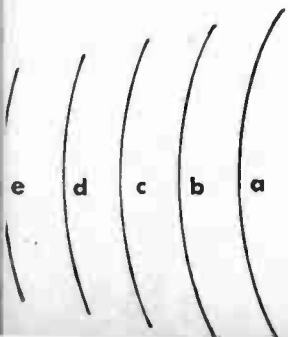

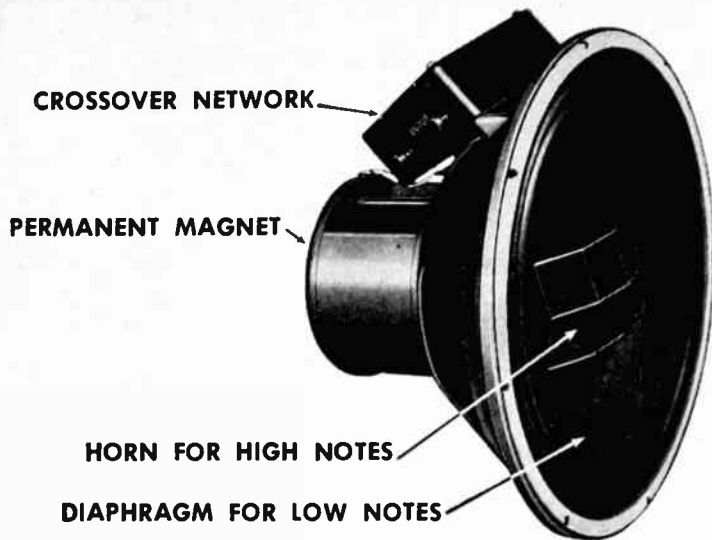

*Coaxial speaker by Stephens uses an over-size permanent magnet, crossover network.*

high fidelity installation. The nominal size of the cone is alone no guarantee of quality. Often a well designed 8-inch loudspeaker will produce better results than a 10 or 12-inch loudspeaker of inferior design. For example, the performance of any loudspeaker depends on the rapidly changing relationship of the two magnetic fields (voice coil and permanent magnet) already mentioned. The more effectively the two are brought into contact, the better the operation. One way to achieve this is through careful design and construction of both the voice coil and the permanent magnet. Another factor is the precise alignment of the two units so that the voice coil is properly centered. It is important, also, to have a large and properly shaped permanent magnet to produce the powerful magnetic field requirement of High Fidelity. Weight comparison between magnetic material used in conventional and high fidelity speakers often shows differences as great as between ounces and pounds.

To produce low notes of the organ or contrabass (otherwise known as the "bull fiddle") a powerful loudspeaker is needed to generate large movements of surrounding air. The voice coil must be capable of moving the diaphragm back and forth over a much longer path than that required for musical notes in the middle registers. To set these large masses of air in motion for the proper reproduction of rich low notes two things are essential—a large cone with a large and powerful magnet.

A note of caution must be injected at this point. This larger speaker, while ideal for the reproduction of low notes, is less effective for high tones. Large cones tend to respond sluggishly to the short staccato beats which generate the upper tones of the scale. To produce these high frequencies best, a light and rigid diaphragm with a delicate and quick-acting voice coil are required. For the fastidious music lover no one loudspeaker unit will serve both needs satisfactorily. Hence the recent trend toward divided units, with two or more speakers separately handling the lows and highs.

In the multiple speaker system each unit can be separately mounted, or two or three speakers can be mounted next to each other. Systems are now sold in which the sound spectrum is divided into two, three, or four sections. There are many ways of designing a speaker system even after the number of sections to be handled has been decided. On the low frequency end, several methods are possible for achieving the large cone area required for low notes. Loudspeakers as large as 18 inches in diameter are commercially available. Electrically connecting a number of loudspeakers is also a possible method. Common arrangements for the more ambitious systems involve two 15-inch speakers, two or more 12-inch speakers, or a whole array of smaller units. For the middle and upper regions of sound both cone speakers and small horns are used. Since upper notes are directional, it is necessary to incorporate a spreading device.

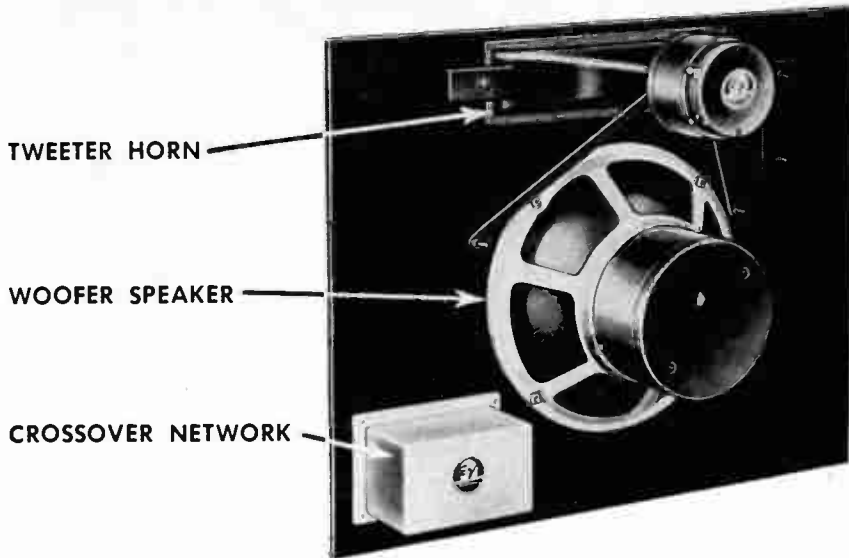

*A complete audio reproducer system as created by Electro-Voice has the crossover point at 800 cycles per second. The separate woofer and tweeter horn are board mounted, as is the crossover network. Weighing 86 pounds, the entire unit sells for \$187.20.*

In the choice of a loudspeaker one or two other considerations should be weighed. If a moderate initial investment is intended, with plans for future improvement, it is advisable to select a 12-inch coaxial speaker or an 8- or 12-inch single radiator speaker with separate tweeter. "Tweeter" is a favored term of Hi Fi fans for high frequency speakers. Speakers designed primarily for low notes are known as "woofers," another term that has defied serious language research. Improvements at both ends of the sound spectrum could be made later without discarding original equipment.

One other method of splitting the frequencies, without a complete double unit, is to employ two driving surfaces; one a metal diaphragm and the other a paper cone, connected to one voice coil. These are so mechanically designed that the metal diaphragm produces high notes and the paper cone produces low notes.

It is not suggested that this multiple system has replaced the single speaker. Far from it. And it should be stressed that a well-designed single speaker and enclosure will prove a better investment than a poorly designed double unit. For one thing, it can later be utilized in a better quality multiple speaker system, should the owner decide time has come to improve his equipment. Actually, the very first step of improvement—from any mass-produced "set" loudspeaker to the most modestly priced high fidelity speaker—is a dramatic and breathtaking musical experience. ■

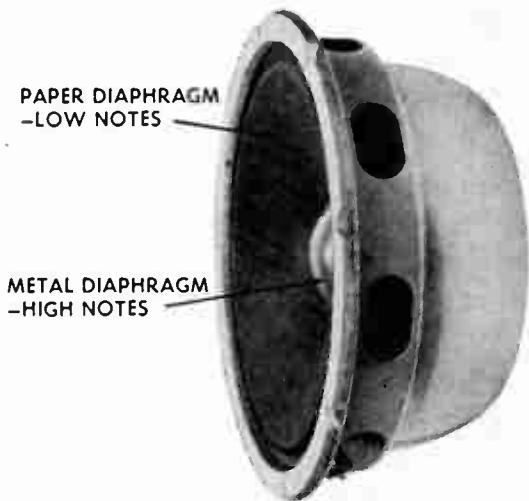

*Unusual Altec Lansing 8-inch speaker uses a small metal diaphragm to extend the tone range higher than other such small speakers.*

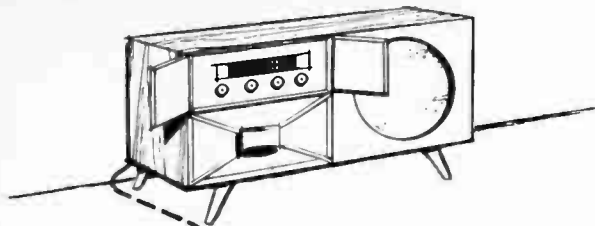

# AMPLIFICATION,

**A**N AMPLIFIER has one prime function—to accept a tiny electrical signal from your radio or phonograph and reproduce it as a powerful electrical signal capable of moving a loudspeaker cone. The speaker cone will then produce a sound identical to that which created the original signal. Use of an amplifier may be compared to the enlarging of a small photograph to a wall-size mural. The difference is that a photographic enlargement may be only a thousandfold.



*"Libretto" remote control-preamplifier is in the form of a lavishly padded leatherette-bound book.*

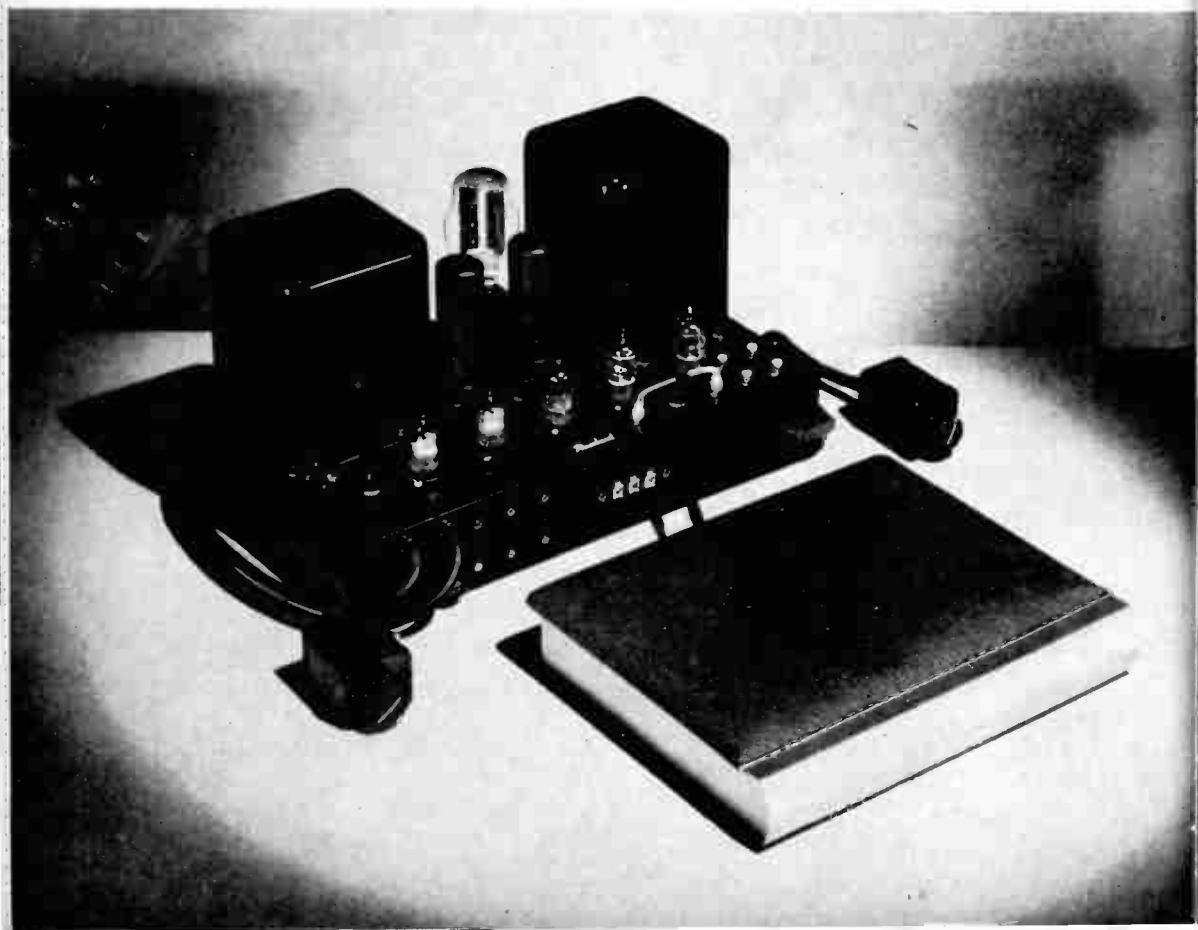



# HEART OF YOUR MUSIC SYSTEM

Philip Turetsky

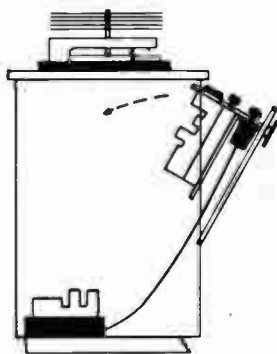

VI

The Hi Fi amplifier must be able to enlarge the electrical signal a millionfold—without the slightest change in tone reproduction. Any change in the image of the original signal is distortion, and the more distortion, the less lifelike the reproduced sound will be.

An amplifier in a high fidelity sound system obtains its signal to be reproduced from many sources. The sound signal may be from a phonograph, a tuner, a tape machine, or a television set. These signals are not all alike in volume or character, so they are usually channeled through a preamplifier before entering the amplifier.

The preamplifier is aptly named. It is that stage of amplification which the original signal goes through before it can be reproduced by the power amplifier. The preamplifier, along with reproducing a signal powerful enough to energize the amplifier, has other functions. It can change tone quality by means of bass and treble controls. This enables the listener to add or diminish either bass or treble quality independently of each other. Room acoustics dictate these changes.

*Other remotely controlled amplifiers are equipped with preamp sections of various sizes. Bell, Regency and Brook units could all be set as shown by Newcomb drawing.*



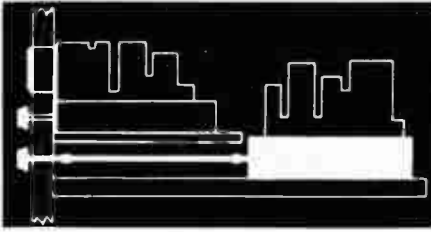

The preamplifier will also have a selector switch that determines which of the original signal sources will be reproduced. These switches have at least two positions (generally phonograph and radio tuner), while more deluxe units will have as many as six or seven available input positions, or channels. Another function of the preamplifier will be record equalization, which is an overall adjustment of tone to make up for deficiencies in the original recording technique. In this realm, there are preamplifiers with only one or two positions to compensate for the most popular records, and other styles which can compensate for almost any record made. The preamplifier generally has the house current on-and-off switch for itself, and the amplifier connected to it. There are other refinements in preamplifiers covered elsewhere in this book (page 68).

There are two ways one can purchase an amplifier. One is a complete amplifier and preamplifier on one chassis, and the other is a separate preamplifier and separate amplifier. When an amplifier is separate from the preamplifier, it is generally known as a basic power amplifier.

Basic power amplifiers are rated according to output in watts. The generally acceptable wattage for a high quality amplifier is anywhere from ten watts to about fifty watts with a minimum of distortion. The determination of how powerful an amplifier you

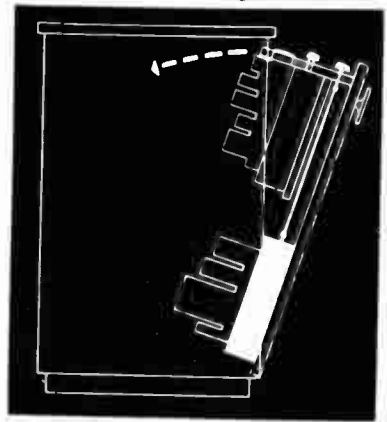
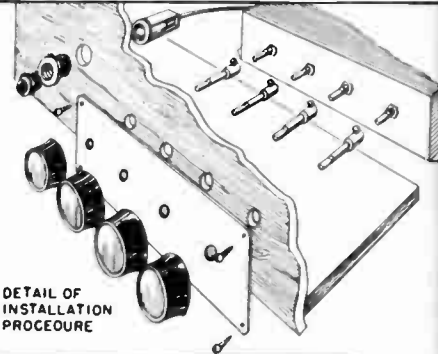
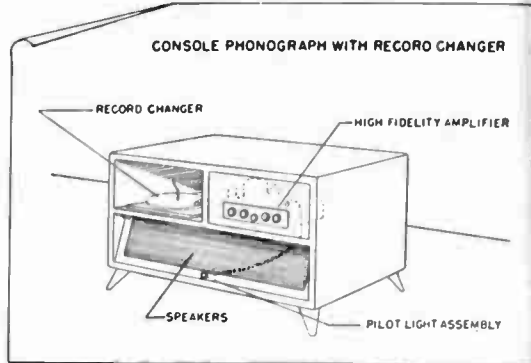

The use of extension rods for amplifier control is shown in these drawings from Newcomb, and Bell, makers of Hi Fi equipment.

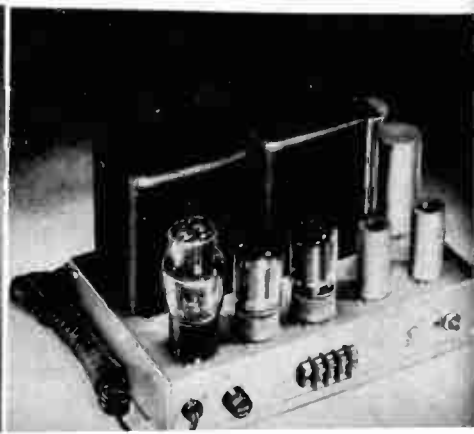



VI

need can be arrived at by a few considerations, including the money available.

The first should be how loudly do you want to listen to your music system, and how large an area do you wish to cover. The average living room of about 3,000 cubic feet can be adequately covered by a ten watt amplifier, using a good quality speaker. If the speaker is of low quality and, therefore, of low efficiency in converting the electrical signal into a sound signal, a more powerful amplifier might be needed. Another consideration could be how many speakers would be connected to the amplifier. If more than one speaker was to be used

at any one time, then a more powerful amplifier (twenty watts or even larger) might be needed depending upon the area to be covered, or extensions used.

Normally the cost of an amplifier increases with its power, and it would be wasteful to use a thirty watt amplifier when a ten watt unit may be more than enough. A ten watt amplifier, playing its full volume with a good quality speaker, would be much too loud to listen to comfortably in a 3,000 cubic foot room. Your dealer can help determine the power you need.

The basic power amplifier is usually the best reproducer in the audio chain of a high



*Left to right are shown power amplifiers of different sizes. First a Radio Craftsmen 10-watt unit, Fisher 25-watt audio amplifier, Bogen 30-watt, and above right a Grinnnes 60-watt.*

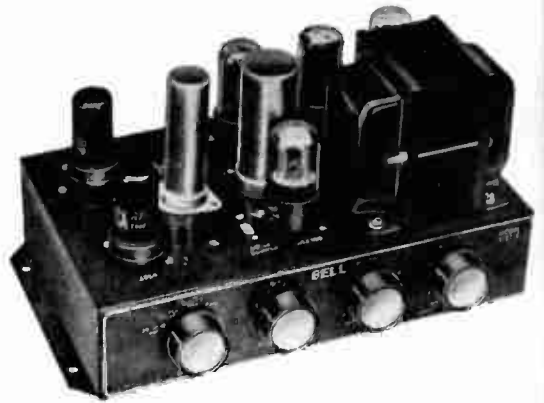

quality sound system. There is generally less distortion in the amplifier than any other link in the system. A maximum harmonic distortion of four percent at full volume is the most permissible in the high fidelity amplifier suitable for home installation.

Most commercial radios have a distortion figure of ten percent and up at full volume. The simple proof of this is to turn your commercial radio to full volume and listen how unintelligible the sound becomes. A high fidelity system will retain its clarity and definition at maximum volume. If you want sound reproduced, not introduced, the high fidelity amplifier is a must.

The basic power amplifier need not be readily accessible since it has no controls on it that would normally need adjustment. It can be mounted in the bottom of a cabinet or on a bookshelf. Often a panel is put in front of it where the unit is mounted on a

bookshelf. It does, however, need ventilation as some heat is generated. When the amplifier has built-in preamplifier and controls, it must be mounted in such a way that the controls are available.

Connection of the basic power amplifier to the rest of the system is very simple. To the amplifier must be connected wires carrying the signal from the preamplifier and generally the electrical power for the amplifier. The only other connection necessary is from the amplifier to the speaker. The basic power amplifier, or combination preamplifier and amplifier, should generally be not more than 20 feet from its immediate preceding signal source. However, the length of wire from the amplifier to the speaker can run as much as 200 or 300 feet without any loss of quality or power. So, in this regard, location of the amplifier in relation to the speaker is quite flexible. ■

*Music system connections in drawing from General Electric show component relationships.*

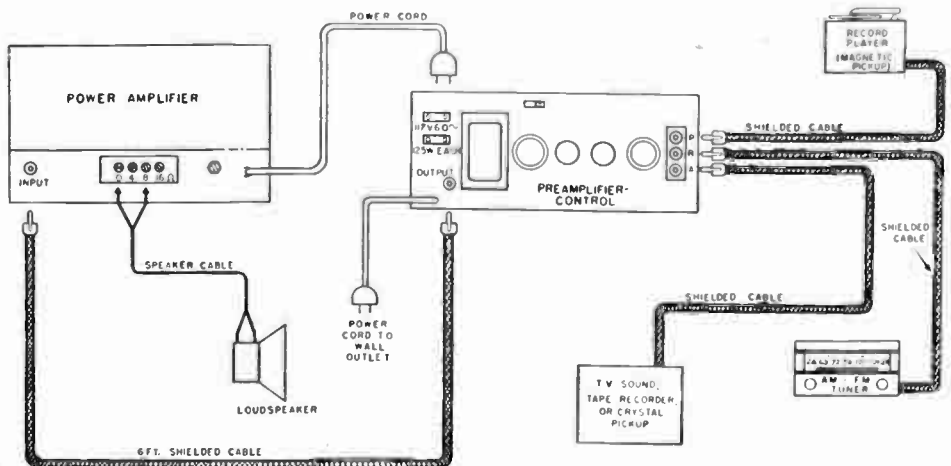

TYPICAL SETTINGS OF  
SEPARATE BASS AND TREBLE CONTROLS  
SHOWING WIDE RANGE OF  
TONAL RESPONSE  
(RADIO OR PHONOGRAPH)

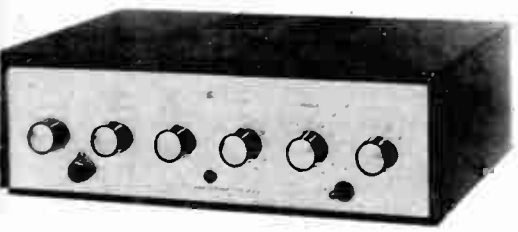
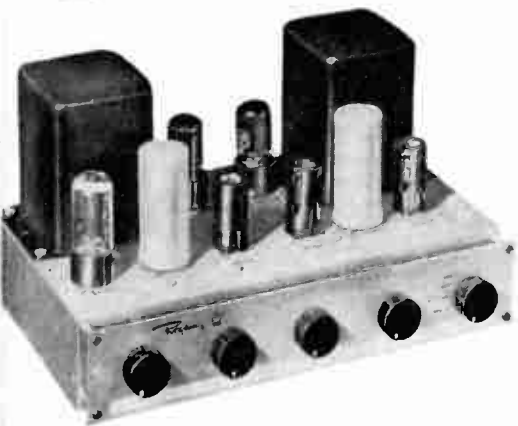

Costs of complete amplifiers are (from left above): Bogen 8-watt \$35.95, Bell 10-watt \$53, Bogen 15-watt \$99, Regency 12-watt \$99.50, and Scott 10-watt for \$99.

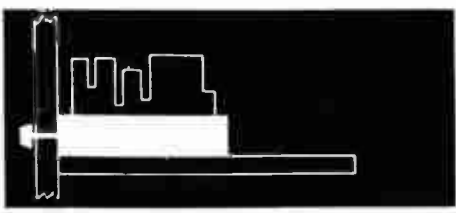

NEWCOMB AUDIO PRODUCTS, HOLLYWOOD, CALIF.

FREQUENCY RESPONSE

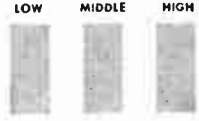

"Flat" position:  
For high volume  
operation

TONE CONTROL SETTING

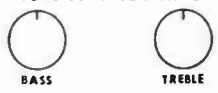

FREQUENCY RESPONSE



Bass and Treble  
boost: For low  
volume operation.

TONE CONTROL SETTING

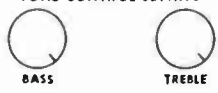

FREQUENCY RESPONSE

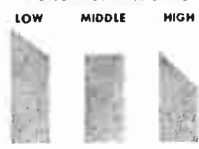

Bass boost and  
Treble cut: Heavy  
Bass Effect. Also  
for scratchy, worn  
records at low vol.

TONE CONTROL SETTING



FREQUENCY RESPONSE

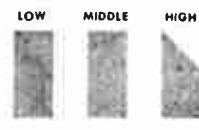

Bass "flat" (nor-  
mal) and Treble  
cut: Excellent for  
worn records.

TONE CONTROL SETTING



CHART BY ADMIRAL CORPORATION, CHICAGO 4, ILL.

VI

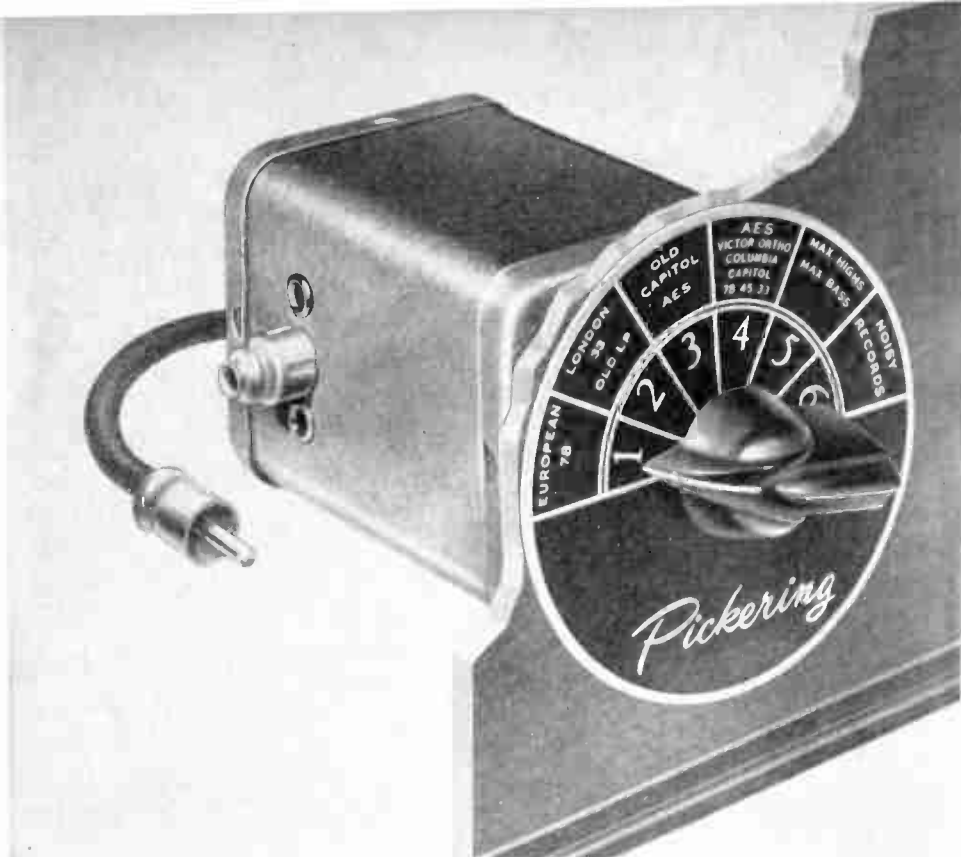

*Record compensator adjusts for all basic types of musical recording in common use.*

*Preamplifier by Fisher connects between phonograph cartridge and power amplifier.*

*For custom panel installations, Grommes pre-amplifier has all controls and compensator.*



## *the preamplifier*

*Philip Turetsky*

A PREAMPLIFIER is that unit in a sound system which takes a very small signal from an original source (record player, radio tuner, tape machine or television set) and amplifies it to a level high enough to energize a basic power amplifier. This action is the primary function of a preamplifier.

Preamplifiers are divided into two basic types. One type is that which preamplifies an incoming signal as previously described. The other has not only this function, but contains the preamplifier with a complete switch control center. A more proper description of this second category would be preamplifier-equalizers, or as more commonly known "front-ends." Preamplifiers may be built into the amplifier or may be a separate unit connected to the amplifier by control cables. In either event, they perform the same duty.

In home music systems the front-end has many uses. It will have a volume control for the entire system. It will usually have the electric current on-off switch for all other components. It will have bass and treble controls which enable the listener to adjust the tone qualities of the music to suit his personal taste. These tone controls are always separate and independent of each other in their operation. There is often a selector switch that will connect the amplifier with any of the other components,

such as radio tuner or phonograph. The number of positions available on a selector switch will vary with different makes of front-ends. They generally have some provision to connect with the record player, the tuner, the tape machine and television set. Some front-ends also incorporate their record tone adjustment or equalization on this switch. Equalization enables the listener to adjust the preamplifier to reproduce most ideally the record manufacturers' original recording characteristics. These recording characteristics vary, and some way to adjust for the differences is desirable.

Some front-ends have a loudness control available. The need for this is brought about because the human ear's sensitivity to the lower and upper frequency sounds tends to decrease as the volume is reduced. A loudness control will increase the bass and treble qualities of the sound when played softly. Another desirable feature found in many front-ends is a connection for recording on a tape machine. This enables music fans to record on tape anything going through the front-end, no matter what its original source. There are other refinements and functions of available front-ends, but the aforementioned are common to most available units.

Any reputable high fidelity distributor will demonstrate the front-ends to you. They are a wonderful piece of equipment. Their flexibility and control over the sound you will hear will amaze you for the front-end is truly the nerve center of a good high fidelity home music system. ■

*Fisher unit is cased for open bookshelves or table use.*

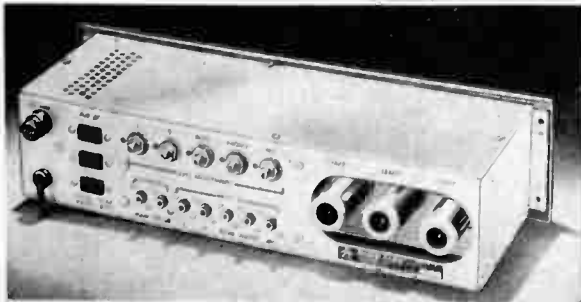
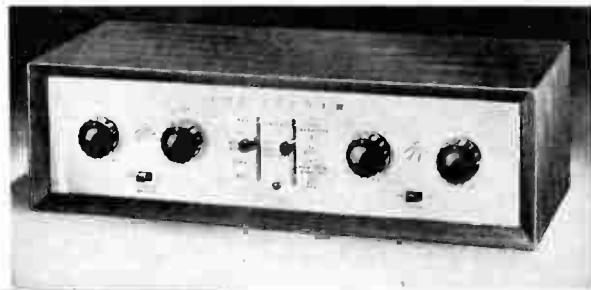

*Back of Fisher preamp shows five inputs and two output circuits.*

# BROADCAST MUSIC

*Philip Turetsky*



F.P.G. PHOTO

## *adding Hi Fi*

**T**HERE ARE THREE basic changes that could be made in your present equipment that will increase its ability to reproduce sound more faithfully. They are: a new record player, new speaker, or a new amplifier. Since replacement of the record player has been fully covered elsewhere, we will explain the replacement of speaker and amplifier.

About the least expensive component in any ordinary commercial radio or television set is its speaker. They range downward from a four or five dollar speaker in the most expensive consoles, to units costing 50 cents in small table radios and television sets. These poor speakers have only one advantage. Because of their very narrow frequency tone range, they mask and hide distortion in both the high and low end of the

audible frequency range heard from the usual commercially produced radio or television set. Such speakers rarely reproduce more than 25 or 30 per cent of the full frequency range, which accounts for their dead, flat sound. This factor, coupled with a most unscientific and cheap mounting, makes their performance pitiful in light of what is possible from a high quality reproducer.

The easiest and most satisfactory manner of improving the old speaker is to replace it with a high fidelity speaker in a cabinet designed for Hi Fi. However, if you wish to proceed slowly, then the high fidelity speaker can be mounted in place of the present one, providing they are the same size.

A good speaker cabinet can be purchased or constructed later and the new speaker transferred to it from the old cabinet. You



must first determine whether your present speaker is a PM (Permanent Magnet) or electrodynamic type. This can be checked by examining wires ending at the speaker. If there are two, it is a PM speaker. If there are more, it is electrodynamic. With electrodynamic speakers it is advisable to have a radio technician make the changes for you as there are fairly high voltages in two of the wires. If it is a PM speaker, you have no problem.

To replace your PM speaker, all that is necessary is to disconnect the two wires. Install the new speaker which will have obvious terminals to reconnect the two wires onto. It will be a very simple change. If you are using a separate cabinet for the speaker, you can put it anywhere in the house and connect it to your radio or television set with ordinary electric lamp-cord wire. The speaker can be up to several hundred feet away from the set without much loss in tone quality. Plans for the construction of a speaker cabinet are available at all high fidelity dealers and are usually very simple to construct. Many speaker cabinets are also available in kit form, which are fairly inexpensive and can be put together in a few hours. The new frequency range of sound available to you when you connect a high fidelity speaker to your present set will prove truly amazing.

If you wish to connect a separate high fidelity amplifier to your present radio, television, or phonograph for virtually distortion-free amplification, it is also fairly simple. All that is necessary is that you connect the new amplifier to your present set at its volume control. Your volume control looks like this from the back:



Note: Do not use this method for AC-DC sets. Consult your technician.

The wire used is known as single conductor shielded wire. This type wire has a single center wire with a braided metal shield outside. The center wire is soldered to the center terminal on the volume control. The braided metal shield is connected to whichever terminal of the volume control has a braided shield already connected to it.

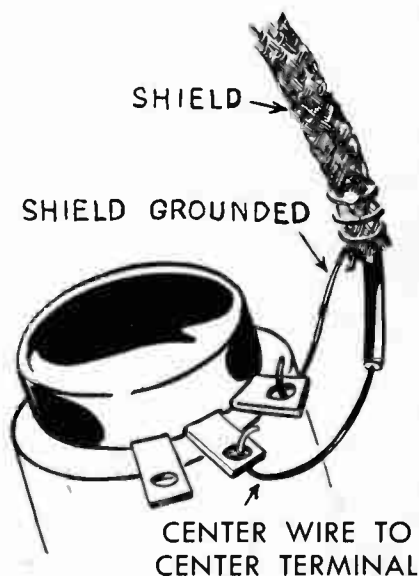

VII

This single conductor shielded wire is available at many radio parts dealers with a plug-in connector already on one end to connect to the amplifier. The other end is stripped for easy connection to the volume control. This connecting wire should not be more than eight or ten feet long or the high frequencies will be dissipated. As mentioned in another chapter, the amplifier should be placed in a well ventilated place as it generates some heat.

Modernizing your present commercially produced equipment has the advantage of enabling you to improve your sound system without discarding your old one completely, plus doing the job on a limited budget, over an extended period of time.

Any of the three changes mentioned here will definitely make a marked improvement in your sound reproduction. All three changes would be even better. They are not difficult to complete and will be well worth the slight effort and expense. ■



*Metropolitan Living 1954  
apartment by Beulah  
Spiers, A.I.D., has  
tuner in bar.*

*Bogen (left)  
and Stromberg-Carlson  
both make tuners  
for custom installations.*

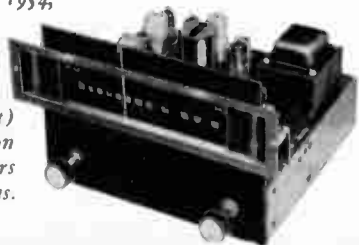

## am-fm tuners

Philip Turetsky

A TUNER is the one item in a high fidelity system that looks somewhat like a commercial radio set. It performs the same job and has a dial and knobs like the commercial radio, but there similarity stops. A high fidelity tuner is a precision-engineered piece of electronic equipment. Most high quality tuners have more tubes than many an expensive radio, which is tuner and amplifier combined on one chassis.

The tuner is only one of the many components in a high fidelity home music system. Like the phonograph or the tape machine, it is the source of a signal that is fed to the amplifier for amplification. A good tuner has the ability to discriminate between stations near each other without spurious background noise. Its signal to the amplifier is free of distortion and it has a high degree of sensitivity. This is very important if the broadcast stations are not in the local area, and the tuner must pull in distant stations.

Tuners are available in many different forms. There are AM, FM, and AM-FM tuners. There are units with preamplifiers and some without. The choice of AM or FM (or both) depends upon the broadcasts available in your area. If FM programs are broadcast, the quality is often of the highest caliber. Many large network stations broadcast simultaneously in both AM and FM. If this is the case, then an FM tuner is most worthwhile. FM broadcasts cover the widest audio frequency range and offer static-free reception. Some FM tuners are equipped with automatic frequency control

(AFC) which keeps the station tuned in, and prevents the tuner from drifting off the station. In AM tuners (although standard broadcasts are not of the same wide frequency range as FM) the programs received on a high fidelity tuner have much greater living presence when compared with commercial radio sets. Programs are received with greater clarity, and with a higher degree of intelligibility through a Hi Fi tuner unit.

If the tuner is to be used with a separate preamplifier (or an amplifier with a preamplifier built in) a basic tuner without a preamplifier should be purchased. It will often have only a tuning control, volume control and an off-on switch. Tone controls on the preamplifier will alter the incoming sound. If the tuner will be used with a basic power amplifier that does not have tone controls, then a tuner which has both tone controls and a preamplifier should be bought. In this latter instance, sound from the phonograph, television set or tape machine would be connected to the tuner, and pass through the tuner's preamplifier to the basic power amplifier.

Most high fidelity tuners are designed so that they can be attractively mounted in a cabinet or a bookshelf. In many localities good AM tuners will not need an external antenna, and an indoor FM antenna will suffice for the FM tuner.

The quality of a high fidelity tuner is of the same order as the equipment broadcast stations use to check their own programs. The high standards of today's broadcasting are wasted in a commercial radio set. Today's programs, whether a symphony or a soap opera, will come alive and amaze you when heard on a high quality home music system using a high fidelity tuner. ■

*The Fisher AM-FM tuner incorporates tone controls and phonograph preamplifier-equalizer.*

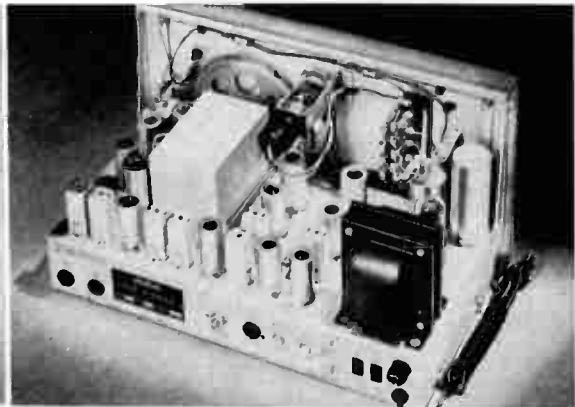

## about binaural

C. M. Brainard

**HEIGHT OF HI FI**—In the field of sound reproduction, designers have nearly reached a point of diminishing returns attempting to improve High Fidelity reproducing equipment. They have developed amplifiers that can reproduce frequencies ten times greater than the range of human hearing, and AM-FM tuners can now receive even the very weakest stations with brilliant clarity. Phonograph records are being made with recorded frequencies beyond the range of normal hearing. Today the pioneers in High Fidelity are looking for new horizons—a new dimension in sound. The answer at this time seems to be “binaural” or “stereophonic” recording and reproducing.

Binaural simply means using both ears, as applied to the recording and reproducing of sound. To explain further, let us consider a person who is facing a nearby highway. A car approaches from the left, passes in front of him, and proceeds on down the highway to his right. With eyes closed, he would have been able to tell from which direction the car approached. The reason being that as the car came closer, his left ear would have picked up most of the sound. As the car passed, his right ear would have received most of the sound waves. Therefore, differing amounts of sound would establish in the brain a sense of direction and distance. If the test subject had covered one ear and closed his eyes, it would have been extremely difficult (if not impossible) to determine direction and distance of the approaching vehicle. With single systems or “monaural” recording and reproducing equipment, it is not possible to produce a true feeling of depth, presence, or 3-dimensions in sound or musical selections.

In making a binaural recording, two separate microphones are spaced 10 to 20 feet apart in front of, or above, an orchestra. The sound picked up by these two microphones is fed separately into a double recording machine. It simultaneously records two separate (one for each microphone) tracks on a record or magnetic tape. In reproducing this sound a special phonograph arm or magnetic tape player uses two pickup heads. Each pickup is connected to one side of a double-section high fidelity amplifier. Each separate section of the amplifier is then connected to one of the two widely separated loudspeakers. These loudspeakers are placed about the same distance apart as the microphones were during the actual performance. Sounds originally picked up by the left-hand microphone are reproduced by the speaker located in the left side of the room. These sounds are heard principally by the left ear. Sounds picked up by the right-hand microphone are reproduced by a speaker on the right-hand side of the room and are heard principally by the right ear. A person sitting between (or at the focal point of) these two speakers receives nearly all the startling realism of an original performance, heard in person.

There are many binaural records and pre-recorded tapes already on the market, with more coming out every week. There are also binaural amplifiers and tuners available to the public. In addition, there have been many binaural broadcasts during the past few months in major cities of the nation. This is done by broadcasting one channel (sound from one microphone) on an AM station, and sending the other channel (microphone) through an FM station. The two separate channels are received by individual tuners, amplified and passed to speakers placed in positions similar to the pickup microphones.

*Brainard binaural tuners and amplifiers can handle two separate programs at the same time.*

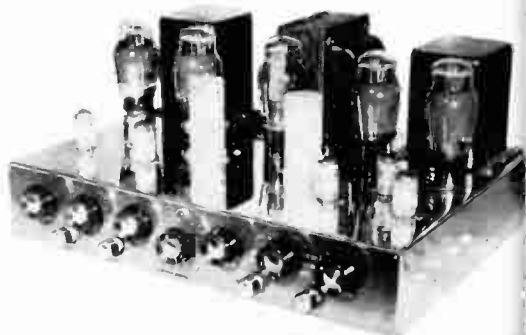

Although binaural amplifiers and tuners are designed primarily for the reception and reproduction of binaural music, their versatility is much greater. For instance, with a binaural tuner and binaural amplifier, two different radio programs can be played in different parts of the home simultaneously. Or, one channel can be used to record an FM program, while the family is listening to an AM program on the other channel. Many other uses will develop as the home music experimenter works with this newest medium of High Fidelity.

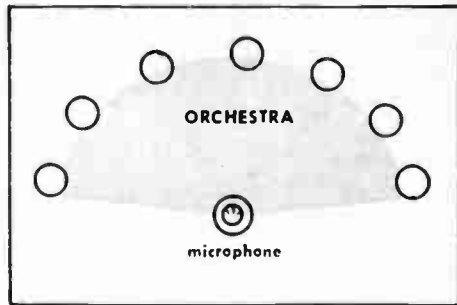

Conventional placement of microphone.

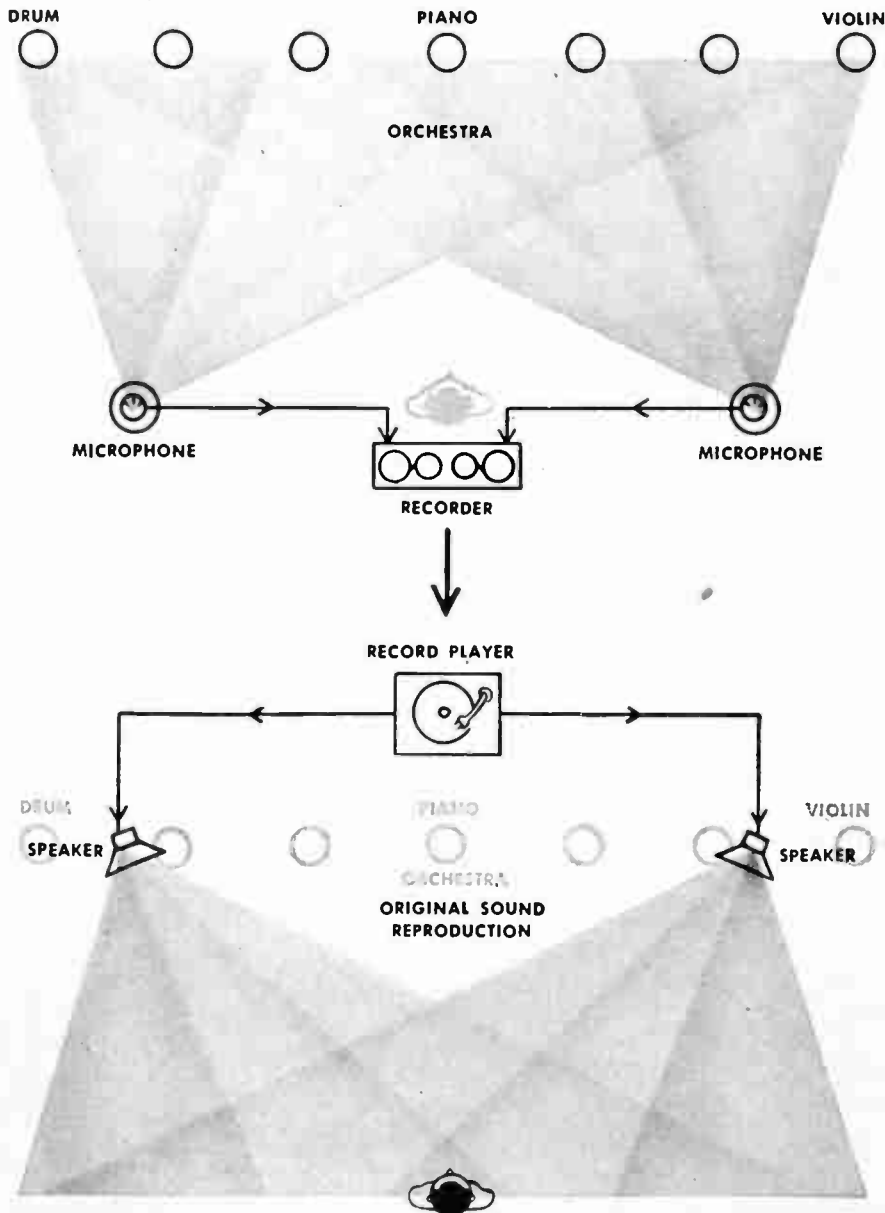

VII

Recording of binaural sound uses two microphones feeding a recorder. On playback, 75 placement of loudspeakers duplicates the illusion of sitting near the orchestra during concert.

# MAGNETIC RECORDING

*Written material and drawings for this section are from Audio Devices, Inc., New York 22, N.Y.*

**T**HE FIRST magnetic recorder was developed by Valdemar Poulsen in Denmark before 1900. His *Telegraphone* was sold and used for commercial purposes in the ensuing years.

During World War II a number of wire recorders were used for speech, and research on magnetic recording was started. Nevertheless, United States wire recording was definitely of non-professional quality.

When our forces occupied Germany, they found tape recorders in wide broadcast use. The results were far superior to those obtained with our wire recorders. The use of plastic tape, coated with a thin layer of fine particles of magnetic iron oxide, had made it possible to achieve results of professional quality. Machines presently available stem from German design philosophy rather than from our own previous work on

*Katie Lee, America's favorite folk singer, uses a tape recorder for multiple song recordings.*

*CONCERTONE PHOTO. LOS ANGELES*





Dual tape recorders with tuner and preamplifier for continuous music. MAGNECORD, CHICAGO, ILL.

High fidelity tape unit in custom cabinet. REVERE CAMERA CORP., CHICAGO, ILL.



wire. One factor helped both the Germans and ourselves: the revival of what is termed "high frequency bias" technique. By this method the rising and falling sound currents from the microphone are applied to the recording head simultaneously with a steady electric current of high (supersonic) frequency. This reduces the background noise and distortion as compared to older methods. The basic patent on high frequency bias was applied for in 1921 by Carlson of the U.S. Navy.

Recording wire is about the size of a human hair. It is, therefore, weak and easy to tangle in handling. A handling kink inevitably develops into a wire break later on,

and a broken wire often leads to a "bird's nest" snarl which may be almost impossible to untangle or reuse for recording.

One turn of recorded wire touching the next on the spool tends to leave an echo of surprising strength, and does raise the background noise. This "printing" effect is negligible in recording tape, as the layers of magnetic coating are separated by thick base material of non-magnetic plastic or paper.

It is necessary to drive wire at very high speed in order to obtain high frequency response, for wire has to be made relatively thick (about .004 inch) to provide strength in handling. The magnetic coating on tape is about .0006 inch, and good

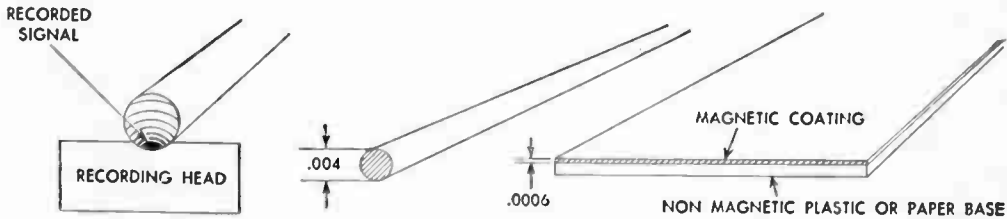

Recorded signal uses only a small area of the wire, but extends across wide section of tape. Relative thickness of tape and wire is graphically illustrated by the two right-hand drawings.

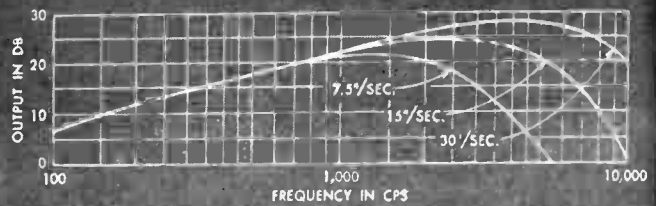
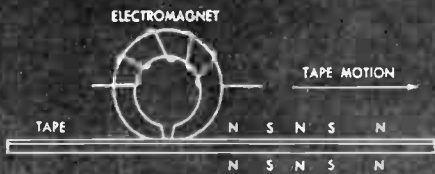

*Tiny electromagnet alters polarity of tape (N S N) in proportion to the sound signal.*

*Response of tape is affected by speed, particularly in the area of maximum frequency.*

high frequency tone response is secured at only a fraction of the speed of wire. Curiously, the paradox which has handicapped wire is that .004-inch wire is simultaneously too thin to handle easily and too thick for good frequency response. Wire recording has been relegated to uses where its advantage of long recording time in small space is important, as in pocket size recorders.

The theory of magnetic recording is easy to understand. Microphone sound currents to be recorded are passed through a magnet coil wound on an iron core. A roll of magnetic tape or wire is drawn past the poles of the magnet, and the varying incoming sounds are recorded as varying degrees of magnetization. To play back the magnetic sound signal, the tape is drawn over the poles of a similar structure. The magnetic fields in the tape generate a varying voltage in the coil. This signal voltage is passed through an amplifier which raises it to an audible level in the speaker or headset.

The magnet coil and pole assembly (recorder or playback) is usually called a head. The magnetic record on the tape produced by a head is only slightly wider than the head itself. Several tracks may be applied to a single tape by using narrow heads side by side on a wide tape.

In theory, erasing the sound is quite straight-forward. The recorded tape is passed by a magnetic field so powerful that it removes all vestiges of magnetic variation. Erasing leaves the tape magnetically smooth and free to be recorded upon again. Erasing may be done any number of times, without injury to the magnetic material.

This has been an oversimplified picture of magnetic recording. Simple in basis, the execution requires as highly developed engineering as that used in disc recording.

Much of the value of a magnetic recorder depends on the performance of its recording and playback heads. An important item

in the playback head is the slit dimension which controls the high frequency response. The recording head is not as critical in this respect. Thus, while a .00025 to .0005-inch slit is used in a good playback head, the recording head may have a .001-inch slit. Faulty contact between pole pieces and tape has a bad effect on recorded sound. Even as little as .001-inch space between a pole and the tape will have a major effect.

Frequency response is critically affected by alignment of the slits used for recording and reproducing. Professional tape machines generally have means for adjustment of the heads. Home tape machines, however, very seldom have provision for such adjustment. A tape recorded on one home machine and played back on another with a different angle between the slit and the direction of tape travel will generally reproduce poorly, with most of the higher frequencies and harmonics lost.

Playback is affected by tape speed, particularly in the higher notes. The effect of increasing tape speed is to increase the high notes which can be recorded or played back to reproduce the recorded sound.

Recently, manufacturers have found that improved heads lead to a great increase of usable frequency range. Thus, home machines using tape at 7.5 inches per second may have good response up to 6000 or 7000 cycles. Professional machines running tape at 7.5 inches per second may have uniform response up to 10 or 15,000 cycles. Machines of this type are all characterized by the improved quality of the reproducing head. The physical modification of the head is almost imperceptible—reducing the slit width by several ten-thousandths of an inch—yet it is enough to double the available frequency range for a given tape speed.

Too high a recording volume (level) leads to unpleasant distortion hanging about the sound in a veritable curtain. It also leads to



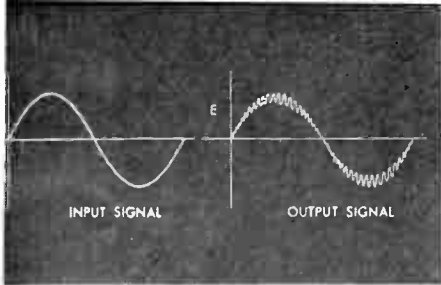

Modulation noise (exaggerated for clarity) distorts original signal.

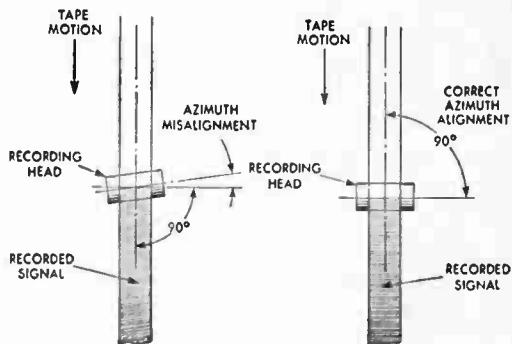
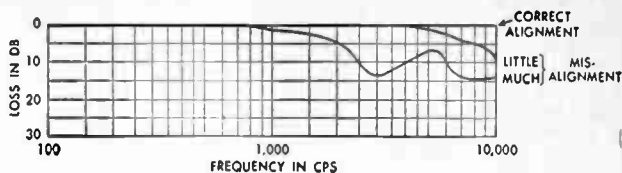

Misalignment of recording (or reproducing) heads causes a serious loss of high notes.

a volume compression effect which removes the accent, the artistic touch. Thus, a drum beating in the middle of an orchestra may overload the tape and lose most of the force of its easily lost sound which follows the initial thump. On playback the relative loudness of the drum may be so diminished that it sounds as though removed to the back of the studio.

It may be noticed that instruction manuals have stated that magnetized (recorded) tape was noisier than unmagnetized. Because of this, there is an increase of noise when a recording is applied to any tape.

Careful inspection on a cathode ray oscilloscope reveals that this noise rises and falls with the recording volume—in fact is modulated (regulated) by it (whence the name "modulation noise"). Modulation noise has been blamed on many factors, with non-uniformity of magnetic properties, non-uniformity of thickness, and the Barkhausen effect being most popular. Under certain conditions, modulation noise is audible to the listener, particularly on solo instrument or solo voice passages, as a fuzzy edge to the tone or as a hoarse background for it.

When paper tape is coated, the top surface of the coating is very smooth, but the bottom surface (being in contact with the paper) is as rough as the paper surface. The resulting microscopic irregularity of coating thickness creates modulation noise—which is why a recording on paper base tape never sounds quite as clean or smooth as the same recording on plastic base tape.

Present-day tapes consist of a non-magnetic base which supplies the necessary mechanical strength, and a coating which supplies the magnetic properties. The base material may be either paper or plastic.

Plastic base uses .0015-inch thick cellulose acetate. This is an improvement over the German machines which used an oriented (stretched) vinyl material that tended to

wrinkle and shrivel up if overheated. This could easily happen in the back of a closed automobile or on an open railroad station platform in the summer sun. Plastic base tape is much smoother and somewhat more uniform in thickness than is paper base. Hence the resulting tape has less background noise, less modulation noise, and lower distortion in its recording of sound.

While the paper and plastic used have approximately the same breaking strength—4 to 5½ pounds—the plastic is generally considered "stronger." It can stretch somewhat under stress and so avoid breaking, while the more rigid paper snaps rather than yields momentarily.

The coating on the base consists of a carefully controlled mixture of magnetic material and binder. The recording material is a magnetic oxide of iron . . . either the black or a brown (generally called "red"). The black oxide is chemically produced, of extreme fineness (the particle size is less than 40 millionths of an inch). The red oxide is produced by heat-treating the black under carefully controlled conditions.

The binder is a tough, flexible combination of synthetic resins, used to hold the oxide to the base. Since tape may be stored tightly wound on reels for long periods, there must be no tendency for one layer of tape to stick to the next. At the same time the

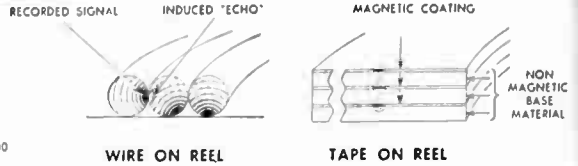
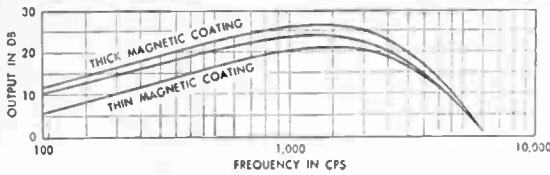

*Variations in thickness of tape coating will greatly change the recording characteristics.*

*"Printing" of tape and wire occurs during storage, producing echoes and tone distortion.*

binder must not be dried so hard that the tape is made stiff—for then it would not fit well over the heads. The amount of friction between the binder and metal must be low, otherwise the tape will not move smoothly over the heads—leading to flutter and to an audible squeal.

Just to make the problem of the formulator more difficult, all these properties must be achieved without injury to the toughness and strength of the binder, and without causing it to curl. A weak binder will rub off onto the heads very rapidly.

For uniform quality from one foot of tape to the next, the oxide and the binder must be completely mixed—an operation known as dispersion. Poor dispersion would increase modulation noise, as well as impair uniformity. The various ingredients are introduced into the grinding mills according to a carefully developed sequence, then milled. A small amount is withdrawn and test-coated. If the test coat shows satisfactory dispersion, the mill contents are released for production use.

Tape is coated in wide strips, then precision slit to the exact width. This has to be done very carefully, leaving the tape perfectly flat and straight. Poorly slit tape will not wind smoothly on the reel, nor unroll smoothly; experience has shown that this leads to frequent tape breakage during reproduction. Fuzzy slitting can be detected by looking through the side of the reel toward a lamp bulb. A cleanly slit reel will show a clear image, while fuzzy edged tape will be far from clear. A fuzzy edge may conceal a multitude of incipient cracks—good starting places for a break at peak stress during rapid rewinding.

One tape defect, created by the recording machine, is often wrongfully blamed on slitting: damage on rewind. Some profes-

sional recording machines have an ultra high speed rewind. When this reaches maximum speed the tape is occasionally overstressed by surges, and made crooked. The next time the tape is played or rewound, these crooked spots catch or jam, and a tape break results. One remedy is to apply the thumb lightly to the reel or flange, applying just enough load to keep the speed below the point at which trouble results.

During slitting the individual reel of tape is wound either oxide-in or oxide-out as the customer wishes. If you happen to have a reel with the tape wrong-side-to, just give the tape a half turn while threading it up for rewind. After rewind it will have the oxide direction you wish to fit your particular type of machine.

If a layer of non-magnetic material sticks to the surface of the recording or reproducing head, it will lift the tape out of contact with the pole pieces and injure the high frequency response. The easiest cleaning method is to wind some soft cloth on a small stick such as a throat swab. Dip the cloth in acetone or nail polish remover, squeeze out the excess liquid, and clean the heads. Do not have the rag so wet that cleaning fluid runs off it and into the heads.

In some machines tape is dragged over a roller or guide in such fashion that ridges of coating accumulate. When this occurs, clean with acetone or nail polish remover.

Magnetic tape coating is an abrasive, very similar to crocus cloth in its characteristics. This is what gives recording heads such a fine polish, but it also wears the heads down slowly. As this occurs, the slit finally increases in width and the high frequency response is impaired, so that heads should be replaced. Professional machine manufacturers will accept worn heads for exchange at a reasonable cost.

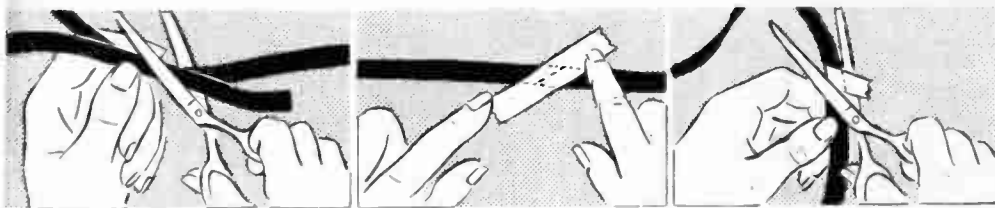

*The splice should be made using a guide so that successive lengths are in exact alignment. Otherwise, there will be a momentary loss of high frequencies at the splice point.*

A loud sound is recorded, preceded and followed by silence, and the tape is wound up on the reel. If it is then played, an echo of the sound will be heard before and after it. This is called magnetic printing, print-through, or cross talk. It occurs because the strongly magnetized tape is wound up next to unmagnetized portions, and some of the magnetic effect transfers over from one layer to another. This seems to occur on all tapes, and may be taken as an inherent limitation of magnetic recording.

It has been found that printing becomes serious as the recording volume level increases. Another precaution is to keep the tape storage temperature below 75 degrees F. Higher temperatures will severely increase printing effect and resulting distortion.

Summarizing, we would suggest the following as possibly the best storage conditions for maximum life:

- A. Temperature: 60 to 70 degrees F.
- B. Relative humidity: 40 to 60%.
- C. Peak distortion during recording: 2% (to minimize printing in storage).
- D. Store away from even slight magnetic fields (to minimize printing).
- E. Store in tape-sealed metal cans.

If one wishes a more certain way to store sound for long periods of time, then phonograph records and metal masters offer the oldest and presently best proven way. A hundred years of experience with tape may reverse this opinion, but since there is no reliable accelerated long-term aging test, we must rely on time itself to supply authentic data.

The strongest and best splice is a diagonal one, with the edges accurately matched together. The splicing tape should be of good quality, and especially made for magnetic tape work—it will not have an excess of adhesive, which would squeeze out under

pressure and stick to the next layer of tape. The splice should be made using a guide so that the successive lengths are in exact alignment, otherwise there will be a momentary loss of high frequencies as the splice goes over the reproducing head.

The past several years have seen many new tape recorders offered to broadcaster, studio, school, and home. Prices vary from under a hundred to over four thousand dollars and it is only natural for the purchaser to want to pay as little as possible. If he is wise, he will also wish to spend enough to secure the facilities and results he needs for his work. A full discussion of machine design would take a book in itself, so we will have to content ourselves, in this section, by pointing out the factors to be considered, and by touching lightly on certain necessary characteristics.

In any application the recording performance is the first thing to be considered, the most important point being the frequency range. If this is too small for your work, there will be complaints of poor intelligibility or of lack of naturalness, or refusal to broadcast your tapes. If the range is too great, you have paid too much for your equipment. The next factor is that of signal to noise ratio, for if this is too small background noise will be offensively loud, and the adjustment of recording level will be too critical. Again, if the ratio is much greater than necessary, then the equipment cost has been higher than it might be. Finally, the distortion should be low, since high distortion leads to a loss of clarity and naturalness, and listener fatigue is rapid.

Next we must consider economy of tape use. Low tape speed means that we need less tape for a given program, but it also means either reduced frequency range or increased noise level, for a given perfection

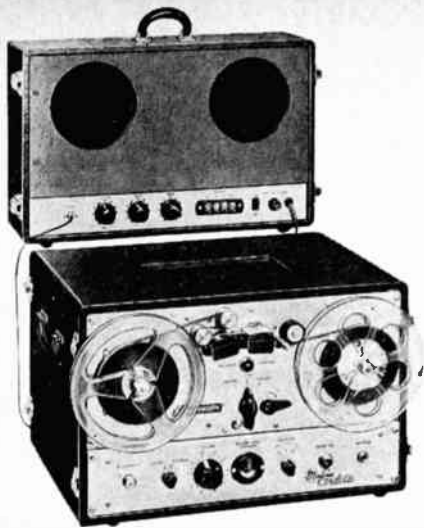

of design. We can cut our tape requirements in half, theoretically, by using dual track recording. Practically, this is often undesirable, for it makes editing impossible, and introduces background noise.

Convenience of operation is particularly important to the non-professional, as are size and weight. No amateur wishes to carry his machine around on a hand truck. Many semi-professionals overvalue the extreme in portability, and so sacrifice some of the quality of performance that they need.

Finally, we must not overlook stability of characteristics, and durability. The broadcaster and the studio must have it, the school needs it, and the home user is irked by the lack. Some machines have been made so that every component is driven too hard, and suitable for operation over only a short period of time, while others will stand use 16 hours a day.

Home use takes either of two forms: speech or music. In the former case, a 6,000 cycle frequency range is likely to be adequate; in the latter, at least 9,000 and preferably 15,000 cycles should be available. Modern phonograph records have good response to at least 12,000 cycles so that comparable tape quality should be had.

The choice between single and dual track recording is again a question of editing versus economy. Portability demands a weight of not over 30 to 35 pounds, though some enthusiasts have managed to handle a 65-pound professional machine. If left in a single place, weight is certainly not a serious matter. Home machines generally have all the input and output circuits required.

If we are to judge by European example, the office dictation field will be a very successful application for magnetic recording, and indeed several manufacturers are in the field. Portability is not essential, but minimum use of desk and floor space is necessary and remote control is important.

A number of features are available in the better grade of machine, and the purchaser should decide in advance which are necessary for his particular application. First we have the question of two-head versus three-head machines. All machines have an erase head; a two-head machine uses the second head alternately for recording and playback. A three-head design has separate record and playback heads. Since the requirements for optimum performance in recording and reproducing are not alike, a double duty head is at best a compromise. Slightly better performance can be achieved with separate heads. They also permit listening to the program being recorded—a wise precaution.

In professional machines recording at 15 inches per second, excessively fast rewind and forward shuttle speeds should be avoided. At very high speed, momentary heavy stresses are induced in the tape, deforming it and leading to trouble.

To minimize head wear it is desirable to have means for lifting the tape off the heads during rewind and fast forward operation.

It may be of interest to discuss preventive maintenance as practiced in a modern recording organization. In the broadcasting and phonograph recording fields the cost of a failure during operation is so great that preventive maintenance is the rule.

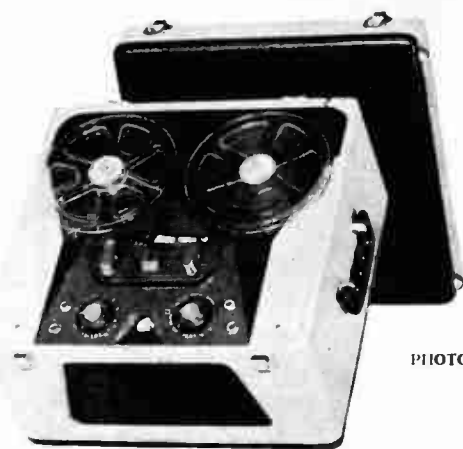

*From left to right: Portable professional recorder with amplifier and playback speaker; high fidelity recorder for custom installation, and an inexpensive portable multi-speed tape recorder.*

PHOTOS FROM MAGNECORD, CONCERTONE, AND PENTRON

Such an organization checks the gain, signal to noise ratio, frequency response, and distortion of every piece of equipment before beginning the day's work. If the recorder uses friction clutches, the tape tension adjustment is checked. The recording head should also be demagnetized, and all heads and guides cleaned thoroughly. Lubrication is accomplished on the schedule recommended by the machine manufacturer.

We may contrast with this the normal school practice of performing no maintenance until it becomes absolutely necessary. The inevitable result is unnecessary wear of the machine, and a lower average level of performance. At the very least, the heads

and guides should be cleaned once a week, and the entire equipment given a rough performance check once a month. The manufacturer's lubrication and adjustment schedule should be executed carefully. Once each term a rigorous performance check of gain, frequency response, distortion and signal to noise ratio should be made. Since the average school is not equipped to perform such tests, an outside organization may well be used for the purpose. Once a year worn parts may be replaced at the nearest repair depot.

The average home user cannot be expected to go to all this trouble, and we can reasonably ask you only to follow the manufacturer's maintenance suggestions. ■

*The amount of recording time available with various combinations of speeds and reels.*

REEL SIZE	3"	4"	5"	7"	10½"	14"
LENGTH IN FEET						
Audiotape	150	300	600	1200	2500	5000
Other Types	150	300	600	1200	2400	4800
RECORDING SPEED	TOTAL RECORDING TIME (Based on Audiotape footage)					
1½" per sec. {						
Single Track	16 min.	32 min.	1 hr. 4 min.	2 hr. 8 min.	4 hr. 26 min.	8 hr. 52 min.
Dual Track	32 min.	1 hr. 4 min.	2 hr. 8 min.	4 hr. 16 min.	8 hr. 52 min.	17 hr. 44 min.
3¾" per sec. {						
Single Track	8 min.	16 min.	32 min.	1 hr. 6 min.	2 hr. 13 min.	4 hr. 26 min.
Dual Track	16 min.	32 min.	1 hr. 4 min.	2 hr. 12 min.	4 hr. 26 min.	8 hr. 52 min.
7½" per sec. {						
Single Track	4 min.	8 min.	16 min.	32 min.	1 hr. 6½ min.	2 hr. 13 min.
Dual Track	8 min.	16 min.	32 min.	1 hr. 6 min.	2 hr. 13 min.	4 hr. 26 min.
15" per sec. {						
Single Track	2 min.	4 min.	8 min.	16 min.	33⅓ min.	1 hr. 6½ min.
Dual Track	4 min.	8 min.	16 min.	32 min.	1 hr. 6½ min.	2 hr. 13 min.
30" per sec. {						
Single Track	1 min.	2 min.	4 min.	8 min.	16½ min.	33⅓ min.
Dual Track	4 min.	4 min.	8 min.	16 min.	33⅓ min.	1 hr. 6½ min.

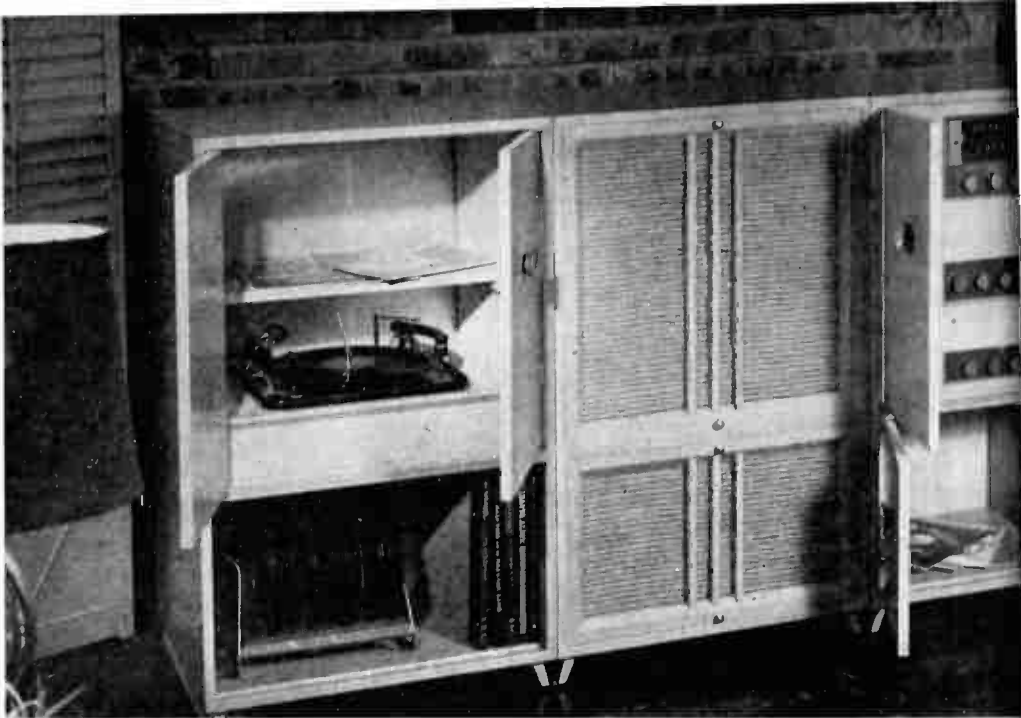

*Folded horn speaker is between the Stromberg-Carlson changer and tuner-amplifier.*

## *automatic changers*

*Jerry Franke*

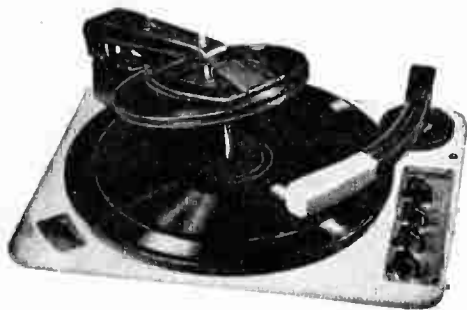

*Gear driven, three-speed automatic changer is made in Switzerland by Thorens Company.*

*Base-mounted changer from Stromberg-Carlson can be moved around house as necessary.*



**T**O MOST PEOPLE, automatic record changers look so much alike that one could naturally assume the differences are minor. And many music fans believe that outside of price, there are few factors to influence their choice.

Changers have more or less the same essential parts. A motor, tone arm, the turntable, a central spindle and some manner of supporting one or a dozen records. But, like cars, there's a lot that doesn't meet the eye; especially in the interior construction and quality of component parts. A lot of cheap equipment is labeled Hi Fi, that isn't. This is truest in changers; with the term being plastered onto nearly every bit of record equipment, including inexpensive portables of sub-standard tone quality.

The average inexpensive two-pole motor is of the induction type which is subject to serious speed variations ("wow"), and rumble, due to lack of balance and pitch. The more expensive four-pole motor is smoother, runs more evenly and reduces turntable rumble to a minimum. Its designed ability to hold a constant speed, especially under heat or load regardless of variations in line voltage, is important since musical pitch depends on a constant speed turntable. Better units are worth their cost.

# RECORDS AND FINE MUSIC

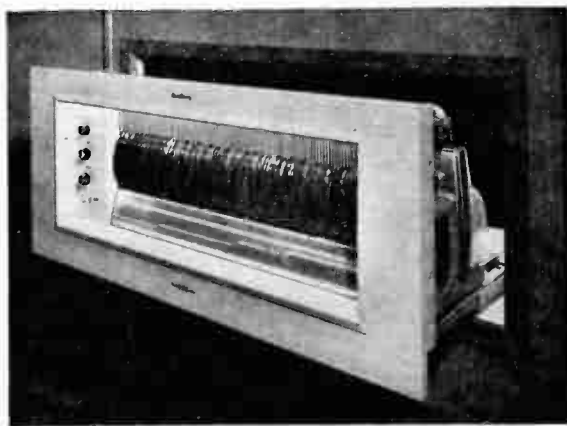

*Both sides of 100 records are played by Seeburg unit.*

The weight, material, and construction of the turntable are vital to smoothness of operation, and the quality of music the changer will produce. The turntable should be heavy and properly balanced, since balanced weight will overcome slight changes in speed. It should sit and turn level to prevent distortion of the music, and poor tracking of the stylus in record grooves. Any unbalance of the turntable will produce rumble and rapid bearing wear. The drive shaft and linkage that connects the motor to the turntable are vital links. The use of belts, pulleys, or excessive use of spring tension add to the possibility of slippage and breakdown in frequently used equipment. Belts and pulleys are completely satisfactory for limited use by the non-critical music fan. Professional changers and turntables are gear driven which is preferred for units in continual or critical use.

The spindle and record dropping mechanism control the life expectancy of your record and its vital center hole. A bent spindle, with pusher-type platform, is preferable. It has the gentlest touch and changes records with a minimum of clatter from discs striking the turntable.

An inter-mix changer mechanism that permits the interchangeable playing of 10 and 12-inch records will add much to your

enjoyment. Interchangeable spindles for 45 rpm records are preferable, rather than discs or slip-on spindles. They will provide better tracking and pitch, since there is no "run-out" or imperfect centering of the small size record.

The tone arm is not just a means of suspending a stylus on the record. Its shape (in the better changers) is designed to describe an arc across the record. Shortness of the arm is offset by its slope, which permits the stylus to stay at the proper angle of the record groove while playing the entire width of the record. For this reason, a well mounted tone arm should be light and rigid, of metal rather than plastic. Its action should be positive, yet smooth; and its movement towards the record's first groove, as gentle as a kiss.

The pickup cartridge used, whether it be crystal, ceramic or magnetic, will determine the range and quality of your music and the life of the records, especially the microgrooves. A changer whose tone arm is designed to accept interchangeable shells (and cartridges) allows a wider selection of professional pickups and saves replacement stylus costs. An important point is to investigate both the single play turntables and changers before you decide which would be best for your installation. ■

IX

## *single-play turntables*

*Jerry Franke*



*Typical turntable is Weathers unit which includes amplifier, pickup and movable base.*

TO THOSE WHO are blessed (or cursed) with an ear of perfect sound comprehension, a "single-play" turntable becomes a "must." Its superior compliance and tracking, quality construction, hushed motor and zeroed-in tempo are of broadcast quality and ability.

Since only a single record is played each time, the weight-load of multiple records and lopsidedness of the weighred spindle are no longer factors. The slippage of record on record is absent, with vibration and resonance lessened as well. No, it won't play for five continuous hours. But with the advent of 12-inch long-playing records, anyone can move at least once each half

*Modern office includes single-play turntable. California Sound Products, Hollywood 46, Calif.*





hour. Efficiency is exchanged for convenience and repair bills are cut to a minimum. Turntable arm construction is finer and the arm, being longer, brings about a better tracking angle while staying in the groove. The lower stylus and arm mass improves tracking with lighter pressure and wearing on the record.

The first noticeable difference between turntables and changers is in the materials used and the precision construction throughout the unit. The stronger and more rigid single-play chassis has less chance of twisting and losing its delicate assembly relationship, with resulting rumble or wow. Close machining tolerances are held for the various rotating parts and tempered motor shafts. The lathe-turned dynamically-balanced aluminum turntables prevent hum and flutter. Extra heavy rims create an effect of flywheel balance. Precision measurements are used in centering the shaft so the table always revolves the records in a perfect circle. Dynamic balancing and hand construction increase the cost, but give the precision of a fine watch to record playing.

On some models is found the fine hysteresis motor with a cobalt rotor in solid form. The solid rotor provides smoother performance and power than the usual laminated metal rotor. This type of synchronous motor maintains perfect pitch and tempo under abnormal conditions of heat, load, and fluctuating power line voltage.

With a larger and often dressier shock-mounted base, turntables often achieve better appearance as well as improved performance. Since the tone arm is a separately installed part of the turntable assembly, a wider choice of precision arms is available. To serve the needs of professional users, several arms can be mounted for varied purpose use, including the new binaural arm which cannot be used on a changer.

Proponents of the various arm makes are willing to defend their choice to the death. Since arguments are for the purists, let's leave it to them and describe a representative group of turntable arms.

The Pickering arm is one in which the vertical motion of the pickup is suspended from a rigid arm. Because the pickup is entirely free of the total weight of the arm, it allows the playing of even a warped record with good tracking. This is due to a wrist-like movement of the cartridge and a tracking pressure of only four grams weight. Even though the grooved tracks are small and side movement is rapid, the groove walls can easily vibrate this pickup of low weight; hence, excellent compliance.

The Gray Viscous Damped arm is light in weight and of excellent balance. It has the happy factor of arm resonance (vibration) virtually eliminated by the use of liquid damping similar to an automobile tubular shock absorber.

The relatively new Ferranti arm, designed by Williamson of amplifier fame, already has its proponents due to low mass, high compliance abilities from its ribbon design, and remarkable tracking ability.

The Fairechild arm was originally designed for professional broadcast use and utilizes a dynamic moving coil pickup. It is a special purpose arm that requires a step-up transformer or a high gain amplifier. The Fairechild provides excellent frequency response with extremely low noise level. This is not an arm for amateur use.

The Weathers Cartridge and arm is an unusual pickup assembly. It utilizes FM (frequency modulation) by taking sound from the record and imposing it upon an oscillator-demodulator FM unit. The Weathers arm is extremely light as the entire assembly weighs only six grams. Since the arm uses a small sable brush ahead of the stylus, the brush absorbs weight from both the arm and stylus. The stylus weight on the record is about 2 grams. Record wear is negligible, yet tracking and compliance are excellent. The stylus is extremely delicate and will not take rough usage.

There are many other arms and turntables that you will discover for yourself. Discovery is a major part of Hi Fi. Search for perfection at a price you can afford. ■

IX

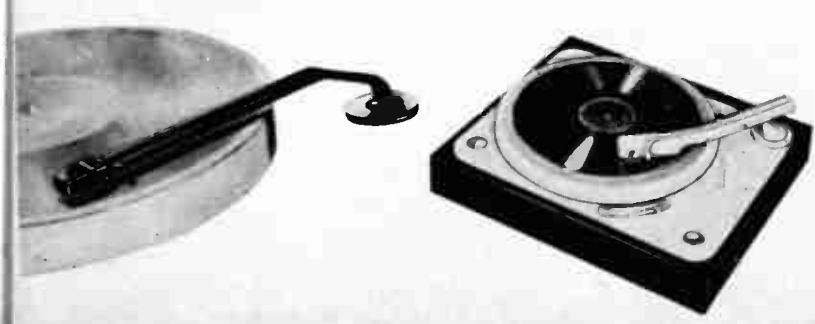

*Ferranti pickup and tone arm (left) and Bogen multi-speed turntable (right) are typical of the Hi Fi equipment available for single-play record fans.*

## *the tone arm*

*Jerry Franke*

THE TONE ARM of any record changer is of vital importance to your entire home music system. Its material, construction, suspension, and versatility in accepting more than one type of cartridge determine how much actual music will be picked up from the record. In addition, it controls how much wear there will be on the record grooves and stylus, as well as the total service potential the unit may be expected to provide its owner.

All tone arms should be as light as possible without sacrificing rigidity and efficiency in tracking the grooves. Plastic, because of low cost and ease of manufacture, is used to a great extent on inexpensive changers where price is the greatest factor. Often the arm is coupled with a crystal pickup and the inadequate "play every record" single stylus. Lightness is not enough; if heat, usage, and wear will tend to warp the arm and render its tracking ability useless. A poor arm can damage both the stylus and records, especially the delicate microgrooves.

Die cast metals such as Dural, aluminum, etc., provide rigidity and efficiency to the arm as well as permit efficient design and better construction.

The arm should move easily and smoothly both vertically and laterally. Its changer action must be one that sets down easily and gently upon the record, with the stylus tangent to the edge of the groove. There should be as little rough motion and clatter as possible for speed is not as important as efficiency. Muting switches which turn off the sound during record changes are now being incorporated in newer changers to eliminate the clatter heard during record dropping cycles.

You don't have to be an engineer to distinguish the difference between quality construction and slipshod production. Lift the tone arm and examine it. Note its material, check its apparent weight, and note if there is provision to adjust the weight and balance of the arm. Check the cartridge and the care with which it is mounted. Make certain there is provision for BOTH types of styli. The "old style" 78 rpm grooves require a 3 mil stylus which is three times as wide as the 1 mil stylus for newer microgroove records. One stylus, no matter what the size, cannot serve both records without sacrificing music quality for cost. Avoid the "compromise" stylus if you value your records and desire the best reproduction of music.

Where the arm is joined to its pivot post, look for something better than just

*Stylus pressure gauge is designed to measure pickup weight which can be controlled on most automatic record changers.*



*Tone arm on Garrard changer is counterbalanced to limit the stylus pressure on delicate record grooves.*

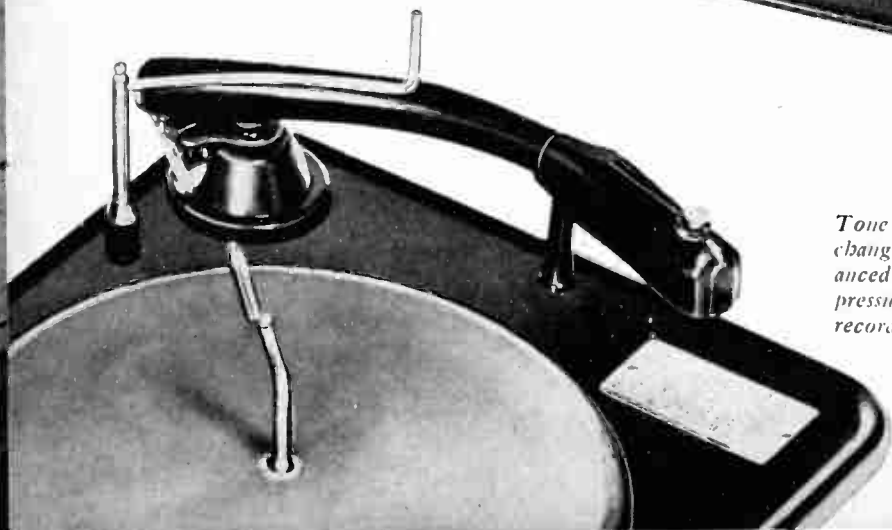

the ordinary "cotterpin" swivel. Jewel or ball bearing mountings will be found on a few of the more expensive changers. In any event, the suspension and pivot should at least be adequately smooth, without excessive side play or looseness.

On the better changers you will often find provision made in "shells" (on the end of the arm) for interchangeable cartridge and stylus heads of the "plug in" type. Others require soldering to attach or remove. These shells permit use of any of the three basic types of cartridges; be they crystal, ceramic, or magnetic. Interchangeable heads make your unit more versatile since they permit the use of the professional cartridges such as the Fairchild, Pickering, Audak, Weathers, and others.

Dual heads are preferable since they contain separate styli for both types of records. Only ONE need be changed as it wears out, instead of the needless cost of replacing both.

Because the arm provides not only tracking for the stylus, but its angle in the groove, (plus weight and balance) it should be chosen with the greatest care. In general it is considered a wise move to buy the changer with the best arm and record handling mechanisms. The difference between good and bad is often only a few dollars of initial cost. ■



*Bottom view of Pickering plug-in shell shows contact points, wiring and turnover mount.*

*Turning the small lever (78) to the left will rotate the cartridge one half turn, placing the microgroove stylus in a playing position. All dual point cartridges have some means of stylus changing such as this Pickering unit.*

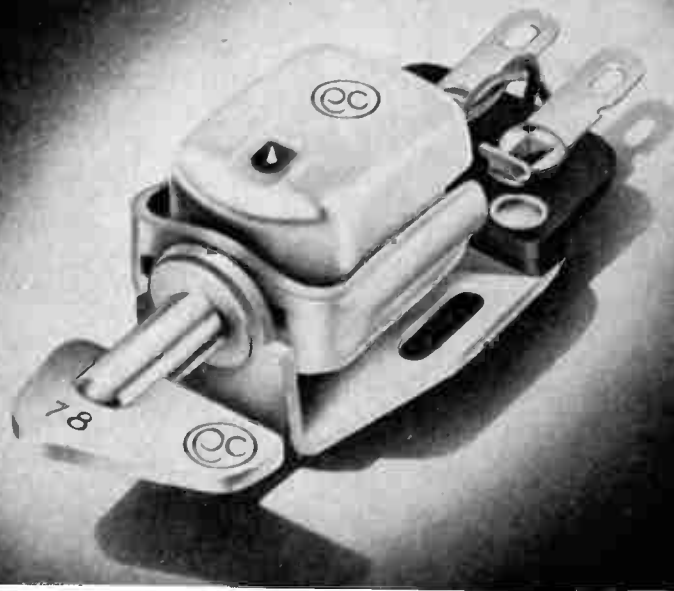

## *cartridges and styli*

*From Columbia Records, Inc.*

MODERN PHONOGRAPH records are the crystallization of years of audio engineering skill and experience. New recording techniques make it possible to capture the entire spectrum of audible sound in correct balance. This achievement brings the thrilling brilliance of the concert hall into your living room. We call this exhilarating experience High Fidelity Recording.

Your Hi Fi record has a treasure house of music imprisoned in its grooves and waiting to be released at a touch of the needle. The fidelity of the original performance is greatly dependent upon the needle's quality.

Most phonograph needles are subject to rapid wear and deterioration. The appearance of wear on a needle results in the

restriction of the tonal range of recordings.

Many people think that a phonograph needle has a sharp point. Actually it is a cone with a smooth ball-shaped tip and is as carefully made as a tiny watch part, and as highly polished as the finest gem.

As you lower the tone arm on the spinning record, the ball point of the needle nestles on the walls of the V-shaped groove. Instantly—the needle is forced to vibrate from side to side at an astonishing speed. Dynamic forces produced by millions of microscopic sound impressions in the groove must be sensitively followed by the needle tip. This is necessary for crystal-clear reproduction of the original performance.

Obviously, in order to avoid unpleasant distortion of sound and to protect delicate grooves, only a needle in good playing condition should be used on your record collection. Records are too costly to ruin for the pleasure of one play.

*Styli diamonds from Tetrad Co., Inc., N.Y.*

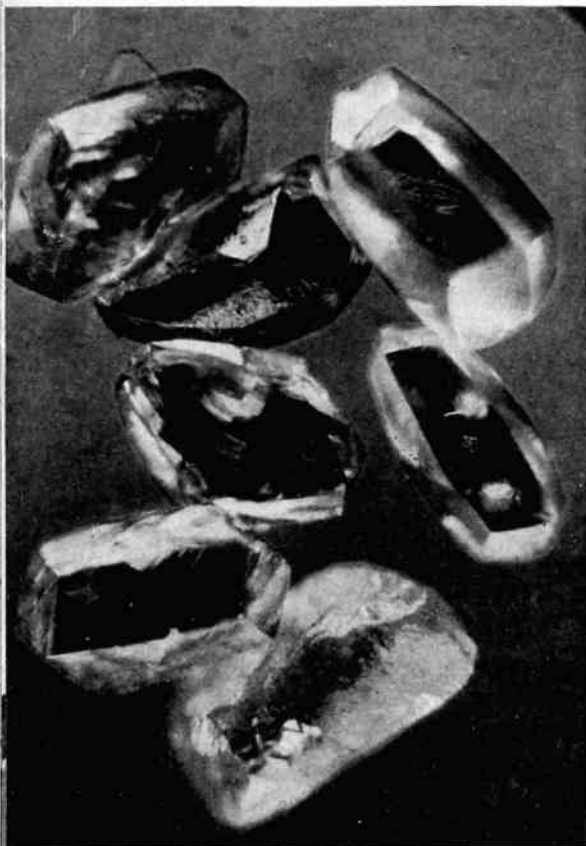

*Diamond  
478 Hours of  
play  
Still usable*



*Sapphire  
50 Hours of  
play  
Worn out*



*Osmium  
15 Hours of  
play  
Dangerous*

*Tetrad Photos,  
N.Y.*

No record or phonograph can play better than the needle will permit. A phonograph needle is only in fleeting contact with any one section of the record groove. In addition to vibrations, pressures between the needle tip and groove walls develop into tons per square inch. High temperatures are generated by friction and rapid motion. Since the tip of the needle is under continual attack by these forces and the groove only momentarily, it is the needle which wears out first, not the record. But, once the needle develops "wear-flats" and sharp edges, it may cause permanent damage to your valuable records.

The needle, like a shoe, is subjected to continuous abrasive wear when in use. Both develop wear-flats which decrease their usefulness. Here the similarity ends; for you can't see the damage on a needle tip until you examine it under a microscope. ■

#### GOOD AND BAD NEEDLES IN RECORD GROOVE



*Phonograph styli can be examined under a microscope for signs of damage-creating wear.*



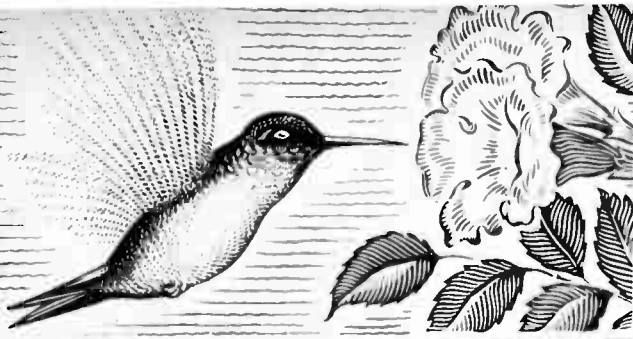

Your phonograph needle vibrates 10,000 times per second which is 50 times faster than the beating of the hummingbird's wings.



1 Mile of Lp grooves

If all the grooves on one standard-size long-playing record were uncoiled, they would measure a full mile in length.



A diamond needle can travel a groove length of 3,000 miles before wearing out—equal to distance between New York and Los Angeles.

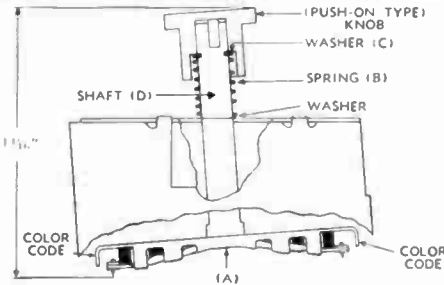

G-E variable reluctance cartridge has two styli on one movable shaft. All cartridge drawings courtesy of General Electric.

- A Stylus pivot pin
- B Bronze guide
- C Six damping blocks
- DD Gold-plated stylus cantilevers
- EE Two styli

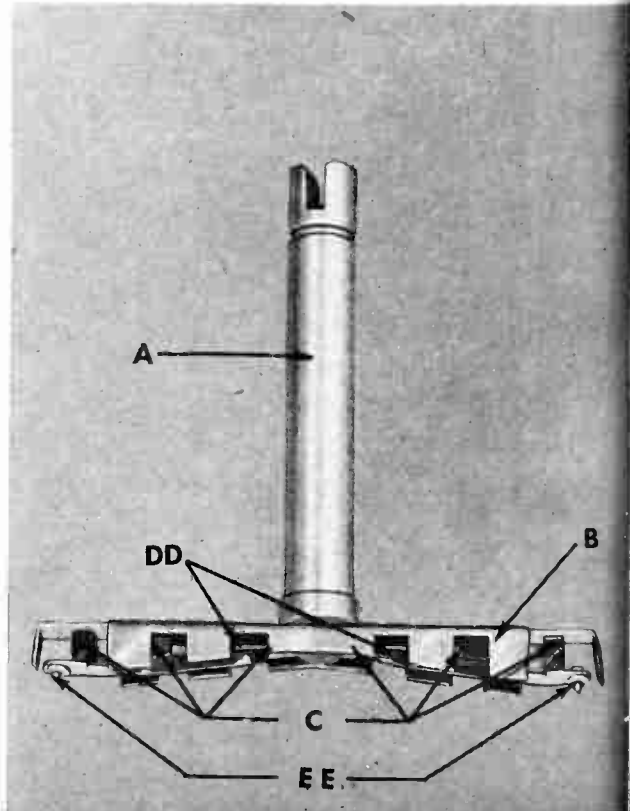

## cartridge operation

From David Bogen, Inc., N.Y. 14

HOW DOES THE cartridge work? Let us recall that the phonograph record is a storehouse of musical reproduction. When the original recording is made, the impulses which constitute the performance inscribe (or "graph") on the disc a mechanical picture of the sounds produced by the performers. The record we play is a reproduction of the original disc. It contains the same "graph" made by the original impulses. When the record rotates on the turntable, the phonograph needle, or stylus, is drawn through the grooves. As it moves from side to side, it is guided by the pressure exerted by the walls of the grooves.

To make use of the signals engraved in the phonograph record it is necessary to convert them to electrical energy, so that they may be amplified to operate the loudspeaker. The phonograph cartridge is the device which does this. The two most popular are known as the crystal and the magnetic. The crystal cartridge operates on

a principle many Hi Fi owners will recall from their high school physics, known as piezo electric effect. Certain materials, among them crystals of Rochelle salts, will produce tiny electrical currents if pressure is properly applied to the crystal. Connect a phonograph needle to a piece of this material and you have the phonograph cartridge. The magnetic cartridge performs the same function, but in a different way. Here the change from mechanical to electrical energy is made on the same principle that gives us the electric generator.

A crystal cartridge is generally less costly; and some, using interior units known as "ceramics," often give surprisingly good performance. But neither, it is felt, approaches the quality of the magnetic cartridge. It is therefore to be preferred, despite the added cost and the extra amplification needed by the signals produced by the magnetic type. Also, the high quality magnetic cartridge is so constructed that it responds more easily to the pressures exerted by the groove walls. This added compliance of the stylus means less wear on the record and a more nearly exact reproduction of sound. ■

*A General Electric variable reluctance cartridge.*

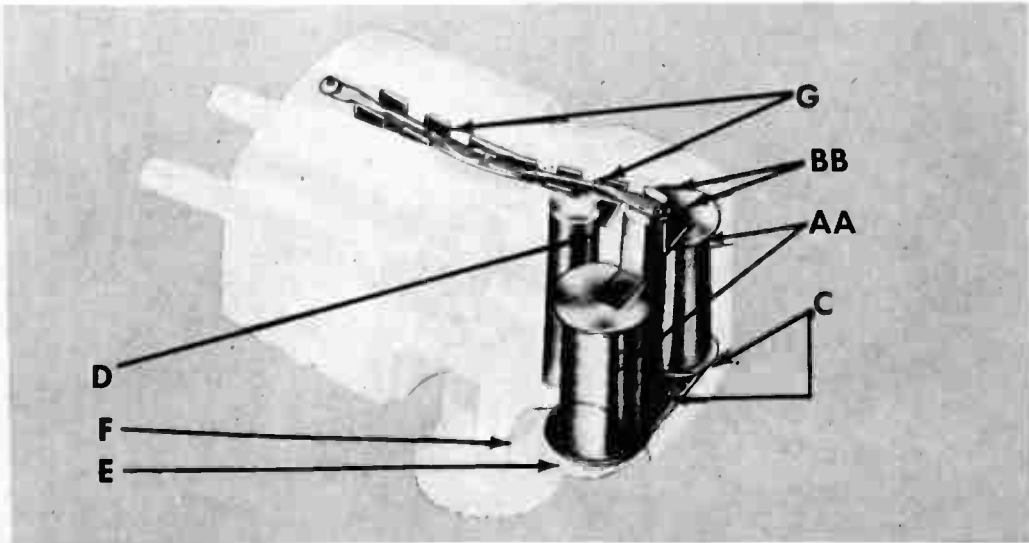

- AA** Copper wire coils wound on nylon spools
- BB** Laminations of high permeability alloy for ideal magnetic properties
- CC** Yokes of same alloy
- F** Mu-Metal case
- D** Alnico 5 magnet
- G** Dual stylus assembly
- E** Sturdy plastic base



1A

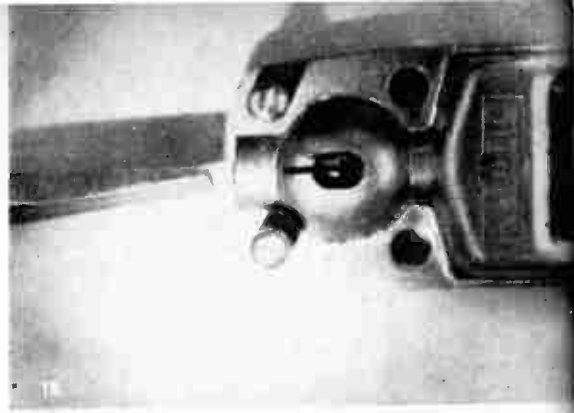

## needle changing



1. Loosen set screw with
  - a. fingers, or
  - b. small screw driver.

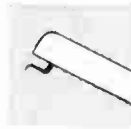

2. Pull needle down with
  - a. fingers or tweezers,
  - b. (upper and lower) small screw driver, or
  - c. knife.

The Terrad Company, Inc., N.Y. 2

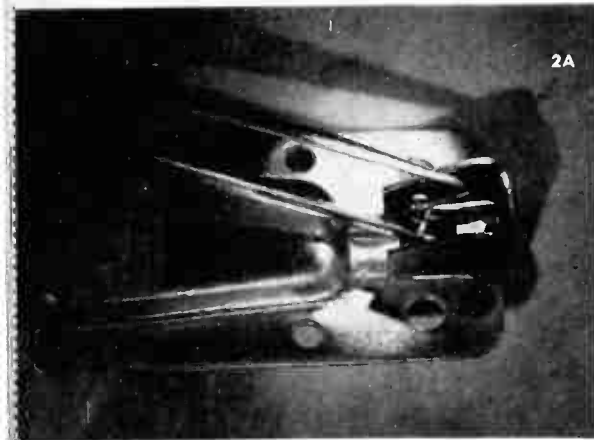

2A

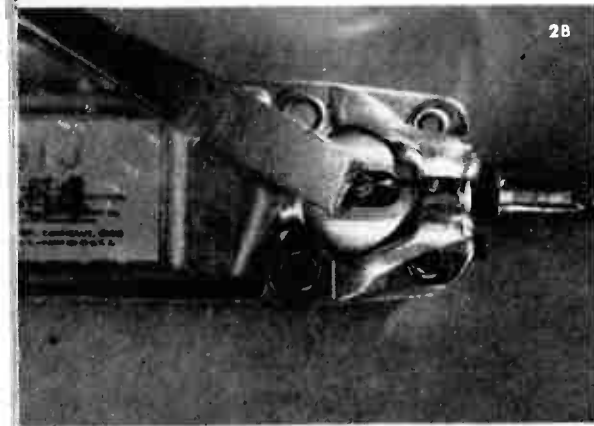

2B



2B

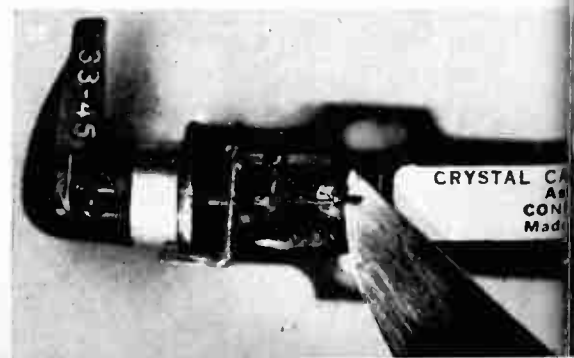

33-45

CRYSTAL CA  
As  
CON  
Made



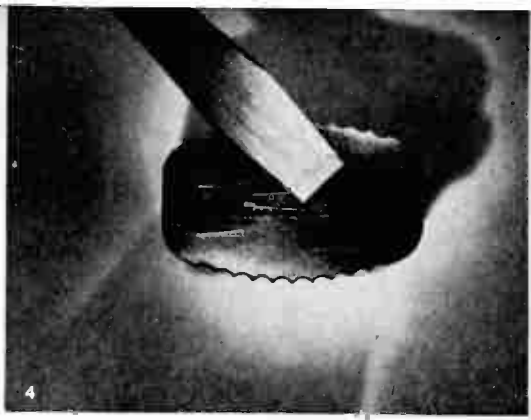
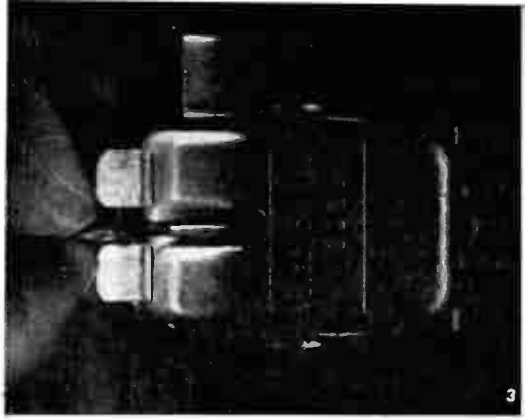

3. Slide needle forward with fingers or pin.

4. Slide needle backward with fingers, pin, or screw driver.

5. Remove nuts and washers, push needle out with paper clip or pin.

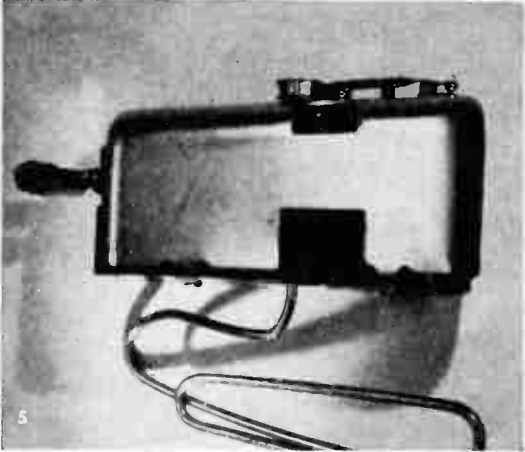

6. Lift lever and remove from channel (note drawing).

7. Pull off knob, slide "C" washer out, remove spring, and the styli shaft will slip from cartridge.

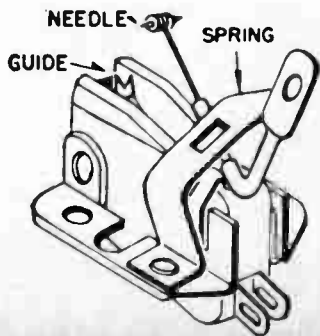
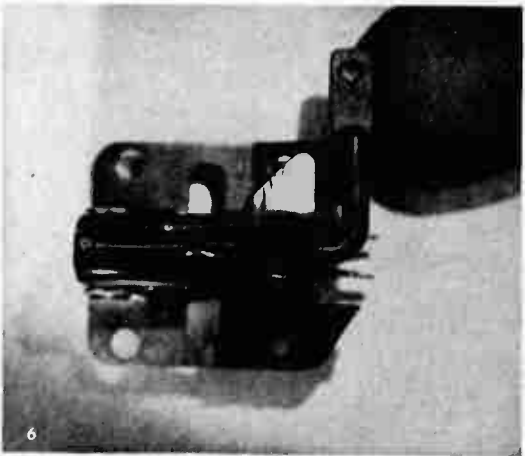

IX

## *records and their care*

*From David Bogen Co., Inc., N.Y. 14,  
and Zenith Radio Corp., Chicago 39*

THE PHONOGRAPH RECORD may be technically defined as a method of storing the mechanical reproduction of sound so that it may readily be converted back to electrical energy and played over and over again as music. A record is made by cutting a wavy groove on a soft plastic disc. From the disc a mold is made, and the finished product is produced by pressing the mold onto heated vinylite or shellac.

A few words now about the types of phonograph records. For several decades all records were pressed on a "shellac" disc made to revolve at 78 rpm. The best of these had fair frequency response and relatively low distortion. But the imperfect composition of the record material caused a hissing sound which contributed to what was known as "listening fatigue." Later came the records made of vinylite, a plastic now almost universally used for long-playing records. This material is flexible, virtually unbreakable, and almost entirely free of the scratchy distortion of the shellac disc. The next step was the gradual disappearance of the 78 rpm record. Few will mourn its passing. Five or more records of the old standard Speed may now be pressed on a single disc of the new 33 $\frac{1}{3}$  rpm development. Excess mass has been replaced by economy and concentration. Today the bulk of the beginner's library investment will naturally go to the two current speeds, 45 rpm and 33 $\frac{1}{3}$  rpm. The former is especially popular as a medium for semi-classical music of the kind ordinarily played at "pop" concerts. Its average playing time is seven minutes per side. The other is favored by those of a broader and more serious cultivation of the enjoyment of music. In all, over fifty domestic and foreign manufacturers account for the huge assortment of 33 $\frac{1}{3}$  rpm long-playing records now on the market.

For technical reasons, it is necessary in the recording process to cut down the

*Left above is a new record groove after cut by a worn stylus. Below is a new record after many playings with a diamond. Photos are from The Tetrad Company, New York.*

*Actress Pat Percy shows proper method of holding records, as moisture from hands can etch the grooves and mar fidelity of tone. Zenith Radio Corporation, Chicago 39, Ill.*

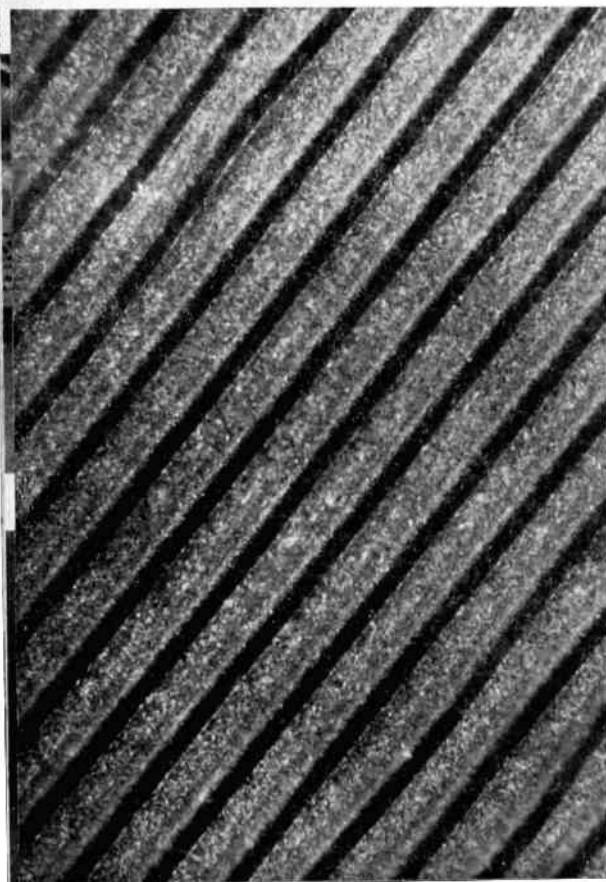
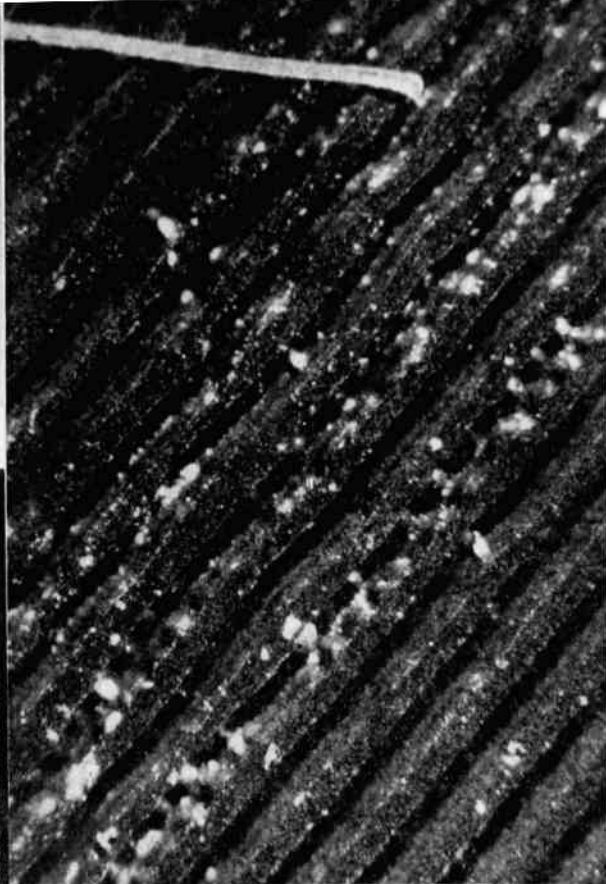

intensity with which low frequency sounds are recorded. Accordingly, all records have for some time been made with what is known as low frequency roll-off. This means that an electrical filter has been placed in the circuit of the recording equipment to thin out the low notes. Now, in designing the amplifier, it is possible to put in the reverse of this filter. Thus, when the record is played back, the low notes are restored to their original fullness.

Of special interest to owners of a home music system is a technique which increases the effective life of their records. This was evolved years before the advent of the long-playing process. The technique is called high frequency pre-emphasis. To understand this it is important to keep in mind that what a phonograph needle picks up from the

record is composed of two parts. One is the music contained in the waves of the grooves on the surface of the record. The other is the so-called "needle scratch." The latter is caused by a combination of wear and particles of dust and dirt that embed themselves in the soft vinylite. Microgroove records are made in such a way that the high frequency notes are emphasized. That is, they are recorded at a higher level than the notes of the middle range. If these notes are then played back through an amplifier designed to diminish the higher frequencies in the same proportion, the correct balance is restored. The result is a perfect reproduction of the original music. Moreover, scratching will be reduced because the play-back amplifier discriminates against those frequencies which scratching covers on





*It's easy to clean records with a soft cloth of deep, fine pile, such as velvet or plush.*

the sound spectrum. The process of restoring the thinned-out low frequencies and diminishing the pre-strengthened high frequencies is known as record equalization.

Maintaining original quality of High Fidelity records demands care in handling and storage of discs, as well as proper care of the record player. Television actress Pat Percy gives a few easy-to-remember rules that will give your records a long and useful life.

Keep records as clean as possible. When you pick up a record, hold it by the outer edges. Fingerprints damage the grooves by grinding in dust particles and acid moisture, always present on hands.

To keep records free of dust accumulations, use a soft velvet or plush cloth. The best time to clean a disc is just before it is played. Let it revolve on the turntable while you apply the soft cloth.

Cleaning records is only half the job, though. Storage of Hi Fi discs is equally important to the long life of high fidelity characteristics. Records should be stored lying flat or standing straight on edge in the cabinet. Slanting albums and overlapping records are invitations to warping and distortion. Pat Percy also points out that records must be played at the exact recorded speed to reproduce the quality of High Fidelity musical productions. ■

*Records are best played at exact speed, which can be adjusted on better players.*





IX

*Storage of records can be either on sides in a flat stack, or filed standing straight up on edge. All photos from Zenith Radio, Chicago 39, Ill.*

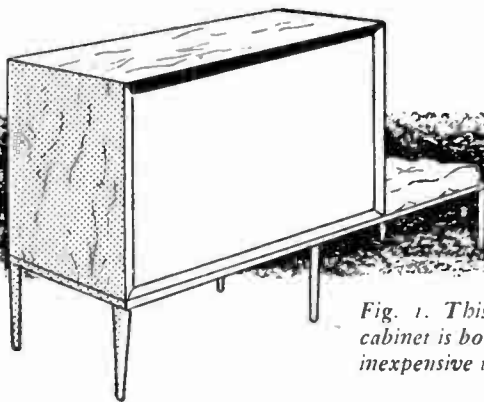

# INSTALL IT

*Fig. 1. This "equipment-only" cabinet is both easy and inexpensive to produce.*

*By Jeff Markell, courtesy Radio & Television News of November, 1952*

**H**IGH FIDELITY has come of age. For the proponent of high fidelity is no longer "a voice crying in the wilderness," or to rephrase the image, he is no longer a voice crying into "tin ears."

As far as electronic components are concerned, the situation is pretty good. In most categories a good selection is currently available, covering various price ranges and performance characteristics.

However, as far as housings for residential systems are concerned the picture is not nearly so bright. Available ready-made cabinets are extremely limited both as to style and finish, which means they will rarely fit in with the user's other furnishings. The person who insists that the cabinetry of his system, both appearance- and construction-wise, should be of comparable quality to its sound can hardly be considered unreasonable, and his number is legion.

Competent designers and cabinet makers, familiar with the problems of housing Hi Fi equipment, are available if the homeowner cares to take the trouble to locate them.

In order for the homeowner to make a reasonably good choice of sources for designing and cabinet work, it will certainly be helpful for him to have at least a nodding acquaintance with the subject of cabinetry and cabinet design.

There is little point or need to try to become an expert in the field, but it is a good idea, in terms of satisfaction, to know at least enough to be able to judge the competence of the people you plan to commission to do the work.

In approaching cabinet design it may be found convenient to consider the question in terms of three general categories. One of these types will apply to most situations requiring a free-standing cabinet. The question of a built-in installation is purposely omitted, since this requires individual consideration in each case.

The first general category is the type of cabinet which houses electrical equipment only, and requires a separate speaker enclosure. Although there is disagreement on the point, a significant group among engineers is quite insistent that the inclusion of the speaker in the same cabinet with the other components impairs the operation of the whole system. This is one reason for separating the speaker. Another is that it will often develop that the location in the room which is most convenient for the placement of the equipment is a poor one for the speaker.

Fig. 1 is an example of the equipment-only type of enclosure. It is extremely simple in design and therefore relatively easy and inexpensive to produce. It is based on a standard cabinet module and is, therefore, most economical of materials, since material costs in plywood are based on the nearest square foot. It has the disadvantage that it opens from the top rather than from the front, necessitating installation of the tuner face up rather than face out. Another disadvantage of this type of cabinet is that the lady of the house will very likely put a pot of flowers on it as soon as it's moved into the front room of her house.

# YOURSELF

*Fig. 3. Conventional cabinet with changer, tuner and amplifier placed over the loudspeaker.*

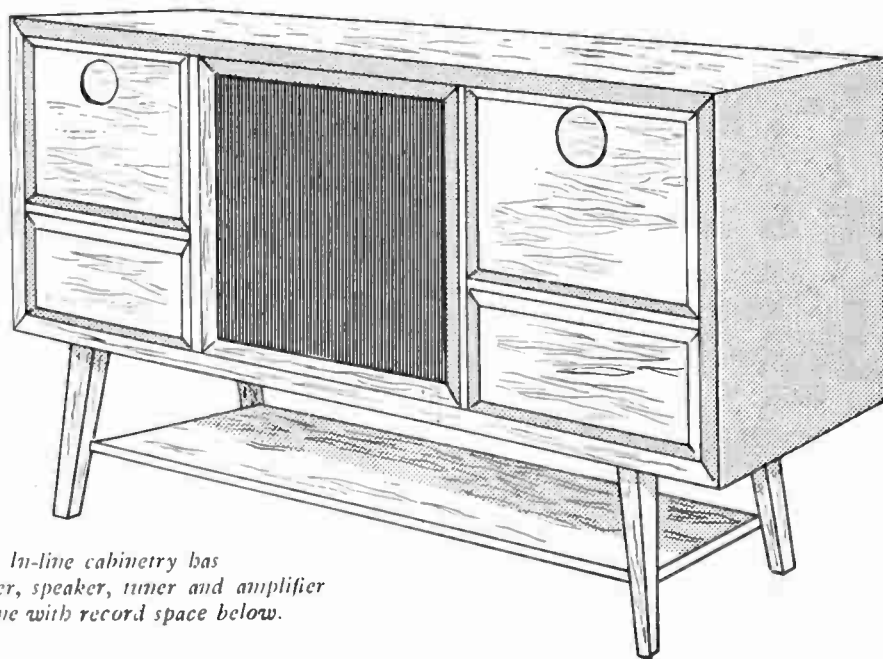
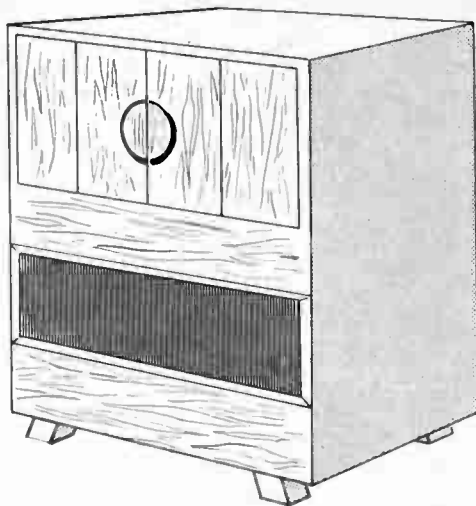

*Fig. 2. In-line cabinetry has changer, speaker, tuner and amplifier in a line with record space below.*

The second general category is the type of enclosure housing the electrical equipment plus the speaker. Although some engineers take a dim view of this type of housing, it is often the treatment of choice for specific situations where space for a separate speaker enclosure is not available. Figs. 2 and 3 are examples of this type. In Fig. 2 the equipment is set in a line—

changer, speaker, tuner, and amplifier—with record storage optional underneath. Placing the changer, tuner, and amplifier over the speaker is a more conventional arrangement (Fig. 3). It is considerably more economical of wall space and less expensive to build than the cabinet shown in Fig. 2. Of course, record storage cannot be included in such a compact and movable design.

X

## BUTTS

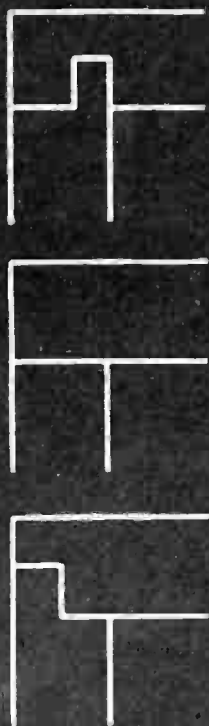

## MITERS

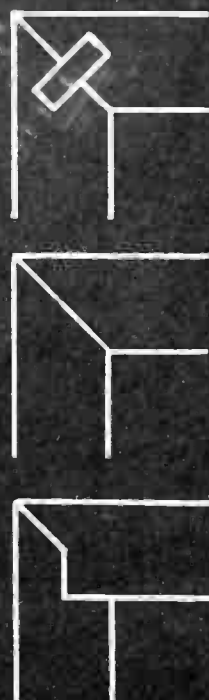

The third general category is a complete wall unit housing equipment and speaker plus various subsidiary cabinet spaces, such as a bar, desk, utility cabinet, and bookshelves or record storage. This type constitutes an extremely extensive cabinet treatment, but where this type of unit is used little or nothing in the way of additional cabinetry is likely to be required in the room, leaving the remainder of the room available for conviviality. Fig. 4 is an example of a treatment of this type.

As regards the question of style, all of the examples have been treated in a strictly modern manner; however, there is no reason why similar treatments cannot be done in a wide variety of period styles to conform to the design of other furnishings in the music room. At the moment, for example, quite a lively revival seems to be going on in the French Provincial style. Any of the



*High quality single-play turntable is installed in shop-made cabinet on iron legs.*  
WEINGARTEN ELECTRONICS, LOS ANGELES

*Fig. 5. Several types of wood joints used in cabinet work. See text for complete details.*



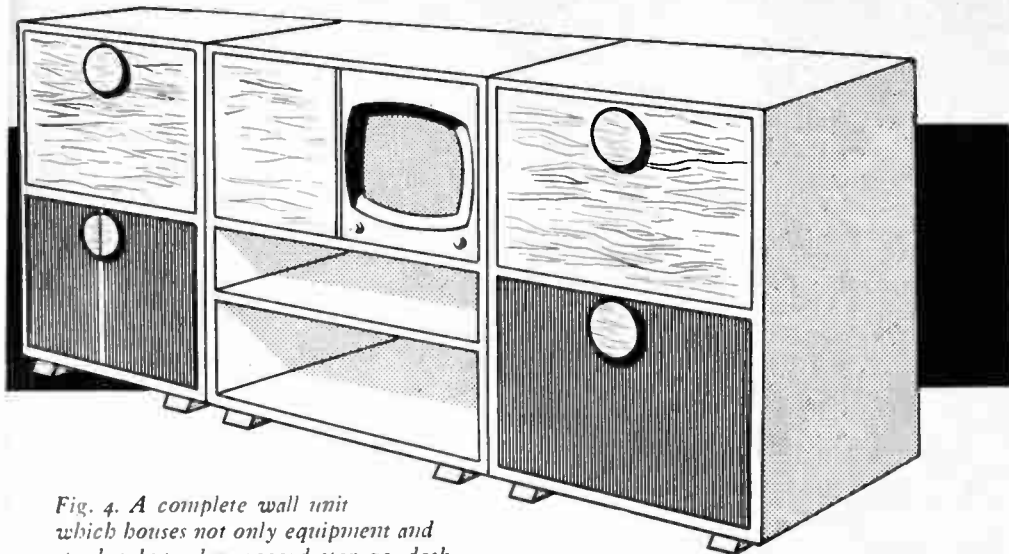

Fig. 4. A complete wall unit which houses not only equipment and speaker but a bar, record storage, desk, utility cabinet, and bookshelves.

basic space arrangements could be translated into French Provincial. When constructing cases for use in period rooms, it is always a question of designing, constructing, and finishing.

Properly done, the cabinet will blend harmoniously with the other furnishings. Only in the case of modern is this not necessarily so. To achieve an effective result as regards the over-all decor, a modern cabinet can be designed either to match the existing furnishings or to contrast sharply with them. Sharp contrast, if employed, will often consist of dramatic color differences; for example, a mixture of bleached with cordovan mahogany pieces. Unfortunately space will not permit of elaboration of the point; however, an extremely modest amount of good taste should keep you out of trouble in this important department.

Construction, for our purposes, can be limited to two basic considerations: first, the type stock, and second, the method of joining. You can build a cabinet in either solid lumber or veneered plywood. In general the writer prefers a good grade of veneered plywood because, by virtue of its construction, it is less subject to warpage under conditions of changes in temperature and humidity. It is perfectly true that good-grade, well-seasoned, solid lumber is highly resistant to warpage when properly joined; but it is increasingly difficult to obtain. Availability will differ depending on your

location. When in doubt specify  $\frac{3}{4}$ -inch veneered plywood of good quality.

Finish is another factor influencing choice of stock. If, for example, a bleached mahogany finish is desired, veneer must be used, since solid mahogany will not bleach evenly to produce an effect of quality.

Fig. 5 illustrates a few types of joints in common use. Butt joining is cheaper than miter joining; however, the miter is infinitely preferable. It looks better and is stronger, which reduces cabinet vibration.

Of course the joints illustrated are for use with standard  $\frac{3}{4}$ -inch stock. The writer has seen a number of cabinets done in  $\frac{3}{8}$ -inch lumber, and has even seen them done in  $1\frac{1}{4}$ -inch plywood on 1 x 2 frames. For a cabinet of any size  $\frac{3}{8}$ -inch wood is not heavy enough to resist warpage adequately, and to build a cabinet of  $\frac{1}{4}$ -inch plywood on a frame is, to this writer's mind, a shoddy dodge not worthy of discussion.

In choosing specific types of woods (mahogany, oak, korina, primavera, birch, etc.) it is well to be guided by the other woods in use in the room. For example, it would probably not be wise to place an oak cabinet in a room that already contains a number of mahogany pieces. A word of caution! It might be noted that strongly grained, exotic woods, such as zebra wood or primavera, should be used with restraint since the eye is likely to tire of a large area that is visually "busy."



As mentioned previously, veneered plywood, although generally more expensive than solid, is the material choice. However, having decided on the use of this material, do not be tempted to use cheap grades. Many cheaper brands of veneered plywood are subject to checking, buckling, or peeling of the veneer itself. Since the largest portion of the cost of a cabinet is labor, not materials, cutting corners on materials usually proves to be a false economy.

The writer has had occasion to see all too many cases of well constructed cabinets ruined by poor finishing. You should be extremely particular about the finish you accept. A good finish should be smooth and satiny, both to the touch and the eye. It will not be if the individual coats are put on too thick or the piece has not been well rubbed. Any competent shop should be able to give you at least a good smooth "commercial finish" at a reasonable price. Insist on it! And then take care of it.

In designing cabinets for high fidelity systems, the most important aspect of the problem is that the internal spaces be adequate to house the desired components. No matter how beautiful the cabinet job may be, if you can't put the equipment inside it's hardly better than useless. Internal space requirements can, of course, be determined by taking a specific set of components and measuring their over-all dimensions—thus arriving at the internal space requirements for the specific set-up. This method is new to no one, but it has one big disadvantage. It does not allow for flexibility in terms of later changes in the system. For this reason the writer has found that the internal dimensions given in Table 1 are useful for practical purposes, since they are based on the largest commonly used components in each category.

In regard to speaker systems, and their enclosures, there is widespread disagreement among engineers. At the risk of appearing cowardly, the writer is leaving the subject alone except to give a tabulation of cubic volume for infinite baffles. The cubic volumes given in Table 2 will suffice for the speaker diameters given in infinite baffles of either rectangular or triangular corner types. An infinite baffle is a solid, fully enclosed box. In many cases smaller volumes will suffice; however, it will very seldom be necessary to exceed those in the table.

Other than internal space requirements, the conditions imposed upon the cabinet designer by the equipment are neither many nor difficult to handle. Power and frequency loss in leads between components is not a factor in cabinet systems, although this problem occasionally arises in built-in systems. Adequate ventilation and accessibility for servicing are important considerations, but these are usually both taken care of by leaving the back of the cabinet open. If, due to the proposed placement of the cabinet in a room, the back must be exposed, there are several types of perforated materials available to cover the back, and still allow adequate ventilation. Even with adequate ventilation, crowding of components does not tend to improve matters.

If by now you have managed to house your equipment allowing for ventilation, allowing a bit of space between components, and if you haven't done something unfortunate such as hanging the phono unit up over a power transformer, internal arrangement is not likely to give you trouble. The only consideration left regarding placement of components in the cabinet is the question of accessibility of controls. The writer prefers to keep controls at least 30 inches above floor level.

<b>CHANGER</b> .....	16" x 16"
Depth (below mounting level).....	4"
Height (above mounting level)—lid opening.....	.6" min.
drawer or door opening.....	.8" min.
<b>TUNERS (behind control panels)</b> .....	17½" x 12" x 10"
<b>AMPLIFIERS (behind control panels)</b> .....	17½" x 12" x 10"
<b>PREAMPLIFIERS (max.)</b> .....	12" x 8" x 3"
<b>TV (inside)</b> .....	22" x 23" x 26"

It is well in laying out control panels to eliminate duplicate controls. Volume and tone controls often appear on both tuner and amplifier, or preamplifier. If the pre-amplifier is included in the tuner or the amplifier, eliminate amplifier controls entirely, controlling it from the tuner. With a separate preamplifier, one usually eliminates duplicated controls from the tuner.

A good design is usually relatively easy to construct. Be wary of designs that are complicated and difficult to build. There is a likelihood that such designs will not be too effective when built. Keep the size and proportions of the cabinet in scale with the room in which it will be placed. In order to do this, decorate the room before building a specific cabinet. ■

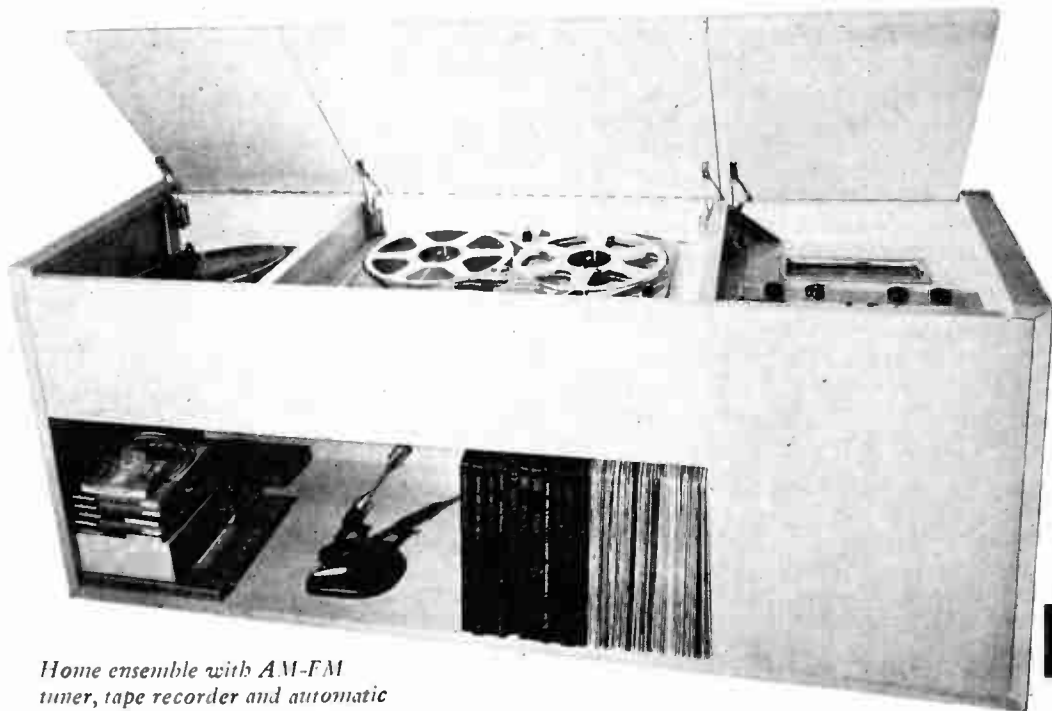

*Home ensemble with AM-FM tuner, tape recorder and automatic record changer. Panel on the lower right hides the power amplifier.*  
WEINGARTEN ELECTRONICS, LOS ANGELES

8" speaker	5½ cu. feet
10" speaker	6¾ cu. feet.
12" speaker	8 cu. feet
15" speaker	10 cu. feet

*Tables 1 and 2. Dimensions of various pieces of equipment found in home systems, plus cubic volumes required for speakers in infinite baffles.*

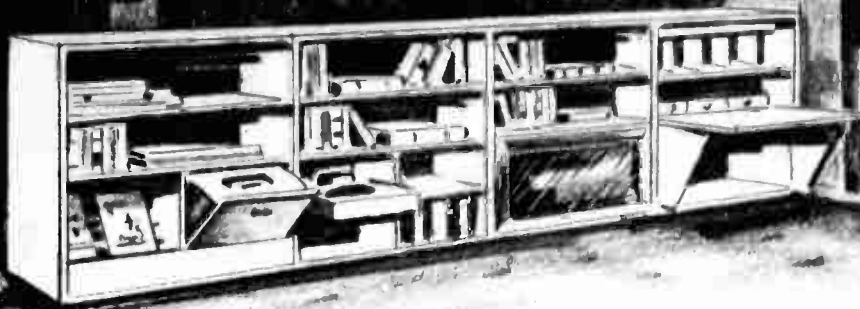

## sectional storage wall

From *Radio Craftsmen*, Chicago 40, Ill.  
Designed by the Douglas Fir Plywood Association

HERE is a smart and clean-lined sectional that provides storage space for everything from desk supplies to music system. The design is similar to a prize winner in a recent national architectural competition.

Easy to build, the built-in consists of four plywood sections. One section holds a built-in desk which folds neatly out of sight when not in use. Others hold books, tuner drawer, record player, and bass-reflex speaker. Sections are hung on wall about six

inches from floor to provide toe space. By adding or subtracting sections, or by altering dimensions, you can make this striking storage wall fit your wall area exactly.

Finishing suggestions: Painting: Fir Plywood should be smooth and ready for painting in colors to complement the decor of your room. First: brush on a coat of flat paint or enamel undercoat. Second: apply second undercoat, tinted to shade of finish coat. Third: apply finish coat of wall or

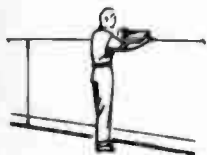

1. TACK AND LEVEL CORD FOR TOP OF 2"x3" BACK SUPPORTS MARK LINE

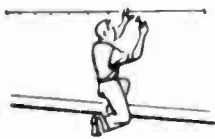

2. TAP WALL WITH HAMMER TO LOCATE STUDS - MARK



3. SPIKE 2"x3" BACK SUPPORTS TO WALL WITH 16D COMMON NAILS



1

2

NOTE: ALL PLYWOOD 3/4" THICK EXCEPT WHERE SHOWN

2"x3" BACK SUPPORTS SPIKED TO WALL

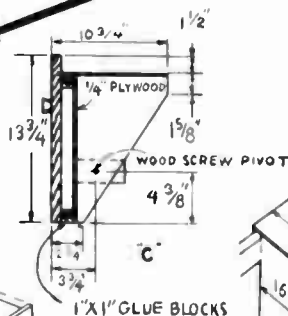
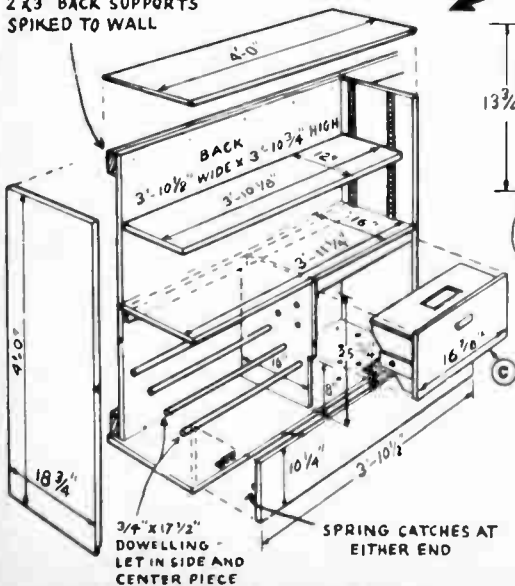

1/2" x 1" HARDWOOD SLIDE TO PREVENT TIPPING

RECORD CHANGER MOUNTING BOARD 4" x 4" x 005

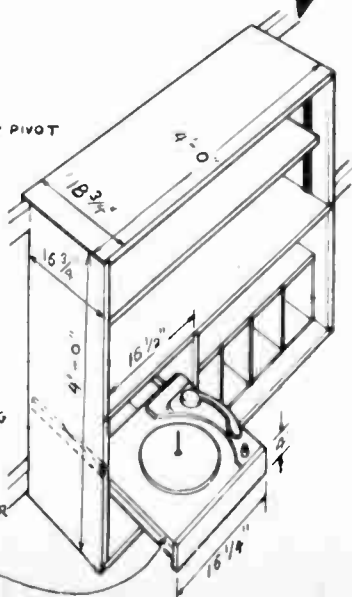

woodwork paint or enamel. (Note: second undercoat may be omitted.) When using water-thinned paints, plywood should be sealed first with clear resin sealer, shellac or flat oil paint before painting.

Natural Finishes: For an easy, inexpensive "blonde" finish, apply one coat of interior

white undercoat, thinned so grain shows through, then one coat of clear shellac, varnish or lacquer.

Fir plywood may also be stained to match your furniture. Attractive one-coat stain-waxes are available in a variety of durable color finishes. ■

#### BILL OF MATERIALS—LUMBER

Size	Quantity	Where Used
2 x3"	32 in.	Frame
3/4" dowels	6 ft.	Magazine rack
1"x2"	40 ft.	Miscellaneous

#### HARDWARE AND MISCELLANEOUS

Description	Quantity	Where Used
Adjustable shelf standards, 21 1/4" long	12	Shelves
5/8" piano hinge	4 ft.	Desk
Bullet catches	3	Desk
2 fluorescent light fixture	1	Desk
2"x2" butt hinge	1 pair	Cabinet No. 1
Spring catches	1 pair	Cabinet No. 1
Fingerpulls	5	Sliding doors, desk tops
Grill cloth	30"x48"	Speaker

#### BILL OF MATERIALS—FIR PLYWOOD

No.	Size	Grade
2 Panels	4'x8'x3/4"	Interior A-A—DFPA
1 Piece	4'x4'x3/4"	Interior A-A—DFPA Used for end, tops, top shelves, desk door, desk supports and magazine rack.
5 Panels	4'x8'x3/4"	Ply Panel (A-D) Counter, bottoms, sides, lower shelves, backs, record player platform and front, speaker front, cabinet partition.
1 Panel	4'x8'x1/2"	Ply Panel (A-D) Used for drawer fronts, backs and sides, drawer and letter file framework, light trough, record storage.
1 Piece	4'x4'x1/4"	Interior A-A—DFPA Used for record storage partitions and drawer bottoms.

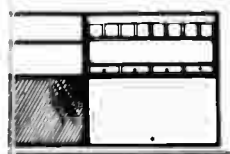

4

1/4" X 1 1/4"  
DOWEL GLUED  
TO STAY DESK SUPPORTS  
DRILL 1/4" HOLE IN  
SUPPORTS TO SUIT  
  
DRILL 1/2" HOLE TO  
RECEIVE DOWEL  
WHEN DESK CLOSED

VIEW OF UNDERSIDE OF DESK  
SHOWING SUPPORTS

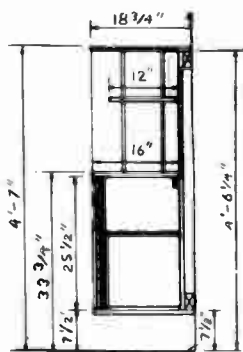

SECTION THROUGH #2

CABINET  
SCREW #2 TO #1 AFTER  
ATTACHING GRILL  
CLOTH

SPEAKER BOARD  
ATTACH GRILL  
CLOTH TO BOARD  
WITH TACKS

1" MOLDING  
TACK MOLDING TO SPKR.  
BOARD LAST

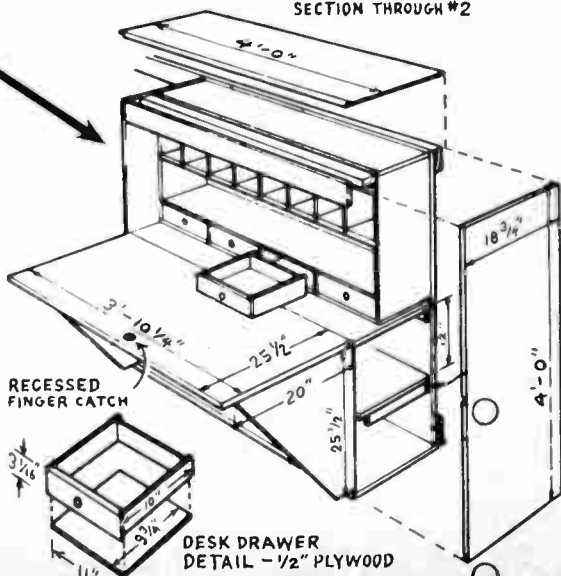
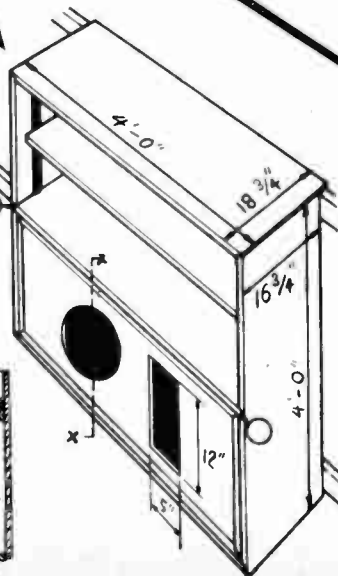
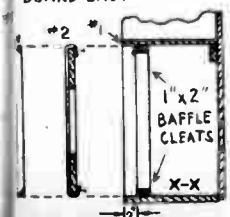

RECESSED  
FINGER CATCH

DESK DRAWER  
DETAIL - 1/2" PLYWOOD



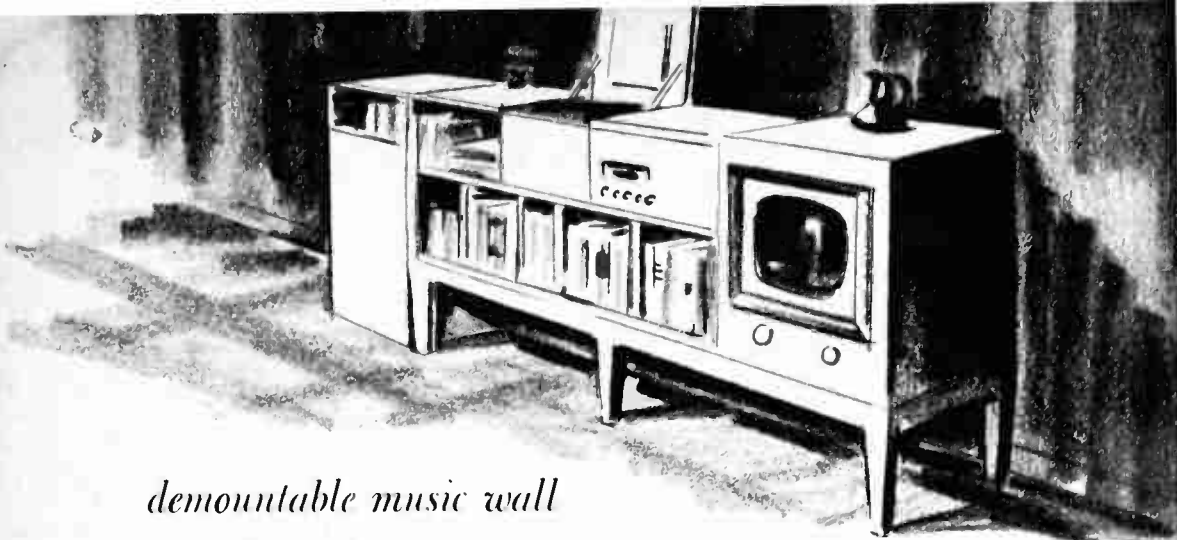

## demountable music wall

From *Radio Craftsmen*, Chicago 40, Ill.

Designed by the Douglas Fir Plywood Association

THIS is an inexpensive installation that groups the units of your home music system into a compact, efficient music wall. Simple, interchangeable fir plywood cases, stacked on a low fir plywood table, bring into your home all the individuality and grace of a fine custom installation.

Finishing suggestions. Painting: Fir Plywood should be smooth and ready for painting in colors to complement the decor of your room. First: brush on a coat of flat paint or enamel undercoat. Second: apply second undercoat, tinted to shade of finish coat. Third: apply finish coat of wall or woodwork paint or enamel. (Note: second undercoat may be omitted.) When using water-thinned paints, plywood should be sealed first with clear resin sealer, shellac or flat oil paint.

Natural Finishes: For an easy, inexpensive "blonde" finish, apply one coat of interior white undercoat, thinned so grain shows through, then one coat of clear shellac, varnish or lacquer.

Fir plywood may also be stained to match your furniture. One-coat stain-waxes are available in a variety of colors. ■

### FIR PLYWOOD—BILL OF MATERIALS

No.	Size	Grade
2 Panels	4'x8'x3/4"	Interior A-A DFPA
Used in areas visible from both sides.		
1 Piece	4'x4'x3/4"	Interior A-A DFPA
3 Panels	4'x8'x3/4"	Ply Panel (A-D)
Used in bottoms, backs, areas visible from one side only.		
1 Piece	2'x8'x1/2"	Ply Panel (A-D)
Used in bench.		

### LUMBER

Size	Quantity	Where Used
1 1/2" x 3 1/2"	30 ft.	Legs, frame
1" x 2"	12 ft.	Speaker unit, radio, TV

### HARDWARE AND MISCELLANEOUS

Item	Use	Quantity
Extension arms	Hold lid of radio, record player, speaker	3 pairs
12"x12"	Underside record player lid	1
Grill cloth	Speaker	As needed
28 1/2" x 16 1/2"	Asbestos sheet Radio lid	1
Semi-concealed cabinet hinge	Lid tops	3 pairs

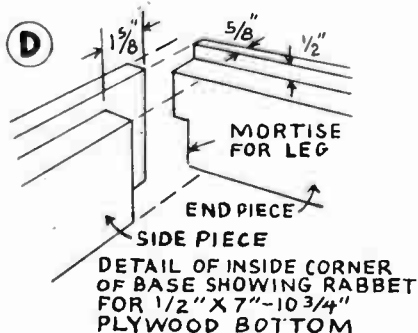
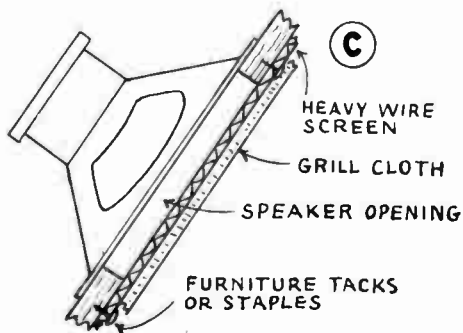

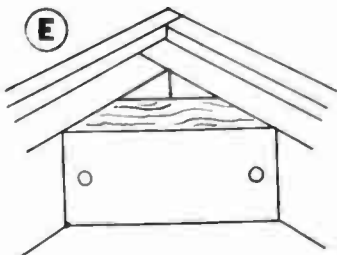
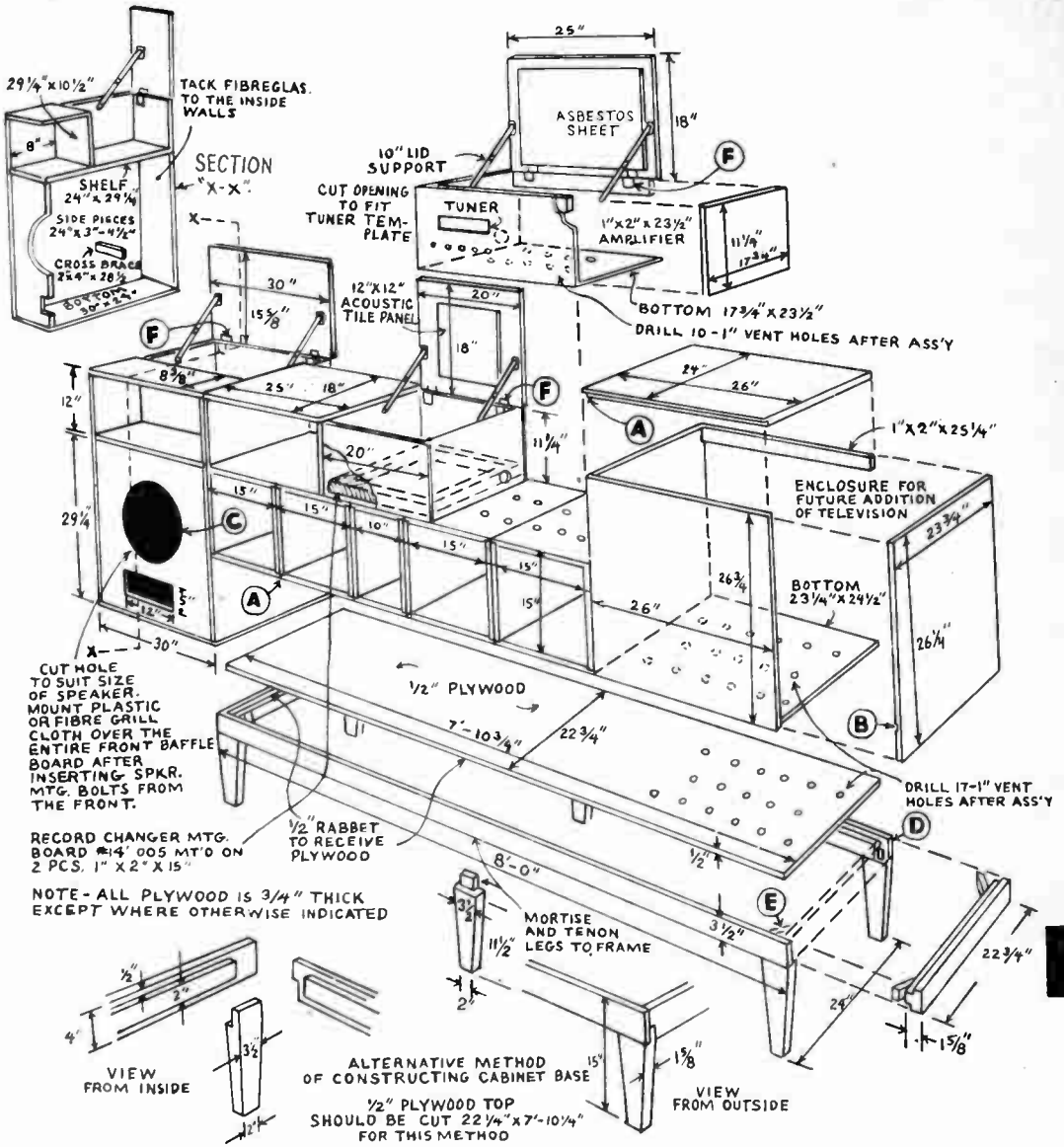

BASE CORNER - 15 1/8" x 3" BRACE

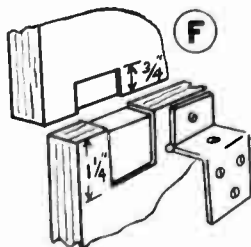

SEMI-CONCEALED CABINET HINGE



X

## *built-in television*

*From Conrac, Inc., Glendora, California*

THE PICTURE chassis should always be mounted in a cabinet, or in an enclosure behind a wall. In either case, the face of the picture tube should be protected by a safety glass window. Suitable laminated safety glass, together with a Royalite Picture Mask and a mounting frame, is available as an Accessory Kit. This safety glass should be mounted on a plywood panel not less than  $\frac{1}{4}$ -inch thick.

If the set is housed in a cabinet, the back of the cabinet should be masonite. Ventilation should be provided by piercing the masonite with holes not larger than  $\frac{1}{4}$ -inch diameter, on centers not greater than  $\frac{1}{2}$ -inch apart across the entire back.

So that the longest possible life may be expected from the tubes and other components in the system, it is imperative that both chassis be installed in a manner to provide adequate ventilation. The shelf on which the picture chassis is mounted should have an opening approximately 10 inches square, near the center of the chassis. This opening should be covered with hardware cloth, or heavy screen.

As an example: The Department of Building and Safety of the City of Los Angeles makes the following requirements of all television sets installed in walls or in recessed portions of buildings within the city.

1. The chassis shall be supplied with a safety glass or an approved plastic window adequately covering the tube front.
2. A. The overall enclosure within which the chassis is mounted in the building shall be constructed on  $\frac{1}{4}$ -inch transite or asbestos, with at least 1-inch air space clearance on the bottom, sides, top, and back. All joints of asbestos shall be lapped.

B. In lieu of "A" above, a complete enclosure of 14 gauge sheet metal with  $\frac{1}{8}$ -inch asbestos will be acceptable. The one inch air space clearance shall be the same as in preceding Section "A."

C. A recess may be completely plastered in lieu of "A" or "B" provided there is at least  $\frac{3}{4}$ -inch of plaster over  $\frac{3}{8}$ -inch plaster board or metal lath. The one inch air space clearance the same as in "A."

3. Ventilation openings shall be provided at the front of the enclosure above and below the chassis. A total area of 10 square inches or more is acceptable; 5 square inches above and below chassis.

4. A pilot light shall be provided either on the television set or in the wall adjacent to the set which indicates the circuit is energized. This pilot light shall be controlled by a wall switch which is adjacent to the television set.

5. An interlock shall be provided so that when the television set is removed for servicing, it also will be disconnected.

If the tuner is to be installed in a piece of furniture, check the thickness of the panel behind which it is to be installed. If the panel is not over  $\frac{1}{2}$ -inch thick, the front panel and the bottom of the tuner may be removed and the dial bezel may be mounted directly on the panel.

An opening of approximately 4 x 6 inches should be made in the shelf beneath the chassis for ventilation, and the opening covered with hardware cloth or heavy screen. Provision must also be made for ventilating the top of the chassis. At least 30 square inches of opening is recommended, at either the top, back, or sides of the tuner. ■



*Television chassis may be easily built into a cabinet or closet wall. The control unit can be installed anywhere in the room as it is connected to the chassis by a plug-in multi-wire cable.*





# furniture finishing

From Angle Genesee Corp., Rochester, N.Y.

## CONTENTS OF KIT

1. 3/0 Sandpaper for sanding cabinet before finishing.
2. 5/0 Sandpaper for sanding finish between coats.
3. 240 Wet-or-dry sandpaper for smoothing final coat of finish.
4. Can of stain to impart the proper color to the wood.
5. Brush for application of stain.
6. Compound for polishing cabinet.
7. Steel wool for cutting down imperfections, etc.
8. 1 pint of varnish.

## PROCEDURE

1. Prepare all surfaces of the cabinet for finishing. The better the wood is sanded, the better will be the final result.

Start by using fresh 3/0 sandpaper to correct all imperfections and to impart a smooth surface. Do not discard the used 3/0 sandpaper. It can be used to impart a final polish to the cabinet after all parts have been smoothed down.

Beware of sanding through the face veneer on plywood surfaces. This veneer is only 1/24-inch thick and can be sanded through unless care is taken. Always sand with the grain, avoiding any scratches across the grain. These will show up after the stain is applied.

Before applying any finish, inspect the cabinet carefully. Be sure all dust and dirt are removed by brushing, blowing and finally scrubbing carefully with a clean rag.

2. Apply stain. Brush stain on, using brush provided. Cover about a panel at a time and wipe off excess stain with a clean rag before it has dried.

After staining all exposed surfaces, inspect carefully. Apply a second coat to any portions that require darkening to blend with the rest of the cabinet.

3. Apply first coat of varnish inside and out. Use a good spar varnish. (Some people prefer a larger and softer brush than that provided, but it is adequate if used carefully.)

Cover all surfaces carefully, brushing with the grain and avoiding runs. The proper application of varnish is not easy and suggestions may prove helpful:

a. Do not agitate the varnish any more than necessary.

b. Do not touch the brush to the side of the can when removing it from the can.



c. Be sure temperature remains at least 70 degrees until varnish has dried.

d. Be sure atmosphere is as dust-free as possible where varnishing is done.

e. Wipe dust off all surfaces.

4. After allowing at least 24 hours for varnish to dry, sand lightly with 5/0 paper. This sanding removes high spots and gloss, so the next coat will adhere properly.

5. Apply as many more coats of varnish to the outside of the cabinet as are necessary to cover the surfaces with an adequate depth of finish, sanding lightly between each coat. Normally three coats will be enough, but more may be required.

6. Smooth the final coat of varnish carefully with 240 wet-or-dry sandpaper. Use a long straight stroke, going with the grain. It is very easy to sand right through all the varnish on any sharp edges.

Use the sandpaper wet, dipping it in clear water whenever necessary. When sanding has been completed, the finish should be flat with no depressions or raised spots.

7. Steel wool may be used to augment the 240 sandpaper where necessary. It is intended for getting into corners and should not be used on larger flat surfaces. After using steel wool, be sure all particles of steel are completely cleaned off before proceeding with the next step.

8. Apply compound to impart a final gloss to the cabinet. Compound is applied with a smooth rag, flannel if possible. The rag should be made up into a smooth ball with no wrinkles on the outside. Place a teaspoonful of compound on the rag and rub back and forth with the grain, working from the edges toward the center of the panel to avoid rounding off the edge.

9. Polish cabinet with a clean dry cloth. Your cabinet should now be completely finished and from now on it requires only the care given fine furniture. ■

# MODERNIZING RADIO-PHONOGRAPHS



FROM WEBSTER-CHICAGO  
CHICAGO 39, ILLINOIS

## BEFORE REMOVING YOUR OLD RECORD CHANGER YOU SHOULD...

A. Be sure you have the record changer with the kind of pickup best suited for your needs. The crystal pickup type is less expensive, yet offers acceptable tone reproduction. The variable reluctance pickup offers greater sensitivity and reproduces tones in superb true-to-life realism. It's the choice

of true high fidelity enthusiasts everywhere. The variable reluctance pickup requires a preamplifier in addition to your present amplifier. So it is slightly more expensive, yet offers more exacting tone reproduction.

B. Be sure your record changer fits the space provided by the limits of your present cabinet. Most changers require at least the space shown in the drawings below.

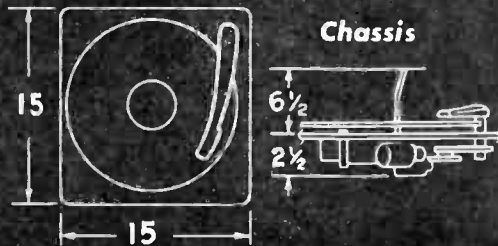
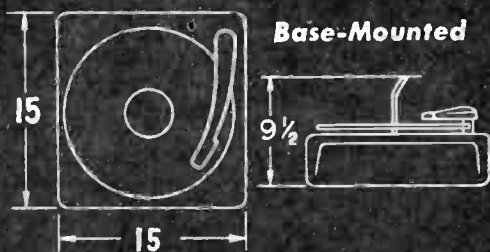

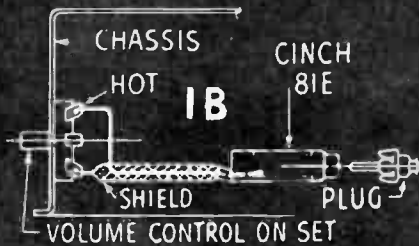
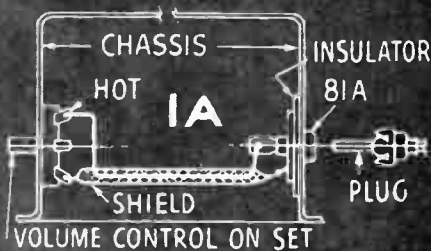

You will find two sets of electrical connections coming from the original record changer—one set carries the alternating current for the changer and motor. The other carries the audio impulses from the pickup cartridge in the tone arm. If this plug is different from the plug on the new changer, remove the plug from the new changer and replace it with the old plug, noting how the connections were made.

Where no connection is provided, a simple one can be made for use with changers having crystal pickups already installed.

The connection in IA requires that a  $\frac{3}{8}$ -inch hole and two mounting screw holes be drilled in the back of the radio or TV chassis. In AC operated sets, the insulator is not usually required, but in AC-DC sets, be sure to use an insulator because the "cold" end of the volume control is usually not at the same ground potential as the receiver chassis.

The connection in IB requires no drilling of the chassis, and it is recommended that the shielded conductor be clamped to some part of the set, relieving mechanical strain on the soldered connections on the volume control of the radio-phonograph.

For installing changers equipped with G.E. Triple Play cartridges or with plug-in shells for your own special magnetic cartridges such as G.E., Pickering or Fairchild, the

connections in figures IA and IB can be used, except that the preamplifiers recommended by these cartridge manufacturers must be incorporated in the circuit. Because the sensitivity of preamps is very high, it is sometimes necessary to mount them on rubber to avoid howling and acoustical feed-back into your audio system.

An ungrounded chassis is required to prevent the possibility of AC shock when touching the changer and ground at the same time. Consequently, most record changers and their pickup cartridges are "ungrounded." This includes metal base and portable models. "Hum" sometimes occurs in a new installation. If the amplifier permits the use of a "grounded" changer, and your changer is not grounded, solder a "jumper" between the shield lug and the ground lug of the 3-lug terminal strip used to connect the pickup leads to the shielded cord going to the receiver.

Run a separate lead between the ground lug of the terminal strip and a ground connection on the amplifier. Using the pickup cord shield as a common ground may set up an induced "hum" in the pickup cord. Proper grounding will eliminate shock or any noticeable "hum" in high fidelity installations.

In playing records, tune the radio to any "empty" spot on the dial, and on TV sets decrease the setting of the contrast control. ■

XI



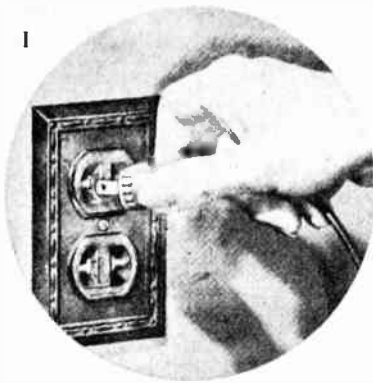

1. First disconnect the power plug from the wall socket.

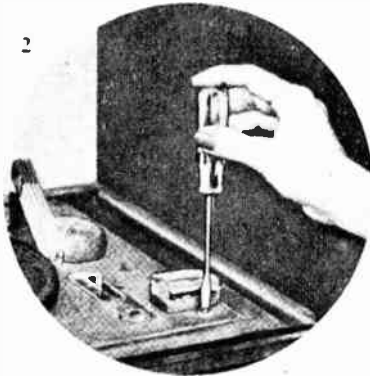

2. Unscrew the bolts or screws that are holding the old changer to the mounting board. Sometimes the mounting bolts are found on the underside of the record changer or mounting board.

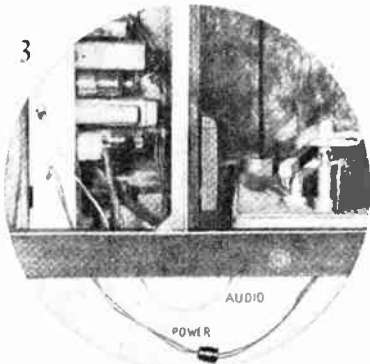

3. There are only two connections between your amplifier and record changer. These must be disconnected before you can lift out the old changer. One is the wire carrying sound from the tone arm. The other is the 117 volt line which supplies power to the record changer motor.

4. Ninety per cent of all console phonographs have record changer amplifier connections in one of four ways shown at lower left. Here's how to handle them: A. Wall socket and plug type. Simply remove the plug as you would disconnect a floor lamp or other household electrical appliance. B. Male and female connectors. Just pull apart. C. Soldered together. Unsolder to remove. D. The simple jack pin plugged into an amplifier's phonojack. Pull out to remove. "A" and "B" are almost always power line connections. "C" and "D" are audio line connections carrying sound impulses.

*Note:* Save any connectors that are attached to the old changer lead wires. You may use these on the leads of your new changer. However, if your old leads are connected the same way as the new changer and have parts exactly like the ones attached

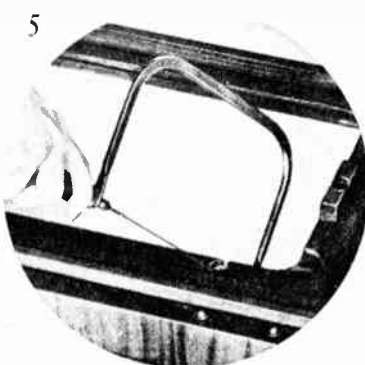
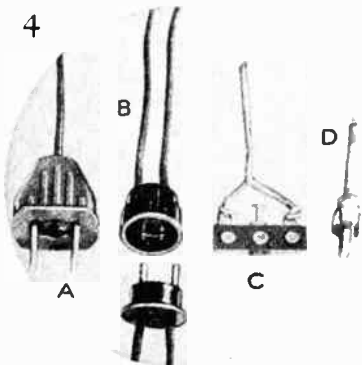

## —installing the changer

to the new lead lines, then you may discard the old connector parts and wiring.

5. After disconnecting the audio lead and power lead, remove the old changer by lifting out. You are now ready to install the new mounting board. If possible, you may use the old mounting board already installed. Simply cut away the inside to conform to the pattern that comes with your new record changer.

6. Or perhaps you prefer using a new mounting board. This is usually best since it has pre-drilled holes for mounting the record changer. The mounting board also provides holes that are countersunk to accommodate the springs provided for "spring mounting" of the baseplate.

If you use a pre-cut mounting board, first measure the space inside your cabinet. Then trim the outside of the mounting board, if necessary, to fit the space. After sanding and smoothing any rough edges, mount the board firmly with screws, or wood glue. You can, if you wish, mount the new board on top of the old board, or remove the old board and simply mount the new one on the mounting platform. Stain or varnish.

7. Next, set your new record changer on the mounting board. Be sure the supporting springs are seated properly in the countersunk holes. The changer should float freely on the spring mounting. If not, contact between the changer and mounting board could cause acoustical feed-back (howling).

8. After seating the new record changer, connect both the AC power line and audio line exactly the way the old changer wires were connected. Sometimes it may be necessary to make connections before installation. If the old changer wires were attached to each other in a different way from that provided by the new changer cords, simply remove the connectors from the old changer leads and attach to the new changer leads. You are now ready to play any 33½, 45 or 78 speed record. Easy, isn't it? If hum is noticeable during phonograph operation, ground the shield (metal outside covering) of the audio lead to the changer chassis. This can be done by connecting a wire jumper from the shield terminal of the standoff to the center terminal. The standoff is located on the underside of the changer chassis and is illustrated below in 4(C). Caution: Do not connect jumper if your set is of the AC-DC type.

9. If you prefer a modern changer having a variable reluctance cartridge you will follow the same procedure above except that you will need a preamplifier. The preamplifier is used on the audio leads to boost the signal before it reaches the regular amplifier. Plug the audio lead jack pin of the changer into the open jack on the preamplifier. In turn, the preamplifier audio lead cord is connected to the regular amplifier. Installation instructions are included with the preamplifier. It can be connected to the regular amplifier on-off switch. ■

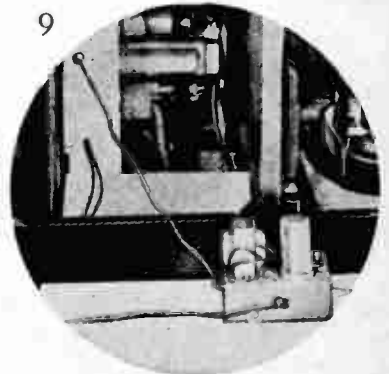
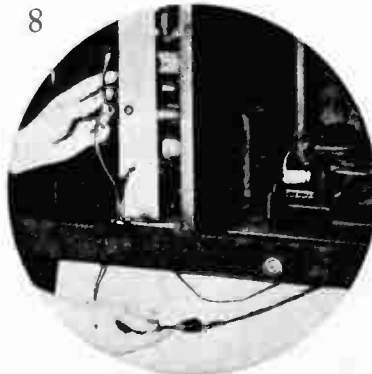
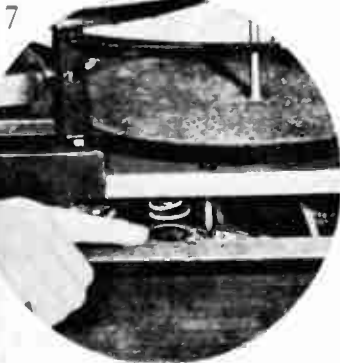

# DO-IT-YOURSELF KITS

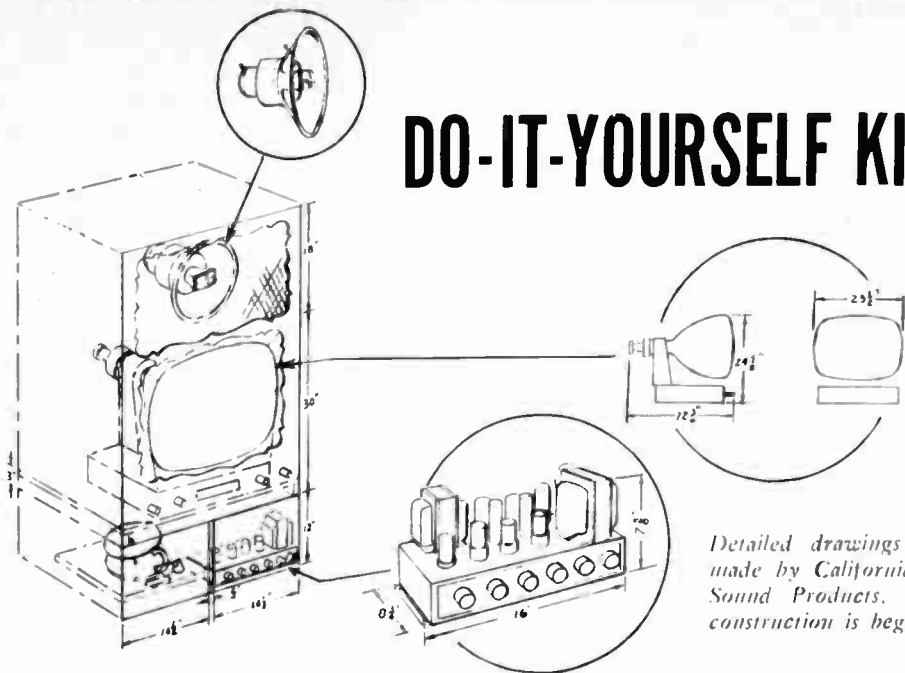

*Detailed drawings are made by California Sound Products, before construction is begun.*

**C**OST CUTTING and fun are two good basic reasons for the Do-It-Yourself Hi Fi kit. It takes no vast background of electronic knowledge to follow the complete instructions. Amplifiers, tuners, preamps, and all sorts of audio gear cost only about half in kit form. A few minutes practice is enough to solder well, and quickly the budget-limited Hi Fi fan can build his units and use them too.

Kits are not limited to the electronic phases of High Fidelity. Beautiful cabinets, unpainted speaker enclosures, and all types of fine audio furniture are available in kits. A hammer and large steel square are the basic tools of home construction, for all the wood is cut to exact size. Finishing is a blessing in disguise, as the matching of furnishings is made easy when you start from bare wood. ■

*Custom TV cabinet from Laude's, North Hollywood, uses closet space when built into wall.*



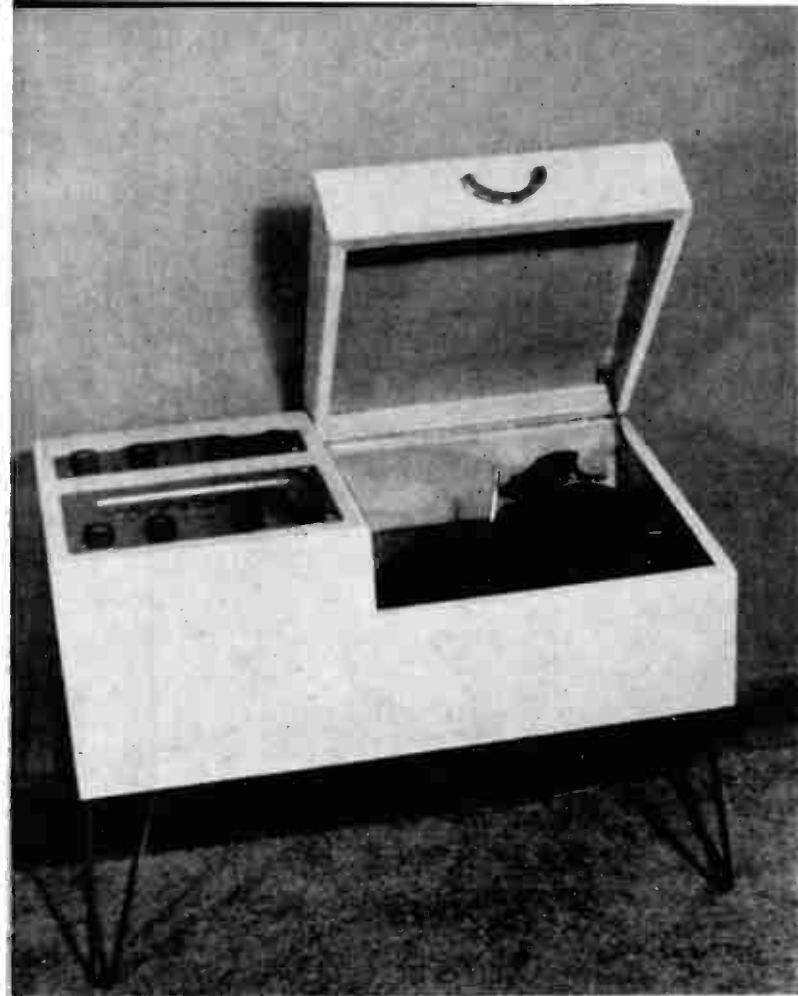

*Handsome cabinets are easily constructed to contain tuner, amplifier, and record changer. This custom-built unit feeds a separate corner speaker. T & W Electronics, Inglewood, California.*



**XII**

*\$275 buys this complete High Fidelity installation. All of the units are wired and the interconnecting cables are color-coded to prevent mistakes. Plans for the construction of suitable cabinetry are also included. Radio Craftsmen, Chicago 40, Ill.*

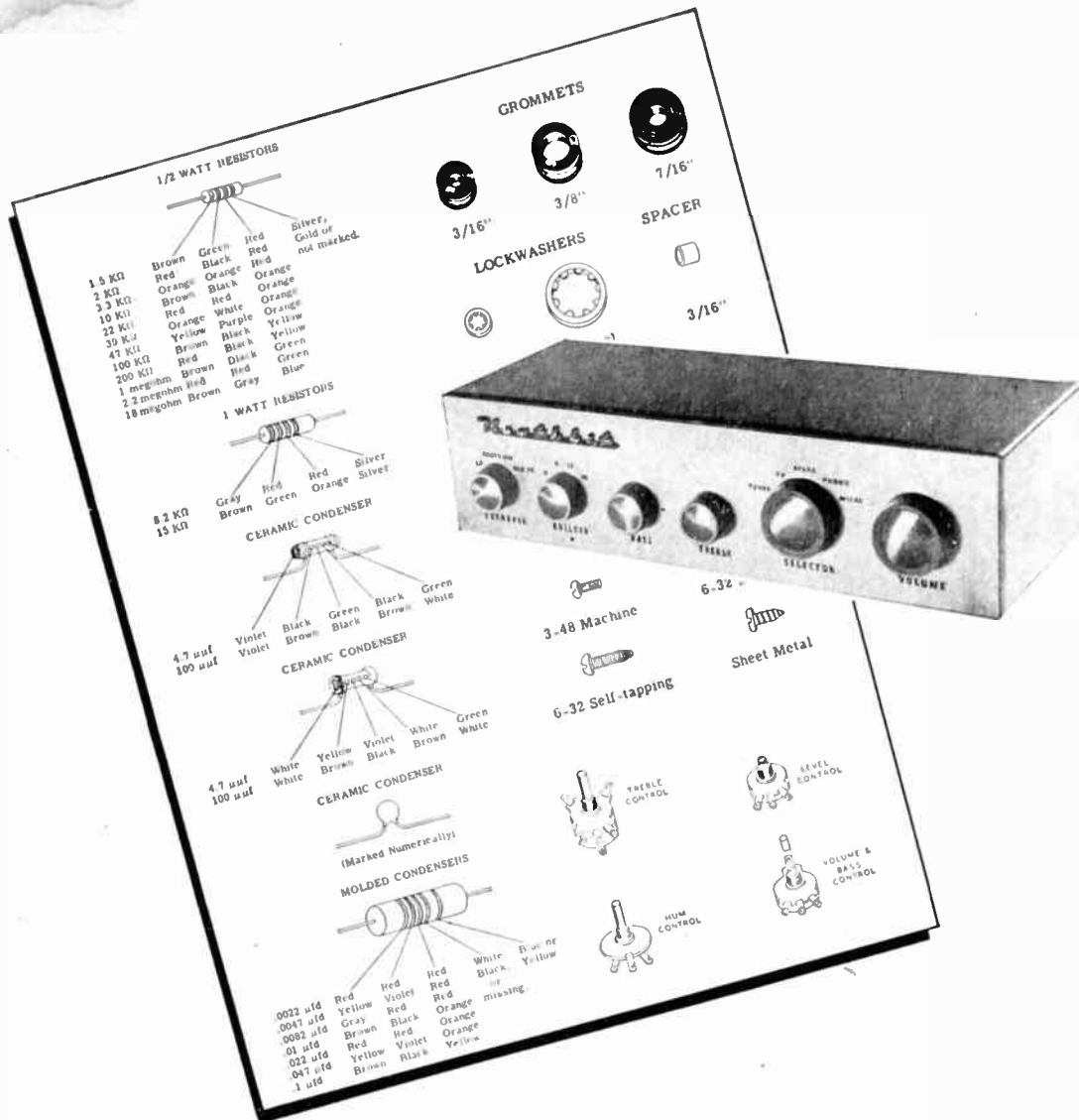

**AMPLIFIER CONSTRUCTION** might seem to be a frightening project. But with the clear instructions accompanying modern kits, even a housewife can be successful.

Producers of these kits have long realized that most kitchen table Hi Fi fans are not electronic experts. As a result, instructions are checked and double checked for lucidity. Every single part is not only pictured, but carefully described and identified. Many small resistors are of the same size and shape but vary in electrical capacity. Such variances are color coded and kit instructions are explicit in identifying the colors and their meanings.

Assembly of the various parts is described on a progressive basis. You take part A and connect it to part B. Then B goes to C and

so on. Space is provided to check off each step as it is completed, before proceeding to the next operation. In addition to this detailed guidance, there are full size drawings which show every part in its proper place. The routing of all wires is clearly shown and their identity is related back to the instruction sheet. In addition to the simplified drawings, complete electrical schematics are included. Should your equipment need service or repair, a radio technician would use the schematic.

Most kits (such as this Hi Fi Amplifier from Heath Co., Benton Harbor, Mich.) provide dial plates and over-long control shafts. After the unit has been housed in a cabinet (or closet), the dial plates are attached and control shafts cut to the proper length. ■



### STEP-BY-STEP ASSEMBLY

Fasten the large pictorial of the unit under construction, to the wall over the work space available. The small reproduction in the manual is intended for reference later on, after the large copy has become mutilated or lost.

Leads on resistors and condensers are usually longer than they need be. These leads should be cut to the proper length as the parts are wired into place. This will result in both superior operation and neater appearance.

Use sleeving on bare wires on condensers and resistors wherever necessary to prevent the leads from accidentally touching other bare wires or metal parts.

Use lockwashers under all 6-32, 8-32 and control nuts.

Check off each step in the space provided as it is completed.

(S) means solder the connection.

(NS) means do not solder yet.

### MOUNTING OF PARTS ON CHASSIS

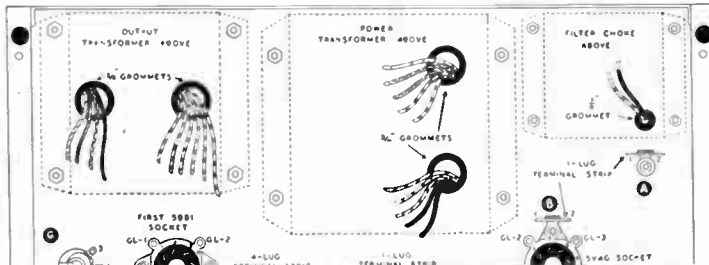

( ) Connect one yellow lead to pin 2 (S) on the 5V4G socket.

( ) Connect one red lead to pin 4 (S) on the 5V4G socket.

( ) Connect one green lead to pin 6 (S) on the 5V4G socket.

( ) Connect one yellow lead to the same socket.

( ) Connect one green lead to the same socket. (If the W-4M will connect the green-yellow lead to ground.)

( ) Connect one red lead to the first 6SN7 socket.

( ) Connect one yellow lead to the first 6SN7 socket.

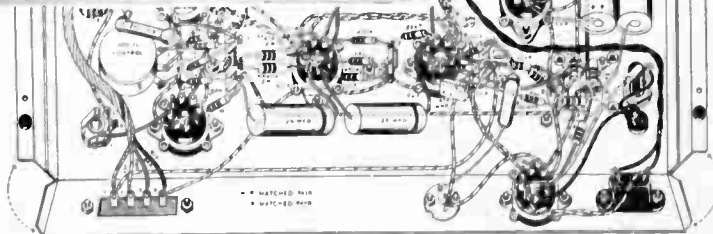
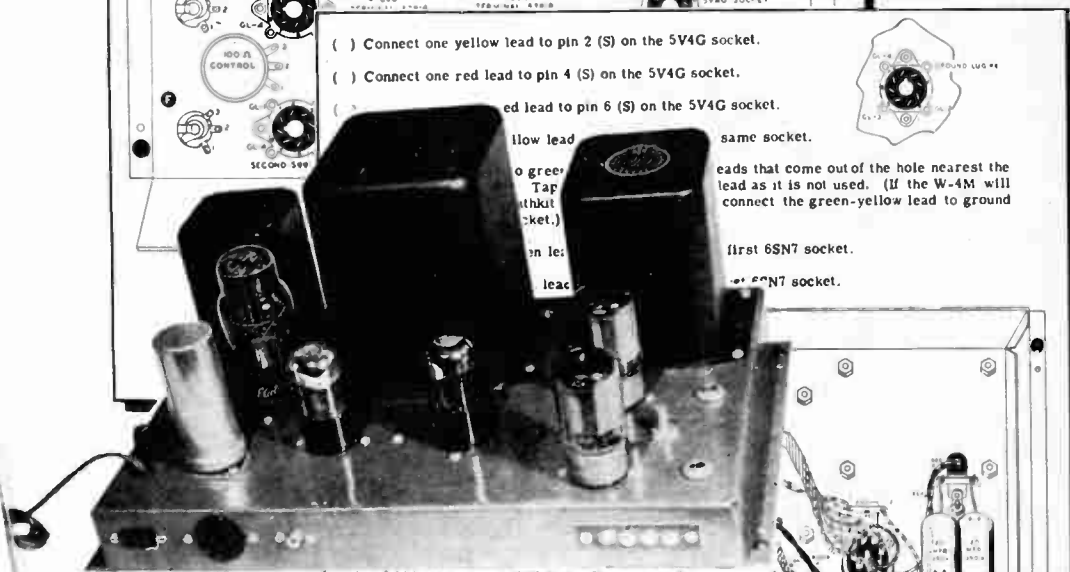

( ) Twist together the two red leads from the output transformer and connect both of them to B1 (S) on the 1-lug terminal strip B.

( ) Connect the red lead from the filter choke to pin 8 (NS) on the 5V4G socket.

( ) Twist two wires together and on one end connect one wire to pin 7 (NS) and the other to pin 8 (NS) of the first 6SN7 socket.

( ) At the other end of the twisted pair of wires, connect one wire to pin 1 (S) and the other wire to pin 2 (S) on the connector socket.

XII

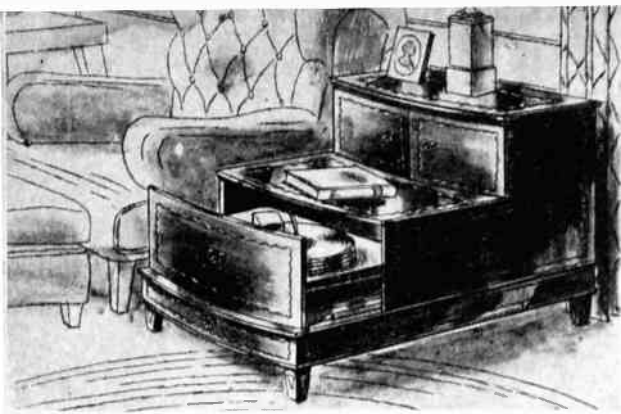

THE DIAGRAM from California Sound Products, Hollywood, California, clearly defines every interior component of this chair-side High Fidelity unit. Even though no record storage is available, broadcast music (plus such records as are on the table) can be enjoyed with the minimum of effort. This is relaxation at its best, with a comfortable chair and fine music to close a busy and tiring day.

A separate speaker enclosure has been placed on the opposite side of the room. Such positioning of the speaker permits adjusting the volume controls to an exact listening level, minus the several trials and errors of the usual method. Our rendering of this chair-side unit is from Altec Lansing, Beverly Hills, California. ■

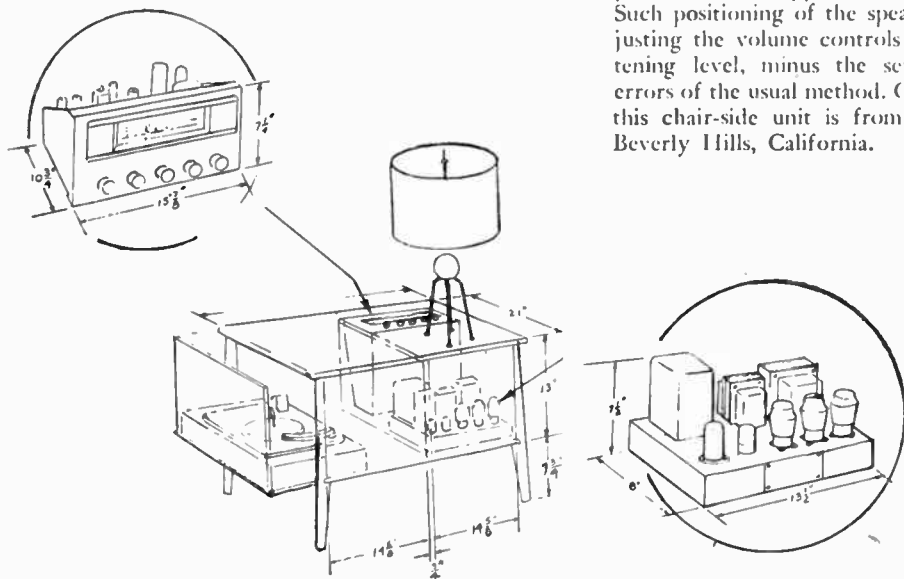

THE SIMPLICITY of kit construction is well shown by the following instructions from Karlson Associates, Brooklyn 30, N.Y. Their speaker enclosure kit is considered to be one of the finest on the market today.

#### FIRST STEP

As you can see from the drawings and photograph, there is quite a bit of internal construction in the enclosure. These inside pieces of wood are cut to fit in the grooves in the sides. This means that the inside pieces must be put together quickly, and in order, from the bottom up.

#### TOOLS NECESSARY

In addition to a hammer, you will need two "C" clamps, two or four furniture pipe clamps, and a pot of glue. Each joint should be both glued and nailed.

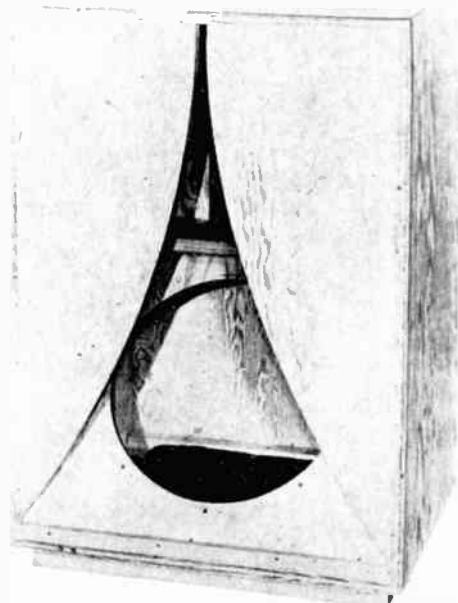

## PRACTICE

Before gluing this kit it is important to try putting it together once or twice for practice. In this way you will be sure you have all of the parts in the right order and will be able to assemble them quickly.

## BOTTOM UP

Lay out the bottom board, baffle locking strip, two sides, baffle board, shelf, slant board, and top so that they can be put together in that order. Be sure to glue each joint carefully, and when they are all together square up the cabinet, nail all the joints and hold it with the pipe clamps.

## WINGS

The two front tapered wings can next be fitted into place, followed by the two front angle strips which fit directly behind each wing and help secure it to the side panel. Nails from the angle strip into the side panel and front wing assure rigidity. Wedge a piece of wood between the top of wings to hold them securely. Two "C" clamps are used to hold bottoms of the wings.

## PORT AND BACK

The two port boards are inserted and glued, then the corner strips to hold them in place. The back cover strips are recessed  $\frac{1}{4}$ -inch so the back cover will be flush with back of cabinet. Tack the largest acoustic pad on the bottom board, the next size on the top board, and the two small pads, one on top of the other under the shelf in the back of the cabinet.

## FRONT CHAMBER

For best operation of the enclosure, the front chamber should be given either two coats of varnish or four coats of shellac. Without this treatment there will be a loss of the high frequencies.

## VIBRATIONS

After installing the speaker, carefully put all the screws in the back cover and tighten them. To test for vibrations, run a sweep audio test record, or an audio oscillator, from 15 cycles through 20,000 cycles, and listen carefully for any buzzing. The range from 20 to 100 cycles will normally find any loose joints.

## FINISHING

The kit is not designed to be finished by sanding, staining and varnishing. It is easily finished by gluing a  $\frac{1}{8}$ - or  $\frac{1}{16}$ -inch layer of hardwood to the top and sides, and covering the front with a grille cloth. The edges can be finished with a matching or contrasting hardwood molding.

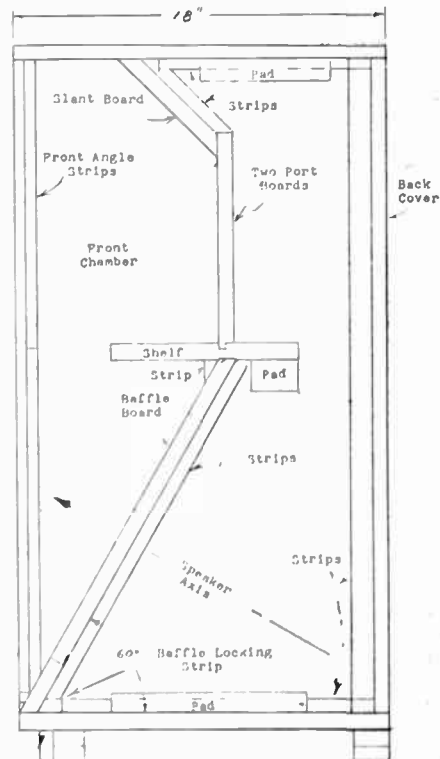
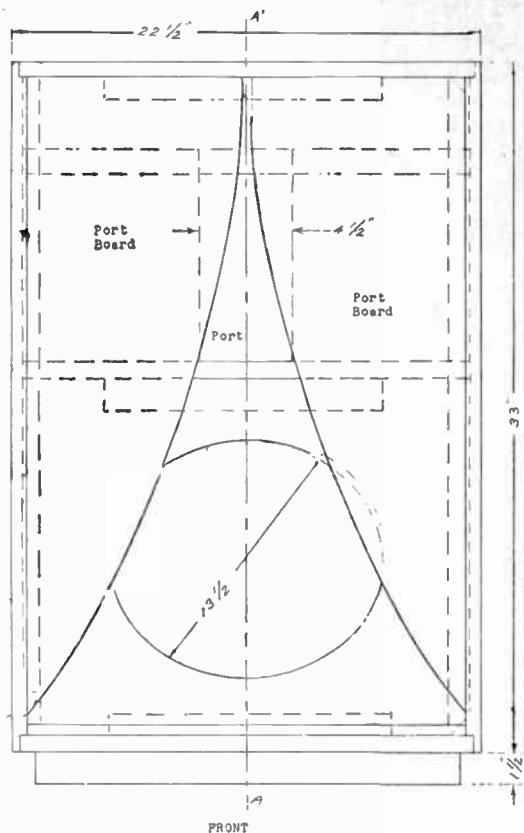

SIDE  
Section A-A

## the test record

EVALUATING RECORDED music is not quite so difficult as it might appear to be. Reproduced on these two pages is material from *FULL DIMENSIONAL SOUND*, a Capitol Records Album. This book (packed with the record album) describes music to be heard, and details the techniques of recording. Sounds are described so vividly you quickly identify them on your equipment. No longer is it necessary to wonder if you are hearing everything. As the disc plays, you can read the critique and add to your delight in the world's finest recorded music. ■

### the recording curve

The transferral of tape-recorded sound for highest quality disk reproduction is effected through the introduction of a carefully selected recording characteristic. This characteristic emphasizes high frequencies to provide a good signal-to-noise ratio, but is not so pronounced as to cause tracing difficulties for the stylus, particularly at the groove spiral's smallest diameter. Excessive high frequency pre-emphasis would also cause distortion by imposing too great mechanical problems on the pickup cartridge.

Low frequencies in the recording are diminished in level in order to limit the amplitude of lateral stylus movement. More bass level, demanding more surface area, would reduce the record's playing time; less level would tend to bring out undesirable equipment noises such as hum and turntable rumble.

Thus the curve of this recording characteristic — which is used on this record — is the most suitable to present-day techniques of disk reproduction, while still providing sufficient latitude for future improvement in reproducing equipment. Recordings made with this curve are reproduced properly only on equipment whose characteristics are represented by an exactly complementary curve, thus producing a uniform response throughout the entire frequency range.

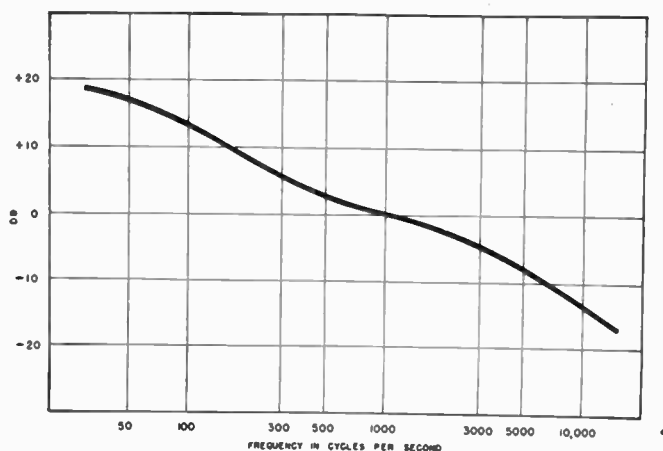

### the playback curve

This appropriate playback curve is shown in the above chart. For those who desire to make accurate measurement of the frequency response of their systems a tabulation of several points along the curve is listed here, using 1000 cycles per second as a reference level (0 db).

FREQUENCY	RELATIVE RESPONSE
40 cps	+17.5 db
100	+13
300	+5.5
700	+1
1000	0
3000	-5
7000	-11
10000	-13.5

Since this playback curve indicates ideal compensation for the recording characteristic, best results depend on accurate conformance of the playback system. In this respect the room acoustics as well as the loudspeaker are a part of the system. As these latter factors are difficult to control, and the preference of the individual listener varies widely, some additional correction by means of a tone control is often necessary to produce the most pleasing sound. Once set, however, relatively minor adjustment of such controls should be required thereafter.

## standards of listening

The individual listener's preferences also involve his own hearing curve, the measure of his ability to detect sounds throughout the frequency range. Hearing above 10,000 cycles is generally weaker than one expects, and there are often areas below that frequency where sensitivity drops off briefly. Some increase in wide-range hearing ability can be developed through practice.

The ear also has a mechanism for appraising balance in sound, and audio engineers have an interesting rule of thumb concerning it. It states that the numerical product of a system's outer frequency limits should be about 400,000. Thus a reproduction system which only passes frequencies between 100 and 4000 cycles will sound balanced, even though the imagination must supply missing tones above and below those limits, a process which can cause considerable listening fatigue. Though this fatigue is generally eliminated by high fidelity systems, they should still be designed to be approximately in conformity with this balance rule, reproducing frequencies within such limits, say, as 30 to 15,000 cycles or, ultimately, 20 to 20,000 cycles.

In order to deal precisely with questions of listening, it is necessary for engineers to establish certain guideposts for purposes of evaluation. The user of this record should find the following set of definitions helpful in his listening; these technical considerations concern the various areas where defects of recording can be found, and every selection in this album has been considered in the light of these definitions, and found to be of highest quality. This, in turn, assures that the record is an excellent test of reproduction quality.

1. **BACKGROUND NOISE** A continuous noise, usually consisting of system and/or tape or groove noise, in the middle or high frequency range, or of rumble or hum, in the low frequency range. It is generally observed

just before start of modulation or during low level or silent passages in a recording

2. **ELECTRICAL DISTORTION** Distorted sound attributable to electrical causes such as clipping of modulation peaks and or slow recovery, leaving "holes" in modulation and creating "buzz" on certain types of modulation, usually on peaks.

3. **ACOUSTICAL DISTORTION** Distorted sound originating in studio pickup and caused by undesirable intermodulation effects, heard as unnatural tone of an instrument or sections of instruments; "confused" sound having unnatural resonances from reverberation characteristics of the studio.

4. **FREQUENCY RANGE** The degree to which a recording contains maximum and minimum frequencies capable of being reproduced by wide range playback systems.

5. **SEPARATION** The clarity, transparency, and definition of sound, in which the blending of instruments and or vocalists is such that individual instruments, inner voices, or choirs are not unnaturally masked by overall sound, but can be distinguished and identified.

6. **DYNAMIC RANGE** Maximum and minimum recorded levels; the degree to which volume range simulates the range demanded by scoring, within the maximum limit which can safely be recorded and the minimum level which will be audible above the normal groove noises.

7. **MUSICAL BALANCE** The degree of perfection in recording a true orchestral balance and perspective of sound which will create an illusion of reality in reproduction. This balance is different from the artificial balance achieved by equalization of the deficient part of the frequency spectrum, which usually destroys the true timbre of instrumental and vocal sound.

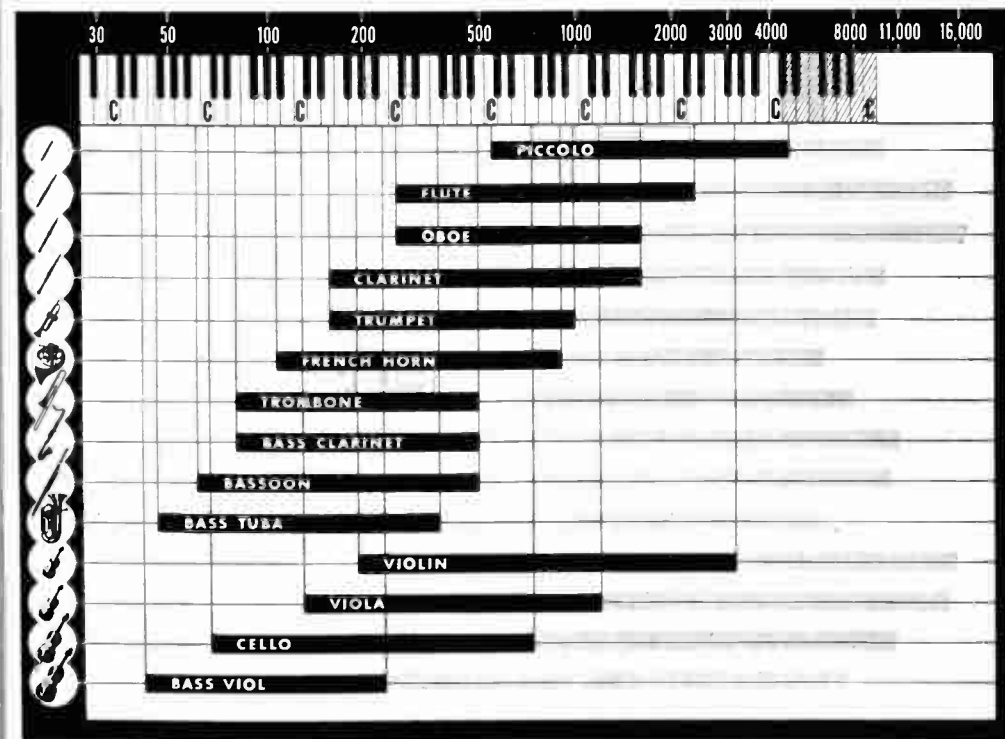

FREQUENCY OF THE MUSICAL SCALE MEASURED IN CYCLES PER SECOND

The black bars show the range of fundamental tones for each instrument, and the shaded portions indicate the extent of the overtones which give each its characteristic timbre — and which only sound systems of wide amplification and frequency range will properly reproduce.

# HI FI FOR YOUR CAR

*Jerry Franke*

**T**O MANY A MOTORIST, weary of radio's incessant commercials and inane product plugging by disc jockeys, has come a wish for music he could select, control and enjoy in the privacy of his car.

The simplest solution is a portable tape recorder of Hi Fi range and quality, coupled to an alternating current converter. The converter provides electricity for the recorder to run from the car's electrical system. Most units plug into the lighter socket.

Thus, the driver uses a selection of one-hour tapes, pre-recorded and programmed to suit his individual taste. (You could also record the wife's driving instructions if she lets you drive alone.)

The beauty of a portable tape recorder is its ability to take the punishment of dips and bumps on the road without missing a beat, plus the fact that it need NOT be a permanent installation. A "strap down" arrangement on the seat is easily devised and the recorder can then be used in the home and office, as well as in the car.

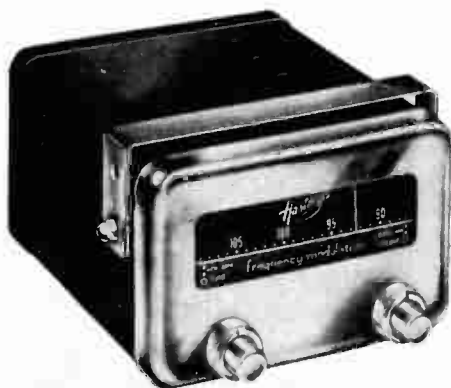
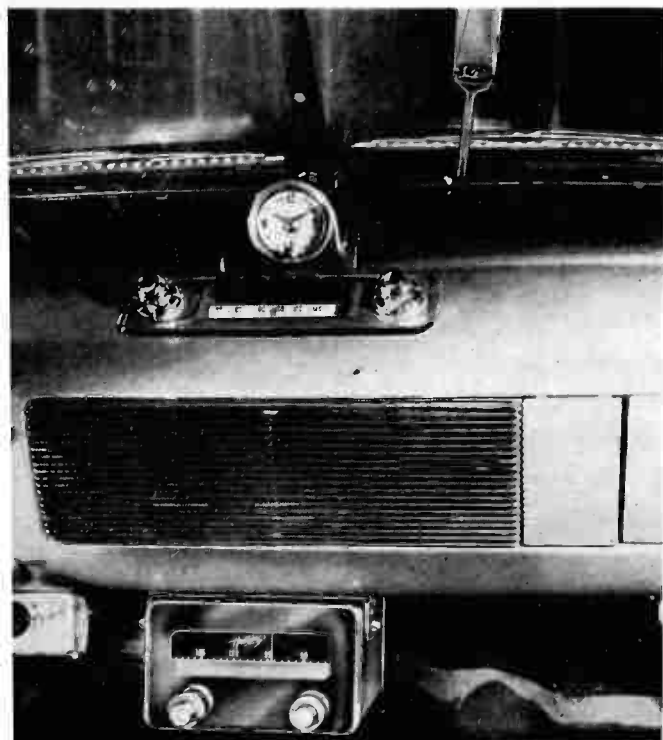

*FM installation fits under dashboard and provides static free reception for automobile radios.*

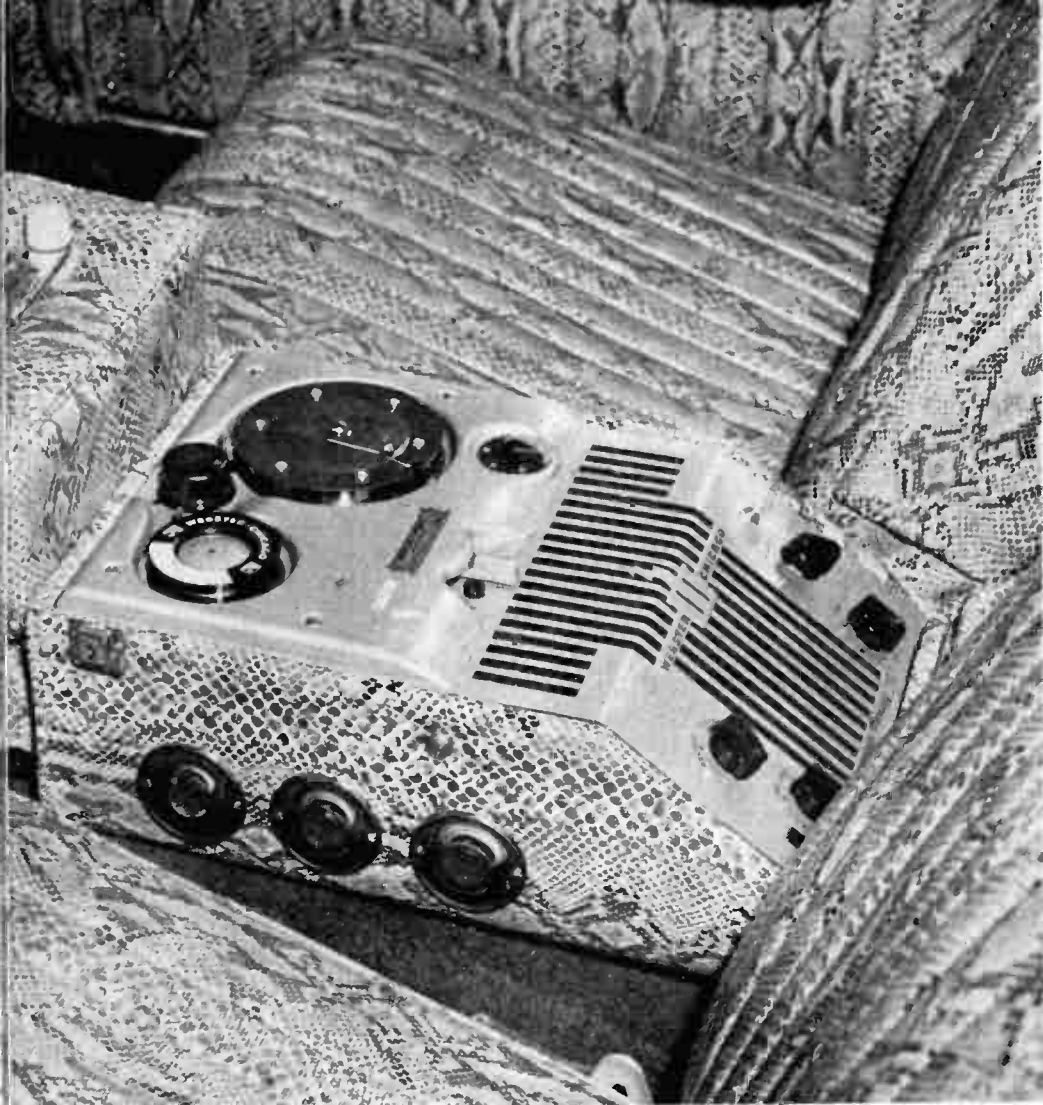

*Custom car has wire recorder and radio between front seats.*

*Robert Lee Behme*

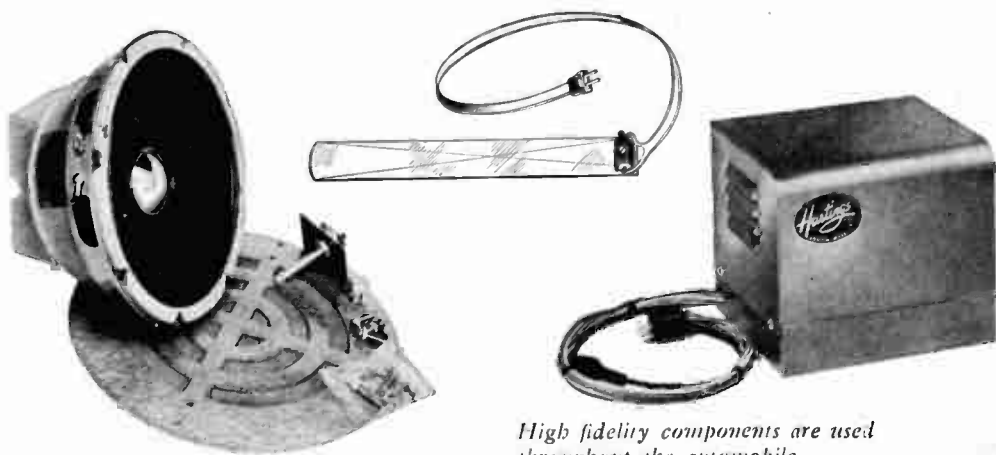

*High fidelity components are used throughout the automobile. FM receiver by Hasting Products of Boston, Massachusetts.*

**XIII**

It has a double purpose as well. Reporters, salesmen and writers have mounted the microphone on a sun visor to dictate reports, etc. Such work is done without interfering with their driving functions in the least.

Several Hi Fi enthusiasts have mounted the extremely compact RCA 45 rpm record player into shock-mounted arm rests or enlarged glove compartments. The new extended play records supply over a full hour of music. The short tone arm, with its good compliance, tracks the stylus well unless a tire-breaking bump is encountered. The large changers haven't, as yet, proved successful, but better shock-mounting may permit their use in easy riding cars.

The ideal auto radio would be an FM unit with its wide band width and full frequency range. As yet there is only one commercial model available. The Telfunken Company (Germany) has an excellent AM-FM portable that may be well worth the seemingly high \$125 price.

So there is hope that the ingenuity of the audiophile will soon be transferred to his car. It **WOULD** be fun to entertain other drivers with a full frequency rendition of the Triumphal March, the next time you are stuck in a traffic jam. ■



*45 rpm record player will play in car, but glove compartment must be enlarged to fit.*



*Recorder uses 110 volt current from converter connected to car battery.*

*Converter plugs into cigarette lighter socket for dictation while driving.*

*Rear seat speaker is easily installed at home to improve car radio tone.*

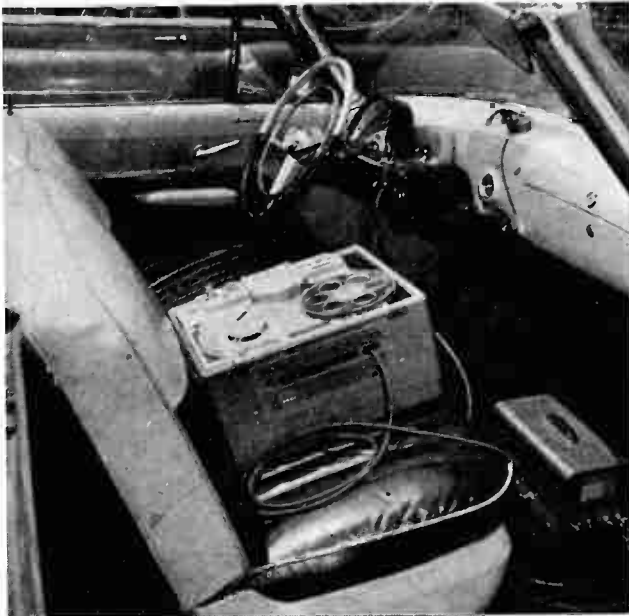
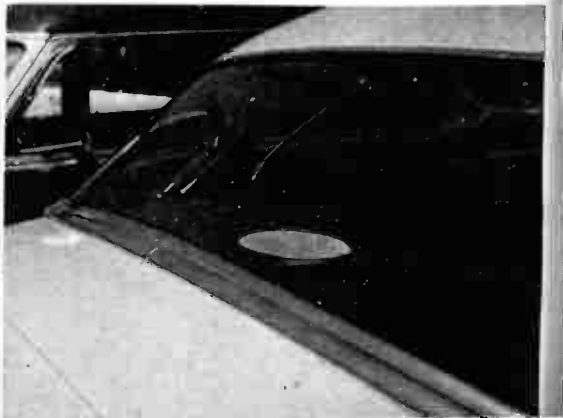



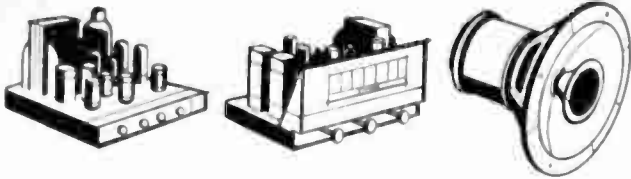

# HI-FI DEFINITIONS

From C. M. Brainard of Master Electronics, Los Angeles 46

**AFC**  
**(Automatic Frequency Control)**— Primarily used in FM radio tuners. Automatically locks the tuning with the station being received, thereby preventing distortion.

**AM**  
**(Amplitude Modulation)**— The method of radio broadcasting generally used by standard broadcasting stations.

**AMPLIFIER**  
 The device which magnifies or multiplies electrical energy so that the output signal is sufficient to actuate a loudspeaker.

**AVC**  
**(Automatic Volume Control)**— Automatically adjusts the volume from different radio stations so that each is received with approximately the same loudness, whether the station is weak or strong, near or far.

**BASS**  
 Generally referred to as the lowest part in harmonic music; of low pitch; usually from middle C (256 cps) down.

**BINAURAL**  
 Having two ears. As applied to a system of recordings wherein two separate recordings or reproducing channels are used to simulate an illusion of reality.

**CPS**  
**(Cycles Per Second)**—Cycles of vibration per second. Example: Middle C on the piano is produced by a string vibrating at 256 cycles per second.

**CHOKE FILTER**  
 Used in most high quality amplifying equipment. Used to remove hum from the power source and to produce a smooth flow of current, thereby allowing clearer reproduction of musical tones.

**DISTORTION**  
 The production of extra vibrations not present in original sound. This results in deterioration of clarity. In a good amplifier harmonic distortion is less than 1%.

**FM**  
**(Frequency Modulation)**— The method of radio broadcasting wherein high fidelity reproduction is greatly improved and noise and static are reduced. This is accomplished by having sound control the rate of vibration of the transmitted signal, instead of strength of signal as in AM broadcasting.

**FREQUENCY**  
 The rate of vibration (see CPS).

**FREQUENCY RESPONSE**  
 The ability of an audio system to reproduce evenly all audible sounds from the lowest to the highest pitch with the same amount of volume. A good amplifier should have a frequency response that is essentially constant from 20 cps to 20,000 cps.

**HERMETICALLY SEALED**  
 A method of installing transformers in a sealed container into which air and moisture cannot enter.

**HIGH FIDELITY**  
 A term used to imply a high degree of faithfulness of reproduced sound to its original. Beware of this term being loosely applied to incapable and inferior equipment. It is not possible to produce high fidelity reproduction with small loudspeakers or inexpensive "all-in-one" table models.

**HUM**  
 A singing note emitted from a sound reproducer due to inadequate filtering, or stray currents picked up by the wires connecting various electrical components.

**LOW IMPEDANCE CATHODE FOLLOWER**

This is a special circuit incorporated in all high quality preamplifier-equalizers designed to be located remotely from the main amplifying equipment. It permits distances between this equipment up to 100 feet without pickup of "hum" or fidelity loss.

**MICROPHONICS**  
 An effect produced by defective radio tubes which causes a musical "bang" when the tube is touched. In severe cases a continual "howl" is produced.

**INPUT**  
 That point at which a signal is introduced into a piece of equipment, such as the phonograph, radio or TV input connections of an amplifier, preamplifier, or tuner.

**OUTPUT**  
 The point at which outgoing signals are taken from a piece of equipment.

**PREAMPLIFIER**  
 A device which magnifies minute electrical energy to the power necessary to be utilized by the main amplifying equipment. It may incorporate tone controls, record compensation, and power switches.

**PRESENCE**  
 A term applied to the quality of naturalness in sound reproduction so the completeness of the illusion is such that the listener believes sounds are being produced intimately at the loudspeaker.

**POWER OUTPUT**  
 A term relating to the power capabilities of an amplifier. Generally stated in the electrical unit of watts.

**POWER RESPONSE**  
 A term meaning the frequency response capabilities of an amplifier running at or near its full rated power. Beware of response ratings given when the power at which these ratings were taken is not stated. The average radio or table model phonograph does not have enough power response to create high fidelity reproduction.

**QUIETING**  
 A term generally used in connection with AM and FM tuners. It refers to the amount of internal background noise as compared with the sensitivity to a signal being received. A good tuner should have at least 20 decibels of quieting for 10 microvolts of sensitivity.

**RECORD COMPENSATOR**  
 An electrical network designed to correct inequality in various recording techniques. This device is essential for the proper reproduction of high fidelity recordings.

**SENSITIVITY**  
 The ability of a circuit to detect minute electrical signals such as from the air or from a phonograph tone arm.

**SELF-POWERED**  
 Meaning that a particular piece of equipment has its own power supply. Desirable in remote preamplifier-equalizers and radio tuners.

**TREBLE**  
 Generally referred to as the higher part in harmonic music or voice, of high or acute pitch; in music from middle C (256 cps) upward.

**TRUE BINAURAL**  
 True binaural is only possible by use of earphones. The sounds from a two-channel amplifier are connected to each earphone separately thereby forcing each ear to hear only one sound channel. Binaural reproduction using loudspeakers should more strictly be referred to as "stereophonic" or 3-dimensional sound.

**TUNER**  
 A radio station selector for either AM or FM reception, or both, but not incorporating a power amplifier on its chassis. Such a device must be operated with a suitable power amplifier in order to have sufficient volume to actuate a loudspeaker.

**TURN-OVER**  
 A term referring to a frequency generally between 250 and 1000 cps., from which point and downward the frequency response (tone) is boosted in a piece of amplifying equipment.

**WATTS**  
 An electrical term (unit of power).

**XIV**

# INDEX

Alignment, recording heads.....	79	Joints, cabinet .....	102
AM radio.....	20	Kit costs .....	14
Amplifier, operation of.....	20	speaker .....	14
to old radio.....	71	Loudspeakers .....	48
tube .....	19	Magnetic coating on tape.....	77, 79
Amplifiers, types .....	62	Materials, demountable music wall	108
Amplitude .....	18	sectional storage wall.....	106
Audio reproducer system.....	61	Modulation, tape noise.....	79
Automobile FM .....	124	Multiple speaker system.....	60
Bass reflex .....	50	Needle changing .....	94
plans .....	51	wear .....	90
Binaural .....	74	Permanent magnet .....	58
Bookcase mounting .....	15	Phonograph, connecting Hi Fi.....	115
Brown, Les .....	4	Pitch .....	18
Building code .....	110	Plans, demountable music wall.....	108
Cabinets, materials for.....	103	sectional storage wall.....	106
typical .....	100	Playback, magnetic recording.....	78
Cartridge, diagram .....	92	Power amplifiers .....	64
needles .....	94	Preamplifiers .....	68
turnover .....	89	Printing, effect on tape/wire.....	80
Changers, automatic .....	84	Racks .....	14
connecting Hi Fi.....	114	Radio, AM .....	20
Children's records .....	9	FM .....	20
Cleaning records .....	98	Record changer dimensions.....	112
Coaxial speaker .....	60	making .....	8
Code, built-in TV .....	110	storage .....	6, 99
Columbia 360 .....	16	wear .....	96
Compensators, record .....	68	Remote control amplifiers .....	64
Component costs .....	14	Shell, plug-in .....	89
Controls, bass and treble .....	67	Sound, intensity chart .....	19
Converter, 6V to 110V .....	126	waves .....	18
Corner enclosure (plans).....	56	Space requirements, equipment.....	104
Critique, record .....	13	Speakers .....	48
Cycles per second.....	18	operation of .....	58
Decibel .....	18	replacement of .....	71
Diamond styli .....	90	Splicing magnetic tape .....	81
Diaphragm .....	58	Stereophonic sound .....	74
Dimensions, equipment .....	104	Storing magnetic tape.....	81
Distortion .....	19	records .....	99
Distributed port enclosure (plans)	53	Styling cabinets .....	102
Electron tube .....	19	Stylus pressure .....	88
Enclosure types .....	50	Tape, plastic, paper.....	79
Equipment dimensions .....	105	recorders .....	81
Extended range speaker.....	61	response at speed .....	78
Factory Hi Fi .....	16	splicing .....	81
Finishing furniture .....	111	storage .....	81
Fireplace installation .....	28	time at various speeds.....	83
FM radio .....	20	Television, built-in.....	110
"Fold-a-flex" .....	51	Tube, electron .....	19
Folded horns .....	50	Tuners .....	73
Frequency .....	18	Turn-over cartridge .....	89
Front end .....	69	Turntables .....	86
Head, tape recording .....	77, 78	"Tweeter" .....	61
Hearing, average person .....	21	Voice coil .....	58
Horn, exponential (plans).....	54	Volume control connecting.....	113
Illusion of fidelity.....	10	Wave (sine/pure) .....	18
Infinite baffle .....	50	Wire recording .....	76
Installation, home music.....	22	"Woofers" .....	61
typical Hi Fi.....	15		

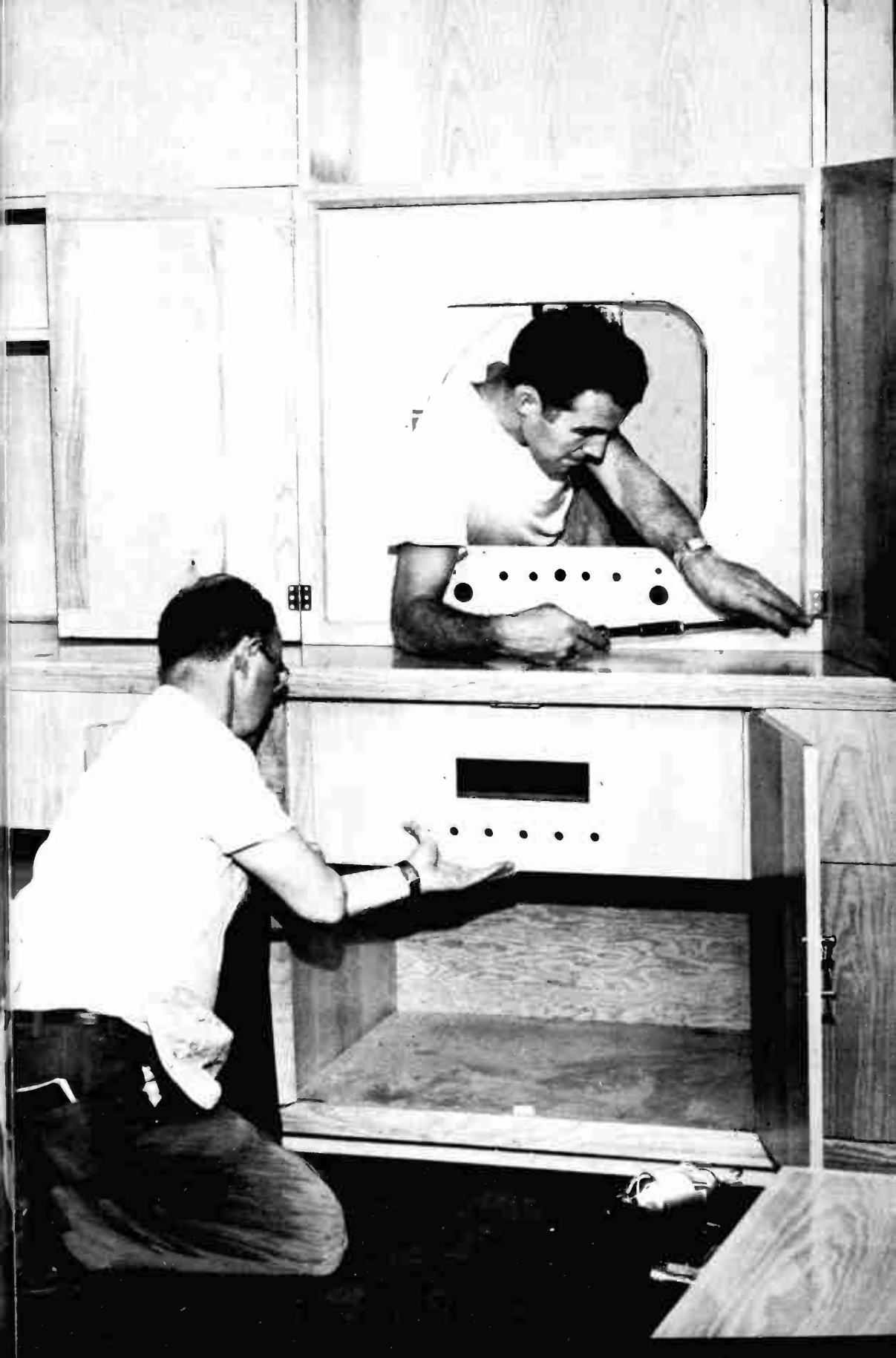

**THIS BOOK SHOWS YOU  
HOW TO ENJOY THE ULTIMATE IN  
MUSIC AT THE LOWEST COST**

*Thrilling New Sounds for Your Home Enjoyment*



**These Four Parts Can Make Your Music System**