

*Handwritten: August 1930*

# JOURNAL OF THE A. I. E. E.

AUGUST 1930



PUBLISHED MONTHLY BY THE  
AMERICAN INSTITUTE OF ELECTRICAL ENGINEERS  
33 WEST 39TH ST. NEW YORK CITY

PACIFIC COAST CONVENTION, PORTLAND, SEPT. 2-5



# Pacific Coast Convention Views

A.—SITE OF ROCK ISLAND DEVELOPMENT ON COLUMBIA RIVER NEAR WENATCHEE, WASHINGTON—PUGET SOUND POWER & LIGHT COMPANY

B.—PORTLAND, OREGON, HOST TO THE 1930 PACIFIC COAST CONVENTION, SEPTEMBER 2-5,—MOUNT HOOD IN THE BACKGROUND

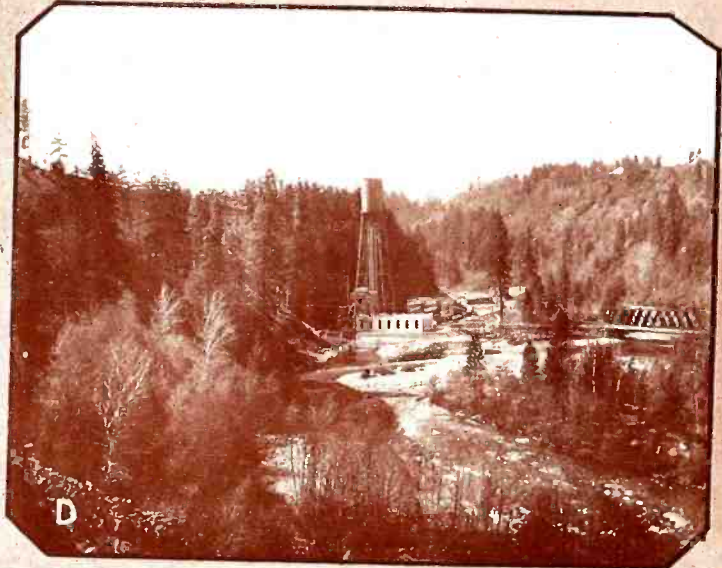
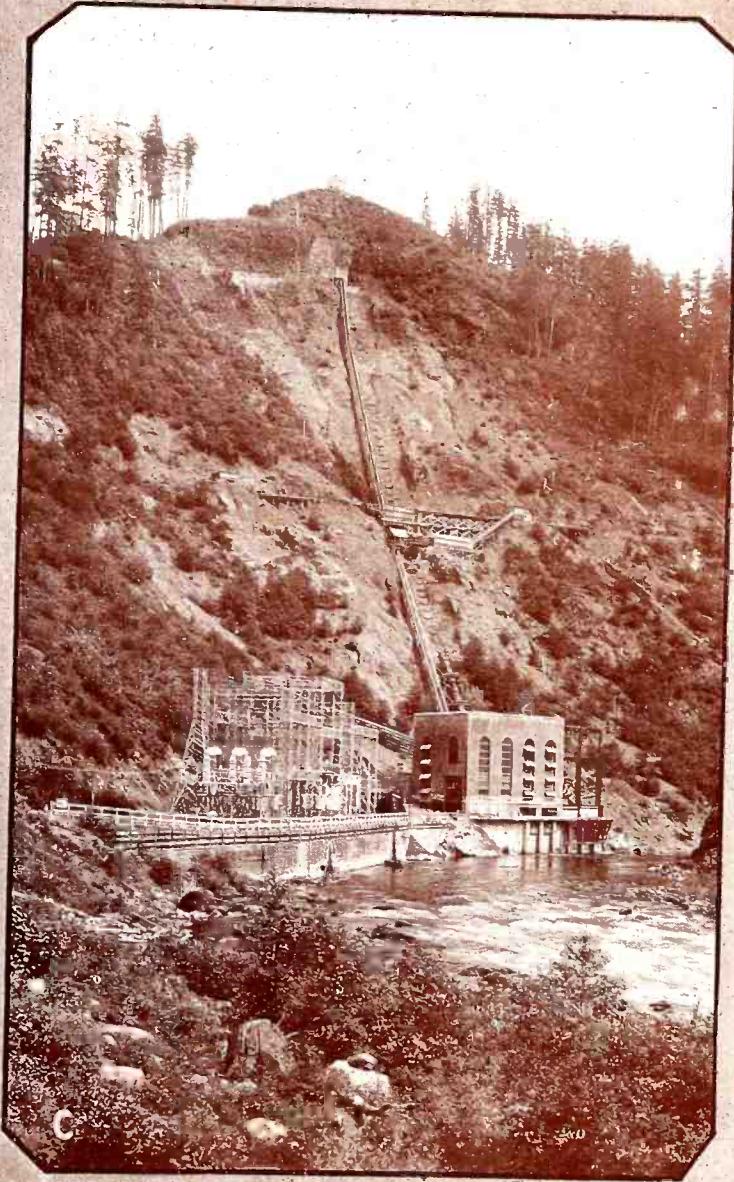
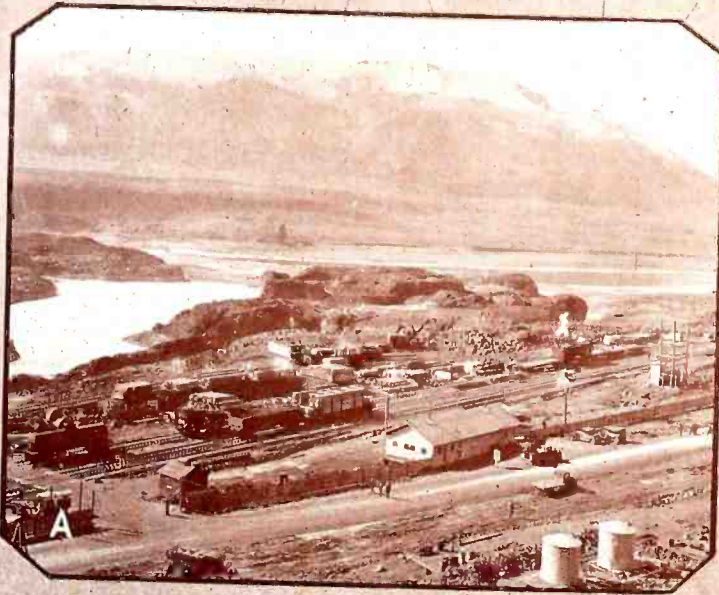

C.—OAK GROVE PLANT OF PACIFIC NORTHWEST PUBLIC SERVICE COMPANY, PORTLAND, ON THE CLACKAMAS RIVER NEAR PORTLAND

D.—POWERDALE HYDROELECTRIC PLANT OF PACIFIC POWER & LIGHT COMPANY, PORTLAND, AS VIEWED FROM MOUNT HOOD LOOP HIGHWAY, NEAR HOOD RIVER, ORE.

E.—THE PORTLAND GOLF CLUB COURSE



# JOURNAL of the A. I. E. E.

PUBLISHED MONTHLY BY THE AMERICAN INSTITUTE OF ELECTRICAL ENGINEERS  
33 West 39th Street, New York

## PUBLICATION COMMITTEE

W. S. GORSUCH, *Chairman*, H. P. CHARLESWORTH, F. L. HUTCHINSON, A. E. KNOWLTON, E. B. MEYER

GEORGE R. METCALFE, *Editor*

Changes of advertising copy should reach Institute headquarters by the 15th day of the month for the issue of the following month.  
Subscription: \$10.00 per year to United States, Mexico, Cuba, Porto Rico, Hawaii and the Philippines, \$10.50 to Canada, Central America, South America, Haiti, Spain and Colonies, and \$11.00 to all other countries.  
Single copies \$1.00.

Entered as matter of the second class at the Post Office, New York, N. Y., May 10, 1905, under the Act of Congress, March 3, 1879.  
Acceptance for mailing at special rate of postage provided for in Section 1103, Act of October 3, 1917, authorized on August 3, 1918.

Vol. XLIX

AUGUST 1930

Number 8

## TABLE OF CONTENTS

### Papers, Discussions, Reports, Etc.

Notes and Announcements			
Proposed Changes in Institute Publications	595	The Calculation of Alternator Swing Curves (Abridged), by F. R. Longley	653
Some Leaders of the A. I. E. E. (E. Bennett)	596	Mutual Impedances of Ground Return Circuits (Abridged), by A. E. Bowen and C. L. Gilkeson	657
Annual Reports of Technical Committees		New Portable Electro-Cardiograph	661
Power Transmission and Distribution	597	Rationalization of Transmission Insulation Strength—II (Abridged), by P. Sporn	662
Protective Devices	604	Electric Power Consumption for Yard Switching (Abridged), by P. H. Hatch	666
Electric Welding	609	Effect of Transient Voltage on Power Transformer Design (Abridged), by K. K. Palueff	670
Application to Marine Work	611	Rationalization of Station Insulating Structures (Abridged), by C. L. Fortescue	674
Automatic Stations	612	Modern Requirements for Protective Relays (Abridged) by O. C. Traver and L. F. Kennedy	678
Power Generation	620	Two-Way Television (Abridged)	682
General Power Applications	622	Essential Factors in the Coordination of Line, Station and Apparatus Insulation (Abridged) by A. E. Silver and H. L. Melvin	684
Hydro Power Practise in Central Europe (Abridged), by A. V. Karpov	638	The First Marine Electric Lighting Installation	688
Long Distance Cable Circuit for Program Transmission (Abridged), by A. B. Clark and C. W. Green	642		
A New Portable Oscillograph, by C. M. Hathaway	646		
Electric Transmission and Control of Power (Abridged), by S. T. Dodd	649		

### Institute and Related Activities

The Pacific Coast Convention	689	An American Society of Danish Engineers Formed	702
Middle Eastern District Meeting	691	New Officers for Automotive Engineers	702
Southern District Meeting at Louisville	691	The 1930 Lamme Medal	702
Outstanding Summer Convention Held at Toronto	691	Personal Mention	702
Report of Technical Sessions	692	Obituary	703
Annual Meeting of the Institute	699	Section Activities	
Report of Tellers of Election of Officers	700	Past Section Meetings	705
Report of Committee of Tellers on Amendment to Constitution	700	Student Activities	
A. I. E. E. Directors Meeting	700	Branch Meetings	705
Lamme Medal Presentation	701	Engineering Societies Employment Service	
Five Engineering Awards Made at A. S. C. E. Annual Convention	701	Positions Open	706
International Conference on Large High-Tension Systems	701	Men Available	706
Advisory Committee on National Hydraulic Laboratory Appointed	701	Engineering Societies Library	
President Hoover Signs Rivers and Harbors Bill	702	Book Notices	707
Federal Water Power Commission Reorganized	702	Membership	
		Applications, Elections, Transfers, etc	709
		Officers, A. I. E. E.	710
		List of Sections	710
		List of Branches	711
		Papers Abridged in JOURNAL	711
		Digest of Current Industrial News	712

A REQUEST FOR CHANGE OF ADDRESS must be received at Institute headquarters at least ten days before the date of issue with which it is to take effect. Duplicate copies cannot be sent without charge to replace those issues undelivered through failure to send such advance notice. With your new address, be sure to mention the old one indicating also any changes in business connections.

Copyright 1930. By A. I. E. E.

Printed in U. S. A.

Permission is given to reprint any article after its date of publication, provided proper credit is given.  
(The Journal of the A. I. E. E. is indexed in Industrial Arts Index.)

# MEETINGS

of the

American Institute of Electrical Engineers

---

PACIFIC COAST CONVENTION, Portland, Oregon,  
September 2-5, 1930

MIDDLE EASTERN DISTRICT MEETING, No. 2,  
Philadelphia, Pa., October 13-15, 1930

SOUTHERN DISTRICT MEETING, No. 4, Louis-  
ville, Kentucky November 19-22, 1930



## MEETINGS OF OTHER SOCIETIES

Institute of Radio Engineers, King Edward Hotel, Toronto,  
Ontario, Canada, August 18-21, (H. P. Westman, 33 West  
39th St. New York, N. Y.)

American Electrochemical Society, Hotel Statler Detroit, Michi-  
gan, September 25-27, (C. G. Fink, Columbia University,  
New York)

National Safety Council, Pittsburgh, September 29-October 4,  
(W. H. Cameron, North Wacker Drive, Chicago)

National Electric Light Association

Great Lakes Division, French Lick Springs, Ind., Sept. 25-27,  
1930, (T. C. Polk, 20 North Wacker Drive, Chicago, Illinois)

New England Division, New Ocean House, Swampscott,  
Mass., September 29-October 1, 1930. (Miss O. A. Bursiel,  
20 Providence Street, Boston)

Rocky Mountain Division, Franciscan Hotel Albuquerque,  
N. M., October 20-22, (O. H. Weller, Public Service Co. of  
Colorado, Denver)

Illuminating Engineering Society, Hotel John Marshall, Richmond,  
Va., Oct. 7-10, (E. H. Hobbie, 29 West 39th St., New York)

American Society of Civil Engineers, Fall Meeting, St. Louis, Mo.,  
October 1-3, (George T. Seabury, Secretary, Engineering  
Societies Building, 29 West 39th Street, New York)

American Gas Association, Atlantic City, N. J., October 13-17,  
1930, (Kurwin R. Boyes, Secretary, 420 Lexington Avenue,  
New York)



# JOURNAL OF THE A. I. E. E.

DEVOTED TO THE ADVANCEMENT OF THE THEORY AND PRACTISE OF ELECTRICAL ENGINEERING AND THE ALLIED ARTS AND SCIENCES

*The Institute is not responsible for the statements and opinions given in the papers and discussions published herein.  
These are the views of individuals to whom they are credited and are not binding on the membership as a whole.*

Vol. XLIX

AUGUST, 1930

Number 8

## Proposed Changes in Institute Publications

**D**URING the past two years, the Publication Committee has been conducting a survey for the purpose of obtaining the points of view of the membership regarding the Institute publications, particularly in respect to what changes, if any, should be made in order to make these publications of greater interest and value to their readers.

After a careful analysis of the various opinions expressed in the numerous replies received, the committee prepared a report which reviewed the situation, and in which recommendations were made that the present policy of publishing the TRANSACTIONS be continued, but that certain important changes be made in the JOURNAL.

The report was presented to the Board of Directors at a meeting in May 1930 but action was deferred pending its consideration at the Conference of Officers and Delegates at the Summer Convention, Toronto, held in June. At this Conference the recommendations of the committee were discussed with great interest and the report was endorsed with the recommendation that the Board of Directors adopt it as a statement of the Institute's policies regarding publications.

The general policy as recommended by the Publication Committee may be briefly summarized as follows:

**TRANSACTIONS**—Continue the present policy of publishing the TRANSACTIONS quarterly and printing papers in full together with discussion thereon.

### MONTHLY JOURNAL—

1. Publish **INTERPRETIVE ABSTRACTS** of all papers presented at Conventions and District Meetings, and papers selected from those presented at Section and Branch Meetings; and print in full only a limited number of outstanding papers which are of general interest to the engineering profession.
2. Print all **ANNUAL REPORTS** of Technical Committees in full in both the JOURNAL and TRANSACTIONS.
3. Print in full **SPECIAL ARTICLES** on timely scientific subjects of particular interest to engineers.
4. Print articles and reviews on recent developments in electrical engineering and related fields, constituting a review of the world-wide achievements in engineering and allied arts and sciences.
5. Record more adequately the **OUTSTANDING ACTIVITIES** of Sections and Branches.
6. Publish important electrical items from the **ENGINEERING INDEX** to the extent of possibly four pages of the JOURNAL per month.

The report, including these recommendations, was formally approved by the Board of Directors at the meeting held in Toronto, June 25, 1930, with the understanding that the recommended changes will become effective January 1st next. In order to put into effect and adequately carry out the proposed plan it will be necessary to rearrange, and make additions to, the editorial staff. The Publication Committee and the National Secretary are giving this matter careful consideration with a view to building up an organization fully capable of successful execution of the recommendations embodied in this report.



### Some Leaders of the A. I. E. E.

Edward Bennett, Chairman of the Department of Electrical Engineering of the University of Wisconsin, and Vice-President of the Institute during 1924-1926, was born in Pittsburgh, Pennsylvania, October 26, 1876. After graduating in Electrical Engineering in 1897 with the degree of E. E. from the Western University of Pennsylvania, (now the University of Pittsburgh)—he served an apprenticeship of a year and a half in the machine shops of the Westinghouse Electric and Manufacturing Company—a period of bench and machine work in the many departments of the Westinghouse factory. From January to September 1899 he was engaged in research work on lightning arresters; chancing one day to observe the subdivision of a spark which occurred when the electric discharge took place across a short gap between kaolin-graphite electrodes of considerable resistivity, he invented and produced the first multi-path lightning arresters which were placed on 600-volt railway systems and the 40,000-volt system of the Telluride Power Company, and also formed a nucleus for later developments of the Westinghouse Company.

From September 1899 to March 1904, Professor Bennett was one of the engineers engaged under A. J. Wurts upon the development work of the Nernst lamp for Mr. George Westinghouse. This was shortly after Mr. Westinghouse undertook the development of the lamp, and in these early stages of its history, Mr. Bennett's lot fell to the specific work of developing the heating element and special grades of non-conducting and heat resisting porcelains. This work grew into the training and organizing of departments for a piece work system for manufacturing these parts, as well as organizing and directing the general testing and inspection of product from the raw material stages to the completed article. As Chief Engineer of the company from 1902 to 1903, he made a special study of the art of illumination, and for his work on the Nernst Lamp, was awarded a silver medal by the Jury of Award at the St. Louis Exposition.

From 1904 to 1905, under the firm name of Beebe and Bennett, he engaged in consulting and electrical contracting work in Pittsburgh. The following year he accepted a position of Head Electrician in charge of experimental work with the National Electric Signaling Company, Washington, D. C., later to be made Acting Manager; he subsequently filled both positions. Among the pioneer investigations conducted during this period may be mentioned the determination of equivalent resistance of the losses in spark-gaps with electrodes of various shapes and materials; of the losses in the available condenser dielectrics; of the energy required to give audible signals with various detectors; the development and checking of wave meters, et cetera. During

this period the company conducted its first transatlantic radio experiments, using the spark system of telegraphy between two 420-ft. insulated vertical steel tubes, one located at Brant Rock, Massachusetts, and the other in Scotland.

During the period from 1906 to 1909, Professor Bennett was with the Telluride Power Company of Utah conducting investigations dealing with high-voltage problems—oscillograph studies on transmission lines to determine the effect of switching operations and the cause of troublesome unbalanced conditions, the properties and design of high-voltage insulators (the design of methods and relays for automatically cutting out defective sections of a transmission system) and a study of interruptions to service due to lightning and methods of preventing the same. In parallel with his engineering work, he conducted classes in mathematics for Telluride Institute and the interest thus created led to his acceptance in 1909, of a professorship in Electrical Engineering at the University of Wisconsin for the first four years as Associate Professor and then for five years as Professor of Electrical Engineering, conducting courses in illumination and photometry, telephony, power transmission and distribution, insulation, and advanced alternation-current theory. Since 1917 he has served as Chairman of Electrical Engineering at this university.

Professor Bennett's work at Wisconsin inspired a number of papers, mainly before the A. I. E. E., the I. R. E., and the S. P. E. E. Among these may be mentioned a series of papers dealing with the losses in radio antennas and the radiating, abstractive, and selective properties of the antennas. In several papers on *Systems of Units*, he has strongly condemned the existing practise of using a mixture of units from three systems—the electrostatic, the electromagnetic, and the practical system—in the same calculation, and has advocated the use in scientific and engineering work of no units other than those of the completed and rationalized system of Practical Units, a system free from all the troublesome conversion factors,  $10^{-1}$ ,  $10^7$ ,  $10^8$ ,  $10^9$ ,  $9 \times 10^9$  etc., which he looks upon as undesirable. Partly to demonstrate the merits of this system of units, he has written (jointly with H. M. Crothers) the text "Introductory Electrodynamics for Engineers" in the system.

For a number of years he has served the Institute Committees on Research, and on Engineering Education. He was elected a Fellow in 1918. He is a Fellow of the Institute of Radio Engineers, the American Physical Society and the A. A. A. S., and a member of the Illuminating Engineering Society, and the History of Science Society. He is at present Vice-President of the Society for the Promotion of Engineering Education. As a research worker his ability has always been outstanding.



# Annual Reports of Technical Committees

These reports which were submitted at the Summer Conventions of the Institute constitute a resume of the progress in the field of each committee. They are printed in full except for the bibliographies, which here are omitted.

## POWER TRANSMISSION AND DISTRIBUTION\*

*To the Board of Directors:*

The Committee on Power Transmission and Distribution has found its problem sufficiently broad to justify the division of the work into several classes. A subcommittee has been appointed to cover the scope of the problems falling within each class, and this year it has been possible to define these problems more carefully and get the work started in a definite direction.

In practically every phase of the work the subcommittees find their activities closely related to the activities of other committees of the Institute or similar committees in other organizations. Particular attention has been given to the coordination of this work with the work of the other committees in order that unnecessary duplication may be avoided and that none of the important phases may be left out of consideration.

The classifications as handled by the several subcommittees this year are as follows:

A subcommittee of which C. T. Sinclair is Chairman has reviewed problems on the distribution of electrical energy in cities and rural communities.

Very active work has been continued by Philip Sporn, Chairman of the Subcommittee on Lightning and Insulators.

A subcommittee of which R. N. Conwell is Chairman has recently been appointed to review problems on steel transmission towers and conductors.

The study of the question of interconnection and stability factors has been continued under the leadership of R. D. Evans, Chairman.

The work of the Subcommittee on Cable Development has been very active under the leadership of T. F. Peterson.

The research work on impregnated-paper insulated cables has been continued by the joint subcommittee of the N. E. L. A. Underground Systems Committee,

A. E. I. C. Committee on High-Tension Cable, and the Committee on Power Transmission and Distribution of the A. I. E. E., with D. W. Roper serving as Chairman of this joint activity.

F. M. Farmer has coordinated the activity of the bodies on standardization within the field of power transmission and distribution.

The problem of interconnection and stability factors has engaged several subcommittees in extensive study, and steps have been taken to coordinate this work by the appointment of a joint subcommittee reporting to the A. I. E. E. committees on Protective Devices, Power Generation, and Power Transmission and Distribution, and carrying on activity in close cooperation with the Power Systems Engineering Committee of the N. E. L. A. Although it is impossible at this time to predict the activities for the coming year, it is thought by all three of the A. I. E. E. committees that this joint subcommittee should be appointed to correlate the work and analyze the problems in this important field.

### DISTRIBUTION

The development of a-c. low-voltage network has altered the methods of distributing electricity in locations having a large load density. Where tall buildings exist, the problem of distributing electrical energy throughout the building has reached the proportions of street distribution and resulted in the introduction of vertical networks within the building.

The rural communities distribution problem has brought forth some interesting solutions to insure reliable service and at the same time keep the cost within the permissible limits.

### LIGHTNING AND INSULATORS

Additional instruments have become available during the past year in studying lightning. These are the lightning stroke recorder which measures the current in a lightning stroke, and the field intensity recorder which records the electrostatic field (kv. per ft.) under the cloud. With these instruments have been recorded currents reported in the order of from 50,000 to 175,000 amperes in a lightning stroke, and field gradients as high as 85 kv. per ft. on an insulated antenna. Field gradients on transmission lines as high as 52 kv. per foot of height have also been recorded by surge recorders.

During the past year, the cathode ray oscillograph has yielded some 150 field records of actual lightning voltage wave shapes on transmission lines. Analysis

#### \*COMMITTEE ON POWER TRANSMISSION AND DISTRIBUTION:

H. R. Woodrow, Chairman,		
P. H. Chase, Vice-Chairman,		
T. A. Worcester, Secretary,		
R. E. Argersinger,	R. D. Evans,	D. W. Roper,
R. W. Atkinson,	F. M. Farmer,	A. E. Silver,
E. T. J. Brandon,	J. H. Foote,	C. T. Sinclair,
A. B. Campbell,	K. A. Hawley,	L. G. Smith,
R. N. Conwell,	D. C. Jackson, Jr.,	Philip Sporn,
O. G. C. Dahl,	A. H. Lawton,	H. C. Sutton,
H. C. Dean,	L. L. Perry,	Percy H. Thomas,
E. W. Dillard,	T. F. Peterson,	H. S. Warren,
L. L. Elden,	G. E. Quinan,	R. J. C. Wood,

*Presented at the Summer Convention of the A. I. E. E., Toronto, Ont., Can., June 23-27, 1930. Complete copy upon request.*



of these records show a maximum crest voltage of 1260-kv. wave fronts in the order of one to over 80 microseconds, and a total length, until the wave falls to zero, of as high as 150 microseconds. These data comprise a large increase of this type of information over the two records of natural lightning secured in the previous year. Lightning voltages up to 15.2 times normal line voltage to neutral have been recorded and switching surges as high as 5.5 times normal observed.

Additional data which further confirm past data and theory on the attenuation of both natural and artificial lightning have been obtained, showing the rapid decrease in the crest value of lightning waves in excess of corona voltage as they travel away from their point of origin. For the past year, the lightning generator has been used extensively in the field, three such installations being in use for a large part of the lightning season.

A study of lightning attenuation has also been carried on to determine the effect of steepness of wave front and polarity, of ground wire size and resistance, and also the effect of counterpoises. Field studies have also been started to show the behavior of traveling waves at the juncture of cables and open-wire lines.

Extensive work has been done in the field, measuring the surge impedance of actual lines and determining the effect of tower footing resistances under lightning conditions.

*Line Design from the Lightning Point of View.* The benefits derived from the use of substantially installed ground wires on steel tower lines are now generally accepted. In some cases, more than one ground wire has been employed, but at the present time, the location of additional ground wires is still an open question due to the lack of definite knowledge as to whether the direct or induced lightning stroke is the more important to protect against on high-voltage lines.

From the lightning aspect, the insulation of wood pole lines has been receiving attention, and there are now in service several such lines using wood crossarm braces, insulated guy wires, and pole ground gaps, in an attempt to raise the lightning flashover of the line and at the same time minimize the possibility of pole and crossarm splitting. The fused grading shield is another design feature which has been given further study in service the past year. In one case, in an attempt to improve the lightning performance of the line, the tower footing resistance of a 56-mi., 132-kv. steel-tower line has been materially lowered by auxiliary ground rods. At the present time, similar work is being done also on another high-voltage 33-mi. line. Over-insulation of steel-tower lines, materially higher than in past practise, is not making much headway although one important line has been designed for extra line insulation should this be found desirable.\*

\*Another method of lowering the tower footing resistance has been tried on a 220-kv. line. This consists of connecting the tower base to buried cable, which, in turn, extends some distance away from the tower.

*Presentation of Data and Results.* During the year, the Committee has sponsored wholly or in part groups of papers at three A. I. E. E. conventions; namely, the Winter Convention, February 1930, where eight papers were presented in the lightning group; the Springfield District Meeting in May 1930, where five papers were presented at the transmission session; and at the Summer Convention in June 1930, where seven papers are to be presented on rationalization of transmission system insulation strength. Practically all of these papers deal with this most important of subjects, lightning, its effect on transmission systems, and protective measures to bring it under control.

Some valuable data which have not yet been analyzed and assimilated have been obtained. It is the intention of the committee, however, not only to cooperate in every way possible to have these data as well as future information made available to the electrical profession for immediate use, but also to encourage the undertaking of new investigations where needed; and to have the results of these investigations made available to the Institute membership.

*1930 Lightning Investigations.* Field investigations of lightning are being carried forward on an increased scale. The instruments available and being used include:

1. Klydonographs and surge recorders.
2. Cathod ray oscillographs.
3. Lightning generators.
4. Lightning stroke recorders.
5. Surge indicators.
6. Field gradient recorders.

The work planned includes a wide field of investigation in which are studies on:

1. Lightning voltage magnitude.
2. Wave shape of natural lightning.
3. Attenuation and change of wave shape of lightning.
4. Effect of tower footing resistance.
5. Effect of counterpoises.
6. Determination of cloud field gradients.
7. Lightning voltage behavior at terminals of open wire line and cable.
8. Current in lightning strokes.
9. Importance of direct and induced strokes.
10. Records of insulator flashovers caused by lightning.
11. General investigation on distribution systems.

*Insulator Situation.* The present situation in the insulator field indicates a feeling among manufacturers that most of the troubles experienced in the past have been overcome. A summary of their attitude shows that:

1. Porous porcelain, under present manufacturing conditions, should seldom if ever be encountered.
2. Raw materials from selected sources, and careful factory inspection, have greatly improved product.
3. Present control of factory processes of mixing,

forming, and firing the porcelain has resulted in a uniform product.

4. Porcelain as made today is practically free from aging.
5. Insulators may deteriorate due to the method of hardware attachment and stress distribution within the porcelain but it is felt that this problem is being worked out satisfactorily.
6. The expected life of suspension insulators should be practically equal to that of the line or towers.
7. The use of high-strength units appears to be making considerable headway.

The manufacturers, with their close attention to the various steps and processes in the manufacture of porcelain, and to the design and assembly of hardware, and with their knowledge of the actual results obtained on their product in the field, seem to have reason for feeling satisfied with conditions as they are. On the other hand, a piece of equipment subject to as many variables as is a completely assembled porcelain insulator, with each variable offering possibilities of deleteriously affecting the product—particularly after a lapse of time—is not a product on which vigilance may be relaxed at any time. It is believed that accelerated life tests and accurate loss measurements on porcelain insulators offer a means for determining in advance the probable performance and life of modern insulators, and of variations in them. Again, it is believed that it is possible to incorporate refinements in the control of temperatures and humidity, involved in the various steps of the insulator manufacture, that will further decrease the variability in the product and increase the possibility of longer life. To these problems, the committee expects to give serious consideration during the coming year.

#### STEEL TRANSMISSION TOWERS AND CONDUCTORS

The numerous unsolved problems in connection with the design of steel transmission towers and conductors indicate the desirability of lending aid and encouragement to research and development work, which work must be coordinated with that carried on by other associations and development bodies. Progress can be made in the matter of simplification and standardization, and this again requires the cooperative efforts with other associations and standardizing bodies.

In particular, the following problems are under review at the present time and these will be brought before the Institute as soon as study has indicated a clearer presentation of the problems or their solution.

1. Definition of terms and the elimination of ambiguous expressions in specifications.
2. Study of clearances required between towers and conductors due to the electrical and mechanical conditions imposed upon the line.
3. Study of protective coatings.

4. Study of the electrical and mechanical features of ground wires in cooperation with the subcommittee on lightning and insulators.
5. Study of the effect of size or amount of steel exposed to a conductor on flashover.
6. Study of whipping, vibration, and impact of conductors including devices for the reduction or elimination of these phenomena.

#### INTERCONNECTION AND STABILITY FACTORS

Interconnections and the increases in the extent of power systems have raised a number of important questions. Of these, the measures necessary to insure reliability of operation are of the greatest importance. Technically, this means that the system, including interconnecting lines, must be so designed and operated that synchronism will be maintained between generating units and the synchronous machines of the load. In other words, interconnected systems must possess adequate stability under normal operating conditions as well as during times of system disturbances.

An outstanding development in interconnection and stability is concerned with the application of high-speed circuit breakers and relays. Because of the inertia, synchronous equipment cannot lose synchronism instantaneously. Consequently the transient stability limits of a system may be materially increased by isolating the faults promptly. This is particularly true of interconnections, since fast isolation of faults on either system minimizes the abnormal load thrown on the interconnection. The use of high-speed circuit breakers and relays offers very considerable promise for improving system stability.

Oil circuit breakers which have been available in the past for use on high-voltage systems have been relatively slow in their operation, their average operating time being of the order of 20 to 40 cycles. The new high-speed breakers recently brought out are capable of isolating a fault in from 8 to 12 cycles from the instant the trip coil is energized until the arc is extinguished. Heretofore, protective relays, being of the induction type, have been relatively slow in their operation. The new high-speed relays will have a maximum operating time of one or two cycles at the most, and even less time for the relays located close to the fault.

Double-winding generators have received considerable attention in connection with metropolitan type systems for reducing the short-circuit currents and at the same time maintaining adequately high synchronizing power.

The use of quick-response excitation for machines on transmission systems has become fairly well established, with the exciter response rate usually arranged for 200 to 600 volts per second. In special situations, higher response rates may be found desirable, especially in connection with synchronous condenser installations.

In connection with certain major transmission



projects, there has been discussion of the use and effects of damper windings. It is probable that the ideas on the use of damper windings will be clarified by papers to be presented in the near future.

The relative merits of different methods of grounding from the standpoint of system stability have been considered. Some operating companies have found it desirable to limit the severity of faults-to-ground at certain locations, and have grounded only a part of the transformer banks at a given location, or have introduced neutral impedance devices. In general, for major transmission systems, direct grounding has been viewed favorably from the protection standpoint and unfavorably from the stability standpoint. The recent development of high-speed circuit breakers and relays tends to remove the latter objection, leaving the choice of the method of grounding to be determined by consideration of protection.

System stability is a subject which has been before the industry for several years. Some of the measures which have been proposed to increase stability have actually been tried out on power systems, and new methods of operation are being put into effect. Thus, the operating data accumulating from year to year provide an increasing amount of information as a guide to the design of power systems with increased stability. A few examples in this connection will be cited. The scheme of system connections known as "synchronized at the load," has now received over a year's operating experience in New York City, and very satisfactory results in both stability and reliability of operation have been secured, the indicated margins of stability being more than adequate. In the southeastern district, one operating company has obtained increased reliability of operation by several means including synchronizing of hydro-generators and transmission lines only at load points, grounding only a part of the transformers at a station, and installing quick response excitation. Observations on the performance of systems under short-circuit tests on high-speed circuit breakers and relays have indicated that the shocks to the system are much reduced by high-speed isolation of faults.

During the past year, the subject of prime-mover governor control has received attention, particularly as a result of operating experience with automatic frequency control. This apparatus provides an arbitrary distribution of prime-mover input increments required by an undetermined distribution of load increments. Hence, this apparatus, while of some advantage from the stability standpoint, does not insure the ideal control of the distribution of prime-mover input. This should not be serious, however, since with complete application of automatic frequency control to a system, generating units will not ordinarily carry loads below 50 or 60 per cent of rating.

The a-c. calculating devices which have been developed permit an accurate determination of current, voltage, power, and phase-angle relations in an a-c.

power system. These devices are an outgrowth of the d-c. calculating tables and the miniature a-c. systems which have been used in the past to represent power system networks.

The a-c. calculating device already has found a wide field of application in making system analyses; for example:

1. *Normal System Studies:* Determination of current distribution, power distribution, and voltage conditions in a-c. power system networks. Also, studies of voltage and power factor control.

2. *System Fault Studies:* Determination of magnitude and distribution of current under three-phase, single-phase, and line-to-ground fault conditions. If the faults are unsymmetrical, the quantities can be determined by the use of the "symmetrical component" method.

3. *System Stability Analysis:* Determination of steady-state power limits, power angle curves, and studies of transient conditions by point-by-point analysis.

The interest in the analysis of power system problems on the part of engineers who deal with system planning and operation is increasing. In this connection, reference may be made to a group of papers on interconnection presented at the Winter Convention under the auspices of the Power Generation Committee, and including a discussion of the system connections in relation to stability. This interest was also reflected at the colloquium on power circuit analysis held at the Massachusetts Institute of Technology June 10-22, 1929, and at the annual fall meeting of the Great Lakes Division of the N. E. L. A. held at Madison, Wis., October 23-26, 1929. The papers presented a general review of the situation at the time, as related to the solution of power circuit problems with particular emphasis on those involving system stability.

The desirability of a standardized terminology for stability investigations is being reviewed by a group of the subcommittee with a view to submitting a report through the regular channels to the proper standardizing committee.

#### CABLE DEVELOPMENT

This year's developments have been largely along lines of standardization, simplification, and reduction of rudimentary and experimental designs and methods to economic and practical feasibility. Such advances, or radical departures from accepted practices, as have appeared, may be ascribed to the ever present urge to meet certain economic conditions, or to the need for adaptation to the new installation and operation requirements which developments in other fields evoke, rather than to fundamental inherent evolution. For example, a-c. network services to tall buildings call forth vertical riser cable designs for high voltage and long suspension; interconnection of operating companies may present unprecedented problems in sub-

marine cable transmission; change-over from open-wire overhead construction necessitates substitution of new types of aerial and buried cable; radio communication with planes in flight prompts studies and developments of shielded wire and cable to prevent interference,—and so on.

Throughout the past year, attention has been given to what may be termed the mechanics of cable installation and operation. The fact that failures due to inherent causes constituted such a small percentage of the total served to emphasize the importance of these aspects of cable use. Although some improvements have been made, the results appearing below indicate that there is still wide enough spread between inherent and non-inherent failures to justify very close study on the part of operating companies.

*Research.* Cable and dielectric researches as described in last year's report have been continued unremittingly. Already the results of coordination are manifesting themselves in improvement in manufacture and operation. Moreover, they have in other instances opened avenues of progress in standardization, etc.

At the present time a subcommittee of the Underground Systems Committee of the N. E. L. A. is engaged in the preparation of rating tables for cables installed under varying conditions. Other groups are working up tables of thicknesses for rubber, varnished cambric, and paper cable.

Although practises abroad do not allow of as high a temperature in cable operation as that met with in this country, and undoubtedly cable is therefore not used so severely there as here, the fact remains that some engineers attribute much of the trouble encountered in operation to voids developed and mechanical stresses set up as a result of the tendency of copper conductors to open when longitudinal thermal expansion is constrained. Special conductors and tensioning devices have been designed to counteract these movements. Information on the results of operation will probably be available to the industry at large and will certainly be watched for with interest. In the meantime, it would be well to have our local inspection forces pay particular attention to this phase of cable failures, in an effort to explain those which may have fallen too readily into the unknown class.

*Inspection, Testing, and Specifications.* There have been no special developments in testing and inspection practise in connection with underground cable. Improvement in technique continues slowly, resulting in greater accuracy and more reliable results. In particular, long-time high-voltage tests are being made more carefully, and greater attention is being given to the results of such tests. A standard method for measuring thermal conductance of cable is being developed at Massachusetts Institute of Technology in connection with extensive research on thermal insulation. Moderate variation in the thermal conductance of the insulation of underground cables is not, in itself, a very

important matter, but it is possible that this quantity can be used as a measure of thoroughness of impregnation. If so, the development of a simple practicable procedure for measuring it in connection with acceptance testing is desirable.

Summaries of a large amount of inspection and test data collected in connection with the inspection of over 9,000,000 ft. of paper-insulated cable are reported in the annual report of the Underground Systems Committee, N. E. L. A., for the year 1929. These data show a continued downward trend in the percentage of deficient cable from over 20 per cent in 1923 to less than 3 per cent in 1929. During that period there has been a steady increase in dielectric strength from less than 300 volts per mil in 1923 to over 500 volts per mil in 1929. There have been corresponding improvements in other characteristics.

Greater effort is being made to secure for use the very valuable information which is available in the service records of the companies operating underground cable systems. More detailed studies are being made particularly, of the probable causes of failures. Many data covering cable failures during 1929 are thoroughly analyzed in the report of the Underground Systems Committee referred to above. Incidentally, it may be noted that these studies confirm the improvement in quality of cable indicated by the inspection and test data. In the calendar year 1929, failures due to causes inherent in the cable were less than 1.5 per 100 mi. of paper-insulated underground cable rated at over 7500 volts; in 1926 this figure was nearly 3.0. The rate, including failures from all causes, has decreased from over 9 to nearly 7 in the same period. The grand total rate of failure in 1929 for underground paper-insulated cable systems, including joints, was a little less than 12 per 100 mi.

The status and developments during the year, in respect to specifications and other standards dealing with wire and cable, are referred to elsewhere in this report.

*Development in Practise.* The records for the year 1929 again bear witness to the fundamentally sound bases for designs of oil-filled 132-kv. cable. The 18 mi. installed in New York and Chicago (referred to in previous reports) have now continued in operation without electrical failure for a period of two and one-half years. Several installations akin to these were made during the past year and are worthy of note at this time.

In New York, a second 132-kv. oil-filled line, 12 mi. in length, was installed paralleling the first one built in 1927. In Chicago, approximately three additional miles of oil-filled cable were placed in service. The outstanding feature of these installations as contrasted with those previously made is that the cable was shipped impregnated and oil-filled so that the only field impregnation necessary was a short treatment of the joints. This, together with the development and use of horizontal stop-joints, effected a considerable reduction in the



time required for installation. In both cases, sections of approximately 1800 ft. were employed between stop-joints. In Chicago, however, about one-half of the new cable was arranged with practically all joints of the positive-stop condenser type. As a result of the use of shorter sections, smaller volumes of oil have to be handled and lower hydrostatic pressures are encountered. This allows of the introduction of a smaller hollow core and a modified sheath construction.

Of the several unique types of cable installations made or operated during the year, the following are worthy of particular note:

In Syracuse, approximately 3000 ft. of three-conductor oil-filled 33-kv. cable were placed in service.

An especially notable installation of high-voltage submarine cable was made between Deep Water, N. J. and Pigeon Point, Delaware, on the Delaware River. Eight lengths, each 4075 ft. without splices, of single-conductor, paper-insulated, leaded and armored cable, rated at 75 kv., were installed for operation at 66 kv. This is understood to be the highest voltage submarine crossing of its kind in the world and uses the longest continuous lengths of paper and leaded cable.

At Birmingham, Alabama, the 10,000 ft. of multiple-conductor buried cable installed have continued to give satisfactory service at 44 kv. during the year. The construction of the cable is unusual in that the insulated conductors are individually leaded before the three are cabled together and protected with jute and flat steel tape over all.

The introduction of new methods of supplying tall buildings in the New York metropolitan district with power led to the design and installation of several types of multiple conductor vertical riser cables for operation at 13.8 kv. Although rubber, varnished cambric, and composite varnished cambric and rubber have found uses in this field, other details are quite uniform. In general, the insulated conductors are shielded with copper tape and cabled without the use of a lead sheath to hold them together. Steel binder tape, jute, and round wire armor serve this purpose, the latter permitting single-point support without undue strain on copper conductors or insulation.

Of late, there has been a marked tendency toward the use of various types of buried cable. These have been of the conventional make-up, as well as with numerous variations in the form of non-metallic sheathed cable. Although the latter have found quite general acceptance for street and airport lighting projects, experiments are now being conducted to determine their advisability for a-c. secondary network mains. There have recently been installed 66,000 ft. of the 0000 non-magnetic buried cable, to serve an area in the metropolitan district which has a moderate load density.

Shielded multiple-conductor cable for transmission continues increasingly in favor throughout this country; the field which it dominates is widening, and there are now many installations for use at voltages as low as 13.8

kv. The extended use of this cable has been accelerated in a measure by the fact that manufacturers have expressed their willingness to guarantee operation of the so-called "H" type of cable at the same maximum temperature as single-conductor cable.

*Papers and Future Projects.* Among the many problems being considered by this and other committees engaged in similar work, are a comparison of the relative merits of aluminum and copper for transmission and distribution cable, and a study of the economics of buried cable installations. The last mentioned had been begun by a subcommittee of the Underground Systems Committee of the N. E. L. A., and is now being carried on with our cooperation.

#### IMPREGNATED-PAPER INSULATED CABLE RESEARCH

In this important field, research work of various types continues unabated. It is being carried on under many different auspices; some of it of a character which justifies formal reports either periodically or at irregular intervals. The progress of other projects, for one reason or another, cannot be formally reported. All of the activities, however, are serving the purpose of research; that is, the increase in knowledge in respect to impregnated-paper insulated cable. A very considerable part of the advancement in the art of underground high-voltage power transmission is undoubtedly the tangible result of the large amount of research work that is being carried on.

The research projects directly under the sponsorship of the impregnated-paper insulated cable research subcommittee have been actively continued during the year. The work at Massachusetts Institute of Technology on the rate of deterioration of impregnated paper was formally completed by the N. E. L. A. in July 1929, with the publication of the results found for wood pulp paper, as given in N. E. L. A. serial report No. 289-87. The findings on manila paper were published in the A. I. E. E. JOURNAL, May 1925, and in the annual report of the N. E. L. A. Underground Systems Committee for 1927. During the past year, the development of a standard test procedure for determining the thermal conductance of high-tension cable has been under way at M. I. T. and it is expected that a final report will be available during 1930.

The work at Johns Hopkins University under Professor Whitehead continues on the original assignment, a study of the effects of residual air and moisture in the insulation of high-voltage cable. Progress reports are made from time to time in the form of papers before the Institute; the last one was presented at the Baltimore Regional Meeting, April 1928 (A. I. E. E. Quarterly TRANS., Vol. 47, July 1928, p. 826). The relation between the amounts of residual air and moisture respectively, and various electrical properties have been pretty well established for the particular materials used. The work for over a year has been devoted to obtaining the relation of these residuals and the life of the insula-

tion under high stress. Much difficulty has been encountered in getting thoroughly satisfactory results, and much time has been expended in developing the technique of preparing test samples which will yield thoroughly reliable results under long-time tests. Furthermore, a large number of test samples must be prepared and tested in order to establish the desired relation beyond question. This work will be reported by suitable publication when the final conclusions are obtained.

At Harvard University Professor Dawes has continued the study of the characteristics of ionization in the insulation in paper-insulated high-voltage cable. A third progress report on this work was presented at the Winter Convention in January 1930.

In the aggregate, a large amount of experimental research work in high-voltage cable is being done by the central station companies, some of it of a fundamental character and of a very high order. These researches are being carried on both by the company staffs and at universities. Conspicuous among the utilities carrying on research work are the Brooklyn Edison Company, the Detroit Edison Company, and the Commonwealth Edison Company. The last also joins with the other Insull companies in supporting the Utilities Research Commission, which sponsors a large number of fundamental researches at universities, and the Bureau of Standards. Several of these are on high-tension cable problems.

Among the many research projects being carried on by the utilities may be mentioned the following:

1. Production of very highly refined and treated oils and study of the electrical characteristics and stability of such oils.
2. Study of high-frequency discharges which accompany ionization in insulation, and their effect.
3. Systematic study of the performance of various types of cable for 132-kv. service.
4. Elimination of sheath losses in single-conductor, high-voltage cable.
5. Study of mechanical properties of cable sheaths with a view to their improvement.
6. Development of method of detecting ionization at any part of a cable.
7. Studies of the fundamental properties of dielectrics used in cable.
8. Studies of the effects of long-time application of electric stress to the cable-insulating materials under various pressure conditions,—rate and kind of gas evolved, change in electrical characteristics, etc.
9. Continuous studies of cable in service, as to rate and kind of gas evolved, changes in electrical properties, etc.

Several of the cable manufacturers are carrying on fundamental researches such as:

1. Chemical effects of internal corona on paper and compounds.
2. Internal hydrostatic pressure versus life of cable.

3. Effect of internal voids at various pressures on life of cable.
4. Study of sheath corrosion.
5. Thermal conductance of insulating materials.
6. Development of a stability test for cable insulation.

A considerable amount of work of a research character is continually carried on by the Electrical Testing Laboratories on behalf of the central station companies in connection with the acceptance, inspection, and testing of cable. Extensive analyses of the summaries of a large amount of inspection and test data are made quarterly. Summaries of these studies are reported annually to the Underground Systems Committee of the N. E. L. A. and the High-Tension Cable Committee of the A. E. I. C. Continual and systematic studies are also made of failures of high-voltage cable in service on the systems of a number of the larger central station companies. The results of these surveys are also reported annually to the above committees. In addition, a certain amount of experimental research work is conducted on problems of particular concern to the operating companies.

The above outline is intended to present a brief picture of the organized research work which is being carried on in this particular field. These activities, together with the fundamental researches on dielectrics under the auspices of the National Research Council and those being carried on by independent workers, justify the conclusion that continued advancement in the high-voltage cable art may be anticipated.

#### STANDARDIZATION ACTIVITIES

The following is a brief summary of the developments during the year of the organized standardization activities in the transmission and distribution field.

*A. S. A. Project C 1, Regulations for Electric Wiring and Apparatus in Relation to Fire Hazard.* The 1930 edition of the National Electrical Code was approved by A. S. A. as American Standard July 19, 1929. It was put into effect by the National Board of Fire Underwriters, January 1, 1930.

Steps are being taken towards another revision in the near future.

*A. S. A. Project C 8, Insulated Wires and Cables.* Standards for so-called "Code" insulation for rubber-insulated wire and cable, for weather-resisting coverings and for fire-resisting coverings have been completed during the year and are now before the sectional committee on Insulated Wires and Cables for consideration.

The remaining standards on the committee's program—namely, those dealing with stranding, varnished-cloth insulation, paper insulation, metallic coverings and fibrous coverings and fillers—are either nearly ready for consideration of the Section Committee on Insulated Wires and Cables, or well under way.

Section No. 30 of the A. I. E. E. Standards, which



deal with wire and cable, was submitted by A. I. E. E. to A. S. A. for approval. The Standards Council of A. S. A. withheld approval and referred it to the sectional committee on Insulated Wires and Cables for recommendation as to changes necessary to make it fit into the program of the sectional committee.

*A. S. A. Project C 17, Specifications for Miscellaneous Pole Line Materials.* This project, originally proposed as a rather comprehensive one, got under way in 1925. However, work being done on separate projects involved in the same general subject made it advisable for the sectional committee to hold up work until progress was well along on these individual projects (tubular poles, trolley construction, line insulators, and wood poles). These are well under way so that a definite start by the sectional committee having Project C 17 in hand is expected soon.

*A. S. A. Projects C 20 and C 29, Specifications for Line Insulators.* Plans are being made to combine these two projects (one for insulators below 750 volts and the other for insulators above 750 volts) and reorganizing the work.

Specifications for insulator tests (a revision of Section No. 41 of A. I. E. E. Standards) have been prepared and approved by the sectional committee having in hand Project C 29. They are now before the sponsors (A. I. E. E. and N. E. M. A.) for approval before submission to the Standards Council of A. S. A.

*A. S. A. Project O 5, Specifications for Wood Poles.* Difficulty has been experienced in securing agreement of the various interests involved in this project, but it is understood that after considerable delay, progress is now being made and that standard specifications will be recommended in the near future.

*A. S. A. Project C 42, Definitions of Electrical Terms.* This project is being planned on a rather comprehensive scale; it will be, in effect, a complete glossary of terms used in the entire electrical field together with their definitions.

The sectional committee having this project in hand has been organized under the chairmanship of Doctor A. E. Kennelly and the work has been started through fourteen subcommittees, each dealing with a branch of the electrical industry. One of these with C. H. Sanderson as Chairman deals with transmission and distribution.

*A. I. E. E. Standards for Transmission and Distribution.* The Transmission and Distribution Committee of the A. I. E. E. recommended to the A. I. E. E. Standards Committee, that complete standards be formulated for transmission and distribution.

*Specifications for Impregnated-Paper Insulated Lead-Covered Cable.* The so-called N. E. L. A. Specifications for this class of cable (Suggested Specifications for Lead-Covered Underground Cable Insulated with Impregnated Paper) have been withdrawn.

The fourth revision of the A. E. I. C. Specifications for Impregnated-Paper Insulated Lead Covered Cable

is under way and it is expected that the revised edition will be issued during 1930.

The progress made by the committee this year is in a very large measure due to the active work of the subcommittees and credit should be passed on to the chairmen and members of these subcommittees who have given so much of their time in the study and analysis of the problems referred to them.

## PROTECTIVE DEVICES\*

*To the Board of Directors:*

Following a custom established a number of years ago, all the work coming under the jurisdiction of the Committee on Protective Devices has been divided among subcommittees, accounts of whose activities are presented as part of this report and as evidence of what has been accomplished during the year. These subcommittees, with their chairmen, are as follows:

1. Circuit Breakers, Switches and Fuses, A. M. Rossman, Sargent & Lundy, Inc., Chicago, Ill.
2. Current Limiting Reactors and Resistors, N. L. Pollard, United Engineers & Constructors, Newark, New Jersey.
3. Lightning Arresters, Herman Halperin, Commonwealth Edison Company, Chicago, Ill.
4. Relays, H. P. Sleeper, Public Service Electric & Gas Co., Newark, New Jersey.

Except for the disbanding of one subcommittee, the organization was the same as that of the preceding year. The subcommittee on Industrial Equipment and Service Protection, which functioned in 1928-1929, reported at the beginning of the year that its work was complete. This subcommittee was therefore discontinued with the understanding that features of protection affecting industrial equipment and service would be followed in a general way by the main committee.

The work of the subcommittees during the past year has followed three established lines:

1. Arranging for and following through the preparation of papers for presentation before the Institute.
2. Revision of existing, and preparation of new, standards.
3. A survey and review of research and development during the year in those things over which the committee has jurisdiction.

### \*COMMITTEE ON PROTECTIVE DEVICES:

E. A. Hester, Chairman,		
Raymond Bailey, Vice-Chairman,		
L. E. Frost, Secretary,		
J. E. Allen,	F. C. Hanker,	A. M. Rossman,
L. N. Blagoveschensky,	L. F. Hickernell,	C. H. Sanderson,
A. C. Cummins,	J. Allen Johnson,	A. H. Schirmer,
H. W. Drake,	M. G. Lloyd,	H. P. Sleeper,
W. S. Edsall,	J. B. MacNeill,	R. M. Spurck,
E. E. George,	J. P. McKearin,	E. R. Stauffacher,
H. Halperin,	R. C. Muir,	H. R. Summerhayes,
	N. L. Pollard,	

*Presented at the Summer Convention of the A. I. E. E., Toronto, Ontario, Canada, June 23-27-, 1930. Complete copy upon request.*

### REVISION AND PREPARATION OF PUBLICATIONS AND STANDARDS

Perhaps the greatest activity has been shown in the matter of preparing a supplement to the Relay Handbook and in revising the proposed Standards on Lightning Arresters.

The Relay Handbook was published in 1926 under the sponsorship of this committee and the Electrical Apparatus Committee of the National Electric Light Association. Developments since then have been of sufficient importance to justify the publication of material necessary to bring the Handbook up to date. The spirit of cooperation between the Subcommittee on Relays and the corresponding subcommittee of The National Electric Light Association has been most gratifying, and at this time, your committee wishes to express its appreciation to that organization for the privilege of joining in this work which promises to produce such good results.

The revision of the lightning arrester standards has been a particularly difficult task, both because of the rapidity of development of this class of equipment and because of new methods of research which result in a continuous uncovering of new facts and the formation of new theories. Excellent progress has been made, however, as is indicated in the report of the subcommittee on lightning arresters, included in this report.

Progress may also be reported in the preparation of standards for fuses. It is expected that the succeeding committee can readily prepare these for presentation to the Standards Committee during the coming year.

A revision of the section of standards covering disconnecting switches is now under way and progress is reported. This revision will include knife switches in its scope.

The question of standards for fault current-limiting devices was given consideration and a recommendation covering this is made in a following subcommittee report.

### INTERCONNECTION AND STABILITY FACTORS

Early in the year your committee was asked to give consideration to the formation of a joint subcommittee to study the problem of interconnection and stability factors. It was proposed that this subcommittee be made up of members selected from the committees on Power Transmission and Distribution, Power Generation, and Protective Devices. This proposal was endorsed by your Committee and it is recommended that the organization be set up early in the coming year.

### MEETINGS

The practise of having all the work covered by subcommittees has resulted in simplifying the work of the main committee, in that it reduces to a minimum the number of main committee meetings.

Two meetings, only, were held this year, the first for purposes of organization, and the second at the end of the year for review of the work of the subcommittees.

It has been found that the smaller groups can work much more efficiently, and that the reduction in the number of main committee meetings is a decided advantage.

It is interesting to observe that another advantage has developed from this method of handling committee work. The chairmen of the subcommittees are usually chosen from the main committee, but its members may be drawn from the general membership of the Institute. This has proved an excellent way to initiate younger members of the Institute into technical committee work, and actually creates an enthusiasm for it. Consequently, there is always available a number of members who are going through a training process, and appointment to a main committee does not find them entirely unprepared.

### REPORTS OF SUBCOMMITTEES

*On Circuit Breakers, Switches, and Fuses.\** During the past year, much time and study have been devoted to research in oil circuit breaker design. A large part of this effort has been aimed at the discovery of the fundamental laws which govern the formation, control, and breaking of an electric arc under oil. These studies led to the development of the deion grid for controlling the arc in a high-voltage oil circuit breaker, probably the outstanding achievement of the year in oil circuit breaker design. The theory of the deion grid, the method of adapting it to oil circuit breakers, and test data from experiments conducted on oil circuit breakers equipped with these grids, were ably presented at the Winter Convention of the A. I. E. E. in two papers; *Extinction of a Long A-c. Arc*, by Dr. Joseph Slepian and *Use of Oil in Arc Rupturing*, by Messrs. B. P. Baker and H. M. Wilcox. The tests presented in these papers show that the addition of deion grids to an oil circuit breaker of moderate operating speed reduces the time of arcing, increases its interrupting capacity, and decreases the energy that must be dissipated during the interrupting process.

The demand for more rapid clearing of short circuits, to increase the stability limits of transmission systems, has stimulated the development of high-speed oil circuit breakers. During the year, two manufacturers of this equipment have announced designs of circuit breakers capable of interrupting circuits of voltages up to 230,000 volts in eight cycles after the trip-coil is energized. Field tests have been made, as high as 230,000 volts demonstrating the claims made by these manufacturers.

Interest in metal-clad switchgear is growing as its advantages are becoming better known. The past year has seen refinements in design and a steady increase in production. The trend is very definitely toward standardized forms which should lead to mass production methods in manufacture and substantial reductions in price. So far, operating experience with

\*A. M. Rossman, Chairman.



metal-clad switchgear has justified the expectations of both designing engineers and operating engineers as is evidenced by the increasing purchases of this type of switchgear by those companies which have had the greatest amount of experience with it.

One of the outstanding installations of this kind of switching equipment was made at the State Line Generating Station in Chicago. A complete description of this installation, together with a recitation of the factors influencing the choice and design, was presented by Mr. A. M. Rossman at the 1930 Winter Convention in a paper entitled *Metal-Clad Switchgear at the State Line Power Station*.

In the matter of standards, it is likely that the revision covering the section on disconnecting switches will be submitted to the Standards Committee before the expiration of the current committee year. In revising this section, a division on knife switches which have not heretofore been covered by the standards is being included.

Work is progressing on a draft of standards for fuses. This probably will not be completed this year and it is recommended that the succeeding subcommittee continue actively in all this standards work.

A number of organizations are engaged in formulating standards and definitions for circuit breakers, switches, and fuses, as well as for accessory equipment. Chief, among these are the N. E. L. A., A. S. A., N. E. M. A. and A. E. I. C. It is recommended that the succeeding subcommittee determine and classify the activities, and coordinate its work with these groups in order to avoid duplication.

*On Current-Limiting Reactors and Resistors.\** The Sub-committee on Current-Limiting Reactors and Resistors has this year sponsored the preparation of papers on reactor and resistor subjects and has studied the question of revising and enlarging the standardization work relating to subjects coming under its jurisdiction. The following papers prepared under its auspices were presented at the North Eastern District Meeting, Springfield, Mass., May 7-10, 1930:

*Shunt Resistors for Reactors*, by L. V. Bewley, F. H. Kierstead, and H. L. Rorden.

*Arcing Grounds and Effect of Neutral Grounding Impedance*, by J. E. Clem.

Carrying out an assignment made at the beginning of the year, the subcommittee secured representative opinion as to the desirability of enlarging the scope of the A. I. E. E. Standards to cover, in one section, all fault current-limiting devices, such as reactors and resistors and possibly grounding transformers. It is possible that the little use made of grounding resistors may not justify the effort necessary to work them into the standards. It is recommended, however, that definite steps be taken to cover in one section the other devices mentioned, and at such time give further consideration to grounding resistors and transformers.

\*N. L. Pollard, Chairman.

Several years ago, the Committee on Protective Devices made an exhaustive study of the general subject of the grounding of neutrals on power systems. This work was done under the direction of a special subcommittee and resulted in a number of excellent papers on the subject being presented before the Institute in 1922 and 1923. The study having been concluded, the subcommittee was disbanded, since which time the subject has been followed in its general aspects by the main committee.

This year, the question was raised as to whether there had been sufficient development during the past six or seven years to warrant another study of the same kind. There was enough uncertainty to cause doubt, so the Subcommittee on Current-Limiting Reactors and Resistors was asked to investigate and recommend as to whether or not the subcommittee should be reorganized.

Obviously this is a matter which will be of vital interest to other A. I. E. E. technical committees, particularly those on Power Transmission and Distribution, and Power Generation. Since it is believed that developments over the past few years have introduced new factors into the problem of grounding, it is recommended that the joint subcommittee referred to elsewhere in this report include this subject in its duties. This recommendation has been endorsed by the main committee and transmitted to the chairmen of the two other committees concerned.

*On Lightning Arresters.\** In the past year, work has been done to determine the effects of lightning on transmission and distribution circuits, and to provide experimental and commercial forms of protection. Field studies of natural and artificial lightning were made by several investigators using high-grade forms of recording devices. The new developments included arresters which were installed experimentally on transmission line towers.

Much of the progress during the last year is well described in several valuable papers which have been presented before the Institute.<sup>1</sup>

Still other instructive papers on the subject can be found in the following publications:

"Lightning Arrester and Factors Affecting Its Performance and Application," by Towne, *G. E. Review*, August 1929.

"The Ideal Lightning Arrester, What is It, Can It Be Produced?" by Atherton, *Electrical Journal*, August 1929.

Several very excellent articles on lightning and protection problems have appeared in European magazines, among them,

"The Present Status of the Problem of Lightning Protection," by Matthias, *Elektrotechnische Zeitschrift*, October 1929.

"Protection of Electrical Systems against Over-Voltages" (Report of Electrical Institute of Technology

\*Herman Halperin, Chairman.

1. A. I. E. E. Quarterly TRANS., April and July, 1930.

College Aachen), by Flegler, *Elektrotechnische Zeitschrift*, January, 1930.

"Over-Voltages in Electrical Systems," by Berger, *Bulletin of Schweizerischer Electrotechnischer Verein*, February-March, 1930.

In all these articles many conclusions are drawn confirming findings by investigators in this country.

In the field studies on overhead transmission lines during the lightning season of 1928, only two oscillograms were obtained of natural lightning. In 1929 over two hundred such oscillograms were obtained, greatly increasing our knowledge of the magnitude and wave shape of lightning surges on transmission lines. Numerous records were obtained of artificial surges applied to overhead lines, the lines being terminated with various apparatus or connections or in series with underground cables. Since the findings of these various tests have been so thoroughly described in the articles listed above as well as summarized in various electrical journals, they need not be repeated here.

For distribution circuits, experiences of several utilities indicate that the proper use of lightning arresters reduces the number of transformer failures by 50 to 90 per cent, depending on the nature of the lightning in the given locality and the nature of the equipment. In general, it has been found that the older transformers, which are usually of the smaller sizes and have smaller clearances between leads and case and over the bushings, are more susceptible to failure due to lightning than the newer transformers. One company found that transformers from 15 to 25 years old had a rate of failure due to lightning several times the rate for transformers made in the last five years. Three years ago this company revised its specifications for 2080- to 230/115-volt distribution transformers, improving the arrangement of the leads and increasing the flashover voltages of the leads to case and over the bushings. Over two thousand of these transformers were in service in 1929 and not one failed due to lightning.

The Commonwealth Edison Company has continued the investigations of lightning damage on its distribution system as described in previous reports. Last year a detailed study was made of transformer locations adjacent to points where transformers failed due to lightning, and the many possible factors of such adjacent points correlated in an attempt to discover the factors causing the failure to occur on the particular transformer. No new factors of importance were discovered. The previous findings were verified; that is, that old transformers and transformers with poor bushings and lead clearances are those most likely to fail. Furthermore, there appears to be a peculiar tendency for failures to occur in greater numbers than is a fair proportion at locations where the ground resistance is less than 20 ohms. Incidentally, 99 per cent of all the ground resistance in the area studied is less than 75 ohms. This tendency is not what would be expected from laboratory tests and is not in agreement with

certain data obtained on some other systems. Studies are being continued.

An extensive klydonograph investigation has been made by the American Telephone and Telegraph Company on communication circuits. Some of the most interesting findings were that the capacity of the protector ground to earth is generally more important than its resistance; that practically all the potential drop in a protector circuit was between the ground rod and the earth; that conductor potentials and sheath potential are nearly equalized a short distance inside a lead-sheathed telephone cable regardless of length of outside conductor exposure; and that large differences, even opposite polarity of induced potentials, can exist in the same overhead wire within short distances.

One of the chief accomplishments of this subcommittee in the past year has been the revision of the proposed Standards for Lightning Arresters. Much time has been spent on this work and it is believed that the proposed preliminary standards are in such good shape that in 1930 they may be adopted with only minor revisions.

Standard laboratory waves have been incorporated in these proposed standards for testing arresters. These waves have been made as severe as possible up to the limit of the laboratory testing equipment, in preference to a simulation of any particular lightning wave.

It is hoped that an active interest will be taken in these proposed standards. Probably after the experience of a few years it will become feasible to revise them and incorporate additional paragraphs, making use of such additional technical information as will no doubt become available. In view of this outlook, it seems advisable to have the advantage of the use of the proposed standards in the meantime.

It is recommended that the succeeding subcommittee actively pursue the adoption of these standards.

It is further recommended that the subcommittee, (1) study a standard test surge and the surge which should be applied in the duty cycle test; (2) investigate the value of merit of low-resistance grounds, (a, on distribution systems, and b, on transmission systems); and (3) investigate the effect of "repeated flash" in lightning stroke on arrester characteristics.

*On Relays.\** The efforts of this subcommittee have been directed into three channels as follows:

1. The completion of the Standards for Relays, begun by the previous subcommittee.
2. The preparation of a supplement to the Relay Handbook.
3. The preparation of a series of papers on the subject of relays for presentation before the Institute.

The previous subcommittee completed the preparation of a set of tentative standards and presented it to the Standards Committee for consideration. Recently,

\*H. P. Sleeper, Chairman.

Working Committee No. 48 was appointed by the Standards Committee, with Mr. George Sutherland as Chairman, and certain members of this subcommittee were appointed on the working committee to assist in the preparation of a final draft of these standards. The part played by this subcommittee consisted largely, therefore, of assistance rendered to Mr. Sutherland's committee. It is expected that a final draft of these standards will be available for distribution this year.

The most important work of the year has been the preparation of a supplement to the Relay Handbook. To carry out this work, a joint subcommittee was appointed whose members are representatives of the relay subcommittee and of the corresponding N. E. L. A. group. The present edition of the Relay Handbook was published in 1926 under the same auspices, and it was felt that the development in design and application of protective relays during the subsequent four year period has been sufficient to warrant the addition of new material to the original publication. The first consideration was to decide upon a method of adding this new material, the two obvious courses being first, to rewrite completely the Handbook and bring all chapters up-to-date, and, second, to review the present book and present the revisions and additions in the form of a supplement. It was finally decided to follow the second course, publishing a supplement to the existing book. Factors affecting this decision were as follows:

1. To rewrite the old book would require at least a year's time, including that necessary for publication, while a supplement could be prepared in a relatively short time.
2. The supplement can be published and sold separately for a small sum and can be added to further editions of the present handbook at no appreciable additional cost.
3. The stock of the existing handbooks is now practically exhausted and it was felt that a reprinting should not be made until such new materials as is available has been added in some form.
4. The immediate preparation of a supplement would enable the stock to be replenished in an up-to-date form, whereas at least a year would elapse before new stock could be obtained containing the new material if rewriting was attempted.

The joint subcommittee therefore proceeded with the preparation of the supplement instead of a revision. The present book was carefully reviewed, necessary corrections made, obsolescent material omitted, and the newest developments added. Fortunately, but few revisions were found to be necessary and the supplement proved to be just what the name implied, added material. Both the manufacturing and operating engineers have cooperated wholeheartedly, and it is felt that all material which will be of value has been included in the new publication. The final report of this joint subcommittee has been submitted to the main

committee for approval and with recommendations for publication.

The subcommittee has been quite active in the preparation of the following papers being presented at the Summer Convention in Toronto:

*Directional Ground Relays*, by E. E. George and R. H. Bennett, Jr.

*High-Speed Relaying*, by L. N. Crichton.

*Modern Requirements for Protective Relays on Important System Interconnections*, by O. C. Traver, and L. F. Kennedy.

*Transmission System Relay Protection, Part III*, by W. W. Edson.

*Problem of Service Security in Large Transmission Systems*, by Paul Ackerman.

The last symposium on the subject of relays was held at the Pittsburgh meeting in 1923. Since then, many papers on relays have been presented in mixed sessions but no concerted effort has been made to bring the Institute records in the art up-to-date. It was felt that the present time was particularly appropriate for this by reason of the revision work being done on the Relay Handbook. An additional reason for holding a symposium at this time is that a new era in protective relay developments seems to be approaching. This is called "High-Speed Relaying" and is the subject of two of the papers scheduled for the Toronto meeting. Furthermore, during the past few years the use of ground or zero-phase sequence relaying has developed rapidly and results and possibilities both deserve more publicity. Indications are that both of these phases of protective relaying have an extensive future ahead.

The paper *Transmission System Relay Protection, Part III*, may be regarded as a sequel to two other papers which have been presented before the Institute. The first of these was written by Messrs. Woodrow, Roper, Traver, and MacGahan in June, 1919. The second, presented at Niagara Falls in June, 1922, was the work of Messrs. Hester, Traver, Conwell and Crichton. Each of these gave a concise summary of current relay practice up to the date indicated, and the paper presented this year is designed to bring the subject up-to-date for Institute records. The scope of this last paper has been broadened to some extent and includes relays and relaying for both apparatus and transmission lines.

It is not necessary in this report to attempt to summarize new developments, since the symposium presented at Toronto completely covers the subject. It would seem fitting, however, to make brief mention of the trend in the art as indicated by the latest developments. The major part of the effort expended in development work during the past year or so seems to be towards the reduction of time element or the development of so-called "high-speed relays." For the past ten years, the so-called "time element relaying" has been accepted rather generally as the solution to protection problems. However, with the advent of high-voltage interconnections, the instantaneous discon-



nection of system faults has assumed vital importance. Where seconds have been acceptable, a few cycles are now often the maximum which can be allowed to maintain system stability. The speed of operation of circuit breakers has been reduced materially and it is obvious that relays must follow suit. Many forms of these high-speed relays are now in commercial use, some of them being entirely new developments and some of them being evolutions of existing time element design.

It cannot be said that the use of time element relays has been, or will be, entirely superseded. They will probably always be of use in some form, and indispensable for certain applications—such as back-up protection. It is certain, however, that the benefits to be derived from the reduction of time in relay and breaker operation are of sufficient value to justify the general use of high-speed relays.

In order that the Institute may have a complete record of the development and use of these high-speed relays, it is recommended that the succeeding subcommittee follow the symposium at Toronto with papers on the application of high-speed relays and their effect on interconnection and system stability.

### ELECTRIC WELDING\*

*To the Board of Directors:*

Your Committee on Electric Welding hereby reports the following activities and developments in its field of activity for the fiscal year May 1, 1929 to May 1, 1930.

#### MEETINGS AND PAPERS

The committee arranged for a symposium on welding which was held on the afternoon of Thursday, January 30, 1930 at the Winter Convention of the Institute held in New York. This symposium comprised a total of five very interesting papers:

1. *Cathode Energy of the Iron Arc*, by Gilbert E. Doan of Lehigh University.
2. *Calorimetric Study of the Arc*, by P. E. Alexander of the Thomson Research Laboratories.
3. *Resistance Welding*, by B. T. Mottinger of Akron, Ohio.
4. *Electrically Welded Structures Under Dynamic Stress*, by Morris Stone and J. G. Ritter of East Pittsburgh, Pa.
5. *Electric Welding by the Carbon Arc*, by J. C. Lincoln of Cleveland, Ohio.

The first two papers brought forth a great deal of discussion, and should undoubtedly stimulate other scientific investigators to carry on the work begun by these authors so that our knowledge of the physics,

chemistry, etc., of the welding arc will eventually be completed, resulting in better welding work being accomplished in the future. The fourth paper likewise brought forth discussion and should serve as a stimulus to others to investigate particularly the behavior of welded joints and structures under dynamic loading, to determine the fatigue resistance of such joints, materials, and structures. The fifth paper brought out some very interesting information and leads one to believe that during recent years, the carbon electrode process of arc welding has not been given the consideration of which it is evidently worthy.

#### AMERICAN WELDING SOCIETY ACTIVITIES

The American Welding Society issued three noteworthy pamphlets during the year covering:

1. *Fusion Welding and Gas Cutting in Building Construction*.
2. *Welding Definitions and Symbols*.
3. *Revised Welding Manual*.

The first publication is so arranged as to permit its being incorporated bodily into existing building codes for the various cities so that the use of welding as a means of shop fabrication and field erection may be applied to structural steel construction on a formal and recognized basis. The second publication sets forth rational definitions and terminology which will be of great help to the welding industry in standardizing and simplifying the production of drawings and designs for welding construction. The use of this work will also assist the industry to understand and adopt the use of welding much more quickly and accurately than would otherwise be the case. The third publication completes a set of four instruction manuals which are available either singly or in complete manual form on the subjects of Resistance, Thermit, Arc Welding and Cutting, and Gas Welding and Cutting. These publications cover their subjects thoroughly and are of great value, especially to industrial plants and to shops which are not thoroughly versed in the various processes.

#### COMMERCIAL ACTIVITIES

*Buildings.* During the year, the Southern California Edison Company has had under way a 12-story, 3600-ton office building which will be approximately 25 per cent arc welded. All of the wind bracing and the seismic bracing for this building is to be of welded design.

The Boston Edison Company is erecting an arc welded 15-story, 1600-ton office building which is rather a unique departure in that the shop fabrication is to be carried on by riveting and the field erection by welding.

One widely known construction company has recently stated in public announcements over its signature that it is ready to bid at competitive prices on welded construction as an alternative to riveted construction on any steel buildings.

Another interesting piece of construction work completed during the year is that of the Forest Lawn Memorial Park Mausoleum at Glendale, California, completed

#### \*COMMITTEE ON ELECTRIC WELDING:

A. M. Candy, Chairman,		
C. A. Adams,	H. M. Hobart,	A. M. MacCutcheon,
P. P. Alexander,	C. J. Holslag,	B. T. Mottinger,
C. W. Bates,	C. L. Ipsen,	J. W. Owens,
Alexander Churchward,	J. C. Lincoln,	William Spraragen,
	Ernest Lunn,	

*Presented at the Summer Convention of the A. I. E. E., Toronto, Ontario, Canada, June 23-27, 1930. Complete copy upon request.*

by the Pacific Iron and Steel Company of Los Angeles. The particular feature of interest in this building is the heaviest all-welded truss that has been produced to date, namely, one weighing 60 ton, with a span of 96 ft. and a height of 18 ft. The weight of the entire welded structure is 123 ton.

A new contribution to the building art was announced by the American Institute of Steel Construction at its Seventh Annual Convention at Biloxi, Mississippi, last November. This was the development of a new type of arc welded steel floor construction known as the "battledack" type which was demonstrated by the erection of a sample structure automatically arc welded. This particular design of floor structure, involving steel-plate material tying beams together, is expected to be revolutionary in its effect on building construction work and to produce a less expensive total structure.

*Pipe Welding.* The use of welding in the construction of pipe and the field construction of pipe lines has been extended rapidly during the past year along the lines that have become pretty thoroughly standardized. No particularly new developments have been made in this field.

*Pressure Vessels.* Probably the most interesting development in this field is the issuance by The A. S. M. E. of Code Revisions for Pressure Vessels. These are proposed for adoption by the A. S. M. E. Code for the Construction of Unfired Pressure Vessels. The proposed changes include the following provisions: for longitudinal seams double V, butt welded, 8000 lb. per sq. in.; for girth or head seams of the single V, butt type, 6500 lb. per sq. in.; for double full fillet lap or girth welds 7000 lb. per sq. in.; and for spot or intermittent girth or head welds, 5600 lb. per sq. in. The above permissible fiber stress values can be used when the welded vessel is welded in accordance with the recommended procedure for fusion welding of pressure vessels given in the Appendix; the strength of the joints may be calculated on a maximum unit working stress ( $s$ ), at right angles to the direction of the joint.

*Machinery Construction.* The large manufacturers of electrical equipment have made a greater proportion of their machinery of welded construction during the past year than ever before. This same practise is being taken up by manufacturers of other lines of equipment. One phase of machinery construction which has been received with particular interest is the construction of jigs, fixtures, and special shop machine tools by the welding process. It has proved to be of great economic advantage not only from a first cost standpoint but also because the manufacturer is able to tool up much more quickly than is possible with the use of cast structures.

*Ship Construction.* The Truss-Weld Barge Corporation launched an 8000-barrel capacity gasoline tanker, 134 ft. long and of all-welded construction.

The Electric Boat Company at Groton, Connecticut, has completed a 100-ton cargo-deck barge 118 ft. long

by 10½ ft. wide of the all-welded Ewertz patented design. In the construction of this barge, 150 ton of steel were used and approximately 18,000 linear ft. of welding was performed requiring about 3500 lb. of welding wire.

The Fore River Yard of the Bethlehem Shipbuilding Corporation delivered two colliers, 350 ft. long each, with the transverse seams of their tank tops welded and with bulk heads wherein two rows of rivets were replaced by one row of rivets and a continuous weld.

The Charleston Dry Dock and Machine Company completed a 120-ft. oil tanker, and at the Standard Steel Shipbuilding Corporation, Los Angeles, a 65-ft. yacht was completed by the arc welding process. Two merchant ships, the *Morro Castle* and the *Oriente*, were constructed at the plant of the Newport News Shipbuilding and Drydock Company, for the Atlantic Gulf and West Indies Navigation Company. The outstanding new applications on these ships are the completely welded inboard shaft alley bulk heads, masts, and bilge keels.

*Resistance Welding.* The use of resistance welding equipment in industry at large and especially in the automotive field has gone forward rapidly within the past year.

Other developments involve the use of this type of welding for the rapid production under commercial conditions of standard steel piping. However, these developments are still in the experimental stage.

#### MISCELLANEOUS

*Non-Destructive Tests of Welds.* Within the past year great advances have been made in methods for the non-destructive testing of welds. In general these come under three heads:

1. X-ray.
2. Stethoscope.
3. Electromagnetic.

1. *X-ray.* The improvement in X-ray apparatus and technique during the past few years has brought this method of examination into the commercial field, and although its application is as yet confined to fairly simple structures, it is bound to prove immensely valuable in many of the applications of autogenous welding.

2. *Stethoscope.* Due to the personal equation of the testing operator, this method is somewhat limited in its applications, and yet in certain cases, it is surprising how sensitive it is to moderately small defects. Not much can be stated regarding its commercial possibilities as it is still in the experimental stage.

3. *Electromagnetic Methods.* (a) Alternating current. This is essentially a differential method, that is, a comparison of the parent metal with the weld. These two portions are subjected to identical alternating current m. m. f., and the two secondary voltages resulting are opposed to each other, the residual being first amplified and then observed by means of an oscillograph. Experience shows that in certain simple cases, such as

tubes or bars of uniform section, the characteristic indications of the oscillograph show changes of metallographic structure, such as grain size, strain, and decarbonization, as well as mechanical defects of porosity inclusions or fissures.

This method is also somewhat limited to fairly simple structures, but in these cases gives an immense amount of valuable information.

(b) Direct current. In this case a very large direct current is passed through the welded joint and a little exploring device moved longitudinally along the joint. The exploring device is so arranged that when it strikes a magnetic field transverse to the joint, an e. m. f. is induced. The only magnetic field transverse to the joint is that due to a longitudinal component of the current which in turn will be produced only when the main or transverse current is deflected by means of some defect in the joint.

In some cases the main current contacts can be moved along the joint at the same time and at the same speed as the detector device; but the principle is the same. As in the other case, this device cannot be readily applied to all types of structures.

Practically all these devices may be applied to some of the simpler and more important types of structures; combined, they constitute a very important advance in the welding art.

During the past year the use of automatic arc welding of several different forms has increased rapidly and industry as a whole is becoming cognizant of the advantages of machine produced welds where the nature of the work is such that the necessary tooling is economically warranted.

Certain improvements in generating equipment have also been made, but these require too much detail to be discussed in this report.

#### SUMMARY

There are numerous other individual welding applications which might be mentioned but we believe that the above summarizes the principal activities in the welding field and will indicate the rapid and increased use that is being made each year of various forms of welding and welded products.

### APPLICATION TO MARINE WORK\*

*To the Board of Directors:*

This Committee's chief activities during the present term have been devoted to an extensive review and revision of Standards No. 45. Having been advised

\*COMMITTEE ON APPLICATIONS TO MARINE WORK:

W. E. Thau, Chairman,

R. A. Beekman, Vice-Chairman,

J. L. Wilson, Secretary,

Edgar C. Alger,

H. C. Coleman,

E. M. Glasgow,

H. F. Harvey, Jr.,

C. J. Henschel,

Wm. Hetherington, Jr.,

H. L. Hibbard,

A. Kennedy, Jr.,

J. B. Lunsford,

E. B. Merriam,

I. H. Osborne,

G. A. Pierce,

W. H. Reed,

Edgar P. Slack,

H. M. Southgate,

A. E. Waller,

Oscar A. Wilde,

R. L. Witham,

W. N. Zippler.

*Presented at the Summer Convention of the A. I. E. E., Toronto, Ont., Canada, June 23-27, 1930. Printed complete herein.*

that the stock on hand was practically exhausted, the committee had its choice of reissuing Standards No. 45 in its present form, or of revising the same to incorporate the latest developments and expansion in the marine practise. In view of the fact that Standards No. 45 is now nationally recognized by naval architects, marine engineers, shipbuilders, and ship owners, as the American Standard governing electrical installations on shipboard, and owing to many desired revisions and additions, the committee decided to review all sections of the rules and bring them up to date.

The task of revision was accomplished completely during the present term and the committee has turned over the revised rules to its Subcommittee on Editing. All sections were carefully reviewed by the working subcommittees and the main committee, and have received the required approval. It is expected that the Subcommittee on Editing will complete its work and submit the revised rules to the A. I. E. E. Standards Committee in the early fall of this year, or before.

New sections have been added on brakes, water-tight doors, electric clutches, and the radio direction finder. The section on gyroscopic stabilizers has been expanded to cover practise which is now considered standard.

Where desirable, the subcommittees consulted outside authorities on their subjects. At the committee's request, the Institute of Radio Engineers appointed representatives to cooperate with the subcommittee handling radio.

Our efforts were continued with the Steamboat Inspection Service to obtain classification and rating for electrical operating engineers on shipboard. A few conferences were held with representatives of that organization and some progress of an educational nature was made.

The chief activities in the marine field to which electricity has contributed its share are:

1. Four additional U. S. Coast-Guard cutters having electric propulsive equipment, are now being constructed.

2. Two 26,500-ship-hp., twin-screw turbine-electric liners for the Dollar Steamship Lines, Inc. are now under construction.

3. One 12,600-ship-hp. twin-screw turbine-electric liner was placed in service for the Grace Line.

4. One 6000-ship-hp. twin-screw turbine-electric yacht was placed in service.

5. One 2600-ship-hp. turbine-electric yacht was placed in service.

6. Two 7200-ship-hp., twin-screw turbine-electric drive lake car-ferries were placed in service.

7. Two 2000-ship-hp. tunnel-screw turbine-electric drive, river tow boats, are under construction.

8. Several small craft now have Diesel-electric drive.

The Jones-White Act is having a decided influence on shipbuilding and several contracts are pending, some of which will use turbine-electric drive. The use of electrical auxiliaries has become standard practise for practically all ships of reasonable size.



## AUTOMATIC STATIONS\*

*To the Board of Directors:*

In accordance with established precedence, your Committee on Automatic Stations submits a review of the past year's development and application of automatic stations.

The committee terminates its third year of activity having kept in step with, and encouraged the rapid advancement in, the development of automatic equipment. Automatic equipment is assuming a most important role in every branch of the electrical industry. Along with these activities the committee has established, so far as possible, coordination of its own functions. This has been made possible by the farsighted organization perfected during the first year of the committee's existence and has accomplished in part the compilation of technical data in the form of subcommittee reports. It has also made possible the first technical session on automatic stations, in the presentation of six technical papers at the Summer Convention of 1930.

The application of various types of automatic equipment has become so extensive that no attempt has been made to cover the multiplicity of uses, it felt that the general phases have been considered in the arrangement of the technical papers for the Summer Convention and the subcommittee reports contained herein.

The committee has suffered a great loss in the untimely death of Walter H. Millan of St. Louis, Missouri, on November 13, 1929. Mr. Millan was Chairman of the Committee on Automatic Stations for the years 1928-1929. His death removes from among us an engineer of distinction, a loyal friend, and a sincere supporter of the ideals of the American Institute of Electrical Engineers.

### DEVELOPMENTS

Numerous developments have been completed during the past year; many of these are concerned principally with telemetering systems while others have been undertaken with a view to simplicity and standardization. The automatic control of power rectifiers has reached a high degree of perfection, particularly in the field of railway electrification.

Some development has taken place in the use of carrier current for operating remotely located switching equipments and in accomplishing telemetering. There seem to be possibilities in this field.

### OPERATING EXPERIENCES

Considerable operating data have been collected in

#### \*COMMITTEE ON AUTOMATIC STATIONS:

F. Zogbaum, Chairman,	H. C. Don Carlos,	Otto Naef,
P. H. Adams,	Joseph Hellenthal,	M. E. Reagan,
Caesar Antoniono,	E. L. Hough,	Garland Stamper,
L. D. Bale,	Chester Lichtenberg,	L. J. Turley,
G. O. Brown,	S. J. Lisberger,	

*Presented at the Summer Convention of the A. I. E. E., Toronto, Ont., Canada, June 23-27, 1930. Complete copy upon request.*

the past years, not only by the Committee on Automatic Stations but by other national organizations. Although operating experience is and always will be an important factor, it now seems that with the increasing stabilization of operating performance, it will be possible to look upon this as a matter of routine.

### STANDARDS

Standards No. 26, Automatic Stations, has again been reviewed by the committee. Recommendations for revisions in the list of device function numbers and in the table of minimum protection for power apparatus have been forwarded to the Standards Committee.

It is recommended that Standards No. 26 be reviewed and revised annually by the Committee on Automatic Stations.

### STANDARDIZATION OF SYMBOLS

A subcommittee, (Messrs. C. Lichtenberg and M. E. Reagan), was appointed to investigate and determine to what extent standard A. I. E. E. symbols were being used on diagrams for automatic stations. This subcommittee reported that these symbols are being used very generally. It was determined, however, that the present symbols are inadequate, and it is recommended that the succeeding Committee on Automatic Stations review this subject and propose additional and revised symbols.

### TECHNICAL PAPERS

The following six papers are being presented under the auspices of the Committee at the Annual Convention, Toronto, Canada, 1930:

1. *An Electron Tube Telemetering System*, by A. S. Fitzgerald.
2. *Development of a Two-Wire Supervisory Control System, with remote Metering*, by R. J. Wensley and W. M. Donovan.
3. *Centralized Control of System Operation*, by J. T. Lawson.
4. *Automatic Power Supply for Steel Mill Electrification*, by Robert J. Harry.
5. *1000-kw. Automatic Mercury Arc Rectifier; of the Union Railway Company, New York*, by W. E. Gutzwiller and O. Naef.
6. *Miniature Switchboards*, by Philip Sporn.

### MEETINGS AND PAPERS

In connection with the presentation of technical committee annual reports, the presentation of technical papers, and the discussion thereof, the Committee recommends that:

1. The reports of technical committees be presented at the special sessions of the committee held during the Annual Convention.
2. Discussion of papers to be presented at technical sessions be scheduled just as papers are now scheduled.

3. Advance copies of papers for technical sessions be in the hands of those selected to discuss them at least seven calendar days before the papers are to be presented.

#### COMMUNICATIONS FROM OTHER COMMITTEES

This committee received from the Committee on Instruments and Measurements, for comment, a set of definitions covering the various phases of telemetering. These definitions were reviewed and comments forwarded.

#### UNFINISHED BUSINESS

The following topics have been under consideration, but no final reports have been rendered:

1. Fire Protection.
2. Economical Construction.
3. Unusual Operations.
4. Load Dispatching.
5. Wire Designations.
6. Suppression of Noise.

#### SUBCOMMITTEE REPORTS

Two comprehensive subcommittee reports were prepared and are contained herein as follows:

##### AUTOMATIC SUBSTATION VENTILATION\*

The purpose of substation ventilation is to maintain within economical and safe limits the temperature rise of electrical apparatus installed therein. This is best accomplished by using outdoor air as a medium on the natural or forced draft principle. During early installations with small capacity electrical machinery and with ample space allowance in buildings, natural ventilation predominated. There were a few exceptions where high temperature rises required more adequate ventilation by the use of blowers or fans. With the gradual growth and development of larger units and the concentration of greater kilowatt capacity within a given area or volume (especially in basements and the crowded metropolitan areas) the problem of effective ventilation became more serious and led to a more scientific application of the various elements.

Practically each installation requires special consideration. The problem of suitably arranged and properly sized inlets and outlets; the location of air ducts for the best directed means of reaching typical suction areas on rotating type machines; the requisite as to quantity and velocity of cool air, together with preventive means of recirculation, are factors involved in the study of realizing the most effective ventilation.

With manually-operated stations, the temperature rise of ambient air caused from recirculation, together with the entire room temperature, must be governed for comfort of operators to meet summer or winter conditions. With partially or totally enclosed rotating units, an effective means has been found in controlling recirculation by conveying the heated air direct to outdoor outlets.

Sound-proofing of buildings and attempts at noise

\*Contributed by L. J. Turley.

prevention with automatically controlled substations have developed the more elaborate system of forced draft. It is a matter of spending energy to handle the necessary volume of air against the resistance of bafflers, sound absorbing material, circuitous routes of air duct lines, and air filters, or washers.

Many valuable articles have been published covering actual installations with complete data on the various methods employed to ventilate effectively both machine and substation building to which reference is hereby directed.

##### GUIDE TO SPECIFICATIONS FOR AUTOMATIC SWITCHING EQUIPMENTS\*

In the application of automatic switching equipments, certain fundamental factors apply equally well to all service classifications; others are necessarily specific. This guide is prepared with the desire to aid in the selection of the type of equipment with proper operating characteristics for a given service. This is given in outline form to call attention to the factors to be considered in this selection.

In general, the various devices comprising the automatic switching equipment should be chosen to meet the interrupting rating, short time rating, continuous and overload rating for the particular service.

#### GENERAL

- I. Selection of equipment for automatic service varies slightly from that chosen for manual control.
  - A. Usually smaller units nearer load centers.
    1. Better voltage regulation.
    2. Saves distribution losses.
    3. Saves feeder copper.
    4. Smaller real estate and buildings.
  - B. Determination of loads and load centers. (In laying out plans of system, several schemes should be considered. Refer to published data. See A. E. R. A. Eng. *Proceedings* as example for railway work).
    1. Survey and analysis of load requirements.
    2. Spot load centers.
    3. Scheme and type of machine. (See "Machines" under F.)
    4. Spare units or portable substation.
  - C. Economic study.
    1. Determination of total investment and annual charges for the several schemes, including transmission, conversion, and distribution.
    2. Calculation and tabulation of losses.
    3. Considerations of factors such as:
      - a. Ratio of unit size to total capacity.
      - b. Desirability of multiple unit stations.
      - c. Standardization on one size of unit.
      - d. Availability of station site.
      - e. Overhead or underground transmission and distribution.
      - f. Electrolysis mitigation.
      - g. Telephone and radio interference.
      - h. Type of building.
    4. Decision based on combined study of economics and practical considerations.
  - D. Characteristics of system.
    1. Effect of a-c. conditions.
      - a. A-c. line regulation should be within recommended limits. (See A. I. E. E. Standards.)

\*Contributed by C. Lichtenberg and M. E. Reagan.

- b. Regulation may determine type of conversion unit employed.
2. Agreement of efficiencies of equipment with service requirements.
  3. Effect of power factor on the power price rate.
  4. Amount and character of maintenance.
- E. Transformers.
1. Considerations in selection of power and auto-transformers.
    - a. Installed cost.
    - b. Weight—foundations.
    - c. Space.
    - d. Efficiency.
    - e. Fire hazard.
    - f. Type.
      - (1) Single-phase.
      - (2) Three-phase.
      - (3) Spare.
    - g. Method of cooling.
      - (1) Air.
      - (2) Oil.
      - (3) Water.
    - h. Windings.
      - (1) High-voltage taps for regulation adjustments.
      - (2) Low-voltage taps for starting equipment.
      - (3) Tertiary windings.
      - (4) Connections ( $\Delta$ - $\Delta$ , Y-Y, etc.).
- F. Machines.
1. Synchronous converter.
    - a. Needs stable a-c. supply.
    - b. Inherently a unity power-factor machine.
    - c. Usually needs no special equipment to parallel with other similar units.
    - d. Inherently a fixed voltage machine except when of the booster type or equipped with other means of varying the a-c. supply voltage.
    - e. May require brush operating mechanism.
  2. Steel tank mercury arc rectifier.
    - a. Inherently a slightly lagging power-factor machine.
    - b. Requires auxiliaries for
      - (1) Vacuum system.
      - (2) Temperature control.
    - c. Needs no special equipment to parallel with other similar units.
    - d. Inherently a fixed voltage machine except when equipped with separate means of varying the a-c. supply voltage.
  3. Synchronous motor generator.
    - a. May operate at leading or lagging power factor.
    - b. Usually needs auxiliary apparatus to parallel with other similar units.
    - c. Inherently a variable d-c. voltage machine.
    - d. Generator may be provided with separate excitation.
  4. Induction motor-generator.
    - a. Inherently a lagging power-factor machine.
    - b. Usually needs auxiliary apparatus to parallel with other similar units.
    - c. Inherently a variable d-c. voltage machine.
    - d. Generator may be provided with separate excitation.
- In choosing the type of unit, consider:
- (1) Installed cost.
  - (2) Weight—foundations.
  - (3) Space.
  - (4) Efficiency.
  - (5) Ventilation and cooling means.
  - (6) Fitting machine characteristics to the service.
  - (7) Noise.
  - (8) Stability of a-c. supply.
  - (9) Service reliability.
    - (a) Heating.
    - (b) Commutation.
    - (c) Sensitivity to short circuits, etc.
  - (10) Safety features.
  - (11) Power-factor correction.
  - (12) Indoor or outdoor.
  - (13) Fly-wheel effect.
  - (14) Amortisseur windings.
  - (15) Amount and character of maintenance.
5. A-c. generator.
  - a. Vertical or horizontal.
  - b. Speed (rev. per min.).
  - c. Synchronous or induction.
  - d. Exciting systems.
    - (1) Individual exciter per unit.
    - (2) Common exciter for all units.
    - (3) Exciter bus.
    - (4) Type of exciter drive.
      - (a) Direct connected.
      - (b) Belted.
      - (c) Geared.
      - (d) Motor.
      - (e) Auxiliary prime mover.
  - e. Voltage regulation.
    - (1) Fixed field.
    - (2) Voltage regulator.
      - (a) Individual regulator for each unit.
      - (b) Common regulator.
  - f. Brakes.
    - (1) Oil operated.
    - (2) Air operated.
    - (3) Water operated.
6. Synchronous condenser.
  - a. Self-cooled.
  - b. Enclosed.
  - c. Water cooled.
  - d. Hydrogen cooled.
7. Rotating machine accessories.
  - a. Bearing thermal relay.
  - b. Synchronous speed device.
  - c. Grounding protective relay.
  - d. Overspeed device.
  - e. Rheostats.
    - (1) Hand operated.
    - (2) Electrically operated.
- G. Switching Equipment.
1. Control power. (In general the source of control power chosen should be a reliable source obtainable at minimum cost.)
    - a. A-c. control: Particularly applicable to less complicated installations. Generally simplest and most inexpensive, making use of control battery and associated charging equipment unnecessary. Special features may be necessary to incorporate in control in order to prevent momentary shut-down on voltage dips.
    - b. A-c. and d-c. operation with tripping battery: Simple and inexpensive arrangement for average installations but requiring a certain amount of battery equipment. Recom-



mended minimum tripping battery voltage is 48.

- c. D-c. operating and tripping battery: Generally ideal arrangement from control standpoint for more complicated stations but results in some additional complication and maintenance due to amount of battery equipment required.
  - d. D-c. with pneumatically operated main circuit devices: Special adaptation used for railway service which has advantage of using standard, pneumatically operated devices used in car equipments, but has the disadvantage of requiring a continuous supply of compressed air and compound equipment.
2. The arrangement and construction of the a-c. bus and mounting of the oil circuit breakers may be of any of the following types:
- a. Indoor.
    - (1) Safety enclosed trucks.
    - (2) Indoor metal clad.
    - (3) Cubicles.
    - (4) Masonry or brick cells.
    - (5) Welded or riveted angle iron framework.
    - (6) Pipe framework.
  - b. Outdoor.
    - (1) Outdoor metal clad.
    - (2) Outdoor oil circuit breakers.
    - (3) Switchhouses.
    - (4) Welded or riveted angle iron framework.
    - (5) Pipe framework.
- The choice of the above is governed by the following considerations:
- a. Installed cost.
  - b. Station construction and arrangement.
    - (1) Floor space.
    - (2) Head room.
    - (3) Time available for initial installation.
    - (4) Self contained unit construction.
    - (5) Future additions.
    - (6) Adaptability to move to new installations.
  - c. Operating features.
    - (1) Phase isolation.
    - (2) Circuit isolation.
    - (3) Interchangeability of units.
    - (4) Readily removable feature.
    - (5) Test position of breaker.
    - (6) Grounding and testing arrangement for breaker.
3. A-c. incoming lines.
- a. Two or more lines for reliability.
    - (1) Parallel lines.
    - (2) Preferred emergency.
      - (a) Synchronous sources.
      - (b) Non-synchronous sources.
      - (c) Non-preferential sources.
  - b. Trip on unbalance, low voltage, reverse power, etc.
  - c. Reclose on reestablished voltage.
4. A-c. feeders.
- a. Stub-end feed.
    - (1) Trip on overcurrent.
    - (2) Reclose periodically a definite number of times with time delay.
  - b. Multiple stub feed.
    - (1) Trip on overcurrent, reverse power, etc.
    - (2) Reclose periodically a definite number of times with time delay.

(3) Automatic synchronism check and automatic synchronizing.

- 5. D-c. feeders.
    - a. Stub feed and stub-multiple feed.
      - (1) Trip on overcurrent, undervoltage or short circuit.
      - (2) Reclose after time delay on reestablished normal conditions.
      - (3) Ratings and reclosing values.
- H. Methods of starting machines.
- 1. Transformer taps.
  - 2. Starting compensator (two- or three-step).
    - a. Short-time rating.
    - b. Oil or air cooled.
  - 3. Star-delta.
    - a. Extended windings.
  - 4. Series reactor.
    - a. Short-time rating.
    - b. Oil or air cooled.
    - c. Per cent normal starting current.
  - 5. Full voltage.
    - a. Per cent normal starting current.
- I. Protection. (For table of minimum protection refer to A. I. E. E. Standards No. 26.)
- J. Metering. (For table of minimum metering refer to table in this report.)
- K. Station construction.
- 1. Site available.
  - 2. Facilities for installing.
  - 3. Temporary or permanent station.
  - 4. Portable station.
  - 5. Type and number of units.
  - 6. Provision for future units or addition.
  - 7. Heating requirements.
  - 8. Noise-proofing.
  - 9. Architectural harmony.
  - 10. Ventilation. (See automatic Subcommittee Report on above subject.)
- L. Inspection and maintenance. (Refer to Automatic Substation Maintenance which forms a part of this report.)
- II. Automatic railway substations
- A. Characteristics.
- 1. Choice of d-c. voltage (600-1500-3000).
  - 2. Rising, flat, or drooping machine characteristic.
  - 3. Ability to withstand frequent short circuits.
- E. Starting and stopping indications.
- 1. Low-voltage starting and undercurrent stopping.
  - 2. Overcurrent starting for additional units.
  - 3. Time switch.
  - 4. Supervisory control.
- III. Automatic Mining Substations.
- A. Characteristics.
- 1. Choice of d-c. voltage (275-550).
  - 2. Rising, flat, or drooping machine characteristics.
  - 3. Ability to withstand frequent short circuits.
- B. Starting and stopping indication.
- 1. Local or remote control.
  - 2. Overcurrent starting for additional units.
  - 3. Time switch.
- IV. Automatic synchronous condensers.
- A. Characteristics.
- 1. Quantity of corrective kv-a. needed (leading and lagging).
  - 2. Excitation systems.
    - a. Direct-connected exciter.
    - b. Voltage regulator.
    - c. High-speed excitation.
  - 3. Means for reducing starting kv-a.

- a. Bearing oil pressure.
  - b. Starting motor.
- B. Starting and stopping indications.
  - 1. Start on high and low voltage and stop on under-current.
  - 2. Power factor starting.
  - 3. Time switch.
  - 4. Supervisory control.
- V. Hydroelectric generating stations.
  - A. Types of prime movers.
    - 1. Reaction turbines.
    - 2. Impulse turbines.
    - 3. Propellor type turbines.
      - a. Hand adjusted.
      - b. Automatically adjusted.
    - 4. Vertical or horizontal.
  - B. Hydraulic control.
    - 1. Servo-motor without speed-head.
      - a. Oil operated.
      - b. Water operated.
      - c. Electrically operated.
    - 2. Governor.
      - a. Speed-head drive.
        - (1). Motor
        - (2). Belt
        - (3). Gear.
      - b. Starting and stopping device. (63s).
      - c. Synchronizing motor.
      - d. Limit stop motor.
      - e. Accelerating device.
      - f. Position switches.
      - g. Latch for closed gate.
      - h. Automatic oil pressure system.
      - i. Miscellaneous valves, by passes and drains.
  - C. Starting and stopping indications.
    - 1. Float switch.
    - 2. Frequency relay start and underload stop.
    - 3. Time switch.
    - 4. Supervisory control.
  - D. Method of synchronizing.
    - 1. Self-synchronizing.
      - a. Ratio of unit to system size.
      - b. Amortisseur windings.
    - 2. Automatic synchronizing.
      - a. Reasonable speed control at no load.
- VI. Automatic lighting substations.
  - A. Characteristics.
    - 1. Two- or three-wire (250-125).
    - 2. Method of voltage regulation.
      - a. Pilot wire from load centers.
      - b. Reenergizing dead system.
    - 3. Balancer sets.
  - B. Starting and stopping indications.
    - 1. Low-voltage starting and undercurrent stopping.
    - 2. Overcurrent starting for additional units.
    - 3. Time switch.
    - 4. Supervisory control.
- VII. Automatic a-c. substations.
  - A. Starting and stopping indications.
    - 1. First unit in service continuously.
    - 2. Overcurrent starting and undercurrent stopping for additional units.
- VIII. Street lighting circuits.
  - A. Types.
    - 1. Series.
    - 2. Multiple.
- B. Types of control.
  - 1. Time clock.
  - 2. Resonant remote audio frequency system (500 cycles).
  - 3. Carrier current system.
- IX. Automatic d-c. industrial substations.
  - A. Characteristics.
    - 1. Two-wire 250-volt.
    - 2. Method of voltage regulation.
      - a. Constant bus voltage.
      - b. Ability to withstand short circuits.
  - B. Starting and stopping indications.
    - 1. Local or remote control.
    - 2. Overcurrent starting of additional units.
    - 3. Time switch.
- X. Automatic battery charging equipments.
  - A. Characteristics.
    - 1. Choice of voltages (to suit battery).
    - 2. Types.
      - a. Motor-generator.
      - b. Static rectifiers.
      - c. Station bus.
  - B. Methods of charging.
    - 1. Trickle charge.
    - 2. Floating charge.
  - C. Starting and stopping.
    - 1. Continuous operation.
    - 2. Start and stop with main unit.
- XI. Supervisory control.
  - A. Characteristics.
    - 1. Supervisory control systems employed to operate and obtain remote supervision of equipment located at a greater distance than it would be economical to carry individual wires for each device.
    - 2. Control wires.
      - a. Construction.
        - (1) Overhead.
        - (2) Underground.
      - b. Type of conductor.
        - (1) Individual conductor.
        - (2) Multi-conductor cable.
      - c. Inductive interference.
      - d. Ground detector.
      - e. Suitable resistance and insulation.
      - f. Duplicate sets of wires.
    - 3. Storage battery.
      - a. Charging equipment.
      - b. Ungrounded usually.
    - 4. Control equipment.
      - a. Control keys arranged in form of system diagram on dispatcher's board.
      - b. Interposing relays.
      - c. Alarm lamps.
    - 5. General.
      - a. Audible or visual indications.
      - b. Alarm to signify any apparatus change.
      - c. Indication showing equipment to which lines wires are connected.
      - d. Remote metering.
      - e. Remote synchronizing.

#### AUTOMATIC SUBSTATION MAINTENANCE

The advent of the automatic substation has brought about a change in maintenance and maintenance methods. The work has become more or less specialized, and a different type of man is required to care for this type of station. The amount of maintenance and inspection necessary to keep the equipment in proper

operating condition varies with the type of equipment and its application, and with the local conditions. It is quite obvious that a hydroelectric station located away from the dirt of the city will not require nearly so much cleaning and blowing out as a railway converter station located on a busy street in the heart of the city. It is also evident that the more complicated stations will require more maintenance work than the simpler type.

This advice is based upon maintenance experience in railway converter stations and all charts and schedules cover this type of equipment. Maintenance of other types of equipment, however, parallel the railway type very closely and the only variation will be in the type of charts used and the amount of maintenance necessary.

tion of any troubles which may arise in the operation and should have complete charge of the testing and calibrating of all protective devices.

The members of the maintenance crew should be trained maintenance men and helpers working in pairs, the maintenance man doing all the inspecting and adjusting and the helper handling the air hose and taking care of the brushes and wiping down the equipment. The frequency with which this maintenance crew visits the stations will depend entirely upon the severity of the service on the station and also upon local conditions regarding dust and dirt. In general, however, it is found that a thorough blowing out and cleaning up accompanied by a general inspection about every two weeks is sufficient. It must be understood, however, that this is only a general average and that

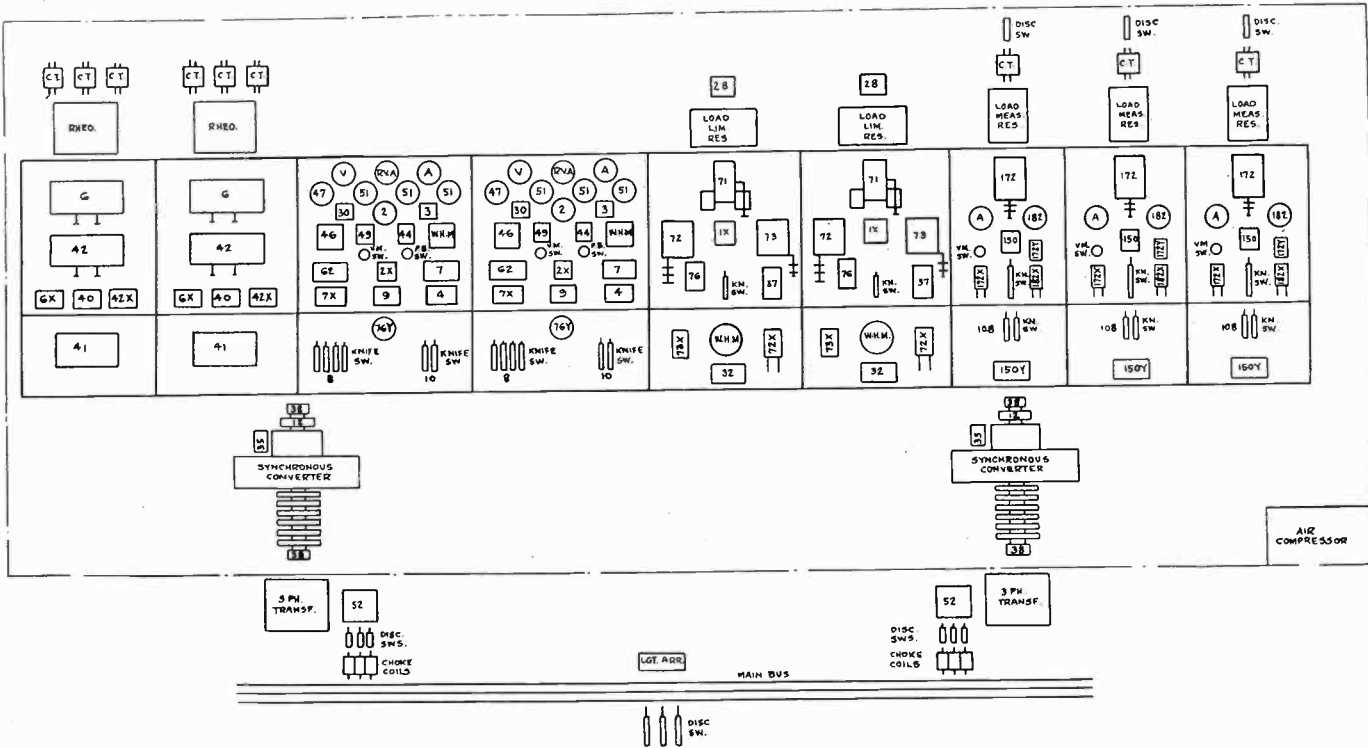

FIG. 1—SUBSTATION INSPECTION CHART

It is assumed that the operating company has a competent crew of maintenance men well versed in general maintenance practises and thoroughly familiar with the sequence of operation of the stations which will be placed in their care. These men may be broken up into two groups—the inspectors and the regular maintenance crew. The inspectors should be men who have proved themselves especially adept in working out the causes of trouble and visualizing the conditions which could produce the troubles which they are to locate and cure. The inspector should visit the stations every two or three days, depending upon the severity of service, and make a casual inspection of the equipment. This casual inspection should consist of reading meters, taking readings on operation indicators, checking oil levels and giving the station a visual check throughout. The inspector should also be charged with the investiga-

this amount of work must be increased or decreased according to the individual needs of the station.

The type of inspection reports and charts varies with the individual operating company, but in general, they all follow the same lines. There are two general forms of inspection charts in common use. One type is merely a numerical list of the devices with suitable blank spaces to be filled in by the workman. This report is very much in detail and calls for answers of the "Yes" and "No" variety and has a slight tendency to destroy the individuality of the maintenance man; in general, it is better to let the maintenance man use his own judgment as to cotter pins, contacts, and general mechanical conditions of the various devices. Another disadvantage in this report is that with the various devices listed in numerical order, it means that to follow the report down from top to bottom, the maintenance



man must keep moving from one piece of equipment to another, numerically and not according to physical location, and unless the report is followed very closely, some pieces of apparatus may be missed.

The type of inspection report or chart shown in Fig. 1 consists of a general plan of substation, with the switchboard placed flat on the floor. All pieces of equipment are shown in their relative positions by small numbered squares and the inspector or maintenance man using this chart may start at one end of the switchboard and check each panel as he goes. A common practise is to have the maintenance man use different colored pencils for checking off the equipment which he has inspected and cleaned. In this manner, if one man checks a certain panel upon which trouble is found later, he can be held accountable for not having discovered and eliminated the trouble on his previous inspection. This type of chart is also useful in that the superintendent of substations, in looking over these reports, can pick out at a glance, the devices that have caused trouble, as this is indicated by a "T" placed in the square representing the device. If the inspector or maintenance man has checked the device and found it o. k., he so indicates by a check mark in the square; but if he finds that there is trouble in this particular piece of apparatus, he places a "T" in the square, turns the inspection report over, indicating the device number, describing the nature of the trouble and what was done to remedy it. This makes a quick and convenient method of locating troubles on the chart and does not necessitate the reading of all of the details.

It is impossible to give any definite instructions regarding the amount of maintenance work necessary to keep a chain of automatic substations in the proper operating condition, as the quantity of the work is entirely dependent upon the severity of the service to which the equipment is subjected and also upon the local conditions regarding dirt, dust, dampness, etc. However, it will be found from six to eight months' experience in caring for a chain of automatic stations, just how much individual maintenance each station will require, and a schedule may be arranged accordingly.

In addition to the regular maintenance work of inspecting, cleaning, and blowing out, there is a certain amount of routine testing and inspection that should be laid out and followed carefully over each year's period of operation. This type of work consists of the testing and calibrating of the various protective devices, the maintenance and inspection of bearings, and the testing of transformer oil. A sample schedule for work of this kind is given below; and while it must be understood that this schedule will not apply to all applications, it can nevertheless be used as a basis for starting an inspection and testing program:

D-c. reverse-current relays, and a-c. reverse power and machine overspeed: Test and calibrate every six months.

D-c. overload, a-c. reverse phase, and low voltage: Test and calibrate every six months.

Bearings of converters and auxiliary rotating equipment: Change oil and flush reservoirs every six months. Take out and inspect converter and motor-generator set bearings once a year, and touch up spots that show signs of slipping or cutting.

Transformer oil: Samples of oil from the oil insulated transformers should be taken every six months and tested for dielectric strength by actual test with an oil testing transformer. If the oil tests low, it should either be changed at once or else run through a dehydrating machine.

Oil in oil breakers: The amount of attention which the oil breakers in a station require is solely dependent upon the number of operations per day and the severity of the loads which they interrupt. For that reason, no

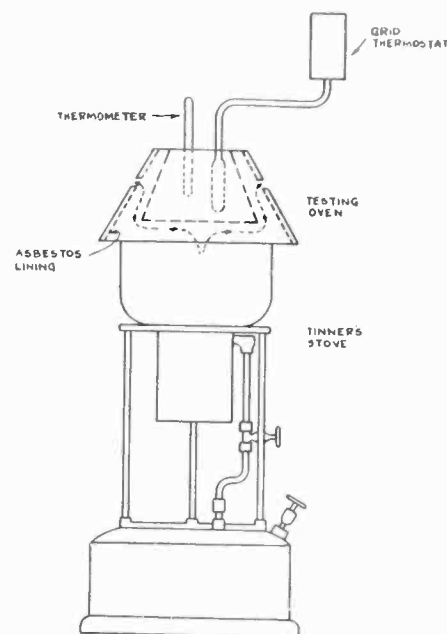

FIG. 2—FURNACE FOR TESTING THERMOSTATS

hard and fast rule can be applied to the number of inspections required. In general, however, it may be said that the oil should be changed and the contacts inspected and adjusted every three to six months. In case the breaker does not perform very many operations it is often possible to extend this period considerably, but this can be proved only by experience.

Thermostats, grid resistance and bearing: Since they operate around 100 deg. cent., bearing thermostats are very easily tested by placing them in a deep pot of oil heated by a Bunsen burner or tinner's furnace. Grid thermostats, however, present a different problem as their operating temperature is usually around 300 deg. cent. This prohibits the use of oil, as it will boil below that temperature. However, a very inexpensive furnace for testing these thermostats may be made similar to that shown in Fig. 2.

This oven is merely a heavy sheet-iron cone, lined with asbestos and designed to fit over the top of an ordinary tinner's stove. Suspended from the closed top of this

cone is another sheet-iron cone of smaller dimensions which forms a chamber for heating up the bulb of the grid thermostat, at the same time keeping it away from the direct flame of the tinner's stove. Small openings are left in the outside cone to carry away the flame and gases. The inner chamber maintains practically an even temperature, so that readings obtained from the thermometer will be equivalent to the temperature to which the grid thermostat bulb is subjected. The grid thermostats and bearing thermostats are probably the most abused of any of the protective devices in an automatic substation because, due to the difficulty of testing them, inspectors and maintenance men often allow them to remain in an improperly calibrated condition for some time without discovering that they are out of calibration. For this reason, they should be tested at least every six months in order to insure the safeguarding of machine bearings and the load-limiting resistors.

Feeder resistance measuring relays: In most applications, it is sufficient to check the calibration of these relays every six months. This work is commonly accomplished by the use of a resistance capable of carrying the measuring current and equal to the resistance of the load upon which it is desired to reclose.

The remaining protective devices can be checked during the general inspection and cleaning-up period; no special time for this work is necessary.

Insulation tests should be made on the station equipment every six months. By insulation test is meant that all control wiring, all high-voltage bus work, and all electrical apparatus should be subjected to an insulation test with a megger. In addition, on all 600-volt installations, the switchboard risers and supports should be tested for grounds and also for potential. The same applies to the cast-iron framework which supports the grid resistors. Occasionally a bank of grid resistors will be found which has broken down its insulation and placed potential on the cast iron end frames. This is a dangerous condition, since workmen may accidentally ground these end frames and cause a bad burn-out. The subjecting of the control wiring to an insulation test often discloses some peculiar condition which would not have been discovered except through the medium of

serious trouble. The use of a megger on the control wiring will often disclose minor grounds caused by collections of copper and carbon along wiring and equipment which at the time of inspection could cause no trouble but might at some future time develop into an arcing ground or short circuit which would cause serious damage. When these faults in control wiring exist an elimination process should be started by taking off connections and progressing slowly down the control wiring until the fault is located. This can be accomplished by following the schematic diagram and checking off the points as they are disconnected and cleared.

If they are to find troubles quickly and properly adjust the various relays, it is essential that the inspectors and maintenance men be supplied with the proper instruments. A set of meters is useful for this purpose. These meters are compact and may be carried in a small leather carrying case. One is a d-c. volt-ammeter with the following ranges: 0-15, 0-150 volts with external resistor for 600 volts, and 0-3, 0-15 amperes. The other is a triple-scale a-c. voltmeter 0-150, 0-300, and 0-600 a-c. volts. Instruments of this kind can easily be carried from station to station and will always be available for testing and inspection work. Furthermore, the fact that the maintenance men have these instruments available will lead them to investigate immediately any condition which may not seem exactly right to them, while if it is necessary to secure the proper instruments from headquarters to investigate the condition, the chances are that it will be postponed and forgotten.

Automatic substations maintenance should be judged not so much by the quantity as by the quality of the work. The maintenance man who understands his station perfectly, as well as the characteristics of the individual relays, will discover while cleaning up the station troubles that the average maintenance man will pass over without notice. With this in mind, all available literature concerning the stations should be turned over to the maintenance men, and frequent classes held, in which maintenance problems and methods may be discussed. By continually bringing up new problems and new phases of the work in these classes, the men will be prevented from falling into

TABLE OF MINIMUM INSTRUMENT AND METERING EQUIPMENT

	Syn. converter			Syn. motor-generator		Gen.	Cond.	Rect.	Trans.	A-C feeders	Balancer sets	Syn. motor
	Rwy. 600-volt	Edison 250-volt	Mining and industrial	Edison 250-volt	Mining and indus.	Syn. hydro.	syn.	Merc.	Static			
A-c. ammeter.....			X §	X	X	X	X		X*	X*		X
A-c. voltmeter.....						X	X					
Reactive volt-ammeter.....	X	X	X §									
Field ammeter.....				X	X	X	X					X
Main d-c. ammeter.....	X	X	X	X	X			X			X †	
Main d-c. voltmeter.....	X	X	X	X	X			X			X †	

\*Single ammeter with three-phase switch or three-phase ammeter.  
 †To read full d-c. voltage and voltage from either side to neutral.  
 ‡With zero center scale in neutral.  
 §Either one.

that rut which transforms maintenance men from a state of creative and constructive thinking into one in which they turn out routine work mechanically. This condition grows out of doing the same work, day in and day out, without learning anything new about the equipment or having any reason to think deeply about its scheme or operation.

So long as the work is instructive and the men are learning through the medium of their experience in the stations, the quality of the maintenance work will be found to be of high degree, but as soon as this drops into a slow, grinding routine, a let-down in the quality of the inspection and the maintenance will be apparent.

#### BIBLIOGRAPHY

In order to provide additional information for those interested, it has been the practise of this Committee to publish each year a bibliography on automatic stations. This has been done again this year and the list has been brought up to the year 1930. This bibliography is attached to this report as Appendix No. 1.

### POWER GENERATION\*

*To the Board of Directors:*

The major work of this committee during the past year devolved upon its subcommittee on interconnection, composed of F. C. Hanker, Chairman, and affiliates, several of whom were selected outside of committee personnel to secure broad contact with current problems in the subject and to serve as liaison members on associated engineering committees handling related subjects. Recognition of the technical import of interconnection was initially made by the Power Generation Committee in a symposium of papers presented at the mid-winter convention in 1928, when the subject was treated chiefly from a regional aspect. Experience throughout 1928 and 1929 focused attention upon several problems of the mechanics of operating interconnections, and the subcommittee appointed in 1929 was enabled to obtain for a symposium at the January, 1930, Convention papers on two operating topics which have been investigated with definite results. The other three papers sponsored for the Winter Convention by the subcommittee were just as pertinent, but covered rather the principles of successful service to separate and contiguous load areas in typical

#### \*COMMITTEE ON POWER GENERATION:

F. A. Allner, Chairman,		
J. R. Baker, Secretary,		
J. W. Andree,	A. H. Hull,	E. L. Moreland,
H. W. Brooks,	G. A. Jessop,	I. E. Moulthrop,
J. B. Crane,	J. H. Lawrence,	F. A. Scheffler,
N. E. Funk,	W. S. Lee,	A. E. Silver,
W. S. Gorsuch,	F. T. Leilich,	W. F. Sims,
F. C. Hanker,	H. W. Leitch,	A. R. Smith,
C. F. Hirshfeld,	E. B. Meyer,	E. C. Stone,
F. H. Hollister,		R. W. Stovel.

*Presented at the Summer Convention of the A. I. E. E., Toronto, Ont., Canada, June 23-27, 1930. Printed complete herein,*

metropolitan districts by relating the fundamental plans upon which the electric systems in Chicago, Detroit, and Philadelphia have been developed. These three papers, together with companion papers describing the method of power supply recently adopted in New York City which had been presented under the auspices of the Power Transmission and Distribution Committee at the 1929 Summer Convention, form an excellent compilation of the status of interconnection of power generation sources in large city electric systems. The papers included in the 1930 Interconnection Symposium were:

*Controlling Power Flow with Phase-Shifting Equipment.* by W. J. Lyman.

*Operating Characteristics of Turbine Governors,* by T. E. Purcell and A. P. Hayward.

*System Connections and Interconnections, Chicago District,* by George M. Armbrust and Titus G. LeClair.

*The Fundamental Plan of Power Supply of The Detroit Edison Company,* by S. M. Dean.

*Fundamental Plan of Power Supply in the Philadelphia Area,* by Raymond Bailey.

To accomplish the most thorough treatment of the subject of Interconnection, a joint interconnection subcommittee has been proposed by H. R. Woodrow, Chairman of the Power Transmission and Distribution Committee, to be composed of representatives of the committees on Power Generation, Power Transmission and Distribution, and Protective Devices. The purpose of this joint committee would be to keep the three major committees advised of all studies and developments pertaining to the subject, and to facilitate the handling of Institute activities with regard to the many interrelated phases of the interconnection problem. Mr. F. C. Hanker has been designated chairman of this joint subcommittee with the expectation of selecting such associates from the three principal committees as may be in position to assist in the prosecution of this work.

The committee has not undertaken for this year's report a resumé of the status of power generation similar to that prepared last year. The committees in the past four years have concluded for several reasons that a continuous and coherent history of power generation development can be written most advantageously at biennial intervals. The present Committee, while cognizant of the wide scope of its subject, believes that the introduction of new ideas in power plant design, construction, and operation, are principally matters of ensuing development over a period of two to three years rather than of immediate and complete innovations. An attempt to portray yearly significant progress would therefore result in duplication if the committee subject were to be covered thoroughly, or else the yearly resúmes would consist of disjointed monographs as might appeal at the time to the individual committee.



It is recommended, in consequence, that unity of outline and continuity of discussion be established between successive résumés and that this can best be accomplished by allowing sufficient perspective between reports of a historical nature on the subject of Power Generation.

Pertaining to the frequently recurring question of the general character of survey reports on the subject of power generation, the Committee is indebted to Mr. J. B. Crane who has made a statistical study of the membership common to both the A. I. E. E. and the A. S. M. E. national societies. It was found that in 1928 only 4.6 per cent of the membership of the A. I. E. E. were members of the A. S. M. E., while likewise only 4.7 per cent of the A. S. M. E. membership were enrolled in the A. I. E. E. In view of these facts the Committee believes there is unquestionable justification in striving for completeness and representative detail in summary reports of the historical development of power generation, irrespective of contemporary surveys which may be prepared by other societies. It is evident that the A. I. E. E. membership would be inadequately served were this Committee to circumscribe its report to avoid likely duplication of progress reports of A. S. M. E. committees treating similar topics.

Subcommittees on the Rehabilitation of Hydro Plants, and on Electric Power Generation Practises in Industrial Plants, were continued from the previous year, as well as Committee effort to keep in contact with the development of European power plant practise. The economic and engineering aspects of the rehabilitation of steam-electric power plants were admirably discussed in a paper by Mr. C. F. Hirshfeld at the 1929 Summer Convention, and it is the sense of the Committee that a companion treatment of the problems incident to the revamping of hydro developments is indicated by the increasing volume of such work that is now technically possible, and in many instances, economically feasible. Data regarding European high-pressure boiler types included in last year's report, and a paper obtained this year on European hydro practise, have seemed both pertinent and valuable, and the Committee therefore believes that this source of information can be profitably investigated by future committees.

The subcommittee on Electric Power Generation Practises in Industrial Plants, consisting of Messrs. F. A. Scheffler, Chairman, H. W. Brooks, and A. R. Smith, and affiliates from the A. S. M. E., Messrs. Fred M. Gibson, and William F. Ryan, endeavored to get in touch with representative industrial plant engineers for the purpose of discovering the problems of electric power generation peculiar to industrial installations and of learning how the activities of the Power Generation Committee could be of greater benefit in the industries. Accordingly notices inviting correspondence with the subcommittee were placed in the A. I. E. E. JOURNAL, A. S. M. E. News, Power, Electrical World, and Power

*Plant Engineering.* In addition, letters were written to various engineers in the coke, steel, paper, automobile, textile, rubber, and soda ash industries for the same purpose. The ensuing correspondence developed suggestions for Institute topics fully appreciated by the subcommittee, but which after review have seemed to the subcommittee to consist almost entirely of topics more related to the work of other technical committees of the A. I. E. E. and of trade and commercial organizations in the various industries, than they are to that of the Power Generation Committee. The subcommittee consequently believes there is no apparent feeling among industrial plant engineers that the services of the Power Generation Committee are not available to them for the presentation of Institute papers on relevant subjects; and in conclusion the subcommittee recommends that it be discontinued after acknowledging the suggestions of its correspondents and offering to facilitate the presentation of such papers as may be prepared, either under its own auspices or through the several Institute technical committees to which the subject matter of the subcommittee's investigation has been transmitted.

The balance of the work of the committee has been undertaken with the idea of securing for Institute presentation papers on the subject of power generation describing recent and salient aspects of power plant design in Europe as well as in this country. The committee is recommending, therefore, as illustrative for this purpose, papers regarding

1. The East River Generating Station of the New York Edison Company.
2. A new system of speed control for a-c. motors.
3. Hydro power practise in Central Europe.
4. Hydraulic and electric possibilities of high-speed adjustable-blade waterwheels for low-head developments.

The first paper named describes a metropolitan power plant in which generators, boilers, and frequency converters of notable size and novel design have recently been installed. The second paper is of interest because the new system of speed control was developed for the regulation of a-c. motor driven auxiliaries in power plants. The paper on European hydro practise is a good exposition of the method of design adopted by European engineers who have had recourse to extensive preliminary model testing of entire hydro developments as well as of component parts. The fourth paper treats of the economic advantages to be derived from the high-speed propeller turbine of the manually and automatically adjustable blade type, through the increased part-gate efficiency, greater reduced-head capacity, and decreased electrical costs, that are possible. The paper foreshadows a wider adoption in this country of the Kaplan turbine that has been successfully applied to low-head installations in Europe.

## GENERAL POWER APPLICATIONS\*

To the Board of Directors:

Your Committee on General Power Applications has continued the method of keeping in touch with developments and suggestions for papers as outlined in the report last year.

Considerable progress has been made along these lines. Sixteen committee members have supplied twelve résumés of developments in fields with which they are intimately connected, and thirteen suggestions for papers have been submitted from which your committee hopes to be able to develop several for presentation at Institute meetings during the coming year.

Your committee believes that a continued development of the existing method and material will produce gratifying results.

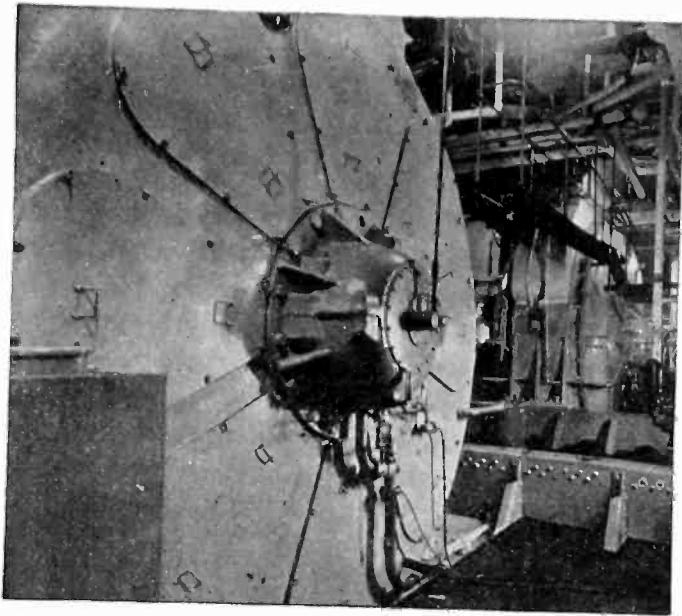

FIG. 1—Two 8500-Hp. A-c. Motors Driving the Twin Screws of *SS. Pennsylvania*

Attention is called to the fact that no attempt has been made in the report to cover the entire industrial field. The efforts of the committee have been confined to certain outstanding industries in which it is believed developments reflect a general picture of the advance during the year.

### MARINE EQUIPMENT

*Steam-Electric.* The year 1929 was marked by exceptional activity in the application of turbine-

#### \*COMMITTEE ON GENERAL POWER APPLICATIONS:

J. F. Gaskill, Chairman,		
D. H. Braymer,	E. W. Henderson,	H. W. Price,
C. W. Drake,	P. C. Jones,	N. R. Stansel,
C. W. Falls,	A. M. McCutcheon,	E. C. Stone,
C. D. Gray,	N. L. Mortensen,	W. H. Timbie,
C. F. Harding,	D. M. Petty,	M. R. Woodward.

Presented at the Summer Convention of the A. I. E. E., Toronto, Ontario, Canada, June 23-27, 1930. Complete copy upon request.

electric drive to large liners of our merchant marine service. There was finished or under construction at the close of the year equipment totaling 114,600-shaft-hp. capacity for six ships, aggregating over 56,000 gross ton. Progress was also made in the application of this type propulsion to smaller vessels such as coast-guard cutters, towboats, and private yachts, making a total for 17 installations for the year of 157,260 shaft-hp. This indicates an increase of 40,660 shaft-hp. or approximately 0.35 per cent over 1928.

The *SS. Pennsylvania*, commissioned during the past year, is the third vessel of this type put into service by the Panama Pacific Line of the International Mercantile Marine, and, together with the *SS. Virginia* and *SS. California*, completes, in tonnage, the largest single fleet of all-electric craft in commercial service. The new ship is very similar to the two preceding vessels, having a power plant consisting of two 6600-kw. 2880-rev.-per-min. a-c. turbine generators and twin screws driven at 120 rev. per min. by 8500-hp. 4000-volt direct-connected motors. (Fig. 1).

Toward the close of the year, the Dollar Steamship

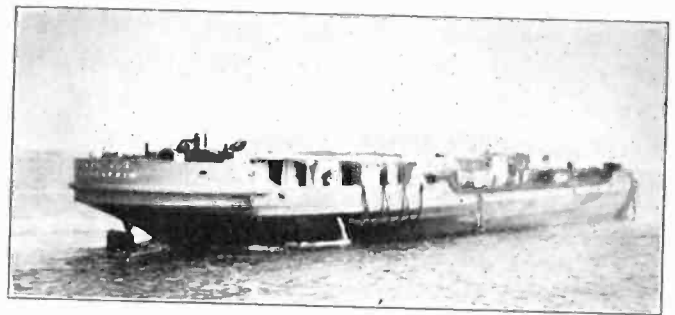

FIG. 2—The *Seneca Sun*, A 320-Hp. Diesel-Electric Tanker Operating in the New York State Barge Canal

Line announced that two ships in round-the-world service will be provided with turbine-electric drive. The driving motors will develop a total of 26,500 shaft-hp., which, from point of size and power, will make them the largest commercial vessels of this type in the United States.

The installation of turbine-electric drive was completed on the private yacht *Viking*, marking the first installation of this kind. The two driving motors are rated at 1300 shaft-hp., each with a speed of 160 rev. per min. Equipment is now under construction for a larger yacht, *The Corsair*, which will have two driving motors of 3000 shaft-hp.

An European adaptation of the turbine-electric drive is interesting to note. The exhaust from the reciprocating engines is sent through the low pressure turbine to a condenser. The alternator driven by this low-pressure turbine motor mounted on the engine shaft, and in some instances, supplies auxiliary power to the ship. This method of utilizing the engine exhaust has

been found to increase the power nearly 25 per cent without increase of fuel.

*Diesel-Electric.* The year saw still wider application of Diesel-electric drive for vessels of all types. Although the total of 8595 shaft hp. is less than the total in 1928, still the number of such ships so equipped was substantially the same. Vessels with this drive include freighters, tankers, ocean tugs, river towboats, ferries and several special boats for government use. The Diesel-

water, has two 100-hp. Diesel engine generator sets and two 80-hp. driving motors. Each set of caterpillar paddles has a motor so that the direction of the tug can be changed by varying the speed of the paddles. When pushing a string of barges as in Fig. 4, the boat acts as the rudder for the tow. This method of propulsion is especially fitted for shallow crooked rivers and possibly may supplant the familiar paddle-wheel native to these rivers for the past century.

#### ELECTRIC RAILWAYS<sup>1</sup>

Although it is understood that electrification of steam railways and traffic problems are more thoroughly covered by other committees of the Institute, several specific applications of new power devices and methods to electric railways may be briefly cited to advantage.

The influence of gasoline motor bus competition and the demand for higher speeds, greater rates of acceleration, lighter weight and less noise in operation have resulted in electric railway cars with light-weight high-speed motors, equipped with largeratio-gear reduction and differentials, the latter being similar to those of the automobile. Aluminum parts, and even whole car trucks and bodies of aluminum alloy, are being tried out.

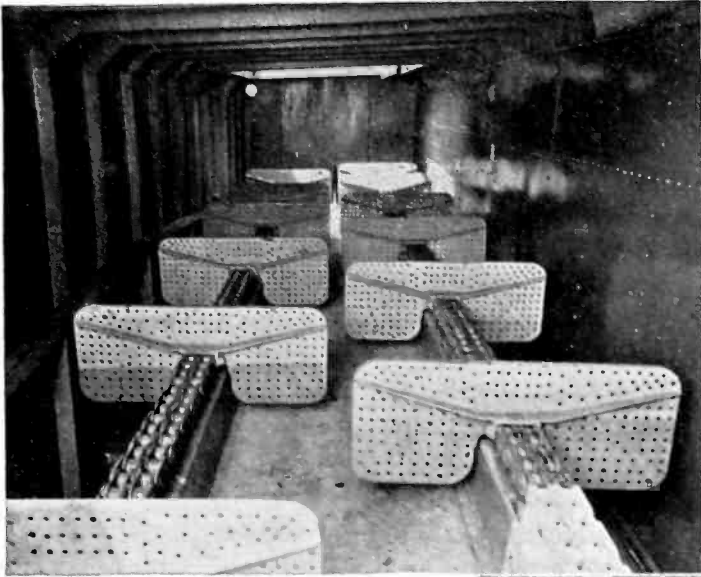

FIG. 3—PADDLE ARRANGEMENT OF CATERPILLAR TRACTOR TUGBOAT

Each set of paddles is driven by a 80-hp. motor

electric drive seems especially favored for vessels operating in sheltered waters as the majority of installations were on boats operating on our rivers or lakes.

The Sun Oil Company commissioned two new tankers for operation on the Great Lakes, New York Barge Canal and the open Atlantic, which are powered by Diesel engines and d-c. generators and motors. Oil engines, free from fire, are especially advantageous for tankers, while electric drive gives the flexibility so desirable in maneuvering in rivers and canals. One of these tankers, the *Seneca Sun*, is shown in Fig. 2.

The government adopted Diesel-electric drive for two survey boats, the *Liston* of the Engineer Corps and the *Hydrographer* of the Coast and Geodetic Survey. The *Liston* will develop a shaft-hp. of 350, while the *Hydrographer* has an installation capable of 650 shaft-hp. The United States Engineer Corps commissioned also two stern-wheel towboats of 150 shaft-hp. Each, for use on the Mississippi and its tributaries.

A unique application of Diesel-electric drive is shown in Fig. 3. This boat, which can operate in two feet of



FIG. 4—CATERPILLAR TRACTOR TUGBOAT ACTS AS THE RUDDER TO THE TOW

The weight of the motor-control resistor has been reduced 75 per cent by the use of non-corrosive resistance strip ribbon, wound on edge, upon insulating tubes mounted on steel bolts in a light structural steel frame. The temperature coefficient is practically constant and local heating is eliminated by means of large radiating areas.

The excessive noise of operation, after careful noise amplified voltages have been determined from test, has been greatly reduced by means of annular iron and lead inserts in car wheels, the use of rubber annular cushions between spider and rims of such wheels and the use of non-resonant type gear construction.

1. Contributed by C. F. Harding.



A new type of control is shown in Fig. 5. During the year, 100 cars with this control were placed in service on the Chicago surface lines. In this car the electro-pneumatic control and air brakes are foot operated, while the magnetic track brakes are operated by hand. This development increases the practicability of the one-man cars.

That the gasoline-electric cars increased in popularity with the large railroad systems for operation on small branch lines is shown by the fact that a total of 63 such units were placed in service by large railroads during

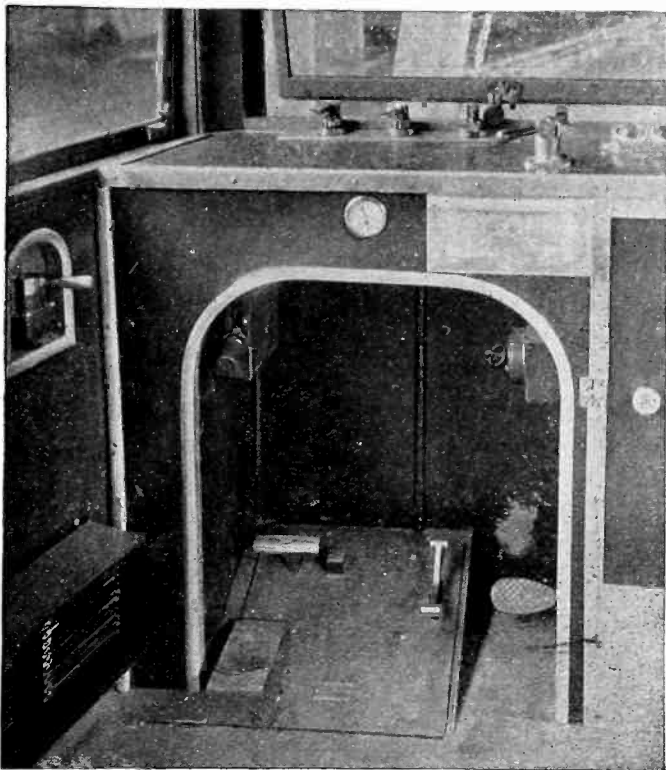

FIG. 5—FOOT CONTROL AND AUXILIARY CONTROL HANDLES IN LIGHT WEIGHT CAR

1929. The general tendency in this equipment is toward an increase in size and total capacity in horsepower installed.

The Diesel-electric cars are newcomers in this field, four being built and put in operation during the year. Tests to date show a surprisingly low cost of fuel per mile with a reliability equal to their predecessor, the gasoline-electric cars.

The "three-power locomotive," arranged to operate from storage batteries, oil engine or third rail, is increasingly popular in the freight yards due to the unusual versatility of its power plant.

Although the substation equipment for the new Philadelphia subway included the largest 60-cycle, compound-wound, inter-pole type synchronous converters ever built, the starting circuits of which included star-delta switching on the high-voltage side of the transformers, the competitor of such converters, the mercury arc rectifier, is apparently increasing in favor and, in many installations, is showing marked economy of operation over the synchronous

converter. Net annual returns as high as 25 per cent have been reported upon new investments in rectifiers, and sustained minimum efficiencies well above 90 per cent have been secured with such apparatus upon 25 per cent load factor applications. Capacity purchased has been doubled during the year and is now well over 125,000 kw. of rating. The use of load shifting and load-limiting resistors located out-of-doors in the feeder circuits has assisted greatly in maintaining continuous service. The extensive introduction of rectifiers upon our electrified steam railroads was attributed to the natural advantage which a unit with no moving parts has over one with rotating parts with wearable and friction surfaces, high efficiency with fluctuating loads, absence of noise and vibration, low maintenance expense and the elimination of extensive ventilation facilities. Fig. 6 illustrates one of these rectifiers in the substation of a western railroad.

Steam railroad electrification has received a forceful impetus during the year. The Pennsylvania Railroad, with its 21,500-kv-a. frequency-changer sets equipped with quick-response excitation, plans for the 3000-volt motor car operation on the Lackawanna Railroad, the extension of the well-proved economies of the Great Northern electrification involving unique motor-generator type locomotives hauling 700-ton trailing load on a 2.2 per cent grade, the Cleveland Union Terminal with a 17-mi. electrified right-of-way now nearing completion, and its 22 new electric locomotives each

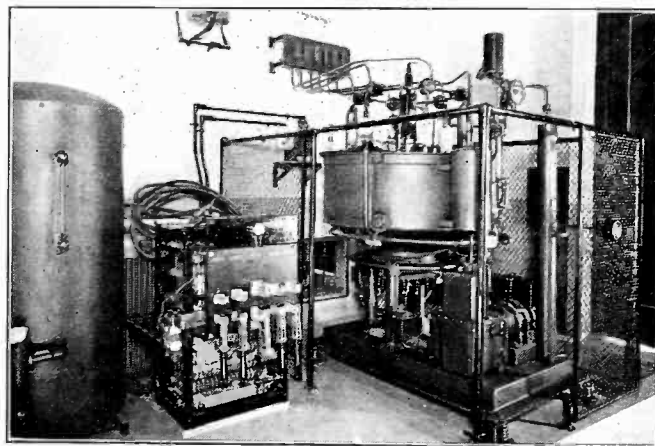

FIG. 6—500-Kw., 1500-VOLT MERCURY ARC RECTIFIER IN RAILROAD SUBSTATION

with six twin-gear, 3000-volt d-c. driving motors, 2900-hp. total capacity,—to say nothing of the extensive Mexican, British, and Austro-Swiss electrification developments—well emphasize the popularity, economy, and variety of electrical applications to heavy railway service.

The acceptance of radio communication between engine cab and caboose of a long freight train was evidenced by the number of installations during the year. In actual operation, advice and direction by radio have proved to be of great value in preventing accidents and saving of time.

## STEEL MILL INDUSTRY

The year 1929 was marked by intense activity in the iron and steel industry. Operating rates were exceptionally high and new records for steel ingot production were established. Electricity contributed a considerable part in maintaining this activity, since it is only through the flexible and easily controlled operation of the mills that such production is possible.

Accompanying this increase in production is the increase in the number of new electrical mill drives that were installed or ordered. During the year, over 325,000 hp. in main-roll drives, each 300-hp. or over, were sold. This makes a total capacity on main-roll drives of over two million and a half horsepower.

As in previous years, d-c. drives exceeded a-c. drives in number and capacity, amounting to approximately 70 per cent of the total horsepower. Especially notable increased number of reversing mill drives contracted for was during the year. Synchronous motors continued extensively applied to constant-speed drives, while to be induction motors were used principally where fly-wheel effect was necessary. All new plants installed 60-cycle equipment while many of the older plants continued with the previously established 25-cycle standard. Several instances were noted where 60-cycle replaced the old 25-cycle machines.

Due to the rapid expansion in this industry during the year many interesting and unique applications of electric drive were made—far too many to be even briefly mentioned in a report of this size. Several specific installations have been selected and will be described, as they indicate the general trend of the progress being made in this industry.

Previous to this year blooming mills have had the upper and lower rolls driven by a single motor through a pinion stand. The new 54-in. blooming mill of the Illinois Steel Company omits the pinion stand, and the upper and lower rolls will be separately driven by two 5000-hp. reversing motors. These motors are capable of a combined emergency torque capacity of 3,940,000 lb-ft., which makes this mill the most powerful of any yet installed.

The 52-in. universal intermediate mill will be driven by a 6000-hp. main and a 2000-hp. auxiliary roll reversing motor. These motors receive power from a synchronous motor-generator set consisting of two 3000-kw. 700-volt d-c. generators, a three-phase 25-cycle 8500-hp. synchronous motor and a direct-connected exciter. This is twice the size of any previous installation using the synchronous motor-generator set instead of the customary fly-wheel and induction motor.

The most sensational installation of synchronous motors for steel mill drive is in a billet mill and sheet bar mill of the Columbia Steel Company, Pittsburg, California. Two motors were installed in this plant, one of them is shown in Fig. 7. They are rated at 5000 hp., 82 rev. per min., 2300 volts and have a diam-

eter of 25 ft., making them the world's largest diameter synchronous motors.

A wide strip mill installation of the Illinois Steel Company is of particular interest as it uses d-c., adjustable-speed motor drives on the roughing stand. This is the first continuous wide strip mill to depart from the previous practise of using alternating current for this drive. The drive uses 12 motors totaling more than 20,000 hp. They are equipped with generator voltage control, thus eliminating the use of starting resistors and contactors.

An unusual application of reversing mill motors is being made in the new plant of the A. M. Byers Company, Ambridge, Pa. A 1200-hp. reversing motor will drive the main 750-ton ram of a large ingot press which will compress wrought iron sponge balls into a rectangular ingot form preparatory to rolling in a blooming mill. An auxiliary 200-ton ram, used for shaping the ends, will be driven by a 325-hp. reversing motor.

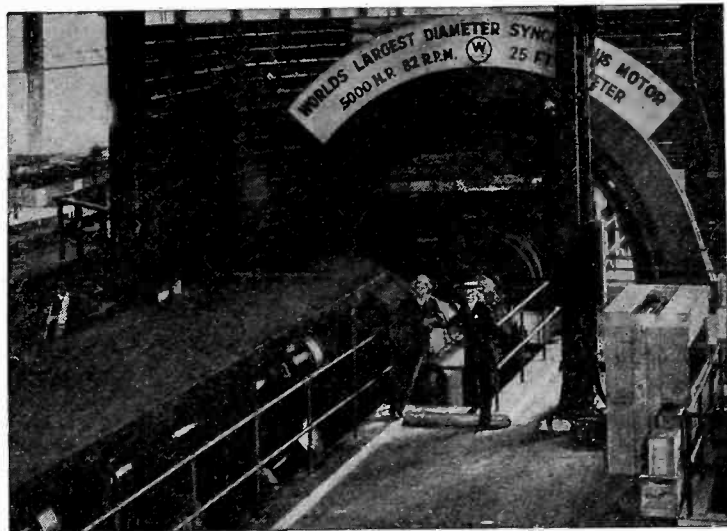

FIG. 7—A 5000-HP. SYNCHRONOUS MOTOR OF 25-FT. DIAMETER

Another example of departure from previous practise is in a new six-stand, 30-in. continuous mill which will be driven by three synchronous motors rated 2500, 3000, and 3500 hp. respectively. Heretofore continuous mills have been driven by a single motor, direct-connected or geared to a lay shaft from which the stands were driven through beveled gears. In this particular case, the three motors tie in through their synchronous speed making it equivalent to the former gearing between stands.

The first universal slabbing mill to utilize separate electric motors on the horizontal and vertical rolls was installed during the year. The horizontal rolls are driven by a 7000-hp., 50/100-rev. per min. motor and the vertical rolls by a 1650-hp., 112.5/270-rev. per min. motor. Control is so arranged that acceleration, retardation, and reversing are simultaneous and in exact speed ratio. Another outstanding characteristic of this installation is that power is supplied to the

motors from three 2400-kw. generators with their armature connected in parallel. This is believed to be the first installation to successfully utilize three generators in parallel to supply power for a reversing drive. Incidentally, the 7000-hp. reversing motor is one of the largest built during the year. Fig. 8 shows a motor of this size installed at the Youngstown Sheet and Tube Company.

Squirrel-cage motors with special stator and rotor design have been substituted satisfactorily for d-c. motors in the operation of pack furnaces. This application is new for squirrel-cage motors as very frequent starting and stopping is involved, sometimes amounting to over 150 starts per hour.

With new design for the control of the conveyer and doors on these pack furnaces it has been possible to eliminate some labor attendance. The operator of the rolling mill receiving the packs from the furnace controls the discharge of the packs by means of a foot switch while conveyer travel is automatically controlled

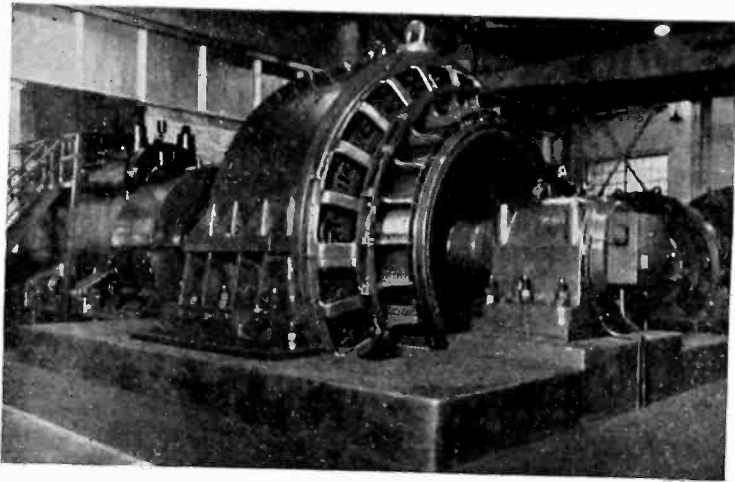

FIG. 8—A 7000-HP. D-C. REVERSING MILL INSTALLED AT THE YOUNGSTOWN SHEET AND TUBE COMPANY

by limit switches. Operation of the doors by means of a-c. motor drive decreases the heat loss and the amount of excessive air admitted to the furnace. The entire layout is very ingenious and tends toward better working conditions as well as better quality in furnace output.

Although it is not classed under the steel industry there is an installation of a new copper mill worthy of mention, since it represents a radical departure from usual practise. The finishing stands of a continuous mill for rolling copper rods are driven by seven adjustable-speed, d-c. motors, totaling 3000 hp. This mill will deliver two strands of copper rod simultaneously, at a maximum speed of 3500 ft. per min.

#### PAPER INDUSTRY<sup>2</sup>

An improvement in the drive of paper super-calenders was obtained by a variable-voltage drive for each calender. Current is supplied to the d-c. motor from a generator driven by an a-c. motor, either synchronous

or induction type. To this motor-generator set is added an exciter where no direct current is available for excitation. The fields of the generator and of the calender motor are separately excited.

Speed control of the calender motor is obtained by varying the field of the generator, thus applying variable voltages to the motor armature. The motor speed

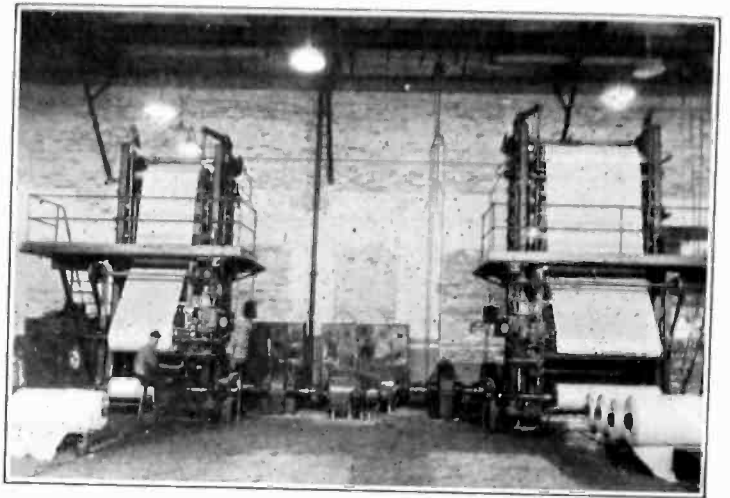

FIG. 9—TWO CALENDERS AT THE RHINELANDER PAPER CO. WITH SEPARATE MOTORS AND VARIABLE-VOLTAGE CONTROL

being proportional to the voltage impressed on the armature, it is possible to obtain a speed range of from 50 ft. per min. to 1000 ft. per min.

In stopping, which is accomplished almost instantly, the fields of the generator are reversed to a value sufficient to give a small reversed voltage. To prevent reversal, a voltage relay causes the generator field to be

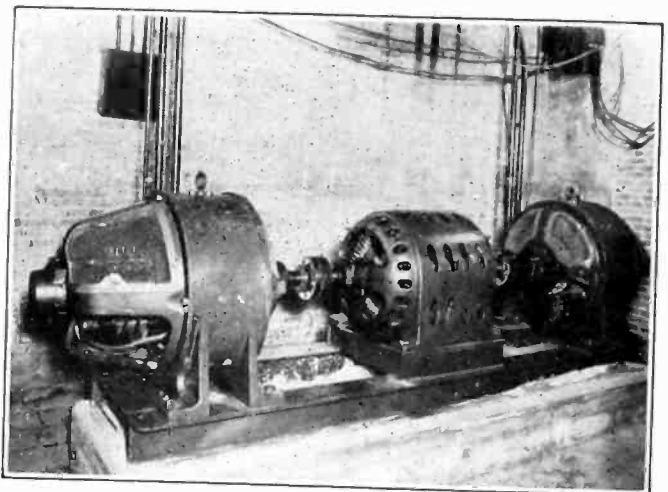

FIG. 10—MOTOR-GENERATOR SET TO SUPPLY DIRECT CURRENT TO CALENDER MOTOR SHOWN IN FIG. 9

opened as the voltage across the motor armature approaches zero. If reversing is desired, this can readily be obtained by reversing the generator field.

Fig. 9 shows two calenders at the plant of the Rhinelander Paper Co., and Fig. 10 indicates the motor-generator set for this application consisting of synchronous motor driving two d-c. generators, one for each of the calender motors.

2. Contributed by E. W. Henderson.



One of the greatest advances in years has been the application of individual motors to the rolls of surface winders. This application not only simplified the mechanical drive but made it possible to wind rolls of paper more evenly so that they were more acceptable to the printer. Waste per roll of paper was very materially reduced by this application. The control of each roll, individually and of the slitter, was obtained electrically. A very definite indication of winding tension was secured by the use of ammeters in each motor circuit.

Fig. 11 shows an application of individual motors to a Moore and White winder.

#### CEMENT INDUSTRY<sup>3</sup>

In a large part of the cement industry the past year has been a period of curtailed production. Although the increase in consumption was about normal, the greater productive capacity due to the construction

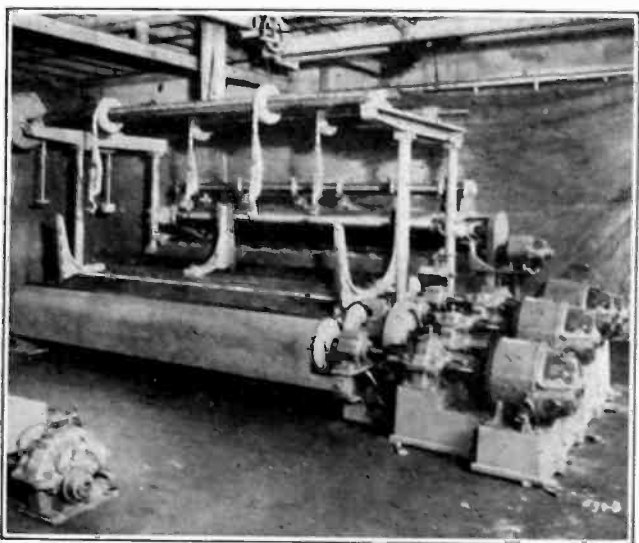

FIG. 11—A MOORE AND WHITE WINDER WITH INDIVIDUAL MOTORS FOR EACH SET OF ROLLS

of new plants and improvements in old plants exceeded that growth.

While this curtailment of production has induced unusual efforts to improve operating methods, other factors influencing this situation were certain changes in the standard specifications for cement, which led many plants to modify their manufacturing procedure to permit a product that would conform to the new standards. Such changes have been accompanied by extended electrification of old mills and refinements in the electrical applications in new mills.

There has developed a marked interest on the part of central stations, in the cement mill loads and the possibility of securing mutual benefit to both the central station and the cement industry by the utilization of off-peak power. New rates have been established and others proposed which make it attractive for cement mills to adjust their operating schedules so as

to increase greatly the power consumption during the off-peak hours, correspondingly curtailing the consumption during the periods of heavy load on the central stations. While the benefits that can be derived from the rates so far promulgated have not usually been sufficient to warrant the installation of additional machinery to permit taking advantage of the low cost of such off-peak power, this factor has been given consideration in designing new plants and some existing plants have been able to benefit by minor modifications in processing methods. This appears to offer a very important field for future reduction in power costs for the cement industry, as suitable adjustment of capacities for grinding equipment and storage bins will permit large blocks of power to be diverted from on-peak to off-peak periods. A collateral benefit of such changes is to be noted in the possible reduction of labor costs where one or more entire shifts can be eliminated from the operating schedule.

The period under consideration has also developed on the part of the central stations a trend to benefit from tie-ins with isolated plants operating on steam produced by waste heat from cement kilns. There is a number of cement mills now connected to central stations under contracts covering interchange of power, which permits these mills to dispose of surplus power during those portions of the day that steam production from waste heat exceeds power demands, and allows the use of central station power when required in emergency. At the rates now usually offered by central stations for such surplus power, the available quantity must be considerable to warrant the installation of a substation which is ordinarily needed. It seems probable that when a more generous return is offered for this surplus power, based not only on the busbar cost to the central station, but also on the improvement in conditions which may be expected from the connection of numerous and widely scattered power sources to a large distribution system, there will undoubtedly be more cement plants which will take advantage of this interchange arrangement. The cement mills may also be justified in charging off a part of the substation and connection costs against the benefits of the emergency service, and to improvements in waste heat plant operation due to steadier load conditions. Such interchange contracts also may be made more attractive by higher allowance for the surplus power furnished during the central station peak-load hours. The mills may then curtail load during such hours, and carry the additional load on the waste heat plant during the night off-peak period when the normal mill load would also be lighter due to the shutdown of quarries and other part time operations.

The confidence of the cement industry in the possibility of profitably disposing of its excess power may be indicated by the installation during the past year of a 10,000-kw., 100 per cent power factor, 3600-rev. per min. turbo generator which will operate from a waste

3. Contributed by M. R. Woodward.



heat power plant. This is, we believe, the largest turbine operating from a cement mill waste heat plant, and the advent of units of this size with their superior economy may be looked upon as significant of probable future developments.

This apparent development of a more sympathetic attitude toward the cement mill problem on the part of those who have power to sell, offers most hopeful prospects for the future, as the load which the mill can offer is normally most attractive to the central station from the standpoint of load factor, power factor and diversity.

In the quarries and mines, the use of electrically operated well drills for primary drilling, and electric shovels for handling quarry product, is fairly well standardized. There are instances where advantage has been taken of improved shovel performance due to the use of Ward Leonard control, and there appears to be a movement towards higher voltage distribution for quarry operations. Portable cables for connecting electrically operated equipment to distribution lines are now quite generally protected with jackets of automobile tire rubber, and more attention is being given to the grounding of such quarry equipment along the lines of recent developments in connection with the grounding of portable apparatus.

In handling material to and from the stone and coal storage, it is worthy to note that there has been completed at least one grab bucket traveling crane installation having motors throughout equipped with anti-friction bearings and complete automatic master switch control and electric braking systems interlocked to permit high operating speeds with minimum danger of over-travel. These refinements have been justified by the very severe duty imposed on such cranes in this industry due to the practically continuous service of twenty-four hours a day, seven days a week.

In the field of fine grinding the large motors used have been generally of the synchronous type with a marked tendency toward units developing sufficient inherent starting torque to eliminate the use of clutches, but the clutch and brake band motor have generally held their own on applications involving the starting of the heavy eccentric loads found in ball type grinding mills. On centrifugal type grinding equipment which present a balanced starting condition, there have been applications of the usual type of salient pole directly connected self-starting synchronous motors with excitation at 125 volts and normal field arrangement. With such motors the starting current is quite high and so in this field there has been some further extension in the use of a special synchronous motor which obtains the desirable high starting torque with low starting current by means of a wound secondary starting winding and external resistance control. This year for the first time, up to 250 volts have been used in the fields by means of a simple centrifugal, automatic field splitting switch built integral with the motor. Both the above

applications have eliminated the use of clutches at a point where with synchronous motors their use had previously been required.

For the above applications the speeds have usually been quite low, ranging from 180 to 450 rev. per min. as the application required, but we have noted one case where eccentric tube mill loads are being started without clutches by high-speed salient-pole synchronous motors connected through gear reduction units.

In connection with kiln drives a marked inclination has developed toward closer speed regulation than is inherent in the slip-ring motors frequently used in the past for this service. This has led to the application of d-c. motors and motor-generator sets in a number of instances, but the requirement has also been very satisfactorily met by the application of the commutator type a-c. motor with speed control through the use of automatic brush shifting and a special speed regulating winding. This type of motor has not only made available practically perfect speed regulation under varying loads but has also permitted almost infinite speed adjustment over a range of about 3 to 1, as well as providing for creeping speeds. With this special motor, the efficiency and power factor also are superior to those of the slip-ring motor, and compare most favorably with the combination of d-c. motors and motor-generator sets previously such motors have been used extensively in the textile and oil industries, but their application to the cement kiln drives is of recent development with results that indicate the possibility of their more extensive use not only for kiln drives but for other applications in cement mills as well.

The effort to improve operating economies has led also to the installation of improved types of coal feeders, and has developed the necessity for much closer speed adjustment on d-c. motors driving these feeders. Closer speed regulation, which also has come to be considered an essential for this application, may lead engineers in the future to turn to the use of commutator brush-shifting a-c. motor for such applications, as such motors seem to have speed regulation characteristics superior to those available in the shunt-wound d-c. motors ordinarily used.

The synchronizing of raw material feeders with kiln speeds continues to claim close consideration and has led to the installation of Selsyn control for this purpose. Last year we reported the use of interconnected but separately excited shunt-wound d-c. motors; and this year has brought the development of mechanical interlocking of the field rheostats to provide the synchronizing of kiln and feeder motors where direct current is used for both drives.

The interlocking of various machines, and the material-conveying equipment is receiving closer attention both with the view of providing greater safety and also preventing delays from flooding elevator pits, conveyers, etc. Where such interlocks are not installed, lamp signals are commonly used, controlled by hatch-

way limit switches to indicate visually by flashing lamps the operation or stopping of elevators and conveyers.

#### RUBBER INDUSTRY<sup>4</sup>

The first three-quarters of 1929, like the entire year before, was a period of expansion rather than one of incorporation of new developments and applications. New plants have been built and existing plants enlarged. Power consumption has increased, and in general, the energies of the engineering staff have been of necessity largely confined to the exigencies of growth.

One of the outstanding trends of new power applications has been the more extensive use of conveyers necessitating a modification of layouts to permit a straight line flow of normal production. The conveyer load, almost negligible a decade ago, is constantly becoming a more considerable part of the total.

For heavy drives, such as mill, refiner, and wash lines, low-speed synchronous motors continue to grow in popularity and usefulness. Although evidences of such use are not yet common, there is little doubt that the synchronous motor will find wider employment in the future for the lighter drives, since its effectiveness in maintaining high power factor on individual feeders cannot be overlooked.

One rubber manufacturer installed the geared drive

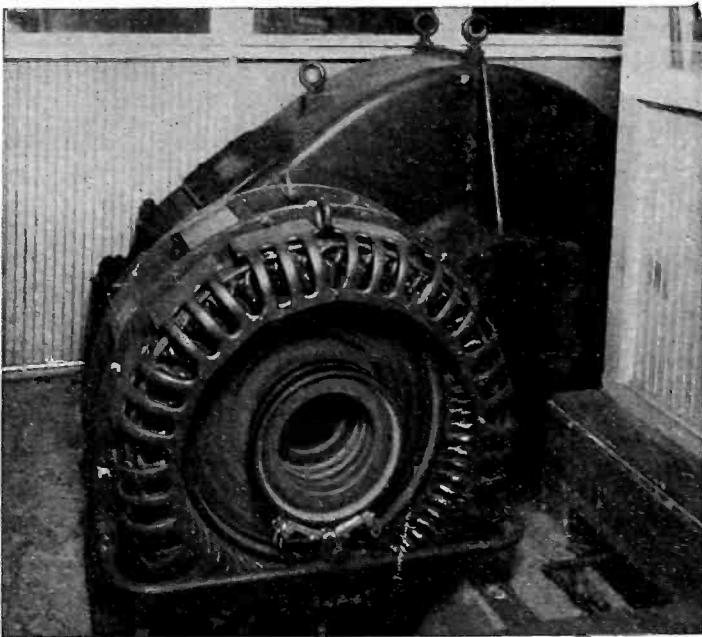

FIG. 12—COMBINATION MOTOR AND GEAR DRIVE ON RUBBER MILL

shown in Fig. 12 instead of the customary low-speed synchronous motor. This drive consists of a high-speed synchronous motor and roller-bearing helical gear built as a unit. It is interesting to note that the efficiency was 3.5 per cent higher than the low-speed motor and 40 per cent more starting torque was developed with the same kv-a. input.

D-c. drives, at least in this industry, show no signs of decreasing. The wider use of conveyers, already

mentioned, and refinements of processes, make speed control constantly more necessary, and in spite of the development of various adjustable speed motors of the a-c. type, direct current still has many attractive features for this purpose.

Automatic control is being more extensively used, and probably has not yet reached its peak. One particularly fertile field is the synchronizing of calender trains. The application of close synchronization to a series of



FIG. 13—THIS ELECTRIC SHOVEL HAS A SCOOP CAPACITY OF 15 TO 20 CU. YD. AND WEIGHS 1800 TON

motors seems, in the rubber industry, to have lagged behind the progress made in comparable drives in the paper industry. This is undoubtedly due to the less stringent requirements; however, a need for better methods undoubtedly exists.

The financial crisis in the last quarter of the year has not seriously disturbed the rubber industry which is looking ahead to a year of perhaps not quite such intensive production in the early part, but a none the less prosperous twelvemonth.

#### MINING

Several power applications in the mining industry during the past year indicated that the progressive trend of this industry noted during 1928 is still continuing. Although two of the following applications are not new developments, they are representative of the trend because of their size either large or small.

In 1928 we reported on the use of electric shovels of 12 cu. yd. capacity in strip mines. The past year saw still further increases in the size of these shovels, so that there are now in service shovels of 15 to 20 cu. yd. capacity and weighing 1800 ton. The mammoth size of one electric shovel is clearly shown in Fig. 13.

Direct current is supplied to the various motors by an installation of one 1700-kv-a. synchronous motor driving three generators with a total output of 1660 kw. The total installed electrical hp. including all the auxiliary apparatus and transformers is nearly 4500. Despite the size of this shovel, it will make a complete digging cycle in 47 sec.

In contrast to the size of the foregoing equipment is

4. Contributed by P. C. Jones.

the new mine locomotive, Fig. 14, for operation in extremely thin coal seams which is the lowest in height of any mining engine of this weight ever built. This 6-ton locomotive is  $24\frac{7}{8}$  in. in height, which includes the trolley, and is rated at 56 hp. It runs at a speed of four miles per hour and is equipped, as a modern street car is, with series-parallel control and dynamic braking. There are two of these now operating in a mine near Huntington, W. Va.

Another development in connection with mine locomotives is the manufacture of the first practical gearless

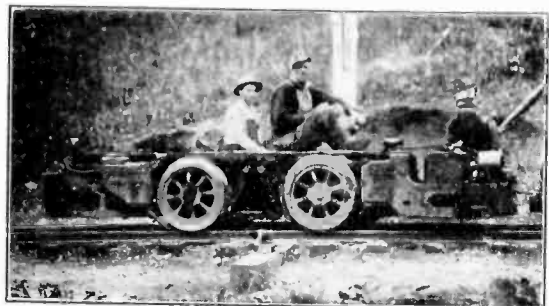

FIG. 14—GATHERING LOCOMOTIVE IN SERVICE AT UTILITIES ELKHORN CORP. MINE.

Over-all height, less than 26 in.

cable reel equipment. This reel is driven direct by the armature shaft and thus revolves at the same speed as as the motor armature. Roller bearings are used at both ends of the shafts, the top one being tapered.

The Consolidated Copper Mines, Kimberly, Nevada, installed a mine hoist so equipped that control can be effected from either of two mine levels or from the surface. The hoist is operated by a 900-hp., d-c. motor, with a modification of the variable-voltage system. From the time a button is pressed starting the hoist, no human governance is required as the stops and dumping are all under automatic control. (Fig. 15).

One of the largest hoist motors in the world was installed during the year. Its motor is rated at 3200 hp. 600 volts, and it will raise a skip 3000 ft. per min., from a shaft 3000 ft. deep.

A hoist application worthy of note is in the new water supply system of the City of New York. The equipment includes 16 hoists, each driven by a 250-hp. 500-rev. per min. d-c. motor, and each motor having a 350-hp. synchronous motor-generator set for its supply of energy. Control is of the semi-automatic type.

#### OIL INDUSTRY<sup>5</sup>

*Pipe Line Pumping.* Electric power is being used more extensively for main line pumping, especially where Public Utility Companies can supply the power without great additional expense for transmission lines, substations, etc., and consequently are able to offer a low rate for electric power.

A paper on *Electrification of Oil Pipe Lines in the Southwest*, by D. H. Levy, was read at the Dallas Regional Meeting May 1929, and printed on page 995 in

5. Contributed by C. D. Gray.

the A. I. E. E. Quarterly TRANS. July 1929. This paper contains comparative cost data on electric pipe line pumping by centrifugal and reciprocating pumps.

*Well Drilling.* There seems to be an increasing demand for electric rotary drilling rigs. Magnetic control is now being used quite extensively on the larger motor equipment, but manual control is standard on the smaller and more common sizes. As the control equipment is mounted or assembled as a unit, it can be easily moved from one well to the next. The control equipment for the mud pumps is also assembled in the same manner.

The size of drilling motors has gradually increased from the 75-hp. motor of a few years ago so that now the use of 125- and 150-hp. motors is common, and several 200-hp. equipments have been operated this year. One manufacturer has a 300-hp. motor in operation. These larger motors are required on account of the increased depth of wells; several have been drilled to over 7000 ft., and a few have reached 8000 ft. in depth. The oil well equipment companies are making designs for much greater depths which may call in the near future for motors as large as 400 or 500 hp. The motors driving the mud pumps have naturally followed the increase in size of the drilling motors.

A new development this year that is interesting is the use of electricity to heat up the heavy lubricant known as "crater compound" so that it will flow in cold weather for applying to the rotary drill bits.

A successful demonstration has been made this year of an automatic electric power feed for a rotary drill rig

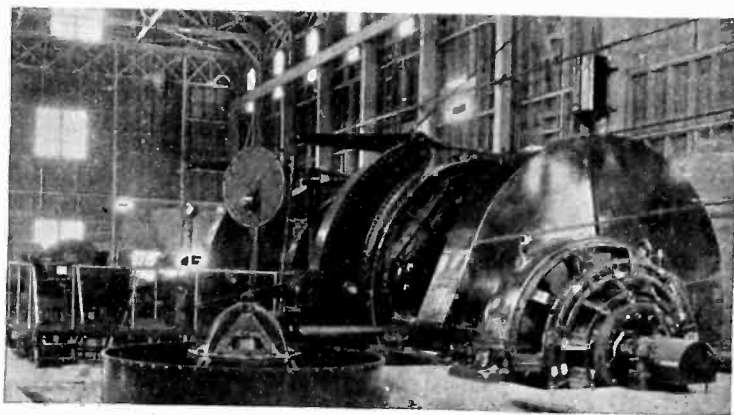

FIG. 15—THIS AUTOMATIC MINE HOIST CAN BE CONTROLLED FROM EITHER OF TWO LEVELS OR FROM THE SURFACE

*Pumping and Pulling.* To meet the demands of heavier pumping service, a larger two-speed motor has been developed. The size of two-speed motors has been increased so that now a  $35\frac{7}{5}$ -hp. motor at 600/1200 rev. per min. has been developed in both open and protected types. Control equipment for these motors, as for other sizes, is mounted on a single frame work so it can be easily transported to the well and installed with minimum field service.

*Open and Protected Control Equipment.* The electrical manufacturers are now able to supply gas pro-

tected control equipments for use in all departments of the oil industry. Open equipments are extensively used where the risk of explosion is small and where the expense of protected equipment would be prohibitive, but there seems to be a growing tendency toward gas protected apparatus in which partial protection is given.

There is an increasing demand for explosion-proof housings on the collector rings of slip-ring variable-speed motors which are made strong enough to resist an internal explosion and are designed to prevent the exit of hot gas that might ignite the exterior gas.

A recent development in gas protected apparatus is the housing of the drum controllers used with variable speed motor equipment. In these controllers the drum axis is mounted vertically and the contacts are made

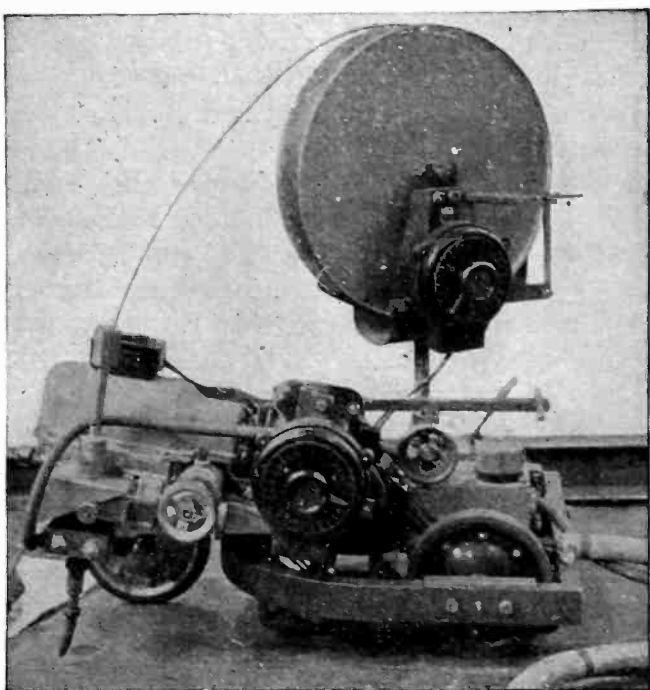

FIG. 16—SELF-PROPELLED AUTOMATIC ARC WELDER FOR WELDING FLOORS, TANKS, SHIP DECKS, ETC.

very sturdy and enclosed in a heavy steel case which is strong enough to resist internal explosion, and so designed that the temperature of any gases forced out from such explosion is reduced so much that an external explosion is prevented.

#### ELECTRIC WELDING<sup>6</sup>

The superior and more economic designs brought about by the recognition of welding as a basic manufacturing process rather than as a substitute for riveting indicate an increasingly effective utilization of the essential advantages of this art. Another outstanding sign of progress is the legal recognition of welding in building construction, as exemplified by the new law in Pennsylvania allowing welding in the construction of buildings in first class cities, and the adoption by 71

cities throughout the country of building codes authorizing this type of building construction.

An interesting example of the use of electric arc welding is the recent extension to the powerhouse of the Haddon Hall and Chalfonte Hotels of Atlantic City, where it was imperative that the work should be done quickly and quietly, without disturbing the guests in the hotels or the residents in their vicinity. This power house has a height of 134 ft. and is one of the tallest welded steel building frames in the world. The Hotel Homstead, Hot Springs, Va., is probably the highest welded steel building so far completed, having eleven stories with an overall height of 150 ft. Another example of welded steel structure is a footbridge 846 ft. long and containing 105 tons of steel, over the Delaware and Hudson Railroad tracks in Schenectady, N. Y.

The announcement by the American Institute of Steel Construction in November, of a new type of arc welded steel floor promises to reduce the weight of buildings to such an extent that an increase of 25 per cent or more in height may be realized without increasing the weight on foundations. The new flooring utilizes steel plates and structural steel beams. The total cost of a floor constructed of 3-in. I beams and 3/16-in. plates, covered on the top with cork tile and fireproofed on the under side, is estimated by the Institute at a little over \$1.00 per square foot, which is less than the cost of a good carpet. This "battle deck" floor is applicable to residences, multiple-story buildings and bridges, and will save from 20 to 60 lb. per sq. ft. of floor in dead weight. Fig. 16 illustrates the type of equipment used in this work.

Several thousand miles of long pipe lines have been constructed during the year 1929 by the arc welding method. Notable examples are as follows: A 714-mi. line from Port Arthur to El Paso, Texas, which carries oil at a pressure of 800 lb. per sq. in.; 425 mi. of 12-in. pipe from Cushing, Okla., to Chicago, Ill.; and a 205-mi. pipe line running from Jal, New Mexico, to El Paso, Texas, 16 in. in diameter, to carry gas for the El Paso Utilities Company.

The new vehicular tunnel under the Detroit River between Detroit and Windsor, Canada, was built on dry land in sections which were placed in position on the bottom of the river and caulked around the full circumference of the shell by the arc welding process.

The manufacturers of electric apparatus are increasingly using arc welded machine structures to replace castings. The stator for a 160,000-kw., turbo generator has recently been constructed of arc welded steel. On another page is illustrated, (Fig. 8) a 7000-hp. d-c. motor of welded construction.

It is interesting to note that 90 per cent of American made airplanes are now of welded steel construction.

The resistance welding process has been advanced and is being used for welding boilers of both the water-tube and fire-tube types. Great savings are realized when arc welding is used for repairing such machine

6. Contributed by W. H. Timbie and E. C. Stone.



parts as locomotive draw bars, broken housings, gear teeth and railroad tracks.

An outstanding example of welding making seemingly impossible repairs possible was noted in St. Joseph, Mo. A 285-ft. stack fractured 190 ft. from the base. Arc welding repaired the break which otherwise would have necessitated rebuilding the entire stack. The first complete arc welded ship, a 2500-barrel oil tanker, was recently launched at Charleston, S. C. This boat, which is 120 ft. long with a 10-ft. draft, required but nine workmen for its construction.

#### INDUSTRIAL HEATING<sup>7</sup>

*Three-Phase Arc Furnaces.* The trend this year, continued from 1928, in the use of the three-phase arc furnace for melting steel was toward larger transformers for a given physical size of furnace. However, there is no common method of rating arc furnaces so there is no way of expressing this trend, such, for example, as kv-a. per ton holding capacity of the furnace. The largest arc furnace in the steel industry has a nominal holding capacity of 80 ton and is equipped with two sets of electrodes, each set being supplied by a 10,000-kv-a. transformer. This is 250 kv-a. per ton. This furnace, installed during the latter part of 1928, has shown during this year a distinct gain in the economy of steel melting by the use of large units. A furnace now being installed for melting steel has a nominal holding capacity of 25 ton. A transformer rated 10,000 kv-a. was supplied for this furnace. This is 400 kv-a. per ton.

There is a tendency to increase the furnace voltage for steel melting furnaces. The upper limit at present is around 250 volts.

The use of multiple voltages for steel melting furnaces has increased. The general trend is towards three operating voltages for furnaces 1000 kv-a. and above.

There was a marked increase in the recognition of the importance of alloy steels during the year. This led to a revival of interest in the induction furnace for the production of this class of steel. A six-ton core type induction furnace was placed in service for remelting alloy steel scrap. This furnace is rated 800 kw., 0.40 power factor, 8.5 cycles, 220 volts, is single-phase and is supplied by a 2000-kv-a. frequency-changer set. The pouring capacity is approximately 30 ton per day of 24 hr. This is the third furnace of this type and size installed in the United States.

The coreless induction furnace made marked progress in the alloy steel industry. The standard frequency for that service is 960 cycles. The largest installation of the year consists of four furnaces which are supplied by two 300-kw. single-phase 800-volt generators, one driven by an induction motor and one by a steam turbine.

Widely different and many new applications of elec-

tric heat for heat-treatment processes were made. Some of particular interest are as follows:

Two new sizes of wire enameling ovens have been brought out that enable a wire speed considerably higher than that previously received. These ovens handle wire sizes from 18 mil to 3 mil. Each oven bakes five separately enameled coats to 16 wires. The resulting product conforms with the most rigid electrical specifications.

In the annealing of fine copper wire the discoloration due to moisture has been overcome by the use of a mixed gas atmosphere in closed steel retorts. The furnace is of the lift type and will handle 6000 lb. of work per 24 hr. day in retorts 2½ ft. in diameter by 3 ft. deep with an economy of 15 to 25 lb. per kw-hr.

One large plant is installing four large furnaces with equipment for controlling the cooling rate. Two of these are rectangular pit furnaces with a connected load of 1100 kw. capable of annealing (temperature 1500 deg. fahr.) in one charge, 50 ton of alloy steel bar stock in 25 ft. lengths. The heating and cooling cycle is completed in 24 hr.

A double-chamber car bottom furnace, each chamber rated 675 kw., is used for annealing bar stock. These furnaces are equipped for accelerated cooling, employing the same method as the pit furnaces, above which is a closed forced air circulation system that prevents the air from coming in contact with the work.

Adjustable timing devices are used to regulate an entirely automatic continuous furnace for normalizing or quenching (1500 to 1650 deg. fahr.) 6000 lb. per hr. of bar stock 23 ft. long. This furnace has a connected load of 1000 kw.

A differential drive is to be used for a flat top continuous conveyor furnace now nearing completion. A production of 600 lb. per hr. is automatically discharged through a chute in the rear. This is similar to the new standard mesh belt conveyor furnace as shown in Fig. 17, which handles 300 lb. per hr. of small steel parts to 1600 deg. fahr.

For annealing the new short-cycle malleable iron, three-elevator type furnaces are used, producing 100 ton per week. The cycle has been shortened to 24 to 30 hours. This new process reduces the inventory, eliminates boxes and packing.

A new type of continuous recuperative furnace has been introduced to the vitreous enameling industry which, due to elevating the firing chamber, has a natural effective heat seal. Recent improvement has reduced the standby losses by the introduction of a lift type refractory tile barrier between the firing and preheating chambers. This furnace shows a gross economy of 14 to 16 lb. per kw-hr. when firing steel at 1450 deg. fahr. to 1700 deg. fahr.

An important design change has been made in the large 70 ft. long, copper, hydrogen brazing furnaces for refrigerator evaporators. The greater portion of the alloy car supporting the work is now in a separate,

7. Contributed by N. R. Stansel.

enclosed chamber (except for a narrow slot) beneath the heating chamber. This has resulted in better economy, longer life of car and permits the use of a less expensive alloy for the car. There is now in use a smaller furnace of the same type which, with a connected load of 100 kw., automatically brazes 120 pieces per hr. The operator has only to place the work on the cars that carry 14 pieces, at 7-minute intervals, into the furnace.

A new pit type furnace with a simplified control equipment has been introduced for heat treating alumi-

shaped top may be removed. In this way one furnace can keep several bases busy, saving in equipment investment, material handling and heat required per charge.

The increasing use of furnaces with a controlled atmosphere has created a demand for equipment to economically produce gases suitable for this work. Development work is now being done to produce a mixed gas of hydrogen and nitrogen from ammonia. Another method is to "crack" city gas and make it suitable by breaking up the methans and causing it to unite with steam, giving a resulting mixture of carbon monoxide, carbon dioxide, hydrogen and nitrogen. A furnace for this work is in operation with a connected load of 65 kw. which delivers 1000 cu. ft. of mixed gas per hour for use in brazing furnaces. Approximately 2 cu. ft. of mixed or cracked gas are obtained from 1 cu. ft. of city gas.

#### ELECTRICAL CONTROL<sup>8</sup>

Gang control, the control by an individual at a distance of a group of electrical drives, has received much attention during the past year. Twelve motors of similar operating characteristics, design and duty cycles, may now be started by means of only two sets of control equipment. With this new interlocking control, applicable to any one of the twelve motors as frequently as is necessary for starting this particular long-hour service, it is possible to eliminate nearly all of

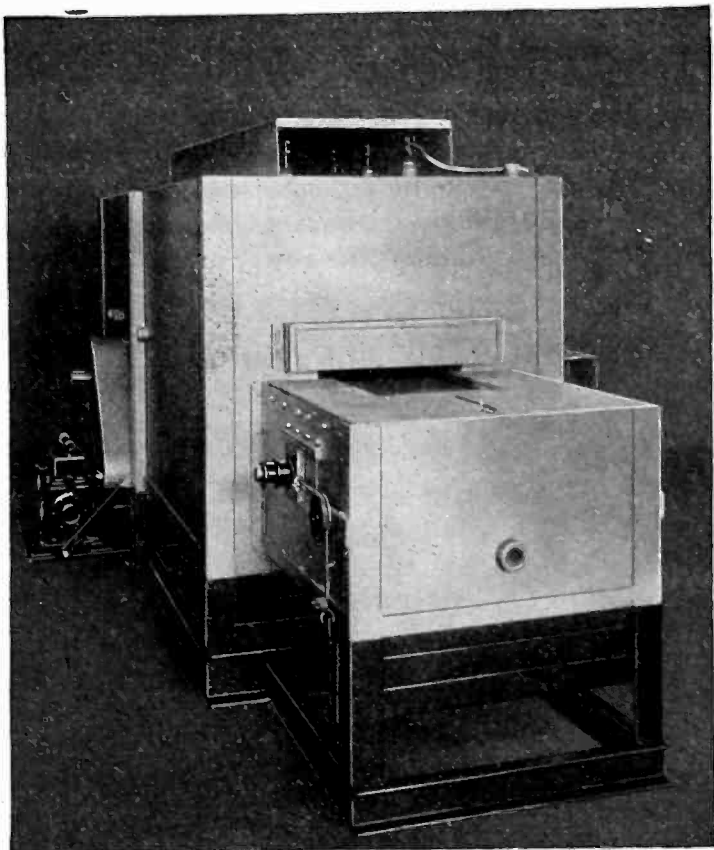

FIG. 17—45-Kw. TWO-CIRCUIT MESH BELT CONVEYER FURNACE

num alloys, Fig. 18. This furnace is equipped with high heat and low heat switches which give a high power input for quick heating and low power, low gradient input so essential for the holding periods. Improvements in the cover design have reduced the losses to an absolute minimum.

Two new glass annealing lehrs have been developed for the continuous annealing of sheet glass at about 100 deg. fahr. The larger of these is 13½ ft. wide and 800 ft. long. Heating units totaling 1600 kw. are installed in the first 400 ft.

The cast-in immersion units, which have been successfully applied to heating stereotype metal with as much as 360 kw. in one melting pot, are now being applied to a cable press pot 3 ft. 2 in. in diameter and 4½ ft. deep. This pot, with a connected load of 210 kw., will be capable of melting 18,000 lb. of lead per hr.

Figs. 19 and 20 show a bell type furnace which uses gas to prevent scaling of the charge. In this particular type furnace the base remains on the floor and the bell

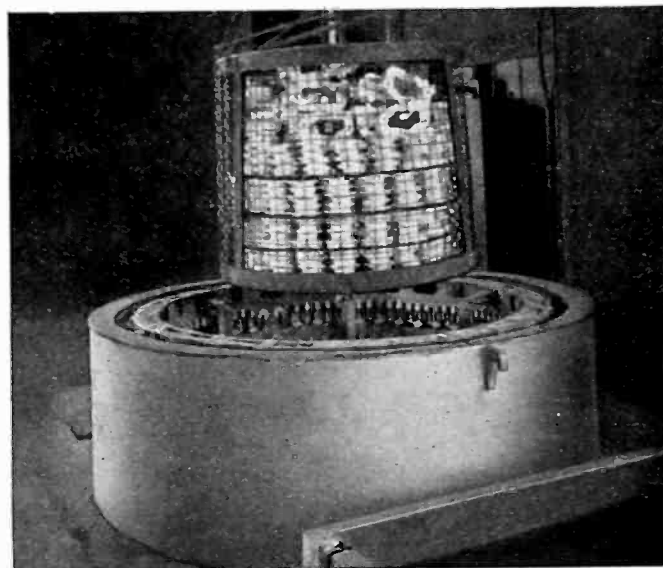

FIG. 18—84-Kw. PIT TYPE ELECTRIC FURNACE FOR HEAT TREATING ALUMINUM ALLOY CASTINGS

the cost of nine complete control equipments previously considered necessary for such an installation. This system provides a method whereby either of two auto-transformer starting equipments may be selectively connected to any one of twelve motors for starting purposes. This unit interlock control is entirely self-contained and is so mounted that each control section can be easily removed from the control benchboard for

8. Contributed by C. F. Harding and N. L. Mortensen.

inspection and maintenance or for replacement with a spare unit. Selector switches and relays of the type used in telephone exchanges have been adapted to this service, the entire interlock control operating from a 48-volt storage battery.

Elevator control has also been perfected to such an extent that uniform rates of acceleration up to speeds of 800 or 900 ft. per min. and correspondingly comfortable

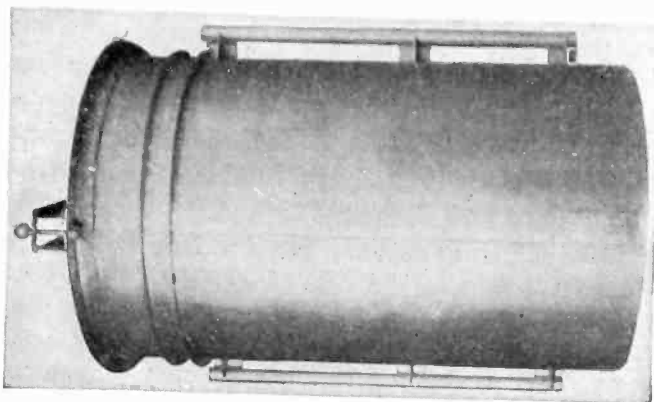

FIG. 19—THE TOP OF THIS FURNACE CAN BE READILY MOVED FROM BASE TO BASE

retardation to standstill at a predetermined floor level, may be made automatically with entirely enclosed passenger elevator cars. It is claimed that the high speeds are not objectionable to passengers if the walls of the shaft cannot be seen and if the acceleration and retardation are uniform.

Elevator control switches operated under the advantages of direct current are now possible from an a-c. supply by the introduction of a recently developed copper-oxide rectifier unit. This adaptation should prove popular because of its low space factor, low cost and rugged construction. Similarly, the d-c. brake can

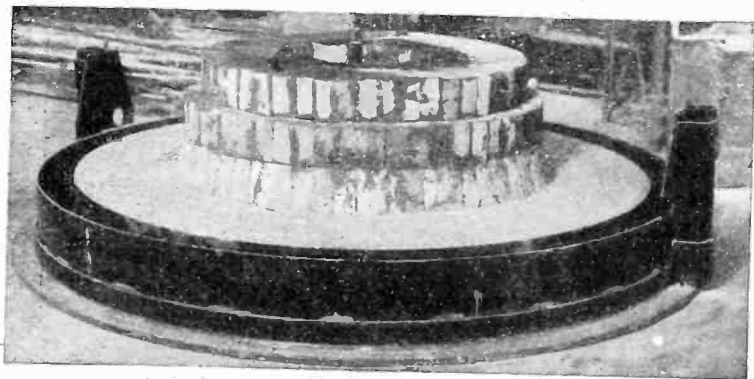

FIG. 20—THE BASE OF THIS FURNACE REMAINS FIXED, THE REMOVABLE HOOD FITTING DOWN OVER THE CHARGE

be used with a-c. drive of hoisting machinery with the intermediate rectifier unit.

Another interesting application of the copper-oxide rectifier was made to the control of polarity in building up the voltage on synchronous converters. A double-wave rectifier supplied a separate source of direct current. A blocking rectifier in the converter field circuit makes it possible properly to bias the excitation

during the starting period by utilizing the positive half of the wave and stopping the negative half. The double-wave rectifier is connected in parallel with the converter armature so that it is only necessary to open the separate source of excitation and short circuit the blocking rectifier when synchronous speed is reached. No transfer equipment is, therefore, necessary. In some of the smaller installations even the brush raising mechanism has been eliminated.

The "fuseless fuse box," or small circuit breaker for domestic appliance and panel-board use, to take the place of fuses, is as simple as a light switch, cannot be "held in" upon injurious overloads, is safe, moisture and shock proof, and should meet with generous usage in the multi-motored home, office, and factory.

The deion principle, which was first applied to relatively high-voltage, heavy-current circuit breakers, is now available for industrial control breakers in 440- to 600-volt motor circuits, thereby providing greater

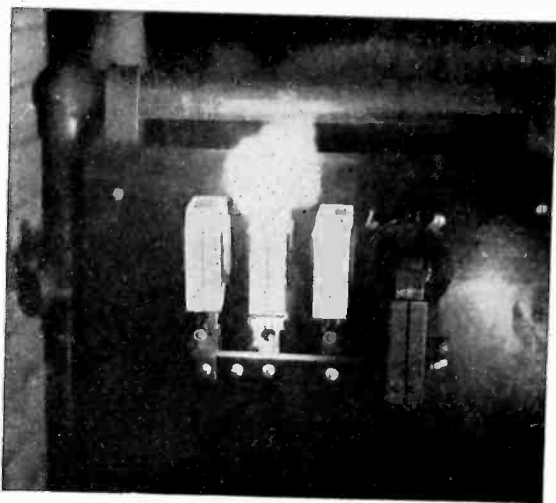

FIG. 21—ORDINARY ARC CHUTE ON A SWITCH

interrupting capacity in small enclosures. The application of this principle produces rapid deionization of the arc path after the factors producing ionization have become inactive at the cyclic zero of the current wave. The magnetic blow-out coil is thus eliminated. A comparison between the flame emitted from an ordinary breaker and a deion breaker when opening the same load is shown in Figs. 21 and 22. Tests have been reported upon a deion contactor rated for a 40 hp., 440-600-volt circuit in which currents as high as 2500-amperes were successfully interrupted at 48 per cent power factor.

A unique oil type hydraulic operating unit to take the place of large a-c. or d-c. magnets and solenoids, or even air cylinders, where quiet and smooth mechanical thrust is desired throughout a definite distance, consists of a motor-driven oil centrifugal impeller pump located within the movable piston itself. The moving impeller is driven from a stationary motor by means of a spline shaft. In the normal position the piston is at the bottom of the cylinder, which is approximately two-

thirds full of oil. When energized, the motor drives the impeller, thereby creating a pressure between the bottom of the piston and the bottom of the cylinder. This pressure tends to move the piston upward throughout the full length of the cylinder.

Metal-clad switchgear continues to merit further application and successful operation, although its details are far from standardized as yet. Fillers of hard asphaltum compound, petrolatum or vaseline and thin insulating oil, each with its advantages for certain classes of service, are being thoroughly tried out. Care should be exercised in defining and developing standards to distinguish between metal-clad switchgear, with its complete insulation of all parts and resultant space reduction, and the contrasting conventional truck type switchgear.

In connection with motor operation of large valves in steam power plants and in the chemical industry, the

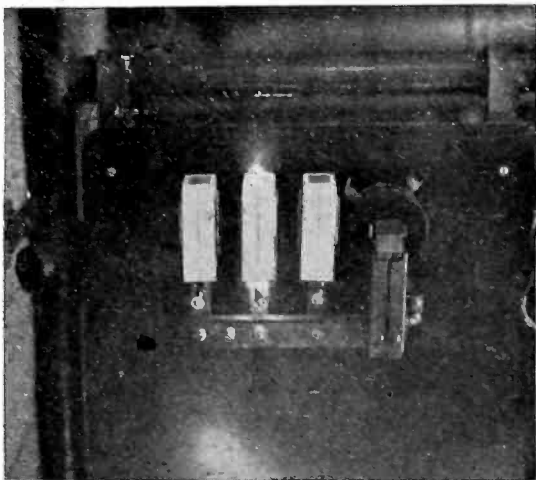

FIG. 22—ARC ON DEION SWITCH WHEN OPENING SAME LOAD AS SWITCH IN FIG. 21

trend toward extremely high pressures, up to 3000 lb. per sq. in., and relatively high temperatures, has imposed unusual requirements as to positive and accurate seating of the valves. Strains and resultant deformation may result from the pressures and from expansion and contraction of parts due to temperature changes. Also dissimilar metals are used, such as monel stems and chrome steel valve bodies which have unlike temperature coefficients of expansion. Therefore, the standard motor control with a mechanical limit set for an accurate number of turns of the yoke nut would not, under certain conditions, close the valve tight, while under other conditions it might seat the valve before this mechanical limit was reached and thus damage the valve seat.

A torque limit device known as a "valve-tight-seating relay" was developed to meet these varying conditions. This relay is used in connection with the valve control and assures a seating of a valve at a definite, predetermined seat pressure, or a fixed torque on the motor.

The "tight-seating relay" operates on the lock-out principle, or rather, the lock-in principle. The pivoted armature of the relay is held in by a calibrated spring and a shunt magnet. A series magnet on the opposite side of the pivot tends to pull the relay armature out. The pull of the shunt coil is in excess of that required to hold the relay in on the high current inrush of starting the motor. The mechanical limit of the valve operating mechanism is connected to the shunt coil. This limit is set to open the shunt coil while the valve is still an appreciable distance from the seat. As the valve approaches the seat, only the spring on the relay tends to hold the contacts closed. The valve seating pressure then builds up and increases the current passing through the motor and the series coil until this current reaches the predetermined value which then snaps the relay open and disconnects the driving latch, allowing the motor to drift on free of the valve mechanism.

This "tight-seating relay" system is unique in that the full torque of the motor is available clear up to the actual tight seated point on the valve. It also does away with the necessity of accurate setting of the mechanical limit.

A new design known as the duplex magnetic clutch has been developed. This type of clutch is for particular application to hard service.

In the duplex design the magnet members have no relative rotation. They are fastened together and rotate as a unit. The armature member is carried on a spring plate which is bolted at the inside to a projection from the field member. The magnet members carry flanges extending outward on which are mounted the metal friction members which clamp the lining faces. Provision is made for adjusting the distance between the metal friction faces and also for setting the lining carrier to provide positive clearance when the clutch is disengaged.

This design increases the lining area and the driving force for a given diameter, and reduces the possible damage which may result from improper maintenance. When the magnet members make contact as the lining wears, the clutch loses all driving force and obliges the maintenance crew to readjust. In that condition, the magnet members cannot score each other since they have no relative rotation.

Several devices for the control of motors are worthy of note. Fig. 23 illustrates a field relay for synchronous motors with definite time element and lockout coil. The lockout coil prevents the timing mechanism from operating until the motor has accelerated to approximately 95 per cent of synchronous speed when the voltage decreases, permitting the lockout coil to release the timing mechanism.

A new line of starters was developed for  $\frac{3}{4}$ -to 3-hp. d-c. motors. This definite-time starter, Fig. 24, is smaller and more compact than previous designs, although the three points of acceleration is an increase.



Definite time acceleration is adjustable over a range of from two to eight seconds.

#### TEXTILE INDUSTRY<sup>9</sup>

During 1929 there were at least two outstanding developments in applying electrical equipment to textile machinery.

The more important development was the large scale

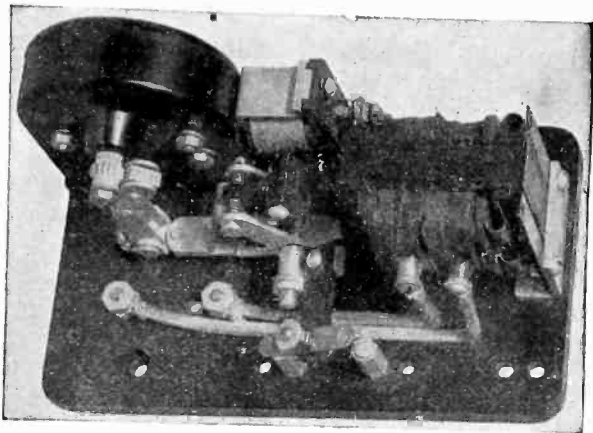

FIG. 23—FIELD RELAY FOR SYNCHRONOUS MOTOR WITH DEFINITE-TIME ELEMENT AND LOCKOUT COIL

application of a-c. variable speed motors to spinning machines, printing and finishing machinery, and full-fashioned hosiery knitting machines. Until recently this type of equipment has been driven with various degrees of success by d-c. adjustable-speed motors, by wound rotor-induction motors, multi-speed squirrel-cage motor or constant-single speed squirrel-cage

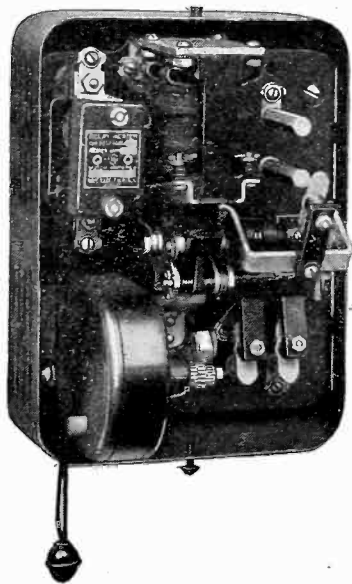

FIG. 24—DEFINITE-TIME AUTOMATIC STARTER FOR D-C. MOTORS

motors with mechanical speed changing devices. With each of these drives there has been one or more undesirable features such as insufficient number of speed points, low efficiency, and inability to obtain exactly the same speed curve repeatedly without resetting the control.

Numerous applications of the a-c. adjustable-speed shunt-characteristic induction motor, Fig. 25, has demonstrated that this motor overcomes all of these disadvantages of the previous drives and permits easy

9. Contributed by C. W. Falls.

but complete control of the process with improved quality and increased production. The successful and increasing use of this adjustable speed alternating current motor represents a distinct advance in the art.

Another definite development or trend has been the increasing use of "built-in" motors and individual drive with more compact control equipment, all tending toward simplification of the complete equipment and a reduction in the amount of floor space required.

The rayon spindle motor offers a notable example of the increasing use of individual drive. The trend for rayon motors has been toward higher speeds, such as

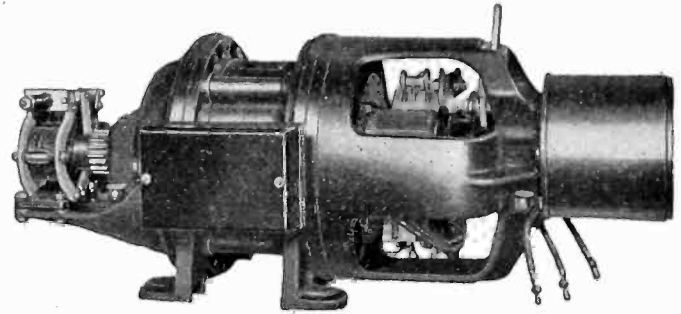

FIG. 25—3-HP. BRUSH-SHIFTING, ADJUSTABLE-SPEED, A-C. MOTOR

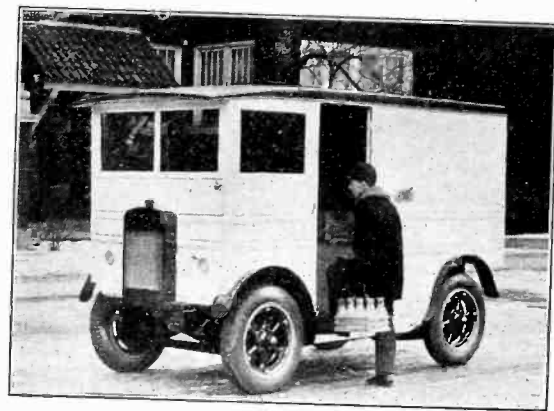

FIG. 26—GAS-ELECTRIC DELIVERY TRUCK IN DOOR-TO-DOOR SERVICE

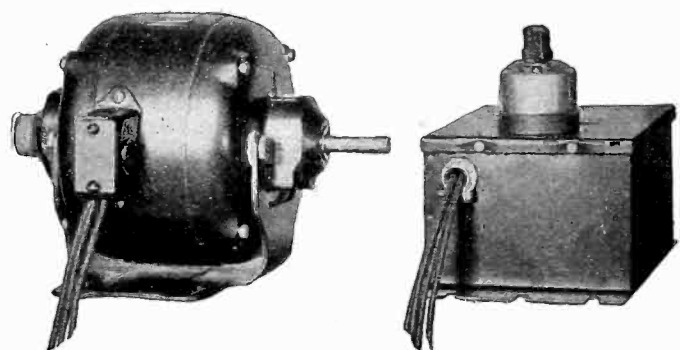

FIG. 27—1/4-HP. CAPACITOR MOTOR WITH THREE SPEEDS

8000 rev. per min. and upwards. While successful motors have been developed for even higher speeds than these, limitations in the strength of the buckets and in the process itself have somewhat retarded this trend. However, these difficulties are gradually being overcome.

The flexibility of individual drives, together with the improved quality of product, as demonstrated in rayon spinning, has caused a movement toward the use of individual spindle motors for silk and cotton machinery.

This trend will be watched with great interest by the textile industry.

During 1929, motors were built more compactly into looms and similar machines, with resulting simplicity and economy in floor space. There seems to be considerable opportunity for development in this direction.

Coincident with this movement has been the introduction of very compact combination controllers, which reduce the required space and wiring to a minimum. These control devices combine in one case the motor

small delivery trucks for door-to-door service. Fig. 26 shows one of the 100 Thorne delivery trucks put in service during the past year.

An unusual application of this drive was made by the U. S. Signal Corps. Three 1½-ton trucks with paneled bodies were equipped with motor-generator sets and switchboards. Two of the trucks supply current at 2000 volts to the radio transmitter and the other supplies 12-volt current for battery charging.

*Capacitor Motors.* In order to meet the demand for an adjustable speed motor in small sizes to drive fans for ventilators and unit heaters, there was developed an adjustable varying speed capacitor motor, Fig. 27. The capacitor is so connected in series with one phase of the two-phase stator that it will transform some of the input to make the motor operate like a polyphase induction motor. The other phase of the stator is connected to the speed adjust-

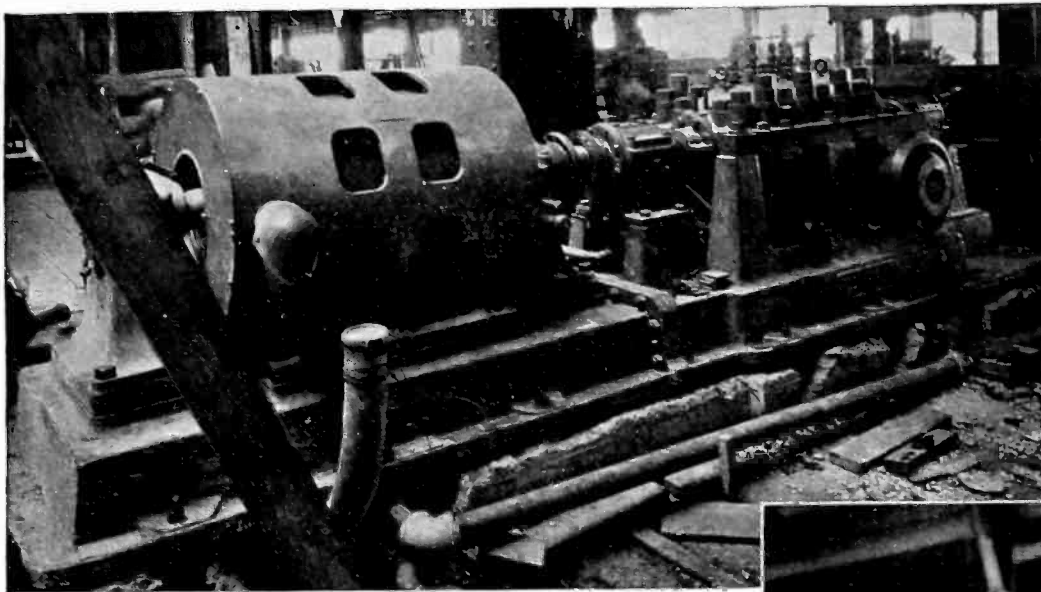

FIG. 28—THE ABOVE MOTOR DEVELOPS 1250 HP. AT 3600 REV. PER MIN. TO THE RIGHT IS THE ROTOR OF ONE OF THESE MOTORS

starter, full protective features, safety disconnecting means and fuses for short-circuit protection.

#### MISCELLANEOUS APPLICATIONS

*Telephones.* The continued and rapid increase in the use of the dial system means, of course, a continually increasing power demand for telephone central offices. In the larger cities the panel system is being employed which uses motors for driving the switches rather than magnets. The telephone central office is thus more and more becoming a user of power of some magnitude, and a larger field of power applications is steadily being opened.

*Gas-Electric Busses.* Over two hundred busses with gas electric drive were put in service during the year. The general trend in busses is toward larger size, which greatly favors gasoline-electric drive as it is superior to mechanical drive in large units.

Development of a pleasure car with this type drive was undertaken during the year. Five cars were so equipped and tests indicate that the smooth acceleration and easy handling obtained with electric drive will make this application a commercial success when equipment is fully developed.

Gasoline-electric drive has already been applied to

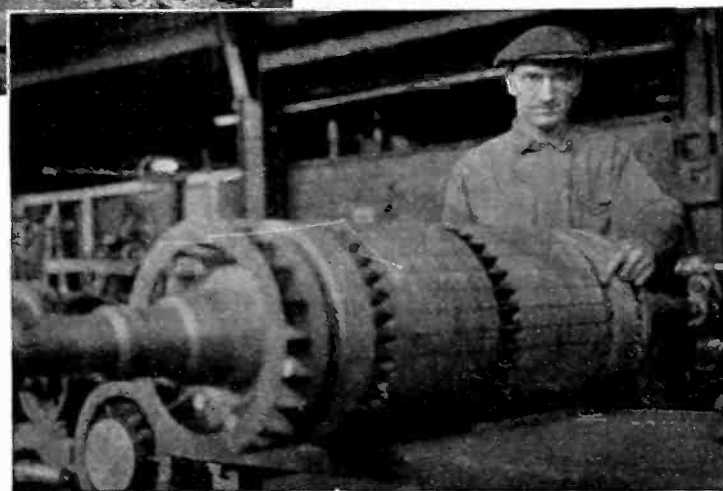

ment switch which has four positions; high, medium, low and off. This causes the motor to operate at 90, 75, and 65 per cent of synchronous speed when loaded to rated capacity.

*High-Speed Motors.* In order to raise the feedwater to a pressure of nearly 1600 lb. in the Deepwater station, New Jersey, eight 1250-hp. induction motors driving five stage centrifugal pumps were installed. These motors develop a speed of 3600 rev. per min., the limit for 60-cycle motors. A feature of the motors is the size of the rotors which have a diameter of about 15 in., which compares favorably with the size of the rotor in a 900-rev. per min., 100-hp. motor. Fig. 28 illustrates these motors.

The committee is indebted to the following firms,

institutions and publications with which committeemen are connected or whose cooperation and publications we have made use of in compiling this report:

American Brown Boveri Company.  
Bethlehem Steel Company.  
Bell Telephone Laboratories.  
Braymer Equipment Company.  
Cutler Hammer Manufacturing Company.  
Duquesne Light Company.  
Electric Power Equipment Company,  
General Electric Company.  
Lehigh Portland Cement Company.

Massachusetts Institute of Technology.  
National Council of American Shipbuilders.  
Philadelphia Electric Company.  
Purdue University.  
Reliance Electric & Engineering Company.  
University of Toronto.  
Westinghouse Electric & Manufacturing Company.  
J. G. White Engineering Corporation.  
Iron and Steel Engineer Magazine.  
Electrical World Magazine.  
Machine Design Magazine.

## Abridgment of Hydro Power Practise in Central Europe

BY A. V. KARPOV<sup>1</sup>

Member, A. I. E. E.

*Synopsis.*—This paper presents the impressions of a European trip made during the summer of the year 1929 and gives a comparative study of the conditions of European developments in so far as they are either of a particular interest or different from the conditions in the United States.

The present day turbine design with particular reference to the development of Propeller and Kaplan turbines is discussed.

The more interesting low-head developments, the international interconnection system in the region of the upper Rhine, as well

as the extensive use of pumping schemes, are briefly described and illustrated.

The tendencies in power house design and the energy destroying problems are mentioned.

Laboratory work, its influence on the European developments and the high standing of the low-head developments are stressed.

A short comparison between the concrete work as done in Europe and in the United States is made.

\* \* \* \* \*

### TURBINE DESIGN

ONLY a few years ago the Francis turbine was a universal type, being used for very low heads, as well as for medium and high heads. Today the Propeller and Kaplan turbines are used entirely for low-head developments. At the same time, the Pelton turbines, because of the increase in the number of jets and runners, are used for much lower heads than before. That leaves to the Francis turbine the medium-head developments only.

The curves of Fig. 1 give an approximate idea of the heads and specific speeds for which the different types of turbines are used.

#### PROPELLER AND KAPLAN TURBINES

The most interesting of the present day European designs are the Propeller and Kaplan turbines. The principal difference between these two turbines lies in the adjusting arrangement of the runner blades of the latter. The runner blades of a Propeller turbine are solidly connected to the hub and the turbine shaft and cannot be adjusted; those of a Kaplan turbine can be adjusted for different operation conditions by means of a special mechanism built into the hub of the runner.

1. Designing Engineer, Aluminum Company of America, Pittsburgh, Pa.

Presented at the Summer Convention of the A. I. E. E., Toronto, Ontario, Canada, June 23-27, 1930. Complete copy upon request.

### CAVITATION

The cavitation problem became of such importance in the Propeller and Kaplan turbine design that special cavitation laboratories were built and the laboratory work cleared to a certain extent this rather obscure problem.

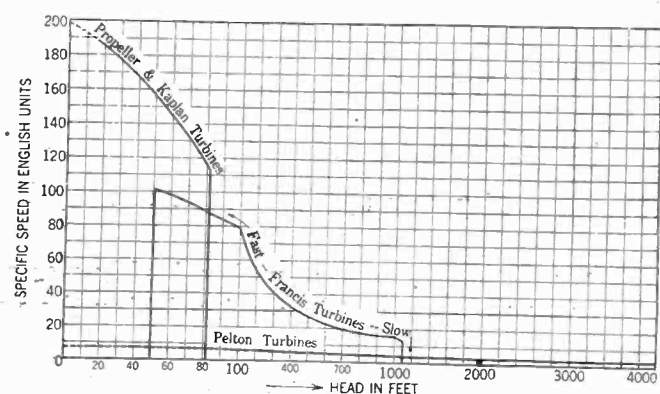

FIG. 1—CURVES OF SPECIFIC SPEED LIMITS FOR SINGLE-RUNNER PROPELLER, KAPLAN, FRANCIS, AND PELTON TURBINES

In the Propeller and Kaplan turbines, the point of lowest pressure is always above the draft tube entrance, being located somewhere on the runner blade. In a turbine of this type, a sufficient pressure at the draft tube entrance is no insurance whatsoever from cavitation troubles.

At one of the leading plants which possesses a cavitation laboratory, the up-to-date practise is to test models of new Francis turbines, as well as Propeller and Kaplan turbines, and to determine the limiting conditions at which the cavitation starts. The actual operation conditions are chosen according to the results of these tests.

**EFFICIENCY OF PROPELLER AND KAPLAN TURBINES**

In order to keep down the friction losses, the original Kaplan turbines were built with only a few small runner blades. This arrangement gave satisfactory results for certain loadings and a very rapid decrease of the efficiency by decreased or increased loadings. Changes in the loading result in an increase of the non-uniformity of the flow, rapid increase of eddy losses, and a correspondingly rapid decrease of the efficiency.

By making the blades adjustable more favorable flow conditions for different loadings can be obtained. In this way the present day Kaplan turbine with its very flat efficiency curve on a wide range of loadings was developed.

**HUNTING OF PROPELLER AND KAPLAN TURBINES**

An unfavorable peculiarity of the first larger Kaplan and Propeller turbines was unsteadiness and the tendency to hunt. Tests indicated that this tendency is due to the irregularity of the water flow in the draft tube. This trouble was cured by building in the draft tube a partition close to the runner and following the axis of the draft tube. Such partition arrangement also increased the efficiency, particularly at partial loadings.

The results obtained with these partitions proved to be of importance in solving structural troubles in building power houses for large Propeller and Kaplan turbines. Vertical partitions in such turbines are built to support the power house structure.

**DRAFT TUBE SHAPE**

Due to the fact that in the low-head developments the efficiency of the draft tube affects considerably the over-all efficiency of the installation, extensive laboratory research is done on draft tubes. Practically all the latest larger low-head developments show remarkably high efficiencies due to the use of an elbow type draft tube.

**INCLINED WICKET GATES**

The latest improvement in Propeller and Kaplan turbine design is the inclined arrangement of the wicket gates which not only affords saving in the over-all sizes of the turbine, but in some cases improves the efficiency. The same scheme can be applied to fast-running, low-head Francis turbines.

**LOW HEAD DEVELOPMENTS**

Probably the most interesting of present day European developments are those for less than 80-ft. water head.

The introduction and rapid increase in size of the

Propeller and Kaplan turbines changed the economical aspects of these developments and made possible plants which a few years ago were considered uneconomical.

The upper part of the Rhine River, between Lake Constance and Strasbourg, gives an interesting picture of the new low-head possibilities.

There are under construction two large plants: the Ryborg-Schworstadt plant on the border line between Germany and Switzerland close to Rhinfelden, and the Kembs plant on the French side of the Rhine, close to Mulhouse.<sup>2</sup>

The turbine units in both are the largest ever built, so far as the physical dimensions and the amount of water handled by each unit are concerned.

The comparative data of the Ryborg-Schworstadt and Kembs plants are as follows:

	Ryborg-Schworstadt	Kembs
Head (ft.)	35	54
Kind of turbines	Kaplan	Propeller
Number of units	4	5
Capacity of unit (hp.)	35,000	36,000
Installed capacity (hp.)	140,000	180,000
Quantity of water handled by each unit (cu. ft. per sec.)	10,500	6,800
Number of rev. per min.	75	94
Diameter of runner (ft.)	23.0	18.4

**PROPELLER OR KAPLAN TURBINES**

For present day low-head developments there are three possible choices of turbines:

1. Propeller turbines only.
2. Kaplan turbines only.
3. Propeller and Kaplan turbines.

The Kembs development is an example of the first choice and the Ryborg-Schworstadt represents the second. The Lilla Edet power plant in Norway with two Propeller (Lawaczeck) and one Kaplan turbine is a good example of the third choice.

The Propeller turbine is simpler and cheaper. It can be designed to have at a loading close to 100 per cent, a very high efficiency; but at smaller loadings the efficiency drops off rapidly. The Kaplan turbine is more complicated and, having a flat efficiency curve at a large range, it will generally have a slightly lower maximum efficiency than the Propeller turbine. These differences in turbines, in connection with local conditions, will govern the proper choice.

In the Kembs power house, with a larger number of units and gradual changes in the amount of water, it was thought that by varying the number of units in operation it would be possible to have them work most of the time in the favorable range of the efficiency curve; therefore the Propeller turbines were decided upon.

<sup>2</sup> These plants were described briefly by the author in *Power* of April 1, 1930.



In Ryborg-Schworstadt, it is expected that all four units will be worked all the time, the loading of each unit to be changed according to the available water flow. Under these conditions it was thought advisable to use the Kaplan turbines for all four units. At the same time local conditions made it possible to eliminate the head gates, and in this way to compensate partly for the higher cost of the Kaplan turbines.

The Lilla Edet power house is probably most representative of average conditions. There the idea is to run the Propeller units always at the point of maximum efficiency and to have all the regulation taken care of by the Kaplan unit.

#### INTERCONNECTION AND IMPROVEMENTS IN WATER UTILIZATION

Most European power plants are connected to some distribution system and are carrying, partly at least, public utility load with its daily and seasonal variations.

The steam power plants of such systems take care of the deficiency in water power, but at the same time provisions are made for the best possible utilization of the available water flow and for adjustments to the variable load conditions.

The extensive use of water pumping schemes and the connection with chemical plants are the most important and interesting means of regulation.

The region of the upper Rhine shows the highest stage of development. Here the Rhine power plants, the power plants of southern and western Germany and of Austria, the Swiss plants and, through Switzerland, the French plants, form one of the largest international interconnected systems of the world.

The whole region is so operated as to avoid waste of water in plants having no storage capacity. Not only the seasonal and daily load variations are cared for, but even the mid-day dropping off of the load is provided for. These regulations are achieved mainly by:

1. Regulating the load of steam plants.
2. Regulating the load or shutting down hydro plants having available storage capacity.
3. Starting and stopping of water pumping in the higher located reservoirs on the German and Swiss sides of the Rhine.
4. Regulating the load of chemical plants.

The chemical plants in some cases are owned by the power plant. Some of them can take on or drop off as high as 20,000 kw. at one-half hour's notice.

#### PUMPING PROBLEMS

A number of possibilities for regulating and improving the output of power plants can be obtained by including in the development a pumping scheme.

The over-all efficiency of any pumping scheme seldom can exceed 60 per cent. On account of this low efficiency, the pumping schemes that utilize the waste water in most cases are the ones that show the best economical advantages. The schemes in which water that could be directly utilized is pumped into reservoirs will be

justified only if the difference in price between the power delivered from the artificially stored water and the power that could be delivered by direct prime mover generation is large enough.

In order to get the full benefit of pumping, the pumping installation should be a part of a large interconnected system, in which the combination of different kinds of high- and low-head plants, with and without storage capacity, creates conditions which will make pumping advantageous.

#### HYDRAULIC LABORATORIES

Any attempt to get an idea of present day hydro power developments in Europe brings out the important part which the hydraulic laboratories are taking in these developments.

In Europe, particularly in Germany and Switzerland, there is an efficient system of hydraulic laboratories supported by technical universities, states, and turbine manufacturers. These laboratories can be divided in the following three types:

1. River hydraulic laboratories which are working mainly in the line of investigation of behavior of rivers under different conditions, the influence of hydraulic structures such as dams, spillways, etc., on the behavior of the river, movements of river beds, and erosions of river and channel beds, river regulation problems, etc.
2. Turbine laboratories in which the work is mainly concentrated on turbine testing problems, cavitation, pitting, water flow in pipes, scroll cases, draft tubes, etc.
3. Naval laboratories that are mainly working on the problems connected with ship design.

The technical university laboratories are of all three types, the state laboratories are mostly river and naval laboratories, and turbine manufacturing concerns have turbine laboratories.

Considering only the river and turbine laboratories, it is to be noted that the progress in hydro development in Europe is due to the close and most beneficial cooperation and friendly competition which exists among these different laboratories. The laboratories connected with the technical universities and the states have more time and a better opportunity to do new development and research work, to check over and correct the work of other investigators, and to make special investigations necessary for the proper design of different hydraulic structures.

The work of the laboratories connected with the turbine manufacturing concerns is necessarily rather limited by the pressing every-day problems that arise in connection with the designs in which the particular concerns are interested. Only at irregular intervals when the pressure of the immediate work is released can such a laboratory attempt to do any new development work. The division of work among these different laboratories and the free exchange of information are responsible for the present day high standing of the low head developments in Europe.

### CAVITATION LABORATORIES

The importance of cavitation led to the development of special cavitation laboratories in which are conducted investigations to determine the exact conditions of draft tube head and water velocity at which the cavitation will start in a particular turbine.

In the laboratory of the Escher Wyss Company in Zurich the stroboscopic method is used. The model of the runner can be observed during the test through a glass window; the observer covers his head and the glass window with a dark cloth, as did the user of an old-fashioned photographic camera, and illuminates the runner by an electrical lamp, which is electrically connected with the runner by means of a commutator and gives one flash for each revolution of the runner. When observed by means of this lamp, the runner appears immovable irrespective of the number of revolutions it actually makes. So long as no cavitation occurs, the water appears perfectly clear. The exact moment at which the cavitation starts can be determined because of the small bubbles of vapor and air that appear as a slight fog along the outer circumference of the runner. With increase of the speed or the draft tube head, the bubbles increase in size and number until finally the water becomes turbulent and opaque.

### LABORATORIES AND LOW-HEAD DEVELOPMENTS

The laboratory cooperation is particularly important in low head developments.

A Propeller or Kaplan turbine can be properly designed only if the preliminary drafting board design is modified and improved in accordance with model tests.

The conditions under which cavitation can be avoided can be properly determined only if the chosen shape of the blade is tested in a cavitation laboratory.

The turns of the blades of a Kaplan turbine corresponding to the position of the wicket gates, the shape and size of the draft tube partitions and of the supporting piers in the draft tube and spiral case can be determined by model tests only.

Not only the turbines but the design of the entire power plant is to be supported by laboratory test. The large quantities of water to be handled and the inability to determine without tests the influence that the proposed structures will have on the behavior of the river, are making the laboratory help of utmost importance. The expenses and time loss that are involved in laboratory tests are saved in more economical structures and better designs resulting from such tests.

### DESIGN OF THE RYBORG-SCHWORSTADT POWER PLANT

A good general idea about the handling of more important low-head designs and about cooperation between the power plant designer, turbine manufacturer and hydraulic laboratory can be gained by considering the way in which the design of this development was worked out.

First, a preliminary study of the development was

made and the approximate location of the proposed dam and power house were determined. This information was given over to the Karlsruhe Laboratory where a complete model of the part of the Rhine River involved in this development was built. Extensive series of tests were made in the laboratory to determine the proper location of the dam and power house, the amount of river protection necessary above and below the dam, the conditions to be met to protect the shipping interests, the possibilities of sand and gravel accumulation at the intake, the influence of the cofferdams, and so on. At the same time the three turbine manufacturing concerns that were chosen to deliver the Kaplan turbines, J. M. Voith in Germany, Escher Wyss and Company and Atelier des Charmilles in Switzerland, made preliminary designs of the turbines, built models of them, including scroll cases and draft tubes, and tested the models to determine efficiency, cavitation limitations, runner blades adjustments, shape and location of the dividing partitions and supporting piers, etc.

The results of tests made in Karlsruhe, as well as tests made by the turbine manufacturers, were put before all parties and the necessary modifications in the preliminary design were discussed and decided.

In this way the preliminary design was modified a number of times until the best possible combination was found and the final design that is now under construction was decided upon.

### CONCRETE WORK

The progress which has been made in the past few years in the States in proper controlling, mixing and handling of big masses of concrete has not yet reached Europe. Observations made in Germany and France show that the concrete work is mostly done in an old fashioned way.

In the United States the uniformity of the concrete work and the predetermined strength and density of the concrete are assured by:

1. Proper proportioning and mixing of the aggregates.
2. Strict maintenance of the necessary water cement ratio.
3. Transportation of the concrete and disposal of it in forms in such way as to prevent any segregation of the aggregate.

These important considerations are very often neglected in Europe. The work is mostly conducted on an arbitrarily chosen cement-sand-broken-stone ratio and no strict water-cement ratio is maintained, the amount of water being left to the discretion of the foreman. In line with this absence of scientific control, the tendency that is so pronounced in the United States to reduce the number of mixing plants and to have the mixing done in large mixers and in properly equipped and controlled plants is absent too. Small mixers under the direct control of the foreman in charge of the particular part of the job are mostly used.

As a result, the concrete work is poor, from the American point of view.

#### ACKNOWLEDGMENTS

The trip was made possible through the assistance and support which the writer received from Messrs. E. S. Fickes, J. W. Rickey, and C. H. Moritz, of the Aluminum Company of America.

The very hospitable, helpful and frank way in which the various developments were shown to the writer is

to be noted, as well as the free method in which interesting and valuable information was given by the concerns and individuals, a few of which are named:

The Escher Wyss and Company, of Zurich, Chief Engineer J. Moser and Engineers A. Messikammer, J. Ackeret, and E. Seitz of this Company; the Ateliers des Charmilles S. A. of Geneva, director R. Neeser and Engineers A. Blum, and G. Bavet of this Company; Prof. Dr. Eng. D. Thoma in Munich and Prof. Dr. Eng. Th. Rehbock in Karlsruhe, and many others.

## Abridgment of Long Distance Cable Circuit for Program Transmission

BY A. B. CLARK<sup>1</sup>

Member, A. I. E. E.

and

C. W. GREEN<sup>2</sup>

Member, A. I. E. E.

**Synopsis.**—The rapid growth of the telephone cable network in this country has made it desirable to develop a system whereby this network may be utilized to transmit programs for broadcasting stations over distances upwards of 2000 mi. Such a system has recently been developed and given a trial with very satisfactory results on a looped-back circuit 2200 mi. long. It transmits ranges of frequency and volume somewhat in excess of those now handled by

the open-wire circuits which are used for program work, and also in excess of those handled by present-day radio broadcasting systems when no long distance lines are involved.

The paper deals first with the transmission requirements of broadcasting systems and then gives a description of this new cable system.

\* \* \* \* \*

AS discussed in two recent papers,<sup>3</sup> one of which was presented before this Institute, telephone circuits are now extensively used for chain broadcasting. Radio broadcasting stations covering various local areas in the United States are connected together by wire circuits so that programs are delivered simultaneously to all of them. Thus it is possible to deliver a program to the whole nation at once. About 35,000 mi. of telephone circuits are now being regularly utilized for this service and about 150 radio broadcasting stations receive programs from one or more of the chains of wire circuits.

Today practically all of this service is being furnished by means of open wires using voice-frequency channels. Long distance cable routes are growing rapidly and are supplementing the open-wire routes, particularly those carrying very heavy traffic. Fig. 1 shows the long distance cable routes now in use in the United States, together with the additional routes proposed for installation within the next few years. The advantages in

placing some circuits in these cables which will adequately handle program transmission service were evident, and led to the development described in this paper.

Because of the special characteristics which program transmission circuits must possess, it was necessary to develop an entirely new type of cable circuit in which the method of placing the wires in the cables, the type of loading and all of the apparatus including amplifiers

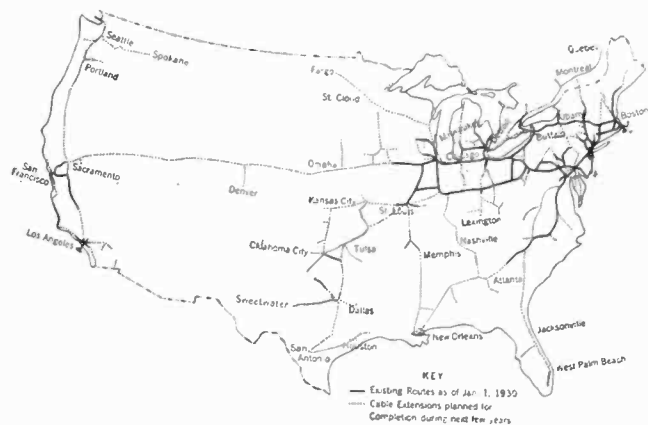

FIG. 1—MAIN TOLL CABLE ROUTES OF UNITED STATES AND CANADA

1. American Telephone and Telegraph Company.
2. Bell Telephone Laboratories.
3. F. A. Cowan, *Telephone Circuits for Program Transmission*, A. I. E. E. TRANS., Vol. 48, 1929, p. 1045. A. B. Clark, "Wire Line Systems for National Broadcasting," presented before the World Engineering Congress at Tokio, Japan, October, 1929, *Proceedings of I. R. E.*, November, 1929, *Bell System Technical Journal*, January, 1930.

Presented at the Summer Convention of the A. I. E. E., Toronto, Ont., Can., June 23-27, 1930. Complete copy upon request.

and distortion correcting apparatus for both amplitude and delay, differ radically from other cable circuits. The development was recently completed and a trial installation made in which wires were looped back and forth in the cables between New York and Pittsburgh,

so as to produce a circuit 2200 mi. in length. Tests were made on this circuit over a period of several months, and very satisfactory results were obtained. It is planned, therefore, to make extensive application of this system, and eventually program circuits may be provided in cable over practically all of the long toll cable routes.

TRANSMISSION REQUIREMENTS

For program transmission, of course, the ideal way is to provide such a transmission line that no distortion whatsoever will be caused to program material transmitted over the line whatever its length may be. Ideally, also, program pick-up apparatus, radio transmitters, radio receivers and loudspeakers, should be such that the program delivered from the loudspeaker should sound exactly like the original program delivered to a direct listener in the best location. To meet this ideal, however, would require that the whole audible range of frequencies extending from about 20 to 20,000 cycles and a tremendously wide range of volumes representing power differences of more than a million-fold, be handled without any distortion whatsoever.

Actually, the radio art is far from attaining this ideal. It does not seem reasonable, therefore, to provide lines far superior in transmission performance to the rest of the system, since this would increase unnecessarily the cost for providing the service. However, telephone lines represent a fixed investment which must remain in service for many years in order to keep costs within reason, and furthermore, it is generally not practical to change the transmission characteristics of the lines once they have been installed. It is necessary therefore to take into account the fact that the broadcasting art has considerably improved in the past and is likely to improve in the future, providing telephone lines of sufficiently good characteristics to anticipate the improvements which are likely to come within a reasonable period of time.

These general considerations have led to the adoption of the following as practical standards of performance for the new cable system:

1. Frequency range to be transmitted without material distortion—from about 50 to 8000 cycles.
2. Volume range to be transmitted without material interference from extraneous line noise—about 40 db., which corresponds to an energy range of 10,000 to 1.

*Frequency Band.* Fig. 2 gives some data in regard to the frequency range required for different musical instruments as well as speech. These data were obtained in the Bell Telephone Laboratories, using an arrangement capable of picking up and reproducing practically the whole audible frequency range. Owing to laboratory limitations, certain very low frequency instruments, such as organ pipes and bass drums, were not included in these tests. A number of observers listened to the reproduced material; first, when practically the whole frequency range was transmitted and

second, with either the high frequencies or low frequencies cut off by means of filters. The observers endeavored to note whether there was any perceptible effect when the filters were introduced, but did not attempt to determine whether introducing the filters made the reproduced material sound more or less pleasing.

Referring to the figure, it will be noticed that at the lower frequencies, little appears to be lost by cutting off frequencies below approximately 50 cycles. At the upper frequencies, however, with certain of the musical instruments, something is lost by cutting off frequencies above 8000 cycles. Hissing sounds, sounds of a percussion nature, and sounds of jingling keys, rustling paper, etc., appear to be most affected by cutting off the high frequencies.

Tests have shown, however, that when the frequency range of from 50 to 8000 cycles is transmitted with very little distortion within the band, the results obtained are very pleasing. The ordinary observer,

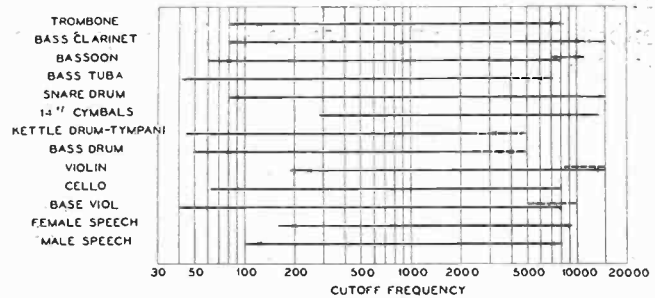

FIG. 2—SUMMARY OF IMPORTANT RANGES REQUIRED FOR DIFFERENT INSTRUMENTS

- Actual tone range
- - - Accompanying noise range
- × Cut-off frequency at which 80 per cent of the observers could detect the filter

without making direct comparison tests, is unlikely to detect the absence of the higher frequencies.

It is not sufficient merely to fix the limits of the frequency band; limits to the allowable distortion within it must be established. Tests have indicated that it is desirable that different frequencies within the transmitted band should not suffer attenuations differing by more than about 5 db., corresponding to power differences of about three-fold.

The transmission delay<sup>4</sup> suffered by different portions of the frequency band must also be considered. This is necessary because when transmission over long distance lines is involved, this delay tends to differ for different parts of the frequency band, and the distortion produced is a function of the frequency delay characteristics. Tests have indicated that the high frequencies—say those in the range of 5000 to 8000 cycles—should not suffer delay in transmission over the

4. "Delay" as used in this paper has the same significance as "envelope delay" used in literature on phase distortion. It is defined as  $dB/d\omega$  where  $\beta$  is the phase shift and  $\omega$  is  $2\pi$  times the frequency.



line more than 5 to 10 milliseconds greater than the delay suffered by frequencies in the neighborhood of 1000 cycles. At the low end of the scale, however, more delay may be tolerated; for example, 50-cycle waves may be delayed as much as 75 milliseconds more than those in the neighborhood of 1000 cycles without noticeable deterioration in quality.

*Volume Range.* A favorably seated listener to a high-grade orchestra is treated to a wide range of volumes. Opinions differ as to just how wide a volume range can be appreciated by such a listener, but it seems certain that it is at least 60 db., corresponding to a power range of one million to one. The human ear can hear volume ranges in excess of 100 db., corresponding to a power range of ten billion to one. For loudspeaker reproduction, it has been found that a room must be particularly quiet in order to be able to appreciate a volume range of 60 db. Rooms in three-quarters of the usual residences are probably too noisy for a volume range as great as this to be appreciated. A 40-db. volume range, corresponding to a power range of 10,000 to 1, can be appreciated in most rooms where radio listening is done, and is quite satisfactory for most musical selections.

From the standpoint of design, the maximum volume of a wire program transmission system is limited by the requirement that the program must not be allowed to spill over unduly as cross-talk into neighboring circuits which may be carrying telephone messages or other programs. The volume may also be limited by the requirement that serious non-linear distortion be not introduced by effects produced in the vacuum tubes of the amplifiers or in any magnetic core coils either in the apparatus or in the line. On the other hand, the minimum volume which a wire program circuit can handle is limited by the tendency of the noise present on the circuit to annoy the listener when the program volume is very weak. Cross-talk from other circuits into the program circuit also enters as an important consideration, since radio listeners must not be able to pick up intelligible conversations during those times when the program volume is very weak or when actual pauses occur in the programs.

From this it is seen that the matter of widening the volume range of a wire program transmission system involves not only added cost to keep non-linear distortion and noise within limits but also—and perhaps even more important—added cost to isolate the circuit from other circuits on the same route.

From the standpoint of the radio part of broadcasting systems, handling very wide volume ranges also presents difficulties. Radio transmitter and other radio equipment noises become more serious as the volume range is widened. More important, however, is the fact that widening the volume range without corresponding increase in the radio transmitter capacity reduces the effective range of a radio broadcasting station, since this increases the tendency for the faint parts of

the programs to sink below the level of atmospheric and receiver-set noises.

At present it is understood that where no long distance wire circuits are involved, most radio broadcast programs are being delivered with a volume range of about 30 db.<sup>5</sup> In order to anticipate improvements which may come in the broadcasting art, however, it has seemed desirable to provide wire circuits in cable to handle a wider volume range than this, and accordingly 40 db. has been taken as a working standard. This volume range appears to satisfy almost everybody with the possible exception of some who listen to broadcasts of symphony orchestras and the like. With the present limitations of volume ranges to about 30 db., there has been some complaint that much of the artistic quality and effectiveness of broadcasts of such high-grade music has been lost because of the fact that the operator manipulating the volume range control seemed to reduce the range an undue amount.

#### DESCRIPTION OF NEW CABLE SYSTEM

In this program transmission system, the nominal telephone repeater spacing of 50-mi. common to message telephone circuits is retained. The pilot wire regulator system, which compensates for changes in transmission caused by temperature changes in message circuits, is also used for the program circuits.<sup>6</sup> The diagram in the top part of Fig. 3 shows several hundred miles of program transmission circuit, illustrating how it is divided up into repeater sections and pilot wire regulator sections and also indicating the principal pieces of equipment located at the repeater stations.

As indicated on the diagram of Fig. 3, there are two classes of repeater stations known as regulator stations and non-regulator stations. At the non-regulator stations, the repeater gains are maintained at fixed values, while at the regulator stations, they are varied under control of the master pilot wire regulating mechanism in such a way as to compensate for the transmission variations of the cable conductors caused by temperature changes.

At each non-regulating repeater station are placed:

1. An attenuation equalizer which corrects for the attenuation differences at different frequencies (at average temperature) introduced by the preceding repeater section.
2. A delay equalizer which corrects for the difference in delay at different frequencies introduced by the preceding cable section.
3. A one-way amplifier introducing sufficient gain to overcome the line loss, together with the added losses introduced by the attenuation and delay equalizers.

At the regulating repeater stations, the arrangement is the same as at the non-regulating stations, except that

5. O. B. Hanson, "Volume Control in Broadcasting," *Radio Broadcast*, March 1930.

6. A. B. Clark, *Telephone Transmission Over Long Cable Circuits*, A. I. E. E. Quarterly TRANS., Vol. 42, 1923, p. 86.

another stage is added to the amplifiers. This stage includes a potentiometer associated with relays controlled by the master pilot wire mechanism, the whole being so arranged as to compensate for the changes in transmission loss of the cable pairs caused by temperature changes.

In the lower part of Fig. 3 is shown a transmission

The delay-frequency characteristics of the 2200-mi. test length of B-22 circuit are shown in Fig. 22. Two curves are given; for the circuit with and without delay equalizers.

The minimum volume which could be transmitted over the cable circuit, which was set by noise and cross-talk picked up by the program circuit, was found to be

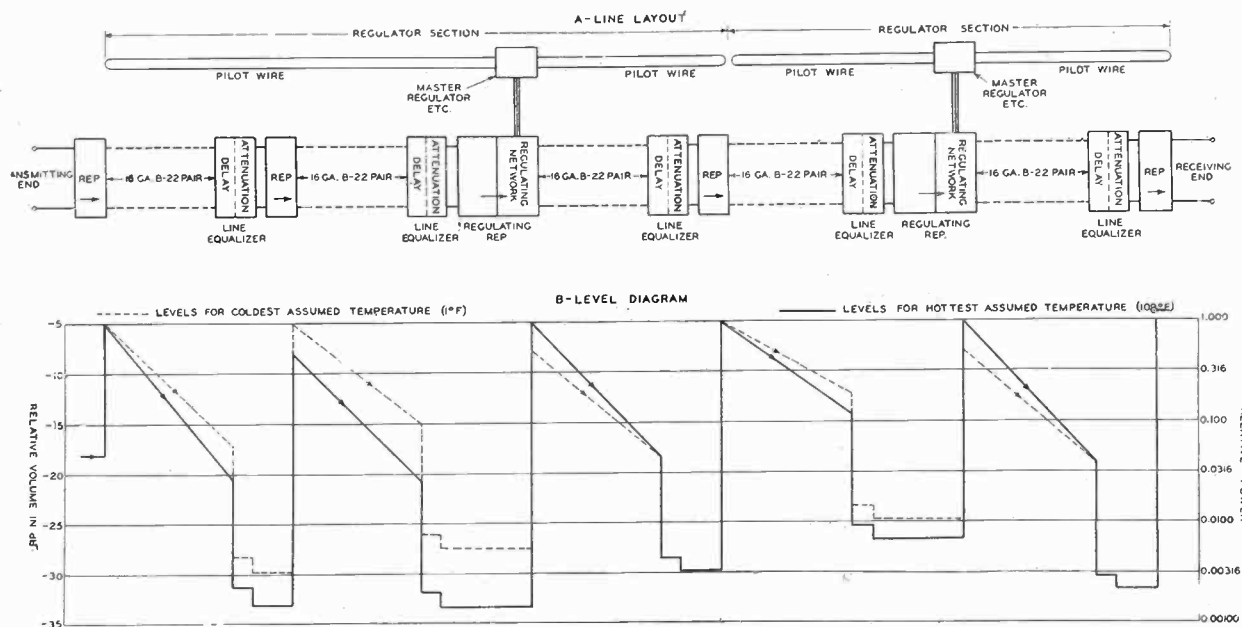

FIG. 3—TYPICAL LINE LAYOUT AND LEVEL DIAGRAM FOR B-22 PROGRAM TRANSMISSION SYSTEM

level diagram, from which can be noted the losses and gains introduced by the different parts of the system, for a frequency of 1000 cycles.

*Over-All Performance of System.* A measurement of the transmission loss of the 2200-mi. test length of B-22-N cable circuit gave results as indicated in Fig. 21. It will be observed that over the range from 35 cycles

about - 50 db. at the repeater outputs. The maximum permissible volume was found to be about - 5 db. so that the volume range carrying capacity of the circuit was about 45 db. just a little more than the figure 40 db. which was previously mentioned as a reasonable standard for present-day conditions of broadcasting. If short bursts of music are allowed to go up to the zero

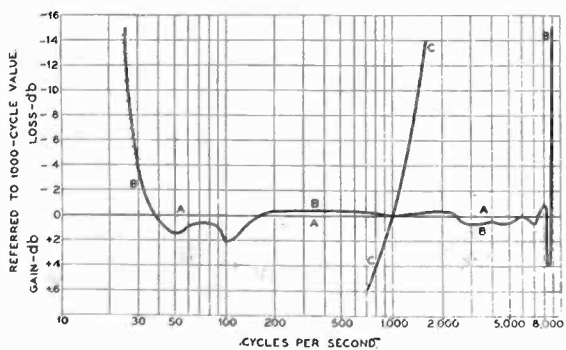

FIG. 21—TRANSMISSION-FREQUENCY CHARACTERISTICS OF 2200 MI. OF 16-GAGE, B-22 CABLE PROGRAM TRANSMISSION CIRCUIT

- Curve A—Ideal characteristic
- Curve B—Measured characteristic
- Curve C—Line without equalizers

to 8000 cycles the transmission loss was practically the same at all frequencies, departing only about  $\pm 2$  db. For comparison, another curve, C, is given on the same drawing, showing the transmission characteristic which would have been obtained if distortionless amplification had simply been added to the line with no attenuation equalizers.

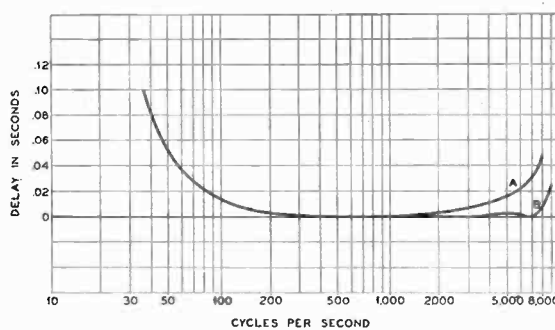

FIG. 22—DELAY CHARACTERISTICS OF 2200 MI. OF 16-GAGE, B-22 CABLE PROGRAM TRANSMISSION CIRCUIT

	Curve	Delay at 1000 cycles
Circuit without delay equalizers . . . . .	A	0.106 sec.
Circuit with delay equalizers . . . . .	B	0.168 sec.

volume at the repeater outputs, the system can evidently handle about 50-db. volume range.

Using special pick-up apparatus and loudspeakers capable of handling practically the whole audible frequency range, tests have been made over the 2200-mi. looped-back circuit in which comparison was made of the transmission with and without the cable included.

When an 8000-cycle low-pass filter was included under both conditions it was found that listeners had considerable difficulty in consistently picking a difference. In fact, the ordinary observer could not be relied upon to pick differences consistently even when the 8000-cycle filter was not included.

#### CONCLUSION

This development was undertaken to provide a system for obtaining satisfactory channels for the transmission of broadcast programs in the rapidly growing cable network of the Bell Telephone System. The time required to complete such a development, and the need

for advance planning in the cable plant, made it essential that the channels be adequate to render service for a number of years. Improvements in broadcast reproduction may be expected to continue and may very well result in changes in the present frequency allocations to give space for wider bands. The cable system described in this paper, therefore, was developed to possess transmission characteristics superior to present-day radio systems, the margin anticipating improvements which may take place in the future.

In the preparation of this paper, the authors gratefully acknowledge the assistance of many of their associates, particularly of Mr. H. S. Hamilton.

## A New Portable Oscillograph

BY CLAUDE M. HATHAWAY<sup>1</sup>

Associate, A. I. E. E.

*Synopsis.*—A knowledge of the wave forms of voltages and currents is often of great value to experimental work or in the analysis of the characteristics of electrical circuits and apparatus. This paper describes a portable oscillograph whereby the wave shapes and phase relations of voltages and currents can be observed and

photographed almost as easily as their effective values can be measured with the ordinary portable instruments. Because of its simplicity of operation, and because the wave shapes can be observed simultaneously by a large group of persons the instrument is of particular value to scientific and engineering schools.

#### INTRODUCTION

THIS paper describes of a new portable oscillograph, developed for directly viewing and photographing the wave shapes of voltages and currents in electrical circuits, either during steady-state conditions or during varying conditions, if the transient state is not of too short duration. Although some of the oscillographs available today have been designed to do this, their primary purpose is for photography during either steady or transient conditions. It is therefore felt that this device is essentially new both in purpose and design, not only because it can better fill its field of application than can the general-purpose instruments, but in addition, because of its greater simplicity and portability.

This oscillograph has been designed to produce sharp and distinct traces of wave shapes on a screen 2½ in. by 3½ in. These traces are sharp enough for small details to be easily examined and are large and brilliant enough so that they may be observed simultaneously by a large group of persons in a darkened room, thus making it particularly useful for classroom demonstration purposes. A film holder is provided for photographing the waves as they appear on the screen.

The design of this oscillograph has removed it from the class of specialized instruments requiring skilled operators, and has made it truly portable. All of the electrical and mechanical parts except the film holder have been placed within the case, the controls being mounted on the panel top. This results in an instru-

ment that is completely self-contained and about as simple and convenient in adjustment and operation as an ordinary portable indicating instrument. The over-all dimensions are approximately 16 in. by 10 in. by 9 in., and the complete oscillograph including the film holder weighs about 27 lb. The power required for

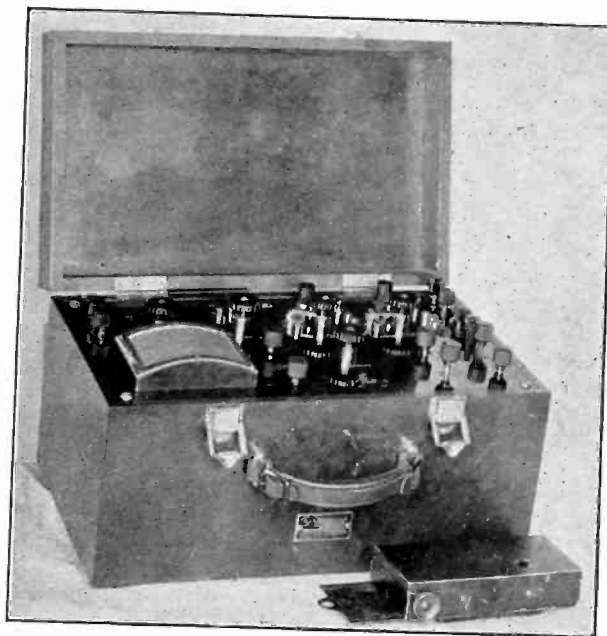

FIG. 1—OSCILLOGRAPH WITH VIEWING SCREEN IN PLACE

operation may be obtained from a lamp socket on any 115-volt a-c. lighting circuit.

#### DESCRIPTION

In Fig. 1 is shown the complete oscillograph with the viewing screen in place at the left end of the top panel. Since the instrument will operate equally well in any

1. General Engineering Laboratory, General Electric Company, Schenectady, N. Y.

Presented at the North Eastern District Meeting of the A. I. E. E., Springfield, Mass., May 7-10, 1930. Printed complete herein.

position, it may be placed on its side as shown in Fig. 2, with the panel and screen in a vertical position. When so placed, the waves on the screen may be seen by an audience of at least fifty persons if the room is sufficiently darkened. For photographing the waves, the screen is removed and the film holder is snapped in its place. (Fig. 3).

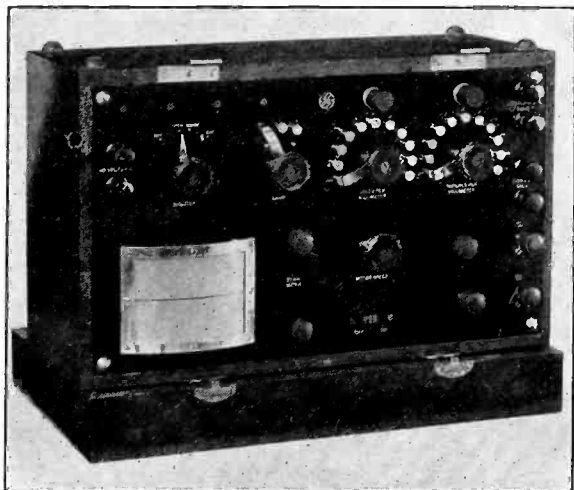

FIG. 2—OSCILLOGRAPH WITH PANEL IN VERTICAL POSITION FOR LECTURE ROOM DEMONSTRATION

This oscillograph is a two-element instrument, designed so that two waves are traced upon the screen in rectangular coordinates simultaneously and in the phase relation to each other that is correct according to convention.

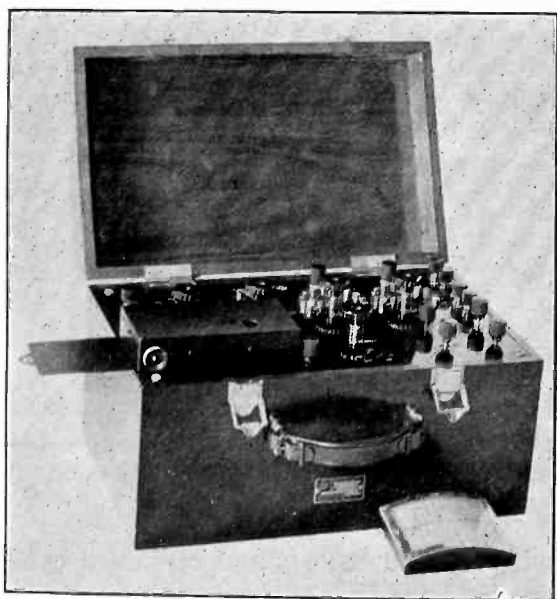

FIG. 3—OSCILLOGRAPH WITH CAMERA IN PLACE

Although the two galvanometers are, themselves, exactly alike and interchangeable, one is intended for voltage measurement and one for current measurement. The potential galvanometer has in series with it within the case, a variable resistor with ten taps brought out to a dial switch on the panel (Fig. 2). Each point of this switch is calibrated in volts per millimeter deflection on the screen. The current galvanometer has shunted

across it within the case, a variable resistor with ten taps brought out to a similar dial switch, each point of which is calibrated in amperes per millimeter deflection on the screen. Without additional series or shunt resistance, the potential galvanometer may be used on circuits up to 250 volts and the current element may be used to measure currents not exceeding seven amperes, these being r. m. s. values. Either element may, however, be used for either current or potential measurements if the proper external shunts or resistors are used.

The elongation of the wave-trace along the time axis is produced by a vibrating plane mirror below the screen, driven through a cam mechanism by a variable-speed a-c. motor. It is, of course, necessary for this mirror to vibrate approximately in synchronism with the phenomena under observation, and this is obtained by adjusting the speed of the motor with a rheostat knob on the panel until the figures on the screen are approximately stationary. Either one cycle or several cycles of a 60-cycle wave may be made to occupy the

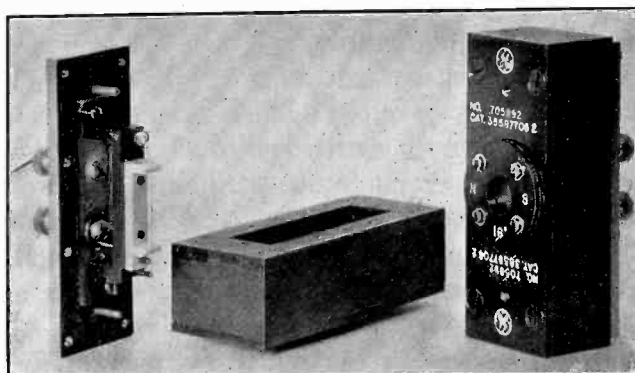

FIG. 4—OSCILLOGRAPH GALVANOMETERS  
One is shown with its vibrator element removed

entire length of the screen, depending on the speed of the motor. This arrangement makes it possible to use the instrument for a wide range of frequencies, and also gives the operator control over the number of cycles visible.

By removing the screen and snapping the film holder in its place (Fig. 3), the waves as viewed on the screen may be photographed at any time for preservation or analysis. An automatic mechanical shutter within the case operates in synchronism with the vibrating mirror in such a way that the beams that trace the curves are allowed to travel only once over the film surface, thus eliminating the necessity for the motor to be operating in synchronism with the phenomena to be photographed when the picture is taken. The shutter is controlled by the knob shown directly above the screen in Fig. 2. For visual use, the shutter is held continuously open and inoperative by turning the control knob to the "open" position. When it is desired to photograph the curves on the screen, the control knob is moved to the "close" position, and the camera put in place. Then, when the knob is moved to the "expose" position, the shutter operates and allows



the beams to trace the curves only once. The shutter mechanism is simple and positive in action at any speed at which it may be desired to operate the motor. The film holder is designed to use standard 2 $\frac{1}{4}$ -in. by 3 $\frac{1}{4}$ -in. roll film, and the roll may be inserted and removed in daylight quite the same as in an ordinary camera. Six exposures may be made with one roll.

The galvanometers used in this oscillograph are of

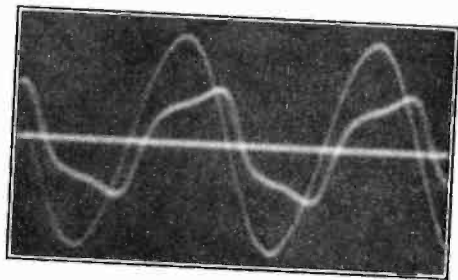

FIG. 5—OSCILLOGRAM OF PRIMARY VOLTAGE AND MAGNETIZING CURRENT IN A TRANSFORMER

the familiar type, consisting of a bifilar suspension stretched tightly across ivory bridges between the poles of a powerful permanent magnet, with a small mirror cemented to the loop midway between the bridges. In this design, the cell-box or cavity in which the vibrator is placed is hollowed out of a block of magnet steel, and the vibrator assembly is attached to a brass plate which is screwed over the opening to the hollow magnet with eight screws. In Fig. 4 is shown both a galvanometer assembled and one with the vibrator removed. Before inserting the vibrator, the cavity is filled with an oil which produces very nearly critical damping of the suspension at normal room temperatures. The vibrator is normally strung to have a natural frequency, undamped, of about 3000 cycles per second; and at this frequency, a current of 60 milliamperes will produce full-scale deflection on the screen of the oscillograph.

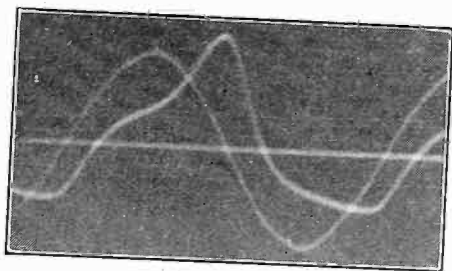

FIG. 6—PRIMARY VOLTAGE AND CURRENT IN A TRANSFORMER WHOSE CORE IS MAGNETIZED BY A DIRECT CURRENT IN THE SECONDARY

In oscillographs employing a beam of light to trace the curves, the optical system is not essentially different from the usual. The light is obtained from a standard 32-cp. automobile headlight which is operated from the same source used to supply power to the motor. By means of a spherical lens and two prisms, an image of the lamp filament is focused upon each galvanometer mirror, and interposed between each prism and galvanometer is an adjustable slit aperture, with provision on the panel for adjusting the width of the slits. The

two knobs to the right of the viewing screen in Fig. 2 are for this purpose. A spherical lens directly in front of each galvanometer focuses an image of its aperture on the screen, and a cylindrical lens between each galvanometer and the screen condenses this image to a small spot. The vibrating mirror below the screen operates in synchronism with a rotating shutter on the motor shaft, and moves the light spots across the screen

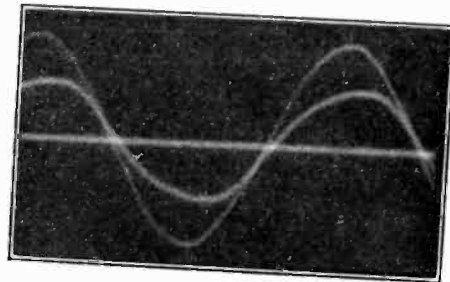

FIG. 7—PRIMARY VOLTAGE AND CURRENT IN A TRANSFORMER WHEN LOADED NON-INDUCTIVELY

from left to right with uniform velocity, thus supplying the element of time or extension to the wave-trace.

#### OPERATION

The steps necessary to put this oscillograph into operation are as follows:

Leads from a lamp socket on a 115-volt a-c. lighting circuit are connected to the proper binding posts to provide power for the lamp and the mirror-driving motor. The voltage and current whose wave forms are to be observed are connected to the potential and current galvanometer binding-posts, respectively. The motor is then brought up to the proper speed, and the amplitudes of the waves adjusted to their desired values.

The waves may be photographed by replacing the

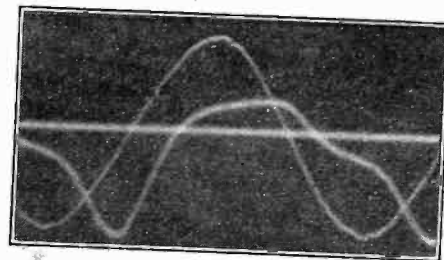

FIG. 8—PRIMARY VOLTAGE AND TRANSIENT MAGNETIZING CURRENT IN A TRANSFORMER IMMEDIATELY AFTER CLOSING THE PRIMARY CIRCUIT

screen with the film holder and operating the shutter control knob.

#### APPLICATIONS

This oscillograph may be used for viewing the wave shapes of currents and voltages just as an operator would use an ammeter or a voltmeter for measuring their effective values. It is therefore generally useful in development work and in testing, and is an adjunct to the larger, general purpose oscillograph.

For demonstrating electrical phenomena in the classroom, its value can hardly be overestimated.

Transient phenomena, such as the establishment of the exciting current in a transformer, may be viewed to show the entire phenomena in a way not otherwise possible. Changes may be made in the constants of circuits and in the conditions under which machines operate, and the resulting effects produced in the wave forms and phase relations of voltages and currents may be simultaneously observed. Fig. 5, for example, is the reproduction of a photograph of the primary voltage and magnetizing current of a transformer taken with this oscillograph, and Fig. 6 shows the results produced in the same transformer by magnetizing the core with a direct current in the secondary. Fig. 7 is the primary voltage and current when the secondary is loaded non-inductively, and Fig. 8 was taken during the transient interval immediately after closing the primary circuit.

## CONCLUSIONS

A new two-element portable oscillograph has been described for showing wave shapes on a screen in rectangular coordinates and in their proper phase relation to each other. Provision has also been made for photographing the curves on the screen. The new features of this instrument include:

1. Compactness and portability, the oscillograph being contained in one case, and weighing about 27 lb.
2. Ease of operation, all controls being readily accessible from the outside.
3. Ability to produce records on a screen that can be seen by a large group of persons.
4. A simple arrangement for photographing the waves as they appear on the screen.

### Abridgment of

# Electric Transmission and Control of Power From Internal Combustion Engines for Transportation

BY S. T. DODD\*

Member, A. I. E. E.

*Synopsis.*—With large internal combustion power plants in transportation service the use of electric transmission is almost a necessity. Furthermore, the interposition of the electric transmission provides a method of obtaining what is the equivalent of a wide change in gear ratio, as well as a cushioning of the characteristic power impulses of the internal combustion engine.

In adapting the internal combustion engine to this character of service there has been a number of problems, such as fitting the generator to the engine curve, the question of hand or automatic control, field control arrangements, single vs. multiple motor drive, and arrangement and operation of auxiliaries.

The use of the combination generator-battery power plant has recently received considerable attention. This application employs a battery operating in parallel with the engine generator power plant, capable of supplementing the power of the engine for short periods.

The characteristics of the engine used in transportation service must be well adapted to the duty required. These characteristics vary somewhat with the size of the unit and the control of the engine throttle is usually adapted to the particular problem in hand.

In this paper, the principal problems connected with the operation and design of complete engine generator units are discussed in detail and many typical schemes of connection are diagrammatically shown. No attempt is made to discuss the question of multiple power plant operation, although this would mean simply the addition of the necessary cross connections to operate the two power plants in parallel; unless, as is sometimes the case, the several power plants are operating independent of each other, each engine generator furnishing power to its own motors. In general, there is given a fairly complete summary of the operation and design of this equipment as now used in American railway practise.

\* \* \* \* \*

WITH any form of motive power, there is required some form of transmission between the prime mover and the driving wheels. With an internal combustion engine, in order to meet the requirements of transportation service, there is required a transmission that offers the possibility of what is equivalent to a change in gear ratio. The necessity for this is almost self-evident; the successive impulses in an internal combustion engine are of an explosive character marked by a wide variation between maximum and minimum pressures; for various engine speeds, the average torque produced at the engine shaft is approxi-

mately uniform. On the other hand, the resistance to be overcome in transportation is due to the movement of trains which develop an approximately uniform resistance at any given speed and cannot well respond to an explosive driving force as produced in an internal combustion engine. The total train resistance, including inertia, grade resistance, and train friction, during the accelerating period may easily be ten times that of the same train when running free on the level. Such a train cannot effectively utilize the torque of a prime mover whose average value is approximately uniform at all speeds. In order to meet conditions varying so widely between the driving force on one hand and the resistance to be overcome on the other, a transmission is required which can deliver at the

\*Transportation Engg. Dept., General Electric Co., Erie, Pa.  
Presented at the Summer Convention of the A. I. E. E., Toronto, Ont., Can., June 23-27, 1930. Complete copy upon request.

driven shaft the output of the engine either in the form of high torque at low speeds or low torque at high speeds, the engine shaft in the meantime running at its normal torque and speed.

### A. VARIOUS FORMS OF TRANSMISSION

The most evident and simplest form of transmission is mechanical gearing between the engine shaft and the driving wheels. This has been used widely in automobiles and trucks where the problem of change in transmitted torque is solved by changing the gear ratio. However, when it comes to applying such transmission to engines of the power, and to trains of the weight

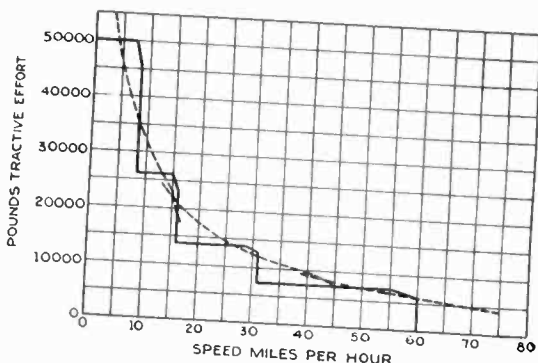

FIG. 1—SPEED-TRACTIVE EFFORT OF DIESEL LOCOMOTIVE

Full line—mechanical transmission  
Broken line—electric transmission

required in railroad service, the disadvantages of the mechanical solution are more evident.

Fig. 1 shows, superposed, the speed-tractive effort characteristics of two 1300-hp. oil engine locomotives. The full line is the characteristic of a locomotive with mechanical transmission. The dotted curve is that of an oil-electric locomotive. The difference in operating results is immediately evident. The mechanical transmission is furnished with four different gear ratios. For each of these, the locomotive develops an approximately constant tractive effort with speeds varying up to the maximum speed set by the maximum rotative speed of the engine. The result of this is that the curve of the mechanical transmission appears as a series of steps corresponding to the different gear ratios. At each of these, the speed of the train is directly proportional to the rotative speed of the engine, the engine shaft and driving wheels being tied together by direct gearing.

### B. ELECTRIC TRANSMISSION

No extensive description of the electric drive is required. With this transmission, the internal combustion engine drives a generator, and the current generated is utilized in motors connected to the driving wheels. By anyone familiar with application of electric power certain features of this transmission will be appreciated at once.

a. There is entire freedom of location of apparatus. The position of the engine, for example, is not dependent upon its relations to the driving axles as is the case where mechanical gearing connects the two.

b. The engine is not subjected to road shocks or inequality of road bed reflected back through the transmission.

c. The location of the operator is independent of the engine. By means of remote control, the locomotive may be operated from any position that may be selected.

d. Since the power of the engine is developed in the form of current and voltage, the same power may be obtained with a wide variation of values of current and voltage, and a correspondingly wide range of tractive effort and speed at the driving motors.

e. This variation of voltage may be gradual through gradually increasing values corresponding to the decreasing values of current, thus obtaining a gradual variation of tractive effort and speed at the driving motors without sudden breaks or fluctuations as illustrated in Fig. 1.

f. The engine speed is not a rigid function of the speed of the train, so that advantage may be taken of idling the engine or of shutting it down with the train coasting at full speed; or, if more efficient, the engine may be driven at normal or even at reduced speed, with the train running at its maximum speed.

### C. ELECTRIC TRANSMISSION PROBLEMS

We have mentioned above the fact that with mechani-

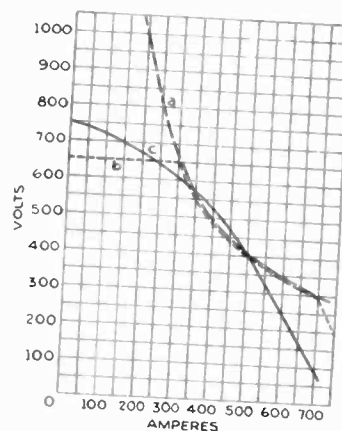

FIG. 3—ELECTRIC TRANSMISSION CHARACTERISTICS

a — — — Engine characteristics  
b - - - - Generator—manual regulation  
c ———— Generator—inherent regulation

cal drive it is possible to utilize the engine horsepower only at a few limited points, while with electric drive it is possible to do so through a wide range of speed and tractive effort, and with a gradual variation from one value to the next. A great deal of thought has been devoted by electrical engineers to the best method of obtaining this result.

*Automatic Differential Control.* Another method of control, which is very widely used and which automatically approximates very closely the desired results, is differential control. The results which can be obtained by this control are shown in Curve *c* of Fig. 3. In this, the inherent regulation of the generator gives it a drooping characteristic so that it does not exceed a maximum given voltage at no-load, nor a maximum

current at full load; nor does it overrun the engine curve so as to overload the engine. A method of connection which has been used to obtain this result is shown in Fig. 5. In this the excitation of the main generator is obtained from a separate exciter mounted on the engine shaft. This separate excitation by itself would give an approximately constant voltage at all loads for a given engine speed. In addition the generator is wound with a differential series field giving it a drooping characteristic. By proper proportioning of

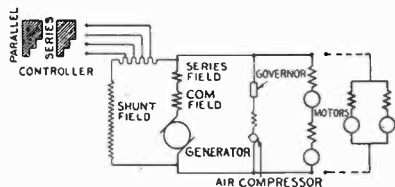

FIG. 4—CONNECTIONS FOR MANUAL CONTROL OF GENERATOR VOLTAGE (SEE CURVE B FIG. 3)

the two fields, the generator characteristic can be made to coincide with the engine curve at one point. If the generator curve slightly exceeds the engine curve, the result will be that the engine will slow down, thus reducing the voltage coordinates of the characteristic and giving it a slightly concave shape at this point. In any event, the regulation of the engine governor has an important influence. If the generator curve just touches the engine curve and loads the engine at one point, the engine will carry less than its full load at points to one side and the other of the full-load point.

*Full Utilization of Engine Power.* Where a still wider utilization of the engine power is desired, some automatic means of progressively varying the generator field must be employed. Referring again to Fig. 4, which shows the simplest form of connection, in order to keep the engine fully loaded at all times, the excitation

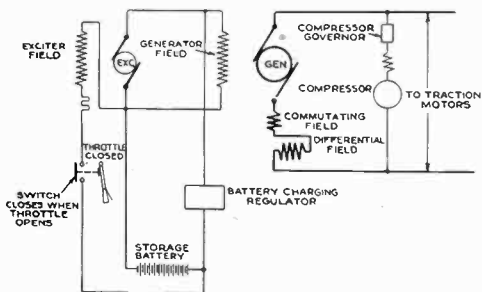

FIG. 5—CONNECTIONS FOR DIFFERENTIAL CONTROL OR INHERENT REGULATION OF GENERATOR VOLTAGE (SEE CURVE c FIG. 3)

of the generator must be controlled by some automatic means thus automatically reproducing the action of a competent and careful engineer. The relay or other device used for this purpose can be arranged to vary the field current to maintain a constant value of any one of several functions. For example, to maintain in one case a constant value of kilowatt output, or, in the other case, a constant speed such a device might be operated in connection with a wattmeter or a speed indicator; or with some other device, to maintain a

constant value of some other function. As a matter of practise, the generator is made separately excited rather than self-excited as shown in Fig. 4. This maintains the field strength for each setting of the rheostat more accurately and definitely than could be obtained by self-excitation. Fig. 12 shows the connections for such a control in which the excitation of the main generator is taken from the auxiliary generator through a rheostat with resistance automatically controlled. (See complete paper.)

Whether any plan for full utilization is to be recommended depends upon economic considerations. It is obvious that with the best utilization the voltage on one hand and the armature current on the other is limited by generator design. Whether or not the addition of the devices necessary to obtain any form of automatic field control is justifiable, as compared with those required for the simple inherent characteristics of the so-called differential control, can be decided only by economic considerations such as price, cost of maintenance, and the results of practical operation.

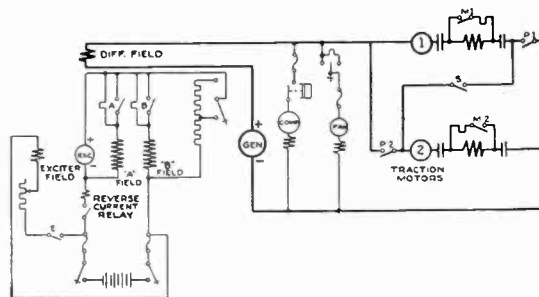

FIG. 7—CONNECTIONS FOR DIFFERENTIAL CONTROL WITH VOLTAGE REGULATION APPLIED TO EXCITER

The idling speed of an oil engine is approximately 50 per cent of its normal speed and it is perfectly feasible to design an auxiliary generator of sufficient capacity to hold its full voltage down to half speed. A gasoline engine, however, frequently has an idling speed of 20 per cent of its full speed, and an auxiliary generator with capacity for holding full voltage down to 20 per cent of its full speed would involve a serious increase in weight and dimensions.

A number of combinations has been suggested: One is operating the auxiliaries from the low-voltage auxiliary generator during full speed, and shifting the connections to the main generator in order to take advantage of whatever voltage it may develop during idling. Other combinations of circuits have been proposed with the general intention of utilizing what voltage is available at reduced speeds. None of these combinations being of wide practical application, we have not discussed or illustrated the details of the connections. Still other combinations of circuits to obtain similar results will suggest themselves to others interested in the subject.

The plans discussed above readily indicate that the ideal arrangement for handling auxiliaries would be one



in which they are entirely independent of the main generator. In other words, by the installation of a separate engine for handling the auxiliaries at constant speed and constant voltage. If, in combination with this, automatic control of the speed of the main engine is installed, we would have an arrangement that would be applicable in all cases, either to locomotive or car equipments where the capacity and cost of the equipment or the exacting demands of the service make it economically advisable.

**Combination Generator-Battery Power Plant.** A form of electric transmission which presents some striking advantages and which seems to have a wide application is the use of a storage battery in parallel with the main generator. Fig. 16 shows a diagram of connections for such an equipment, and it will be noted that the arrangement of the equipment is radically altered by the introduction of the battery.

As the excitation and all auxiliary operation is taken from the battery, no exciter is required.

The generator operates at a constant speed and approximately constant voltage as required for battery charging.

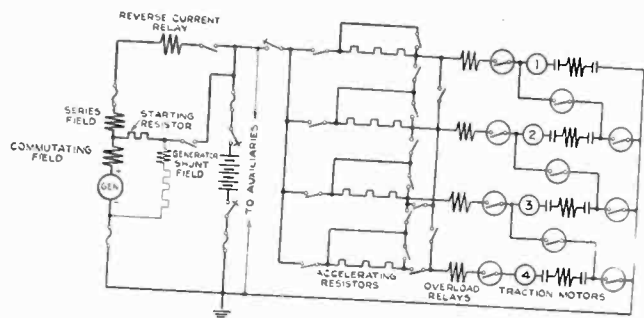

FIG. 16—CONNECTIONS FOR COMBINATION GENERATOR-BATTERY POWER PLANT

The battery carries all the peak loads, leaving the generator and engine to carry a fairly uniform load. The generator load is added to the battery output in periods of high demand and is expended in charging the battery when the load falls off. This uniform load and high load factor is apparent in its effect on the fuel efficiency and engine maintenance.

Since the battery maintains an approximately constant voltage, the control is of the constant potential type similar to that on equipments using trolley or other constant potential source of power. In general, the equipment and its control is so similar to trolley control and operation that it would not be mentioned in this paper except that it illustrates one of the combinations which are used in transforming the power of an internal combustion engine into power for traction purposes.

#### ENGINE CHARACTERISTICS AS AFFECTING ELECTRIC EQUIPMENT

Up to this point, the discussion has confined itself to control of the power transmitted at full output of the engine. It is necessary also to operate and control

such an equipment at reduced output either during acceleration or during operation of trains at reduced speeds. The features of the electric control for such reduced power are conditioned largely on the engine characteristics and control. It is necessary to distinguish therefore between engines for constant speed and engines for variable speed; and between engines of different capacity.

With an engine designed for constant speed, the control of the train speed is necessarily by control of the generator voltage. This type of engine, running at a constant speed with voltage control, has not been widely used in this country, although it is used in Europe.

The equipment used in this country generally obtains reduced output and control of the train speed by varying the engine speed. While this is true in a general sense, the problem presented varies with the type of engine. It is frequently stated as a fact that the torque of an internal combustion engine is approximately constant. Whether the electric equipment is to be adjusted to take advantage of this torque depends on the design of the engine.

**Small Engines.** For small engines, such, for example, as are used on busses, the full torque of the engine is generally available at all engine speeds. The bus generator is therefore designed to deliver a torque equal to the full torque of the engine within normal operating limits which may be from 75 per cent to 100 per cent of full speed. The generator can therefore absorb the full torque of the engine at full speed. By over-excitation of the generator, this torque can be raised so as to cut the torque at still lower speeds, and this is a method very generally used on such equipments.

As a general thing, the following represents the sequence of acceleration and operation of such an equipment:

The bus is accelerated at full engine speed and full load, which is obtained by a partially excited field. After the full running speed has been obtained, the generator is excited to its full excitation, the increased torque on the generator pulls down the engine speed, and a balance is obtained with the engine at perhaps 75 per cent of its full speed driving the generator at full voltage with full field. When more power than this is desired the generator field is weakened, allowing the engine to come up to full speed and full horsepower. In other words, it may be said that with an engine of this sort, it is possible to operate the torque of the generator balanced directly against the maximum torque of the engine at that speed. This scheme of operation can be used only with an engine of such design that the generator torque may be allowed to absorb all the torque of the engine.

For electric transmission, it would be preferable to have a constant torque of the engine within the range of operation, and one which did not fall off with increasing speeds.

**Large Engines.** With engines as they are designed

today we find that when we reach a certain capacity, the engine designers raise objection from the standpoint of excessive pressure on engine bearings, excessive temperatures of exhaust gases, danger of pre-ignition and other features disastrous to an electric equipment which will absorb the full torque possible from the engine at reduced speeds. If such a requirement is to be met, the field and torque of the generator must be modified to correspond to the desirable engine torque. This will be done generally by operating a section of the generator field rheostat in connection with the engine control handle, so as to change the generator field simul-

taneously with the engine speed. To what that reduction amounts and the characteristics of the equipment at various speeds depends entirely on the engine design.

*Engine Control.* In connection with the combination of engine and generator, the generator characteristics are affected by the question of whether the engine speed is controlled by the throttle or by adjustment of the governor. In one case, the fuel supply is limited to hold down the maximum horsepower output but the engine at light load runs up to its full speed; in the other case, the speed is maintained at any step of the control, independent of load.

### Abridgment of

# The Calculation of Alternator Swing Curves

## The Step-by-Step Method

BY F. R. LONGLEY\*

Associate, A. I. E. E.

*Synopsis.*—The paper is intended to give a thorough explanation of step-by-step calculations of the synchronous rotor oscillations and other transients which occur in electrical power systems when faults or other sudden changes take place. It is divided essentially into two parts. In Part I a descriptive illustration of the phenomena is given in order that the reader may visualize the conditions. In Part II general formulas are developed for calculations where any

number of salient or non-salient pole machines are operating at various points on an impedance network. In Appendix I (complete paper) a special and simplified example is set up and analyzed. In Appendixes II and III the numerical calculations of the swing curve for the special example in Appendix I are given, and a brief discussion is offered on the accuracy of this step-by-step method of calculation.

### Part II

#### DEVELOPMENT OF GENERAL SWING CURVE FORMULAS

*The Impedance Network of the System.* A balanced three-phase shunt impedance may be switched across a three-phase circuit at any point where a fault is considered to occur, producing a flow of balanced three-phase power which is exactly equal in magnitude to the flow of power, balanced or unbalanced, resulting from a balanced or unbalanced fault. By the method of "Symmetrical Components"<sup>3,4</sup> any set of three-phase currents or voltages, balanced or unbalanced, can be divided into three sets of three-phase symmetrical components. One set is balanced and revolves in a positive direction (the positive-phase sequence components); the second is balanced and revolves in a positive direction with the sequence of the phases reversed (the negative-phase sequence components). In the third set all three vectors are equal in magnitude and lie in the same phase position (the zero-phase sequence components). They revolve in a positive direction.

Under balanced conditions the negative and zero-phase sequence components are zero.

\*Western Massachusetts Companies, Springfield, Mass., (Formerly of the General Electric Co., Schenectady, N. Y.)  
3. For all references see Bibliography, complete paper.

Presented at the North Eastern District Meeting of the A. I. E. E., Springfield, Mass., May 7-10, 1930. Complete copy upon request.

Each of the three sets of components meets its own particular impedances in the network joining the machines resulting in three distinct types of networks.

The total electrical power is the sum of that produced by the positive-phase sequence current flowing in the positive-phase sequence network, the negative-phase sequence current flowing in the negative-phase sequence network, and the zero-phase sequence current flowing in the zero-phase sequence network.

The balanced network which gives a flow of power equal in magnitude to that resulting from a fault, balanced or unbalanced, is obtained by placing a balanced three-phase impedance  $Z$  at the point of fault.

Where

$$Z = Z_n + Z_z \quad (4)$$

if the fault is from one conductor to ground.

$$Z = Z_n \quad (5)$$

if the fault is between two conductors.

$$Z = \frac{Z_n Z_z}{Z_n + Z_z} \quad (6)$$

if the fault is from two conductors to ground.

$$Z = 0 \quad (7)$$

if the fault is between all three conductors.

$Z_n$  = Total negative-phase sequence impedance of the system, viewed from the point of fault.

$Z_0$  = Total zero-phase sequence impedance of the system viewed from the point of fault.

The Relations between the Electrical Quantities of All Machines on the Network. The excitation voltage  $e_1$  of an alternator is the voltage "behind" the synchronous impedance of the machine projected on the quadrature axis. It is the voltage which would be generated at no load and no saturation when the load field current flows in the rotor winding. It is proportional to the field current  $I$  and in percentages it is equal to the field current  $I$ . Likewise  $e_Q$  is the voltage "behind" the quadrature impedance projected on the quadrature axis, and  $e_\psi$  is the voltage "behind" the transient impedance projected on the quadrature axis.

The direct component  $\psi_d$  of the field flux linkages is proportional to  $e_\psi$ .

The slip-ring voltage is  $E$ .

The stator terminal voltage is  $e$ .

The stator current is  $i$ . Its projection on the quadra-

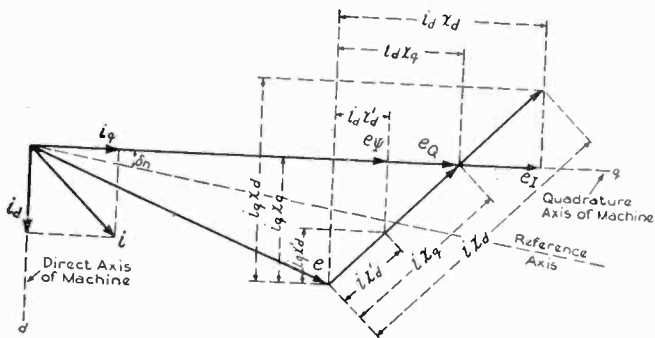

FIG. 8—VECTOR DIAGRAM OF STATOR VOLTAGES AND CURRENT OF A SYNCHRONOUS ALTERNATOR

ture axis is the quadrature component  $i_q$  and its projection on the direct axis is the direct component  $i_d$ .

Unit terminal voltage may be any value decided on but is usually taken as the rated voltage of the machine.

Unit field current is the field current which will produce unit stator voltage at unit speed (taken here as rated speed of the machine) at no saturation and at no load.

Unit field flux linkage is the field flux linkage which will produce unit stator voltage at rated speed and at no load.

Unit slip-ring voltage is the slip-ring voltage required to give unit field current under steady-state conditions.

Unit power is the base power selected.

Fig. 8 is a vector diagram showing voltages and currents for any one machine. Its quadrature axis is designated by  $q$  and its direct axis is designated by  $d$ . The diagram is a true time diagram of stator voltages and currents, and is sufficient to calculate the flow of power into or out of any of the machines on the network.

The machines are assumed to have zero time constants in their quadrature axes.

Consider any  $s$  number of synchronous machines connected to an impedance network and let the ma-

chines be designated by the numbers 1, 2, 3, 4 . . .  $s$ .

Currents flowing from a machine will be taken as positive while currents flowing into a machine will be taken as negative.

The subscripts have the following significances:

When one subscript only occurs it designates the machine to which the quantity having the subscript applies.

For stator currents  $i$  the first subscript designates the machine from which the current is flowing while the second subscript designates the machine into which the current is flowing. For impedances  $Z$  two duplicate subscripts designate the driving point impedance of the machine designated by the subscripts, while two unlike subscripts designate the transfer impedance between the machines designated by subscripts.

The driving point impedance is the total impedance of the system from the point taken. The transfer impedance is the impedance between any two machines. Thus  $Z_{11}$  is the driving point impedance of machine No. 1, while  $Z_{21}$  is the transfer impedance between machines 1 and 2.

A rotor angle  $\delta$  having only one subscript is the angle between the rotor axis of the machine designated by the subscript, and the reference vector. A rotor angle  $\delta$  having two subscripts is the angle between the rotor axes of the two machines designated by the two subscripts and is mathematically equal to the angle between the rotor of the machine designated by the first subscript and the reference vector, minus the angle between the rotor of the machine designated by the second subscript and the reference vector.

The angle  $\theta$  is an impedance angle and the subscripts of  $\theta$  are the same as those of the impedance  $Z$  to which  $\theta$  applies.

The movement of the rotor of each machine will be measured from some arbitrary reference vector.

Formulas will be written for the  $n$ th machine.

From Fig. 8 the following relations may be obtained.

$$e_{Qn} = e_{1n} - (x_{dn} - x_{qn}) (i_n \cdot d_n) q_n \quad (8)$$

where  $d_n$  and  $q_n$  are unit vectors along the direct and quadrature axes respectively of machine  $n$ .

$$e_{\psi n} = e_{1n} - (x_{dn} - x_{dn}') (i_n \cdot d_n) q_n \quad (9)$$

Combining (8) and (9)

$$e_{\psi n} = e_{Qn} - (x_{qn} - x_{dn}') (i_n \cdot d_n) q_n \quad (10)$$

The stator currents<sup>s</sup> are

$$i_n = -i_{1n} - i_{2n} \dots + i_{nn} \dots - i_{sn} \quad (11)$$

where

$$i_{mn} = \frac{e_{Qm}}{Z_{mn}} \quad (12)$$

Since  $e_Q$  exists only along the quadrature axis we may also write

$$e_{Qn} = (e_{Qn} \cdot q_n) q_n \quad (13)$$





$$\Delta S_{(n-1/4)} = \frac{\Delta t}{2M} (T_1 - T_{en'}) \quad (38)$$

and

$$\Delta S_{(n+1/4)} = \frac{\Delta t}{2M} (T_1 - T_{en''}) \quad (39)$$

where  $T_1$  is the mechanical torque applied to the shaft at the instant  $n$ .

At the instant  $(n + 1/2)$  the speed is:

$$S_{(n+1/2)} = S_{(n-1/2)} + \Delta S_{(n-1/4)} + \Delta S_{(n+1/4)} \quad (40)$$

Substituting (38) and (39) in (40)

$$S_{(n+1/2)} = S_{(n-1/2)} + \frac{\Delta t}{M} \left( T_1 - \frac{T_{en'} + T_{en''}}{2} \right) \quad (41)$$

The rotor angle  $\delta$  at the instant  $n + 1$  is:

$$\delta_{(n+1)} = \delta_n + \Delta \delta_{(n+1)} \quad (42)$$

Where  $\Delta \delta_{(n+1)}$  is the increase in  $\delta$  at the instant  $(n + 1)$

The average speed between the instants  $n$  and  $(n + 1)$  is:

$$S_{(n+1/2)} = \frac{\Delta \delta_{(n+1)}}{\Delta t} \quad (43)$$

which is the slope of the angle time curve between the instants  $n$  and  $(n + 1)$ .

Rearranging (43)

$$\Delta \delta_{(n+1)} = (\Delta t) S_{(n+1/2)} \quad (44)$$

Substituting (41) in (44)

$$\Delta \delta_{(n+1)} = (\Delta t) S_{(n-1/2)} + \frac{(\Delta t)^2}{M} \left( T_1 - \frac{T_{en'} + T_{en''}}{2} \right) \quad (45)$$

From (44)

$$\Delta \delta_n = (\Delta t) S_{(n-1/2)} \quad (46)$$

Substituting (46) in (45)

$$\Delta \delta_{(n+1)} = \Delta \delta_n + \frac{(\Delta t)^2}{M} \left( T_1 - \frac{T_{en'} + T_{en''}}{2} \right) \quad (47)$$

Since all terms in (47) are per unit quantities the term  $\frac{(\Delta t)^2}{M} \left( T_1 - \frac{T_{en'} + T_{en''}}{2} \right)$  is a per unit angle.

Unit angle is the electrical angle through which the rotor moves at normal or unit speed in unit time or one second. Hence:

$$\text{Unit angle} = 360 f \text{ degrees} \quad (48)$$

where  $f$  = normal frequency.

If (47) is to be in degrees we have from (48),

$$\Delta \delta_{(n+1)} = \Delta \delta_n + \frac{360 f (\Delta t)^2}{M} \left( T_1 - \frac{T_{en'} + T_{en''}}{2} \right) \quad (49)$$

Letting

$$\frac{360 f (\Delta t)^2}{M} = k \quad (50)$$

(49) becomes:

$$\Delta \delta_{(n+1)} = \Delta \delta_n + k \left( T_1 - \frac{T_{en'} + T_{en''}}{2} \right) \quad (51)$$

It is convenient to let the accelerating torque  $\left( T_1 - \frac{T_{en'} + T_{en''}}{2} \right)$  in (51) be

$$\left( T_1 - \frac{T_{en'} + T_{en''}}{2} \right) = T_{an} \quad (52)$$

and (51) becomes:

$$\Delta \delta_{(n+1)} = \Delta \delta_n + k T_{an} \quad (53)$$

When there is no discontinuous change in  $T_{en}$  we have  $T_{en} = T_{en'} = T_{en''}$  and (52) becomes  $(T_1 - T_{en})$ , whence (51) becomes:

$$\Delta \delta_{(n+1)} = \Delta \delta_n + k (T_1 - T_{en}) \quad (54)$$

The swing starts as the result of a discontinuous change in  $T_{en}$ . Under these conditions  $\Delta \delta_n = \Delta \delta_0 = 0$ ,  $T_{en'} = T_1$ ,  $T_{en''} = T_{en}$ , and  $\Delta \delta_{(n+1)} = \Delta \delta_1$ , whence (51) becomes

$$\Delta \delta_1 = \frac{k}{2} (T_1 - T_{en}) \quad (55)$$

Any change in the governor position changes  $T_1$  and  $T_1$  may be altered accordingly if the governor characteristics are known. If electrical damping occurs, such as would be produced by an amortisseur winding, it may be included as shown by R. H. Park and E. H. Bancker in Appendix XII of Bibliography 2. The derivations of (54) and (55), which are special forms of (51), are also given in Appendix XII of Bibliography 2. (For Appendixes see complete paper.)

In calculating the swing curve (55) is used for the first step, (54) is used for subsequent steps until switching or the removal of the fault, or both take place, when (51) is used for the first step following the change in  $T_{en}$ , after which (54) is used again in the subsequent steps until another discontinuous change takes place in  $T_{en}$  when (51) is again used as described above, and so on.

*Procedure for the Calculation of the Swing Curves.*  
The procedure for making a step-by-step calculation may be summed up as follows:

I. Determine  $e_{Q1} e_{Q2} \dots e_{Qs}$  and  $\delta_1 \delta_2 \dots \delta_s$  from steady state conditions before the fault is applied in the same manner that steady state voltages are usually found, considering that  $e_Q$  is the voltage existing behind the quadrature reactance of the machine.

II. Find  $e_{\psi n}$  before the fault is applied from Equation (20).

III. Apply fault and determine new driving point and transfer impedances.

IV. Determine new value of  $e_{Qn}$  from (28), letting  $e_{\psi n}$  remain constant and using new values of impedances. Later when this step is repeated after an angle change

the new angles are used instead of the new impedances.

V. Find  $T_{en}$  from (22) using  $e_{Qn}$  just obtained.

VI. Determine  $e_{In}$  from

$$e_{In} = e_{Qn} \left( \frac{x_{dn} - x_{dn}'}{x_{qn} - x_{dn}'} \right) - e_{\psi n} \left( \frac{x_{dn} - x_{qn}}{x_{qn} - x_{dn}'} \right) \quad (56)$$

This formula is obtained by combining (8) and (9)

VII. Calculate change in  $e_{\psi n}$  from

$$\Delta e_{\psi n} = \frac{(E_n - e_{In}) \Delta t}{T_{on}} \quad (57)$$

where  $\Delta t$  is the increment of time used for one step;  $E_n$  is the average slip ring volts, during the  $\Delta t$  considered;  $e_{In}$  is the value of the synchronous stator voltage at the beginning of the  $\Delta t$  considered;  $T_{on}$  is the open circuit time constant of the machine; and  $\Delta e_{\psi n}$  is the change which takes place in  $e_{\psi n}$  during the  $\Delta t$  considered.

This formula<sup>9</sup> comes directly from the well known relation that the applied voltage is equal to the resistance drop plus the inductive drop, the quantities being all in per unit values.

VIII. Calculate new value of  $e_{\psi n}$  from  $e_{\psi n}$  found in II and  $\Delta e_{\psi n}$  found in VII.

$$e_{\psi n} = e_{\psi n} + \Delta e_{\psi n} \quad (58)$$

new II. VII.

IX. Calculate change in angle from (55). The other angular changes are to be calculated as explained in the discussion of (55), (54), and (51).

X. Allow the angle to shift and repeat IV to X.

Appendices I and II of the paper will be devoted to illustrating the procedure by means of a special example. The general procedure is modified in this special case for convenience in illustrating fully each step.

#### ACKNOWLEDGMENT

The author wishes to acknowledge the valuable assistance of Mr. I. H. Summers. Certain especially valuable improvements were made by Mr. Summers in the general formulas of Part II which simplify their derivation, and form, and reduce the amount of labor required in their use. The author also wishes to thank Mr. R. H. Park for his interest and suggestions and Mr. R. G. Lorraine for his assistance.

#### Abridgment of

# Mutual Impedances of Ground Return Circuits Some Experimental Studies

BY A. E. BOWEN\*

Non-member

and

C. L. GILKESON†

Associate, A. I. E. E.

**Synopsis.**—This paper describes some of the results of the work of the Joint Development and Research Subcommittee of the National Electric Light Association and Bell Telephone System on the mutual impedances of ground return circuits.

The first part of the paper deals with some experiments which were performed to establish an experimental background for the testing of theoretical ideas. Different theories, one involving an "equivalent ground-plane," a second, a d-c. distribution in the earth, and a third, an a-c. distribution in the earth, are discussed in the light of the experimental results. While none of these is adequate to explain all the

observed phenomena, each has a field in which it can be made useful

The second part of the paper is devoted to a description of practical means for predetermining the mutual impedances of power and telephone lines. This involves an experimental determination of a curve of mutual impedance as a function of separation in the region of the proposed exposure and the calculation of the over-all mutual impedance between the proposed lines from this curve and the dimensions of the exposure. The results of trials of this method in two locations are given indicating that it should be of sufficient accuracy for engineering purposes.

#### INTRODUCTION

THE magnitude of the inductive coupling between power and telephone lines is a factor of fundamental importance in problems of coordination of these two classes of lines to prevent interference. Accordingly, this is one of the subjects under investigation by project committees of the Joint Committee on Development and Research of the National Electric Light Association and the Bell Telephone System. It is the purpose of this paper to present the results of some work which has been done under the auspices of the committee on one phase of this problem; namely, the mutual impedance of ground return circuits.

\*Am. Tel. & Tel. Co., New York, N. Y.

†N. E. L. A., New York, N. Y.

Presented at the Summer Convention of the A. I. E. E., Toronto, Ont., Canada, June 23-27, 1930. Complete copy upon request.

The mutual impedance of two ground return circuits in one circuit and the open-circuit voltage at the terminals of the second circuit. The vector ratio of the open-circuit voltage to the ground return current is then defined as the mutual impedance of the two circuits.

For any normal or abnormal operating condition of a power system, the currents either at fundamental frequency or at any harmonic frequency in any of the lines can be resolved into components, some of which are entirely confined to the wires while another component flows in a circuit composed of all the wires as one side with the ground as a return path. The work which is described in this paper deals with the magnitude of the induced voltages on exposed telephone lines caused by the latter component. The work is presented in two parts, the first giving the results of tests made at a field

laboratory, and then tests in which the practical side of the problem was investigated are described.

CROSS KEYS TESTS—THEORETICAL BACKGROUND

*Cross Keys Tests.* An extended series of measurements were made at a field laboratory near Cross Keys, New Jersey. A magnetic field was set up by sending a current over a single-conductor line approximately 8500 ft. in length, which used the earth as a return conductor. The voltages induced in a number of circuits parallel to this line were measured. These

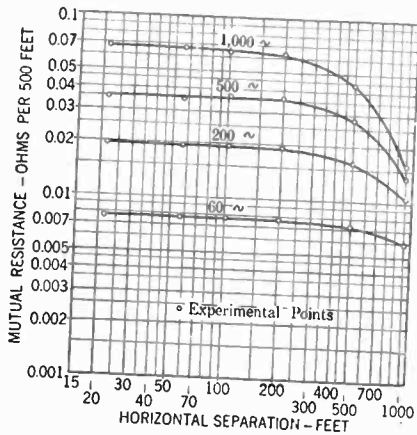

FIG. 2—CROSS KEYS TESTS—MUTUAL RESISTANCE

exploring circuits consisted of single insulated wires with ground return about 500 ft. in length at separations from the disturbing line varying from 20 to 1000 ft. These wires were placed near the center of the disturbing line. The frequency of the disturbing current covered a range from 60 to 1000 cycles.

The more important conclusions which may be drawn from these measurements are summarized as follows: (See Figs. 2 and 3)

1. The mutual impedance between ground return circuits consists of both a resistive and reactive component. The resistive component is of considerable importance at the wider separations.
2. The mutual inductance is a function of separation and frequency of the disturbing current, decreasing as the separation and frequency are increased. The mutual resistance decreases rather slowly with increase in separation, but increases with frequency.
3. At close separations the angle between the induced voltage and the disturbing current is about 80 deg., and decreases with increased separation.
4. The voltage induced in an exploring wire is closely proportional to its length.
5. The voltage induced in an exploring wire perpendicular to the disturbing circuit is practically negligible.

In addition to the measurements of induced voltage on exploring wires near the center of the line, measurements were also made in the vicinity of one of the grounding points of this line. These exploring wires were made so short that the gradient of the mutual impedance was determined. Measurements were made on three radii diverging from the grounding point, one radius being directly under the disturbing line, the second perpendicular to it, and the third along the

extension of the line. The result of these measurements may be summarized as follows:

1. In the immediate vicinity of the ground, the gradient is very steep and approximately equal along the three radii.
2. Along the radius under the power line, the gradient approaches the value of induced voltage per unit length found near the middle of the line; along the other two radii, however, the voltage gradient continues to decrease indefinitely.
3. In the immediate vicinity of the ground, the mutual impedance is almost entirely resistive. Along the radius under the power line, this angle increases very rapidly, approaching asymptotically the value under the middle of the line. Along the other two radii the angle remains small.

*Equivalent Ground Plane Theory.* A derivation and discussion of the equivalent ground-plane formula together with some experimental results are given in the report published by the California Railroad Commission in 1919.<sup>1</sup> This method assumes that the returning earth current may be considered as flowing in a hypothetical plane surface of perfect conductivity located some distance below the actual surface of the earth. The depth of the equivalent ground plane below the actual surface of the earth varies in different locations from about 50 ft. to 5000 ft. or more, depending upon the character and resistivity of the earth and the frequency.

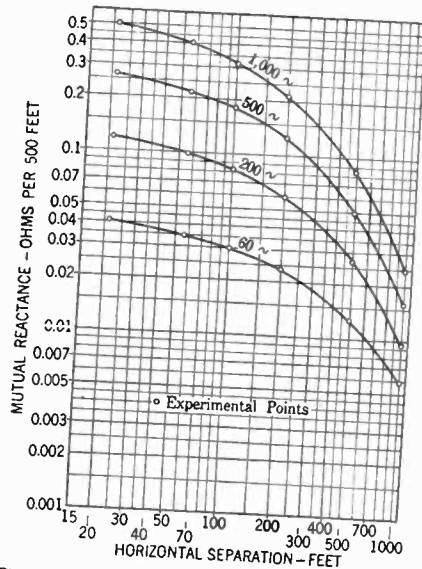

FIG. 3—CROSS KEYS TESTS—MUTUAL REACTANCE

A comparison of values computed by the formula with the observed results indicate the following interesting points. (See Fig. 7)

1. If the depth of the ground plane is properly chosen, this formula may be used to calculate magnitude of induced voltage with a reasonable degree of accuracy.
2. It is inadequate as a complete explanation of the observed phenomena for it does not consider mutual impedance as made up of a resistive and reactive component. A further objection is that the depth of ground plane must be changed for each frequency.

It should also be noted that the ground plane theory is not designed to handle "end effects."

1. For all references see Bibliography, complete paper.

*Method Assuming D-C. Distribution in the Earth.* For an earth of uniform conductivity, the distribution of the current in the earth for a ground return circuit energized from a d-c. source has been employed to derive formulas for the mutual resistance and inductance of ground return circuits. The mutual resistance is expressed by a formula which involves only the earth resistivity and the distances between the points of ground connection. For the calculation of the mutual inductance, formulas and graphs re-

writers.<sup>3</sup> In the interpretation of the experimental results, the papers of J. R. Carson<sup>4</sup> and F. Pollaczek<sup>5</sup> have been used. Physically this method recognizes and takes into account the fact that in a conductor of large extent, such as the earth, the distribution of alternating current will be influenced by the changing magnetic field. Qualitatively the effects are similar to those involved in the well-known skin effect, and may be thought of in terms of a distribution of eddy currents in the earth. It is obvious that the distribution of the eddy currents will depend on the earth conductivity and also on the frequency. The resultant fields, and hence the mutual impedances, will then be functions of earth conductivity and of frequency.

Fig. 13 shows a comparison between the experimental and theoretical values of mutual impedance at 60 and 500 cycles, the computations being made using the formula given by Carson. It will be seen that with the proper choice of earth conductivity there is excellent

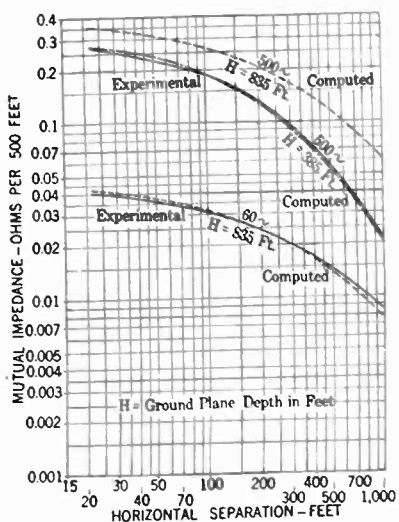

FIG. 7—CROSS KEYS TESTS GROUND PLANE THEORY

Comparison of measured and calculated values of mutual impedance

quiring only a knowledge of the mutual arrangement of the wire parts of the disturbing and disturbed circuits with respect to each other and the earth are given.

A comparison of the observed results and calculations based upon Campbell's formula may be summarized as follows:

Exposures which are not affected by conditions in the Vicinity of the grounding point.

1. Since this formula is based upon the assumption of d-c. distribution it obviously cannot represent the changes in either the mutual resistance or inductance which are observed to be dependent upon the frequency of the disturbing circuit.

2. The mutual inductance approaches the value calculated from this formula as the frequency is decreased, but even at 60 cycles the agreement between observed and calculated values is quite poor.

*Exposures in the Immediate Vicinity of the Grounding Point.* The qualitative agreement between the ob- quite good. The discrepancy in the quantitative values can be explained on the basis of a non-homogeneous earth. Comparison indicates a stratified earth, with an upper layer of very poor conductivity, and a lower layer of excellent conductivity.

*Methods Considering A-C. Distribution of Earth Current.* The problem of computing the mutual impedance of ground return circuits, considering an a-c. distribution in the earth, has been attacked by several

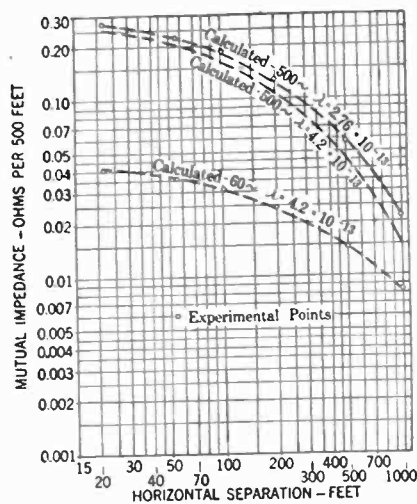

FIG. 13—CROSS KEYS TESTS—CARSON THEORY

Comparison between calculated and measured values of mutual impedance

agreement between the measured and the calculated values of mutual impedance. However, to get the

TABLE I

CROSS-KEYS TESTS

Earth Conductivity Giving Best Agreement Between Calculated and Measured Values of Mutual Impedance

Frequency cycles	Indicated earths conductivity from Carson's formulas abmhos per cm. cube
60	$4.2 \times 10^{-13}$
200	$3.75 \times 10^{-13}$
500	$2.76 \times 10^{-13}$
1000	$2.0 \times 10^{-13}$

best agreement at each frequency it is necessary to change the value of earth conductivity. Table I shows

3. References 3 to 9.
4. Reference 7.
5. Reference 6.
6. Reference 9.



the value of earth conductivity which gives the best fit between the observed and calculated values at the various frequencies. This variation of earth conductivity with frequency is such as to suggest a stratified earth with an upper layer of poor conductivity and a lower layer of good conductivity.

Carson's work has been extended to include the case of a stratified earth. An approximation to the present condition may be obtained by considering that the upper layer carries no current. Such calculations have been carried out for this particular location and have shown excellent agreement between the observed and theoretical values.

A comparison of observed values of mutual impedance with values calculated from Carson's formulas indicates the following:

1. Carson's formulas give an adequate explanation of the observed phenomena when the disturbed circuit is sufficiently removed from points of grounding of the disturbing circuit as not to be influenced by them.
2. The qualitative agreement is good, as is also the quantitative agreement, when correction is made for the stratified earth. As in the case of the ground plane theory, it is to be noted that this formula does not apply in the region near the ends of the disturbing circuit.

#### PRACTICAL METHODS FOR PREDETERMINING COUPLING BETWEEN POWER AND TELEPHONE LINES

The ultimate purpose of this phase of the work of the committee is to develop simple methods to enable the calculation of the mutual impedance between power and telephone circuits before they are built. From the foregoing discussion, it is evident that the use of any formula for the mutual impedance of ground return circuits requires a knowledge of the conductivity of the earth or of the depth of the equivalent ground plane. In the relatively few places in which tests have been made, a range of earth conductivity from  $10^{-12}$  to  $10^{-14}$  abmhos per cm. cube has been observed, and within this range of earth conductivity, a variation in mutual impedances of 20 to 1 or more may exist. Therefore, other experimental work has been done with the object of developing relatively simple testing schemes, the results of which could be used to predict the coupling coefficients in advance of the construction of the power or telephone line.

An obvious method is to determine an experimental coupling curve by performing tests similar to those made at Cross Keys, using short-length disturbed circuits and either an existing power or telephone line, or a specially laid out conductor, as the disturbing line. This experimental curve would then be used to compute the coupling between power and telephone lines. One advantage of using an experimentally determined coupling curve is that it obviates the necessity of knowing or assuming a structure and conductivity of the earth; the coupling curve can be used directly without reference to any theoretical formulas. To determine the practicability of such a scheme and the accuracy with which experimental observations could be pre-

dicted 60-cycle tests have been made in two locations where existing exposures were present.

*Tests at Glens Falls, New York.* At Glens Falls, New York, there is an exposure about seven miles in length between a power and telephone line. The exposure is irregular, the separations ranging in general from 100 to 3500 ft., with three crossings. At a convenient place within the region occupied by the exposure, exploring wires similar to those used at Cross Keys were laid out at separations ranging from 50 to 4500 ft. The general characteristics of the coupling curve for a frequency of 60 cycles, derived from measurements in these circuits, were quite similar to those found at Cross Keys with the exception that the effective earth conductivity appeared to be higher, about  $1.75 \times 10^{-12}$ . Tests were made also to determine the mutual impedance between the power and telephone line in the exposure, both for the whole exposure and for selected parts. In Table II the observed mutual impedances are

TABLE II  
GLENS FALLS TESTS  
Measured Mutual Impedances of Power and Telephone Circuits and Comparison with Values Calculated from Experimentally Determined Coupling Curves

Section of telephone line	Measured mutual impedance—ohms	Calculated mutual impedance—ohms
0-1	0.0586 /68.5°	0.0614 /63.3°
1-2	0.0294 /52.4°	0.0564 /49.8°
2-3	0.0476 /73.4°	0.0382 /69.0°
3-4	0.107 /56.4°	0.113 /49.2°
4-5	0.100 /44.4°	0.0117 /35.8°
0-5	0.347 /53.8°	0.267 /55.3°

compared with values calculated with the use of the experimentally determined coupling curve. Generalizing, the agreement is only fair, although for two of the parts of the exposure it is excellent.

*Tests at Massillon, Ohio.* At Massillon, Ohio, tests similar to those made at Glens Falls were conducted. In this location, however, a considerably more extended system of exploring wires was used. The effective earth conductivity was about  $3.6 \times 10^{-13}$ , and the characteristics of the coupling curves were quite similar to those of the curves found for Cross Keys and Glens Falls.

In Table III comparison is made between the measured mutual impedances between the power and telephone lines and those computed using the experimentally derived coupling curve. In general, the agreement is quite satisfactory.

*D-C. Determination of Earth Conductivity.* Some work has been done on a method of determining directly the earth conductivity and the stratification if such a condition exists. Formulas have been worked out for a stratified earth involving the distances between the grounding electrodes and the conductivities and the thicknesses of the several strata. By means of measurements of the mutual resistance for direct current of circuits with suitably located ground elec-

TABLE III  
MASSILLON TESTS

Measured Mutual Impedances of Power and Telephone Circuits and Comparison with Values Calculated from Experimentally Determined Coupling Curves

Exposure		Measured mutual impedance—ohms	Calculated mutual impedance—ohms
From pole	To pole		
5134	5211	0.0308 /45.9°	0.0415 /35.5°
5211	5268	0.0532 /44.7°	0.0442 /34.2°
5268	5386	0.282 /63.7°	0.280 /64°
5386	5511	0.0707 /30.3°	0.0630 /28.2°
5511	5614	0.0386 /29.7°	0.0427 /28.5°
5614	5682	0.0164 /18.4°	0.0117 /14.8°
5682	5805	0.141 /62.4°	0.149 /59.2°
5134	5805	0.609 /53.7°	0.612 /52.5°

trodes, the conductivities and thicknesses of the strata can be determined. The results have been sufficiently interesting to justify additional work on this method.

#### CONCLUSION

In conclusion, it is well to recall the end towards which the work described in this paper has been directed. It was first desired to obtain a sufficiently detailed experimental study of the mutual impedances of ground return circuits to enable the formation of an adequate picture of the physical phenomena involved; also to test out the theoretical formulas available. Second, the aim was to investigate practical means for enabling the calculation of the ground return mutual impedances of power and telephone lines.

With regard to the first item, it was found that an analysis in terms of an "equivalent ground plane" was inadequate to represent completely the observed phenomena. However, when information is available as to the proper value of ground depth, this method can be used to advantage in many cases where approximate results only are desired. A theory based on the assumption of a d-c. distribution in the earth gave a somewhat better explanation (particularly in connection with the mutual impedances of circuits in which the points of ground connection were in close proximity) but left much to be desired in the way of quantitative agreement with the experimental results. The results of a theory which considers the effect of eddy currents in the earth are shown to be in fair qualitative agreement with some of the test values, and by a slight extension of the theory, good quantitative agreement can be found. This theory, however, does not explain end effects.

In the investigation of practical means for enabling the calculation of the mutual impedances of power and telephone lines, a scheme involving the experimental determination of a coupling curve has been found to give quite satisfactory results. Further work is to be done on this problem, and similar tests must be made in several other locations before it can be considered completely and satisfactorily solved. Other methods are also being investigated.

#### ACKNOWLEDGMENT

The authors wish to express their appreciation of the assistance of Messrs. F. J. Grueter and B. C. Griffith in the field testing, analysis of the data, and preparation of this paper as well as to many others who have assisted in the work. Thanks are due to the operating power and telephone companies who furnished facilities for some of the work described, and to members of their organizations who assisted in the tests.

#### NEW PORTABLE ELECTRO-CARDIOGRAPH

Announcement has recently been made of a portable electro-cardiograph, an instrument for recording on photograph film the electric currents that accompany heart action.

The instrument produced by Westinghouse Company is a compact, self-contained unit, with no auxiliary equipment necessary, or even requiring an outside source of energy, for it operates exclusively from dry batteries contained within the case. This type of operation has a decided advantage over wet batteries of being light in weight and exempt from acid fumes. Replacement of the batteries is necessary only at long intervals.

The scheme of operation is as follows: the minute currents generated by the heart and flowing through the body are transmitted to the instrument through the electrodes attached to the two arms and the left leg. The heart current is then amplified by tubes similar to those used in radio receivers. The amplified current causes the vibration of a tiny mirror in the galvanometer upon which is directed a beam of light. This vibrating light beam causes the impulses that are caught and recorded by a spring motor-driven camera.

The combined efforts of galvanometer and amplifier have been carefully calculated to prevent any distortion of the impulses. These calculations are based on the present standards of one inch per second film speed with one cm. deflection per millivolt; it has the characteristics of the recording apparatus. The wave is correct for phase relations up to the 75th harmonic and the amplitude can be relied upon to values discernible on the film.

The control board has the simplest possible arrangement, making it unnecessary to go through complex adjustments to obtain satisfactory records.

The circuit used requires no compensation for body resistance or skin currents, thus allowing standardization to be made with or without the patient in the circuit. Tests show that static caused by elevators, X-ray machines, and other electrical apparatus, causes no interference with the instrument's operation or records.

Abridgment of  
**Rationalization of Transmission Insulation  
Strength—II**

**Need for, Present Status of, and Necessary Developments for  
Carrying Through**

BY PHILIP SPORN\*

Member, A. I. E. E.

*Synopsis.*—This paper, prepared with the cooperation of the members of the Insulator and Lightning Subcommittee, points out the present need for rationalizing transmission system strength on the basis of lightning voltage. The higher grade of service demanded of transmission systems today requires fewer interruptions. It is pointed out that for a four-year period the line interruptions due to lightning on an extensive 132-kv. network average 75 per cent of all line outages.

Apparatus failures due to lightning, while not numerically great, can be materially reduced if the system insulation is coordinated on the lightning basis.

Over-insulation of lines has been tried in some cases, particularly on wood pole lines, with varying degrees of success in reducing line outages. But this method of attacking the lightning problem does not consider the protection of station equipment where the most costly apparatus is subject to damage, and where apparatus damage may result in long service outage.

It is pointed out that additional knowledge is necessary on lightning strengths of insulation, and apparatus to rationalize system voltage strengths on a lightning basis. This information is gradually being secured by various groups working on the problem.

To aid in solving the lightning problem, it is proposed that a set of standard test waves be adopted, by which insulation and apparatus if possible may be tested. With this knowledge of the lightning insulation strength of apparatus, it will be possible to design transmission systems more intelligently on a lightning basis so far as insulation is concerned, in addition to the present 60-cycle basis.

On the basis of field data secured last year on wave-shapes of natural lightning, three standard test waves are proposed, having voltage-time characteristics similar to those actually observed.

It is pointed out that lightning voltage should be designated in units peculiar to lightning and not in terms of 60-cycle voltage values.

\* \* \* \* \*

### I. INTRODUCTION

THIS paper is intended to represent the standpoint of the Insulator and Lightning Subcommittee in regard to rationalization. A standpoint representative of the committee as a whole, in so far as that is possible, is given. Several of the committee members believe strongly that a lightning test wave cannot be standardized at the present time; another group, however, feels equally convinced that a single wave or a group of waves can be standardized at the present time to great advantage and to the great benefit of all those interested in the advancement of the electrical insulation art, particularly as it affects the transmission system.

### II. THE NEED FOR RATIONALIZATION

The general subject of rationalization of transmission system insulation strength, although perhaps known and practised for some time previous, was presented formally before the Institute in the Spring of 1928.<sup>1</sup> Subsequent events have demonstrated the importance

\*Chief Elec. Eng. American Gas & Elec. Co., New York, N. Y. Report of Subcommittee on Insulation and Lightning:

Philip Sporn Chairman	J. G. Hemstreet
W. W. Lewis	C. A. Jordan
J. H. Cox	Herman Halperin

I. W. Gross

Presented at the Summer Convention of the A. I. E. E., Toronto, Ont., Can., June 23-27, 1930. Complete copy upon request.

of this phase of engineering and the need for its further development.

In the paper already referred to, it was pointed out that the principal high voltages for which insulation has been provided are those due to lightning. For example, on the 132-kv. system of the subsidiaries of the American Gas and Electric Company, the lightning outages in percentage of total outages have been as follows: In 1926—81.6%; in 1927—77.2%; in 1928—68.2%; in 1929—75.7%.

In short it may be said that while service on transmission systems has in general been pretty good, it has been only that. On the other hand, the crying need is for practically perfect service. But there are still too many cases of trouble that interfere with this very necessary and ideal standard, and much blame for such trouble can undoubtedly be ascribed to failure to properly rationalize system insulation strengths.

### III. THE PRESENT STATUS OF RATIONALIZATION

A first examination of the present status of rationalization gives the impression of a rather hopeless situation. Very little progress has been made since 1928. In fact, the more the situation is examined the more confusing it appears. Even the 60-cycle flashover values for standard suspension units of the same spacing and of substantially the same design, as given by various manu-

1. For references see Bibliography in complete paper.

facturers do not agree; differences of from 10 to 15 per cent are quite common.

As regards the lightning phase, there is still apparent the same tendency to let well enough alone. The idea that service is pretty good and that the situation need not be disturbed is still found among many people who ought to take the situation more seriously. There continues a haphazard adjustment or readjustment of insulation values. Points that are found apparently weak are strengthened without too much regard to the rest of the system; for example, the use of wood to further increase the lightning flashover of the transmission line circuit can be cited.

The insulator and bushing manufacturers, have done little toward the problem of coordination in which they should be vitally interested. The entire problem has apparently been left to the transformer manufacturers (among these only a selected group has obviously been able to tackle the problem intelligently) and to large users of equipment.

Several committees of the Institute have taken the problem for their own, and have done a considerable amount of work on it. Among these are the Transformer Subcommittee of the Electric Machinery Committee, the Insulator and Lightning Subcommittee of the Transmission Committee, and the Lightning Arrester Subcommittee of the Protective Devices Committee. Each of these has attempted in its way to contribute to the problem of rationalization of the transmission system insulation and although none of the three has concluded its work each one has made some progress.

IV. NECESSARY DEVELOPMENTS FOR CARRYING THROUGH THE PROBLEM OF RATIONALIZATION

The question arises as to what can be done to carry rationalization completely through. Many items are needed, the most important being:

1. *Knowledge as to Lightning Strength.* If the major insulation problem is that under lightning conditions, then the first thing necessary is a knowledge as to fundamental lightning strength in all links of insulation in the transmission chain. Expressing this strength in terms of any other unit, (for example, in terms of the power frequency unit) is most certainly not satisfactory and will result only in delaying progress in the solution of the problem. It is inconceivable that for all classes of insulation, the relationship between 60 cycles and lightning strength can remain the same under varying lightning voltages. Nor will the lightning problem be placed on a stable and scientific foundation so long as a unit representative of the insulation strength of a piece of apparatus under lightning conditions, is evaded. The form of this lightning strength is immaterial so long as the unit is one definitely expressive of lightning conditions. Whether it is in the form of volts and time

or volts in terms of a standardized impulse wave is immaterial so long as it is expressed in terms of its own rather than in 60-cycle or power frequency values.

2. *Necessity for Standard Lightning Waves.* There is no question but that the establishing of a standard lightning wave will considerably expedite the solution of the problem. Under present conditions, data gathered by various investigators are not readily comparable; some investigators have even cautioned that their data are not comparable with results obtained by others. The adoption of a standard test wave would automatically remove all these difficulties.

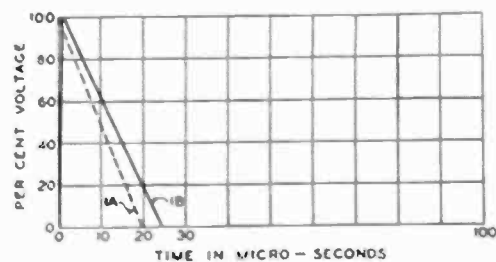

FIG. 1—PROPOSED STANDARD IMPULSE TEST WAVE

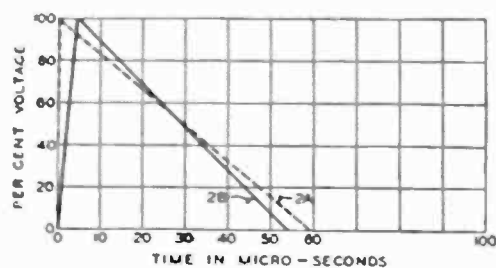

FIG. 2—PROPOSED STANDARD IMPULSE TEST WAVE

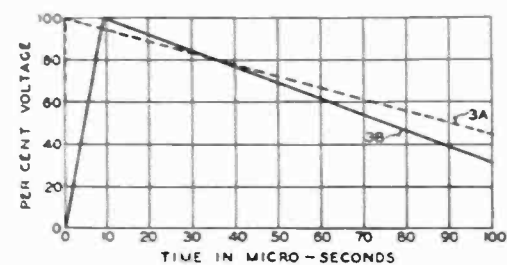

FIG. 3—PROPOSED STANDARD IMPULSE TEST WAVE

It is admitted that a single wave would cover the situation rather unsatisfactorily; but it is not necessary to limit the standard to a single wave. It is possible, for example, to adopt three different waves, and it is this proposal that is now made in this paper; let three waves referred to as 10-microsecond, 30-microsecond, and 90-microsecond waves\* be adopted. That such an

\*It is proposed that all waves have a 1/4-microsecond front; the time referred to in the designation of the waves may be considered as a special time constant, and is the value in microseconds required for the wave to fall to 50 per cent of its crest value.



arrangement would represent a situation in fairly close conformity with the data as gathered to date may be seen from Figs. 1, 2, and 3. In each of these curve A represents one of the three proposed standards; Fig. 1 curve A, showing the 10-microsecond standard, Fig. 2 curve A, the 30-microsecond standard, and Fig. 3 curve A, the 90-microsecond standard.

The B curves in these are based on 15 natural lightning voltage waves obtained in the field during the 1929 season.<sup>9</sup> The crest values of 12 of these vary from 500 kv. to 1260 kv. The voltage-time characteristics of the 15 waves are as follows:

TABLE II  
(TIME IN MICROSECONDS)

	To Crest	Drop to 50% Crest
Maximum.....	11	69 +
Minimum.....	2.5	16.
Average.....	6.3	30.2

The B curves based on Table II, have the following characteristics:

TABLE III  
(TIME IN MICROSECONDS)

	Curve	To Crest	Drop to 50% Crest
Maximum.....	3-B	10	75
Minimum.....	1-B	1*	15
Average.....	2-B	5	30

\*This value has been taken as less than one-half the observed value to allow for possible errors in determining wave fronts in the field, and further, to recognize the limitations of field observations where it is believed in many cases the lightning stroke did not occur close to the line.

It will be noted that, in each case, the proposed standard is a very fair approximation of the range in lightning wave-shape that it is intended to cover, and it is believed that in the light of existing data, the three proposed standards, or slight modifications of them, may be undertaken very definitely.

3. *Data on Variation in Lightning Strength of Insulation.* The lightning strength of insulation and of the apparatus is dependent upon the type of wave to which the apparatus is subjected or, put it another way, it is dependent not only upon voltage but upon the time of application. Specific data are desirable as to the characteristics of all apparatus under these conditions. Here, however, it should be recognized that while specific data covering the volt-time characteristics of apparatus can, and will ultimately, be obtained for all classes of material, the process is necessarily long and tedious.

It is admitted that data on apparatus insulation strength expressed in terms of a particular impulse wave, or in terms of a group of waves, will give, to say the least, a good approximation of the complete data referred to above; and it would certainly give data more

suitable than any available at the present time. Further, such data could be obtained rather quickly. If the gathering of such data is to be undertaken, however, it is necessary to have a standard wave, or a series of waves, such as the three outlined above, definitely adopted.

4. *Determination of Relative Frequency and Importance of the Direct and Induced Strokes.* There are at the present time divergent opinions as to relative frequency and importance of direct and induced strokes in high-voltage circuits. Experimental data and opinions are about equally divided in assigning paramount importance to the direct stroke or to the induced stroke as a source of trouble. Such divergence does not exist with respect to low-voltage lines, where it is admitted that the direct and induced strokes are perhaps equally important as a cause of trouble. But difference of opinion with regard to high-voltage circuits makes it more imperative than ever to obtain sufficient information to clarify the situation and find out the true state of affairs. It is obvious that the method of protection adopted may vary considerably, and it will depend greatly upon the type of disturbance for which protection is being provided. This makes the necessity of authoritative data on that particular phase of extreme importance.

5. *Further Data on Shape of Natural Lightning Waves.* While a considerable amount of field data was obtained during the last year on the shape of natural lightning waves, these data are far from complete and far from being conclusive. Too many were obtained on waves at a considerable distance from the point of origin. While mathematical analysis can give a solution for the probable shape of the original lightning wave if the distance from the point of disturbance is known, such data are of course difficult to obtain. A more satisfactory solution will be to secure records of direct strokes. This data may immediately be utilized in a revision of any standard for lightning waves that may exist at that time.

6. *More Extensive and Accurate Field Data on Performance of Lines and Apparatus.* During the past two years great progress has been made in the accumulation of laboratory data with artificial lightning, also in collecting data in the field laboratories with both natural lightning and artificial lightning. A third phase of investigation which has advanced considerably has not been mentioned, but its importance is equal to each of the other two classes. This is the detailed record and analysis of actual operating experience with lines and apparatus under various conditions of lightning. Particular emphasis should be laid on the recording and analysis of data relative to the lightning conditions and, if possible, to the data regarding intensity of lightning storms encountered.

7. *Fundamental Data as to the Effects of Various*

*Types of Station Designs and Apparatus on Incoming Lightning Waves.* While some data have been obtained on this phase of the problem, much more information of an authoritative nature is needed to determine definitely the effect of various types of structures and terminal apparatus on incoming waves; also the effect of travel of an incoming wave through such apparatus on the apparatus itself and upon the connected equipment. Particularly is it necessary to have further data on the effect of bushings, cable terminals, insulated cable, and similar apparatus.

8. *The Segregation of Insulation Strength—Especially Lightning Insulation—from Operating or Nominal Voltage Rating.* Again and again it has been brought out that insulation strength under lightning conditions differs for different materials which may have the same strength under power frequency or 60-cycle conditions; and yet it may be desirable that all these pieces of apparatus have the same or definitely related values of lightning strength. The logical procedure seems to be to specify insulation strength and operating voltage independently.

9. *Authentic Data on 60-Cycle Flashover Values.* It would seem that as a prelude to the rationalization of the entire problem of insulation, first, and without delay, a definite standard sufficiently detailed and specific, should be adopted for measuring 60-cycle values, so that measurements taken at any reliable laboratory will agree within the limits of accuracy for the measuring apparatus used and measurements taken at any other laboratory. Today this is far from true.

## V. CONCLUSIONS

Lightning being the cause of approximately 75 per cent of service interruptions on high-voltage transmission systems, it is of first importance that it be brought under full control in order to make the service of these systems meet the necessary requirements of the electrical art of today.

There is evident at the present time, a continuation of a practise of insulating one portion of a transmission system without too much regard to the rest of the system. Too often when service failures occur, the weak points are more highly insulated, resulting in merely transferring the trouble to another portion of the system.

The conditions outlined under 1 and 2, above, show very forcefully the need of rationalizing system insulation strength on the basis of performance under lightning conditions. Some steps in this direction have been made, and numerous developments are under way which show that the gravity and importance of the problem are fully realized. Several committees of the Institute are working on the problem, and many fundamental researches are under way in the laboratories and in the field, but very little that is definite has as yet been accomplished.

It has been shown that a continuation of many of the fundamental lightning researches now being carried out in the field and in the laboratory are highly essential to the problem of rationalization. It has also been shown that one of the great obstacles to such a rationalization program is the failure to adopt some definite unit by which to express lightning insulation strength. To express it in terms of 60-cycle strength when what is needed is rationalization on the basis of lightning insulation strength, seems for several reasons illogical. As a first step in this plan, a set of three standard impulse waves is proposed, in terms of which all types of insulation may be tested. Each of the three waves is to have a  $\frac{1}{4}$ -microsecond front, and should attenuate to 50 per cent of crest value in 10, 30, and 90 microseconds, respectively. The values and shapes chosen are very similar to, and are based on, wave-shapes of natural lightning, obtained on actual transmission lines, and therefore approximating actual conditions which insulation and apparatus may have to withstand in the field. From time to time, when and as additional field data show it to be necessary, these shapes may have to be altered. Further it is recognized that it may not be commercially feasible at the present time to apply these waves to certain types of apparatus with built-up insulation. It is believed, however, that the adoption of these test waves will hasten the time when such apparatus can be so tested; certainly it will make possible the determination of the lightning strength of various design and accelerate the general problem of research on the lightning strength of various types of apparatus, since it will make possible the comparison and checking of data obtained in different laboratories and by different observers.

It is recognized that electrical breakdown of insulation is a function of both voltage and time, and that this type of data should be obtained for all types of insulation and, ultimately, for all types of apparatus. It is believed, however, that to secure such data will take a great deal of time; but the problem cannot wait. The proposed system of standard waves will make much data possible, however, and these data are fundamental and necessary if advance is to be made in rationalization.

As previously pointed out and once more emphasized here, lightning strength and operating voltage of transmission systems are independent. To a large extent the lightning strength will depend upon the type of service a system is called upon to deliver, and not upon its operating voltage. It is believed that a distinct advantage will result in rationalizing insulation of transmission systems by considering the lightning strength independent of the normal frequency operating voltage.

## ACKNOWLEDGMENT

Special acknowledgment is due Mr. I. W. Gross, Secretary of the Lightning Committee, for his help in the preparation of this paper.

# Abridgment of Electric Power Consumption for Yard Switching

BY P. H. HATCH<sup>1</sup>

Member, A. I. E. E.

*Synopsis.*—In the application of various types of locomotives to switching service, it is at times quite desirable to have data concerning the energy requirements involved. A convenient figure for expressing such requirements in relation to work done is watthours per ton-mile.

The determination of such a figure involves certain difficulties peculiar to switching service, in that trailing loads and distances moved are continually varying.

The electrified Oak Point Yard of the New York, New Haven & Hartford Railroad in New York City offered an excellent opportunity for determining figures of watthours per ton-mile for different kinds of switching. Accordingly, two electric locomotives were equipped with the necessary instruments, and a total of 39<sup>1</sup>/<sub>6</sub> hr. of operation was observed and recorded.

The paper describes in some detail the entire procedure of the tests and lists in tabulated form the data obtained.

Basic figures necessary for calculating watthours per ton-mile, it was found, could be expanded to give a much broader scope to the results, so that many interesting data became available. Incidentally, the data will permit of even further expansion where certain special figures or factors are desired.

Although electric locomotives of different types were used, the results set forth in the paper should be considered without regard to either type.

It is hoped that data concerning switching operations on other railroads may become available.

\* \* \* \* \*

## I. GENERAL

IN the case of electric locomotives operating in road passenger or freight service, the problem of determining the power consumption per unit of work done has not been difficult. From one end of a given run to the other, train weights undergo few, if any, changes; when they do, such changes are easily accounted for. Distances present no problems of measurement; nor do the meter readings necessary for computing total energy. In other words, power consumption per unit of work done, or (to use a more familiar expression) watthours per ton-mile present no especial difficulties in such cases.

Where watthours per ton-mile are desired for switching service, however, the problem becomes radically different. This is because when the number of cars is changed from the previous move, tonnage and distance must be determined for every individual move that the switch engine makes. It takes little imagination to understand that this makes necessary the calculation of ton-miles practically every time the switcher moves.

A reasonably accurate figure of watthours per ton-mile for switching service is of use in many ways. For instance, it is helpful in figuring battery capacity necessary for a storage battery switching locomotive, where the switching service to be handled by the locomotive is known. Also, in the case of the oil or gasoline-electric switcher, some idea of fuel quantities necessary for a given service may be obtained. Similarly in the case of applying an electric switcher to a particular location, advance information relative to power requirements can be determined. Still another side

of the matter is disclosed when it is considered that watthours per ton-mile for a given locomotive in a given service may be taken as an approximate index to performance. Other uses of the watthours per ton-mile figure for switching service are readily possible.

It should be emphasized at this point that the tests herein described had for their primary object the determination of energy consumption (based on a sufficient number of hours of service) in terms of watthours per ton-mile for various classes of yard switching, without regard to type or types of electric locomotives used.

## II. DESCRIPTION OF TEST AND APPARATUS

In order to arrive at definite facts regarding the power consumption per ton-mile for electric switching locomotives, a series of tests was run in the Oak Point Yard of the New York, New Haven and Hartford Railroad in New York City. This yard is devoted primarily to classification work in connection with the interchange business with the Erie, Lehigh Valley, Central New Jersey and Lackawanna railroads, such business being carried on between the various harbor terminals by means of car floats. Therefore in general there are two distinct kinds of service performed by the switching locomotives in Oak Point Yard; namely, float loading and unloading, and general switching and classifying. The switching locomotives have varied duties; classifying, float pulling and loading, switching the shop tracks, pushing outgoing trains, etc., are some of the services each engine may be called upon to perform.

For purposes of the test, it was decided to equip a locomotive with the necessary test instruments and then have the engine put into normal service, neglecting the test entirely so far as the engine and crew were concerned. It was thought that this would give the most comprehensive results for the test, as well as burden the yard forces and engine crews as little as pos-

<sup>1</sup> Engineer of Automotive Equipment, The New York, New Haven and Hartford Railroad Company, New Haven, Conn.

Presented at the Summer Convention of the A. I. E. E., Toronto, Ont., Canada, June 23-27, 1930. Complete copy upon request.

sible. To the men running the test was left the classification of results according to service.

For measuring wathours, the regular locomotive wathour meter was utilized. It was calibrated both before and after the test. For determining distances moved, a magnetic counter was used in conjunction with dry cells and a contact-making device mounted in the end of one of the locomotive axles. From readings of the counter, the number of revolutions of the wheel

90-TON ELECTRIC SWITCHING LOCOMOTIVE

Classification	B + B
Energy supply	11,000-volt, 25-cycle, single-phase, a-c.
Type of conductor	Overhead
Total weight of locomotive	181,000 lb.
Total weight on drivers	181,000 lb.
No. of driving wheels	4
Diameter of driving wheels	63 in.
Total wheel base	23 ft. 6 in.
Rigid wheel base	7 ft. 0 in.
Length over coupler faces	39 ft. 1 1/2 in.
Height over pantagraph locked down	14 ft. 3 1/2 in.
No. of motors	4
Type of motors	A-c. commutator type series
Drive	Gear quill
Gear ratio	17:101
Tractive effort, hourly rating	23,200 lb.
Speed at hourly rating	8.1 mi. per hr.
Tractive effort, continuous rating	14,500 lb.
Speed at continuous rating	11.4 mi. per hr.

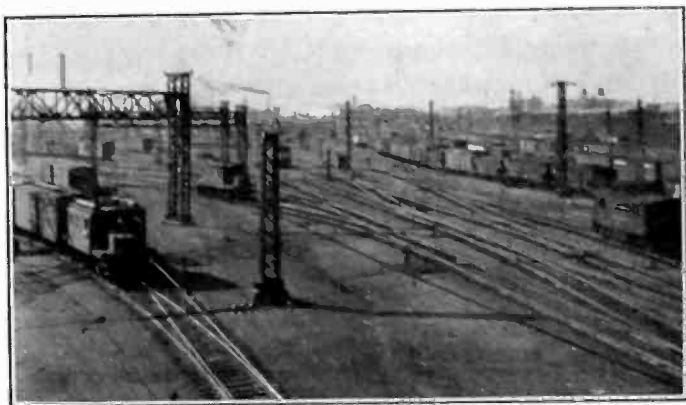

FIG. 1—GENERAL VIEW OF OAK POINT YARD  
(Note curved classifying tracks at left)

was determined, from which were calculated the distances moved.

The test was run in two periods of three days each. Two different locomotives were used—one for each period. The same test procedures were followed and much the same classes of work were performed by each. Each locomotive operated from the 11,000-volt a-c. single-phase supply. Specifications for the two locomotives follow:

106-TON ELECTRIC SWITCHING LOCOMOTIVE

Classification	B + B
Energy supply	11,000-volt, 25-cycle, single-phase, a-c.
Type of conductor	Overhead
Total weight of locomotive	211,500 lb.
Total weight on drivers	211,500 lb.
No. of driving wheels	4
Diameter of driving wheels	42 in.
Total wheel base	25 ft. 0 in.
Rigid wheel base	8 ft. 3 in.
Length over coupler faces	38 ft. 3 in.
Height over pantagraph locked down	14 ft. 8 in.
No. of motors	4
Type of motors	D-c. series (d-c. from motor-generator set)
Drive	Gear
Gear ratio	17:72
Tractive effort, hourly rating	23,200 lb.
Speed at hourly rating	8.1 mi. per hr.
Tractive effort, continuous rating	14,500 lb.
Speed at continuous rating	11.4 mi. per hr.

For the greater part of the time in each period, weather and rail conditions were good; a little rain was experienced in both. Average summer temperatures prevailed.

The personnel of the test consisted of three men. One rode continuously in the cab of the locomotive and read the wathour meter and revolution counter; one was on the ground, recording car numbers for each move; the third assisted in this work, obtained car weights from the various sources, endeavored to discover in advance the moves to be made, and keep track generally of the test as a whole.

III. ANALYSIS OF TEST CONDITIONS

The test was of necessity subject to certain errors. Regular engines on their regular runs were used, and regular procedures as to switching were followed all through, with the possible exception that the work of the engine under test was not varied quite as much as usual. This did nothing to detract from the test as indicating actual average conditions, and did help some in separating the results according to class of service performed.

Gross weights for loaded cars were taken in the round numbers as shown in the various yard records, float lists, etc. Empty car weights were taken as 20 tons. This is the figure used in making up train weights and may be considered as a good average for all empty cars.

Distance readings were accurate to lengths less than the circumferences of the driving wheels to which the revolution counter was attached. These circumferences for the two locomotives used were 16 1/2 ft. and 11 ft. Slipping of the drivers to the axle to which the revolution counter was attached was a potential source of error; fortunately, practically no slipping of these particular wheels on the locomotives was noted.

It was first intended to read the locomotive wathour meter for each move, but this was impossible as the



meter, of the regular locomotive type, did not register enough for accurate reading in the case of the shorter moves. The meter readings were confined, therefore, to changes in classes of service, or to other sufficiently long intervals, to insure accurate data.

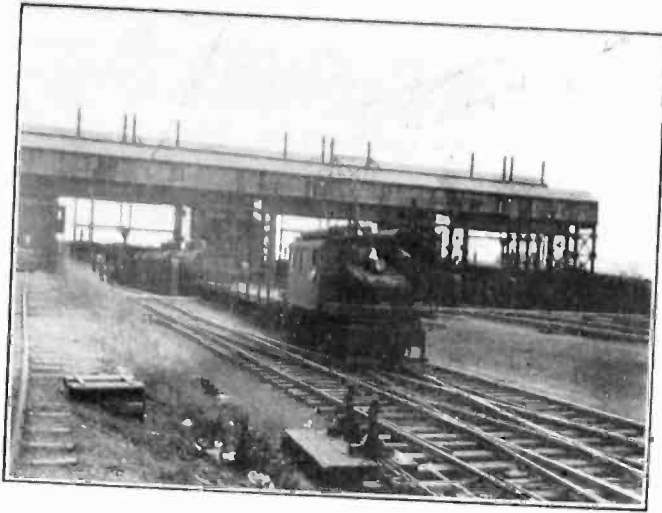

FIG. 4—ELECTRIC LOCOMOTIVE IN FLOAT SERVICE—OAK POINT YARD

View showing locomotive, reacher cars, and float bridge. Note incline of bridge apron

The meters on both locomotives were calibrated before and after the tests and were accurate to within 1 per cent during the tests. A certain inaccuracy in scheme of meter connections was present; this, how-

ever, was considered within the accuracy limits of the tests as a whole.

Where the locomotive and its load made short moves of less than a car length or two, no record was made. The only effect of this was to increase the wathours per ton-mile figures very slightly.

In the tabulated summaries for the first period and for the test as a whole, a certain discrepancy may be noted in that the sum of the number of moves, miles, ton-miles, etc., for the different classes of service does not equal the total figures for the entire period or periods. The latter figures take into account five moves totaling 426 ton-miles which were omitted from the records of classes of service as not belonging specifically to either, yet properly belonging to switching service.

When a rate of energy consumption with respect to work performed is desired, there are two methods of obtaining the final result. In the particular case under discussion, the wathours per ton-mile could be calculated for each move, and an average taken for as many moves as constitute a certain period or class of service. The other method consists of taking the sum of the ton-miles for a given series of moves and dividing this figure into the sum of the wathours for these moves. It was thought that the latter method gave the more representative results over a given period, is more accurate, and as previously pointed out, lends itself more readily to the test procedure as regards meter readings.

THE NEW YORK, NEW HAVEN AND HARTFORD RAILROAD

Electric Power Consumption for Yard Switching  
Condensed Summary—Oak Point Yard, New York

First Period  
July 25-27, 1928

Period of Service	No. of moves	Mileage	Avg. speed (m. p. h.)	Car miles	Trailing ton-miles	Total ton-miles	Trailing tons per move	Kw-hr.	Kw-hr. per mile	Watt-hr. per car mile	Watt-hr. per trailing ton-mile	Watt-hr. per total ton-mile
July 25, 1928, 6 hr. ....	110	19.03	3.13	169.4	4180	5901	214	527	27.7	3111	126	89
July 26, 1928, 6 hr. ....	91	17.11	2.81	149.9	5441	6987	330	525	30.7	3502	97	75
July 27, 1928, 7 hr. ....	129	22.71	3.28	193.4	7858	9914	321	711	31.3	3676	91	72
Three-day period, 19 hr. ....	330	58.85	3.08	512.7	17479	22802	288	1763	30.0	3439	101	77
Yard classifying .....	267	47.17	—	427.0	14833	19102	292	1480	31.4	3466	100	77
Loading car floats .....	32	5.88	—	45.6	1215	1746	244	131	22.3	2873	108	75
Unloading car floats .....	26	4.37	—	29.0	1133	1528	337	130	29.8	4483	115	85
Both loading and unloading car floats .....	58	10.25	—	74.6	2348	3274	286	261	25.5	3500	111	80

Second Period  
August 13-15, 1928

Aug. 13, 1928, 3 2/3 hr. ....	113	13.76	3.73	76.8	4070	5528	314	573	41.7	7457	141	104
Aug. 14, 1928, 8 1/2 hr. ....	115	21.63	2.55	164.2	5184	7477	269	1030	47.6	6272	199	138
Aug. 15, 1928, 8 hr. ....	134	24.55	3.08	202.8	8314	10966	370	1131	46.1	5576	136	103
Three-day period, 20 1/6 hr. ....	362	59.94	2.99	443.9	17568	23971	320	2734	45.6	6159	156	114
Yard classifying .....	277	42.93	—	322.6	13990	18591	333	1950	45.4	6045	139	105
Loading car floats .....	25	7.14	—	52.7	1207	1964	234	249	34.9	4728	206	127
Unloading car floats .....	60	9.86	—	68.6	2371	3416	299	535	54.2	7794	226	157
Both loading and unloading car floats .....	85	17.00	—	121.3	3578	5380	280	784	46.1	6364	219	146

Both Periods  
July 25-27 and August 13-15, 1928

Six-day period, 39 1/6 hr. ....	692	118.79	3.03	956.6	35047	46773	305	4497	37.9	4699	128	96
Yard classifying .....	544	90.10	—	749.6	28823	37603	313	3430	38.0	4575	119	91
Loading car floats .....	57	13.02	—	98.3	2422	3710	240	380	29.2	3865	157	102
Unloading car floats .....	86	14.23	—	97.6	3504	4944	310	665	46.6	6810	189	135
Both loading and unloading car floats .....	143	27.25	—	195.9	5926	8654	282	1045	38.4	5332	176	121

In final figures of watthours per ton-mile, inasmuch as the accuracy of the test as a whole would not make them particularly significant, decimal points are omitted.

#### IV. TABULATIONS

The tabulations of data obtained in the test show results for each period, for each class of service, and a composite summary for both periods.

#### V. ANALYSIS OF RESULTS

Inasmuch as yard switching operations are continually changing—no two days being alike—no unfavorable comparisons are justified as between the locomotives used in the first and second periods; nor is any comparison intended, as there are too many variables encountered in two three-day periods, a month apart, to make such a comparison at all significant. The differences which do exist in the results of the two periods serve to illustrate the fact that many hours of switching service must be recorded before a representative figure for watthours per ton-mile can be obtained, regardless of the type of locomotive used.

Although figures of watthours per ton-mile for the various services were primarily desired, it is interesting to note the extent of the data obtained from basic records of kilowatthours, number of cars, tons, and distances moved.

In general, each period was similar in classes of service performed, with the exception that the second included considerably more float unloading or "pulling." Comparison of the figures will show that float unloading is the highest in power consumption per ton-mile.

This is no doubt due to the incline of the float bridge apron at low tide, a great number of small moves and considerable waiting time. During the tests, the apron incline was for the most part against movements from the float. At high tide, this incline is reversed but not to the same extent as at low tide. The number of small moves comes in the fact that the floats must be loaded or unloaded in parts; when unloading, the parts are additive; that is, each succeeding move is with a greater tonnage; (on the other hand, in loading, each succeeding move is with a decreasing tonnage). It can readily be understood, therefore, that a low tide will definitely tend to increase the energy consumption for float unloading. Waiting time is another factor which enters into the situation; a certain stipulated time is allowed for unloading, loading, and releasing a car float. Hence a switcher is often dispatched to a float bridge to wait for an approaching float. If the stand-by losses of the locomotive are relatively great, the watthours per ton-mile for float unloading are correspondingly increased.

The tests under consideration showed that the general impression that float service is more severe a variety of switching than classifying, is in the main correct though local and tidal conditions may vary this somewhat.

General yard switching and classification work showed reasonable figures for power consumption per ton-mile. Such figures would no doubt vary for

different yards, since grades and curves in no two yards would be alike. But Oak Point Yard is sufficiently large enough for the figures indicated to give what is considered a good average for flat yard switching. In this connection it would be extremely interesting if a comparison of watthours per ton-mile for flat switching and hump switching could be obtained. Of course figures for the latter type of switching should not be considered without due reference to the gradients of the hump approaches.

It will be noted that the figures of watthours per ton-mile for each period show a decided difference. This is undoubtedly due in part to the difference in types of locomotives used as regards stand-by losses. Another factor tending to increase this difference between the two periods was that the second included more float work, particularly unloading. Undoubtedly other variables such as different rates of acceleration, different proportions of power-on and power-off time, etc., were present and had their part in the difference noted.

#### VI. CONCLUSION

As previously remarked, extreme accuracy was more or less impossible of attainment under the conditions of the test. Regular operating procedures were followed as closely as possible, as it was considered that the results thus obtained would show average every-day conditions and would be of greater value than if laboratory precision of measurements were undertaken at the expense of the test as a whole.

To obtain two three-day periods of switching service exactly alike is well-nigh impossible. In spite of the general similarity of service for the two periods under discussion, there were certain differences between the two which make undesirable any conclusions regarding the types of switching locomotives used. Where comparisons are mentioned, they are simply for explanation of test results and are not to be considered as reflecting upon either type of locomotive.

It is believed, therefore, that the data herein set forth represent actual average conditions of switching service in Oak Point Yard. The various figures obtained for electric power consumption in watthours per ton-mile, it is thought, are well within the accuracy range of existing freight car loaded and light tonnage figures. It is felt that an important object will have been gained if this study may lead to similar tests being made under different conditions on other railroads.

Thanks are due to all those participating in or arranging for the tests, with particular mention of W. T. Kelley, Assistant Engineer, and E. S. McConnell, Mechanical Inspector, for their very able assistance in the running of the test and calculation of results; to the Oak Point Yard forces under Messrs. E. J. Cotter and John Dunford, Assistant Superintendent and Yard Master respectively, for their excellent cooperation; and to S. Withington, Electrical Engineer, and A. L. Ralston, Mechanical Superintendent, for their encouragement, and criticism of results.

Abridgment of  
**Effect of Transient Voltage on Power  
 Transformer Design**  
 The Behavior of Transformers with Neutral Isolated or  
 Grounded through an Impedance

BY K. K. PALUEFF\*

Member, A. I. E. E.

*Synopsis.*—The results of theoretical and oscillographic study of transient voltage phenomena in shell type and core type transformers with neutral isolated from ground, and also with neutral grounded through impedances of different characteristics, are briefly described.

In the case of isolated neutral, the majority of lightning traveling waves cause the potential of the entire winding, including neutral, to rise above ground to a value at least equal to the applied voltage.

In the case of switching surges, the voltage of the neutral as well as of the rest of the winding is apt to rise to a value considerably in excess of the applied voltage. In the case of transformers excited with damped oscillations similar to switching surges, oscillographic records of both shell and core type transformers indicate internal voltages to ground approximately four times the applied.

Grounding of a transformer through resistance, inductance, or capacitance does not reduce the above internal transient voltages,

unless a certain relation is established between these constants, the constants of the transformer circuit, and the wave shape of the line surge.

If the proper relation of these constants is established, then internal transient voltages are reduced practically to those of a solidly grounded transformer.

A grounding device called an "impedor," can be designed to have impedance at operating frequency equal to any desired value and to act at transient voltage frequencies as if its impedance were practically zero. This device can be designed for each transformer bank or for a number of banks in parallel.

If grounded through a suitable impedor a non-resonating transformer retains its uniform transient voltage distribution.

During the last year and a half, nearly 800,000 kv-a. of transformers of non-resonating type, have been built so that they can be operated with impedor in the neutral.

#### INTRODUCTION

THE desire to increase system stability has created demand for grounding transformer neutrals through inductance or resistance. This paper describes in a non-mathematical way the behavior of transformers with neutral isolated, or grounded through any impedance when subjected to transient voltages, and shows the effect of this behavior on transformer design.

#### Part I. Principles Governing Transient Phenomena

Familiarity with the preceding paper<sup>3</sup> of the author is assumed; therefore only a very brief description will be given here of the principal laws governing transient voltage phenomena.

At operating frequency, many pieces of electrical apparatus act practically as pure inductance, capacitance, or resistance; but at high frequency, such as that produced by lightning, switching, and other disturbances, they behave as complex networks composed of elementary inductances, capacitances, and resistances, distributed in a manner characteristic of the given piece of apparatus.

As has been shown in previous publications,<sup>2,3,4</sup> the character of internal oscillations depends principally

upon values of  $\frac{C_s}{C_g}$  and  $\frac{M}{L}$  or  $\left(1 - \frac{M}{L}\right)$  where  $C_s$

is capacitance between adjacent elements,  $C_g$  is capacitance between the elements and ground,  $M$  is mutual inductance between adjacent elements, and  $L$  their self-inductance.

$\frac{C_s}{C_g}$  and  $\frac{M}{L}$  have minimum values in a transmis-

sion line and maximum in a transformer.

Examples of various equivalent circuits are given in Fig. 1. Resistance is neglected.

To give a general idea of the behavior of transformers under certain transient conditions, the simplified circuit (6 or 7 of Fig. 1) is found sufficiently accurate. This simplified circuit is quite unsatisfactory, however, for numerical analysis of transient phenomena.

A circuit will pass through a transient state if the distribution of voltage in this circuit at the moment immediately following a sudden application of potential  $E$  is different from one that finally takes place after  $E$  has been maintained for an infinite length of time. Therefore the transient is the readjustment of local potentials from their initial to their final values.

#### Part 2. Transformer with Neutral Isolated

In ordinary power transformers, either of shell or core type, the initial voltage distribution produced by lightning surges when the neutral is isolated is similar to that shown in curve 1 of Fig. 3A. The final voltage distribution and envelope of maximum voltages to ground are shown in curves 2 and 3. In Fig. 5, voltage oscillations at four points of a shell type transformer winding with isolated neutral are shown.

\*General Electric Company, Pittsfield, Mass.

3. For references see Bibliography.

Presented at the North Eastern District Meeting of the A. I. E. E., Springfield, Mass., May 7-10, 1930. Complete copy upon request.

The importance of switching transients is often underestimated due to the fact that the amplitude of the average switching transient is about half of that of the lightning wave but as was pointed out in the previous paper, the switching transient is a damped oscillation and produces forced or cumulative oscillations in transformer windings. Thus, while the terminal potential is reduced to half in comparison with lightning disturbances, the internal voltages if expressed in per cent of terminal voltage are at least doubled (curves 5 and 6 of Fig. 7). The result is that the absolute values of internal stresses produced by an average lightning or switching transient are very nearly the same. (Curves 7 and 8 of Fig. 7.)

It may appear that the probability of resonance and

of at least 3.46 times normal operating voltage from line to neutral (so-called "leg-voltage").

### Part 3. Neutral Grounded through Impedance

*Neutral Grounded through Resistance, Inductance, or Capacitance.* The behavior of transformer windings subjected to transient voltages, while grounded through

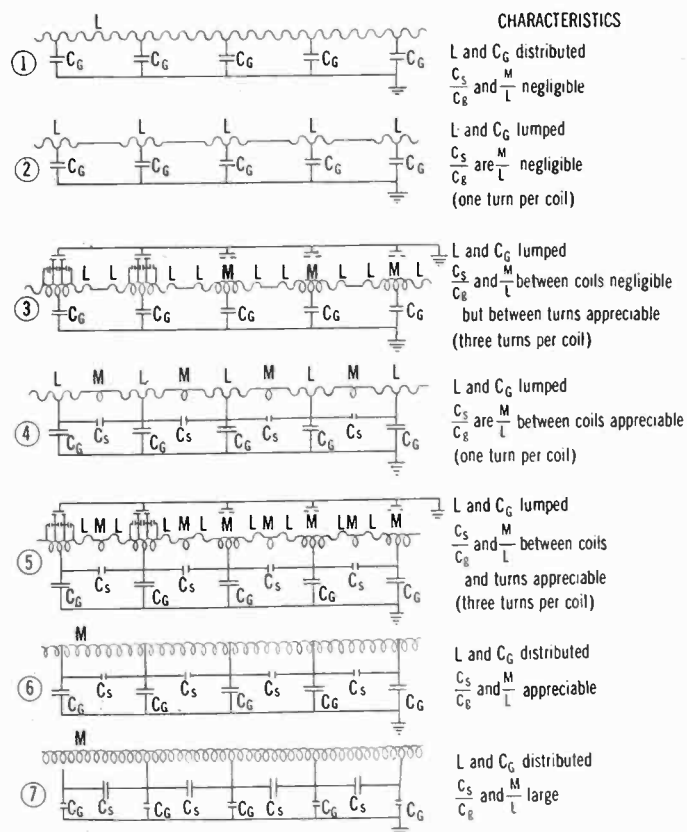
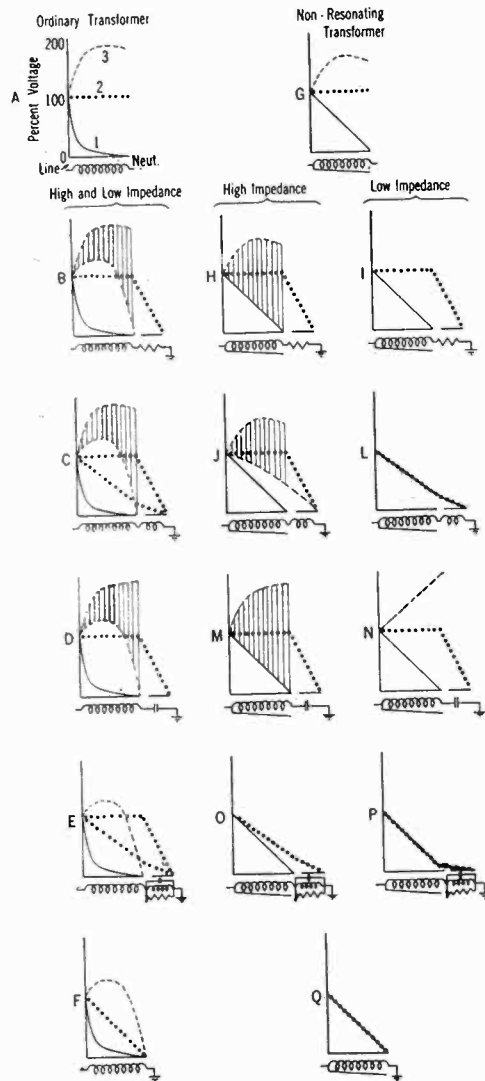

FIG. 1—SPECTRUM OF HIGH-FREQUENCY EQUIVALENT CIRCUIT

resulting forced oscillations is too small to be considered as one of service conditions. However, curve 5 of Fig. 7 was obtained with 20 per cent difference between the applied frequency and the fundamental natural frequency of the transformer. As an ordinary transformer may have as many as eleven natural frequencies, and these frequencies different for different transformers, it appears more probable than not that with transmission systems as complicated as they are, many switching operations produce surges of dangerous frequencies.

*Effect on Transformer Design.* The obvious conclusion is that in the case of transformers operating with isolated neutral, the entire winding must be insulated for line voltage. This means that the winding must be capable of withstanding a high potential test

FIG. 3—SUMMARY OF EFFECT OF VARIATION OF NEUTRAL IMPEDANCE FROM ZERO TO INFINITY ON INTERNAL TRANSIENT VOLTAGES IN AN ORDINARY AND A NON-RESONATING TRANSFORMER PRODUCED BY TRAVELING WAVES MET IN SERVICE



— initial voltage distribution  
 - - - - envelope of maximum voltage to ground  
 . . . . . final voltage distribution  
 Shaded areas indicate the range in variation of voltages due to internal oscillation with increase of neutral impedance from zero to infinity  
 A & G—neutral isolated  
 F & Q—neutral grounded directly  
 E, O, P—neutral grounded through impedor  
 The remainder grounded as shown

resistance, reactance, and capacitance, was studied and the results shown in the complete paper. (See Fig. 3.)

The desirable values of the neutral reactance are generally such that the transient neutral potential would necessarily rise to dangerous magnitudes under most voltage disturbances.

Furthermore, during switching-out operations, when



breaking single- or two-phase ground short-circuits, sudden rupturing of the neutral current may produce an "inductive kick" of very destructive magnitude.

This necessitates special measures when it is desired to keep the rise of neutral transient voltage below values which would be attained with only inductance  $L_n$  between the neutral and ground.

Careful consideration of all aspects of the problem makes it appear that the most satisfactory means of controlling neutral transient voltage is an addition of capacitance and resistance in shunt with the inductance. The capacitance and resistance are so selected that on one hand, the neutral voltage does not rise above a specified fraction of the applied voltage regardless of the type of the line transient, and on the other hand,

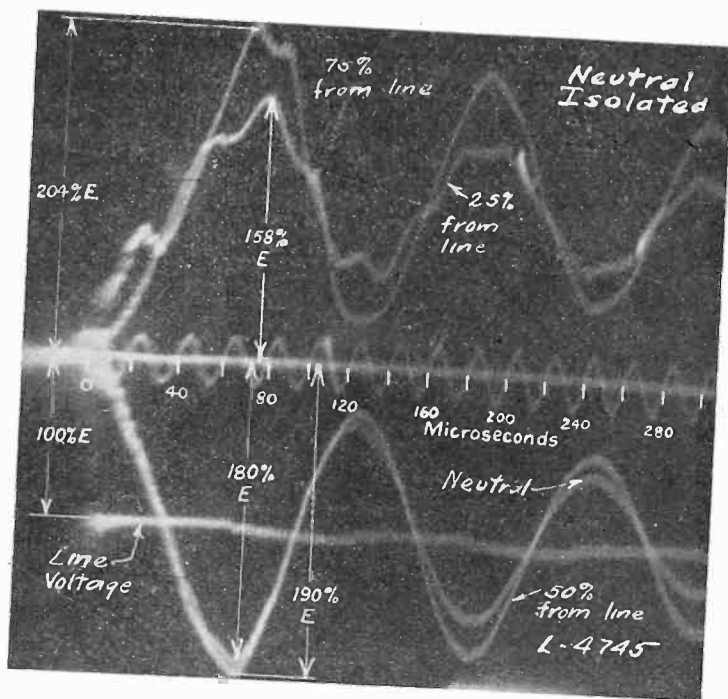

FIG. 5—OSCILLATIONS IN A SHELL TYPE TRANSFORMER WITH ISOLATED NEUTRAL

1—Voltage at line terminal  
2, 3, 4, and 5 are voltages-to-ground at points 75, 50, 25, 0 per cent away from neutral terminal with crest values of 158, 190, 204, 180 per cent of applied voltage respectively. Note all voltages recorded below zero line are taken with reversed polarity

the impedance of such a grounding device at operating frequency is equal to the desired value. In addition, the rate of rise of neutral potential produced by any surge is made so slow in comparison with the natural frequency of the transformer that the transformer winding oscillates as if it were solidly grounded. It is suggested that the above device be called an impedor.

#### Part 4. Impedor with Non-Resonating Transformer

A non-resonating transformer, which is designed for solidly-grounded neutral when grounded through ordinary resistance or capacitance, oscillates very like an ordinary transformer, as shown diagrammatically on Fig. 3. However, the neutral capacitance may be so chosen that for the finite waves which are found in practise, the neutral will remain substantially at ground

potential. Under such conditions, the transient voltage distribution along the winding will be uniform. Since the impedance of such an impedor at operating frequency can be made very high, the transformer may be made to act at operating frequency as if its neutral were isolated.

When it is desired not only to retain the non-resonating characteristics, but also to limit the neutral voltage under transient conditions, an impedor is designed to

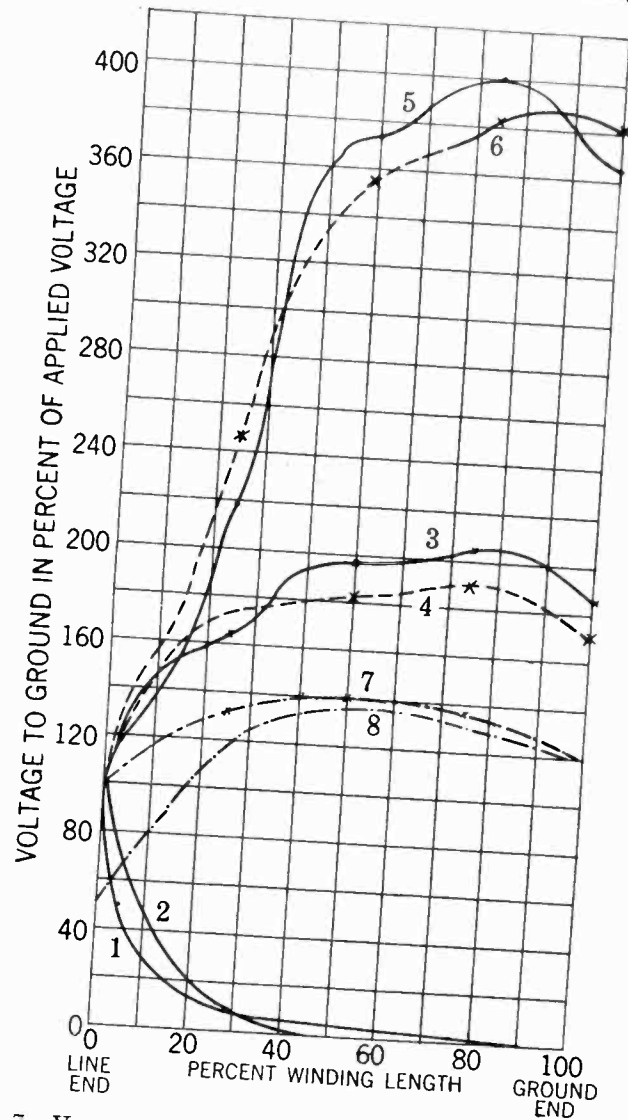

FIG. 7—VOLTAGE-TO-GROUND IN SHELL AND CORE TYPE TRANSFORMERS DUE TO LIGHTNING AND SWITCHING TRANSIENTS. (TEST)

1 & 2—Initial voltage distribution  
3 & 4—Maximum voltage-to-ground due to lightning  
5 & 6—Maximum voltage-to-ground due to switching  
(1, 3, & 5 refer to shell type—2, 4, & 6 refer to core type transformers)  
7—Estimated voltages met in practise, due to lightning  
8—Estimated voltages met in practise, due to switching

hold the neutral voltage and its rate of rise below a specified value for the longest traveling wave possible in practise.

During the last year and a half, nearly 800,000 kv-a. of transformers of non-resonating type have been built to be operated with an impedor in the neutral.

#### Conclusions

Ordinary Transformers. It has been shown in previous papers that the insulation of ordinary transformers

with solidly grounded neutral should not be graded in the order of the normal frequency voltage stress to ground, due to the presence under transient voltage stress of high voltages to ground along a major portion of the winding from line toward the neutral. The insulation immediately adjacent to the neutral terminal, say the last 10 per cent, and the neutral bushing itself, may be of lower insulation strength.

In this paper it is shown that:

1. Where the neutral is not solidly grounded but is grounded through inductance, the insulation of the

and the insulation between neutral end of the winding and ground may be reduced depending on the dynamic rise of the neutral voltage, but the insulation between the rest of the winding and ground and low-voltage winding cannot be graded.

*Non-Resonating Transformers.* 1. Where the neutral is solidly grounded, the insulation from line terminal to neutral may be graded in the order of the normal frequency voltage stress.

2. Grounding the neutral through an inductance is not permissible with a non-resonating transformer of the construction described in the papers referred to.

3. Grounding the neutral through a resistance not exceeding 30 or 40 ohms is permissible with non-resonating transformers. The insulation of the winding may be graded in the order of the fall of voltage from line terminal to the neutral under the maximum value of

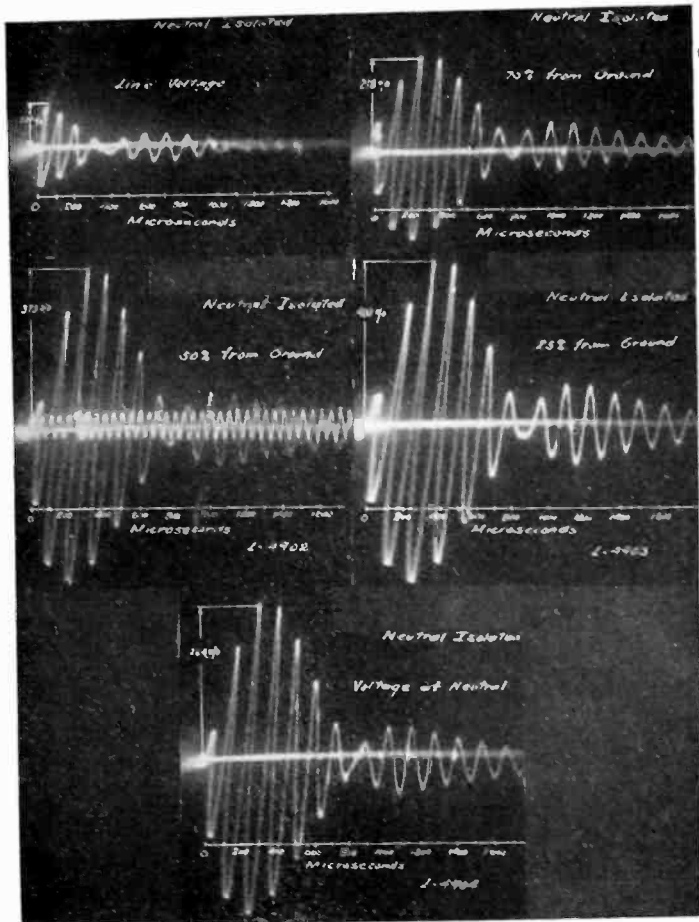

FIG. 9—OSCILLOGRAMS OF VOLTAGES IN A SHELL TYPE TRANSFORMER PRODUCED BY DAMPED OSCILLATIONS SIMILAR TO WITCHING

- 1—Voltage at the line terminal
- 2, 3, 4, and 5—Voltages to ground at points 75, 50, 25, and 0 per cent away from neutral terminal, with crest values of 218, 373, 400, 364 per cent of applied voltage, respectively

whole of the winding and neutral bushing must be equal to that of the line terminal.

2. Where the neutral is grounded through resistance, if this resistance exceeds 300 to 400 ohms per transformer bank, the insulation of the whole of the winding and neutral bushing should be equal to that of the line terminal. For lower values of resistance, the insulation of the neutral bushing may be reduced depending upon the dynamic rise of neutral voltage and the transformer high-frequency characteristics.

3. Where the neutral is grounded through an impedor of proper characteristics, the neutral bushing

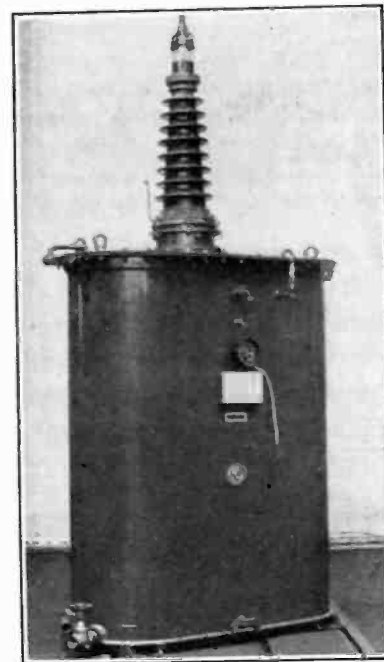

FIG. 19—IMPEDOR FOR BANK OF (3) 40,000-KV-A. 220-KV. TRANSFORMERS

dynamic neutral voltage rise. For higher values of resistance, a capacitance shunt across the ground resistance must be used.

4. Grounding the neutral through an impedor of proper characteristics is permissible with non-resonating transformers. The insulation of the winding may be graded in the order of the fall of voltage from line terminal to the neutral under the maximum value of dynamic neutral voltage rise. The impedor may consist of:

- a. A combination of resistance and capacitance.
- b. A combination of resistance, capacitance, and inductance, when the latter is required by short-circuit considerations.

The author wishes to express his indebtedness to Mr. J. H. Hagenuth for his assistance with tests and

calculation of curves, and to Messrs. A. N. Garin and S. T. Martin for editing the paper during the author's absence.

### Bibliography

1. *Progress in the Study of System Stability*, by I. H. Summers and J. B. McClure, A. I. E. E. Quarterly TRANS., Jan. 1930, Vol. 49, p. 132.

2. *Lightning Studies of Transformers by the Cathode Ray Oscillograph*, by F. F. Brand and K. K. Palueff, A. I. E. E. Quarterly TRANS., July 1929, Vol. 48, pp. 998-1012.

3. *Effect of Transient Voltage on Power Transformer Design*, by K. K. Palueff, A. I. E. E. Quarterly TRANS., July 1929, Vol. 48, pp. 681-706.

4. *Abnormal Voltages within Transformers*, by L. F. Blume and A. Boyajian, A. I. E. E. TRANS., 1919, Vol. 38, p. 577.

## Abridgment of Rationalization of Station Insulating Structures With Respect to Insulation of the Transmission Line

BY C. L. FORTESCUE<sup>1</sup>

Fellow, A. I. E. E.

**Synopsis.**—The purpose of this paper is to present a logical basis for the insulation of transmission lines and substations using as a basis the characteristics of traveling waves produced by lightning discharges. The method presented was formulated from the data obtained from the cathode ray oscillograms of actual line surges and upon the laboratory work in which the impulse flashover characteristics of insulating structures was determined. The breakdown volt—time characteristics of various forms of insulations are presented. Using these curves of various forms of gaps in the known characteristics of traveling waves, insulation of the

transmission line at various distances from the gap is determined so that flashover will be unlikely to occur at these points. A similar method of analysis is made upon substations and lines protected by lightning arresters, but with the known characteristics of lightning arresters, the insulation on the line up to points 1000 to 5000 ft. away can be apportioned so that the lightning arrester will take the discharge, preventing the flashover of insulation. The system set forth in the paper enables the transmission engineer to design the line and substation in an economical manner and obtain adequate protection for all points desired.

### INTRODUCTION

THE increased amount of information on lightning phenomena which has been obtained during the last few years has given engineers a new insight into the problems of insulating transmission lines and station insulating structures against lightning. It is now becoming common practise to vary the insulation of the transmission line itself to correspond with the severity of the exposures which occur at different points along their lengths. The improvement in the insulation of transmission lines has created some concern in the minds of manufacturers of transformers as to the severity of the surges which as a result of the increased insulation will have to be met by the insulation of station apparatus, and it would be wise to limit the insulation of the transmission line to correspond to the voltage class of the apparatus installed in conformity with the results of past experience with apparatus in the field. The suggestion has been made to limit the insulation of the transmission line for a half a mile outside the station.

### USE OF LIGHTNING ARRESTERS MANDATORY

At this time the author wishes to point out that as a protective measure for the transformers, the reduced insulation is not intended to replace the lightning arrester, but is intended as a back-up protection and in case something happens to the lightning arrester.

1. Consulting Transmission Engineer, Westinghouse Elec. & Mfg. Co., East Pittsburgh, Pa.

Presented at the Summer Convention of the A. I. E. E., Toronto, Ont., Canada, June 23-27, 1930. Complete copy upon request.

It should not be assumed that an insulator string constitutes a good lightning arrester, as its flashover time lag characteristics are not conducive to its functioning as a lightning arrester. This will be easily seen by reference to Fig. 1 in which the flashover of a string of insulators and the surge potential of the corresponding lightning arrester are shown, as well as the full wave to

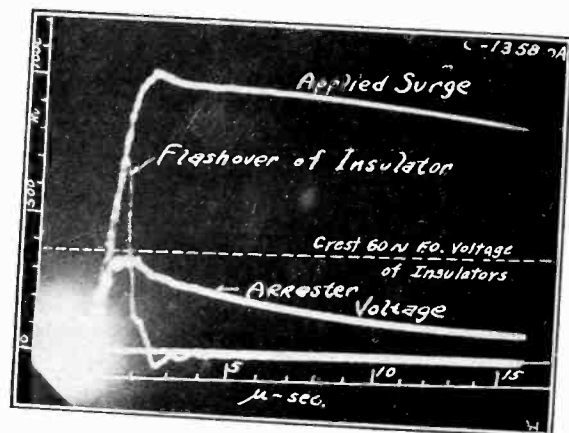

FIG. 1

which they were subjected. A further consideration of the characteristic curves of insulating structures will make this still clearer.

### LABORATORY WORK TO DETERMINE IMPULSE FLASHOVER CHARACTERISTICS OF INSULATING STRUCTURES

Our laboratory work on lightning has been carried out on the supposition that the characteristics of insu-

lating strings should be based on the most severe type of lightning likely to be encountered. This has a further advantage, in that the curves obtained in this manner are drawn in volts and time lag of flashover, and completely specify the impulse time lag characteristics of the insulating structure or insulator without regard to the shape of the wave, and the behavior of the

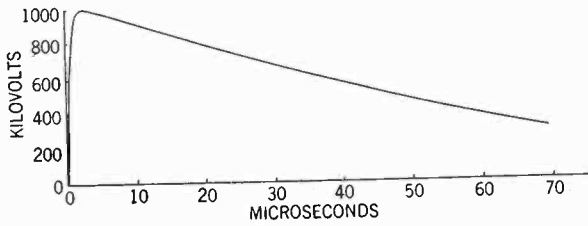

FIG. 3

insulator string for any shape of wave can be very easily obtained from these characteristics.

The laboratory work on impulse characteristics was done with the wave shown in Fig. 3. It will be seen

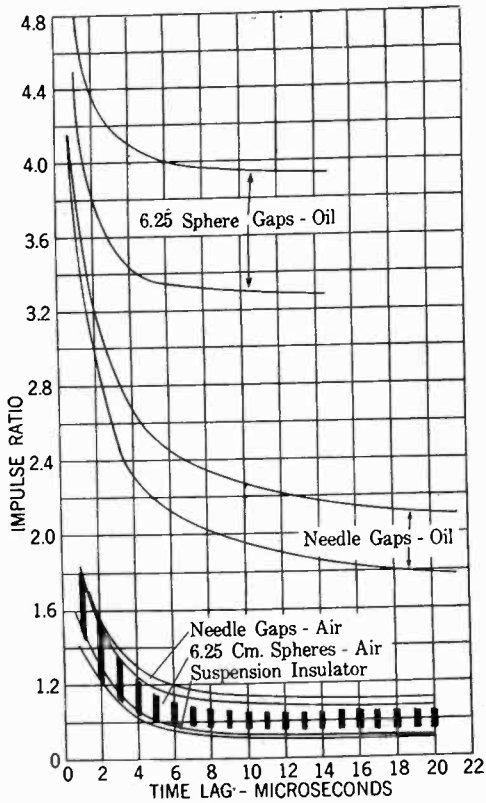

FIG. 4—IMPULSE RATIO CURVES FOR INSULATORS AND SPARK-GAPS

Negative Terminal Grounded

that this wave corresponds very closely to a square-topped wave. The procedure for obtaining flashover voltage time-lag characteristics is completely described in a contemporary paper by J. J. Torok.<sup>3</sup> It is obviously of great importance for transmission engineers to know the flashover voltage time-lag characteristics of the various types of insulating structures that enter into their transmission line and station designs. During

3. J. J. Torok, *Surge Characteristics of Insulators and Gaps*, A. I. E. E. Quarterly TRANSACTIONS, July 1930, p. 866.

the past two years, a great many data of this type covering the flashover voltage time-lag characteristics of the various types of insulation which are presented in Torok's paper have been obtained in the Trafford High-Voltage Laboratory. For purposes of illustration, in the discussion on application which follows, some of the curves are reproduced here. Fig. 4 shows the envelopes of the impulse ratio time-lag curves for needle- and sphere-gaps for a large number of different spacings in air and oil, and suspension insulator strings of from 2 to 16-units. Fig. 5 shows the flashover voltage time-lag curves of suspension insulators with and without arcing

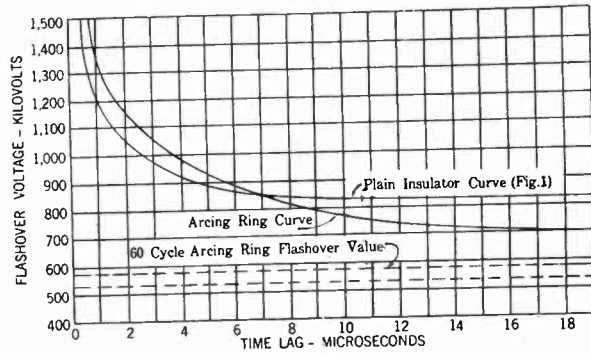

FIG. 5—TIME-LAG CURVE FOR 24-IN. X 30-IN. ARCING RINGS

Nine No. 641 units; 43.5-in. spacing

rings and Fig. 6 shows the same information plotted in terms of impulse ratio. The work done in investigating the time-lag flashover characteristics of needle-gaps and sphere-gaps of various sizes at wide spacings in air is particularly important in connection with the deter-

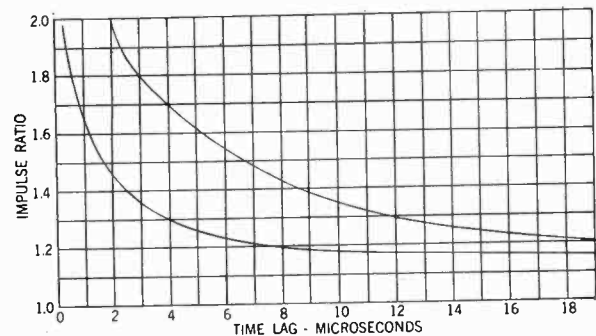

FIG. 6—IMPULSE RATIO CURVES FOR NINE SUSPENSION UNITS NO. 641 AND 24-IN. X 30-IN. ARCING RINGS

mination of the best form of relief gap to be used in connection with the rationalization of the station insulation and the line insulation, in cases where it is not feasible to reduce the latter for a distance of one-half mile outside the station. It should be noted that the divergence in characteristics of needle-gaps in air for large and small gaps is extremely small. With spheres, the divergence is greater. In Fig. 4 it will be noted that the divergence in impulse characteristics for suspension insulators in going from two-unit to 16-unit strings is extremely small. Fig. 7, which gives the data on suspension insulators drawn in a somewhat different manner, shows a comparison of our Trafford Laboratory

4. F. W. Peek, Jr., *Progress in Lightning Research*, A. I. E. E. Quarterly TRANSACTIONS, April 1929, p. 436.



data with laboratory data published by Peek,<sup>4</sup> which comprises the values he obtained with three types of wave; namely 5-, 20-, and 80-microsecond waves, according to his definition.

#### DISCUSSION OF FLASHOVER TIME-LAG CHARACTERISTICS

Let us now compare the characteristics of the impulse ratio curves for needle-gaps with those for insulators; in Fig. 4 it will be noted that the general shape of the curves is very similar, and that if the 60-cycle flashover point of the needle-gaps is reduced 12 per cent over that of the string of insulators, the voltage time-lag curves will practically coincide. The needle-gap will show a slightly greater time lag at the high voltages. In Fig. 6 it will be observed that the effect of the arcing rings is to very greatly increase the time lag for a given ratio of surge voltage above the 60-cycle flashover voltage. However, for a given string of insulators, the effect of the arcing rings is also to decrease the 60-cycle flashover as shown in Fig. 5. Consequently, the flashover voltage time-lag curve of the insulator string provided with arcing rings will cross that of the plain string somewhere in the neighborhood of eight microseconds; hence for waves that take more than eight microseconds to flash over the plain string, the string provided with arcing rings will have a shorter time lag, and will therefore flash over before the plain string; but for surges that take less than eight microseconds to flash over the plain string, the string provided with arcing rings will have a greater time lag, and therefore such a string will require a higher voltage for flashover with the same time lag. Since about the longest time lag for a lightning wave to flash over an insulator string is 15 microseconds, in order to bring the impulse flashover strength of the two to equality at this point, the string provided with arcing rings would have to have its 60-cycle flashover raised in inverse proportion to the relative value of the impulse ratio at this time lag.

It does not follow that because an insulator string provided with arcing rings and with its 60-cycle voltage raised so as to produce equal impulse strength at 15 microseconds has higher time lag for waves which flash over at less than 15 microseconds, it will result in lower outages on a line than the simple string. It is true that with lightning waves of short duration, this will be the case; but such lightning waves are not sufficiently numerous to be of any great consequence in determining outage factors. With high surges of long duration the string provided with arcing rings will flash over just as frequently as the plain string.

#### PROPER BASIS FOR RATIONALIZATION OF STATION INSULATION AND TRANSMISSION LINE INSULATION

Obviously, the station insulating structure should be rationalized with respect to the transmission line whenever possible and not with respect to any extraneous device such as the horn-gap, since the object is to insure that the station insulation will be at least as strong as the line insulators adjacent to the station so that if a

flashover should occur, it will take place on a line and not on station apparatus. In contrast to the line flashover which occurs and is suppressed without damage, flashover in the station insulating structure may involve more than the particular structure which flashes over, and may result in serious damage to the station and prolonged outage. Measurements of the impulse ratio range of pillar type insulators have been made in the laboratory, and it has been determined that this range is above that of suspension insulator strings; consequently, if at 15 microseconds the 60-cycle flashover of the pillar type insulator is slightly higher than that of the insulator strings near the station, the pillar type insulator will be properly rationalized with respect to the transmission insulation. Other important insulating structures used in stations are outlet bushings which form part of circuit interrupters and transformers. The impulse ratio time-lag characteristics of bushings may be modified by proper terminal arrangements so that they will have the same flashover voltage time-lag characteristics as the insulator string over a range of 20 microseconds; and if the flashover voltage at each value of time lag is made 5 per cent higher than that of the transmission line insulators, the conditions of rationalization are satisfied.

With lightning arresters at the station, the necessity for rationalizing the insulating structures with the line is sometimes questioned, but cases have been known where a direct stroke at the station has resulted in destruction of the lightning arresters, in which case for subsequent operation—until the arresters are replaced—the station has to fall back on the impulse flashover of the insulators to limit the surge potential to which the apparatus is subjected.

#### PROTECTION OF TRANSMISSION LINES BY MEANS OF ARRESTERS

The impulse time-lag curves of transmission line insulators may be very usefully applied to the protection of transmission lines by means of lightning arresters. The range over which a lightning arrester will afford protection to a transmission line depends to a great extent upon the wave form of the surge. However, if we assume the most severe type of lightning surge, which is one that comes to its maximum in a relatively short time,—say not more than one microsecond,—and at the end of 20 microseconds has a value of not less than 75 per cent of the crest value, we find that the protection afforded by a lightning arrester may be quite simply estimated on the following basis. We shall divide the line into sections, approximately one microsecond light intervals from the arrester. Let us take a point three microseconds (approximately 3000 ft.) distant from the arrester, and let us suppose that the surge approaches the arrester from the direction of this point; then this point will be subjected to the full value of the wave for three microseconds before it reaches the arrester. The action of the arrester, as we have indicated above, consists in absorbing part of the

energy of the surge and reflecting the remainder so that the wave that passes the arrester is the difference between the actual wave and the reflected portion. It will be noted that if we take the energy of the portion that passes plus the energy of the portion that is reflected, this will be less than the total energy of the incident wave; the difference between the two values is the energy absorbed by the arrester. This reflected wave will take three microseconds to reach the given point so that the total time during which this point is

mission line will have a cut-off voltage equal to the crest of the normal line voltage; the maximum voltage will therefore be 2.0 to 2.5 times the line voltage. We may assume that if the crest value of the wave which remains after the arrester has functioned is impressed on the insulator string for more than 15 microseconds, it will just cause flashover. We therefore take 15 microseconds on the curve of Fig. 6, and find that the impulse ratio is 1.15. So we assume that in order to receive 100 per cent protection from the transmission line, the insulator string must have a 60-cycle flashover equal to 2.2 times line voltage. On this basis, a 132-kv. line will require only five insulators at the arrester point. Let us suppose that we wish to protect the point farthest from the lightning arrester from all waves which have a crest value less than 1500 kv.; at six microseconds we have an impulse factor of 1.23, so that the 60-cycle crest value must be 1500 divided by 1.23 or a root-mean-square value of 860, which would require a string of insulators of 16 units. For the insulator string two light microseconds away the time lag is four microseconds and the impulse factor 1.3, giving a 60-cycle flashover of the string of 815 kv. and requiring 15 units. For the insulator string one light microsecond away the time lag will be two and the impulse factor will be 1.56, which requires an insulator string having a 60-cycle flashover of 680 kv.; this requires a string having 12 units. The average number of units will therefore be 13, and the system will be protected against all lightning surges of maximum severity below 1500 kv.

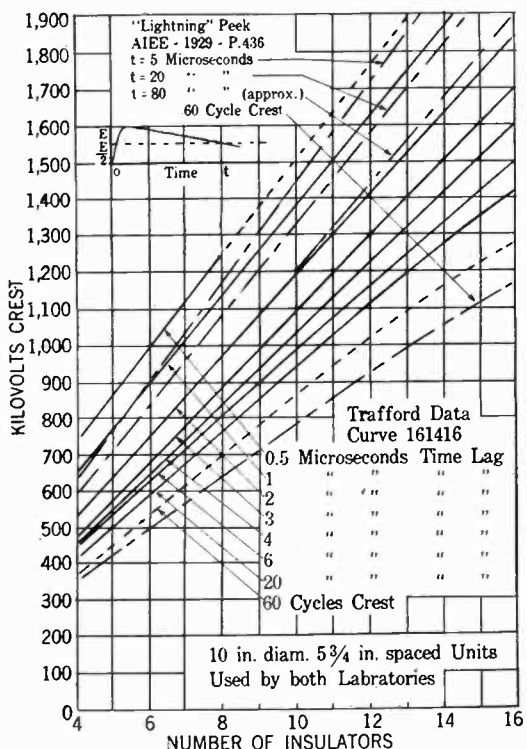

FIG. 7—COMPARATIVE SURGE DATA (GENERAL ELECTRIC COMPANY—WESTINGHOUSE ELEC. & MFG. CO.)

subjected to the full value of the wave is six microseconds. Let us now refer to Fig. 6; we find that with six microseconds given in the lower curve, the insulator string will have an impulse ratio of 1.23, and the conclusion is that all waves of this type having a crest value above 1.23 times the 60-cycle flashover of the insulator string will cause a flashover, and waves below this value will not cause a flashover. By using the probability curve of lightning surge occurrence in the manner discussed by H. L. Wallau,<sup>5</sup> we can estimate the probable reduction in outages at this point as a result of the presence of the lightning arresters placed three light microseconds from this point. If the lightning arresters are placed six light microseconds apart, this value will be the outage factor for the middle points between the lightning arresters.

RATIONALIZATION OF TRANSMISSION LINE INSULATION IN PROPORTION TO PROTECTION

Another way of applying the line type arresters is to equalize the outage factors by varying the insulation. The lightning arrester that is used in protecting a trans-

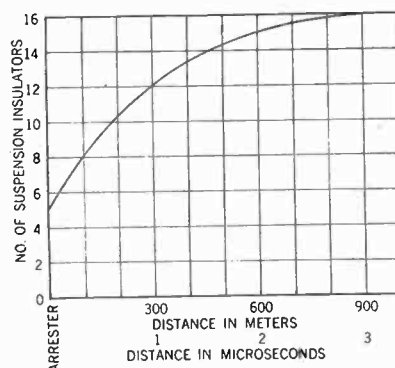

FIG. 8—CURVE SHOWING INSULATION REQUIRED AT VARIOUS DISTANCES FROM LIGHTNING ARRESTER FOR 132-KV. LINE FOR PROTECTION AGAINST A VOLTAGE OF 1500 KV.

The above example has been based on practically square-topped waves. The actual protection for waves having slopes of two to three microseconds will be much better. It has also been assumed that the string was a straight string without arcing rings. When arcing rings are used, the protection is still further increased and fewer units may be used. For example, if strap type rings are used (Fig. 6), the impulse factor at 15 microseconds is 1.24 as compared to 1.15. This would mean practically that the five-unit string would probably be satisfactory at this point. At the point three light microseconds away with strap type rings, we would have an impulse factor of 1.54 which

5. H. L. Wallau, "Relative Frequency of Voltage Surges Induced by Charged Clouds," *Electric Journal*, August 1928.

corresponds to a 60-cycle flashover of 685 kv. with arcing rings, or a plain string flashover of 760 kv. which would therefore require 14 units instead of 16 with the plain string. At the point two light microseconds away, the time lag is four microseconds and the impulse factor is 1.8, which gives a 60-cycle flashover of 590 for the string with strap rings, corresponding to 670 for a plain string. This would require a string of 12 units. At the tower one light microsecond away, we shall have a time lag of two microseconds and an impulse factor of 2.3. This gives a 60-cycle flashover of 460 kv. with arcing rings corresponding to 530 kv. for a plain string which requires nine units. The average length of string would then be less than 11 insulators.

This method of rationalizing the insulation in relation to the amount of protection it receives from the arrester offers the lowest outage factor possible for a given average length of string. It will be necessary, however, in practical construction work, to consider other elements such as the tower design; but it appears that by

properly organizing the construction work, several towers of different size could be used with an average cost of tower not appreciably greater than if flat insulation were used. A great reduction in actual outage factor due to lightning should be possible therefore with little added cost. It should also be remarked that as has been indicated the performance of the 132-kv. line would be better than that of a line without arresters having a flat insulation of 16 units. In other words, the arrester-protected line with graded insulation would give protection superior to that of a line over-insulated with 16 units. In this case the arresters are placed seven light microseconds apart; with closer spacings, fewer insulators will be required for the same degree of protection. A curve may be plotted giving 60-cycle voltage or number of insulators against distance or light microseconds. Such a curve illustrating the above example is shown in Fig. 8. Thus the cost of arresters and insulators with different spacings of arresters along the line may be readily obtained.

## Abridgment of Modern Requirements for Protective Relays on Important System Interconnections

BY O. C. TRAVER<sup>1</sup>

Member, A. I. E. E.

and

L. F. KENNEDY<sup>1</sup>

Non-member

### INTRODUCTORY

**T**HE usual methods of relaying are becoming inadequate for tie line application. The need for limiting the duration of faults on lines of major importance is unquestioned. The possibility of maintaining stability by quicker operation of protective equipment is well recognized. These considerations have resulted in the development of the high-speed relays and oil circuit breakers as steps in the over-all reduction of short-circuit duration.

Besides limiting the duration of short circuits, it is frequently necessary that the protective equipment function correctly at current values below rated load. On some important interconnections, the range in capacity is such that the minimum short-circuit current is but a fraction of the full load value. It is a requisite, therefore, that the new protective relay types and methods should give rapid, selective action, even at low current values.

It is obvious that the use of cumulative or graded settings will not produce the desired results. Preferably, therefore, the relay equipment should make no attempt to operate except when a fault occurs on the circuit protected or as back-up for disorders in a contiguous line. Furthermore, excepting where the through current is limited chiefly by the impedance of the

protected line alone, its absolute magnitude is of little value in determining where a fault exists.

### COMPARISON—THE MODERN FOUNDATION

Time having been excluded in the concept of our problems, and current magnitude or any other single quantity being too variable to be trustworthy, an immediate comparison of two or more electrical quantities is needed, as a prompt means of discriminating between good and bad. These comparisons may be listed as:

Series Balance . . . . .	Comparison of currents at the two ends of a circuit.
Parallel Balance . . . . .	Comparison of currents at one end of two parallel circuits.
Balance of Dissimilar Quantities . . . . .	<i>e. g.</i> current and voltage.

The speed of operation of the directional reslay is of unusual importance. They must be fast under all expected voltage and phase angle conditions. A tardy relay may impair otherwise excellent protection.

Though quick action of the relay nearest the fault is a highly desirable feature, it does not necessarily rid the system of the disturbance. The opposite end is sometimes obliged to wait and thereby double the time to completely clear. The various means dealt with in this paper range from about 60 per cent to 100 per cent of effective simultaneous and complete isolation.

### SERIES BALANCE

The series balance method gives a comparison of the

<sup>1</sup> General Electric Company, Philadelphia, Pa.

Presented at the Summer Convention of the A. I. E. E., Toronto, Ont., Can., June 23-27, 1930. Complete copy upon request.

relative magnitude of current values at two points in the same circuit. It is the best method of obtaining selective action. This is the familiar differential protection, in which an instantaneous comparison is easily made between currents, normally equal, at two points reasonably close to each other. A fault is indicated by an inequality between the two current values. For line protection, such methods involve the use of pilot wires with their attendant expense and technical problems, in proportion to their length. Quick action is secured with simultaneous tripping of both ends of the line for faults over its entire length.

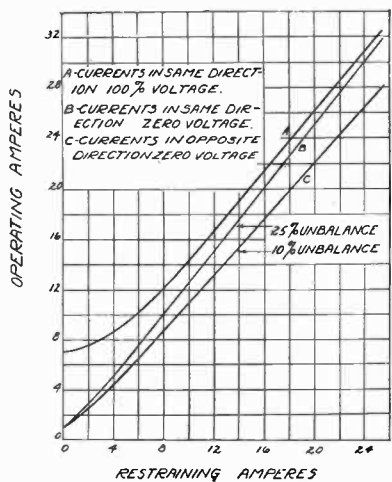

FIG. 1—OPERATING CHARACTERISTICS OF BALANCED CURRENT RELAY USING VOLTAGE RESTRAINT

Related to the foregoing is the carrier-current pilot protective system which provides a comparison of relative direction of the currents at the two ends of a line. The breakers at both ends of the line can be simultaneously tripped in 0.1 sec. or less. For a description of this method, see paper by A. S. Fitzgerald.<sup>2</sup>

PARALLEL BALANCE

A comparison between currents in two lines which normally bear a definite relation constitutes a parallel balance.

On account of the simplicity, reliability, and speed of this equipment, two similar parallel lines should be protected by balanced relays which will operate to trip one line when its current is a certain percentage above that in the other line. The percentage unbalance is chosen high enough to prevent false operation on small differences such as may be due to variation in current transformer or transmission line characteristics, unequal mutual inductance, and similar causes. The usually accepted value is 25 per cent unbalance on outgoing lines.

For faults close to one end of a pair of parallel lines, the current will flow in opposite directions in the two circuits. Since the direction of current flow in two parallel lines is always the same unless one of them is at fault, it is permissible to operate on a 10 per cent

2. A Carrier Current Pilot System of Transmission Line Protection, A. I. E. E. Quarterly TRANS., Jan. 1928, Vol. 47, p. 22.

unbalance when the currents are in opposite directions. Such a characteristic makes for wider application of the parallel balance methods. In cases where the generating capacity at the end nearest the fault is very low, and where there may not be 25 per cent unbalance, it is possible with relays operating in the order of one cycle, to obtain action on current fed from synchronous condensers or induction motors. This combination makes balance current relays almost universally applicable for parallel trunk lines.

Balanced relays should have a straight line percentage characteristic at the higher current values, as shown in Fig. 1. In order to cover the entire range, including low-current faults, it is necessary that the curve continue on down below the normal load. Such a curve with a minimum operating point of one ampere is shown in Curve B.

Where balanced relays are used, they are prevented by means of auxiliary switches on the breakers from tripping the second line after one opens. With the characteristic referred to above, however, the relay would be ready to trip the line carrying load if an attempt were made to close the associated circuit. To prevent this, a voltage restraining feature is added to the current balance relay, modifying its characteristic at 100 per cent voltage, as shown on Curve A of Fig. 1. This novel feature adds an impedance factor and normally raises the minimum operating point above full load, thereby permitting switching in the open line without special operating requirements. Under short-circuit conditions, a family of curves between A and B is obtained, Curve B being the zero voltage characteristic and A the full-voltage characteristic. Curve C shows the effect of reversing current in one line,

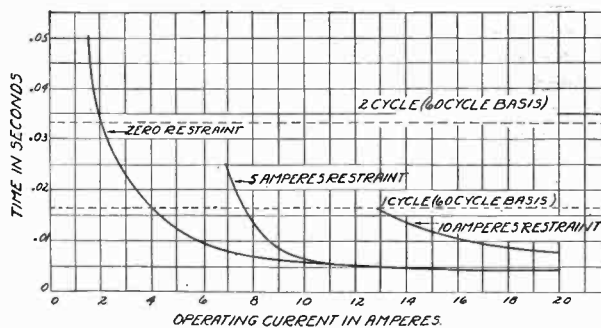

FIG. 5—TIME-CURRENT CURVES OF BALANCED CURRENT RELAY

automatically reducing to the 10 per cent unbalance characteristic previously discussed.

This balanced current relay is immediately discriminating, without cascading over an average of at least 80 per cent of the length of the lines. In this regard it occupies the place next to the 100 per cent pilot wire schemes.

The construction of the relay is such that small travel and relatively large forces are used to obtain fast operating time with assurance against false operation from shock or vibration. The current cores and voltage restraining cores are shaded to quiet the



operation of the relay under normal conditions and to make it less sensitive to surges.

A holding coil is provided which seals the contacts closed until the breaker has opened. In accordance with long established practise the trip circuit is interrupted to both breakers by auxiliary contacts on either breaker.

A time characteristic, (Fig. 5), shows the extremely low values obtained. It is to be noted that at 20 amperes, the time is 0.004 sec. and, in general, is less than 0.016 sec. (1 cycle on a 60-cycle basis).

In the application of these to two parallel lines, four

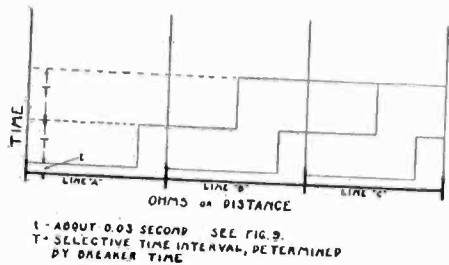

FIG. 6—STEPPED TIME CHARACTERISTICS FOR DISTANCE RELAY

relays are used, one in each phase and one in the residual circuit for ground faults. Usually, the residual relay will not require the voltage restraining feature.

COMPARISON OF DISSIMILAR QUANTITIES

In any circuit there is a distinct difference in the relative values of current and voltage between load and fault conditions. A relay operating on the ratio of these quantities is valuable therefore in indicating the occurrence and location of a fault. The ratio between voltage and current is impedance, and impedance, neglecting the fault component, is a measure of distance.

Since it is not practical to set a relay with an impedance pick-up to cover 100 per cent of a given section,

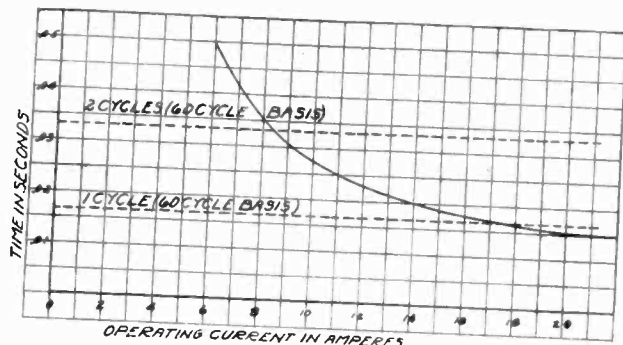

FIG. 9—TIME CURRENT CURVE OF IMPEDANCE RELAY WHEN OPERATING BELOW 90 PER CENT OHMIC SETTING

it is necessary to provide some means of protection for the far end of the section as well as the bus to which it connects. This protection can be provided by a second similar impedance unit operating at a higher ohmic value and giving the desired time delay.<sup>3</sup>

An efficient type of protection using an ohmic relay is indicated on Fig. 6. This "step characteristic" protects Line A in the minimum time up to about 80 per cent of its length. At this point, time is introduced for the protection of the last 20 per cent of the line and

3. A. I. E. E. TRANS., 1923, Vol. XLII, p. 532—Discussion by P. Ackerman.

the bus, overlapping well into the next line. The relay on Line B would have a similar characteristic. Provision can also be made to give back-up protection at A for faults in Line B, in case of failure of its circuit breaker to clear. This unit requires still higher ohm and time settings.

Three time steps can thus be provided, one as low as practical and operating for faults up to 80 per cent of the line ohms; a second step, higher than the first by the selective time interval required by the breaker and operating up to a value including about half the next line; and a third step for back-up only.

A time characteristic of this kind may be secured by a group of units functioning on ohms and on time. In an elemental form, the ohm unit is operated by current and restrained by voltage, thereby functioning on impedance. The time desired is measured with precision by an escapement mechanism.

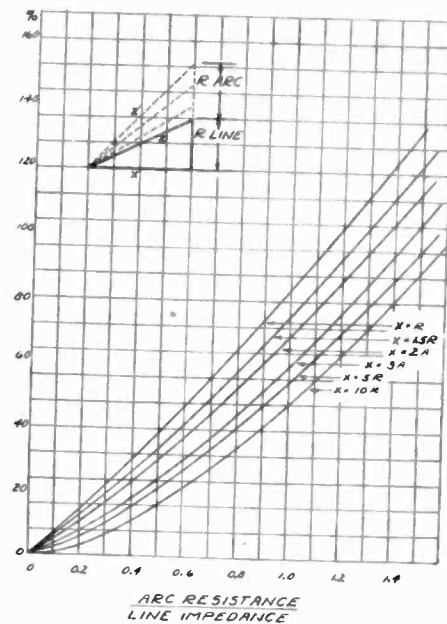

FIG. 11—EFFECT OF ARC RESISTANCE IN INCREASING IMPEDANCE OF FAULTY LINE

The induction type impedance unit has the time characteristic illustrated in Fig. 9. This time is fast enough to match the associated directional unit and at the same time sufficiently deliberate to avoid false action on transients, etc.

In setting impedance relays, arc resistance must be taken into account; in fact, on short lines, the arc may have a higher impedance than the line. For composite effect see Fig. 11; it should be noted that this illustrates a simple mathematical computation based on the assumption that there is no reactance in the arc. It is therefore even more optimistic than actual test values indicate. As either metallic or arcing faults are possible, it may be difficult to obtain the proper setting of impedance relays. Even if one were to disregard metallic faults, because of the lesser chance of their occurring, the arc itself is extremely variable due to changing current and length as discussed later under field tests. Of course the effect of the arc is proportionately less as the line increases in length.

REACTANCE RELAYS

The chief component of an arc is resistive although contrary to a general belief, it also has a very pronounced reactive effect which may appear in proportions approximating the resistance. This reactive tendency is largely fictitious and becomes decreasingly effective as it is added to line impedance. Furthermore, by the proper choice of instruments, even this fictitious effect can be practically discounted.

Under these conditions, it is submitted that the ohm unit, most reliable for a distance relay, will work on the

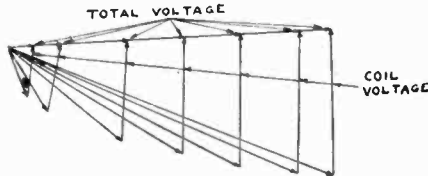

FIG. 14—PHASE RELATIONS OF THE AMPLIFYING POTENTIAL CIRCUIT

inductive reactance component rather than on impedance.

DIRECTIONAL ACTION

A distance relay can operate no faster than the directional unit which is a part of it. The shortest time is desired when the voltage, and accordingly the torque, is the lowest. Ample torque under short-circuit conditions must not be secured at the expense of excessive temperature or burden at normal voltage.

This problem has been solved by the use of a potential circuit which is resonant at low voltage but not so at full voltage.

This very useful principle can be put to work by

At low voltage the thyrite resistance is so high that practically no current flows through it, leaving the coil and condenser in resonance, and the current through the coil limited only by its own resistance. As the voltage increases, the thyrite resistance decreases rapidly (exponentially) until resonance is destroyed.

With thyrite in parallel with the coil and no saturation, the angular relation between the line voltage and the coil voltage is nearly constant as shown in Fig. 14.

A polyphase relay embodying this feature will give speeds of the same order as the distance relay. By providing this relay with a voltage restraining element

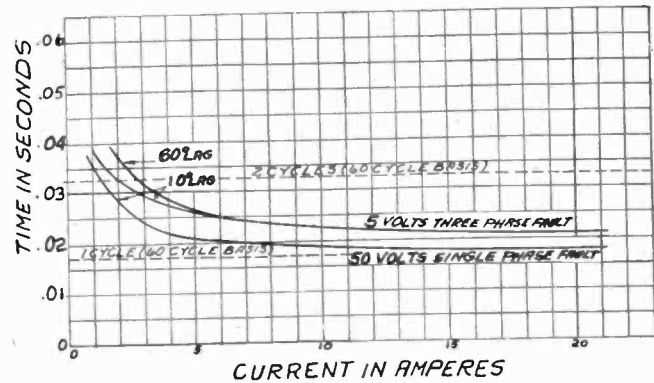

FIG. 15—POLYPHASE DIRECTIONAL RELAY WITH VOLTAGE RESTRAINT

it can be given a characteristic which will prevent the relay from closing its contacts except when there is a fault on the system. This restraint is secured by the use of a watt element with two potential coils arranged to produce a torque equal to the product of the voltages times the sine of the angle between. If these are excited from two adjacent delta voltages obtained from

TABLE I  
MISCELLANEOUS ARC DATA

Test No.	System voltage	Position of arc	Approx. length of arc in ft.	Instruments used	Current	Arc voltage	Volts per foot	Arc impedance ohms	Ohms per foot	Arc kv-a.	Kv-a. per foot	Measurement taken after arc duration of
1	110 kv.	φ to gr.	4.25	Instrument	960	2,040	480	2.13	0.5	1,960	461	2 seconds
2	110 kv.	φ to gr.	4.25	Instrument	640	4,000	940	6.25	1.48	2,560	606	2 seconds
3	110 kv.	φ to gr.	4.25	Instrument	640	3,740	870	5.84	1.39	2,295	540	1 1/2 seconds
4	110 kv.	φ to gr.	4.25	Instrument	624	3,070	715	4.95	1.16	1,930	453	3 seconds
5	110 kv.	φ to gr.	4.25	Instrument	592	3,600	850	6.1	1.44	2,130	500	1 1/2 seconds
6	110 kv.	φ to gr.	4.25	Instrument	480	4,560	1070	9.5	2.24	2,190	515	2 seconds
7	115 kv.	φ to gr.	6	Oscill.	800	1,500	250	1.8	0.3	1,200	200	0.1 seconds
8	115 kv.	φ to gr.	6	Oscill.	605	2,600	433	4.32	0.72	1,570	261	0.05 seconds
9	154 kv.	φ to φ	12	Oscill.	405	23,100	1916	57	4.75	9,350	779	0.5 seconds
10	154 kv.	φ to φ	30	Oscill.	385	30,700	1023	78.7	2.6	11,830	394	0.5 seconds
11	154 kv.	φ to φ	40	Oscill.	385	35,000	875	90.8	2.27	13,500	337	0.5 seconds
12	154 kv.	φ to φ	40	Oscill.	135	58,500	1462	433.	10.8	7,900	197	0.7 seconds

tuning the potential coil with a series condenser at low values and detuning at high values. The detuning is accomplished by a thyrite resistor connected in parallel with the coil. Thyrite has the valuable property of changing its resistance to suit the need.<sup>4</sup>

4. Thyrite—A New Material for Lightning Arresters, by K. B. McEachron, A. I. E. E. Quarterly TRANS., April 1930, Vol. 49, p. 410.

the line being protected, the torque will be proportional to the area of the voltage triangle. This feature insures return of the relay to the contact open position immediately after the fault is cleared, and prevents false operation due to surges.

The time—current curves for a three-phase fault with 5 volts at 60 deg. and 10 deg. are shown in Fig. 15; also for a single-phase metallic short circuit.

## SIMULTANEOUS TRIPPING AT BOTH ENDS vs. CASCADING

To require that the breaker most remote from the fault must delay tripping until the nearer end has opened means double time for many disturbances before the circuit can be cleared.

Expressed as a percentage of perfection in simultaneous tripping without cascading, the various methods discussed earlier stand about as follows:

Pilot Wire.....	100%
Balanced Current.....	80%
Distance.....	60%

## TESTS

*Arc Impedance.* In connection with various field tests, the authors have been privileged to secure some data concerning the characteristics of arcs such as occur in case of a flashover of a high-voltage transmission line.

The accuracy of these data is not of a high order, since in each case they were obtained as a secondary consideration, without the equipment or preparation which would be needed for a true investigation. The information is included, therefore, in the hope that it will shed its flickering light on a very hazy subject.

It is certain that as the current decreases and approaches an unstable condition, the arc voltage rises rapidly until there is not enough potential in the circuit to support it.

Paul Ackerman has advanced the theory that an arc will follow the characteristic of an approximately constant value of 400 volts per foot.<sup>5</sup>

Some of the discrepancies in our tests are probably due to the method used to start the arc and to the length of time it has been playing. The presence of the metallic vapor of a fuse wire must have a material effect, particularly at the start. In tests 9 to 12, the arc voltage doubled, on the average, after one-half second, with no appreciable change in current or in arc length.

In another test, the total current in each phase on a three-phase-to-ground fault was 605 amperes and at the start of the arc the phase-to-phase voltage was 4500, giving an arc resistance of 7.45 ohms. At the end of 15 cycles of arc, the voltage was 10,280, with practically the same current flow or 16.95 ohms. At the end of 15 cycles, one breaker opened, reducing the current to 322 amperes. The arc lengthened and the voltage continued to rise to a value of 61,000 volts, 40 cycles after the start of the fault.

## ACKNOWLEDGMENT

The authors wish to express their thanks to the officials of the New England Power Company and the Tennessee Electric Power Company for the opportunity offered to obtain these field test data, and particularly to Messrs. E. E. George, C. F. Powers, and H. H. Spencer, for their assistance.

5. "A Study of Transmission Line Power-Areas," by Paul Ackerman, *The Engineering Journal*, (Canada) May, 1928, p. 309.

Abridgment of  
TWO-WAY TELEVISIONPART I—IMAGE TRANSMISSION SYSTEM\*  
PART II—SYNCHRONIZATION SYSTEM†  
PART III—SOUND TRANSMISSION SYSTEM‡

Ever since the initial demonstration of television both by wire and by radio at Bell Telephone Laboratories in 1927, experimental work has been steadily pursued in order to learn the problems and possibilities of this newest branch of electrical communication. The latest development to be demonstrated is that of two-way television as an adjunct to the telephone. As a result of our development work, there is now set up an experimental and demonstration system between the headquarters building of the American Telephone and Telegraph Company at 195 Broadway and the building of the Bell Telephone Laboratories at 463 West Street, New York City, two miles away. This system makes it possible to experiment with a method of communication in which the parties engaged not only speak with each other but at the same time see each other. Study of this system will serve to give information on the importance of the addition of sight to sound in communication and will give valuable experience in handling the technical problems involved.

In principle the two-way television system consists of two complete systems of the same sort as those used for one-way transmission in the demonstration from Washington to New York City in 1927. In place of a scanning disk and set of photoelectric cells at one end for generating the television signals, and a single disk and neon lamp at the receiving end for viewing the image, there are, in the two-way system, two disks at each end and a bank of photoelectric cells; also a neon lamp at each end. One of the disks, which, in the system as constructed is of 21-in. diameter, serves to direct the scanning beam from an arc lamp onto the face of one of the parties to the conversation. Three banks of photoelectric cells, making 12 in all, are arranged at either side and above the person's face, and serve to pick up the reflected light and generate the television signals. The second disk which is 30 in. in diameter is placed below the sending disk and exposes through its holes the neon lamp, which the observer sees through a magnifying lens in a position slightly below that of the scanning beam. This neon lamp is of course actuated by the signals coming in from the distant end of the system where there is a similar arrangement of two disks, photoelectric cells, and neon lamp.

\*By H. E. Ives, (Fellow, A. I. E. E.), Frank Gray (Non-Member), and M. W. Baldwin (Non-Member), Members of the Technical Staff, Bell Telephone Laboratories, New York, N. Y.

†H. M. Stoller, (Member, A. I. E. E.), Apparatus Development Department, Bell Telephone Laboratories, New York, N. Y.

‡By D. G. Blattner, (Associate, A. I. E. E.), and L. G. Bostwick, (Non-Member), Telephone Engineers, Bell Telephone Laboratories, New York, N. Y.

Presented at the Summer Convention of the A. I. E. E., Toronto, Canada, June 23-27, 1930. Complete copy upon request.

The two parties to the conversation take their places in sound-proof and light-proof booths where, sitting in front of the photoelectric cells, they look at the image of the person at the other end at the same time that the scanning beam plays over their faces. A problem of illumination is immediately encountered, in that the scanning beam is of necessity intensely bright and tends to dazzle the eyes to the extent that the somewhat faint neon lamp image is hard to see. This difficulty is met by using for scanning, light to which the photoelectric cells are extremely sensitive, but to which the human eye is relatively insensitive; that is, blue light. By interposing a filter in the path of the scanning beam, the spot of light in the lens which projects it is seen as a blue disk of light not bright enough to interfere with clear vision of the neon lamp which provides the image of the person located at the distant end.

In our original demonstrations of one-way television, scanning disks were used which had 50 holes arranged in a spiral. With this number of holes, it is possible to secure a definitely recognizable representation of the human face. It was decided, however, that for the two-way system a degree of definition should be provided such that faces were rendered in an entirely recognizable and satisfactory manner. Accordingly, the number of scanning holes has been increased to 72, which provides just twice the number of image elements. The transmission band is of course doubled by this change, requiring wire connections of considerably higher quality than heretofore. When a 72-hole scanning disk is used, the component frequencies of the image signal encompass a range of from 10 cycles to 40,000 cycles per sec. whereas intelligible speech may be reproduced by a signal wave whose component frequencies cover a range of 2500 cycles per sec. This comparison indicates roughly how much more difficult it is to transmit high quality television images than it is to transmit ordinary speech. In general, the electrical features of the apparatus are similar to those previously used, although in the interval improvements and refinements have been made in many directions.

Light reflected into the photoelectric cells gives rise to an alternating electric current whose effective value is of the order of a ten-thousand-millionth ampere. The neon glow lamp on which the image is received at the distant station reproduces the image satisfactorily when the effective value of the alternating current is of the order of one-tenth ampere. This thousand millionfold increase in current variation, considerably greater than required for the earlier one-way system, is effected by amplifiers in which the vacuum tubes are coupled by condensers and resistances. The tubes, which operate at low-energy levels, are shielded against electrical, mechanical, and acoustical interference.

For the transmission of images between 463 West Street and 195 Broadway, the appropriate stages of the amplifier system are coupled by special transform-

ers to telephone cable circuits equipped with special distortion correcting networks which are capable of transmitting the extremely complex current variations without distortion. The amounts of distortion inherent in other parts of the system are either kept small by design or annulled by means of correcting networks.

An indispensable part of a television system is the means for holding several scanning disks accurately at the same speed. For the two-way television system, a simplified and improved synchronizing arrangement is used. The disks at the receiving and transmitting ends, which rotate at a speed of 18 rev. per sec., are synchronized by means of a vacuum tube oscillator located at one end of the line and delivering a frequency of 1275 cycles per sec. at a low-power level. This frequency is transmitted over a separate pair of wires. At the receiving end this frequency, through vacuum tube means, controls the field strength of the motor and thereby holds its speed exactly proportional to the frequency. In the same way, the speed of the motor at the transmitting end is controlled by a similar vacuum tube circuit so that its speed is also proportional to the frequency of the same oscillator, and thus the motors driving the scanning disks at both ends of the line are held in synchronism. By using a frequency of 1275 cycles per sec., the degree of synchronization is held within sufficiently close limits to keep the picture at the receiving end central within its frame within a small fraction of the picture width. Novel features of this synchronizing system are the use of mechanical damping couplings between the disks and the motor shafts to improve the steadiness of the image, and of an electrical phase shifter for framing the images.

The acoustic portion of the two-way television system is unusual in that it permits simultaneous two-way conversation without requiring either person to make any apparent use of telephone instruments. It is obviously desirable to arrange the acoustic system in this way because the ordinary telephone instrument conceals part of the face and would thus prevent the system from approximating the conditions of ordinary face to face conversation. The elimination of telephone instruments is accomplished by the use of a microphone sensitive to remote sounds, and a loud speaker concealed near the television image at each station. The microphone is connected at one station through suitable vacuum tube amplifiers and a telephone circuit to the loudspeaker at the other station. This permits conversation in one direction while a similar connection between the other microphone and loudspeaker permits conversation in the other direction. The persons using the system then communicate as if face-to-face and with no telephone system apparently involved.

In order that the sounds transmitted may be familiar and natural, distortion in the sound transmission system has been reduced to a minimum. The microphones are of the condenser type used extensively in radio.



broadcasting and sound picture recording. Being of small size, they are readily concealed near the television image in the most advantageous position for picking up the voice. The loudspeaker, also of small size but capable of reproducing a broad frequency range, is likewise concealed near the television image so that the sounds produced appear to emanate from the image itself. This loudspeaker is of the moving coil type with a small piston diaphragm.

In any system such as that described, the microphone is of course incapable of distinguishing between the sounds from the local speaker and a speaker at the remote end of the circuit reproduced locally by the local loudspeaker. If the sounds from the local loudspeaker should be impressed upon the local microphone in sufficient magnitude, "singing" would result, and the system become no longer operable. To prevent this the microphone and the loudspeaker are installed in carefully chosen positions and the inner surfaces of the sound-proof booths are specially treated to prevent so far as possible the reflection of sounds from the walls into the microphone. Under these conditions, the attenuation of sounds transmitted is of about the same magnitude as would be experienced if the listener were, say, 10 or 12 ft. away but in the same room. This acoustic illusion of distance is in harmony

with the visual appearance of the television image. In addition to the television synchronizing and acoustic circuits, others are provided for signaling and monitoring purposes. Matters are so arranged that an operator can see both the outgoing and incoming image, and, by the means of movable lens and prism systems, can insure the scanning being properly directed to correspond to the height of the observer and the magnifying lens in front of the receiving disk directing the image to the observer's eyes.

Operating arrangements are made so that the two parties to the conversation, after taking their positions in the booths, do not see or hear each other until adjustments are made, whereupon the operators expose the images and connect the talking circuits simultaneously. The experimental service is arranged on an appointment basis. The two parties to the conversation, having arranged with attendants at the two stations for their time, proceed to the respective booths where they are ushered into chairs in position before the photoelectric cells and instructed as to the operation of the system. Immediately the attendant closes the booth door; the operators make the necessary adjustments; and the simultaneous sight and sound communication is carried on until, upon the parties leaving their chairs, the connections are interrupted.

## Abridgment of Essential Factors in the Coordination of Line, Station and Apparatus Insulation

A. E. SILVER<sup>1</sup>

Fellow, A. I. E. E.

and

H. L. MELVIN<sup>2</sup>

Member, A. I. E. E.

*Synopsis.*—Consideration of generated voltages and switching surges might logically be taken as the basis for determining the minimum amounts of insulation required for lines and stations. Lightning, when it is encountered, affects service primarily through its influence on lines. The lightning insulation strengths which may be suitable for the lines may bear little or no relation to the operating voltage or the basic insulation strengths found satisfactory at the stations.

In order that service will be affected a minimum by the excessive lightning voltages which may be propagated to, or originate at the stations, it is desirable that they be discharged external to the station and its apparatus. To accomplish this four lightning insulation levels are proposed; the basic or lowest level (determined by consideration of generated and switching surge voltages) being established by

the line insulation or spillway gaps at the line entrances; the buses and connections constituting the next higher level; apparatus bushings next; and finally the apparatus internals.

More complete data on the nature of transient voltages and the performance of insulation with these voltages applied, are required before insulation can be coordinated with assurance. During the interim period however it should be possible to accomplish substantial improvement to service by applying to specific cases as they arise, the knowledge and data already available and being gathered.

Since the entire project is distinctly in the development and research stage, the authors believe more progress should be accomplished before recognized standardization can be undertaken to advantage of such features as test waves, characteristics of insulation and insulation levels for lines, stations and apparatus.

### I. INTRODUCTION

THE insulation of electric circuits has been prominent among the problems commanding the attention of investigators, manufacturers, and operators since the beginning of electric service. In light of the new knowledge being acquired concerning

transient voltages as they are imposed upon insulation, the performance of insulation and its application to power systems are now receiving renewed consideration.

Present practise for line, substation, and apparatus insulation has grown up largely through actual operating experience augmented by theoretical conceptions, research, and tests using in the main test voltages of 25 and 60 cycles, together with rather meager data on transient over-voltages. Due, however, in large part to the incomplete fundamental knowledge of the nature of transient voltages and of the corresponding perform-

1. Electrical Engineer, Electric Bond and Share Company.

2. Assistant Electrical Engineer, Electric Bond and Share Company.

Presented at the Summer Convention of the A. I. E. E., Toronto, Ontario, Canada, June 23-27, 1930. Complete copy upon request.

ance characteristics of conventional insulations, many inconsistencies and variations exist. But it now seems probable that insulation layout may soon be placed on efficient and economic bases, well in advance of its somewhat haphazard present state.

Three general types of voltages are encountered by power system insulations, namely; normal frequency generated voltages; switching and system disturbance transient over-voltages; and lightning voltages. Insulating for generated voltage is quite well understood; insulating for switching surges is not a serious problem; but lightning is still uncontrolled, and no practicable amount of insulation seems adequate in itself to sustain the more severe lightning voltages.

Since station equipment and terminal connections are concentrated and need represent only an extremely limited direct exposure to the influence of lightning, switching surges, or those transients arising within the circuits, may logically be taken as determining minimum or basic insulation levels. On the other hand, lightning voltages which bear no relation to generated voltages usually originate on, and influence, service by affecting the performance of lines, so that in lightning territories the line insulation may be determined from the consideration of lightning. Suitable insulation strengths for lines and for terminal equipment, therefore, may not bear any direct relation, one to the other. The two, however, must be coupled in an effective manner.

The intensive lightning investigations both in the field and laboratory are yielding much new data and information, however the entire surge voltage problem is distinctly in the development stage. It is too early to predict that the finally applied results will be from these investigations but it is easy to conceive of quite radical modifications being made in the design and application of insulation during the next few years. For these reasons, caution may well be observed in the premature establishing of standards of insulation practise and laboratory tests, but rather the task of obtaining fundamental data should be stressed. The new knowledge gained should be applied in the most constructive manner possible as it becomes available in order that standardization when it can be accomplished will reflect operating conditions.

The following, therefore, is intended to treat of the more essential factors as they now appear, pertaining to the selection, application, and coordination of power system insulation.

## II. INSULATING FOR GENERATED VOLTAGES

The maximum probable generated voltage, and the condition of the surface of the insulation due to weather and contamination may, in some cases, but not generally, determine the minimum amounts of insulation required for apparatus, stations, transmission and distribution lines. Under some conditions outdoors,—such as near

cement mills, chemical plants, paper mills, or along seacoasts,—unusual amounts of insulation may be required and in extreme cases, it may not be economically practicable to provide sufficient porcelain leakage surface to overcome contamination, thus making necessary the alternative of periodically cleaning the insulators.

In arriving at the insulation requirements for generated voltages, insulator deterioration and loss of insulation due to physical damage, either from extraneous causes or flashovers, are factors to be considered. Another important consideration in the selection of the type, (and possibly the amount of insulation), is radio interference, as it has become essential that power circuits be adapted to successful radio coordination.

Only under unusual conditions would it be expected that generated voltages would determine the amounts of insulation which are satisfactory in actual service, as such voltages are considerably lower than switching surges. When insulator contamination is the controlling or a major factor, operating experience and tests simulating the particular conditions encountered seem to be the best guides in selecting the amounts of insulation.

## III. INSULATING FOR SWITCHING AND SYSTEM DISTURBANCE SURGES

Recent investigations and theoretical considerations indicate that over voltages may originate within the circuit having maximum values of five to six times the normal circuit crest voltage to ground. The nature of these surges and their magnitudes have not been fully determined though they appear to have the characteristics of damped high-frequency oscillations. The performance of conventional types of line insulators and apparatus insulation has not been sufficiently investigated to be positive regarding their failure strengths with these types of voltages applied. From the information available, however, it seems reasonable to assume that these voltages are of sufficiently long duration to take on some of the characteristics of 60-cycle voltages so far as failure values are concerned. If this reasoning is correct, the minimum strengths of insulation required to sustain switching surges would be five or six times normal generated voltage to ground with the insulation in its normal operating condition. Experience would appear to indicate, however, that if lightning voltages are eliminated from consideration, insulation having 60-cycle wet flashover values considerably lower than this has performed successfully. Whether this has been due to diversity whereby the maximum switching surge has not occurred with the insulation in its worst condition, or because of assigning an incorrect cause of flashover, cannot be stated.

More complete and careful investigation along the lines of determining the nature of switching surges and

the characteristics of insulation under these voltages would seem essential. The influence of present trends toward higher speed switching on the magnitudes of switching surges should also be taken into consideration. These data are of prime importance, because the maximum values of transient over-voltages originating within the circuit may logically be used as the basis for establishing insulation levels for stations and station equipment.

#### IV. INSULATING FOR LIGHTNING VOLTAGES

Lightning voltages attain higher values than any of the other voltages which insulation is called upon to support. The problem of insulating lines and equipment to give the best, or even acceptable, service is at the present time in a speculative state. The magnitudes and nature of lightning voltages have been only partially determined, though investigations in progress bid fair to accomplish this within the next few years. In general, records obtained to date have been measurements of the insulating strengths of various types and amounts of insulation under lightning surges, and of the characteristics of lightning voltage waves as they appear traveling on lines.

On the assumption that both induced and direct lightning strokes affect line performance, there would seem to be at least three methods of attack for their control: first, the diversion of direct strokes before contact with the conductors and provision of sufficient insulation to support the maximum induced voltages; second, similar to the first, except for the combination of conventional overhead ground wires and less insulation for the induced voltages; and third, provision of means of discharging the lightning appearing on the conductors without generated current follow up. In addition to these are the present compromise methods for minimizing the number of flashovers and their influence on service, including provision of effective amounts of insulation in combination with conventional overhead ground wires, increase of the lightning insulation strengths, and improvement in switching and relaying.

An analysis of present practise will show wide variations in insulation strengths of lines to lightning voltages even for those operating in comparable territories. To a large extent, these can be accounted for, by the repeated attempts of engineers to improve performance by applying greater and greater amounts of insulation, or the utilization of wood, either intentionally or accidentally, in the quest of satisfactory lightning insulation for the lines. These conditions illustrate present and possible future variations in line insulation practise. They further indicate that present practise cannot be averaged or taken as a criterion of what the final solutions may be for the line insulation problem.

If maximum generated and switching surge voltages are used as the bases for determining the amounts of insulation for lines and terminal equipment, their

insulation strengths should be similar. On the other hand, if lightning control is the basis for the line insulation strength, and switching surges for terminal equipment, no particular relation may exist between line and station insulation levels. However, the two must be brought together in a manner to avoid any injurious reaction of either on the other.

#### V. COORDINATION OF LINE, STATION AND APPARATUS INSULATION STRENGTHS

Since it is not practicable from present knowledge completely to safeguard service against lightning voltages, it would seem essential as an interim procedure, that the component strengths of the insulation along the circuit be so selected and coordinated that voltages, which do exceed the established insulation levels will find relief by spilling at chosen locations where no damage will result or it will be minimized.

Viewed from the standpoint of service,—to accomplish this for the substation and terminal facilities, four insulation levels, each having a suitable margin over the next lower, are proposed, as follows:

The basic, or lowest insulation level would be the line entrance to the station, the insulation strength of this level being set at a value having a safety margin above the maximum switching or similar surge. When differing from the line insulation level, this line entrance section would be equipped as a free spillway, capable of repeatedly discharging excess surges of any kind without damage, whether originating within or without the station.

The next higher insulation level, or second defense, would be the busses and bus connections.

The next higher insulation level, or third defense, would be apparatus bushings.

The highest insulation level would be the internal insulation of apparatus, thus placing this most expensive and most difficult to repair portion of plant in the position of maximum security against over-voltage, and rendering each item of apparatus self-protecting in itself.

For stations where the integrity of the main busses is of major importance, on account of inability to take them out of service for inspection and repairs, or their failure seriously affecting service, these busses might well be placed in the highest insulation level.

With the foregoing voltage levels throughout the station separated by proper intervals, it is believed that excess voltages of any nature encountered at the station will find relief at the spillway sections at the line entrances. It is assumed that direct strokes of lightning to the power conductors within a station will be avoided by utilizing the supporting structures, perhaps reinforced by grounded overhead cables, as diverters.

For the line, the source of lightning surges and seat of lightning flashovers, the insulation level would be determined by the conditions specific to each individual

situation, and set at any requisite value quite independent of the levels established in the stations and terminals to which the line connects. In localities without lightning, the general insulation level of the line might be the same as that of the spillway section at the line entrance to the station.

Fig. 1 represents these insulation level relations diagrammatically.

To determine what the insulation levels should be, also the intervals between levels, will require much more data than are now available. These include the nature of surge voltages with their reflections, attenuation, absorption, modifications in magnitude and character due to changes in the electrical constants of the circuit, the characteristics of insulation with these voltages applied, as well as operating experience. Proper intervals between the levels will be considerably influenced by physical arrangement; for example, in the case of extensive switchyards, it might be possible that negative intervals would be ample for incoming surges; but this would hardly be the case for lightning voltages originating at the terminals. On the other hand, in simple stations of relatively small dimensions and with no branch circuits, large intervals may be necessary.

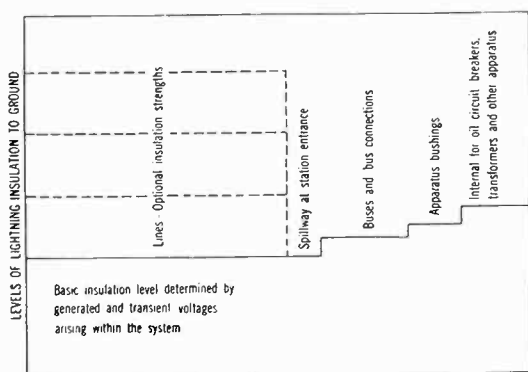

FIG. 1—DIAGRAMMATIC ILLUSTRATION OF RELATIVE LIGHTNING INSULATION STRENGTHS

Even though definite values for these intervals between insulation levels cannot be intelligently assigned at this time, nevertheless, pending more dependable knowledge of the problem, approximately 10 per cent between the spillway at the station entrance and the bus and 5 per cent between bus and apparatus bushings are proposed for trial to advance the experience on this point. These intervals represent the minimum separations between the impulse sparkover curves for the various insulators and spillway gaps, determined by the application of a range of waves giving impulse ratios extending from the higher values to approximately unit, or between volt-time curves covering a similar range.

It must be recognized that the foregoing proposals are not free from conjecture. However, meager experience with installations where the insulation has been so coordinated from the limited data on insulation characteristics available gives promise of quite satisfactory results. At least it may be stated in general that, where insulation flashovers due to lightning voltages have been experienced, they have occurred at points which, upon analysis, appear to be weak. These weak points are frequently at locations where failures are most injurious.

It may not always be practicable to obtain the desired grading of insulation levels by selections from present standard insulators; also, if contamination is a controlling factor, the amounts of insulation capable of supporting the low-frequency voltages may have impulse insulation strengths higher than desired for apparatus safety. In these cases, relief gaps might be employed at one or more levels.

As in the past, manufacturers of insulators and manufacturers of bushings may be depended upon to recognize their important position in this problem and to be alert to progress in this branch of the art. They will be able to contribute much in the way of molding their scheduled standards to facilitate the selection of suitably related types and sizes for satisfactory coordination.

Variations from this basic plan of insulation coordination must be expected. For example, for economic and practical reasons, some types of apparatus may have inherently low insulation strengths to lightning voltages as encountered in suitably insulated stations. In such cases there may be an additional problem of providing protection specific to, and supplementing, the insulation of the apparatus.

So long as lightning voltages of magnitudes beyond practicable control must be dealt with, occasional discharges at the spillway gaps as proposed must be accepted; but these should occur without injury to station apparatus and insulation. However, with these gaps spilling freely in air, service interruptions will result. There is then a strong need for a simple and efficient barrier to normal frequency follow-up current to place in these gaps without impeding the unrestricted discharge of the lightning surge, even though its origin be at the spillway. Such devices are not as yet available.

## VI. DATA REQUIRED FOR THE COORDINATION OF INSULATION

More complete fundamental knowledge of the nature of transient over-voltages originating within the circuit, and especially of lightning voltages at their origin upon circuits, is essential in order that the characteristics of insulation under these voltages may be fully investigated. This work is progressing, though it must be realized that it is a large task and time will be required for the development of instruments and



technique, as well as for the actual accumulation of the data.

In the laboratory, complete volt—time characteristics of the various types and sizes of insulation must be obtained, both clean and as influenced by weather conditions, for the full range of wave shapes encountered from 60-cycle to the steepest lightning impulse.

Volt—time characteristics of air clearances, such as may obtain between conductors and grounded parts of structures and those which may be used for spillway gaps, are also a necessary part of the data.

New knowledge obtained from lightning research work as it progresses may materially modify present ideas, and extend the scope of investigations and tests. Even before these researches have been completed, data as they become available, can doubtless be applied to advantage in improving insulation designs and practise. Operating experience from such improved designs, and from existing installations, will be of demonstrating value.

These further investigations of lightning and other extraneous surge voltages encountered in power circuits as at present, can best be carried on cooperatively between the operators of the power systems and the manufacturers equipped with suitable research facilities. On the other hand, as in the past, the facilities of the high-voltage laboratories must be looked to for the insulation calibration work.

During the interim, until more complete insulation characteristic data are available, limited use of the conventional 10-in. diameter suspension insulator as an insulation strength yardstick may be expedient. However, as a standard of reference it is an undesirably crude device since the characteristics of various types or insulation evidently do not remain in similar relation over the range of transient voltages met with in practise. Length of air-gap might be a more suitable substitute for the insulator string as an interim reference standard.

Very substantial results have already been accomplished in the investigation of insulation characteristics. Testing facilities are well established. Many data have been obtained and although somewhat scattering and incomplete, can be used to advantage. Notable among these contributions are: the early work of F. W. Peek, Jr., the results of which were published in Franklin Institute papers, this work being supplemented and extended from time to time, and summarized in his paper on *Lightning*, A. I. E. E. TRANS., Vol. 48, April 1929, p. 436; the investigations by K. B. McEachron on the volt—time characteristics of insulation, also article by E. J. Wade and G. S. Smith on the subject of "Time Lag of Insulators," *Electrical World*, Aug. 18, 1928, p. 309; and the comprehensive work of C. L. Fortescue and J. J. Torok, the general results of which are included in the paper by J. J. Torok on *Surge Characteristics of Insulators and Gaps* published in abridged form in JOURNAL of the A. I. E. E., April 1930, p. 276.

## THE FIRST MARINE ELECTRIC LIGHTING INSTALLATION

Half a century of electricity in continuous use on ocean vessels is marked this month by the anniversary of the voyage which the steamship *Columbia* began in May 1880, from New York to Portland, Oregon, with a complete installation of Edison's incandescent electric lights, says the National Electric Light Association. So doubtful were the marine underwriters about this innovation that they refused to insure the boat, and she sailed all the way around the Horn without any protection against loss.

The *Columbia* had only electric lights, and even these were crudely installed and even more crudely controlled. Yet in her day the *Columbia* was considered the finest and most up-to-date passenger vessel that had thus far been constructed.

Proceeding to New York for her final equipment, she docked at the foot of Wall Street and Francis R. Upton one of Edison's chief assistants, carried the incandescent lamps aboard in a market basket.

It was the first installation of Edison's incandescent lights outside of Menlo Park, where the Edison lamp was born. Before any commercial plant was established on land, this little system on board the *Columbia* was put in service. As one of the bulletins of the Edison Electric Light Company expressed it, this was the "first plant ever put in operation in the hands of strangers." The actual work of installation was done by Philip Seubel under Upton's supervision.

An interesting aspect of the installation was the arrangement governing the use of the electric lights by passengers in their staterooms. The individual lamps were controlled by lock switches enclosed in rosewood cases, which were located outside the doors of the staterooms. The key which operated these switches was in the permanent possession of the steward. Consequently, if a passenger wanted his electric lamp turned on, he had to summon the steward by ringing a call bell and the steward then operated the switch. The same procedure was necessary when the passenger wanted to turn out his electric light. (*Trans. I. E. S.*)

The three micarta propellers used in the giant transatlantic plane "Southern Cross" were made principally from cotton; namely, ordinary canvas compressed into a non-corrosive product of metallic strength.

They also represent the most advanced engineering practise in aviation, for besides having a high efficiency, each blade is a unit which is detachable from the hub, and of superior efficiency and physical stability in the air. Because of their exceptional resistance to moisture of any kind, have proved especially successful in India and other tropical countries.

# INSTITUTE AND RELATED ACTIVITIES

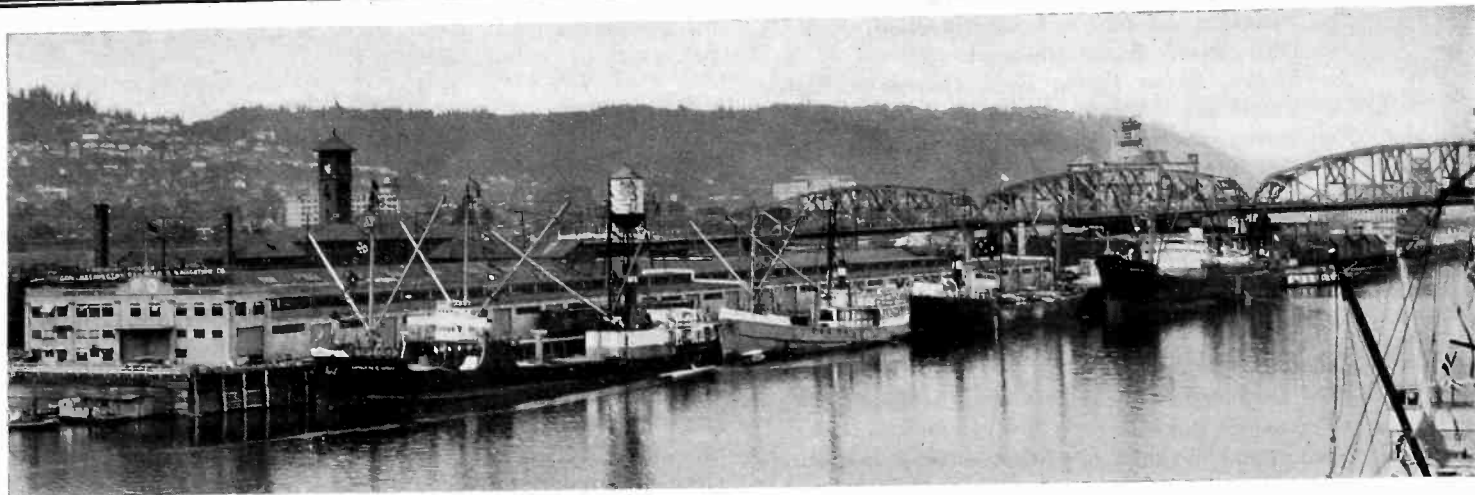

PORTLAND'S HARBOR, THROUGH WHICH OVER 9,000,000 TONS OF FOREIGN, DOMESTIC AND INLAND WATERWAY FREIGHT  
CLEARED IN 1929

## The Pacific Coast Convention

OFFERS DIVERSIFIED PROGRAM AND EXCEPTIONAL OPPORTUNITY TO  
SEE THE NORTH WEST

Portland, a completely modern city in a setting of unusual scenic beauty, will act as host to the 1930 Pacific Coast Convention, September 2-5. Here, local members have been planning for months to provide a convention program of wide interest as well as inclusive of trips, entertainment and recreation which will find appeal with the diversity of tastes to be presented by a representative gathering of the Institute members and their friends. Convention headquarters will be at the Multnomah Hotel.

Situated on the Willamette River near its confluence with the Columbia River and abundantly served by railroad, highway, air and water lines, Portland is in the heart of that great playground area comprised of the northwestern states. Vacation time in this area of benign climate extends well into September, so that visitors contemplating attending this convention in conjunction with a vacation trip will find a variety of pleasurable occupation available, with the "convention city" a focal point.

The business program includes five technical sessions: two on Transmission, one on Power Stations, one on Communication, and one on General Research and Development. Students will take an active part in two sessions, and one evening will be given over to a conference on Student Activities, by the Counselors Committee from the Pacific and North West Districts No. 8 and No. 9, respectively.

### THE PROGRAM

#### Tuesday, September 2nd

- 9:00 a. m. Registration at Convention Headquarters, Multnomah Hotel.
- 10:00 a. m. Opening of the Convention.
- 10:30 a. m. Technical Session on Transmission.  
*Wood Arms on Steel Structures*, A. O. Austin, Ohio Insulator Company.  
*Critique of Ground Wire Theory*, L. V. Bewley, General Electric Company.  
*Influence of Polarity on High-Voltage Discharges*, F. O. McMillan and E. C. Starr, Oregon State College.
- 2:00 p. m. Technical Session on Transmission.  
*The Mechanical Performance of Oil Circuit Breakers*, A. C. Schwager, Pacific Electric Manufacturing Company.

*Corona Loss Measurements on a 220-Kv. 60 Cycle Three Phase Experimental Line*, J. S. Carroll, L. H. Brown, and D. P. Dinapoli, Stanford University, Palo Alto, Calif.

*Development in the Porcelain Insulator*, K. A. Hawley, Locke Insulator Corporation, Baltimore, Md.

#### Wednesday, September 3rd

- 9:00 a. m. Technical Session on Power Stations.  
*Steam Power Developments of Pacific Gas & Electric Company*, R. C. Powell, Pacific Gas & Electric Company.  
*Grounding Banks of Transformers with Neutral Impedance and Resultant Transient Conditions in Windings*, J. K. Hodnette and F. J. Vogel, Westinghouse Electric & Manufacturing Company.  
*Relay Developments on Southern California Edison System*, E. R. Stauffacher, Southern California Edison Company.  
*New Trends in Mercury Arc Rectifier Developments*, O. K. Marti, American Brown Boveri Company, Inc.
- 2:00 p. m. Technical Session on Communication.  
*Commercial Aircraft Radiophone Communication*, R. H. Freeman, Boeing Air Transport Incorporated.  
*Harmonic Generation by Means of Grid Circuit Distortion*, F. E. Terman, E. H. Fisher, and D. E. Chambers, Stanford University.  
*The Communication System of the Southern California Edison Co., Ltd.*, R. B. Ashbrook and F. B. Doolittle, Southern California Edison Company, Ltd.
- 8:00 p. m. Conference on Student Activities by Counselors Committee Districts No. 8 and No. 9.

#### Thursday, September 4th

- 9:00 a. m. First Student Session.  
Afternoon Recreation and Golf Tournament.  
Evening Informal Banquet.

**Friday, September 5th**

- 9:00 a. m. Technical Session on Research and Development.  
*The Pennsylvania Railroad Electrification*, J. V. B. Duer, Pennsylvania Railroad.  
*An Electric China Firing Kiln*, George S. Smith, University of Washington.  
*Forecasting Precipitation*, A. F. Gorton, Scripps Institute of Oceanography.  
*Electricity's Part in the Copper Mining Industry*, R. J. Corfield, Utah Copper Company.
- 2:00 p. m. Second Student Session.

**Saturday, September 6th**

- Morning Inspection Trips.  
 Choice of:  
 Ariel Development of Northwestern Electric Company on Lewis River (6 hrs.).  
 Oak Grove Development of Pacific Northwest Public Service Company on Clackamas River (all day).  
 Camas Paper Mill of Crown-Willamette Paper Company, Camas, Wn. (5 or 6 hrs.).

**Trips**

A variety of installations of electrical interest are to be found in Portland and immediate vicinity. Arrangements may be made with the local committee to visit any of these during the convention. Unusual activity in hydroelectric development and industrial plant expansion near Portland, however, has led the committee to single out three inspection trips of diverse appeal. These trips, any of which will take the better part of a day, are scheduled for Saturday, September 6. Luncheon will be served on each, and round-trip transportation by automobile will be provided free of expense to registered delegates and guests. Visiting ladies are invited.

At the Oak Grove Development of the Pacific Northwest Public Service Company on the Clackamas River a second 40,000-hp. reaction waterwheel and a 30,000-kv-a. generator are being installed, requiring an addition to the powerhouse and a new penstock. This plant, operating at 860-ft. head, contains a turbine of the highest head reaction in the world. Delegates will leave Portland by auto or interurban train about 8:00 a. m., transferring to the company's speeder. The last twenty miles of the ride to the plant parallels the beautiful Clackamas River through rugged forest country. The right of way for a two-circuit steel tower line has been hewn through this timberland.

Those choosing the trip to the Ariel project of the Northwestern Electric Company on the Lewis River north of Portland will find the dam construction of a 180,000-kw. development in full swing. This dam will be of single-arch construction, approximately 200 ft. in height and with a gravity section at each end, the crest length being 1295 ft. Delegates will travel to and from this site by automobile.

The third choice for Saturday's trip contemplates the inspection of the Camas, Wash., plant of the Crown-Willamette Paper Company some twenty-five miles east of Portland on the Columbia River. This mill, one of the largest in the North West, has increased its manufacturing facilities by the installation of a new steam plant and a large amount of new machinery. Particular interest centers around the combination central station and local plant power sources, with new motor drives and controls. Luncheon will be served by the paper company to the visitors. The trip will be made by automobile to and from Portland over a section of the North Bank Columbia highway.

Other construction projects are to be found in the North West. Stone & Webster Engineering Corporation are exceedingly busy with the construction of the first major hydroelectric development on the Columbia River at the Rock Island site near Wenatchee, Wash., the second Lake Cushman project of the city of Tacoma is well along toward completion, and Seattle is working on its Diablo development on the Skagit River. In addition,

recent installations of steam units may be viewed in Portland, while the latest and largest steam plant in the Pacific North West, the Shuffleton plant of the Puget Sound Power & Light Company, may be visited in Seattle.

**Other Trips**

The lavish wealth of natural attractions in the country available for trips preceding or following the convention preclude the possibility of listing all these points which might interest visitors. It may be stated that resorts at mountains, beaches, lakes and rivers where fishing, golf, swimming and other types of diversion can be found in profusion abound. Naming only a few, it is suggested that the Loop Trip around Mount Hood, including a 70-mile section of the famous Columbia River Highway, is one of the outstanding highway trips in the world. This is an easy one day's drive with luncheon at one of the several mountain resorts situated close under the glaciers of Mount Hood. Crater Lake, Ore., Rainier National Park, Wash., Seaside and Cannon beaches, Ore., a number of fishing streams and mountain and beach resorts all lie within easy access by private motor car, bus or train from Portland.

**Entertainment**

Principal entertainment features of the convention will be an informal reception and dance at the Multnomah Hotel, Tuesday evening, Sept. 2. Thursday evening following the golf tournament, an informal banquet will be staged at the Portland Golf Club at which District Paper Prizes will be presented as well as golf prizes and prizes for the ladies putting contest. Dancing and other entertainment features will be included at this event.

**LADIES' PROGRAM**

The ladies are invited to all events including the three regularly scheduled inspection trips. In addition special events are being provided for them each afternoon by the Ladies' Entertainment Committee as follows:

**TUESDAY, SEPTEMBER 2ND**

- Afternoon—Drive around the city through Portland's beautiful residential districts followed by tea at the White Owl Tea Room on Council Crest.  
 Evening —Reception and dance at the Multnomah Hotel.

**WEDNESDAY, SEPTEMBER 3RD**

- Luncheon at the Waverly Country Club followed by a visit to the Lloyd Frank gardens on Palatine Hill, which are among the finest in the North West.

**THURSDAY, SEPTEMBER 4TH**

- Afternoon—Bridge, Tea, and Putting Contest at the Multnomah Golf Club. (High heels cannot be permitted on the putting greens.)  
 Evening —Informal banquet at Portland Golf Club.

**FRIDAY, SEPTEMBER 5TH**

- Motor trip on the famous Columbia River Highway.  
 (Such men as might be interested in this feature are invited to accompany the ladies on this trip.)  
 In addition to these regularly planned events, the Ladies' Entertainment Committee will be pleased to assist visitors in arranging trips to any other places in and around Portland.

**Golf**

The fame of Portland's golfers abroad has led to the characterization of the city as the Golf Capital of America. There are seventeen private, municipal and semi-public courses within easy access of the city. Practically any of these may be made available to members and guests during their visit.

The Annual Convention Tournament will be played on the Portland Golf Club course, one of the oldest and best in the city, on Thursday afternoon of Sept. 4th. The John B. Fiske cup will again be in competition, open only to members of the Pacific Coast Sections. Eighteen hole medal play at a handicap will determine the winner. In addition to this trophy, however, a

number of prizes will be offered for a variety of events and will be open to any registered member and guest.

**Transportation**

Portland is well served by railroads. To or from the south all rail travel is via the Southern Pacific while the Great Northern, Northern Pacific, Spokane, Portland & Seattle, and Union Pacific compete for business to and from the north and east. All trains arriving or leaving Portland use the Union station located on the west side of the Willamette River about a half mile from the business and hotel centers.

Summer round-trip rates of one and a third fares will apply to delegates from California, but not from points in the north west. However, delegates from the north west can avail themselves of the group rate which provides that any party of ten or more traveling together on the going trip, returning together or individually as desired, but using the same route in both directions, will be granted a special rate of one and one-third fares for the round-trip.

Those wishing to take advantage of the established air routes should have little difficulty in arranging schedules as Portland is served by the Boeing System, the West Coast Air Transport Company, and the Varney Air Lines. Passenger planes are now in daily operation direct from the following points to Portland: Los Angeles, San Francisco, Salt Lake, Spokane, Seattle and Vancouver, B. C. Fares can be estimated at six cents per rail mile. Time enroute San Francisco to Portland is approximately six hours.

Incidentally, transportation to and from all the regularly scheduled events of the convention will be supplied by the local committee and in addition special trips around Portland may be arranged with the committee by those delegates desiring such service.

Summer excursion rates will be in effect from the East. Those purchasing railroad tickets should ask the ticket agent for the lowest excursion rate obtainable when purchasing their tickets.

**HOTEL ACCOMODATIONS**

Convention headquarters will be at Multnomah Hotel. Rates for this and other hotels are given below. Advance registration should be made direct with the hotel at as early a date as possible.

	Hotel rates					
	Single rooms			Double rooms		
	With-out bath	With shower	With bath	With-out bath	With shower	With bath
Hotel Benson . . . . .		\$3.00	\$3.50 4.00 4.50		\$5.00	\$5.50 6.00 *6.50
Heathman Hotel . . . . . and New Heathman Hotel . . . . .		2.50	3.00 4.00		3.50	4.00 5.00 *6.00
					Parlor suites	10.00 12.00
Multnomah Hotel . . . . . (Convention head- quarters)	\$2.00 2.50		2.50 3.00 3.50 4.00 5.00 6.00	\$3.00 3.50 4.00		3.50 4.00 5.00 6.00 7.50 8.00 10.00 12.00
					Parlor suites	10.00 12.00
The Portland Hotel . . . . .	2.00 2.50		2.50 to 5.00	3.00 4.00		4.00 to 7.00

\*Twin beds.

**Committees**

The General Convention Committee consists of the following members and subcommittee chairman who are handling the

various activities in connection with the convention: H. H. Schoolfield, chairman; E. Baughn; H. V. Carpenter; C. E. Fleager, L. F. Fuller, N. B. Hinson, A. C. Kelm, A. E. Knowlton, T. H. Morgan, G. E. Quinan, L. N. Robinson, R. D. Sloan, and J. Teasdale.

The subcommittee chairmen are as follows: Program, H. H. Cake, Golf, R. J. Cobban; Entertainment, C. W. Fick; Registration, A. H. Kreul; Ladies' Entertainment, Mrs. A. S. Moody; Finance, A. S. Moody; Hotel, A. K. Morehouse; Transportation, C. P. Osborne; Local Trips, E. F. Pearson; Publicity, B. Snow; and Reception, J. E. Yates.

**Middle Eastern District Meeting**

A meeting of the Middle Eastern District, No. 2, will be held at Philadelphia, October 13-15, inclusive with headquarters at the Benjamin Franklin Hotel.

Twenty-one technical papers are tentatively scheduled for presentation in five technical sessions, which are as follows: Radio and Communication; Hydroelectric Power; Electrical Equipment and Selected Subjects; Transmission; Railway Electrification and Electric Traction.

A Student Session will also be held at which specially selected papers will be presented by the students.

The subject of railway electrification and electric traction is of particular local interest. On July 21, the Pennsylvania Railroad completed and put into operation electrification of one of its suburban divisions. Work on the main line electrification of the Pennsylvania System has been in progress for some time and when completed will comprise one of the most extensive electrified railway systems in the world.

Inspection trips of major interest will be arranged by the local meeting committee. Philadelphia and its environs has many modern power generating stations and public utility projects of unusual interest.

**Southern District Meeting at Louisville**

A meeting of the Southern District, No. 4, will be held at Louisville, Kentucky, November 19-22, inclusive. Active interest is already being manifested on the part of the local committee which is making arrangements for the engineering information to be presented at this meeting. Indications point toward the inclusion of five technical sessions covering the subjects of Transmission, Electrolysis, Communication, Transportation, and Industrial Applications in Manufacturing Plants of the South.

Interesting and instructive inspection trips will be arranged by the local Meeting Committee. The Louisville hydroelectric plant is equipped with miniature switchboard control, installed during 1926 and 1927. At the present time these miniature switchboard installations are of considerable interest to the electrical industry.

**Outstanding Summer Convention Held at Toronto**

An outstanding Annual Summer Convention of the Institute was held at the Royal York Hotel, Toronto, Canada, June 23-27. Over 1110 members and guests attended and enjoyed the unusually fine program offered by the Summer Convention Committee. Excellent technical papers and committee reports were presented, an important Annual Business Meeting and Conference of Officers, Delegates and Members was held, many interesting inspection trips were taken, and a most enjoyable entertainment program was duly appreciated.

Forty-five engineering papers and fifteen technical committee reports were presented in eight technical sessions. A list of the papers presented at each session and a brief abstract of the discussions is published in subsequent paragraphs of this report.



A Conference of Officers, Delegates and Members was held on the afternoon of June 23, and continued on the afternoon of June 24. The important proceedings of this conference are also given in a separate report and published elsewhere in this JOURNAL.

The 1930 Annual Business Meeting of the Institute was held following the opening of the convention on the morning of June 23. Mr. C. E. Sisson, Chairman of the General Convention Committee, opened the convention and introduced Mr. James Simpson, of the Control Board of the City of Toronto, who welcomed the convention in behalf of the city. President Harold B. Smith replied to the address of welcome and then called for the transaction of the official business of this meeting, which is reported elsewhere in this JOURNAL. The meeting concluded with an address by President Harold B. Smith entitled *The Status of the Young Engineer*. This address was published in the July issue of the JOURNAL, page 532.

A luncheon meeting of the Board of Directors was held on Wednesday, June 25, and important business was transacted.

Another outstanding event of the convention was the presentation of the Lamme Medal at the convention banquet held on the evening of June 25. This medal was presented to Mr. Rudolf Emil Hellmund "for his contributions to the design and development of rotating electrical machinery." Professor C. F. Scott, Chairman of the Lamme Medal Committee, and Mr. A. M. Dudley gave short addresses. President Harold B. Smith then presented the Medal to Mr. Rudolf Emil Hellmund. A more complete account of the presentation is given elsewhere in this JOURNAL.

Following a response by the medalist, Mr. C. A. Magrath, Chairman of the Canadian Section of the International Waterways Commission and chairman of the Hydro-Electric Power Commission of Ontario, gave a very interesting address on international relations.

During the convention a number of interesting inspection trips were taken to power plants, substations, industrial plants, the University of Toronto, and points of historical interest. Thursday an all day trip was taken crossing Lake Ontario by boat for the purpose of inspecting the flight locks of the new Welland Canal.

Splendid entertainment was provided for those attending the convention by the General Convention Committee. Tuesday evening, June 24, a Get-Together Dinner was held. Besides the convention banquet and the President's Reception, a luncheon was held on Friday. Dancing was enjoyed every evening during the first four days of the convention.

A committee of Toronto ladies provided excellent and most enjoyable entertainment features which were greatly appreciated by the visiting ladies.

Golf and tennis tournaments were played for the respective Mershon Cups. The winner of the golf tournament was Wills Maclachlan and President-Elect W. S. Lee was the runner-up. In the tennis tournament, E. F. Lopez was the winner and A. H. Frampton the runner-up. An International Golf Tournament was held and the final score was, United States 37, Canada 53. At a luncheon on Friday, Mr. H. C. Don Carlos, Chairman of the Sports Committee acted as chairman at the luncheon. President-Elect W. S. Lee presented the sports prizes, except this own prize as runner-up, which was presented by Mr. H. C. Don Carlos.

The 1930 Summer Convention Committee, who made the arrangements, deserve much praise for the excellent program provided. This committee consists of the following members who are officers of the General Convention Committee or chairmen of other committees as indicated, or general members:

C. E. Sisson, Chairman; A. H. Hull, Vice-Chairman; W. L. Amos, Secretary; A. E. Knowlton, Meetings and Papers; W. P. Dobson, Local Representative, Meetings and Papers; W. B. Kouwenhoven, Sections; W. A. Bucke, Finance; H. U. Hart, Finance; F. R. Ewart, Publicity; A. B. Cooper, Enter-

tainment; H. C. Don Carlos, Sports; J. F. Neild, Transportation; M. B. Hastings, Trips; F. F. Ambuhl, Hotel and Registration; H. C. Barber, Ladies; W. C. Adams, C. V. Christie, J. L. Clarke, J. R. Cowley, E. P. Fetherstonhaugh; J. A. Johnston, H. Milliken, J. Morse, W. F. McKnight, J. Teasdale and J. B. Woodyatt.

### REPORT OF TECHNICAL SESSIONS

The following is a brief report of the discussions, together with the titles of papers presented at each session. Discussors were requested to submit their remarks in writing to Institute headquarters, and a stenographer was not present to report discussions from the floor.

Complete discussion will be published with the respective papers in the TRANSACTIONS.

#### A. Protective Devices—Symposium on Transmission Line Relays

E. A. HESTER, Chairman

*The Problem of Service Security in Large Transmission Systems*, Paul Ackerman, Consulting Electrical Engineer

*Transmission Systems—Relay Protection, No. III*, W. W. Edson, The Edison Electric Illuminating Company of Boston

*Modern Requirements for Protective Relays on Important System Interconnections*, O. C. Traver and L. F. Kennedy, General Electric Co.

*Directional Ground Relays*, E. E. George and R. H. Bennett, Tennessee Electric Power Co.

*High-Speed Protective Relays*, L. N. Crichton, Westinghouse Electric & Mfg. Co.

In discussing reactance or impedance relays, such as described in the papers by Messrs. Ackerman, Crichton and Traver, Mr. H. H. Spencer explained why there appears to be a real limit below which it is unwise to carry the operating time on this type of relay.

Mr. W. H. Colburn discussed the split-conductor scheme mentioned on page 4 of Mr. Edson's paper. He stated that for the reasons mentioned by Mr. Edson and two additional reasons here given this scheme of protection is not being extended. First because split-conductor construction limits the size of cable and consequently the power transmitted. Second the split-conductor scheme of protection protects only the line itself whereas some other protective schemes safeguard the station as well.

Mr. Spencer pointed out that in the balanced-current schemes discussed by Mr. Edson, the usual plan involve opening the trip of the balanced-current relays when a line is returned to service after an interruption; otherwise, upon releasing the first breaker, the corresponding breaker of the line which remained in service would immediately open. The new balanced-current relay presented by Messrs. Traver and Kennedy has a voltage restraining coil which completely avoids the difficulty and has been substantiated by tests made on the New England Power Company's system.

Mr. P. Ackerman, in discussing the papers by Mr. Crichton and Messrs. Traver and Kennedy, expressed his gratification that the trend of the profession is now toward the principle of instantaneous protection and coincident with some of the views expressed in his own paper. He further stated, however, that he does not believe that relay clearance as short as a half-cycle is at present warranted; relay time of from one to two cycles now seems to be sufficient as it appears that the lower limit of proposed circuit breaker time is from 6 to 8 cycles.

Mr. A. S. Fitzgerald, in his discussion of the Traver and Kennedy and L. N. Crichton papers describes several phases of the development of the carrier current relay scheme. Through the cooperation of operating companies, records of performance in the field are being obtained. A special test was conducted to determine if the power arc would cause interference, but

this phenomena of concern to a great many engineers was not substantiated.

Mr. H. W. Haberl discussed the new style distance relay time curves shown in the papers by Messrs. Traver and Kennedy and Crichton. For connections where two or more lines in service are on the same tower, Mr. Haberl presents a scheme, applicable even to the older style of distance relay and its distance proportional time curve, whereby instantaneous clearance to 100 per cent line length can be obtained by using a combination of distance relay and balanced relay. These connections were illustrated by a sketch.

Mr. J. H. Neher submitted some general remarks, a portion of which pertain to the paper by Messrs. George and Bennett, describing the operation and schemes used on a 220-kv. system.

Mr. R. E. Hellmund pointed out, in a general way, that the commercial demand for such short periods as one-half to one-cycle relay operation first originated on single-phase railway systems for the purpose of shortening arcs of several cycles duration which caused considerable interference in telephone systems, and resulted in the so-called "acoustic shock" to operators.

### B. Transportation

SIDNEY WITHINGTON, *Chairman*

*Electric Power Consumption for Yard Switching*, P. H. Hatch, N. Y., N. H. & H. R. R. Co.

*Control Systems for Oil and Gasoline Electric Locomotives and Cars*, N. L. Freeman, Westinghouse Electric & Mfg. Co.

*Electric Transmission and Control of Power from Internal Combustion Engines for Transportation*, S. T. Dodd, General Electric Co.

*Auxiliaries for High-Voltage D-C. Multiple Unit Cars*, C. J. Axtel, General Electric Co.

*Auxiliary Circuits for High-Voltage D-C. Motor Car Equipments*, O. K. Marti and W. A. Giger, American Brown Boveri Co., Inc.

*Railbonding Practise and Experience on Electrified Steam Railroads*, H. F. Brown, N. Y., N. H. & H. R. R. Co.

In his discussion of Mr. Freeman's paper Mr. R. D. Krape pointed out that differential field control is today being used to a large extent and to substantiate his statement cited locomotive and car sales. He further stated that in his opinion 90 per cent of the oil electric locomotives in service today in the United States use differential field control and are equipped to supply air and battery charging at idling speeds of the engine. Mr. Krape further believes that any scheme of control depending upon electrical characteristics for engine loading is subject to temperature changes in apparatus, while a control dependent upon mechanical characteristics is unaffected by temperature variation in allied electrical equipment.

Where inadequate maintenance facilities exist the use of simple, sturdy, reliable equipment is advocated, in preference to apparatus which slightly increases the theoretical engine utilization.

Mr. H. Lemp, in his discussion of Mr. Freeman's paper, complimented him upon the work. Mr. Lemp described the steps leading up to the development of "inherent automatic control" and called attention to the fact that it does not vary from an ideal perfect control by more than from 2 per cent to 5 per cent. European practise was cited and reference made to the objection of running Diesel engines at variable speed. The discussor pointed out that the control described by Mr. Freeman offers a very fine solution of the operation of auxiliaries, particularly the air compressor, and battery charging, by alternately operating them from main generator during idling speed, and from auxiliary generator during full speed. Mr. Lemp also described a system of pneumatic control. In conclusion tribute was paid to the late Mr. Ward Leonard. Also appreciation was expressed of the fine engineering skill displayed in facts presented by Mr. Freeman's paper.

Mr. T. H. Murphy in discussing Mr. S. T. Dodd's paper pointed out that with advances in the electrical field more importance is now attached to transmission and much thought has been given to improvement and elimination of the undesirable loading features of internal combustion engines used for transportation. In his discussion Mr. Murphy cited the essentials of a modern control, discussed many of the curves given by Mr. Dodd and drew attention to the operation of auxiliary equipment, air compressor, and battery charging schemes.

Mr. H. Rosenthal, in his discussion pertaining to Mr. Dodd's paper, pointed out the infrequency with which the field engine horsepower can be utilized when a mechanical transmission having four different gear ratios is employed.

In connection with the papers by Mr. C. J. Axtel and Messrs. O. K. Marti and W. A. Giger, Mr. Parodi, Consulting Engineer of the Paris-Orleans Railroad, described the French practise of using auxiliary apparatus for high-voltage locomotives and cars.

Mr. H. H. Febrey in discussing *Railbonding Practise and Experience on Electrified Steam Railroads* complimented the author, Mr. Brown on having gathered together so comprehensive a history of rail bond development. The need for standardization of rail bonds permitting of manufacture on a production basis and the further reduction of bonding costs was pointed out. Different kinds of welding were discussed and the advantages of steel terminals over copper terminals cited. Costs of flame weld bonding were considered and announcement made that experiments to further reduce these costs are being conducted. Fatigue and vibration tests were discussed and a statement made that by the use of the electric telemeter oscillograph, records could be made in the field of rail vibrations and it was hoped that the data obtained therefrom might be applied to laboratory vibration equipment. In conclusion, Mr. Brown's summary was discussed and it was pointed out that many maintenance renewals are due to rail changes which occur regardless of the type of bond used.

In connection with the discussion of Mr. Brown's paper, rail bonding practise in France, Germany, Great Britain, Italy, Sweden and Switzerland was described by prominent European railway engineers.

### C. Automatic Stations

F. ZOGBAUM, *Chairman*

Report of Committee on Automatic Stations presented by F. Zogbaum, Chairman.

*An Electron Tube Telemetering System*, A. S. FitzGerald, General Electric Co.

*Development of a Two-Wire Supervisory Control System with Remote Metering*, R. J. Wensley and W. M. Donovan, Westinghouse Electric & Mfg. Co.

*Centralized Control of System Operation*, J. T. Lawson, Public Service Electric & Gas Co.

*Automatic Power Supply of the Carnegie Steel Company*, Robert J. Harry, Eliance Machine Co.

*1000-Kw. Automatic Mercury Arc Rectifier of the Union Railway Company*, New York, W. E. Gutzwiller and Otto Naef, American Brown Boveri Co.

*Miniature Switchboards*, Philip Sporn, American Gas & Electric Co.

In connection with the paper entitled *An Electron Tube Telemetering System*, Professor Kouwenhoven's comments were to the effect that the use of the vacuum tube brings nearer the day when the Public Utility may dispense with its meter readers. As few experimental data were presented in the paper Professor Kouwenhoven raised some questions as to the operation of the scheme and the construction of certain parts of the apparatus used in connection with the system.

Mr. Lichtenberg in his discussion of Mr. FitzGerald's paper pointed out that recent developments in telemetering systems had reduced errors, and increased transmission distances as well as the number of readings which might be automatically and

continuously sent over one pair of connecting lines from one to twenty. In further discussion, Mr. Lichtenberg commented upon both the scope and limitations of the practical applications of telemetering at the present time, pointing out that cost is now a limiting factor.

In connection with the subject telemetering systems, Mr. Pierce cited the limitations imposed on different systems and discussed each electrical quantity—voltage, current, frequency and phase-angle which might be used. He pointed out that Mr. FitzGerald's paper describes a system which is a real contribution to the frequency type of telemetering system. Mr. Pierce further stated that impulse methods have simplified the apparatus involved and still retain the advantages of being able to transmit over unlimited distances, while the electron tube or heat type is a further simplification of the impulse types.

From the standpoint of an operator, Mr. Rutan, in his discussion of Mr. FitzGerald's paper, called attention to the need of data pertaining to the accuracy of performance and the maintenance of an electron tube telemetering system. It was his opinion that data obtained from the trial installation on the accuracy of transmission of voltage, current and power would increase the value of the paper. The question was raised, can tubes be replaced without any change in accuracy? Other equally important questions were propounded by Mr. Rutan in his discussion.

Mr. J. E. Goodale, discussing the paper *Development of a Two Wire Supervisory Control System with Remote Metering*, described the operating experience of the New York and Queens Electric Light and Power Company's supervisory control system, which has relay equipment similar to that which was given in detail in this paper, although in the former a larger number of wires are used. Mr. Goodale suggested that it may be desirable to perform other operations, such as operating induction regulators from the control station at the same time reading the voltage on the lines being regulated. Synchronizing was also discussed, Mr. Goodale believing that these operations could not be performed over a two-wire system. In further discussion, control cables were described and also the advantage of being able to divide the equipment into individual groups when a three wire system is used. Important questions pertaining to any intention to install and operate one of the systems described in the paper were also raised by Mr. Goodale.

Mr. Mayo in connection with the discussion of *Centralized Control of System Operation and Development of a Two-Wire Supervisory Control System* described the supervisory control system of the Malden Electric Company. He points out that an attended substation costs approximately \$5500 per year while an unattended substation with supervisory control costs \$2000 per year. Mr. Mayo feels that there are many installations for some type of supervisory control which could be justified from an investment standpoint.

Mr. H. W. Coddling in his discussion of *Centralized Control of System Operation* looks toward a future which predicts that the load dispatcher will become more of a supervising official, concerning himself with load control rather than supervising the detail instructions pertaining to switching operations. This will result in a saving of time and more efficient system operation.

In further discussing this same paper D. W. Proebstel cited the importance of locating the load dispatcher's office and the operating department together. A safety point was also raised in connection with having no indication of the position of disconnecting switches.

Mr. C. Lichtenberg outlined the advances of centralized control of system operation with the conclusion, from Mr. Lawson's experience, that automatic indicating equipment, backed up with accessory apparatus, gives the best results with regard to the safety, service, and economical handling of station load.

Mr. C. Lichtenberg discussed Mr. Harry's paper *Automatic*

*Power Supply of the Carnegie Steel Company* pointing out that it substantiates the increasing satisfactory use of automatic switchgear.

Mr. C. Lichtenberg in connection with Mr. Sporn's paper, described and defines a miniature switchboard installation. He pointed out the economy of such an installation which results in the saving effected through the conduit and wiring systems brought about by the use of lower voltages. Attention was directed to the advantages of its control and saving of space.

Mr. R. M. Stanley in connection with his discussion on *Miniature Switchboards* cited the benefits obtained from the operation of a complete control installation in the Louisville hydro plant, built during 1926 and 1927.

Mr. H. B. Wood discussing these miniature switchboards called attention to the increased possibilities of operating errors from the gathering together of so many small identical instruments. He was of the opinion that some of the apparatus was not sufficiently rugged for large high-capacity plants.

#### D. Selected Subjects

PROFESSOR C. E. MAGNUSSON, *Chairman*

*Rural Line Construction in Ontario*, R. E. Jones, Hydroelectric Power Commission of Ontario

*Mutual Impedances of Ground-Return Circuits—Some Experimental Studies*, H. E. Bowen, American Telephone & Telegraph Co., and C. L. Gilkeson, National Electric Light Association

*Theory and Characteristics of Grid-Controlled Glow and Arc Discharge Tubes*, D. D. Knowles and S. P. Sashoff, Westinghouse Electric & Mfg. Co.

*Effects of the Magnetic Field on Lichtenberg Figures*, C. E. Magnusson, University of Washington

*A Survey of Room Noise in Telephone Locations*, W. J. Williams, National Electric Light Association, and R. G. McCurdy, American Telephone & Telegraph Co.

#### Technical Committee Reports

W. S. RODMAN, *Vice-President*

*Communication*, G. A. Kositzky, Chairman  
*Electrical Machinery*, P. L. Alger, Chairman  
*Electric Welding*, A. M. Candy, Chairman  
*Electrophysics*, O. E. Buckley, Chairman  
*General Power Applications*, J. F. Gaskill, Chairman  
*Instruments and Measurements*, E. S. Lee, Chairman  
*Applications to Iron and Steel Production*, M. M. Fowler, Chairman  
*Production and Application of Light*, G. S. Merrill, Chairman  
*Applications to Marine Work*, W. E. Thau, Chairman  
*Applications to Mining Work*, Carl Lee, Chairman  
*Power Generation*, F. A. Allner, Chairman  
*Power Transmission and Distribution*, H. R. Woodrow, Chairman  
*Protective Devices*, E. A. Hester, Chairman  
*Transportation*, Sidney Withington, Chairman

In discussing *Rural Line Construction in Ontario*, Mr. Karcher called attention to some of the construction features in the United States, and wherein they differed from practise in Ontario. He cited the importance of stating all of the factors which make up the total cost per mile of line. From the experience obtained by a recent study of using No. 2 and No. 4 A. C. S. R., it was found that by using No. 2 with the proper height of pole and certain span lengths the cost was increased only 2.5 per cent and the carrying capacity was increased 45 per cent. For single-phase lines from 4000/23,00-volt, star-connected, four-wire systems, Mr. Karcher finds it preferable from the standpoint of better regulation, as well as economically justifiable, to run two phase wires and the neutral instead of extending one phase wire with a neutral. Mr. Karcher points out in further discussion that it is interesting to know that bare wire secondaries with only 12 in. vertical separation, as stated in the paper by Mr. Jones, are being used with satisfaction.

In discussing *Mutual Impedances of Ground-Return Circuits—Some Experimental Studies*, Mr. Peck described a test checking the structure of the earth by an entirely different method from that described in the paper. Mr. Peck's results, however, check closely with those obtained by Messrs. Bowen and Gilkeson.

Mr. D. A. Pierce, in discussing this same paper, contributes valuable supplementary information to the paper pertaining to the work and an interpretation of the results obtained.

Mr. King in discussing Messrs. Bowen and Gilkeson's paper stated that during the past year, over thirty sets of cooperative tests between power and communication circuits have been conducted in various localities. The results of these tests were summarized briefly as indicating a wide range of equivalent earth conductivities.

Mr. L. C. Peterson's discussion on the paper explained that the phenomena presented applies to steady-state conditions only. He also discussed formulas in connection with the work on the problem of transient induced voltages.

In connection with his discussion of this paper Mr. Maurier emphasized the importance of determining in advance of construction the self and mutual constants of circuits which either directly or indirectly involve the earth. A series of field tests conducted to determine these constants were described. These tests were conducted in the eastern part of Pennsylvania in connection with advance estimates of induced voltages from a railroad electrification.

Mr. Riordan in discussion on the paper briefly described some work done in finding formulas for the transient impedances of ground-return circuits based upon a formula for steady-state mutual impedance between ground-return wires of finite length, recently given by R. M. Foster.

Mr. L. P. Ferris discussed the Bowen and Gilkeson paper in the light of the difference in geological condition. In mountainous districts he asserted the earth's strata are greatly inclined with respect to a horizontal position. The direction of the primary circuit with relation to this direction of the stratification planes in such regions has an important influence upon the mutual impedance between grounded circuits. Mr. Ferris described a test conducted in a mountainous region and called attention to the need of such data.

Mr. H. A. Erikson commenting on Dr. Magnusson's paper said that results showed in a conclusive manner that the electric transfer involved in the negative and positive discharges is negative in character. The compound character of the discharge line connecting the two pole centers and its directions of curvature are, it seemed, conclusive on this point. This is a distinct accomplishment and is a step of advancement.

Mr. C. M. Foust pointed out that Dr. Magnusson's experiments were certain to result in a better understanding of the electrical mechanism in the formation of these figures. This may result in far-reaching consequences with regard to corona phenomena, surges, surge breakdown of insulation and electricity in gases. Mr. Foust also cited the difficulties to be encountered in conducting such an experiment and pointed out questions which had arisen from recent and extensive use of the Lichtenberg figures for measurement of surges on power systems. A number of the figures in the paper were discussed and important questions raised.

Mr. G. E. Quinan in his discussion in connection with Dr. Magnusson's paper stated that this is the first to point out the support given to the hypothesis of Yoshida by this experiment; namely that the positive figures are produced by electrons being drawn into the positive electrode and not by moving positive ions. Mr. Quinan further suggested that in continuing these experiments, the possibility of finding a more satisfactory fundamental hypothesis should not be overlooked.

In discussing the paper *A Survey of Room Noise in Telephone Locations* by Messrs. Williams and McCurdy, Mr. R. S. Tucker cited that the results were of value to the Noise Abatement

Commission of the City of New York in connection with measurements of outdoor noise in New York City.

### E. Transmission

H. R. WOODROW, *Chairman*

*The 220,000-Volt System of the Hydro-Electric Power Commission of Ontario*, E. T. J. Brandon, Hydro-Electric Power Commission of Ontario

*The Analytics of Transmission Calculations*, T. R. Rosebrugh, University of Toronto

*Study of the Effect of Short Lengths of Cable on Traveling Waves*, K. B. McEachron, General Electric Co.; J. G. Hemstreet, Consumers Power Co. and H. P. Seelye, Detroit Edison Co.

*Buried Distribution. Type Transformers*, C. E. Schwenger, Toronto Hydro-Electric System

*Dancing Conductors*, A. E. Davison, Hydro-Electric Power Commission of Ontario

Mr. M. M. Samuels in discussing Mr. Brandon's paper congratulated the author on the completeness of the paper and its systematic presentation. He stated that the paper contains an abundance of new ideas—many radical but interesting departures from conventional designs—and a concise description of each particular of detail.

Mr. V. G. Smith in discussing *The Analytics of Transmission Calculations* called attention to the definitions of some of the terms and facts to be kept in mind when using the work. He submitted six vector diagrams and equations for determining circular loci on them, for a constant value of any linear function of the four quantities  $z$ ,  $w$ ,  $x$  and  $y$ .

In connection with the discussion on *Study of the Effect of Short Lengths of Cable on Traveling Waves*, Mr. L. V. Bewley called attention to the fact that the principal difficulty in computing the effect of short lengths of cable inserted in a transmission line circuit is to keep track of the multiplicity of reflections which occur at the junctions. He submitted a lattice for the solution of the problem and offered an example illustrating its use.

Mr. H. G. Brinton, in discussing this same paper stated that the effect of a short length of cable is best determined by considering a long rectangular traveling wave as any other wave shape is considered the superposition of a number of rectangular waves.

An analysis of two cases was made, one with an outgoing line at the far end of the cable the other without an outgoing line connected at the far end of the cable.

In connection with the discussion of this paper by Messrs. McEachron, Hemstreet and Seelye, Messrs. Halperin and Miller set forth the conclusions reached from a theoretical consideration previous to the installation of the 132-kv. single-conductor oil-filled cable at Chicago. The discussors stated that the experiments of the authors substantiated these conclusions, which were based on standard theories.

### F. Electrical Machinery and Transmission-Symposium on Coordination of Line, Station, and Apparatus Insulation

H. R. WOODROW, *Chairman*

*Rationalization of Station Insulating Structures with Respect to Insulation of Transmission Lines*, C. L. Fortescue, Westinghouse Electric & Mfg. Co.

*The Effect of Transient Voltages on Dielectrics—IV; Law of Impulse Sparkover and Time Lag*, F. W. Peek, Jr., General Electric Co.

*Rationalization of Transmission Line Insulation Strength—II*, Philip Sporn, American Gas and Electric Co.

*Recommendations on Balancing Transformer and Line Insulation on Basis of Impulse Voltage Strength*, V. M. Montsinger, General Electric Co., and W. M. Dann, Westinghouse Electric & Mfg. Co.



*Coordination of Insulation as a Design Problem*, G. D. Floyd, Hydro-Electric Power Commission of Ontario

*Standards of Insulation and Protection for Transformers*, J. A. Johnson, Buffalo, Niagara and Eastern Power Corp., and E. S. Bundy, Niagara, Lockport & Ontario Power Co.

*Essential Factors in the Coordination of Line, Station, and Apparatus Insulation*, A. E. Silver and H. L. Melvin, Electric Bond and Share Co.

Discussing the paper by Mr. Fortescue, Mr. K. B. McEachron had some questions to ask concerning the number of insulators used in the test, the rating of the arrester, whether for grounded or ungrounded neutral service, and some other matters pertaining to the applied surge described in the paper. He explained why he did not favor changes in insulation to the coordinated level at a point half a mile away from the station. Of the use of the gap method he does approve and believes that it should be of value in proving the benefit of the modern arrester as well as acting as a last line of defence for direct strokes or in case for any reason the arrester goes out of service.

Mr. S. M. Jones in discussing the subject also favored maintaining line insulation at a uniform level up to the station, using either lightning arresters or voltage-limiting gaps, or both, to protect the station apparatus.

Mr. Jones explained that the non-agreement on the 60-cycle flashover values given out by different manufacturers for substantially the same type and design of units, as mentioned in Mr. Sporn's paper were possibly due to differences in temperature or humidity (or both) at which the insulators had been tested.

Mr. Jones stressed the importance of including other factors; method of potentiometer coupling, polarity of the test wave, the method of mounting the test piece, length and size of test leads, the location of the potentiometer and cathode ray oscillograph, and the temperature and humidity at which tests are taken. Until the majority of these factors can be included in any insulator impulse test standards it would be preferable Mr. Jones believes not to attempt standardization of wave shapes.

Discussing the same paper Mr. A. O. Austin called attention to the need of considering two conditions of wave form. He also cited other factors besides wave form that should be considered in standardizing lightning spark-over tests. These factors he stated must be considered before the results of different laboratories can be compared on a numerical basis.

Mr. Bewley discussing *The Effect of Transient Voltages on Dielectrics—IV; Law of Impulse Spark-over and Time Lag* submitted a mathematical treatise with examples and curves supplementing parts of Mr. Peek's paper.

Mr. E. Beck was of the opinion that the intensity of direct strokes and the magnitude of the currents involved are only in unusual cases of the order of the higher values which have been mentioned. To verify his opinion, experiment was made by the installation of 200 new autovalve type lightning arresters on exposed 66-kv. and 110-kv. transmission lines where flashovers have been frequent. Only one failure of a line arrester of this type occurred and discharge currents in excess of 10,000 amperes for the duration of oscillographic records of lightning destroyed the arrester.

In discussing Mr. Peek's paper, J. J. Torok described his own work parallel in nature to that of Mr. Peek, giving reasons leading up to his belief that with greater quantities of insulation and a given wave, flashover will take place in a period of time much longer than if the insulation were reduced. This means that the impulse ratio would be much lower on a 220-kv. line than on a 110-kv. line.

F. D. Fielder and P. H. McAuley in their work, did not check with some of Mr. Peek's results on the surge breakdown in air. Messrs. Fielder and McAuley described their methods and stated the reasons why there is risk of introducing considerable error, by calibrating the oscillograph with the sphere-gap. It was believed that in connection with the adoption of a standard wave

much work remains to be done in securing fundamental data.

With regard to Mr. Sporn's statement that variations exist in 60-cycle flashover values given out by the various manufacturers, Messrs. Fielder and McAuley pointed out that the discrepancy is not readily detected. They cited a case where a 100-cm. brass sphere-gap and a voltage rise at an average rate of 11,500 volts r. m. s. per sec. was used. Another group, using an aluminum gap and a higher rate of rise, reported lower flashover values. Both groups used the same calibration curves and correction factors.

In connection with the discussion of a preferred test wave, Mr. W. W. Lewis submitted a mean oscillatory wave and a mean unidirectional wave. Equations for the waves were given and Mr. Lewis explained how they are based on data presented at the lightning symposium at the A. I. E. E. Winter Convention.

In connection with Mr. Austin's information concerning flashover tests of insulator strings and the variation with humidity, Mr. Lewis pointed out that a sphere-gap which is authorized by A. I. E. E. rules and is not affected by humidity should be used in preference to other gaps which vary with humidity and are not authorized by the A. I. E. E.

Referring to the scheme proposed by Messrs. Silver and Melvin, of setting a spillway gap and eliminating the use of lightning arresters, Mr. Lewis suggested that rather close margins are proposed between the setting of the spillway gap and the insulation of the bus, etc. The lightning arrester will allow a higher setting of the spillway gap and at the same time tend to prevent the gap from flashing over.

Mr. Palueff discussed the effect of the shape of the voltage wave on the distribution of dielectric stresses within transformer windings, pointing out the danger of using gaps without resistance in series with them. The relation between line insulation and the number of arcovers was discussed as well as some service experience with the coordination of insulation.

Mr. M. M. Samuels discussed rationalization of insulation strength and stressed the point that proper subdivision should be made of the questions involved. In his discourse he subdivided and defined these questions, giving answers to them and suggested that the Committee canvass the questions in some such form obtaining answers from practical men.

Mr. R. Treat commends the basic idea expressed by Messrs. Johnson and Bundy that there need not and should not be too much coordination between transmission line insulation and substation and transformer insulation. Mr. R. Treat points out that while the lightning arrester in former years was an unreliable piece of apparatus, of later years through development of test apparatus, such as the cathode ray oscillograph and the lightning generator, it has become a very reliable piece of apparatus.

In discussing the symposium, Mr. H. L. Wallau summed up the contents of the papers presented and stated that coordination is not only desirable but necessary. He pointed out that no one suggested a maximum insulation limit for the line. In further discussion he substantiated Mr. Sporn's proposal to measure impulse strength by means of impulse voltages and standardize these waves. In conclusion it was acknowledged that considerable test data are necessary to set up and determine safe limits, but this will be progress in the right direction.

Mr. J. F. Peters in discussing the proposals outlined in the paper by Messrs. Silver and Melvin, believes that present ideas of insulation will be considerably modified after more field and laboratory data are obtained but until such data become available it is better in his opinion to follow the method given in the paper by Messrs. Montsinger and Dann.

## G. Communication

G. A. KOSITZKY, *Chairman*

*Symposium of Toll Telephone Service*

*General Switching Plan for Telephone Toll Service*, H. S. Osborne, Transmission Engineer, American Telephone and Telegraph Company

*Long Telephone Lines in Canada*, J. L. Clarke, Transmission & Foreign Wire Relations Engineer, Bell Telephone Company of Canada

*Long Distance Cable Circuit for Program Transmission*, A. B. Clark, (Development & Research) Toll Trans. Development Engr. American Telephone and Telegraph Company; C. W. Green, Telephone Engineer, Bell Telephone Laboratories, Inc.

*Transmission Characteristics of Open-Wire Telephone Lines*, E. I. Green (Development & Research Dept.), American Telephone and Telegraph Co.

*Study of Telephone Line Insulators*, L. T. Wilson, (Development & Research), American Telephone and Telegraph Company

At the opening of the Session, Mr. Kositzky stated by way of introduction that this part of the program had been divided into two parts—(A) Symposium on Toll Telephone Service and (B) Symposium on Two-Way Television, the subjects having been selected as most appropriate, in that these branches of communication best represented the rapidity of progress in this field.

In a toll plant where in 1876 the first message between cities was from Boston to Salem—a distance of 14 mi.—development and research engineers have been working constantly to further improvement in the distance of communication. Forty years later the range had been extended to about 3000 mi., or between New York and San Francisco, and today it is possible to communicate with 24 separate countries, or about 70 per cent of all the telephones outside the country and 90 per cent including the telephones in this country.

Research and Development Engineers, he added are not yet satisfied with present accomplishments. The heavy growth in toll service is requiring still further improvements as evidenced by the first part of our program where five different phases of the toll telephone service problem are presented.

He expressed regret that the time allotted would not permit as full presentation and discussion of each of these subjects, and that each speaker was necessarily limited in the presentation of his subject.

The Chairman then introduced Mr. S. P. Grace, Assistant Vice-President of the Bell Telephone Laboratories who personally addressed the meeting.

Doctor H. E. Ives was then presented and gave to the members an interesting and instructive talk on the sixth paper of the session entitled, *Two-Way Television*, by himself, with Messrs. Gray, Baldwin, Stroller, Blattner and Bostwick in collaboration.

In connection with the discussion of the subject of *Two-Way Television*, Mr. N. S. Amstutz contributed the following:

It is with no little thrill that I arise to congratulate the Institute and Doctor Ives on a realization of the vision of one of those dreamers who thirty-six years ago wrote about "Visual Telegraphy" and assumed the role of a prophet, outlining a two-way working system to be used in combination with a telephone circuit. [*Electricity*, (New York) Feb. 28, 1894, pp. 77-80, and March 14, 1894, pp. 110-111]. There was described a television sending circuit, a television receiving circuit, a speech transmission circuit and a motor synchronizing circuit. The *one-way* television circuit and scanning disk device of Nipkow was described in detail, among a number of other proposals. The simultaneous sending and receiving of television currents were by means of two separate cylinders direct connected to a synchronous motor, each cylinder carried a group of openings arranged spirally.

It is indeed a great personal satisfaction to have the dreams of yester year come true, and this opportunity is taken to congratulate Doctor Ives along with other workers, such as Jenkins at Washington, Alexanderson at Schenectady, and Baird of London, England, all of whom,—thanks to sensitive light re-

sponsive devices, neon lamps, carrier currents, ultra precision apparatus, adequate financing and technical staffs,—are hastening the day when television will not only be spectacular but harnessed to the service of man.

Doctor Ives, in his address, referred to television as having been "in the air" for a long time, as far back as the "Arabian Nights." Conjecture reverts to an incident described in Dr. Guthries "General History of the World" 1764, Vol. VII, pages 3 and 4 in which portraits were made and sent in some mysterious manner during the reign of the twenty-sixth califf of the house of Al Abbas, circa A. D. 1037. This is referred to as follows "Avicenna, was obliged to fly to Forjan, where Washmakin reigned. Upon this, Mahmud, having got one of his portraits, ordered a great number of copies of it to be made and dispersed all over the east, that Avicenna might be seized." \* \* \* "Washmakin knew him, by one of his portraits which had been sent him by Sultan Mahmud." The engineers of today may well wonder how the feat described above was accomplished.

## H—Power Generation

F. A. ALLNER, *Chairman*

*East River Generating Station of the New York Edison Company*, C. B. Grady, W. H. Lawrence and R. H. Tapscott, New York Edison Co.

*Present Day Hydro Power Practise in Central Europe*, A. V. Karpov, Aluminum Company of America

Discussion submitted by Mr. M. S. Sloan on *East River Generating Station of the New York Edison Co.*, was presented by Mr. Tapscott, and demonstrated the many economic and administrative ramifications by the engineering decisions of a large consolidated system in adapting the plan of 60-cycle generation in future development. Lantern slides were shown illustrating the increasing trend during the past two decades toward the manufacture of 60-cycle electrical machinery.

In connection with the discussion following the presentation of the paper Mr. Gorsuch asked two questions:

Are any special features of feed-water treatment required for a boiler having a capacity of approximately 1,000,000 lb. of steam per hour?

Will future developments in the electrical system influence the final decision as to the size of boilers and turbine installed in the last extension of the plant?

He also stated that it would be of interest if the authors would describe the method of handling the steam from the steam-driven auxiliaries in the feed-water system.

In his discussion of this paper Professor Kouwenhoven asked:

If the authors would describe the features of design, to which they attribute so marked a saving in electrical construction, of the recent addition to the electrical galleries? and also:

Would the discussors of this paper expect a further high reduction in electrical gallery construction costs by the adoption of 60-cycle units at higher voltage than is used at present with the 25-cycle generators, and what difficulties in the station layout would they expect such an innovation to cause?

Mr. Allner in discussing Mr. Karpov's paper described tests that may be conducted in a recently built cavitation laboratory constructed by one of the major hydroelectric companies in the East. Turbine models complete with settings as proposed for another low-head project on the same river, are now being tested there for cavitation behavior, and facilities have also been provided at this laboratory for making tests on model structures such as spillway sections, sluice gates, flashboards and other similar structures.

In his closing remarks he emphasized his thought that the reason for the presentation of his paper was to stress the shortcomings in theoretical and laboratory research work as now existing in the United States due to the lack of adequate laboratory facilities.

**H—Electrical Machinery—(Continued)**P. L. ALGER, *Chairman**Effects of Lightning Voltages on Rotating Machines and Methods of Protecting Against Them*, F. D. Fielder and E. Beck, Westinghouse Electric & Mfg. Co.*Voltage Oscillations in Armature Windings under Lightning Impulses—I*, E. W. Boehne, General Electric Co.*Vertical Shaft 25,000 Kv-a. Synchronous Condensers*, H. A. Ricker, J. R. Dunbar and R. E. Day, Canadian Westinghouse Co.*Metal-Clad, Gum-Filled Switching Equipment*, L. B. Chubbuck, Canadian Westinghouse Co.

In discussing the paper by Messrs. F. D. Fielder and E. Beck, Mr. C. W. Guth described a series of tests made on turbine generator coil insulation when tested with an impulse voltage to the dielectric breakdown strength of the insulation when tested at 60 cycles. Results of the tests indicated a ratio of impulse breakdown to 60-cycle breakdown of approximately  $1\frac{1}{2}$  to 1.

In discussing *Effect of Voltage Surges on Rotating Machinery*, Mr. L. V. Bewley analyzed some of the oscillograms and the results obtained by Mr. E. W. Boehne.

Mr. K. B. McEachron in connection with the papers by Messrs. Fielder and Beck and Mr. E. W. Boehne, submitted curves and described a method of making accurate calculations relating to arrester performance—either alone or in combination with capacitors—for protection of rotating machinery.

In connection with the discussion of *Vertical-Shaft 25,000-Kv-a. Synchronous Condensers*, Mr. G. D. Floyd discussed tests recently made to determine the quickness of response of these condensers under various conditions. Results were illustrated by three figures. Data worked up from the tests indicated that the response of the two condensers was approximately the same, being at the rate of approximately 20,000 kv-a. per sec. if the abnormal condition is limited to approximately two seconds.

Mr. F. H. Chandler in connection with the discussion of *Vertical-Shaft 25,000-Kv-a. Synchronous Condensers*, described the automatic CO<sub>2</sub> ventilating system and an analysis of soil conditions made previous to the installation of the machine foundations. A very accurate balance of the machine has been made. A two-pound weight one side of the rotor 20 in. from shaft center will throw the machine considerably out of balance.

In discussion of *Vertical-Shaft 25,000-Kv-a. Synchronous Condensers*, Mr. T. W. Riggs discussed several design features. He stated that in general, vertical machines will cost more and be more difficult to ventilate due to supporting structures for bearings impeding the flow of air. Mention was made of the many possibilities of varying the design of external parts to suit any weather or ventilating conditions. One of the nicest designs was to recirculate the air through surface water coolers. Other layouts may incorporate air conditioning apparatus either in the machine housing or in a separate structure. Springs have been used under the field coils to take up expansion of copper or shrinkage of insulation.

**CONFERENCE OF OFFICERS, DELEGATES, AND MEMBERS**

For the purpose of increasing the attendance of members in general at the Conference of Officers, Delegates, and Members, heretofore held on the first day of the Summer Convention, the conference was this year held on Monday and Tuesday afternoons, June 23 and 24. As in previous years, the conference was under the auspices of the Sections Committee and the Committee on Student Branches.

The attendance of official delegates was unusually large, there being present representatives of 51 of the 58 Sections, 8 District Secretaries, and 8 Counselor Delegates. Also a con-

siderable number of Institute and Section Officers, Branch Counselors and other members were present.

After a brief opening session on Monday afternoon, Sessions A and B were held in parallel, Doctor W. B. Kouwenhoven, Chairman, Sections Committee, presiding over Session A on Institute and Section problems, and Professor W. H. Timbie, Chairman, Committee on Student Branches, presiding over Session B dealing with topics concerning Enrolled Students and the Student Branches. On Tuesday afternoon, the two groups met together to discuss subjects of common interest.

The topics on the program, which had been prepared in advance by a special committee and mailed to the delegates, are given below:

MONDAY, JUNE 23, 1930—2:00 P. M. (DAYLIGHT SAVING TIME)

1. Opening of Conference:
  - Announcements by Dr. W. B. Kouwenhoven, Chairman, Sections Committee.
2. Remarks by President H. B. Smith.
3. Remarks by President-Elect W. S. Lee.
4. Remarks by National Secretary F. L. Hutchinson.
5. Recess of five minutes to divide into parallel Section and Branch Sessions.

**Session A—The Institute Section**

DR. W. B. KOUWENHOVEN, CHAIRMAN

6. The Institute Membership—J. Allen Johnson.
  - (a) The Institute Membership Policy and Progress in Membership as Viewed by the National Membership Committee.
  - (b) The Institute Membership Policy and Progress in Membership as Viewed by the Sections.
  - (c) The Institute Membership Policy and Progress in the Transfer of Qualified Engineers to Higher Grades in the Institute.
  - (d) The Institute Membership Policy for Future Progress.
7. The Institute Section Functions—H. H. Henline.
  - (a) How Can the Institute Section Assist the Members to Perform Their Part in Civic Affairs?
  - (b) The Financing of the Section.
  - (c) Provision of Routed and Scheduled Speakers of Prominence Among a Number of Contiguous Sections.
  - (d) Questions and Answers Relating to Institute and Section Affairs in General.

**Session B—The Enrolled Student and the Student Branches**

PROFESSOR W. H. TIMBIE, CHAIRMAN

8. Should Qualifications for the Grade of Enrolled Student be Established?
9. What Can the Institute Do to Inform the Pre-College Student of the Opportunities and the Need for Trained Electrical Engineers?
10. How Can the Student Branch Assist Most Largely in the Development of Its Member as Engineers?
11. What Service Can the Student Branch Render to the College?

TUESDAY, JUNE 24, 1930—12:30 P. M. (DAYLIGHT SAVING TIME)

12. Luncheon of Officers and Delegates.

**Session C—General**

2:00 P. M. (DAYLIGHT SAVING TIME)

DR. W. B. KOUWENHOVEN, CHAIRMAN

13. The Institute Publication Policy—W. S. Gorsuch.
  - (a) Consideration of the Report to the Board of Directors by the Publication Committee Embodying Recommendations.

14. Cooperation Between Sections and Student Branches—  
W. H. Timbie.
- (a) How Can Cooperation Between Students and Engineers and Between Sections and Branches in the Same Locality be Increased.
- (b) Questions and Answers About Relations Between Sections and Branches.
15. The Training of the Engineer—Prof. Edward Bennett.
- (a) How Can the Section Assist Its Members in Their Post-College Education?
16. Miscellaneous Questions and Answers.

Copies of the Annual Report on Section and Branch Activities, for the fiscal year ending April 30, 1930, were distributed. Institute members may secure copies without charge by applying to headquarters.

The following recommendations were adopted:

1. The appointment by the Board of Directors of a committee to consider matters of membership grades below that of Member, entrance and transfer fees to all grades, and the requirements for membership in each grade, together with the suggestions on these topics offered in the discussion.

2. The adoption of President Smith's plan for providing for the Sections occasional lectures by the most able and interesting speakers who can be secured, usually from the Institute membership, each visiting on one trip perhaps 10 to 15 Sections. (See President's message in July JOURNAL.)

3. That the Board of Directors bring to the attention of the Sections the possibility of interesting selected practising engineers in each high school community in counseling with high school students and faculties as to the qualifications necessary for success in engineering, and that there be collected or prepared suitable pamphlets for the use and guidance of the high school counselors and students.

4. That provisions be made for a prize in each District for the best paper by a graduate student who is still an Enrolled Student of the Institute.

5. The approval of the recommendations in the report of the Publication Committee. (See summary on front page of this issue.)

6. That consideration be given to the request of the Mexico Section, in connection with the publication of the *Boletín of the A. I. E. E.*, for such assistance as may be feasible in promoting the best service of the Institute to the Spanish speaking members in Latin-America.

7. That the 1931 Conference of Officers, Delegates, and Members be held on the first two afternoons of the Summer Convention.

Recommendations Nos. 2, 5, and 6 were considered by the Board of Directors on June 25, 1930, and actions were taken as follows:

2—Approved.

5—Approved.

6—Referred to the Committee on Coordination of Institute Activities.

Recommendations Nos. 3 and 4 above were made by the Counselor Delegates in Session B on Monday afternoon, and were adopted on Tuesday at the combined meeting. They will be considered by the Board of Directors later.

An abstract of the proceedings of the entire Conference will be printed in pamphlet form and mailed to all Delegates present and to Institute, Section, and Branch officers. Any Institute member who is interested may obtain a copy of the pamphlet without charge upon application to Institute headquarters.

## Annual Meeting of the Institute

TORONTO, ONTARIO, JUNE 23, 1930

### MINUTES

The Annual Meeting of the Institute was held at the Royal York Hotel, Toronto, Ontario, as the opening session of the annual Summer Convention, on Monday morning, June 23, 1930. President Harold B. Smith presided.

Vice-President C. E. Sisson, Chairman of the General Convention Committee, opened the meeting with a brief address, which was followed by an address of welcome by Mr. James Simpson of the Control Board of the City of Toronto.

The Annual Report of the Board of Directors was presented in abstract by National Secretary F. L. Hutchinson. Printed copies were distributed to members in attendance and are available to any member upon application to Institute headquarters, New York. The Report, which constitutes a résumé of the activities of the Institute during the fiscal year ending April 30, 1930, showed a total membership on that date of 18,003. In addition to the three National conventions and two District meetings, 1489 meetings were held during the year by the local organizations of the Institute in the principal cities and educational institutions in the United States, Canada and Mexico. The Report will be published in full in the Quarterly TRANSACTIONS of the Institute.

The report of the Committee of Tellers on the election of officers of the Institute was presented (as published in this issue) and, in accordance therewith, President Smith declared the election of the following officers, whose terms will begin on August 1, 1930:

- President:* WILLIAM S. LEE, Consulting Engineer, President of the W. S. Lee Engineering Corporation, Charlotte, N. C. (See biographical sketch in July issue of the JOURNAL, page 575.)
- Vice-Presidents:* I. E. MOULTROP, Chief Engineer, Edison Electric Illuminating Co., Boston, Mass.  
H. P. CHARLESWORTH, Vice-President, Bell Telephone Laboratories, New York, N. Y.  
T. N. LACY, Chief Engineer, Michigan Bell Telephone Co., Detroit, Mich.  
GEORGE C. SHAAD, Dean, School of Engineering and Architecture, University of Kansas, Lawrence, Kans.  
H. V. CARPENTER, Dean of Mechanic Arts and Engineering, State College, Pullman, Wash.
- Directors:* A. B. COOPER, General Manager, Ferranti Electric Limited, Toronto, Ont.  
A. E. KNOWLTON, Associate Editor, *Electrical World*, New York, N. Y.  
R. H. TAPSCOTT, Electrical Engineer, New York Edison Co., New York, N. Y.
- National Treasurer:* GEORGE A. HAMILTON, Elizabeth, N. J., (re-elected).

(These officers, together with the following hold-over officers, will constitute the Board of Directors for the next administrative year, beginning August 1: Harold B. Smith (retiring President), Worcester, Mass.; R. F. Schuchardt, Chicago, Ill.; Herbert S. Evans, Boulder, Colo.; W. S. Rodman, Charlottesville, Va.; C. E. Fleager, San Francisco, Calif.; E. C. Stone, Pittsburgh, Pa.; C. E. Sisson, Toronto, Ont.; F. C. Hanker, East Pittsburgh, Pa.; E. B. Meyer, Newark, N. J.; H. P. Liversidge, Philadelphia, Pa.; J. Allen Johnson, Buffalo, N. Y.; A. M. MacCuteheon, Cleveland, Ohio; A. E. Bettis, Kansas City, Mo.; J. E. Kearns, Chicago, Ill.; C. E. Stephens, New York, N. Y.)

President Smith then congratulated President-Elect Lee upon his election and presented him with a President's badge. Mr. Lee responded with a brief address, which was enthusiastically received.

The report of the Committee of Tellers on the voting upon proposed Constitutional amendments, which had been submitted to the membership in a circular letter dated March 1, 1930, was then presented and, in accordance therewith, President Smith declared all the proposed amendments adopted. (This report is published in full elsewhere in this issue.)

The Report of the Committee on Award of Institute Prizes, as published in the June 1930 issue of the JOURNAL, was then



read by Chairman A. E. Knowlton of the Committee of Award. Prizes were then presented by President Smith.

The annual presidential address was then delivered by President Smith, the subject being "The Status of the Young Engineer." This address was published in full in the July issue of the JOURNAL.

Adjourned.

F. L. HUTCHINSON,  
National Secretary.

### Report of Committee of Tellers on Election of Officers

To the President  
American Institute of Electrical Engineers

DEAR SIR:

This Committee has canvassed the ballots cast for the election of Institute officers in the year 1930, and reports as follows:

Total number of ballot envelopes received.....	5831
Ballots rejected, in accordance with Art. VI, Secs. 32 and 34 of the Constitution:	
From members in arrears for dues for year ending May 1, 1930.....	106
Received in envelopes unmarked by identifying signature.....	57
Received in improper envelope.....	3
Received after May 1, 1930.....	31
Leaving as valid ballots.....	5634

These 5634 valid ballots were counted, and the result is shown as follows:

FOR PRESIDENT

William S. Lee.....	5208
Blank.....	426

FOR VICE-PRESIDENTS

<i>District</i>	
No. 1 <i>North Eastern</i>	
I. E. Moulthrop.....	5308
Blank.....	326
No. 3 <i>New York City</i>	
H. P. Charlesworth.....	5313
Blank.....	321
No. 5 <i>Great Lakes</i>	
T. N. Lacy.....	5326
Blank.....	308
No. 7 <i>South West</i>	
G. C. Shaad.....	5298
Blank.....	336
No. 9 <i>North West</i>	
H. V. Carpenter.....	5289
Blank.....	345

FOR DIRECTORS

A. B. Cooper.....	5370
A. E. Knowlton.....	5361
R. H. Tapscott.....	5363
Blank.....	808

FOR NATIONAL TREASURER

George A. Hamilton.....	5278
Blank.....	356

Respectfully submitted

W. E. COOVER, *Chairman*  
P. ELLIOTT  
J. V. MOSES  
F. J. RASMUSSEN  
A. JOHNSON  
GEORGE H. BROWN

Committee of Tellers.

Date May 15, 1930

### Report of Committee of Tellers on Amendments to the Constitution

To the Board of Directors

American Institute of Electrical Engineers

GENTLEMEN:

This Committee has canvassed the ballots cast on the proposed amendments to the Constitution submitted to the membership in a circular letter dated March 1, 1930, and the result is as follows:

Total number of envelopes received.....	9114
Ballots rejected, in accordance with the Constitution and By-laws, for the following reasons:	
From members in arrears for dues for year ending May 1, 1930.....	214
In envelopes unmarked by identifying signature..	129
In non-official envelopes.....	20
Received after May 1, 1930.....	39
In envelopes bearing illegible signature.....	2
Leaving as valid ballots.....	8710

These valid ballots were counted and the result is as follows:

	In favor of	Against	Blank
Amendment No. 1: Corporate Members, Art. II, Sec. 3.....	8550	94	66
Amendment No. 2: Honorary Members, Art. II, Sec. 3.....	8377	272	61
Amendment No. 3: Qualifications of teachers, Art. II, Sec. 5.....	8531	112	67
Amendment No. 4: Enrolled Students, Art. II (addition).....	8537	110	63
Amendment No. 5: Enrolled Students—exemption from entrance fee, Art. IV, Sec. 16.....	8323	323	64
Amendment No. 6: District Meetings, Art. VIII, Sec. 50.....	8556	85	69

The total membership of the Institute on May 1, 1930, was 18,003. From the above it is evident that more than 20 per cent of the total membership voted, and that more than 75 per cent of those who voted were in favor of the adoption of each amendment. Under the provisions of the Constitution, therefore, all the proposed amendments are adopted and go into effect July 23, 1930.

Respectfully submitted

W. E. COOVER, *Chairman*  
F. J. RASMUSSEN  
J. V. MOSES  
A. JOHNSON  
P. ELLIOTT  
H. KURZ

Committee of Tellers.

Date May 20, 1930

### A. I. E. E. Directors Meeting

The regular meeting of the Board of Directors of the American Institute of Electrical Engineers was held at the Royal York Hotel, Toronto, Ontario, on Wednesday, June 25, 1930.

There were present: President Harold B. Smith, Worcester, Mass.—Vice-Presidents H. S. Evans, Boulder, Colo.; B. D. Hull, Dallas, Texas; H. A. Kidder, New York, N. Y.; E. B. Merriam, Philadelphia, Pa.; W. S. Rodman University, Va.; W. T. Ryan, Minneapolis, Minn.; C. E. Sisson, Toronto, Ont.—Directors H. C. Don Carlos, Toronto, Ont.; J. A. Johnson, Buffalo, N. Y.; W. S. Lee, Charlotte, N. C.; A. M. MacCutcheon, Cleveland, Ohio—also by invitation the following officers elect: Vice-Presidents H. V. Carpenter, Pullman, Wash.; H. P. Charlesworth, New York, N. Y.; T. N. Lacy, Detroit, Mich.; G. C. Shaad, Lawrence, Kans.—Directors A. B. Cooper, Toronto, Ont.; A. E. Knowlton, New York, N. Y.; R. H. Tapscott, New York, N. Y.—also F. L. Hutchinson, National Secretary; H. H. Henline, Assistant National Secretary, New York, N. Y.

The minutes of the Directors' meeting of May 23, 1930, were approved.

Reports of meetings of the Board of Examiners held June 4 and June 20 were presented; and upon the recommendation of the Board of Examiners, the following actions were taken upon pending applications: 54 Students were enrolled; 254 applicants were elected to the grade of Associate; 5 applicants were reelected to the grade of Associate; 1 applicant was reinstated to the grade of Associate; 27 applicants were elected to the grade of Member; 1 applicant was reinstated to the grade of Member; 1 applicant was reelected to the grade of Fellow; 18 applicants were transferred to the grade of Member; 10 applicants were transferred to the grade of Fellow.

The Finance Committee reported approval of the payment of monthly bills amounting to \$32,200.22. This action was ratified by the Board.

In accordance with the recommendation of the Committee on Student Branches, requests for authorization to establish Student Branches in the following institutions were granted: Harvard University, University of British Columbia, and Villanova College.

The report of the Publication Committee on "Proposed Changes in Policy of Institute Publications," which had been presented at the May Board meeting and action postponed, was considered. This report had been considered and recommended to the Board of Directors for adoption at the Conference of Officers, Section Delegates and Members, held Tuesday, June 24th. It was voted to approve the report, adopt all the recommendations embodied therein, and to express to the members of the Publication Committee the Board's appreciation of the Committee's work.

President Smith announced that, in accordance with the Board's action at the May meeting, he, after conference with President-elect Lee, had appointed the following committee to recommend candidates for the Popular Science Monthly's \$10,000 Award, to be made in the fall of 1930: Messrs. H. P. Charlesworth, Chairman, A. E. Knowlton and C. E. Stephens.

In accordance with a request of the officers of the South West District, the dates for holding the District Meeting in Kansas City, already authorized by the Board for October 1931, were approved, namely, October 23-25, 1931.

The Board voted its approval of President Smith's proposal for providing for the Sections occasional lectures by able and interesting speakers, usually from the Institute membership, each visiting on one trip perhaps ten to fifteen Sections,—the expenses to be met as follows (1) All traveling expenses to be paid from the Institute treasury; (2) All local expenses to be paid in each instance by the Section concerned; (3) the lecturer to contribute his services.

Other matters were discussed, reference to which may be found in this and future issues of the JOURNAL.

### Lamme Medal Presentation

The Lamme Medal for 1929, which was awarded to Rudolf Emil Hellmund, as reported in the February 1930 issue of the JOURNAL, was presented to him during appropriate ceremonies at the banquet held on Wednesday evening June 25 at the Summer Convention in Toronto. The award was made "for his contributions to the design and development of rotating electrical machinery."

The program during which the presentation was made was conducted by Past-President Charles F. Scott, Chairman of the Lamme Medal Committee, who opened it with a brief address upon the career of Mr. Lamme, the founder, and the significance of the medal, and also mentioned the variety and importance of Mr. Hellmund's achievements.

He then introduced A. M. Dudley, Engineering Supervisor of Development, Westinghouse Electric & Manufacturing Company, who was closely associated with Mr. Lamme in technical

work during the later years, and has been almost a lifetime associate of Mr. Hellmund. Mr. Dudley summarized in an admirable manner the outstanding characteristics and achievements of the Medalist.

President Smith presented the Medal and Certificate to Mr. Hellmund, who responded briefly, and then gave an address in which he recommended closer cooperation between the schools and industries in the training of young men for careers in engineering.

### Five Engineering Awards Made at A. S. C. E. Annual Convention

At the opening session of the Annual Convention of the American Society of Civil Engineers, Cleveland, Ohio, July 9th, five Phebe Hobson Fowler medal awards were made for special achievements by engineers; Arthur W. Berresford, President of the Institute for the period 1920-1921, and, since his retirement from the presidency of American Engineering Council, Managing Director of the National Electrical Manufacturers Association, was presented with the gold bronze medal First Prize "In recognition of his particularly efficient administration of American Engineering Council during the past two years;" the second silver bronze medal award was to J. Vipond Davies, President of Jacobs and Davies Inc., Consulting Engineers, Past-President of the United Engineering Society and Member of the Research Board of Engineering Foundation; the medals of architectural award were presented to Morris Goodkind, for his design of the Raritan River Bridge; Professor Charles M. Spofford, of Massachusetts Institute of Technology for design of the Lake Champlain Bridge; and G. F. Burch, bridge engineer of the Illinois Department of Public Works, for the design of the Dixon Springs Bridge.

John Bellamy Taylor, Consulting Engineer for General Electric and Fellow of the Institute, gave a most entertaining demonstration, making a ray of light produce growls, shouts of laughter, speech and song.

### The International Conference on Large High-Tension Electric Systems

For the 1931 meeting of the International Conference on Large High-Tension Electric Systems, the Executive Board of the Conference has stipulated that the maximum number of papers shall not exceed 75—25 per section—and that no paper shall be accepted later than December 31, 1930. The opportunity is open for any Institute member wishing to present a paper at this conference to do so if notice is sent at once to Institute headquarters.

### Advisory Committee on National Hydraulic Laboratory Appointed

Doctor George K. Burgess, Director of the Bureau of Standards, has appointed the following as an Advisory Committee on the New National Hydraulic Laboratory recently authorized by Congress:

John R. Freeman, President, Mfrs. Mutual Fire Ins. Co. also Consulting Engineer, New York Board of Water Supply, Providence, R. I.; William B. Gregory, Professor of Exper. Engineering, Tulane University, New Orleans, La.; Ely C. Hutchinson, Editor *Power*, New York, N. Y.; Lewis F. Moody, Consulting Engineer, Cramp-Morris Industrials Inc., Philadelphia, Pa. Sherman M. Woodward, Professor of Mechanics and Hydraulics, University of Iowa, Iowa City; J. P. Dean, Office of Chief of Engineers, War Department, Washington, D. C.; S. H. McCrory, Chief, Division of Agricultural Engineering, U. S. Bureau of Public Roads, Dept. of Agriculture, Washington, D. C.; N. C. Grover, Chief Hydraulic Engineer, U. S. Geological Survey, Dept. of Interior, Washington, D. C.; E. W. Lane, Reclamation

Bureau, Dept. of Interior, Denver, Colo.; B. R. Van Leer, Asst. Secy., American Engineering Council, Washington, D. C.

The Committee has held one meeting in Washington at which Mr. John R. Freeman, originator of the idea of the National Hydraulic Laboratory, submitted the most comprehensive set of plans yet devised for a hydraulic laboratory. These plans are to be printed in Senate Document form. The committee has these plans under advisement and will give further thought to them at its meeting on July 14, at which time other questions of vital importance to the future of the laboratory will also be considered.

### President Hoover Signs Rivers and Harbors Bill

On July 4 President Hoover affixed his signature to the omnibus Rivers and Harbors Bill, H. R. 11781, Public Law 520, authorizing the expenditure of \$130,000,000. The ultimate total to which the Government is committed on the basis of projects sanctioned in the new act approaches \$350,000,000. The bill carries provision for the Federal Government to cooperate with State Agencies in a study of Beach and Shore Erosion problems.

In approving the bill, President Hoover issued a statement declaring that it gave him particular satisfaction to sign this measure since it represents the final authorization of the engineering work by which will be constructed and coordinated the Nation's systems of waterways and harbors advocated by him for five years and recommended to Congress. This inland waterway undertaking represents in the aggregate, the President asserted, a project larger even than the Panama Canal and added that it would provide employment for thousands; that it should be fruitful of decreased transportation charges on bulk goods and bring great benefits to the Nation's farms and industries and result in a better distribution of population away from congested centers.

### Federal Water Power Commission Reorganized

The bill (S. 3619) to reorganize the Federal Power Commission became Public Law 412, 71st Congress, when President Hoover signed it on June 23. This authorizes the appointment of five full-time Commissioners to assume the duties of the old Federal Power Commission which was composed of Secretaries of War, the Interior and of Agriculture. The reorganization plans provide for an entirely independent staff in the District of Columbia, and authorizes the Commission to call upon the President for detail of engineers in the other Governmental agencies to perform the field work.

A five-year term of office after the original commissioners have served terms graduated from one to five years is authorized. The President has named as first Chairman, General Edgar Jadwin, former Chief of Engineers. The Commission will elect his successors to serve during their term of office.

### An American Society of Danish Engineers Formed

An American Society of Danish Engineers has been formed for "the furtherance of collegiate and social relations between engineers of Danish birth or descent, residing in America." Its Constitution and By-Laws were adopted at a meeting held the early part of the present year and its officers are; H. Osterberg, President; A. C. Gronbech, Vice-President; and S. G. Thyrré, Secretary-Treasurer,—all of New York City. Working Committees are also formulated on employment, social affairs, membership and general development.

### New Officers for the Automotive Engineers

To succeed the late Coker F. Clarkson who has held office for the past twenty years and who was the only other incumbent of this office, John A. C. Warner, Research Engineer for the Studebaker Corporation, has been appointed Secretary and General Manager of the Society of Automotive Engineers. Mr. C. B. Veal, who has already served the Society as Chairman of numerous committees, will become Assistant General Manager.

Expansion of the organization and development of new offices are dictated by the constantly increasing variety and complexity of the Society's work.

### The 1930 Lamme Medal

#### A. I. E. E. MEMBERS INVITED TO SUBMIT NOMINATIONS BY OCTOBER 1

The Lamme Medal was founded as a result of a bequest of the late Benjamin G. Lamme, Chief Engineer of the Westinghouse Electric & Mfg. Company, (deceased July 8, 1924), to provide for the award by the Institute of a gold medal—together with bronze replica thereof—annually to a member of the A. I. E. E. "who has shown meritorious achievement in the development of electrical apparatus or machinery," and for the award of two such medals in some years if the accumulation from the funds warrants.

The second (1929) Lamme Medal has been awarded to Rudolf Emil Hellmund, Chief Electrical Engineer, Westinghouse Electric and Manufacturing Company, East Pittsburgh, Pa., "for his contributions to the design and development of rotating electrical machinery," and will be presented during the Summer Convention at Toronto, Ont., Canada, June 23-27.

Special attention is called to the fact that names of members of the Institute, who are considered suitable candidates for the Lamme Medal to be awarded in the Fall of 1930, may be submitted by any member in accordance with Section 1 of Article VI of the By-laws of the Lamme Medal Committee, which is quoted below:

"The Committee shall cause to be published in one or more issues of the A. I. E. E. JOURNAL each year, preferably including the June issue, a statement regarding the 'Lamme Medal' and an invitation for any member to present to the National Secretary of the Institute by October 1 the name of a member as a candidate for the Medal, accompanied by a statement of his 'meritorious achievement' and the names of at least three engineers of standing who are familiar with the achievement."

Each nomination should give concisely the specific grounds upon which the award is proposed, and also a complete detailed statement of the achievement of the nominee, which will enable the Committee to determine its significance as compared with those of other candidates. If the work of the nominee has been of a somewhat general character, in cooperation with others, specific information should be given regarding the contributions of the individual. Names of endorsers should be given as specified above.

### PERSONAL MENTION

L. H. FLETMEYER, Electrical Engineer, Purdue University 1930, has joined the Roessler & Hasslacher Chemical Company, Niagara Falls, N. Y.

ROBERT L. ROCKWELL, Consulting Engineer, Seattle, Washington, announces the removal of his office from the Empire Building to the Alaska Building, that city.

E. F. PEARSON, formerly Electrical Engineer of the Northwestern Electric Company, Portland, Oregon, has been promoted to the position of Chief Engineer of that company.

JOHN A. KELLY has been engaged as Director of the Research Bureau of The Electrical Guild of North America, and will be located at the general headquarters, Investment Building, Washington, D. C.

EDWARD L. WILDER formerly of the Industrial Sales Department of the Rochester Gas & Electric Corporation, on February 1st took office as Manager of Gas Sales with the J. G. White Management Corporation.

J. P. BARTON has resigned from the Radio Engineering Dept. of Westinghouse Elec. & Mfg. Co., Chicopee Falls, Mass., and has joined the Audio and Socket Power Group of General Motors Radio Corporation, Dayton, Ohio.

R. L. DAVIS, engineer in charge of radio development at the East Pittsburgh plant of the Westinghouse Electric and Manufacturing Company, has been named Manager of the Radio Engineering Department of the Westinghouse Chicopee Falls, Mass. plant.

THEODORE DREIER, for the past five years an electrical engineer at the General Electric Company in Schenectady, N. Y., has been appointed Assistant Professor of Physics at Rollins College for the coming year. Mr. Dreier will fill a vacancy caused by the death of Dr. William S. Franklin in June.

GORDON R. BATEMAN, who has been Assistant Electrical Instructor at the London Technical & Commercial High School, London, Ontario, Canada, has now been chosen Electrical Instructor for the Northern Vocational School at Toronto.

DANA PIERCE, President, Underwriters' Laboratories, Chicago, in recognition of his contribution to engineering progress in the fire protection field, has had conferred upon him by Armour Institute of Technology the degree of Doctor of Engineering.

AUSTIN ARMER, for several years connected with the Magnavox Company of Chicago, Ill., as Director of Engineering Sales Work, is now engaged as a consultant in electrical problems pertaining to sound, and will be located at the Oakland, California plant of the Magnavox Company.

PHILIP H. FALTER, on May first resigned from the American Cyanamid Company which he has served as Research Engineer, and will retire from business. He expects to make his home at Massena, New York, occupying some of the future time with travel both here and abroad with his family. Mr. Falter joined the Institute in 1919.

CHARLES A. R. DECARVAJAL, who since November 1929 has been taking a Student Engineer Course in the Plant Operation and Engineering Department of the National Broadcasting Company, New York, on June 1 was assigned for duty as a member of the staff at the WEAJ broadcasting station at Bellmore, L. I., in its Plant Operation and Engineering Department.

IRA W. FISK and EDWARD A. ROBERTS, Consulting Engineers at 82 Beaver Street, New York, have been retained by the State of New Jersey Public Service Commission to appraise the bus equipment of the Public Service Coordinated Transport of New Jersey, which operates approximately 2300 busses and is one of the largest companies of its kind in the United States. (In correction of notice in July issue.)

E. S. AUMEND formerly Assistant to the President of the Commercial Credit Corporation, R. J. BLAIS, formerly U. S. Vice-Consul at Havre, France, specializing in commercial investigation and reporting, and A. B. SMITH now secretary of the Associations' Casualty and Fire Prevention committee, and formerly was in the Electrical Department of the Underwriters' Laboratories, have been added to the headquarters staff of the National Electrical Manufacturers Association.

CARROLL O. BICKELHAUPT, who has been Vice-President of the Southern District (No. 4) of the A. I. E. E., removed from Atlanta, Georgia, during the month of June to become Assistant Vice-President of the American Telegraph & Telephone Company, 195 Broadway, New York. In his previous office, Mr. Bickelhaupt rendered the Institute much of valuable service

and it is to be expected that the New York Section will now benefit greatly from his enthusiastic membership here. He joined the Institute as a Member in 1922 and in 1928 was transferred to the grade of Fellow. He has always been most active in Institute affairs.

DOCTOR LEONARD F. FULLER, Executive Vice-President of the Federal Telegraph Company, has been appointed chief professor of Electrical Engineering at the University of California. His appointment is one of several steps taken recently by the University to carry out a plan for reorganizing the administration of the engineering colleges. Doctor Fuller has had very extensive engineering experience with leading corporations manufacturing electrical equipment and with the Federal Telegraph Co., with which he will retain his present connection. He joined the Institute in 1912 and since 1923 has been a Fellow.

## Obituary

**William Newton Ryerson**, President of the Trojan Engineering Corporation, 40 Exchange Place, New York, and a Director of the Peoples Light and Power Corporation, 27 William Street, New York, died at his residence in the Hotel Shelton, New York, on the morning of July 7th, after a lingering illness of several months.

He was born in New York City, December 7, 1874, and attended the New York Public Schools and Columbia Grammar School, where he was graduated in 1892. He entered the School of Mines at the Columbia University the following year, from which he was graduated in 1896 with the degree of Electrical Engineer. Following his graduation, he was employed for two years by the Sprague Electric Elevator Company, Bloomfield, New Jersey, on electrical testing and drafting. In the same year, 1898, he worked as draftsman for the Western Electric Company, New York, and as assistant to the Chief Engineer of the Waldorf Astoria Hotel. In 1898 Mr. Ryerson became associated with the Metropolitan Street Railway Company of New York on construction and power work and substation operation, remaining with it until June, 1901, when he left to become connected with the Manhattan Company as Chief Operator of its steam electric generating station. His chief interest at that time seemed to be electric railways and subways, and in October 1901 he became Superintendent of the substations for the Interborough Rapid Transit, with which interests he remained until 1905. About that time, some of the big hydro developments on the Canadian side of Niagara Falls were started and Mr. Ryerson became Assistant Superintendent of Construction for the Niagara Construction Company; later in the same year, Superintendent of Construction for the Ontario Power Company, Niagara Falls, Ontario, which position he held until January, 1909.

He then left the East to become General Manager and Chief Engineer, and a Director, of the Great Northern Power Company, Duluth, Minnesota, a position he held for over 13 years. It was here that he became well-known to light and power companies of the country, serving on several committees of the National Electric Light Association. About the time the Duluth properties were acquired by the Electric Bond & Share Company, Mr. Ryerson left to become Assistant Manager of the Public Utility Management Department of Day & Zimmerman, Philadelphia. Here he supervised details of operation of all the utility properties, budgets, new business, rates, public relations, accounting and major construction progress. In January 1925, the United Gas Improvement Company of Philadelphia made him Assistant to the Vice-President in charge of operations and engineering. His duties involved supervision of operations of gas and electric properties, budgets, rates and engineering projects. One of his principal undertakings while there was an investigation and preparation of a report on a superpower scheme, involving the pooling of resources of several electric utilities in New York, New Jersey, and Eastern Pennsylvania. When the Trojan Engineering Corporation was organized in September 1928, Mr. Ryerson



became its President, which is the position he held at the time of his death. While connected with the Trojan Engineering Corporation in this capacity, he served for a brief period as Vice-President and General Manager of the Green Mountain Power Corporation of Vermont, a subsidiary of the Peoples Light and Power Corporation, of which he was also a Director.

Mr. Ryerson was a Fellow of the American Institute (1912) and a Member of American Society of Mechanical Engineers, National Electric Light Association, International World Power Conference, American Gas Association, and The Engineering Institute of Canada.

**C. Wellman Parks, C. E., LL. B.**, retired Rear Admiral of the United States Navy, died June 25, 1930, at the Naval Hospital, Washington, D. C. He was 67 years old and received the Distinguished Service Medal for his wartime service as Chief of the Bureau of Yards and Docks to which office he was appointed in January 1918. His birthplace was Woburn, Massachusetts and in 1884 he was graduated from Rensselaer Polytechnic Institute with a degree in Civil Engineering. In 1899 he was graduated from the Columbia Law School and in 1921 received his LL. D. from George Washington University. As a civilian for a number of years before he was commissioned in the Navy, Admiral Parks served as Chief Engineer of the Denver, Memphis and Atlantic Railroad, Electrical Engineer for the Electric Manufacturing Company of Troy, and Head of the Department of Physics at Rensselaer Polytechnic Institute for nine years, (calibrating electrical testing instruments). From 1900 to 1903 he was Civil Engineer at the San Juan Naval Station, where he built and operated the central station and lighting system. He then came back to Boston, where he superintended construction (in the Navy Yard) and operation of the central power plant, also designing and installing distribution systems for light and power. He performed a similar duty at the Portsmouth Navy Yard and did valuable work on the construction and design of the Naval Station at Pearl Harbor. In 1912 and until 1915, he was Public Works Officer at the Philadelphia Navy Yard, designing and installing power, lighting, and telephone systems. When Chief of the Bureau of Yards and Docks, he was responsible for all power plants and distributing systems at all navy yards and naval stations; plans and specifications were approved and contracts made by the Chief of the Bureau. In 1921 he retired from active service.

He was a Fellow of the American Association for the Advancement of Science and a Member of the American Society of Civil Engineers. He served as Superintendent of Liberal Arts at the Paris Exposition in 1889 and was a special agent of the Bureau of Education at the Chicago Exposition in 1893. He visited and reported on expositions at Antwerp, Lyons and Zurich and also reported forestry systems of Europe. He was officer de l'instruction publique, France, in 1889 and in 1920 was commander of the Legion of Honor. Admiral Parks also belonged to the Cosmos Club and the Army and Navy Clubs. He joined the Institute as an Associate in 1887 and was transferred to the grade of Fellow in 1923.

**Ivan H. Summers**, Electrical Engineer for the General Electric Company and extremely active in Institute affairs since 1924 when he became an Associate, was killed in a glider accident at Schenectady, New York, on June 28, 1930. He was a young engineer of great promise, who was well-known to Institute members as a result of his recent papers on *Eddy Current Losses in Armature Windings*, *High-Speed Synchronous Motors*, and *System Stability*.

Born in Portsmouth, Ohio, January 29, 1898, he was educated in California, where he lived after the death of his father in 1910. He was graduated from the University of Southern California in 1920 with the degree of B. S., and the same year entered the test course of the General Electric Company. On leaving test, he went to Los Angeles to teach in the Polytechnical High School, but in 1923 he returned to the General Electric Company and entered the Turbine Engineering Department. He was one of

the first graduates of the Advanced Engineering Course of the company, in which he made an enviable record. In 1928 he was transferred to the Central Station Engineering Department, where he had recently been given important responsibilities, and where he had already made substantial contributions to knowledge in the field of power system stability. In June of this year he was awarded the degree of E. E. by the University of Southern California.

Mr. Summers had many interests besides his professional work; he did original work in photography and music, and for the past two years had been an enthusiastic participant in the activities of the Schenectady Glider Club.

Two years ago he was transferred to the Institute grade of Member.

**Eugene Livingston Delafield**, a member of the old New York family and an Associate of the Institute since 1907, died July 25 in the New York Hospital for Joint Diseases. He had been ill only a short time, having come to the hospital but two days previous from his home at Riverdale-on-Hudson. Born in 1882 at West Hampton, Long Island, in 1905 he was graduated from Stevens Institute of Technology in Hoboken with the degree of Master in Engineering. He served in the World War and upon his return to civil life continued his activities in many engineering fields. He retired from active service about a year ago.

Mr. Delafield was descended from John Delafield who migrated to this country in 1783 and became president of the United Insurance Company; two generations later, his grandfather, Major Joseph Delafield, represented the government in fixing the northern boundary of the United States under the Treaty of Ghent. Another ancestor was Francis Lewis who came from England and settled in New York as a merchant in 1713; he was one of the signers of the Declaration of Independence. He was also descended from Morgan Lewis, Chief Justice of New York in 1793, Governor of New York State 1804-1807 and Quartermaster General of the United States in 1812. He was a member of the Engineers Club and also of the Society of the War of 1812.

**John F. Shoemaker**, President of the Electric Service Company, Inc., Cincinnati, and a Member of the Institute since 1906, died in an airplane accident which occurred just outside of Springfield, Illinois, June 28th. He was born at Bloomington, Indiana, and after finishing high school and preparatory school, he spent a short time at the Indiana State University, after which he completed a correspondence course with the Scranton Schools in Electrical and Steam Engineering. In addition to this, he did a great deal of home study prior to assuming his first position and ten years of subsequent work with various power and light companies as either electrician or steam engineer. He then took a position on the erecting and testing floors of the Northern Electrical Mfg. Company, subsequently becoming Operating Steam Engineer for this Company. For four years thereafter he was Electrical Engineer for the Gisholt Machine Company; this immediately preceded his connection with the Electric Service Company. Mr. Shoemaker was well known in the central station field, where he had a large circle of friends.

**Waldo C. Bryant**, well known as an inventor, and Chairman of the Board of Directors of the Bryant Electric Company, Bridgeport, Connecticut, died July 5, 1930, at Colorado Springs, whence he had gone to rid himself of a persistent grippe cold. At the local hospital an operation for embolism was found to be advisable and was performed, and Mr. Bryant's strength, already greatly reduced by the long siege of the cold, was not sufficient to permit of his recovery. He was 66 years old, and a native of Winchendon, Mass., and completed a course at Worcester Polytechnic Institute. A pioneer in the manufacture of electrical equipment, developed the company of which he was head from a working capital of \$5000 to one employing 2000 persons and with an earning capacity of three millions of dollars, in the manufacture of sockets, switches and wiring devices, with New York, Chicago and San Francisco offices. His first work after the completion of his schooling was with the Thompson-

Houston Electric Company at Lynn, but he was soon transferred to Bridgeport, later going to Waterbury, Conn., as assistant operator of the local electric light plant. Following his invention of the Bryant push-pull switch in 1888, he returned to Bridgeport and started the production of lighting supplies under the Bryant Electric Company name. In 1921 he sold his holdings to the Westinghouse Company, but continued as President and General Manager until 1927, when he was appointed Chairman of the Board of Directors. Mr. Bryant became an Associate of the Institute in 1903. He has given much of valuable advice to many banking interests, as well as assisting industrial and philanthropic organizations.

**Fred D. Lyon**, at one time Chairman of the Institute's St. Louis Section and of late years, a resident of San Diego, California, died recently at San Diego. He was born in Chicago the 13th of August 1870, and after completing grammar and high school, took three years of night work at Lewis and Armour Institute of Technology. From 1902 to 1905 he was engaged on the construction of the Fisk Street Power House in Chicago, and for the next three years, on construction of the Quarry Power House. From 1909 to 1912, substation construction and alteration occupied him; during 1913-1915 he was working on the construction of the Northwest Station, Chicago; from 1916-1917, on the construction and installation of the Field Museum in Chicago; 1918 on the Symington Munition Plant; from 1919 to 1920 upon general building and construction work; 1921-22, on the construction and installations at the Providence Biltmore Hotel and from 1922 to 1924, he was General Superintendent of the Cahokia Power Plant.

He joined the Institute with the grade of Member in 1925 and has always been active in this membership. He was also a member of the National Electric Light Association, the Western Society of Engineers, the Providence Engineering Society of Providence, R. I. and the St. Louis Engineers Club and Associated Society.

**Erik G. Sohlberg**, Design Engineer in the Construction Engineering Department of the General Electric Company, Schenectady, died June 13 of appendicitis.

He was born in 1880 at Oekelbo, Sweden, in 1900 with the degree of M. E., and in 1902 went to England to become associated with the British Thomson-Houston Company. In 1905 he came to the United States and joined the General Electric Company, and in 1912 was made Design Engineer of Construction, specializing in power-plant and substation design. Mr. Sohlberg has been an Associate of the Institute since 1913.

**Albert Benton Mathis**, Manager of the Telephone and Telegraph Department of the Atchinson, Topeka & Santa Fe Railroad Company, San Francisco, California, died June 16th at Richmond, California. He was born at Humboldt, Tennessee, August 10, 1895, and after two years' high school, graduated from the International Correspondence School as Telegraph Wire Chief. He went directly to the railroad company as Telegraph Wire Chief and worked up to the position of Manager. He had been an Associate of the Institute for the past two years.

## A. I. E. E. SECTION ACTIVITIES

### PAST SECTION MEETINGS

#### Atlanta

Ladies' Night. Dinner was followed by moving pictures and entertainment. Joint meeting with the A. S. M. E. June 2. Attendance 84.

#### Detroit-Ann Arbor

Golf tournament followed by a dinner, after which the election of officers for the coming year was announced as follows: Leroy Braisted, Chairman; Oscar E. Hauser, Vice-Chairman; J. J. Shoemaker, Secretary-Treasurer. June 14. Attendance 44.

### Fort Wayne

Banquet and dancing. May 23. Attendance 70.

### Ithaca

*Dynamic Balance of Rotating Machinery*, by Ernest L. Thearle, General Electric Research Laboratory. Election of officers for the coming year as follows: Professor Wm. C. Ballard, Jr., Chairman; W. E. Meserve, Secretary-Treasurer. Joint meeting with the A. I. E. E. and A. S. M. E. Student Branches at Cornell University. May 26. Attendance 105.

### Los Angeles

Inspection trip to the Mount Wilson Observatory. Following dinner at the Mount Wilson Hotel, a lecture dealing with the physical and scientific problems encountered by astronomers was presented. The party was then escorted through the observatory housing a 60 inch telescope, where an opportunity was presented to view the moon. June 6. Attendance 155.

### Philadelphia

Election of officers as follows: D. H. Kelley, Chairman; E. C. Drew, Treasurer; J. L. MacBurney, Secretary. June 9.

### St. Louis

Dinner-dance held at the Westborough Country Club. Entertainment followed. May 9. Attendance 150.

### San Francisco

*The Development of Steam-Electric Plant Equipment*, by F. G. Philo, Southern California Edison Co. Election of officers as follows: P. B. Garrett, Chairman; G. Ross Henninger, Vice-Chairman; E. A. Crellin, Secretary. Joint meeting with the A. S. M. E., preceded by dinner. May 23. Attendance 148.

### Sharon

Banquet. *The Joyful Job of Living*, by Edmund Vance Cooke, Author. H. V. Putman, Westinghouse Elec. & Mfg. Co., acted as toastmaster. June 6. Attendance 242.

### Vancouver

Chairman J. Teasdale reviewed the work of the Section during the past year. Short talk by W. H. Tierney, visiting member from the Seattle Section. Election of officers as follows: H. Vickers, Chairman; C. Arnott, Secretary. A dinner preceded the meeting. June 13. Attendance 26.

### Worcester

Inspection of dispatching station and description by operators. June 12. Attendance 28.

## A. I. E. E. STUDENT ACTIVITIES

### PAST BRANCH MEETINGS

#### Carnegie Institute of Technology

Annual banquet. C. T. Sinclair, Byllesby Engineering and Management Corp., and Mr. Cartwright, West Penn Power Company, were the speakers of the evening. Professor B. C. Dennison, Counselor, acted as toastmaster. May 21. Attendance 58.

#### University of Detroit

*Automatic Substation Control*, by Fred Meno, Westinghouse Electric & Mfg. Co. Film—"From Mine to Consumer." Election of officers as follows: Raymond Moyers, Chairman; George Trudell, Vice-Chairman; L. F. Ross, Secretary; Louis Higgins, Treasurer. June 19. Attendance 21.

#### University of Idaho

Election of officers as follows: Frank Meneely, President; Harold Doty, Vice-President; Clyde Ross, Secretary-Treasurer. Vote of thanks extended to Professor J. H. Johnson, Counselor, and President Wayne McCoy for their help in making Engineers' Day a success. May 19. Attendance 24.

#### University of New Hampshire

*Gas Tube Signs*, by Mr. Jones, Student;

*Electric Motor Buses*, by V. T. Swain, Student;

*Reconcentration of Telephone Subscribers*, by Mr. Duquette, Student. May 17. Attendance 42.

Messrs. Elliott, New York Telephone Co., and Pierce, Bell Telephone Laboratories, Inc., reviewed their experiences since graduation. May 31. Attendance 37.

#### University of New Mexico

Election of officers as follows: Carl E. Henderson, Chairman; Harry G. Bangertor, Vice-Chairman; S. M. Pelatowski, Secretary-Treasurer. May 20. Attendance 14.

# Engineering Societies Employment Service

Under joint management of the national societies of Civil, Mining, Mechanical and Electrical Engineers cooperating with the Western Society of Engineers. The service is available only to their membership, and is maintained as a cooperative bureau by contribution from the societies and their individual members who are directly benefited.

Offices:—31 West 39th St., New York, N. Y.—W. V. Brown, Manager.  
1216 Engineering Bldg., 205 W. Wacker Drive, Chicago, Ill., A. K. Krauser, Manager.  
57 Post St., San Francisco, Calif., N. D. Cook, Manager.

**MEN AVAILABLE**—Brief announcements will be published without charge but will not be repeated except upon requests received after an interval of one month. Names and records will remain in the active files of the bureau for a period of three months and are renewable upon request. Notices for this Department should be addressed to **EMPLOYMENT SERVICE, 31 West 39th Street, New York City**, and should be received prior to the 15th day of the month.

**OPPORTUNITIES**.—A Bulletin of engineering positions available is published weekly and is available to members of the Societies concerned at a subscription of \$3 per quarter, or \$10 per annum, payable in advance. Positions not filled promptly as a result of publication in the Bulletin may be announced herein, as formerly.

**VOLUNTARY CONTRIBUTIONS**.—Members obtaining positions through the medium of this service are invited to cooperate with the Societies in the financing of the work by contributions made within thirty days after placement, on the basis of one and one-half per cent of the first year's salary; temporary positions (of one month or less) three per cent of total salary received. The income contributed by the members, together with the finances appropriated by the four societies named above will it is hoped, be sufficient not only to maintain, but to increase and extend the service.

**REPLIES TO ANNOUNCEMENTS**.—Replies to announcements published herein or in the Bulletin, should be addressed to the key number indicated in each case, with a two cent stamp attached for reforwarding, and forwarded to the Employment Service as above. Replies received by the bureau after the positions to which they refer have been filled will not be forwarded.

## POSITIONS OPEN

**CHIEF ELECTRICAL TESTER**, not over 43. Must be thoroughly experienced executive to take charge of testing department. Must also be a graduate electrical engineer whose practical experience covers a period of years on a-c. and d-c. motor and generator engineering and testing. Must be capable of advancing solutions of problems arising in the course of testing small and large electrical motors and generators of various types. Apply by letter giving a complete outline of technical training and practical experience. State names and addresses of past employers with the nature of the position held at each place, present affiliation, age, nationality, social condition and salary expected. Location, East. W-1410.

**ENGINEERING ORGANIZATION HAS OPPORTUNITY** for technical graduate with several years' experience in the electrical industry, for position involving preparation of material for publication, including abstracts of engineering reports and other editorial work. Apply by letter stating age, education and experience in detail. Location, New York. W-1177.

**GRADUATE ELECTRICAL ENGINEER**, technical writer, experienced in patent and technical writing. Apply by letter. Location, New York. W-1290.

**DESIGNER**, graduate electrical engineer, with three or more years' experience in design of electrical instruments and control mechanisms. Apply by letter. Location, New York. W-1291.

**PRODUCTION ENGINEER**, graduate electrical engineer, with two or more years' shop production experience in manufacturing electrical apparatus. Apply by letter. Location, New York. W-1292.

**TEST ENGINEER**, graduate electrical engineer, with two or more years' experience in testing electrical apparatus. Apply by letter. Location, New York. W-1293.

**DRAFTSMEN**, experienced in electrical and mechanical mechanisms. Apply by letter. Location, New York. W-1294.

**DESIGNING ENGINEER**, for fractional horsepower motors. Apply by letter stating education, previous experience, age and salary expected. Location, Middle West. W-1461-C.

## MEN AVAILABLE

**MECHANICAL AND ELECTRICAL ENGINEER**, 31, married, 1923 graduate, skilled in design, manufacture and development; electrical, mechanical or chemical. Can lay out and build necessary additions to machine shop, foundry, plant, powerhouse, oil refinery, etc. Available soon. B-8246.

**ELECTRICAL ENGINEER**, 45, married, 20 years' experience covering two years factory testing of generators, motors, and control equipment, 12 years as designing engineer of power apparatus, last three years chief engineer of manufacturing plant. A practical man with the necessary theoretical and technical knowledge. Available due to closing of plant. C-7686.

**ELECTRICAL ENGINEER**, 25, single. E. E. degree, Columbia University. Two years' experience with eastern utility, including cadet course, and distribution design and estimating. Desires connection with technical department of progressive utility. Available on two weeks' notice. C-7480.

**GRADUATE ELECTRICAL ENGINEER**, 26. One year's experience large public utility, power engineer, 1½ years' experience research department, manufacturing company. Experience design of electromagnetic appliances, also design mechanical equipment. Considerable drafting experience. Best references. Ability to handle men. Desires connection, public utility, with motor or industrial control manufacturer. Available two weeks' notice. C-7737.

**ELECTRICAL ENGINEER**, age 26, now employed. Four years' experience in maintenance of way work on railroads covering engineering, construction, maintenance and valuation of signals and signal systems, and six months in the non-destructive testing of rails for internal failures. Desires a more permanent location. C-7729.

**TECHNICALLY TRAINED ELECTRICAL ENGINEER**, with 20 years' experience in electric distribution engineering and executive positions of responsibility. Desires to locate with public utility in East or Middle West. Would also consider position where experience in radio engineering could be acquired. Best of references and services; available immediately. C-7700.

**GRADUATE ENGINEER**, 22 years old, single, Protestant, and graduate of Clarkson College of technology, Potsdam, N. Y., with B. S. degree in Electrical Engineering. Desires location South. Would be interested in South American position. C-7675.

**RESPONSIBLE GRADUATE ELECTRICAL ENGINEER**, with 12 years' broad experience in the manufacturing and public utility field. Desires position as foreign representative. Is qualified to take entire charge of any kind of electrical enterprise. Has executive and foreign representation business experience. C-3296.

**ELECTRICAL ENGINEER**, college graduate, 31, 11 years' experience on major design and operating problems of public utilities. Past four

years engaged as technical assistant to electrical engineer of nationally prominent engineering organization in responsible charge of relay, voltage regulation and stability studies; system planning; checking plant operation, estimates, etc. B-9401.

**ELECTRICAL ENGINEER**, over 20 years' experience power and industrial plant design, technical graduate, to take charge of work or men. Permanent or part-time work. Prepared to make inexpensive slide rules for any involved or much used formulas or charts, thus saving work and minimizing error. C-6542.

**ELECTRICAL AND MECHANICAL ENGINEER**, broad experience in the development of electromechanical devices. Capable and independent laboratory worker, competent designer. Languages: German and French. Available on short notice. C-6994.

**COMMUNICATION ENGINEER**, 22 years' experience telephone work. Past eight years, railroad, communication work including Morkin-Kleinschmidt Seletypes, train announcing systems, dispatcher's equipment, tubes, etc. Experienced aerial construction, merchandise of signal and power work, aerial underground cable. Permanent position desired in merchandise work or supervisory capacity. Employed now. Available upon short notice. C-7753.

**ELECTRICAL ENGINEERING STUDENT**, 4th year evenings; married; experienced electrical test laboratories, various apparatus, network equipment, burglar alarm, radio, remote control apparatus, experience in manufacture of small electrical parts, etc. Desires connection with manufacturing or operating organization where there are opportunities in accordance with services rendered. New York preferred. C-5646.

**ELECTRICAL ENGINEER**, 47, married. Sales engineer for distribution apparatus, appliance, stations apparatus, can superintend construction inside or outside below 22 K. V. Can take charge of industrial plants or office buildings. Acquainted with steam, motors, etc. Twenty years' electric and merchandise experience. Now available. Location, immaterial. C-7762-307-C-4.

**INSTRUCTOR, ELECTRICAL ENGINEERING**, 36, married, college graduate, also graduate U. S. Navy Electrical School, U. S. Navy Radio School. Ten years' experience teaching electrical engineering, radio. Successful teacher and organizer. Member honorary and professional societies. Desires position Assistant Professor in Electrical Engineering or would consider research work in engineering experiment station. C-5885.

**ELECTRICAL ENGINEER**, 25 years' experience; practical electrician; sub-foreman, foreman,



chief electrician; maintenance, construction, industrial plants, public buildings, sub-stations. Some design lighting, power industrial plants, public bldgs.; 6 years chief electrician U. S. Government. Employed present; technical graduate 1923. Age 38, married. Available 15 days. Desires permanent responsible position. C-7670.

GRADUATE ELECTRICAL ENGINEER, 30, 2½ years' experience with distribution and power stations desires position with progressive concern. Speaks English and German and has knowledge of French, Italian and Spanish. Available on reasonable notice. C-7749.

YOUNG MAN, age 28, ten years' experience management construction, operation of medium size utility properties, electric, water, ice and telephone. Employed at present, desires change. C-851.

GRADUATE, 1924, Georgia Tech. and Yale, single, 35. Four years' experience in electrical installation work; four years' with public utility as chief engineer; for three years head of electrical engineering department of engineering college, traveled extensively. Desires connection with public utility or industrial organization. C-3404.

ENGINEER, electrical training, 28, married. Desires position as plant engineer, assistant, or with public utility. Six years' experience factory layout, electrical power, lighting, construction and maintenance, good grounding in mechanical phases of this work. Two and one-half years public utility d-c. network layouts and studies. Location preferred, near New York City. C-7745.

MECHANICAL AND ELECTRICAL ENGINEER, 36, married, college graduate, 14 years' shop, maintenance, designing and construction experience. Employed for the past five years as mechanical and electrical engineer and assistant mining engineer with large salt mining company. Location anywhere. Available on short notice. C-274.

RADIO ENGINEER, at present with the concern of a highest standing in radio research field. Experienced in the design of radio receivers of screen grid and neutrodyne types, radio frequency, transformers, tube volt meters, standard signal generators for radio frequency measurements, audio heat oscillators, etc. Wishes broader responsibilities. A-165.

ELECTRICAL ENGINEER, 39, married. Graduate University of Michigan. Twelve years' experience design, construction and operation of transmission and distribution systems with large utilities and engineering and construction company. Also some automotive experience. Executive ability. Location preferred, Eastern States. B-6703.

ELECTRICAL ENGINEER, age 28, one year's standardizing laboratory, calibrating and testing of instruments. One year research and acceptance tests on automatic network equipment for distribution system. Seven years' research and inspection of electrical equipment in power plants. Two years' layout and design of electrical equipment for bridges. B-9349.

MANAGER, EXECUTIVE ENGINEER, SUPERINTENDENT, CONSULTANT, sales ENGINEER, 41, ASSISTANT TO MAJOR EXECUTIVE. Electrical utility properties, management organizations, industrials, manufacturers. Broadly trained 20 years' of diversified responsibilities, five connections. Demonstrated ability large projects. Sound economical design, construction, operation. Extensive changeover programs, networks, underground systems. Vitally energetic, American. Early change imperative. Salary not immediate objective. C-3963.

ELECTRICAL ENGINEER, five years' large modern power plant and substation design. Four years' power plant and factory construction. Seven years' factory and industrial plant main-

tenance. Four years' power plant and substation operation. Last ten years executive position. Desires connection with public utility as electrical engineer with manufacturer as plant engineer. B-9194.

SALES ENGINEER, electrical and mechanical training at Worcester Polytechnic Institute. One year manufacturing, five years sales and executive experience. Would like opportunity to develop sales or assist in sales management. C-5431.

EXECUTIVE, graduate mechanical engineer, 37, married; 15 years' general industrial, business experience covering practically every phase management, control, manufacturing methods, equipment development, engineering installation wage incentive, production and material control, operations, financial analysis. Desires connection works management or assistant where comprehensive viewpoint and ability to obtain cooperation and profitable results can be capitalized. B-5848.

ELECTRICAL-MECHANICAL ENGINEER, 47; twenty years' practical experience, maintenance, operation, construction, public utilities or industrial; 10 years' superintendent central station 145,000 hp., maintenance, operation, construction. Ten years' industrial plant, maintenance, operation, construction. Large refrigeration experience, oil burners and steam. Will handle anything, active worker, good executive. Desires position anywhere. Available immediately. B-945.

ELECTRICAL ENGINEER, B. S. degree, age 32, seeks connection with utility company in Middle West. Four years' office experience, cost accounting. Five years' operating experience which included both steam and hydro stations, this work being operation, inspection, instruction, experimental, test and safety work. Available immediately. C-7796.

## Engineering Societies Library

The Library is a cooperative activity of the American Institute of Electrical Engineers, the American Society of Civil Engineers, the American Institute of Mining and Metallurgical Engineers and the American Society of Mechanical Engineers. It is administered for these founder societies by the United Engineering Society, as a public reference library of engineering and the allied sciences. It contains 150,000 volumes and pamphlets and receives currently most of the important periodicals in its field. It is housed in the Engineering Societies Building, 29 West Thirty-ninth St., New York.

In order to place the resources of the Library at the disposal of those unable to visit it in person, the Library is prepared to furnish lists of references to engineering subjects, copies or translations of articles, and similar assistance. Charges sufficient to cover the cost of this work are made.

The Library maintains a collection of modern technical books which may be rented by members residing in North America. A rental of five cents a day, plus transportation, is charged.

The Director of the Library will gladly give information concerning charges for the various kinds of service to those interested. In asking for information, letters should be made as definite as possible, so that the investigator may understand clearly what is desired.

The library is open from 9 a. m. to 10 p. m. on all week days except holidays throughout the year except during July and August, when the hours are 9 a. m. to 5 p. m.

### BOOK NOTICES, JUNE 1-30, 1930

Unless otherwise specified, books in this list have been presented by the publishers. The Institute does not assume responsibility for any statement made; these are taken from the preface or the text of the book.

All books listed may be consulted in the Engineering Societies Library.

ARBEIT UND KAMPF; Erlebnisse eines Deutschen Luftschiff-Ingenieurs.

By Paul Charpentier. Strassburg, Heitz & cie., 1930. 179 pp., illus., 9 x 6 in., paper. 4-r. m.

About 20 years ago Gustav Unger designed a rigid airship which was considered by various experts to have several advantages over that of Count Zeppelin. Since that time the inventor has tried vainly to obtain financial support for the project.

This book is an account of his difficulties with governments and competitors, intended to call attention to the invention.

### DICTIONARY OF COLOR.

By A. Maerz and M. Rea Paul. N. Y., McGraw-Hill Book Co., 1930. 207 pp., plates, 12 x 9 in., cloth. \$12.00.

A collection of plates containing, the authors assert, the most extensive range of colors yet printed, with a list of practically all recorded color names in use in the English language. It makes it possible to identify quickly the particular color sensation intended by any color word.

In addition to this dictionary the authors have included much useful and interesting information upon the history and use of colors, a bibliography of books on colors and glossaries of foreign color names. The book should be of great practical value to dyers, paint manufacturers, ink makers and others interested in colors.

### DIE ELEKTROMAGNETE.

By Erich Jasse. Berlin, Julius Springer, 1930. 198 pp., diags., 9 x 6 in., bound. 22,50 r. m.

Discusses the basic laws governing the design of electromagnets and the calculation of the forces acting in them and illustrates the



method of calculation by various examples. The mathematical results are checked by tests of the magnets themselves. The author has confined his book to the general question and has not attempted to cover the many special designs used in telephony, telegraphy, etc.

#### ELEMENTS OF FERROUS METALLURGY.

By Joseph L. Rosenholtz. N. Y., John Wiley & Sons, 1930. 248 pp., illus., 9 x 6 in., cloth. \$3.00.

Presents concisely the fundamental principles and methods involved in the manufacture and fabrication of iron and steel, with the needs of civil and mechanical engineering students in mind, rather than those of the prospective metallurgist. As a result, much detail is omitted, and special attention is paid to matters that affect the mechanical properties of products. The book is an admirable introduction to the subject.

#### ELEMENTS OF STEAM AND GAS POWER ENGINEERING.

By Andrey A. Potter and James P. Calderwood. 3rd edition. N. Y., McGraw-Hill Book Co., 1930. 367 pp., illus., tables, 8 x 6 in., cloth. \$2.75.

An introductory account of the principles underlying the construction and operation of steam and gas power equipment. Boilers and boiler-room equipment, steam engines and turbines and their auxiliaries, internal-combustion engines and auxiliaries, plant testing, and power applications to locomotives, automobiles and airplanes are treated briefly. The new edition is revised and has added theoretical material.

LOCOMOTIVE CYCLOPEDIA OF AMERICAN PRACTICE. 9th edition, 1930. Compiled and edited for the American Railway Association—Mechanical Division, by Roy V. Wright and others. N. Y., Simmons-Boardman Publ. Co., 1930. 1440 pp., illus., diags., 12 x 9 in., cloth. \$5.00.

This reference work is too well known to railway mechanical engineers to need any introduction. The new edition is similar to former ones in plan, but has been enlarged and revised to include new designs of locomotives and appliances. The book continues to be the best exposition of American locomotive practice.

#### OVERHEAD EXPENSE IN RELATION TO COSTS, SALES AND PROFITS.

By A. Hamilton Church. N. Y., McGraw-Hill Book Co., 1930. 418 pp., 9 x 6 in., cloth. \$5.00.

Starting from the fundamental idea that overhead is the cost of maintaining a plant in a condition of manufacturing preparedness, the author develops a method for precisely costing the manufacturing capacity of a plant as a whole, or that of a single process. Once this is done, the further determination of overhead expense in any detail desired becomes, the author says, a mere matter of mechanism. The book expands the principles developed in the author's previous works.

#### RADIOTECHNIK, v. 7; Die Sender.

By Gg. Jahn. Berlin, Walter de Gruyter & Co., 1930. 120 pp., illus., diags., 6 x 4 in., bound. 1.80 r. m.

Does not discuss different varieties of transmitters, but instead deals with a series of important general problems that must be met to achieve good economic transmission. The finding of positions at sea and the transmission of photographs are discussed briefly.

#### ROBOTS OR MEN? A French Workmen's Experience in American Industry.

By H. Dubreuil. An authorized translation for the Taylor Society, by Frances and Mason Merrill. N. Y., Harper & Bros., 1930. 248 pp., port., 9 x 6 in., cloth. \$3.00.

The author, a skilled French machinist and Secretary of Confédération Générale du Travail, came to America in 1927 in order to investigate at first hand factory conditions as they affect the worker. He recounts his experiences during fifteen months in various eastern and middle-western factories and draws conclusions that are, on the whole, favorable to mechanization, scientific management, and human relations in industry as practiced here. A most readable, interesting book.

STATISTIK FÜR DAS JAHR 1928. Compiled by Vereinigung der Elektrizitätswerke. Dortmund, W. Crüwell, 1929. 635 pp., 12 x 9 in., boards. 50.-r. m.

A carefully planned statistical exhibit of the electrical power plants of Germany and of some plants in neighboring countries. The plants are indexed by names, sources of current, and motive power. Full statistical data are given for each plant and are also summarized under a group classification.

#### STREET LIGHTING PRACTICE.

By Ward Harrison, O. F. Hull and Kirk M. Reid. N. Y., McGraw-Hill Book Co., 1930. 270 pp., illus., diags., 9 x 6 in., cloth. \$3.50.

A discussion of the many problems involved in street lighting, including not only those of a purely engineering nature, but also such questions as methods of financing, maintenance provisions, etc. Many charts and distribution curves are included.

#### TABLES ANNUELLES DE CONSTANTES ET DONNÉES NUMÉRIQUES

v. 7, pt. 1. Compiled by Le Comité International. 1930. 946 pp., diags., 11 x 9 in., cloth. \$25.00 per set, (2 v.).

This annual summary of chemical, physical and engineering facts reviews the new constants and numerical data that have appeared in any of the leading periodicals of the world. Because of its completeness and convenience, it is almost indispensable to research workers in every line. It forms, also, a supplement to the International Critical Tables. The present volume covers the years 1925 and 1926.

#### DIE TECHNIK DER ELEKTRISCHEN INSTALLATION.

By Friedrich Schoof. Berlin, Walter de Gruyter & Co., 1930. 114 pp., illus., 6 x 4 in., bound. 1.80 r. m.

A concise practical guide to equipment for house wiring and to its installation.

#### THEORIE DER ELEKTRIZITÄT, Bd. 1.

By Max Abraham. Revised by R. Becker. Lpz. u. Ber., B. G. Teubner, 1930. 242 pp., 9 x 6 in., cloth. 15.-r. m.

Professor Becker of the Berlin Technical High School has undertaken this revision of Abraham's popular treatise on the theory of electricity. The general plan is retained, and the point of view throughout is that of the physicist rather than the electrical engineer. New material has been used freely to bring the book up to date.

#### VERSUCHE ÜBER TEMPERATURVERTEILUNG, WÄRMEABGABE UND VERBRENNUNGSVERLAUF IN EINEM NEUZEITLICHEN KOHLENSTAUBKESSEL.

By E. Kuhn. (Berichtfolge des Kohlenstaubausschusses des Reichskohlenrates, No. 21). Berlin, V. D. I. Verlag, 1930. 56 pp., diags., tables, 11 x 8 in., paper. 2.50 r. m.

This report contains the results of a test of a modern boiler using pulverized coal, made with unusual precautions to ensure results of practical value. The boiler was tested during actual use. Special measuring instruments and methods were devised to give accurate results.

The boiler and the equipment and methods are described in detail, as are the methods of calculation and the results. The work extends our knowledge of the phenomena in the firebox of these boilers.

#### VERZEICHNIS DER DEUTSCHEN ELEKTRIZITÄTWERKE, 1928.

Compiled by Vereinigung der Elektrizitätswerke. Dortmund, W. Crüwell, 1929. 314 pp., 12 x 9 in., boards. 15.-r. m.

A directory of German central stations except those that use their entire output in their own work. The arrangement is geographic with an alphabetic index. The owners, capacity, voltage, etc., are given in each case.

#### DER WASSERBAU, Bd. 2.

By Armin Schoklitsch. Wien, Julius Springer, 1930. p. 485-1199, illus., diags., tables, 11 x 8 in., bound. 78.-r. m.

The concluding volume of this treatise is devoted to dams and reservoirs, hydraulic power plants, irrigation and drainage, river regulation and navigable canals. We have a comprehensive description of current practice, especially that of Central Europe, profusely illustrated from drawings and photographs.

#### DIE WASSERKRAFTWIRTSCHAFT DEUTSCHLANDS; Festschrift zur

Tagung der II. Weltkraftkonferenz, Berlin 1930. Berlin, Deutscher Wasserwirtschafts- und Wasserkraftverband, E. V. 1930. 391 pp., illus., plates, tables, 12 x 9 in., cloth. 25.-r. m. For sale by V. D. I. Verlag.

This survey of the hydraulic power resources of Germany and of their present utilization has been prepared for the Second World Power Conference, by German hydraulic interests, with government assistance. General articles deal with the fundamentals of the subject and there are detailed descriptions of the hydraulic power plants of the country, with useful up-to-date statistics. The volume is a handsome one with fine illustrations,

and sold at a very low price. It affords a good review of activities in its field.

**WEHRE UND SOHLENABSTÜRZE.**

By Josef Einwachter. Mün. u. Ber., R. Oldenbourg, 1930. 59 pp., illus., diagrs., tables, 11 x 8 in., paper. 7.-r. m.

Gives the results of investigations at the Karlsruhe Hydraulic Laboratory upon the flow of water over weirs and the erosion of the bed under various conditions. The erosive effect of various kinds of flow is investigated and methods of alleviating it are discussed. A number of interesting photographs show the actual flow in the experimental channels.

**WIRTSCHAFTLICHE MÖGLICHKEITEN DER MASCHINEN-UNTERHALTUNG IN LANDWIRTSCHAFTLICHEN GROSSBETRIEBEN.**

By Friedrich Buschmann. Berlin, V. D. I. Verlag, 1930. 39 pp., diagrs., tables, 12 x 8 in., paper. 3.-r. m.

The advantages of machinery in farming can be realized only when facilities exist for economical repairs. In the present work the author investigates repair practice at a number of large German farms and discusses the advantages of various methods of maintenance, methods of ascertaining the true cost of machine farming, and ways of deciding when machinery will be profitable.

**MEMBERSHIP—Applications, Elections, Transfers, Etc.**

**RECOMMENDED FOR TRANSFER**

The Board of Examiners, at its meeting held July 15, 1930, recommended the following members for transfer to the grade of membership indicated. Any objection to these transfers should be filed at once with the National Secretary.

**To Grade of Fellow**

- d'HUMY, FERNAND E., Central Office Engr., Western Union Telegraph Co., New York.
- ESPENSCHIED, LLOYD, High Frequency Transmission Engr., American Tel. & Tel. Co., New York.
- KIRSTEN, K. F. J., Prof. of Aeronautical Engg., University of Washington, Seattle, Wash.
- LINCOLN, EDWIN S., Consulting Engr., New York, N. Y.
- MARTIN, WILLIAM H., Local Transmission Engr., American Tel. & Tel. Co., New York.
- MILNOR, JOSEPH W., Research Engr., Western Union Telegraph Co., New York.
- WINKLER, George H., President, Burke Elec. Co., Erie, Pa.

**To Grade of Member**

- ASLANIDES, D. J., Partner in the firm of Aslanides Brothers, Athens, Greece.
- BROKAW, GEORGE A., JR., Asst. Engr., Brooklyn Edison Co., Brooklyn, N. Y.
- BUNDY, EDWIN S., Elec. & Operating Engr., Niagara Lockport & Ontario Pr. Co., Buffalo, N. Y.
- CHRISTIE, J. SAYRE, Owner, Christie Testing Laboratory, Cleveland, Ohio.
- CORFIELD, RAYMOND J., Asst. Elec. Engr., Utah Copper Co., Garfield, Utah.
- CRISSON, GEORGE, Telephone Engr., American Tel. & Tel. Co., New York.
- DANIELSON, W. A., Officer in Charge of Maintenance and Operation of Army Stations, Washington, D. C.
- DEMUTH, ORIN A., Asst. Elec. Engr., Stone & Webster Engg. Corp., Seattle, Wash.
- DETURK, Asst. Supt. of Transmission and Distribution, Metropolitan Edison Co., Reading, Pa.
- DUCEY, WALTER J., Asst. Elec. Engr., Allied Engineers, Inc., Jackson, Mich.
- FALKNER, ROBERT M., Asst. Engr., Brooklyn Edison Co., Brooklyn, N. Y.
- FOSTER, RONALD M., Dept. of Development and Research, American Tel. & Tel. Co., New York.
- FUGILL, ALFRED T. P., Engg. Division, Detroit Edison Co., Detroit, Mich.
- FULNER, RAY L., Building and Equipment Engr., Cincinnati & Suburban Bell Telephone Co., Cincinnati, Ohio.
- GINNA, ROBERT E., Consulting Engr., E. J. Cheney Co., New York.
- GORMAN, LAWRENCE J., Electrolysis Engr., N. Y. Edison Co., New York.

- GRAY, CECIL, Manager, Westinghouse Elec. & Mfg. Co., Richmond, Va.
- GREEN, ESTILL I., Engineer, American Tel. & Tel. Co., New York.
- HATCHER, CHARLES T., Asst. Engr., United Elec. Lt. & Pr. Co., New York.
- HAYDEN, HENRY T., Sales Engr., Ward Leonard Elec. Co., Mt. Vernon, N. Y.
- HIGH, SELDEN F., President and General Mgr., G. W. Sullivan Elec. Co., Cincinnati, O.
- HODNETTE, JOHN K., Transformer Engr., Westinghouse Elec. & Mfg. Co., Sharon, Pa.
- HYNEMAN, JOHN R., Engg. Asst., Western Union Telegraph Co., New York.
- JEANNE, PAUL A., Engr., American Tel. & Tel. Co., New York.
- JONES, SAMUEL MURRAY, Sales Engr., Ohio Brass Co., Mansfield, Ohio.
- KELLEY, CLARENCE B., Asst. to Elec. Engr. of Stations, Kansas City Pr. & Lt. Co., Kansas City, Mo.
- KNICKERBOCKER, WALTER G., Asst. Supt. of Meters, Detroit Edison Co., Detroit, Mich.
- LANGAN, THOMAS R., Northeastern Transportation Mgr., Westinghouse Elec. & Mfg. Co., New York.
- MARR, ARTHUR P., Consulting Engr. and President, The Marr Brothers, Inc., New York.
- MAX, CHARLES, Engenheiro Director, Companhia Electrica Lobito e Benguella, Catumbella, Angola, W. Africa.
- MILLER, C. KARLETON, Asst. Engr., Brooklyn Edison Co., Brooklyn, N. Y.
- NOYES, MAXWELL E., Sales Engr., Aluminum Co. of America, Pittsburgh, Pa.
- PALMER, GEORGE W., Division Engr., Brooklyn Edison Co., Brooklyn, N. Y.
- PATTERSON, EDWARD W., Auditorium Equipment Engr., R. C. A. Victor Co., Camden, N. J.
- PINKERTON, E. M., Manager, General Elec. Co., Minneapolis, Minn.
- PLUMER, WESLEY C., Engr., General Elec. Co., Newark, N. J.
- PRAY, RUTLEGE P., President and Manager, Goodwin & Pray, Inc., Newark, N. J.
- REAGAN, MAURICE E., Section Engr., Westinghouse Elec. & Mfg. Co., E. Pittsburgh, Pa.
- SEELEY, HOWARD B., Division Engr., Brooklyn Edison Co., Brooklyn, N. Y.
- SIMS, WILLARD D., Supt. of Power, Green Mountain Power Corp., Montpelier, Vt.
- SLEEPER, HARVEY P., Protection Engr., Public Service Elec. & Gas Co., Newark, N. J.
- SONTUM, WALTER C., Elec. Engr., Pennsylvania Elec. Co., Johnstown, Pa.
- SORDONI, ANDREW J., President, Harvey's Lake Light Co.; Commonwealth Telephone Co.; Luzerne Telephone Co.; Owner—Andrew J. Sordoni, Contractor, Forty Fort, Pa.
- STEWART, CLARENCE R., Engr., Stone & Webster Engg. Corp., Boston, Mass.

- TAYLOR, EDWARD W., Elec. Coordinator, Pennsylvania Pr. & Lt. Co., Allentown, Pa.
- TEMME, ALFRED M., General Foreman, Brooklyn Edison Co., Brooklyn, N. Y.
- THOMSON, JOHN M., Designing Engr., Ferranti Elec. Ltd., Mt. Dennis, Ont., Canada.
- THVEDT, CHRISTIAN B. M., Chief of Maps and Records, Westchester Lighting Co., Mt. Vernon, N. Y.
- WATSON, EDWARD F., Engr., American Tel. & Tel. Co., New York.
- WOPAT, JOHN W., Consulting Engr., Diversified Investments, Inc., Kansas City, Mo.
- YATES, CLARENCE C., Engr., Southwestern Bell Telephone Co., Kansas City, Mo.
- ZANGLER, HERBERT M., Elec. Engr., General Elec. Co., Schenectady, N. Y.

**APPLICATIONS FOR ELECTION**

Applications have been received by the Secretary from the following candidates for election to membership in the Institute. Unless otherwise indicated, the applicant has applied for admission as an Associate. If the applicant has applied for direct admission to a grade higher than Associate, the grade follows immediately after the name. Any member objecting to the election of any of these candidates should so inform the Secretary before August 31, 1930.

- Burger, R. E., (Fellow), Cities Service Pr. & Lt. Co., New York, N. Y.
- Ehrsam, J. J., Westinghouse Elec. Mfg. Co., Newark, N. J.
- Fletcher, G. R., Virginia Public Service Co., Alexandria, Va.
- Hairston, T., Missouri Public Service Commission, Jefferson City, Mo.
- Hills, C. D., Koontz-Wagner Electric Company, South Bend, Ind.
- Hongo, T., General Electric Co., Schenectady, N. Y.
- Huang, K., Canadian Mazda Lamp Works, Toronto, Ont., Can.
- Kennedy, W. M., Royal Development Co., Leavenworth, Wash.
- Kime, E. E., (Member), Needles Gas & Electric Co., Needles, Calif.
- Laddlaw, D. A., Consumers Power Co., Grand Rapids, Mich.
- Lambert, A. B., (Member), Crompton-Parkinson, Toronto, Ont., Can.
- Lebedeff, G. M., Federal Telegraph Co., Palo Alto, Calif.
- Levinger, D., (Member), Western Electric Co., Inc., New York, N. Y.
- Milliken, A. W., New Bedford Gas & Edison Light Co., New Bedford, Mass.
- Morris, J. O., John O. Morris, Inc., Jersey City, N. J.
- Ohart, T. C., General Electric Co., Schenectady, N. Y.
- Peterson, C. G., A. G. Electrical Mfg. Co., San Francisco, Calif.
- Pfeil, J., Koontz-Wagner Electric Co., South Bend, Ind.
- Polindexter, V. J., Eugene Water Board, Eugene, Ore.

Radell, J. P., American Tel. & Tel. Co., New York, N. Y.  
 Shrader, T. M., (Member), R. C. A. Radiotron Co., Harrison, N. J.  
 Silver, M. W., University of Utah, Salt Lake City, Utah  
 Stack, J. P., Koontz-Wagner Electric Co., South Bend, Ind.

Stevens, G. V. E., 150 West 74th St., New York, N. Y.  
 Total 24

Foreign

Barlow, E. B., (Member), Messrs. The Urban Electric Supply Co. Ltd., Berwick-upon-Tweed, Eng.

Delagrango, C. R., Frestone Tire & Rubber Co., Ltd., Singapore, S. S.

Lewis, E., English Electric Co., Ltd., Marunouchi, Tokyo, Japan

Morris, J. A., Sao Paulo Tramway Lt. & Pr. Co., Ltd., Sao Paulo, Brazil, So. America

Total 4

OFFICERS A. I. E. E. 1930-1931

**President**  
 WILLIAM S. LEE

**Junior Past Presidents**  
 R. F. SCHUCHARDT      HAROLD B. SMITH

**Vice-Presidents**  
 HERBERT S. EVANS      H. V. CARPENTER  
 W. S. RODMAN      G. C. SHAAD  
 C. E. FLEAGER      I. E. MOULTROP  
 E. C. STONE      H. P. CHARLESWORTH  
 C. E. SISSON      T. N. LACY

**Directors**  
 F. C. HANKER      J. E. KEARNS  
 E. B. MEYER      C. E. STEPHENS  
 H. P. LIVERSIDGE      A. B. COOPER  
 J. ALLEN JOHNSON      A. E. KNOWLTON  
 A. M. MACCUTCHEON      R. H. TAPSCOTT

**National Treasurer**  
 GEORGE A. HAMILTON

**National Secretary**  
 F. L. HUTCHINSON

**General Counsel:**      PARKER & AARON, 30 Broad Street, New York

A. I. E. E. COMMITTEES AND REPRESENTATIVES

The list of committees and representatives is omitted from this issue, as new appointments are being made for the administrative year beginning August 1, and these will be listed in the September issue.

LIST OF SECTIONS

Name	District	Chairman	Secretary	Name	District	Chairman	Secretary
Akron	(2)	H. C. Paiste	M. Berthold, Berthold Elec. & Engg. Co., 368-70 Water St., Akron, Ohio	New York	(3)	J. B. Bassett	C. R. Jones, Westinghouse Elec. & Mfg. Co., 150 Broadway, New York, N. Y.
Atlanta	(4)	H. C. Uhl	O. O. Rae, Westinghouse Elec. & Mfg. Co., Atlanta, Ga.	Niagara Frontier	(1)	E. S. Bundy	G. W. Eighmy, General Elec. Co., 1100 Elec. Bldg., Buffalo, N. Y.
Baltimore	(2)	W.B.Kouwenhoven	J. Wells, Western Electric Co., 25 Broening Rd., Baltimore, Md.	North Carolina	(4)	E. P. Coles	Marshall E. Lake, Duke Power Co., Power Bldg., Charlotte, No. Car.
Birmingham	(4)	W. E. Bare	O. E. Charlton, Alabama Power Co., Birmingham, Ala.	Oklahoma City	(7)	F. J. Meyer	C. E. Bathe, Oklahoma Gas & Elec. Co., Oklahoma City, Okla.
Boston	(1)	J. P. Kobrock	G. J. Crowdes, Simplex Wire & Cable Co., Sidney St., Cambridge, Mass.	Philadelphia	(2)	D. H. Kelly	J. L. MacBurney, Electric Storage Battery Co., 1955 Hunting Park Ave., Philadelphia, Pa.
Chicago	(5)	F. H. Lane	L. R. Mapes, Illinois Bell Telephone Co., 212 W. Washington St., Chicago, Ill.	Pittsburgh	(2)	C. T. Sinclair	F. A. Connor, General Elec. Co., 1309 Oliver Bldg., Pittsburgh, Pa.
Cincinnati	(2)	T. C. Reed	L. L. Bosch, Columbia Engg. & Mgt. Corp., 314 West 4th St., Cincinnati, Ohio	Pittsfield	(1)	C. H. Kline	L. H. Burnham, General Electric Co., Pittsfield, Mass.
Cleveland	(2)	F. W. Braund	John M. Smith, Nela Park, Cleveland, Ohio	Portland, Ore.	(9)	A. H. Kreul	C. W. Fick, General Electric Co., Portland, Oregon
Columbus	(2)	C. D. Price	A. F. Wilson, 42 E. Gay St., Columbus, Ohio	Providence	(1)	F. W. Smith	O. W. Briden, Blackstone Valley Gas & Elec. Co., 231 Main St., Pawtucket, R. I.
Connecticut	(1)	Samuel Ferguson	R. G. Warner, Yale University, 10 Hillhouse Ave., New Haven, Conn.	Rochester	(1)	Harvey J. Klumb	F. C. Young, Stromberg-Carlson Tel. Mfg. Co., 100 Carlson Rd., Rochester, N. Y.
Dallas	(7)	L. T. Blaisdell	G. A. Dyer, Southwestern Bell Telephone Co., Dallas, Texas	St. Louis	(7)	C. B. Fall	E. A. Forkner, Wagner Elec. Corp., 6400 Plymouth Ave., St. Louis, Mo.
Denver	(6)	R. B. Bonney	N. R. Love, 807 Tramway Bldg., Denver, Colo.	San Antonio	(7)	D. W. Flowers	Eugene Bissett, San Antonio Pub. Serv. Co. 201 N. St. Mary's St., San Antonio, Texas
Detroit-Ann Arbor	(5)	LeRoy Braisted	J. J. Shoemaker, Detroit Edison Co., 2000-2nd Ave., Detroit, Mich.	San Francisco	(8)	P. B. Garrett	E. A. Crellin, Pacific Gas & Elec. Co., 245 Market St. San Francisco, Calif.
Erie	(2)	G. R. McDonald	G. I. LeBaron, General Elec. Co., Erie, Pa.	Saskatchewan	(10)	J. R. Cowley	A. B. Coward, Light and Power Dept., Regina, Sask. Canada
Fort Wayne	(5)	W. J. Morrill	C. M. Summers, General Elec. Co., Fort Wayne, Indiana	Schenectady	(1)	E. S. Henningsen	E. P. Nelson, D. C. Engg. Dept., General Electric Co., Schenectady, N. Y.
Houston	(7)	C. D. Farman	Hezzie Clark, 2012 Melrose St., Houston, Texas	Seattle	(9)	L. N. Robinson	Philip D. Jennings, Puget Sound Pr. & Lt. Co., 7th and Olive Sts., Seattle, Wash.
Indianapolis-Laf.	(5)	E. G. Ralston	C. E. Dutton, American Tel. & Tel. Co., 256 N. Meridian St., Indianapolis, Ind.	Sharon	(2)	S. S. Cook	R. M. Field, Westinghouse Elec. & Mfg. Co., Sharon, Pa.
Iowa	(5)	J. K. McNeely	H. B. Hoffhaus, Des Moines Elec. Lt. Co., 312-6th Ave., Des Moines, Iowa	Southern Virginia	(4)	J. H. Berry	Cecil Gray, Westinghouse Elec. & Mfg. Co., 912 Electric Bldg., Richmond, Va.
Ithaca	(1)	W. C. Ballard, Jr.	W. E. Meserve, 614 E. Buffalo St., Ithaca, N. Y.	Spokane	(9)	Loren A. Traub	C. F. Norberg, Washington Water Power Co., Spokane, Wash.
Kansas City	(7)	J. S. Palmer	Bruce E. Dolch, 736 Board of Trade Bldg., Kansas City, Mo.	Springfield, Mass.	(1)	J. N. Alberti	L. C. Packer, Westinghouse Elec. & Mfg. Co., Page Blvd., Springfield, Mass.
Lehigh Valley	(2)	W. M. Harbaugh	J. H. Diefenderfer, Pennsylvania Pr. & Lt. Co., Hazleton, Pa.	Syracuse	(1)	F. E. Verdin	Charles W. Henderson, 504 University Pl., Syracuse, N. Y.
Los Angeles	(8)	H. W. Hitchcock	Philip S. Biegler, 3551 University Ave., Los Angeles, Calif.	Toledo	(2)	F. H. Dubs	Max Neuber, 1257 Fernwood Ave., Toledo, Ohio
Louisville	(4)	James Clark, Jr.	Philip P. Ash, Louisville & Nashville Rd. Bldg., 9th and Broadway Ave., Louisville, Ky.	Toronto	(10)	D. A. McKenzie	G. D. Floyd, Hydro Electric Pr. Comm., 190 University Ave., Toronto, Ont., Canada
Lynn	(1)	A. L. Ellis	W. K. Dickinson, General Elec. Co., West Lynn Works, Lynn, Mass.	Urbana	(5)	C. E. Skroder	W. J. Putman, 123 Mat. Test. Lab., University of Illinois, Urbana, Ill.
Madison	(5)	L. C. Larson	G. F. Tracy, Elec. Lab. Bldg., University of Wisconsin, Madison, Wis.	Utah	(9)	L. B. Fuller	Paul Ransom, Utah Apex Mining Co., Bingham Canyon, Utah
Memphis	(4)	M. Eldredge	W. A. Gentry, Memphis Pr. & Lt. Co., Memphis, Tenn.	Vancouver	(10)	H. Vickers	C. Arnott, B. C. Electric Railway Co., Ltd., 425 Carrall St., Vancouver, B. C. Canada
Mexico	(3)	G. Solis-Payan	E. Leonarz, Jr., Apartado 2601, Mexico City, Mexico	Washington	(2)	George W. Vinal	J. L. Carr, General Elec. Co., 800-15th St. N. W., Washington, D. C.
Milwaukee	(5)	F. A. Kartak	I. L. Illing, Milwaukee Elec. Ry. & Lt. Co., 380 Public Serv. Bldg., Milwaukee, Wis.	Worcester	(1)	J. K. Oldham	R. P. Bullen, c/o General Elec. Co., Worcester, Mass.
Minnesota	(5)	D. K. Lewis	H. J. Pierce, Northwestern Bell Telephone Co., Minneapolis, Minn.	Total 58			
Nebraska	(6)	W. O. Jacobi	A. L. Turner, 1109 Telephone Bldg., Omaha, Nebraska				

LIST OF BRANCHES

- Akron, Municipal University of, Akron, Ohio.  
 Alabama Polytechnic Institute, Auburn, Ala.  
 Alabama, University of, University, Ala.  
 Arizona, University of, Tucson, Ariz.  
 Arkansas, University of, Fayetteville, Ark.  
 Armour Institute of Technology, 3300 So. Federal St., Chicago, Ill.  
 Brooklyn Polytechnic Institute, 99 Livingston St., Brooklyn, N. Y.  
 Bucknell University, Lewisburg, Pa.  
 California Institute of Technology, Pasadena, Calif.  
 California, University of, Berkeley, Calif.  
 Carnegie Institute of Technology, Pittsburgh, Pa.  
 Case School of Applied Science, Cleveland, Ohio.  
 Catholic University of America, Washington, D. C.  
 Cincinnati, University of, Cincinnati, Ohio.  
 Clarkson College of Technology, Potsdam, N. Y.  
 Clemson Agricultural College, Clemson College, S. C.  
 Colorado State Agricultural College, Fort Collins, Colo.  
 Colorado, University of, Boulder, Colo.  
 Cooper Union, New York, N. Y.  
 Cornell University, Ithaca, N. Y.  
 Denver, University of, Denver, Colo.  
 Detroit, University of, Detroit, Mich.  
 Drexel Institute, Philadelphia, Pa.  
 Duke University, Durham, N. C.  
 Florida, University of, Gainesville, Fla.  
 Georgia School of Technology, Atlanta, Ga.  
 Idaho, University of, Moscow, Idaho.  
 Iowa State College, Ames, Iowa.  
 Iowa, State University of, Iowa City, Iowa.  
 Kansas State College, Manhattan, Kansas.  
 Kansas, University of, Lawrence, Kans.  
 Kentucky, University of, Lexington, Ky.  
 Lafayette College, Easton, Pa.  
 Lehigh University, Bethlehem, Pa.  
 Lewis Institute, Chicago, Ill.  
 Louisiana State University, Baton Rouge, La.  
 Louisville, University of, Louisville, Ky.  
 Maine, University of, Orono, Maine.  
 Marquette University, 1200 Sycamore St., Milwaukee, Wis.  
 Massachusetts Institute of Technology, Cambridge, Mass.  
 Michigan College of Mining & Technology, Houghton, Mich.  
 Michigan State College, East Lansing, Mich.  
 Michigan, University of, Ann Arbor, Mich.  
 Milwaukee, School of Engineering of, 163 East Wells St., Milwaukee, Wis.  
 Minnesota, University of, Minneapolis, Minn.  
 Mississippi Agricultural & Mechanical College, A. & M. College, Miss.  
 Missouri School of Mines & Metallurgy, Rolla, Mo.  
 Missouri, University of, Columbia, Mo.  
 Montana State College, Bozeman, Mont.  
 Nebraska, University of, Lincoln, Neb.  
 Nevada, University of, Reno, Nevada.  
 Newark College of Engineering, 367 High St., Newark, New Jersey.  
 New Hampshire, University of, Durham, N. H.  
 New Mexico, University of, Albuquerque, N. M.  
 New York, College of the City of, 139th St., & Convent Ave., New York, N. Y.  
 New York University, University Heights, New York, N. Y.  
 North Carolina State College, Raleigh, N. C.  
 North Carolina, University of, Chapel Hill, N. C.  
 North Dakota Agricultural College, State College Station, Fargo, N. D.  
 North Dakota, University of, University Station, Grand Forks, N. D.  
 Northeastern University, 316 Huntington Ave., Boston 17, Mass.  
 Notre Dame, University of, Notre Dame, Ind.  
 Ohio Northern University, Ada, Ohio.  
 Ohio State University, Columbus, O.  
 Ohio University, Athens, O.  
 Oklahoma A. & M. College, Stillwater, Okla.  
 Oklahoma, University of, Norman, Okla.  
 Oregon State College, Corvallis, Ore.  
 Pennsylvania State College, State College, Pa.  
 Pennsylvania, University of, Philadelphia, Pa.  
 Pittsburgh, University of, Pittsburgh, Pa.  
 Pratt Institute, Brooklyn, N. Y.  
 Princeton University, Princeton, N. J.  
 Purdue University, Lafayette, Indiana.  
 Rensselaer Polytechnic Institute, Troy, N. Y.  
 Rhode Island State College, Kingston, R. I.  
 Rose Polytechnic Institute, Terre Haute, Ind.  
 Rutgers University, New Brunswick, N. J.  
 Santa Clara, University of, Santa Clara, Calif.  
 South Carolina, University of, Columbia, S. C.  
 South Dakota State School of Mines, Rapid City, S. D.  
 South Dakota, University of, Vermillion, S. D.  
 Southern California, University of, Los Angeles, Calif.  
 Southern Methodist University, Dallas, Texas.  
 Stanford University, Stanford University, Calif.  
 Stevens Institute of Technology, Hoboken, N. J.  
 Swarthmore College, Swarthmore, Pa.  
 Syracuse University, Syracuse, N. Y.  
 Tennessee, University of, Knoxville, Tenn.  
 Texas A. & M. College of, College Station, Texas.  
 Texas Technological College, Lubbock, Texas.  
 Texas, University of, Austin, Texas.  
 Utah, University of, Salt Lake City, Utah.  
 Vermont, University of, Burlington, Vt.  
 Virginia Military Institute, Lexington, Va.  
 Virginia Polytechnic Institute, Blacksburg, Va.  
 Virginia, University of, University, Va.  
 Washington, State College of, Pullman, Wash.  
 Washington University, St. Louis, Mo.  
 Washington, University of, Seattle, Wash.  
 Washington and Lee University, Lexington, Va.  
 West Virginia University, Morgantown, W. Va.  
 Wisconsin, University of, Madison, Wis.  
 Worcester Polytechnic Institute, Worcester, Mass.  
 Wyoming, University of, Laramie, Wyoming.  
 Yale University, New Haven, Conn.

Total 106

AFFILIATED STUDENT SOCIETY

Brown Engineering Society, Brown University, Providence, R. I.

Note: Names of new counselors and officers will be printed in the September issue of the JOURNAL. Names of officers serving to July 31 may be found in the July JOURNAL.

ORDER FORM FOR REPRINTS OF PAPERS ABRIDGED IN THIS ISSUE OF THE JOURNAL\*

(August 1930) Number	Author	Title
<input type="checkbox"/> 30-68	K. K. Palueff	Effect of Transient Voltage on Power Transformer Design
<input type="checkbox"/> 30-79	F. R. Longley	The Calculation of Alternator Swing Curves
<input type="checkbox"/> 30-84	S. T. Dodd	Electric Transmission and Control of Power
<input type="checkbox"/> 30-86	C. L. Forteseue	Rationalization of Station Insulating Structures
<input type="checkbox"/> 30-94	P. H. Hatch	Electric Power Consumption for Yard Switching
<input type="checkbox"/> 30-98	P. Sporn	Rationalization of Transmission Insulation Strength
<input type="checkbox"/> 30-99	A. E. Silver and H. L. Melvin	Essential Factors in the Coordination of Line Station and Apparatus Insulation
<input type="checkbox"/> 30-127	A. B. Clark and C. W. Green	Long Distance Cable Circuit for Program Transmission
<input type="checkbox"/> 30-139	A. V. Karpov	Hydro Power Practise in Central Europe
<input type="checkbox"/> 30-141		Symposium on Two-Way Television
<input type="checkbox"/> 30-119	L. F. Kennedy	Modern Requirements for Protective Relays

\*Members, Enrolled Students and subscribers are entitled to one complete copy of any paper abridged if it is requested within one year from date of its JOURNAL publication. Thereafter a charge of twenty-five cents per complete copy will obtain.

Name .....

Address .....

Please order reprints by number. Address Order Department, A. I. E. E., 33 West 39th Street, New York, N. Y.



# DIGEST OF CURRENT INDUSTRIAL NEWS

## NEW CATALOGUES AND OTHER PUBLICATIONS

*Mailed to interested readers by issuing companies*

**Arc Welders.**—Bulletin 901, 8 pp. Describes Burke arc welders. Burke Electric Company, Erie, Penna.

**Mercury-Arc Rectifiers.**—Bulletin GEA-1151A, 20 pp. Describes mercury-arc rectifiers for railway service. General Electric Company, Schenectady, N. Y.

**Vitreous Resistors.**—Bulletin, 4 pp. Describes the new Electrad "Vitmonel" vitreous resistors. Electrad, Inc., 175 Varick Street, New York.

**Electrical Steel.**—Bulletin, 12 pp. Describes "Armeo" electrical sheet steel grades for motors, generators and transformers. American Rolling Mills Company, Middletown, Ohio.

**Laboratory Apparatus.**—Bulletin GEA-1185, 60 pp. Describes electric laboratory apparatus and educational service for colleges and technical schools. General Electric Company, Schenectady, N. Y.

**Motor Generator Sets.**—Bulletin 401, 8 pp. Describes high cycle motor generator sets for use with high cycle tools. They are designed to operate from various sources of primary current. Burke Electric Company, Erie, Penna.

**Network Equipment.**—Bulletin GEA-1248, 44 pp. Describes a-c. network equipment. The bulletin presents a compilation of information on protectors, relays and transformers for low-voltage alternating-current, secondary networks. General Electric Company, Schenectady, N. Y.

**Resistors.**—Bulletin, 4 pp. Describes "Duratrol" adjustable resistors. Made in single or multiple units with uniform or tapered resistance curve, and adaptable for all types of voltage control where an adjustable resistor of relatively high resistance and current carrying capacity is required. Electrad, Inc., 175 Varick Street, New York.

**Induction Motors.**—Bulletin 101, 8 pp. Describes Burke S and SV motors, squirrel cage and slipring types, in capacity from 1/2 hp. to 200 hp., for two or three phase, for all standard voltages and cycles. Burke Electric Company, Erie, Penna.

**Motors.**—Bulletin 1002-B, 8 pp. Describes series intermittent service motors with and without speed reducers, designed principally for applications requiring a reliable slow speed drive of comparatively small horsepower. Bodine Electric Company, Oakley Boulevard and Ohio Street, Chicago, Ill.

**Carbon Brushes.**—Catalog 24, 56 pp. Describes Speer motor and generator brushes and carbon products. Comprehensive treatment is given to brush characteristics, various types of standard and special brushes. Diagrams illustrating applications are included. Sections are devoted to welding carbon electrodes; battery carbons; contacts; resistance units and other specialties. Speer Carbon Company, St. Marys, Penna.

**Radio Accessories.**—Folder. Describes the Electrad line of radio parts, including enameled high resistances, grid leaks, and mountings, amplifier kits, mica fixed condensers, rheostats, by-pass and filter condensers, jacks and switches. Electrad's new super Tonatrol (volume control) is also listed, as are variable and all-wire resistances. Electrad, Inc., 175 Varick Street, New York.

## NOTES OF THE INDUSTRY

**Westinghouse in Spain.**—The Westinghouse Electric and Manufacturing Company announces that through its subsidiary, the Westinghouse Electric International Company, it has joined with a group of Spanish financial and industrial leaders in the formation of a new company, known as Constructora Nacional Maquinaria Electrica and capitalized at twelve million pesetas, to manufacture electric generators, motors, transformers, and other electrical apparatus in Spain.

Arrangements have been made whereby the new Company will collaborate with both the Westinghouse Electric Inter-

national Company and Le Materiel Electrique S-W, the French Company formed recently by Schneider-Creusot and Westinghouse interests. These arrangements secure for the Spanish Company engineering, manufacturing, and research information, the granting of exclusive patent rights for Spain, and the technical guidance of the Westinghouse Company.

**Schweitzer & Conrad Merge with Cutler-Hammer, Inc.**—Announcement has been made by Cutler-Hammer, Inc., of Milwaukee, Wis., that on July 1 they acquired all common stock of Schweitzer & Conrad, Inc., Chicago, manufacturers of high voltage equipment. Schweitzer & Conrad will continue to operate as an independent manufacturing and selling unit. No changes in organization or personnel will be made except Beverly L. Worden, president of Cutler-Hammer has also been elected president of Schweitzer & Conrad. Mr. Conrad and Mr. Schweitzer have been retained as consulting engineers and will continue their interest in the management as members of the board of directors.

**Meter Test Switches.**—The Bull Dog Electric Products Company, Detroit, announces a new combination meter testing switch and distribution panel for range and lighting circuits. It combines in one cabinet a 60-ampere externally operated meter test entrance switch of the SAFTtoFUSE type, and a branch distribution panel consisting of a 60-ampere SAFTtoFUSE (permitting a 40-ampere fusible circuit for range or other device) and 4 or 6—30 ampere plug fusible circuits for lights, hot water heater, etc.

**New Suspension Clamp.**—The Lapp Insulator Company, Inc., LeRoy, N. Y., announces a new trunnion type suspension clamp of copper bearing forged steel in conductor sizes from 1/4 in. to 2 1/4 in. The clamp is designed to eliminate surplus weight and further designed to crowd as much weight as possible toward the center of oscillation so the clamp will have a low moment of inertia. The larger sizes particularly are very light in weight as compared to conventional designs. A number of items favorable to construction have been added, including special unthreaded guide tip placed on the ends of the bolts so that the nut will center and catch the thread without difficulty. A locking device is incorporated in the design, utilizing a lock washer between serrated teeth on the lock and nut body ears so that the nut once in place cannot be loosened by continued vibration. There are no loose U bolts or J bolts. A substantial 7/8 in. square section is provided for attaching any type of arc protection devices.

**New Magnetic Starter.**—The Electric Controller & Manufacturing Company, of Cleveland, announces a new 2300 volt, full voltage magnetic starter, complete with overload relays and self-contained potential transformer (to secure 220 volts for the control circuit) and intended for across-the-line starting of squirrel cage and synchronous motors. It may also be used to control the primary of slipring motors. The starter is built for reversing, non-reversing and plugging applications. The design of this starter is radically different from the switchboard circuit breaker type of starter commonly used in the past for full voltage starting of high voltage a-c. motors. There are no cranks, toggle mechanisms or lever systems between the magnet armature and movable contact arm. The magnet armature carrying the movable contact arm, is direct acting and is supported by only one large bearing pin and since the entire unit is totally oil-immersed, all working parts are always well lubricated and protected from dust and corrosion. This insures the equipment is ready for operation at any time, whether it is out of service for a few minutes or for several months. The unit construction provides a flameproof, corrosionproof and dustproof installation that may be mounted anywhere with perfect safety. It is not necessary to build an expensive control room for these starters. Frequently it will prove very economical to mount them out in the plant alongside the motors they control.



**KERITE**

In 1752 Franklin invented the Lightning Conductor and identified lightning and electricity. A century later, Day invented

**KERITE**

Three-quarters of a century of experience has identified it as the most reliable and permanent insulation for Electrical Conductors



**THE KERITE INSULATED WIRE & CABLE COMPANY INC**  
NEW YORK CHICAGO SAN FRANCISCO

# PAPER . . . CAMBRIC . . . RUBBER



Whatever the conditions—in outlying districts, in areas of heavy population—underground, aerial or submarine—high voltage or low—there is a time-tried Safety Power Cable which fills the need exactly. Experienced engineering cooperation is always at your service.

## GENERAL CABLE CORPORATION

EXECUTIVE OFFICES: 420 LEXINGTON AVENUE, NEW YORK • OFFICES IN PRINCIPAL CITIES

Please mention the JOURNAL of the A. I. E. E. when writing to advertisers.





✓ ✓ ✓ Approximately 90 lbs. of  
dead-weight per running foot  
saved on this job by using ✓ ✓  
Alcoa Aluminum Busses

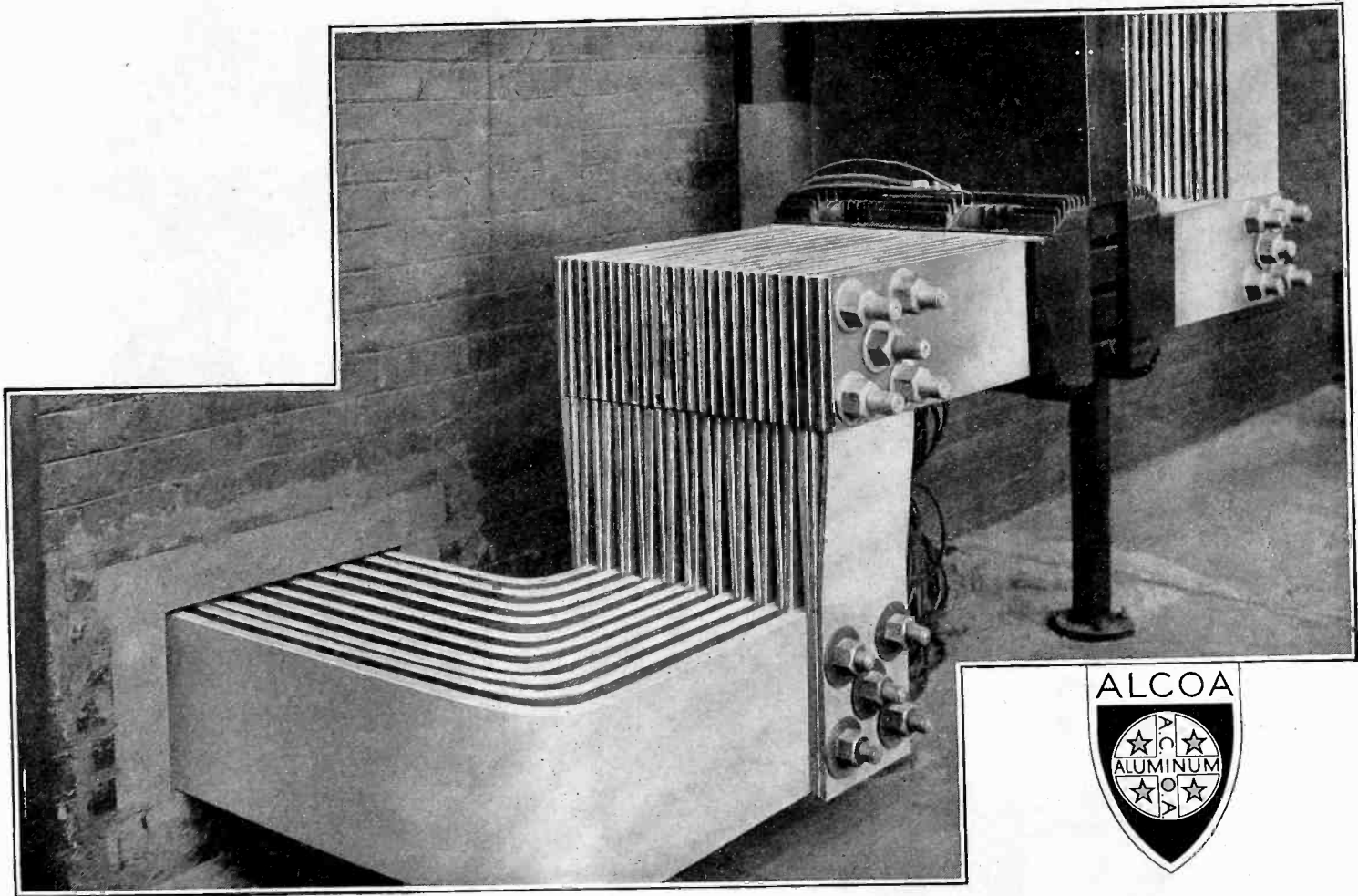

This picture shows Alcoa Aluminum Bus Bars used in connection with a 50,000 ampere direct current meter shunt. The ten large bars entering from the wall are 1" x 12". The twenty-four bars connecting with the shunt are 1/2" x 10". All are made of Alcoa Aluminum, at a dead-weight saving of approximately 90 lbs. per running foot.

This big weight saving was made possible because, for the same conductance, the weight of Alcoa Aluminum Bus Bars is only 48% of that of other bars commonly used for busses.

Alcoa Aluminum Bus Bars make possible longer spans and fewer joints. Their light weight calls for the use of lighter supporting structures.

Another unique advantage of Alcoa Aluminum Bus Bars is that, for the same conductance, they have a lower operating temperature than busses made of other metals.

Tables of weights, carrying capacities and other technical data are contained in the booklet, "Aluminum Bus Bars". May we send you a copy? ALUMINUM COMPANY OF AMERICA; 2448 Oliver Building, PITTSBURGH, PENNSYLVANIA.

BUS BARS MADE OF

# ALCOA ALUMINUM

Please mention the JOURNAL of the A. I. E. E. when writing to advertisers.



# VIGILANCE!

Reliable insurance against losses due to outage on major transmission systems is provided by the superior design and construction of Pacific Electric floor mounted oil circuit breakers.

The rugged roller bearing equipped bevel gear assembly evidences modern design and construction.

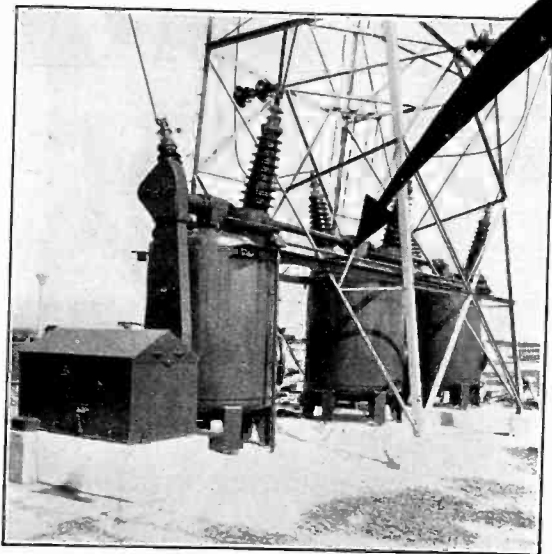
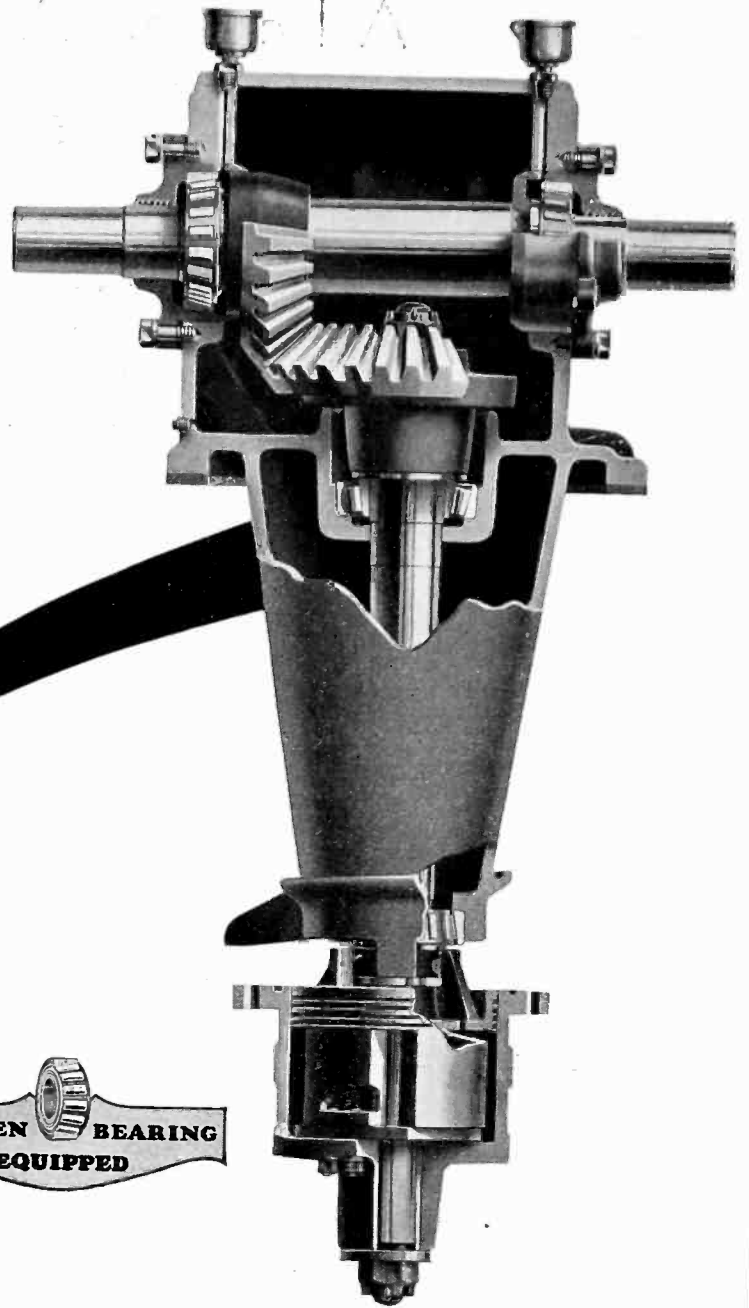

Pacific Electric 115 KV-600 Amp.  
Floor Mounted Type  
Oil Circuit Breaker.

Roller Bearing Bevel Gear Assembly  
with Concentric Oil Dash Pot for  
Pacific Electric Floor Mounted Oil  
Circuit Breakers.

## Pacific Electric Manufacturing Corp.

Bay View, San Francisco, Cal.

Dunes Highway, Gary, Indiana



30 Church St., New York City  
Allen Building, Dallas, Texas  
H. W. Hellman Bldg., Los Angeles, Cal.  
Liggett Building, Seattle, Wash.  
Public Service Bldg., Tulsa, Okla.

1700 Sansom St., Philadelphia, Pa.  
Dwight Building, Kansas City, Mo.  
Symes Building, Denver, Colo.  
Plymouth Bldg., Minneapolis, Minn.  
P. O. Box 263, Phoenix, Ariz.  
Bedell Building, Portland, Ore.



Please mention the JOURNAL of the A. I. E. E. when writing to advertisers.

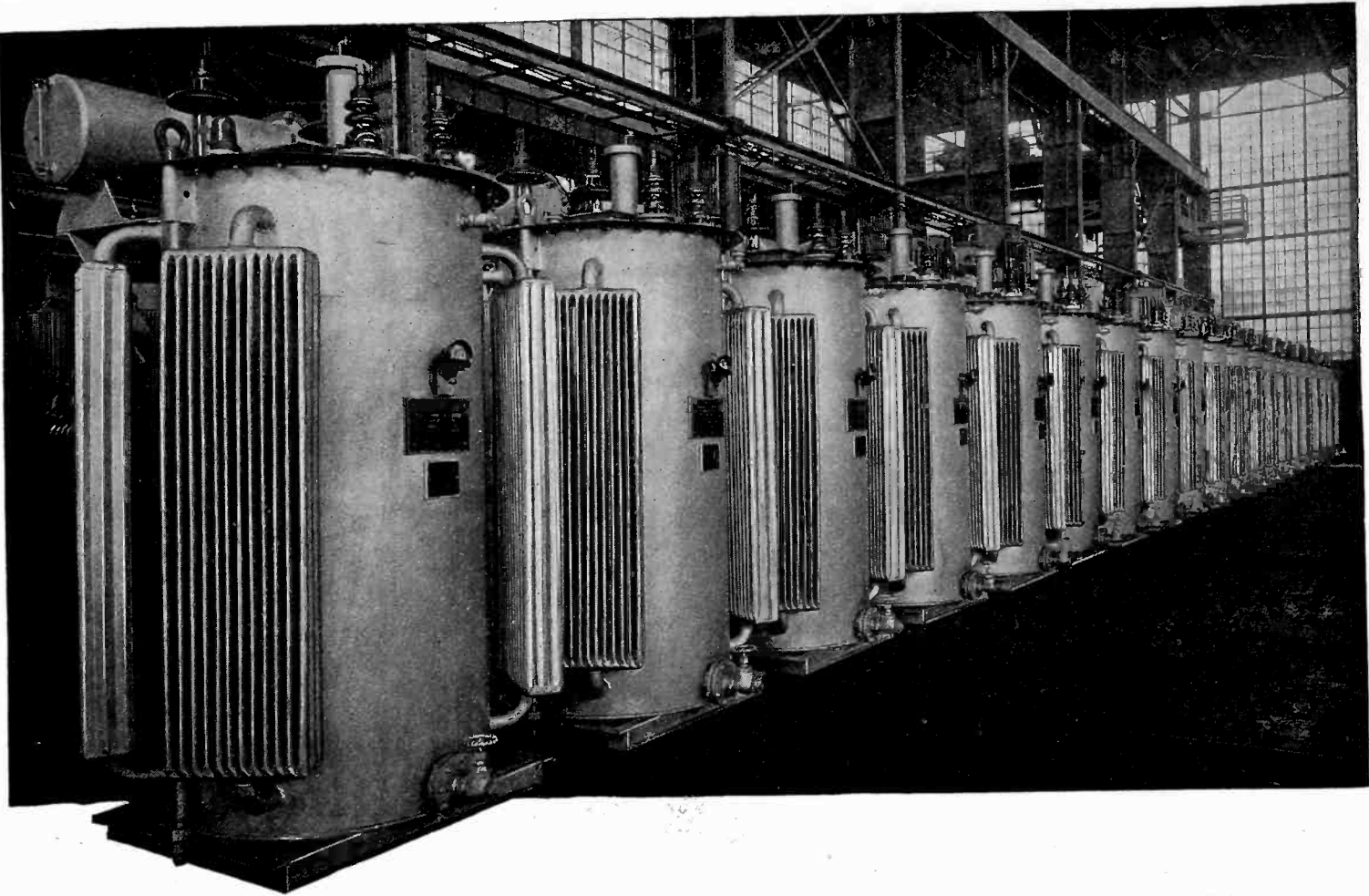

## Typifying the Growth of the West . . .

. . . are the twenty-one 1000 kv-a., 11,500/2400-4150 volt transformers built for Southern California Edison Company and shown above ready for shipment. These transformers are representative of the equipment Allis-Chalmers has built for the generation, distribution and utilization of electric power throughout the West.

There are many reasons why discriminating engineers specify Allis-Chalmers transformers. Among these are the well designed tanks and radiators, low core loss, and patented, balanced double magnetic circuit, which assures even flux distribution. Coil designs incorporate vertical oil ducts, giving uniform heat dissipation and eliminating possibility of hot spots.

Allis-Chalmers builds power and distribution transformers for most any service requirements. Write nearest office for detailed information.



# ALLIS-CHALMERS

Allis-Chalmers Manufacturing Company, Milwaukee

Please mention the JOURNAL of the A. I. E. E. when writing to advertisers.

# High Voltage Transformers....

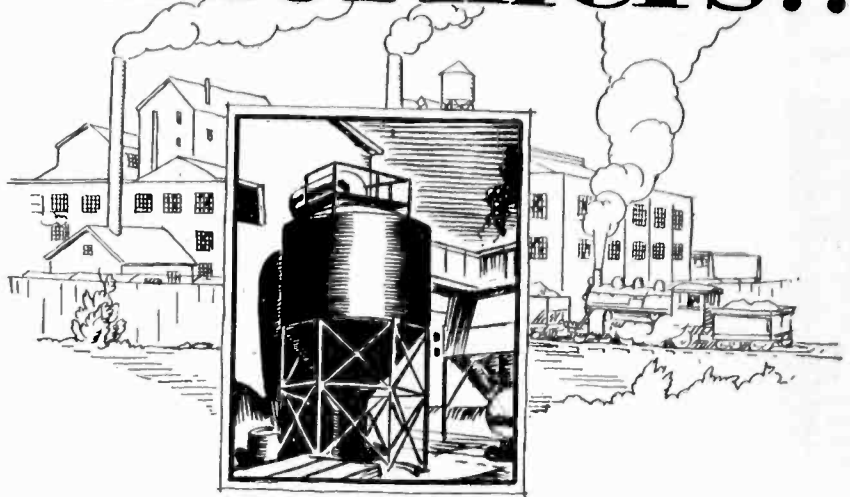

## for the Cottrell Process

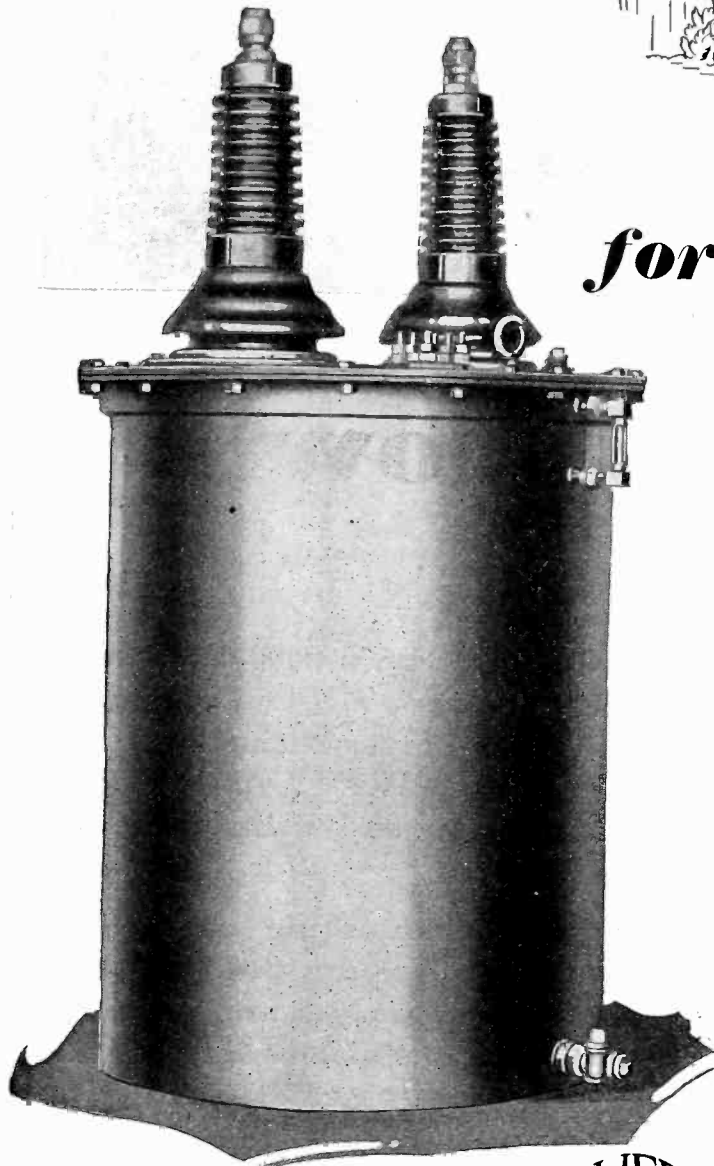

These Cottrell Process Precipitation Transformers are built in sizes from 2½ KVA to 50 KVA, with standard high-tension voltages of 45,000, 50,000, 55,000, 60,000, 65,000 volts secondary.



Refineries, smelters, gas companies, and others using the Cottrell Process have found the high-voltage transformers especially designed by the American Transformer Company entirely satisfactory for such mechanical rectifier service.

These Cottrell Process Precipitation Transformers are built in sizes from 2½ KVA to 50 KVA, with standard high-tension voltages of 45,000, 50,000, 55,000, 60,000, 65,000 volts secondary. They are specially insulated for use with a mechanical rectifier, which alternately grounds the ends of the high-tension winding sixty times a second. Choke coils are mounted on the high-tension terminals to reduce high-frequency disturbances in the transformer. The range in secondary voltages is obtained by means of taps in the primary winding.

Transformers for every industrial and laboratory application are supplied by the American Transformer Company. Our engineering staff is at your service on any unusual problem.

### AMERICAN TRANSFORMER COMPANY

*Transformer builders for over 29 years*

180 Emmet Street

Newark, N. J.

#### Representatives

Atlanta, Ga.—H. Douglas Stier, 101 Marietta Street

Montreal, Canada—W. O. Taylor & Co., Ltd., 415 Canada Cement Bldg.

Boston, Mass.—Electrical Apparatus Sales Co., 10 High Street

Philadelphia, Pa.—L. D. Joralemon, 112 South 16th Street

Chicago, Ill.—Westburg Engineering Co., 53 W. Jackson Blvd.

San Francisco, Calif.—James H. Southard, 682 Mission Street

Knoxville, Tenn.—Arthur L. Pollard

St. Louis Mo.—J. W. Jones, 432 Pennant Building

Minneapolis, Minn.—Elliott Equipment Co., 708 Sixth Avenue, South

# AMERICAN TRANSFORMERS

Please mention the JOURNAL of the A. I. E. E. when writing to advertisers.

# IF INSTRUMENTS *were calibrated* in DOLLARS and CENTS—

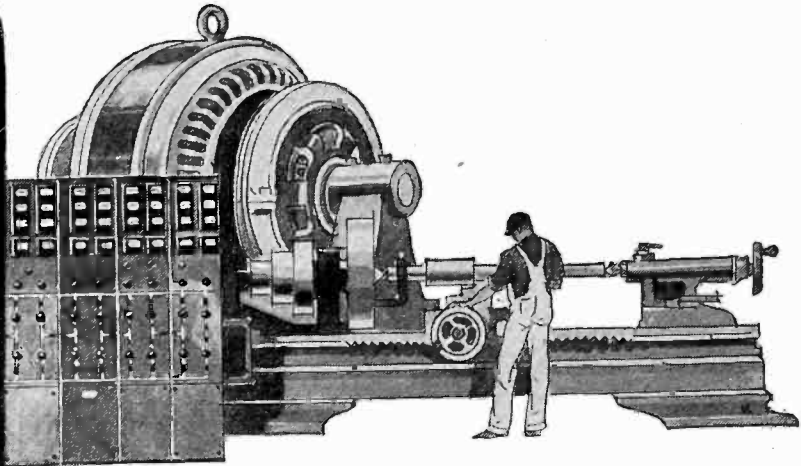
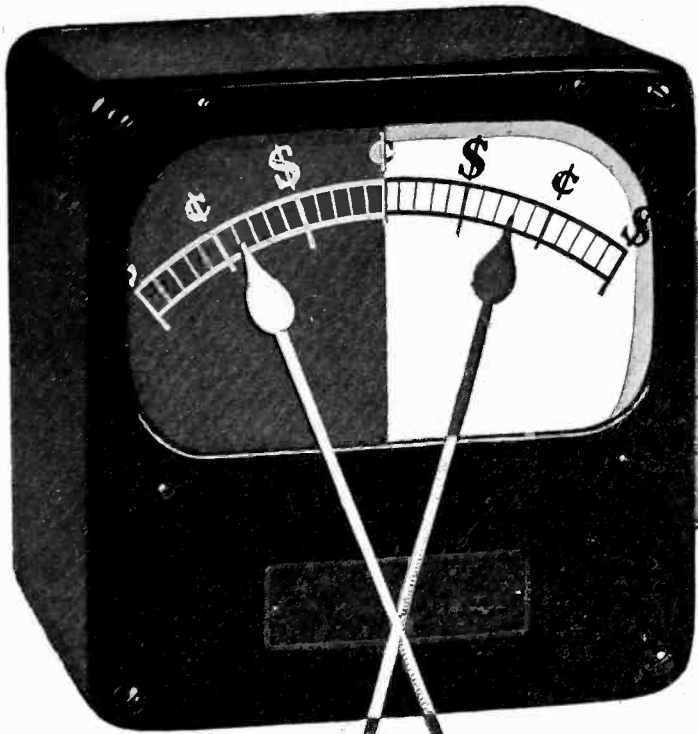

... It is more than likely that the financial, as well as engineering and purchasing departments of your company, would demand a voice in their selection. It is also likely that no instruments would pass *Acceptance Tests* unless the resources and standing of the Supplier, as well as the electrical characteristics of the samples submitted, gave assurance of utmost service responsibility.

Acceptance Tests all too often do not go deep enough into inherent features of design and construction which make for long-life dependability. Look to see if any manufacturing short-cuts have pared the veneer of quality *down to the quick*, exposing imperfections which ultimately will result in instrument fatigue and inaccuracies of measurement.

Think of your instruments as if they were calibrated in dollars and cents—their pointers indicating the profits and losses of electrical operation directly upon the pages of your business ledger. You would then make certain that they were above the suspicion of error, year in year out accurately accountable for every penny of power costs.

Then why not regard your switchboard instruments as charged with a similar responsibility and employ Weston Rectangulars on all your important circuits—for their records of service give proof of the most dependable performance and highest integrity.



  
 WESTON  
 PIONEERS  
 SINCE 1888  
 INSTRUMENTS

WESTON ELECTRICAL INSTRUMENT CORPORATION  
584 Frelinghuysen Avenue Newark, N. J.

Please mention the JOURNAL of the A. I. E. E. when writing to advertisers.



# ABCO POLES, TOWERS SUB-STATIONS

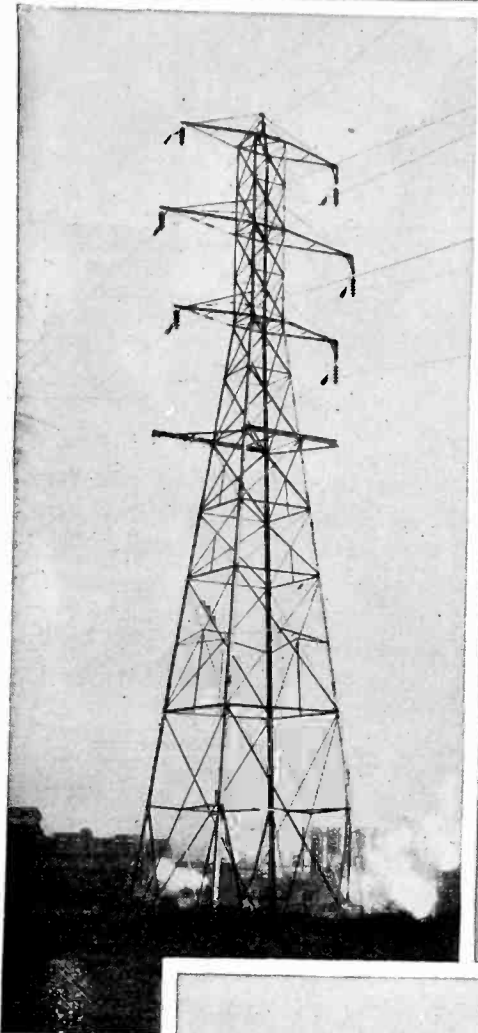

*Designed for  
Economy in Erection,  
Maintainence and  
Dependability  
in Service*

ABCo poles, towers,  
sub-stations and  
other high tension  
structures are de-  
signed by engineers  
of experience in this  
work.

Inquiries are invited,  
especially with respect  
to designs meeting un-  
usual problems of weather,  
erection, or transmission.

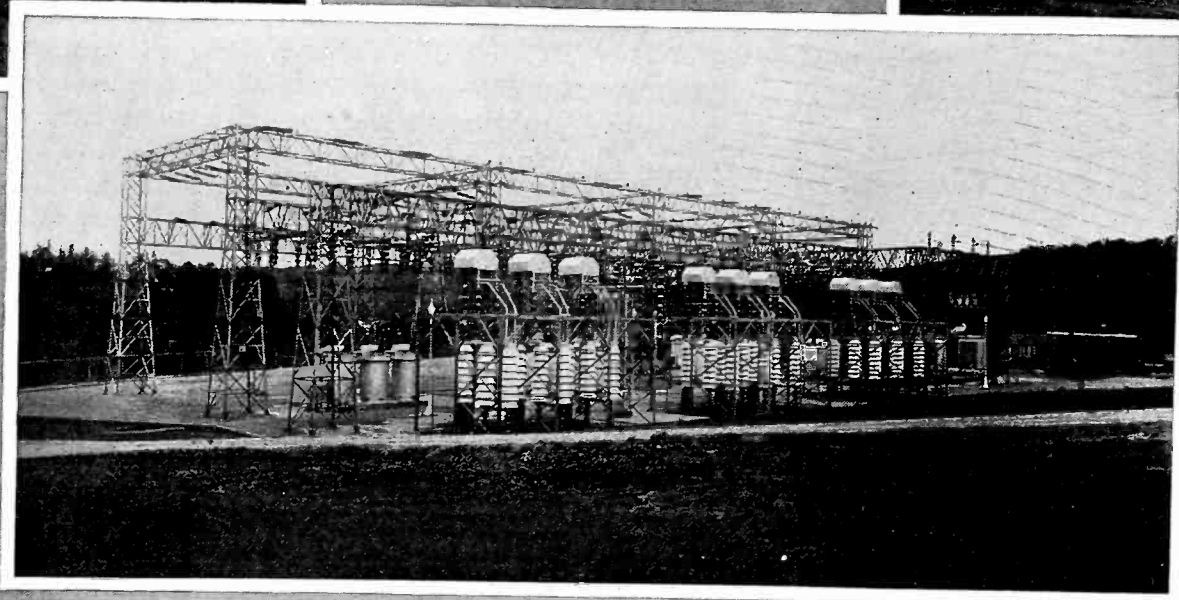
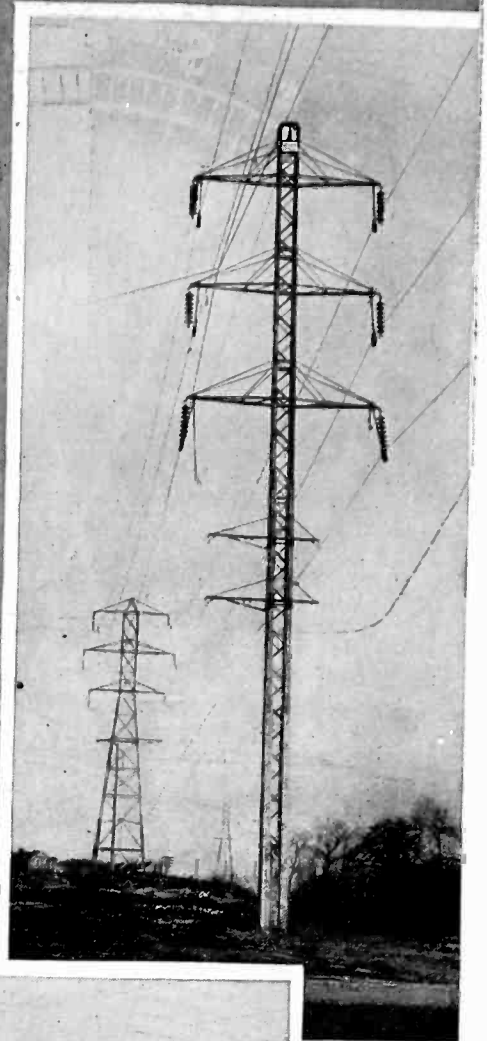

## AMERICAN BRIDGE COMPANY

*Subsidiary of United States Steel Corporation*

**General Office: 71 Broadway, New York City**  
**Tower Dept., Frick Bldg., Pittsburgh, Pa.**

Please mention the JOURNAL of the A. I. E. E. when writing to advertisers.

**New!**

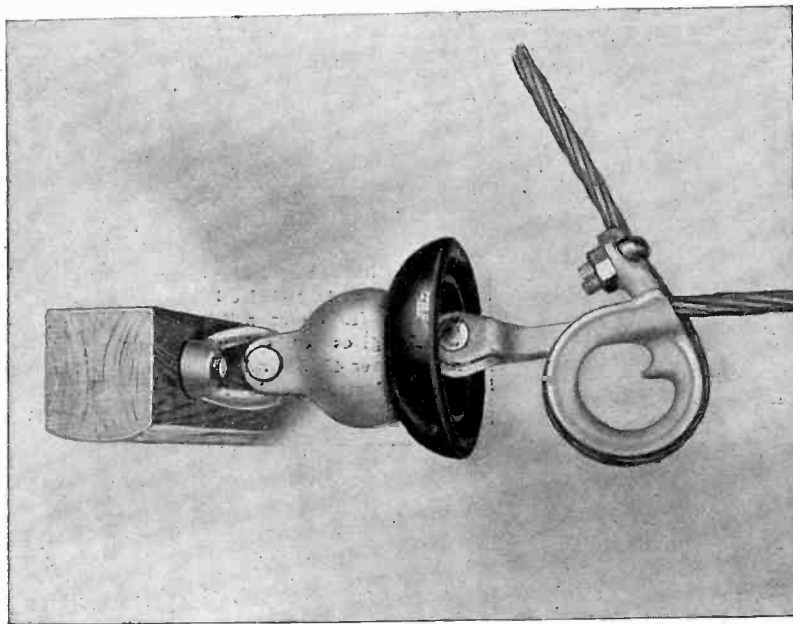

Lapp Insulator No. 6810 and Clamp No. 7511

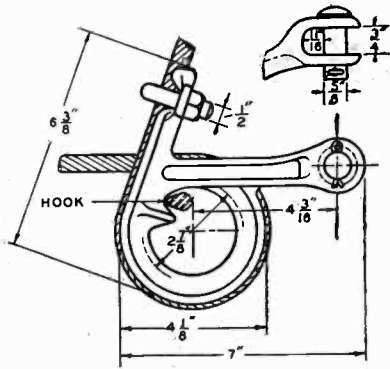

This clamp is recommended for following conductors:

- Bare, solid No. 2 to 2/0 inc.
- Bare, stranded No. 3 to 4/0 inc.
- Triple braid W. P. No. 6 to No. 1 inc.

For heavier T. B. W. P. it is customary to strip the insulation and clamp over the bare metal.

Clamps are suitable for copper or aluminum.

## Save Money with this Clamp

**HERE'S** a dead-end clamp for farm lines, distribution circuits, substation busses, etc., that offers several economies.

**IT** accommodates the entire range of customary conductor sizes, thus reducing warehouse stocks. Installation is simple, the ring providing a hold for pulling up the conductor exactly as desired; an easy bend and tightening two nuts completes the job. Hold conductor to breaking at full rated strength.

**CONDUCTOR** can be trained away to pin type insulator or other equipment. Jumper can be run above or below cross-arm. Maximum grip with little distortion of cable. Few parts to adjust. Hot line work is easy.

Ask for sample and surprisingly low price on this "SS" clamp No. 7511. Fully described in Bulletin No. 80.

# LAPP

INSULATORS



LAPP INSULATOR CO. INC. LEROY, N.Y. U.S.A.

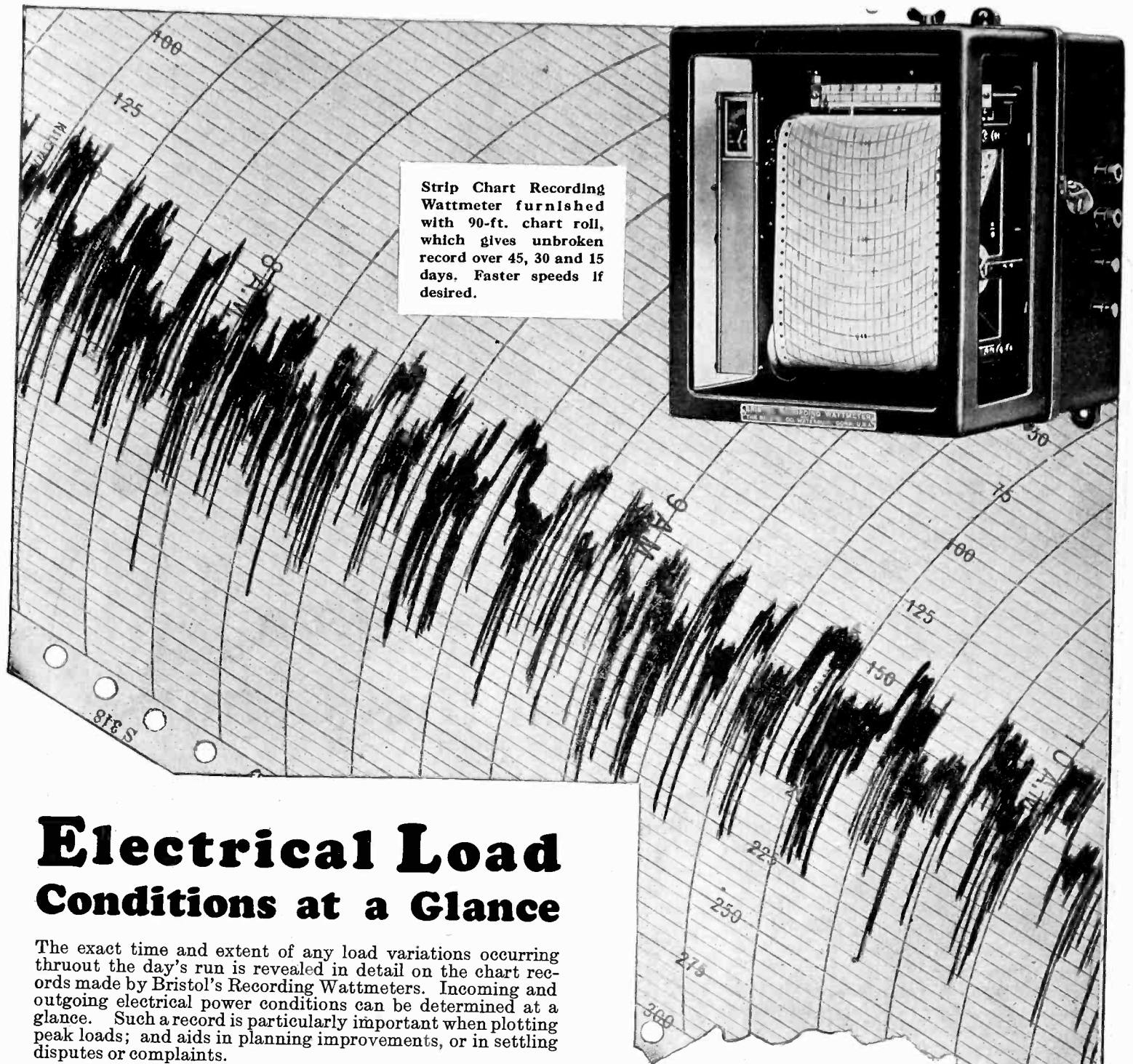

Strip Chart Recording Wattmeter furnished with 90-ft. chart roll, which gives unbroken record over 45, 30 and 15 days. Faster speeds if desired.

## Electrical Load Conditions at a Glance

The exact time and extent of any load variations occurring thruout the day's run is revealed in detail on the chart records made by Bristol's Recording Wattmeters. Incoming and outgoing electrical power conditions can be determined at a glance. Such a record is particularly important when plotting peak loads; and aids in planning improvements, or in settling disputes or complaints.

At the power plant, Bristol's Recording Wattmeters can be used to show output of complete station, or of individual generators as may be desired. Also in customer's plant to furnish information as to input to entire plant, load of each building or department, and for making individual motor tests, etc.

The accuracy and durability of Bristol's Instruments can best be attested by the fact that many installations in steel mills, where operating conditions are particularly critical, have piled up continuous service records ranging up to more than 30 years, and in many instances are still on the job 24 hours a day.

Send for Catalog No. 1502. It Contains Complete Information.

### The Complete Bristol's Electric Recording Instrument Line includes:

Wattmeters, Ammeters, Milli Ammeters, Shunt Ammeters, Voltmeters, Milli Voltmeters, Frequency Meters. Also Recording Instruments for Pressure, Vacuum, Liquid Level, Temperature, Speed Motion, etc., and Automatic Control equipment for temperature, pressure, liquid level, etc.

# The Bristol Co., Waterbury, Conn.

## BRANCH OFFICES

New York  
114 Liberty St.

Boston  
Consolidated Bldg.

Philadelphia  
Widener Building

Denver  
U. S. Nat. Bank Bldg.

Birmingham  
Widener Bldg.

Pittsburgh  
Frick Bldg.

Detroit  
Book Bldg.

Chicago  
Engineering Bldg.

Akron  
572 High Street

St. Louis  
Boatmen's Bank Bldg.

San Francisco  
Rialto Bank Bldg.

Please mention the JOURNAL of the A. I. E. E. when writing to advertisers.



# FERRANTI

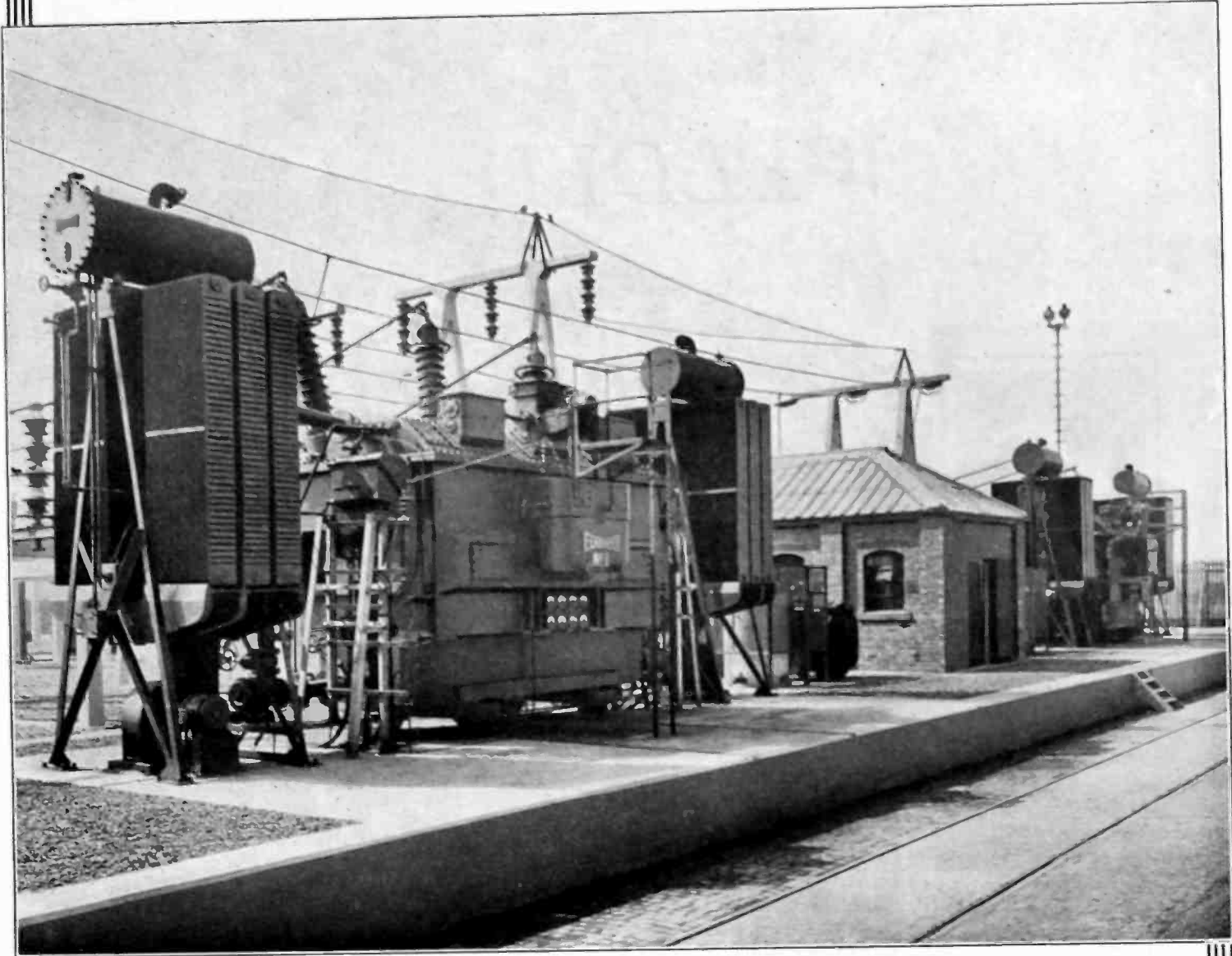

Typical Installation of 132 KV.  
Ferranti Transformers on the  
British National Grid System Scheme  
in England.

## TRANSFORMERS

FERRANTI, LTD.  
Hollinwood  
England

FERRANTI, INC.  
130 West 42nd Street  
New York, N. Y.

FERRANTI ELECTRIC, LTD.  
26 Noble Street  
Toronto, Canada



# EVERY Electrical Connection is WELDED or BRAZED

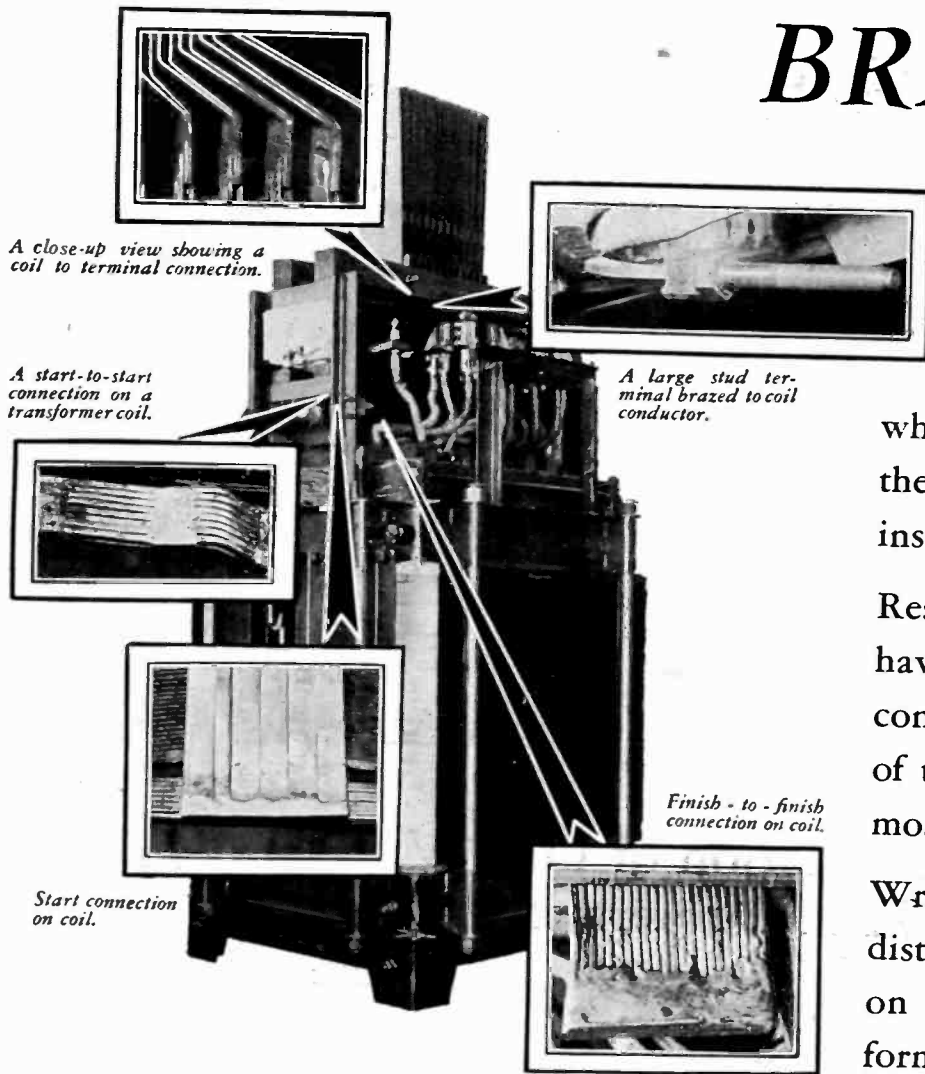

A PIONEERING achievement in the construction of Westinghouse power transformers was realized when welding and brazing replaced the process of soldering on all inside electrical connections.

Results of extensive engineering tests have proved that this new type of connection greatly increases the ability of transformers to stand up under the most severe operating conditions.

Write to the nearest Westinghouse district office for complete information on this improvement in power transformer construction.

*Service, prompt and efficient, by a coast-to-coast chain of well-equipped shops*

## Westinghouse

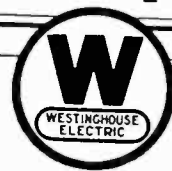

T 31432

TUNE IN THE WESTINGHOUSE SALUTE OVER THE N. B. C. NATION-WIDE NETWORK EVERY TUESDAY EVENING.

Please mention the JOURNAL of the A. I. E. E. when writing to advertisers.

*A Rust-proof Metal  
of great strength and  
high fatigue limit for*  
**Electrical  
Accessories**

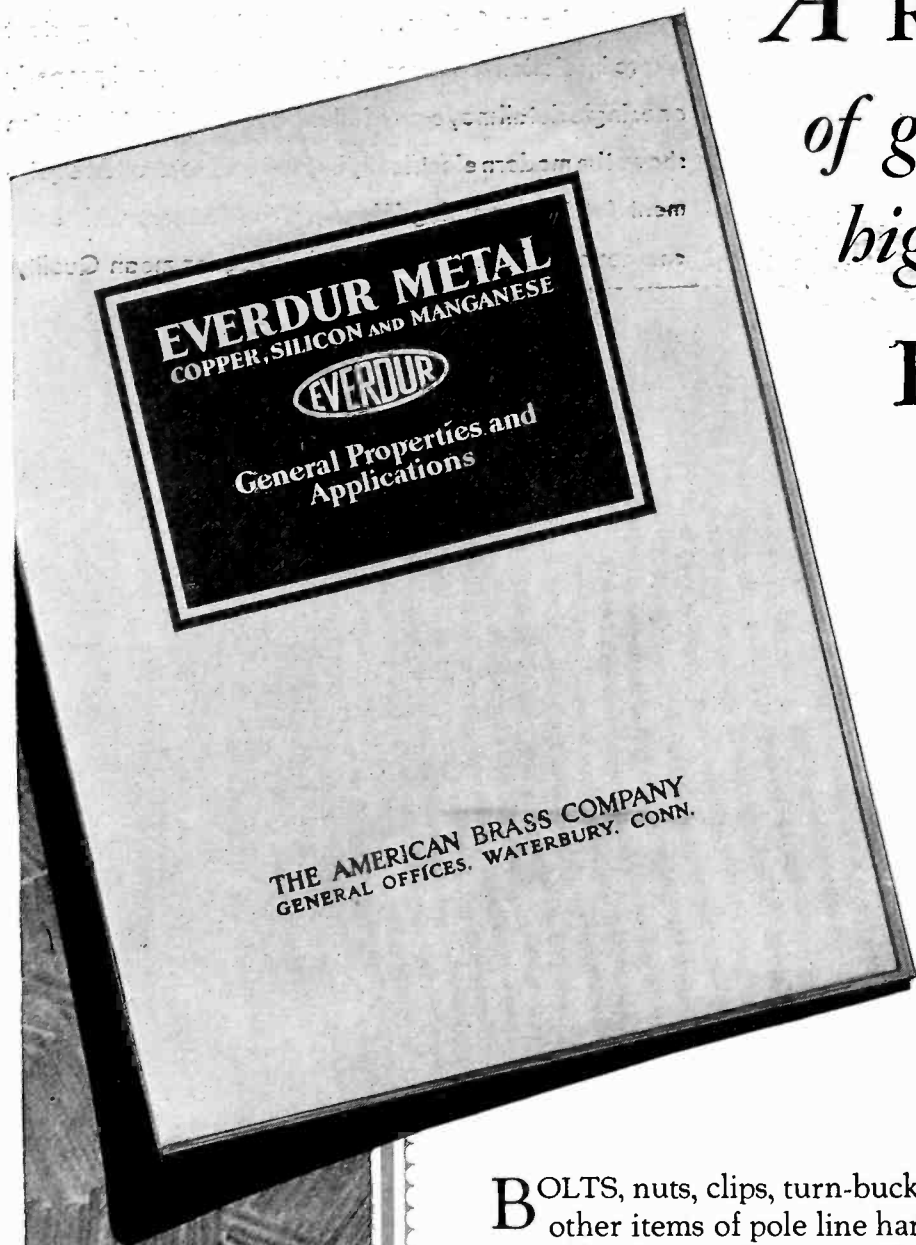

**B**OLTS, nuts, clips, turn-buckles and other items of pole line hardware, bus structure equipment and switch-gear apparatus made of non-magnetic Everdur Metal possess the tensile strength and elastic limit of steel and exceed copper in resistance to corrosion. Everdur Metal is an exclusive Anaconda alloy of copper (96%), silicon and manganese. For your further information, Publication E-2 will be sent on request.

**THE AMERICAN BRASS COMPANY**  
General Offices: Waterbury, Connecticut  
Offices and Agencies in Principal Cities  
Canadian Mill: Anaconda American Brass Ltd.  
New Toronto, Ontario

The American Brass Company manufactures Everdur in the form of plates, sheets, rods, wire, pipe, hot-pressed parts, forging blanks and ingots.

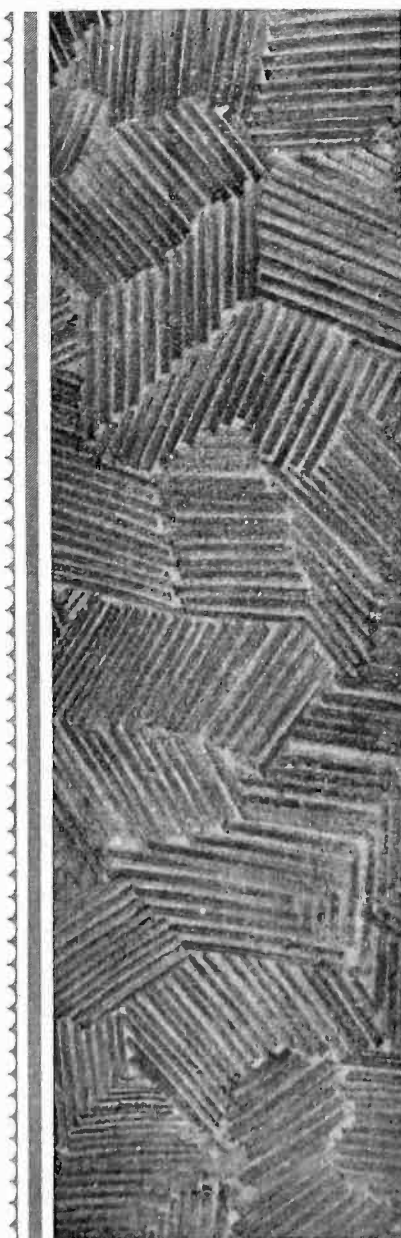

**AN ANACONDA METAL**

Please mention the JOURNAL of the A. I. E. E. when writing to advertisers.

# Power Insurance Insulation



One reason for Wagner Transformer reliability is Wagner honesty of manufacture. Particularly is honesty important where insulation is concerned. Failure to carry out properly one single detail may cause failure in service. The illustration shows the modern electrically heated and controlled equipment for impregnating Wagner Transformers with solid compound. Wagner details make Wagner mean Quality

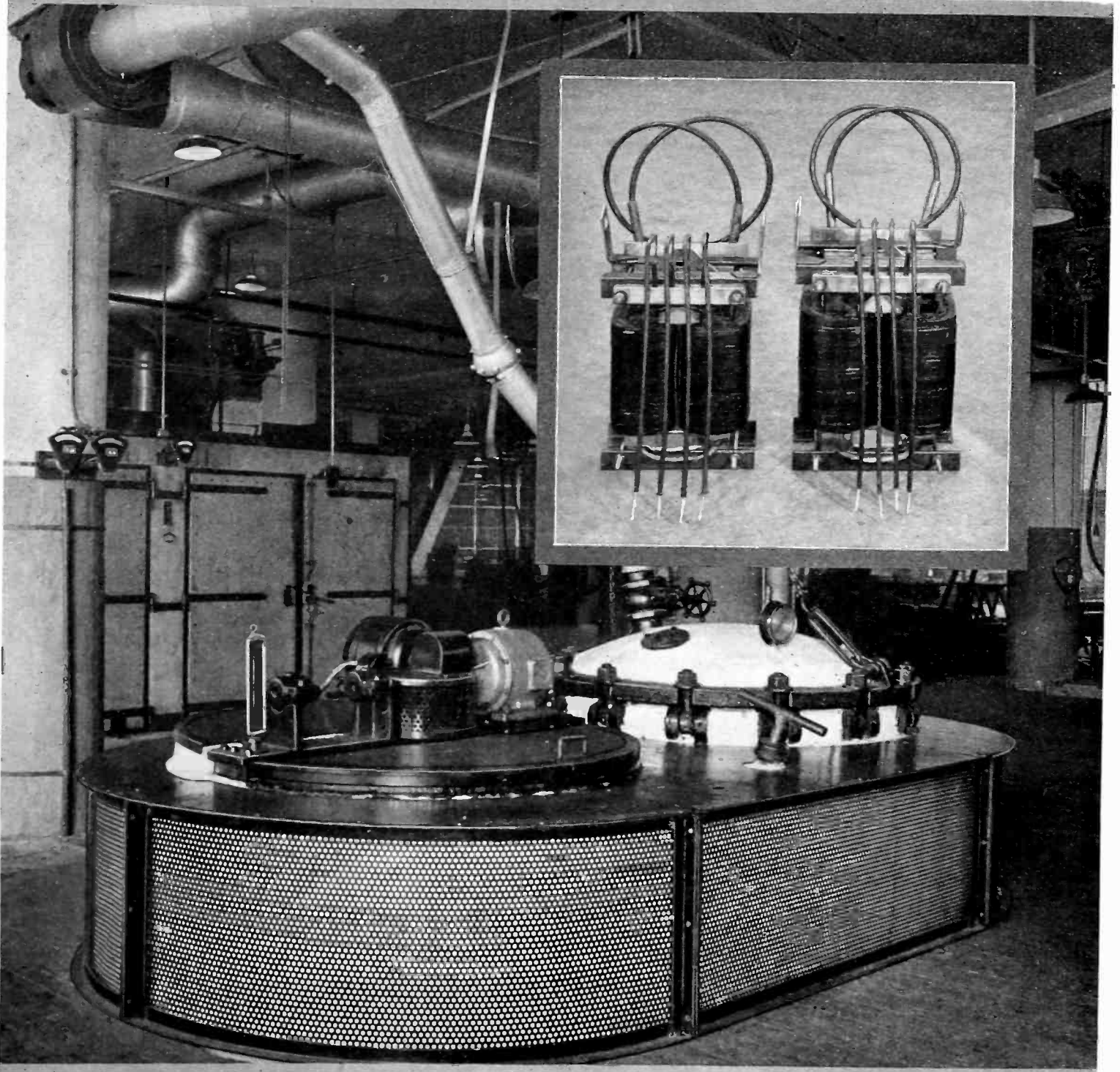

# Wagner, Quality



Wagner builds a full line of Transformers . . . Power, Distribution and Subway. Write for details.

**WAGNER ELECTRIC CORPORATION**

6400 Plymouth Ave., St. Louis

Sales and Service in 25 Principal Cities

PRODUCTS . . . FANS . . . DESK . . . WALL . . . CEILING  
TRANSFORMERS . . . POWER . . . DISTRIBUTION . . . INSTRUMENT  
MOTORS . . . SINGLE-PHASE . . . POLYPHASE . . . DIRECT CURRENT

# PERFORMANCE IS THE ONLY ~ ~ MEASURE OF QUALITY

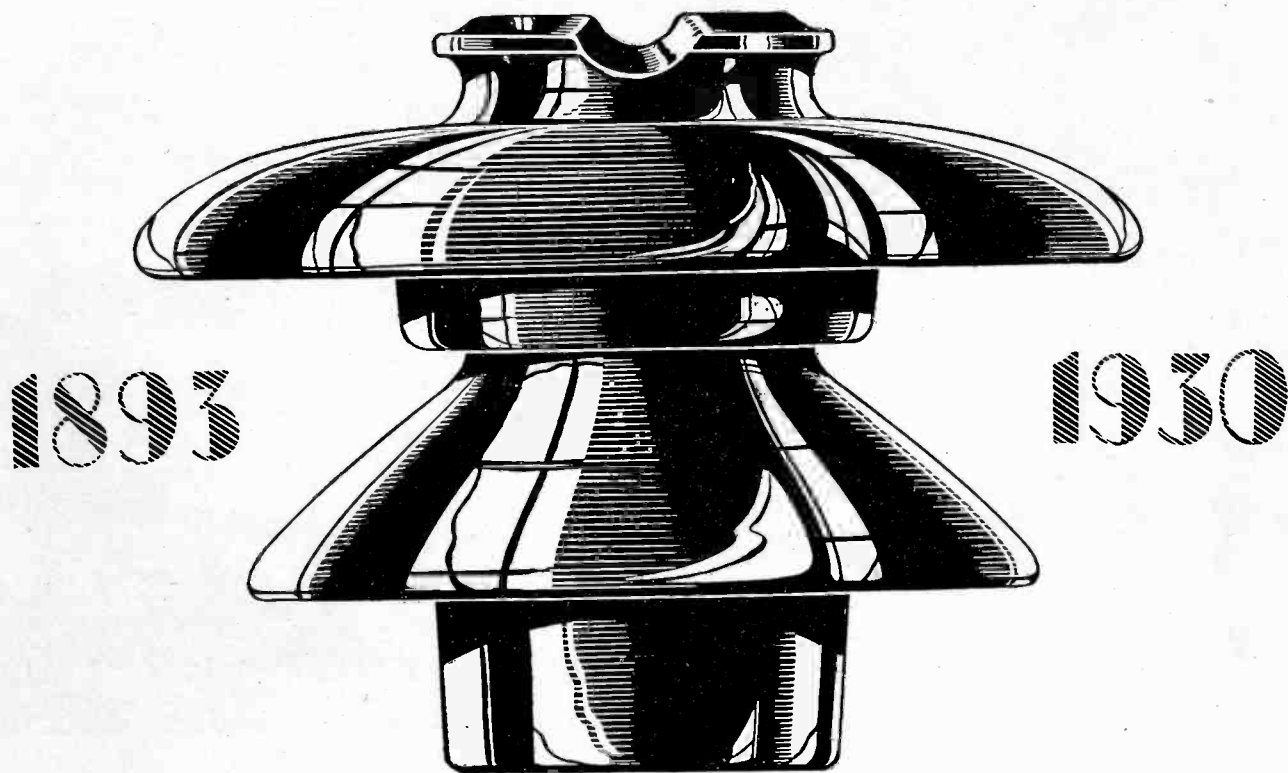

**THE PURPOSE** of the glaze on the outside of an insulator is to provide a smooth surface to which dirt will not adhere, but the actual devising of a glaze which will 'fit' the porcelain perfectly through the entire temperature range is a matter of extreme delicacy. The slightest variation will cause surface stresses which will materially decrease the life of the insulator.

The outstanding glaze research done in the Locke Ceramic Laboratories is just another example of the painstaking attention to detail which has contributed so much to the performance of Locke insulators.

*\* Reprints of a paper on the practical application of this research work will be gladly sent you. The part glaze plays in the life and strength of insulators is an entirely new subject and one in which you will doubtless be interested.*

## LOCKE

### PORCELAIN INSULATORS

LOCKE INSULATOR CORPORATION ~ ~ BALTIMORE, MARYLAND

Please mention the JOURNAL of the A. I. E. E. when writing to advertisers.



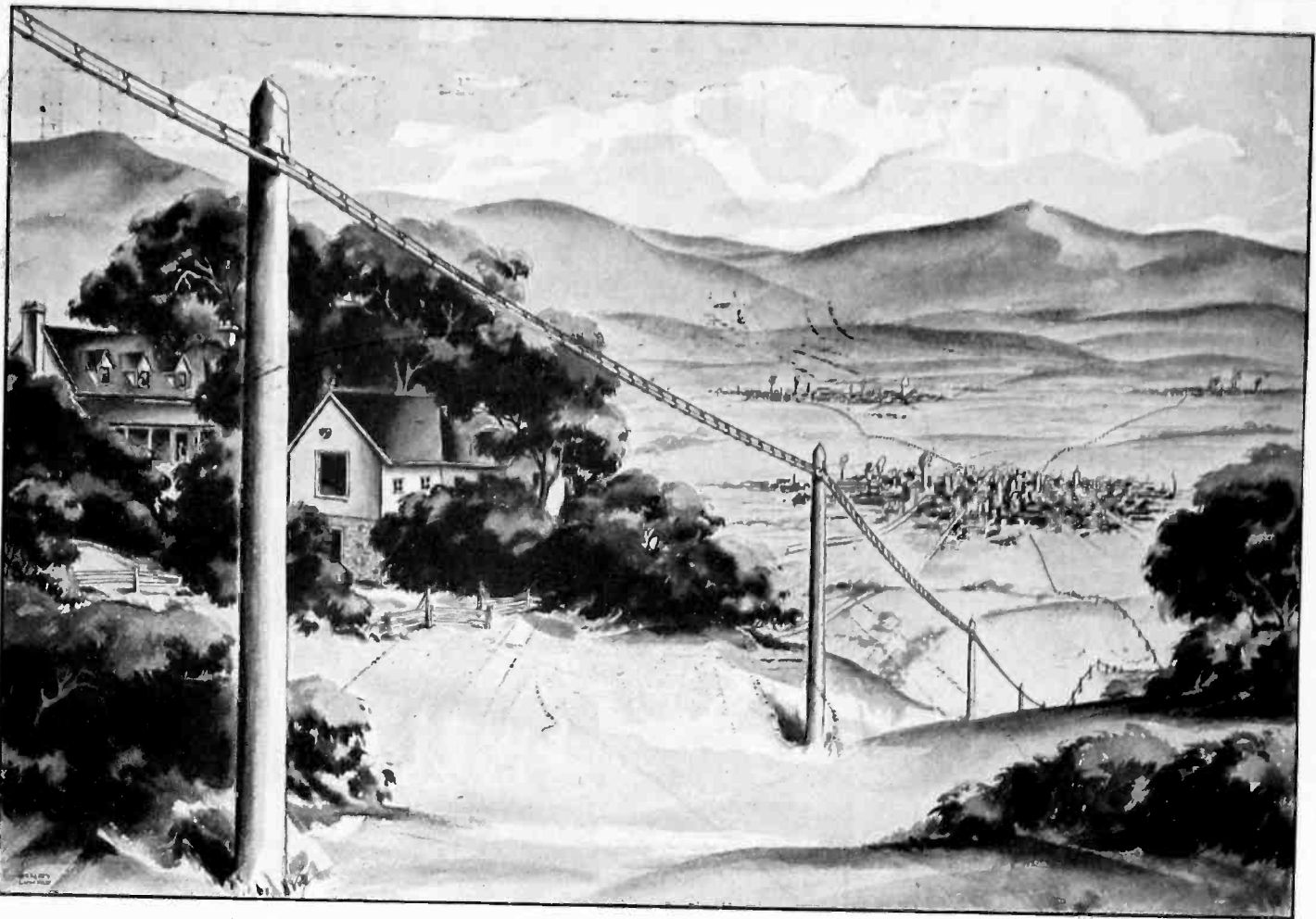

AN INTER-CITY CABLE, PART OF THE BELL SYSTEM NETWORK THAT UNIFIES THE NATION

## Vast, to serve the nation . . . personal, to serve you

*An Advertisement of the American Telephone and Telegraph Company*

So THAT YOU may telephone from house to house in a Southern village, from farm to farm in the Middle West, or from the Pacific to the Atlantic Coast—the Bell Telephone System *must* be large. Its work is to give adequate telephone service to one of the world's busiest and most widespread nations. There is 4000 million dollars' worth of telephone plant and equipment in the Bell System, any part of which is subject to your call day or night.

Every resource of this system is directed to the end that you may have quick, clear and convenient telephone service.

In order to meet the telephone needs of the country most effectively, the operation of the Bell System is carried on by 24 Associated Companies, each attuned to the area it serves. Working with these companies is the staff

of the American Telephone and Telegraph Company, giving them the benefit of its development of better methods.

The Bell Laboratories and the Western Electric Company utilize the talents of thousands of scientists for constant research and improvement in the material means of telephony. Western Electric, with its great plants and warehouses in every part of the country, contributes its specialized ability for the precise and economical manufacture of equipment of the highest quality for the entire system.

The Bell System is vigorously carrying forward its work of improving the telephone service of the country. It is building for today and tomorrow—for the benefit of every one who lives and works in America.



Please mention the JOURNAL of the A. I. E. E. when writing to advertisers.

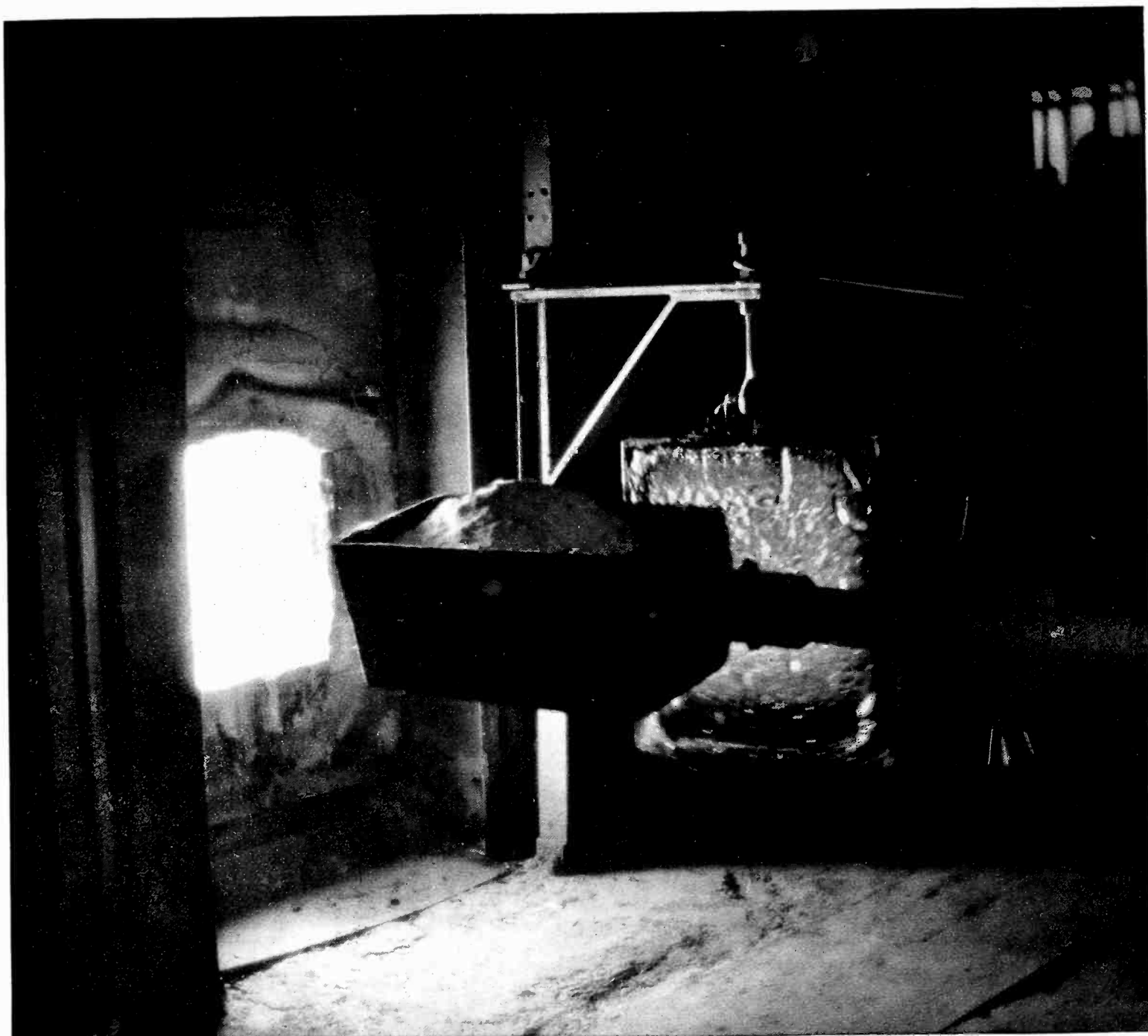

## Now--into the tank! A PYREX insulator is on its way

**S**LOW — this method of melting PYREX electrical resistant glass. Slow, but accurate as no other method could be. A ladle-full at a time the carefully mixed ingredients are measured out under the eye of the Corning laboratories. Then into the tank to be melted and molded into uniform PYREX insulators. Turn the page and see what happens inside the tank.

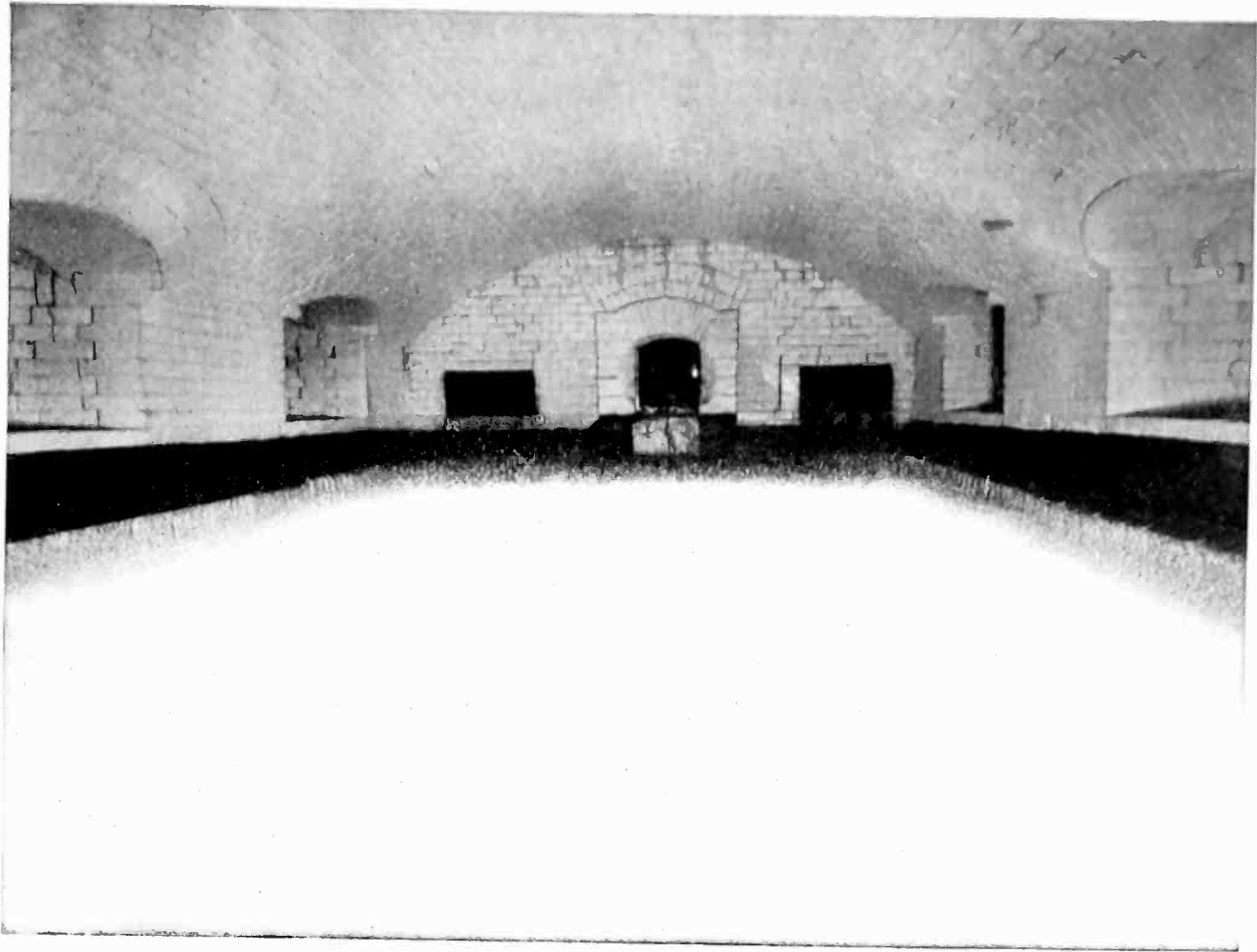

One hundred and ninety-five tons of PYREX electrical resistant glass simmering day after day at a temperature of 1440° C. Always a little is

being added at one end and a little drawn off at the other—so thoroughly mixed by this long super-fusing that uniformity is inevitably assured in the finished PYREX Insulators.

#### PROPERTIES

Specific Gravity .....	2.25
Modulus of Elasticity .....	$9 \times 10^6$ lb. per sq. in.
Thermal Coeff. of Expansion .....	0.0000018 per ° F.
Sunlight transmission through 1 in. of material ..	96%
Dielectric Constant .....	4.48
Dielectric Strength in Air .....	> 175 kv. per 1/16 in.
Power Factor .....	0.28% (30,000 cycles)
Volume Resistivity .....	> $4 \times 10^{13}$ ohms per cu. in.
Surface Resistivity	
at 34% humidity .....	$10^{14}$ ohms per sq. in.
at 84% humidity .....	$14 \times 10^8$ ohms per sq. in.

**PYREX Insulators withstand**  
 Power Arcs of 2,000 amp. for 2 sec. without failure.  
 Repeated lightning impact voltages of 1½ million volts without failure.

T. M. PYREX REG. U. S. PAT. OFF.

PRINTED IN U. S. A.

---

A PRODUCT OF CORNING GLASS WORKS, CORNING, NEW YORK

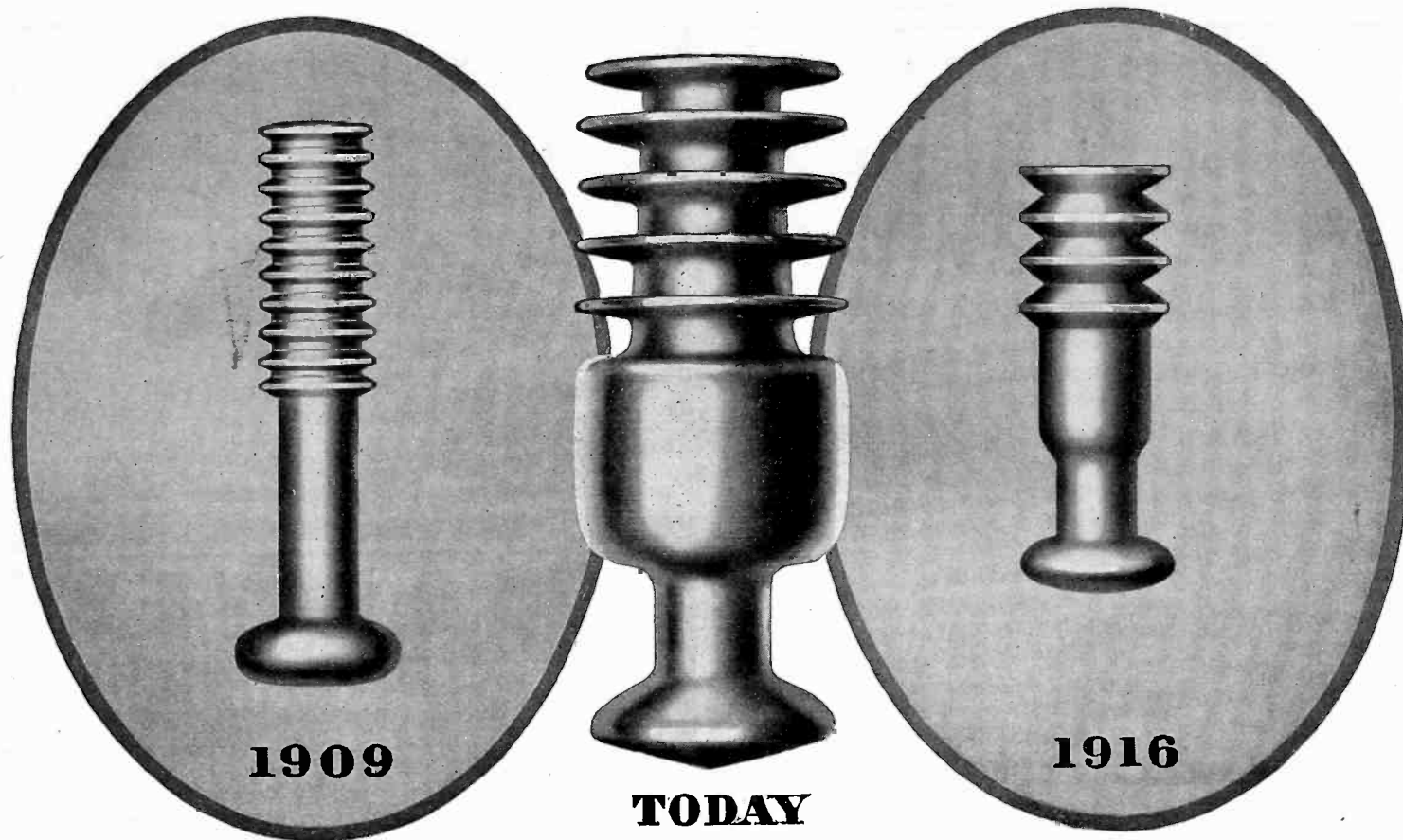

## The Greatest Insulator Refinement in a Decade

DEVELOPMENT of the treated sanded surface by O-B was an important contribution to reliability in suspension insulators. It opened the way for further refinement in pin design and, in 1919, O-B introduced an entirely new design of pin for suspension insulators—the *resilient steel pin*.

This new pin—the most important insulator refinement in the last ten years—gives adequate relief from thermal stresses. This is accomplished by reducing the mass of the pin, thus reducing expansion; and by subjecting it to an elastic coating before cementing into the insulator. This coating provides the “give and take” needed to enable the pin to return to its original shape and position as temperatures and load conditions change. Careful machining eliminates high spots and as a consequence does away with concentrated stresses caused by such points.

Proper arrangement and design of fins and their coating, permits the distribution of stresses over a

greatly increased area, reducing the unit stresses as compared to the stress distribution of the type of pin discarded by O-B in 1919. The flexing of the fins of the *resilient steel pin* permits the loading of the increased area without incurring the hazards of dangerous shears between adjacent areas.

The *resilient steel pin* has been used in O-B Suspension Insulators since 1919. Its use in connection with the treated sanded surface has resulted in definitely increased reliability and service life on lines insulated with O-B Suspension Insulators.

Further information on the *resilient steel pin* will be found in a paper by Mr. A. O. Austin presented at the World Engineering Congress in Tokyo last fall, entitled, “Insulation of High Voltage Overhead Transmission Lines”. A copy will be sent upon request. Please ask for Technical Publication 565H and address Ohio Brass Company, Mansfield, Ohio. In Canada, Canadian Ohio Brass Company, Limited, Niagara Falls, Canada.

1290H

# Ohio Brass Co.

PORCELAIN  
INSULATORS  
LINE MATERIALS  
RAIL BONDS  
CAR EQUIPMENT  
MINING  
MATERIALS  
VALVES

NEW YORK  
PHILADELPHIA

PITTSBURGH  
BOSTON



CHICAGO CLEVELAND ST. LOUIS ATLANTA DALLAS  
LOS ANGELES SAN FRANCISCO SEATTLE

Please mention the JOURNAL of the A. I. E. E. when writing to advertisers.



**DO NOT EXPERIMENT**

When you install High Voltage Underground Cables use a tried Insulating Compound in Joints, Pot-heads and Bells we would recommend **MINERALLAC** a favorite **INSULATING COMPOUND** for over twenty years.

**MINERALLAC ELECTRIC COMPANY**  
25 North Peoria Street  
Chicago, Illinois

**INSULATORS**

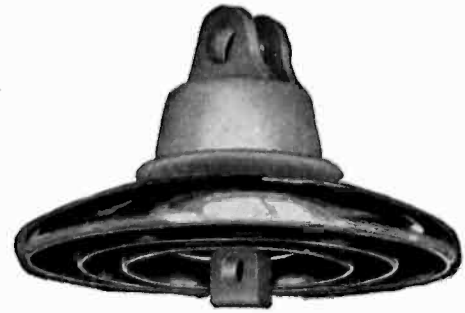

**CANADIAN PORCELAIN CO., Ltd.**  
Hamilton—Ontario—Canada  
Quebec District Office: 612 Transportation Bldg. Montreal, Qu.  
London Office: 343 Abbey House, 4 Victoria Street London, S. W. 1.

**KEARNEY FUSE-SWITCHES**



**OTHER KEARNEY PRODUCTS**  
Screw Anchors—4 in 1 Expansion Anchors—Guy Wire Clips—Double Duty Cutouts—Solderless Wire Connectors—Single Insulator Fuse-Switches—Fuse Choke Coil Combinations—Sleeve Twisters—Live Line Tools and Accessories.

Complete Catalog Sent On Request  
**JAMES R. KEARNEY CORPORATION**  
4220 CLAYTON AVE. ST. LOUIS, MO.

**HEMINGRAY GLASS INSULATORS**

The transparency of Hemingray Glass Insulators makes line inspection very simple. The lineman can tell at a glance whether the insulator is intact or not. Hemingray insulators are mechanically and dielectrically dependable, non-porous and uniform in structure. They defy moisture and age.

Send for Bulletin No. 1.  
**HEMINGRAY GLASS COMPANY**  
Muncie, Indiana

**Thomas Quality**  
PORCELAIN INSULATORS  
LINE HARDWARE  
WIRING PORCELAINS  
and  
Porcelain Specialties  
An American Standard since '73

**THE R. THOMAS & SONS CO.**  
New York Boston Lisbon, Ohio Chicago London

**TRANSFORMERS**

**— And Nothing Else —**

That's why we can offer real quality at low prices. We serve many big public utility companies.

We are exclusively **TRANSFORMER** specialists. We handle nothing else.  
We sell, buy, and repair and maintain **TRANSFORMERS** only.



*The* **ELECTRIC SERVICE CO. Inc.**  
America's Used Transformer Clearing House  
212 Walnut Street Cincinnati, Ohio



We buy modern type transformers—any size—any quantity.  
Wanted, especially—high voltage large capacity transformers in carload shipments.  
Please mention the **JOURNAL** of the A. I. E. E. when writing to advertisers.

# How a 124,500 kva station handles connections

—from a report by the engineer in charge

## MAIN HIGH TENSION BUS

{ All taps made with Dossert cable taps, 500,000 to 250,000 C. M. }

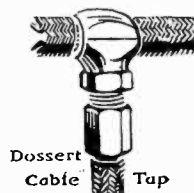

## DISCONNECTING SWITCHES

{ All leads, both top and bottom, connected with Dossert lugs. }

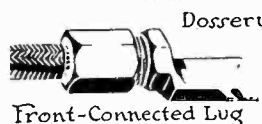

## STARTING BUS

{ Connected to strain insulator with Dossert "Style S" anchor, and all taps made with Dossert cable taps. }

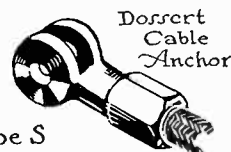

## OIL SWITCHES

{ All leads connected to switch studs of oil switches with Dossert "Style M" stud connectors. No soldered connections of any kind in these compartments. Same is true of high capacity automatics. }



## HIGH TENSION BUS COMPARTMENTS

{ Dossert connectors used throughout in the high tension bus compartments. }



## TRANSFORMERS.

{ All connections of primary and secondary leads (750,000 C. M. conductors) and all Delta connections made with Dossert lugs and cable taps. }

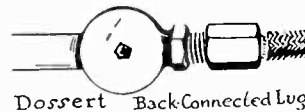

## ROTARIES

{ All connections from switchboard to copper, copper to 1,000,000 C. M. leads, and leads to rotary made with Dossert lugs, both offset and straight through types. }

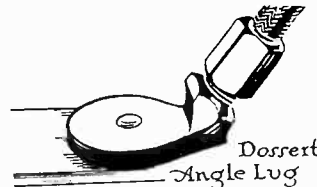

Outgoing D. C. feeders, outgoing neutral, feeder to main bus, taps for selector, connections to balancer, feeds to excitation box, connections to auxiliary switch for rotaries, center leg from excitation box to outgoing neutral, and taps from primary side of rotary to oil switches, all connected, tapped or joined with Dossert connectors.

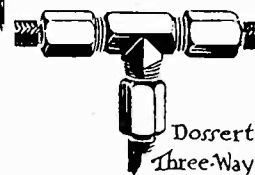
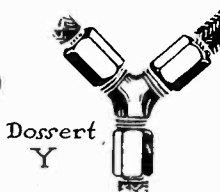
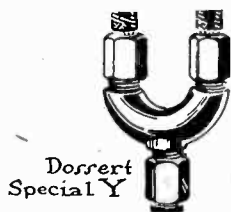

# DOSSERT & COMPANY

H. B. LOGAN, President

242 West 41st St., New York, N. Y.

# BURKE CLAMP TYPE CONNECTORS

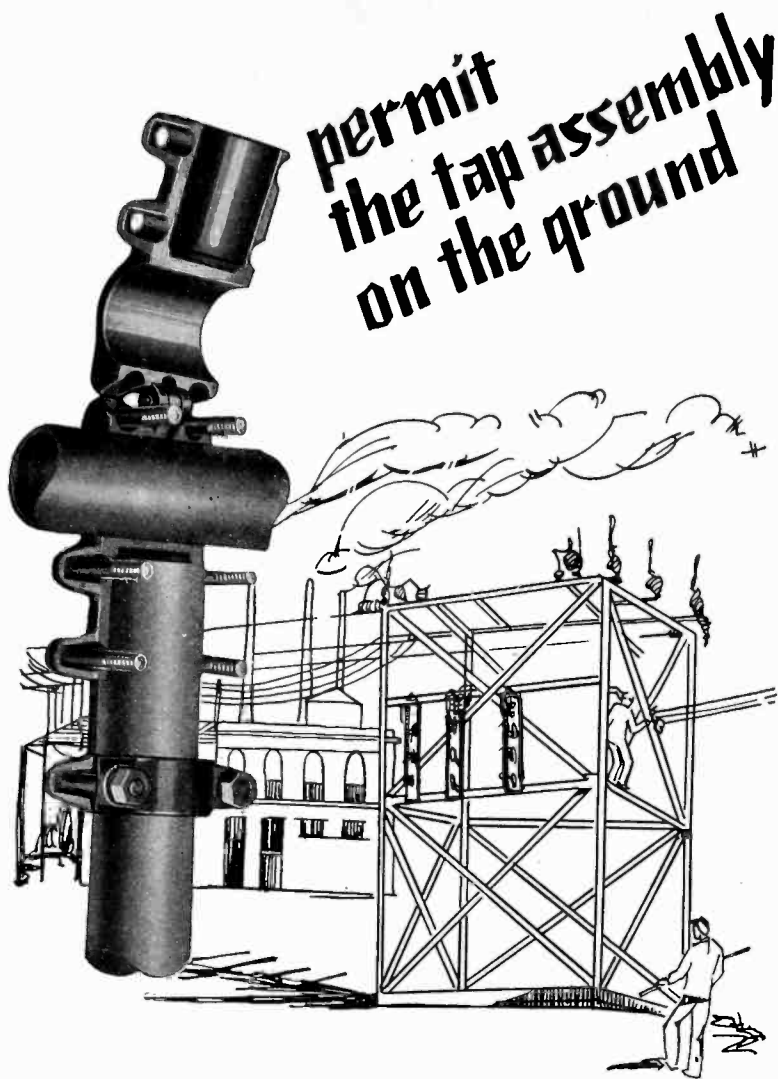

permit  
the tap assembly  
on the ground

BURKE CLAMP TYPE CONNECTORS and the tap may be assembled on the ground and can be elevated to the run as a unit. The connector is held firmly in position on the tap by means of the auxiliary clamp. This leaves the operator with both hands free to place the hinge clamp over the run and insert the bolts—a wrench is all you need. Tighten the bolts and you have a positive grip on both the run and tap.

BURKE High Tension Copper Connectors and Moulded Insulation are designed by practical engineers with Central Station experience and knowledge. Used from coast to coast and from border to border BURKE High Tension Fittings are meeting the needs of Central Stations in their transmission and distribution problems.

The following High Tension Equipment is made and guaranteed by BURKE: Bus Bar Clamps, Cable Clamps, Terminal Lugs, Leaf Terminals, End Connectors, Bracing Clamps, Connectors, Junction Boxes, Expansion Joints, Moulded Insulation, Terminal Blocks.

## BURKE

**ELECTRIC COMPANY**  
main office and works: ERIE, PA.

SALES AND SERVICE OFFICES IN PRINCIPAL CITIES

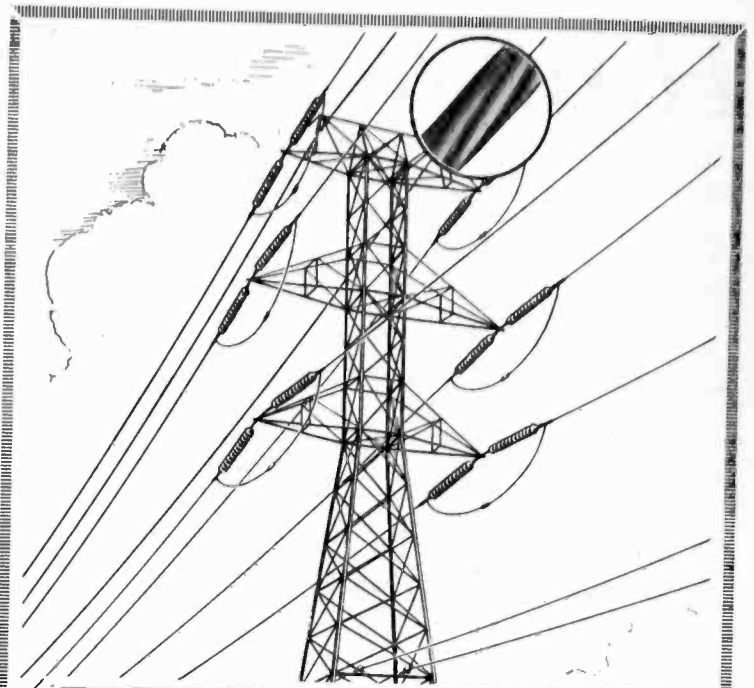

Improve the reliability of  
your transmission lines with  
**"COPPERWELD"**  
Overhead Ground Wire

Copperweld Steel Company  
Glassport, Penna.

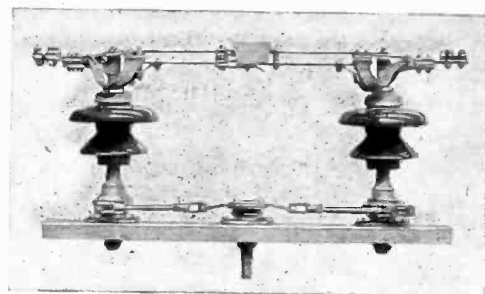

HORIZONTAL BREAK SWITCH

Have you  
a copy  
of our  
NEW  
BULLETIN  
No. 39-A?

Copy upon  
Request

This  
Bulletin  
tells you  
the story  
of the  
Single  
Center Bolt  
Switch  
Insulator  
Unit

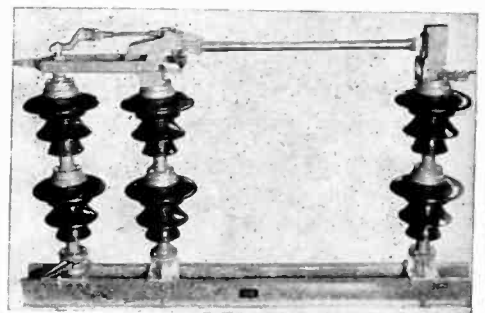

VERTICAL BREAK SWITCH

Delta-Star  Electric Co.

2400 BLOCK, FULTON ST.  
CHICAGO, ILLINOIS

Please mention the JOURNAL of the A. I. E. E. when writing to advertisers.

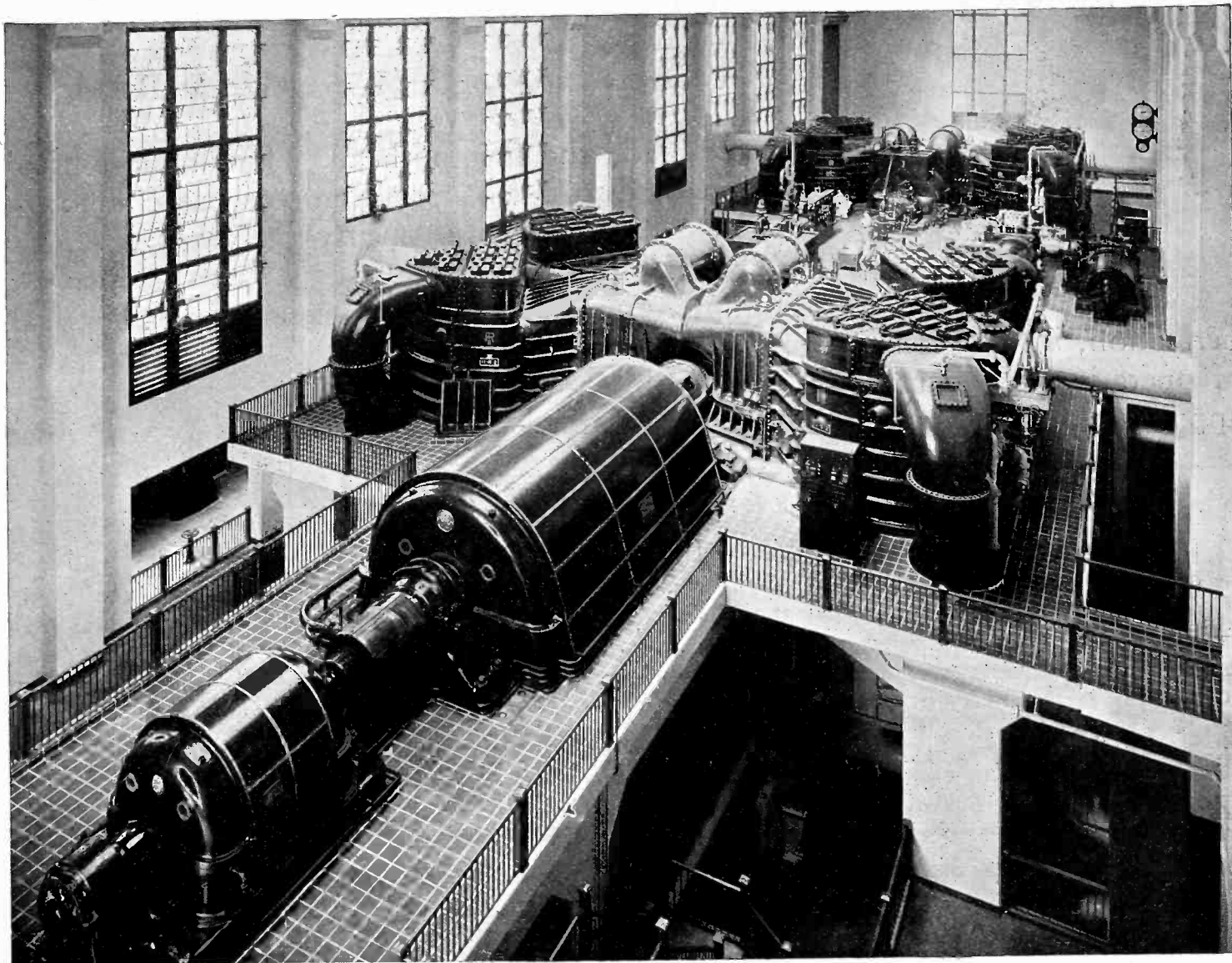

## Saving costs in large unit installations

The unusual condenser installation at Long Beach Steam Plant No. 3, of the Southern California Edison Company, Ltd., makes a substantial saving in the cost of the station's structure.

This plant, as well as Plant No. 2, was designed and built by Stone & Webster Engineering Corporation under the supervision of the client's Department of Engineering Design.

**BUILDERS and ENGINEERS**  
For The  
**BUSINESS LEADERS**  
OF AMERICA

**STONE & WEBSTER ENGINEERING CORPORATION**

A SUBSIDIARY OF STONE & WEBSTER, INCORPORATED



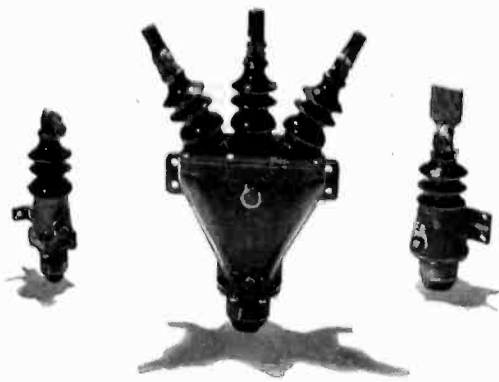

Type "T" Outdoor Capnut Potheads Listed in New Bulletin "B"

# NEW G & W POTHEADS

*A Good Line of Potheads Made Better*

perfection, installation convenience, and flexibility of operation are features all distribution men will appreciate.

G&W made the first pothead. This same anticipation of distribution requirements has characterized G&W products for twenty-five years. . . And now still further advances have been made. A combination of mechanical excellence, electrical



Type "S" Disconnecting Outdoor Potheads Listed in New Bulletin "D"

### NEW CATALOG AVAILABLE

If you have not already received your copy, let us know. The catalog is easy to use—Containing detail dimension drawings, illustrations, installations, and systematic tabulations with prices.

Potheads / Subway Boxes / Cable Terminal Devices / Automatic Transfer Switches  
**G & W Electric Specialty Co.**  
 7780 Dante Avenue, Chicago / / / / Representatives in Principal Cities



**like Buddha**

**W**ITH a hand to serve each need, Burndy connectors include a hundred types for as many different purposes. They support, couple, tap, and terminate the bus, and being made of a high copper alloy, clamped with Everdur bolts, should, like Buddha, last forever.

**BURNDY**  
**ENGINEERING CO. INC**  
 230 EAST 45TH STREET • NEW YORK

*Depend on Burndy*

## Roebling

### Electrical Wires & Cables

High in  
 Conductivity  
 and Reliability

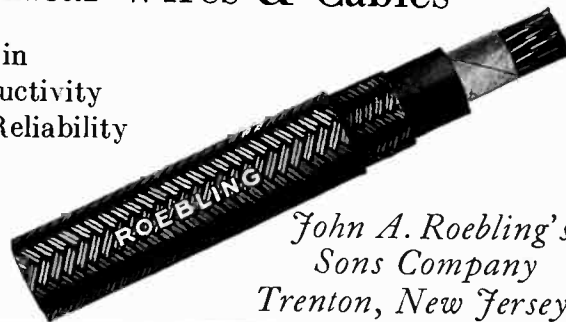

*John A. Roebling's  
 Sons Company  
 Trenton, New Jersey*

## MEMCO

- Insulator Clamps
- Copper Fittings
- Splicing Sleeves
- Disconnects
- Choke Coils
- Fuse Mountings
- Substation Combinations
- Air Break Switches
- Bus Supports

*Memco builds  
 this equipment  
 in all standard  
 and special  
 sizes—ask for  
 bulletins of in-  
 terest to you.*

**Memco Engineering & Manufacturing Company, Inc.**  
 381 Hamilton Street, Long Island City, N. Y.

# PURIFYING TRANSFORMER OIL

FOR MONTREAL LIGHT, HEAT & POWER CO., LTD., MONTREAL, QUE.

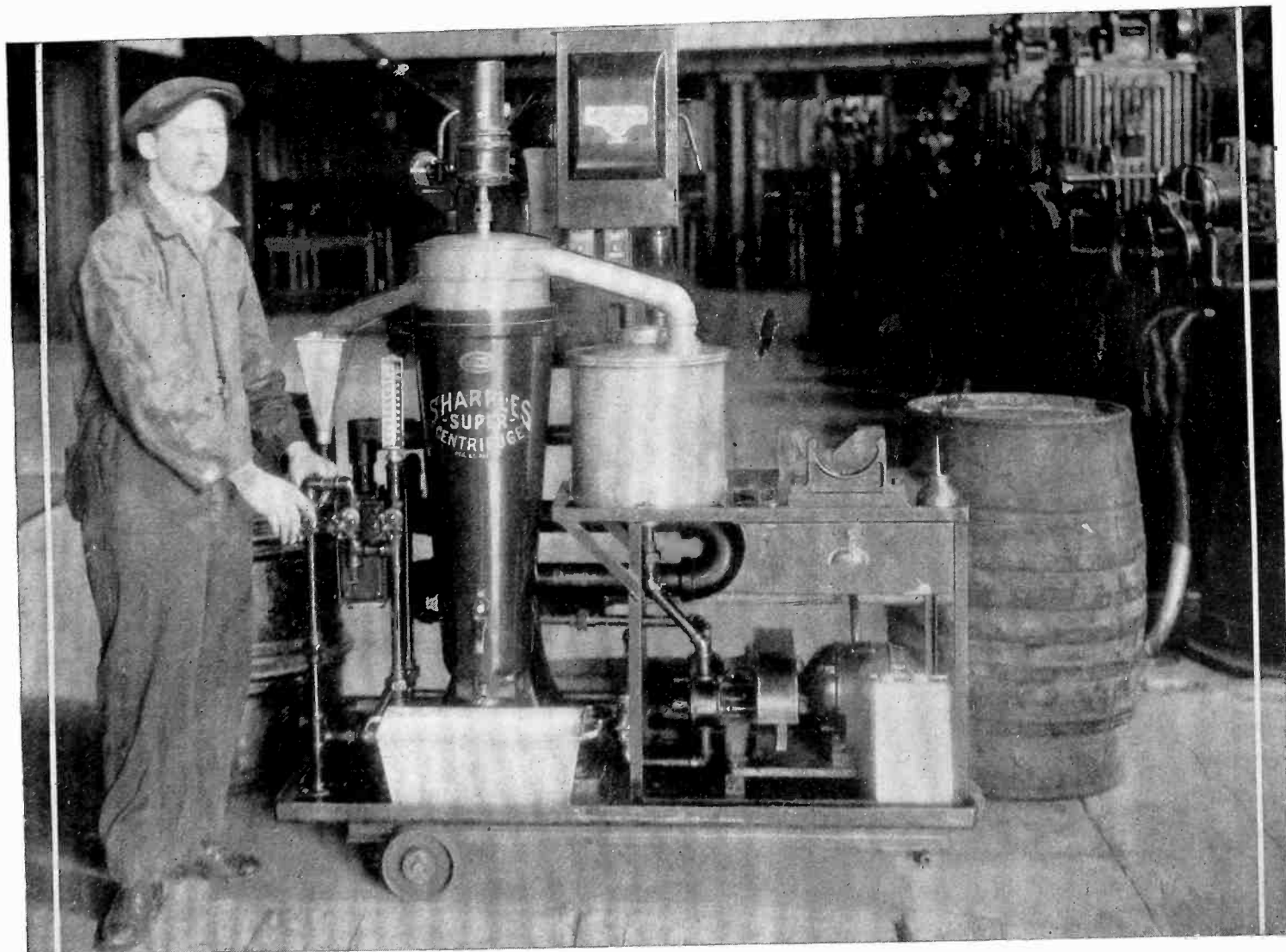

Unusually high dielectrics are secured by this Sharples Portable for the oil in the largest transformers on the system or for a drum of bad oil in the shop.

Sharples purifiers will produce more gallons of high dielectric oil per day because they are easy to start, easy to stop, easy to clean and develop the greatest centrifugal force available at high capacity. Complete data on request.

THE SHARPLES SPECIALTY COMPANY, 2324 WESTMORELAND STREET, PHILADELPHIA. Boston, New York, Pittsburgh, Chicago, Detroit, Tulsa, San Francisco, Los Angeles, Toronto. Factories in England and France.

# SHARPLES

CENTRIFUGAL ENGINEERS ♦ ♦ PHILADELPHIA

Please mention the JOURNAL of the A. I. E. E. when writing to advertisers.

# Achievement in Submarine Cables

Laying parallel and simultaneously three Submarine Cables across the Mississippi River at Davenport, Iowa, for the Peoples Power Company. Each Cable of the leadless three conductor type, four inches in diameter and one mile in length, operating at 15,000 volts.

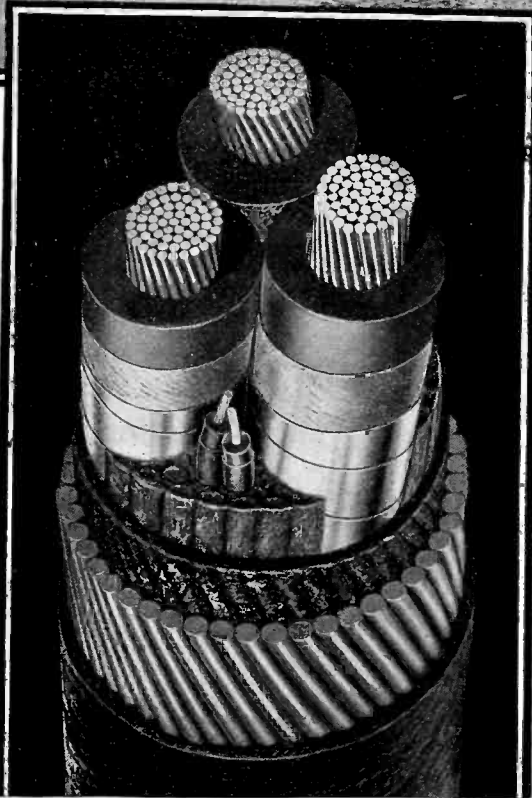
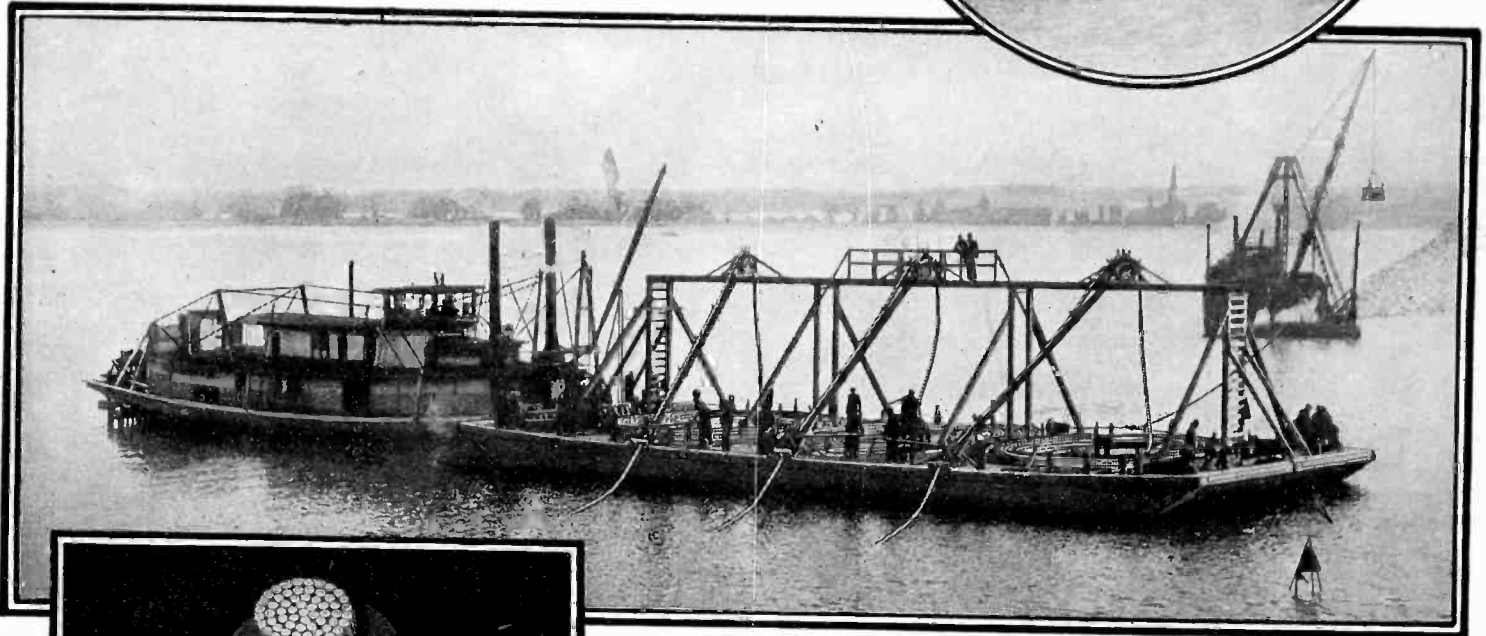
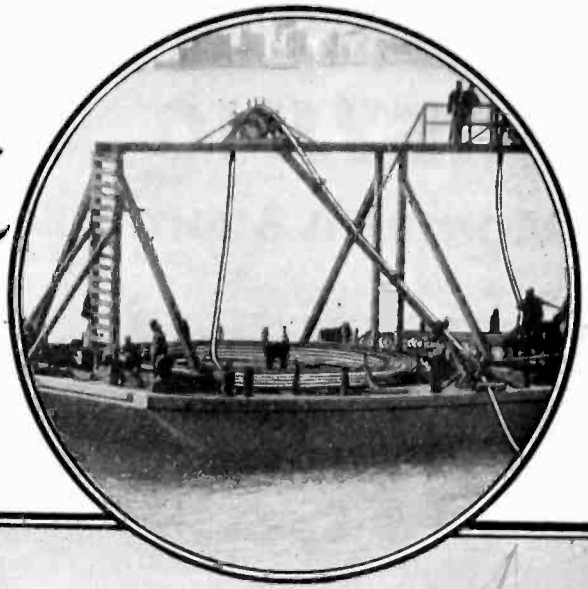

**T**HE development of submarine cables to meet every need—to render far longer service and assure the greatest efficiency of transmission—has been the constant aim of the American Steel & Wire Company.

Back of these outstanding products are years of wire making experience—and this is apparent in superior engineering service—reasonable cost, and proved quality.

No matter what your electrical problem may be—whether you need standard or special cables for submarine, overhead or underground use, you will find us ready to serve you efficiently and economically. We make cables in any quantity, of any size or type and for any voltage, to meet the most rigid specifications.

## AMERICAN STEEL & WIRE COMPANY

208 S. La Salle Street, Chicago

*Other Sales Offices:* Atlanta Baltimore Birmingham  
Denver Detroit Kansas City Memphis Milwaukee  
Pittsburgh Salt Lake City St. Louis

*Pacific Coast Distributors:* Columbia Steel Company,  
San Francisco Los Angeles Portland Seattle Honolulu

SUBSIDIARY UNITED STATES STEEL CORPORATION



30 Church Street, New York  
Boston Buffalo Cincinnati Cleveland Dallas  
Minneapolis-St. Paul Oklahoma City Philadelphia  
Wilkes-Barre Worcester

*Export Distributors:* United States Steel Products Co.,  
30 Church St., New York City

Please mention the JOURNAL of the A. I. E. E. when writing to advertisers.

# TALKING PICTURES CAME OUT OF THE TELEPHONE

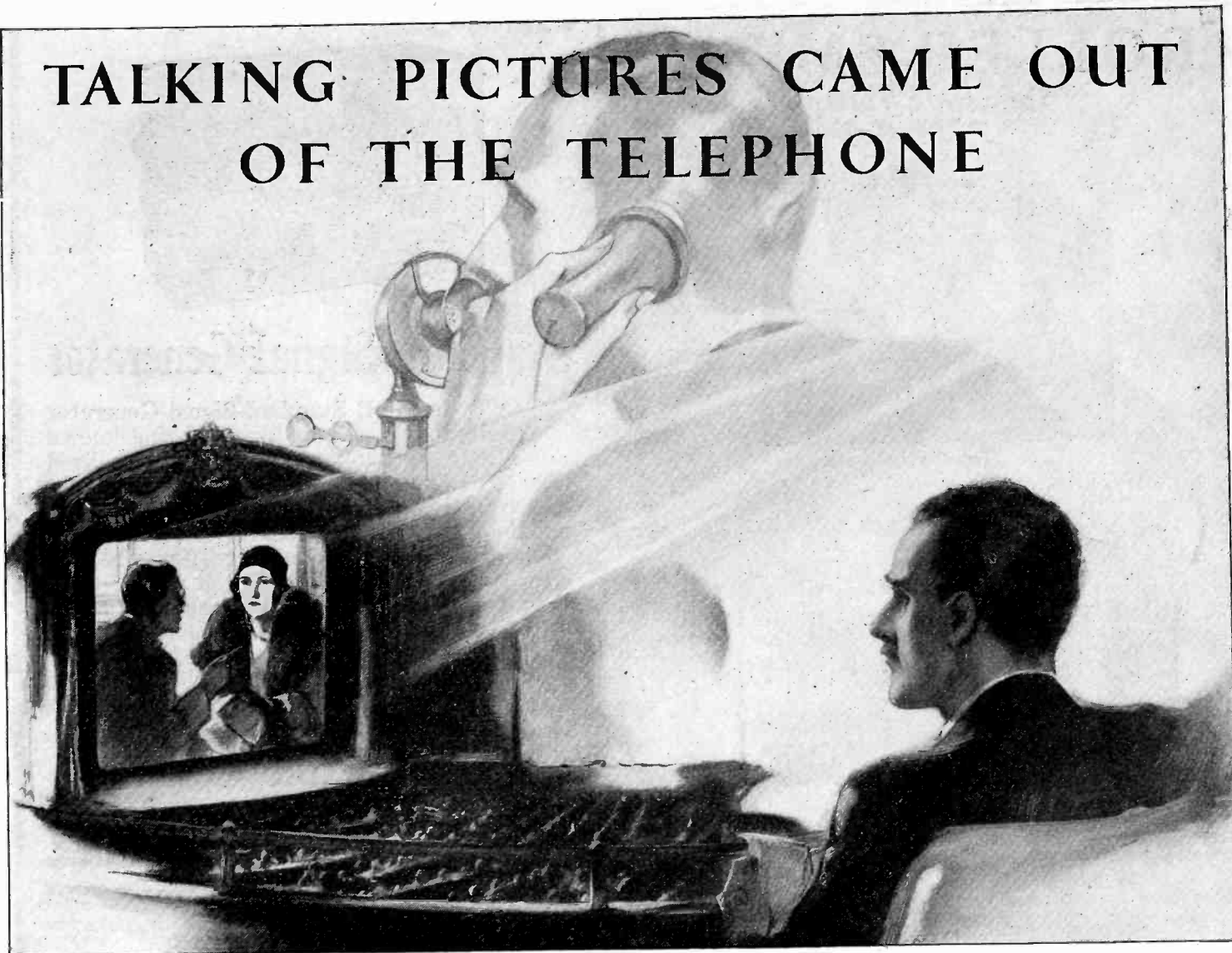

Made possible by  
*Western Electric* and now  
 broadened to industrial  
 and educational use . . .



*In Industry* a talking picture shows how a product is made and tested—one of many uses.

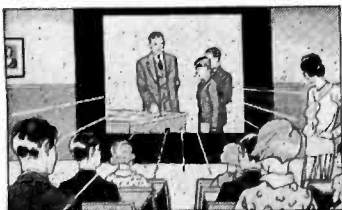

*In Education* the talking picture is used to supplement teaching and for teacher training.

You enjoy talking pictures today because telephone engineers developed the first successful system for recording and reproducing sound with motion pictures.

Western Electric, maker of Bell telephones, manufactured the apparatus.

Today 4000 of the country's leading theatres are Western Electric sound-

equipped. In them you enjoy all that personality and art which your favorite actors put into their lines and songs.

Business leaders and educators now recognize the non-theatrical talking picture as a valuable aid. In uses which range from selling automobiles to teaching civic government, vividness and realism make this medium a powerful force.

Western Electric licenses producers to make these pictures, and it manufactures portable reproducing apparatus. In the greater development to come, this company will continue to take a leading part.

**Western**  **Electric**  
**SOUND** **SYSTEM**

Made by the Makers of Bell Telephones

Northern Electric in Canada

Please mention the JOURNAL of the A. I. E. E. when writing to advertisers.



# ROLLER-SMITH

Type BME Tester  
For No. 6 Dry Cells



Tester in Use

The Type BME No. 6 Cell Tester meets the need for an instrument with which the REAL condition of dry cells can be ascertained quickly.

There are two ordinary methods used in checking dry cells:  
(1) Voltage check with a voltmeter. Unsatisfactory, because a voltage reading is not a true indication of battery condition.  
(2) Current check with an ammeter. Unsatisfactory, because an ammeter test means a "dead short" on a battery and that is not good for it.

The BME Tester replaces these unsatisfactory methods and enables rapid and accurate testing of cells without the need of any special knowledge on the part of the user.

With ordinary care the instrument should last indefinitely.  
New Supplement No. 2 to Bulletin No. AE-210 is now ready.

Send for your copy

Over thirty-five years' instrument experience is back of

**ROLLER-SMITH COMPANY**  
Electrical Measuring and Protective Apparatus

MAIN OFFICE:  
12 Park Place, NEW YORK



WORKS:  
Bethlehem, Penna.

Offices in principal cities in U. S. A. and Canada



## Standard-Signal Generator

The Type 403-B Standard-Signal Generator is a calibrated oscillator for delivering known radio-frequency voltages which are localized between two terminals. Its principal use is in measuring radio field intensity (field strength) and in taking sensitivity, selectivity, and fidelity characteristics on radio receivers. It may be used either with or without modulation; a 400-cycle modulating oscillator is contained in the instrument and there is provision for supplying modulating voltages from an external oscillator.

Its range is from 500 to 1500 kilocycles, but others can be built to cover other bands on special order.

**GENERAL RADIO COMPANY**

Manufacturers of Electrical and Radio Laboratory Apparatus

30 State Street CAMBRIDGE, MASSACHUSETTS

# Getting New Facts Takes Time

Research should be done in anticipation of need

Research is the function of ENGINEERING FOUNDATION, the joint research instrumentality of:

*American Society of Civil Engineers*

*American Institute of Mining and Metallurgical Engineers*

*American Society of Mechanical Engineers*

*American Institute of Electrical Engineers*

The Foundation Aids Their Research Committees

## Engineering Societies Building

29 West 39th Street, New York

Write for Annual Report

Please cut out and mail this coupon to

Colonel E. A. Simmons, Chairman Endowment Committee,  
Room 1617, 29 West 39th Street, New York, N. Y.

Please send me information about Engineering Foundation and methods for contributing to the Funds for Research and the Library.

NAME .....

ADDRESS .....

(DATE) (INITIALS OF SOCIETY)

Please mention the JOURNAL of the A. I. E. E. when writing to advertisers.

# MASTER INSTRUMENTS for Industrial Service



Pattern 170—  
Current Transformer

Pattern 171—  
D. C. Volt or Ammeter

Pattern 172—  
A. C. Volt or Ammeter

Pattern 173—  
Single Phase Wattmeter

Pattern 174—  
VoltAmpWattmeter

Pattern 176—  
Thermal Voltmeter

Pattern 175—  
Polyphase Wattmeter

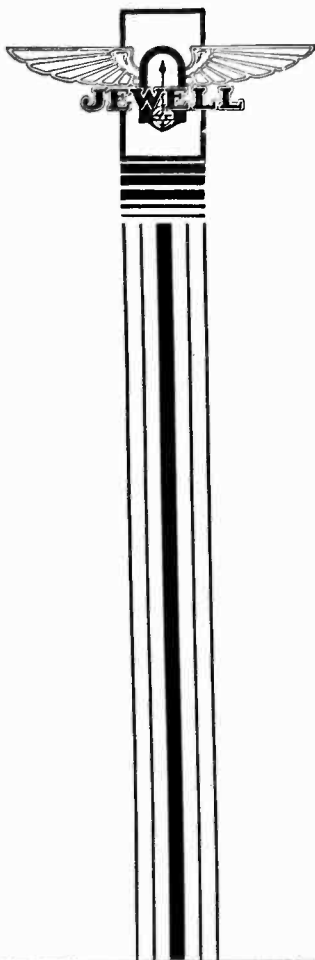

**J**EWELL Master Instruments are the logical choice for all types of field service, factory testing, and much industrial laboratory work. The complete line includes instruments in bakelite cases of uniform dimensions for practically every purpose.

Movements of Jewell Master Instruments are famous for their ability to maintain a high degree of consistent accuracy under the hardships of portable testing service.

Scales are much longer than scales of competitive instruments of comparable size. A remarkably large scale opening enclosed with non-shatterable glass makes reading easy and accurate. Write for descriptive bulletin which tells all about them.

No matter what your instrument requirements, you will profit by calling in a Jewell Representative and letting him show you the Jewell Instrument that will serve you best.

**JEWELL ELECTRICAL INSTRUMENT CO.**  
1650 Walnut St. Chicago, Illinois

30 YEARS MAKING GOOD INSTRUMENTS  
**JEWELL**

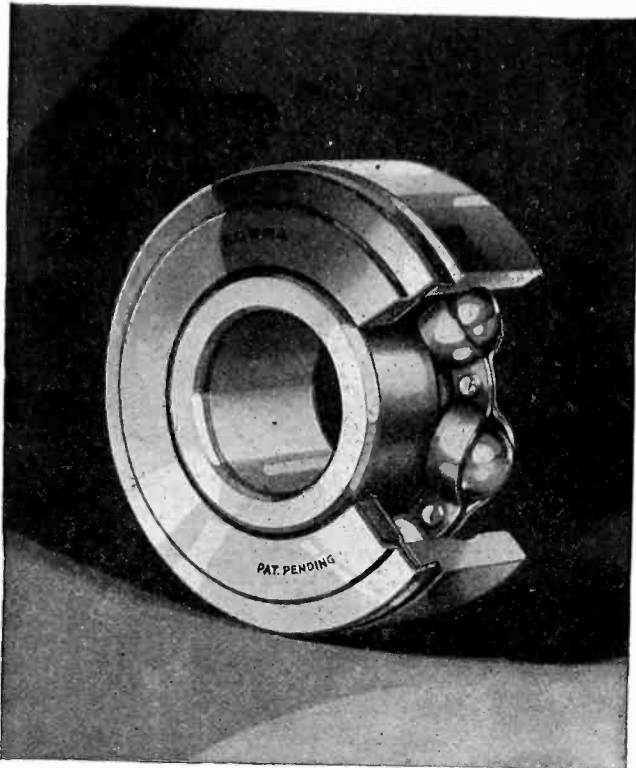

# Another "PRECISION" Bearing

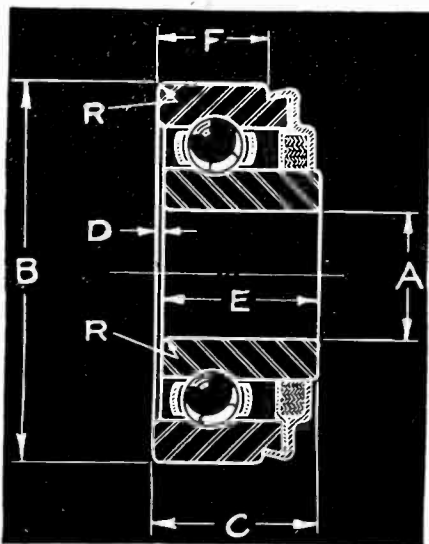
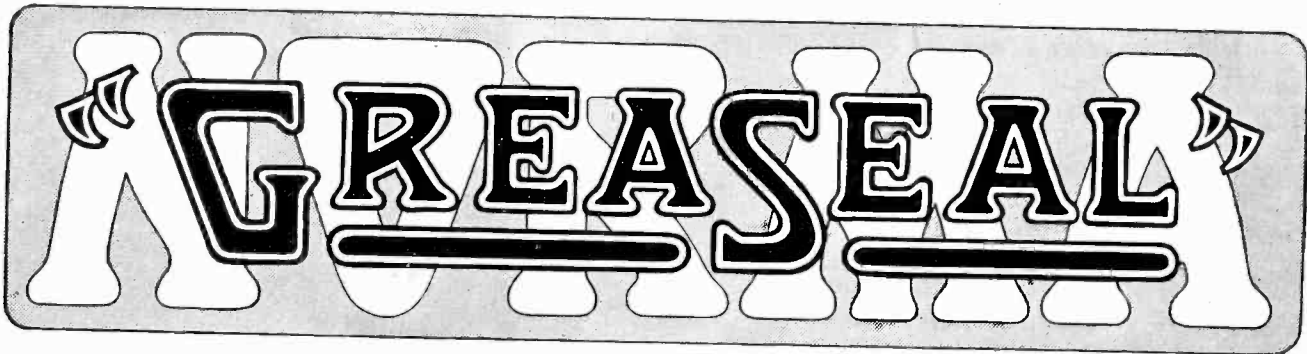

Write for the "Greaseal" Data Sheets, showing details of application

## BALL BEARING

*A Notably Better Bearing  
With Distinctive Economic Advantages*

A self-contained, self-sealed, grease-packed, dirt-proof bearing with a larger grease capacity, ready for years of service without renewal of lubricant.

Needs only the most simple and inexpensive mounting, with the very minimum of machining and assembling cost.

AN ALL-STEEL BEARING, WITH A SOLID, ONE-PIECE OUTER RING.

Bearing Number	Bore "A"		O. Dia. "B"		Width "C"	Offset "D"	Length "E"	Width "F"	RAD. "R"	
	M. M.	Inches	M. M.	Inches					M. M.	Inches
GS-96	6	.2362	19	.7480	.3543	.016	.3383	.2362	1	.039
GS-97	7	.2756	22	.8661	.4060	.016	.3900	.2756	1	.039
GS-98	8	.3150	22	.8661	.4060	.016	.3900	.2756	1	.039
GS-98246	6	.2362	24	.9449	.4060	.016	.3900	.2756	1	.039
GS-98247	7	.2756	24	.9449	.4060	.016	.3900	.2756	1	.039
GS-9824	8	.3150	24	.9449	.4060	.016	.3900	.2756	1	.039
GS-99	9	.3543	26	1.0236	.4527	.016	.4367	.3150	1	.039
GS-200	10	.3937	30	1.1811	.5118	.016	.4958	.3543	1	.039
GS-201	12	.4724	32	1.2598	.5512	.016	.5352	.3937	1	.039
GS-202	15	.5905	35	1.3780	.5905	.016	.5745	.4330	1	.039
GS-203	17	.6693	40	1.5748	.6693	.016	.6533	.4724	1	.039
GS-204	20	.7874	47	1.8504	.7480	.016	.7320	.5512	1	.039
GS-205	25	.9843	52	2.0472	.7874	.016	.7714	.5906	1	.039

**NORMA-HOFFMANN BEARINGS CORPORATION STAMFORD, CONN., U.S.A.**

NB-1967

Please mention the JOURNAL of the A. I. E. E. when writing to advertisers.

# A NEW 2300 VOLT MOTOR STARTER BY EC&M . . .

This is an entirely new development, specifically designed for the control of high voltage A. C. motors. It is intended for full voltage control of squirrel cage and synchronous motors and may be used to control the primary of slipping motors.

This new 2,300 volt starter is of very sturdy construction with high arc-rupturing capacity and at the same time, it is built to stand frequent operation handling heavy currents.

The starter is a single self-contained unit complete with overload relays, potential transformer (to secure 220 volts for the control circuit) and a Type ZHS Magnetic Contactor, totally enclosed and oil-immersed in a heavy welded steel tank.

This unit construction provides a dust-proof, flameproof and shockproof installation which may be mounted in dusty or explosive atmospheres with perfect safety, because all main contacts operate under oil and overload contacts can be supplied with flameproof contacts which operate in a vacuum. This eliminates the need of an expensive control room and permits the mounting of the starter out in the plant alongside of the motor it controls, thereby insuring a very low cost for conduit and wiring between the motor and starter.

Complete information on this equipment for reversing, non-reversing and plugging applications is given in Bulletin 1062-J, just off the press. Write for a copy.

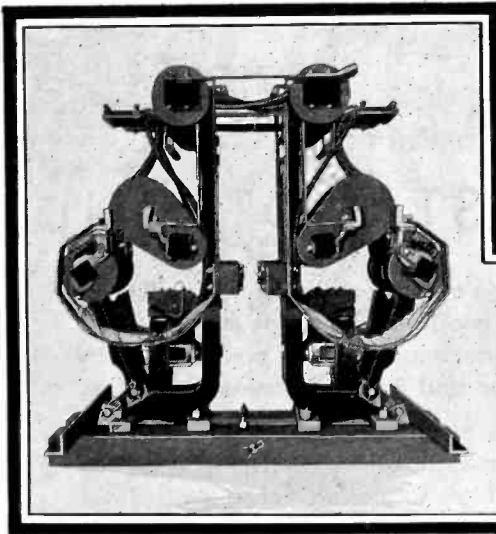

The double-contactor unit, mechanically interlocked, for reversing and plugging applications. Note the wide opening of contacts; this, combined with a high head and large volume of oil insures high arc-rupturing capacity.

The case for the single unit is shown directly below; a longer tank is used for reversing or plugging applications. Self-contained ammeters with their current transformers mounted in the case under the oil can be supplied.

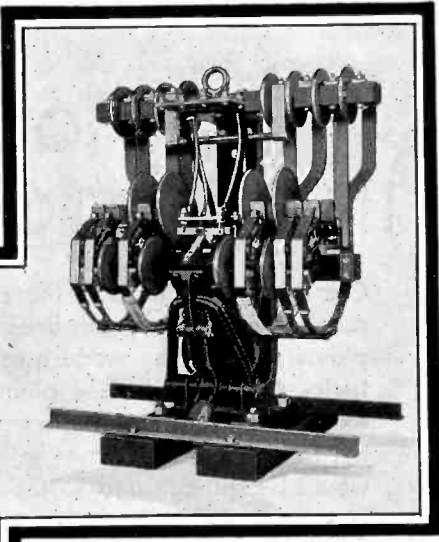

The single Type ZHS Magnetic Contactor, showing liberal electrical clearances, large bakelite barriers between phases and large contact areas.



## THE ELECTRIC CONTROLLER & MFG. CO.

NEW YORK-50 CHURCH ST.  
CHICAGO-CONWAY BLDG.  
DETROIT-DIME BANK BLDG.  
BIRMINGHAM-BROWN-MARX BLDG.  
CINCINNATI-127 NATIONAL BANK BLDG.  
ST. LOUIS-422 1/2 A CASTLEMAN AVE.

CLEVELAND, OHIO

LOS ANGELES-912 E. THIRD ST.  
HOUSTON-P.O. BOX 4182  
TORONTO-REFORD BLDG.

PHILADELPHIA-WITHERSPOON BLDG.  
PITTSBURGH-OLIVER BLDG.  
SAN FRANCISCO-CALL BUILDING  
MONTREAL-CASTLE BLDG.  
TULSA-217 E. ARCHER ST.  
SEATTLE-ALASKA BLDG.



Please mention the JOURNAL of the A. I. E. E. when writing to advertisers.





Control box and switch,  
and the insulation parts  
formed of Bakelite  
Materials. Made by  
Fairbanks-Morse & Co.,  
Chicago.

## OUT ON THE FARM INSULATION PARTS MUST NOT FAIL

Out in rural sections of the country, beyond the reach of power company lines, home electric light plants provide the modern convenience of electricity. In building these plants, Fairbanks-Morse exert every effort to attain absolute dependability. To make repairs many miles from the factory would be difficult and costly.

Only parts and materials with a reputation for reliability go into this equipment. With such a standard, Bakelite Materials were naturally selected

*Bakelite Engineering Service*—We manufacture a wide variety of phenol resinoid molding materials, varnishes, lacquers, enamels, cements, and other products. Twenty years experience in the development of these materials for electrical and other uses, provides a valuable background for the cooperation offered by our engineers and laboratories. Write for Booklets 3M, "Bakelite Molded" and 2L "Bakelite Laminated".

for the insulation of the control box and switch. Although twenty-two insulation parts are employed the varying requirements of all are satisfied by Bakelite Molded and Bakelite Laminated.

Throughout the electrical industry manufacturers confidently employ Bakelite Materials. Combining properties of high insulating value, mechanical strength, uniformity and resistance to heat, these materials are admirably suited to the industry's insulating jobs.

BAKELITE CORPORATION, 247 Park Avenue, New York      CHICAGO OFFICE, 635 West 22nd Street  
BAKELITE CORPORATION OF CANADA, LIMITED, 163 Dufferin Street, Toronto, Ontario

# BAKELITE

REGISTERED U. S. PAT. OFF.



"The registered Trade Mark and Symbol shown may be used only on products made from materials manufactured by Bakelite Corporation. Under the Logo for 'B' is the numerical sign for infinity, or unlimited quantity. It symbolizes the infinite number of present and future uses of Bakelite Corporation's products."

## THE MATERIAL OF A THOUSAND USES

Please mention the JOURNAL of the A. I. E. E. when writing to advertisers.

THEY KEEP A-RUNNING

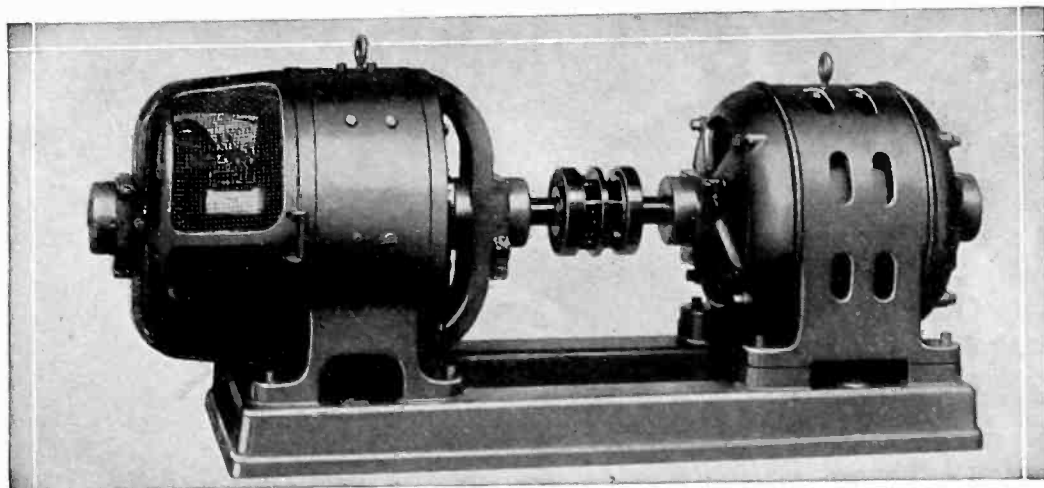

25 K. W. Motor Generator Set

## MOTOR GENERATOR SETS

*Rugged...Compact...Accessible*

Roth Motor Generator Sets are available in 2- and 4-bearing types—both types being generously proportioned, liberally rated, ruggedly built, and with all working parts easily accessible.... They are built in sizes from .3 to 100 KW for standard commercial power voltages and special voltages for Magnetic Chucks, Motion Picture Projection, Emergency Lighting, Signal Systems, Radio Broadcasting, Magnetic Separators and other applications.... Both Motors and Generators are regularly equipped with phosphor bronze sleeve bearings with ring oilers. Ball bearings can be supplied in all 2-bearing and most of the 4-bearing sets.

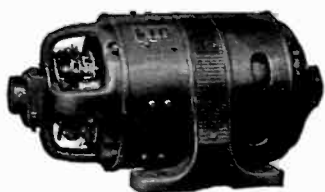

*The 2-bearing Motor Generator Set is especially compact. Its single-point center suspension maintains bearing alignment.*

*Bulletin 20-301 describes them.*

**ROTH BROTHERS AND COMPANY**

*Division of Century Electric Company*

1400 W. Adams St. • • • Chicago, Ill.

DIRECT CURRENT  
MOTORS AND  
GENERATORS

**ROTH**

MOTOR GENERATOR SETS AND ROTARY CONVERTORS



# Have You Tested **SHAKEPROOF** Lock Washers on Your Product

**T**HERE'S a real surprise waiting for you when Shakeproof Lock Washers are given a trial in your shop. This new locking method employs a principle that is totally different from the ordinary washer. The results are different, too—in fact, so different that you will be amazed at what you see.

Each twisted tooth of the Shakeproof Lock Washer forms a double lock—biting into both the nut and the work surface. Then, multiply this powerful action by the number of teeth on the washer and you can realize its tremendous holding strength.

Next, expose it to intense vibration—far greater than you ever expect your product to experience. You will see the teeth dig in deeper—never slipping or spreading and always holding the nut or screw absolutely tight. Make this test on your product now and see for yourself. Free samples will be furnished on request.



*"It's the Twisted Teeth that lock"*

## **SHAKEPROOF** Lock Washer Company

(Division of Illinois Tool Works)

2517 NORTH KEELER AVE.

CHICAGO, ILLINOIS

Please mention the JOURNAL of the A. I. E. E. when writing to advertisers.

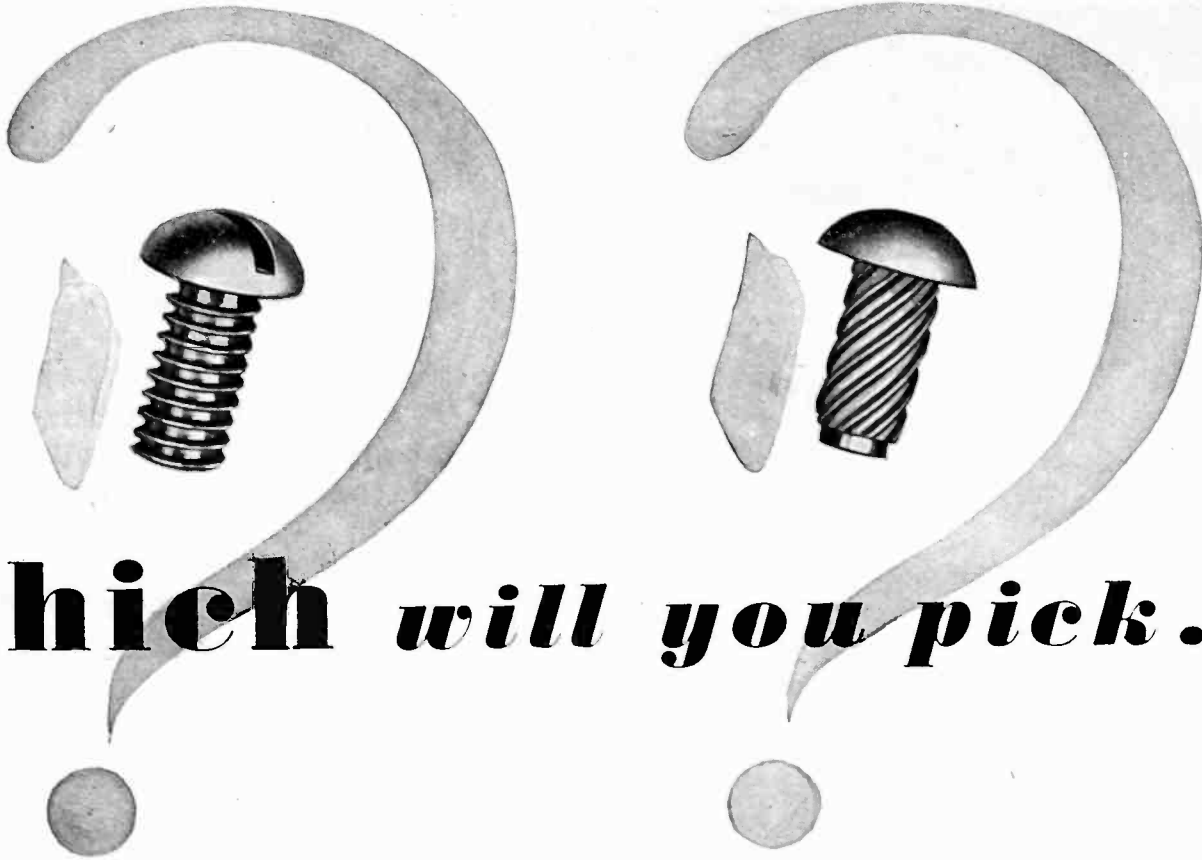

**Which will you pick...**

**the right one may save 50% in  
assembly time and labor!**

**A** FASTENING may often be made with a number of different devices. But one of them is almost certain to offer greater ease, speed or security. The wise manufacturer tests and compares one with another . . . then adopts the device most advantageous to the assembly of his product.

When an assembly requires a permanent fastening to iron, brass, aluminum, steel, Bakelite, etc., comparative tests usually result in the adoption of Hardened Metallic Drive Screws. No other means is so easy, speedy and economical.

Fastenings are made with these unique Screws in one simple operation. Just hammer them into holes drilled or molded in the material. They tap their own thread. And they make better fastenings than machine screws, escutcheon pins, etc.—they will not loosen under vibration.

Always try Hardened Metallic Drive Screws. If they are suitable for the assembly, you will save time, labor and money. Samples for test will be furnished free. Just send a brief description of your assembly.

PARKER-KALON CORPORATION, 198 Varick Street, NEW YORK

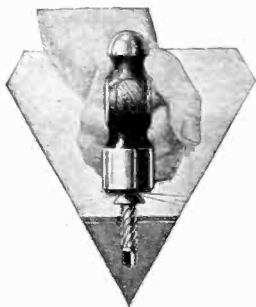

By using this unique Screw instead of a machine screw one company saved \$25,321 a year. Another cut assembly costs 50%. Still another speeded up production and improved their fastenings. These are typical examples of the advantages obtained through the elimination of costly and troublesome tapping operations.

**PARKER-KALON**  
TRADE MARK  
**HARDENED METALLIC**  
REG. U.S. PAT. OFF.  
**Drive Screws**

PAT. JAN. 29, 1924-No. 1482151-OTHERS PENDING



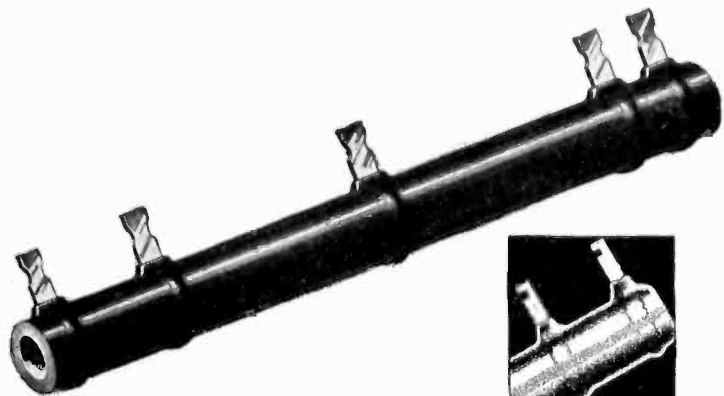

# VITROHM RESISTORS



## Refractory, Wire and Enamel

**M**OST engineers in the Electrical Industry know how we manufacture our resistors\*, and buy them.

Yet more is purchased than refractory, wire, and enamel when VITROHM  RESISTORS are specified. Added to the physical components and processes — each the finest possible — is the intangible leaven of experience gained during the past 39 years through the zeal of men

determined to make the best. This is protection when you SPECIFY VITROHM  RESISTORS.



There is no one terminal which can be used for all needs



Ward Leonard has had much experience in terminal practice



And, when knowing the application, can often suggest the most



Suitable type. The screw-type terminal above and the

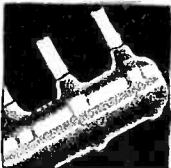

Plain tab-type shown here meet two entirely different conditions.



This terminal often saves time and money. It solders to the terminal screws.

\*Vitrohm Resistors are made by winding resistance wire of low temperature coefficient of resistivity upon a refractory tube. The resistance wire and terminal connections are then entirely surrounded by and completely protected with a fused-on coating of vitreous enamel.

**WARD LEONARD ELECTRIC CO.**  
Mount Vernon, New York  
*resistor specialists for more than 39 years*

# ELECTRITITE

**A high grade fibre board for electrical insulation.**

**A material of quality possessing high tensile and dielectric strength.**

**Tested and approved by the Underwriters' Laboratories.**

*Pulp Products Department*

**WEST VIRGINIA PULP & PAPER COMPANY**

230 Park Avenue  
New York, N. Y.

35 East Wacker Drive  
Chicago, Ill.



## CORES for Resistance Units

Threaded or grooved to any specifications, our Cores attain the perfection expected of 30 years' experience.

**AMERICAN LAVA CORPORATION**

27-67 Williamson St.,  
CHATTANOOGA, TENNESSEE  
*Manufacturers of Heat Resistant Insulators*

SHUNT WOUND BATTERY CHARGER

**THE DIVERTER POLE GENERATOR**

CONSTANT VOLTAGE INHERENT RUNS AS MOTOR SAFELY

ROCHESTER ELECTRIC PRODUCTS CORP. PATENTED JAN. 1926 ROCHESTER, N. Y. U. S. A.

**FOR ALL KINDS OF BATTERY CHARGING—WITH SAFETY & ECONOMY**  
*ESPECIALLY ADAPTED TO FULL FLOATING*

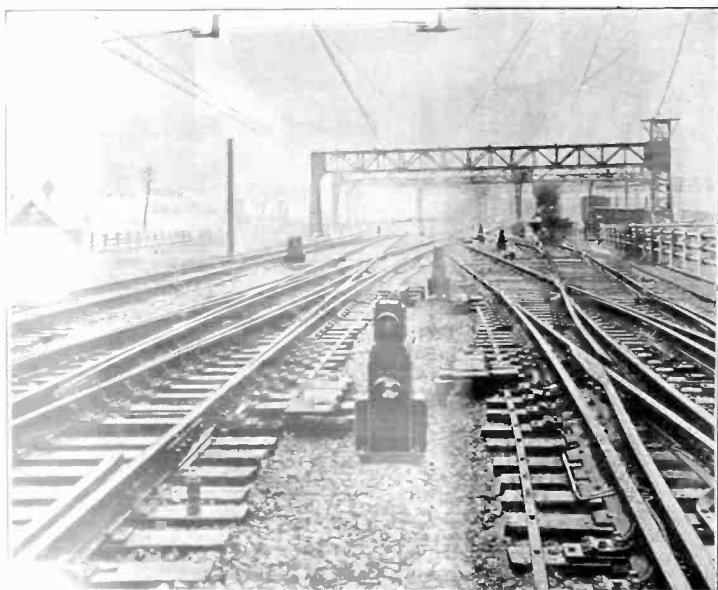

Western approach to the terminal

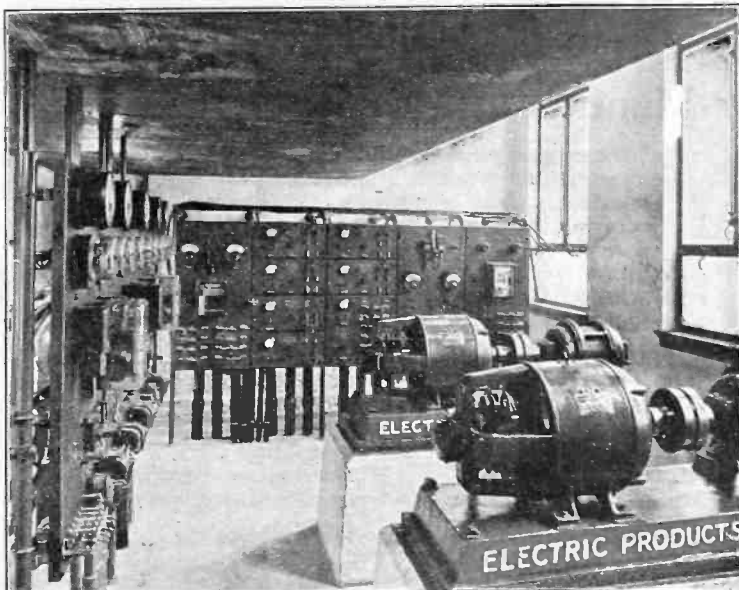

Power plant, track, and signal control

The new Cleveland Union Terminal (a \$175,000,000.00 project) is one of the world's greatest terminals. The power for the control of track and signal facilities is furnished by Diverter Pole generators floating with a 110 dl, 240 ampere hour Exide storage battery.

The rapidly growing use of Diverter Pole generators for installations where reliability and economy are both necessary makes it advisable to increase our manufacturing facilities, and we are pleased to announce our merger with the Electric Products Company of Cleveland, Ohio.

**ROCHESTER ELECTRIC PRODUCTS CORP., ROCHESTER, N. Y.** until September 1, 1930  
**ELECTRIC PRODUCTS COMPANY, 1725 Clarkstone Road, CLEVELAND, OHIO** after September 1, 1930

**BUILDERS OF D. I. MOTORS AND GENERATORS FOR 30 YEARS**

Please mention the JOURNAL of the A. I. E. E. when writing to advertisers.

Trade "ESCO" Mark

## ELECTRIC SPECIALTY CO.

Engineers and Manufacturers



DESIGN —  
DEVELOP —  
PRODUCE —

TYPE NA AIRPLANE GENERATOR

Small Motors, Generators, Dynamotors,  
Motor Generators, Rotary Converters, Etc.  
FOR SPECIAL PURPOSES—Send Us Your Problems

222 South Street, STAMFORD, CONN., U.S.A.

To . . . . . Engineers  
Manufacturers ✦ Inventors

We possess exceptional facilities for doing your experimental work . . . models, dies, tools, instruments, light machinery . . . general manufacturing . . . inventions developed. Customer's supervision in machine shop permitted. Over thirty years' specialized experience. Clients include Bell Telephone Laboratories, All-America Cables, Inc., and other well known organizations.

MANUFACTURERS' & INVENTORS' ELECTRIC CO.  
Incorporated 1897  
228 West Broadway, New York  
(Smith Building at Franklin St.)  
Tel. Walker 8687-8688 Cable Address "MANDIELECO"

## The Pioneer Manufacturer

— of —

# Interpole & Ball Bearing Motors

½ to 1000 H. P. D. C. and A. C.

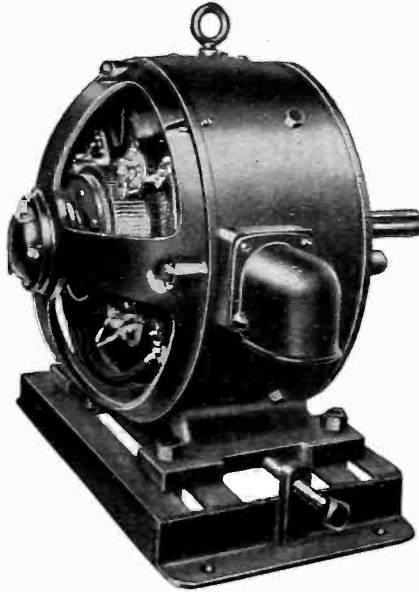

Type "S" Ball Bearing Motor

**ELECTRO DYNAMIC COMPANY**  
Manufacturers of Ball Bearing Motors Since 1904  
BAYONNE, N. J.  
Sales Offices in Principal Cities

"Quality for Half a Century"

## Complete Vapor Proof Motor Starting Installation

WHEN it's a motor starting installation and you are confronted with the problem of atmospheric conditions, it will pay you to investigate Rowan's complete line of oil immersed equipment.



# ROWAN CONTROL

THE ROWAN CONTROLLER CO., BALTIMORE, MD.

## Engineering Societies Employment Service

WALTER V. BROWN, Manager  
31 West 39th Street, New York City  
Tel. Penn. 9220

Chicago Office: 205 W. Wacker Drive  
San Francisco Office: 57 Post Street

Under the auspices of

- Am. Soc. of Civil Engineers
- Am. Soc. of Mech. Engineers
- Am. Inst. of Min. & Met. Engineers
- Am. Inst. of Electrical Engineers

You are invited to use this service, representing over fifty thousand members, to supply your needs for all classes of engineers, executives and assistants. Kindly be specific regarding requirements, salary, location, nature of work, etc.

Employers wishing to withhold their identity will be sent records of candidates meeting requirements specified, otherwise, qualified applicants will be sent in person.

*Chandeysson*

**Generators**  
25 to 25,000 Amperes

Direct Connected to



**Motors**

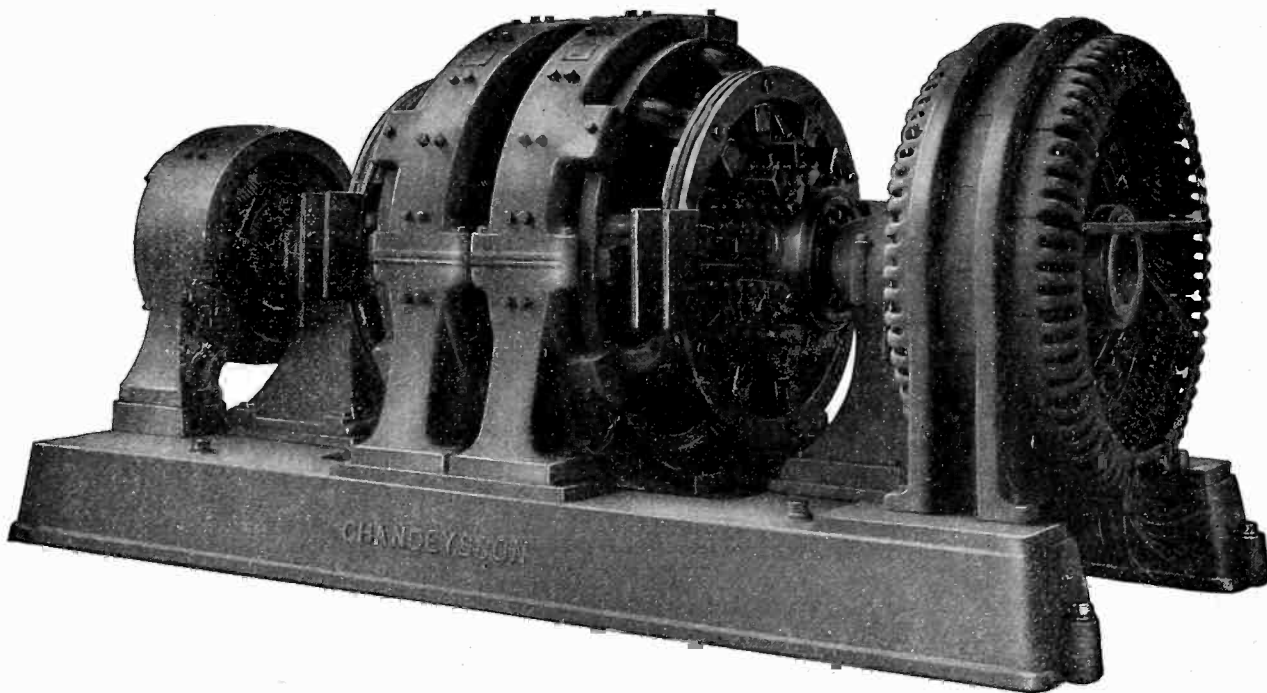

## TWIN GENERATOR TYPE

- 1 Greater Flexibility
- 2 Higher Efficiency
- 3 Floor Economy
- 4 Lower Cost

Write for Bulletin 114

CHANDEYSSON ELECTRIC CO., St. Louis, U. S. A.



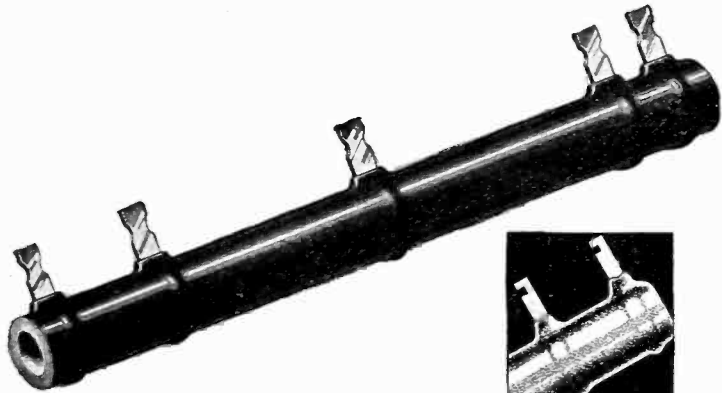

VITROHM  RESISTORS



**Refractory, Wire and Enamel**

**M**OST engineers in the Electrical Industry know how we manufacture our resistors\*, and buy them.

Yet more is purchased than refractory, wire, and enamel when VITROHM  RESISTORS are specified. Added to the physical components and processes — each the finest possible — is the intangible leaven of experience gained during the past 39 years through the zeal of men

determined to make the best. This is protection when you SPECIFY VITROHM  RESISTORS.

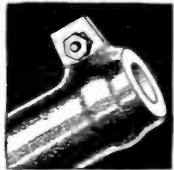

There is no one terminal which can be used for all needs

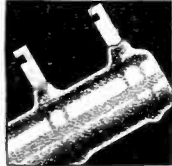

And, when knowing the application, can often suggest the most

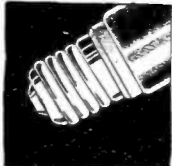

Suitable type. The screw-type terminal above and the

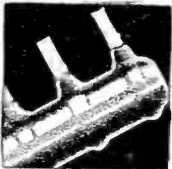

Plain tab-type shown here meet two entirely different conditions.



This terminal often saves time and money. It solders to the terminal screws.



Ward Leonard has had much experience in terminal practice

\*Vitrohm Resistors are made by winding resistance wire of low temperature coefficient of resistivity upon a refractory tube. The resistance wire and terminal connections are then entirely surrounded by and completely protected with a fused-on coating of vitreous enamel.

**WARD LEONARD ELECTRIC CO.**  
Mount Vernon, New York  
*resistor specialists for more than 39 years*

**ELECTRITE**

**A high grade fibre board for electrical insulation.**

**A material of quality possessing high tensile and dielectric strength.**

**Tested and approved by the Underwriters' Laboratories.**

*Pulp Products Department*

**WEST VIRGINIA PULP & PAPER COMPANY**

230 Park Avenue  
New York, N. Y.

35 East Wacker Drive  
Chicago, Ill.



**CORES for Resistance Units**

Threaded or grooved to any specifications, our Cores attain the perfection expected of 30 years' experience.

**AMERICAN LAVA CORPORATION**

27-67 Williamson St.,  
CHATTANOOGA, TENNESSEE

*Manufacturers of Heat Resistant Insulators*

SHUNT WOUND BATTERY CHARGER

**THE DIVERTER POLE GENERATOR**

CONSTANT VOLTAGE INHERENT RUNS AS MOTOR SAFELY

**FOR ALL KINDS OF BATTERY CHARGING—WITH SAFETY & ECONOMY**  
*ESPECIALLY ADAPTED TO FULL FLOATING*

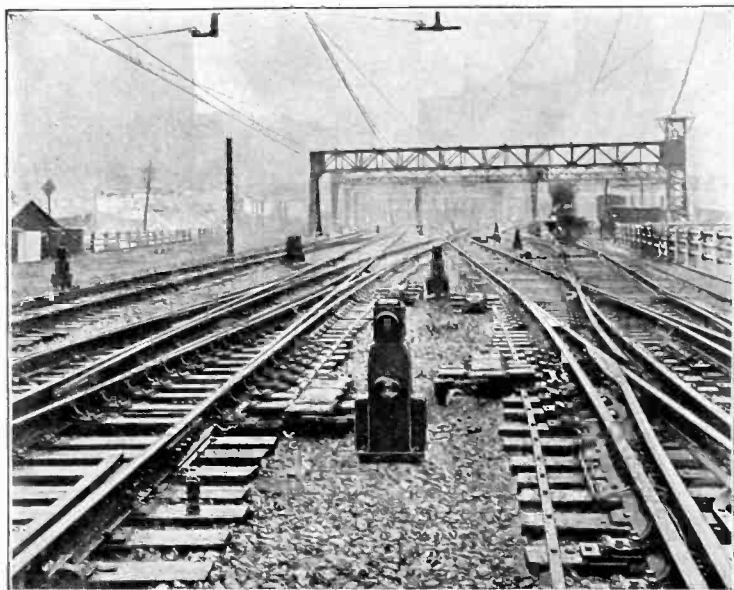

Western approach to the Terminal

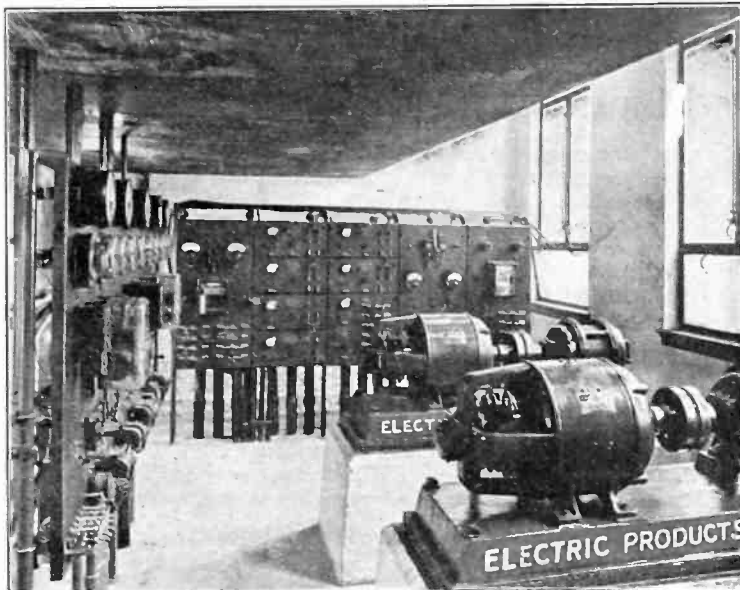

Power plant, track, and signal control

The new Cleveland Union Terminal (a \$175,000,000.00 project) is one of the world's greatest terminals. The power for the control of track and signal facilities is furnished by Diverter Pole generators floating with a 110 cell, 240 ampere hour Exide storage battery.

The rapidly growing use of Diverter Pole generators for installations where reliability and economy are both necessary makes it advisable to increase our manufacturing facilities, and we are pleased to announce our merger with the Electric Products Company of Cleveland, Ohio.

**ROCHESTER ELECTRIC PRODUCTS CORP., ROCHESTER, N. Y.** *until September 1, 1930*  
**ELECTRIC PRODUCTS COMPANY, <sup>1725</sup>Clarkstone Road, CLEVELAND, OHIO** *after September 1, 1930*

**BUILDERS OF D. C. MOTORS AND GENERATORS FOR 30 YEARS**

Please mention the JOURNAL of the A. I. E. E. when writing to advertisers.

Trade "ESCO" Mark

**ELECTRIC SPECIALTY CO.**

Engineers and Manufacturers



TYPE NA AIRPLANE GENERATOR

DESIGN —  
DEVELOP —  
PRODUCE —

Small Motors, Generators, Dynamotors,  
Motor Generators, Rotary Converters, Etc.

FOR SPECIAL PURPOSES—Send Us Your Problems

222 South Street, STAMFORD, CONN., U.S.A.

To . . . . . Engineers  
Manufacturers ✦ Inventors

We possess exceptional facilities for doing your experimental work . . . models, dies, tools, instruments, light machinery . . . general manufacturing . . . inventions developed. Customer's supervision in machine shop permitted. Over thirty years' specialized experience. Clients include Bell Telephone Laboratories, All-America Cables, Inc., and other well known organizations.

MANUFACTURERS' & INVENTORS' ELECTRIC CO.

Incorporated 1897

228 West Broadway, New York

(Smith Building at Franklin St.)

Tel. Walker 8687-8688

Cable Address "MANDIELECO"

*The Pioneer Manufacturer*

— of —

**Interpole & Ball Bearing Motors**

½ to 1000 H. P. D. C. and A. C.

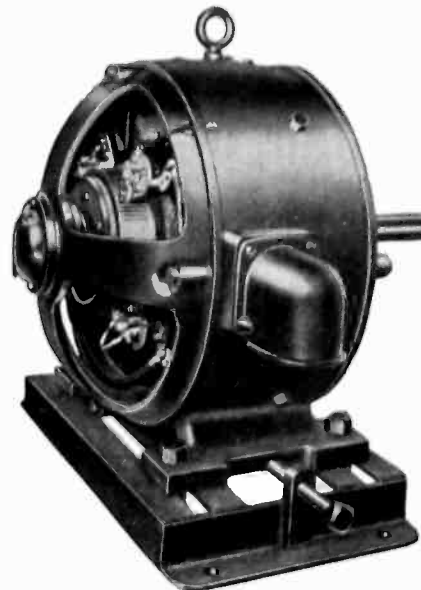

Type "S"  
Ball  
Bearing  
Motor

**ELECTRO DYNAMIC COMPANY**

Manufacturers of Ball Bearing Motors Since 1904

BAYONNE, N. J.

Sales Offices in Principal Cities

"Quality for Half a Century"

**Complete  
Vapor Proof Motor  
Starting Installation**

WHEN it's a motor starting installation and you are confronted with the problem of atmospheric conditions, it will pay you to investigate Rowan's complete line of oil immersed equipment.

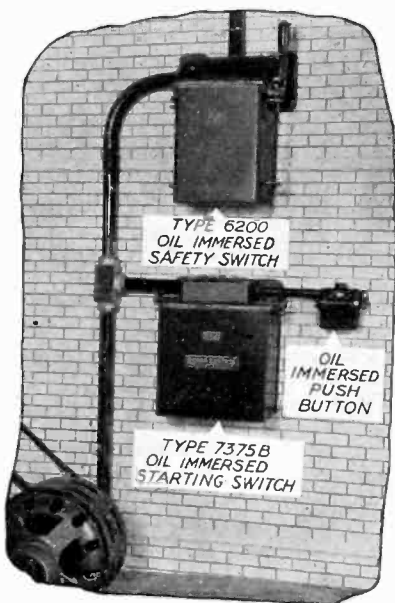

**ROWAN CONTROL**  
THE ROWAN CONTROLLER CO., BALTIMORE, MD.

**Engineering Societies  
Employment Service**

WALTER V. BROWN, Manager

31 West 39th Street, New York City

Tel. Penn. 9220

Chicago Office: 205 W. Wacker Drive

San Francisco Office: 57 Post Street

Under the auspices of

Am. Soc. of Civil Engineers

Am. Soc. of Mech. Engineers

Am. Inst. of Min. & Met. Engineers

Am. Inst. of Electrical Engineers

You are invited to use this service, representing over fifty thousand members, to supply your needs for all classes of engineers, executives and assistants.

Kindly be specific regarding requirements, salary, location, nature of work, etc.

Employers wishing to withhold their identity will be sent records of candidates meeting requirements specified, otherwise, qualified applicants will be sent in person.

*Chandeysson*

**Generators**  
25 to 25,000 Amperes

Direct Connected to



**Motors**

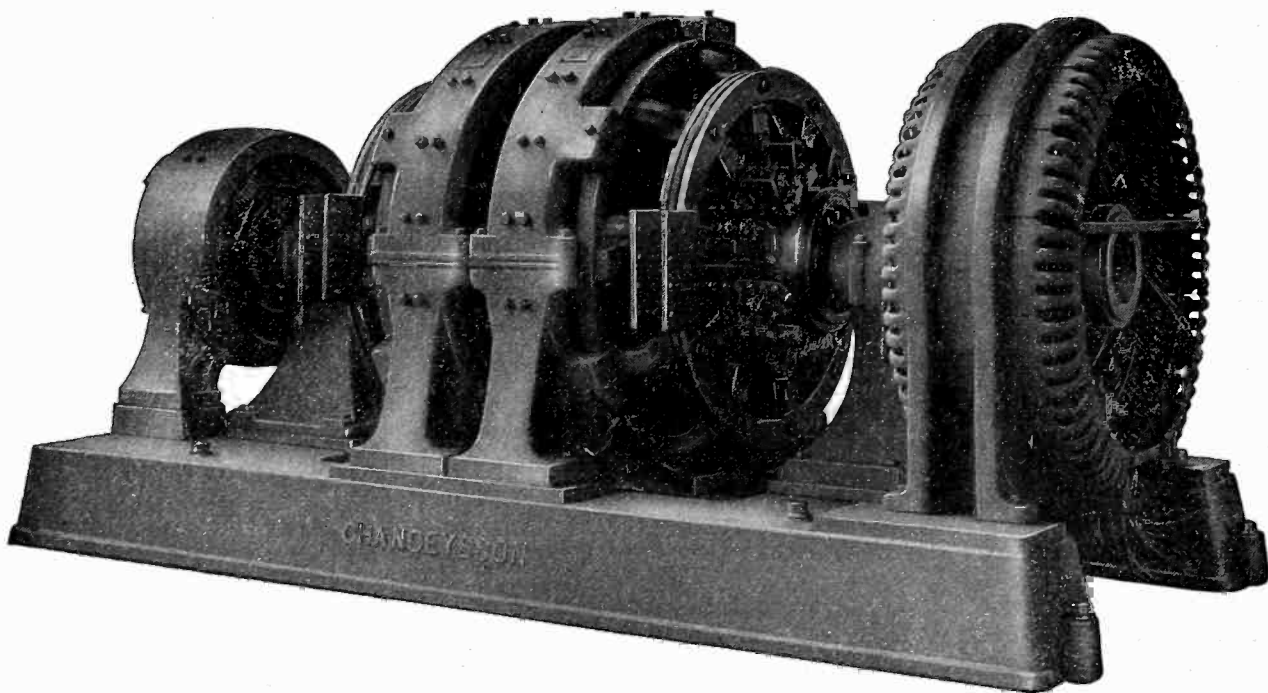

**TWIN GENERATOR TYPE**

- 1 Greater Flexibility
- 2 Higher Efficiency
- 3 Floor Economy
- 4 Lower Cost

Write for Bulletin 114

CHANDEYSSON ELECTRIC CO., St. Louis, U. S. A.



# PROFESSIONAL ENGINEERING DIRECTORY

For Consultants in the Fields of Engineering, and Related Arts and Sciences

## ALLIED ENGINEERS, Inc.

Engineers and Constructors

120 WALL STREET, NEW YORK

Birmingham, Ala. Jackson, Mich.

## EDWARD E. CLEMENT

Fellow A. I. E. E.

Attorney and Expert  
in Patent Causes

Soliciting, Consultation, Reports,  
Opinions

McLachlen Bldg. Washington, D. C.  
700 10th St., N. W.

## ROBERT S. KRUSE

Consultant for Radio  
Stations and Manufacturers

103 Meadowbrook Road Telephone  
West Hartford, Conn. Hartford 4-5327

## AMBURSEN DAMS

Hydroelectric Developments  
Water Supply and Irrigation Dams  
DAMS ON DIFFICULT FOUNDATIONS

AMBURSEN CONSTRUCTION CO.

Incorporated  
Grand Central Terminal, New York  
Kansas City, Mo. Atlanta, Ga.

## DAVID V. FENNESSY

Consulting Power Engineer

1108 Bassett Tower EL PASO, TEXAS

## N. J. NEALL

Consulting Engineer

for  
Electrical and Industrial Properties

12 Pearl Street 41 Broad Street  
BOSTON, MASS. NEW YORK CITY

## W. S. BARSTOW & COMPANY

Incorporated

Engineering Design  
Construction

50 Pine Street, New York  
412 Washington St., Reading, Pa.

## FORD, BACON & DAVIS

Incorporated

ENGINEERS

39 Broadway, New York

Philadelphia Chicago San Francisco  
New Orleans Chattanooga

## NEILER, RICH & CO.

Electrical and Mechanical  
Engineers

Consulting, Designing and  
Supervising

431 So. Dearborn St. — — — Chicago

## BATTEY & KIPP

Incorporated

ENGINEERS

Complete Industrial Plants  
Power Plants & Electrical Installations  
Engineering Reports, Analyses & Appraisals

231 South LaSalle Street CHICAGO

## FRANK F. FOWLE & CO.

Electrical and Mechanical  
Engineers

221 No. La Salle Street CHICAGO

## FARLEY OSGOOD

Consultant

Design, Construction, Operation  
Inter-Connection

of  
PUBLIC UTILITIES

National Bank of Commerce Building  
31 Nassau Street, New York, N. Y.  
Tel.: Rector 7878 Cable Address: Fargood

## BLACK & VEATCH

Consulting Engineers

Water, Steam and Electric Power Investiga-  
tions, Design, Supervision of Construction,  
Valuation and Tests.

Mutual Building KANSAS CITY, MO.

## FREYNGENGINEERING COMPANY

Industrial Electric Power  
Generation—Application—Purchase

Combustion Engineering  
Electric Furnace Installations

310 South Michigan Ave. CHICAGO

## G. R. SACKMAN, M. E.

Assoc. A. I. E. E.

Counsellor at Law  
PATENT ATTORNEY

1860 BROADWAY NEW YORK CITY  
Suite 1715-16 Phone: Columbus 8945

## ROBERT C. BURT, E. E., Ph. D. DONALD H. LOUGHRIDGE, Ph.D.

Consulting Physicists  
Designers and Makers of  
Scientific Instruments

327 So. Michigan Ave. PASADENA  
California

## HOOSIER ENGINEERING CO.

Erectors of  
Transmission Lines and Substations

100 W. Monroe Street  
CHICAGO

NEW YORK INDIANAPOLIS  
31 Nassau Street 5 E. Market Street

## SANDERSON & PORTER ENGINEERS

for the  
FINANCING—REORGANIZATION—  
DESIGN—CONSTRUCTION  
of  
INDUSTRIALS and PUBLIC UTILITIES

Chicago New York San Francisco

## BYLLESBY

ENGINEERING AND MANAGEMENT  
CORPORATION

231 S. La Salle Street  
CHICAGO

New York San Francisco

Dugald C. Jackson  
Edward L. Moreland

## JACKSON & MORELAND

CONSULTING ENGINEERS

31 St. James Ave. Boston, Mass.

## SARGENT & LUNDY

Incorporated

ENGINEERS

20 NORTH WACKER DRIVE  
CHICAGO, ILLINOIS

When you require technical advice —  
Or a solution to an engineering problem —

CONSULT THIS DIRECTORY

# PROFESSIONAL ENGINEERING DIRECTORY

For Consultants in the Fields of Engineering, and Related Arts and Sciences

**SCOFIELD ENGINEERING CO.**  
**CONSULTING ENGINEERS**  
 Utility and Industrial Plants  
 Design, Construction, Operation  
 Valuations and Appraisals  
**PHILADELPHIA**

**STOCKBRIDGE & BORST**  
 Patent Law  
 41 PARK ROW NEW YORK CITY

**THE J. G. WHITE**  
**ENGINEERING CORPORATION**  
 Engineers—Constructors  
 Oil Refineries and Pipe Lines,  
 Steam and Water Power Plants  
 Transmission Systems, Hotels, Apartments,  
 Offices and Industrial Buildings, Railroads  
 43 EXCHANGE PLACE NEW YORK

**JOHN A. STEVENS, INC.**  
 Established 1909  
**CONSULTING ENGINEERS**  
 Power Plants Paper Mills  
 Dye Houses Surveys  
**LOWELL, MASSACHUSETTS**

**STONE & WEBSTER**  
 Incorporated  
 DESIGN AND CONSTRUCTION  
 EXAMINATIONS APPRAISALS REPORTS  
 INDUSTRIAL AND PUBLIC SERVICE  
 PROPERTIES  
 New York Boston Chicago

**J. G. WRAY & CO.**  
 Engineers  
 J. G. Wray, Fellow A. I. E. E. Cyrus G. Hill  
 Utilities and Industrial Properties  
 Appraisals Construction Rate Surveys  
 Plans Organizations Estimates  
 Financial Investigations Management  
 2130 Bankers Bldg., Chicago

Your card in each issue of this publication—12 times a year, will keep your name and specialized service constantly before the electrical industry.

**ELECTRICAL  
 TESTING  
 LABORATORIES**  
 80th Street and East End Ave.  
**NEW YORK**

*Inspections — Tests — Research*  
 Tests may be used by the purchaser for the following purposes:  
 (1) **To determine the quality of competing samples. This enables the purchase of the best quality for the money.**  
 (2) **To make sure that shipments comply with specifications. This makes possible the assurance to the customer that shipments match buying samples.**  
 (3) **To furnish an impartial decision in case of disputes between purchaser and manufacturer.**  
 Testing places the whole buying problem on a sound basis.

## Science Abstracts

**A**LL electrical engineers actively engaged in the practice of their profession should subscribe to "Science Abstracts."

Published monthly by the Institution of Electrical Engineers, London, in association with the Physical Society of London, and with the cooperation of the American Institute of Electrical Engineers, the American Physical Society and the American Electrochemical Society, they constitute an invaluable reference library.

Through "Science Abstracts" engineers are enabled to keep in touch with engineering progress throughout the world, as one hundred and sixty publications, in various languages, are regularly searched and abstracted. "Science Abstracts" are published in two sections, as follows:

- "A"—PHYSICS—deals with electricity, magnetism, light, heat, sound, astronomy, chemical physics.**
- "B"—ELECTRICAL ENGINEERING—deals with electrical plant, power transmission, traction, lighting, telegraphy, telephony, wireless telegraphy, prime movers, engineering materials, electrochemistry.**

Through special arrangement, members of the A.I.E.E. may subscribe to "Science Abstracts" at the reduced rate of \$5.00 for each section, and \$10 for both. Rates to non-members are \$7.50 for each section and \$12.50 for both.

Subscriptions should start with the January issue. The first volume was issued in 1898. Back numbers are available, and further information regarding these can be obtained upon application to Institute headquarters.

**American Institute of Electrical Engineers**  
 33 West 39th Street, New York



Please mention the JOURNAL of the A. I. E. E. when writing to advertisers.

# Classified Advertiser's Index for Buyers

Manufacturers and agents for machinery and supplies used in the electrical and allied industries.

Note: For reference to the advertisements see the Alphabetical List of Advertisers on page 48.

- AIR COMPRESSORS**  
Allis-Chalmers Mfg. Co., Milwaukee  
General Electric Co., Schenectady  
Western Electric Co., All Principal Cities
- AMMETER COMPENSATING COILS**  
Minerallac Electric Co., Chicago
- AMMETER, VOLTMETERS**  
(See INSTRUMENTS, ELECTRICAL)
- ANCHORS, GUY**  
Copperweld Steel Co., Glassport, Pa.  
Kearney Corp., Jas. R., St. Louis  
Matthews Corp., W. N., St. Louis
- BATTERY CHARGING APPARATUS**  
Electric Specialty Co., Stamford, Conn.  
General Electric Co., Schenectady  
Rochester Electric Products Corp., Rochester, N. Y.  
Wagner Electric Corp., St. Louis  
Ward Leonard Electric Co., Mt. Vernon, N. Y.  
Western Electric Co., All Principal Cities  
Westinghouse Elec. & Mfg. Co., E. Pittsburgh
- BEARINGS, BALL**  
Norma-Hoffman Bearings Corp., Stamford, Conn.
- BOXES, FUSE**  
Bull Dog Electric Products Co., Detroit  
General Electric Co., Schenectady  
Kearney Corp., Jas. R., St. Louis  
Metropolitan Device Corp., Brooklyn, N. Y.  
Western Electric Co., All Principal Cities  
Westinghouse Elec. & Mfg. Co., E. Pittsburgh
- BOXES, JUNCTION**  
Burke Electric Co., Erie, Pa.  
G & W Elec. Specialty Co., Chicago  
Metropolitan Device Corp., Brooklyn, N. Y.  
Standard Underground Cable Co., Pittsburgh
- BRUSHES, COMMUTATOR**  
*Carbon*  
Morganite Brush Co., Inc., L. I. City, N. Y.  
National Carbon Co., Inc., Cleveland  
Westinghouse Elec. & Mfg. Co., E. Pittsburgh  
*Copper Graphite*  
Morganite Brush Co., Inc., L. I. City, N. Y.  
National Carbon Co., Inc., Cleveland  
Westinghouse Elec. & Mfg. Co., E. Pittsburgh
- BUS BARS, ALUMINUM**  
Aluminum Co. of America, Pittsburgh
- BUS BAR FITTINGS**  
Burke Electric Co., Erie, Pa.  
Burndy Engineering Co., Inc., New York  
Delta-Star Electric Co., Chicago  
General Electric Co., Schenectady  
Memco Engg. & Mfg. Co., L. I. City, N. Y.  
Ohio Brass Co., Mansfield, O.  
Westinghouse Elec. & Mfg. Co., E. Pittsburgh
- BUSHINGS, PORCELAIN**  
Ohio Brass Co., Mansfield, O.
- CABLE ACCESSORIES**  
Burke Electric Co., Erie, Pa.  
Delta-Star Electric Co., Chicago  
Dossert & Co., New York  
G & W Electric Specialty Co., Chicago  
General Electric Co., Schenectady  
Minerallac Electric Co., Chicago  
Standard Underground Cable Co., Pittsburgh  
Western Electric Co., All Principal Cities
- CABLE RACKS**  
Metropolitan Device Corp., Brooklyn, N. Y.
- CABLES**  
SEE WIRES AND CABLES
- CABLEWAYS**  
American Steel & Wire Co., Chicago  
Roebling's Sons Co., John A., Trenton, N. J.
- CASTINGS, ALUMINUM**  
Aluminum Co. of America, Pittsburgh
- CIRCUIT BREAKERS**  
*Air—Enclosed*  
Condit Elec. Mfg. Corp., Boston  
I-T-E Circuit Breaker Co., The, Philadelphia  
Roller-Smith Co., New York  
Ward Leonard Electric Co., Mt. Vernon, N. Y.  
Western Electric Co., All Principal Cities  
*Oil*  
Condit Electrical Mfg. Corp., Boston  
General Electric Co., Schenectady  
Pacific Electric Mfg. Corp., San Francisco  
Roller-Smith Co., New York  
Westinghouse Elec. & Mfg. Co., E. Pittsburgh
- CLAMPS, GUY & CABLE**  
Burke Electric Co., Erie, Pa.  
Burndy Engineering Co., Inc., New York  
Kearney Corp., Jas. R., St. Louis  
Matthews Corp., W. N., St. Louis
- CLAMPS, INSULATOR**  
Memco Engg. & Mfg. Co., L. I. City, N. Y.
- COILS, CHOKE**  
Burke Electric Co., Erie, Pa.  
General Electric Co., Schenectady  
Kearney Corp., Jas. R., St. Louis  
Memco Engg. & Mfg. Co., L. I. City, N. Y.  
Westinghouse Elec. & Mfg. Co., E. Pittsburgh
- COILS, MAGNET**  
Belden Mfg. Co., Chicago  
General Electric Co., Schenectady  
Westinghouse Elec. & Mfg. Co., E. Pittsburgh
- COMMUTATOR SEGMENTS AND RINGS**  
Mica Insulator Co., New York
- CONDENSATION PRODUCTS**  
Bakelite Corporation, New York
- CONDENSERS, RADIO**  
General Radio Co., Cambridge, Mass.  
Sangamo Electric Co., Springfield, Ill.
- CONDENSERS, STEAM**  
Allis-Chalmers Mfg. Co., Milwaukee  
General Electric Co., Schenectady  
Westinghouse Elec. & Mfg. Co., E. Pittsburgh
- CONDUIT, UNDERGROUND FIBRE**  
Western Electric Co., All Principal Cities
- CONNECTORS, SOLDERLESS**  
Burke Electric Co., Erie, Pa.  
Dossert & Co., New York  
Kearney Corp., Jas. R., St. Louis  
Westinghouse Elec. & Mfg. Co., E. Pittsburgh
- CONNECTORS AND TERMINALS**  
Belden Mfg. Co., Chicago  
Burke Electric Co., Erie, Pa.  
Burndy Engineering Co., Inc., New York  
Dossert & Co., New York  
G & W Electric Specialty Co., Chicago  
Western Electric Co., All Principal Cities  
Westinghouse Elec. & Mfg. Co., E. Pittsburgh
- CONTACTS, TUNGSTEN**  
General Electric Co., Schenectady
- CONTROL SYSTEMS**  
Ward Leonard Electric Co., Mt. Vernon, N. Y.
- CONTROLLERS**  
Electric Controller & Mfg. Co., Cleveland  
General Electric Co., Schenectady  
Rowan Controller Co., Baltimore, Md.  
Westinghouse Elec. & Mfg. Co., E. Pittsburgh
- CONVERTERS—SYNCHRONOUS**  
Allis-Chalmers Mfg. Co., Milwaukee  
Electric Specialty Co., Stamford, Conn.  
Wagner Electric Corp., St. Louis  
Westinghouse Elec. & Mfg. Co., E. Pittsburgh
- COPPER CLAD WIRE**  
Belden Mfg. Co., Chicago  
Western Electric Co., All Principal Cities
- COPPERWELD WIRE**  
Copperweld Steel Co., Glassport, Pa.  
Standard Underground Cable Co., Perth Amboy, N. J.
- CUT-OUTS**  
Bull Dog Electric Products Co., Detroit  
Condit Electrical Mfg. Corp., S. Boston  
General Electric Co., Schenectady  
G & W Electric Specialty Co., Chicago  
Kearney Corp., Jas. R., St. Louis  
Metropolitan Device Corp., Brooklyn, N. Y.  
Wagner Electric Corp., St. Louis  
Westinghouse Elec. & Mfg. Co., E. Pittsburgh
- DIMMERS, THEATRE**  
Ward Leonard Electric Co., Mt. Vernon, N. Y.
- DIVERTER POLE GENERATORS**  
Rochester Electric Products Corp., Rochester, N. Y.
- DYNAMOS**  
(See GENERATORS AND MOTORS)
- DYNAMOTORS**  
Burke Electric Co., Erie, Pa.  
Electric Specialty Co., Stamford, Conn.  
Rochester Electric Products Corp., Rochester, N. Y.
- ELECTRIFICATION SUPPLIES, STEAM ROAD**  
General Electric Co., Schenectady  
Ohio Brass Co., Mansfield, Ohio  
Westinghouse Elec. & Mfg. Co., E. Pittsburgh
- ENGINEERS, CONSULTING AND CONTRACTING**  
(See PROFESSIONAL ENGINEERING DIRECTORY)
- ENGINES**  
*Gas & Gasoline*  
Allis-Chalmers Mfg. Co., Milwaukee  
*Oil*  
Allis-Chalmers Mfg. Co., Milwaukee  
*Steam*  
Allis-Chalmers Mfg. Co., Milwaukee
- EXPERIMENTAL WORK**  
Manufacturers' and Inventors' Electric Co., New York
- FANS, MOTORS**  
Century Electric Co., St. Louis  
General Electric Co., Schenectady  
Wagner Electric Corp., St. Louis  
Westinghouse Elec. & Mfg. Co., E. Pittsburgh
- FLOW METERS**  
General Electric Co., Schenectady
- FURNACES, ELECTRIC**  
General Electric Co., Schenectady  
Westinghouse Elec. & Mfg. Co., E. Pittsburgh
- FUSES**  
*Enclosed Refillable*  
General Electric Co., Schenectady  
Westinghouse Elec. & Mfg. Co., E. Pittsburgh  
*Enclosed Non-Refillable*  
General Electric Co., Schenectady  
*Open Link*  
General Electric Co., Schenectady  
Metropolitan Device Corp., Brooklyn, N. Y.  
*High-Tension*  
Delta-Star Electric Co., Chicago  
Metropolitan Device Corp., Brooklyn, N. Y.
- FUSE MOUNTINGS**  
Memco Engg. & Mfg. Co., L. I. City, N. Y.
- FUSE PULLERS**  
Kearney Corp., Jas. R., St. Louis



Is your name on our mailing list for bulletins and catalog?

# Morganite Brushes

Morganite Brush Co., Inc.  
3302-3320 Anable Ave.,  
Long Island City,  
N. Y.

Please mention the JOURNAL of the A. I. E. E. when writing to advertisers.

# MOLONEY

## TRANSFORMERS

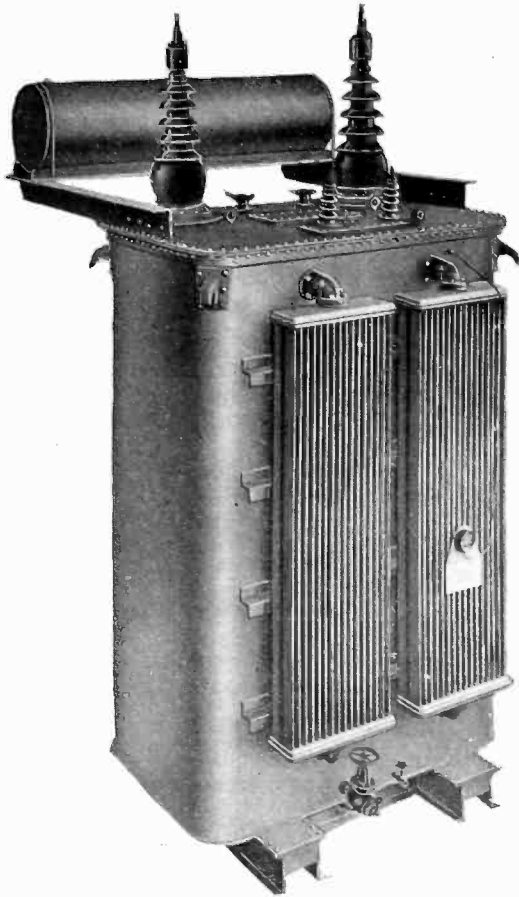

**MOLONEY power transformers totaling many hundred thousand KVA. in capacity are performing satisfactory service in all parts of the country.**

**MOLONEY distribution transformers likewise serve the industry in all sections of the country. A large stock is available at all times.**



**MOLONEY ELECTRIC CO., St. Louis, Mo.**

Please mention the JOURNAL of the A. I. E. E. when writing to advertisers.



# Classified Advertiser's Index for Buyers—Continued

- GEARS, FIBRE**  
General Electric Co., Schenectady
- GENERATORS AND MOTORS**  
Allis-Chalmers Mfg. Co., Milwaukee  
Burke Electric Co., Erie, Pa.  
Century Electric Co., St. Louis  
Chandeysson Electric Co., St. Louis  
Electric Specialty Co., Stamford, Conn.  
Electro-Dynamic Co., Bayonne, N. J.  
General Electric Co., Schenectady  
Rochester Electric Products Corp., Rochester, N. Y.  
Wagner Electric Corp., St. Louis  
Westinghouse Elec. & Mfg. Co., E. Pittsburgh
- GENERATING STATION EQUIPMENT**  
Allis-Chalmers Mfg. Co., Milwaukee  
Burke Electric Co., Erie, Pa.  
General Electric Co., Schenectady  
Westinghouse Elec. & Mfg. Co., E. Pittsburgh
- GROUND RODS**  
Copperweld Steel Co., Glassport, Pa.
- HARDWARE, POLE LINE AND INSULATOR**  
Ohio Brass Co., Mansfield, O.  
Westinghouse Elec. & Mfg. Co., E. Pittsburgh
- HEADLIGHTS**  
Ohio Brass Co., Mansfield, O.  
Westinghouse Elec. & Mfg. Co., E. Pittsburgh
- HEATERS, INDUSTRIAL**  
General Electric Co., Schenectady  
Westinghouse Elec. & Mfg. Co., E. Pittsburgh
- INDICATORS, REMOTE, WATER LEVEL**  
Bristol Co., The, Waterbury, Conn.
- INDICATORS, SPEED**  
Bristol Co., The, Waterbury, Conn.  
Roller-Smith Co., New York  
Weston Elec. Instr. Corp., Newark, N. J.
- INSTRUMENTS, ELECTRICAL**  
*Graphic*  
Bristol Co., The, Waterbury, Conn.  
Cambridge Instrument Co., New York  
Ferranti, Ltd., Hollinwood, England  
Ferranti, Inc., New York  
Ferranti Electric, Ltd., Toronto, Ont.  
General Electric Co., Schenectady  
Roller-Smith Co., New York  
Westinghouse Elec. & Mfg. Co., E. Pittsburgh  
*Indicating*  
Bristol Co., The, Waterbury, Conn.  
Cambridge Instrument Co., New York  
Ferranti, Ltd., Hollinwood, England  
Ferranti, Inc., New York  
Ferranti Electric, Ltd., Toronto, Ont.  
General Electric Co., Schenectady  
Jewell Elec. Instrument Co., Chicago  
Roller-Smith Co., New York  
Sangamo Electric Co., Springfield, Ill.  
Westinghouse Elec. & Mfg. Co., E. Pittsburgh  
Weston Elec. Instr. Corp., Newark, N. J.  
*Integrating*  
Ferranti, Ltd., Hollinwood, England  
Ferranti, Inc., New York  
Ferranti Electric, Ltd., Toronto, Ont.  
General Electric Co., Schenectady  
Sangamo Electric Co., Springfield, Ill.  
Western Electric Co., All Principal Cities  
Westinghouse Elec. & Mfg. Co., E. Pittsburgh  
*Radio*  
Cambridge Instrument Co., New York  
General Radio Co., Cambridge, Mass.  
Jewell Elec. Instrument Co., Chicago  
Roller-Smith Co., New York  
Weston Elec. Instr. Corp., Newark, N. J.  
*Repairing and Testing*  
Cambridge Instrument Co., New York  
Electrical Testing Laboratories, New York  
Jewell Elec. Instrument Co., Chicago  
Roller-Smith Co., New York  
Weston Elec. Instr. Corp., Newark, N. J.  
*Scientific Laboratory, Testing*  
Cambridge Instrument Co., New York  
General Electric Co., Schenectady  
Jewell Elec. Instrument Co., Chicago  
Metropolitan Device Corp., Brooklyn, N. Y.  
Roller-Smith Co., New York  
Western Electric Co., All Principal Cities  
Westinghouse Elec. & Mfg. Co., E. Pittsburgh  
Weston Elec. Instr. Corp., Newark, N. J.
- INSULATING MATERIALS**  
*Board*  
General Electric Co., Bridgeport, Conn.  
West Va. Pulp & Paper Co., New York  
*Cloth*  
General Electric Co., Bridgeport, Conn.  
Mica Insulator Co., New York  
Minerallac Electric Co., Chicago  
Westinghouse Elec. & Mfg. Co., E. Pittsburgh
- INSULATING MATERIALS—Continued**  
*Composition*  
American Lava Corp., Chattanooga  
Bakelite Corporation, New York  
Belden Mfg. Co., Chicago  
General Electric Co., Bridgeport, Conn.  
Westinghouse Elec. & Mfg. Co., E. Pittsburgh  
*Compounds*  
General Electric Co., Bridgeport, Conn.  
Mica Insulator Co., New York  
Minerallac Electric Co., Chicago  
Standard Underground Cable Co., Perth Amboy, N. J.  
Western Electric Co., All Principal Cities  
Westinghouse Elec. & Mfg. Co., E. Pittsburgh  
*Fibre*  
Belden Mfg. Co., Chicago  
General Electric Co., Bridgeport, Conn.  
West Va. Pulp & Paper Co., New York  
*Lava*  
American Lava Corp., Chattanooga, Tenn.  
*Mica*  
Chicago Mica Co., Valparaiso, Ind.  
Mica Insulator Co., New York  
Westinghouse Elec. & Mfg. Co., E. Pittsburgh  
*Paper*  
General Electric Co., Bridgeport, Conn.  
Mica Insulator Co., New York  
Westinghouse Elec. & Mfg. Co., E. Pittsburgh  
*Silk*  
General Electric Co., Bridgeport, Conn.  
*Tape*  
Belden Mfg. Co., Chicago  
General Electric Co., Bridgeport, Conn.  
Mica Insulator Co., New York  
Minerallac Electric Co., Chicago  
Okonite Co., The, Passaic, N. J.  
Western Electric Co., All Principal Cities  
Westinghouse Elec. & Mfg. Co., E. Pittsburgh  
*Varnishes*  
General Electric Co., Bridgeport, Conn.  
Mica Insulator Co., New York  
Minerallac Electric Co., Chicago  
Westinghouse Elec. & Mfg. Co., E. Pittsburgh
- INSULATORS, HIGH TENSION**  
*Composition*  
Burke Electric Co., Erie, Pa.  
General Electric Co., Schenectady  
*Glass*  
Hemingray Glass Co., Muncie, Ind.  
*Porcelain*  
Canadian Porcelain Co., Ltd., Hamilton, Ont.  
General Electric Co., Schenectady  
Lapp Insulator Co., Inc., LeRoy, N. Y.  
Locke Insulator Corp., Baltimore  
Ohio Brass Co., Mansfield, O.  
Thomas & Sons Co., R., Lisbon, O.  
Westinghouse Elec. & Mfg. Co., E. Pittsburgh  
*Post Type*  
Delta-Star Electric Co., Chicago  
Ohio Brass Co., Mansfield, O.
- INSULATORS, TELEPHONE & TELEGRAPH**  
Hemingray Glass Co., Muncie, Ind.  
Ohio Brass Co., Mansfield, O.
- INSULATOR PINS**  
Ohio Brass Co., Mansfield, O.  
Thomas & Sons Co., R., Lisbon, O.
- LAMP GUARDS**  
Matthews Corp., W. N., St. Louis
- LAVA**  
American Lava Corp., Chattanooga
- LIGHTNING ARRESTERS**  
Delta-Star Electric Co., Chicago  
General Electric Co., Schenectady  
Western Electric Co., All Principal Cities  
Westinghouse Elec. & Mfg. Co., E. Pittsburgh
- LOCOMOTIVES, ELECTRIC**  
General Electric Co., Schenectady  
Westinghouse Elec. & Mfg. Co., E. Pittsburgh
- LUBRICANTS**  
Texas Co., The, New York
- MAGNETIC SEPARATORS**  
Electric Controller & Mfg. Co., Cleveland
- METERS, ELECTRICAL**  
(See INSTRUMENTS ELECTRICAL)
- METER SEALS**  
Metropolitan Device Corp., Brooklyn, N. Y.
- MICA PRODUCTS**  
Chicago Mica Co., Valparaiso, Ind.  
Mica Insulator Co., New York  
Westinghouse Elec. & Mfg. Co., E. Pittsburgh
- MOLDED INSULATION**  
Bakelite Corporation, New York  
Belden Mfg. Co., Chicago  
Burke Electric Co., Erie, Pa.  
Westinghouse Elec. & Mfg. Co., E. Pittsburgh
- MOTORS**  
(See GENERATORS AND MOTORS)
- OHMMETERS**  
Jewell Elec. Instrument Co., Chicago  
Roller-Smith Co., New York  
Weston Elec. Instr. Corp., Newark, N. J.
- OIL SEPARATORS & PURIFIERS**  
Sharples Specialty Co., The, Philadelphia  
Westinghouse Elec. & Mfg. Co., E. Pittsburgh
- PANEL BOARDS**  
(See SWITCHBOARDS)
- PATENT ATTORNEYS**  
(See PROFESSIONAL ENGINEERING DIRECTORY)
- PLATING GENERATORS**  
Burke Electric Co., Erie, Pa.  
Chandeysson Elec. Co., St. Louis  
Electric Specialty Co., Stamford, Conn.  
Rochester Electric Products Corp., Rochester, N. Y.
- PLUGS**  
Delta-Star Electric Co., Chicago  
General Electric Co., Schenectady  
Westinghouse Elec. & Mfg. Co., E. Pittsburgh
- POLE LINE HARDWARE**  
Ohio Brass Co., Mansfield, O.
- POTHEADS**  
G & W Electric Specialty Co., Chicago  
Ohio Brass Co., Mansfield, O.  
Standard Underground Cable Co., Perth Amboy, N. J.
- PUBLIC ADDRESS SYSTEMS**  
Western Electric Co., All Principal Cities
- PULLERS, SLACK**  
Matthews Corp., W. N., St. Louis
- PUMPS**  
Allis-Chalmers Mfg. Co., Milwaukee
- RADIO LABORATORY APPARATUS**  
General Radio Co., Cambridge, Mass.  
Western Electric Co., All Principal Cities  
Westinghouse Elec. & Mfg. Co., E. Pittsburgh
- RAILWAY SUPPLIES, ELECTRIC**  
General Electric Co., Schenectady  
Ohio Brass Co., Mansfield, O.  
Westinghouse Elec. & Mfg. Co., E. Pittsburgh
- REACTORS**  
General Electric Co., Schenectady  
Metropolitan Device Corp., Brooklyn, N. Y.
- RECTIFIERS**  
General Electric Co., Schenectady  
Wagner Electric Corp., St. Louis  
Westinghouse Elec. & Mfg. Co., E. Pittsburgh
- REELS, PAYOUT AND TAKEUP**  
Matthews Corp., W. N., St. Louis
- REGULATORS, VOLTAGE**  
General Electric Co., Schenectady  
Westinghouse Elec. & Mfg. Co., E. Pittsburgh
- RELAYS**  
Automatic Electric, Inc., Chicago  
Condit Elec. Mfg. Corp., Boston  
Electric Controller & Mfg. Co., Cleveland  
General Electric Co., Schenectady  
Roller-Smith Co., New York  
Westinghouse Elec. & Mfg. Co., E. Pittsburgh
- RESISTORS, VITREOUS**  
Electrad, Inc., New York  
Ward Leonard Electric Co., Mt. Vernon, N. Y.
- RESISTOR UNITS**  
Electrad, Inc., New York  
General Electric Co., Schenectady  
Ward Leonard Electric Co., Mt. Vernon, N. Y.  
Westinghouse Elec. & Mfg. Co., E. Pittsburgh
- RHEOSTATS**  
General Electric Co., Schenectady  
Ward Leonard Electric Co., Mt. Vernon, N. Y.  
Western Electric Co., All Principal Cities  
Westinghouse Elec. & Mfg. Co., E. Pittsburgh
- ROPE, WIRE**  
American Steel & Wire Co., Chicago  
Roebbling's Sons Co., John A., Trenton, N. J.

Please mention the JOURNAL of the A. I. E. E. when writing to advertisers.

## The Most Significant Switchboard Achievement In Four Decades!

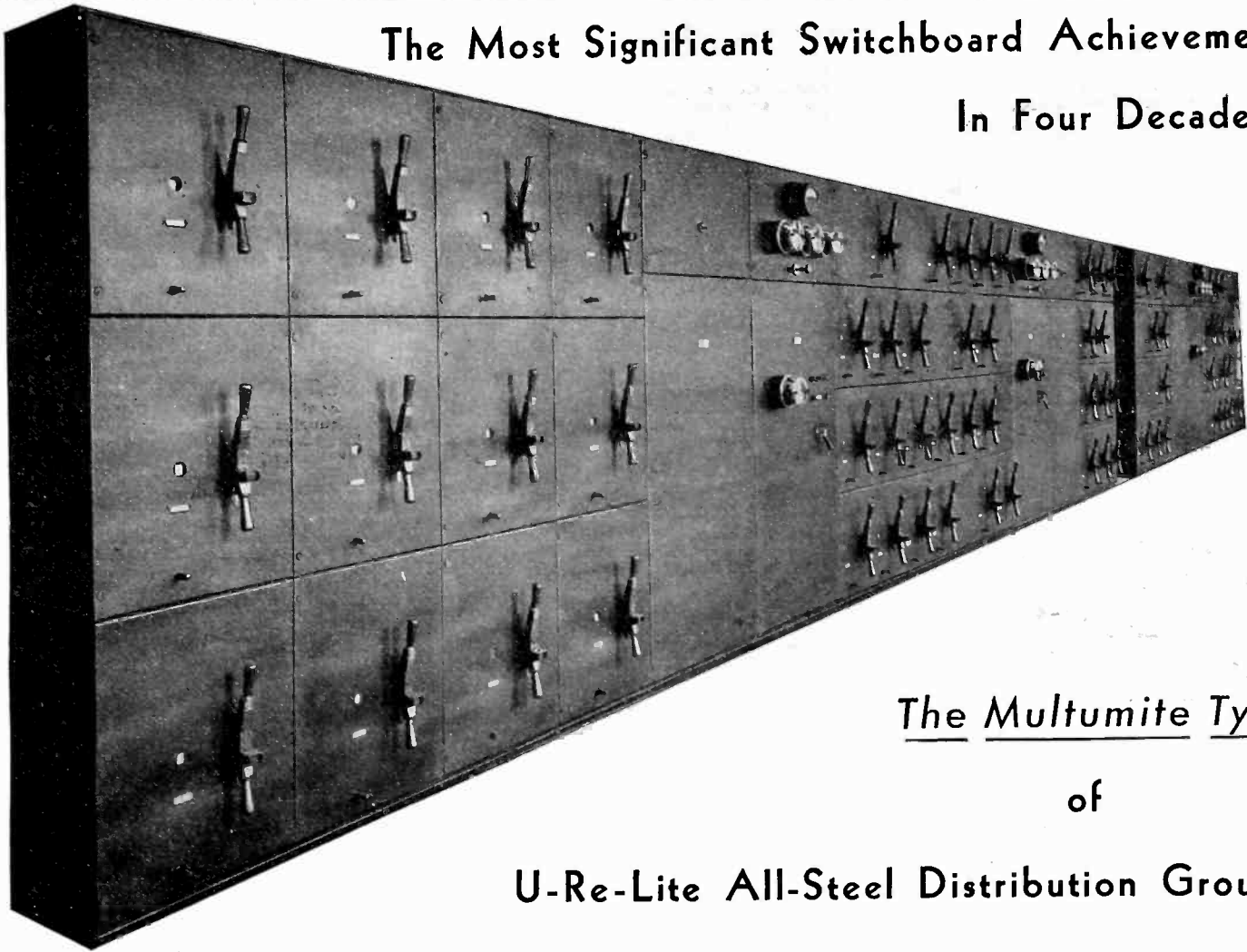

### The Multumite Type

of

### U-Re-Lite All-Steel Distribution Groups

Forty years ago, open switchboards consisted of switches, circuit breakers and meters, mounted on marble. Open switchboards today are practically the same, using slate instead of marble and with refinements in switches, circuit breakers and meters.

The Multumite type of U-Re-Lite All-Steel Distribution Groups, therefore, marks a real achievement in switchboard improvement.

The Multumite group combines these significant advantages:—

1. *Utmost Safety to Operators*—every live part, including buses, enclosed in steel—circuit breakers operated by insulated external U-Re-Lite handles and non-closable against overload or short circuit.

2. *Protection and Control*—positive overload and short circuit protection and time delay for lighting circuits—across-the-line starting of motors, combined with overload and short circuit protection.

3. *Rupturing Capacity*—U-Re-Lites with the new Min-Arc-Ite (minimum arc) barriers have higher rupturing capacities at 550 volts A.C. and under than any protective equipment of a like nature.

4. *Space Saving*—in less than one-third the length of an open switchboard, this group protects three 2500 ampere main circuits, with automatic transfer from normal to emergency

source; 66 feeder circuits ranging from 200 amperes to 1250 amperes each; and provides for 14 future feeders.

5. *Easy Accessibility*—to inspect the circuit breakers it is only necessary to open the hinged doors.

6. *Double Disconnects*—any feeder circuit breaker can be disconnected from the line and the load, easily and safely by means of disconnecting contacts on the rear of the circuit breaker panels (Hingite construction).

7. *Minimum Field Work*—these groups are shipped complete, can be inspected before shipment and the only field work required is bolting to floor channels, making main bus connections and running in feeder cables.

8. *Flexibility*—provision for future feeders can be made in present groups, or future groups can be added any time.

9. *Appearance*—the black Duco finish, the flush fronts and backs, and the uniform height of these groups add to the workmanlike appearance of any modern power plant.

It will pay you to study the application of a Multumite group to your switchboard requirements—get in touch with the nearest I-T-E representative.

I-T-E CIRCUIT BREAKER COMPANY  
19th and Hamilton Sts., Philadelphia

Birmingham, Boston, Buffalo, Chicago, Cincinnati, Cleveland, Dallas, Denver, Detroit, Duluth, Kansas City, Los Angeles, Minneapolis, Montreal, New Orleans, New York, Omaha, Philadelphia, Pittsburgh, St. Louis, San Francisco, Seattle, Toronto, Vancouver, Winnipeg.

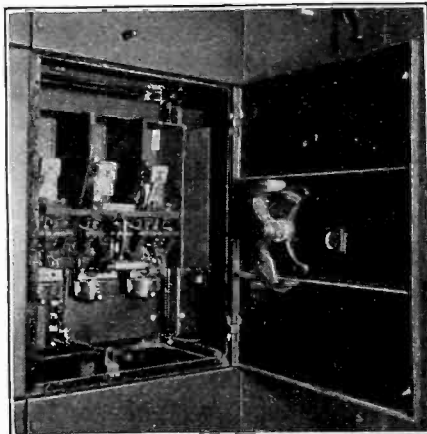

# Classified Advertiser's Index for Buyers—Continued

- SCREWS**  
*Drive Hardened Metallic*  
 Parker-Kalon Corp., New York  
*Self-Tapping Hardened*  
 Parker-Kalon Corp., New York  
*Sheet Metal, Hardened Self-Tapping:*  
 Parker-Kalon Corp., New York
- SEARCHLIGHTS**  
 General Electric Co., Schenectady  
 Westinghouse Elec. & Mfg. Co., E. Pittsburgh
- SLEEVE TWISTERS**  
 Kearney Corp., Jas. R., St. Louis
- SLEEVES, SPLICING**  
 Memco Engg. & Mfg. Co., L. I. City, N. Y.
- SOCKETS AND RECEPTACLES**  
 General Electric Co., Schenectady  
 Westinghouse Elec. & Mfg. Co., E. Pittsburgh
- SOLENOIDS**  
 Belden Mfg. Co., Chicago  
 Electric Controller & Mfg. Co., Cleveland  
 General Electric Co., Schenectady  
 Roebing's Sons Co., John A., Trenton, N. J.  
 Ward Leonard Electric Co., Mt. Vernon, N. Y.  
 Westinghouse Elec. & Mfg. Co., E. Pittsburgh
- SPRINGS**  
 American Steel & Wire Co., Chicago
- STARTERS, MOTORS**  
 Condit Electrical Mfg. Corp., Boston  
 Electric Controller & Mfg. Co., Cleveland  
 General Electric Co., Schenectady  
 Roller-Smith Co., New York  
 Rowan Controller Co., Baltimore, Md.  
 Ward Leonard Electric Co., Mt. Vernon, N. Y.  
 Westinghouse Elec. & Mfg. Co., E. Pittsburgh
- STOKERS, MECHANICAL**  
 Westinghouse Elec. & Mfg. Co., E. Pittsburgh
- SUB-STATIONS**  
 American Bridge Co., New York  
 General Electric Co., Schenectady  
 Memco Engg. & Mfg. Co., L. I. City, N. Y.  
 Westinghouse Elec. & Mfg. Co., E. Pittsburgh
- SWITCHBOARDS**  
 Allis-Chalmers Mfg. Co., Milwaukee  
 Bull Dog Electric Products Co., Detroit  
 Condit Electrical Mfg. Corp., Boston  
 General Electric Co., Schenectady  
 Metropolitan Device Corp., Brooklyn, N. Y.  
 Westinghouse Elec. & Mfg. Co., E. Pittsburgh
- SWITCHES**  
*Automatic Time*  
 General Electric Co., Schenectady  
 Minerallac Electric Co., Chicago  
 Westinghouse Elec. & Mfg. Co., E. Pittsburgh  
*Disconnecting*  
 Bull Dog Electric Products Co., Detroit  
 Burke Electric Co., Erie, Pa.  
 Condit Electrical Mfg. Corp., Boston  
 Delta-Star Electric Co., Chicago  
 General Electric Co., Schenectady  
 Kearney Corp., Jas. R., St. Louis  
 Matthews Corp., W. N., St. Louis  
 Memo Engg. & Mfg. Co., L. I. City, N. Y.  
 Pacific Elec. Mfg. Corp., San Francisco  
 Roller-Smith Co., New York  
 Westinghouse Elec. & Mfg. Co., E. Pittsburgh  
*Fuse*  
 Bull Dog Electric Products Co., Detroit  
 General Electric Co., Schenectady  
 Kearney Corp., Jas. R., St. Louis  
 Matthews Corp., W. N., St. Louis  
 Metropolitan Device Corp., Brooklyn, N. Y.  
*Knife*  
 Electric Controller & Mfg. Co., Cleveland  
 General Electric Co., Schenectady  
 Matthews Corp., W. N., St. Louis  
 Westinghouse Elec. & Mfg. Co., E. Pittsburgh  
*Magnetic*  
 Electric Controller & Mfg. Co., Cleveland  
 Ward Leonard Electric Co., Mt. Vernon, N. Y.  
*Oil*  
 Condit Electrical Mfg. Corp., Boston  
 General Electric Co., Schenectady  
 Pacific Elec. Mfg. Corp., San Francisco  
 Roller-Smith Co., New York  
 Westinghouse Elec. & Mfg. Co., E. Pittsburgh  
*Remote Control*  
 Automatic Electric, Inc., Chicago  
 Condit Electrical Mfg. Corp., Boston  
 General Electric Co., Schenectady  
 Roller-Smith Co., New York  
 Rowan Controller Co., Baltimore, Md.  
 Westinghouse Elec. & Mfg. Co., E. Pittsburgh
- TELEPHONE CONNECTORS**  
 Kearney Corp., Jas. R., St. Louis
- TELEPHONE & SIGNALING SYSTEMS**  
 Automatic Electric, Inc., Chicago
- TERMINAL BLOCKS**  
 Burke Electric Co., Erie, Pa.
- TESTING LABORATORIES**  
 Electrical Testing Labs., New York
- TOWERS, TRANSMISSION**  
 American Bridge Co., New York
- TRANSFORMERS**  
 Allis-Chalmers Mfg. Co., Milwaukee  
 American Transformer Co., Newark, N. J.  
 Electric Service Co., Cincinnati  
 Ferranti, Ltd., Hollinwood, England  
 Ferranti, Inc., New York  
 Ferranti Electric, Ltd., Toronto, Ont.  
 General Electric Co., Schenectady  
 Kuhlman Electric Co., Bay City, Mich.  
 Moloney Electric Co., St. Louis  
 Sangamo Electric Co., Springfield, Ill.  
 Wagner Electric Corp., St. Louis  
 Westinghouse Elec. & Mfg. Co., E. Pittsburgh
- Factory*  
 American Transformer Co., Newark, N. J.  
 Kuhlman Electric Co., Bay City, Mich.  
 Moloney Electric Co., St. Louis, Mo.  
 Wagner Electric Corp., St. Louis
- Furnace*  
 Allis-Chalmers Mfg. Co., Milwaukee  
 American Transformer Co., Newark, N. J.  
 Moloney Electric Co., St. Louis  
 Westinghouse Elec. & Mfg. Co., E. Pittsburgh
- Metering*  
 American Transformer Co., Newark, N. J.  
 Ferranti, Ltd., Hollinwood, England  
 Ferranti, Inc., New York  
 Ferranti Electric, Ltd., Toronto, Ont.  
 Roller-Smith Co., New York  
 Sangamo Electric Co., Springfield, Ill.  
 Weston Elec. Inst. Corp., Newark, N. J.
- Radio*  
 American Transformer Co., Newark, N. J.  
 Ferranti, Ltd., Hollinwood, England  
 Ferranti, Inc., New York  
 Ferranti Electric, Ltd., Toronto, Ont.
- Street Lighting*  
 Kuhlman Electric Co., Bay City, Mich.
- TRANSFORMERS, USED**  
 Electric Service Co., Cincinnati
- TROLLEY LINE MATERIALS**  
 General Electric Co., Schenectady  
 Ohio Brass Co., Mansfield, O.  
 Westinghouse Elec. & Mfg. Co., E. Pittsburgh
- TURBINES, HYDRAULIC**  
 Allis-Chalmers Mfg. Co., Milwaukee
- TURBINES, STEAM**  
 Allis-Chalmers Mfg. Co., Milwaukee  
 General Electric Co., Schenectady  
 Westinghouse Elec. & Mfg. Co., E. Pittsburgh
- TURBO-GENERATORS**  
 Allis-Chalmers Mfg. Co., Milwaukee  
 Westinghouse Elec. & Mfg. Co., E. Pittsburgh
- VALVE CONTROL, ELECTRIC**  
 Bristol Company, The, Waterbury, Conn.
- VALVES, BRASS**  
*Gas, Water, Steam*  
 Ohio Brass Co., Mansfield, O.
- VARNISHES, INSULATING**  
 General Electric Co., Bridgeport, Conn.  
 Mica Insulator Co., New York  
 Minerallac Electric Co., Chicago  
 Westinghouse Elec. & Mfg. Co., E. Pittsburgh
- WASHERS, LOCK**  
 Shakeproof Lock Washer Co., Chicago
- WELDING MACHINES, ELECTRIC**  
 Burke Electric Co., Erie, Pa.  
 General Electric Co., Schenectady  
 Ohio Brass Co., Mansfield, O.  
 Westinghouse Elec. & Mfg. Co., E. Pittsburgh
- WELDING WIRES & RODS**  
 Aluminum Co. of America, Pittsburgh  
 American Steel & Wire Co., Chicago  
 Ohio Brass Co., Mansfield, O.
- WIRES AND CABLES AND A. C. S. R.**  
*Aluminum*  
 Aluminum Co. of America, Pittsburgh  
*Armored Cable*  
 American Steel & Wire Co., Chicago  
 Belden Mfg. Co., Chicago  
 General Electric Co., Schenectady  
 Kerite Ins. Wire & Cable Co., New York  
 Okonite Company, The, Passaic, N. J.  
 Roebing's Sons Co., John A., Trenton, N. J.  
 Simplex Wire & Cable Co., Boston  
 Standard Underground Cable Co., Perth Amboy, N. J.  
 Western Electric Co., All Principal Cities  
*Asbestos Covered*  
 American Steel & Wire Co., Chicago  
 Belden Mfg. Co., Chicago  
 General Electric Co., Schenectady  
 Rockbestos Products Corp., New Haven, Conn.  
*Asbestos, Varnished Cambric*  
 Rockbestos Products Corp., New Haven, Conn.  
*Automotive*  
 American Steel & Wire Co., Chicago  
 Belden Mfg. Co., Chicago  
 General Electric Co., Schenectady  
 Kerite Ins. Wire & Cable Co., New York  
 Roebing's Sons Co., John A., Trenton, N. J.  
 Simplex Wire & Cable Co., Boston  
 Western Electric Co., All Principal Cities
- WIRES AND CABLES—Continued**  
*Bare Copper*  
 American Steel & Wire Co., Chicago  
 Anaconda Wire & Cable Co., New York  
 Belden Mfg. Co., Chicago  
 Roebing's Sons Co., John A., Trenton, N. J.  
 Standard Underground Cable Co., Perth Amboy, N. J.  
 Western Electric Co., All Principal Cities  
*Copper Clad*  
 Belden Mfg. Co., Chicago  
 Western Electric Co., All Principal Cities  
*Copperweld*  
 Copperweld Steel Co., Glassport, Pa.  
 Standard Underground Cable Co., Perth Amboy, N. J.  
*Flexible Cord*  
 American Steel & Wire Co., Chicago  
 Belden Mfg. Co., Chicago  
 General Electric Co., Schenectady  
 Okonite Company, The, Passaic, N. J.  
 Roebing's Sons Co., John A., Trenton, N. J.  
 Simplex Wire & Cable Co., Boston  
 Standard Underground Cable Co., Perth Amboy, N. J.  
*Flexible Cord, (Heater) Asbestos Insulated*  
 Rockbestos Products Corp., New Haven, Conn.  
*Heavy Duty Cord*  
 American Steel & Wire Co., Chicago  
 Belden Mfg. Co., Chicago  
 Okonite Company, The, Passaic, N. J.  
 Safety Cable Company, New York  
 Simplex Wire & Cable Co., Boston  
*Fuse*  
 Aluminum Co. of America, Pittsburgh  
 American Steel & Wire Co., Chicago  
 General Electric Co., Schenectady  
 Roebing's Sons Co., John A., Trenton, N. J.  
*Lead Covered (Paper and Varnished Cambric Insulated)*  
 American Steel & Wire Co., Chicago  
 Anaconda Wire & Cable Co., New York  
 General Electric Co., Schenectady  
 Kerite Ins. Wire & Cable Co., New York  
 Okonite Company, The, Passaic, N. J.  
 Okonite-Callender Cable Co., The, Inc., Passaic, N. J.  
 Roebing's Sons Co., John A., Trenton, N. J.  
 Safety Cable Company, New York  
 Simplex Wire & Cable Co., Boston  
 Standard Underground Cable Co., Perth Amboy, N. J.  
 Western Electric Co., All Principal Cities  
*Leads, Asbestos Insulated*  
 Rockbestos Products Corp., New Haven, Conn.  
*Magnet*  
 Aluminum Co. of America, Pittsburgh  
 American Steel & Wire Co., Chicago  
 Anaconda Wire & Cable Co., New York  
 Belden Mfg. Co., Chicago  
 General Electric Co., Schenectady  
 Roebing's Sons Co., John A., Trenton, N. J.  
 Western Electric Co., All Principal Cities  
*Magnet, Asbestos Insulated*  
 Rockbestos Products Corp., New Haven, Conn.  
*Rubber Insulated*  
 American Steel & Wire Co., Chicago  
 Belden Mfg. Co., Chicago  
 General Electric Co., Schenectady  
 Kerite Ins. Wire & Cable Co., New York  
 Okonite Company, The, Passaic, N. J.  
 Roebing's Sons Co., John A., Trenton, N. J.  
 Safety Cable Company, New York  
 Simplex Wire & Cable Co., Boston  
 Standard Underground Cable Co., Perth Amboy, N. J.  
 Western Electric Co., All Principal Cities  
*Switchboard, Asbestos Insulated*  
 Rockbestos Products Corp., New Haven, Conn.  
*Tree Wire*  
 Okonite Company, The, Passaic, N. J.  
 Roebing's Sons Co., John A., Trenton, N. J.  
 Simplex Wire & Cable Co., Boston  
 Standard Underground Cable Co., Perth Amboy, N. J.  
*Trolley*  
 American Steel & Wire Co., Chicago  
 Anaconda Wire & Cable Co., New York  
 Copperweld Steel Co., Glassport, Pa.  
 Roebing's Sons Co., John A., Trenton, N. J.  
 Standard Underground Cable Co., Perth Amboy, N. J.  
 Western Electric Co., All Principal Cities  
*Weatherproof*  
 American Steel & Wire Co., Chicago  
 Anaconda Wire & Cable Co., New York  
 Copperweld Steel Co., Glassport, Pa.  
 General Electric Co., Schenectady  
 Kerite Ins. Wire & Cable Co., New York  
 Okonite Company, The, Passaic, N. J.  
 Roebing's Sons Co., John A., Trenton, N. J.  
 Simplex Wire & Cable Co., Boston  
 Standard Underground Cable Co., Perth Amboy, N. J.  
 Western Electric Co., All Principal Cities
- WOOD RESIN**  
 Hercules Powder Co., Wilmington, Del.
- ZINC**  
 St. Joseph Lead Co., New York

Please mention the JOURNAL of the A. I. E. E. when writing to advertisers.

# RESTLESSNESS ...



A horse to "run in the money" must have spirit and surging vitality ... all evidenced at the post by a restless urge to get under way.

And business organizations in this respect are like horses. The laurels go to the organization that is never satisfied to let well enough alone ... the organization that is constantly striving for greater achievement and better service.

The Kuhlman organization has this restlessness ... this striving to better serve the light and power companies.

KUHLMAN ELECTRIC COMPANY, Bay City, Mich.

## KUHLMAN TRANSFORMERS

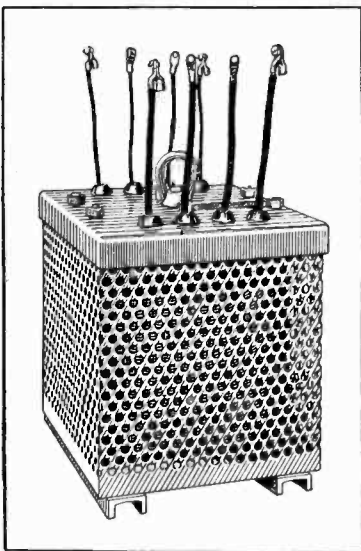

Akron, Ohio  
Electric Motor & Repair Co.  
High and Barges Sts.

Asheville, N.C.,  
Electric Supply Co.,  
Commerce Street.,

Atlanta, Georgia  
Roy Young  
1431 Healy Bldg.

Baltimore, Md.  
Industrial Power Equip. Co.  
421 W. Camden St.

Boston, Mass.  
Geo. H. Wahn Co.  
69-71 High Street

Buffalo, N. Y.  
John E. Hoffman  
280 Carolina St.

Chicago, Ill.  
John R. Smith  
844 Rush St.

Cincinnati, Ohio  
S. L. Currier  
833 Union Trust Bldg.

Cleveland, Ohio  
Public Service Supply Co.  
627 Union Trust Bldg.

Dallas, Texas  
F. T. Morrissey & Co.  
1408 Allen Bldg.

Denver, Colo.  
Joy & Cox, Inc.  
314 Tramway Bldg.

Detroit, Michigan  
Richard P. Johnson  
10-230 General Motors Bldg.

Indianapolis, Indiana  
Scott Jacqua Co., Inc.  
202 Indiana Terminal Whse.

Lincoln, Neb.  
Enterprise Electric Co.  
1425-35 M. St.

Los Angeles, Cal.  
Thomas Machinery Co.  
912 E. 3rd St.

Milwaukee, Wis.  
Wm. H. Fernholz  
1031 Clybourn St.

Minneapolis, Minn.  
Joseph L. Barnard  
2101 Blaisdel Ave.

Montreal, Quebec  
W. O. Taylor & Co.  
415 Canada Cement Bldg.

New Orleans, La.  
Lyman C. Reed  
1230 Hibernia Bank Bldg.

New York, N. Y.  
D. F. Potter, Jr.  
Graybar Bldg.

New York (Export)  
Parr Electric Export Corp.  
77 Warren St.

Omaha, Neb.  
J. H. Nicholson  
6315 N. 33rd St.

Philadelphia, Pa.  
J. Edward Bolich  
1015 Chestnut St.

Phoenix, Arizona  
Frank C. Fassett  
15 East Jackson St.

Pittsburgh, Pa.  
Continental Sales & Eng. Co.  
839 Oliver Bldg.

Richmond, Va.,  
Edwin Wortham, Engineers,  
Box 910.

San Francisco, Cal.  
C. F. Henderson  
Call Building

Seattle, Wash.  
Equipment Sales Co.  
514 Lloyd Bldg.

Toledo, Ohio  
Howard J. Wittman  
319 Spitzer Bldg.

York, Pa.  
Harry W. Motter  
25 N. Duke St.



*Flexibility - Durability - Long life*  
*in every length of*  
**TIREX Welding Cable**

Welding Cables must be unusually flexible and so designed as not to be a drag on the operator's wrist; they must be safe for both operator and public when used on streets and public ways; they must strip clean to facilitate making connections.

TIREX Welding Cable meets all of the above requirements. It consists of fine copper wires stranded to give maximum flexibility. The insulation is a "selenium rubber" compound, cured to meet the unusual service for which this type of cable was designed. It strips clean from the copper conductor because of the separator between the conductor and the insulation.

Where records are kept and the value of equipment is measured by performance under actual service conditions you will find TIREX "selenium rubber sheathed" Cables.

Write for full details, a sample and prices.

**SIMPLEX WIRE & CABLE CO**

MANUFACTURERS

201 DEVONSHIRE ST., BOSTON

BRANCH SALES OFFICES

CHICAGO, 564 W. Monroe St. SAN FRANCISCO, 390 Fourth St.  
 NEW YORK, 1328 B'way CLEVELAND, 2019 Union Trust Bldg.  
 PHILADELPHIA, 1227 Fidelity-Philadelphia Trust Building  
 JACKSONVILLE, 1010 Barnett National Bank Building

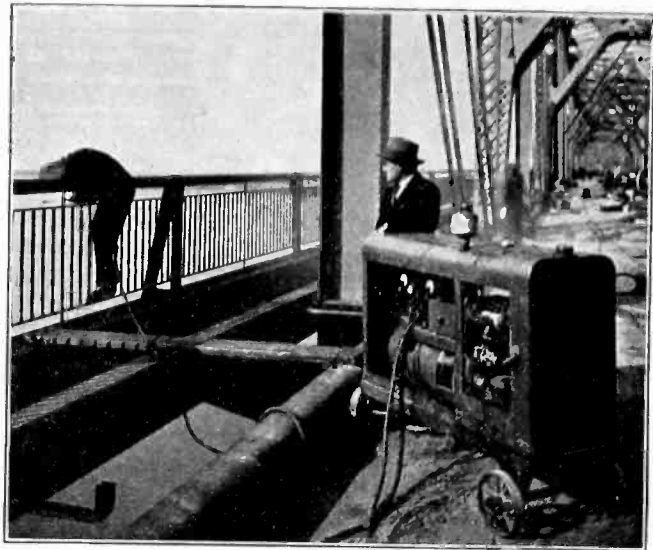

**What "Selenium Rubber" is**

"Selenium rubber" is a rubber compound vulcanized with selenium, an element in the same chemical group with sulphur and tellurium. When used in combination with sulphur for the vulcanization of rubber it produces a rubber compound which has remarkably long life and unusual resistance to abrasion.

Selenium constitutes the outer protection of all TIREX Cables enabling them to operate for long periods of time under conditions which otherwise might shorten their serviceability.

**ALPHABETICAL LIST OF ADVERTISERS**

PAGE	PAGE	PAGE
Allied Engineers, Inc. .... 40	Engineering Foundation ..... 28	Ohio Brass Company ..... 19
Allis-Chalmers Manufacturing Company .... 5	Engineering Societies Employment Service 38	Okonite Company, The ..... Third Cover
Aluminum Company of America ..... 3	Fennessy, David V. .... 40	Okonite-Callender Cable Co., Inc. .... Third Cover
Ambursen Construction Company, Inc. .... 40	Ferranti, Incorporated ..... 11	Osgood, Farley ..... 40
American Brass Company ..... 13	Ford, Bacon & Davis, Inc. .... 40	
American Bridge Company ..... 8	Fowle & Company, Frank F. .... 40	Pacific Electric Manufacturing Corporation . 4
American Lava Corporation ..... 36	Frey Engineering Company ..... 40	Parker-Kalon Corporation ..... 35
American Steel & Wire Company ..... 26	G & W Electric Specialty Company ..... 24	Rochester Electric Products Corporation ... 37
American Telephone & Telegraph Co. .... 16	General Cable Corporation ..... 2	Roebing's Sons Company, John A. .... 24
American Transformer Company ..... 6	General Radio Company ..... 28	Roller-Smith Company ..... 28
Bakelite Corporation ..... 32	Hemingray Glass Company ..... 20	Roth Brothers & Company ..... 33
Barstow & Company, Inc., W. S. .... 40	Hoosier Engineering Company ..... 40	Rowan Controller Company ..... 38
Batley & Kipp, Inc. .... 40	I-T-E Circuit Breaker Company ..... 45	Sackman, G. R. .... 40
Belden Manufacturing Company .. Fourth Cover	Jackson & Moreland ..... 40	Sanderson & Porter ..... 40
Black & Veatch ..... 40	Jewell Electrical Instrument Company ..... 29	Sargent & Lundy, Inc. .... 40
Bristol Company, The ..... 10	Kearney Corporation, James R. .... 20	Science Abstracts ..... 41
Burke Electric Company ..... 22	Kerite Insulated Wire & Cable Co., Inc. .... 1	Scofield Engineering Company ..... 40
Burndy Engineering Company, Inc. .... 24	Kruse, Robert S. .... 40	Shakeproof Lock Washer Company ..... 34
Burt, Dr. Robert C. .... 40	Kuhlman Electric Company ..... 47	Sharples Specialty Company ..... 25
Byllesby Engineering & Management Corp. 40	Lapp Insulator Company, Inc. .... 9	Simplex Wire & Cable Company ..... 48
Canadian Porcelain Company, Ltd. .... 20	Locke Insulator Corporation ..... 15	Stevens, Inc., John A. .... 41
Chandeysson Electric Company ..... 39	Manufacturers' & Inventors' Elec. Co. .... 38	Stockbridge & Borst ..... 41
Clement, Edward E. .... 40	Memco Engineering & Mfg. Co., Inc. .... 24	Stone & Webster, Inc. .... 23, 41
Copperweld Steel Company ..... 22	Metropolitan Device Corporation ..... 50	Texas Company, The ..... 49
Corning Glass Works ..... 17, 18	Minerallac Electric Company ..... 20	Thomas & Sons Company, The R. .... 20
Delta Star Electric Company ..... 22	Moloney Electric Company ..... 43	Wagner Electric Corporation ..... 14
Dossert & Company ..... 21	Morganite Brush Company, Inc., The ..... 42	Ward Leonard Electric Company ..... 36
Electric Controller & Mfg. Co., The ..... 31	Neall, N. J. .... 40	West Va. Pulp & Paper Company ..... 36
Electric Service Company, Inc., The ..... 20	Neiler, Rich & Company ..... 40	Western Electric Company ..... 27
Electric Specialty Company ..... 38	Norma-Hoffman Bearings]Corporation. .... 30	Westinghouse Elec. & Mfg. Company ..... 12
Electrical Testing Laboratories ..... 41		Weston Electrical Instrument Corp. .... 7
Electro Dynamic Company ..... 38		White Engineering Corp., The J. G. .... 41
Engineering Directory ..... 40, 41		Wray & Company, J. G. .... 41

(For classified list of Advertisers see pages 42, 44 and 46)

Please mention the JOURNAL of the A. I. E. E. when writing to advertisers.



AN EXTRA MARGIN OF . . .

# SAFETY

. . . IN TURBINE LUBRICATION

STEAM turbine operators who once experience the effective lubricating performance of Texaco Regal Oil are never in doubt as to the proper lubricant. It's the extra margin of safety in Texaco Regal Oil that builds this confidence.

Texaco refining is carried far beyond the production of an oil that will just pass the specifications. It is carried to the final degree of purity—to the final perfection of *all* the physical qualities required of a turbine lubricant even under the most adverse conditions.

Engineers *know* they can depend on Texaco Regal Oil to maintain effective lubrication—and they have the added certainty of complete cooperation from the Texas Company, its chemists and engineers to insure continuous protection. Write The Texas Company.

# TEXACO



THE TEXAS COMPANY  
135 East 42nd Street, New York City

# LUBRICANTS

Please mention the JOURNAL of the A. I. E. E. when writing to advertisers.

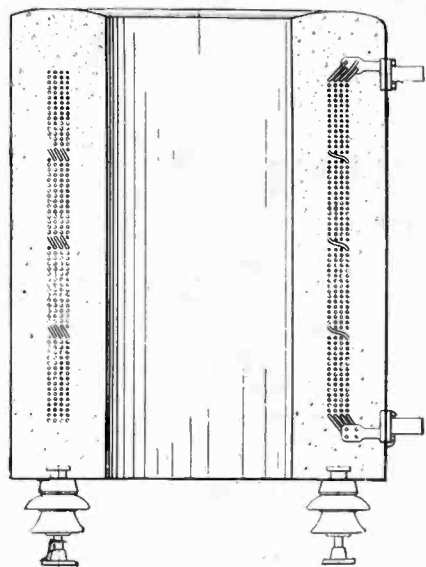
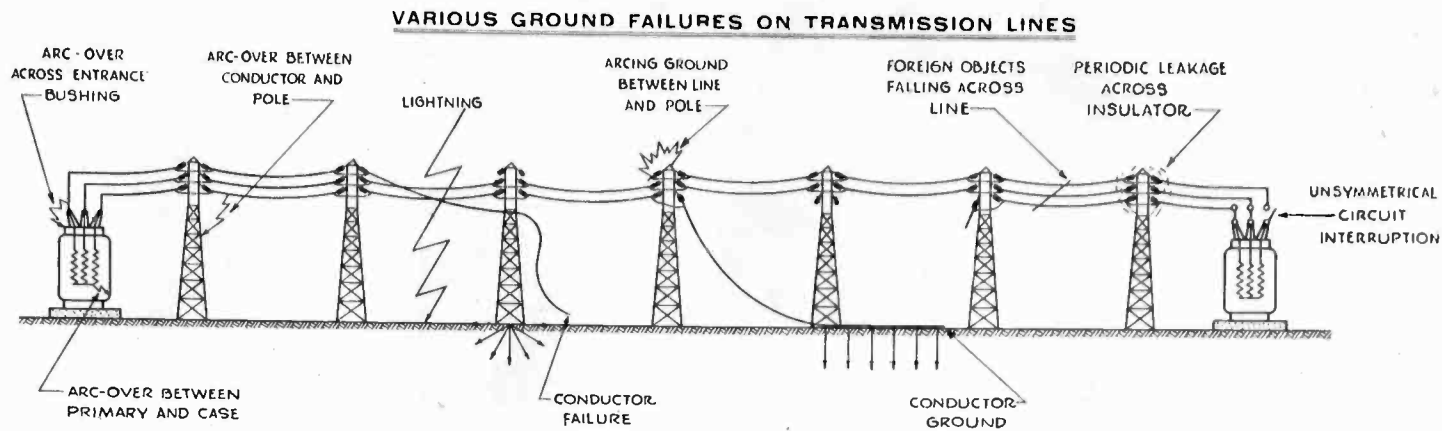

## Outdoor Protection

Protect against shut-downs with MURRAY LOW LOSS dry type outdoor reactors. The in concrete, all imbedded conductor protects against any external damage.

Sufficient breathing space is provided between the copper conductor and the concrete housing. Built in capacities up to 1000 ampere and in voltages up to 33 K.V.

### Metropolitan Device Corporation

1250 Atlantic Ave.                      Brooklyn, N. Y.

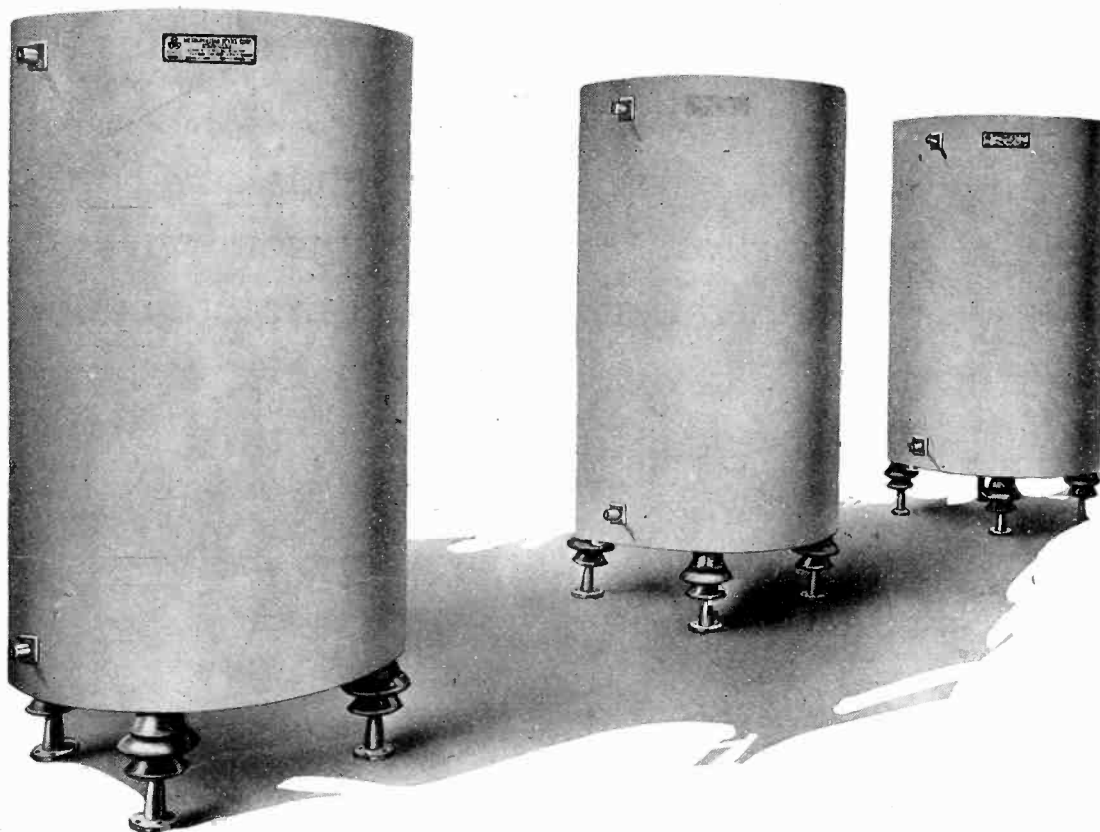



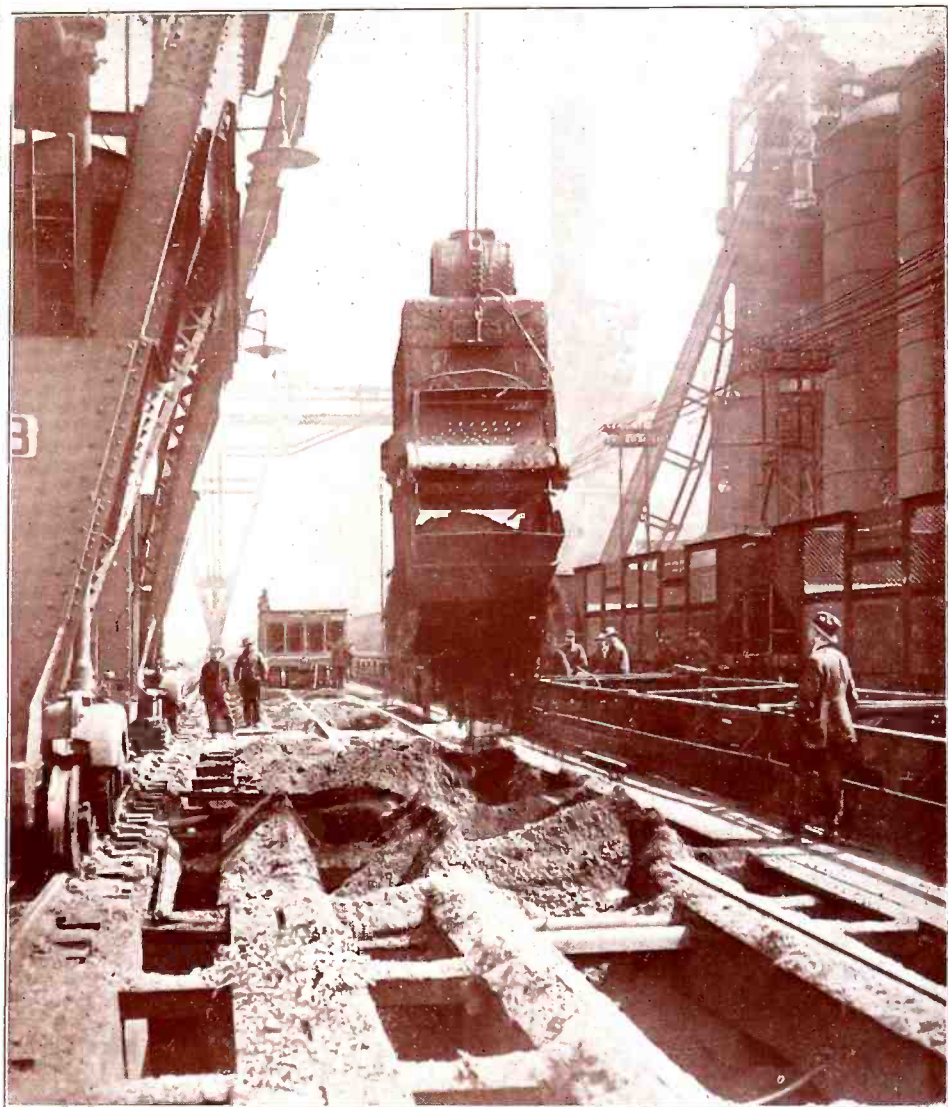
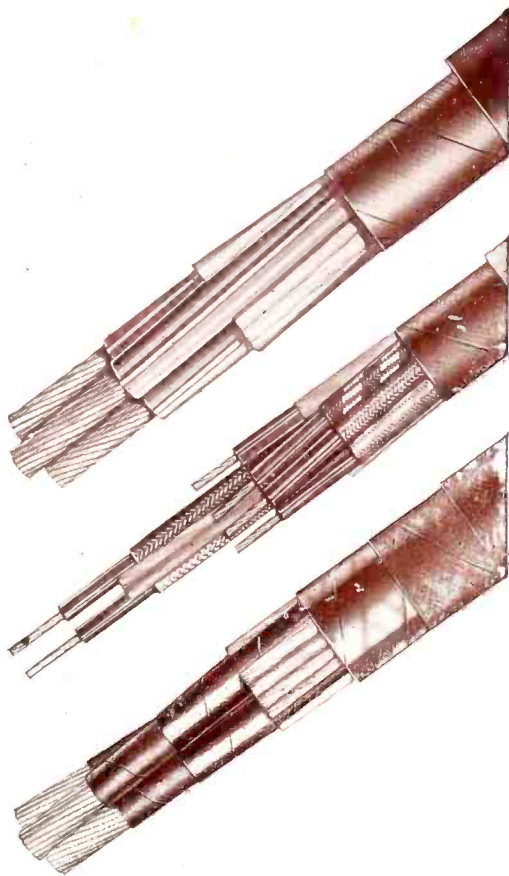

**INTERRUPTIONS  
TO PRODUCTION  
ARE REDUCED**

**BY OKONITE**

WHERE manufacturing costs are dependent upon a steady flow of the product through the various processes, anything that reduces the liability of interruption to production is a valuable contribution toward efficiency.

OKONITE insulated wires and cables are the top-quality products in their field. That they are actually more reliable than those of lower price has been proven by over fifty-two years of service in industry. In these times of strenuous competition, OKONITE insulated wires and cables lend reliability to electrical power supply and thus promote uninterrupted production and lower costs. They are extensively used throughout the steel industry.

- OKONITE PRODUCTS
- Okonite Insulated Wires and Cables
  - Varnished Cambric Cables
  - Okonite Insulating Tape
  - Manson & Dundee Friction Tapes
  - Okocord
  - Okaloom
- OKONITE-CALLENDER PRODUCTS
- Impregnated Paper Cables
  - Super-tension Cables
  - Splicing Materials

**THE OKONITE COMPANY**

Founded 1878

THE OKONITE-CALLENDER CABLE COMPANY, INC.

Factories: Passaic, N. J.

Paterson, N. J.

SALES OFFICES:

NEW YORK  
BIRMINGHAM

CHICAGO  
SAN FRANCISCO

PITTSBURGH  
LOS ANGELES

ST. LOUIS

BOSTON  
SEATTLE

ATLANTA  
DALLAS

Novelty Electric Co., Philadelphia, Pa.  
F. D. Lawrence Electric Co., Cincinnati, O.

Canadian Representatives:  
Engineering Materials, Limited, Montreal

Cuban Representatives:  
Victor G. Mendoza Co., Havana

**OKONITE QUALITY CANNOT BE WRITTEN INTO A SPECIFICATION**



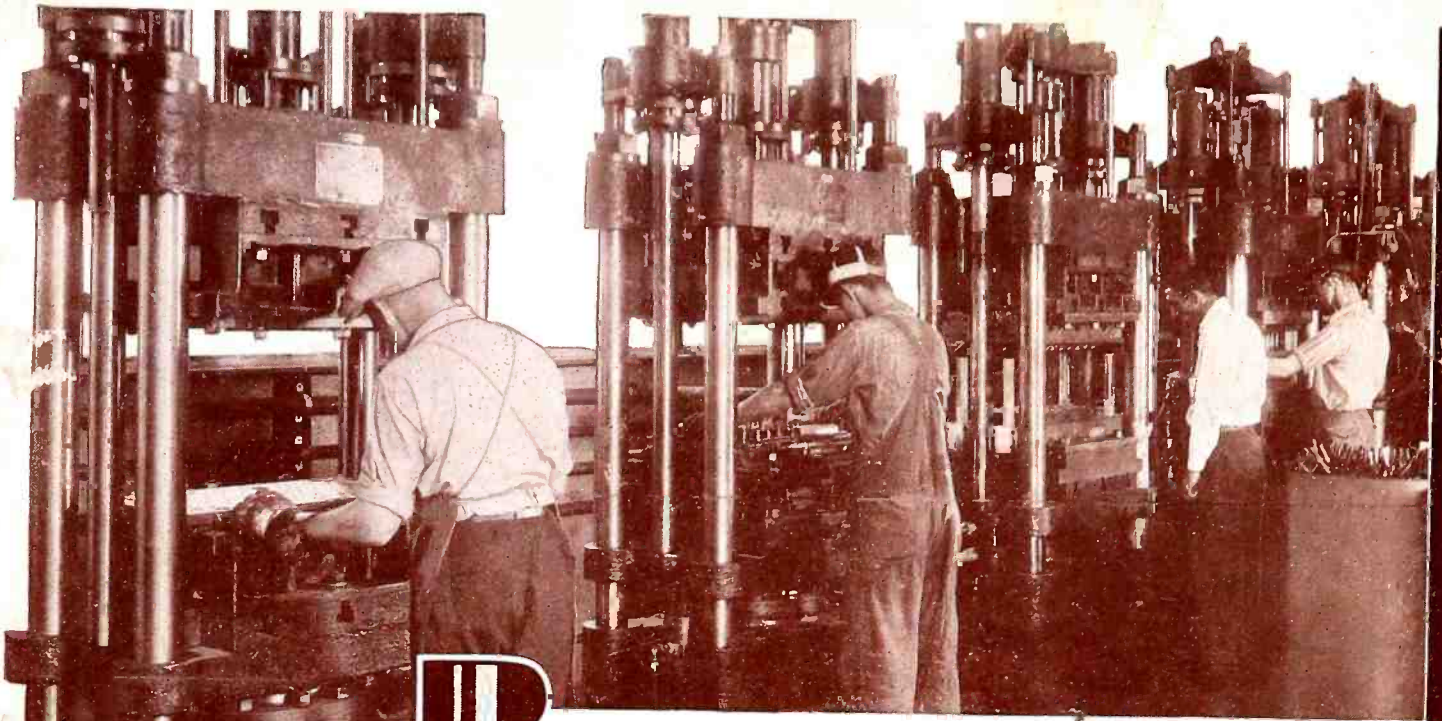

# **B**eldenmold Parts for Every Service

**molded in modern high-speed presses**

Use Beldenmold parts of Bakelite, Durez and similar materials to improve the appearance and performance of your finished products. Screws, studs, holes, projections and irregular recesses can be molded so accurately and with such perfect finish that additional machining is not required.

Trade marks, patent numbers or any other descriptive lettering or decorative features can be molded. Standard colors such as black and brown or special colors, opaque or translucent, can be produced.

By replacing wood, metal, rubber, porcelain, glass, and cold molded parts with Beldenmold parts, you are assured of maximum uniformity, minimum labor in assembling, and consequently lower cost. Send us samples or blueprints of any parts now used or contemplated in your products and let us quote you.

A new enlarged Belden plant assures prompt service.

Belden Manufacturing Company, 4631 W. Van Buren St., Chicago

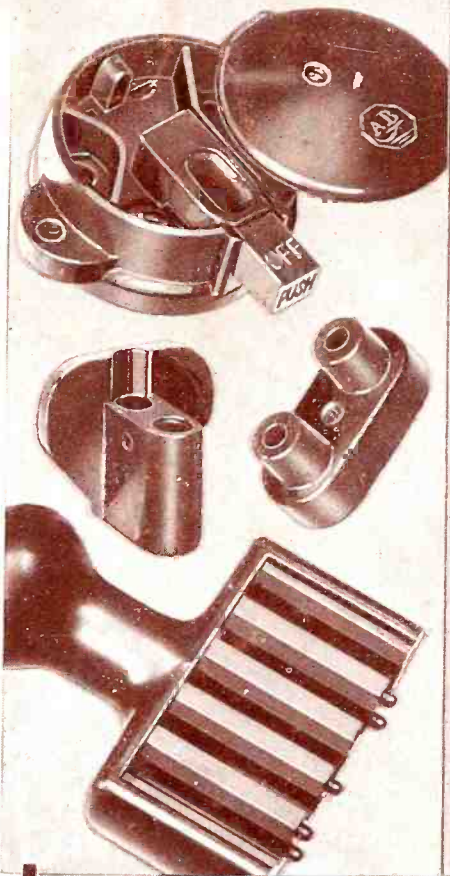

# **Belden**

## **Belden Products**

**Beldenamel and Textile Magnet Wire • Beldenmold Parts • Coil Windings • Automotive Wires and Cables • Airplane Assemblies • Radio Wires, Cords and Cables • Rubber Covered Wires • Armored Cables • Flexible Armature Wires • Motor Lead Wires • Braided and Stranded Copper Cables • Cotton Sleaving**

The Richmond Plant of the Belden Mfg. Co.  
at Richmond, Indiana

