

JOURNAL  
OF THE  
A. I. E. E.

SEPTEMBER 1929



PUBLISHED MONTHLY BY THE  
AMERICAN INSTITUTE OF ELECTRICAL ENGINEERS  
33 WEST 39TH ST.  
NEW YORK CITY

# MEETINGS

of the

American Institute of Electrical Engineers

---

PACIFIC COAST CONVENTION, Santa Monica,  
Calif., September 3-6, 1929

DISTRICT MEETING, Great Lakes District No. 5,  
Chicago, Illinois, December 2-4, 1929



## MEETINGS OF OTHER SOCIETIES

National Electric Light Association.

Rocky Mountain Division, Hotel Colorado, Glenwood  
Springs, Colo., Sept. 9-11 (O. A. Weller, Public Service Co.  
of Colorado, Denver)

New England Division, Hotel Griswold, New London, Con-  
necticut, Sept. 9-12 (Miss O. A. Bursiel, 20 Providence St.,  
Boston)

Great Lakes Division, French Lick Springs, Ind., Sept. 26-28;  
Engineering Section, Lorain Hotel, Madison, Wis., October  
23-26 (T. C. Polk, Rm. 110, 140 South Dearborn Street,  
Chicago, Ill.)

Illuminating Engineering Society, Bellevue-Stratford, Philadel-  
phia, Penna., Sept. 24-27 (G. Bertram Regar, Philadelphia  
Electric Company)

American Electrochemical Society, Hotel William Penn, Pitts-  
burgh, Pa., September 19-21 (G. C. Fink, Columbia Uni-  
versity, New York)

American Electric Railway Association, Atlantic City, Sept. 28-  
October 4, 1929 (J. W. Welsh, 292 Madison Avenue, New  
York)

American Society of Mechanical Engineers, National Fuel Meet-  
ing, Bellevue-Stratford Hotel, Philadelphia, Oct. 7-10



# JOURNAL

## OF THE

# American Institute of Electrical Engineers

PUBLISHED MONTHLY BY THE AMERICAN INSTITUTE OF ELECTRICAL ENGINEERS  
33 West 39th Street, New York

**PUBLICATION COMMITTEE**

W. S. GORSUCH, *Chairman*, H. P. CHARLESWORTH, F. L. HUTCHINSON, DONALD McNICOL, E. B. MEYER

GEORGE R. METCALFE, *Editor*

Changes of advertising copy should reach Institute headquarters by the 15th day of the month for the issue of the following month.  
Subscription: \$10.00 per year to United States, Mexico, Cuba, Porto Rico, Hawaii and the Philippines, \$10.50 to Canada, Central America, South America, Haiti, Spain and Colonies, and \$11.00 to all other countries.  
Single copies \$1.00.

Entered as matter of the second class at the Post Office, New York, N. Y., May 10, 1905, under the Act of Congress, March 3, 1879. Acceptance for mailing at special rate of postage provided for in Section 1103, Act of October 3, 1917, authorized on August 3, 1918.

Vol. XLVIII

SEPTEMBER 1929

Number 9

### TABLE OF CONTENTS

#### Papers, Discussions, Reports, Etc.

The President's Message.....	659	Radio Interference from Line Insulators, by Ellis Van Atta and E. L. White.....	682
Notes and Announcements.....	660	Motor Control for Wind Tunnel, by William A. Lewis.....	686
Flames from Electric Arcs, by J. Slepian.....	661	High-Voltage Low-Current Fuses and Switches, by Roy Wilkins.....	692
Electric Heating Elements (Abridged), by E. Fleischmann.....	665	The Interconnected Integrator, by Robert E. Glover and Henry H. Plumb.....	695
Application of Induction Regulators (Abridged), by E. R. Wolfert and T. J. Brosnan.....	669	Report of the Committee on Instruments and Measurements (Abridged), E. S. Lee, Chairman.....	698
Report of the Committee on Protective Devices, E. A. Hester, Chairman.....	673	Report of the Committee on Power Generation (Abridged), F. A. Allner, Chairman.....	702
Report of the Committee on Education, Edward Bennett, Chairman.....	677	Automatic Reclosing of High-Voltage Circuits (Abridged), by E. W. Robinson and S. J. Spurgeon.....	707
D-C. Railway Substation for the Chicago Terminal Electrification (Abridged), by A. M. Garrett.....	678	Correspondence, H. B. Dwight.....	711

#### Institute and Related Activities

The Pacific Coast Convention.....	712	A. I. E. E. Directors Meeting.....	713
District Meeting in Chicago, December 2-4.....	712	Secretarie's Fourth Conference.....	714
World Engineering Congress Delegates to Visit Washington.....	712	New Volume of Research Narratives Available.....	715
American Electric Railway Association Convention.....	712	The National Electrical Code.....	715
Illuminating Engineers to Meet in Philadelphia.....	712	Diesel and Oil Engine Course at Brooklyn Polytechnic Institute.....	715
Industry to Cooperate with Electrochemists.....	712	Personal Mention.....	715
Standards		Obituary.....	716
Three New American Standards.....	712	Engineering Societies Library	
Standards for Relays.....	712	Book Notices.....	718
American Standards for Electric Welding to be Developed.....	713	Engineering Societies Employment Service	
American Standards for Oil Circuit Breakers and Horn-Gap Switches and for Disconnecting.....	713	Positions Open.....	719
National Research Council		Men Available.....	719
Advisory Aid Solicited from Engineers and Scientists.....	713	Membership	
American Engineering Council		Applications, Elections, Transfers, etc.....	720
Committee Appointed on Engineering and Allied Technical Professions.....	713	Officers A. I. E. E.	
A New Edition of Constitution and By-Laws.....	713	A. I. E. E. Committees.....	721
A. E. C. Publishes Roster.....	713	A. I. E. E. Representatives.....	723
		List of Sections.....	724
		List of Branches.....	724
		Order Form for Papers Abridged in Journal.....	725
		Digest of Current Industrial News.....	726

A REQUEST FOR CHANGE OF ADDRESS must be received at Institute headquarters at least ten days before the date of issue with which it is to take effect. Duplicate copies cannot be sent without charge to replace those issues undelivered through failure to send such advance notice. With your new address, be sure to mention the old one, indicating also any changes in business connections.

Copyright 1929. By A. I. E. E.

Printed in U. S. A.

Permission is given to reprint any article after its date of publication, provided proper credit is given,  
(The Journal of the A. I. E. E. is indexed in Industrial Arts Index.)

# AMERICAN INSTITUTE OF ELECTRICAL ENGINEERS

## —Some Activities and Services Open to Members—

**To Members Going Abroad.**—Members of the Institute who contemplate visiting foreign countries are reminded that since 1912 the Institute has had reciprocal arrangements with a number of foreign engineering societies for the exchange of visiting member privileges, which entitle members of the Institute while abroad to membership privileges in these societies for a period of three months and members of foreign societies visiting the United States to the privileges of Institute membership for a like period of time, upon presentation of proper credentials. A form of certificate which serves as credentials from the Institute to the foreign societies for the use of Institute members desiring to avail themselves of these exchange privileges may be obtained upon application to Institute headquarters, New York.

The societies with which these reciprocal arrangements have been established and are still in effect are: Institution of Electrical Engineers (Great Britain), Societe Francaise des Electriciens (France), Association Suisse des Electriciens (Switzerland), Associazione Elettrotecnica Italiana (Italy), Koninklijk Instituut van Ingenieurs (Holland), Verband Deutscher Elektrotechniker E. V. (Germany), Denki Gakkwai (Japan), Norsk Elektroteknisk Forening (Norway), Elektrotechnicky Svaz Ceskoslovensky (Czechoslovakia), and The Institution of Engineers, Australia (Australia).

**Conventions.**—The Institute holds three national conventions each year; the Winter Convention in January, the Summer Convention in June, and the Pacific Coast Convention usually in September.

**Scope of Papers**—Institute papers should present information which adds definitely to the theoretical or practical knowledge of electrical engineering and may be derived from activities in any of its branches. Acceptable subject matter is as follows: New theories or new treatments of existing theories; Mathematical solution of electrical engineering problems; Researches, fundamental or practical; Design of equipment, and of electrical engineering projects; Engineering and economic investigations; Operation and tests of electrical equipment or systems; Measurements of electrical quantities; Electrical measurement of non-electrical quantities; Applications of electricity to industrial or social purposes; Education; Standardization; Cooperative engineering organizations; Ethical and social aspects of the profession.

**Library Service.**—The Engineering Societies Library is the joint property of the four national societies of Civil, Mining, Mechanical, and Electrical Engineers and comprises one of the most complete technical libraries in existence. Arrangements have been made to place the resources of the library at the disposal of Institute members, wherever located. Books are rented for limited periods, bibliographies prepared on request, copies and translations of articles furnished, etc., at charges which merely cover the cost of the service. The Director of the library will gladly give any information requested as to the scope and cost of any desired service. The library is open from 9 a. m. to 10 p. m. every day except holidays and during July and August, when it closes at 5 p. m.

**The Winter Conventions** are usually the outstanding technical meetings of each year and are held in the eastern section of the country, generally in New York City. The programs consist chiefly of technical sessions which occupy practically all the available time of a five-day meeting, except one day, which is set aside for inspection trips to engineering works of interest in the neighborhood of the convention city. The only social function, aside from the entertainment provided for ladies in attendance, is a dinner-dance held on one evening during the convention. The Winter Conventions have been described as the "working conventions" of the Institute because the social and entertainment features are almost entirely subordinated to the consideration of technical papers.



# JOURNAL OF THE A. I. E. E.

DEVOTED TO THE ADVANCEMENT OF THE THEORY AND PRACTISE OF ELECTRICAL ENGINEERING AND THE ALLIED ARTS AND SCIENCES

*The Institute is not responsible for the statements and opinions given in the papers and discussions published herein.  
These are the views of individuals to whom they are credited and are not binding on the membership as a whole.*

Vol. XLVIII

SEPTEMBER, 1929

Number 9

*A Message From the President.*

## The Interrelationship of the Section and the Section Member.

THE message appearing on this page of the August Journal may have some of its applications emphasized. The Section is that integral part of the American Institute of Electrical Engineers designed to carry the spirit and stimulus of the whole body to the individual member. These centers of Institute life are being so effectively distributed throughout the country that we may expect to see such a focus accessible to almost every member of the Institute.

What are the interrelated responsibilities and advantages of the Section and its members?

The electrical engineer, whether a member of the Institute or not, is frequently isolated to a degree depending upon personal characteristics, environment, location, etc. Except in rare cases, inaccessibility of a Section is no longer a reason for lack of association. In some cases, more of isolation and less of inspiration may be found in our larger cities than obtains upon the prairies or in the mountains. A function of the Section is to reduce that isolation in so far as the Section member will permit. The individual cannot fully develop himself without that contact and stimulus to thought and endeavor which Section life should, and does, afford. Each person has his own reservoir of vital, useful thought and inspiration which, for lack of flow, may stagnate or evaporate, and which, allowed copiously to overflow, requires refreshment and replenishment. Is it not the responsibility of the member to allow himself to be drawn upon by the Section, and likewise, is it not the responsibility of the Section to act as source to the member? Herein lies that interrelated advantage to both which, through adherence and application of Institute ideals,\* evolves the valuable and effective engineer and citizen.

Recognizing that each Section must work out the detail of its own activities in accordance with its own needs and the wishes of its members, there are at least four elements requisite for the life and usefulness of any Section, and to be applied in proportion to its particular requirements. Frequent, ordinarily monthly, meetings may involve yearly:

- a. Five to ten meetings of a professional character for member contact, experience, stimulation, information and development through interchange of thought and experience. This opportunity the Section usually supplies. It depends upon the member to make the most of this for personal development.
- b. Occasional meetings, possibly annual, of a distinctly social or "entertainment" character for contact and good fellowship.
- c. The Section, through its district organization, should, at least once a year, bring to itself the best of its district membership, its Vice-President or other able engineer.
- d. The Section, through cooperation of the district and national organizations, should bring, at least once a year, and usually from outside of the district, the best that the national membership has to offer of stimulation, leadership, or professional ability.

Where there is a *will* on the part of the Section to secure such result, the means to accomplish it are at hand and no electrical engineer could then afford to refrain from active Section membership in the American Institute of Electrical Engineers.

*Harold B. Smith*

*President*

\*See Code of Principles of Professional Conduct, Sections 16 and 20.

### Some Leaders of the A. I. E. E.

Norman Willson Storer, Manager of the Institute 1911-1914, one of its Vice-Presidents for 1914-1916 and 1921-1923, and now Consulting Railway Engineer for the Westinghouse Electric & Manufacturing Company, East Pittsburgh, is a native of Orangeville, Trumbull County, Ohio. After completing work in the public schools and a preparatory course, he took a course at Ohio State University, from which he was graduated in 1891 with the degree of M. E. in E. E. He immediately joined the Westinghouse company, spending the first four months in the winding room, with work on transformer coils and field and armature coils for No. 3 single-reduction railway and special ring type d-c. generator armatures. Another four months was spent making a complete set of tests on the No. 3 railway motor and developing curves. The next three months were occupied in the drawing-room, followed by eight months in charge of new lines of a-c. generators, and synchronous and induction motors, including those exhibited at the World's Fair. In May 1893 he started in design work as first assistant to Benjamin G. Lamme, developing a line of small d-c. multipolar generators and motors,—the standard of the company for 10 years or more. He was in general charge until 1904. During this time, several complete lines of engine type generators as well as belted generators were developed and built for all classes of service. The ventilated armature windings and core were developed and applied to all machines. In 1895 laminated poles were introduced in the railway motor.

In the early days, the rating and application of street railway motors was largely a matter of guess work, there being no adequate method for connecting up the capacity of the motor with the service requirements. The only rating was the so-called nominal or one-hour rating, which served only as a rough means of comparison of two motors but did not give sufficient data for applying motors successfully. The need for a different method of rating was apparent and a number was proposed, all of which were either incorrect in principle or too complicated in application to be acceptable. Mr. Storer who, had given the subject much thought, outlined a method of rating or defining motor capacity, enabling the engineer to predict service capacity and apply a motor very accurately. The method consisted of finding the root-mean-square current required by the motor in a given service, which could be taken from test or typical speed-time curves, making a continuous test of the motor in the shop at that current and the voltage which would give the average core loss in service. This resolved itself into giving a motor both a one-hour rating and continuous rating, the latter being in terms of amperes at 300 and 400 volts (for 600-volt motors). The method, at once so simple, accurate and easy to apply, met with immediate success, and was later adopted by the Institute and also by the International Electrotechnical Commission as standard.

Mr. Storer presented a brief paper before the Institute, calling attention to the importance of inertia of the rotating parts of a car in calculating rates and power requirements for acceleration. He proposed a simple approximation which has since been generally used. The inertia of the armatures, wheels, etc., *had never before* been considered in electric railway practise. In 1904 he was appointed Engineer of the Railway Division of the Engineering Department, of his company in charge of all railway development work, including railway motors, multiple unit control and electric locomotives. In those 8 years, the a-c. d-c. passenger locomotives both gearless and geared, and the freight switcher locomotives for the New York, New Haven & Hartford Ry. were developed; also several experimental locomotives including that adopted for the Pennsylvania terminal at New York, the a-c. locomotives for St. Clair Tunnel, Hoosac Tunnel, and the first 1500-volt d-c. locomotives ever built, which were applied on the Piedmont & Northern Railway. With the advent of the commutating poles for railway motors, the use of field control for efficient operation, and speed control, which had been abandoned years before on account of commutator troubles, was again brought into general use. It was used on the New Haven locomotives in the d-c. zone, the Pennsylvania locomotives, subway, street car, and interurban railways. Since 1912, Mr. Storer's work has been along general lines. He was responsible for the use of six motors giving  $\frac{1}{3}$ ,  $\frac{2}{3}$ , and full speed, as well as the scheme of regenerative braking and other features on the 3000-volt d-c. Milwaukee locomotive; he designed the motors and control used on the 5000-volt experimental car which was run on the Grass Lake Line of the Michigan Railways in 1915-1917. This was the highest d-c. voltage ever used in commercial railway service and was a complete success.

He designed the flash suppressor for the 3000-volt generators used on the Chicago, Milwaukee & St. Paul Railway, making it possible to short-circuit the generators without causing a flashover or serious sparking. He was largely responsible for the development of the single-phase motor-generator type locomotives used on the Detroit & Ironton Railway of the Ford Motor Company, and the Cascade Tunnel Division of the Great Northern Railway. He has also taken an active part in the development of oil electric cars and locomotives.

Beside his work as Chairman of Institute Subcommittee on Standards for several years, and his contributions of many papers along the lines of railway electrification, he has been Chairman of Advisors on Traction Motors for the U. S. National Committee of the I. E. C.

He joined the Institute in 1895 and became a Fellow in 1913. Beside other technical societies, he is a member of American Society of Mechanical Engineers, the Engineers Society of Western Pennsylvania, Pittsburgh Railway Club, and of the Engineers Club of New York, and of the University Club in Pittsburgh.

# Flames from Electric Arcs

BY J. SLEPIAN<sup>1</sup>

Fellow, A. I. E. E.

**Synopsis.**—The origin of flames from arcs is considered. Their low dielectric strength is attributed to ionization, and their rate of recovery of normal dielectric strength is computed. The large in-

fluence of temperature is brought out. Computations are given and experiments described which show how flames can be reduced by passing the arc gases through narrow channels.

## FLAMES FROM ELECTRIC ARCS

IT is well known that heavy current arcs in air such as occur in switches of usual construction give off large volumes of luminous gases or flames. These flames have a large volume in comparison to the arc itself which forms a core of comparatively small section, and it is quite certain that they have a much lower temperature and much lower electrical conductivity than the arc core itself.<sup>2</sup> Nevertheless these flames constitute one of the most troublesome features of switching in air in circuits of more than a few hundred volts, because they have a very small dielectric strength and will cause breakdown if they bridge live parts. This low dielectric strength persists for a relatively long time, and because of their large volume, considerable clear space must be provided in which these flames may dissipate themselves.

### I. ORIGIN OF FLAMES

In general, these flames consist of gases which have passed through the arc core itself. The temperature of the arc core is more than 2500 deg. cent.<sup>3</sup> and hence the density of the air or gas there is one-ninth or less of the density of the air originally occupying the arc core space. The air displaced by the formation of the arc core will thus make up some of the flame, and if the flame temperature is more than 1000 deg. cent., will occupy a volume more than four times the volume of the arc core. This, however, will account for only a small portion of the arc flame.

The motion of the air in the neighborhood of the arc while it is playing, probably accounts for a great deal more of the flame. When the motion of the air is regular, (stream line motion) and such as does not tend to change the cross-sectional area of the core, the arc will merely move with the air, and little air will pass through the arc core itself. When, however, the motion of the air is such as to tend to increase the cross-sectional area of the core, and particularly when the air motion is turbulent, then a considerable volume of air will pass through the arc core. Such turbulent motion is to be expected from the magnetic reactions in a heavy cur-

rent arc and when an arc is moved laterally very rapidly as in a magnetic blowout switch.

The gases and vapors given off by the electrodes will also contribute very largely to the flame. When the end products of the combustion of the electrode materials are gases, as in the case of carbon for example, the contribution of large volumes to the flame will be apparent; but also when the electrode vapors may be expected to condense to finely divided solids or liquids in the relatively cool flame, as in the case of copper and other metals, the projection of large volumes of vapor from the electrodes longitudinally into the arc will cause a turbulent motion which will bring large volumes of air through the arc core.

Flames will also result from gases which do not pass through the arc core, if the arc passes near a material which is decomposed by heat into an easily combustible gas. Thus if the inner faces of the arc chute of a switch are lined with fiber, paper, or similar material, a great increase in the volume of flame will result. In fuses of the expulsion type where the arc plays in a fiber tube, a large part of the flame is probably due to burning decomposition products of the fiber.

### II. LOW DIELECTRIC STRENGTH OF FLAMES DUE TO IONIZATION

The dielectric strength of the flames from arcs is astonishingly low. Many instances are known where the flames from arcs caused breakdown between parts having potential differences of less than one thousand volts, and separated by inches through the air. The normal breakdown between such electrodes would be 50,000 volts or more.

This very low dielectric strength indicates that the flames are in a state of considerable ionization, a conclusion which would be reached from their luminosity also. If the flames were only very slightly ionized, like ordinary air, we should expect a dielectric strength approximately proportional to their density, that is reduced from normal only three or four fold. The presence of ions in large numbers causes the field produced by an applied potential to be considerably distorted, so that the breakdown voltage is lowered very considerably, and made approximately independent of electrode separation. This is explained in the author's paper, *Extinction of an A-C. Arc*, (A. I. E. E. Quarterly TRANS., Vol. 47, October 1928, p. 1398).

The flame gases which have passed through the arc

1. Consulting Research Engineer, Westinghouse Electric & Manufacturing Company, East Pittsburgh, Pa.

2. Hagenbach, "Der Elektrische Lichtbogen," Leipzig, 1924, p. 257.

3. *Ibid.*, p. 216.

Presented at the Pacific Coast Convention of the A. I. E. E., Santa Monica, Calif., Sept. 3-6, 1929. Printed complete herein.



core are of course intensely ionized at the moment they leave the core. Recombination reduces the density of ionization very rapidly at first, but later the rate of recombination becomes much smaller so that ionization may persist for some little time.

The temperature of the flame gases very shortly after they leave the core is far too low to account for any ionization on a purely thermal basis, as may be seen by calculating from Saha's equation.<sup>4</sup> The only other obvious source of ionization is chemical effects such as arise in combustion flames.<sup>5</sup> Where there are combustible materials in the flame this ionization may persist for a long time, since the rate of combustion is limited by the rate of diffusion of oxygen into the flame which is a relatively slow process.

### III. DIELECTRIC STRENGTH OF AN IONIZED GAS

In the paper, *Extinction of an A-C. Arc*, referred to above, the following formula is derived for the breakdown voltage of ionized air.

$$V = 2.42 \times 10^{13} \times \left( \frac{273}{T + 273} \right)^2 \times \frac{1}{n} \quad (1)$$

Here  $V$  is the breakdown voltage,  $T$  is the absolute temperature, and  $n$  is the number of ion pairs per cm.<sup>3</sup> of the gas. It will be noticed that the distance between the electrodes does not appear in the equation.

This equation, which must be regarded as only very approximate, was derived by considering conditions in the layer of air immediately adjacent to the cathode. On the application of voltage, this layer becomes at once denuded of electrons, and until breakdown occurs, bears practically the whole impressed voltage.<sup>6</sup> The thickness of this layer for a given impressed voltage was calculated on the hypothesis that the positive ions were relatively immovable in space, and breakdown was assumed to occur when the maximum gradient in this

layer reached  $30,000 \times \frac{273}{273 + T}$  volts per cm.

Actually, the positive ions do move, and their motion will cause the gradient in the cathode gas layer to be considerably less than calculated. Also the gradient for breakdown at lower voltages is much greater than

$30,000 \times \frac{273}{273 + T}$  volts per cm. Equation (1) then

can only be used to give very rough orders of magnitude. It can be very useful, however, in bringing out the strong influence of the temperature of the gas, and the value of any means for reducing the density of ionization of the gas.

4. *Phil. Mag.*, 40, 1920, p. 972.

5. *Handb. d. Physik*, Geiger & Scheel, Berlin, 1927, Vol. XIV, p. 190.

6. For detailed quantitative treatment of the physics of these deionized sheaths around electrodes in ionized gases see Langmuir & Mott Smith, *General Elec. Rev.*, Vol. XXVII, 1924, pp. 449, 538, 616, 762, 810.

### IV. THE DECAY OF IONIZATION IN A GAS

Immediately after leaving the arc core, if the gases are not exposed to deionizing surfaces of solids, the density of ionization is practically entirely determined by the rate of recombination of the ions. This rate of recombination is proportional to the density of positive ions and also to the density of negative ions, so that we have<sup>7</sup>

$$-\frac{dn}{dt} = \alpha n^2 \quad (2)$$

If  $\alpha$ , the recombination constant, was really constant in time Equation (2) could be readily integrated giving

$$\frac{1}{n} - \frac{1}{n_0} = \alpha t \quad (3)$$

$n_0$  being the initial density of ionization, and if  $n_0$  is very large, as it is in the arc core itself,  $\frac{1}{n_0}$  is negligible and Equation (3) becomes

$$n = \frac{1}{\alpha t} \quad (4)$$

Plimpton<sup>8</sup> has found that  $\alpha$  for ions generated by X-rays shows an aging effect, being considerably smaller for older ions than for newly formed ones. This result may, however, be due to the non-uniform distribution of ions formed by X-rays. For air at normal pressure and temperature several investigators have found  $\alpha = 1.6 \times 10^{-6}$  for "aged" ions.  $\alpha$  is found to be greatly affected by the temperature, increasing very rapidly as the flame cools. Meager experimental data show that  $\alpha$  varies inversely as the cube of the temperature. Equation (2) might then be better written

$$-\frac{dn}{dt} = \alpha(t, T) n^2 \quad (5)$$

showing explicitly the dependence of  $\alpha$  upon the time  $t$ , and absolute temperature  $T$ .

However, since it is not the purpose of this paper to determine actual numerical values of the dielectric strength of arc flames, but merely to get orders of magnitude and to show the great influence of temperature, we shall work with the following assumptions:

1. We shall take the value of  $\alpha$  for air at normal pressure and temperature to be  $7.6 \times 10^{-6}$ .

2. We shall assume that the flame gases, immediately upon leaving the arc core, take on the absolute temperature  $T$ , and keep that value of temperature thereafter. We shall assume that  $\alpha$  varies inversely as the cube of the absolute temperature. Thus

$$\alpha = 7.6 \times 10^{-6} \times \left( \frac{273}{T + 273} \right)^3 \quad (6)$$

7. Townsend, "Electricity in Gases," Oxford, 1913, Chap. VI.

8. *Phil. Mag.*, (6), 25, 1913, p. 63.

V. THE DIELECTRIC STRENGTH OF FLAMES FROM ARCS

From the standpoint of the designer of switches, it is the dielectric strength of flames from arcs which is important, rather than their luminosity, temperature, or other properties. Where the ionization of the flames is almost entirely residual, or that is, where there is little combustible material in the flames, Equations (1), (4), and (6) above serve to determine the dielectric strength of the arc flame as a function of the flame temperature  $T$  and the time  $t$ , in the resultant equation

$$V = 1.84 \times 10^9 \left( \frac{273}{T + 273} \right)^5 t \quad (7)$$

A few numerical values will best bring out the significance of Equation (7) and particularly the great influence of the temperature. Consider the dielectric strength of the flame 0.01 sec. after it has left the core of the arc, during which time it may have traveled several feet.

DIELECTRIC STRENGTH OF FLAME  
0.01 Seconds after leaving arc

Temperature of gas	Density of ionization ion pairs/cm. <sup>2</sup>	Dielectric strength volts
2000°C	$7.6 \times 10^9$	450
1500°C	$3.6 \times 10^9$	1,610
1000°C	$1.3 \times 10^9$	8,300
500°C	$3.0 \times 10^8$	98,500
0°C	$1.3 \times 10^7$	1,840,000

The advantage gained by cooling the flame gases, which is considered desirable instinctively by switch

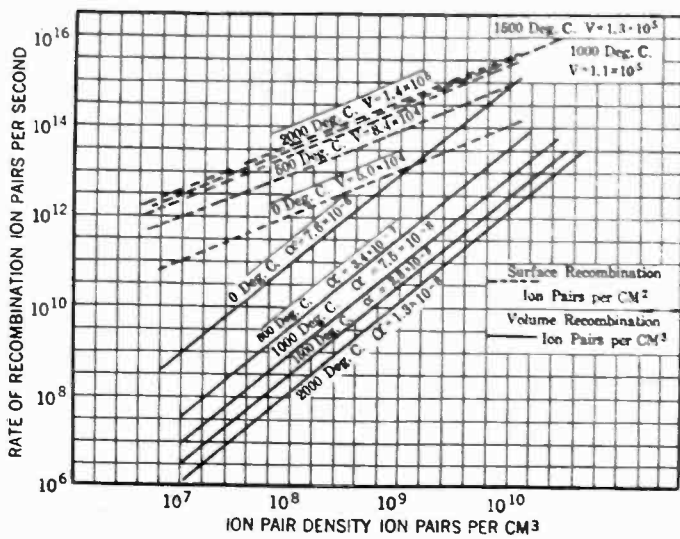

FIG. 1

designers, is forcibly brought out in the table. However, the direct instantaneous effect of lowering the flame temperature is only slight. The great increase in dielectric strength follows the lowered temperature shortly in time as a result of the large increase in the recombination rate of the ions in the cooler gas.

VI. RECOMBINATION OF IONS AT SURFACES OF SOLIDS

When an ionized gas is exposed to the surface of a solid, ions are lost by diffusing to the surface and being caught and recombining there. Under proper circum-

stances this loss of ions to surfaces of solids may far exceed the loss by recombination in the volume of the gas.

The rate of loss of ions to a surface will be given by

$$N = \frac{1}{4} n \nu \quad (8)$$

where  $n$  is the density of ions in the gas adjacent to the surface,  $\nu$  is the mean velocity of agitation of the ions, and  $N$  is the number of ions reaching the surface per

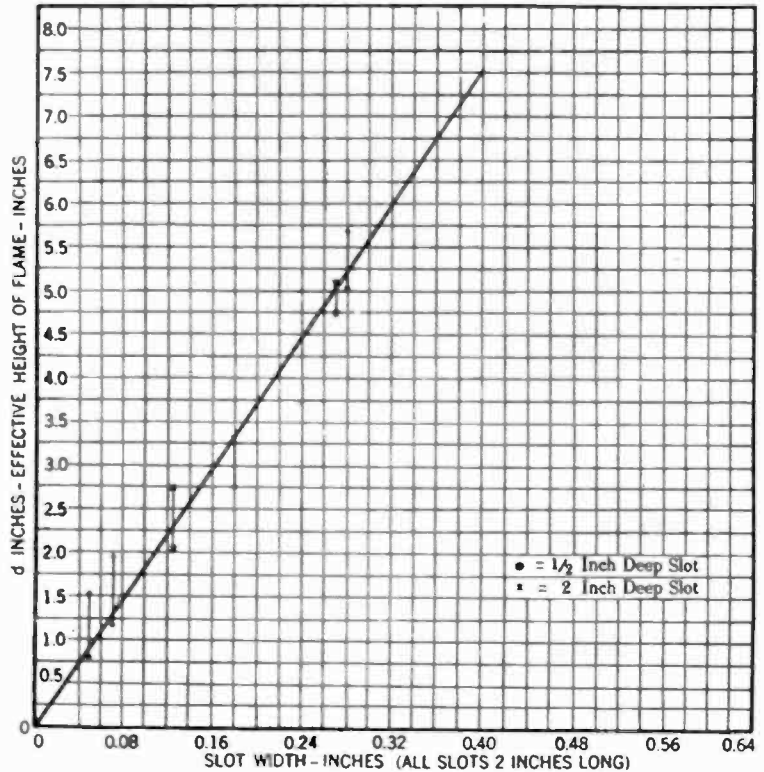

FIG. 2

cm.<sup>2</sup> per sec.<sup>9</sup> When the velocity of agitation of the ions of one sign exceeds that of the ions of the other sign, an electric field sets itself up at the surface which retards the faster ion, so it is the velocity of the slower ion which must be used in Equation (8).

The curves of Fig. 1 give a comparison of the recombination rates of ions at a surface with the recombination rates of ions in the volume of the gas for conditions which are of practical importance in the flames from switch arcs. We see that the recombination rate per cm.<sup>2</sup> of surface is 100 to 1,000,000 times as great as the recombination rate per cm.<sup>3</sup> of the gas immediately adjoining.

If the gas is at rest relative to the surface, the layer of gas immediately adjacent to the surface becomes very quickly denuded of ions, and then ions which further reach the surface must diffuse through this layer of deionized gas. The surface then loses most of its deionizing efficacy. If, however, the gas is in rapid turbulent motion past the surface, fresh portions of the

9. Langmuir & Mott-Smith, *General Elec. Rev.*, XXVII, 1924, p. 450.

ionized gas are constantly exposed to the surface, and its deionizing activity is maintained.

#### VII. EXPERIMENTS OF C. L. DENAULT ON REDUCTION OF FLAMES FROM ARCS

The considerations given above of the influence of temperature and the deionizing effect of surfaces would lead one to expect that the flames from arcs would be greatly reduced in volume if the gases from the arcs were compelled to pass through narrow channels between solid walls. This is beautifully confirmed by



FIG. 3

experiments of C. L. Denault (which have not yet been published).

In these experiments an arc was formed by blowing a fuse in a soapstone chamber with an open top, 9/16 in. by 2-1/8 in. and 1-9/32 in. high. Covers were then placed over the chamber which compelled the escaping flame to pass through slots of various widths. A spark gap consisting of 1/2-in. diameter brass rods



FIG. 4

with rounded ends, separated 0.9 in., and with 2200 volts 60 cycles impressed upon it, was used to determine the effective height of the flame, by determining what was the shortest distance above the vent at which the spark gap could be placed without breaking down. The breakdown voltage of the spark gap in normal air was 30,000 volts.

The curve of Fig. 2 and the photographs in Figs. 3 and 4, show the remarkable reduction in flame obtained by exposing the arc gases to deionizing surfaces.

#### VIII. THE DEION CONTACTOR

Recently contactor switches have been developed which use a weak blowout magnetic field and which

extinguish the arc by means of a column of deionizing metal plates. These switches show an enormous reduction of flame in comparison with previous types of switches.

In the Deion contactor by the use of the deionizing

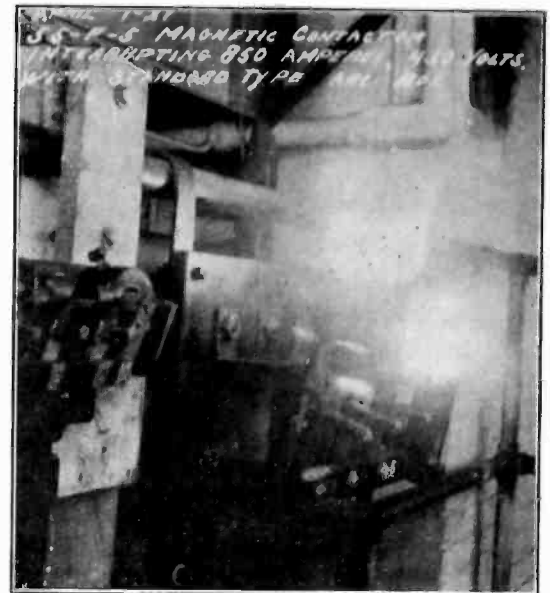

FIG. 5

plates the arc length has been considerably shortened, which in itself would cause a reduction in the total volume of arc flame. The arc is in a weaker magnetic field, which reduces the amount of air carried turbulently through the arc core, and therefore also the volume

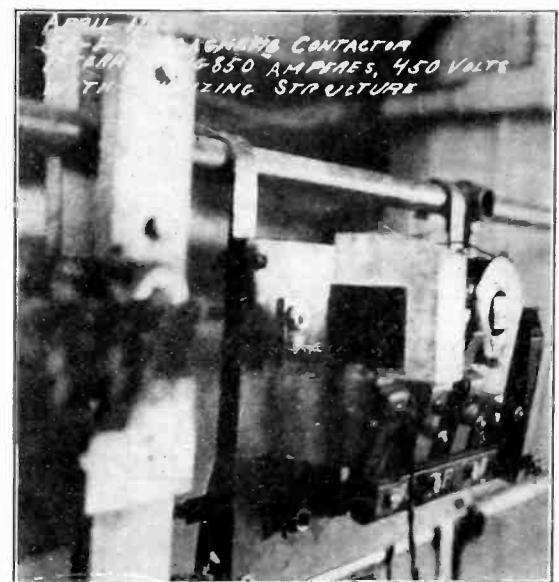

FIG. 6

of flame. Lastly, before escaping from the switch the flame gases pass through 1/16-in. channels between the deionizing plates where they are effectively cooled and deionized.

Figs. 5 and 6 show a comparison of the amount of flame emitted by a magnetic blowout contactor of the usual type, and a Deion contactor. The size of arc box is the same for the two switches, and the arc current is of the same magnitude. The absence of flame from the Deion contactor is quite remarkable.



# Abridgment of Electric Heating Elements Some Fundamentals Used in Their Design

BY EDWIN FLEISCHMANN\*

Member, A. I. E. E.

*Synopsis.*—The paper presents the derivation from elementary principles of equations for the design of heating elements. These are then connected with Stefan's law of radiation, and also with a

much-used rating curve which has given good results. The reason for the conservatism of this latter curve is shown, and a numerical example worked out for both the theoretical and empirical curves.

## INTRODUCTORY

THE classical basis upon which the theory of electric heating design rests, need only be suggested. It is founded on several well-known electrical and thermal laws,—for example, those of Ohm, Wien and Planck, and the familiar Stefan-Boltzman equation. To be sure, certain data which are based solely upon fortuitous experiment have been useful; but the fundamental relationships must not be ignored. It is the purpose of the present paper to outline briefly some principles in the use of electricity for heat, pointing out particularly those basic ones which govern its skilful employment.

In this paper, attention is confined to metallic resistors for high-temperature work (up to 1850 deg. fahr.). It is here that the upper safe value of the operating temperature of the heating unit is approached.

## MATERIAL FOR HEATING ELEMENTS

For temperatures up to 1850 deg. fahr., there is really only one material from which a practical life can be obtained. This is an alloy containing normally about 80 per cent nickel and 20 per cent chromium, with practically no iron. The susceptibility of iron to oxidation endangers the life of the metal at elevated temperatures; so that in the best metals it is carefully avoided. The alloy has the property of forming upon its surface a complicated metallic layer, of which the metallography is still not clearly understood. It is known, however, that this coating effectively prevents further oxidation of the body of the material below 2100 deg. fahr. (1150 deg. cent.). Thus, it assures the life of the element at ordinary heat-treating temperatures.

As indicated by the curves in Fig. 1, the resistivity of nickel chromium is consistent and fairly uniform.

## OHM'S LAW

The familiar law of Ohm states that

$$E = I R \quad (1)$$

where

$I$  = the current in amperes,

$E$  = the impressed voltage, and

$R$  = the resistance in ohms.

The power in watts is the product of  $E$  and  $I$ , or

$$E I = I^2 R \quad (2)$$

\*Industrial Heating Engineer, The Niagara Falls Power Co. Presented at the Summer Convention of the A. I. E. E., Swampscott, Mass., June 24-28, 1929. Complete copies upon request.

A variant form of Equation (2) may be obtained by substituting for  $I$  its value  $E/R$  from (1):

$$E I = \frac{E^2}{R} \quad (3)$$

The general expression for resistance of a conductor at any temperature is

$$R = m \rho \frac{L}{A} \quad (4)$$

where

$R$  is the resistance in ohms,

$m$  is a constant for any given temperature expressing

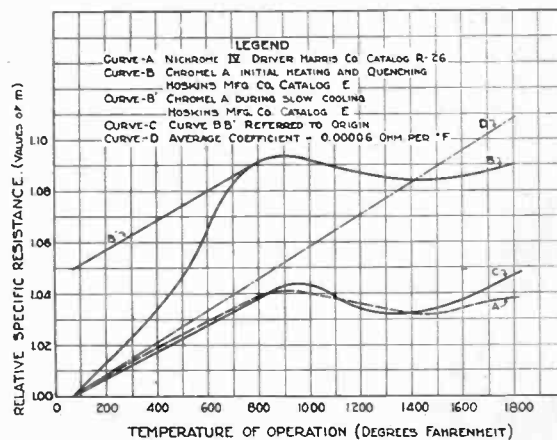

FIG. 1—RESISTANCE OF NICKEL-CHROMIUM AT ELEVATED TEMPERATURES

the ratio of the resistivity at that temperature to the resistivity at some temperature of reference. For nickel chromium, the values of  $m$  are shown in Fig. 1.

$\rho$  is the specific resistance, or resistivity at the temperature of reference. In the case of nickel chromium, the value of  $\rho$  is 625 ohms per cir. mil-ft., or 0.00004091 ohms per in. of length per sq. in. of cross-sectional area. The latter figure will be used hereafter, because we shall define  $L$  as the length in in., and  $A$  as the cross-sectional area in sq. in.

If, now, this value of  $R$  be substituted in Equations (2) and (3), they become

$$E I = \frac{I^2 m \rho L}{A} \quad (6)$$

and, <sup>FOR STRAIGHT CONDUCTOR</sup>  $E I = \frac{E^2 A}{m \rho L}$  (8)

There is no difficulty in applying the laws to other shapes. The equations already derived, (4), (6), and (8), are perfectly general. The geometrical simplicity of the rectangular and circular cross-section recommends them for this elementary discussion.

The cross-sectional areas in the two cases will be:

<u>Round Rod</u>		<u>Flat Ribbon</u>
$A = \frac{1}{4} \pi D^2$ (10a)		$A = a b$ (10b)

where  $D$  is the diameter of the rod in in. where  $a$  is the width of the ribbon in in., and  $b$  is the thickness of the ribbon in in.

<u>Round Rod</u>		<u>Flat Ribbon</u>
$E I = \frac{4 m \rho I^2 L}{\pi D^2}$ (11a)		$E I = \frac{I^2 m \rho L}{a b}$ (11b)

$E I = \frac{\pi E^2 D^2}{4 m \rho L}$ (13a)		$E I = \frac{E^2 a b}{m \rho L}$ (13b)
----------------------------------------------	--	----------------------------------------

The wattage per sq. in. can be related to the physical dimensions of the heating unit itself. If the peripheral surface of the resistor be denoted by  $S$ ,

<u>Round Rod</u>		<u>Flat Ribbon</u>
$S = \pi D L$ (15a)		$S = 2(a + b) L$ (15b)

The wattage per sq. in. of surface will, then, be  $E I / S$ . For convenience, set

$$G = E I / S \quad (16)$$

Then, using this value, and, for

<u>Round Rod</u>		<u>Flat Ribbon</u>
dividing by (15a), $\frac{I^2 m \rho L}{\pi D^2}$		dividing by (15b), $\frac{I^2 \rho m}{2 a b (a + b)}$
$G = \frac{4 I^2 \rho m}{\pi^2 D^3}$ (17a)		$G = \frac{I^2 \rho m}{2 a b (a + b)}$ (17b)

And, in a similar manner, dividing (13a) by (15a),  $\frac{E^2 D}{4 m \rho L^2}$  dividing (13b) by (15b),  $\frac{E^2 a b}{2 m \rho L^2 (a + b)}$

$G = \frac{E^2 D}{4 m \rho L^2}$ (19a)		$G = \frac{E^2 a b}{2 m \rho L^2 (a + b)}$ (19b)
----------------------------------------	--	--------------------------------------------------

Several simple transformations suggest themselves. One is often interested in the current density in the conductor. The density

$$Q = I / A \quad (21)$$

whence, for

<u>Round Rod</u>		<u>Flat Ribbon</u>
$Q = \frac{4 I}{\pi D^2}$ (22a)		$Q = \frac{I}{a b}$ (22b)

and, *beginning*

$$I = \frac{\pi}{4} Q D^2 \quad (23a) \quad I = Q a b \quad (23b)$$

$$G = \frac{\pi}{4} Q^2 \rho D m \quad (24a) \quad G = \frac{Q^2 m \rho a b}{2(a + b)} \quad (24b)$$

In short the wattage per sq. in. of the surface varies with the square of the current density, for any given cross-section.

The voltage per unit length may also be of importance, in its relation to the wattage per sq. in. of surface. This appears very easily from Equation (19). Setting  $F$  equal to the voltage per in. of length, and  $F'$  equal to the voltage per ft. of length,

$$F = E / L, \quad \text{or } E = F L \quad (26)$$

$$F' = \frac{12 E}{L}, \quad \text{or } E = \frac{F' L}{12} \quad (27)$$

<u>Round Rod</u>		<u>Flat Ribbon</u>
$G = \frac{F^2 D}{4 \rho m}$ (28a)		$G = \frac{F^2 a b}{2 m \rho (a + b)}$ (28b)

$G = \frac{F'^2 D}{576 \rho m}$ (30a)		$G = \frac{F'^2 a b}{288 m \rho (a + b)}$ (30b)
---------------------------------------	--	-------------------------------------------------

STEFAN-BOLTZMAN LAW

The Stefan-Boltzman equation is an hypothesis guessed at by Stefan<sup>1</sup> in 1879 as a result of one of Tyndall's experiments, and conclusively proved by Boltzman<sup>2</sup> mathematically in 1884, being substantiated by many subsequent investigations. It states that the total radiation from a body is proportional to the fourth power of its absolute temperature:

$$R = K T^4 \quad (32)$$

where

$R$  is the total radiation per unit of surface in fundamental units;

$T$  is the absolute temperature on the Kelvin scale; and  $K$  is the constant of proportionality.

The equation is not very useful in this form, since the total radiation is scarcely ever of much import. Rather is the exchange of heat between hot and cold bodies, or between resistor and charge in the furnace chamber of interest.  $R$  may, therefore, be expressed in watts per sq. in. of radiating surface, and

$$G = K' e \left[ \left( \frac{T_1 + 459.4}{1000} \right)^4 - \left( \frac{T_0 + 459.4}{1000} \right)^4 \right] \quad (33)$$

wherein

$K'$  is the constant of proportionality;

$e$  is the relative emissivity of the radiating material.

For black bodies,  $e = 1.00$ ; for nickel chromium,  $e = 0.9$ ;

1. Sitzungsberichte der Königlichen Gesellschaft der Wissenschaften zu Wien, Band LXXIX, p. 391, 1879.

2. Annalen der Physik, Band XXII, pp. 31 and 291, 1884.

$T_1$  is the temperature of the resistor in deg. fahr.; and  $T_0$  is the temperature of the furnace chamber in deg. fahr.

Frequently, however, the full effect of the radiating periphery is not obtained. Proximity of walls or charge, or adjacent strands of the element exercise a blanketing effect, which reduces the liberation of heat at any given temperature.<sup>10</sup> Where the efficiency of radiation is less than 100 per cent under such conditions as those described by Keene and Luke, Fig. 2 defines the limiting allowable conditions for design of nickel chromium units. It is based upon a maximum allowable element temperature of 2100 deg. fahr. To insure long life of the heaters, their rating must fall below the curve which represents the condition of size, spacing, and radiating efficiency ( $C$ ) under consideration.

COMBINATIONS OF THE TWO LAWS

It is at once evident that in designing resistors, both of the laws must be heeded; and some very useful relationships can be adduced, by substituting the values of  $G$  in Equation (34). For this purpose, set  $T_1 = 2100$  deg. fahr., and write

$$G_0 = 3.169 C \left[ 42.85 - \left( \frac{T_0 + 459.4}{1000} \right)^4 \right] \quad (37)$$

in which  $C$  is the radiating efficiency already defined, as shown in Fig. 2.

Round Rod

Flat Ribbon

$$D = 0.7401 \sqrt[3]{\frac{I^2 \rho m}{G_0}} \quad ab(a+b) = 0.5 \frac{I^2 \rho m}{G_0} \quad (38a) \quad (38b)$$

$$D = \frac{4 m \rho G_0 L^2}{E^2} \quad \frac{ab}{a+b} = \frac{2 m \rho L^2 G_0}{E^2} \quad (40a) \quad (40b)$$

$$D = \frac{4 G_0}{Q^2 m \rho} \quad \frac{ab}{a+b} = \frac{2 G_0}{Q^2 m \rho} \quad (42a) \quad (42b)$$

$$D = \frac{4 m \rho G_0}{F^2} \quad \frac{ab}{a+b} = \frac{2 m \rho G_0}{F^2} \quad (44a) \quad (44b)$$

$$D = \frac{576 m \rho G_0}{F'^2} \quad \frac{ab}{a+b} = \frac{288 m \rho G_0}{F'^2} \quad (46a) \quad (46b)$$

The values of  $G_0$  for any temperature and radiating efficiency may be taken directly from Fig. 2.

For any value of  $C$ , these relationships provide complete design data. In the case of the round rod, they may be plotted. (Fig. 3).

10. A discussion of the relative efficiency of several arrangements of heating units may be found in *Rating of Heating Elements for Electric Furnaces*, by A. D. Keene and G. E. Luke, A. I. E. E. TRANSACTIONS, Vol. XLV, 1926, p. 475

EMPIRICAL RELATIONSHIPS

The straight line,

$$G = \frac{2100 - T_0}{30} \quad (53)$$

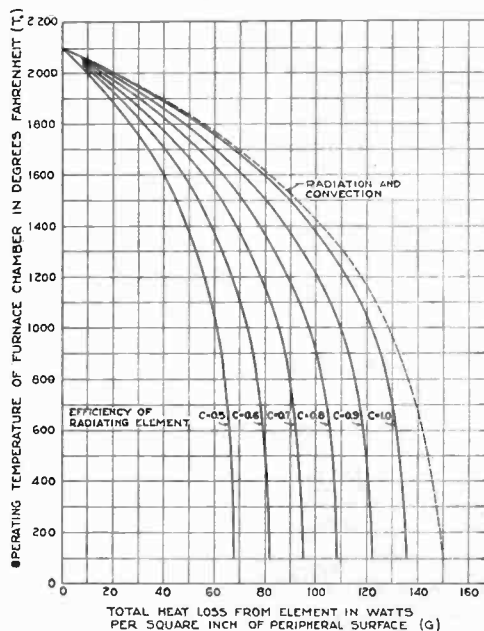

FIG. 2—THEORETICAL RADIATION FROM NICKEL-CHROMIUM RESISTOR OPERATING AT 2100 DEG. FAHR.

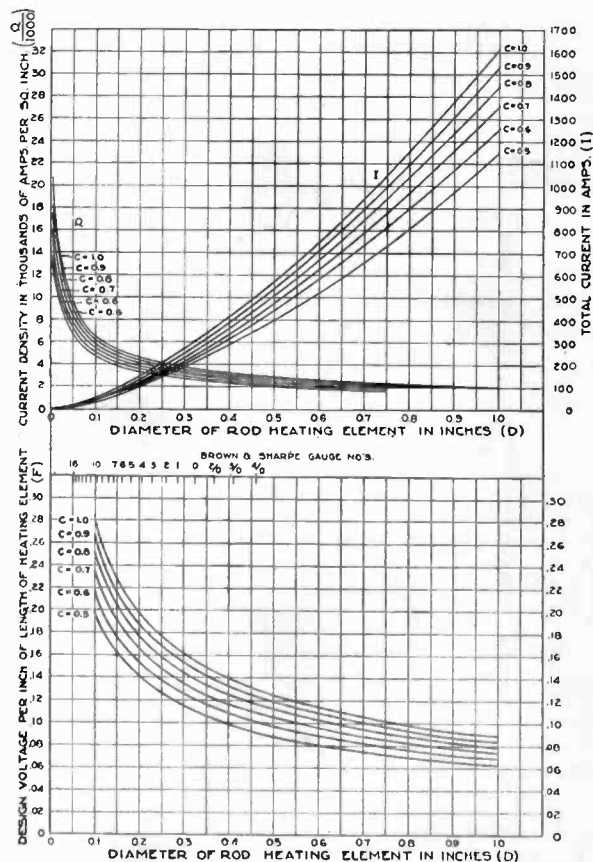

FIG. 3—THEORETICAL DESIGN CURVES FOR NICKEL-CHROMIUM ROD HEATING ELEMENTS IN ELECTRIC FURNACES OPERATING AT 1850 DEG. FAHR.

is shown in Fig. 4 (Curve B), in its relation to curve A,— 50 per cent radiating efficiency replotted from Fig. 2. It is evident that the line gives an extremely conserva-



tive rating, especially at moderate temperatures, even under such conditions as the double banking or close spacing of units.

Substituting for  $G$  its value

Round Rod	Flat Ribbon
$T_0 = 2100 - \frac{120 I^2 \rho m}{\pi^2 D^3}$ (55a)	$T_0 = 2100 - \frac{15 I^2 \rho m}{a b (a + b)}$ (55b)
$T_0 = 2100 - 7.5 \frac{E^2 D}{m \rho L^2}$ (57a)	$T_0 = 2100 - 15 \frac{E^2 a b}{m \rho L^2 (a + b)}$ (57b)
$T_0 = 2100 - 7.5 Q^2 \rho D m$ (59a)	$T_0 = 2100 - 15 \frac{Q^2 m \rho a b}{(a + b)}$ (59b)
$T_0 = 2100 - 7.5 \frac{F^2 D}{\rho m}$ (61a)	$T_0 = 2100 - 15 \frac{F^2 a b}{m \rho (a + b)}$ (61b)
$T_0 = 2100 - \frac{F'^2 D}{19.2 \rho m}$ (63a)	$T_0 = 2100 - \frac{F'^2 a b}{9.6 m \rho (a + b)}$ (63b)

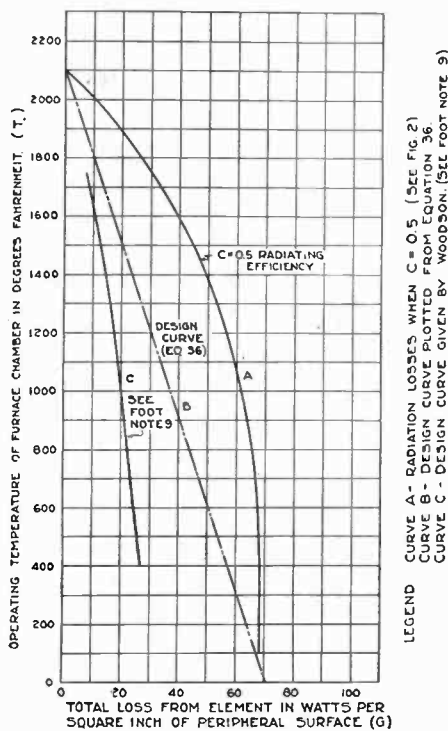

FIG. 4—COMPARISON OF THEORETICAL WITH OTHER RADIATION CURVES FOR NICKEL-CHROMIUM HEATING ELEMENT TEMPERATURE OF 2100 DEG. FAHR.

NUMERICAL EXAMPLE

For example, assume that it is desired to design the heating elements for a 20-kw. furnace, to operate on 220 volts, single-phase, with maximum operating temperature of 1850 deg. fahr. and  $C = 0.5$ .

The designer may choose whichever of the elements best suits the space available in the furnace and the manner of mounting. The theoretical values are as follows:

Round Rod	Flat Ribbon
125.6 ft. of No. 4 wire	36.86 ft. of 1-in. $\times$ 0.008-in. ribbon
	51.65 ft. of $\frac{3}{4}$ -in. $\times$ 0.0159-in. ribbon
	71.77 ft. of $\frac{1}{2}$ -in. $\times$ 0.032-in. ribbon

Conservative practise dictates that the empirical values provide some factor of safety; and, although

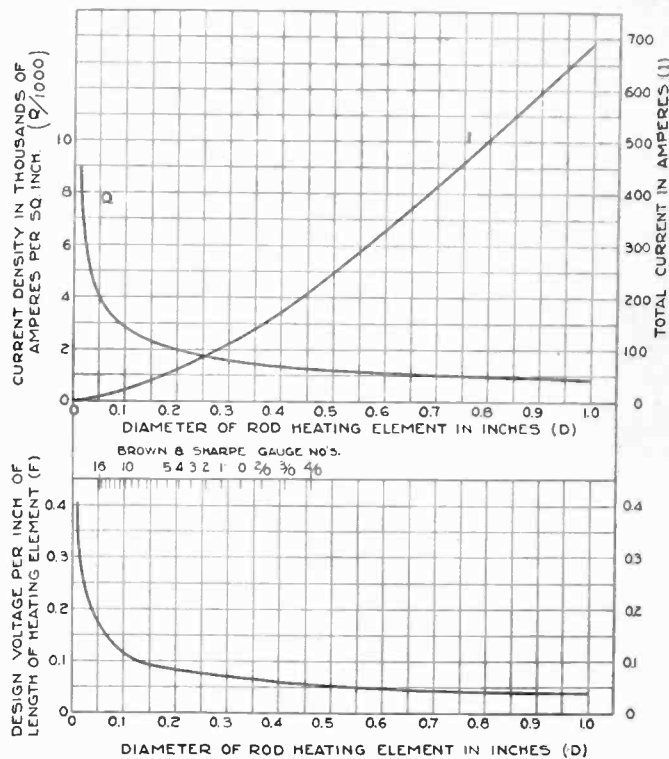

FIG. 5—DESIGN CURVES FOR NICKEL-CHROMIUM ROD HEATING ELEMENTS IN ELECTRIC FURNACES OPERATING AT 1850 DEG. FAHR. (BASED ON CURVE B, FIG. 4)

they involve the use of more metal, they mean lower ratings, decreased element temperatures, greater mechanical strength, and longer life. They are:

Round Rod	Flat Ribbon
246.35 ft. of No. 2 wire	107.95 ft. of 1-in. $\times$ 0.0253-in. ribbon
	133.6 ft. of $\frac{3}{4}$ -in. $\times$ 0.04-in. ribbon.

CONCLUSION

The derivation of fundamental equations for use in the design of electric heating elements has shown what are the physical limitations of the problem. As a sequel thereto, it has been found that one of the earliest rules-of-thumb gives good factors of safety at all electric furnace temperatures.

# Protective Devices

## ANNUAL REPORT OF COMMITTEE ON PROTECTIVE DEVICES\*

### To the Board of Directors:

The work of the Committee this year has been; first, the revision of present and preparation of new standards; second, a survey and review of research and development made during the past year in the several fields covered by the Committee; and third, arranging for the preparation of papers for presentation before meetings of the Institute.

The work of the Committee, as organized at the meeting in New York in November 1928, has been carried out by subcommittees, each under the direction of its own chairman. The fields covered and the chairmen in charge of the subcommittees are as follows:

Lightning Arresters	Herman Halperin	Commonwealth Edison Company, Chicago, Ill.
Industrial Equipment and Service Protection	R. O. Muir	General Electric Company, Schenectady, N. Y.
Current Limiting Reactors	N. L. Pollard	Public Service Production Company, Newark, N. J.
Oil Circuit Breakers, Switches, and Fuses	A. M. Rossman	Sargent & Lundy, Chicago, Ill.
Relays	H. P. Sleeper	Public Service Electric and Gas Company, Newark, N. J.

The Subcommittee on Communication Line Protection which reported last year has been discontinued as it was felt its work overlapped with that of the Technical Committee on Communication Lines.

### SUBCOMMITTEE ON LIGHTNING ARRESTERS

Work has been continued on the A. I. E. E. Standards for Lightning Arresters. Two preliminary reports of these standards have already been published, (one in 1926 and the other in 1928), under the title *Report on Standards for Lightning Arresters and Other Apparatus for Protection Against Abnormal Transient Voltages*. Because of the wide variation in requirements and practices of arresters for all types of circuits, in the present revision the standards may be limited in scope to arresters for power circuits and the title shortened to *Standards for Lightning Arresters*. As soon as it is practicable, the subcommittee hopes to turn its attention to standards for arresters for other applications and to standards for other protective devices, such as surge absorbers, choke coils, ground wires, fused grading shields, etc.

#### \*COMMITTEE ON PROTECTIVE DEVICES:

E. A. Hester, Chairman,		
Raymond Bailey, Vice-Chairman		
V. J. Brain, Secretary		
A. C. Cummins,	F. C. Hanker,	R. C. Muir,
E. W. Dillard,	F. L. Hunt,	N. L. Pollard,
H. W. Drake,	B. G. Jamieson,	A. M. Rossman,
W. S. Edsall,	J. Allen Johnson,	A. H. Schirmer,
L. E. Frost,	S. M. Jones,	H. P. Sleeper,
E. E. George,	R. L. Kingsland,	R. M. Spurck,
James S. Hagan,	M. G. Lloyd,	E. R. Stauffacher,
H. Halperin,	J. B. MacNeill,	H. R. Summerhayes.

Presented at the Summer Convention of the A. I. E. E., Swampscott, Mass., June 24-28, 1929. Printed complete herein.

Research on lightning has been continued in the field and laboratory by the manufacturers, in several instances, in cooperation with a number of the operating companies. Extensive tests have been made on the transmission, reflection, attenuation and effect on terminal apparatus of surges applied on full-sized transmission lines. These tests are being continued and are being correlated with the effects of natural lightning on the same or similar lines.

Further studies of natural lightning on transmission lines by the cathode ray oscillograph will be continued during the present lightning season, so that several records of great value and interest may be expected this year as a result of the extensive program. Investigations of surges, their effect on apparatus and diminution by arresters has been greatly aided by continued development in portability, ease of manipulation and automatic timing features of cathode ray oscillographs. A new type which appears to have many good features has been developed by R. E. George of Purdue University.

A large scale and detailed program of investigation is still being actively pursued by one of the large operating companies on the causes of transformer failures on 4-kv. distribution circuits and their 115/230-volt secondaries during lightning storms and on the possible methods of reducing the number of service interruptions due to such failures. Studies are being made of the effects of resistance in the arrester ground, and laboratory and field tests are being made on the effect and practicability of lightning arrester protection on the secondary side of the transformers.

In the field of high-voltage transmission, work has been continued on the use of fuses in connection with grading shields on insulator strings. Recent development indicate the feasibility of using expulsion type fuses as arcing horns at the tower end of the string. These developments indicate a tendency to build lightning arrester characteristics into the insulator string itself and perhaps, in the future other elements will be developed for connection in series with or in shunt with part of the insulator string to accomplish this end.

There are several problems the solution of which will require further tests and study. Some of these are as follows:

1. *Gap-Setting.* The proper setting of gaps in series with arresters depends largely upon the type of arrester and its application. The application must take into consideration the maximum dynamic voltage, which is dependent on such factors as grounded or ungrounded neutral, relaying, arcing grounds, and also whether the plant is steam or hydro.

2. *Ground Resistance.* With the increasing size of power systems, the problem of obtaining good grounds

tive rating, especially at moderate temperatures, even under such conditions as the double banking or close spacing of units.

Substituting for  $G$  its value

<i>Round Rod</i>	<i>Flat Ribbon</i>
$T_0 = 2100 - \frac{120 I^2 \rho m}{\pi^2 D^3}$	$T_0 = 2100 - \frac{15 I^2 \rho m}{a b (a + b)}$
(55a)	(55b)

$T_0 = 2100 - 7.5 \frac{E^2 D}{m \rho L^2}$	$T_0 = 2100 - 15 \frac{E^2 a b}{m \rho L^2 (a + b)}$
(57a)	(57b)

$T_0 = 2100 - 7.5 Q^2 \rho D m$	$T_0 = 2100 - 15 \frac{Q^2 m \rho a b}{(a + b)}$
(59a)	(59b)

$T_0 = 2100 - 7.5 \frac{F^2 D}{\rho m}$	$T_0 = 2100 - 15 \frac{F^2 a b}{m \rho (a + b)}$
(61a)	(61b)

$T_0 = 2100 - \frac{F'^2 D}{19.2 \rho m}$	$T_0 = 2100 - \frac{F'^2 a b}{9.6 m \rho (a + b)}$
(63a)	(63b)

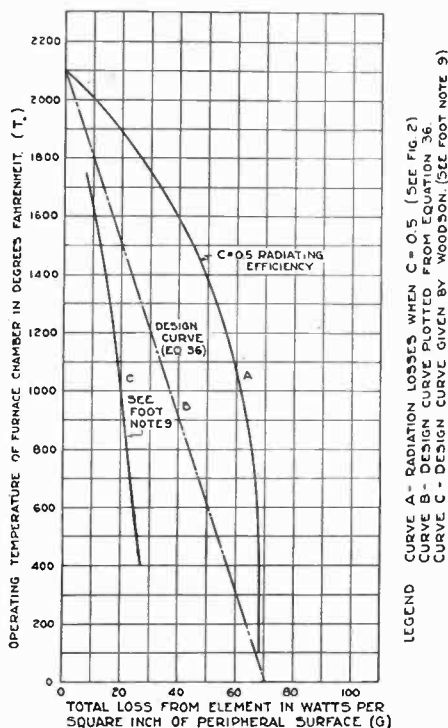

FIG. 4—COMPARISON OF THEORETICAL WITH OTHER RADIATION CURVES FOR NICKEL-CHROMIUM HEATING ELEMENT TEMPERATURE OF 2100 DEG. FAHR.

NUMERICAL EXAMPLE

For example, assume that it is desired to design the heating elements for a 20-kw. furnace, to operate on 220 volts, single-phase, with maximum operating temperature of 1850 deg. fahr. and  $C = 0.5$ .

The designer may choose whichever of the elements best suits the space available in the furnace and the manner of mounting. The theoretical values are as follows:

<i>Round Rod</i>	<i>Flat Ribbon</i>
125.6 ft. of No. 4 wire	36.86 ft. of 1-in. × 0.008-in. ribbon
	51.65 ft. of 3/4-in. × 0.0159-in. ribbon
	71.77 ft. of 1/2-in. × 0.032-in. ribbon

Conservative practise dictates that the empirical values provide some factor of safety; and, although

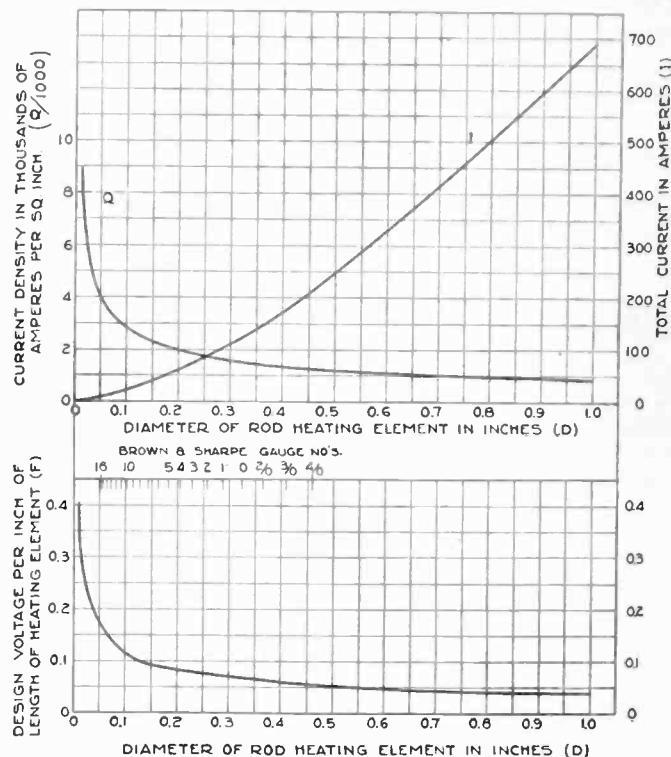

FIG. 5—DESIGN CURVES FOR NICKEL-CHROMIUM ROD HEATING ELEMENTS IN ELECTRIC FURNACES OPERATING AT 1850 DEG. FAHR. (BASED ON CURVE B, FIG. 4)

they involve the use of more metal, they mean lower ratings, decreased element temperatures, greater mechanical strength, and longer life. They are:

<i>Round Rod</i>	<i>Flat Ribbon</i>
246.35 ft. of No. 2 wire	107.95 ft. of 1-in. × 0.0253-in. ribbon
	133.6 ft. of 3/4-in. × 0.04-in. ribbon.

CONCLUSION

The derivation of fundamental equations for use in the design of electric heating elements has shown what are the physical limitations of the problem. As a sequel thereto, it has been found that one of the earliest rules-of-thumb gives good factors of safety at all electric furnace temperatures.



# Protective Devices

## ANNUAL REPORT OF COMMITTEE ON PROTECTIVE DEVICES\*

### To the Board of Directors:

The work of the Committee this year has been; first, the revision of present and preparation of new standards; second, a survey and review of research and development made during the past year in the several fields covered by the Committee; and third, arranging for the preparation of papers for presentation before meetings of the Institute.

The work of the Committee, as organized at the meeting in New York in November 1928, has been carried out by subcommittees, each under the direction of its own chairman. The fields covered and the chairmen in charge of the subcommittees are as follows:

Lightning Arresters	Herman Halperin	Commonwealth Edison Company, Chicago, Ill.
Industrial Equipment and Service Protection	R. C. Muir	General Electric Company, Schenectady, N. Y.
Current Limiting Reactors	N. L. Pollard	Public Service Production Company, Newark, N. J.
Oil Circuit Breakers, Switches, and Fuses	A. M. Rossman	Sargent & Lundy, Chicago, Ill.
Relays	H. P. Sleeper	Public Service Electric and Gas Company, Newark, N. J.

The Subcommittee on Communication Line Protection which reported last year has been discontinued as it was felt its work overlapped with that of the Technical Committee on Communication Lines.

### SUBCOMMITTEE ON LIGHTNING ARRESTERS

Work has been continued on the A. I. E. E. Standards for Lightning Arresters. Two preliminary reports of these standards have already been published, (one in 1926 and the other in 1928), under the title *Report on Standards for Lightning Arresters and Other Apparatus for Protection Against Abnormal Transient Voltages*. Because of the wide variation in requirements and practices of arresters for all types of circuits, in the present revision the standards may be limited in scope to arresters for power circuits and the title shortened to *Standards for Lightning Arresters*. As soon as it is practicable, the subcommittee hopes to turn its attention to standards for arresters for other applications and to standards for other protective devices, such as surge absorbers, choke coils, ground wires, fused grading shields, etc.

#### \*COMMITTEE ON PROTECTIVE DEVICES:

E. A. Hester, Chairman,  
Raymond Bailey, Vice-Chairman  
V. J. Brain, Secretary

A. C. Cummins,	F. C. Hanker,	R. C. Muir,
E. W. Dillard,	F. L. Hunt,	N. L. Pollard,
H. W. Drake,	B. G. Jamieson,	A. M. Rossman,
W. S. Edsall,	J. Allen Johnson,	A. H. Schirmer,
L. E. Frost,	S. M. Jones,	H. P. Sleeper,
E. E. George,	R. L. Kingsland,	R. M. Spurck,
James S. Hagan,	M. G. Lloyd,	E. R. Stauffacher,
H. Halperin,	J. B. MacNeill,	H. R. Summerhayes.

Presented at the Summer Convention of the A. I. E. E., Swampscott, Mass., June 24-28, 1929. Printed complete herein.

Research on lightning has been continued in the field and laboratory by the manufacturers, in several instances, in cooperation with a number of the operating companies. Extensive tests have been made on the transmission, reflection, attenuation and effect on terminal apparatus of surges applied on full-sized transmission lines. These tests are being continued and are being correlated with the effects of natural lightning on the same or similar lines.

Further studies of natural lightning on transmission lines by the cathode ray oscillograph will be continued during the present lightning season, so that several records of great value and interest may be expected this year as a result of the extensive program. Investigations of surges, their effect on apparatus and diminution by arresters has been greatly aided by continued development in portability, ease of manipulation and automatic timing features of cathode ray oscillographs. A new type which appears to have many good features has been developed by R. E. George of Purdue University.

A large scale and detailed program of investigation is still being actively pursued by one of the large operating companies on the causes of transformer failures on 4-kv. distribution circuits and their 115/230-volt secondaries during lightning storms and on the possible methods of reducing the number of service interruptions due to such failures. Studies are being made of the effects of resistance in the arrester ground, and laboratory and field tests are being made on the effect and practicability of lightning arrester protection on the secondary side of the transformers.

In the field of high-voltage transmission, work has been continued on the use of fuses in connection with grading shields on insulator strings. Recent development indicate the feasibility of using expulsion type fuses as arcing horns at the tower end of the string. These developments indicate a tendency to build lightning arrester characteristics into the insulator string itself and perhaps, in the future other elements will be developed for connection in series with or in shunt with part of the insulator string to accomplish this end.

There are several problems the solution of which will require further tests and study. Some of these are as follows:

1. *Gap-Setting.* The proper setting of gaps in series with arresters depends largely upon the type of arrester and its application. The application must take into consideration the maximum dynamic voltage, which is dependent on such factors as grounded or ungrounded neutral, relaying, arcing grounds, and also whether the plant is steam or hydro.

2. *Ground Resistance.* With the increasing size of power systems, the problem of obtaining good grounds

has become increasingly important. In the case of large stations, the expense of providing adequate grounding facilities is low enough relative to the total station costs involved so as not to be serious from an investment standpoint, but in the case of small stations, tower footings, etc., the cost of securing adequate ground connections may be high enough relative to the total investment to be rather serious.

3. Quantitative ratings with respect to impulse voltage of lightning arresters and apparatus to be protected in order to give greater assurance of protection.

All things considered the subcommittee feels that splendid progress has been made in the study of lightning and in apparatus and methods of mitigating its interference with power transmission. It looks forward with confidence to accelerated progress in protection against lightning in the immediate future.

Several valuable papers have been presented before the Institute on these and allied subjects, among which the following may be mentioned:

*A Graphical Theory of Traveling Electric Waves*, by V. Karapetoff, A. I. E. E. Quarterly TRANS., Vol. 48, April 1929, p. 508.

*Progress in Lightning Research in the Field and Laboratory*, by F. W. Peek, Jr., A. I. E. E. Quarterly TRANS., Vol. 48, April 1929, p. 436.

*1927 Lightning Experience on 132-Kv. Transmission Lines*, by Philip Sporn, A. I. E. E. Quarterly TRANS., Vol. 48, April 1929, p. 480.

*Theoretical and Field Investigations of Lightning*, by C. L. Fortescue, A. L. Atherton, and J. H. Cox, A. I. E. E. Quarterly TRANS., Vol. 48, April 1929, p. 449.

*Protection of Transmission Lines from Interruption by Lightning*, by 1928 Subcommittee of Power Transmission and Distribution Committee, A. I. E. E. Quarterly TRANS., Vol. 48, April 1929, p. 487.

*Rationalization of Transmission System Insulation Strength*, by Philip Sporn, A. I. E. E. Quarterly TRANS., Vol. 47, Oct. 1928, p. 998 (Discussion p. 1009).

*Relation Between Transmission Line Insulation and Transformer Insulation*, by W. W. Lewis, A. I. E. E. Quarterly TRANS., Vol. 47, Oct. 1928, p. 992. (Discussion 1009).

*Symposium on Surge Voltage Investigation on Transmission Lines*, A. I. E. E. Quarterly TRANS., Vol. 47, Oct. 1928, pp. 1111-1154.

*A New Type of Hot Cathode Oscillograph*, by R. E. George. Presented at the A. I. E. E. Regional Meeting, Cincinnati, Mar. 20-22, 1929.

*Fused Arcing Horns and Grading Rings*, by P. B. Stewart, A. I. E. E. J.L., May 1929, p. 390.

*Investigation of Transmission Lines with Artificial Lightning*, by K. B. McEachron and V. E. Goodwin, A. I. E. E. J.L., May 1929, p. 382

*Lightning Studies of Transformers by the Cathode Ray Oscillograph*, by F. F. Brand and K. K. Palueff, A. I. E. E. Regional Meeting, Dallas, Texas, May 7-9, 1929.

#### SUBCOMMITTEE ON INDUSTRIAL EQUIPMENT AND SERVICE EQUIPMENT

Addition to A. I. E. E. Standards No. 15 (A. E. S. C. C-19) Industrial Control Apparatus has been completed, and will be submitted to the A. I. E. E. Standards Committee for joint action with N. E. M. A.

These additions are considered necessary to the Industrial Control Standards inasmuch as there is no standardized basis of short-time current rating or short-circuit interrupting rating of contactors and consequently information is not available whereby contactors might be properly applied.

A paper dealing with the general development and application of industrial control equipment and protective devices is being prepared under the auspices of this committee. Little has been published on this general subject, particularly with reference to the application of contactors, and it is felt that this paper will be of material assistance to engineers and will stimulate progress along the right lines in industrial equipment and service protection.

#### SUBCOMMITTEE ON CURRENT-LIMITING REACTORS

Some thought has been given to new standards for current-limiting reactors, but it has not been considered practicable to draw any up at the present time.

Last year's report called attention to the progress being made in the field of oil-insulated reactors. This progress has continued, large oil-immersed reactors having been built during the last year for circuit voltages ranging from 2.3 kv. to 73 kv., and in one instance for as high a circuit voltage as 120 kv. This type of reactor has increased the field of application of current limiting reactors, since it can be designed for higher voltages than the dry type and is particularly adaptable for outdoor service.

In the case of the 120-kv. circuit mentioned above, the reactors are used for sectionalizing the 120-kv., 60-cycle bus of a generating station having a capacity of 375,000 kv-a. Each reactor is rated at 2800 kv-a. and introduces 10 per cent reactance at 75,000 kv-a.

During the past year there has been a considerable increase in the number of dry type reactors installed with a marked increase in the use of reactors for grounding the neutral at generating stations.

Two, and possibly three, papers will be published and presented before the Institute in the near future under the auspices of this committee.

#### SUBCOMMITTEE ON OIL CIRCUIT BREAKERS, SWITCHES AND FUSES

The preparation of more comprehensive standards for fuses is now under way. It is expected that the preparation of these standards will be greatly facilitated by tests which have been conducted during the past year by several operating companies on fuses rated at voltages from 2.3 to 66 kv. A series of tests have also been conducted on fuses of potential transformers.

Several manufacturers have increased their gen-

erating facilities available for testing oil circuit breakers and have carried out, on a large scale, systematic programs of testing their standard circuit breakers. These tests have resulted in improvements in details and have given an increased knowledge of the safe interrupting capacities of these oil circuit breakers.

Field tests have been extended to include 220-kv. oil circuit breakers, and additional tests are scheduled to be made this year. It is expected that the results of these tests will be published as soon as the tests have been completed and the data available for publication.

Increased interest has also been taken in higher speed oil circuit breakers for use on high-voltage transmission lines to improve stability of operation by the more rapid clearing of faults.

Circuit breakers of extremely high speeds have been developed for electric railway protection. Tripping speeds as high as 0.012 to 0.016 sec. for a d-c. breaker and 0.04 sec. for an a-c. breaker have been obtained.

The past year has shown an increased interest in metal-enclosed switching structures. A number of the manufacturers of switching equipment in this country are now building structures of this type. A 33-kv. structure has been in successful operation for over a year and several others are now being built for this voltage. A 22-kv. structure of the oil filled type, the largest structure of this type to be installed in this country, will handle the entire output of one of the largest power stations in the Middle West. The first section comprising 23 units was placed in service this Spring. Several hundred units of this type have also been installed on 2300-volt circuits.

These structures greatly reduce the hazard to human life because the live parts are inaccessible and because the moving or removable parts may be interlocked to prevent incorrect operations. Most of the structures have been built without disconnecting switches, the oil circuit breaker being disconnected from its connections with the bus bars and circuits by being moved bodily away from its operating positions. This has permitted a very simple system of interlocking with the use of but five or six sturdy parts.

The metal-enclosed design is completely fabricated in the shops of the manufacturer, and the equipment is shipped in a semi-assembled condition. These factors tend to promote standardization of design and eliminate a large amount of field work, both of which should in time be reflected in lower costs of switching structures.

Papers on theory, design, and test of the Deion circuit breaker were presented at the Winter Convention of the Institute. This development appears to be a notable contribution to the circuit breaker art, as it eliminates the use of oil, and while at present confined to relatively low voltages, it is hoped that it will later be found possible to adopt it for use on higher voltages. It is also hoped that this development will stimulate further research which may lead to the discovery and

application of other new principles for interrupting power circuits.

Through the efforts of the members of this subcommittee, the following papers have been submitted for presentation before the Institute some time during the coming fall or winter:

*A Method of Fuse Testing*, by B. M. Jones and E. H. Coxe.

*Fuse Tests*, by S. Murray Jones, Supplemented by comments on recent oil circuit breaker tests.

*Potential Transformer Fuses*, by H. P. Sleeper and M. F. Riley.

*The Effectiveness of Different Types of Barrier Construction in Switch Houses*, by P. H. Adams and B. M. Jones.

#### SUBCOMMITTEE ON RELAYS

The feasibility of standardizing the operating characteristic of relays of different manufacturers has been investigated. This refers to the standardization of characteristic relay curves, operating current values of relay indicators, and various other characteristics of relays which are possible of standardization. It is apparent that the subject is one which will require considerable discussion by the members of the Institute before a representative concensus of opinion can be obtained, and as sufficient data are not yet at hand, it will be desirable to continue the work of this group for another year.

A review of protective relay schemes in use at this date indicates that there have been no radical changes in relay practice made in the past few years. However, there have been some new schemes introduced and the trend at the moment is a departure from the old standard schemes and is worthy of note.

The great majority of all relay installations in service at this time on transmission lines is some form of the so-called time differential system whereby selectivity between adjacent breakers is secured by the use of selective time settings. This involves the use of overcurrent and directional overcurrent relays in the same manner as has been used for many years heretofore. This system, of course, has the disadvantage of limiting the number of sectionalizing points in series by reason of the cumulative time settings at the source end. It has the further disadvantage of requiring time settings in excess of instantaneous settings.

To enable instantaneous settings to be used with the resulting increase in stability to power systems and minimizing of damage at the point of fault, there has been a tendency to use increased number of installations of differential schemes of transmission line protection. The series scheme of differential protection of transmission lines,—namely, pilot wire relaying,—has never found much favor in this country, although one operating company reports that it has used this method extensively on its 12-kv. loops out of substations, and the scheme has been quite satisfactory. They have

adopted recently the use of pilot wire protection on 66-kv. lines and installed several hundred thousand feet of such pilot wire last year. Modifications of the pilot wire scheme are becoming more in favor, however, as indicated below. The scheme of parallel differential protection of transmission lines, where one line is balanced against another, is the form most commonly used in this country and its use has increased considerably in the past few years.

At this time there is a very definite trend toward the use of schemes of transmission line protection which have not been named but might be called "independent" schemes. By this is meant schemes of relay protection wherein the protection of one section of line is entirely independent of that on an adjacent section. The pilot wire scheme falls within this category but as indicated above has never been commonly used. The impedance relay is a scheme embodying some of the features of this type of protection, and its application is slowly increasing. It is perhaps the simplest scheme of protection that is available at the moment. One of the most interesting applications of this type of protection is a case where the short-circuit current under certain conditions may be less than the full-load current. Here impedance relays are intended to be used for short-circuit protection, which are normally short-circuited out of service by fault detector relays. The latter are operated either by low voltage or the presence of short-circuit current which cuts in the impedance relays and allows them to operate during fault conditions.

A further and more elaborate scheme of this type is one which is now being used on a small scale and has possibilities for improvement and application in the future. This is a modification of the pilot wire scheme where the pilot wires are replaced by high-frequency oscillations on the transmission wires themselves. Two schemes are in use, one a high or radio frequency scheme, and the other a low or audio frequency scheme, both of which are fundamentally the same in operation. At the present time, auxiliary equipment of considerable cost and size is required at the line terminals to enable this scheme to function properly, and tends to limit its use. However, it is probable that these schemes will be perfected and fundamentally they seem to offer the most promising solution for future protection problems, particularly of the more complicated type. They embody all of the most desirable characteristics of relay protection; namely, high speed of operation, independent settings and no limitations as to numbers of stations in series. It is probable that the future trend of the art will be definitely in the direction of applications of this so-called independent scheme of relaying.

There is a growing tendency toward recognition of the importance of bus protection in high-tension stations. Heretofore, the protection of busses in such stations was considered unnecessary, but the increasing capacities involved, with the resulting seriousness of outages, has urged the use of this type of protection. It usually

partakes of the form of series differential protection. For this protection, and also for the protection of transformer banks and rotating machines, the use of ratio differential relays is becoming more common and superseding the old type of differentially connected over-current relays.

A scheme for securing overcurrent protection on balanced lines without the use of additional relays has been developed. The high- and low-set directional relays are connected in much the usual manner, except that the balance point is made at the mid-point of an auto current transformer, and the overcurrent element of a high-set relay is connected across the entire winding of the auto, instead of in the balanced circuit. It is obvious that the high-set relay receives line current at all times and is connected to trip both breakers. This of course requires the use of a double-contact directional element on the low-set directional relay.

A new scheme of protecting load ratio control units has been developed, using a restrained overcurrent relay. One winding is connected to the exciting winding of the load ratio control unit. The other winding is connected to the line. The effect is to change the setting of the relay so that a percentage tripping characteristic is obtained.

A scheme for detecting ground faults in apparatus by using a restrained current relay with multiple restraining coils has been developed. These coils are connected to the phase current transformers and the operating coil is energized by the residual current.

Radio differential relays have been applied to bus differential protection and their characteristic used to tend to eliminate incorrect operations due to secondary wiring troubles.

There are also two new types of network relays. One of these is designed to operate on high reverse current at normal voltage and is still very sensitive at short-circuit voltage. The other is for the protection of low-voltage a-c. networks, the feeder transformers of which are connected in delta on the low-voltage side and with the middle tap of one winding brought out to obtain lighting voltage. It is essentially a combination of three relays: (a power directional, an overcurrent and an overvoltage) set to trip quickly on transformer or feeder faults, but not being sensitive to small reversals of power.

Several existing types of relays have been modified and improved to give better operation. The ratio differential relay has been modified for application to the protection of three-winding transformers. The induction type overcurrent relay has been speeded up so that it will operate in approximately three cycles. The residual directional relay has been modified so that it will operate correctly over an extended power-factor range. Various types of condenser devices have been developed for securing potential for relay operation without the use of high-tension potential transformers. The most common of these is in connection with the condenser type high-voltage bushing, but other con-



denser types of devices have been developed for this same purpose.

A paper entitled *New Directional Relay Schemes*, by E. E. George and R. H. Bennett is in preparation and

will be presented sometime in the near future. Two other papers are also in preparation for presentation before the Institute, dealing with relay acceptance specifications, and with relay experience.

## Education

### ANNUAL REPORT OF COMMITTEE ON EDUCATION\*

*To the Board of Directors:*

The continued rapid increase in scientific knowledge and in the diversity and complexity of the engineering applications and the engineering responsibilities, combine to make the four-year engineering program a less and less adequate preparation for effective engineering work.

This situation is not peculiar to the engineering profession. The medical and the legal professions have been confronted by a similar situation and to meet it they are requiring students aspiring to those professions to remain on the college campus for a period of 6 years, and after that to serve an apprenticeship of 6 months or a year as a law clerk or a medical interne.

The study of engineering education conducted by the S. P. E. E. has disclosed the fact that very few teachers or engineers propose to meet the situation by requiring *all* engineering students to remain upon the college campus for a fifth or sixth year. Before increasing the length of the engineering course for all students, the engineering profession first proposes to try out thoroughly an alternative method.

This alternative method is to encourage the comparatively few graduates of the four-year engineering course who are possessed of the requisite interest, ability, and financial means, to continue in residence by enrolling in the Graduate Schools, and to encourage the majority, who will continue to enter at once upon their engineering apprenticeships, to continue their educational efforts in a more systematic manner and to a more definite end than at present.

Of all the possible educational movements in which the Institute Committee on Education might engage, none seemed to the committee to have greater possibilities of advancing the standards of professional attainment and proficiency than this movement to stimulate interest in the systematic continuation of engineering education after college and to make adequate provision for a program of post-college education.

The full development and realization of the great possibilities of post-college education will require the cooperation of the engineering profession with the

industries and the colleges, and it seemed to the committee that it could render its most effective service:

1st, by seeking to bring the thought of the Institute membership to bear upon the possibilities and the problems of post-college education and upon the responsibilities of the profession relative to this period of training;

2nd, by seeking to stimulate the local Sections to promote this movement by setting to work to canvass or inventory the post-college needs and the educational facilities of their districts and to coordinate the two;

3rd, by seeking to act as a center through which a knowledge of distinctive and effective developments in the field of post-college education may be made known generally.

The views and the aims of the committee have been stated in a brief article entitled *The Post-College Education of Engineers*, which appeared in the April, 1929 issue of the JOURNAL. In this article it is suggested that the local sections, particularly in the industrial centers in which Colleges of Engineering are located, each appoint a Committee on Education. It is suggested that the function of the section committee on education be to canvass the needs and the wishes of the engineers of the district, particularly the younger engineers, and to make these needs and wishes articulate by bringing them to the attention of the college administrations, or the industrial managements, or the engineering authorities in the district in the form of explicit statements such as the following: We have a group of 20 men who will enroll in a course in differential equations, to meet one evening a week for a year, or 15 men who will enroll in a course in advanced circuit theory, or 30 men who will enroll in a course in engineering economics. What provision can be made to meet the needs of these men?

A fully developed program of post-college education will mean a large and important expansion of the work of the colleges of engineering and will play an important part in the development of engineering teachers. This post-college training will compel and will reward a broader and more thorough training than is common in the teaching ranks today. It will afford greater opportunities to determine the adequacy, the relative importance, and the real significance of the principles and the methods taught to undergraduates. It will make teaching attractive to a wider range of engineers by making it possible for men in teaching to have closer contact with engineering practise.

#### \*COMMITTEE ON EDUCATION:

Edward Bennett, Chairman.

E. W. Allen,	A. B. Gates,	H. S. Osborne,
J. L. Beaver,	W. B. Hartshorne,	A. G. Pierce,
H. W. Buck,	Paul M. Lincoln,	C. S. Ruffner,
V. Bush,	C. E. Magnusson,	W. S. Rugg,
O. J. Ferguson,	W. E. Mitchell,	W. E. Wickenden.

Presented at the Summer Convention of the A. I. E. E., Swampscott, Mass., June 24-28, 1929. Printed complete herein.

# Abridgment of D-C. Railway Substation for the Chicago Terminal Electrification, Illinois Central Railroad

BY A. M. GARRETT<sup>1</sup>

Associate, A. I. E. E.

*Synopsis.*—D-c. substations designed to meet the demands of heavy railway terminal service are described in this paper. This d-c energy is furnished at 1500 volts from seven substations located in the Chicago district and owned and operated by the power companies. In addition to 1500-volt supply for traction purposes, 4000/2300-volts alternating current is provided for the railway company's light, power, and signal system.

Approximately 80 per cent of conversion capacity is in synchronous converters and the remainder in mercury rectifiers. Reasons for selecting the latter units are given as well as some of the characteristic features of them.

To meet the rigorous requirements as to voltage and current demands under the agreement with the railway company, the conversion units have a rating of 300 per cent load for one minute.

The synchronous converters are of the field-control type, and in

order to hold the d-c. voltage to definite values for any load within the rating of the units, and to maintain the reactive current of the unit within the safe limits, there is provided, common to all the converters in a substation, a counter e. m. f. regulating set, a four-circuit rheostat, and a voltage regulator. High-speed air breakers are used on the d-c. side of the units and all 1500-volt feeders.

Another feature of interest is the use of truck-mounted enclosed switch units on both the high- and low-tension sides of the substation. This type was selected in order to eliminate certain operating hazards which exist with fixed type switching arrangements, and to provide the customary factors of accessibility and maintenance.

In operating experience, the substation equipment has met all expectations, the performance of the synchronous converters and high-speed breakers being exceptional, while confidence in the mercury rectifier not lessened.

## INTRODUCTION

THE purpose of this paper is to describe that group of electrical equipment which comprises the substation, presenting the characteristics of this installation as a type representative of a d-c. application in modern railway practise.

These d-c. substations, owned and operated by the power companies, the Commonwealth Edison Company, and the Public Service Company of Northern Illinois, receive the 60-cycle energy for conversion to direct current from the 12-kv. transmission system of the Commonwealth Edison Company and the 33-kv. transmission system of the Public Service Company.

To meet the exacting demands of heavy railway terminal service, the selection of the various electrical units and the arrangement of them in the substation layout followed along tried and proven lines. Yet consideration was also given to some equipment which, lacking at the time experience in the American field, gave promise of satisfactory adaptation to American practise through experience gained with the equipment in foreign use.

The studies, trial investigations, and test set-ups, made jointly by the engineering staffs of the railway company, the manufacturers, and the power companies, gave a satisfactory solution of the various problems imposed by the standards of service, and these, coupled with the thought and experience of the power companies in furnishing conversion service for so many years to the traction systems of Chicago, were indispensable considerations in the design of the substation, including not only the major converting and switching units, but the elements of connection as well.

1. Engineer of Substations, Commonwealth Edison Company, Chicago Illinois.

Presented at the Summer Convention of the A. I. E. E., Swampscott, Mass., June 24-28, 1929. Complete copies upon request.

## CONVERSION UNITS

To furnish converted energy under the current and voltage stipulation necessary to maintain the high rate of acceleration and high schedule speed demanded by the suburban service on this electrified terminal, and to approximate these same duties under extra or congested traffic conditions were the principal requirements that had to be imposed on the conversion units.

Over 80 per cent of the total conversion capacity is developed from 11 units of the rotating type synchronous converters, while the remainder is developed from four units of the stationary type, namely, the mercury converter or rectifier.

The decision to use rectifiers can be assigned to several reasons, principal among them being that this new type had the natural advantage which a unit with no moving parts has over one with rotating parts and wearable and friction surfaces, and that it gave every indication through future development and application of meeting the demands placed upon it by American practise. Other reasons included the generally known advantages of the rectifier—high-efficiency with fluctuating loads, absence of noise and vibration, low maintenance expense, and elimination of extensive ventilation facilities sometimes required with the synchronous converter. Also, in this instance a considerable amount of reserve capacity permitted the installation of a representative number of rectifiers.

## SYNCHRONOUS CONVERTERS

The synchronous converters, which are of General Electric manufacture, are furnished in 3000-kw. sizes with a d-c. voltage of 1500. Each outfit consists of two 1500-kw. 750-volt units operating in series. Each converter set is provided with a 3150-kv-a. air-blast transformer, arranged, as stated before, in a compact group by mounting the transformer on the bedplates of the a-c. side of the two machines.

To meet the stiff voltage regulation required under the agreement with the railway company, which permits a voltage variation within the narrow limits of 1400 to 1550 d-c. volts, together with the high drafts of current drawn by the system during the maximum rush hour, the converters are designed with a rating of 50 per cent overload for two hours, and 300 per cent load for one minute. They are shunt-wound and of the field-controlled type whereby the control of the d-c. voltage is obtained by changing the excitation of the unit and providing regulation by means of the reactive current drawn from the line or converter. Because of the reactive current involved, several limits as to rating were established so that overloading by the reactive current or the load current, or by both, would not exist. As previously stated the useful load output varies from 50 per cent overload for two hours to 300 per cent load for one minute, the corresponding rating for the reactive current output varies from 60 per cent reactive current at no-load to 30 per cent for the 50 per cent overload, and 50 per cent reactive for the 300 per cent load of one-minute duration.

To keep the reactive kv-a. within the prescribed limits, and hold the d-c. voltage to definite values for any load within the rating of the unit, there are provided, common to all the converters in each substation, a counter e. m. f. regulating set, a four circuit rheostat, and a voltage regulator.

In order to maintain normal voltage conditions on the low-tension secondary connections to the rotary at times when there may be low primary or system voltage, or to increase the amount of the secondary voltage during periods of high load, the ratio of transformation between the high and the low side of the transformer may be changed in the ratio of 5 per cent by means of a tapped primary winding that is connected to two oil breakers, one of which provides a normal or 100 per cent voltage on the secondary side and the other connection 105 per cent voltage.

These switch positions are known as the high and the low delta. In addition to this, the transformer is provided with a no-load tap changer on the primary side. Excitation to the converter fields is furnished through a direct-connected exciter operating on the shaft of the low-voltage converter. The exciter provides energy to the shunt fields of both machines at a fixed pressure, and each exciter and the shunt fields of the converters are connected in series to an excitation bus common to all the converter sets in the substation. Also to this bus is connected the d-c. motor of the counter e. m. f. regulating set. This places the motor of the regulating set in series with each exciter and the shunt field of each converter, and by varying the voltage of the motor, the voltage applied to the converter field is likewise changed or controlled. A field rheostat common to both shunt fields is provided and is used chiefly during starting periods or when the regulating set is taken off and the converters are controlled by hand.

The function of the motor-operated four-circuit rheostat and the Tirrill regulator on the d-c. side is to control the operation of the converter and its regulating equipment under both normal and abnormal voltage conditions on the a-c. supply system in conjunction with the load and voltage conditions on the d-c. side of the unit; and to hold the performance of the unit within the prescribed reactive kv-a. limits over the full range of capacity.

Each converter is connected to the 1500-volt d-c. bus through 3000-ampere high-speed circuit breakers of the bucking bar type, located in both the positive and negative leads. The positive breaker, which is located in a metal enclosure on the operating floor, is arranged to trip in case of a reverse current arising either from faults within the unit or on the transmission system. The negative breaker, which is the more active of the two breakers, takes care of overloads or short circuits in the forward direction; that is, those overloads or disturbances occurring on the 1500-volt bus or feeder system.

#### MERCURY RECTIFIERS

Four of the substations contain mercury rectifiers of the iron tank type. Three of these units operate in

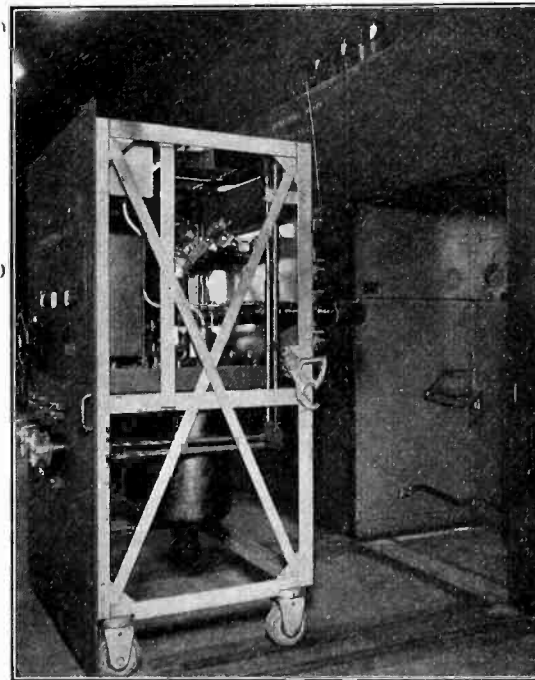

12,000-VOLT ENCLOSED SWITCH UNIT

parallel with the shunt converters described above. Two of the units are of 3000-kw. size, each consisting of two 1000-ampere, 1500-volt rectifiers operated as a single unit. These sets, which are of Brown Boveri manufacture, have separate transformers and under-load tap changers, but are connected to a common oil-breaker. The water-cooled rectifier tank is connected to the double six-phase windings of the transformers. This arrangement provides for 12 anodes which are equipped with air-cooled radiators. The water consumption at rated load is approximately one-third gallon

for 100 amperes of load per minute. The units are designed to carry 50 per cent overload for 20 min. and 300 per cent load momentarily. Each bowl or rectifier is provided with an ejector or mercury vapor pump and a single-stage rotary oil pump, both for the evacuation of gases from the interior of the rectifier. The mercury vapor pump, a stationary device, which operates on the injector principle, is actuated by an electric heater located in the base of the pump.

The vacuum, or, conversely, the pressure of gases within the unit, is measured by balancing the gases against a column of mercury known as the McLeod gage. A means of more quickly indentifying conditions within the bowl is obtained by the direct-reading vacuum meter. This device consists essentially of a hot wire gage operating on the Wheatstone bridge principle, arranged so that two of the arms of the bridge are subject to the gas pressure within the rectifier while the other two are exposed to the pressure of the atmosphere.

All seals within the unit are made with mercury,

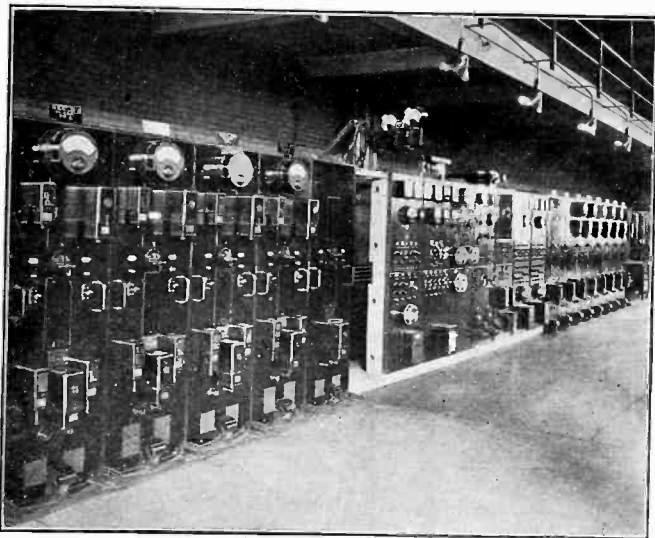

1500-VOLT SWITCHBOARD (TRUCK AND PANEL TYPE) 16TH STREET

asbestos, or by rubber gaskets. The unit is connected to the 1500-volt buses through a high-speed breaker placed in the positive lead of each cylinder.

The air-breakers are interlocked with the oil-breakers so that in case the oil-breaker opens from overload or short circuit, the air-breaker opens also. The rectifier is provided with relay equipment designed to take the unit off the service if excessive temperatures are present within the rectifier cylinder.

The rectifier with the transformers, which are of the oil-filled and self-cooled type, take the ordinary floor construction customarily found in station and substation structures. However, no conservation of space is found with the rectifier, the floor area occupied by the rectifier being equal to that of the synchronous converter. Absolutely no noise of operation is associated with the rectifier proper. Some noise will be found in the rotary pump, but none that cannot be reduced to any desirable degree.

The 1500-kw. rectifiers are of General Electric manufacture, two 500-ampere cylinders operating in parallel from a single transformer and oil breaker. Each cylinder consists of six anodes of graphite composition and are provided with wire-wound heaters to keep the anode insulators at proper temperature during periods of external low temperature and low loads that mercury will not condense on them. The water-cooled chamber is supplied with heaters for the same purpose. To reduce possibility of high transient voltages appearing on the rectifier, condensers in the form of power capacitors are connected to one set of three anodes and across the interphase transformer. That the load will divide equally between the bowls, anode reactors are provided. These rectifiers have practically the same other protective features as the 3000-kw. units, except that following the same design provided for the General Electric converter, high-speed breakers of the bucking bar type are placed in the positive as well as the negative lead of the rectifier. These units have a rating of 50 per cent overload for 20 min. and 300 per cent load momentarily. The inherent regulation of the rectifier is approximately 5 per cent.

#### SWITCHING FACILITIES

Another feature of interest in these substations, especially those which are supplied from the 12-kv. system, is the design and arrangement of switching equipment on each side of the conversion units. Fundamentally this consists in having the breakers and disconnecting devices truck mounted and enclosed in metal housing.

The use of the enclosed switch unit is not a new idea, having been on the market in various forms for some considerable time; but its application to both high- and low-tension switching in the same substation is somewhat unusual. The point of principal interest in these installations, however, is the application of the switch unit to certain ideas gained from the operating and engineering experience with other switching arrangements. By means of interlocks, it prevents that kind of operating hazard which seems to be always with us in the old style of fixed bus and switch structure; namely, that of pulling disconnective switches while under load. The switch unit makes readily accessible for maintenance, repairs, and inspection all, of the wearable, adjustable parts. Not only is the factor of safety improved but, because of the accessibility, better maintenance and repair work is done and therefore better performance is obtained.

Certain operating practises, entirely practical with 600-volt switching equipment, are not acceptable when the pressure has been increased to 1500 volts or above. Correction by isolation, through elevation may not always be desirable, or lack of clearance may render the arrangement impractical; therefore the use of the switch unit with the added advantage of accessibility is in many cases an entirely satisfactory solution. The



advantages accruing to the truck-mounted breaker are considerably lessened when it is necessary to unbolt and, in many cases, untape, the breaker connection from the fixed conductors within the structure. The use of the automatic disconnecting devices for both the current-carrying circuits and the control circuits does away with the unwieldy and, in many instances, dangerous method of manual disconnection. The principle of pressure-contact disconnects can be used in many truck designs so that danger and bother from overheated disconnect switches is appreciably reduced.

By the enclosure of the individual switches in separate metal compartments, the tendency of the arc to spread in case of breakdown is greatly reduced over those cases which have occurred in the open, fixed type of structures. Confining the arc to one or two immediate compartments is quite different from the trouble experienced in the old design where the entire structure and sometimes the room becomes, involved from one breakdown.

The incoming transmission lines, bus-tie connections, and connections to the individual conversion and transforming units within the substation are connected to the 12,000-volt busses through three-phase, 15,000-volt, 600-ampere, type O. E. 6, oil-breaker. The breaker, automatic disconnecting devices and hand-throw disconnecting devices are carried in a panel-mounted truck, the panel serving the double purpose of closing the cell compartment and providing the switchboard facility for all instruments, relays, control switches, and interlocks. The principal features of this type of iron-clad switch gear are that nothing electrical is accessible until the breaker is in the open position, and that when the truck is withdrawn, live parts are shuttered off or set back in protecting recesses. In addition to these features, the switch unit is provided with manually operated knife disconnecting devices which permit all grounding operations to be made through the oil breaker, a practise which has been in force in the substations of the power company for many years. The grounding of any line, bus, or unit directly through cable, clamp, and knife-switch devices means that when the last connection of the circuit is made to a ground source, the operator must be in the immediate proximity of a fault-to-ground should an operating error occur. The simple method of making any set of disconnecting devices used in conjunction with a breaker, double throw, with one side connected to a ground bus, permits the operator to be at a safe distance when the last link in the ground connection is made (the closing of the oil switch) and also provides relay protection should an error exist and live circuits be grounded.

This equipment is arranged so that an oil-breaker can be partially drawn out of the cell for inspection of the parts, at the same time leaving the control intact for operation of the breaker, but cutting off contact with all live high-tension connections. This group of breakers and housings is properly insulated for later installation of a fault bus system should one be found

necessary. The high-speed air-breaker connected to the positive lead of the conversion units, as well as all the breakers on the feeders, are truck-mounted and enclosed in metal compartments similar to the switching facilities for the 12,000-volt equipment. The 1500-volt bus is also enclosed in same metal housings. The principle and characteristics of this breaker and its application to the 1500-volt distribution system of the railway terminal have been presented to the Institute by Messrs. Monroe and Allen.<sup>2</sup>

One bay of each substation contains the transformers, regulating, and switching equipment for the a-c. supply to the railway company light, power, and signal systems. Energy is taken off the 12-kv. bus and stepped down to 4000 volts for the three-phase four-wire railway light and power system and the 2300-volt for the single-phase signal system.

#### OPERATING EXPERIENCE

Without exception the synchronous converter has shown a remarkable performance not only in the matter of regulation but under short-circuit conditions in which the number of flashed commutators has been practically negligible. Successful parallel operation with the mercury rectifier has been proved at all ranges of load.

Taking the group of mercury rectifiers as a whole, it cannot be said that our confidence in them has lessened. On the contrary, the operating experience shows that a great number of them could have been installed. For this class of service, it has been demonstrated clearly that the use of one rectifier in a substation, operating as a base load unit with the converters reserved for the peak loads, results in a most satisfactory combination. In some instances a certain amount of trouble on the rectifiers can be charged to an overload condition, as the earlier type lacked capacity comparable with that of the synchronous converter operating in the same substation.

In general, the rectifier under normal operation has shown gratifying results and with recent improvements made upon the unit and its auxiliaries, a reliability practically equal to that of the synchronous converter has been indicated.

The performance of the high-speed breaker has been exceptional, especially in preventing the spread or reflection of short circuits back into the substation.

In agreement with the opinion given of the operating experience of the entire terminal, as expressed in a previous paper, that "From every point of view the equipment has met all expectations and the complete operation has apparently been successful," the operating experience of the substation equipment has indicated a similar result. Troubles have occurred as they naturally do on systems of this magnitude, but in no instance has anything happened that seemed impossible of solution and in most cases, immediate remedies have been found.

2. A. I. E. E. Quarterly TRANS., Vol. 47, Oct. 1928, p. 1307.

# Radio Interference from Line Insulators

BY ELLIS VAN ATTA<sup>1</sup>

Non-member

and

E. L. WHITE<sup>2</sup>

Associate, A. I. E. E.

*Synopsis.*—This paper presents a discussion of the causes of radio interference from insulators on high-voltage equipment. The present methods of eliminating this kind of disturbance are explained, and the question of future design is discussed.

## INTRODUCTION

**R**ADIO broadcasting has brought with it the problem of radio interference. The radio listener is, of course, the one most affected by interference; but the broadcasting companies, the manufacturers of electrical apparatus, and the producers of electrical energy are likewise concerned since the solution of the problem devolves upon them. During the past few years each of these interests has done much to eliminate unnecessary interference; and every kind of equipment used in the supply and consumption of electrical energy has been tried and tested for interfering qualities.

Their experience has shown that radio interference may be classified under five headings, with respect to its origin. These sources are as follows:

1. Consumers' equipment.
2. Low-voltage supply circuits and apparatus (110-550 volts).
3. Intermediate-voltage circuits and equipment (1100-7500 volts).
4. High-voltage equipment (11,000-220,000 volts).
5. Atmospheric disturbances.

Ways have been devised for eliminating practically all radio interference which originates on any of the first three classes of equipment. The last item is obviously beyond human control. The fourth classification includes numerous items of equipment which can be made free from radio interference, and a few other items for which no remedy has been devised as yet. The scope of this paper is limited to the latter group, particularly line insulators of the pin and suspension types.

## GENERAL

The principles underlying radio interference are similar to those of spark telegraphy and carrier current telephony. In brief, a spark occurring on electrical equipment of any kind sets up a wave train which produces damped oscillations at a multitude of frequencies. The predominating frequencies are the resonant frequencies of the associated lines and equipment, and their harmonics, including those in the radio broadcasting band.

Since the electrical constants which determine the

1. Radio Engineer, Pacific Power & Light Company, Walla Walla, Wash.
2. Communication Engineer, Puget Sound Power & Light Company, Seattle, Wash.

*Presented at the Pacific Coast Convention of the A. I. E. E., Santa Monica, Calif., Sept. 3-6, 1929. Printed complete herein.*

above frequencies are distributed, and several kinds of equipment may be concerned, the resonant peaks are usually broad and overlapping. Consequently a broadcast receiver which has radio interference is usually affected over the entire broadcasting range, with occasional points of greater disturbance.

The extreme sensitiveness of modern receivers, and the use of a-c. supply, make them very susceptible to radio interference. The comparatively small amounts of energy involved in the electrical discharges described later are therefore sufficient to produce a great amount of disturbance in broadcast receivers, particularly when the discharges occur along high-voltage lines.

The distinction between corona and brush discharge should be kept in mind when radio interference from line insulators is considered. Corona discharge usually occurs at lower voltages than brush discharge, and appears as a bluish glow when viewed in a dark room. Brush discharge occurs after corona discharge, and takes the form of fine white streamers. This condition is usually considered as another form of corona discharge, but will be classed separately in this case because of the different interfering characteristics of the two discharges. In a broadcast receiver, corona discharge produces a soft, hissing sound which is not ordinarily objectionable. Brush discharge, however, produces a crackling, frying noise which is very annoying.

## PIN-TYPE INSULATORS

Corona and brush discharges may occur on high-voltage lines in any or all of the following ways:

1. Between metallic surfaces.
2. Between insulating surfaces.
3. Between metallic surfaces and insulating surfaces.

To entirely free a line of radio interference, all discharges must be stopped. In order to accomplish this purpose, all hardware must be tight; adjacent pieces of hardware must either have sufficient separation to prevent discharges, or must be bonded together; conductors and tie-wires must make perfect electrical contact with the tops of the insulators; and the pins must make perfect electrical contact with the entire surface of the thread in the pin holes. On lines using pin-type insulators these requirements can be met with the exception of the last two. Conductors, tie-wires, and pins do not make good electrical contact with the surfaces of the insulators, and every insulator is therefore a potential source of radio interference.

For the purpose of this discussion, a pin-type insu-

lator will be considered as the dielectric of a condenser, with the conductor and tie wire acting as one plate and the pin acting as the other. When potential is applied to the plates, a charging current, the magnitude of which is determined by the reactance of the condenser and the applied voltage, will flow into the condenser. Since the reactance of a condenser is a function of its electrostatic capacity and the frequency of the applied voltage, it follows that the charging current is affected by the three factors, voltage, frequency, and capacity.

Consider a 66-kv. pin-type insulator, whose electrostatic capacity is approximately  $10 \mu \mu f$ . A charging current of 0.14 milliamperes will flow into it when used on a line operated at a voltage of 38.1 kv. to ground and a frequency of 60 cycles per second. If the conductor, tie-wire, and pin all made perfect electrical contact with the insulating surfaces, this charging current could easily flow into the insulator. Unfortunately, resistance is offered to the flow of charging current by insufficient contact between the wires, pins, and insulating surfaces. Due to the fact that the dielectric strength of air is lower than that of the insulator material, the potential differences at these points of poor contact are sufficient to ionize the adjacent air, with resultant corona and brush discharges.

The problem of radio interference from pin-type insulators is thus reduced to the matter of overcoming resistance to the flow of charging current into the insulator.

Since the magnitude of the charging current into the insulator is determined by the voltage and the frequency applied, and by the electrostatic capacity of the insulator, a reduction in any of these factors will decrease the charging current. In practise, the voltage and frequency are fixed, but the capacity can be reduced by overinsulating the lines. This method has been tried with only partial success, particularly on lines operated at 55 and 66 kv. If larger pin-type insulators are used, the problem of insufficient contact between wire, pin, and insulator is still present.

The best solution of the problem appears to be some method of insuring good contact between the conductors, tie-wires, and insulating surfaces. On existing pin-type insulators, this result can probably be secured by treating the insulator heads and pin-holes in some manner which will eliminate the poor contact between the wires, pins, and insulators.

Metallic paints have been tried, without success, because such paints form a coating of metal particles suspended in varnish and do not offer a good conducting surface. Metal disks, attached to the conductors above the insulators, have proved partially successful, due to the reduction in current density where the conductors and tie-wires contact the insulators. Tests have shown that the same result may be accomplished by looping the tie-wire to form a ring several inches in diameter over the head of the insulator. Tests have also shown that dis-

charges to the heads of insulators are materially reduced by the addition of several extra turns of tie-wire in the insulator grooves. Metal gauze, placed in the tie-wire groove, has proved effective in some cases, and seems to be the best solution of the problem at the present time. Experiments are still being conducted, however, and it is hoped that a compound can be found which will fill in the air spaces between wires and insulators, will be unaffected by weather conditions, and will not be expensive to apply.

The problem of new pin-type insulators is being attacked in several ways. Some manufacturers employ a metal cap cemented on the head of a standard insulator. Another one uses solder-impregnated gauze in the tie-wire groove. Other insulators have layers of metal applied to the heads and the wire grooves. These metals are of various kinds and varying thicknesses. Most of them are too thin to be practical but all have a good contact surface. Still another insulator is treated in the wire grooves and the pin-hole with a special glaze. This last insulator proved to be the best of all when subjected to rated voltage in a comparative test.

Obviously, the use of metal-coated heads and metal caps on pin-type insulators will result in an increase in the electrostatic capacity of such insulators. The charging current will be increased and consequently the current density at the surface of the pin-hole will be increased. Tests have shown that this point is a very important one. It is therefore imperative that the pin-hole be treated in some manner to insure good contact between the pin and the insulator. Metal threads, cemented into the insulator, are being used in most cases, while one insulator is treated with a special glaze, as mentioned before.

At the beginning of this discussion it was stated that corona and brush discharges may occur between insulating surfaces such as the petticoats of pin-type insulators. The presence of such discharges is an indication of faulty design or too high an applied voltage. The remedy is obvious in either case.

#### SUSPENSION INSULATORS

Suspension insulators can be classified under three general types, cap-and-pin, link, and spider. The cap-and-pin type, as the name implies, consists of a porcelain disk with a cap cemented to one side, and a pin to the other. Two kinds of hardware are used for attaching adjacent units, the clevis type and the ball-and-socket type. The link type of insulator consists of porcelain disks connected together by loops of metal, so that the porcelain is in compression. The spider type consists of extra-heavy porcelain disks, with the connecting hardware imbedded in both sides in the form of a spider, and secured by a metal alloy instead of cement.

Until recently, suspension insulators as a group have been considered free from radio interference. The potential impressed upon individual disks of a string, as they are used in practise, is comparatively low. On

55-kv. lines, using three units per phase wire, the maximum duty is about 11,000 volts. For 110-kv. lines using six or seven units per string, the maximum potential per unit is 14,000 volts. On 220-kv. lines, using fourteen units per string, the maximum voltage per unit is 23,000 volts without grading rings or shields, and about 15,000 volts with such devices.

When individual ball-and-socket-type insulators are tested in a dark room corona discharge appears at the cap and at the pin when potentials as low as 18,000 volts are applied. Brush discharge occurs at voltages as low as 26,000. This type of insulator, therefore, should not cause interference under ordinary conditions.

Corona and brush discharges also appear on clevis-type insulators at the above voltages when the cotter key is removed from the clevis bolt. With the cotter key in place, and the pointed ends turned upward, brush discharges occur between the points of the key and the innermost petticoat at potentials as low as 11,000 volts. The cotter keys on clevis-type insulators which have been in service on 110-kv. lines for only short periods, show unmistakable evidence of brush discharge, not only from the pointed ends but from the round ends as well. Cotter keys on the units next to the line are affected most, but the keys on other units also show signs of discharge. Obviously the cotter key is at fault on the clevis-type of insulator, and ways of eliminating this source of interference will be taken up later.

Insulators of the link type are even more liable to cause interference than clevis-type insulators. In the older models, no attempt is made to obtain good contact between the links and the porcelain, and brush discharges take place at potentials as low as 2000 volts per unit. When weights are used to simulate line loading, the brush-discharge potential rises to 4000 volts.

The newer models of link-type insulators employ lead shims, soft copper links, etc., in order to get better contact between the metal and the porcelain. Without loading, radio interference starts at 6000 volts per unit. Under 340-lb. tension, interference does not begin until 14,000 volts are impressed. Since the potential across the line unit of a string of six link-type insulators used on a 110-kv. line is about 20,000 volts, interference will be present under those or similar conditions.

On the spider-type of insulator, corona discharge does not start until potentials of 21,000 volts are applied across individual disks. Brush discharge occurs at 26,000 volts. Both discharge points are higher than the corresponding points for either cap-and-pin or link-type insulators, a fact which is accounted for by the heavy mass of porcelain used in this type of insulator, and the absence of sharp points or rough edges at points of high electrostatic flux density.

Both the spider type and the ball-and-socket type of insulator are designed to have certain values of mechanical strength, flashover voltage, and leakage dis-

tance, rather than high values of corona or brush discharge voltage. Fortunately these discharge points are higher than the usual operating voltages, and the insulators are satisfactory from the point of view of radio interference.

Clevis-type insulators are also satisfactory when the cotter key is properly designed. One manufacturer has designed a clevis-type insulator in which the cap is recessed to overlap the cotter key and prevent it from turning. One of the large power companies is replacing the regular cotter key with a circular key, so designed that the ends are concealed inside the clevis bolt when in place. Comparative tests show that clevis-type insulators equipped with circular cotter keys are on a par with ball-and-socket insulators.

The link type of insulator is satisfactory if sufficient loading is applied to keep the porcelain and the links in intimate contact, and the voltage per unit does not exceed 14,000 volts. Much of the discussion pertaining to pin-type insulators is also applicable to link-type insulators. The problems involved are similar and can probably be solved by using similar methods.

Many lines using suspension insulators also use arcing horns to protect the insulator disks during flashover and to prevent burning of the conductor. Grading rings, shields, etc., also accomplish this purpose and change the potential distribution along the insulator string, so that the maximum voltage per unit is very much reduced. Tests show that the arcing horn is the only one of the above devices which ordinarily causes radio interference. Brush discharges take place at the ends of the horns, which produce an interference similar in sound to that of pin-type insulators. These discharges can be eliminated in the present design of arcing horn by adding a small metal ball to the end of the horn. The surface area is thus increased, and sharp points are avoided.

#### OTHER SOURCES OF INTERFERENCE

Pin-type and suspension insulators behave alike when subjected to moisture and dirt. The presence of either of these factors will usually increase the amount of interference, particularly on pin-type insulators. Tests in the laboratory show differences of 50 per cent or more in interference caused by insulators when dirty and the same insulators when cleaned. Moisture has a similar effect as shown by the curves of Fig. 1 where the noise level is three times as high for a line with insulators wet as it is for the same line when dry.

Defective, cracked, and broken insulators of either kind set up a disturbance which often affects radio receiving sets several miles away. Small projections on the surface of the porcelain sometimes create interference, especially when they are located in a heavy electrostatic field. Discharges frequently occur from the ends of tie-wires which are not bent closely enough to the conductor.

The remedy in each case is clear. Defective insulators must be replaced. Dirty insulators can be cleaned.



Wet-weather conditions are sometimes minimized by overinsulation, and tie-wire ends should always be bent back as closely to the conductor as possible. Proper inspection and maintenance are therefore essential to the elimination of radio interference from high-voltage lines.

CURVES

The curves in Fig. 1 are intended to show the effect of attenuation on radio interference which is being propagated along a transmission line, to give an idea of

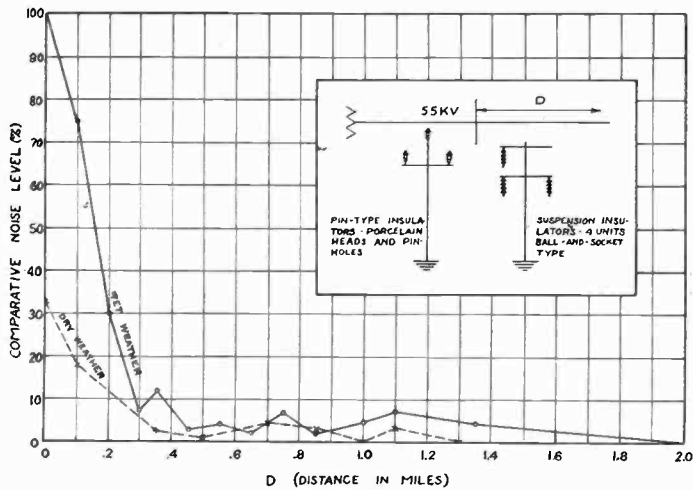

FIG. 1—ATTENUATION OF INTERFERENCE ALONG A TRANSMISSION LINE

the distances to which interference will travel before it is reduced to a non-interfering level, and to show the effect of overinsulation. The observations were made on a 55-kv. line, one mile of which is constructed with pin-type insulators, and the remainder, about 20 miles, with ball-and-socket type suspension insulators.

The origin of the curves is taken at the point where the two types of construction join, and the abscissas are measured from that point along the section using suspension insulators. The ordinates are measured by means of a milliammeter coupled to the output circuit of a superheterodyne receiver through a transformer. Although the readings of this meter have no absolute value, their significance becomes apparent when it is known that signals from a 5000-watt radio broadcasting station 75 miles away could not be heard with noise levels of ten per cent or more. At ten per cent the signals were about equal in intensity to the interfering noise. At five per cent the signals were stronger than the interference. With a zero-reading on the meter the interference was not objectionable, although it could still be heard along with the signals from the broadcasting station.

The readings for the upper curve were taken during a rain-storm. The lower curve was taken about thirty minutes after the storm ceased. In the case of the upper curve, a slight amount of interference could still be heard at a distance of four miles, which was attributed to the effect of rain on the suspension insulators.

The curves of Fig. 2 are similar to those of Fig. 1. These curves show the attenuation of radio interference at right-angles to a 55-kv. line for two conditions, (1) with no distribution circuits to radiate the disturbance, and (2) with distribution circuits paralleling the 55-kv. line and connected to other circuits at right-angles to the 55-kv. line. The latter condition is one which occurs frequently in cities and towns, but no way of overcoming it has been devised yet. The most effective method of minimizing this kind of radio interference is the elimination of the interference at its source. In many cases, however, the cheapest remedy for the situation may be the use of radio-frequency choke coils inserted in the distribution circuits where they leave the high-voltage line. Standard lightning-arrester choke coils have been tried, but were not successful because their inductance is too low. One company is successfully preventing radio interference on high-tension lines from following its telephone circuits by inserting choke coils in the telephone leads at points where they leave the high-voltage lines. Another company is experimenting with carrier current choke coils, and still another one is trying specially constructed choke coils of about 0.5 milli-henry inductance. No reports are available on these tests, however.

CONCLUSIONS

Radio interference is one of the problems which must be considered in future insulator designs. On pin-type

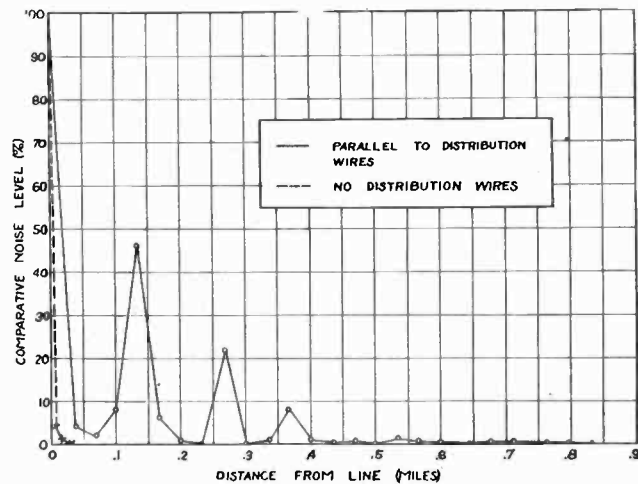

FIG. 2—ATTENUATION OF INTERFERENCE PERPENDICULAR TO A TRANSMISSION LINE

insulators, corona and brush discharges can be eliminated by proper design of the petticoats, by using metal-coated or metal-capped heads, by using metallic threads in the pin-holes, and in some cases, by using a special glaze on the head and in the pin-hole. Suspension insulators can be improved by changing the design of the cotter key in the clevis type, by eliminating discharges between the links and the porcelain in the link type, and by redesigning all arcing horns to eliminate discharges at the ends. The corona-discharge point on cap-and-pin insulators can be raised by proper

design of hardware, by elimination of sharp points, by insuring adequate clearances at the cap and the pin, and by making the shape of the porcelain conform more closely to the lines of electrostatic flux.

Existing pin-type insulators present the most difficult problem of all. Copper mesh placed under the tie-wires has proved fairly successful in eliminating discharges at the head of the insulator, but experiments are still being made to discover a process which can be easily applied, is not too expensive, and which will

stand up under operating conditions during the life of the insulator.

Radio interference from line insulators will always be a problem, because corona and brush discharges occur so readily on high-voltage equipment. Much work has been done to minimize this type of disturbance, and more is contemplated. Adequate maintenance and good construction are essential to the solution of the problem, but the greatest needs are for improved designs and continued experimenting.

## Motor Control for Wind Tunnel

### Precision Speed Regulation for the Wind Tunnel Motor at California Institute of Technology

BY WILLIAM A. LEWIS<sup>1</sup>

Associate, A. I. E. E.

*Synopsis.*—A wind tunnel for testing model airplanes and their parts requires accurate control of the air velocity. This paper describes a tunnel having electric drive for producing the air movement and explains a system of control, which allows a wide range of

speeds and holds the speed very constant at any set value. Either hand or automatic regulation may be employed. The hand control is used for fairly constant speed while the automatic control gives very close regulation.

#### INTRODUCTION

THE widespread interest in aviation developed during the last few years has resulted in a large increase in the facilities both for teaching aeronautics and for carrying on further investigations in this field. Under the terms of a grant from the Daniel Guggenheim Fund for the Promotion of Aeronautics, a graduate school of aeronautics was recently established at the California Institute of Technology. One of the principal features of the laboratory, built for the purpose of carrying on the experimental work in this department, is a high-speed wind tunnel with a working section ten feet in diameter. The propeller which forces the air through the tunnel is electrically driven, and the equipment and its control present several interesting features, which will be described in this paper.

#### WIND TUNNELS

Before proceeding to a discussion of the drive, a general description of the tunnel and its use would be desirable. Wind tunnels are used for testing model airfoil sections and new plane designs to determine performance, in the case of planes particularly with regard to taking off and landing. The model to be tested is supported in the center of the working section, usually in an inverted position, and when a stream of air passes the model, the relative motion of air and

model simulate flying conditions. The model is supported by wires attached at three points and is held in position by the wires and a series of counterweights. The supporting wires are attached to a set of balances either directly or, as in this case, through a subframe. The reactions of the model may be separated into two components, a force downstream or drag, and an upward force or lift. Since the model is inverted, the upward force with respect to the model is downward with respect to the balances. These forces are instantly felt at the balances and can be computed from the balance readings. The values of the forces together with the temperature, pressure, and velocity of the air, are the data for determining the performance of the model.

This tunnel is of the closed-circuit type, the same air being recirculated. A longitudinal section is shown in Fig. 1. The tunnel occupies a height of nearly four floors, the over-all vertical dimension being about 45 ft. It consists of sections of circular cylinders and cones, connected end-to-end to form the closed circuit shown in the illustration. The four sections in the observation room are made of redwood staves held together by hoops of steel rod and angle iron on the outside. If desired, one or more of the sections may be removed and the tunnel operated with open throat, the circuit being closed by the observation room itself. The remainder of the tunnel is made of reinforced concrete, the interior surface of which was formed by the Gunitite spraying process. At the intersections of the vertical and horizontal sections a series of deflecting vanes

1. Formerly Teaching Fellow, California Institute of Technology; General Engineer, Westinghouse Electric & Mfg. Co., East Pittsburgh, Pa.

Presented at the Pacific Coast Convention of the A. I. E. E., Santa Monica, Calif., Sept. 3-6, 1929. Printed complete herein.

changes the direction of the wind with minimum loss of energy. The completed vane installation in the lower 20-ft. intersection is shown in Fig. 2. The vanes in the two left-hand corners are arranged so that at a future date, cooling water may be circulated through them to assist in cooling the air in the tunnel. The entire tunnel is supported on its own foundation free from the building, to minimize transmission of vibration.

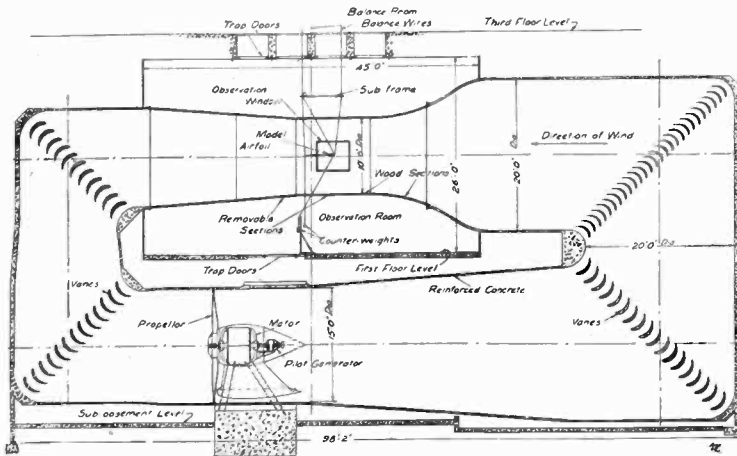

FIG. 1—LONGITUDINAL SECTION OF THE WIND TUNNEL (VERTICAL PLANE)

WIND VELOCITY REQUIREMENTS

For preliminary work it is desirable to control the velocity of the wind from the observation room, but for accurate testing the performance is determined entirely from the balance readings so that the balance operator must have instant and accurate control over the propeller speed. Because of the many variables involved, engineering accuracy requires that the variation in each, particularly wind speed, be kept as small as possible. The maximum allowable variation in propeller speed for satisfactory operation is  $\pm 0.25$  per cent. At the same time, in order to make a complete series of tests it is necessary that the air speed be adjustable over a wide range.

To fulfill these requirements the equipment described below was designed and installed. With it, any wind velocity past the model from a slight breeze produced by a propeller speed of only about 40 rev. per min. to a cyclone of approximately 200 mi. per hr. at a propeller speed of 850 rev. per min., can be easily obtained by operating a single control, located at any point desired. Within the range from 130 to 850 rev. per min. the speed control can be transferred to a regulator which will maintain the speed constant with a very high degree of accuracy. This range corresponds to air velocities of 10 to 200 mi. per hr. By adjusting the positions of a coarse and fine rheostat, one of which is located at each station, the speed held by the regulator may be easily adjusted to any value in its range.

PROPELLER MOTOR

The propeller is made with four detachable blades mounted in a central cast hub. The diameter of the

propeller is 14 ft. 11 in. and of the tunnel at the section where the propeller is located approximately 15 ft., so that clearance between the propeller and the tunnel wall is very small. After consideration of all advantages and disadvantages, it was decided to place the motor inside the tunnel, supporting it on a structural steel frame extending out through the walls of the tunnel into a heavy concrete base, and to mount the propeller directly on the end of the motor shaft. The obstruction introduced is not serious if the motor and its framework are not too large, since aerodynamical considerations require that the wind stream be contracted just beyond the propeller.

To drive the propeller at the maximum speed requires an input of approximately 750 hp. However, the time for obtaining a set of readings is not great and it was estimated that a machine of 500 hp. continuous capacity with short-time overload ratings, would be satisfactory. The standard machine of this size is equipped with bed-plate and pedestal bearings, and was not well adapted for the type of mounting required. A special design, with bearings mounted in end brackets supported directly from the motor frame, developed for submarine and other transportation purposes, solved the problem. In this way a motor having a completely cylindrical frame and an over-all diameter of only 4 ft. 8 in. was

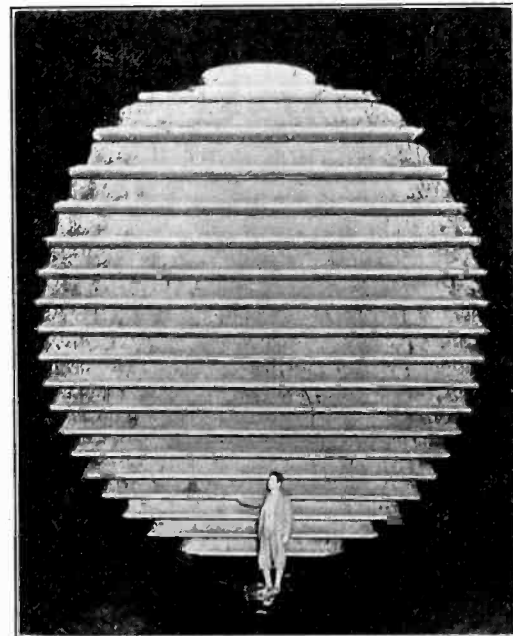

FIG. 2—ONE OF THE LOWER DEFLECTING VANE INSTALLATIONS

obtained. The motor, before installation, is shown in Fig. 3. The feet shown in the figure were used for transportation only, it being found that a smaller over-all diameter of motor and covering would result if the feet were eliminated, and the supporting framework made to fit the motor frame. Because of the errors which would be introduced into the speed regulation by vibration, the framework was made very heavy and rigid so that its natural frequency is far higher than any introduced by the propeller. A semi-cylindrical

steel-plate cradle fits the lower half of the motor frame and is bolted directly to the motor. Four heavy H-section columns form the supporting legs and are riveted to the cradle. In assembling, the heavily reinforced concrete base for the framework was first cast complete, with the exception of four pockets for the legs. The legs were then inserted in these pockets, and

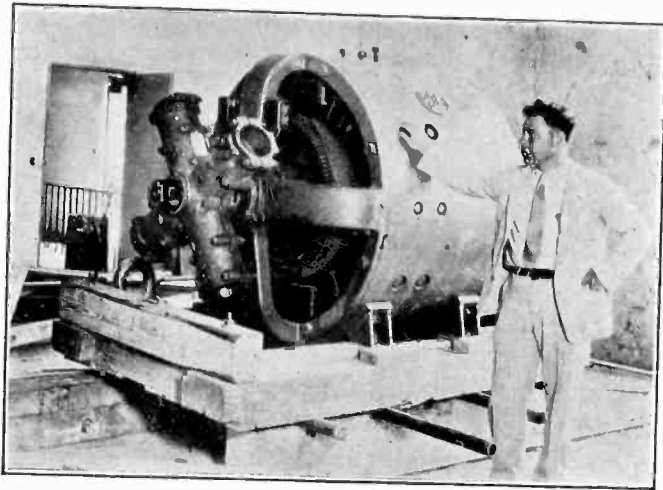

FIG. 3—PROPELLER MOTOR, 500 HP. CONTINUOUS RATING

the cradle riveted to the legs. Next the motor was mounted, the entire structure alined as a unit, and the pockets filled with concrete to unite the framework and base into a continuous whole. The U-shaped pockets in the rear H-section legs were covered with steel plates and used for wiring gutters, cored ducts in the concrete base forming a continuation of these gutters to accessi-

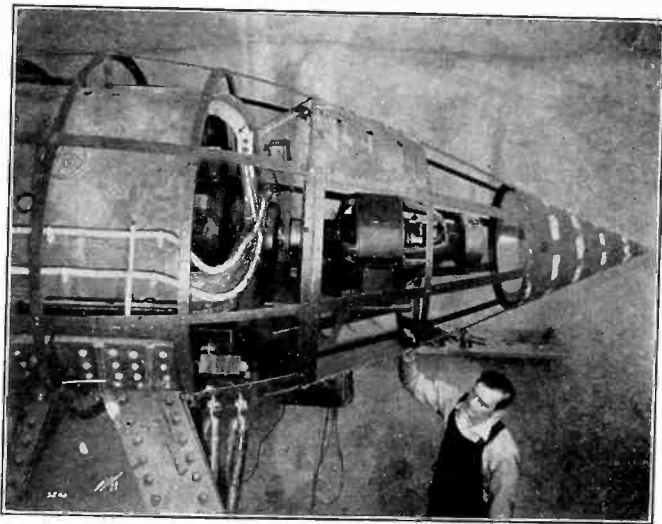

FIG. 4—PROPELLER MOTOR AND PILOT GENERATOR MOUNTED IN THE TUNNEL AND PARTLY COVERED BY STREAM LINE FAIRING

ble locations. The details of the structure can be seen in Figs. 4 and 5.

#### COOLING THE MOTOR

One serious problem, introduced by mounting the motor inside the tunnel, is that of securing adequate ventilation and cooling. The entire output of the propeller is eventually converted into heat by friction of the air, and since the air is recirculated, this heat, to-

gether with that due to the losses in the motor, will be taken up by the air and walls of the tunnel. As data for determining the heat transfer from the air to the tunnel walls were meager and inaccurate, it was impossible to predict the temperature to which the air would rise or the time required to reach equilibrium. If the tunnel air remained within reasonable temperature limits, it could be used for cooling the motor, but an air temperature much in excess of 50 deg. cent. would make a separate cooling system necessary. Several estimates placed the average air temperature in the tunnel at 45 deg. cent. Because of the expense of external cooling and in view of the difficulty of carrying on work in the observation room when the temperature of the tunnel is excessive, it was felt that use of the tunnel air for motor cooling would be satisfactory. Part of the air from the propeller is deflected through the motor air passages.

In order to keep the friction loss caused by the air

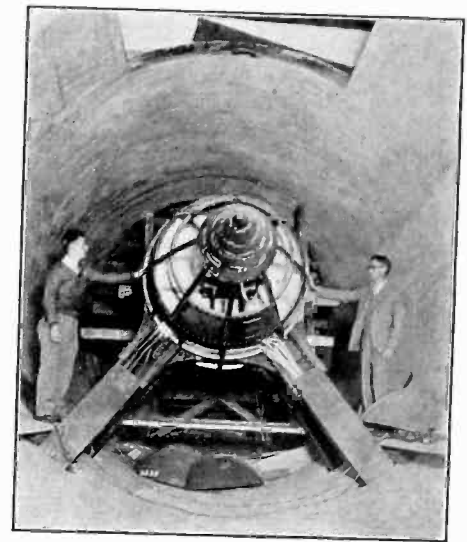

FIG. 5—END VIEW OF MOTOR SHOWING SUPPORTING LEGS USED FOR WIRE GUTTERS

passing outside the motor at a minimum, it was necessary to enclose the motor and its support in a stream line fairing, broad nosed at the propeller end and tapering off to a point at the tail. An opening in the nose and louvres in the sides allow the ventilating air to pass through the motor. In order to keep the pilot generator, (a small generator connected to the main shaft and used with the speed regulator) at as constant a temperature as possible, it is ventilated separately. A baffle inserted between the two machines produces the desired result. A second set of louvres behind the baffle and a third set in the tail provide the necessary cooling air circulation. The fairing is composed of a skeleton framework, Fig. 4, covered with steel plates screwed in place. The section covering the propeller hub revolves with the propeller but the remainder is stationary. To obtain access to any part of the motor it is necessary merely to remove the adjacent plates. An ingenious assembly of the skeleton frame allows a large section of the fairing to be removed as a unit in case of major repairs. Views of the fairing framework with several



of the plates mounted are shown in Figs. 4 and 5. After the fairing of the motor itself had been completed, the legs on each side of the shaft were enclosed in additional fairings. Views of the completed installation are shown in Figs. 6 and 7.

#### MOTOR-GENERATOR SET

The propeller motor is a d-c. commutating pole machine, since such a speed range could not be obtained

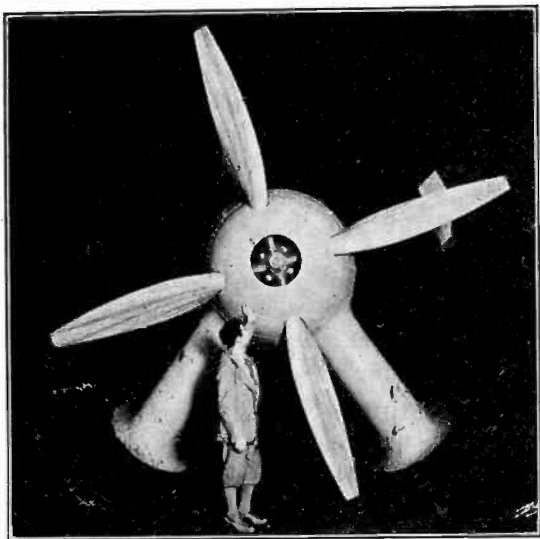

FIG. 6—PROPELLER END OF MAIN MOTOR WITH FAIRING COMPLETED

with constant frequency alternating current. For furnishing the direct current and providing a simple means of speed variation, an individual synchronous motor-generator set is provided. In order to make available the maximum possible amount of direct current for physical experiments, the nominal d-c. voltage was established at 230 volts, although the actual voltage varies from residual of the generator up to about 300 volts, depending upon the speed of the propeller motor. Both the synchronous motor and the d-c. generator are provided with direct-connected exciters, separate machines being required because of the speed regulator.

#### METHOD OF CONTROL

As the motor-generator set had to be located quite close to the propeller motor, because of the large currents involved, it was placed in the sub-basement of the building, just outside the tunnel. The most desirable location for the control station being near the balances in the balance room, five floors above, electrical remote control was adopted for all equipment requiring operation during normal running of the tunnel. Direct current was considered the most suitable for control power, and continuity of service not being absolutely essential, a small induction motor-generator set, giving 125 volts direct current was provided instead of the more expensive storage battery. The former type of control, however, is not absolutely reliable and provision had to be made for disconnecting all the main

machines upon failure of control voltage, thus complicating the control circuits considerably.

The apparatus for starting and controlling the a-c. end of the motor-generator set is practically standard automatic equipment and need not be described here. However, since the propeller motor is neither visible nor audible from the point of normal operation and the operators are in general non-electrical men, it was considered worth while to design the entire installation for unattended operation and most of the features common to automatic stations, such as lock-out relay-bearing temperature relays, reverse-phase voltage, current relays, etc., are provided. Also the switching operations of starting are automatically controlled so that the field is applied and the transfer to full voltage is accomplished without the intervention of the operator.

To secure the wide speed range necessary for the propeller motor, the armature voltage or Ward Leonard system of control is necessary. To obtain good efficiency and regulation with this system it is necessary to vary the voltage of the generator which supplies the motor armature. Control is exercised in this case by varying the excitation of the generator either by changing the position of the generator field rheostat or the voltage of the exciter or both. The field of the motor must, of course, be supplied from a separate constant voltage source and in this case was connected to the control generator because the voltages of both direct-connected exciters for the motor-generator set

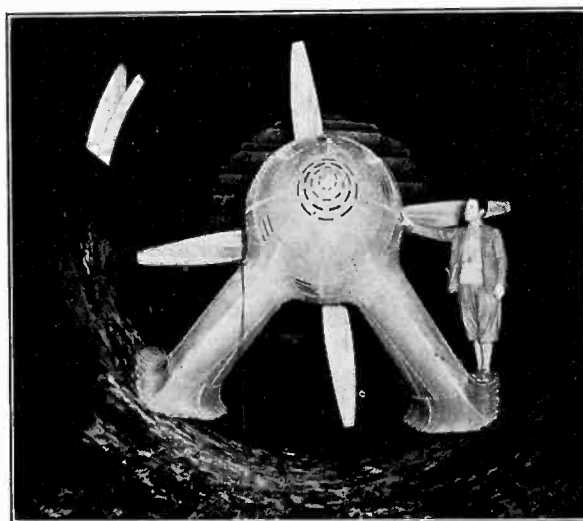

FIG. 7—DOWN STREAM END OF MAIN MOTOR SHOWING COMPLETED INSTALLATION

are subject to excessive changes. This connection also resulted in the smallest installed auxiliary capacity, since field for the propeller motor is not required until all the large oil circuit breakers have been closed and the closing solenoids deenergized, thus making possible joint use of the same control-generator capacity. The main d-c. connections are shown in Fig. 8, and the armature and field circuits may be easily traced on the diagram. It will be noticed that a series of double-

throw switches are inserted in the armature circuit of the main generator and that the two right-hand switches must be closed in the lower position in order to connect the propeller motor. Under these conditions the differential series field is in circuit, acting to stabilize the speed by opposing a change in current. When the generator is used for other experiments, the differential field may or may not be desired and the third switch allows a choice to be made.

It may also be noticed that no starting resistance is provided in the propeller-motor circuit. The starting current is kept within sufficiently low limits by reducing the generator voltage to its minimum value before closing circuit breaker 172. It is also necessary, of course, that the field circuit be closed before the armature circuit is closed, and that the armature circuit open whenever the field circuit opens. These conditions are obtained by means of suitable interlocks so that circuit breaker 172 cannot be closed until the motor-operated rheostat is "all in," and as soon as the circuit breaker opens, connections not shown in the diagram run the

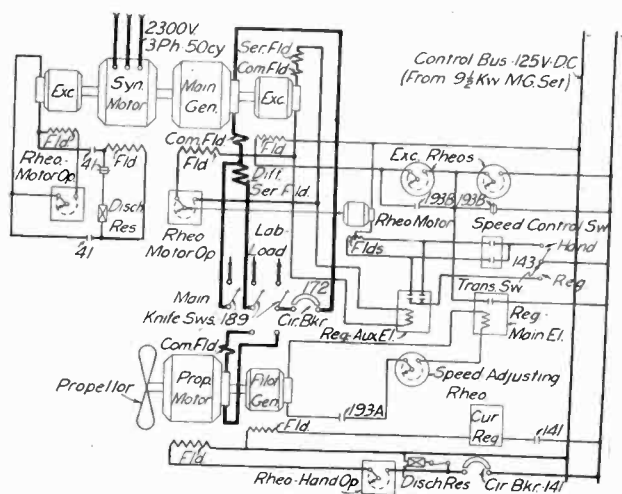

FIG. 8—SCHEMATIC D.-C. CIRCUITS FOR AUTOMATIC SPEED CONTROL AND POWER SUPPLY

rheostat to this position. The motor is started by operating a single control switch. If the rheostat is in the proper position, the motor starts immediately. If not, the motor will start as soon as the rheostat reaches the "all in" position. The connections are arranged so that field circuit breaker 141 closes first, followed by the closing of circuit breaker 172. When stopping, whether by hand or by one of the protective features, the breakers open in the reverse order. If the field breaker opens for any reason, the armature circuit breaker opens immediately.

After the motor has been started, two types of speed control are available. Under hand control the speed of the motor is brought to the desired value and remains nearly constant due to the inherent regulation of the system, although small variations and a gradual creep in speed, due to temperature effects, occur. However, this type of control is much simpler and is very satisfactory for rough or preliminary work. Under regulated

control the speed is set at a given value corresponding to the position of the speed adjusting rheostat, consisting of a coarse and fine section, separately adjustable, and is held at that speed with a high precision by the speed regulator. Although several control stations of both types are provided, only one of each is shown in the diagram. To accommodate additional stations the number of positions of transfer switch 143 is increased, and additional speed adjusting rheostats and relays, 193, are provided for each regulated station and additional speed control switches for each hand control station. For hand control, the entire adjustment is obtained by control of the generator field rheostat, whereas the two elements of the regulator control both the voltage of the exciter and the position of the generator rheostat.

For hand control, transfer switch 143 is closed in the hand position, thus connecting the speed-control switch to a source of power, and the operation of this switch will cause the rheostat to be driven in one direction or the other, thus increasing or decreasing the generator voltage and consequently the speed of the propeller motor. It may be noticed that there are two rheostats in the exciter field circuit, so that the voltage of the exciter is dependent on the position of both rheostats. However, under hand control, relay 193-B is deenergized so that its back contact is closed, short-circuiting the right-hand rheostat, and the exciter voltage is thus determined in this case entirely by the position of the left-hand rheostat. The latter is set at a position which will give normal exciter voltage and is left unchanged, so that the generator rheostat has complete control of the propeller-motor speed.

To obtain regulated control, transfer switch 143 is changed to the "Reg." position. Auxiliary circuits, not shown, immediately run the generator rheostat to the "all in" position, and energize relays 193-B and 193-A. Relay 193-A connects the pilot generator armature to the main element of the speed regulator through the speed adjusting rheostat. Relay 193-B short circuits the left-hand exciter rheostat and inserts the right-hand one in the circuit. The field of the pilot generator is energized through an auxiliary contact of the field circuit breaker 141 and the current regulator, and therefore carries a constant current whenever the propeller motor is running. Under these conditions the voltage generated by the pilot generator is directly proportional to speed. A definite fraction of this voltage, depending upon the position of the speed adjusting rheostat, is impressed upon the main element of the regulator. If this voltage is below the amount required to open the regulator contacts, the contacts close and short-circuit the exciter rheostat. This raises the exciter voltage, hence also the generator voltage, the motor speed, and the pilot generator voltage. If the increase in pilot generator voltage is sufficient, the contacts will open, the exciter voltage will fall and with it, the generator voltage, the propeller motor speed, and the pilot gen-

erator voltage, until the contacts close again. The process repeats continuously. An auxiliary coil and plunger, not shown in the diagram but connected across the exciter terminals, react on the contacts in the same manner as the d-c. coil in an a-c. generator voltage regulator, preventing hunting and keeping the oscillations in speed, produced by the above described opening and closing of contacts, within the most minute limits. Under this condition the mean speed is a function of the position of the speed adjusting rheostat, since the average current in the regulator coil must be a constant and the drop across the rheostat then depends only on its position.

If, in the first instance, the increase in pilot generator voltage was insufficient to open the contacts, the vibrating action does not occur and a speed balance is not obtained. The speed range over which a balance can be obtained with a fixed position of the generator field rheostat is very small, and to increase this range, the auxiliary element of the regulator is provided. If the main contacts remain closed, the exciter voltage will rise above a predetermined value at which one of the contacts of the auxiliary element closes, and this contact changes the position of the generator rheostat until the regulator contacts open, the exciter voltage falls, and the auxiliary contact opens again. Conditions are now satisfactory and the vibrating action of the contacts is immediately set up and a balance obtained. In case the resistance in the speed-adjusting rheostat is reduced, the regulator contacts immediately open, reducing the exciter voltage, the generator voltage, the motor speed, and the pilot generator voltage in turn. If the drop is sufficient, the contacts will close again, a new vibrating action will be set up and a new speed maintained. If the contacts do not close, the exciter voltage will fall so low that the other contact of the auxiliary element will close, increase the resistance in the generator field, reduce the speed of the propeller and finally the pilot generator voltage, until the contacts again close and a new vibrating point is established. Thus, the quick-acting vibrating regulator maintains a precision control over a narrow range and this range is shifted to the proper part of a much broader range by means of the auxiliary element, thus providing a precise speed control over a broad range.

#### OPERATING RESULTS

The installation described above is giving entire satisfaction in the operation of the wind tunnel at California Institute of Technology, both with regard to ease of control and accuracy of speed regulation. Although no precision instruments are available for measuring the actual instantaneous variations, observations of an accurate electric tachometer indicate instantaneous variations of less than 0.2 per cent plus or minus, after the regulating equipment has assumed operating temperature, requiring about one half-hour.

There are innumerable causes of instantaneous speed variation, the principal ones being resistance changes

due to temperature variations in the armature and field of the propeller motor, main generator and excitors, change in load due to change in angle of attack of the model, change of supply frequency, etc. However, none of these changes can exceed the limit given above of  $\pm 0.2$  per cent without bringing about a corrective action from the regulator, so that none of these effects produce any permanent variations or any beyond the stated limits unless they are of such extreme magnitude and so rapid that the regulator is unable to respond and correct them before the limit is reached.

The only causes of permanent variation are those which affect the accuracy of the speed regulator, and include changes in resistance of the regulator circuits and change in permeability of the pilot-generator field with temperature. Such effects cause a gradual increase in speed of approximately 0.25 per cent per hour after operating temperature has been reached, and may be easily corrected for by adjustment of the speed-adjusting rheostat.

As explained above, no permanent speed change is caused by variation in a-c. line voltage or frequency, the changes being immediately corrected for by action of the speed regulator. No data are available regarding the speed of corrective action of the regulator or the amount and rate of change necessary to prevent the regulator keeping the speed within the allowable limits. Although the assembly was developed for a special application, it is composed entirely of standard apparatus and has several features which may be adaptable to other purposes requiring a wide speed range with a high degree of accuracy in speed regulation.

#### ACKNOWLEDGMENT

The author wishes to acknowledge the kind cooperation of many members of the staff of the California Institute of Technology, especially Mr. L. G. Fenner, Superintendent of Wiring; also of many members of the engineering staffs of the Westinghouse Electric & Manufacturing Company and General Electric Company.

#### Appendix

##### APPARATUS

Propeller Motor: 500-hp., 230-volt, 700-rev. per min., at full load, shunt connected.

Main Generator: 430-kw., 230-volt, 1000-rev. per min., differential compound.

Main A-C. Motor: 610-hp., 2200-volt, 3-phase synchronous.

M-G Set for Control Supply:  $9\frac{1}{2}$ -kw., 125 volt, 1500-rev. per min. compound generator; 220-volt, 3-phase induction motor.

Pilot Generator on the Propeller Motor Shaft: Rated 1.5 kw. (but in a larger frame for negligible temperature rise) 600-volt, 700-rev. per min., separately excited.

Automatic Switchboard contains: 3000-ampere automatic circuit breaker, accelerating relays, misc. relays, field contactor, overload relays, annunciator relay.

Speed Control Switchboard contains: Phase balance relay, voltage balance relay, control switches and indicators and regulator operating from the pilot generator.

Much additional apparatus such as excitors and switchboard meters have not been listed in detail.

# High-Voltage Low-Current Fuses and Switches

BY ROY WILKINS<sup>1</sup>

Follow, A. I. E. E.

*Synopsis.*—For interruption of small currents at relatively high voltages, fuses and air-break switches are most commonly employed. This paper treats of these devices which are suitable for such service as protection on the transmission lines supplying small

blocks of power such as rural lines. The requirements for this service are outlined and a discussion is given of the ability of the devices to meet these requirements.

\* \* \* \* \*

FROM the beginning of the commercial use of electricity one of the problems has been the interrupting of the flow of current in time of need. This is still, after forty or more years, the major problem in the operation of the transmission networks supplying power throughout the world. On its successful accomplishment depends the continuity of electric service so essential to modern life and industry.

In those parts of the transmission network handling large blocks of power, the economic apportioning of cost allows both a high initial capital outlay and a high maintenance cost, and because of its importance demands the best in research and development that the industry affords, resulting in advanced types of circuit breakers and relays to control them.

On the other hand very small blocks of power, found for instance in rural communities, have economic limitations which limit the amount that may be spent and still expect a reasonable return on the investment. They must be supplied by a moderately high-tension line because of the distances covered, and the efficiency of the lines and transformers corresponds within reasonable limits to those on the major circuits. Circuit-interrupting equipment for this class of service is notably deficient if kept within the usual economic limits, particularly so, since the advent of automatic service restoring equipment now in common use on the low-tension side of the transformers used. The greater portion of such installations now are protected on the high-tension side by fuses of various designs and automatic airbreak switches are employed to a smaller extent.

The second important application of high-tension fuses at the present time is for the protection of potential transformers used as metering equipment. Since it has become almost universal practise to sacrifice the transformer when it gets into trouble and depend on the fuse to clear the system from it, the necessity for very low-current fuses has disappeared and the place filled by a fuse having a rating of from five to ten amperes in series with a resistor. For these conditions present day fuses perform reasonably well.

<sup>1</sup> Consulting Engineer, Pacific Electric Mfg. Corp., San Francisco, Calif.

Presented at the Pacific Coast Convention of the A. I. E. E., Santa Monica, Calif., Sept. 3-6, 1929. Printed complete herein.

## FUSES

The original circuit-interrupting equipment was simply a reduced section of the conductor which opened the circuit by melting. As the demands increased, various alloys melting at lower temperature than the usual conductor were employed. For the use on high-tension circuits, however, the more durable metals are required for sturdy construction.

The melting curves for ideal conditions follow a logarithmic law, and if the time is short enough or the fuse heat-insulated, as for instance sealed in a vacuum, the law holds quite closely for long fuses. For very short sections a correction for heat transfer to the terminals must be made.

Theoretically there is a definite quantity of heat required to melt a given quantity of each metal to be supplied as watt seconds by  $I^2 R$  in the fuse. Practically the various indeterminates, such as conduction and radiation, make the calculation of fusing time for a given fuse on a given current very difficult and generally unsatisfactory, so that various empirical or semi-empirical formulas have been proposed similar for instance to:

$$C = K d^{3/2}$$

where  $C$  = amperes

$K$  = a constant for each metal and

$d$  = the diameter of the fuse

Such formulas were determined empirically for each fuse for given conditions.

Of the more general formulas in common use those having a factor for the fusing time are the most serviceable, for example:

$$t = \frac{0.262 \pi^2 d^4 s w}{I^2 r_0 \alpha} \log \frac{1 + \alpha T_m}{1 + \alpha T_r}$$

where  $t$  = time in seconds

$d$  = diameter of wire cm.

$s$  = mean value of specific heat of wire in calories per gram per deg. cent. for temperature range

$w$  = density in grams per cu. cm.

$I$  = current in amperes

$r_0$  = resistivity of wire in ohms per cm.<sup>3</sup>

$\alpha$  = temperature coefficient of wire (average value for temperature range)

$T_m$  = melting point of wire in deg. cent.

$T_r$  = initial temperature.



Such formulas give approximate values, since no account is taken of latent heat radiation, conduction and the effect of wave form, etc. All values are considered as effective values of uniform sine waves of current and voltage.

It is especially difficult to secure accurate values for the power absorbed by the fuse even with modern oscillographic wattmeters because of phase angle, ratio errors, and inductive effects. Unless exceptional care is taken to eliminate such errors, the records of individual trials of watts may vary as much as 1000 per cent. For the same reasons integration of the current and voltage waves is equally unsatisfactory.

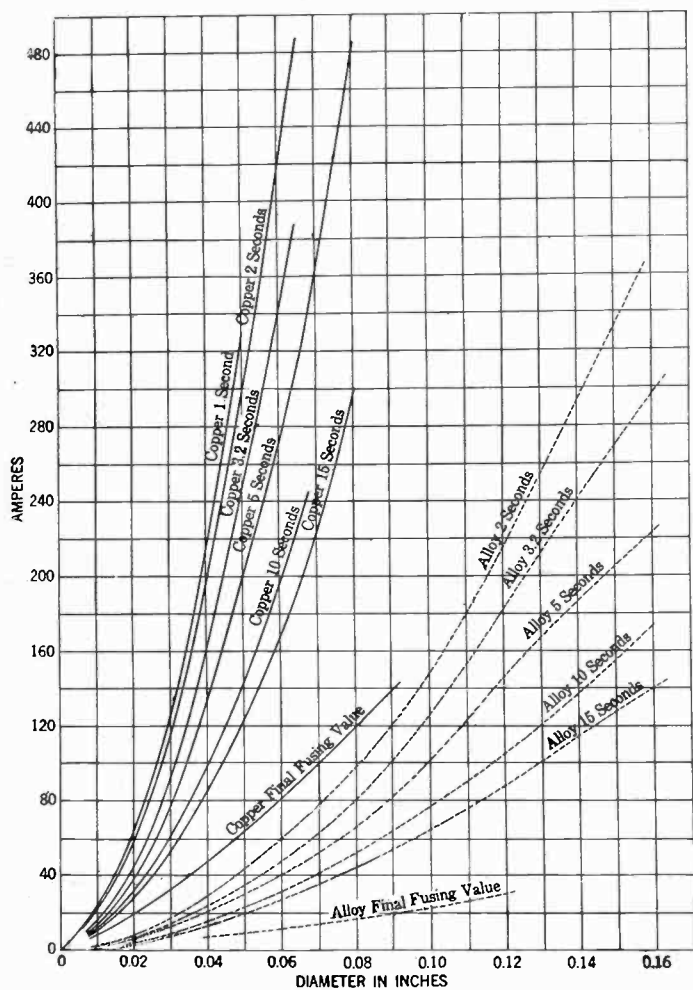

FIG.—1 FUSING CURRENT OF COPPER AND ALLOY FUSES

Comparative data can be secured, however, by averaging a considerable number of trials of each type and the average performance deduced therefrom, as shown in Fig. 1.

In general, if the fuse be tested at low voltage using preferably a good oscillograph and proper control, three or four points plotted on logarithmic paper are sufficient to determine its time-current characteristics. The time clearing characteristics at high voltage, however, do not follow the time fusing curves, since it requires more than the melting of the fuse to clear the circuit, and this time taken up by contact travel or expulsive action is recorded as arc current and is not definitely separated from the true fusing time on the record. The

arcing time is moreover dependent upon recovery voltage which is in turn controlled by the connected circuit. The available current is also controlled by the connected circuit and may be many times that required to melt the fuse, frequently volatilizing it directly, whereupon the major portion of the required clearing time is taken up in arcing time.

Since the time of melting is controlled by the size and resistance under control in manufacture, and by the current controlled by the circuit, those fuses having a relatively good conductor of small section such as silver or copper show the most uniform action in service. Silver is particularly desirable since it is not easily corroded under the usual service conditions and the small amount necessary does not form a conducting cloud of vapor such as some of the commoner metals used in low-tension fuses. Nearly all fuses now available have too much metal to be volatilized before they clear, the common expedient of threading a shotgun wad on the element of the expulsion type in order to clear the tube, being a practical demonstration of this fact.

The same limitations which are driving time-current relay settings out of transmission networks in favor of some form of differential or impedance control, operate to limit the success of high-tension fuses for selective clearing of faults. Fuses usually require a far higher current rating on a given installation than the relay setting would be for the same case were it economically possible to use an oil circuit breaker and relays.

The operating requirements of an acceptable fuse may be outlined as follows:

1. Must fuse on a given current in a given time;
2. Must clear circuit under all conditions;
3. Must remain an insulator after clearing.

There might be added desirable requirements calling for the fulfilling of all of the functions of a good relay controlled oil circuit breaker but the above three are fundamental and serve to bar most present day high-tension fuses from being classed as successful when viewed from the user's standpoint.

The present day high-tension fuses may be grouped according to their method of functioning as follows:

1. Plain fusible links
2. Expulsion types
3. Mechanically retracted contacts
4. Explosively propelled contacts.

They all have in common several faults which limit their usefulness. First, the time-current control is very limited; so much so that it is not practical to operate fuses and circuit breakers in series and get selective action where the short-circuit current range is more than two or three to one, because for heavy currents the fuses approach 1/2-cycle clearing time whereas the relay oil circuit breaker combination have several cycles minimum. The better the fuse as regards its own clearing performance the worse this objection becomes, resulting in a higher rating for a quick acting fuse

for the same duty than for one of the heavier slower acting types.

Practically all fuses now manufactured emit flame and incandescent gas on operation and in addition some types metallic parts and jumpers as well. Few high-tension fuses in commercial use at present are entirely free from this serious objection.

In addition to the above the several types have the following troubles:

Classes one and two above both fail to clear on normal voltage at very slightly above their melting point since the containers, glass, porcelain, or organic material, are all conductors when heated; it follows that if the fuse is gradually heated to incandescence the container will be rendered conducting. Fig. 2 shows examples of such failures. Some rather spectacular results can be expected from either type if the load is gradually in-

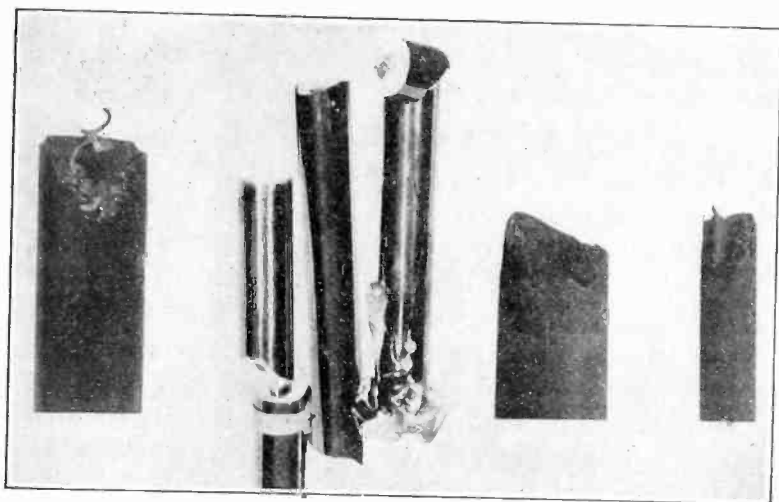

FIG. 2—FUSE CONTAINERS WHICH HAVE BECOME CONDUCTORS BY BEING HEATED

creased at normal voltage for several hours and finally allowed to melt the fuse.

Class three has the primary objection of cost particularly where liquid filled, because of the necessary close supervision in manufacture and careful handling necessary.

They also have to be carefully vented with some form of baffle between the fuse chamber and the liquid in order to prevent shattering the container. In effect this results in an expulsion fuse with a very small chamber and a liquid insulation chamber below.

Under-rating, such as using a 10-ampere fuse in 100-ampere casing, increases the safety but exceeds the economic limit except in very special cases.

In practise considerable care must be exercised in order to prevent liquid leakage either direct or by evaporation.

There are at present very few examples of number four type in service, the so-called shotgun fuse being the best known example. In this type the contact movement is caused by an explosive, usually powder such as is commonly used in fire arms. The fuse itself imbedded in such powder ignites it as soon as either sufficient

temperature is reached or an arc is started. The clearing speed is always the same and for this reason the general type is easily adapted to very small fuses at high voltage.

One disadvantage is the necessary clearance required for the exit of flame and contacts.

In application some thought must be given the location of the fuses when blown, a common trouble being to mount them in such a position that when blown in wet weather they will fill with water and thereby become conducting.

#### AIR BREAK SWITCHES

Because of the lack of available time delay in high-tension fuses and due to the cost of refilling them when blown, many attempts have been made to use automatic air-break switches instead.

The major portion of the air-break switches used for such service are manually closed against a spring or weight and tripped by series overload coils. The tripping is accomplished either direct or through an insulated rod of glass or Bakelite which is used to close a contact on a battery circuit.

The usual clearance between phases is approximately eight feet for 44-kv., and ten feet for 66-kv., and the usual tendency is to carry the arc upward from the insulators rather than across phases.

Practise in automatic air-break switches has demonstrated that the most satisfactory results are secured by moderate speeds, for instance, as the speed usually secured in hand operation from two to four feet per second contact travel.

Compared to high-tension fuses very few automatic air-break switches are in service so that data on their general performance are not readily available.

The same factors which tended in the early days of transmission to force better control of the clearing action and thereby caused development of relays and modern circuit breakers, are operating now to limit the use of the same class of equipment in modern high-voltage distribution lines to those locations where selective clearing action is not essential. For service where overload protection only is desired and moderate interrupting capacity sufficient, present day fuses are reasonably satisfactory.

For higher duties, underrating both in current and voltage minimizes trouble, but is usually not economically feasible.

The building code proposed by the American Welding Society for the construction of buildings has recently been adopted by a large number of Southern and Western cities and has also been recognized by the State of Pennsylvania where the Legislature passed a law making welding available for buildings in first-class cities. The use of welding in the erection of steel frame buildings is increasing very rapidly.

# The Interconnected Integraph

BY ROBERT E. GLOVER  
Non-member

and HENRY H. PLUMB  
Member, A. I. E. E.

*Synopsis.*—A machine for solving differential equations in two variables is described. The equations may be linear or non-linear and may have variable or constant coefficients. The machine draws out the solution in the form of a curve, together with its deriv-

atives. By altering the connections in various ways, a wide variety of equations may be solved with a limited number of integrating and reflexing elements.

\* \* \* \* \*

THE occurrence of a number of difficult problems in differential equations with which the writers were required to deal, led them to seek some method of general applicability whereby the solution of such problems might be obtained. Since it was known that a large number of differential equations exist which have no solution in terms of the known functions, success by formal methods seemed hopeless and consideration was given to the possibilities of solution by mechanical means. Working along this line the writers evolved the idea of the interconnected integraph which fulfills the requirements to the extent that it appears to be possible with a moderate amount of equipment to solve a wide variety of ordinary differential equations or parametric equations in three variables. The solution is given by the machine in the form of a graph in Cartesian coordinates, together with similar graphs of its successive derivatives to an order one less than the order of the differential equation. The machine is adapted to the problem at hand by the manner in which the various elements are connected. In order to test out the soundness of the principle, an experimental machine was built which operated as expected. In the article which follows, the order of development will be adhered to, the principle upon which the machine is based being given first, followed by a description of the experimental machine.

The principle upon which the machine operates can be illustrated most clearly by means of an example. For the purpose, let it be assumed that the equation

$$\frac{dy}{dx} = ky$$

is to be solved where  $x$  and  $y$  have their usual meaning and  $k$  is a constant. The wiring diagram for a machine to solve this equation is shown in Fig. 1. At the left is shown in diagrammatic form a d-c. integrating wattmeter element which in this case is to be operated by alternating current. Mounted on the meter shaft is a contactor which closes the platen motor circuit, one or more times each revolution of the meter. The platen motor is fitted with a pawl-and-ratchet device to move the platen a small distance in the direction of its length each time an impulse is received. The platen consists of a non-conducting shell which carries a uniformly spaced winding. This winding interlinks with the flux from an iron core whose primary is energized from an a-c. source. The winding of the platen is symmetrical with respect to its center so that the voltage induced

is proportional to the departure of the platen from its mid-position and changes sign when the mid-point is passed. The armature of the meter and the platen primary are connected to a constant potential source and the leads from the platen are connected to the field of the meter. Under these conditions the speed of the meter is proportional to the departure of the platen from its mid-position, and since the construction of the machine insures that the departure of the platen will be proportional to the time integral of the meter

speed, we have  $\frac{dy}{dt}$  proportional to  $y$ , where  $y$  now represents the departure of the platen from its mid-

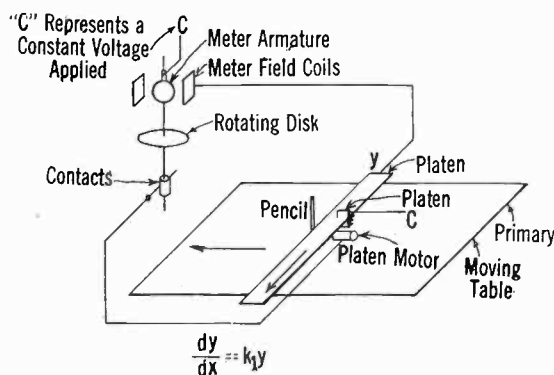

FIG. 1

position. If a pencil is attached to the platen and a table be run beneath it at constant speed in a direction normal to the direction of motion of the platen, the pencil will draw out upon the table a graph of the curve which is a solution of

$$\frac{dy}{dx} = ky$$

where  $x$  is measured parallel to the direction of motion of the table. The curve drawn is not smooth, but consists of a series of steps of constant height but varying length. On the experimental machine the height of these steps is about a quarter of an inch. It would be preferable, however, to reduce them to about one-hundredth of the maximum ordinate or to about one-tenth of an inch for a machine of twenty inch span. In figures 2 and 3 are given wiring diagrams for two other representative types of equations. The platens marked  $X_1$ ,  $X_2$ , and  $X_3$  in Fig. 2 and  $X_4$  in Fig. 3 are controlled manually by the operators who cause them to follow graphs of the appropriate functions previously plotted to scale upon the table. In order to simplify

the diagrams, circuits have been represented by a single line.

To carry the example a step further a curve from the experimental machine (connected as in Fig. 1) will be applied to the problem of calculating the relation between barometric pressure and height.

The given data are:

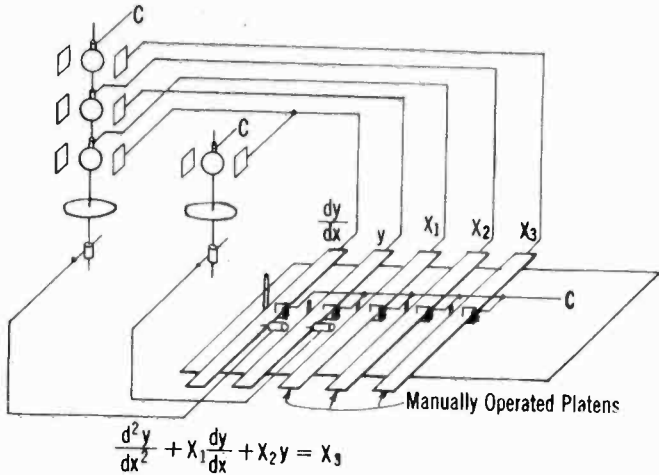

FIG. 2

Weight of one cubic foot of air at 760 mm. pressure and 0 degrees centigrade 0.08072 lb.

Pressure at sea level = 760 mm. of mercury or 2116.35 lb. per sq. ft.

Slope of curve drawn to natural scale by machine with 110 volts on the armature and the platen displaced one inch = -0.190. Let:

$p$  = pressure in pounds per sq. ft.

$h$  = height in feet

$k$  = weight of one cubic foot of air at deg. cent. and one

$$\text{pound per sq. ft. pressure} = \frac{0.08072}{2116.35}$$

Since at constant temperature the weight per cubic foot of a gas is proportional to the pressure, the differential

$$\text{equation which applies in this case is } \frac{dp}{dh} = -k p$$

Using the curve drawn by the experimental machine, the elements of which are given at the close of the article, let the point where  $y$  is 15 inches be chosen to represent conditions at sea level. The scale of  $p$  is then determined by the condition that 15 inches must represent 2116.35 pounds per square foot. The scale

$$\text{is then: } \frac{2116.35}{15} = 141.09 \text{ pounds per square foot}$$

per inch. The slope of the machine curve at this point is - (0.190) (15) = - 2.85 inches per inch.

For each inch of vertical scale this slope will subtend

$$\frac{1}{2.85} = 0.3509 \text{ inches on the horizontal scale. The}$$

scale of  $h$  is then determined by finding how many feet would be required to produce the pressure represented by one inch of vertical scale with air of the density

found at sea level. The horizontal scale is therefore:

$$\frac{141.09}{(0.08072) (0.3580)} = 4981 \text{ ft. to the inch. Let it now}$$

be required to find the pressure at a height of 3.4 miles above sea level.

$$h = \frac{(3.4) (5280)}{(4981)} = 3.604 \text{ in. to scale}$$

From the curve  $y = 7.77$  in.

Therefore  $p = (7.77) (141.09) = 1096$  lb. per sq. ft.

As a check assume a point 8 in. from the axis to represent conditions at sea level.

As before:

$$\text{Scale of } p = \frac{2116.35}{8} = 264.5 \text{ lb. per sq. ft. per inch.}$$

$$\text{Slope at } y = 8. = - (0.190) (8) = - 1.520 \text{ in. per inch}$$

$$\frac{1}{1.520} = 0.6579$$

$$\text{Scale of } h = \frac{264.5}{(0.08072) (0.6579)} = 4981. \text{ ft. to the inch.}$$

$$\frac{(3.4) (5280.)}{4981} = 3.604 \text{ in. From the curve } y = 4.08 \text{ in.}$$

Then:

$$p = (408) (264.5) = 1079. \text{ lb. per sq. ft.}$$

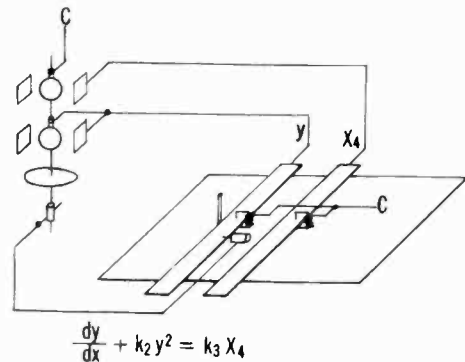

FIG. 3

Checking by formal methods the exact value is found to be 1066 lb. per sq. ft.

#### DESCRIPTION OF THE MACHINE

A standard d-c. commutator type watt-hour meter was somewhat modified for this experiment. The 110-volt shunt armature circuit was used without alteration but the series current winding was removed and replaced with a 10-volt shunt winding. The meter was thus made adaptable for integrating the product of two variable voltages, and because there was no iron in the magnetic fields its response should be undistorted when supplied with alternating voltages. The integrated quantities instead of being registered on the customary dials were given effect through a contacting device on the meter shaft to give two contacts per revolution. Studies of periodic functions would



require that the meter reverse its rotation and in order to eliminate frictional effect, a biasing speed of the disk was resorted to, above and below which speed the effects of the meter coils might operate, as long as the bucking effects did not reduce the disk speed to zero. The undesired or extra number of contacts due to the biasing speed were sifted out by the differential gear described later, so that only the registration due to the meter coils alone was finally effective. For the particular problem selected for checking purposes, no periodic functions were involved, however, and this device was not strictly needed. For supplying the biasing speed to the disk, the friction compensator was removed and replaced with a standard type of single-phase induction meter element placed to operate on the damping magnet drag disk. Sufficient load was given to this ele-

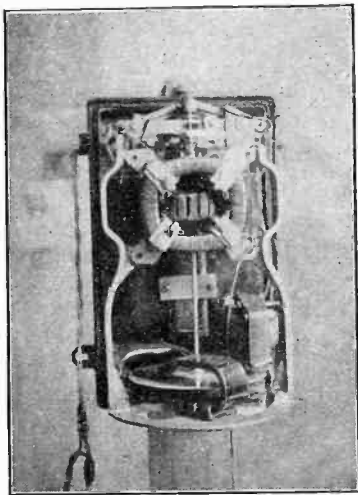

FIG. 4

the motor. The differential gear arrangement shown in Fig. 5 was worked out so that the two motions could be applied simultaneously to the platen. Any constant speed device could be used for this purpose so long as it was adjusted to exactly neutralize the effect of the biasing speed of the meter. It was therefore taken from the constant speed drive of the moving table. The contacting device necessarily moved the platen by steps while the motion of the moving table gave a uniform restoring motion to the platen. A pencil was attached to the platen in such a way that the motion of the platen was recorded at right angles to the motion of the moving table underneath which carried a paper chart on which the integral curve of the differential equation was automatically drawn. The table was simply drawn along by a constant speed motor operating through a lead screw and a nut fastened to the table, the nut being split for easy resetting of the table.

In order to test the accuracy of the experimental machine an exponential curve was passed through

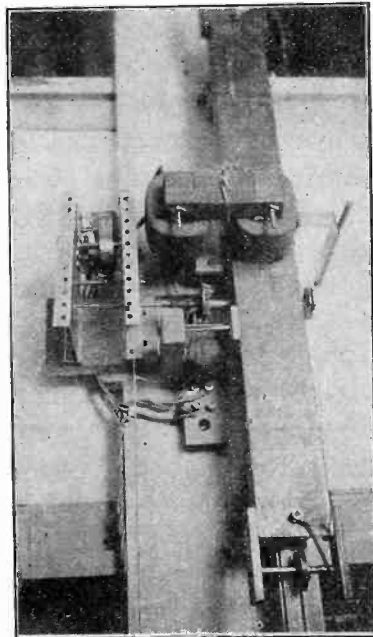

FIG. 5

ment to produce an initial disk speed of about 10 revolutions per minute.

The second important unit of the integraph was what may be called the platen. This consisted of a transformer core containing an air-gap, with primary winding connected to 115-volt, 60-cycle supply, the secondary or platen winding being wound in a spiral manner to give a smoothly variable voltage from - 10 through zero to 10 volts, the algebraic signs indicating 180 deg. phase difference.

The means was thus provided for supplying a variable voltage from the platen to the field winding of the d-c. watt-hour meter. The meter contacting device must be interconnected or reflexed upon the platen in such a manner that each impulse accomplishes a slight motion or displacement of the platen. This arrangement whereby each element is controlled by the element which it controls is the characteristic feature of the machine.

The contacting device operated a relay controlling a small motor which furnished the desired motion to the platen by rotating the spool upon which the platen rested at a point near the air-gap. In order to compensate for the number of impulses given out at biasing speed it was necessary to provide a second motion to the platen in the opposite direction from that supplied by

three points of one of its curves. The comparison for points two inches apart is shown in the following table:

$x$	$0.190x$	$y = 15.31e^{-0.190x}$	$y$ from the machine curve
0 inches	0.0	15.31 inches	15.31 inches
2 "	0.380	10.46 "	10.40 "
4 "	0.760	7.16 "	7.20 "
6 "	1.140	4.90 "	4.98 "
8 "	1.520	3.35 "	3.39 "
10 "	1.900	2.29 "	2.29 "

**Bibliography**

"Treatise on Natural Philosophy," Thomson & Tait, Vol. 1. Part 1, New Edition 1879, Appendix B 1, pp. 497-504 inclusive,  
 "A Continuous Integragraph," Bush, Gage, & Stewart, *J. Franklin Institute*, 1927, p. 63.  
 "Integragraph Solution of Differential Equations," Bush & Hazen, *J. Franklin Institute*, 1927, p. 575.  
 "Stability of Synchronous Motors," Leo Teplow, *General Electric Review*, July 1928, pp. 356-365.

# Abridgment of Instruments and Measurements

## ANNUAL REPORT OF COMMITTEE ON INSTRUMENTS AND MEASUREMENTS\*

To the Board of Directors:

The Committee on Instruments and Measurements reports activities for the past year as follows:

1. Revision of Electrical Units
2. Measurement of Core Losses in Terms of Sine-Wave Core Losses
3. Distortion Factor—Definition and Method of Measurement
4. Technique of Temperature Measurement.
5. Measurement of Variable Power and Large Blocks of Energy
6. Dielectric Power Loss and Power-Factor Measurements
7. Measurement of Non-Electrical Quantities by Electrical Means
8. High-Frequency Measurements
9. Remote Metering
10. Shielding in Electrical Measurements
11. Papers
12. Conclusion.

### REVISION OF ELECTRICAL UNITS

The progress during the past year of the movement in favor of absolute electrical units in place of those defined by means of arbitrary standards is considered by the Instruments and Measurements Committee to be most gratifying and the actions taken to be epoch making. This progress is recorded in the following report by Dr. H. B. Brooks, Chairman of the Subcommittee on Revision of Electrical Units.

The resolutions on Revision of Electrical Units which were prepared by the Committee on Instruments and Measurements and transmitted to the Board of Directors, through the Standards Committee, were adopted with a slight change at the meeting of the Board in Denver in June 1928. The resolutions cited the discrepancies existing between the international electrical units and the absolute units they were intended to represent, and called on the United States Bureau of Standards and foreign national standardizing laboratories to undertake the researches necessary to eliminate the discrepancies, and to bring about the legalization of absolute electrical units in place of those defined by means of arbitrary standards. Copies of the resolutions were sent to the appropriate committees of the

#### \*COMMITTEE ON INSTRUMENTS AND MEASUREMENTS:

Everett S. Lee, Chairman,  
H. C. Koenig, Secretary,  
E. J. Rutan, Vice-Chairman,  
O. J. Bliss, W. N. Goodwin, Jr., W. J. Mowbray,  
Perry A. Borden, F. C. Holtz, T. E. Penard,  
W. M. Bradshaw, I. F. Kinnard, R. T. Pierce,  
H. B. Brooks, A. E. Knowlton, G. A. Sawin,  
A. L. Cook, W. B. Kouwenhoven, R. W. Sorensen,  
Melville Eastham, E. B. Merriam, H. M. Turner.

Presented at the Summer Convention of the A. I. E. E., Swampscott, Mass., June 24-28, 1929. Complete copies upon request.

U. S. Senate and House of Representatives, the Bureau of Standards, and to the national standardizing laboratories of England, France, Germany, Japan, and Russia.

To assist in formulating proposals incorporating a consensus of the opinions held in the United States, Dr. G. K. Burgess, Director of the Bureau of Standards, invited a number of organizations to name members of an American Advisory Committee representing the scientific, industrial, and commercial organizations most directly concerned with electrical measurements. These organizations were as follows: National Academy of Sciences, American Institute of Electrical Engineers, American Physical Society, National Electric Light Association, Association of Edison Illuminating Companies, National Electrical Manufacturers Association, and the American Telephone and Telegraph Company. This American Committee met at the Bureau of Standards on June 16, 1928. After due consideration of the information available regarding the present status of electrical measurements, the American Advisory Committee unanimously adopted the following resolutions:

“(1) Resolved, that in the opinion of this Committee, in view of improvements which are being made in absolute measurements, electrical standards should in future be based upon the absolute system of units.

“(2) Resolved, that in the opinion of this Committee, the functions which it is desirable to have the International Bureau of Weights and Measures undertake in connection with the electrical units, are as follows:

“(1) A central secretariat to arrange for systematic exchange of standards and compilation of results of intercomparisons thus made among the national laboratories.

“(2) A laboratory to which concrete standards representing the results obtained in the different countries may be brought for precise comparisons.

“(3) A repository for international reference and working standards with the necessary equipment so that other standards may be compared with these standards on request.

With the backing of these resolutions, Dr. Burgess attended the first meetings of the (international) Advisory Committee on Electricity, which were held at Sèvres and Paris November 20-22 inclusive, 1928. The timeliness and the importance of the question of the revision of the electrical units are shown by the fact that delegates felt it worth while to come from the far countries of the world, so that the Advisory Committee had a complete attendance of all members. Communications from various countries concerning the electrical units were considered. The cordial spirit and the unselfish aims of the committee are shown

by the gratifying fact that all the decisions reported were reached unanimously.<sup>1</sup> The committee realized the great importance of dealing adequately with the electrical units, in the light of past experience and present knowledge, and ultimately adopted, by unanimous vote, the following resolutions:

"1. The Advisory Committee on Electricity established by the International Committee of Weights and Measures, considering the great importance of unifying the systems of electrical measurements upon a basis deprived of all arbitrary character, recognizes from the beginning of its first session that the absolute system, derived from the c. g. s. system, may be substituted with advantage for the international system of units for all scientific and industrial determinations and decides to propose its adoption to the International Committee of Weights and Measures.

"2. The Advisory Committee on Electricity, while recognizing fully the great forward steps already taken in the domain of electrical measurements of high precision, does not believe, however, that it is possible immediately to fix with all the necessary and possible accuracy the ratios which exist between the absolute units derived from the c. g. s. system and the international units of current, electromotive force, and resistance, as they were defined by the International Congress at Chicago in 1893 and the London Conference in 1908, and expresses the wish that researches may be carried on toward that end in suitably equipped laboratories, in accordance with a program previously worked out in cooperation with the Advisory Committee on Electricity."

Dr. Burgess was unanimously chosen to report the proceedings of the Advisory Committee to the International Committee of Weights and Measures. The approval of the latter is necessary to put into effect the resolutions of the Advisory Committee. The Committee on Instruments and Measurements regards the action of the Advisory Committee on Electricity as an epoch-making event, and looks forward hopefully to the time when the units of the electrical engineer and those of the mechanical engineer will rest alike upon the fundamental bases, the meter, the kilogram, and the second of time.

#### MEASUREMENT OF CORE LOSSES IN TERMS OF SINE-WAVE CORE LOSSES

A working committee of the Instruments and Measurements Committee under the chairmanship of Mr. W. M. Bradshaw has been studying for the past year the best way to make core loss measurements on transformers so that they will give accurate "sine-wave" core losses regardless of the wave form employed for excitation. In this connection the working committee issued a questionnaire on the practise of measuring

1. A full account of the proceedings of the Advisory Committee on Electricity is given in *Revue Générale de l'Electricité* for Dec. 22, 1928.

core losses in transformers. This was sent to fourteen known manufacturers of transformers. Replies were received from ten of them. Of the ten replies, five were from manufacturers of power and distribution transformers, all of whom either recognized the necessity for corrections or actually used corrections. The other five were from manufacturers of instrument transformers or special transformers in which core losses need not be measured. Those who only recognized the general necessity for corrections state that they have available a pure sine wave which remains undisturbed.

As a result of the replies to this questionnaire and from the results of their study, the Working Committee recommended desirable procedure in making core loss measurements to the Instruments and Measurements Committee, which recommendations have been regularly transmitted to the Standards Committee. These recommendations provided for the measurement of core loss of transformers preferably with a sine wave of applied voltage; if this is not practicable, the results obtained with a distorted wave of applied voltage shall be corrected to a sine-wave basis by a suitable method.

Three suitable methods, as follows, have been studied and are outlined in detail in the report:

- No. 1. Standard Core Method
- No. 2. Iron-Loss Voltmeter Method
- No. 3. Flux Voltmeter Method

Methods No. 1 and No. 2 use miniature representative sample cores. In Method No. 3 the correct average voltage is applied to the transformer under test irrespective of the wave form of the applied voltage.

The committee recommended preference for methods utilizing average voltage for correcting core loss results to a sine-wave basis to those utilizing sample cores since the sample may not represent correctly the actual transformer under test.

#### DISTORTION FACTOR—DEFINITION AND METHOD OF MEASUREMENT

A working Committee of the Instruments and Measurements Committee, under the chairmanship of Mr. W. M. Bradshaw, has studied the definition of distortion factor and method of measurement as disclosed in a report of the French Electrotechnical Commission entitled "Methods of Determining the Distortion of the Voltage Wave of Alternators," and have recommended action concerning these, which recommendations the Instruments and Measurements Committee have regularly referred to the Standards Committee. The definition recommended is the same in substance as proposed in the French report, but differs in form to be in agreement with the form of the present A. I. E. E. definition of Deviation Factor, and is as follows:

The distortion factor of a voltage wave is the ratio of the effective value of the residue, after the elimination of the fundamental, to the effective value of the original wave.

A general definition to include all periodic waves was recommended as follows:

Distortion factor of a periodic voltage or current wave is the ratio of the effective value of the residue, after the elimination of the fundamental, to the effective value of the original wave.

Details of methods for measuring the distortion factor of a voltage wave were submitted for use in obtaining data for the establishment of suitable limiting values of distortion factor, as follows:

A. Method of Boucherot using an alternator with a sinusoidal wave and a voltmeter.

B. Method of Belfils using a bridge to suppress the fundamental of the wave to be analyzed, and a voltmeter to read the residue.

C. By oscillogram.

D. By harmonic analyzer.

The method (B) seems at the present time to be the most promising, though further study and development of the apparatus are necessary. This work is proceeding.

#### TECHNIQUE OF TEMPERATURE MEASUREMENT

The Standards Committee has referred to the Instruments and Measurements Committee the broad question of Standards for the Technique of Temperature Measurement. A subcommittee has been appointed and work is progressing on writing a standard on the technique of temperature measurement. The initial activity will be confined to those temperature measurements included in the present A. I. E. E. Standards.

#### MEASUREMENT OF VARIABLE POWER AND LARGE BLOCKS OF ENERGY

The subcommittee on this subject, under the chairmanship of Mr. T. E. Penard, is collecting literature from the various manufacturers of meters and metering equipment relative to this phase of the art. The questions of metering large blocks of d-c. energy requiring the use of large capacity shunts in connection with watthour meters and the calibration of such shunts, as well as the use of several low current shunts in parallel with resistance compensated potential connections, are being studied.

A new oscillating meter clamped directly on the bus bars and working on the stray field produced by the currents in the bus is being studied.

#### DIELECTRIC POWER LOSS AND POWER-FACTOR MEASUREMENTS

The Subcommittee on Dielectric Power Loss and Power-Factor Measurements under the chairmanship of Mr. H. C. Koenig has rendered the following report:

In 1928 Messrs. J. A. Scott, H. W. Bousman, and R. R. Benedict presented a paper before the Institute entitled *A Thermal Method of Standardizing Dielectric Power Loss Measuring Equipment*, (A. I. E. E. Quarterly TRANS., Vol. 47, July, 1928, p. 819). In this paper the authors pointed out the effect of humid-

ity on an air capacitor. As a result of this paper, at least two new investigations along these lines have been made. In one of them, at the Electrical Testing Laboratories, it was shown that a properly constructed air condenser had a power factor of less than 0.01 per cent over a range of voltage up to 20 kv. per inch between plates, and over a range of humidity up to, at least, 85 per cent in clean air. In the other investigation at the Johns Hopkins University, two successful runs of varying humidity and voltage were made, one at a temperature of 77 deg. fahr. and the other at 85 deg. fahr. No air conduction could be detected up to about 90 per cent humidity. At the time of writing further experiments are still in progress.

In the subcommittee report of 1928, attention was called to the development of standards loads for use in checking dielectric loss equipment. Following the successful application of this standard load rated at 20 kv., a similar load has now been developed for use up to 75 kv. This latter load was also used very successfully in making factory inter-checks of dielectric loss equipment. In general, the results of the inter-comparison of dielectric loss equipments were very satisfactory.

As a result of the inter-check made at various factories two conditions have been noticed which are of interest. (1) It has been noted that while most laboratories are in fair agreement as to power factor measurements, there is a decided lack of agreement on current (and, therefore, watt) determinations. It appears that currents of the order of 1 to 10 milliamperes present a somewhat difficult measurement problem. Most laboratories use the same instruments for watt and current determinations, changing the coil connections and using it as a deflection instrument. The laboratories using a bridge method depend on the capacitance of their reference condenser. One of the most satisfactory methods for measuring these currents appears to be a modification of the transformer bridge. This method requires the use of a potential transformer of known ratio and the accuracy of the method depends only on the potential transformer and the capacitance of a condenser used in making the balance. (2) In a number of cases the condition was encountered where the test plate of the reference air condenser was mounted on insulators in such a way that the field from the high-voltage plate to these insulators terminated on the test plate. This sometimes caused the condensers to have power factors as great as 0.5 per cent. In each case it has been found possible to bring the power factor to zero by guarding and shielding these insulators. This condition is quite noticeable with the large open pedestal type condensers used in many of the cable test laboratories.

During the past months there has been considerable discussion regarding the possible effects of the high-frequency discharges occurring in insulations under high stress on measurements of dielectric loss and power factor. While these high-frequency discharges prob-



ably represent energy losses, it is questionable whether or not any of the present methods of measurements include these losses.

The question of dielectric loss and power factor measurements with particular reference to the shielding of both the measuring equipment and the cables under test will be covered in a symposium to be held at the Summer Convention on Shielding in Electrical Measurements. Two papers covering this work will be presented, entitled *Shielding Cables in Dielectric Loss Measurements*, by E. H. Salter and *Some Problems in Dielectric Loss Measurements* by Professor C. L. Dawes.

A new test cell has been developed for determining the insulation resistance, power factor, and dielectric constant on liquid insulating materials. This cell makes it possible to test more rapidly and under better controlled conditions than was previously possible.

Some recent modifications of the Schering bridge have been made which may be of interest. The Schering bridge as ordinarily constructed necessitates the computation of capacitance and power factor of the test condenser from the values of the condensers and resistors in the other arms of the bridge. In order to eliminate the need of these computations, a modified circuit has been developed and used in the construction of several bridges whereby it is possible to adjust the bridge for the capacitance of the standard air condenser, and to make the bridge direct reading in both power factor and capacitance of the unknown condenser. These bridges have also been provided with shields on the various sections to reduce the effect of stray capacitances. In order to readily adjust the potentials of these shields, one public utility company laboratory has had a dummy bridge constructed wherein it is only necessary to set the arms of this bridge to correspond to those of the main Schering bridge in order to establish the proper potentials on the various guard circuits.

The construction of large power-factor correction capacitors has brought about the need for a ready means of measuring the capacitance and power factor of capacitors on voltages ranging from 200 to 4000 volts and with line currents as high as 75 amperes. Several stationary test sets have been constructed for this purpose, which enable power factor and capacitance to be read directly from the scale of a variable self and mutual inductor, utilizing a reflecting dynamometer as a null deflection instrument. Such testing sets are readily adjustable as to both voltage and current. The impedance of the measuring circuit, which must be inserted in series with the condenser, is so low that the drop across it does not exceed 300 millivolts.

#### MEASUREMENT OF NON-ELECTRICAL QUANTITIES BY ELECTRICAL MEANS

A symposium on this subject was held during the Winter Convention, sponsored by the subcommittee on this subject, under the chairmanship of Mr. Perry A. Borden. The following papers were presented:

*Magnetic Analysis of Materials*, by R. L. Sanford.

*Measurements of Flow by Use of Electrical Instruments*, by W. H. Pratt.

*Use of the Oscillograph for Measuring Non-Electrical Quantities*, by D. F. Miner and W. B. Batten.

*Study of Noises in Electrical Apparatus*, by T. Spooner and J. P. Foltz.

*Electrical Aids to Navigation*,<sup>2</sup> by R. H. Marriott.

The increasing extent of articles in the literature describing the use and application of electrical means to the measurement of non-electrical quantities has made it practically impossible for the subcommittee to compile the many articles on the subject into a bibliography as has been done during the past three years. Hence this bibliography which has appeared annually will not appear this year except as bibliographies are available with the above papers. This growth speaks for the extension of electrical means into fields of non-electrical measurements.

#### HIGH-FREQUENCY MEASUREMENTS

The subcommittee on this subject, through its chairman Professor H. M. Turner, maintains contact with the radio and high-frequency field through the Standardization Committee of the Institute of Radio Engineers. Under the auspices of this committee, there has recently been issued a preliminary bibliography on high-frequency measurements which is available.

The subcommittee has prepared a list of papers published during the past two years on the subject of high-frequency measurements since the symposium held in May 1927, on the subject. This list is not complete, but it reflects the progress in the art of high-frequency measurements. The list is attached to this report as Appendix A., of the complete report.

#### REMOTE METERING

Two papers were presented at the Winter Convention under the auspices of this subcommittee, under the chairmanship of Mr. E. J. Rutan. These were:

*Telemetering*, by C. H. Linder, H. B. Rex, C. E. Stewart, and A. S. Fitzgerald.

*Totalizing of Electric System Loads*,<sup>2</sup> by P. M. Lincoln.

The information presented in these papers supplements that reported by the subcommittee in 1928.

The subcommittee is now studying the nomenclature applicable to remote metering.

#### SHIELDING IN ELECTRICAL MEASUREMENTS

A symposium on Shielding in Electrical Measurements will be held at the Summer Convention 1929, under the chairmanship of Mr. H. C. Koenig. The following papers will be presented:

*Shielding and Guarding Electrical Apparatus*, by H. L. Curtis.

*Some Problems in Dielectric Loss Measurements*, by C. L. Dawes.

2. These papers will be published in the A. I. E. E. Quarterly TRANS., Vol. 48, July 1929.

*Shielding in Heavy Alternating Circuits*, by F. B. Silsbee.  
*Shielding Short Lengths of Cable in Dielectric Loss Measurements*, by E. H. Salter.  
*Shielding in High Frequency Measurements*, by J. G. Ferguson.  
*Magnetic Shielding*, by S. L. Gokhale.

#### CONCLUSION

The past year has been one of activity for the In-

struments and Measurements Committee. Not all of the present advances in the art have been studied directly by the committee, but these remain for future study and report. Chief among these are the advances in frequency measurement and control, and the remarkable progress in cathode ray oscillography. These and other projects bespeak progress in the measurements field which may truly be called gratifying.

## Abridgment of Review of Status of Power Generation\*

### ANNUAL REPORT OF COMMITTEE ON POWER GENERATION

#### STATISTICS ON POWER GENERATION

The volume of electric energy generated in central stations in the United States during 1928 was almost exactly 10 per cent greater than during the preceding year; and it is only a matter of months now until the yearly production in such plants will have reached a figure of 100 billion kw-hr. Hydro plants produced 40 per cent or more of the total output, a share of the total power generation larger than in any year of the last decade and due in part to better than average rainfall conditions. Coal constituted almost 90 per cent of the fuel burned for the generation of electric energy. The volume of electric output in plants other than central generating plants was about 30 per cent of central station production.

#### GENERATING PLANT CONSTRUCTION DEVELOPMENTS

1928 was a peak year both for the number of new hydroelectric stations and for the total hydroelectric capacity installed. More novel features of hydroelectric practise were exemplified in the 1928 additions than in any recent year. On the other hand practically all the increase in steam-electric generating capacity was added to existing plants, while the only major characteristic of the 1928 additions has been a continuing growth of individual boiler and turbo-generator capacity, with perhaps increased interest in the use of very high steam pressure.

#### GENERATING PLANT EFFICIENCIES

Peak efficiency of 92 to 94 per cent based on net effective head is being obtained in hydroelectric

plants with the Francis type of turbines; an efficiency of 87 to 90 per cent with the propeller type turbine operating under low heads; and efficiencies better than 85 per cent are being secured over a broad load range by the impulse wheel under the very high heads prevalent in the West. In steam-electric stations, turbine efficiencies of 80 to 84 per cent, boiler efficiencies of 85 to 90 per cent, and overall plant efficiencies from coal pile to bus bar of 23 to 27 per cent, are being attained. The average coal rate, or equivalent pounds of coal per net kw-hr., of fuel burning plants has decreased 9 to 10 per cent within the last two years, and stood at 1.76 lb. at the end of 1928.

#### FACTORS AFFECTING HYDROELECTRIC DEVELOPMENT AND DESIGN

An apparent slackening in hydroelectric developments in the United States within the last few months is being attributed to the average high-fuel efficiency, the lowered cost of fuels, and the reduced investment cost of steam-electric plants; also to the fact that the more costly hydroelectric sites adjacent to a market and the low cost sites remote from load centers require development on a large scale to make them economically feasible. It is being realized that the combination of hydro with steam generation often leads to the lowest over-all cost of power generation; and that hydro power has more than an energy and minimum flow capacity value on systems mainly steam, while on systems largely hydro, there is an advantage in small cost steam capacity steps for deferring large scale hydro developments until economical. Such reasons are leading to the adoption of extensive steam plant facilities in regions dependent in the past on water power.

In many instances the efforts of hydro designers center around the development of maximum output of secondary power, both by the use of a machinery installation that is large compared to the minimum steady output, and by the maintenance of output under unfavorable hydraulic conditions. The first scheme requires a system load capable of absorbing the secon-

#### \*COMMITTEE ON POWER GENERATION

F. A. Allner, Chairman,

Pennsylvania Water & Power Co., 1611 Lexington Bldg. Baltimore, Md.		
J. R. Baker,	A. H. Hull,	E. B. Meyer,
A. E. Bettis,	A. H. Kehoe,	W. E. Mitchell,
J. B. Crane,	H. A. Kidder,	I. E. Moulthrop,
P. M. Downing,	G. L. Knight,	F. A. Scheffler,
James H. Ferry,	W. H. Lawrence,	W. F. Sims,
N. E. Funk,	W. S. Lee,	A. R. Smith,
W. S. Gorsuch,	F. T. Leilich,	E. C. Stone,
F. C. Hanker,	James Lyman,	R. W. Stovel,
C. F. Hirschfeld,		William M. White.

Presented at the Summer Convention of the A. I. E. E., Swampscott, Mass., June 24-28, 1929. Complete copies upon request.

dary power in high-water periods and protected by available generating capacity during low water; the second scheme depends upon the adaptability of the hydraulic design to fluctuating water stages. The possibility of increasing the hydro output for peak purposes in low water periods by means of pumped storage has been of much interest recently in connection with the first pumped storage development of large size in the United States. Efforts to reduce capital cost by the omission of the generator room superstructure have received prominence during the past year, as well as the subject of system stability in the case of hydro generating plants at the end of long transmission lines. The rehabilitation or redevelopment of older hydro plants or water power sites was another phase of hydro activity during the past year, being stimulated by the considerable improvement in hydraulic efficiency and resulting increase in capacity and output that is made possible by the substitution of modern water-ways, settings, and wheels in plants of older design; in some instances the site head has been materially increased by new dam construction, that has also been the means of enlarging the pondage above the plant.

#### REPRESENTATIVE HYDROELECTRIC DEVELOPMENTS

*Conowingo.* This run-of-the-river development on the Susquehanna River has a medium head of 89 ft. and is noteworthy in being the plant of largest capacity that was placed in operation in 1928, including both hydro and steam plants. Its seven 54,000-hp. Francis type waterwheels initially installed are the largest water turbines in physical size ever built; the butterfly valves at the inlets of the scroll cases are also of record size. The location of the 220-kv. switch structure on the generator room roof is probably unique. Quick response excitation for the main generators is obtained from individual motor-generator exciter sets that are equipped with pilot exciters and driven by power from auxiliary generators mounted on the main unit shaft.

*Dnieperstroy.* An order has been recently received in this country for delivery in Russia of four Francis type turbines that will each develop over 100,000-hp. under a head of 123 ft. These wheels will have a higher capacity rating than any other hydraulic turbines in the world. They will operate at 88.2 rev. per min., and will generate power at 13,800 volts, three-phase, and 50-cycle.

*Louisville.* This low-head development of 110,000-hp. is an example of a plant built for secondary power generation only, there being on the average 40 days in the year when generation is impossible because of high water. The construction of the plant was made economically feasible largely through the use of the high speed propeller type turbine that allows power to be developed over a range of heads from 37 ft. maximum to 7½ ft. when the plant goes out of operation. In this plant was made the first application of water tube surface coolers with the enclosed system of air circulation for the cooling of hydro generators; a

pioneer development of supervisory control for machine operation was also made at the Louisville plant. The necessary provision for powerhouse stability during high water on conjunction with the extreme variation in head and the location of the waterwheels, led to a somewhat unusual building structure design.

*Rocky River.* While numerous pumped-storage plants are in operation in Europe, the Rocky River development is the first major instance of this idea in America, far eclipsing any previous projects in size and scope. An artificial reservoir having a capacity of 5.9 billion cu. ft. in the average year has been constructed on the flow line of the Rocky River near its junction with the Housatonic River, with the idea of pumping to the reservoir from the Housatonic River during off-peak load periods. Two 8100-hp. centrifugal pumps are motor driven with energy from steam plants on the system, and pump against a head of 240 ft. The water is released from the reservoir through a 33,000-hp. turbine, using a common penstock for pumping or for power draught. The water accumulated in the reservoir is available for use at another hydro plant situated on the Housatonic River at some distance below the Rocky River plant, so that the regulation of the river flow has an increased value above that for power generation at Rocky River.

*Saluda River.* The regulation of this river for the purpose of power production is being secured by the construction of an impounding reservoir of 96 billion cu. ft. An earth dam almost a mile and a half in length and over 200 ft. in height is being thrown across the river valley. The power house in which four 55,650-hp. units are being installed initially to operate at an average head of 180 ft. will be located just below the dam, in contrast to the usual location miles away from the storage reservoir of power plants on artificially regulated streams.

*Gatineau River.* The erection of three modern power plants on this stream in Canada has been carried out in connection with the development of artificial storage reservoirs of about 140 million cu. ft. total capacity, situated over one hundred miles above the power plants. With the recent completion of the Pagan Falls plant the installed hydro capacity on the river reached a figure of about 500,000-hp. The first 220-kv. transmission line in Canada has been built between the Pagan Falls plant and the City of Toronto, about 230 mi. distant. The high-tension ring bus layout at both ends of this line is somewhat of a novelty in high-tension switching facilities.

*Norwood.* This plant, containing two 22,000-kw. and one 18,000-kw. generators, is noteworthy in the use of removable plate steel housings over its three generators that are served by an outdoor gantry crane; also due to the initial installation of turbines of different capacities and specific speeds for the purpose of maintaining high part-gate efficiencies under the particular variations in stream flow and load conditions obtaining

at the plant. A device for automatically holding the proper distribution of load between the three units in the plant has also been developed for improvement of normal operating supervision.

*Propellor-Type Plants.* The propeller type wheel with provision for adjustment of the blade angles to give maximum efficiency for any gate opening or maximum output for any variation of head, was introduced last year at the Chippewa Falls plant in Wisconsin where six 5000-hp. wheels operating under a head of 29.6 feet were installed. The runner blades in this case are shifted by hand after shutting down the turbine. A Kaplan turbine of 1900-hp. capacity, having an automatic arrangement for varying the pitch of the runner blades while in operation, was installed in the Devils River plant in Texas, and is the first instance of the use of this European developed turbine in America. Wheels of the greatest power of the manually-adjusted propellor type are being built for the Back River Plant of the Montreal Island Power Company in Canada, where six units rated at 8800 hp. under a head of 26 ft. will be installed.

*High-Head Impulse Wheel Plants.* The recently completed Bucks Creel plant on the Feather River in California develops to date the highest head at any hydro plant in America, its static head being 2562 ft. A flow of 300 cu. ft. per sec. operates the two 35,000-hp. turbines in the plant. Another outstanding installation in the Pacific Coast states was the addition to the Big Creek 2A plant of the Southern California Edison Company, of two impulse wheel units, rated at 56,000-hp. each, that exceed in capacity any impulse wheels ever built.

#### TRENDS IN STEAM PLANT DESIGN

Steam plant designers have been busy discussing the application of extremely high steam pressures and calling attention to the possibilities of higher steam temperatures; the selection of the most suitable method of combustion has also been a major concern. A great deal of consideration is being given to the most appropriate use of the various ideas of plant design and arrangement that have been tried out successfully in practise. The introduction of regenerative and reheating cycles, high-stream pressures, and pulverized fuel firing, has not simplified the design layout, particularly in the domain of the sub-auxiliary control equipment that is necessary. A very considerable reduction of investment charges has been made by the concentration of capacity in boilers and turbo-generators of large size. However, the relation of investment charges to the fuel and operating costs in steam plants does not appear to change to any degree for as the first is decreased by the use of large capacity units, the other has been falling because of the betterment of efficiency. In many instances the necessity of maximum capacity has been the compelling motive in the design.

*High Pressures.* The wider use of steam at 1200 to

1400 lb. has been conspicuous during the past year, and following the successful trial of these pressures in stations equipped with 300- to 400-lb. boilers for the major portion of their steam supply, plants are now under construction in which the entire steam output will be generated at high pressure and passed through high-pressure cross-compound turbines. The high-pressure turbines, as well as high-pressure boilers in this country, have been satisfactory adaptations of previous turbines and boiler designs. Both impulse and reaction type turbines are being used with high-pressure steam. Straight tube and bent tube boilers seem suitable for high-pressure steam generation to American designers, but in Europe, the Atmos, Benson, Schmidt-Hartmann, and Loeffler boilers, of radically new design, have been developed to overcome the suspected problems of steam generation at high pressures. Forged steel drums are employed in this country for all high-pressure boiler construction.

The necessity of reheating the exhaust steam from the high-pressure turbine, in order to avoid excessive wetness losses in the low-pressure turbine element, has led to a distribution of heating surface in the straight tube boiler setting in which the boiler surface itself is minimized, principally to provide a sufficient temperature head for the convection type superheaters and reheaters, as well as to reduce the number and cost of high-pressure boiler parts. Quite extensive air preheaters form a part of the high-pressure boiler setting, and in nearly all cases a high-pressure economizer is also included.

The list of high-pressure steam stations now includes plants at Boston, at Holland, South Amboy, and Deepwater in New Jersey, at Milwaukee, Kansas City, and San Francisco. Two "combustion steam generators" at the Philip-Carey Manufacturing Company, at Lockland, Ohio, will be used shortly to produce steam at 1840 lb. gage, the highest steam pressure developed to date in large boilers in this country. Both stoker and pulverized fuel firing are being used under high-pressure boilers.

*Steam Temperatures.* The limit of steam temperature for power generation in this country appears to be around 750 deg. fahr., although turbine guarantees can be obtained for temperatures up to 800 deg. fahr. Valves and piping can be made for higher temperatures, and alloy steels are available for superheater construction that will give a steam temperature measurably higher than present practise. The unavoidable pressure and thermal stresses, and the "creep" of metals under high temperature and stresses appear to be inhibiting any material increase in the working temperatures.

*Large Boilers.* Boilers are now being built to supply as much as 800,000 lb. of steam per hour, as illustrated by the new boilers for the East River Station in New York. These boilers will be of the bent-tube A-type setting, fired with pulverized coal, and will generate



steam at 425 lb. per sq. in. and 725 deg. fahr. A decidedly novel arrangement of two separate boiler sections, each composed of a standard bank of horizontal tubes and vertical headers and placed over a common pulverized coal-fired furnace, will have a maximum combined rating of the same capacity in the Hell Gate plant in New York. Boilers having normal continuous capacities of 300,000 to 450,000 lb. of steam per hour, fired either by stokers or pulverized coal, are no longer really notable. The size of riveted boiler drums was raised to a diameter of 72 in. during the past year, and are being built for pressures up to 475 lb. per sq. in. The problem of priming and of water level control at high capacity ratings seems to be leading to an increase in boiler drum volume. An interesting example of this is the cross-drum boiler installation being made in a San Francisco plant where the main drum will be 72 in. in diameter and 40 ft. along, and above which, 11 ft. higher, a supplementary dry drum 36 in. in diameter is being mounted; the two 2225-hp. boilers in the plant will be fired with fuel oil and will be subjected to widely varying steam demands, with the expectation of being able to assume a 35,000-kw. turbine load suddenly applied.

*Combustion Practises.* The protection of furnace walls, through cooling of their exposed surface by water or steam elements connected to the boiler circulation, has probably been of increasing application. Instances of the virtual exclusion or absence of the ordinary types of refractories from the walls of both stoker and pulverized coal fired furnaces appear to be multiplying. Metal cooling of the furnace walls seems to be practically necessary when any appreciable heat recovery is affected by air preheaters; but its chief advantage lies in the possibility of higher ratings with decreased furnace wall maintenance. Water and steam cooled walls have been developed in several types with varying amounts of metal and refractory exposure to the interior of the furnace.

Recent development of underfeed stokers has been directed towards an increase in coal burning capacity per foot of boiler width, principally through the lengthening of the coal feeding area by an extension of the retort zone. Stokers are being made up to 65 tuyeres in length. Progress has been made also in adapting the rotary ash discharge type of stoker for the efficient burning of low grade fuels in quantity. The requirements placed upon the modern stoker have brought about the wider use of steel and parts machined and cast to specifications not before justified.

Probably the most noticeable trend in pulverized coal practise has been the increased use of mills delivering their product directly to the furnace, and the horizontal arrangement of burners. The pulverized method of combustion has been applied on a large scale to almost every kind of coal commercially available in this country. The initial cost of the requisite pulverized fuel equipment external to the furnace has been

reduced by placing the pulverizing mills adjacent to the furnace and by drying the coal in the mills during pulverization. Heated air from the flue gas air-preheater is ordinarily employed for mill drying although steam air-heaters are installed in some plants. The average size of boilers fired by the unit system appears to be increasing. Horizontal firing has been used with both the bin and unit mill systems, being particularly convenient with unit mill layouts. Horizontal and vertical firing are being employed together in the same furnace. Horizontal burners having relatively large coal capacity lend themselves to the use of forced draft which must be employed for the maximum of turbulence.

Turbulent firing and extensive metal cooling of the furnace walls appear to be effecting an increase in the maximum rates of heat liberation in recently constructed furnaces. Two years ago, 16,400 and 21,800 B. t. u. per cu. ft. of furnace volume per hr. represented the most frequent maximum heat liberation for bin and unit fired furnaces respectively. The newest furnaces installed in the Cahokia, St. Louis, plant develops a maximum rate of 26,700 B. t. u.; the recent Hell Gate furnaces, in New York, 35,000 B. t. u.; and the last installation at the Charles R. Huntley Station in Buffalo, a liberation of 37,900 B. t. u. per cu. ft. per hr.

The "slag bottom" furnace is one of the recent novelties in pulverized fuel practise, consisting of a furnace with a flat uncooled bottom on which the ash collects in a molten state. The liquid slag is tapped out at intervals into a stream of high-velocity water that shatters and disintegrates it into small particles that can be handled hydraulically.

#### TURBO-GENERATOR INSTALLATIONS

Previous records for size of single-element turbines were exceeded in the 75,000-kw. capacity units installed in the plants at St. Louis and Buffalo. The Cahokia, St. Louis, unit is an 1800-rev. per min., 60-cycle machine, operating on steam at 315 lb. and 725 deg. fahr., while the Buffalo unit is a 1500-rev. per min., 25-cycle, 275-lb., 689-deg. fahr., machine. Steam is expanded in these turbines from the throttle pressure direct to the exhaust vacuum.

The 160,000-kw. tandem-compound machine that is being installed in the East River station in New York will embrace both the largest tandem-compound turbine and the largest single generator ever built. The turbine will be supplied with steam at 400 lb. and 750 deg. fahr. The generator is a three-phase, 25-cycle, 11,400-volt machine operating at 1500 rev. per minute. This generator will have two stator windings, the circuits of which are entirely separate and coupled only by the mutual reactance between them. The windings will be connected to separate bus sections whose only tie normally will be through the transformer action of the two generator windings. Smaller circuit breakers may be used with this arrangement, and it is predicted

that the effect of short-circuits on either bus will be minimized by the absolute synchronism between the two busses.

Two record breaking two-element, cross-compound turbo-generators, of 160,000-kw. capacity each, have been recently installed in the Hell Gate plant in New York City. Each unit consists of a single flow high-pressure element and a double flow low-pressure element. The throttle steam conditions are 265 lb. and 611 deg. Fahr. The 137,500-sq. ft. two-pass horizontal surface condensers serving these turbines each consist of two separate condenser shells and tube nests, with a common central water box horizontally divided for inlet and outlet condensing water placed between the two halves. One-half of the double condenser is solidly attached to one exhaust nozzle of the low-pressure turbine, while the other half is flexibly connected to the corresponding nozzle.

The 208,000-kw. three-element cross-compound machines for the State Line Plant near Chicago, announced some two years ago, still remain the largest units in total capacity developed to date.

#### GENERATOR VOLTAGES AND SPEEDS

There was an advance in voltage of large generators when the 94,000-kw., 1500-rev. per min., 16,500-volt unit went into service in the Long Beach Plant No. 3 of the Southern California Edison Company. This voltage is now exceeded in the 55,000-kw. turbo-generator in the Pekin, Illinois, plant of the Super-Power Company, that operates at 22,000 volts and 1800 rev. per min. In England, a 25,000-kw. 80 per cent power factor, 3000-rev. per min. machine, that generates at 33,000 volts, has been recently put into service in the new Brimsdown plant, and is believed also to represent the highest capacity developed to date above 1800 rev. per min. In this country the 12,500-kw. 80 per cent power factor generators, driven at 3600 rev. per min. by the 1200-lb turbines, mark the peak capacity produced to date in machines operating at speeds above 1800 rev. per min.

#### SURVEY OF EXCITATION PRACTISE IN ELECTRIC POWER PLANTS

A survey has been made of the excitation layouts in

Design feature	Relative application
Excitation voltage of 230-250	100 per cent
Systems individual to a generator	93 per cent
Individual systems with transfer bus to spare excitation capacity (non-automatic change-over)	81 per cent
Individual systems having battery spare	27 per cent
Individual systems using motor-gen. exciters driven from shaft generators	11 per cent
Individual systems using subexcitation of exciters	33 per cent
Installations using shunt windings on main exciters	87 per cent
Installations omitting main field rheostats	50 per cent

some 26 modern large central stations, the majority of which have been in operation less than five years. The generating units in these stations range in individual capacity from 12,500 kw. to the largest yet operated. The frequency of application of the salient features of excitation layouts is shown by the following tabulation, which, though not including all modern stations, yet is believed to be representative of present day practise.

#### SURVEY OF AUXILIARY DRIVE PRACTISE IN ELECTRIC POWER PLANTS

Present practise with regard to auxiliary drives has been summarized below from the data obtained from a list of some 21 modern central stations, in which the generators range in individual capacity from 12,500 kw. to the largest yet operated. Motor drive for auxiliaries is used in practically all cases, however, the installation of a steam driven boiler feed pump for starting and reserve purposes appears to be universal. In approximately one-half of the stations each turbo-generator and its corresponding essential auxiliaries form a station operating unit. The sources of auxiliary power are shown by the following tabulation:

Source of auxiliary power	Relative use
Transformers ahead of generator switch	22 per cent
Generators on main unit shaft	22 per cent
Installations of house turbines	39 per cent
Transformers on busses or supply from other stations (duplicate sources in above cases)	universal

#### SURVEY OF HAZARDS TO SERVICE RELIABILITY IN MODERN GENERATING STATIONS

Special hazards of major importance prominent recently in hydroelectric plants include the failure of high head penstocks in plants that were designed and constructed some years ago. Over-voltage upon sudden loss of load at hydroelectric stations supplying transmission lines seems to be of increasing aggravation with the transmission of large blocks of power at high voltages. In steam plants, turbine blade failures and generator winding burn-outs still continue to be reported, notwithstanding the intensive research and improvement that has been accomplished in the selection and fabrication of materials.

Fires resulting from the failure of oil-filled equipment such as circuit breakers, regulators, and transformers, are probably the most common and serious hazard. Extensive damage is reported in switch houses due to the spreading of vapors arising from short circuits and faults to ground. The possibility of a bus short circuit and the resulting effects on system stability appear to be of vital concern in the design layout of the generator and transformer facilities in modern stations of large capacity.

# Abridgment of Automatic Reclosing of High-Voltage Circuits

BY E. W. ROBINSON<sup>1</sup>  
Non-member

and S. J. SPURGEON<sup>1</sup>  
Non-member

*Synopsis.*—The experience of the Alabama Power Company with the reclosing of high-voltage circuits covering numerous installations on 22-, 44-, and 110-kv. circuits is described. No definite reclosing

*cycles are recommended but instead, this paper deals with various typical applications of high-voltage reclosing oil circuit breakers on the Alabama Power Company system.*

## INTRODUCTION

ALABAMA Power Company operates over a wide expanse of territory where the load density is generally low. About 1922 a large expansion program started which immediately developed the desirability of more primary substations, where the 110-kv. system might be tapped and voltage reduced to 44 kv., and of more switching stations where the existing 44-kv. lines might be interconnected. The cost of attendance at these primary substations and switching stations intervened, however, as a serious obstacle and brought about an active interest in automatic reclosing switching equipment which might allow the substitution of a daily or weekly inspection of such stations for continuous attendance.

## GENERAL DISCUSSION

No suitable reclosing relays or devices were commercially available at the time so, the Power Company started a series of experiments and developments which resulted in 1922 in the application of a reclosing device to a standard 50-kv. oil circuit breaker controlling a 44-kv. feeder. This device is of interest as being a self-contained mechanism including a motor-driven breaker operating device, reclosing relay, and lock-out relay. It required a minimum amount of power, could be operated from any available a-c. or d-c. source, and was applicable to any standard breaker by minor alterations. As originally built, the interval between breaker operations was approximately one minute, and the device could be set to lock-out after one, two, or three reclosures. Considerable numbers of each of several types of reclosing installations have been put in service and it is interesting to note that in 1928 all types showed better than 85 per cent of correct operations, and the two preferred types in excess of 95 per cent.

On the Alabama system there was originally a uniform period of one minute between breaker operations. Experience showed that this was satisfactory and subsequently the initial interval was reduced to 45 sec. and in some cases to 30 sec. Later intervals were also reduced in some instances to 45 sec. Originally, two reclosures before lock-out were provided for, and this schedule has been followed consistently. Two reclosures

gave ample time for the controlled line to be restored to service, if this were possible, and there seemed to be no valid argument for a greater number, as it was extremely unlikely that a line would prove to be bad on two trials and good on the third, while on the other hand, a larger number of reclosures prolonged system disturbances vastly increased the duty on the breakers and resulted in increased cost of maintenance and inspection.

The engineers of Alabama Power Company have not been impressed with the necessity nor desirability of a standard reclosing cycle for high-voltage breakers. Instead, they have preferred to treat each case separately, taking into account the character of the controlled line, peculiarities of the load supplied, possible short-circuit duty on breaker, rupturing capacity of breaker for various duty cycles, and class of service to be maintained. In most instances the reclosing cycle is adjustable and in fact is changed from time to time depending on operating conditions. With proper consideration given these factors, satisfactory applications will result. This is borne out by the experience of Alabama Power Company where, in a six-year period, there have not been in excess of two failures of reclosing high-voltage breakers which might possibly have been avoided had the substations where these failures occurred been attended and breakers non-reclosing.

A better conception of the application of reclosing high-voltage breakers on the Alabama Power Company system may be obtained from brief descriptions of various typical installations. Therefore, descriptions and illustrations are included for one or more examples of each of the following typical applications of automatic reclosing high-voltage oil circuit breakers.

- a. To plain radial feeders—44 and 110 kv.
- b. To 44-kv. networks fed from one source.
- c. To 44-kv. networks fed from several sources.
- d. In conjunction with specially designed accessory switching equipment.

These examples follow.

### RADIAL FEEDERS—44-Kv. AND 110-Kv.

The application of automatic reclosing switches to radial feeders is the simplest and most common of all the applications. This type of installation is applied on a large number of substations on the Power Company's system, but because of the simplicity of the application, will not be described here. No unusual main-

<sup>1</sup> Both of Alabama Power Co.

Presented at the Regional Meeting of the Southwest District of the A. I. E. E., Dallas, Texas, May 7-9, 1929. Complete copies upon request.

tenance problems have been encountered on radial feeder reclosing breakers.

#### 44-Kv. NETWORK FED FROM ONE SOURCE

The application of reclosing breakers to networks fed from one source presents a more difficult problem, especially when various switching stations are remotely located with respect to the source of power and attended stations. The application becomes even more difficult when it is desired to isolate automatically trouble in relatively small sections of the entire network. A good illustration of this type of network is the Blocton Loop shown in Fig. 1. This network feeds a great many important customers distributed over a large area. The network is tied together with reclosing oil circuit breakers and numerous automatic sectionalizing switches specially designed for the purpose. These circuit breakers and automatic sectionalizing switches are so arranged and timed that trouble in sections A, B, C, D, E, F, G, or H is isolated automatically from all the other sections

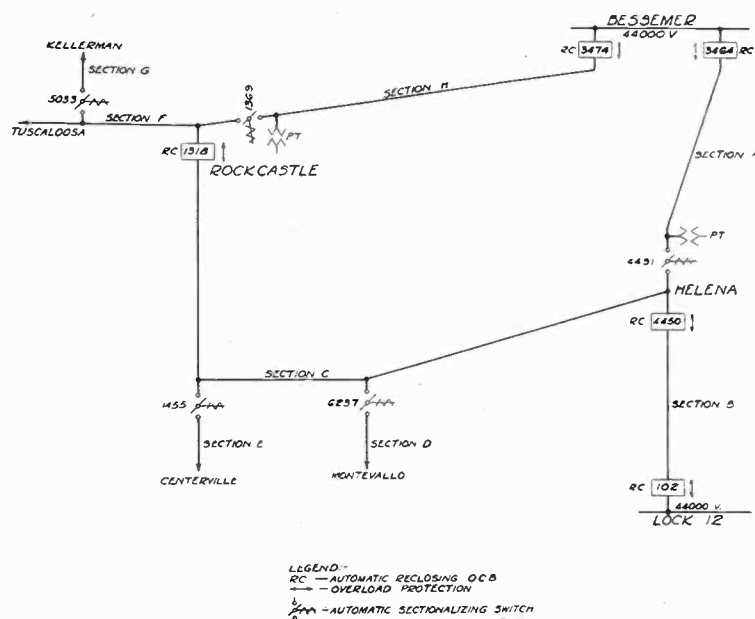

FIG. 1—BLOCTON LOOP AUTOMATIC SWITCHING SCHEME

of line and service restored to all the network except the section in trouble. The particular type of automatic sectionalizing switch used in the Blocton Loop network is designed to reduce the number of automatic reclosing oil circuit breakers necessary to secure complete sectionalization, thereby decreasing the initial installation cost. These switches are essentially spring-actuated automatic gang-operated air-break switches. Each phase includes a high-voltage solenoid connected through an insulating member to an inverse time-limit circuit-closing relay. These switches operate in conjunction with special timing relays. Their function is to open a line automatically after it has carried excess current momentarily a given number of times within a given period of time. They are so designed that they cannot open ordinarily when the line is energized, though in some cases it is necessary to add low-voltage relays to make this positive.

The following examples describe the functioning of

the Blocton Loop in case of permanent trouble. Transient disturbances are not considered as they result in no permanent derangement of the loop.

Assuming trouble in Section A, (Fig. 1,) automatic reclosing oil circuit breakers 3464, 1318, and 4450 open. This "notches up" the timing relays and starts a timing cycle on the automatic sectionalizing switches 1369 and 4491. In one minute, all three of the above mentioned oil circuit breakers reclose and open again immediately and the timing relays on switches 1369 and 4491 "notch up" again and start a new timing cycle. After another minute has elapsed, oil circuit breakers 3464, 1318 and, 4450 again reclose and again open immediately. The timing relays on switches 1369 and 4491 then "notch up" the third time, close their trip contacts and start a new timing cycle. When the trip contacts on the timing relay on switch 4491 are closed, the trip circuit is completed through an undervoltage relay connected to a 44,000/110-volt potential transformer, and the switch opens. Breakers 3464, 1318 and 4450, which are set for three reclosures (four openings) before lock-out, then reclose. Breaker 3464 opens immediately after reclosing the third time, and locks out, isolating Section A. Service is then restored to all other sections through oil circuit breakers 1318 and 4450. Switch 1369 does not open since oil circuit breaker 3474 does not open during the sectionalization and consequently there is always potential on the line between breaker 3474 and switch 1369, thus keeping the trip circuit of 1369 open at the contacts of an undervoltage relay.

All the automatic sectionalizing switches in the Blocton Loop have in their operation a certain definite relation to the terminal oil circuit breakers, and since each of them operate similarly to sectionalizing switch 4491 treated above, no further description of their detailed operation is made. The total loop is divided into relatively small sections and when a section of line is in trouble it is readily sectionalized and located.

While this loop is fed from Bessemer and Lock 12, it is considered to have one source of power supply as there is little chance of the two stations being out of synchronism and no provision is made for automatically checking synchronism either at Bessemer or Lock 12.

#### 44-Kv. NETWORK FED FROM SEVERAL SOURCES

The application of reclosing breakers to networks fed from several sources is complicated by the necessity for automatic synchronizing or synchronism checking. Two good illustrations of this type of network are shown in Figs. 2 and 4.

The Alabama-Mississippi network shown in Fig. 2 has three sources of power,—Gorgas, Haleyville, and West Point. The power that can be furnished the network from West Point is not sufficient to carry much load in Alabama and the normal power flow is from Alabama to Mississippi. The chief sources of power are from Haleyville and Gorgas.

This network has three special features, all of which



are necessary for a complete automatic switching scheme of this kind. These special features consist of an automatic synchronizing device for the control of breaker 1932 at West Point, synchronism check devices at Brilliant on breaker 7858 and at Haleyville on breaker 5122, and a special timing relay at Haleyville on switch 5122. The automatic synchronizing device at the West Point Substation will close breaker 1932 only when there is potential on both the bus and line terminals and then only when both systems are in synchronism.

The synchronism check schemes at Brilliant and

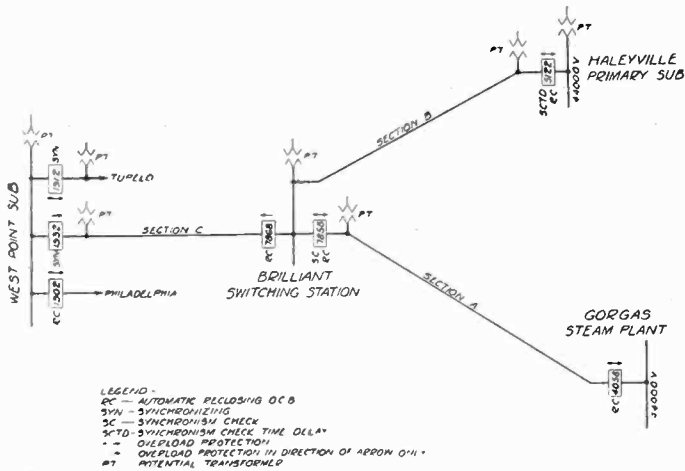

FIG. 2—ALABAMA-MISSISSIPPI AUTOMATIC SWITCHING SCHEME

Haleyville on breakers 7858 and 5122 consist of a number of relays which allow the breakers controlled to close only when the two sources of power are in synchronism for a period of several seconds. There are other relays used in connection with the synchronism check schemes which automatically select the breaker across which synchronism is to be checked. For example, if for any reason breakers 4058 at Gorgas and 7858 at Brilliant open, breaker 7858 does not reclose until after breaker 4058 at Gorgas recloses. This scheme then allows synchronism to be checked across breaker 7858 at Brilliant. If, however, Section B is deenergized by the opening of breakers 7858, 5122, and 1932, breaker 7858 becomes automatic reclosing and synchronism is then checked across breaker 5122 at Haleyville. The synchronism check scheme on breaker 5122 is further controlled by a timing relay which is the third special feature mentioned above. The function of the timing relay is to prevent breaker 5122 from reclosing until breaker 7858 has restored power to the Brilliant side of breaker 5122, or until breaker 7858 has locked out because of trouble. This timing relay is set to operate for four minutes before closing its contacts. The closing of the timing relay contacts makes breaker 5122 full automatic reclosing. If, however, permanent potential is established on the Brilliant side of breaker 5122 before the four-minute timing cycle of the timing relay is completed, the timing cycle is terminated immediately and the synchronism check scheme functions to close breaker 5122 if the two sources of power

are in synchronism. Momentary restorations of voltage across breaker 5122, due to operations of breaker 7858 during trouble, do not affect the timing cycle of the timing relay nor the functioning of the synchronism check scheme on breaker 5122. All breakers in this network are normally closed.

Assuming a permanent case of trouble occurs in Section A automatic reclosing oil circuit breakers 4058 and 7850 opens and clear the trouble. After one minute, breaker 4058 recloses, but opens automatically again immediately. It then recloses again after one minute, opens, and locks out. This isolates Section A, as breaker 7858 does not reclose, being prevented from so doing by the synchronism check scheme, on account of lack of permanent voltage on the Gorgas side. Had voltage been restored, breaker 7858 would have reclosed.

Assuming temporary trouble occurs in Section B, breakers 1932, 7858, and 5122 open. Breaker 7858 closes in one minute and restores service to Sections C and B. Breaker 1932 then synchronizes and closes immediately. The timing cycle on breaker 5122 is terminated as soon as permanent voltage is established from Brilliant. The synchronism check scheme then

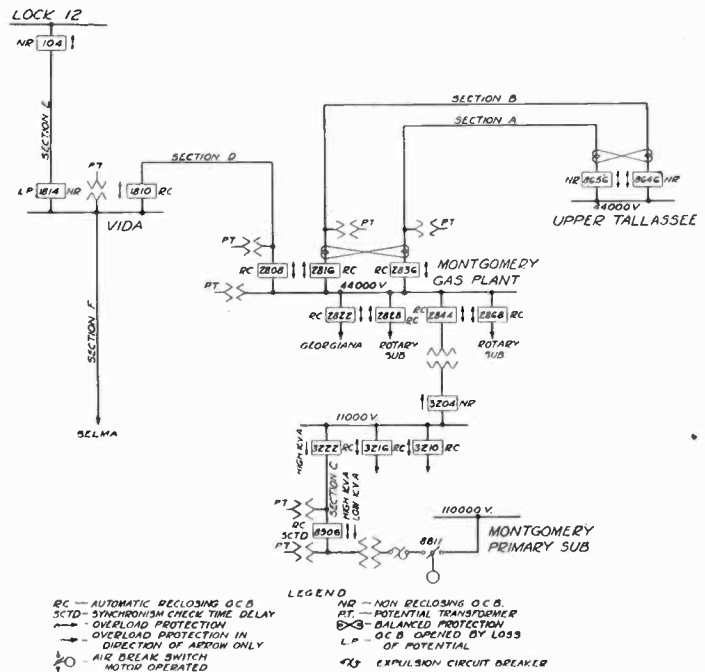

FIG. 4—MONTGOMERY AUTOMATIC SWITCHING SCHEME

checks synchronism and closes breaker 5122, thus restoring the network to normal. In case of permanent trouble in Section B, breakers 1932, 7858, and 5122 open. Breaker 7858 recloses and opens twice and locks out on the third opening. The timing relay on breaker 5122 completes its four minute timing cycle and at the end of that time breaker 5122 becomes straight reclosing and locks out after the second reclosure. Since breaker 1932 does not synchronize on a deenergized line, the trouble is isolated.

Assuming trouble in Section C, breakers 7868 and 1932 open. If the fault is temporary, breaker 7868 recloses and breaker 1932 synchronizes and closes.

If a permanent fault, breaker 7868 locks out after the second reclosure (third opening) and breaker 1932 does not close until potential is again reestablished from Brilliant.

The Montgomery automatic switching scheme shown in Fig. 4 employs the synchronism check scheme and a timing relay similar to that installed at Haleyville on breaker 5122, but is much more complex. Almost the entire Montgomery load is carried through the gas plant substation.

Montgomery is normally served from Upper Tallassee and the Montgomery Primary Substation. All breakers in the network are normally closed except breaker 2808 at Montgomery which is not closed except in emergencies.

Breakers 8656 and 8646 at Upper Tallassee open for trouble on lines designated as Sections A and B. Breakers 2836 and 2816 are automatic reclosing and lock out after the second reclosure (third opening).

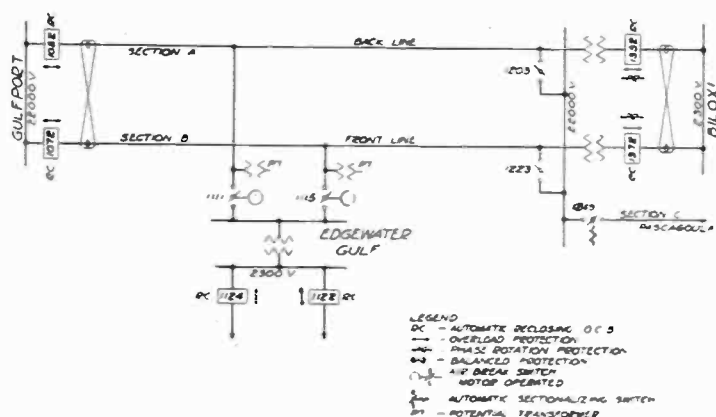

FIG. 6—GULFPORT-BILOXI AUTOMATIC SWITCHING SCHEME

If for any reason potential fails on both the lines from Upper Tallassee, breaker 3204, which is non-reclosing, opens on reverse power. The primary substation will then carry the 11-kv. load in Montgomery. When breaker 3204 opens, the 44-kv. bus is deenergized and breaker 2808 closes after a few cycles and breakers 2836 and 2816 both open, if not already in the open position. These provisions are made for isolating the power supply from the primary substation, since the entire load of Montgomery cannot be carried from that source and the source of power from Lock 12 through Vida is not adequate to carry the Montgomery load and the load on all the 44-kv. feeders. When potential is again restored to the Upper Tallassee side of breakers 2836 and 2816, they again reclose. All switching at Montgomery is brought to the attention of the local organization through a signal system, and after the automatic switching as described above is performed, an operator goes to the station, closes breaker 3204 and opens breaker 2808, thus restoring the station to normal.

Any trouble in the transformer bank at the Gas Plant Substation is cleared by breaker 2844, which

locks out after the second reclosure (third opening) and breaker 3204, which is non-reclosing.

A fault in Section C is isolated by automatically reclosing breakers 3222 and 8906. Breaker 8906 is equipped with a synchronism check scheme and a timing relay as explained in the above discussion. Ordinarily, if not interfered with by the synchronism check scheme or timing relay, breaker 3222 closes in one minute. If the fault is temporary, the four-minute timing cycle of the timing relay on breaker 8906 is terminated as soon as permanent voltage is established from the gas plant substation. The synchronism check scheme then checks synchronism and breaker 8906 closes, thus restoring the network to normal. If the fault is permanent, breaker 3222 locks out after the second reclosure (third opening). The timing relay on breaker 8906 then completes its four-minute timing cycle, and at the end of that time, the breaker becomes straight automatic reclosing and locks out after the second reclosure (third opening). It is noted that breaker 3222 opens on overload toward the primary substation. This breaker is set to open at a higher kv-a. and longer time than breaker 8906 for a power flow toward the 110-kv. bus. This allows breaker 8906 to open in advance of breaker 3222 in case the 110-kv. line is deenergized or when trouble occurs in the primary substation. Under these conditions, breaker 8906 does not reclose until power is again applied to the 110-kv. line, and then only after synchronism is checked. Breaker 8906 is opened also by overload relays set for relatively high kv-a., and operates only when there is trouble in Section C.

When trouble occurs in Section D, breaker 1810 opens on overload. Breaker 2808 immediately closes on failure of potential on Section D. If trouble is only temporary, power is restored by breaker 2808, and in one minute, breaker 1810 recloses. An operator then goes to the Montgomery gas plant substation and opens breaker 2808 to restore the system to normal. If, however, trouble persists after the first and second reclosure, then both breakers lock out after their second reclosure (third opening) and the trouble is isolated in Section D.

When trouble occurs in Section E, breaker 104 opens and clears the trouble. This opens breaker 1814 on failure of voltage. Breaker 2808 then closes and restores service to Sections D and F.

When trouble occurs in Section F, the same operations take place as when trouble occurs in Section E, but the operator at Lock 12 is able to restore service to Section E when breaker 1814 opens upon failure of bus voltage. When breaker 2808 closes, it provides a new source, so that breaker 1810 may open three times and lock out, leaving Section D supplied through breaker 2808.

None of these extensive applications of reclosing

breakers has developed any particular or fundamental difficulties in reclosing high-voltage circuits.

#### IN CONJUNCTION WITH SPECIALLY DESIGNED ACCESSORY SWITCHING EQUIPMENT

The use of automatic reclosing high-voltage oil circuit breakers in conjunction with specially designed accessory equipment is common on the Alabama Power Company and affiliated systems. Fig. 6 covers an interesting application at Gulfport, Mississippi.

The automatic switching scheme described includes three distribution substations,—Gulfport, Edgewater Gulf Hotel, and Biloxi,—with two lines connecting Gulfport and Biloxi as shown in Fig. 6. The source of power is Gulfport and the network is designed to eliminate interruptions to Edgewater Gulf Hotel and Biloxi so far as possible. The loop is normally closed at Biloxi through the two transformer banks and their low-voltage automatic reclosing breakers 1372 and 1352. A transfer bus at Biloxi allows Pascagoula to be served from either the "back" or "front" line through the gang-operated air-break switches 1203 or 1223. Normally, switch 1223 is open and switch 1203 is closed. The line to Pascagoula is equipped with automatic sectionalizing switch 1249, which isolates trouble on that line after the "back" line terminal breakers 1352 and 1082 have opened twice within a one and one-half minute period.

Assuming a permanent case of trouble on the "front" line, both the automatic reclosing oil circuit breakers 1072 and 1372 act as straight automatic reclosing breakers which lock out after the second reclosure. When a permanent fault occurs on the line to Pascagoula, the same automatic switching takes place as when trouble occurs on the "back" line except that the automatic sectionalizing switch 1249 isolates the trouble after the second opening of breakers 1082 and 1352 and service is restored to the "back" line by the reclosing breakers 1352 and 1082 after which the Edgewater Gulf Hotel is transferred to the "back" line as previously explained.

#### CONCLUSIONS

There is nothing experimental about automatic reclosing of high-voltage circuits. Selection of breakers and choice of reclosing duty cycles should be made separately for each application, based on the various factors outlined. Highly reliable reclosing relays or reclosing devices are now available from various manufacturers. While with automatic reclosing of circuits attendants at stations and substations become unnecessary, extremely careful and regular inspection and maintenance of breakers and reclosing equipment is essential; in fact vastly more important than in the case of attended stations or substations. Even at points where attendants are stationed, it is sometimes economical and desirable to install reclosing equipment, either to improve service or to reduce attendance.

## CORRESPONDENCE

To the Editor of the JOURNAL:

In the paper on *Electrification of Oil Pipe Lines in the Southwest*, by D. H. Levy, published in the JOURNAL of the A. I. E. E., June 1929, p. 434, it is stated that squirrel-cage induction motors are used for driving the centrifugal pumps in all cases, and that if there were a power-factor penalty the use of static condensers would be justified in most cases.

The paper describes the electrification of six pipe lines, each several hundred miles long, and with about 300-kw. average load for each of the stations tabulated. Evidently, many of the motors are over 50-hp. Synchronous motors of such sizes are suitable for driving centrifugal pumps in many cases. Since static condensers cost from \$15 to \$25 per kv-a., and since synchronous motors of the sizes considered cost only about \$1 to \$8 per kv-a. more than induction motors, it would appear that if there is a power-factor penalty, synchronous motors should be seriously considered instead of static condensers, for new installations.

A useful basis of comparison, where the synchronous motor is to operate in parallel with other induction motors, is to take on the one hand an 80 percent power-factor synchronous motor, and on the other hand an induction motor with a static condenser of the same kv-a. rating as the synchronous motor. These give practically the same improvement in system power factor. This is shown as follows: An induction motor of 100 kw. has about 50 kv-a. magnetizing reactive kv-a. (lagging). An 80 per cent power-factor synchronous motor of 100 kw. has a rating of 125 kv-a., and takes 75 reactive kv-a. leading. The difference between the synchronous motor and the induction motor is, therefore, equivalent to 125 reactive kv-a., leading, and this is equal to the rating of the synchronous motor.

It is to be noted that the synchronous motor is chiefly advantageous where the remainder of the load has a lagging power factor, or where the power-factor penalty is so described that it pays to operate with the power factor leading to some extent.

To supply a large number of motor-driven pump stations, scattered 30 or 40 miles apart, as described for the pipe lines, is to a considerable extent a transmission problem, and the transmission costs are less for a high lagging power factor or a leading power factor. If one company owned both the power lines and the pipe lines, so that the type of motor depended on the over-all economy rather than on the enforcement or the particular terms of a power-factor penalty clause, then synchronous motors would seem to be the logical choice for this application.

H. B. DWIGHT

Boston, Mass.

# INSTITUTE AND RELATED ACTIVITIES

## The Pacific Coast Convention

SEPTEMBER 3-6

A technical program of diversified values and the enjoyable recreation to be found at one of California's most famed seashore resorts, are offered to those who attend the 1929 Pacific Coast Convention at the Hotel Miramar, Santa Monica, Calif., September 3 to 6.

Nineteen papers are included in the general technical program, in addition to twelve Student technical papers. Sports, trips, and other entertainment are important features of the Convention, a complete program of which was published in the August issue of the JOURNAL, page 642.

## District Meeting in Chicago December 2-4

A three-day District Meeting will be held by the Great Lakes District of the Institute in Chicago, December 2 to 4.

Nineteen technical papers have been proposed dealing with the general subjects of power stations, transmission and distribution, communication, and general research and development.

A Student Session will be one of the important features of the meeting.

Further details of the convention will be announced in the next issue of the JOURNAL.

## World Engineering Congress Delegates to Visit Washington

On their way to attend the World Engineering Congress at Tokio, Japan, the major delegation of foreign and national engineers will arrive in Washington, Wednesday, October 2. O. C. Merrill, Chairman of the Entertainment Committee, has requested L. W. Wallace, Executive Secretary, American Engineering Council, to form a reception committee composed of the presidents of the engineering organizations in Washington.

Those who have already consented to serve on this committee are: Starr Truscott, President of the Washington Society of Engineers; W. E. Doying, Chairman of the Institute's Washington Section; Admiral H. I. Cone, representing the American Society of Mechanical Engineers; E. W. James of the American Society of Civil Engineers; G. K. Burgess, of the American Institute of Mining and Metallurgical Engineers; and Charles H. Tompkins, Chairman of the Washington Post of the American Society of Military Engineers. The Japanese Ambassador is entertaining the guests of honor at dinner on the evening of their anticipated arrival, October 2.

## American Electric Railway Association Convention

SEPTEMBER 28-OCTOBER 4

At the coming convention of the American Electric Railway Association, at Atlantic City, September 28-October 4, inclusive; the subject of "Today's Transit Task" will be discussed by three of industry's leaders, from the standpoint of general utility, improvement of cars and buses, and "ways of modernizing the human organization of local transportation companies." Other subjects to be taken up will be traffic regulations, education and training, small city problems, and interurban and long-distance operation of buses. The broad subject of "Progress" will include valuable discussions on the benefits of unified transportation maintenance of motor buses, etc.

Entertainment plans also are well formulated, with bridge, golf, and other attractions scheduled.

Reduced fares are being offered by all railroads and special folders of information in this regard are being sent to all members.

## Illuminating Engineers to Meet in Philadelphia

The program for the forthcoming twenty-third Annual Convention of the Illuminating Engineering Society, to be held at the Bellevue-Stratford, Philadelphia, September 24-27, includes some 25 papers by leading illuminating engineers on subjects of vital interest to all branches of the lighting art. And in addition to the regular convention program, elaborate preparations have been made for a pre-convention meeting September 23rd of those interested in lighting service, while another meeting of the Committee on Lighting Service will be held the morning of Wednesday, September 25th. One entire session will be devoted to Light's Golden Jubilee, commemorating the 50th anniversary celebration of the invention of the incandescent lamp by Thomas A. Edison. G. Bertram Regar, of the Philadelphia Electric Company, is Chairman of the Convention Executive Committee.

## Industry to Cooperate with Electrochemists

In conjunction with the fall meeting of the American Electrochemical Society, to be held at Pittsburgh, Pa., September 19-21, special trips will be arranged to the works of the Westinghouse Electric & Mfg. Company, Firth Sterling Steel Company, National Tube Company, U. S. Aluminum Company, Duquesne Light Company, Carnegie Steel Company, Pittsburgh Coal Company, U. S. Light Storage Battery Company, Jones & Laughlin Steel Corporation, Lustrco Coated Steel Company, Standard Steel Spring Company, National Casket Company.

The meeting will have a number of technical sessions, with special sessions devoted to a symposium on "Contributions of Electrochemists to Aeronautics," "Electrothermics," and "Electrodeposition." Sight-seeing tours, golf, and a special program for the ladies have been carefully planned.

There will also be an exhibit of recently developed apparatus and electrochemical products.

## STANDARDS

### Three New American Standards

Advice has just been received of the approval by the American Standards Association of three new standards. These are *Dimensions Governing Fil of Four-Pin Vacuum Tube Bases*, and *Arrangement of Terminals*, the work of a Sectional Committee on Radio under joint sponsorship of the A. I. E. E. and the Institute of Radio Engineers. This was approved as an American Tentative Standard July 26, 1929. The other two standards are *Graphical Symbols for Telephone and Telegraph Use* and *Symbols for Hydraulics*. Both of these projects are the results of the work of the Sectional Committee on Scientific and Engineering Symbols and Abbreviations of which the Institute is one of five joint sponsors. Both were approved as American Tentative Standards as of July 26, 1929.

### Standards for Relays

A subcommittee of the A. I. E. E. Standards Committee has just been organized to develop A. I. E. E. Standards for Relays. This committee which will be known as Working Committee No. 48 and will be under the chairmanship of George Sutherland, Asst. General Superintendent of the New York and Queens Electric Light and Power Company will cover relays and relaying devices for the protection and control of apparatus and circuits for the generation, transmission conversion, distribution and utilization of electric power. The standards will not include



relays as applied to telephone, telegraph, traffic control and similar devices. Work will begin actively early in the fall.

#### **American Standards for Electric Welding to be Developed**

A Sectional Committee on Electric Welding is now being organized under the rules of procedure of the American Standards Association. This committee will have as the basis of its work the two A. I. E. E. Standards, Nos. 38 and 39, Electric Arc Welding Apparatus and Resistance Welding Apparatus. The joint sponsors for the project are the A. I. E. E. and the National Electrical Manufacturers Association.

#### **American Standards for Oil Circuit Breakers and for Disconnecting and Horn-Gap Switches to be Developed**

The joint sponsors, the A. I. E. E. and the National Electrical Manufacturers Association, are organizing a Sectional Committee under the rules of procedure of the American Standards Association to develop American Standards for Oil Circuit Breakers and for Disconnecting and Horn Gap Switches. Because of the similarity of the two projects it is felt that the work can be most efficiently handled by a single sectional committee, divided into necessary subcommittees. The basis for the committee's work will be the two A. I. E. E. Standards, Nos. 19 and 22.

## **NATIONAL RESEARCH COUNCIL**

### **ADVISORY AID SOLICITED FROM ENGINEERS AND SCIENTISTS**

In a desire to interpret science graphically to the world at large with regard to the progress it has made during the last century, trustees of the Chicago World's Fair Centennial Celebration planned for 1933 are enlisting the aid of engineers and scientists from all parts of the United States. The Research Council Science Advisory Committee has been appointed to cooperate in formulating a basic plan to adequately portray these advances to the public, all fields of science and engineering being represented in the personnel of the committee appointed as follows: Doctor F. B. Jewett, Chairman, Doctor M. I. Pupin, Mr. R. F. Schuchard, W. D. Ryan; Maurice Holland, Executive Secretary. These appointments were made by Doctor George K. Burgess, Chairman of the Council.

The committee will meet early in the fall to submit ideas to be coordinated into one central plan for the Exposition, of which science will be a dominating feature. A preliminary meeting has already been held to begin the work and outline the project. Members of the Executive Committee of the Advisory Board are: Doctor F. B. Jewett, Chairman; Doctor George K. Burgess; Gano Dunn; Doctor Vernon Kellogg; Doctor M. I. Pupin, and Doctor William Allen Pusey.

## **AMERICAN ENGINEERING COUNCIL**

### **COMMITTEE APPOINTED ON ENGINEERING AND ALLIED TECHNICAL PROFESSIONS**

With an aim to improving the status of the profession and uncovering new possibilities for the betterment of society, the appointment of a special committee to be known as the Committee on Engineering and Allied Technical Professions, to direct such a study under the auspices of the American Engineering Council has been announced by President Berresford.

This Committee will consist of H. C. Morris, retired mining engineer of Washington, D. C., Chairman; A. B. McDaniels of Washington, D. C., representing the American Society of Civil Engineers; Conrad N. Lauer, of Philadelphia, representing The American Society of Mechanical Engineers; and H. A. Kidder, representing the American Institute of Electrical Engineers;

and L. W. Wallace, of Washington, Executive Secretary of the Council. Individual committees of the A. S. M. E., the A. I. E. E., and the Washington, D. C. Society of Engineers will work with this joint committee, to "collect, tabulate, analyze, and disseminate information—and to give a clear conception along the various lines of endeavor."

As a result of the survey the Council hopes to be in position to give expert guidance in matters affecting the professions and contingent branches in both local and national relations.

### **A NEW EDITION OF CONSTITUTION AND BY-LAWS**

Following the adoption of the revised and amended Constitution and By-Laws of American Engineering Council at the meeting of the Assembly in January, 1929, Council has edited and delivered the revised document for printing.

The committee upon the final editorial revision of the amended Constitution is composed of: Gardner S. Williams, Detroit Engineering Society; James R. Withrow, Engineers Club of Columbus; and W. C. Lindemann, Engineers Society of Milwaukee.

The booklet will be carefully indexed and will carry a list showing the geographical distribution of the member organizations of Council. Engineers interested may secure copy of the new edition by addressing the American Engineering Council, 26 Jackson Place, Washington, D. C.

### **A. E. C. PUBLISHES ROSTER**

American Engineering Council is having printed a roster of prominent engineers who have served as members of its Assembly since the organization of Council in 1921. This roster will be a 6 x 9 in. booklet, of 48 pages and will contain brief professional biographies of the 191 engineers who have at one time or another served as members of the Assembly of American Engineering Council.

The 1929 edition of the roster will contain the biographies of many well-known men, among them W. L. Abbott, L. P. Alford, A. W. Berresford, William Boss, Mortimer E. Cooley, Alex Dow, Gano Dunn, W. F. Durand, C. E. Grunsky, G. H. Herrold, Herbert Hoover, F. L. Hutchinson, D. S. Kimball, Fred R. Low, Anson Marston, M. I. Pupin, E. W. Rice, Jr., Chas. M. Schwab, G. T. Seabury, S. W. Stratton, Francis Lee Stuart, G. S. Williams, James R. Withrow. Copies may be had by addressing 26 Jackson Place, Washington, D. C.

### **A. I. E. E. Directors Meeting**

The first meeting of the Board of Directors of the American Institute of Electrical Engineers for the administrative year beginning August 1, was held at Institute headquarters, New York, on Tuesday, August 6, 1929.

There were present: President Harold B. Smith, Worcester, Mass.; Past-President Baneroft Gherardi, New York, N. Y.; Vice-Presidents H. A. Kidder, New York, N. Y., and E. B. Merriam, Schenectady, N. Y.; Directors H. C. Don Carlos, Toronto, Ont.; F. C. Hanker, East Pittsburgh, Pa.; E. B. Meyer, Newark, N. J.; J. Allen Johnson, Niagara Falls, N. Y.; A. M. MacCutehon, Cleveland, Ohio; W. S. Lee, Charlotte, N. C.; J. E. Kearns, Chicago, Ill., and C. E. Stephens, New York, N. Y.; National Secretary F. L. Hutchinson, New York.

The minutes of the Directors Meeting of June 25, 1929, were approved.

A report was presented of the meeting of the Board of Examiners held July 31, and the actions taken at that meeting were approved. Upon the recommendation of the Board of Examiners, the following action was taken upon pending applications: 22 Students were enrolled; 68 applicants were elected to the grade of Associate; five applicants were elected to the grade

of Member; one applicant was elected to the grade of Fellow; 31 applicants were transferred to the grade of Member.

As provided in Sec. 22 of the Constitution, Messrs. H. D. Reed and H. H. Wait were made "Members for Life."

The Board ratified the action of the Finance Committee in approving for payment monthly bills for July amounting to \$40,256.58, and for August amounting to \$23,331.83. The July disbursements included traveling expenses of officers and delegates in connection with the Summer Convention, at Swampscott, Mass., in June.

Consideration was given to recommendations that had been made at a number of District conferences on student activities held in various parts of the country, that National or District officers visit the Student Branches annually or biennially, and to the recommendation of the Committee on Student Branches and of the Student Branch Counselors in conference during the Summer Convention in June that traveling expenses be paid at the usual rate for the Vice-Presidents to visit the Student Branches, as well as the Sections (already authorized) within their Districts. The Board voted that the provision covering traveling expenses for Vice-Presidents for visits to Sections be amended to read as follows: "For each Vice-President of the Institute to one meeting each year of each Section and each Student Branch within his Geographical District, it being understood that joint meetings of Sections and Branches will be arranged as far as may be expedient."

Carrying out the previous action of the Directors at the June meeting, in approving the recommendation made at the Conference of Officers and Delegates held June 24, that "Regional Meetings be hereafter referred to as 'District Meetings' and that the By-laws be changed accordingly," Secs. 35 and 67 of the By-laws were amended by the substitution of the terms "District Meeting" for "Regional Meetings" and "District Meeting Committees" for "Regional Meeting Committees."

The President announced the appointment of committees and representatives of the Institute for the administrative year beginning August 1, 1929. (A complete list of committees and representatives appears elsewhere in this issue.)

In accordance with the By-laws of the Edison Medal Committee, the Board confirmed the appointment by the President of Mr. Samuel Insull as chairman of the Committee for the administrative year beginning August 1, and of the following members of the Committee for terms of five years each beginning August 1, 1929: Messrs. L. W. W. Morrow, W. S. Rugg, and R. F. Schuchardt; and of Professor C. F. Harding to fill the unexpired term of Charles F. Brush (deceased), ending July 31, 1933. Also, the Board elected three of its own members to serve on the Edison Medal Committee for terms of two years each beginning August 1; namely, Messrs. J. Allen Johnson, W. S. Lee, and A. M. MacCutcheon.

As required by the By-laws of the committee, the Board confirmed the appointment by the President of Messrs. A. C. Bunker, H. P. Charlesworth, and C. C. Chesney as members of the Lamme Medal Committee for the three-year term beginning August 1, 1929, and of Professor Charles F. Scott as Chairman of the committee for the coming year.

Local Honorary Secretaries were appointed for terms of two years each, beginning August 1, to succeed those whose terms expired July 31, 1929, as follows: Axel F. Enstrom, for Sweden; A. P. M. Fleming, for England; T. J. Fleming, for Argentina; P. H. Powell, for New Zealand; Guido Semenza, for Italy; F. M. Servos, for Brazil.

In connection with designation by the President (as authorized by the Directors in March) of Mr. H. A. Kidder for appointment as a member of the American Engineering Council's Committee on Engineering and Allied Technical Professions, with the understanding that he would become the chairman of an Institute committee on the same general subject if and when it seemed de-

sirable to set up a separate Institute committee, the duties of which would include cooperation with the Council's committee, the Board adopted a resolution authorizing the President "to appoint a Committee on the Engineering Profession, consisting of five or seven members, to consider and report to the Board of Directors upon various matters affecting the status of the engineering profession; one function of the committee to be cooperation with the American Engineering Council's Committee on Engineering and Allied Technical Professions."

Inasmuch as the new Committee on the Engineering Profession will cooperate with American Engineering Council's Committee on Engineering and Allied Technical Professions, and as one of the subjects to be considered by the latter committee is that dealing with the licensing of engineers, it was voted that the Special Committee on Licensing of Engineers, which has been in existence for the past few years, be discontinued and its former functions assigned to the new Committee on Engineering Profession.

An invitation from the American Society of Mechanical Engineers to appoint two official delegates to participate in the observance of the Fiftieth Anniversary of the Society in April 1930 was accepted, and the President was authorized to appoint the delegates.

It was decided that the October meeting of the Board of Directors will be held in New York on Friday, October 18, and that the December meeting will be held in Chicago, during the Chicago District Meeting, December 2-4.

Other matters were discussed, reference to which may be found in this and future issues of the JOURNAL.

### Secretaries' Fourth Conference

The Fourth Conference of Secretaries of Engineering Societies met June 6-7, in the club rooms of the Western Society of Engineers, Chicago, Ill.; E. S. Nethercut, Secretary of the Western Society of Engineers, presided. A. W. Berresford, President of American Engineering Council addressed the conference, and was followed by L. W. Wallace, Executive Secretary, who explained briefly the history of American Engineering Council's participation in the Engineering Secretaries Conferences.

C. R. Sabin reported that the Committee on Standardization of Membership Requirements and Transfer of Membership between Local Societies had prepared a questionnaire which was sent to the various engineering societies and that approximately 25 societies had shown interest toward the standardization of membership requirements recommended by the previous Secretaries Conference. The conference felt greatly the need of an up-to-date list of engineering and allied technical societies of the United States and voted to request American Engineering Council to prepare as accurate a list as possible. Such a list will soon be published in the A. E. C. Bulletin.

Following the report of the committee, the conference adopted the committee's recommended form for intersociety membership transfer.

The report of Ernest Hartford, Assistant Secretary, American Society of Mechanical Engineers, Chairman of the Committee on Physical and Financial Relations Between the Local Sections of National Societies and Local Engineering Societies, gave many helpful suggestions for methods of cooperation between national and local engineering organizations.

C. E. Billin, Chairman of the Committee on Participation in Civic Affairs, presented the results of a questionnaire showing that practically all engineering societies felt that participation in civic affairs was both helpful to the society and the membership. The conference voted to recommend that each engineering organization appoint a standing committee on public affairs.

## New Volume of Research Narratives Available

A third group of fifty Research Narratives was completed in May. Requests for these Narratives in book form having continued, a third volume was printed for delivery about the middle of August. To this, General John J. Carty, Vice-President, American Telephone & Telegraph Company, Past-President, American Institute of Electrical Engineers, has written a brief Introduction, in part as follows:

"The publication of Popular Research Narratives does more than provide scientific reading in an entertaining and instructive manner. They constitute in themselves a distinct contribution to the cause of scientific research because they present to the reader in authentic form, concrete examples of the methods, vicissitudes and triumphs of scientific research. . . . The progress of scientific research in our country depends in the last analysis upon the support which it receives from the public. There is no lack of problems to be solved, all of which in one way or another affect the welfare of the Nation, and there will be no lack of competent scientific investigators who will solve them if the necessary financial support is provided. . . .

But the higher values of scientific research must be stated in terms of human achievement, the elimination of poverty and disease, the advancement of learning, the growth of right living and good understanding among men. . . . According to the vision of Science, life must no longer be regarded as a struggle among men for a limited store where one man's gain or one nation's gain must be another's loss. Under the banner of scientific research we are asked to join with our fellow men, working together in controlling and utilizing the boundless forces of nature. Such is the message of Research Narratives."

## The National Electrical Code

The 1929 edition of the National Electrical Code has been declared an Approved American Standard by the American Standards Association. For 30 years the Code, originally drafted in 1897, has been the basic guide for safe practices in the wiring of consumer premises for the use of electricity for light, heat, and power, and the forthcoming edition is the 15th revision of the original text.

The Code was drafted by a sectional committee under the sponsorship of the National Fire Protection Association, and the electrical committee includes 75 members and alternates representing 36 national and local organizations.

Supplies of the new edition may be ordered from the American Standards Association, 29 West 39th Street, New York, or from the National Board of Fire Underwriters, 85 John Street, New York.

## Diesel and Oil Engine Course at Brooklyn Polytechnic Institute

Direct and personal supervision of the conduct of the evening course in Diesel and oil engines which is to be given by the Department of Mechanical Engineering, Brooklyn Polytechnic Institute, is in the hands of Professor E. F. Church, Jr., Head of the Department. Lectures will be delivered by Julius Kuttner, editor of *Oil Engine Power* and for two years test engineer and designer for oil engine manufacture in Germany. Edgar J. Kates, for the past twenty years connected with the design and construction of several types of oil engines including supervision of layout, erection, and operation of numerous oil engine installations, will discuss the design, management, and cost of Diesel power plants, while Professor W. J. Moore, in charge of the Institute's laboratory work, will personally conduct laboratory exercises and demonstrations in conjunction with the course. Students may register any time after Sept. 1.

## PERSONAL MENTION

BLIGHT S. ROBINSON, formerly Assistant Editor of the *Electrical World*, has been appointed to the staff of the Waterbury Cable Service, Inc., New York.

B. L. CONLEY has resigned as Electrical Engineer of The Holtzer-Cabot Electric Co., Boston, Mass., to accept the position of Chief Engineer with The Sunlight Electrical Mfg. Co., Warren, Ohio.

GORDON R. ANDERSON has been recently transferred from the Indianapolis Works of Fairbanks Morse & Co. to the Beloit Works, where he will be in charge of the Single-phase Motor Division of the Company.

GEORGE W. BRICKER, JR., who has been with H. C. Hopson & Co., Inc., New York, N. Y., has become associated with Lybrand Ross Bros. & Montgomery, Boston, Mass. to specialize in public utility problems in the capacity of accountant.

MYRON ZUCKER has joined the Detroit Edison Co., having resigned from the General Electric where he has been working in the Central Sta. Department with Doctor E. F. W. Alexander on stability, high-speed excitation and thyatron.

H. W. YOUNG, President of the Delta-Star Electric Company, Chicago, returned on the *Olympic* August 7, from a two-months' trip to France, Germany and England. While abroad, he visited many of the European manufacturers of high-voltage switching equipment.

PAUL M. DOWNING, Vice-President in Charge of Electrical Construction and Operation of the Pacific Gas and Electric Company has just been elected First Vice-President and General Manager, to succeed Frank A. Leach, Jr., whose retirement has just been announced.

W. M. VERNOR, recently of the Westinghouse Electric International Co., has been appointed salesman for the Westinghouse Electric Elevator Company in the New York District. While with the International Co., Mr. Vernor spent three years in Manila and Hongkong.

JOHN S. RIDDILE, who for nearly ten years was associated with Ralph D. Mershon in hydroelectric developments in Canada, has been made Executive Engineer of the Shawinigan Water & Power Company which last year purchased the Laurentide Power Company, Ltd., Grand Meere, with which Mr. Riddile was previously identified.

YASUJIRO SAKAI has recently been elected a Fellow of the Royal Society of Arts, London, England. Mr. Sakai joined the Institute in 1907 as Associate and was advanced to Member in 1919. He is a Member of the Examination Committee of the Imperial Government of Japan, as well as a patent attorney and consulting engineer at in Tokio.

GILBERT H. DUNSTAN recently resigned as Instructor in Drawing and Machine Design at Tulane University, La., and has accepted a position as Instructor in Civil Engineering at the University of Southern California. He will have charge of work in drawing and descriptive geometry, with students in the branches of engineering, and in addition, expects to teach one course in the Electrical Engineering Department.

ROSS EWING, on August 1, 1929, became associated with C. M. Adams as Manufacturers' Representative for the American Steam Pump Company, the Clarage Fan Company, J. Struthers Dunn, H. H. Stricht & Co., H. E. Trent Company, Edwin L. Wiegand Co. and the Vicking Products Company. Mr. Ewing was previously with Westinghouse interests in Detroit. He remains in that city in his new connection.

F. B. PHILBRICK, for nine years at the Gamewell Company's Factory as Engineer, has been appointed District Sales Manager for the Pacific Coast, with headquarters at 939 Larkin Street, San Francisco, California. Mr. Philbrick has had extensive experience in fire alarm and police signal engineering and his new ap-

pointment will include making surveys and recommendations for the improvement of fire and police signaling systems in that vicinity.

O. W. A. OETTING, effective September 1st resigned from his position as Chief Engineer of the Willard Storage Battery Company of Cleveland, Ohio, which he joined in 1917 as an engineer in the Sales Department on applications of storage batteries to electrical systems of cars. Prior to his connection with the Willard Company, Mr. Oetting was in the Research Department of the Westinghouse Electric & Manufacturing Company. He has made no announcement of future plans except a trip shortly to the Coast.

T. J. FLEMING, who has been Transmission Engineer for the Santa Monica Bay Telephone Company, Associated Telephone Company, Long Beach, Calif., has been made its Transmission and Protection Engineer with offices in the Petroleum Securities Building, Los Angeles, Calif. The Associated Telephone Co., which was formed by a consolidation of six independent telephone companies in and about Los Angeles, is an operating unit of the Associated Telephone Utilities Company, with several such units throughout the United States.

CHARLES E. TAFF, until recently Assistant Manager of Construction for the Standard Underground Cable Company, at Pittsburgh, is now Manager of Henry Ihle, Incorporated, Brooklyn, of which he also has been elected a director and the secretary. Mr. Taff's connection with the Standard Company dates back to 1907 and includes the installation of cable systems throughout the United States and Canada, as well as active service in the electrification of the Pennsylvania Railroad Station Terminal in New York, work on the 33-kv. submarine cable crossing at Cohokia Plant, St. Louis, and the Holland Tunnel.

## Obituary

**E. H. Smith**, Equipment Engineer of the Bell Telephone Laboratories, Inc., died June 11, 1929. He was born at Spencer, Massachusetts, November 13, 1888, and attended the Leicester Academy, Leicester, Massachusetts and Worcester Polytechnic Institute. In 1911 he joined the Western Electric Company's Engineering Department, and from that time until 1923 was occupied with telephone equipment and telephone system engineering,—nine years in the Chicago and New York offices of the company; for thirteen years he was at the Hawthorne plant of the company. He became an Associate of the Institute in 1923 and was advanced to the grade of Member in 1926.

**Max G. Newman**, Electrical Engineer for the General Electric Company at Pittsfield, Mass., and an Associate of the Institute since 1912, died July 14, 1929. Mr. Newman was assistant to the head of the Experimental Division of the company's Pittsfield works. He was born at Fryburg, Maine, April 21, 1885, and was graduated from the Fryburg Academy in 1902. He was graduated in 1907 from the University of Maine, immediately after which he joined the General Electric Company's Schenectady office, engaged on test work. In 1909 he left the test work to take a position in the standardizing laboratory at Schenectady, removing to the company's laboratories at Pittsfield in 1910. His record with the company covered a period of twenty years of representative service.

**Armistead K. Baylor**, 61, General Electric commercial engineer and veteran of the electrical industry, died suddenly early on the morning of August 1 at Ipswich, Mass., where he was summering. In 1891 Mr. Baylor went with the Thomson-Houston Electric Company at West Lynn, Mass., and removed to Schenectady, N. Y. in 1894 when the headquarters and main offices of the General Electric Company were established there. In 1896 he went abroad to become manager of the Traction Department of the British Thomson-Houston Company, becoming

General Sales Manager there. After 14 years he returned to this country to re-enter the General Electric organization, and for several years was in the commercial general department. Mr. Baylor was also Vice-President, director and a member of the Executive Committee of the Edison Electric Appliance Company. He became a Member of the Institute in 1926.

**Charles W. Kincaid**, a special engineer in the Industrial Motor Engineering Department of the Westinghouse Electric & Mfg. Co., and an Associate of the Institute since 1913, died Sunday, July 14, after an extended illness. He was born in Pittsburgh in 1889 and was educated in the Pittsburgh public schools, followed by a course at the University of Pittsburgh, from which he was graduated in 1910 with the degree of E. E. He entered the employ of the Westinghouse Company that same year and during his 19 years of service with the company held successively positions of a-c. motor designer, Section Engineer on a-c. motors and Consulting Specialist on industrial problems. For several years he was closely associated with B. G. Lamme, at Mr. Lamme's death taking up and carrying on much of the experimental and theoretical investigation of induction motor problems initiated by Mr. Lamme. He was the author of numerous technical articles, published of recent years in *The Electric Journal*, on the fundamental theory of the various types of induction motors, as well as other papers presented before the Institute and included in its Transactions.

**Charles B. Larzelere**, Designing Engineer of the General Electric, Philadelphia, died in that city June 25, at the age of 54. Mr. Larzelere was born at Seneca Falls, New York, and was a graduate of the Mynderse Academy there; also of Cornell University, from which he was graduated in 1897 with a degree of M. E. in E. E. He began his technical work with one year in charge of a small electric lighting plant, after which, in 1899, he became draftsman for the General Electric Company at Schenectady. Three years later, he removed to England to become Designing Engineer in the Traction Dept. of the British Thomson-Houston Company, Rugby, England. In 1905 he returned to the Schenectady office of the General Electric Company as Designing Engineer in the Railway Engineering Equipment Department and the Controller Department. Patents covering inventions by Mr. Larzelere were held by both of these companies. For nearly four years he was Assistant Engineer in the office of the Assistant Chief Engineer of the Isthmian Canal Commission, Culebra, Canal Zone, engaged in various engineering problems, particularly in connection with the control of the lock machinery. His return to the General Electric Company's Philadelphia office took place several years ago.

**Samuel M. Kennedy**, retired Vice-President of the Southern California Edison Company in charge of business development and public relations, died at his home, Alhambra, Calif., July 18. Mr. Kennedy achieved a national reputation in electrical circles by his pioneer work on the subject of public relations, and his authorship of the three publications "The Man in the Street" "Service" and "Winning the Public." He was a native of Toronto, Canada and was graduated from the Upper Canada College in that city. For a time after leaving college, he lived in London, the Resident Manager of a wholesale importing business of which his father was head, but at the early age of 31 his health failed him and he removed to California. In 1900 he became Assistant to the President of the United Electric Power & Gas Company, Los Angeles and when in 1903 this company was absorbed by the Southern California Edison Company, Mr. Kennedy was placed in charge of the Commercial Department. In this office his rare ability to organize and promote progressive methods contributed greatly to the development of his own company's interests and acted as a widely felt stimulus to electrical industry along the entire reach of the Pacific Coast. His articles have appeared frequently in the *Electrical World* and other publications, impressing valuable and well-taken points upon the minds of the executives in industry.



Mr. Kennedy became an Associate of the Institute in 1911 and was transferred to the grade of Member in 1926. Besides his connection with the Southern California Edison Company, he has been Vice-President of the Santa Barbara Suburban Railway and the Pacific Gasoline Company; and a Director of the Alhambra Savings and Commercial Bank. He was a Member of the Electrochemical Society and has also been actively connected with the National Electric Light Association.

**Alfred Hutchinson Cowles**, inventor and metallurgist and President of the Electric Smelting & Aluminum Company of Sewaren, New Jersey, died at his home August 13, 1929 at 70 years of age. He was a native of Cleveland, Ohio, the son of Edwin Cowles, who founded the *Cleveland Leader* and was later editor of the *Cleveland Evening News*. Mr. Cowles studied electrical science and physics under Professor Mendenhall at Ohio State University in 1876 and 1877. These studies were continued under Professor William Anthony at Cornell University from 1877 to 1882. While at Cornell, Mr. Cowles was a noted crew member—in fact he was one of the crew of four that rowed at Henley, Putney, and Vienna in 1881. After graduating from college, he joined his brother in a prospecting tour into New Mexico, where mining properties which have since proved of great value were opened. In 1881 he visited the Paris Electrical Exhibition. With his brother, Eugene H. Cowles, he developed the first electric furnace in connection with producing aluminum and alloys and the company thus organized erected the first electric furnace in the world, at Lockport, New York, in 1886. Mr. Cowles was one of the inventors of the Cowles process of electric smelting, and due to the development of their electric furnace in addition to aluminum was the production of calcium carbide—now an important commercial factor,—cheaper carbon bisulphide and cheaper phosphorus.

Many honors have been bestowed upon him for his scientific discoveries; he was a member of the American Association for the Advancement of Science and Franklin Institute awarded him the Elliot Cresson Medal and the John Scott Legacy Medal in 1886. In 1889 he was the recipient of the Paris Exposition gold medal. He has been Vice-President of the American Institute of Mining and Metallurgical Engineers, the American and Metallurgical Society of America, the Franklin Institute and Zeta Psi. He joined the Institute in 1886 and was among the first to be elected to the grade of Fellow when it was first adopted by the Institute in 1912. He was also President of the Pecos Copper Company from 1902 to 1918 and Vice-President of the Cleveland Leader Printing Company from 1899 to 1904. Mr. Cowles was also a representative member of the United States Naval Institute.

**James T. Hutchings**, Vice-President of The United Gas Improvement Company, in charge of engineering development, died suddenly on Saturday, August 17, at Ocean City, N. J., of heart disease.

Mr. Hutchings had returned on August 13 from a two months' trip abroad, and apparently was in his usual health. He had been in his office in The U. G. I. Building until late Friday afternoon, August 16, when he left for the seashore to spend the week-end with his family.

Mr. Hutchings entered the employ of The U. G. I. Company in 1920, as Assistant General Manager. In August, 1921, he became General Manager, and two years later was elected Vice-President in charge of operations. In February 1927 he became Vice-President in charge of engineering development.

Born in Amherst, Mass. in 1889, he attended Amherst public schools and was graduated from Massachusetts Agricultural College with the degree of Bachelor of Science in 1889. His first position after graduating was with the Thomson-Houston Electric Company, of Amherst, with which he remained about four months. In that same year he came to Philadelphia to accept a

position as foreman of wiring with the Germantown Electric Company, and later became Superintendent of the West End Electric Company, in which position he remained until that company and numerous other small companies in the city were consolidated into the Philadelphia Electric Company. From 1897 to 1904 he was employed by the latter company as Assistant Electrical Engineer.

Then followed sixteen years with the Rochester Gas and Electric Corporation during which he held the positions of Superintendent of the Electric Department, Assistant Manager, General Manager and President. He capably filled the latter position for two years, until 1920, when he entered U. G. I. employ.

During the World War, Mr. Hutchings was Chairman of the Manufacturers' Committee of the Rochester District in charge of production, and despite the exigencies of that and his regular work, was also power expert for the Ordnance Department in charge of munitions production.

He was a member of the American Gas Association, National Electric Light Association, Engineers Clubs of Philadelphia and New York, the University Club of Philadelphia, and the Overbrook Golf Club. He joined the Institute as an Associate in 1903 and was elected a Member in 1912.

**E. B. Craft**, wire engineer and head of the Bell Telephone Laboratories since 1922, died at his home in Hackensack, New Jersey, August 20, after suffering from high blood pressure for several months. Mr. Craft was a member of an old American family, the Crafts having come to Massachusetts in 1630. He himself was born in Cortland, Ohio, and was educated in the grade and high schools of Warren, Ohio. His first electrical position, from 1900 to 1902, was as Superintendent of the Lamp Department of the Warren Electrical and Specialty Company. This he gave up to join the Western Electric Company in Chicago, where his first work was editing orders for telephone switchboards. Soon he was placed in charge of making models, and in this capacity he produced his first invention, an indicating device for fuses to protect telephone equipment from electrical disturbances. This proved to be so absolutely correct that it has remained in constant use for the last 23 years. In 1907, with a nucleus from the force he had organized in Chicago, he came to New York as development engineer for the Western Electric Company. Here he began his career as an organizer of development activities, and with a growing need for expansion in the field, his work was rapid. In 1917 he became Assistant Chief Engineer, serving as such for five years, responsible for the development work in the Engineering Department of the Western Electric Company which then operated the works out of which the Bell Telephone Laboratories grew. To the introduction and development of the dial telephone system Mr. Craft contributed not only certain specific inventions but was among the first to appreciate the value of this new method inspiring others with his own faith in its operation. He was also the first to demonstrate the talking motion picture process in 1926 before a meeting of the New York Electrical Society. With the entrance of the United States into the World War, Mr. Craft became a Captain in the Signal Corps, and was promoted to the rank of Major in December 1917. From June to October 1918 he was technical advisor of the United States Navy in London. In 1922 he became Chief Engineer of the Western Electric Company and in 1925 was made Executive Vice-President of the Bell Telephone Laboratories, Inc. At the time of his death, he was a member of the Edison Medal Committee, Chairman of the Library Board, and the Institute's representative to the Newcomen Society. He was Vice-Chairman of the Division of Engineering and Industrial Research of the National Research Council; a member of the Council of the American Institute of Weights and Measures; of the American Society of Automotive Engineers; and a Fellow of the Institute of Radio Engineers. Mr. Craft joined the Institute in 1911 and was elected to the grade of Fellow in 1926.

# Engineering Societies Library

The Library is a cooperative activity of the American Institute of Electrical Engineers, the American Society of Civil Engineers, the American Institute of Mining and Metallurgical Engineers and the American Society of Mechanical Engineers. It is administered for these Founder Societies by the United Engineering Society, as a public reference library of engineering and the allied sciences. It contains 150,000 volumes and pamphlets and receives currently most of the important periodicals in its field. It is housed in the Engineering Societies Building, 29 West Thirty-ninth St., New York.

In order to place the resources of the Library at the disposal of those unable to visit it in person, the Library is prepared to furnish lists of references to engineering subjects, copies or translations of articles, and similar assistance. Charges sufficient to cover the cost of this work are made.

The Library maintains a collection of modern technical books which may be rented by members residing in North America. A rental of five cents a day, plus transportation, is charged.

The Director of the Library will gladly give information concerning charges for the various kinds of service to those interested. In asking for information, letters should be made as definite as possible, so that the investigator may understand clearly what is desired.

The library is open from 9 a. m. to 10 p. m. on all week days except holidays throughout the year except during July and August when the hours are 9 a. m. to 5 p. m.

## BOOK NOTICES, JULY 1-31, 1929

Unless otherwise specified, books in this list have been presented by the publishers. The Society does not assume responsibility for any statement made; these are taken from the preface or the text of the book.

All books listed may be consulted in the Engineering Societies Library.

### APPLICATIONS DE L'ÉLECTRICITÉ AUX MINES.

By Georges Hacault. Paris, J.-B. Baillière et fils, 1929. 552 pp., illus., diags., 9 x 6 in., paper. 85 fr.

The author confines himself to electrical hoisting, pumping, ventilating, and air compressing machinery. In this field, he gives a good description of various types of equipment, points out the advantages of each, gives the data necessary for selecting suitable sizes, and directions for testing.

### EINFLÜSSE AUF BETON, pt. 1. Ed. 3.

Edited by A. Kleinogel. Berlin, Wilhelm Ernst & Sohn, 1929. To be complete in 6 or 7 pts. Illus., diags., tables, 10 x 7 in., paper. 6.-r. m. each.

A convenient compendium of information upon the chemical and mechanical action of air, water, and chemicals of all kinds upon concrete. The information is in dictionary form, is comprehensive enough for ordinary requirements, and is supplied with references to sources for further details. Methods of preventing action are also given.

### ELEKTRISCHE GLEICHRICHTER UND VENTILE.

By A. Güntherschulze. 2d edition. Berlin, Julius Springer, 1929. 330 pp., illus., diags., tables, 9 x 6 in., bound. 29.-r. m.

A systematic discussion of electric rectifiers and valves, with special attention to those for currents greater than those encountered in high-frequency work. The physical characteristics, calculation, types and uses are treated. There is a valuable list of German patents in this field and a good bibliography. The new edition is nearly twice the size of the former one, and is practically a new book.

### L'ENFANT AND WASHINGTON, 1791-1792.

Edited by Elizabeth S. Kite. (Institute Français de Washington. Historical documents, cahier 3). Balt., Johns Hopkins press, 1929. 182 pp., plate, 11 x 8 in., bound. \$3.00.

Here are brought together in chronological order all the existing documents upon L'Enfant's work in planning the city of Washington. They give an interesting picture of his labors, the difficulties with which he met, and the reason for his final dismissal. Ambassador Jusserand's introduction is a fine account of L'Enfant's life.

### HOCHDRUCKDAMPF II.

Sonderheft der V. D. I. Zeitschrift. Berlin, V. D. I. Verlag, 1929. 171 pp., illus., diags., 12 x 8 in., paper. 6.-r. m.

This volume brings together the more important papers on high-pressure steam which have appeared in the Zeitschrift des Vereinus deutscher Ingenieure during the last five years. The papers discuss a variety of questions connected with the production and use of steam at high pressures, such as modern methods of generation, the influence of high pressures and temperatures upon engine design, and the transformation in industrial practise caused by the introduction of higher pressures.

### INTERNATIONAL AIRPORTS.

By Stedman S. Hanks. N. Y., Ronald Press Co., 1929. (Ronald Aeronautic series) 195 pp., illus., 9 x 6 in., cloth. \$5.00.

In 1928 the author visited the principal European airports to ascertain what lessons could be learned that would be useful in constructing and managing airports in America. He collected much information upon the layout of these ports, the buildings, the methods of handling traffic, and the other details of air travel. This is presented and compared with American practise.

### DAS IT—DIAGRAM DER VERBRENNUNG.

By P. Rosin & R. Fehling. Ber., V. D. I. Verlag 1929. 32 pp., 10 charts, 12 x 8 in., paper. Price not quoted.

Starting with a hitherto unknown relation between the heating value of a fuel and the volume of gas evolved, the author has prepared charts from which the heat capacity of the flue gas can be read off. With these diagrams, it is only necessary to know the heating value of a fuel and the excess of air used to obtain the temperature of combustion, the available heat drop and similar data. The pamphlet explains the theory, illustrates the practical use of the method, and gives diagrams for solid, liquid, and gaseous fuels.

### RAILWAYS OF TODAY.

By Cecil J. Allen. London & N. Y., Frederick Warne & Co., 1929. 400 pp., illus., plates, 7 x 6 in., cloth. \$5.00.

A popular description of the modern railroad, its equipment, and the way it is operated, with emphasis upon the engineering features. The author writes with skill and understanding, and has compressed a remarkable amount of information into a small volume. English practise is the basis of the account, but variations in other countries are noted. The book is elaborately illustrated with photographic cuts and colored plates.

### TRAILS, RAILS & WAR; the LIFE OF GENERAL G. M. DODGE.

By J. R. Perkins. Indianapolis, Bobbs-Merrill Co., 1929. 371 pp., illus., ports., 9 x 6 in., cloth. \$5.00.

This work, based on the original documents of General Dodge, and prepared with the assistance of his family, is an authoritative account of his life as a surveyor of western railroad routes, as a military man, and as a promoter of railroads. The story of the building of the Union Pacific, and of the struggles for its control, are told in detail. The book is not only a good biography of a famous engineer, but is also an important contribution to our railroad history.

# Engineering Societies Employment Service

Under joint management of the national societies of Civil, Mining, Mechanical and Electrical Engineers cooperating with the Western Society of Engineers. The service is available only to their membership, and is maintained as a cooperative bureau by contribution from the societies and their individual members who are directly benefited.

Offices:—31 West 39th St., New York, N. Y.,—W. V. Brown, Manager.  
1216 Engineering Bldg., 205 W. Wacker Drive, Chicago, Ill., A. K. Krauser, Manager.  
57 Post St., San Francisco, Calif., N. D. Cook, Manager.

**MEN AVAILABLE.**—Brief announcements will be published without charge but will not be repeated except upon requests received after an interval of one month. Names and records will remain in the active files of the bureau for a period of three months and are renewable upon request. Notices for this Department should be addressed to **EMPLOYMENT SERVICE, 31 WEST 39th Street, New York City**, and should be received prior to the 15th day of the month.

**OPPORTUNITIES.**—A Bulletin of engineering positions available is published weekly and is available to members of the Societies concerned at a subscription of \$3 per quarter, or \$10 per annum, payable in advance. Positions not filled promptly as a result of publication in the Bulletin may be announced herein, as formerly.

**VOLUNTARY CONTRIBUTIONS.**—Members obtaining positions through the medium of this service are invited to cooperate with the Societies in the financing of the work by contributions made within thirty days after placement, on the basis of one and one-half per cent of the first year's salary; temporary positions (of one month or less) three per cent of total salary received. The income contributed by the members, together with the finances appropriated by the four societies named above will it is hoped, be sufficient not only to maintain, but to increase and extend the service.

**REPLIES TO ANNOUNCEMENTS.**—Replies to announcements published herein or in the Bulletin, should be addressed to the key number indicated in each case, with a two cent stamp attached for reforwarding, and forwarded to the Employment Service as above. Replies received by the bureau after the positions to which they refer have been filled will not be forwarded.

See also p. 42 of Advertising Section

## POSITIONS OPEN

**ELECTRICAL ENGINEER**, college graduate, experienced in the design of polyphase induction motors. Opportunity for advancement. Apply by letter. Location, Pacific Coast. X-9031-C-R-2609-S.

**RECENT GRADUATE**, as part-time instructor who desires to do advance study work. Will be obliged to teach 9 to 10 hours a week, and the balance of the time devote to research or advanced study. Apply by letter. Salary \$1200 a year. Location, New York State. X-8980.

**ELECTRICAL ENGINEER**, about 35, with practical experience in general manufacturing of transformers, motors, switchgear; able to diagnose trouble in repairing of apparatus, full knowledge of mechanical tools and winding necessary. All-round man required to take charge of plants. Apply by letter stating full details with references and salary expected. Opportunity. Location, Western Canada. X-8608-CS.

## MEN AVAILABLE

**ELECTRICAL ENGINEER**, desires position doing research or development work. Thoroughly trained and competent meter engineer. Experienced in combustion and general laboratory and power-plant testing. Have been successful along development lines. Also extensive public utility experience. C-5258.

**ELECTRICAL AND MECHANICAL ENGINEER**, 31, graduate, single, three years' experience teaching mathematics and electrical engineering laboratory, two years selling, past two years in charge of engineering department of a large manufacturing company which has recently merged with a larger company. C-2697.

**PUBLIC UTILITY ENGINEER**, age 33, electrical engineering graduate with knowledge of corporation finance and ten years' experience in consulting service on railway, bus, and electric light operation appraisals and public utility regulation problems in major cities throughout the country would like connection with large operator or holding company. B-446.

**ELECTRICAL DRAFTSMAN**, age 29, six years' experience in the preparation of switchgear engineering wiring diagrams, two years' switchgear test and one year shop wiring. Desires position with an operating company which is permanent and has room for advancement. C-6326.

**GRADUATE**, 32, married, who has obtained a B. S. in electrical engineering work. Speaks

Russian (citizen of United States), well acquainted with Manchuria, China. Location, immaterial. C-6290.

**MANUFACTURER'S REPRESENTATIVE.** Desires to represent several manufacturers of electrical machinery and accessories in India. At present employed in electric power supply company. C-6298.

**ELECTRICAL AND MECHANICAL ENGINEERING TEACHER**, with five years' teaching experience and two years' design and research experience with large electrical company. Desires position with manufacturer of gasoline or diesel engines. Has had considerable experience in testing of gasoline engines. Good knowledge of German. Member S. A. E. Available on reasonable notice. B-7830.

**UNIVERSITY GRADUATE**, 35, 15 years' work and sales experience, wishes to represent American firm or firms in British Isles for machinery and apparatus, insulators, materials, etc. Well introduced to largest buyers. Headquarters, London, England, C-6305.

**SALES MANAGER, BRANCH SALES MANAGER, OR SALES ENGINEER**, 42, married, electrical and mechanical engineer, 18 years' practical experience, design, construction, valuation and management of public utilities, and sales of equipment. Location, Middle West or Pacific Coast. C-6327.

**ELECTRICAL ENGINEER**, graduate, 39, married; executive with extensive Latin-American experience. Capable of taking complete field managerial charge operating, construction, public relations, new business, development work along acquisition lines with public utility or holding company with both domestic and foreign properties. Well acquainted Latin American Government requirements. C-761.

**ELECTRICAL ENGINEER**, 29, single, recent graduate. Over six years' experience in motor installations and elevator control board wiring. Desires position with industrial and construction company. Willing to start low, working knowledge of Russian. Location, immaterial. C-6246.

**SYSTEM PLANNING ENGINEER**, single, 29, seven years' experience in system planning, tests, calculations, etc. Desires position with broader opportunities, particularly with company just starting system planning. East or Middle West preferred. Available on reasonable notice. C-6303.

**RECENT GRADUATE**, Electrical Engineer, 1928, desires opportunity with public utility or industrial concern, preferably in preparation for commercial or sales work, and this preferably in the illuminating line. Some public utility experience. Location, Northeast preferred. C-6294.

**EFFICIENCY ENGINEER**, with over 20 years of practical experience in manufacture and electrical laboratory, desires position in close contact with chief executive and accounting department to establish an original system for developing the personnel efficiency as well as that of the mechanical equipment. C-1867.

**ELECTRICAL ENGINEER**, 28, married, wishes engineering economic work with utility, consulting engineer, or financial firm. Well trained engineering, economics. Practical experience varied to obtain thorough grounding chosen field. Two years survey, construction, Westinghouse graduate course, one year public utility valuation, two years plant installation, operation, management. Location, United States. C-3082.

**ELECTRICAL ENGINEER**, B. S. 1921, one year as inspector and assistant research engineer on cables, seven years as electrical designer of substations, power house, oil and copper refineries. Desires position in New York City or Newark, N. J. C-5473.

**ELECTRICAL ENGINEER**, university graduate, 36. Wide knowledge of electrification including generation, substations, distribution, motor application, control, lighting, etc., as applied to mining, cement mills, and other industries. Experience covers estimates, design and layout, construction and maintenance. Desires to correspond with large industrial concern requiring the services of a man of above qualifications. B-9113.

**ELECTRICAL ENGINEER**, 20 years' experience on construction work, design and appraisals, as foreman and engineer in charge. At present employed as construction engineer. Available on short notice with best of references. C-6347.

**JUNIOR ELECTRICAL ENGINEER**, 25, Rousselaer Polytechnic Institute 1926. Three years' experience with large public utility in general and acceptance tests of equipment and materials. In supervisory capacity for the past 18 months. Would like a position in general or electrical engineering or sales with good opportunity for advancement. C-2667.

# MEMBERSHIP—Applications, Elections, Transfers, Etc.

## RECOMMENDED FOR TRANSFER

The Board of Examiners, at its meeting held July 31, 1929, recommended the following members for transfer to the grade of membership indicated. Any objection to these transfers should be filed at once with the National Secretary.

### To Grade of Fellow

MONTSINGER, V. M., Research and Development Engineer, General Electric Co., Pittsfield, Mass.  
 YORKE, GEORGE M., Vice-President in charge of Engineering, Western Union Telegraph Co., New York, N. Y.

### To Grade of Member

ALBRECHT, AUGUST H., Electrical Engineer, Standard Oil Co. of Calif., Whittier, Calif.  
 BARRY, EDWARD J., Electrical Engineer, Perkins Building, Tacoma, Washington.  
 BOWLES, EDWARD L., Associate Professor, Mass. Inst. of Tech., Cambridge, Mass.  
 BROKAW, Electrical Engineer, Eastern Oregon Light and Power Co., Baker, Oregon.  
 CAMPBELL, WALTER W., Manager and Owner, Industrial Electric Service Co., Aberdeen, Wash.  
 CHANDEYSSON, PIERRE I., President, Chan-deysson Elec. Co., St. Louis, Mo.  
 CHARLEY, REGINALD M., Manager, Transformer Dept., The English Elec. Co. Ltd., Stafford, England.  
 ERICKSON, JOHN R., Foreman, General Electric Co., Erie, Pa.  
 ERSKINE, HARRY E., Instructor, Wentworth Institute and Franklin Union, Boston, Mass.  
 EVANS, WILLARD M., Automatic Control Supervisor, Duquesne Light Co., Pittsburgh, Pa.  
 FRANKEL, MORTIMER, President, Audiola Radio Co., Chicago, Ill.  
 HATCH, PHILIP H., Engineer of Automotive Equipment, N. Y., N. H. & H. R. R., New Haven, Conn.  
 HERZOG, EUGENE, Electrical Test Engineer, State Line Generating Co., Chicago, Ill.  
 HIGGINS, WARREN S., Teacher, Georgia School of Technology, Atlanta, Ga.  
 HILL, ARTHUR P., Engineer, Southern Calif. Tel. Co., Los Angeles, Calif.  
 HOLMGREN, VIKING R., General Electric Co., Lynn, Mass.  
 HUGHES, CALVIN T., Design Engineer, Conn. Lt. & Pr. Co., Waterbury, Conn.  
 JANES, LEONARD R., Development Engineer, Public Service Co. of No. Illinois, Chicago, Ill.  
 KELLY, NICHOLAS J., Chief Engineer of Light and Power, Dept. Water Supply, Gas and Electricity, New York, N. Y.  
 LEONARD, ALTON W., President, Puget Sound Power & Light Co., Seattle, Wash.  
 OWENS, THURSTON D., Asst. Prof. of Elec. Engg., Case School of Applied Science, Cleveland, Ohio.  
 REID, MATTHEW, Resident Electrical Engineer, St. George County Council, Kogarah, Sydney, N. S. W., Australia.  
 RUTAN, EVERETT J., Supt. Test Dept., New York Edison Co., New York, N. Y.  
 SCHREGARDUS, W. F., General Plant Supervisor, Northwestern Bell Telephone Co., St. Louis, Mo.  
 SHAND, ERROL B., Electrical Engineer, Westinghouse Elec. & Mfg. Co., E. Pittsburgh, Pa.  
 SINCLAIR, CARROLL T., Electrical Engineer, Bylesby Engg. & Mgt. Corp., Pittsburgh, Pa.  
 SMITH, ROBERT C., Chief Civil and Electrical Engineer, Public Service Dept., Glendale, Calif.

STOUT, MELVILLE B., Asst. Prof. of Elec. Engg., University of Michigan, Ann Arbor, Mich.  
 TURNER, HAROLD L., Asst. Engr., New England Power Co., Boston, Mass.  
 WADDICOR, HAROLD, Chartered Electrical Engineer, Wembley, England.  
 WILLS, GEORGE M., General Supt., The Southern Sierras Power Company, Riverside, Calif.  
 WOOD, LEON F., Toll Fundamental Plan Engr., Northwestern Bell Telephone Co., Des Moines, Iowa.

## APPLICATIONS FOR ELECTION

Applications have been received by the Secretary from the following candidates for election to membership in the Institute. Unless otherwise indicated, the applicant has applied for admission as an Associate. If the applicant has applied for direct admission to a grade higher than Associate, the grade follows immediately after the name. Any member objecting to the election of any of these candidates should so inform the Secretary before September 30, 1929.

Absolon, L. F., Westinghouse Elec. & Mfg. Co., New York, N. Y.  
 Bacher, J., Brooklyn Edison Co., Brooklyn, N. Y.  
 Beardsley, W. P., Altoona & Logan Valley Electric Railway Co., Altoona, Pa.  
 Bellaschi, P. L., Westinghouse Elec. & Mfg. Co., Sharon, Pa.  
 Brewer, N. E., United Electric Service Co., Abilene, Kans.  
 Cohn, N., Leeds & Northrup Co., Philadelphia, Pa.  
 Cole, C. M., 1814 Grove St., Berkeley, Calif. (Applicant for re-election.)  
 Deckman, F. H., Columbia Engineering & Management Corp., Columbus, Ohio  
 Eich, F. L., Electrical Research Products, Inc., Hollywood, Calif.  
 Elder, R. W., Edison Electric Illuminating Co. of Boston, Boston, Mass.  
 Falkenstein, L. F., New York Edison Co., New York, N. Y.  
 Fernando, K. A., United Electric Light & Power Co., New York, N. Y.  
 Gieszczykiewicz, S., Chicago Central Station Institute, Chicago, Ill.  
 Grobe, H. J., New York Electrical Contractors Assn., New York, N. Y.  
 Higgins, R. E., Western Union Ticker Dept., Los Angeles, Calif.  
 Hilliard, J. K., (Member), United Artists Studio Corp., Hollywood, Calif.  
 Johnsen, R. T., Solvay Process Co., Syracuse, N. Y.  
 Kilmer, T. W., Jr., New York Telephone Co., New York, N. Y.  
 Kurz, H., Westinghouse Elec. & Mfg. Co., New York, N. Y.  
 Luedeke, H. A., Western Electric Co., Kearny, N. J.  
 MacLoskey, J. W., Electrical Testing Laboratories, New York, N. Y.  
 Mills, G. H., Case School of Applied Science, Cleveland, Ohio  
 Miskela, E. J., Western Electric Co., Kearny, N. J.  
 Muehter, M. W., Signal Engineering & Manufacturing Co., New York, N. Y.  
 Norton, R. H., Southern California Edison Co., Big Creek, Calif.  
 Pirrung, J. A., Brooklyn Edison Co., Brooklyn, N. Y.  
 Plant, C., Public Service Electric & Gas Co., Newark, N. J.  
 Pomeroy, J. G., (Member), U. S. Navy, Bureau of Engineering, Washington, D. C.

Renshaw, D. E., (Member), Westinghouse Elec. & Mfg. Co., East Pittsburgh, Pa.  
 Schmal, C. L., Illinois Testing Laboratories, Inc., Chicago, Ill.  
 Schug, H. L., Cornell University, Ithaca, N. Y.  
 Shively, E. K., Union Electric Light & Power Co., St. Louis, Mo.  
 Stockton, H. M., Dallas Power & Light Co., Dallas, Texas  
 Swingle, D. R., Hedges, Walsh, Weidner Co., Chattanooga, Tenn.  
 Terpening, L. H., Fox-Case Corp., New York, N. Y.

Terrell, T. F., (Member), Birmingham Tank Co., North Birmingham, Ala.  
 Wallace, B. W., Toledo Edison Co., Toledo, Ohio  
 Weiss, D., Midwest Electric Service, Casper, Wyoming  
 Total 38.

## Foreign

Anschau, J., New South Wales Government Railways & Tramways, Sydney, Australia  
 Barton, C. A., The Rio de Janeiro Tramway Lt. & Pr. Co., Ltd., Rio de Janeiro, Brazil, So. America  
 Biais, B. T., Buenos Aires University, Buenos Aires, Argentina, So. America  
 Chantrill, R. L., British Thomson-Houston Co., Ltd., Willesden, London, Eng.  
 Fernando, E. A., 112 Gower St., London, W. C. 1, Eng.  
 Gilbert, W., Bombay Boroda and Central India Railway, Borivlee P. O., India  
 Payne, C. C., Riegos y Fuerza del Ebro S. A. & Energia Electrica de Cataluna, S. A., Barcelona, Spain  
 Siebert, T. F., (Member), The Uitenhage Municipality, Uitenhage, South Africa  
 White, T. G., Westcliffe Radio Service & Electrical Co., Westcliff-on-Sea, Essex, Eng.  
 Wright, L. D., Municipal Council of Sydney, Sydney, Australia  
 Total 10.

## STUDENTS ENROLLED

Allen, Henry O., Worcester Polytechnic Institute  
 Deck, Harold, University of New Mexico  
 Gross, Morris H., Michigan College of Mining & Technology  
 Gruber, Norman L., Michigan College of Mining & Technology  
 Hanlon, Pat. H., University of Notre Dame  
 Komerska, Frank J., Michigan College of Mining & Technology  
 Kramer, Howard H., Michigan College of Mining & Technology  
 Ledesma, Montano C., Engineering School of Milwaukee  
 Little, George R., University of Southern Calif.  
 McCanna, F. James, State College of Washington  
 Nelson, Lewis N., North Dakota Agricultural College  
 Rowell, Irving H., University of Washington  
 Sawin, George A., Jr., Harvard University  
 Sawyer, Charles F., Michigan College of Mining & Technology  
 Schweitzer, William, Detroit Inst. of Technology  
 South, Ben J., University of Notre Dame  
 Stroyny, Ferdynand M. W., Worcester Polytechnic Institute  
 Thompson, Loren B., Drexel Institute  
 Vers, Joseph Jr., University of Detroit  
 Waisanen, Walter F., Michigan College of Mining & Technology  
 Wyman, Arthur W., Northeastern University  
 Yeomans, Richard H., McGill University  
 Total 22.



**Officers A. I. E. E. 1929-1930**

**PRESIDENT**  
(Term expires July 31, 1930)  
**HAROLD B. SMITH**

**JUNIOR PAST PRESIDENTS**  
(Term expires July 31, 1930) **BANCROFT GHERARDI**  
(Term expires July 31, 1931) **R. F. SCHUCHARDT**

**VICE-PRESIDENTS**  
(Terms expire July 31, 1930) **E. B. MERRIAM** (District No. 1)  
**H. A. KIDDER** (District No. 3)  
**W. T. RYAN** (District No. 5)  
**B. D. HULL** (District No. 7)  
**G. E. QUINAN** (District No. 9)

(Terms expire July 31, 1931) **HERBERT S. EVANS** (District No. 6)  
**W. S. RODMAN** (District No. 4)  
**C. E. FLEAGER** (District No. 8)  
**E. C. STONE** (District No. 2)  
**C. E. SISSON** (District No. 10)

**DIRECTORS**  
(Terms expire July 31, 1930) **I. E. MOULTROP**  
**H. C. DON CARLOS**  
**F. J. CHESTERMAN**  
(Terms expire July 31, 1931) **F. C. HANKER**  
**E. B. MEYER**  
**H. P. LIVERSIDGE**

(Terms expire July 31, 1932) **J. ALLEN JOHNSON**  
**A. M. MACCUTCHEON**  
**A. E. BETTIS**  
(Terms expire July 31, 1933) **W. S. LEE**  
**J. E. KEARNS**  
**C. E. STEPHENS**

**NATIONAL TREASURER**  
(Terms expire July 31, 1930) **GEORGE A. HAMILTON**

**NATIONAL SECRETARY**  
**F. L. HUTCHINSON**

**HONORARY SECRETARY**  
**RALPH W. POPE**

**GENERAL COUNSEL**  
**PARKER & AARON**  
30 Broad Street, New York

**PAST PRESIDENTS—1884-1929**

*NORVIN GREEN, 1884-5-6.	LOUIS A. FERGUSON, 1908-9.
*FRANKLIN L. POPE, 1886-7.	LEWIS B. STILLWELL, 1909-10.
*T. COMMERFORD MARTIN, 1887-8.	DUGALD C. JACKSON, 1910-11.
EDWARD WESTON, 1888-9.	GANO DUNN, 1911-12.
ELIHU THOMSON, 1889-90.	RALPH D. MERSHON, 1912-13.
*WILLIAM A. ANTHONY, 1890-91.	C. O. MAILLOUX, 1913-14.
*ALEXANDER GRAHAM BELL, 1891-2.	PAUL M. LINCOLN, 1914-15.
FRANK JULIAN SPRAGUE, 1892-3.	JOHN J. CARTY, 1915-16.
*EDWIN J. HOUSTON, 1893-4-5.	H. W. BUCK, 1916-17.
*LOUIS DUNCAN, 1895-6-7.	E. W. RICE, JR., 1917-18.
*FRANCIS BACON CROCKER, 1918-19	COMFORT A. ADAMS, 1918-19.
A. E. KENNELLY, 1898-1900.	CALVERT TOWNLEY, 1919-20.
*CARL HERING, 1900-1.	A. W. BERRESFORD, 1920-21.
*CHARLES P. STEINMETZ, 1901-2.	WILLIAM MCCLELLAN, 1921-22.
CHARLES F. SCOTT, 1902-3.	FRANK B. JEWETT, 1922-23.
BION J. ARNOLD, 1903-4.	HARRIS J. RYAN, 1923-24.
JOHN W. LIEB, 1904-5.	FARLEY OSGOOD, 1924-25.
*SCHUYLER SKAATS WHEELER, 1905-6.	M. I. PUPIN, 1925-26.
*SAMUEL SHELDON, 1906-7.	C. C. CHESNEY, 1926-27.
*HENRY G. STOTT, 1907-8.	BANCROFT GHERARDI, 1927-28.
*Deceased.	R. F. SCHUCHARDT, 1928-29.

**LOCAL HONORARY SECRETARIES**

T. J. Flenting, Calle B. Mitre 519, Buenos Aires, Argentina, S. A.  
H. W. Flashman, Aus. Westinghouse Elec. Co. Ltd., Cathcart House, 11 Castlereagh St., Sydney, N. S. W., Australia.  
Frederick M. Servos, Rio de Janeiro Tramways Lt. & Pr. Co., Rio de Janeiro, Brazil, S. A.  
A. P. M. Fleming, Metropolitan Vickers Elec. Co., Trafford Park, Manchester, England  
A. S. Garfield, 45 Bd. Beausejour, Paris 16 E., France.  
F. W. Willis, Tata Power Companies, Bombay House, Bombay, India.  
Guido Semenza, 39 Via Monte Napoleone, Milan, Italy.  
P. H. Powell, Canterbury College, Christchurch, New Zealand.  
M. Chatelain, Lesnoi Polytechnic Institute, Apt. 27, Leningrad, U. S. S. R.  
Axel F. Enstrom, 24a Greitregatan, Stockholm, Sweden.  
W. Elsdon-Dew, P. O. Box 4563, Johannesburg, Transvaal, Africa.

**A. I. E. E. Committees**

**GENERAL STANDING COMMITTEES**

**EXECUTIVE COMMITTEE**  
Harold B. Smith, Chairman, Worcester Polytechnic Institute, Worcester, Mass.  
F. J. Chesterman, G. A. Hamilton, H. A. Kidder,  
Bancroft Gherardi, J. Allen Johnson, E. B. Meyer.

**FINANCE COMMITTEE**  
E. B. Meyer, Chairman, 80 Park Place, Newark, N. J.  
H. A. Kidder, C. E. Stephens.

**MEETINGS AND PAPERS COMMITTEE**  
A. E. Knowlton, Chairman, Dunham Laboratory, Yale University, New Haven, Conn.  
E. H. Hubert, Secretary, 33 W. 39th St., New York, N. Y.  
V. Bush, H. A. Kidder, C. E. Skinner,  
H. P. Charlesworth, L. W. W. Morrow, H. R. Woodrow,  
W. H. Harrison, T. A. Worcester.  
Chairman of Committee on Coordination of Institute Activities, *ex-officio*.  
Chairmen of Technical Committees, *ex-officio*.

**PUBLICATION COMMITTEE**

W. S. Gorsuch, Chairman, 600 W. 59th Street, New York, N. Y.  
H. P. Charlesworth, F. L. Hutchinson, E. B. Meyer,  
A. E. Knowlton,

**COMMITTEE ON COORDINATION OF INSTITUTE ACTIVITIES**

H. A. Kidder, Chairman, 600 W. 59th Street, New York, N. Y.  
W. S. Gorsuch, A. E. Knowlton, E. B. Meyer,  
F. L. Hutchinson, W. B. Kouwenhoven, L. F. Morehouse.

**BOARD OF EXAMINERS**

E. H. Everit, Chairman, Southern New England Tel. Co., New Haven, Conn.  
J. T. Barron, S. P. Graco, L. W. W. Morrow,  
F. J. Chesterman, Erich Hausmann, A. L. Powell,  
H. W. Drake, A. H. Kehoe, S. D. Sprong,  
H. Goodwin, Jr., George Sutherland.

**SECTIONS COMMITTEE**

W. B. Kouwenhoven, Chairman, Johns Hopkins University, Baltimore, Md.  
E. S. Lee, W. S. Rodman, W. H. Timbie,  
I. M. Stein,  
Chairmen of Sections, *ex-officio*.

**COMMITTEE ON STUDENT BRANCHES**

W. H. Timbie, Chairman, Massachusetts Institute of Technology, Cambridge Mass.  
J. L. Beaver, Edward Bennett, Charles F. Scott,  
Herbert S. Evans,  
Counselors of Student Branches, *ex-officio*.

**MEMBERSHIP COMMITTEE**

J. Allen Johnson, Chairman, Niagara Falls Power Co., Niagara Falls, N. Y.  
*Vice-Chairmen*  
E. F. Gehrckens, George J. Yundt, D. I. Cone,  
R. L. Kirk, S. H. Mortensen, C. E. Carey,  
C. R. Jones, Herbert B. Dwight, E. M. Wood,  
James Harrison,  
*Ex-Officio*  
Chairmen of Section Membership Committees.

**HEADQUARTERS COMMITTEE**

R. H. Tapscott, Chairman, 124 E. 15th Street, New York, N. Y.  
F. L. Hutchinson, E. B. Meyer.

**LAW COMMITTEE**

L. F. Morehouse, Chairman, 195 Broadway, New York, N. Y.  
L. Beaver, G. L. Knight, E. C. Stone,  
W. I. Slichter.

**PUBLIC POLICY COMMITTEE**

D. C. Jackson, Chairman, 31 St. James Avenue, Boston, Mass.  
C. C. Chesney, F. B. Jewett, Harris J. Ryan,  
Gano Dunn, John W. Lieb, R. P. Schuchardt.

**STANDARDS COMMITTEE**

F. D. Newbury, Chairman, Westinghouse Elec. & Mfg. Co., East Pittsburgh, Pa.  
H. E. Farrer, Secretary, 33 W. 39th St., New York, N. Y.  
C. M. Gilt, J. F. Meyer, L. T. Robinson,  
C. R. Harte, V. M. Montsinger, C. E. Skinner,  
A. M. MacCutcheon, W. I. Slichter.  
*Ex-Officio*  
Chairmen of Working Committees.  
Chairmen of A. I. E. E. delegations on other standardizing bodies.  
President of U. S. National Committee of I. E. C.

**EDISON MEDAL COMMITTEE**

*Appointed by the President for term of five years.*  
(Terms expire July 31, 1930)  
George Gibbs, Samuel Insull, Chairman, Ralph D. Mershon.  
(Terms expire July 31, 1931)  
John W. Howell, L. F. Morehouse, David B. Rushmore.  
(Terms expire July 31, 1932)  
Paul M. Lincoln, C. E. Skinner.  
(Terms expire July 31, 1933)  
C. F. Harding, D. C. Jackson, Elmer A. Sperry.  
(Terms expire July 31, 1934)  
L. W. W. Morrow, W. S. Rugg, R. F. Schuchardt.  
*Elected by the Board of Directors from its own membership for term of two years*  
(Terms expire July 31, 1930)  
B. Gherardi, H. A. Kidder, E. B. Merriam.  
(Terms expire July 31, 1931)  
J. Allen Johnson, W. S. Lee, A. M. MacCutcheon.  
*Ex-Officio*  
Harold B. Smith, President, George A. Hamilton, National Treasurer,  
F. L. Hutchinson, National Secretary.

LAMME MEDAL COMMITTEE

- P. M. Lincoln, (Terms expire July 31, 1930) E. B. Meyer, L. W. W. Morrow.
- H. H. Barnes, Jr., (Terms expire July 31, 1931) Charles F. Scott, Chairman N. W. Storer.
- A. C. Bunker, (Terms expire July 31, 1932) H. P. Charlesworth, C. C. Chesney.

COMMITTEE ON CODE OF PRINCIPLES OF PROFESSIONAL CONDUCT

- F. B. Jewett, Chairman, 195 Broadway, New York, N. Y.
- A. H. Babcock, John W. Lieb, R. F. Schuchardt,
- G. Faccioli, Harris J. Ryan, John B. Whitehead.

COMMITTEE ON COLUMBIA UNIVERSITY SCHOLARSHIPS

- W. I. Slichter, Chairman, Columbia University, New York, N. Y.
- Francis Blossom, H. C. Carpenter.

COMMITTEE ON AWARD OF INSTITUTE PRIZES

- A. E. Knowlton, Chairman, Dunham Laboratory, Yale University, New Haven, Conn.
- H. P. Charlesworth, W. S. Gorsuch, S. M. Kintner.

COMMITTEE ON SAFETY CODES

- A. W. Berresford, Chairman, 1 Fifth Avenue, New York, N. Y.
- A. E. Bettis, J. P. Jackson, R. H. Nexsen,
- Philander Betts, M. G. Lloyd, John D. Noyes,
- L. L. Elden, Wills Maclachlan, F. A. Pattison,
- J. C. Forsyth, F. V. Magalhaes, H. R. Sargent,
- H. B. Gear, R. W. E. Moore, H. S. Warren.

SPECIAL COMMITTEES

ADVISORY COMMITTEE TO THE MUSEUM OF THE PEACEFUL ARTS

- J. P. Jackson, Chairman, 130 East 15th Street, New York, N. Y.
- Randolph H. Nexsen, George K. Thompson.

TECHNICAL COMMITTEES

AUTOMATIC STATIONS

- F. Zogbaum, Chairman, New York Edison Co., 130 E. 15th St., New York, N. Y.
- P. H. Adams, Ernest S. Fields, S. J. Lisberger,
- Caesar Antoniono, Joseph Hellenthal, W. H. Millan,
- L. D. Bale, E. L. Hough, Otto Naef,
- G. O. Brown, Chester Lichtenberg, L. J. Turley,
- H. C. Don Carlos, R. J. Wensley.

COMMUNICATION

- G. A. Kositzky, Chairman, Ohio Bell Telephone Co., 750 Huron Road, Cleveland, Ohio.
- G. R. Benjamin, R. D. Evans, J. L. Niesse,
- W. H. Capen, E. H. Everit, H. S. Osborne,
- H. P. Charlesworth, D. H. Gage, R. D. Parker,
- F. J. Chesterman, S. P. Grace, F. A. Raymond,
- J. L. Clarke, Erich Hausmann, J. K. Roosevelt,
- R. N. Conwell, H. L. Huber, H. A. Shepard,
- B. R. Cummings, Ray H. Manson, H. M. Turner,
- H. W. Drake, J. W. Milnor, F. A. Wolff.

EDUCATION

- Edward Bennett, Chairman, University of Wisconsin, Madison, Wis.
- H. H. Henline, Secretary, 33 W. 39th St., New York, N. Y.
- M. W. Alexander, W. B. Hartshorne, W. T. Ryan.
- E. W. Allen, E. A. Loew, R. F. Schuchardt,
- E. J. Berg, A. H. Lovell, G. B. Thomas,
- P. S. Biegler, J. H. Morecroft, W. H. Timbie,
- H. W. Buck, H. S. Osborne, W. E. Wickenden,
- H. E. Dyche, J. C. Parker, C. C. Whipple,
- O. J. Ferguson, H. W. Price, W. R. Work,
- W. S. Rugg,

ELECTRICAL MACHINERY

- Philip L. Alger, Chairman, General Electric Co., Schenectady, N. Y.
- E. B. Paxton, Secretary.
- L. F. Adams, A. L. Harding, V. M. Montsinger.
- B. L. Barns, C. F. Harding, E. L. Moreland,
- W. M. Dann, S. L. Henderson, F. D. Newbury,
- H. B. Dwight, J. Allen Johnson, R. W. Owens,
- W. J. Foster, H. C. Louis, A. M. Rossman,
- C. M. Gilt, A. M. MacCutcheon, R. B. Williamson,
- W. S. Gorsuch, O. K. Marti, H. L. Zabriskie,
- L. W. McCullough,

ELECTRIC WELDING

- A. M. Candy, Chairman, Westinghouse E. & M. Co., East Pittsburgh, Pa.
- C. A. Adams, H. M. Hobart, A. M. MacCutcheon,
- P. P. Alexander, C. J. Holslag, B. T. Mottinger,
- C. W. Bates, C. L. Ipsen, J. W. Owens,
- Alexander Churchward, J. C. Lincoln, William Spraragen.
- Ernest Lunn,

ELECTROCHEMISTRY AND ELECTROMETALLURGY

- P. H. Brace, Chairman, Westinghouse E. & M. Co., East Pittsburgh, Pa.
- Lawrence Addicks, F. C. Hanker, H. Speight,
- A. N. Anderson, W. E. Holland, Magnus Unger,
- T. C. Atchison, S. A. Huntington, G. W. Vinal,
- Parley G. Clark, F. A. Lidbury, J. B. Whitehead,
- S. K. Colby, R. G. Mansfield, E. A. Williford,
- F. A. J. Fitzgerald, C. G. Schluederberg, J. L. Woodbridge,
- J. C. Hale, J. A. Seede, C. D. Woodward,
- C. E. Sisson,

ELECTROPHYSICS

- O. E. Buckley, Chairman, 463 West Street, New York, N. Y.
- V. Bush, W. B. Kouwenhoven, H. Nyquist,
- W. P. Davidson, G. M. J. Mackay, W. S. Rodman,
- C. L. Fortescue, K. B. McEachron, J. Slepian,
- A. Hund, R. A. Millikan, F. E. Terman,
- Liaison Representatives of American Physical Society:*  
Professor Leigh Page, Dr. W. F. G. Swann.

GENERAL POWER APPLICATIONS

- J. F. Gaskill, Chairman, Philadelphia Electric Co., 1000 Chestnut St., Philadelphia, Pa.
- D. H. Braymer, E. W. Henderson, H. W. Price,
- C. W. Drake, P. C. Jones, N. R. Stansel,
- C. W. Falls, A. M. MacCutcheon, E. C. Stone,
- Clyde D. Gray, N. L. Mortensen, W. H. Timbie,
- C. Francis Harding, D. M. Petty, M. R. Woodward.

INSTRUMENTS AND MEASUREMENTS

- Everett S. Lee, Chairman, General Electric Co., Schenectady, N. Y.
- O. J. Bliss, W. N. Goodwin, Jr., F. A. Laws,
- Perry A. Borden, F. C. Holtz, T. E. Penard,
- W. M. Bradshaw, J. Allen Johnson, R. T. Pierce,
- H. B. Brooks, I. F. Kinnard, E. J. Rutan,
- A. L. Cook, A. E. Knowlton, G. A. Sawin,
- E. D. Doyle, H. C. Koenig, R. W. Sorensen,
- Melville Eastham, W. B. Kouwenhoven, H. M. Turner.

APPLICATIONS TO IRON AND STEEL PRODUCTION

- M. M. Fowler, Chairman, General Electric Co., 230 S. Clark St., Chicago, Ill.
- A. C. Bunker, A. M. MacCutcheon, G. E. Stoltz,
- F. B. Crosby, A. G. Pierce, Wilfred Sykes,
- A. C. Cummins, F. O. Schnure, T. S. Towle,
- S. L. Henderson, W. B. Shirk, J. D. Wright.

PRODUCTION AND APPLICATION OF LIGHT

- George S. Merrill, Chairman, Nela Park, Cleveland, Ohio.
- J. W. Barker, E. E. Dorting, P. S. Millar,
- W. T. Blackwell, L. A. Hawkins, W. T. Ryan,
- H. S. Broadbent, H. H. Higbie, B. E. Shackelford,
- J. M. Bryant, W. C. Kalb, C. J. Stahl,
- W. T. Dempsey, C. L. Kinsloe, G. H. Stickney.

APPLICATIONS TO MARINE WORK

- W. E. Thau, Chairman, Westinghouse Elec. & Mfg. Co., 150 Broadway, New York, N. Y.
- R. A. Beekman, Vice-Chairman.
- J. L. Wilson, Secretary.
- Edgar C. Alger, H. L. Hibbard, Edgar P. Slack,
- H. C. Coleman, A. Kennedy, Jr., H. M. Southgate,
- E. M. Glasgow, J. B. Lunsford, A. E. Waller,
- H. F. Harvey, Jr., E. B. Merriam, Oscar A. Wilde,
- C. J. Henschel, I. H. Osborne, R. L. Witham,
- Wm. Hetherington, Jr., G. A. Pierce, W. N. Zippler,
- W. H. Reed,

APPLICATIONS TO MINING WORK

- Carl Lee, Chairman, 1652 McCormick Building, Chicago, Ill.
- A. R. Anderson, E. J. Gealy, S. O. Miller,
- Graham Bright, L. C. Ilsley, W. F. Schwedes,
- John H. Edwards, J. E. Kearns, F. L. Stone,
- Frank E. Fisher, W. H. Lesser, J. F. Wiggert.

POWER GENERATION

- F. A. Allner, Chairman, Pennsylvania Water & Power Co., Lexington Building, Baltimore, Md.
- J. W. Andres, F. H. Hollister, I. E. Moulthrop,
- H. W. Brooks, A. H. Hull, F. A. Scheffler,
- J. B. Crane, J. H. Lawrence, A. E. Silver,
- N. E. Funk, W. S. Lee, W. F. Sims,
- W. S. Gorsuch, F. T. Leilich, Arthur R. Smith,
- F. C. Hanker, H. W. Leitch, E. C. Stone,
- C. F. Hirshfeld, E. B. Meyer, R. W. Stovel,
- E. L. Moreland,

**POWER TRANSMISSION AND DISTRIBUTION**

H. R. Woodrow, Chairman, Brooklyn Edison Co., Pearl & Willoughby, Sts., Brooklyn, N. Y.  
 P. H. Chase, Vice-Chairman, Philadelphia, Pa.  
 R. E. Argersinger, R. D. Evans, A. E. Silver,  
 R. W. Atkinson, F. M. Farmer, C. T. Sinclair,  
 E. T. J. Brandon, J. H. Foote, L. G. Smith,  
 A. B. Campbell, K. A. Hawley, Philip Sporn,  
 R. N. Conwell, D. C. Jackson, Jr., H. C. Sutton,  
 O. G. C. Dahl, A. H. Lawton, Percy H. Thomas,  
 H. C. Dean, L. L. Perry, H. S. Warren,  
 E. W. Dillard, T. F. Peterson, R. J. C. Wood,  
 L. L. Elden, G. E. Quinan, T. A. Worcester,  
 D. W. Roper.

**PROTECTIVE DEVICES**

E. A. Hester, Chairman, 435 Sixth Ave., Pittsburgh, Pa.  
 L. E. Frost, Secretary  
 J. E. Allen, H. Halperin, N. L. Pollard,  
 Raymond Bailey, F. C. Hanker, A. M. Rossman,  
 A. C. Cummins, J. Allen Johnson, A. H. Schirmer,  
 H. W. Drake, M. G. Lloyd, H. P. Sleeper,  
 W. S. Edsall, J. B. MacNeill, R. M. Spurck,  
 E. S. Fields, J. P. McKearin, E. R. Stauffacher,  
 E. E. George, R. C. Muir, H. R. Summerhayes.

**RESEARCH**

S. M. Kintner, Chairman, Research Dept., Westinghouse E. & M. Co., East Pittsburgh, Pa.  
 H. D. Arnold, W. P. Dobson, Chester W. Rice,  
 Edward Bennett, F. M. Farmer, D. W. Roper,  
 V. Bush, J. Allen Johnson, R. W. Sorensen,  
 E. H. Colpitts, V. Karapetoff, T. Spooner,  
 E. C. Crittenden, A. E. Kennelly, T. S. Taylor,  
 W. F. Davidson, F. W. Peek, Jr., John B. Whitehead.

**TRANSPORTATION**

Sidney Withington, Chairman, N. Y., N. H. & H. R. R. Co., New Haven, Conn.  
 Reinier Beeuwkes, W. K. Howe, A. S. Richey,  
 A. E. Bettis, D. C. Jackson, N. W. Storer,  
 J. V. B. Duer, John Murphy, W. M. Vandersluis,  
 H. H. Field, W. S. Murray, H. M. Warren,  
 K. T. Healy, W. B. Potter, Richard H. Wheeler,  
 E. R. Hill, Ralph H. Rice, G. I. Wright.

**A. I. E. E. Representatives**

**ALFRED NOBLE PRIZE COMMITTEE**

H. P. Charlesworth.

**AMERICAN ASSOCIATION FOR THE ADVANCEMENT OF SCIENCE COUNCIL**

Edward Bennett O. J. Ferguson.

**AMERICAN BUREAU OF WELDING**

H. M. Hobart.

**AMERICAN COMMITTEE ON ELECTROLYSIS**

B. J. Arnold, N. A. Carle, F. N. Waterman.

**AMERICAN ENGINEERING COUNCIL ASSEMBLY**

H. H. Barnes, Jr., \*M. M. Fowler, \*Farley Osgood,  
 A. W. Berresford, F. L. Hutchinson, E. W. Rice, Jr.,  
 C. O. Bickelhaupt, \*H. A. Kidder, \*R. F. Schuchardt,  
 C. C. Chesney, William McClellan, Charles F. Scott,  
 F. J. Chesterman, L. F. Morehouse, \*C. E. Skinner,  
 \*John H. Finney, I. E. Moulthrop, Calvert Townley.  
 \*Representatives on Administrative Board.

**AMERICAN MARINE STANDARDS COMMITTEE**

R. A. Beekman

**AMERICAN STANDARDS ASSOCIATION**

F. D. Newbury, John C. Parker, L. T. Robinson,  
 H. H. Henline, H. M. Hobart, H. S. Osborne, Alternates.

**AMERICAN YEAR BOOK, ADVISORY BOARD**

Henry H. Henline

**BOARD OF TRUSTEES, UNITED ENGINEERING SOCIETY**

H. P. Charlesworth, H. A. Kidder, G. L. Knight.

**CHARLES A. COFFIN FELLOWSHIP AND RESEARCH FUND COMMITTEE**

Harold B. Smith

**COMMITTEE OF APPARATUS MAKERS AND USERS, NATIONAL RESEARCH COUNCIL**

C. E. Skinner

**COMMITTEE ON ELIMINATION OF FATIGUE, SOCIETY OF INDUSTRIAL ENGINEERS**

C. Francis Harding

**COMMITTEE ON HEAT TRANSMISSION, NATIONAL RESEARCH COUNCIL**

T. S. Taylor

**ENGINEERING FOUNDATION BOARD**

Gano Dunn, L. B. Siltwell.

**JOHN FRITZ MEDAL BOARD OF AWARD**

C. C. Chesney, Bancroft Gherardi, R. F. Schuchardt,  
 M. I. Pupin.

**JOINT COMMITTEE ON WELDED RAIL JOINTS**

D. D. Ewing, A. P. Way.

**JOINT CONFERENCE COMMITTEE OF FOUNDERS SOCIETIES**

The Presidents and Secretaries, *ex-officio*.

**LIBRARY BOARD OF UNITED ENGINEERING SOCIETY**

Edward D. Adams, F. L. Hutchinson, W. I. Slichter,  
 W. B. Jackson.

**NATIONAL FIRE PROTECTION ASSOCIATION, ELECTRICAL COMMITTEE**

A. W. Berresford.

**NATIONAL FIRE WASTE COUNCIL**

John H. Finney, A. W. Berresford.

**NATIONAL RESEARCH COUNCIL, ENGINEERING DIVISION**

F. B. Jewett, S. M. Kintner, F. W. Peek, Jr.,  
 F. L. Hutchinson, *ex-officio*.

**NATIONAL SAFETY COUNCIL, ELECTRICAL COMMITTEE A. S. S. E.—ENGINEERING SECTION**

A. W. Berresford

**THE NEWCOMEN SOCIETY**

**RADIO ADVISORY COMMITTEE, BUREAU OF STANDARDS**

A. E. Kennelly

**SOCIETY FOR THE PROMOTION OF ENGINEERING EDUCATION BOARD OF INVESTIGATION AND COORDINATION**

Gano Dunn, Frank B. Jewett.

**U. S. NATIONAL COMMITTEE OF THE INTERNATIONAL COMMISSION ON ILLUMINATION**

A. E. Kennelly, C. O. Mailloux, Clayton H. Sharp.

**U. S. NATIONAL COMMITTEE OF THE INTERNATIONAL ELECTROTECHNICAL COMMISSION**

E. W. Allen, F. V. Magalhaes, L. T. Robinson,  
 W. A. Del Mar, C. O. Mailloux, D. W. Roper,  
 Gano Dunn, William McClellan, C. H. Sharp,  
 F. C. Hanker, E. B. Meyer, (*ex-officio*) C. E. Skinner,  
 C. R. Harte, J. F. Meyer, W. I. Slichter,  
 H. M. Hobart, F. D. Newbury, (*ex-officio*) Harold B. Smith,  
 (*ex-officio*)  
 D. C. Jackson, H. S. Osborne, A. R. Stevenson, Jr.,  
 F. B. Jewett, Farley Osgood, N. W. Storer,  
 A. E. Kennelly, F. W. Peek, Jr., Elihu Thomson,  
 John W. Lieb, E. W. Rice, Jr., John W. Upp.

**WASHINGTON AWARD, COMMISSION OF**

L. A. Ferguson, Charles F. Scott.

LIST OF SECTIONS

Name	Chairman	Secretary	Name	Chairman	Secretary
Akron	W. A. Hillebrand	R. R. Krammes, The Ohio Power Co., Canton, O.	Niagara Frontier	Raymond T. Henry	E. P. Harder, Buffalo General Elec. Co., 205 Electric Bldg., Buffalo, N. Y.
Atlanta	H. L. Wills	W. P. Bellinger, Electric & Gas Bldg., Atlanta, Ga.	North Carolina	E. P. Coles	Marshall E. Lake, Duke Pr. Co., Power Bldg., Charlotte, N. C.
Baltimore	W. B. Kouwenhoven	G. S. Diehl, Pa. Water & Pwr. Co., 1611 Lexington Bldg., Baltimore, Md.	Oklahoma City	C. Walker Mier	C. T. Almquist, Univ. of Oklahoma, Norman, Okla.
Birmingham	R. W. Lamar	O. E. Charlton, Alabama Power Co., Birmingham, Ala.	Panama		
Boston	W. H. Colburn	G. J. Crowdes, Simplex Wire & Cable Co., Sidney St., Cambridge, Mass.	Philadelphia	R. H. Silbert	J. L. MacBurney, Elec. Storage Battery Co., 1855 Hunting Park Ave., Philadelphia, Pa.
Chicago	T. G. LeClair	F. R. Innes, c/o Electrical World, 7 So. Dearborn St., Chicago, Ill.	Pittsburgh	J. A. Cadwallader	C. T. Sinclair, Byllesby Engg. & Mngmt. Corp., 435 Sixth Ave., Pittsburgh, Pa.
Cincinnati	T. C. Reed	L. L. Bosch, Columbia Engg. & Mgmt. Corp., 314 West 4th St., Cincinnati, O.	Pittsfield	L. T. Blaine	L. H. Burnham, General Electric Co., Pittsfield, Mass.
Cleveland	T. D. Owens	Wm. H. LaMond, Simplex Wire & Cable Co., 2019 Union Trust Bldg., Cleveland, O.	Portland, Ore.	H. H. Cake	A. H. Kreul, Portland Elec. Pr. Co., Hawthorne Bldg., Portland, Ore.
Columbus	W. E. Metzger	R. A. Brown, 87 E. Dunedin Rd., Columbus, O.	Providence	F. W. Smith	O. W. Briden, Blackstone Valley Gas & Elec. Co., Pawtucket, R. I.
Connecticut	E. J. Amberg	R. G. Warner, Yale Univ., New Haven, Conn.	Rochester	Virgil M. Graham	Charles F. Estwick, General Railway Signal Co., Rochester, N. Y.
Dallas	J. B. Thomas	A. Chetham-Strode, Dallas Pwr. & Light Co., Interurban Bldg., Dallas, Texas	St. Louis	G. H. Quermann	O. J. Rotty, Union Elec. Lt. & Pr. Co., 315 No. 12th Blvd., St. Louis, Mo.
Denver	W. H. Bullock	N. R. Love, 807 Tramway Bldg., Denver, Colo.	San Francisco	L. F. Fuller	G. Ross Henninger, Electrical West, 883 Mission St., San Francisco, Cal.
Detroit-Ann Arbor	L. F. Hickernell	T. N. Lacy, Michigan Bell Tel. Co., 1365 Cass Ave., Detroit, Mich.	Saskatchewan	J. R. Cowley	A. B. Coward, Light & Power Dept., Regina, Sask., Canada
Erie	W. H. Pelton	Geo. I. LeBaron, General Electric Co., Erie, Pa.	Schenectady	E. S. Lee	E. E. Johnson, Rm. 435, Bldg. 2, General Electric Co., Schenectady, N. Y.
Fort Wayne	F. W. Merrill	E. J. Schaefer, General Electric Co., Ft. Wayne, Ind.	Seattle	L. N. Robinson	George S. Smith, Elec. Engg. Dept., University of Washington, Seattle, Wash.
Houston	L. K. Del'Homme	C. D. Farman, Southwestern Bell Tel. Co., Houston, Texas	Sharon	J. B. Gibbs	S. S. Cook, Westinghouse E. & M. Co., Sharon, Pa.
Indianapolis-Laf.	J. R. Bailey	H. M. Stradling, 353 Mass. Ave., Indianapolis, Ind.	Southern Virginia	H. C. Leonard	Cecil Gray, Westinghouse E. & M. Co., 912 Electric Bldg., Richmond, Va.
Ithaca	R. F. Chamberlain	H. H. Race, School of Elec. Engg., Cornell Univ., Ithaca, N. Y.	Spokane	Earl Baughn	C. B. Carpenter, Washington Water Pr. Co., Spokane, Wash.
Kansas City	A. B. Covey	J. S. Palmer, Kansas City Pr. & Lt. Co., 1330 Grand Ave., Kansas City, Mo.	Springfield, Mass.	Fred L. Hunt	B. V. K. French, American Bosch Magneto Corp., Springfield, Mass.
Lehigh Valley	H. D. Baldwin	E. F. Weaver, Pa. Pr. & Lt. Co., 901 Hamilton St., Allentown, Pa.	Syracuse	W. R. McCann	F. E. Verdin, 1206 Hills Bldg., Syracuse, N. Y.
Los Angeles	N. B. Hinson	H. W. Hitchcock, So. Cal. Tel. Co., 740 So. Olive St., Los Angeles, Cal.	Toledo	E. B. Featherstone	Max Neuber, 1257 Fernwood Ave., Toledo, O.
Louisville	H. W. Wischmeyer	Philip P. Ash, Louisville & Nashville Rd. Bldg., 9th & B'way Ave., Louisville, Ky.	Toronto	F. F. Ambuhl	W. F. Sutherland, Toronto Hydroelec. Sys., 225 Yonge St., Toronto, Ont., Canada
Lynn	I. F. Kinnard	H. K. Nock, General Elec. Co., West Lynn, Mass.	Urbana	M. A. Faucett	C. E. Skroder, Univ. of Ill., Urbana, Ill.
Madison	R. E. Purucker	L. C. Larson, Univ. of Wisconsin, Madison, Wis.	Utah	A. C. Kelm	L. B. Fuller, Utah Pr. & Lt. Co., Salt Lake City, Utah
Mexico	P. M. McCullough	F. Aubert, 2 A De Queretaro 22, Mexico City, Mexico	Vancouver	J. Teasdale	D. Robertson, Canadian Gen. Elec. Co., Ltd., Vancouver, B. C., Canada
Milwaukee	E. R. Stoekle	R. R. Knoerr, 553 Milwaukee St., Milwaukee, Wis.	Washington	W. A. E. Doying	G. L. Weller, Chesapeake & Potomac Tel. Co. & Assoc. Cos., 725-13th St., N. W., Washington, D. C.
Minnesota	V. E. Engquist	Oscar Gaarden, Northern States Pr. Co., 15 S. 5th St., Minneapolis, Minn.	Worcester	H. H. Newell	R. P. Bullen, General Elec. Co., 704 State Mutual Bldg., Worcester, Mass.
Nebraska	D. H. Braymer	W. O. Jacobi, Omaha & Council Bluffs St. Ry. Co., 19 & Far-nam Sts., Omaha, Neb.			
New York	H. P. Charlesworth	T. F. Barton, General Elec. Co., 120 Broadway, New York			
			Total 56.		

LIST OF BRANCHES

Name and Location	Counselor (Member of Faculty)	Name and Location	Counselor (Member of Faculty)
Akron, Municipal University of, Akron, Ohio	J. T. Walther	Brooklyn Poly. Inst., 99 Livingston St., Brooklyn, N. Y.	Robin Beach
Alabama Polytechnic Institute, Auburn, Ala.	W. W. Hill	Bucknell University, Lewisburg, Pa.	W. K. Rhodes
Alabama University of, University, Ala.		California Institute of Technology, Pasadena, Calif.	R. W. Sorensen
Arizona, University of, Tucson, Ariz.	J. C. Clark	California University of, Berkeley, Calif.	L. E. Reukema
Arkansas, University of, Fayetteville, Ark.	W. B. Stelzner	Carnegie Institute of Technology, Pittsburgh, Pa.	B. C. Dennison
Armour Institute of Tech., 3300 Federal St., Chicago, Ill.	E. H. Freeman	Case School of Applied Science, Cleveland, Ohio.	H. B. Dates



LIST OF BRANCHES—Continued

Name and Location	Counselor Member of Faculty	Name and Location	Counselor Member of Faculty
Catholic University of America, Washington, D. C.	T. J. MacKavanaugh	Northeastern University, 316 Huntington Ave., Boston 17, Mass.	Wm. L. Smith
Cincinnati University of, Cincinnati, Ohio	A. M. Wilson	Notre Dame, University of, Notre Dame, Ind.	J. A. Caparo
Clarkson College of Technology, Potsdam, N. Y.	A. R. Powers	Ohio Northern University, Ada, Ohio	I. S. Campbell
Clemson Agricultural College, Clemson College, S. C.	Sam. R. Rhodes	Ohio State University, Columbus, Ohio	F. C. Caldwell
Colorado State Agricultural College, Ft. Collins, Colo.	H. G. Jordan	Ohio University, Athens, Ohio	A. A. Atkinson
Colorado, University of, Boulder, Colo.	W. C. DuVall	Oklahoma A. & M. College, Stillwater, Okla.	P. S. Donnell
Cooper Union, New York, N. Y.	A. J. B. Fairburn	Oklahoma, University of, Norman, Okla.	F. G. Tappan
Cornell University, Ithaca, N. Y.	H. H. Race	Oregon State College, Corvallis, Oregon	F. O. McMillan
Denver, University of, Denver, Colo.	R. E. Nyswander	Pennsylvania State College, State College, Pa.	L. A. Doggett
Detroit, University of, Detroit, Mich.	H. O. Warner	Pennsylvania, University of, Philadelphia, Pa.	C. D. Fawcett
Drexel Institute, Philadelphia, Pa.	E. O. Lange	Pittsburgh, University of, Pittsburgh, Pa.	H. E. Dyché
Duke University, Durham, N. C.	W. J. Seeley	Princeton University, Princeton, N. J.	Malcolm MacLaren
Florida, University of, Gainesville, Fla.	J. M. Weil	Purdue University, Lafayette, Indiana	A. N. Topping
Georgia School of Technology, Atlanta, Ga.	T. W. Fitzgerald	Rensselaer Polytechnic Institute, Troy, N. Y.	F. M. Sebast
Idaho, University of, Moscow, Idaho	J. N. Johnson	Rhode Island State College, Kingston, R. I.	Wm. Anderson
Iowa State College, Ames, Iowa	F. A. Fish	Rose Polytechnic Institute, Terre Haute, Ind.	C. C. Knipmeyer
Iowa State, University of, Iowa City, Iowa	E. B. Kurtz	Rutgers University, New Brunswick, N. J.	Paul S. Creager
Kansas State College, Manhattan, Kansas	R. G. Kloeffler	Santa Clara, University of, Santa Clara, Calif.	L. J. Neuman
Kansas, University of, Lawrence, Kansas	G. C. Shaad	South Carolina, University of, Columbia, S. C.	T. F. Ball
Kentucky, University of, Lexington, Ky.	W. E. Freeman	South Dakota State School of Mines, Rapid City, S. D.	J. O. Kammerman
Lafayette College, Easton, Pa.	Morland King	South Dakota, University of, Vermillion, S. D.	B. B. Brackett
Lehigh University, Bethlehem, Pa.	J. L. Beaver	Southern California, University of, Los Angeles, Calif.	Philip S. Biegler
Lewis Institute, Chicago, Ill.	F. A. Rogers	Southern Methodist University, Dallas, Texas	E. H. Flath
Louisiana State University, Baton Rouge, La.	M. B. Voorhies	Stanford University, Stanford University, Calif.	T. H. Morgan
Louisville, University of, Louisville, Ky.	D. C. Jackson, Jr.	Stevens Institute of Technology, Hoboken, N. J.	F. C. Stockwell
Maine, University of, Orono, Maine	Wm. E. Barrows, Jr.	Swarthmore College, Swarthmore, Pa.	Lewis Fussell
Marquette Univ., 1200 Sycamore St., Milwaukee, Wis.	J. F. H. Douglas	Syracuse University, Syracuse, N. Y.	C. W. Henderson
Massachusetts Institute of Technology, Cambridge, Mass.	W. H. Timbie	Tennessee, University of, Knoxville, Tenn.	C. A. Perkins
Michigan State College, East Lansing, Mich.	L. S. Foltz	Texas, A. & M. College of, College Station, Texas	H. C. Dillingham
Michigan, University of, Ann Arbor, Mich.	B. F. Bailey	Texas, University of, Austin, Texas	J. A. Correll
Milwaukee School of Engineering of, 163 E. Wells St., Milwaukee, Wis.	John D. Ball	Utah, University of, Salt Lake City, Utah	J. H. Hamilton
Minnesota University of, Minneapolis, Minn.	J. H. Kuhlmann	Vermont, University of, Burlington, Vt.	L. P. Dickinson
Mississippi Agricultural & Mechanical College, A. & M. College, Miss.	L. L. Patterson	Virginia Military Institute, Lexington, Va.	S. W. Anderson
Missouri School of Mines & Metallurgy, Rolla, Mo.	I. H. Lovett	Virginia Polytechnic Institute, Blacksburg, Va.	Claudius Lee
Missouri, University of, Columbia, Mo.	M. P. Weinbach	Virginia, University of, University, Va.	W. S. Rodman
Montana State College, Bozeman, Mont.	J. A. Thaler	Washington, State College of, Pullman, Wash.	R. D. Sloan
Nebraska, University of, Lincoln, Neb.	F. W. Norris	Washington University, St. Louis, Mo.	H. G. Hake
Nevada, University of, Reno, Nevada	S. G. Palmer	Washington, University of, Seattle, Wash.	G. L. Hoard
Newark College of Engineering, 367 High St., Newark, N. J.	J. C. Peet	Washington & Lee University, Lexington, Va.	R. W. Dickey
New Hampshire, University of, Durham, N. H.	L. W. Hitchcock	West Virginia University, Morgantown, W. Va.	A. H. Forman
New York, College of the City of, 139th St. & Convent Ave., New York, N. Y.	Harry Baum	Wisconsin, University of, Madison, Wis.	C. M. Jansky
New York University, University Heights, New York, N. Y.	J. Loring Arnold	Worcester Polytechnic Institute, Worcester, Mass.	E. W. Starr
North Carolina State College, Raleigh, N. C.	R. S. Fouraker	Wyoming, University of, Laramie, Wyoming	G. H. Sechrist
North Carolina, University of, Chapel Hill, N. C.	J. E. Lear	Yale University, New Haven, Conn.	R. G. Warner
North Dakota Agricultural College, State College Sta., Fargo, N. D.	H. S. Rush	Total 101	
North Dakota, University, University Station, Grand Forks, N. D.	H. F. Rice		

AFFILIATED STUDENT SOCIETY

Brown Engineering Society, Brown University, Providence, R. I.

Note: Names of new Chairmen and Secretaries will be printed in the October issue of the JOURNAL.

ORDER FORM FOR REPRINTS OF PAPERS ABRIDGED IN THE JOURNAL\*

(September 1929)  
Number

Author

Title

- 29-94 E. Fleischmann ..... Electric Heating Elements
- 29-97 E. S. Lee ..... Report of Committee on Instruments and Measurements
- 29-102 A. M. Garrett ..... D-C. Railway Substations for the Chicago Terminal
- 29-115 E. R. Wolfert and T. J. Brosnan ..... Application of Induction Regulators
- 29-119 F. A. Allner ..... Report of the Committee on Power Generation

\*Members, Enrolled Students, and JOURNAL subscribers are entitled to one complete copy of each paper free of charge; additional copies at 25 cents each.

Name.....

Address.....

Please order reprints by number. Address Order Department A. I. E. E., 33 West 39th Street, New York, N. Y.

# DIGEST OF CURRENT INDUSTRIAL NEWS

## NEW CATALOGUES AND OTHER PUBLICATIONS

*Mailed to interested readers by issuing companies*

**Park Cable.**—Bulletin, 12 pp. Describes "Condex" park cable for use in underground systems of distribution. Simplex Wire & Cable Co., Boston, Mass.

**Pipe Fittings.**—Bulletin 70. Describes the Delta-Star drop forged "Uniclamp" pipe fittings, a radically new type of fitting comprising five parts from which innumerable combinations can be assembled in the field. Delta-Star Electric Company, 2400 Block, Fulton Street, Chicago, Ill.

**Motors.**—Bulletin 159, 4 pp. Describes Wagner large vertical motors covering all types in ratings of 1½ to 30 horsepower. Wagner Electric Corporation, 6400 Plymouth Street, St. Louis, Mo.

**Choke Coils.**—Bulletin 23, 8 pp. Describes Pacific Electric Type C choke coils, insulator mounted and suspension types. Pacific Electric Manufacturing Corp., 5815 Third St., San Francisco, Cal.

**Mine Locomotives.**—Bulletin 1841, 26 pp. Describes the various types of Baldwin-Westinghouse mine and industrial locomotives. Westinghouse Electric & Manufacturing Co., East Pittsburgh, Pa.

**Meters.**—Bulletin 73 Addenda, 4 pp. Describes narrow-type HN switchboard meters for alternating current, designed for maximum utilization of space without sacrifice of either performance or appearance. Sangamo Electric Company, Springfield, Ill.

**Current Transformers.**—Bulletin 25, 4 pp. Describes Pacific Electric neutral current transformers for residual relays on grounded neutral systems. Characteristics and applications of these instruments are shown. Pacific Electric Manufacturing Corp., 5815 Third St., San Francisco, Cal.

**Controllers.**—Bulletin 114, 8 pp. Describes Monitor automatic, brake-stop, printing press controllers intended for application to alternating-current, slip-ring motors. The Monitor Controller Co., 55 E. Gay St., Baltimore, Md.

**Electric Heat for Industry.**—Bulletin, 34 pp. This booklet was compiled by the Public Service Company of Northern Illinois, 72 West Adams St., Chicago, for the education of its customers on electric heat and its industrial application.

**Oil Purifiers.**—Bulletin 20240-C, 4 pp. Describes Sharples Super Centrifuge oil purifiers. The capacity of the units ranges from 180 to 1200 gallons. Westinghouse Electric & Manufacturing Company, East Pittsburgh, Pa.

**Circuit Breakers.**—Bulletin C-1852, 8 pp. Describes types F-24 and F-24-R oil circuit breakers with current ratings of 400, 600 and 800 amperes at operating voltages of 15,000 or less. Westinghouse Electric & Mfg. Co., East Pittsburgh, Pa.

**Groundmeters.**—Bulletin 110, 12 pp. Describes the "Groundometer," a modified Wheatstone bridge designed particularly for measuring the resistance of earth electrodes. The Borden Electric Co., 480 Broad St., Newark, N. J.

**Electrical Maintenance Equipment.**—Catalog 14, 44 pp. Describes the complete line of Martindale electrical maintenance equipment, including undercutting and slotting devices, commutator stones, blowers, sprayers, insulation meters, circuit testers, etc. The Martindale Electric Company, 1260 West 4th Street, Cleveland, O.

**Meters.**—Bulletin C-1753-A "Registers of Revenue," 12 pp. The requisites of a good watthour meter and its construction are explained, and a short discussion on the origin and history of the watthour meter is included. "OB" meters, portable meters and remote control meters with equipment are described. The need of subdivided metering is discussed with the aid of charts. Westinghouse Electric & Manufacturing Company, East Pittsburgh, Pa.

## NOTES OF THE INDUSTRY

**The Champion Switch Company, Kenova, West Va.,** are adding 10,000 feet of floor space to their switch assembly department to take care of increasing demands for this equipment. The New York office of the Company has been moved from 2 Rector Street to 140 Cedar Street, where increased space and facilities have been secured.

**Wagner Electric Organization Changes.**—The Wagner Electric Corporation of St. Louis, announces the transfer of F. C. Hosimer from the St. Louis home office to the Chicago branch sales office. Ralph R. Rugheimer is now a member of the Atlanta branch sales office. The Cleveland service station and branch sales office has been moved to a new building at 3756 Carnegie Avenue.

**Another Large Unit for Brooklyn Edison.**—An order has been placed with the Westinghouse Electric & Manufacturing Company for a 110,000 kw. generating unit consisting of steam turbine, condensing equipment and electric generator to be installed as the sixth unit in the Brooklyn Edison Company's Hudson Avenue Station. It is expected that the new equipment will be ready for operation in the spring of 1931. With this installation, the capacity of the Hudson Avenue Station will be 450,000 kw. When completed the station will have eight generating units with a total capacity in excess of 1,000,000 horsepower.

**General Electric Consolidates Supply Companies.**—Effective October 1, 1929, the fourteen wholesale distributing corporations owned by the General Electric Company will be consolidated into the General Electric Supply Corporation (of Delaware). These companies have for many years distributed General Electric products and the plan involves no change of ownership. The consolidated corporation will be in a much better position to offer nation-wide service through its ability to give service from any one of the seventy-six houses, through interchangeability of stocks, and speedier and more economical operation.

**Changes in Allis-Chalmers Organization.**—J. R. Jeffrey, manager of the electrical department of the Allis-Chalmers Manufacturing Company, Milwaukee, has resigned and is retiring after twenty-eight years' service with the company. During his connection with the electrical department it has grown from a small beginning to one of the largest departments of the company. R. S. Fleshiem succeeds Mr. Jeffrey. He has been with the company since 1919 as assistant manager of the electrical department. L. W. Grothaus, assistant manager of the electrical department has been transferred from the company's Bullock Works at Norwood, O., to Milwaukee, succeeding Mr. Fleshiem. C. J. Rattermann has been appointed assistant manager of the electrical department and will be located at the Norwood plant. W. G. May has been appointed manager of the Cincinnati district office, located in the First National Bank Building.

**A New Wire Producer.**—George A. Jacobs, founder and former president of the Dudlo Manufacturing Company, and his associates, have organized the Inca Manufacturing Corporation at Fort Wayne, Indiana, to manufacture copper wire products for electric, radio, automotive and kindred industries, specializing in magnet wire and windings. Offices have already been established and construction of a mammoth plant is well under way on the eleven-acre factory site purchased. It is expected to have the plant in operation in actual production within the next few weeks. The first unit of the factory covers an area of 200 by 300 feet, and will afford immediate employment for 500 workers. It is planned to establish another large factory unit at Los Angeles, California, later. Officers of the new company are: George A. Jacobs, president; Wendell C. Glass, vice-president; George W. Spindler, secretary-treasurer and S. A. Jacobs, in charge of sales.

From the Early Period  
of the Telegraph to the present  
remarkable development in the field of Electricity

# KERITE

has been continuously demonstrating the  
fact that it is the most reliable and  
permanent insulation known

THE KERITE INSULATED WIRE & CABLE COMPANY, INC.  
NEW YORK CHICAGO SAN FRANCISCO



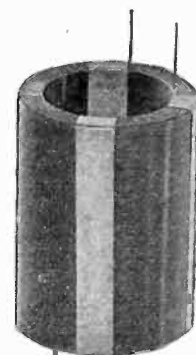

## More Compact, More Accurate Compare — for Economy

Centers of wires precisely equidistant. Turns as close together as the dimensions of the wire permit.

Layers exactly alike in number of turns, and in spacing. Turns of the layer above fit with mathematical precision into the valleys of the layer below.

A new and higher factor of space utilization. Smaller coils for the same work to be done. Greater uniformity and higher accuracy both electrically and physically.

These are the unusual characteristics of Rome Precision Heavy Wire Coils.

Such improvements are typical of the accuracy of manufacture of all Rome Precision Coils of heavy wire—for any purpose.

To what extent will such coils affect improvements and economies in your product? The best way to determine their net VALUE to you is to ask our engineers to submit a sample built to meet your own specifications.

ROME WIRE COMPANY  
Division of General Cable Corporation  
R O M E , N E W Y O R K

# ROME PRECISION COILS

Please mention the JOURNAL of the A. I. E. E. when writing to advertisers.



On your  
 resistance  
 problems  
 consult these  
 Resistance  
 Specialists

**T**HE manufacturers of DURHAM Metalized Resistors place at the service of electrical engineers, the facilities of a broadly experienced staff of resistance specialists together with probably the most complete experimental laboratory of its kind in existence.

staff are available to all engineers. We cordially invite you to consult with us on your resistance problems.

Whatever your resistance problem may be, the utilization of this service should not only save time and money in bringing about a proper solution, but will also provide you the highest degree of accuracy in design and manufacture, together with minimum costs for the finished products.

Probably the best indication of the value of this service lies in the fact that our engineers are constantly cooperating with electrical engineers of many of the largest manufacturers and experimental laboratories and are continually developing new ideas, new designs and new uses for DURHAM Resistance Units.

The facilities of our experimental laboratories plus the experience of our specialist



*A standard Durham Metallized resistance unit, made in a wide variety of ranges and used by the millions in the radio industry.*

**DURHAM**  
**METALLIZED**

RESISTORS & POWEROHMS  
 INTERNATIONAL RESISTANCE CO.  
 2006 Chestnut Street, Philadelphia, Pa.

Please mention the JOURNAL of the A. I. E. E. when writing to advertisers.

# Developed for Modern Industry

MODERN production demands better locking—surer locking—faster locking—that's why modern industry has turned to SHAKEPROOF to solve its locking problems. Twisted steel teeth set round the circumference of the washer grip both the nut and the work and won't let go—vibration only tightens their hold. Whatever your product, there is a place for SHAKEPROOF. Write us today for samples to test out in your own shop—determine for yourself the advantages and savings of SHAKEPROOF for you.

## SHAKEPROOF Lock Washer Company

Division of Illinois Tool Works

2517 North Keeler Avenue Chicago, Illinois

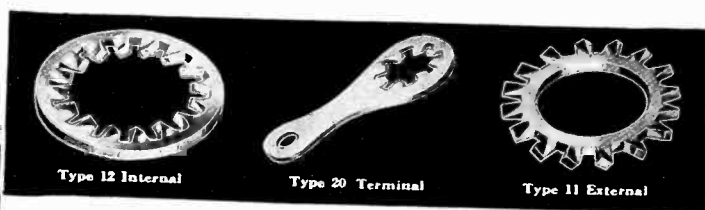

U. S. PATENTS 1,419,564; 1,604,122; 1,697,952,  
OTHER PATENTS PENDING.  
FOREIGN PATENTS.

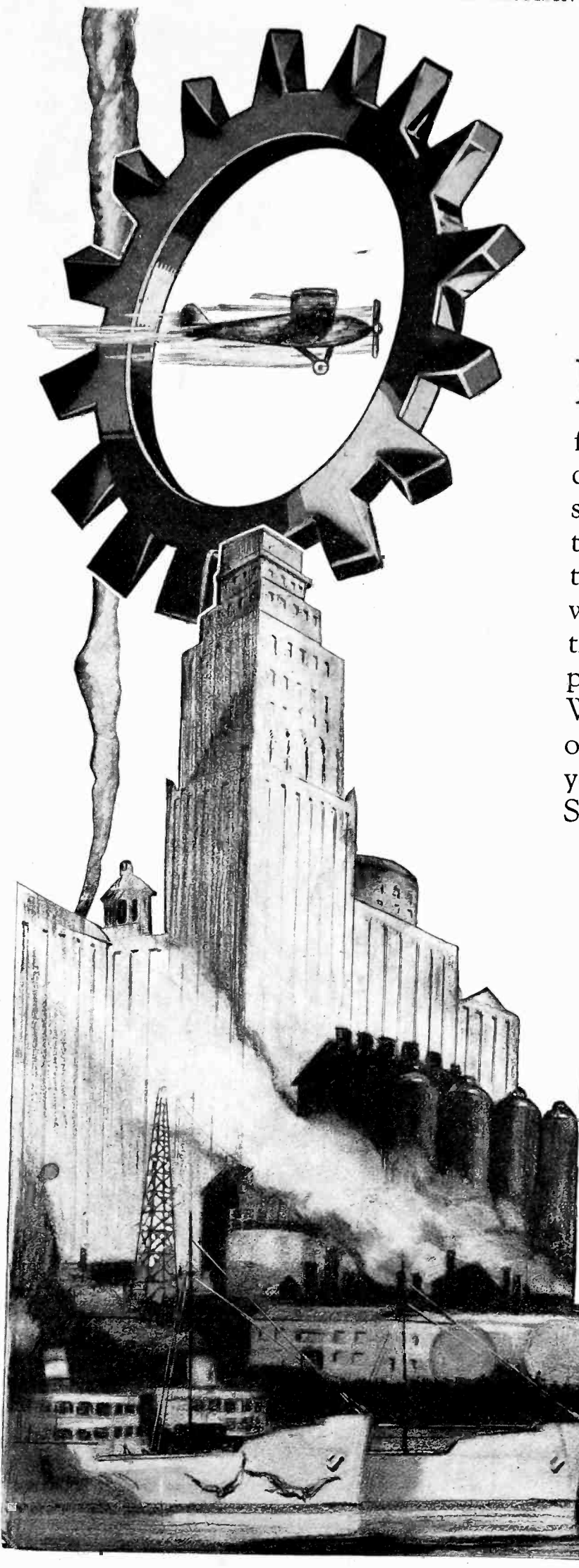

Please mention the JOURNAL of the A. I. E. E. when writing to advertisers.

# BUS-DUCT ~ ~ ~

## Unit of The Bull Dog AMP System

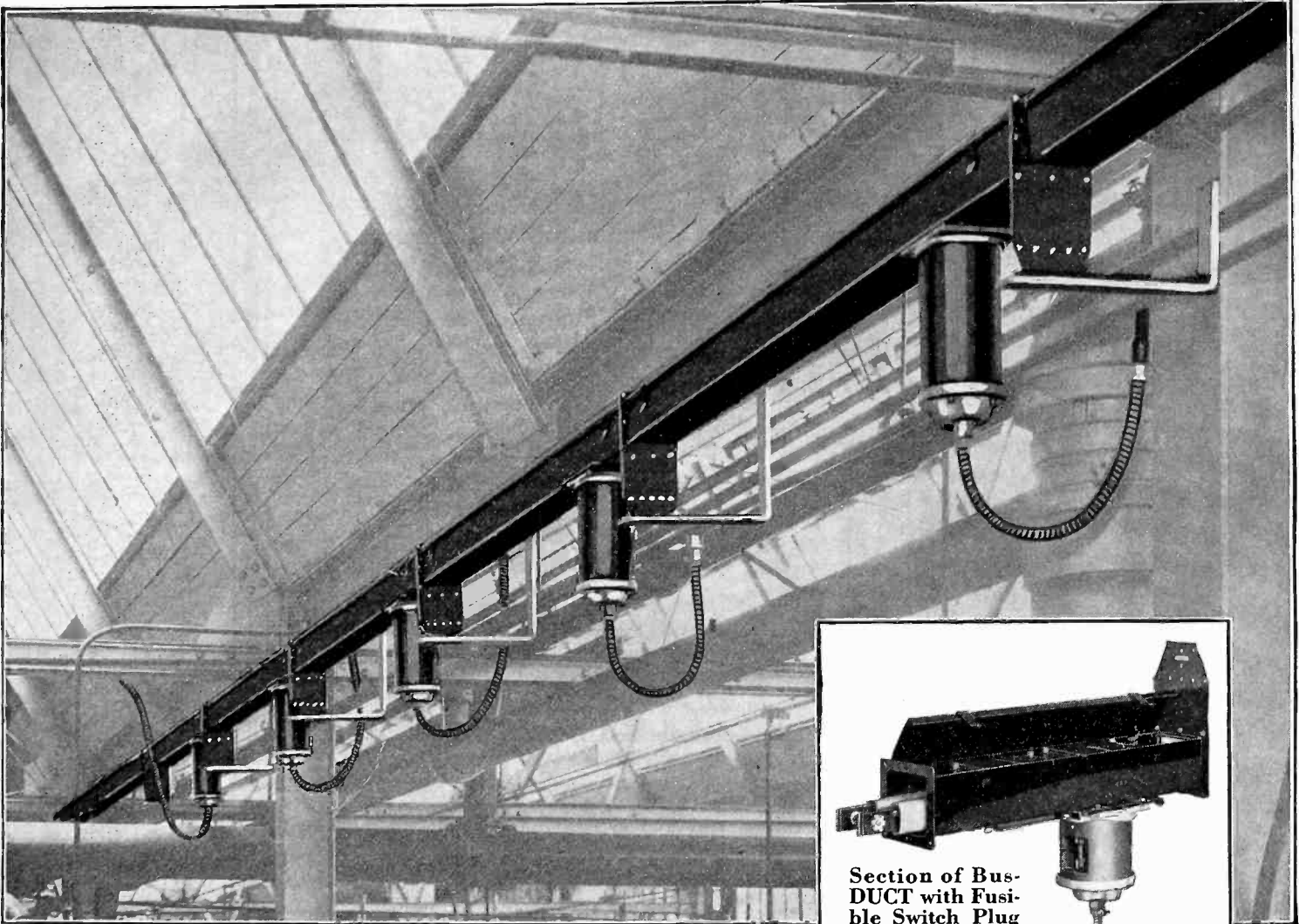

Bull Dog Bus-DUCT Installation in Graham Bros. Plant, Evansville, Ind.

**BULL DOG** Bus-DUCT is a flexible Electrical Distribution System for modern Industrial Plants employing Mass Production Methods where frequent changes in location of machines, motors and sometimes whole departments are made.

**BULL DOG** Bus-DUCT consists essentially of Busbars installed in enclosed DUCT, having bakelite Receptacles provided at frequent intervals throughout the length of the DUCT for the reception of Removable Fusible Switch Plugs which in turn are connected to the motor or machine they control by flexible cable or conduit.

**BULL DOG ELECTRIC PRODUCTS CO.** - Detroit, Michigan

*Write for detailed information*



**BULL DOG**  
**AMP**  
 APPARATUS for MASS PRODUCTION

AMP AMP AMP AMP AMP AMP AMP

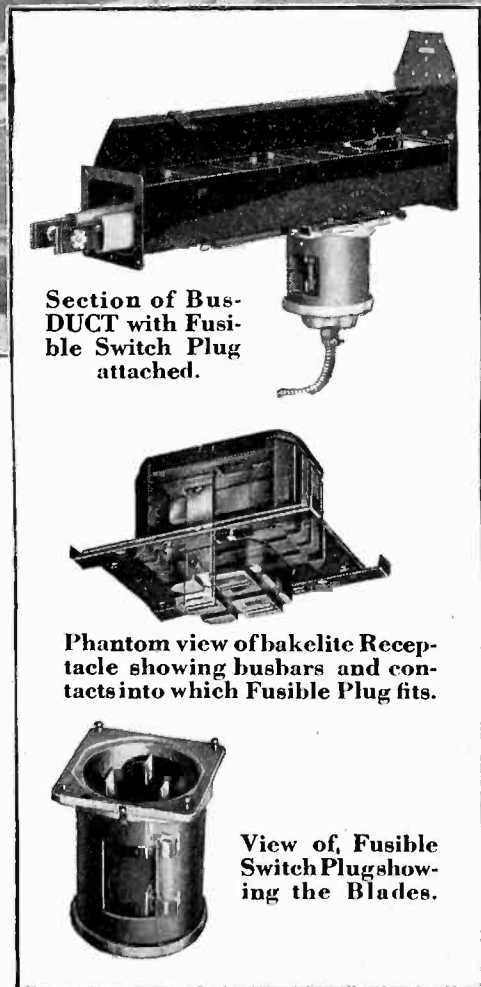

Section of Bus-DUCT with Fusible Switch Plug attached.

Phantom view of bakelite Receptacle showing busbars and contacts into which Fusible Plug fits.

View of Fusible Switch Plug showing the Blades.

Please mention the JOURNAL of the A. I. E. E. when writing to advertisers.

# To relieve Bushing strain

**A**NACONDA Hollow Conductors are being used for tap conductors from outdoor high voltage copper tube busses to the porcelain bushings of oil circuit breakers and transformers. They are stiff enough to span the required distance, yet flexible enough to absorb vibration and sway of the overhead bus support, thus minimizing the danger of breaking porcelain bushings.

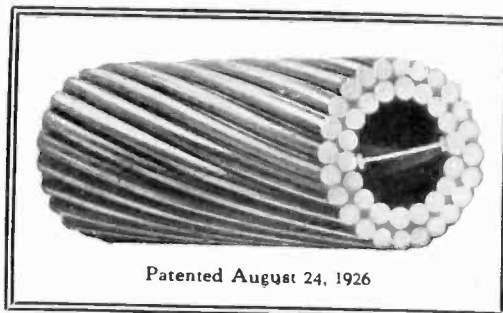

Side view of Anaconda Hollow Conductor showing the hollow construction.

Patented August 24, 1926

Sectional view of the twisted I-Beam copper core.



Anaconda Hollow Conductors consist of one, two or three layers of copper wires stranded over a copper core, I-Beam in shape and twisted around its longitudinal axis. This construction saves conductor costs in that it obviates the necessity of using a non-conductive or perishable filler material to provide the desired diameter. By changing the size of the I-Beam core and the size and number of the surrounding wires, Anaconda Hollow Conductors can be efficiently designed for any given transmission requirement.

## ANACONDA WIRE & CABLE CO.

General Offices: 25 Broadway, New York

Chicago Office: 111 West Washington Street

Exclusive Selling Agent for Wire and Cable Products of  
THE AMERICAN BRASS COMPANY

# ANACONDA

## WIRE PRODUCTS



An Engineering Department is maintained to assist electrical engineers in the design of cables to meet special requirements. Sag tables and other engineering data furnished promptly upon request.

Seven conveniently located wire mills offer a coast-to-coast service unequalled in promptness and dependability.



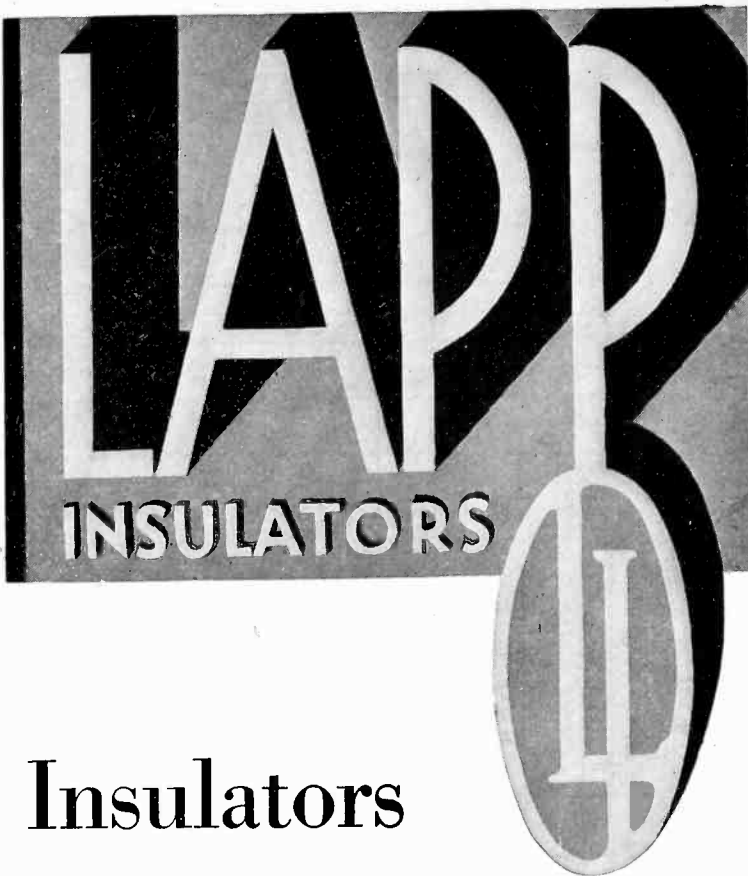
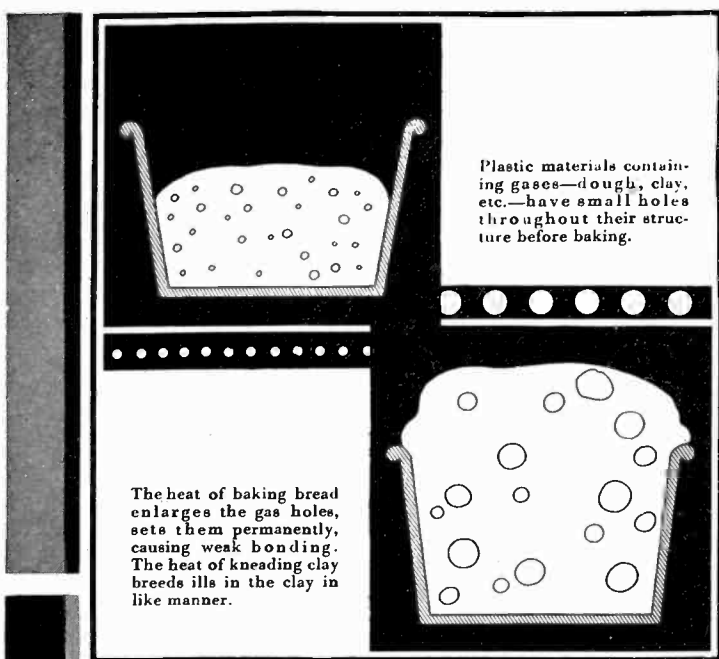

## Permanent Insulators

A MAJOR reason why insulators fail is that the clay occludes air. This later breeds many ills in the insulators, weakening the structure. Ageing, by the usual method of letting the raw clay stand, removes a modicum of the air. There is only one known way to remove all the air—the Lapp Vacuum Process (patented).

In two seconds clay is thereby aged more than by 100 years of the ancient method. The air actually boils out of the liquid "slip." This avoids laminations, blebs, checks, lack of plastic bond and other ills. Perfectly obvious, isn't it?

No wonder you find Lapp Insulators carrying up to 220,000 volts, regardless of atmospheric conditions, for indefinite periods, without failure or trouble.

*With Lapp Insulators line maintenance costs come down and stay down.*

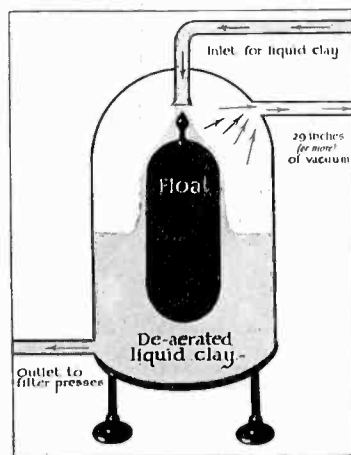

Here's how the Lapp Vacuum Process acts.

**LAPP INSULATOR CO. INC. LEROY, N.Y. U.S.A.**

# Progress

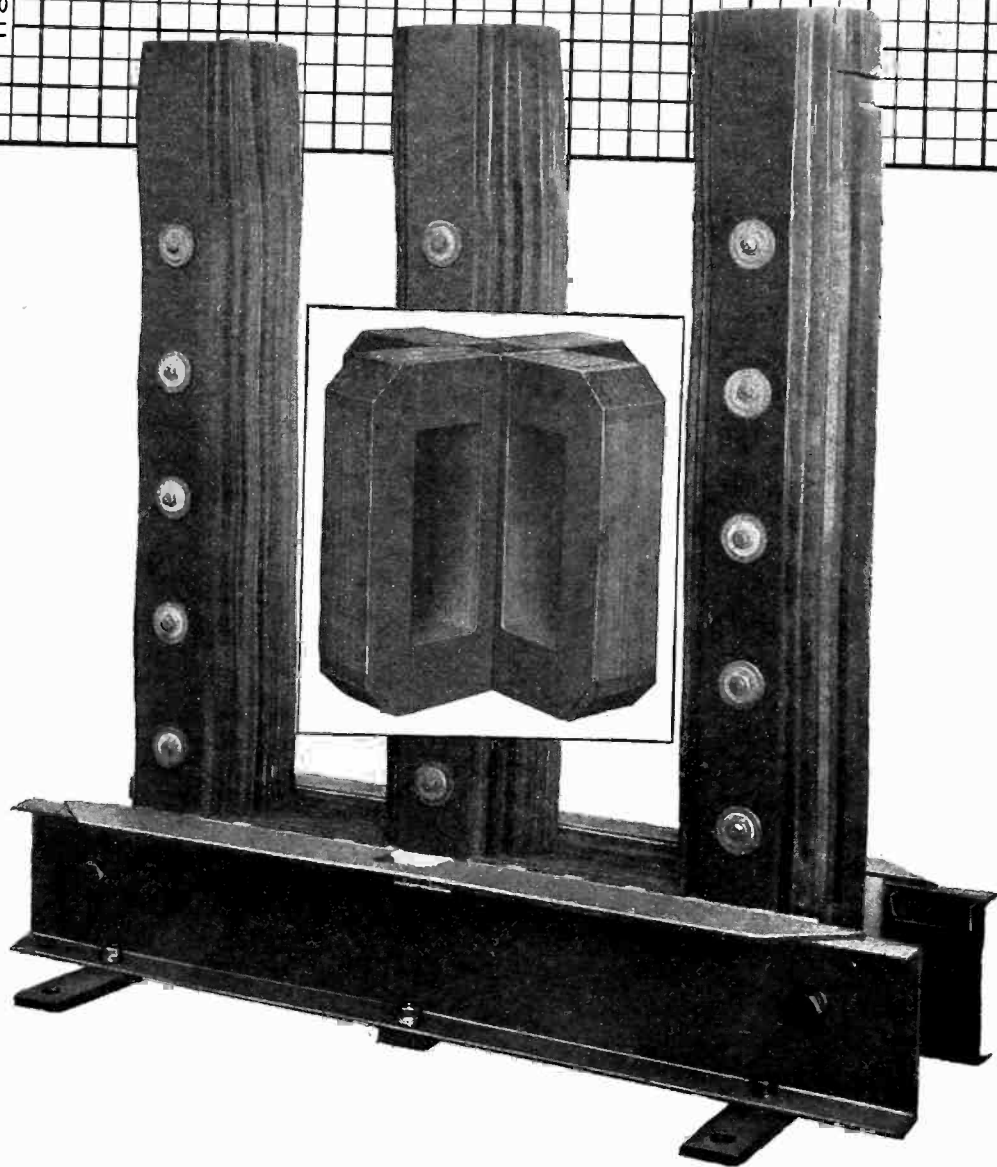
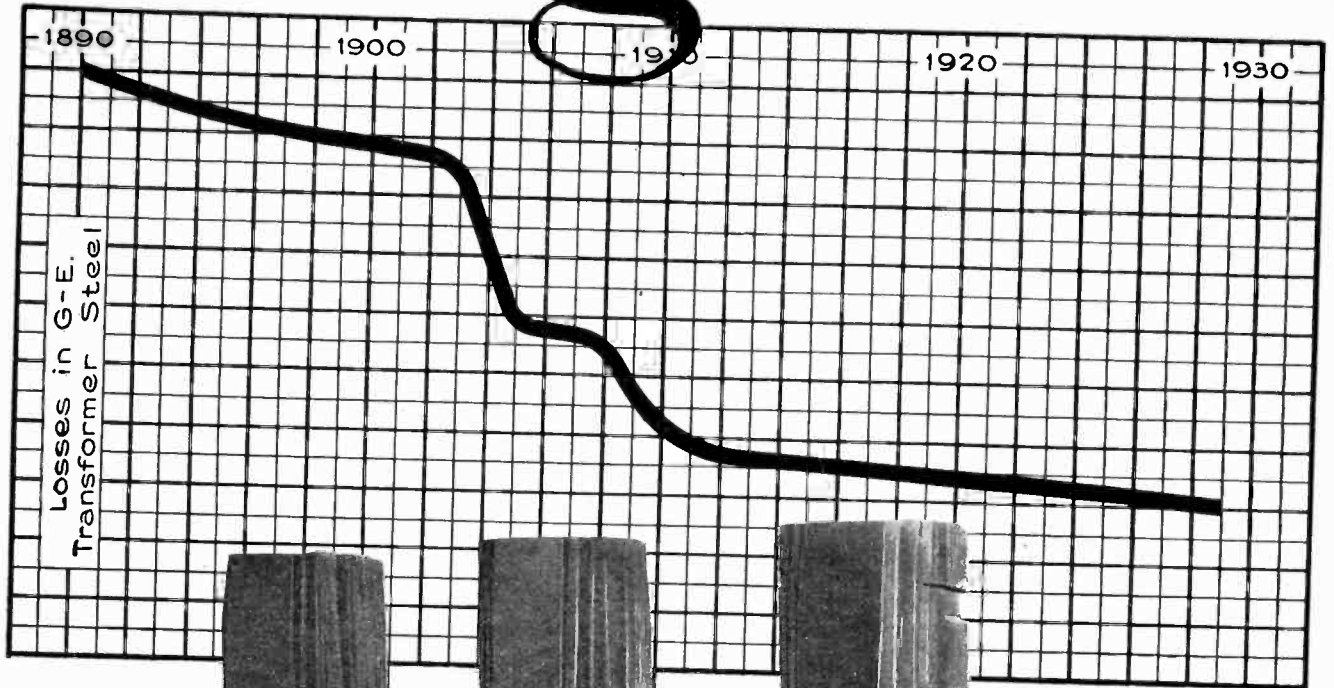

**GENERAL**  
 GENERAL ELECTRIC COMPANY, SCHENECTADY, N. Y.

Please mention the JOURNAL of the A. I. E. E. when writing to advertisers.

# *in the development of steel for G-E transformers*

The General Electric Company's leadership in the transformer field is due in no small degree to its continual pioneer work on magnetic steel. As early as 1895 the Company undertook to improve the properties of this steel and has worked incessantly on the problem since that time.

Early in this development the Company's engineers were convinced that lower losses could be obtained from alloyed steels than from the commercial irons and steels, and they realized that the best results required the close cooperation of transformer engineers, the research laboratory, and the steel manufacturer.

As the pioneer in this development, the General Electric Company was the first:

- to adopt Sir Robert Hadfield's silicon-steel alloy
- to develop, through coöperative effort with a steel manufacturer, processes for reducing it to sheet form
- and to offer a complete line of transformers containing this non-ageing low-

loss steel. This was in the year 1905.

The General Electric Company has spent millions of dollars on this investigation and continues its work, even though transformer efficiencies above 99.5 per cent have been obtained.

The result has been a constant improvement in the magnetic properties of the steel regularly used in General Electric transformers, as shown by the accompanying curve covering a period of 40 years.

To-day's product has only 50 per cent of the loss in the original silicon steel and only 35 per cent of the loss in the best steel available before silicon steel was produced. Not only are present-day G-E transformers smaller and lighter, but their efficiencies would be unattainable with the earlier steels even if many times the amount of material were used.

The progress shown by the curve represents a constantly increasing saving in operation through lower losses, which, for General Electric transformers alone, amounts annually to approximately \$25,000,000.



JOIN US IN THE GENERAL ELECTRIC HOUR, BROADCAST EVERY SATURDAY  
AT 8 P.M., E.S.T. ON A NATION-WIDE N.B.C. NETWORK

**E L E C T R I C** 410-21  
S A L E S   O F F I C E S   I N   P R I N C I P A L   C I T I E S

Please mention the JOURNAL of the A. I. E. E. when writing to advertisers.

# dependable

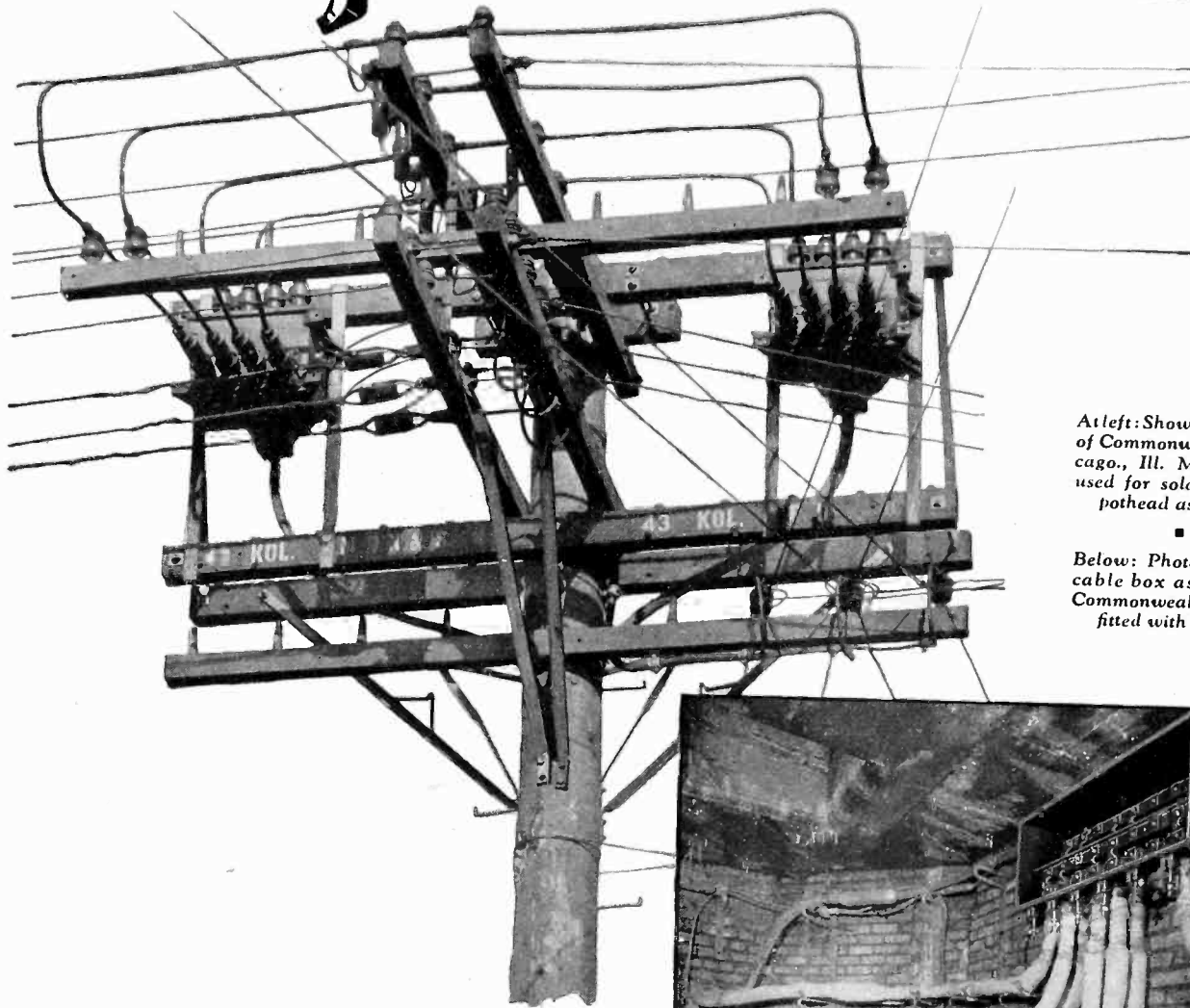

At left: Showing installation on lines of Commonwealth Edison Co., Chicago, Ill. Monel Metal bolts are used for solderless connectors and pothead assembly as specified.

Below: Photo shows underground cable box assembly installed in Commonwealth Edison lines. Box fitted with Monel Metal bolts.

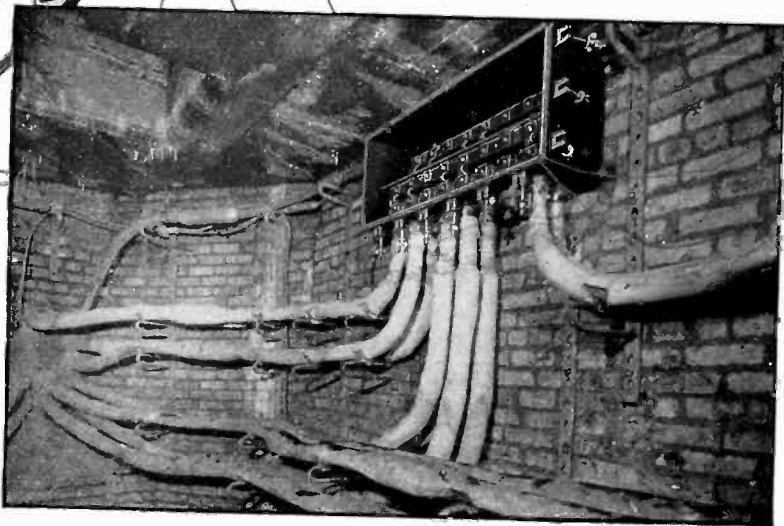

**COMMONWEALTH  
EDISON COMPANY  
CHICAGO, ILL.**

*Uses Monel Metal bolts both overhead and underground*

IN engineering circles, the name Commonwealth Edison stands for highest standards, efficient operation and dependable performance. Therefore, it is significant that this widely-known Company uses Monel Metal bolts BOTH overhead and underground.

The rare combination of properties offered by Monel Metal insures dependable performance under a wide range of severe conditions.

Whether underground and exposed to dampness and earth acids—or overhead, where snow, sleet and gaseous atmospheres

attack—Monel Metal stands up under stress and pull. It has a tensile strength of well over 100,000 psi.—it is free from corrosion-cracking—it will not rust—it is not subject to fatigue failures.

The rolled uniformity of Monel Metal recommends its use where service is most severe—where dependability must be insured. You can play safe by specifying Monel Metal for future installations.

Monel Metal is a technically controlled Nickel-Copper alloy of high Nickel content. It is mined, smelted, refined, rolled and marketed solely by The International Nickel Company, Inc. The name "Monel Metal" is a registered trade mark.

## MONEL METAL

SEND FOR FOLDER—"BOLTS THAT WILL NOT FAIL"

THE INTERNATIONAL NICKEL COMPANY, INC., 67 WALL STREET, NEW YORK, N. Y.



Please mention the JOURNAL of the A. I. E. E. when writing to advertisers.



# ACTS AS A UNIT - UNDER LOAD



You may have a copy of "Lead Tip Steel Pins", more generally called Booklet 516-H. If not, you need this source of valuable information. Send for it.

O-B Lead Pins have a machine finished tapered section. This section fits into a machine-finished socket in the interchangeable base. So, when assembled on the cross arm, the pin and base perform as a unit, able to withstand recurring heavy strains as well as the every day loads.

The tapered section rotates freely in the base socket, assuring proper lining up of the wire groove in the insulator without loosening the insulator on the pin, yet providing accurate seating of the base on the cross arm.

Futhermore, the tapered section insures a perfect fit between the pin and the interchangeable base, even when a variation in dimension occurs. Booklet 516-H—which should be in your hands for ready reference—explains this feature in detail.

Ohio Brass Company, Mansfield, Ohio  
Canadian Ohio Brass Co., Limited  
Niagara Falls, Canada  
1087-H

# Ohio Brass Co.



NEW YORK CHICAGO  
PHILADELPHIA BOSTON

PITTSBURGH ATLANTA CLEVELAND  
ST. LOUIS SAN FRANCISCO LOS ANGELES

PORCELAIN  
INSULATORS  
LINE MATERIALS  
RAIL BONDS  
CAR EQUIPMENT  
MINING  
MATERIALS  
VALVES



## THE CHARLES A. COFFIN MEDAL

**T**HIS medal, awarded annually, is the highest recognition of accomplishment that can come to a public utility company.

In eight years it has been won four times by companies under the Executive Management of Stone & Webster, Inc.

NORTHERN TEXAS TRACTION COMPANY

PUGET SOUND POWER & LIGHT CO.

VIRGINIA ELECTRIC AND POWER COMPANY

*And now it's the* EL PASO ELECTRIC COMPANY

"which by its initiative, skill, and enterprise has during the year 1928 made a distinguished contribution to the development of electric light and power for the convenience of the public and the benefit of the industry."

---

# STONE & WEBSTER

INCORPORATED



Please mention the JOURNAL of the A. I. E. E. when writing to advertisers.

# LOCKE

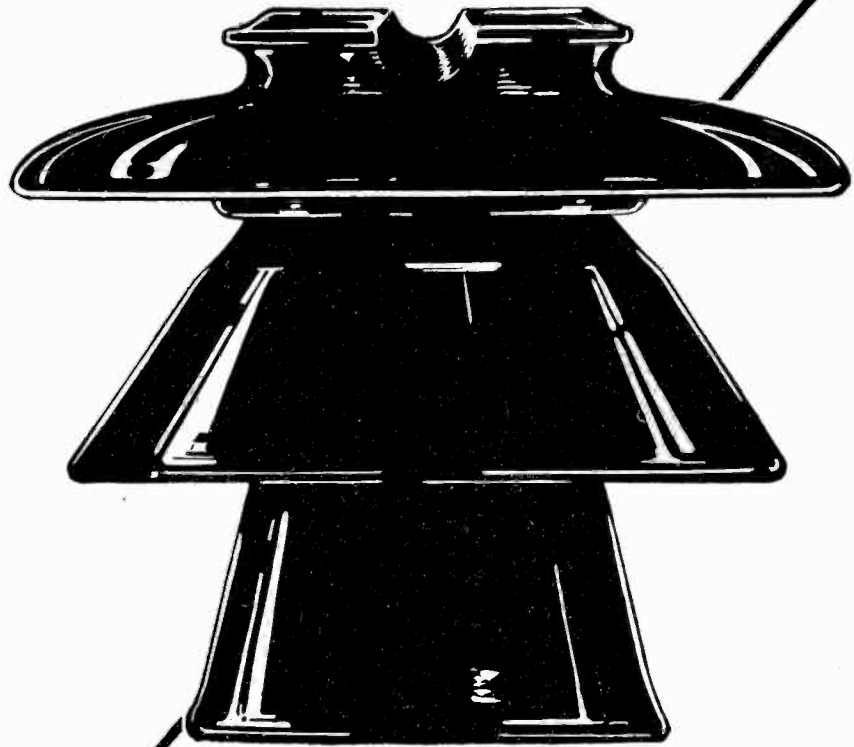

Locke 1066 insulator is an outstanding example of the perfect balance which is characteristic of all Locke designs.

The record which these insulators have established is the natural outcome of consistent research and study, in both laboratory and field, extending over a period of more than thirty-five years. Refinements in design have been paralleled by improvements in manufacturing methods and materials, stricter standards and more exact factory control. Today—as the fruit of this—Locke offers you insulators which will give unequalled performance under any service conditions.

When service counts, specify **LOCKE**.

**LOCKE INSULATOR CORPORATION**  
BALTIMORE MARYLAND

# PORCELAIN INSULATORS

Please mention the JOURNAL of the A. I. E. E. when writing to advertisers.

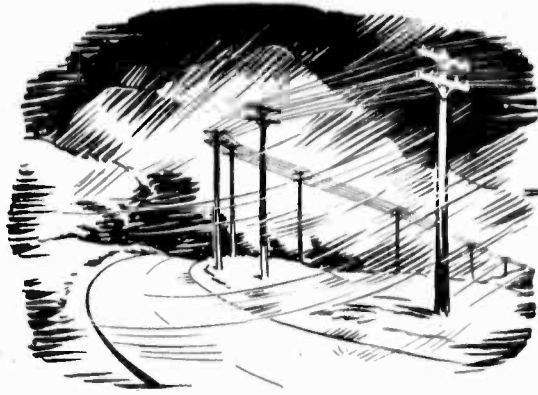

# On the job every hour

The need for uninterrupted service — regardless of the date or hour — is well understood by Standard. So, you will find that all Standard wires and cables are built to assure minimum interruption.

Our representatives have an interesting story for you. Trained in practical problems, they have contributed much to Standard's ability to supply all types of wires and cables for the most exacting job. And they are fully capable of interpreting *our* service to *you*.

Engineers, research technicians, personnel, laboratories, wide manufacturing facilities — together they constitute a source of consultation, experiment, or supply which is worthy of your complete knowledge.

When may we tell this story? Will you name a date convenient for you?

STANDARD UNDERGROUND CABLE COMPANY

*Division of General Cable Corporation*

Perth Amboy, N. J.

# STANDARD UNDERGROUND \* CABLE COMPANY \*

Please mention the JOURNAL of the A. I. E. E. when writing to advertisers.



# g r e a t e r h o l d i n g   p o w e r f r o m   s a m e   s i z e   a n c h o r g o e s   d o w n   2   f e e t   d e e p e r !



*Note uncomfortable position of men screwing down old style screw anchor. Speed is retarded. Note how wrench handle catches on ground while anchor rod is still two feet above ground.*



*Installing new Matthews Scrulix Anchor with new style Matthews Wrench. Handle can be moved up and down wrench and set at comfortable position for men to screw down anchor. Note how end of anchor rod (shown by dotted line) is only slightly above surface of ground—anchor is down at least two feet deeper than other anchor. Men work in comfortable position during entire installation. Deeper installation means at least 50% greater holding power!*

The helix of Matthews Scrulix Anchors is so designed that under strain the lines of force radiate from the anchor helix at a 45 degree angle so that hundreds of cubic feet of earth hold the anchor in place. This principle is what gives Matthews Scrulix Anchors their tremendous holding power in comparatively soft earth. Deeper installation gives tons of earth more holding power.

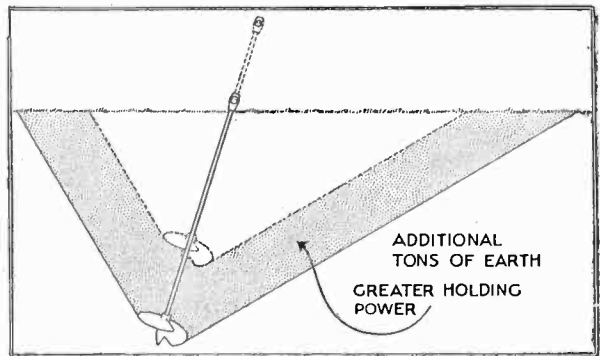

*The shaded portion shows how greatly the cone of earth is increased in size by deeper installation, giving much greater holding power.*



W. N. MATTHEWS CORPORATION  
Engineers and Manufacturers  
3706 Forest Park Blvd., St. Louis, Mo.  
Offices in all principal cities

The New Preheated Certified Malleable Matthews Scrulix Anchors have been standardized by a large number of Power Companies and Bell and Independent Telephone Companies.

**THE NEW PREHEATED CERTIFIED MALLEABLE**

# MATTHEWS SCRULIX ANCHORS





... IT CONTRIBUTES TO THE PROSPERITY OF THE PEOPLE AND TO THE COMFORT AND CONVENIENCE OF LIVING

## The telephone grows with the country

*An Advertisement of the  
American Telephone and Telegraph Company*

THE Bell System must march a pace ahead of the new civilization on this continent, a civilization of better opportunity for the average man. The telephone contributes to the prosperity of the people and adds to the comfort and convenience of living.

It is used by the many. The time and money it saves are as important to the small business as to the large. The humblest home depends on it for aid in emergency, to run errands, maintain friendships. It is the aim of the Bell System to keep telephone service so good and so cheap that it will be used universally to make life richer and better.



It seeks to lead the way in social and business growth. It is raising buildings this year in more than two hundred cities, adding vast mileage to the expanding network of cable, and installing new telephones by the hundreds of thousands.

It is spending more than 550 million dollars this year—one and one-half times the cost of the Panama Canal—for new plant and service improvements. This program is part of the telephone ideal that anyone, anywhere, shall be able to talk quickly and at reasonable cost with anyone, anywhere else. There is no standing still in the Bell System.

# The Effective Surge Absorber

For the protection of inductive apparatus at the terminals of Transmission Lines from surges of steep wave-front.

Connected in series with the line, the Absorber dissipates the energy in the surge without grounding the line.

Its effectiveness has been determined by actual test under conditions which approximate closely to those obtaining in service.

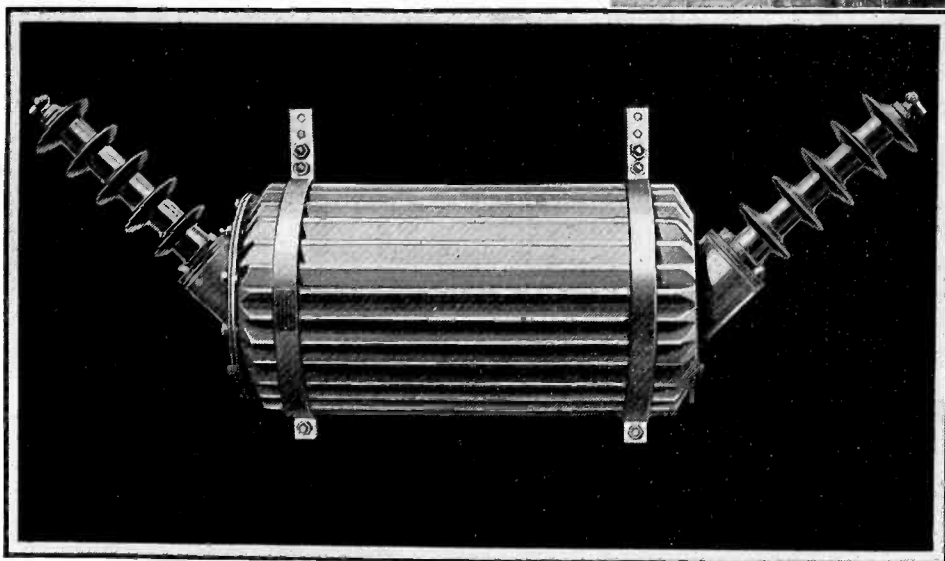
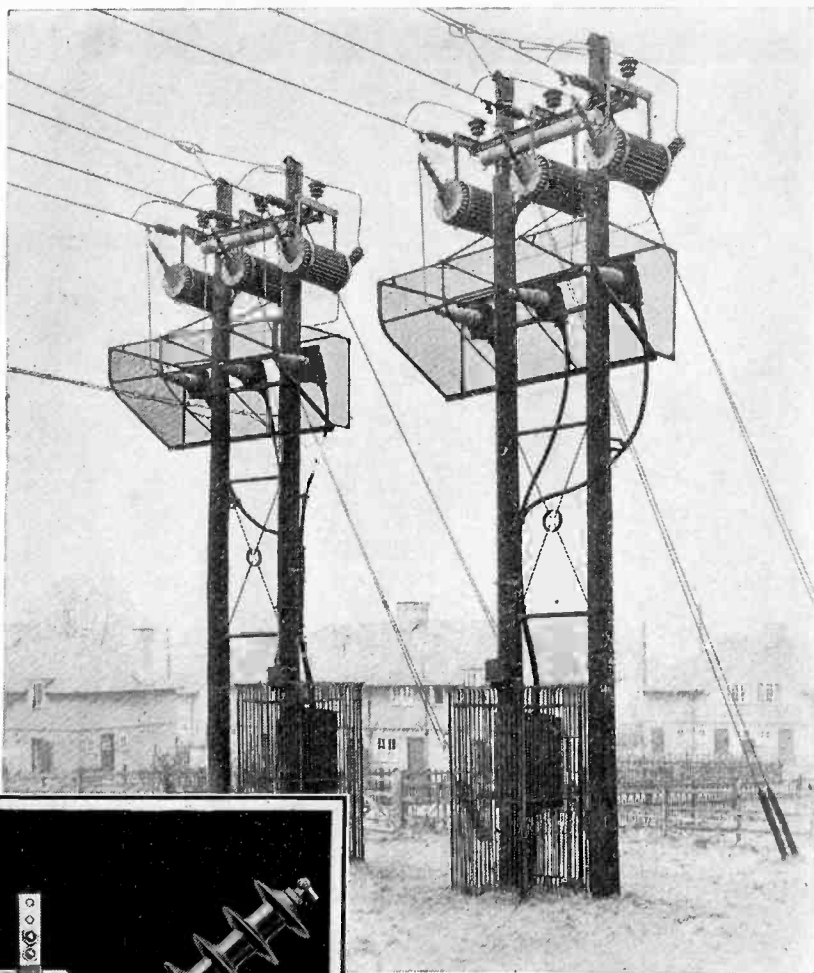

*Suitable for connecting in cables and transmission lines of voltages from 220 to 220,000.*

## FERRANTI SURGE ABSORBER

Ferranti, Inc.  
130 West 42nd Street  
New York, U. S. A.

Ferranti, Ltd.  
Hollinwood  
Lancashire, England

Ferranti Electric Limited  
26 Noble Street  
Toronto, Canada

# Wagner Transformers



Wagner has built transformers about forty years and introduced many of the basic improvements. The Wagner line is complete and thoroughly up to the requirements of modern powerservice. Wagner Transformers complete Wagner Power Service to Industry.

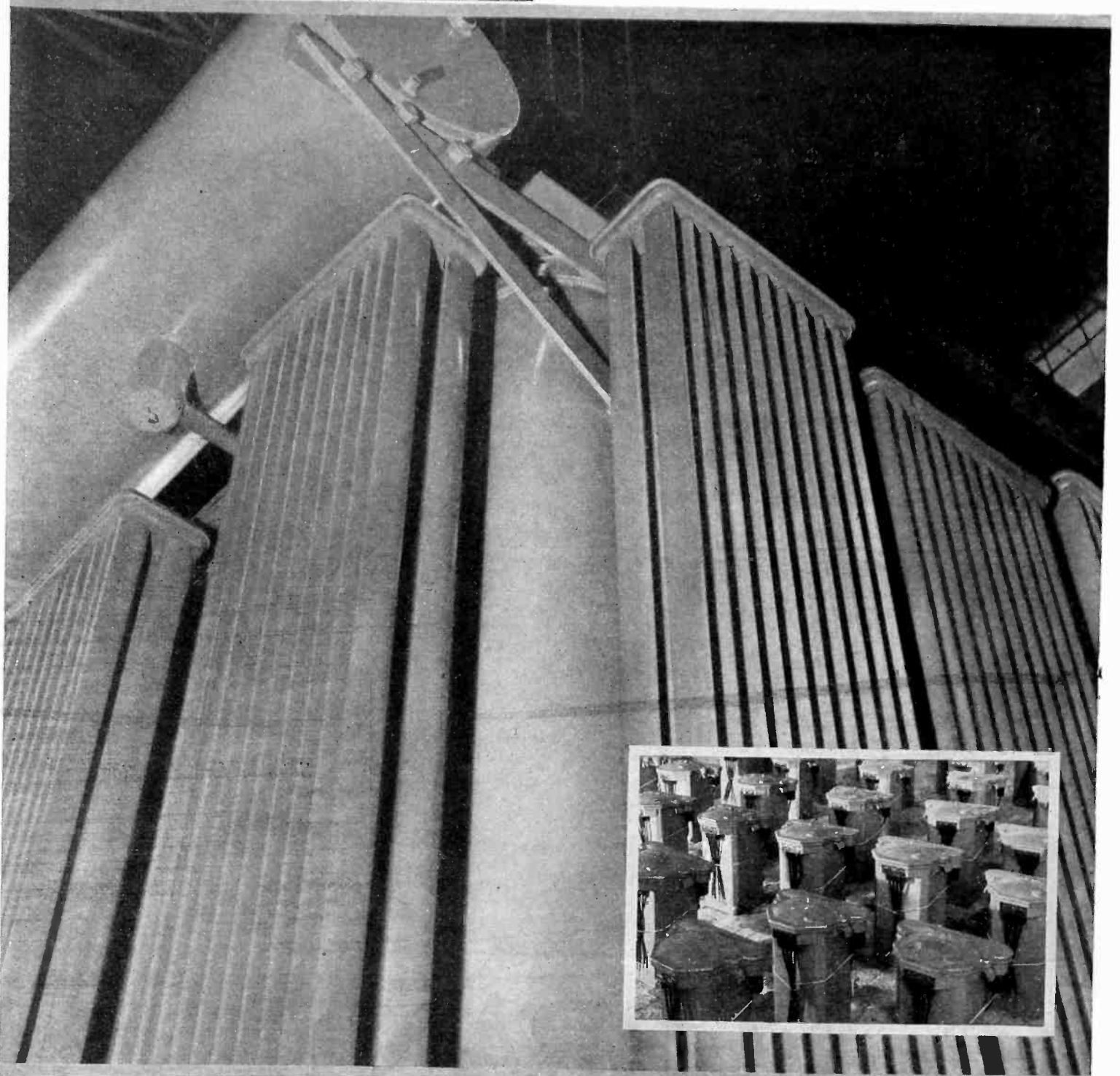

Write for complete details of Wagner Distribution, Power and Subway Type Transformers.

*Literature on Request*

**WAGNER ELECTRIC CORPORATION**  
6400 Plymouth Avenue, St. Louis, U. S. A.

*Wagner Sales Offices & Service Stations in 25 Principal Cities*

**Products:** FANS . . . . . Desk, Wall and Ceiling  
TRANSFORMERS . . . Power, Distribution and Instrument  
MOTORS . . . Single-phase, Polyphase and Direct Current.



# Wagner ... quality





# Aluminum Busbars for long life—Lower Cost...

**M**ORE than twenty years of hard steady service in this country has proven what Europe already knows. That Aluminum Busbars not only effect a real saving in cost, but perform their transmission functions steadily and reliably, day after day and year after year.

The booklet, "Aluminum Busbars," contains useful tables of weights, carrying capacities and physical properties. May we mail you a copy?

ALUMINUM COMPANY OF AMERICA  
2448 Oliver Bldg., Pittsburgh, Pa.  
*Offices in 19 Principal American Cities*

## ALUMINUM



*Busbar*

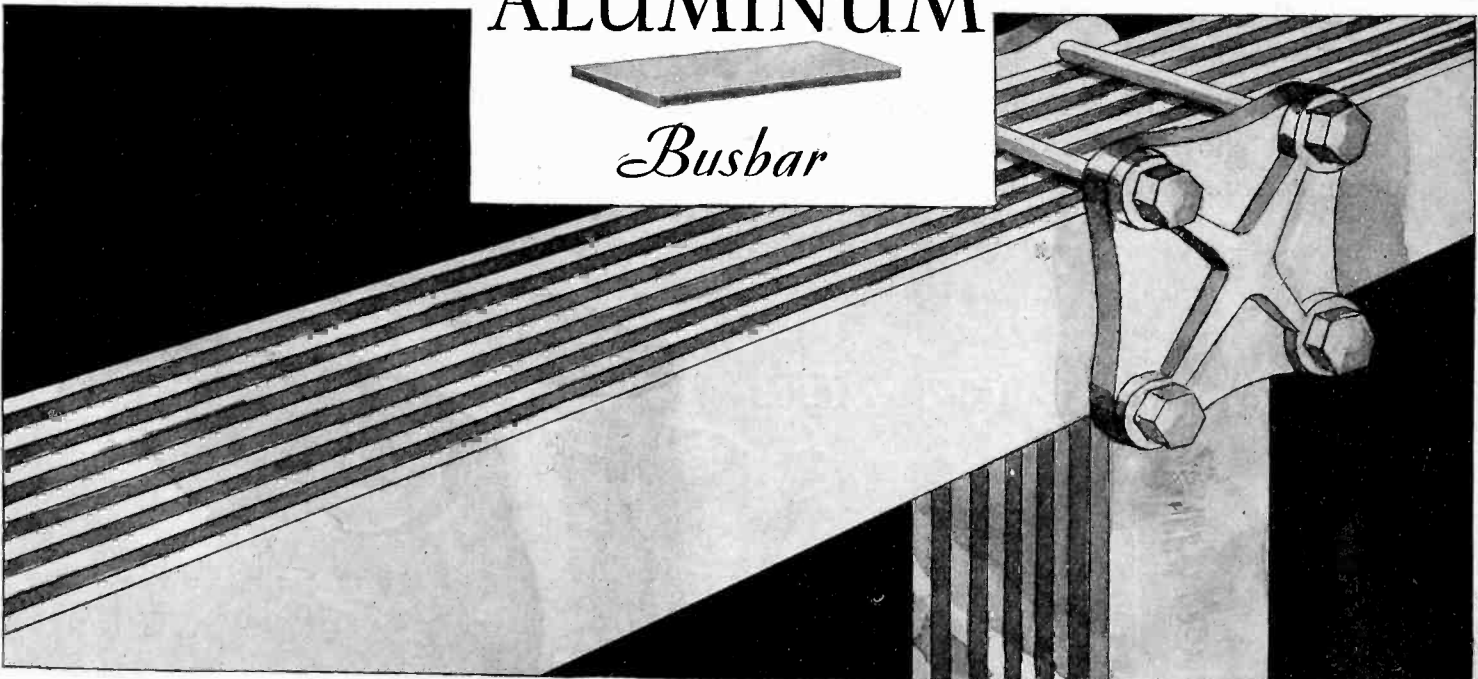

Please mention the JOURNAL of the A. I. E. E. when writing to advertisers.

DOSSERTS

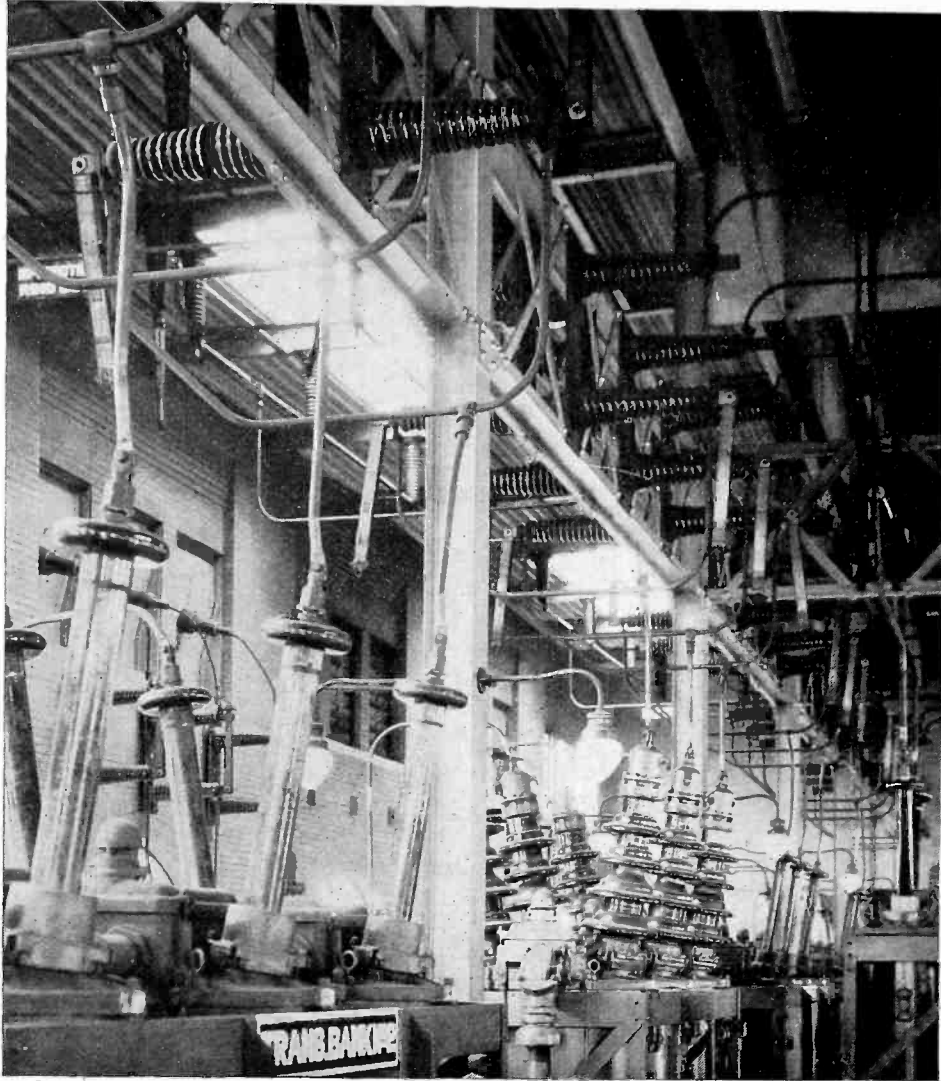

DOSSERTS

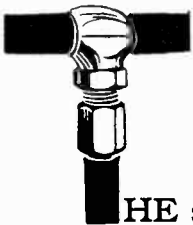

DOSSERTS used on the 23,000 volt bus at Acme Station  
of Toledo Edison Company

THE standardization on Dosserts for connecting stranded and solid wires, rods and tubing has given engineers a quick and effective method of providing neat wiring layouts.

With the aid of a Dossert colored wall hanger, showing a dozen representative connections with the proper Dossert to

be used on each . . . your wiring layouts can be effected more quickly and at less cost than with former methods.

*Write for the DOSSERT year book*

**DOSSERT & COMPANY**

H. B. LOGAN, President

242 West 41st St., New York

Where your Wires or Cables Come Together

CONNECT 'EM WITH

**DOSSERTS**

THE TAPERED SLEEVE  
SOLDERLESS CONNECTORS

# Another KUHLMAN Installation

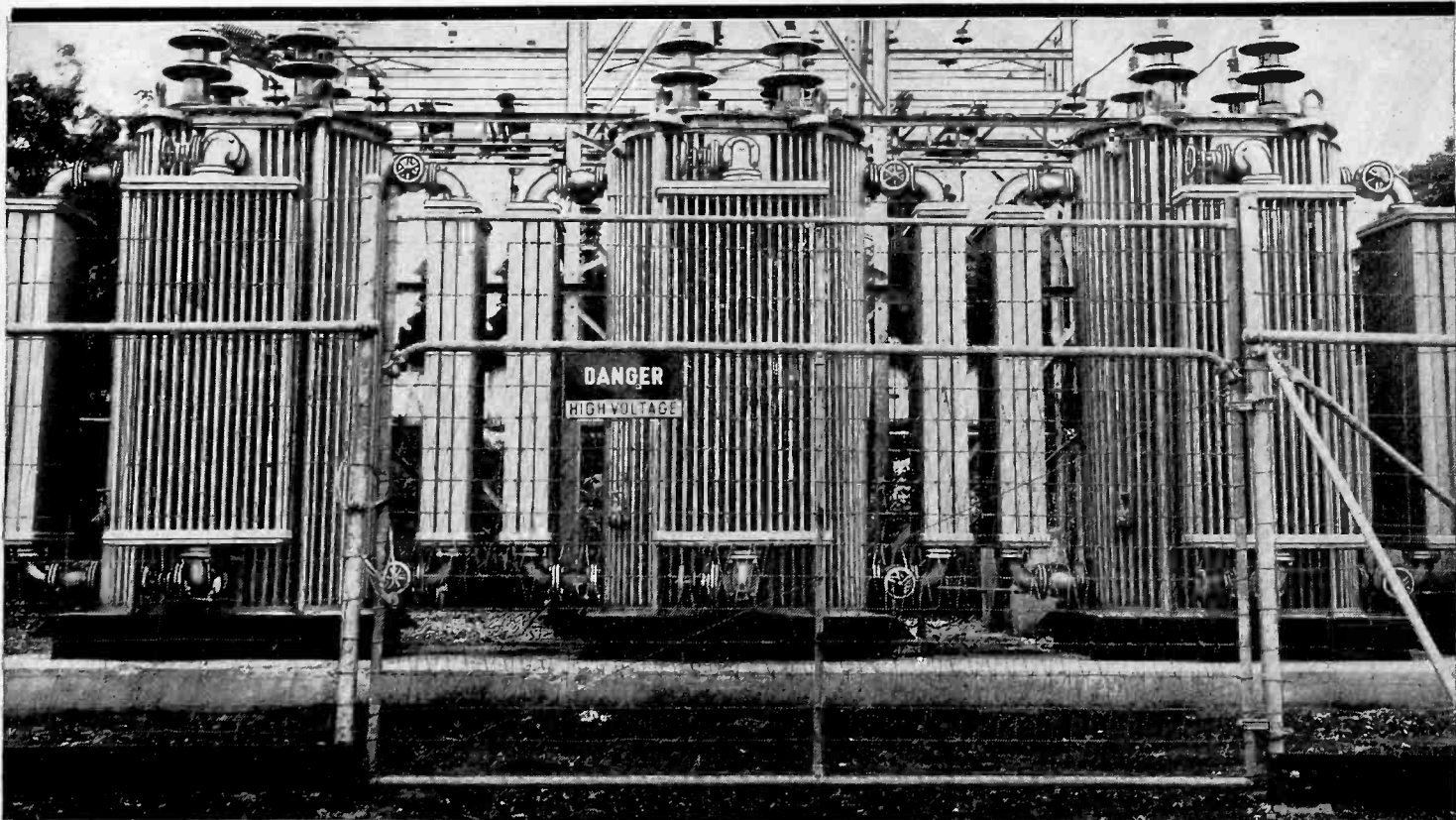

— on the lines of the Alabama Power Co., at Russellville, Ala.

Kuhlman Power and Distribution Transformers are day-after-day doing their work well in central stations, sub-stations, industrial plants, theatres, railroads and a host of other special fields. Each installation is additional testimony to the complete reliability and high operating efficiency of Kuhlman Transformers. When you are in the market for transformers, it will be to your advantage to get in touch with the nearest Kuhlman office.

**KUHLMAN ELECTRIC CO.**  
BAY CITY, MICHIGAN

**KUHLMAN TRANSFORMERS**  
**KUHLMAN ELECTRIC CO.**  
BAY CITY MICHIGAN

## OFFICES

- Akron, Ohio  
Electric Motor & Repair Co.  
High and Barges Sts.
- Atlanta, Georgia  
E. K. Higginbottom  
1431 Healy Bldg.
- Baltimore, Md.  
Industrial Power Equip. Co.  
421 W. Camden St.
- Boston, Mass.  
Geo. H. Wahn Co.  
69-71 High Street
- Buffalo, N. Y.  
John E. Hoffman  
280 Carolina St.
- Chicago, Ill.  
John R. Smith  
844 Rush St.
- Cincinnati, Ohio  
S. L. Currier  
833 Union Trust Bldg.
- Cleveland, Ohio  
Public Service Supply Co.  
627 Union Trust Bldg.
- Dallas, Texas  
F. T. Morrissey & Co.  
1408 Allen Bldg.
- Denver, Colo.  
Electric Sales Co.  
1535 Broadway
- Detroit, Michigan  
Richard P. Johnson  
10-230 General Motors Bldg.
- Indianapolis, Indiana  
Scott Jacqua Co., Inc.  
202 Indiana Terminal Whse.
- Lincoln, Neb.  
Enterprise Electric Co.  
1425-35 M. St.
- Los Angeles, Cal.  
Thomas Machinery Co.  
912 E. 3rd St.
- Milwaukee, Wis.  
Wm. H. Fernholz  
1031 Clybourn St.

## OFFICES

- Minneapolis, Minn.  
Joseph L. Barnard  
1727 Lagoon Ave.
- Montreal, Quebec  
W. O. Taylor & Co.  
415 Canada Cement Bldg.
- New Orleans, La.  
Lyman C. Reed  
1230 Hibernia Bank Bldg.
- New York, N. Y.  
D. F. Potter, Jr.  
Graybar Bldg.
- New York (Export)  
Parr Electric Export Corp.  
77 Warren St.
- Omaha, Neb.  
J. H. Nicholson  
6315 N. 33rd St.
- Philadelphia, Pa.  
J. Edward Bolich  
1015 Chestnut St.
- Pittsburgh, Pa.  
Continental Sales & Eng. Co.  
839 Oliver Bldg.
- Rochester, N. Y.  
Geo. W. Foote  
601 Temple Building
- Saint Paul, Minn.  
E. H. Heins  
4179 Blair St.
- San Francisco, Cal.  
C. F. Henderson  
Call Building
- Seattle, Wash.  
Equipment Sales Co.  
514 Lloyd Bldg.
- Tampa, Fla.  
Tampa Hardware Co.  
Polk & Morgan Sts.
- Toledo, Ohio  
Howard J. Wittman  
319 Spitzer Bldg.
- York, Pa.  
Harry W. Motter  
25 N. Duke St.

Please mention the JOURNAL of the A. I. E. E. when writing to advertisers.



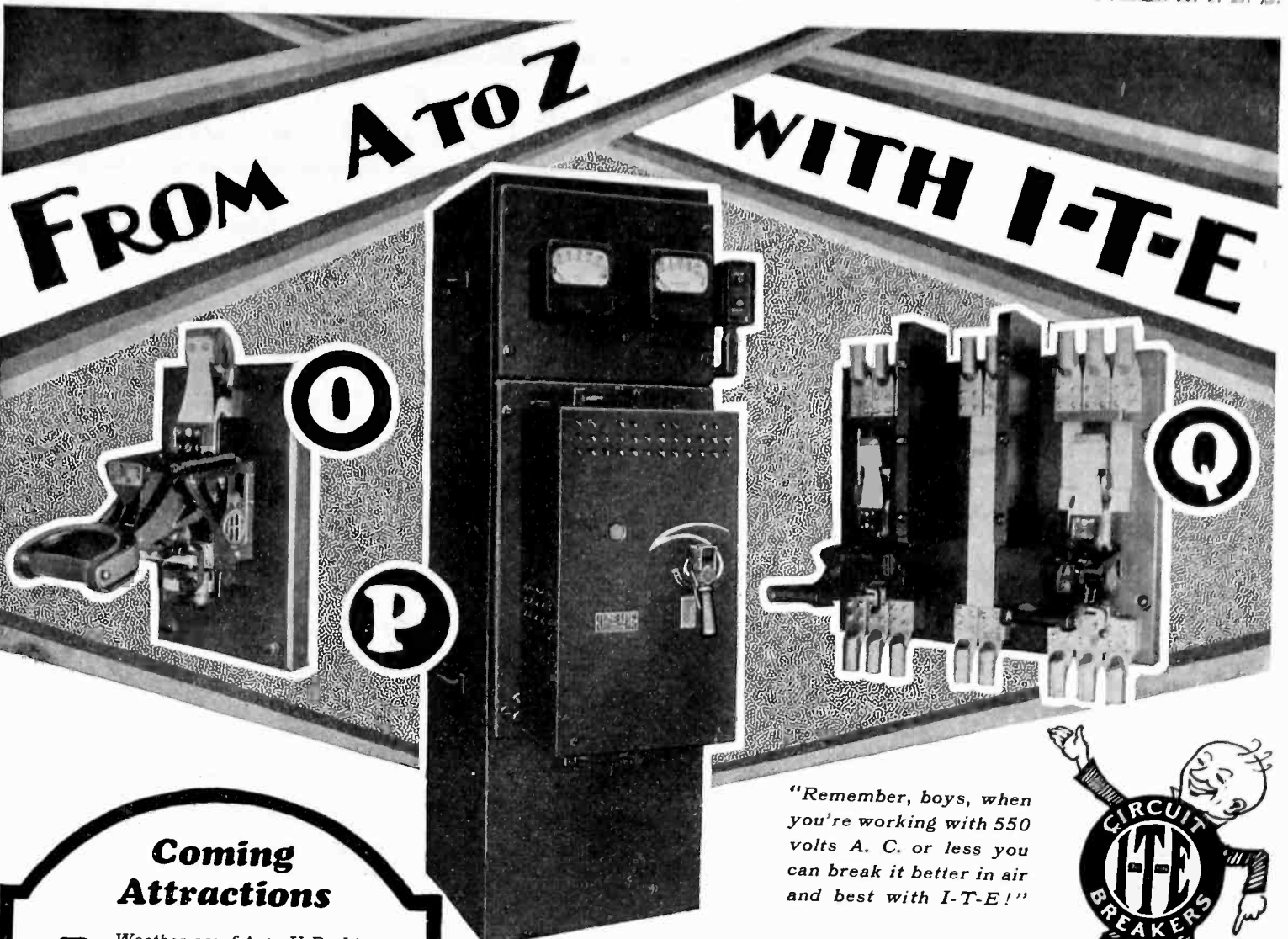

**Coming Attractions**

- R** Weather-proof Auto U-Re-Lite—400 amperes at 115 volts A. C.—type W Auto U-Re-Lite in cast iron box.
- S** Type LL circuit breaker—1000 amperes at 220 volts A. C. 2 phase, 4 wire—4 pole—4 direct acting overload coils with 4 direct acting time limits (Dalites)—non-closable against overload or short circuit (Autoite)—shunt trip.
- T** Type W circuit breaker—200 amperes at 250 volts D. C.—2 poles—2 direct acting overload coils with 2 direct acting time limits (Dalites)—non-closable against overload or short circuit (Autoite).
- U** Type LL air circuit breaker truck—1600 amperes at 550 volts A. C.—fitted with wheels, racking gear and separable contacts for easy removal from switchboard.
- V** I-T-E semi-automatic transfer switch—400 amperes at 480 volts A. C.—automatically connects load to emergency source—re-connected to normal source by operator.
- W** Type J circuit breaker—40 amperes at 250 volts D. C.—2 poles with direct acting overload coils and time limits (Dalites).

For complete information on dependable protection for any circuit up to 750 volts D. C. or 550 volts A. C. write or call our nearest office.

"Remember, boys, when you're working with 550 volts A. C. or less you can break it better in air and best with I-T-E!"

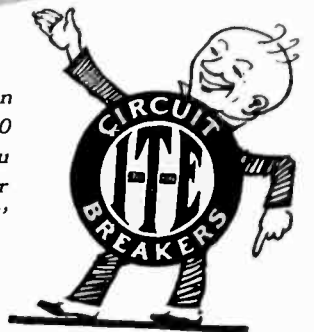

- O** Type LX circuit breaker—600 amperes at 250 volts D. C.—single pole—direct acting overload protection with time limit (Dalite)—non-closable against overload or short circuit (Autoite)—also made in 2, 3 and 4 pole form, from 200 to 1250 amperes for 250 volts D. C. and 550 volts A. C.
- P** I-T-E unit for operation and protection of motors—200 amperes at 550 volts A. C.—steel enclosed structure mounting remote control U-Re-Lite and meters—for across-the-line starting of motors and overload and short circuit protection.
- Q** Entrance breaker—1500 amperes at 110/220 volts A. C.—with front connections for cables and solid, removable neutral connection.

I-T-E CIRCUIT BREAKER COMPANY  
19th and HAMILTON STS., PHILADELPHIA

Birmingham, American-Traders Bank Building; Boston, 201 Devonshire; Buffalo, Ellicott Sq. Bldg.; Chicago, 333 N. Michigan Ave.; Cincinnati, Union Trust Bldg.; Cleveland, 439 Terminal Tower Bldg.; Dallas, 1810 Allen Bldg.; Denver, Tramway Bldg.; Detroit, Penobscot Bldg.; Duluth, 611 Providence Bldg.; Kansas City, Midland Bldg.; Los Angeles, 106 W. 3rd; Minneapolis, Plymouth Bldg.; Montreal, P. Q., 35 Notre Dame St. West; New Orleans, Hibernia Bank Bldg.; New York, 12 E. 41st St.; Omaha, Electric Bldg.; Philadelphia, 1505 Race St.; Pittsburgh, Park Bldg.; St. Louis, Bank of Commerce Bldg.; San Francisco, Russ Bldg.; Seattle, 802 3rd Ave.; Toronto, 149 Adelaide Street East; Tulsa, Oklahoma, 1165 N. Elwood Street; Vancouver, 500 Beatty Street.

**I-T-E PROTECTION**  
U-RE-LITES ~ I-T-E CIRCUIT BREAKERS



# A New Phase of Sustained Accuracy

The Sangamo Meter of 1914 (Type H) set a standard for accuracy *sustained over long periods of time.*

The new Sangamo Meter (Type HC), without a single sacrifice of the desirable characteristics of the old meter, has added accuracy *sustained over wide variations of load, power-factor and temperature.* In sections where load is increasing and is subject to wide fluctuations, the HC Meter should be used. It has a straight-line accuracy from the lightest up to 300 per cent load and is temperature compensated from 20 to 120 deg. F. at all power-factors. Neither do frequency and voltage variations appreciably affect the accuracy. The attached diagram shows the load characteristics at unity and 0.5 power-factor.

Supplement 67 tells all about the HC Meter. Sent on request.

All modern American meters are far superior in their performance on overload and varying temperature to the best made five years ago. This high degree of perfection in manufacture is due largely to the full co-operation between the American meter manufacturers and the two great national meter committees.

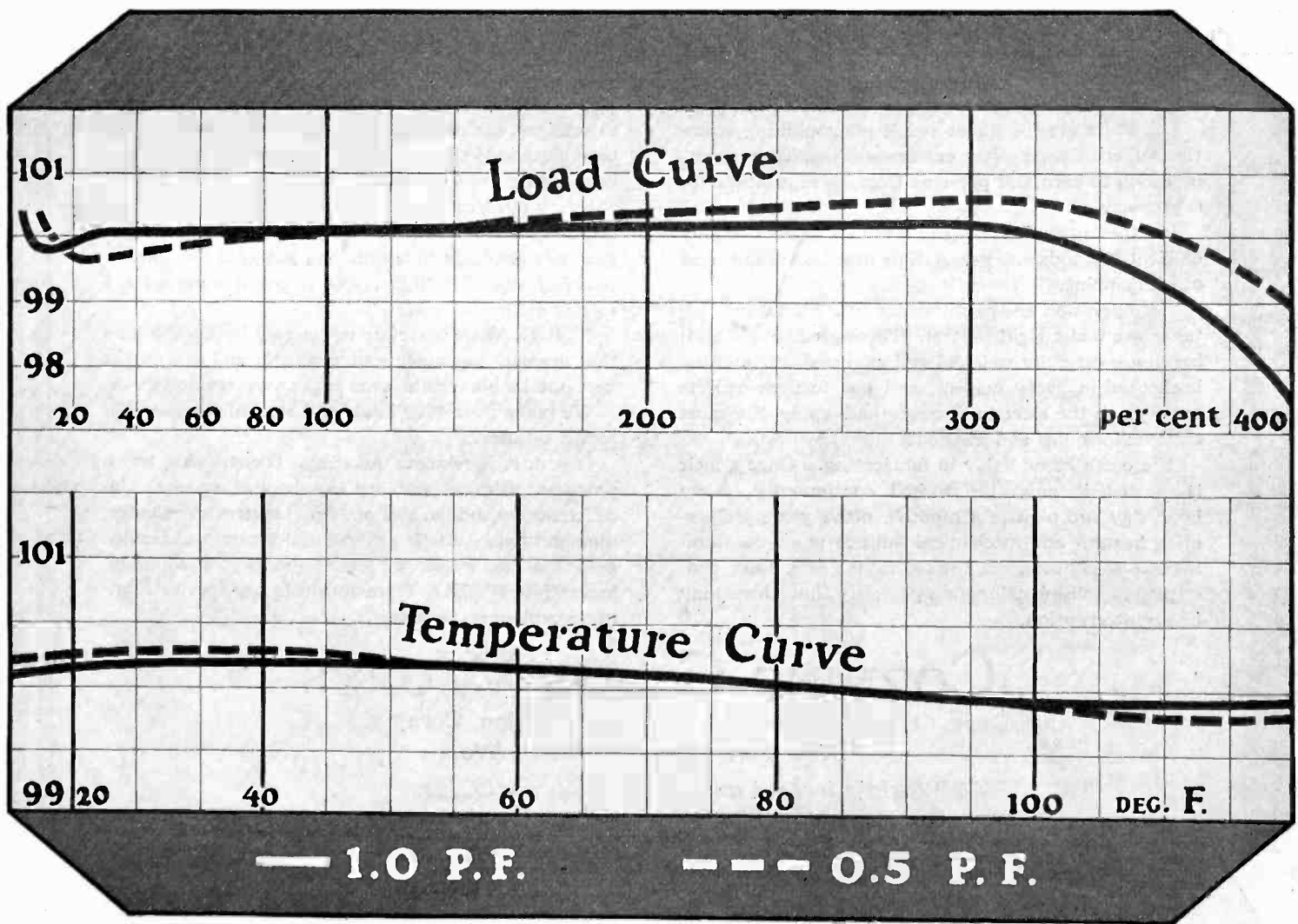

# SANGAMO

ELECTRIC COMPANY • • • SPRINGFIELD, ILLINOIS

86-8331-14

Please mention the JOURNAL of the A. I. E. E. when writing to advertisers.

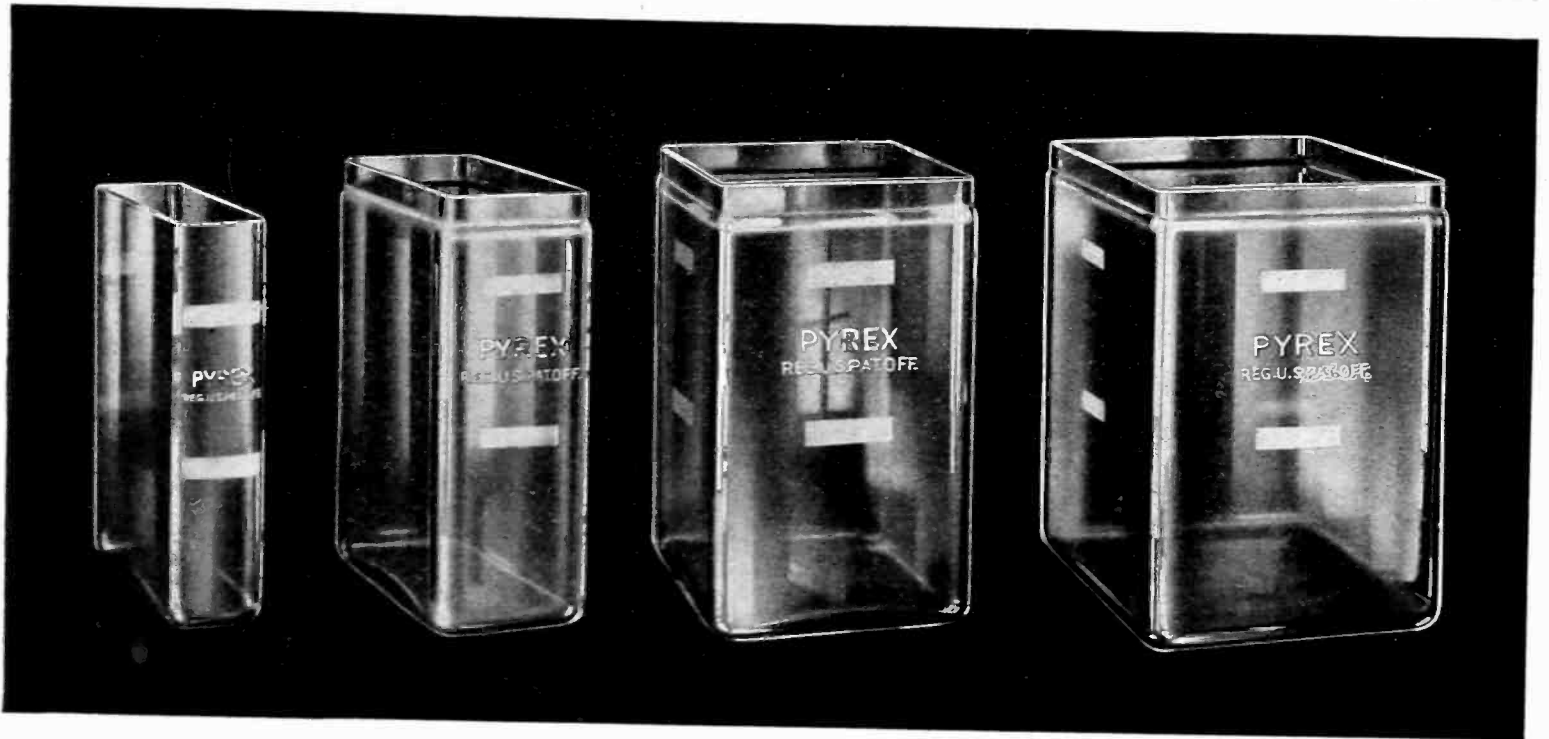

Battery jars. We make them by the thousand or hundred thousand

## Made Scientifically for Scientific Service

**T**HE unique characteristics of PYREX Industrial Ware are the direct result of combining scientific supervision, master craftsmanship and a determination to earn and preserve Corning reputation for supremacy.

In the manufacture of PYREX Ware, highly efficient methods and painstaking precision are utilized at every point.

The operation and maintenance of PYREX melting tanks are under rigid control. The ingredients of each batch are carefully weighed and analyzed, the melting is checked in every respect, and our furnace experts are ever on the alert to discover and apply the most efficient formulas and methods.

There can be no delay in fabricating. Once a melt is started, it must be worked continuously, every hour, day and night, for months, often years. Operating hazards and mechanical failures must be eliminated. Gas producers, mains, valve gears, tank construction—all must function perfectly that there may be no interruption.

The moulds are made to micrometer accuracy, and throughout the periods of the blowing operations, the temperature of the moulds is constantly checked and kept within uniform limits.

Every piece of the finished product is individually inspected. Any which is not perfect for its purpose, goes straight back to the melting pot. No "seconds" bearing the PYREX trade mark are permitted to get onto the market.

PYREX Ware therefore is the very best of its kind that human ingenuity can produce, and assures the best obtainable results, even in the most trying service.

We make over 4500 kinds and sizes of glassware for industrial uses.

If your requirements include parts combining transparency, chemical stability, mechanical strength, indifference to sudden and extreme temperature change, diamond-hard smooth surface, uniformity, and reasonable cost in small or large quantity production, investigate PYREX Ware and have our Service Engineers explain its possibilities.

## CORNING GLASS WORKS

Dept. 61, Industrial and Laboratory Division, Corning, N. Y.

New York Office: 501 Fifth Ave.

*World's largest makers of Technical Glassware*

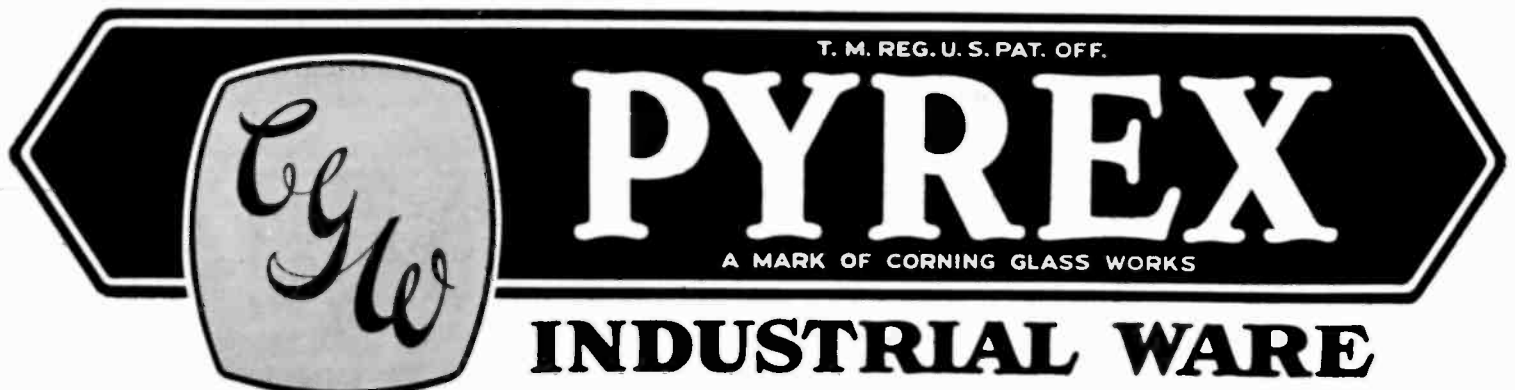

Please mention the JOURNAL of the A. I. E. E. when writing to advertisers.

# Transformer Efficiency In the Cottrell Process Of Precipitation ~ ~ ~

**E**FFICIENT operation of the Cottrell Process of Precipitation depends, in a large measure, upon the transformer used. Many leading public utility and other industrial plants\* have found that American Transformers give the most efficient and economical service for the Cottrell Process. A number of these companies\* are still using the original American Transformer installations after ten years of service! Data concerning these installations together with Bulletin 1110-J describing the latest type, will be sent upon request.

[ There is an American Transformer for every industrial service. The advice of our engineers on your problem entails no obligation. ]

\*Names upon request.

**AMERICAN TRANSFORMER COMPANY**  
176 Emmet Street Newark, N. J.

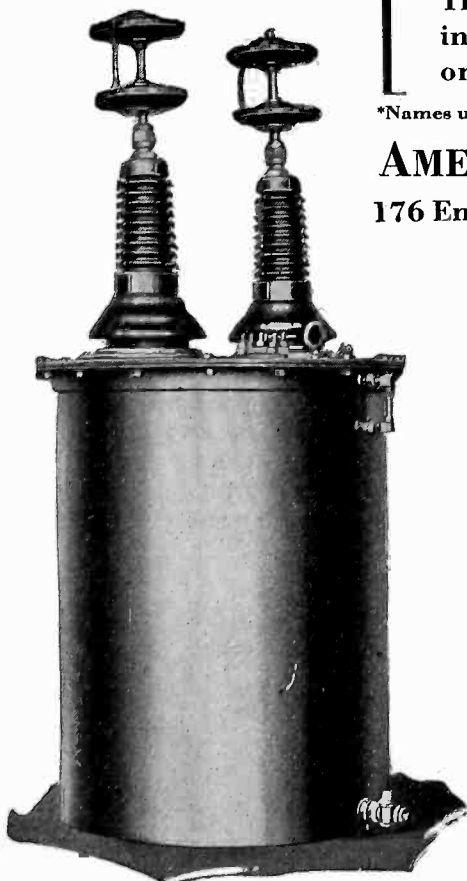

These transformers are built in sizes from 2½ kva. to 50 kva., and the standard high-tension voltages are 75000, 70000, 65000, 60000 and and 55000.

*Representatives*

- Montreal, Canada  
W. O. Taylor & Co., Ltd.  
415 Canada Cement B'ldg.
- Minneapolis, Minn.  
Elliott Equipment Co.  
708-6th Avenue, South
- San Francisco, Calif.  
James H. Southard  
682 Mission Street
- Chicago, Ill.  
L. C. Herrmann  
4433 North Richmond St.  
Ravenswood Station
- Knoxville, Tenn.  
Arthur L. Pollard
- Philadelphia, Pa.  
L. D. Joralemon  
112 South 16th Street
- St. Louis, Mo.  
J. W. Jones  
432 Pennant B'ldg.
- Atlanta, Ga.  
H. Douglas Stier  
101 Marietta Street

**AMERICAN TRANSFORMER**

Please mention the JOURNAL of the A. I. E. E. when writing to advertisers.

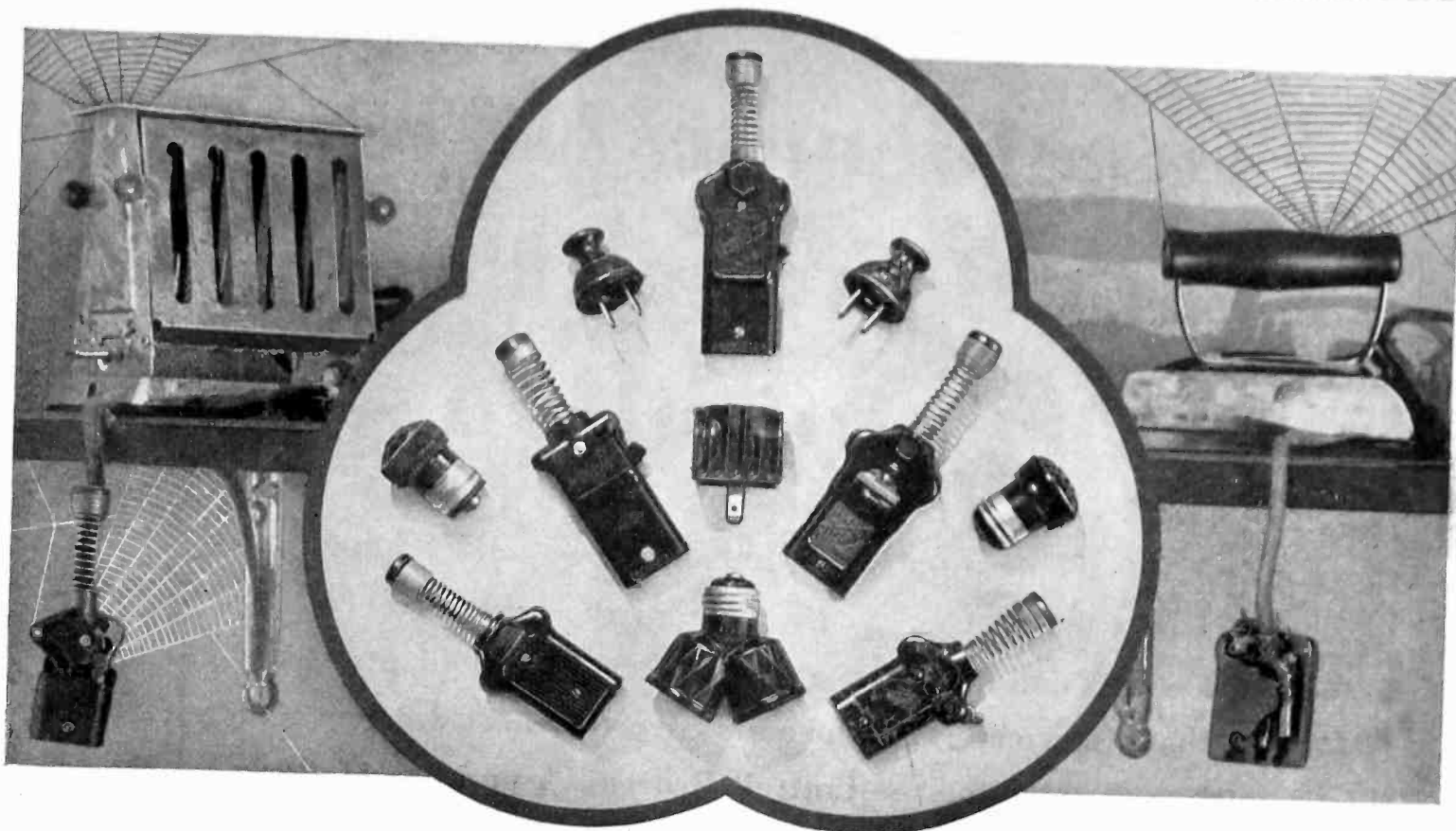

## Longer appliance life—higher energy loads through the use of durable Bakelite Insulation

**W**HEN an appliance "burns out", or a wiring device breaks, the dissatisfied user immediately becomes a factor of resistance to any program for increasing appliance sales and raising the residential load. To provide durable insulation equal to the mechanical life of the appliance and sufficiently strong for constant use, leading manufacturers throughout the industry have adopted Bakelite Materials.

In the production of insulating parts, Bakelite Materials afford the advantage of high mechanical and dielectric strength. Improved designs and more rugged assemblies have been made possible. Adapted to the requirements of mass production, Bakelite Materials provide unvarying uniformity and have effected outstanding reductions in cost.

Bakelite Materials are non-hygroscopic and retain their high insulation value in the temperature and humidity extremes of any climate. Mechanically strong, these materials will not crumble, crack or disintegrate. Over a period of years, Bakelite Insulation has proved to be a strong selling advantage, demonstrating in appliance service an unequalled standard of durability.

### *Bakelite Engineering Service*

To the manufacturer of electrical appliances and devices, we offer the full cooperation of our engineers and research laboratories. Write us today, and we will immediately place at your service a specialist, who will assist you in working out your present insulation problems, or plan new features for future production.

### **BAKELITE CORPORATION**

247 Park Ave., New York, N. Y. Chicago Office: 635 West 22nd St.  
**BAKELITE CORP. OF CANADA, LTD.**, 163 Dufferin Street, Toronto, Ont., Canada

# BAKELITE

REGISTERED

U. S. PAT. OFF.

THE MATERIAL OF  A THOUSAND USES

"The registered Trade Mark and Symbol shown above may be used only on products made from materials manufactured by Bakelite Corporation. Under the capital 'B' is the numerical sign for infinity, or unlimited quantity. It symbolizes the infinite number of present and future uses of Bakelite Corporation's products."

Please mention the JOURNAL of the A. I. E. E. when writing to advertisers.



# ROCKBESTOS

*-the asbestos insulated wire*

*This Multi-Conductor Cable was built for you!*

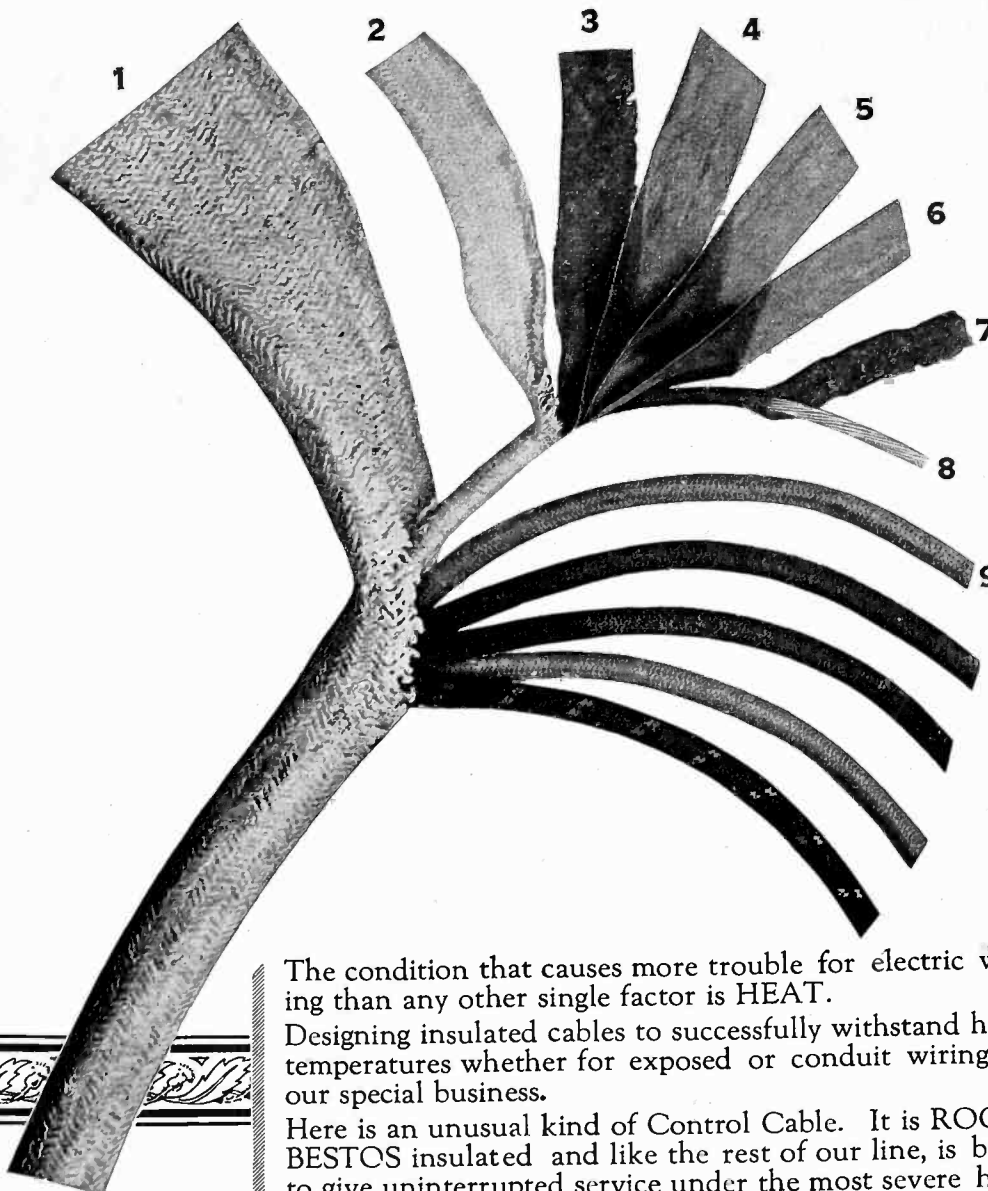

- Description of Construction**
1. Heavy asbestos outer braid.
  2. Cotton braid color coded to your specifications.
  3. Compactly felted asbestos wall impregnated against flame and moisture.
  - 4, 5, and 6. Varnished Cambric tapes, laid in petrolatum.
  7. Compactly felted asbestos wall impregnated against flame and moisture.
  8. Conductor according to your specifications.
  9. Any number of conductors up to 19.

The condition that causes more trouble for electric wiring than any other single factor is HEAT.

Designing insulated cables to successfully withstand high temperatures whether for exposed or conduit wiring, is our special business.

Here is an unusual kind of Control Cable. It is ROCKBESTOS insulated and like the rest of our line, is built to give uninterrupted service under the most severe heat conditions existing in industrial plants and in the boiler rooms of central stations. This control cable in actual use has successfully demonstrated these characteristics:

- It is flame proof and heat proof.
- May be used open or in conduit.
- It will not cause nor communicate fire.
- It will never deteriorate.
- It is permanently flexible.
- Can be made in any number of conductors up to 19.
- Once installed, you can forget it.
- It is Rockbestos insulation.

Check up your control cable performance. Send this coupon

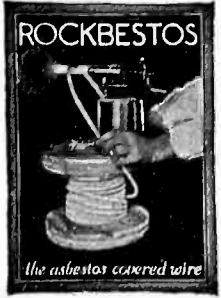

**ROCKBESTOS PRODUCTS CORPORATION**  
 NEW HAVEN, CONN.

NEW YORK      PITTSBURGH      CHICAGO  
 On the Pacific Coast—Anaconda Wire & Cable Co.

**Dept. J**

Send details of  
 Multi-Control Cable  
 for ..... conductors  
 size .....

Name .....

Firm .....

Address .....



**BETTER  
BEARINGS**  
*for*  
**BETTER MOTORS**

**NORMA-HOFFMANN**

**NORMA-HOFFMANN BEARINGS CORPORATION** Stamford, Conn. U.S.A.

Please mention the JOURNAL of the A. I. E. E. when writing to advertisers

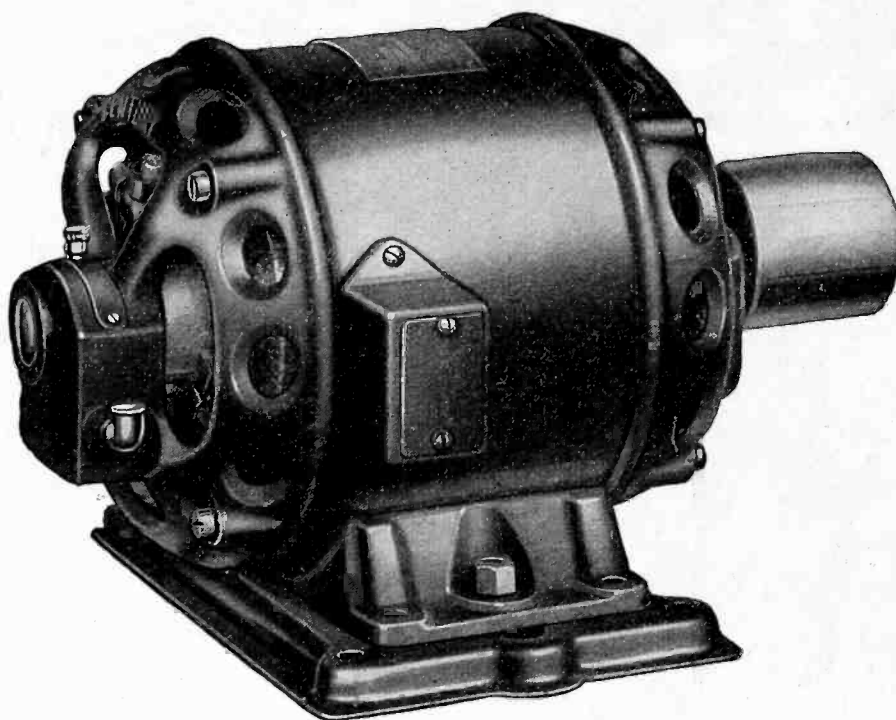

$\frac{1}{4}$  Horse Power Century Type RS  
Repulsion Start Induction Single Phase Motor

## Electric Refrigerators Oil Burners

**R**EFRIGERATORS and oil burners are more exacting service than most installations. Century Single Phase Motors were particularly suited to this severe service long before these commercial and domestic appliances were popularized. Century Single Phase Motors have the proper starting and operating characteristics, they resist dampness, are quiet in operation, require the very minimum of attention and "Keep a-Running".

Built in Standard sizes from  $\frac{1}{8}$  to 40 horse power. Temperature rating, 40° C.

**CENTURY ELECTRIC CO.**

1806 Pine St.

St. Louis, Mo.

40 U. S. and Canadian Stock Points and More Than 75 Outside Thereof



**“THEY KEEP A-RUNNING”**

Please mention the JOURNAL of the A. I. E. E. when writing to advertisers.



Part of an order of 72 5-h.p., 750 r.p.m. type "AR" Motors direct connected to Sturtevant Convertible Multivane Fans for installation in a large rayon plant.

## All Fan Bearings are Eliminated in this Unique Motor Installation

**I**T WAS possible to entirely eliminate the fan bearings in building these convertible multivane fan units for the air conditioning system of a large rayon plant. Because of the rugged construction, high mechanical efficiency and short shafts of the Allis-Chalmers motors, the rotating elements of the fans were mounted directly on the motor shaft extensions. This resulted in a more silent and efficient as well as a more compact unit. From the opposite ends of the motors, Texrope Drives operate other parts of the equipment.

The sturdy mechanical construction of Allis-Chalmers motors is emphasized in the frames, shafts and bearings. Electric steel frames and spiders give maximum strength with minimum weight. Compactness in design permits shorter and more rigid shafts. These features, together with the greater load area and thrust capacity of the bearings, make these motors peculiarly adaptable to direct drives.

**ALLIS-CHALMERS MANUFACTURING COMPANY, MILWAUKEE, WIS.**

# ALLIS-CHALMERS MOTORS

Please mention the JOURNAL of the A. I. E. E. when writing to advertisers.



# DANGER — HIGH VOLTAGE . . .

—one man is killed— — —

**WORKMAN IS ELECTROCUTED**  
 William Willingham, 33, of 1441 E. 123rd st., a laborer in the \_\_\_\_\_ Coal Co. yards at 12535 \_\_\_\_\_ ave., was electrocuted late Thursday when he touched high voltage wires on an electrically driven coal loading machine, police reported.

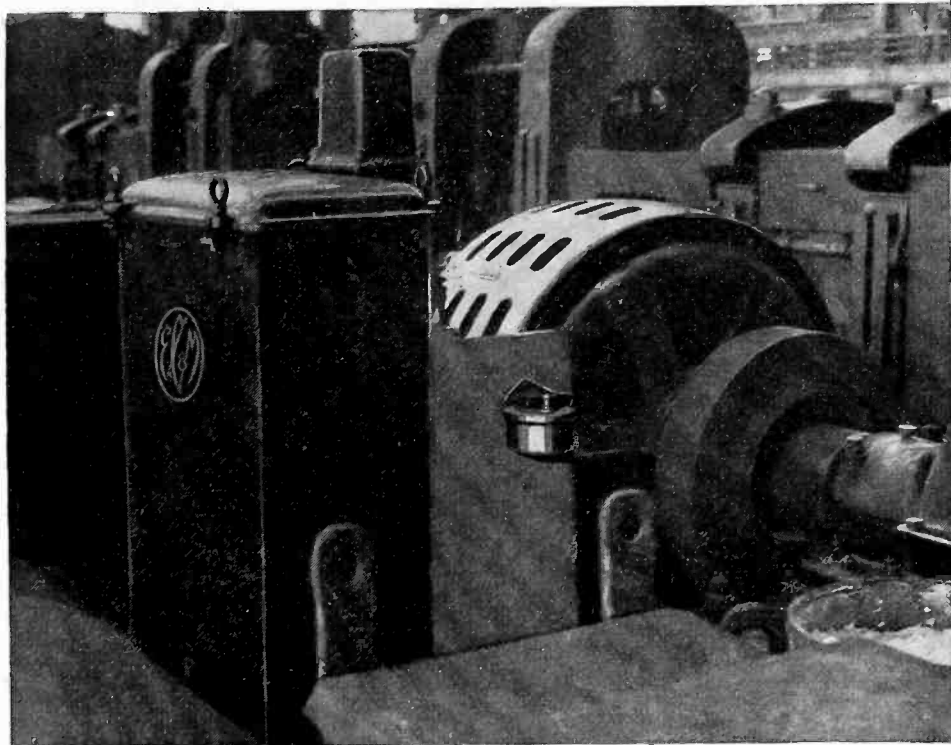

## It is too late then to buy this Safe motor starter

**T**HE cause of injury to a workman can not always be blamed on carelessness, because the injured one may have ordinarily been a most careful workman. It may only be during the waning moments of a day—a day in which he has given his best to turn out maximum production—that he will, during a case of “brain failure” or mental lapse of the brain, be injured or possibly killed.

To safeguard the workman from electric shocks or burns not only during these periods of forgetfulness but throughout the entire day is one of the features of the EC&M 2300 volt Automatic Compensator. It is a complete unit, in which all live parts are totally enclosed and oil-immersed in a steel tank, which, when grounded, provides a shockproof installation.

Write for a copy of Bulletin 1047, which fully describes this and many other superiorities of EC&M High-Voltage Compensators.

An example of the safety of the starter illustrated directly above is shown by the above photograph of an installation of this unit in a large brass rolling mill. Even though the starter is mounted out in the mill alongside the motor it controls, the workmen are protected because all live parts are enclosed.

The operator uses the small master switch shown to the right of the starter to start and stop the motor. This switch carries only a low voltage control circuit which is supplied by a potential transformer self-contained in the starter.



### THE ELECTRIC CONTROLLER & MFG. CO.

NEW YORK-50 CHURCH ST.  
 CHICAGO-CONWAY BLDG.  
 DETROIT-DIME BANK BLDG.  
 BIRMINGHAM-BROWN-MARX BLDG.  
 CINCINNATI-124 NATIONAL BANK BLDG.  
 DENVER-KITTREDGE BLDG.

CLEVELAND, OHIO

LOS ANGELES-912 E. THIRD ST.  
 HOUSTON-1006 WASHINGTON AVE.  
 TORONTO-REFORD BLDG.

PHILADELPHIA-WITHERSPOON BLDG.  
 PITTSBURGH-OLIVER BLDG.  
 SAN FRANCISCO-CALL BUILDING  
 MONTREAL-CASTLE BLDG.  
 TULSA-217 E. ARCHER ST.  
 SEATTLE-ALASKA BLDG.



Please mention the JOURNAL of the A. I. E. E. when writing to advertisers.

# ONLY

Westinghouse  
LINESTARTERS  
have the NEW

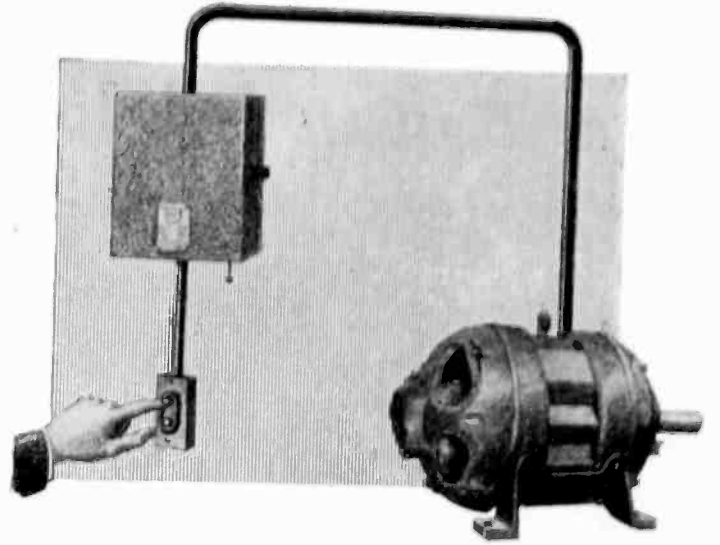

## DEION Arc Quencher

**T**URNING the blinding arc-flash of an interrupted current into a mere glow, gives a longer lived, safer, more reliable motor-starter. The new Westinghouse Deion Linestarter does this.

One 75-ampere contactor, equipped with the Westinghouse Deion Arc Quencher, interrupted a short circuit current of 2500 amperes—successfully, repeatedly. More than three thousand percent of its rating!

A 7½-hp. Linestarter with the Westinghouse Deion

Arc Quencher performed 50 operations on a locked rotor 25-hp. motor after having performed 50 times on a 20-hp. motor, a 15-hp. motor and a 7½-hp. motor—50 times on each and all with locked rotor!

These, of course, were tests, but they indicate the factor of safety that is built into the Westinghouse Deion Linestarter.

Linestarters are made in sizes and types for across-the-line starting of motors from ¼ to 50 horsepower. All have the Westinghouse Deion Arc Quencher.

WESTINGHOUSE ELECTRIC & MANUFACTURING COMPANY  
EAST PITTSBURGH PENNSYLVANIA  
SALES OFFICES AND SERVICE SHOPS IN ALL PRINCIPAL CITIES

# Westinghouse

T 30701

Please mention the JOURNAL of the A. I. E. E. when writing to advertisers.

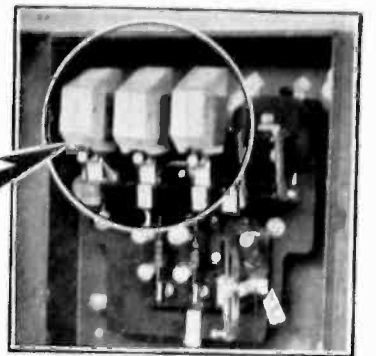

Interrupting a current of 320 amperes, 450 volts with the standard magnetic blowout —

and—

with the Westinghouse Deion Arc Quencher

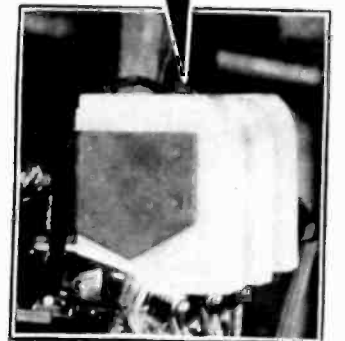

*A nation-wide chain of well-equipped and efficiently-manned Service Shops bring factory service within over-night shipping distance of every purchaser of Westinghouse products.*



◆◆ BEHIND THE PYRAMIDS—9 ◆◆



# 20 days in a unique furnace



*View of part of a ring furnace*

THE "green" blocks as they come from the moulding machines are entirely unsuitable for use as brushes, though they have gone through eight major manufacturing operations, and innumerable minor ones, all under accurate scientific control. The next operation is baking. This is done in an unusual ring-type furnace, of exclusive design. The blocks, or in the case of small brushes, the pre-formed brushes themselves, are packed in the furnace, which is then fired by gas to a high temperature, carefully kept within close limits. The entire operation takes about 20 days. During it, the pitch binder is carbonized, the blocks and brushes made mechanically strong, and the material given the proper degree of electrical conductivity.

This unusual ring furnace is so arranged as to make continuous operation possible. All operations necessary to this process—loading, heating, firing, cooling, unloading—are conducted continually. In design, in efficiency, and in closeness of temperature control this furnace is most unusual, in fact, unique in brush manufacture.

We feel that our pride in it is fully justified by its results.

Time and money are saved by this furnace, which savings are passed along to you. In addition, better quality brushes are made possible, with that degree of uniformity for which National Pyramid Brushes are famous.

*An interesting moving picture film illustrating in detail the processes used in the manufacture of carbon brushes will gladly be shown on request to any organization of engineers or students.*

**NATIONAL CARBON COMPANY, INC.**

Unit of Union Carbide **UCC** and Carbon Corporation

Carbon Sales  
Division



Cleveland, Ohio

*Branch Offices and Factories*

New York Pittsburgh Chicago Birmingham San Francisco

Please mention the JOURNAL of the A. I. E. E. when writing to advertisers.

# More and still more telephones for tomorrow

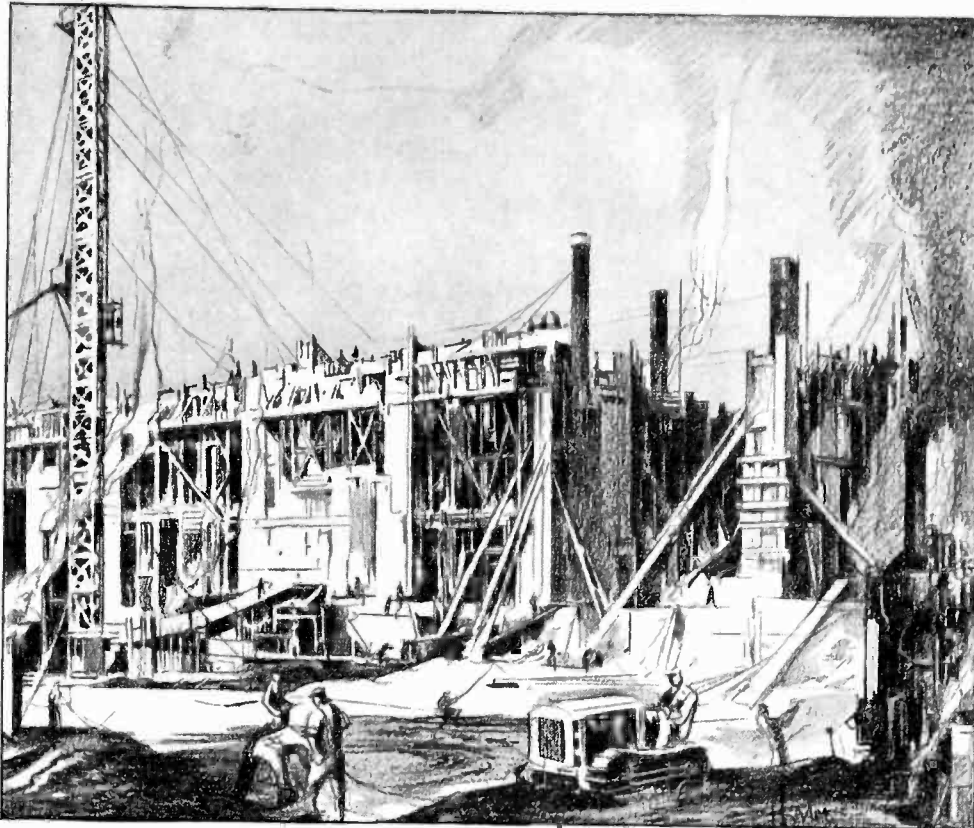

## Your voice starts new factories a-building

Day by day, the telephone becomes a more significant factor in social and business intercourse. As a means of communication on land and across the ocean, its use grows steadily and it is soon destined to become an accepted adjunct to travel in the air.

More and more equipment will be needed—telephones by the million, copper wire by the millions of miles, parts and accessories ranging from delicate springs to giant reels of cable, from the simple transmitter mouthpiece to the highly complex telephone switchboard.

To meet this program of expansion Western Electric's manufacturing facilities are being doubled. Huge additions to plants at Chicago and at Kearny, N. J.—a new factory at Baltimore—all this is evidence that however great the demand for telephones in 1930 or 1940, that demand will be satisfied.



In homes



In offices



In airplanes



Across the ocean



*This busy scene is typical of Western Electric growth at Baltimore, Chicago and Kearny, N. J. It is growth made necessary to provide telephone apparatus whenever and wherever needed.*



# Western Electric

MAKERS OF YOUR TELEPHONE

Please mention the JOURNAL of the A. I. E. E. when writing to advertisers.



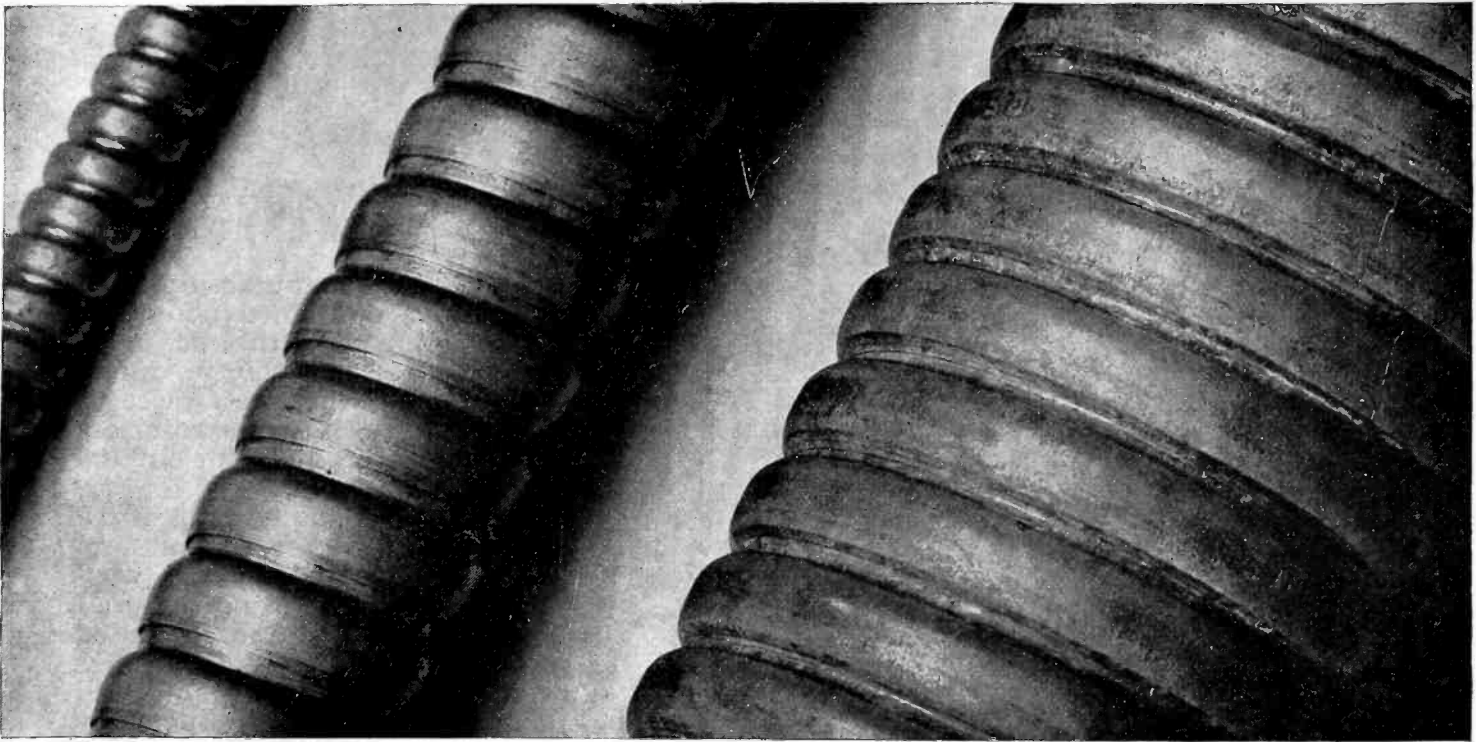

# No Conduit is Needed

## G-E interlocking armor for power-plant and industrial wiring

**P**OWER and control cable with interlocked, flexible, metal armor for wiring without conduit is now available in long lengths. Varnished-cambric and rubber-insulated cables—taped, braided, or leaded—and paper-leaded cables, in any number and combination of conductors up to 3 in. outside diameter, can be furnished with this armor.

The armor is one layer of overlapping and interlocking metal tape, either galvanized steel or aluminum, so applied that the cable is always mechanically protected under reasonable installation conditions. The steel armor is suitable for most installations. The aluminum tape is for use where a non-corroding armor is required and for single-conductor cable carrying alternating current where the magnetic effect of steel is undesirable.

Address inquiries to the nearest G-E office.

810-9



JOIN US IN THE GENERAL ELECTRIC HOUR, BROADCAST EVERY SATURDAY AT 8 P.M., E.S.T. ON A NATION-WIDE N.B.C. NETWORK

# GENERAL ELECTRIC

GENERAL ELECTRIC COMPANY, SCHENECTADY, N. Y., SALES OFFICES IN PRINCIPAL CITIES

Please mention the JOURNAL of the A. I. E. E. when writing to advertisers.

# ELECTRITE

**A high grade fibre board  
for electrical insulation.**

**A material of quality pos-  
sessing high tensile and  
dielectric strength.**

**Tested and approved by  
the Underwriters' Labora-  
tories.**

*Pulp Products Department*

**WEST VIRGINIA  
PULP & PAPER COMPANY**

230 Park Avenue  
New York, N. Y.

35 East Wacker Drive  
Chicago, Ill.

**GUARD YOUR EQUIPMENT  
with**

**MICABOND**  
THE STANDARD MICA INSULATION

You and other manufacturers or users of electrical equipment should be most vitally interested in the mica insulation which enters into your products.

You realize that the finest piece of electrical apparatus is utterly valueless without dependable and efficient insulation.

For this reason, many progressive manufacturers have been and are "mica-bonding" their products with MICABOND—the insulating material which has been the standard for 30 years.

You too, can insure long life and dependability in your products by standardizing on MICABOND.

*Investigate now! Write for the names of MICABOND users, and more information concerning its use. MICABOND is furnished in the form of Molding - Segment and Heater Plate - Tubes - Segments - V-Rings Special Shapes - Tape*

**CHICAGO MICA COMPANY**  
432 Campbell Street  
VALPARAISO INDIANA

**FIBROC**

**PANELS and PARTS  
for INSULATION**

FIBROC is a standard material for insulating panels and bases for mounting various electrical instruments and devices.

FIBROC is strong and durable—it is unaffected by changing temperatures and atmospheric conditions—it does not change dimensions—will neither warp nor crack and presents a smooth finish that lasts indefinitely.

*Fibroc can be furnished in the form of completely machined insulating parts to specification. It will pay you to investigate Fibroc for your use.*

**FIBROC INSULATION COMPANY**  
510 Lincoln Avenue  
VALPARAISO - INDIANA

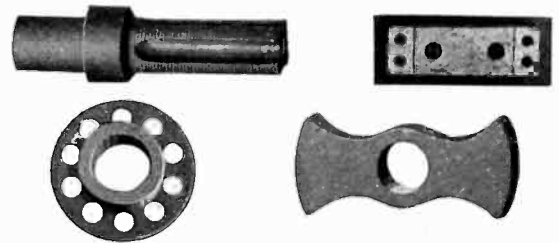

# LAVA INSULATORS

meet the requirements of varied industries where dielectric strength and heat resistant properties are essential.

**AMERICAN LAVA  
CORPORATION**

27-67 Williamson St. Chattanooga, Tenn.

*Manufacturers of Heat Resistant Insulators*



*This* **MARK**  
*is your* **GUARANTEE**

Look for the word "Empire" on oiled electrical insulations! It is your guarantee of uniform high quality, of an insulation that successfully withstands the ravages of time.

Only the finest of linseed oil, the strongest, most uniform of cloths and papers are used. Rigid inspection assures this. Manufacture has been perfected to such an extent that the original high dielectric strength and flexibility of Empire electrical insulation is retained indefinitely.

If you require cloth, silk, paper or any of the other oiled insulations be sure to ask for "Empire"—the age-resisting electrical insulation.

**MICA INSULATOR COMPANY**

New York: 200 Varick St. Chicago: 542 So. Dearborn St.  
Works: Schenectady, N. Y. London, England  
Cleveland, Pittsburgh, Cincinnati, Seattle, San Francisco, Montreal, Toronto, Los Angeles



*Electrical*  
**INSULATION**



**MICA INSULATION**

**OILED CLOTH INSULATION**

Please mention the JOURNAL of the A. I. E. E. when writing to advertisers.

ELIMINATE TAPPING WITH THESE UNIQUE SCREWS



**E**liminated!  
tapping . . . crossed threads  
. . . scrapped parts . . .

by making fastenings with  
**Hardened Metallic Drive Screws**

Gone is the expense of tapping and the loss formerly resulting from stripped and crossed threads! Parker-Kalon Hardened Metallic Drive Screws have simplified the job of fastening to iron, brass and aluminum castings, steel, Bakelite, etc.

A hammer is the only tool needed. These Screws cut their own thread in the material as they are driven into drilled or cast holes. No tapping . . . no scrapped parts. Fastenings are made easily and quickly . . . production is speeded up. And the fastenings hold securely under vibration and severe service.

Such concerns as Western Electric, Westinghouse, Cutler-Hammer and General Electric have adopted these Screws in place of machine screws, escutch on pins and rivets. They use them to advantage for all kinds of assemblies.

Try Hardened Metallic Drive Screws! Send a brief description of your assemblies—we will furnish suitable samples.

PARKER-KALON CORPORATION  
198 Varick Street, New York, N. Y.

Distributed in Canada by  
Aikenhead Hdw., Ltd., 19-21 Temperance St., Toronto

**PARKER-KALON**  
TRADE MARK  
**HARDENED METALLIC**  
REG. U.S. PAT. OFF.  
**DRIVE SCREWS**  
PAT. JAN. 29, 1924 No. 1482151 - OTHERS PENDING



For Making Fastenings to Iron, Brass  
and Aluminum Castings, Steel, Bakelite, etc.

## ACME WIRE PRODUCTS

Magnet Wire — All Insulations  
Coils—Magnet Wire Wound  
Varnished Insulations  
Parvolt Filter and By Pass Condensers

All products made to Recognized Commercial Standards including those of:

National Electric Mfrs. Assn.

Radio Manufacturers Assn.

American Society for Testing Materials

For 25 years manufacturers and suppliers to the largest and most discriminating users.

**THE ACME WIRE CO.**  
New Haven, Conn.

Branch Offices  
New York 52 Vanderbilt Ave. Chicago 842 N. Michigan Ave.  
Cleveland Guardian Bldg.

**UNIQUE**  
TRADE MARK REG'D.  
**THIN LEAD**  
**COLORLED PENCILS**  
**24 Colors**  
*Make fine lines in color*

Engineers regard **UNIQUE** Thin Lead Colored Pencils as their most satisfactory dry color medium for map drawing, field sketches, blue-print checking, etc. **UNIQUE** leads are almost unbreakable, but silky-smooth. Can be sharpened in a pencil sharpener to a fine point.

All primary colors and shades

	Per Box
12 Colors (Asst. No. 1116)	\$1.00
24 Pencils (Asst. No. 1117)	\$2.00

At all dealers or write direct  
American Pencil Co.  
524 Venus Bldg. - Hoboken, N. J.

**\$1.00 per dozen**

**A VENUS Pencil Factory Product**

Please mention the JOURNAL of the A. I. E. E. when writing to advertisers.



# AMERICAN STEEL & WIRE COMPANY

# MAGNET WIRE

**SINGLE AND DOUBLE COTTON COVERED  
ROUND ~ SQUARE ~ FLAT  
ENAMELED MAGNET WIRE  
PLAIN, SINGLE AND DOUBLE COTTON COVERED  
PAPER WRAPPED MAGNET WIRE**

In 1834 American Steel & Wire Company's predecessor, Washburn & Moen Manufacturing Company, established the first Electrical Wire manufacturing plant. Through these many years up to the present time, the standard of high quality and experienced workmanship has constantly been embedded into Magnet Wires which we offer to you. Our long experience is at your disposal in any way that we may be of service. Your Magnet Wire, also Electrical Wire and Cable problems are welcome.

## **American Steel & Wire Company**

*Subsidiary of United States Steel Corporation*  
208 S. La Salle St., Chicago 30 Church St., N. Y.  
*Offices in all Principal Cities*

**UNITED STATES STEEL PRODUCTS CO.**  
San Francisco Los Angeles Portland Seattle

*Other Electrical Wires  
manufactured by American  
Steel & Wire Company:*

Bare Copper, Weather-proof, Rubber Insulated Wires, Annunciator and Office Wires, Lamp Cords, Automobile Cables, Submarine Cables, Park and Suburban Cables, Power Cables, either Rubber, Cambric or Paper Insulated.

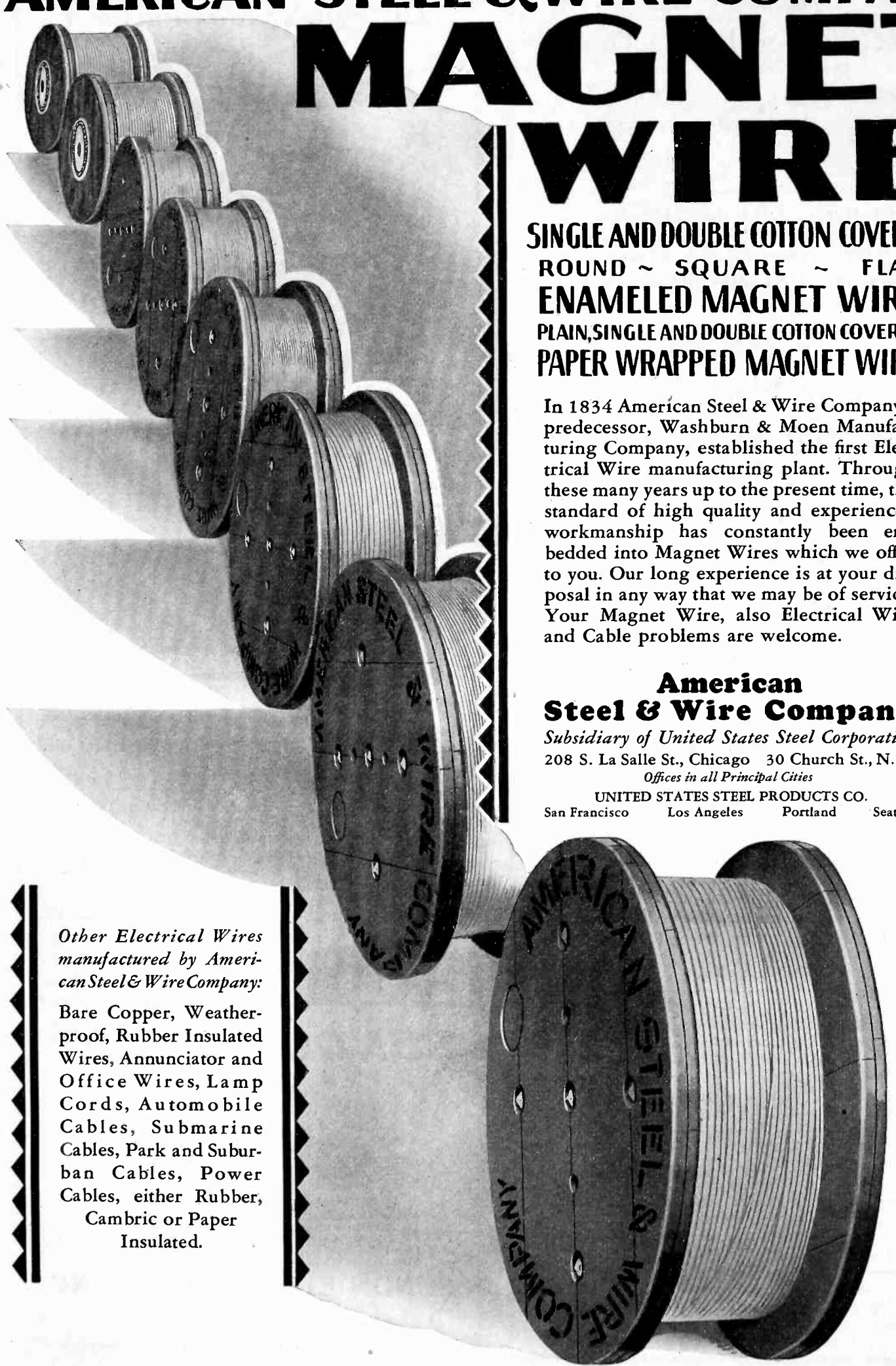

Trade "ESCO" Mark

## ELECTRIC SPECIALTY CO.

Engineers and Manufacturers



DESIGN —  
DEVELOP —  
PRODUCE —

TYPE NA AIRPLANE GENERATOR

Small Motors, Generators, Dynamotors,  
Motor Generators, Rotary Converters, Etc.  
FOR SPECIAL PURPOSES—Send Us Your Problems

222 South Street, STAMFORD, CONN., U.S.A.

SHUNT WOUND BATTERY CHARGER

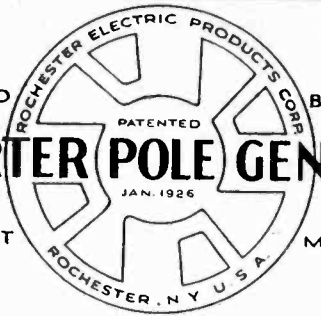

## THE DIVERTER POLE GENERATOR

CONSTANT VOLTAGE INHERENT RUNS AS MOTOR SAFELY

**MOST ECONOMICAL  
FOR ALL KINDS OF BATTERY CHARGING**

Ask Us for the Name of a User in Your Vicinity

**Rochester Electric Products Corp.**  
87 Allen Street Rochester, N. Y.

## The Pioneer Manufacturer

— of —

# Interpole & Ball Bearing Motors

½ to 1000 H. P. D. C. and A. C.

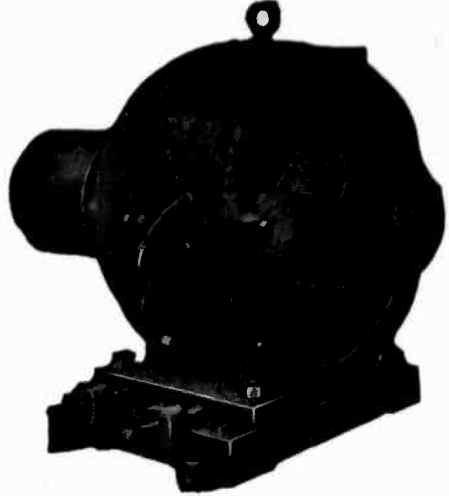

Type "S" Ball Bearing Motor with base and pulley

## ELECTRO DYNAMIC COMPANY

Manufacturers of Ball Bearing Motors Since 1904  
BAYONNE, N. J.  
Sales Offices in Principal Cities

"Quality for Half a Century"

# CLASSIFIED ADVERTISEMENTS

**RATES:** Fifty cents per line; minimum charge based on use of five lines; maximum space cannot exceed twenty lines. Copy is due the 15th of the month preceding publication date.

---

**WANTED:** A copy of The California Railroad Commission's Report on Inductive Interference. W. J. Seeley, Duke University, Durham, N. C.

---

**TRANSMISSION ENGINEER WANTED:** Position open with a manufacturing company for an engineer experienced in the solution of insulator and construction problems involved in the design of transmission lines. Should be familiar with latest practise in electrical and mechanical design. Address Box 150, JOURNAL of A. I. E. E., 33 West 39th Street, New York.

---

**ELECTRICAL ENGINEER:** Available. College graduate, ambitious, with excellent training, nine years' experience in design, calculation and testing of electrical machinery, power transmission and radio apparatus, now holding responsible position, desires connection with reliable concern. Address Box 149, JOURNAL of A. I. E. E., 33 West 39th Street, New York.

---

**FOR SALE:** JOURNAL of the A. I. E. E., from January 1924 to July 1929, complete, for sixteen dollars. Address Box 151, JOURNAL of A. I. E. E., 33 West 39th Street, New York.

To . . . . . Engineers  
Manufacturers & Inventors

We possess exceptional facilities for doing your experimental work . . . models, dies, tools, instruments, light machinery . . . general manufacturing . . . inventions developed. Customer's supervision in machine shop permitted. Over thirty years' specialized experience. Clients include Bell Telephone Laboratories, All-America Cables, Inc., and other well known organizations.

**MANUFACTURERS' & INVENTORS' ELECTRIC CO.**  
Incorporated 1897  
228 West Broadway, New York  
(Smith Building at Franklin St.)  
Tel. Walker 2210-2211 Cable Address "MANDIELECO"

# SUNDH ELECTRIC COMPANY

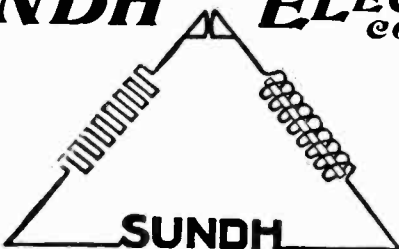

Automatic Starters  
Circuit Breakers  
Float Switches  
Hand Starters  
Magnet Switches

Pressure Regulators  
Remote Switches  
Speed Regulators  
Transfer Switches  
Valve Control

## SUNDH ELECTRIC CO., INC.

Parkhurst St. at Ave. C  
NEWARK, N. J., U. S. A.  
Branch Offices or Sales Representatives in Principal Cities

Please mention the JOURNAL of the A. I. E. E. when writing to advertisers.



**YOU CAN HAMMER  
THE BELDEN SOFT  
RUBBER PLUG-  
IT WON'T BREAK**

**Bang the Belden Soft  
Rubber Plug against  
a fine piece of furni-  
ture. It will not scratch  
the furniture or hurt  
the plug.**

Belden Soft Rubber Plugs are furnished in black or brown, with or without long shanks as illustrated, and on any kind of conductor desired cut to specifications.

## A Big Selling Feature For Home Appliances

**H**OUSEWIVES appreciate the elimination of plug troubles which results when Belden Soft Rubber Plugs are used on electrical appliances, such as flat irons, toasters, waffle irons and heaters.

Dealers appreciate the ready acceptance the Belden Soft Rubber Plug enjoys with housewives, and are glad to stock appliances that are equipped with it.

You should have the complete story which shows the preference of housewives and dealers for appliances equipped with Belden Soft Rubber Plugs.

Write today for this important information and prices.

**Belden Manufacturing Company**  
2316-B South Western Ave. Chicago, Ill.

- BELDEN PRODUCTS**
- Beldenamel and Textile Magnet Wire*
  - Coil Windings*
  - Beldenmold (Molded Bakelite Products)*
  - Automotive Wires and Cables*
  - Airplane Assemblies*
  - Radio Wires, Cords and Cables*
  - Rubber Covered Wires*
  - Armored Cables*
  - Flexible Armature Wires*
  - Motor Lead Wires*
  - Braided and Stranded Copper Cables*
  - Cotton Sleaving*

*Specify  
Belden*



# The Experience of Others —Use It



“NO MAN, other than a genius, can hope to crowd into his own personal experience during his few years of productivity, all the information needed for his progress—nor need he, when the experiences of others are so readily available.”

—and genius knows the folly of not utilizing the world's experience. Particularly in the still young electrical industry, every man needs to keep ever in contact with kaleidoscopic changes.

The coming National Electrical Exposition will focus the world's electrical achievements at Grand Central Palace, New York.

From October 7 to 12 this great exposition will display the newest and best of the equipment, appliances, materials, instruments, tools, accessories and supplies for the generation, transmission, distribution, control, measurement and application of electrical energy.

Whatever your niche in the electrical industry, visit this exposition. You could not spend a week with greater profit to yourself, your business and your industry.

Note the place, the date . . . . . and come.

## NATIONAL ELECTRICAL EXPOSITION

*Auspices of*  
New York Electrical League      New York Electrical Board of Trade

**Grand Central Palace, New York**  
**October 7 to 12, 1929**

Management of International Exposition Co.  
Largest Industrial Exposition Organization in the World

Ⓢ 3752

# ROLLER-SMITH PRODUCTS

ROLLER-SMITH products comprise complete lines of electrical measuring instruments, indicating and graphic, relays and air and oil circuit breakers. Bulletins covering the various devices will be sent promptly on request. Use the coupon.

		Bulletin No.
SWITCHBOARD INSTRUMENTS	{ D. C. Ammeters, Voltmeters and Volt-ammeters, 3 1/2" and 4" sizes . . . . .	AE-400
	{ A. C. Ammeters, Voltmeters and Wattmeters, 3 1/2" and 4" sizes . . . . .	AE-420
	{ D. C. Ammeters and Voltmeters, large sizes . . . . .	AE-430
	{ A. C. Ammeters, Voltmeters, Wattmeters, Power Factor Meters, Frequency Meters, large sizes . . . . .	AE-450
	{ Radio Frequency Ammeters, all sizes . . . . .	AE-810
PORTABLE INSTRUMENTS	{ A. C. and D. C. Ammeters, Voltmeters and Volt-ammeters; Ohmmeters and Circuit Testers for signal system and train control apparatus testing . . . . .	AE-100
	{ D. C. Ammeters, Voltmeters and Volt-ammeters, small size . . . . .	AE-110
	{ A. C. Ammeters, Voltmeters, Volt-ammeters, Wattmeters, Frequency Meters and Power Factor Meters, small and large sizes . . . . .	AE-160
	{ Rail Bond Testers . . . . .	AE-200
	{ D. C. Ammeters, Voltmeters, Volt-ammeters and Galvanometers, large sizes . . . . .	AE-210
INSTRUMENT TRANSFORMERS	{ Precision Torsion Balances for weighing lamp filaments and other small bodies . . . . .	AE-240
	{ Ohmmeters and Circuit Testers . . . . .	AE-300
AIR CIRCUIT BREAKERS	{ Portable types . . . . .	AE-160
	{ Switchboard types . . . . .	AE-450
	{ A. C. and D. C., Industrial Type, all styles of trips, 100 amperes and less . . . . .	AE-520
OIL CIRCUIT BREAKERS	{ A. C. and D. C., Standard Type, all styles of trips, all ampere capacities . . . . .	AE-530
	{ A. C. and D. C., Enclosed Type, 800 amperes and less . . . . .	AE-580
RELAYS	{ All classes . . . . .	AE-600
	{ D. C. Relays, reverse current, etc. . . . .	AE-550

Roller-Smith Co.—Please send following Bulletins:

Name . . . . .  
 Company . . . . .  
 Address . . . . .  
 City & State . . . . .

## ROLLER-SMITH COMPANY

Electrical Measuring and Protective Apparatus

MAIN OFFICE            WORKS  
 12 Park Place, NEW YORK      Bethlehem, Penna.

Offices in Principal Cities in U. S. and Canada  
 Representatives in Australia, Cuba, Japan and Philippine Islands

Please mention the JOURNAL of the A. I. E. E. when writing to advertisers.



## Cambridge Instruments For High Frequency Measurements

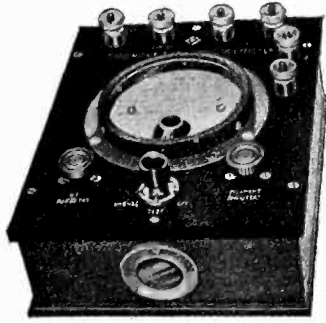

Thermionic  
VOLTMETER

RECENT developments in wireless telegraph and its allied fields, have been responsible for the introduction of many precision instruments designed especially for the measurement of high frequency constants.

List 162, fully describing the following, among other contributions of the Cambridge Instrument Company to this important field of research, will be sent on request.

- |                                        |                          |
|----------------------------------------|--------------------------|
| Thermionic Voltmeters                  | Oscillographs            |
| Frequency Meters                       | Inductometers            |
| Capacitance Bridges                    | Vibration Galvanometers  |
| Precision Resistances                  | Inductances & Condensers |
| Thermal Galvanometers and Milliameters |                          |

## CAMBRIDGE INSTRUMENT CO. INC.

Pioneer Manufacturers of Precision Instruments  
3510 Grand Central Term., New York

## PORTABLE CAPACITY BRIDGE

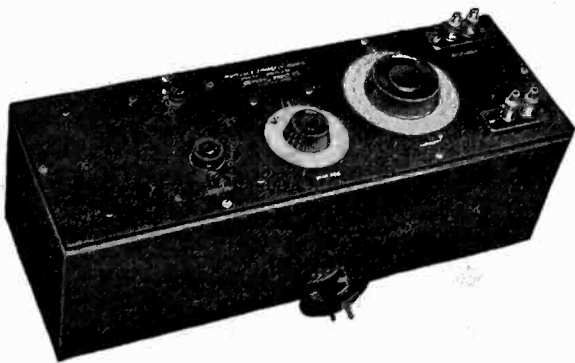

TYPE 383

The Type 383 Bridge is an easily portable, thoroughly shielded, direct reading bridge, made in two ranges.

The Type 383-A Bridge is suitable for the measurement of capacitances up to 30 micromicrofarads. It is particularly adapted to the measurement of the capacitance between vacuum tube elements, the capacitance of tube bases, phone plugs and others of small magnitude.

The Type 383-B Bridge has a range extending to 600 micromicrofarads. It is suitable for testing variable air condensers of the usual capacitances, and particularly adapted to the matching of capacitor units.

PRICE . . . . . \$80.00

GENERAL RADIO COMPANY  
30 State Street Cambridge, Massachusetts

# INSPECTION

*the  
cue  
to  
quality*



YOUR PRODUCTS must earn the right to markets which each year are becoming more critical of QUALITY.

Checking the manufacture of the product, step by step, with frequent inspections is not only the cue to quality, but the best means of accelerating production, improving deliveries and keeping pace with sales demand.

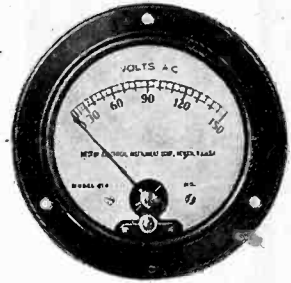

3 1/4" diameter A. C.  
panel type.

Manufacturers of radio receivers, tubes and other electrical equipment have told our representatives without reservation that they could not possibly maintain the speed necessary to meet production schedules without the unstinted use of Weston Instruments—particularly the 3 1/4" diameter panel models which can be employed for the majority of electrical inspection tests.

The unusual electrical characteristics, speed of measurement and dependability of these instruments for bench testing work, their adaptability to every type of service both for panel mounting and portable testing sets, coupled with their low cost, easily make them the outstanding choice.

Many manufacturers carry stocks of selected ranges constantly on hand, both for mounting on their products and for maintenance and inspection testing. Communicate with our nearest sales office for full particulars, ranges and prices.

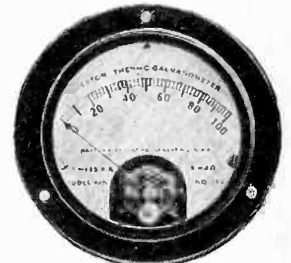

3 1/4" diameter Thermo-  
Couple type.

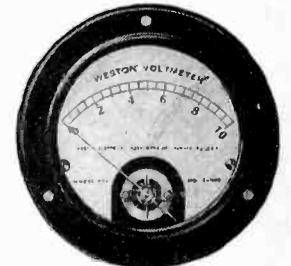

3 1/4" diameter D. C.  
panel type.

WESTON ELECTRICAL INSTRUMENT CORP.  
584 Frelinghuysen Avenue Newark, N. J.



Please mention the JOURNAL of the A. I. E. E. when writing to advertisers.

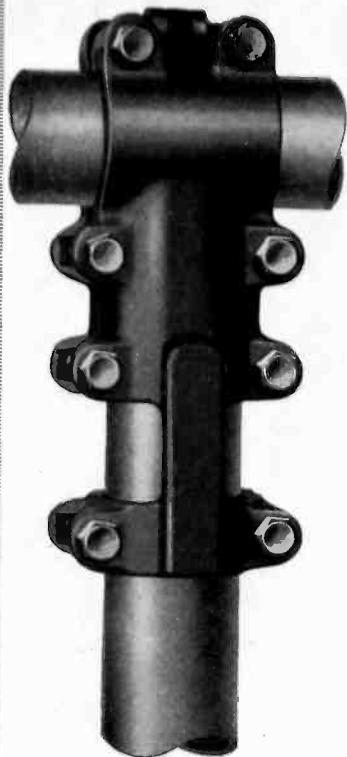

# BURKE

## Positive Grip Connectors

The only connector  
which can be  
partially assembled  
on the ground.

Made from high  
conductivity copper  
Tobin Bronze or  
Monel Metal Bolts.

*Bulletin on Request.*

**BURKE ELECTRIC CO.**  
ERIE, PA.

Offices in Principal Cities

Pacific Coast—JONES-LYMAN, INC., San Francisco, Los Angeles

# MINERALLAC 150

A Cable-Pulling Compound

that

Saves the wear and tear

on the

Cable Sheath

*Write for Bulletin 120*

**MINERALLAC ELECTRIC COMPANY**

25 North Peoria St., Chicago, Illinois

## FOR NON-RUSTING OVERHEAD CONSTRUCTION

**"COPPERWELD"**

GUY WIRES

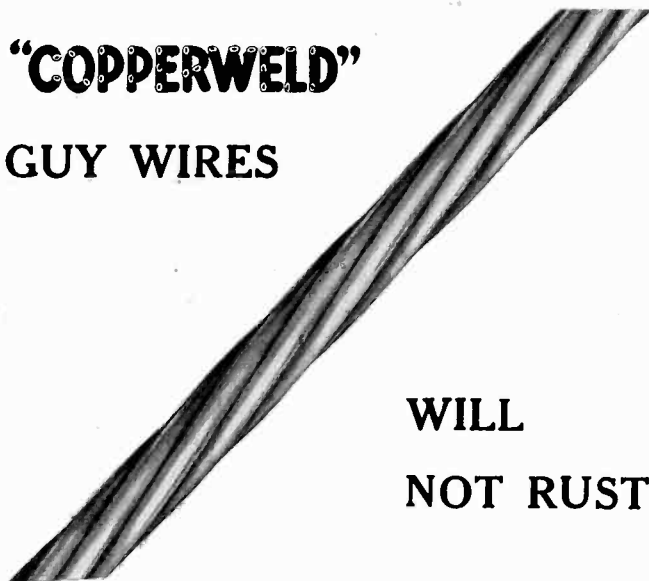

WILL  
NOT RUST

**Copperweld Steel Company**

General Offices and Mills

Glassport, Penna.

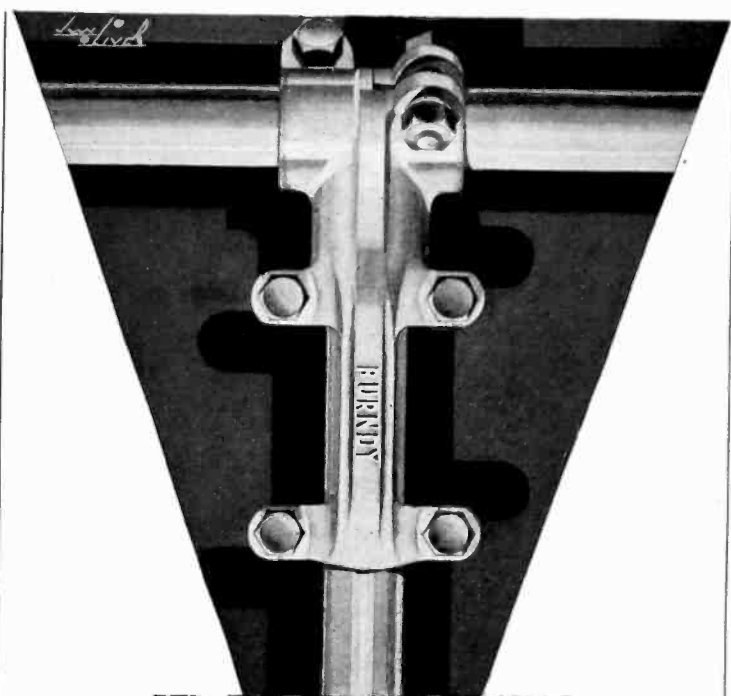

# BURNDY CONNECTORS

*For Tubing, Cable and Bar*

**BURNDY ENGINEERING CO.**  
*Incorporated*

10 East 43rd Street, New York

# G & W THREE PIECE CAPNUTS

G & W capnuts furnish a complete watershed for the porcelain top—whether the aerial lug is connected or not. There are no exposed threads for water leakage troubles. The hood nut encloses the connector threads and seats on a gasket. See lower left sketch. G & W capnut potheads are oil tight.

Three capnut parts, a gasket and a one piece wet process porcelain tube form the simple upper assembly. Five styles of aerial lugs are optional for each pothead rating. See upper right illustration. Aerial lug clamps over and locks hood nut on connector. Maximum possible clearance between phases due to small diameter of live parts of capnut.

G & W capnut potheads are easy to install. Made for all cables and all voltages. Specify G & W for your next layout.

G & W Electric Specialty Co.  
7780 Dante Ave., Chicago, Ill.

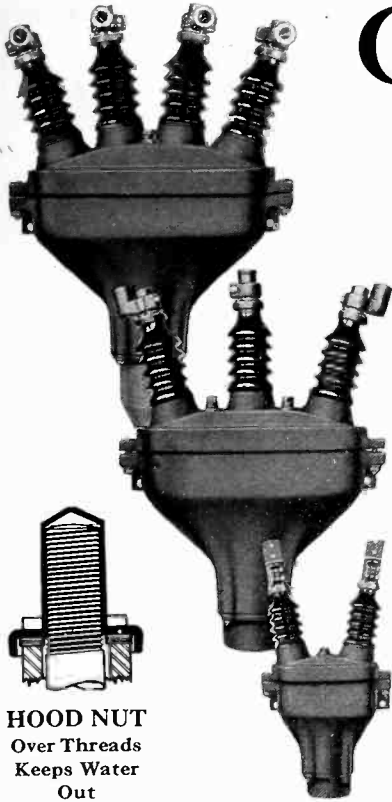

HOOD NUT  
Over Threads  
Keeps Water  
Out

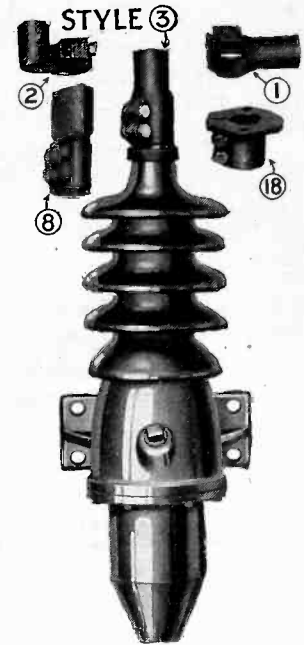

## More than Protection POTHEADS AND BOXES for the Cable Ends

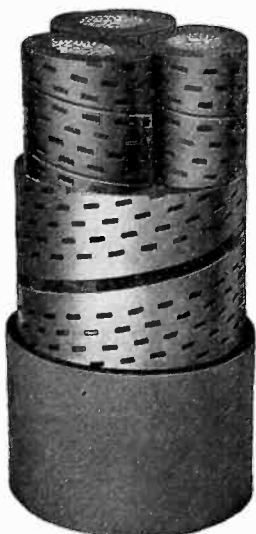

TYPE H — POWER CABLE

### TYPE H - POWER CABLE

*For High Voltage Installations*

Type H Cable is especially suited to high voltage systems. The outstanding characteristic of Type H Cables is a thin layer of conducting material which surrounds the insulation and acts as an electro-static shield. In single conductor cable of this type a thin layer of metal is usually applied over the insulation, immediately under the lead sheath whereas in multi-conductor cables, the metal is applied around each conductor. Conductors are then twisted together and rounded out with filler material. The assembled conductors are surrounded by a strong metallic binder which holds the conductors together during manufacture and helps resist the disruptive effects of short-circuit currents in service.

The conducting layer of metal is usually a metal tape. Possible induced losses in the tape may be minimized by properly designed perforations which also facilitate the thorough impregnation of the cable.

Among the advantages of Type H Cable are: Control of Temperature, Avoidance of Tangential Insulation Stresses, Elimination of Voids, and Assurance that Faults will be Conductor-to-Ground.

Further information on request.

- Other SIMPLEX Cables
- FIBREX Tree Wire
  - CONDEX Park Cable
  - TIREX Cables
  - PAPER Insulated Cables
  - VARNISHED Cambric Cables

### SIMPLEX WIRE & CABLE CO

MANUFACTURERS

201 DEVONSHIRE ST., BOSTON

BRANCH SALES OFFICES

CHICAGO, 564 W. Monroe St. SAN FRANCISCO, 390 Fourth St.  
NEW YORK, 1328 B'way CLEVELAND, 2019 Union Trust Bldg.  
JACKSONVILLE, 1010 Barnett Nat'l Bank Bldg.



**Faradon**

ASSURES  
LONG  
LIFE

WIRELESS SPECIALTY APPARATUS COMPANY  
Jamaica Plain, Boston Est. 1907

*Electrostatic Condensers for All Purposes*

**MEMCO**

- Insulator Clamps
- Copper Fittings
- Splicing Sleeves
- Disconnects
- Choke Coils
- Fuse Mountings
- Substation Combinations
- Air Break Switches
- Bus Supports

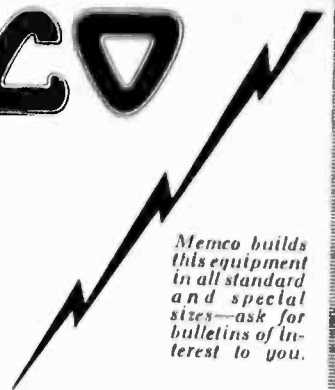

*Memco builds this equipment in all standard and special sizes—ask for bulletins of interest to you.*

Memco Engineering & Manufacturing Company, Inc.  
381 Hamilton Street, Long Island City, N. Y.

**INSULATORS**



CANADIAN PORCELAIN CO., Ltd.  
Hamilton—Ontario—Canada  
Quebec District Office: 612 Transportation Bldg., Montreal, Qu.  
London Office: 343 Abbey House, 4 Victoria Street, London, S. W. 1.

**Roebbling**

Electrical Wires and Cables

High in Conductivity  
and Reliability

John A. Roebblings' Sons Company  
Trenton, New Jersey



Elevator Control Cable

**COMPLETE SWITCHING EQUIPMENT**

- OIL CIRCUIT BREAKERS
- AIR BREAK SWITCHES
- FUSES
- STEEL STRUCTURES
- FUSE CUTOUTS
- CHOKE COILS

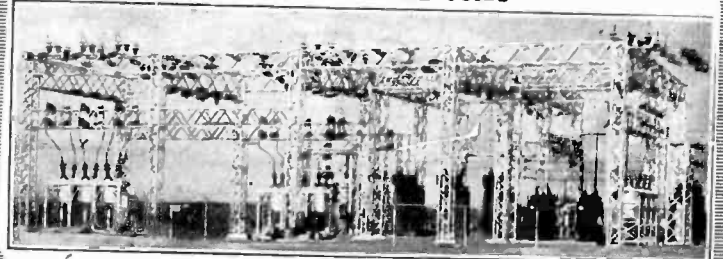

**Pacific Electric Manufacturing Corp.**

5815 THIRD STREET, SAN FRANCISCO, CALIF.  
Representatives in Principal Cities

**KEARNEY**

Manufacturers of

- Screw Anchors; Hi-Tension 4-in-1 Expansion Anchors; Solderless Service Connectors; Double Duty Fuse Cutouts; 7500, 12,000 and 15,000 volt Fuse, Disconnect and Fuse-Choke Coil Switching Equipment; Fuse Pullers; Plug Cutouts; Guy Wire Clips; Sleeve Twisters with Interchangeable Dies; Hot Tap Clamps; Yokes; Economy Cable Clamps; Live Line Maintenance Tools and Accessories, previously Tip's Tools.

*A Complete Catalog Will be Sent on Request*

**JAMES R. KEARNEY CORPORATION**  
4220 Clayton Avenue • • • • • ST. LOUIS, MO.

Specify  
**Thomas  
Quality  
Insulators**  
for  
Permanently  
Dependable  
SERVICE



THE R. THOMAS & SONS CO.  
Lisbon, Ohio  
New York Boston Chicago London





# PROFESSIONAL ENGINEERING DIRECTORY

For Consultants in the Fields of Engineering, and Related Arts and Sciences

**AMBURSEN DAMS**  
Hydroelectric Developments  
Water Supply and Irrigation Dams  
DAMS ON DIFFICULT FOUNDATIONS  
AMBURSEN CONSTRUCTION CO.  
Incorporated  
Grand Central Terminal, New York  
Kansas City, Mo. Atlanta, Ga.

**HAROLD A. DANNE**  
LIGHT AND POWER PLANTS  
Valuation : Equipment : Design  
41 Park Row, New York Tel. Cort. 2142-3

**ROBERT S. KRUSE**  
Consultant for Radio  
Stations and Manufacturers  
103 Meadowbrook Road Telephone  
West Hartford, Conn. Hartford 4-5327

**W. S. BARSTOW & COMPANY**  
Incorporated  
Financial and Operating  
Managers of  
Public Utilities  
50 Pine Street New York

**DAVID V. FENNESSY**  
Consulting Power Engineer  
MILLS BUILDING EL PASO, TEXAS

**N. J. NEALL**  
Consulting Engineer  
for  
Electrical and Industrial Properties  
12 Pearl Street 100 Broadway  
BOSTON, MASS. NEW YORK CITY

**BATTEY & KIPP**  
Incorporated  
ENGINEERS  
Complete Industrial Plants  
Power Plants & Electrical Installations  
Engineering Reports, Analyses & Appraisals  
231 South LaSalle Street CHICAGO

**FORD, BACON & DAVIS**  
Incorporated  
ENGINEERS  
115 Broadway, New York  
Philadelphia Chicago San Francisco

**NEILER, RICH & CO.**  
Electrical and Mechanical  
Engineers  
Consulting, Designing and  
Supervising  
431 So. Dearborn St. — — — Chicago

**BLACK & VEATCH**  
Consulting Engineers  
Water, Steam and Electric Power Investiga-  
tions, Design, Supervision of Construction,  
Valuation and Tests.  
Mutual Building KANSAS CITY, MO.

**FRANK F. FOWLE & CO.**  
Electrical and Mechanical  
Engineers  
MONADNOCK BUILDING CHICAGO

To appear in the following  
issue, cards must be re-  
ceived not later than the  
20th day of the month.

**ROBERT C. BURT, E. E., Ph.D.**  
**DONALD H. LOUGHRIDGE, Ph.D.**  
Consulting Physicists  
Designers and Makers of  
Scientific Instruments  
PASADENA  
327 So. Michigan Ave. California

**FREYN ENGINEERING COMPANY**  
Industrial Electric Power  
Generation—Application—Purchase  
Combustion Engineering  
Electric Furnace Installations  
310 South Michigan Ave. CHICAGO

**OPHULS & HILL, INC.**  
ENGINEERS AND CONSTRUCTORS  
Steam Generating and Electric Power Plants  
Ice Making and Refrigerating Plants  
112 WEST 42nd ST.  
NEW YORK CITY

**BYLLESBY**  
ENGINEERING AND MANAGEMENT  
CORPORATION  
231 S. La Salle Street  
CHICAGO  
New York San Francisco

**HOOSIER ENGINEERING CO.**  
Erectors of  
Transmission Lines and Substations  
100 W. Monroe Street  
CHICAGO  
NEW YORK INDIANAPOLIS  
31 Nassau Street 5 E. Market Street

**FARLEY OSGOOD**  
Consultant  
Design, Construction, Operation  
Inter-Connection  
of  
PUBLIC UTILITIES  
National Bank of Commerce Building  
31 Nassau Street, New York, N. Y.  
Tel.: Rector 7878 Cable Address: Fargood

**EDWARD E. CLEMENT**  
Fellow A. I. E. E.  
Attorney and Expert  
in Patent Causes  
Soliciting, Consultation, Reports,  
Opinions  
McLachlen Bldg. Washington, D. C.  
700 10th St., N. W.

Dugald C. Jackson  
Edward L. Moreland  
**JACKSON & MORELAND**  
CONSULTING ENGINEERS  
31 St. James Ave. Boston, Mass.

**SANDERSON & PORTER**  
ENGINEERS  
PUBLIC UTILITIES & INDUSTRIALS  
Design Construction Management  
Examinations Reports Valuations  
Chicago New York San Francisco

When you require technical advice —  
Or a solution to an engineering problem —

CONSULT THIS DIRECTORY

# PROFESSIONAL ENGINEERING DIRECTORY

For Consultants in the Fields of Engineering, and Related Arts and Sciences

**SARGENT & LUNDY**  
Incorporated  
Mechanical and Electrical  
Engineers  
1412 Edison Bldg., 72 West Adams Street  
CHICAGO ILLINOIS

**STEVENS & WOOD**  
INCORPORATED  
Engineers and Constructors  
60 JOHN STREET, NEW YORK  
Youngstown, O. Jackson, Mich.  
Chicago, Ill.

**PERCY H. THOMAS**  
Consulting Engineer  
ELECTRIC POWER  
Generation—Transmission  
Applications  
120 BROADWAY NEW YORK

**SCOFIELD ENGINEERING CO.**  
CONSULTING ENGINEERS  
Utility and Industrial Plants  
Design, Construction, Operation  
Valuations and Appraisals  
PHILADELPHIA

**STOCKBRIDGE & BORST**  
Patent Law  
41 PARK ROW NEW YORK CITY

**THE J. G. WHITE**  
ENGINEERING CORPORATION  
Engineers—Constructors  
Oil Refineries and Pipe Lines,  
Steam and Water Power Plants  
Transmission Systems, Hotels, Apartments,  
Offices and Industrial Buildings, Railroads  
43 EXCHANGE PLACE NEW YORK

**JOHN A. STEVENS**  
CONSULTING POWER ENGINEER  
16 Shattuck Street  
LOWELL MASSACHUSETTS

**STONE & WEBSTER**  
Incorporated  
DESIGN AND CONSTRUCTION  
EXAMINATIONS APPRAISALS REPORTS  
INDUSTRIAL AND PUBLIC SERVICE  
PROPERTIES  
New York Boston Chicago

**J. G. WRAY & CO.**  
Engineers  
J. G. Wray, Fellow A. I. E. E. Cyrus G. Hill  
Utilities and Industrial Properties  
Appraisals Construction Rate Surveys  
Plans Organizations Estimates  
Financial Investigations Management  
2130 Bankers Bldg., Chicago

**Y**OUR CARD in each issue of this publication—12 times a year, will keep your name and specialized service constantly before the electrical industry. Qualified advertisers in the Professional Engineering Directory are invited to send for rates.

<p><b>ELECTRICAL TESTING LABORATORIES</b> 80th Street and East End Ave. NEW YORK</p>	<p><i>Inspections — Tests — Research</i></p> <p>Tests may be used by the purchaser for the following purposes:</p> <ol style="list-style-type: none"> <li>(1) To determine the quality of competing samples. This enables the purchase of the best quality for the money.</li> <li>(2) To make sure that shipments comply with specifications. This makes possible the assurance to the customer that shipments match buying samples.</li> <li>(3) To furnish an impartial decision in case of disputes between purchaser and manufacturer.</li> </ol> <p>Testing places the whole buying problem on a sound basis.</p>
----------------------------------------------------------------------------------------------	-------------------------------------------------------------------------------------------------------------------------------------------------------------------------------------------------------------------------------------------------------------------------------------------------------------------------------------------------------------------------------------------------------------------------------------------------------------------------------------------------------------------------------------------------------------------------------------------------------------------------

**Practice Public Utility Economy on Transformer Repairs**

When transformers fall or need overhauling—many of the largest public utility companies send them to us for rewinding and other repairs. Experience has proved that we can save them 30 to 60% of the cost of new equipment.

We can offer similar savings to you. Every job is guaranteed. All work is done strictly A. I. E. E. standard. Our large staff and modern facilities enable us to make prompt deliveries.

You can buy rebuilt transformers from our large stock of about 5,000 at a big saving. We have nearly 5,000 on hand ranging from 1 to 1,000 kva. and for voltages from 110 to 66,000. Investigate these bargains. Guaranteed A. I. E. E. standard.

Send for our Monthly Bulletin and rewinding prices.

**WE BUY MODERN TYPE TRANSFORMERS—ANY SIZE—ANY QUANTITY**

**The ELECTRIC SERVICE CO. Inc.**  
America's Used Transformer Clearing House  
212 Walnut Street Cincinnati, Ohio



Please mention the JOURNAL of the A. I. E. E. when writing to advertisers.

# Classified Advertiser's Index for Buyers

Manufacturers and agents for machinery and supplies used in the electrical and allied industries.

Note: For reference to the advertisements see the Alphabetical List of Advertisers on page 56.

## AIR COMPRESSORS

Allis-Chalmers Mfg. Co., Milwaukee  
General Electric Co., Schenectady

## AMMETER COMPENSATING COILS

Minerallac Electric Co., Chicago

## AMMETER, VOLTMETERS

(See INSTRUMENTS, ELECTRICAL)

## ANCHORS, GUY

Copperweld Steel Co., Glassport, Pa.  
Kearney Corp., Jas. R., St. Louis  
Matthews Corp., W. N., St. Louis

## BATTERY CHARGING APPARATUS

Electric Specialty Co., Stamford, Conn.  
General Electric Co., Schenectady  
Rochester Electric Products Corp., Rochester, N. Y.  
Wagner Electric Corp., St. Louis  
Westinghouse Elec. & Mfg. Co., E. Pittsburgh

## BEARINGS, BALL

Norma-Hoffmann Bearings Corp., Stamford, Conn.

## BOXES, FUSE

General Electric Co., Schenectady  
Kearney Corp., Jas. R., St. Louis  
Metropolitan Device Corp., Brooklyn, N. Y.  
Westinghouse Elec. & Mfg. Co., E. Pittsburgh

## BOXES, JUNCTION

G & W Elec. Specialty Co., Chicago  
Metropolitan Device Corp., Brooklyn, N. Y.  
Standard Underground Cable Co., Pittsburgh

## BRUSHES, COMMUTATOR

*Carbon*  
Morganite Brush Co., Inc., L. I. City, N. Y.  
National Carbon Co., Inc., Cleveland  
Westinghouse Elec. & Mfg. Co., E. Pittsburgh  
*Copper Graphite*  
Morganite Brush Co., Inc., L. I. City, N. Y.  
National Carbon Co., Inc., Cleveland  
Westinghouse Elec. & Mfg. Co., E. Pittsburgh

## BUS BAR FITTINGS

Aluminum Co. of America, Pittsburgh  
Burndy Engineering Co., Inc., New York  
Delta-Star Electric Co., Chicago  
General Electric Co., Schenectady  
Memco Engg. & Mfg. Co., L. I. City, N. Y.  
Ohio Brass Co., Mansfield, O.  
Westinghouse Elec. & Mfg. Co., E. Pittsburgh

## BUSHINGS, PORCELAIN

Ohio Brass Co., Mansfield, O.

## CABLE ACCESSORIES

Delta Star Electric Co., Chicago  
Dossert & Co., New York  
G & W Electric Specialty Co., Chicago  
General Electric Co., Schenectady  
Minerallac Electric Co., Chicago  
Standard Underground Cable Co., Pittsburgh

## CABLE RACKS

Metropolitan Device Corp., Brooklyn, N. Y.

## CABLES

SEE WIRES AND CABLES

## CABLEWAYS

American Steel & Wire Co., Chicago  
Roebeling's Sons Co., John A., Trenton, N. J.

## CARRIER CURRENT TELEPHONE EQUIPMENT

Wireless Specialty Apparatus Co., Boston

## CIRCUIT BREAKERS

*Air—Enclosed*

I-T-E Circuit Breaker Co., The, Philadelphia  
Roller-Smith Co., New York  
Sundh Electric Co., Newark, N. J.

*Oil*

Condit Electrical Mfg. Corp., Boston  
General Electric Co., Schenectady  
Pacific Electric Mfg. Corp., San Francisco  
Roller-Smith Co., New York  
Westinghouse Elec. & Mfg. Co., E. Pittsburgh

## CLAMPS, INSULATOR

Memco Engg. & Mfg. Co., L. I. City, N. Y.

## CLAMPS, GUY & CABLE

Burndy Engineering Co., Inc., New York  
Kearney Corp., Jas. R., St. Louis  
Matthews Corp., W. N., St. Louis

## COILS, CHOKE

Burke Electric Co., Erie, Pa.  
General Electric Co., Schenectady  
Kearney Corp., Jas. R., St. Louis  
Memco Engg. & Mfg. Co., L. I. City, N. Y.  
Westinghouse Elec. & Mfg. Co., E. Pittsburgh

## COILS, MAGNET

Acme Wire Co., New Haven, Conn.  
Belden Mfg. Co., Chicago  
Dudlo Mfg. Corp., Ft. Wayne, Ind.  
General Electric Co., Schenectady  
Westinghouse Elec. & Mfg. Co., E. Pittsburgh

## COMMUTATOR SEGMENTS AND RINGS

Mica Insulator Co., New York

## CONDENSATION PRODUCTS

Bakelite Corporation, New York

## CONDENSERS, COUPLING

*For Carrier Current Telephone*

Wireless Specialty Apparatus Co., Boston

## CONDENSERS, RADIO

General Radio Co., Cambridge, Mass.  
Sangamo Electric Co., Springfield, Ill.  
Wireless Specialty Apparatus Co., Boston

## CONDENSERS, STEAM

Allis-Chalmers Mfg. Co., Milwaukee  
General Electric Co., Schenectady  
Westinghouse Elec. & Mfg. Co., E. Pittsburgh

## CONNECTORS, SOLDERLESS

Dossert & Co., New York  
Kearney Corp., Jas. R., St. Louis  
Westinghouse Elec. & Mfg. Co., E. Pittsburgh

## CONNECTORS AND TERMINALS

Belden Mfg. Co., Chicago  
Burke Electric Co., Erie, Pa.  
Burndy Engineering Co., Inc., New York  
Dossert & Co., New York  
G & W Electric Specialty Co., Chicago  
Westinghouse Elec. & Mfg. Co., E. Pittsburgh

## CONTACTS, TUNGSTEN

General Electric Co., Schenectady

## CONTROLLERS

Electric Controller & Mfg. Co., Cleveland  
General Electric Co., Schenectady  
Sundh Electric Co., Newark, N. J.  
Westinghouse Elec. & Mfg. Co., E. Pittsburgh

## CONVERTERS—SYNCHRONOUS

Allis-Chalmers Mfg. Co., Milwaukee  
Electric Specialty Co., Stamford, Conn.  
Wagner Electric Corp., St. Louis  
Westinghouse Elec. & Mfg. Co., E. Pittsburgh

## COPPER CLAD WIRE

Belden Mfg. Co., Chicago  
Standard Underground Cable Co., Pittsburgh

## COPPERWELD WIRE

Copperweld Steel Co., Glassport, Pa.

## CUT-OUTS

Condit Electrical Mfg. Corp., S. Boston  
General Electric Co., Schenectady  
G & W Electric Specialty Co., Chicago  
Kearney Corp., Jas. R., St. Louis  
Metropolitan Device Corp., Brooklyn, N. Y.  
Wagner Electric Corp., St. Louis  
Westinghouse Elec. & Mfg. Co., E. Pittsburgh

## DIVERTER POLE GENERATORS

Rochester Electric Products Corp., Rochester, N. Y.

## DYNAMOS

(See GENERATORS AND MOTORS)

## DYNAMOTORS

Burke Electric Co., Erie, Pa.  
Electric Specialty Co., Stamford, Conn.  
Rochester Electric Products Corp., Rochester, N. Y.

## ELECTRIFICATION SUPPLIES, STEAM ROAD

General Electric Co., Schenectady  
Ohio Brass Co., Mansfield, Ohio  
Westinghouse Elec. & Mfg. Co., E. Pittsburgh

## ENGINEERS, CONSULTING AND CONTRACTING

(See PROFESSIONAL ENGINEERING DIRECTORY)

## ENGINES

*Gas & Gasoline*

Allis-Chalmers Mfg. Co., Milwaukee

*Oil*

Allis-Chalmers Mfg. Co., Milwaukee

*Steam*

Allis-Chalmers Mfg. Co., Milwaukee

## FANS, MOTOR

Century Electric Co., St. Louis  
General Electric Co., Schenectady  
Wagner Electric Corp., St. Louis  
Westinghouse Elec. & Mfg. Co., E. Pittsburgh

## FIRE EXTINGUISHING APPARATUS

Walter Kidde & Co., Inc., New York

## FLOW METERS

General Electric Co., Schenectady

## FURNACES, ELECTRIC

General Electric Co., Schenectady  
Westinghouse Elec. & Mfg. Co., E. Pittsburgh

## FUSES

*Enclosed Refillable*

General Electric Co., Schenectady  
Westinghouse Elec. & Mfg. Co., E. Pittsburgh

*Enclosed Non-Refillable*

General Electric Co., Schenectady

*Open Link*

General Electric Co., Schenectady  
Metropolitan Device Corp., Brooklyn, N. Y.

*High-Tension*

Delta-Star Electric Co., Chicago  
Metropolitan Device Corp., Brooklyn, N. Y.

## FUSE MOUNTINGS

Memco Engg. & Mfg. Co., L. I. City, N. Y.

## FUSE PULLERS

Kearney Corp., Jas. R., St. Louis



Is your name on our mailing list for bulletins and catalog?

# Morganite Brushes

Morganite Brush Co., Inc.  
3302-3320 Anable Ave.,  
Long Island City,  
N. Y.

Please mention the JOURNAL of the A. I. E. E. when writing to advertisers.



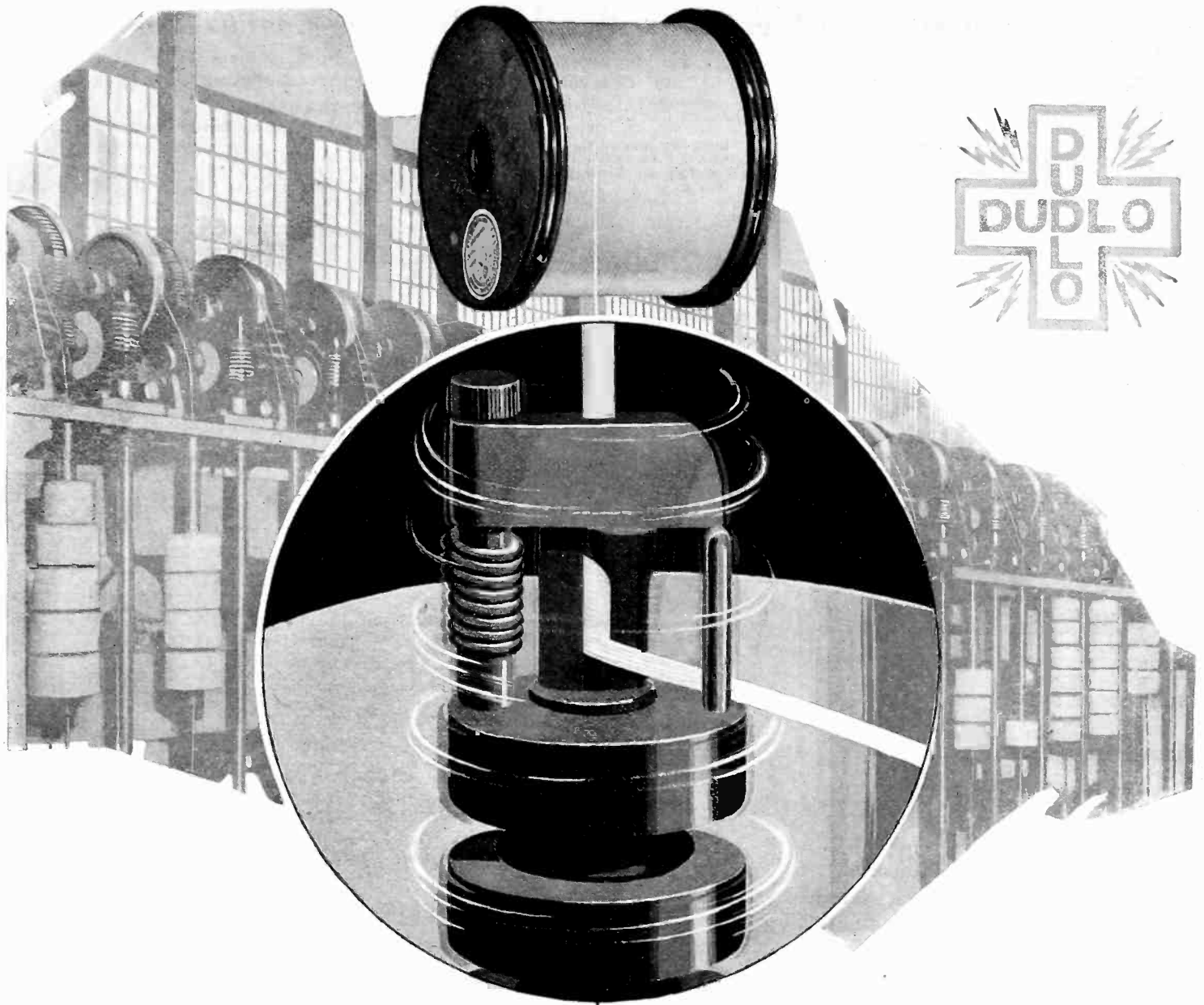

Firm, even wrapping . . . uniform diameter . . . complete insulation without skips. ¶ These important characteristics are always incorporated in Dudlo Standard Cotton Covered Magnet Wire. Highly perfected machinery embodying many exclusive Dudlo features wrap the cotton around the steadily moving wire all strands butting close together. Even tension and constant speed hold diameters perfectly uniform. ¶ Such precision insulation means much to the electrical manufacturer but even more to Dudlo, whose self-imposed ideals, consistently followed, have made

Dudlo Magnet Wire the standard of the world.

# DUDLO

DUDLO MANUFACTURING CO.

*Division of*

FORT WAYNE, INDIANA

*General Cable Corp.*

Please mention the JOURNAL of the A. I. E. E. when writing to advertisers.

## Classified Advertiser's Index for Buyers—Continued

### GEARS, FIBRE

Fibroc Insulation Co., Valparaiso, Ind.  
General Electric Co., Schenectady

### GENERATORS AND MOTORS

Allis-Chalmers Mfg. Co., Milwaukee  
Burke Electric Co., Erie, Pa.  
Century Electric Co., St. Louis  
Chandeysson Electric Co., St. Louis  
Electric Specialty Co., Stamford, Conn.  
Electro-Dynamic Co., Bayonne, N. J.  
General Electric Co., Schenectady  
Rochester Electric Products Corp., Rochester, N. Y.  
Wagner Electric Corp., St. Louis  
Westinghouse Elec. & Mfg. Co., E. Pittsburgh

### GENERATING STATION EQUIPMENT

Allis-Chalmers Mfg. Co., Milwaukee  
Burke Electric Co., Erie, Pa.  
General Electric Co., Schenectady  
Westinghouse Elec. & Mfg. Co., E. Pittsburgh

### GROUND RODS

Copperweld Steel Co., Glassport, Pa.

### HARDWARE, POLE LINE AND INSULATOR

Ohio Brass Co., Mansfield, O.  
Westinghouse Elec. & Mfg. Co., E. Pittsburgh

### HEADLIGHTS

Ohio Brass Co., Mansfield, O.  
Westinghouse Elec. & Mfg. Co., E. Pittsburgh

### HEATERS, INDUSTRIAL

General Electric Co., Schenectady  
Westinghouse Elec. & Mfg. Co., E. Pittsburgh

### INDICATORS, REMOTE, WATER LEVEL

Bristol Co., The, Waterbury, Conn.

### INDICATORS, SPEED

Bristol Co., The, Waterbury, Conn.  
Roller-Smith Co., New York

### INSTRUMENTS, ELECTRICAL

#### Graphic

Bristol Co., The, Waterbury, Conn.  
Cambridge Instrument Co., New York  
Ferranti, Ltd., Hollinwood, England  
Ferranti, Inc., New York  
Ferranti Electric, Ltd., Toronto, Ont.  
General Electric Co., Schenectady  
Lincoln Meter Co., Inc., Springfield, Ill.  
Roller-Smith Co., New York  
Westinghouse Elec. & Mfg. Co., E. Pittsburgh

#### Indicating

Bristol Co., The, Waterbury, Conn.  
Cambridge Instrument Co., New York  
Ferranti, Ltd., Hollinwood, England  
Ferranti, Inc., New York  
Ferranti Electric, Ltd., Toronto, Ont.  
General Electric Co., Schenectady  
Jewell Elec. Instrument Co., Chicago  
Lincoln Meter Co., Inc., Springfield, Ill.  
Roller-Smith Co., New York  
Sangamo Electric Co., Springfield, Ill.  
Westinghouse Elec. & Mfg. Co., E. Pittsburgh  
Weston Elec. Inst. Corp., Newark, N. J.

#### Integrating

Duncan Elec. Mfg. Co., Lafayette, Ind.  
Ferranti, Ltd., Hollinwood, England  
Ferranti, Inc., New York  
Ferranti Electric, Ltd., Toronto, Ont.  
General Electric Co., Schenectady  
Sangamo Electric Co., Springfield, Ill.  
Westinghouse Elec. & Mfg. Co., E. Pittsburgh

#### Radio

Cambridge Instrument Co., New York  
General Radio Co., Cambridge, Mass.  
Jewell Elec. Instrument Co., Chicago  
Roller-Smith Co., New York

#### Repairing and Testing

Cambridge Instrument Co., New York  
Electrical Testing Laboratories, New York  
Jewell Elec. Instrument Co., Chicago  
Roller-Smith Co., New York

#### Scientific Laboratory, Testing

Cambridge Instrument Co., New York  
General Electric Co., Schenectady  
Jewell Elec. Instrument Co., Chicago  
Metropolitan Device Corp., Brooklyn, N. Y.  
Roller-Smith Co., New York  
Westinghouse Elec. & Mfg. Co., E. Pittsburgh  
Weston Elec. Inst. Corp., Newark, N. J.

### INSULATING MATERIALS

#### Board

Acme Wire Co., New Haven, Conn.  
General Electric Co., Bridgeport, Conn.  
West Va. Pulp & Paper Co., New York

#### Cloth

Acme Wire Company New Haven, Conn.  
General Electric Co., Bridgeport, Conn.  
Mica Insulator Co., New York  
Minerallac Electric Co., Chicago  
Westinghouse Elec. & Mfg. Co., E. Pittsburgh

### INSULATING MATERIALS—Continued

#### Composition

American Lava Corp., Chattanooga  
Bakelite Corporation, New York  
Belden Mfg. Co., Chicago  
Fibroc Insulation Co., Valparaiso, Ind.  
General Electric Co., Bridgeport, Conn.  
Westinghouse Elec. & Mfg. Co., E. Pittsburgh

#### Compounds

General Electric Co., Bridgeport, Conn.  
Mica Insulator Co., New York  
Minerallac Electric Co., Chicago  
Standard Underground Cable Co., Pittsburgh  
Westinghouse Elec. & Mfg. Co., E. Pittsburgh

#### Fibre

Belden Mfg. Co., Chicago  
Fibroc Insulation Co., Valparaiso, Ind.  
General Electric Co., Bridgeport, Conn.  
West Va. Pulp & Paper Co., New York

#### Lava

American Lava Corp., Chattanooga, Tenn.

#### Mica

Mica Insulator Co., New York  
Westinghouse Elec. & Mfg. Co., E. Pittsburgh

#### Paper

Acme Wire Company, New Haven, Conn.  
General Electric Co., Bridgeport, Conn.  
Mica Insulator Co., New York  
Westinghouse Elec. & Mfg. Co., E. Pittsburgh

#### Silk

Acme Wire Company, New Haven, Conn.  
General Electric Co., Bridgeport, Conn.

#### Tape

Belden Mfg. Co., Chicago  
General Electric Co., Bridgeport, Conn.  
Mica Insulator Co., New York  
Minerallac Electric Co., Chicago  
Okonite Co., The, Passaic, N. J.  
Westinghouse Elec. & Mfg. Co., E. Pittsburgh

#### Varnishes

Acme Wire Company, New Haven, Conn.  
General Electric Co., Bridgeport, Conn.  
Mica Insulator Co., New York  
Minerallac Electric Co., Chicago  
Westinghouse Elec. & Mfg. Co., E. Pittsburgh

### INSULATORS, HIGH TENSION

#### Composition

General Electric Co., Schenectady

#### Glass

Hemingray Glass Co., Muncie, Ind.

#### Porcelain

Canadian Porcelain Co., Ltd., Hamilton, Ont.  
General Electric Co., Schenectady  
Lapp Insulator Co., Inc., LeRoy, N. Y.  
Locke Insulator Corp., Baltimore  
Ohio Brass Co., Mansfield, O.  
Thomas & Sons Co., R., Lisbon, O.  
Westinghouse Elec. & Mfg. Co., E. Pittsburgh

#### Post Type

Delta-Star Electric Co., Chicago  
Ohio Brass Co., Mansfield, O.

### INSULATORS, TELEPHONE & TELEGRAPH

Hemingray Glass Co., Muncie, Ind.  
Ohio Brass Co., Mansfield, O.

### INSULATOR PINS

Ohio Brass Co., Mansfield, O.  
Thomas & Sons Co., R., Lisbon, O.

### LAMP GUARDS

Matthews Corp., W. N., St. Louis

### LAVA

American Lava Corp., Chattanooga

### LIGHTNING ARRESTERS

Delta-Star Electric Co., Chicago  
General Electric Co., Schenectady  
Westinghouse Elec. & Mfg. Co., E. Pittsburgh

### LOCOMOTIVES, ELECTRIC

General Electric Co., Schenectady  
Westinghouse Elec. & Mfg. Co., E. Pittsburgh

### LUBRICANTS

Texas Co., The, New York

### MAGNETIC SEPARATORS

Electric Controller & Mfg. Co., Cleveland

### MAXIMUM DEMAND METERS

Lincoln Meter Co., Inc., Springfield, Ill.

### METERS, ELECTRICAL

(See INSTRUMENTS ELECTRICAL)

### METER SEALS

Metropolitan Device Corp., Brooklyn, N. Y.

### MICA PRODUCTS

Mica Insulator Co., New York  
Westinghouse Elec. & Mfg. Co., E. Pittsburgh

### MOLDED INSULATION

Bakelite Corporation, New York  
Belden Mfg. Co., Chicago  
Burke Electric Co., Erie, Pa.  
Westinghouse Elec. & Mfg. Co., E. Pittsburgh

### MOTORS

(See GENERATORS AND MOTORS)

### OHMMETERS

Jewell Elec. Instrument Co., Chicago  
Roller-Smith Co., New York  
Weston Elec. Instr. Corp., Newark, N. J.

### OIL SEPARATORS & PURIFIERS

Sharples Specialty Co., The, Philadelphia  
Westinghouse Elec. & Mfg. Co., E. Pittsburgh

### PANEL BOARDS

(See SWITCHBOARDS)

### PATENT ATTORNEYS

(See PROFESSIONAL ENGINEERING DIRECTORY)

### PLATING GENERATORS

Burke Electric Co., Erie, Pa.  
Chandeysson Elec. Co., St. Louis  
Electric Specialty Co., Stamford, Conn.  
Rochester Electric Products Corp., Rochester, N. Y.

### PLUGS

Delta-Star Electric Co., Chicago  
General Electric Co., Schenectady  
Westinghouse Elec. & Mfg. Co., E. Pittsburgh

### POLE LINE HARDWARE

Ohio Brass Co., Mansfield, O.

### POTHEADS

G & W Electric Specialty Co., Chicago  
Ohio Brass Co., Mansfield, O.  
Standard Underground Cable Co., Pittsburgh

### PULLERS, SLACK

Matthews Corp., W. N., St. Louis

### PUMPS

Allis-Chalmers Mfg. Co., Milwaukee

### RADIO LABORATORY APPARATUS

General Radio Co., Cambridge, Mass.  
Westinghouse Elec. & Mfg. Co., E. Pittsburgh

### RAILWAY SUPPLIES, ELECTRIC

General Electric Co., Schenectady  
Ohio Brass Co., Mansfield, O.  
Westinghouse Elec. & Mfg. Co., E. Pittsburgh

### REACTORS

General Electric Co., Schenectady  
Metropolitan Device Corp., Brooklyn, N. Y.

### RECTIFIERS

General Electric Co., Schenectady  
Kodel Elec. & Mfg. Co., Cincinnati, O.  
Wagner Electric Corp., St. Louis  
Westinghouse Elec. & Mfg. Co., E. Pittsburgh

### REELS, PAYOUT AND TAKEUP

Matthews Corp., W. N., St. Louis

### REGULATORS, VOLTAGE

Burke Electric Co., Erie, Pa.  
General Electric Co., Schenectady  
Westinghouse Elec. & Mfg. Co., E. Pittsburgh

### RELAYS

Electric Controller & Mfg. Co., Cleveland  
General Electric Co., Schenectady  
Roller-Smith Co., New York  
Westinghouse Elec. & Mfg. Co., E. Pittsburgh

### RESISTOR UNITS

General Electric Co., Schenectady  
International Resistance Co., Philadelphia  
Westinghouse Elec. & Mfg. Co., E. Pittsburgh

# A New Breaker for Underground Service

Condit M-210 is a new oil circuit breaker built to control and protect underground lines requiring moderate interrupting capacity.

It is compact, water-tight, full-automatic.

Condit principles of design and Condit standards of workmanship give the new Type M-210 a safety, dependability and efficiency that cover generously the exacting demands of modern subway and manhole service.

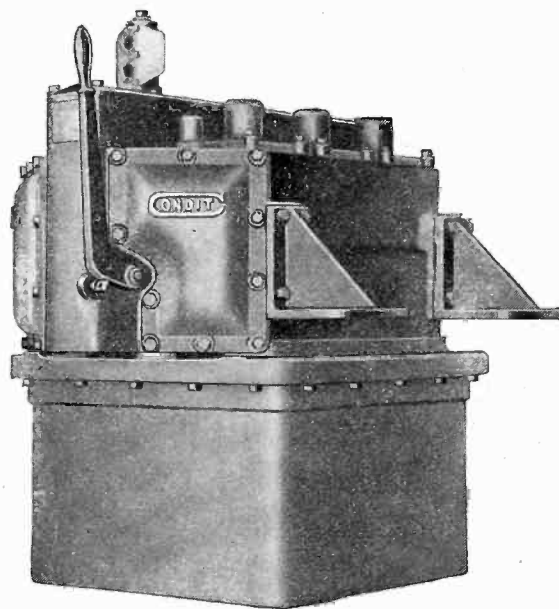

## Features of the New Type M-210

- Trip free automatic
- Provision for 6 bushing type current transformers
- Position indicator
- Provision for venting
- Mechanism rust-proof by parkerizing
- Provision for 6 trip coils
- Large expansion chamber
- Easy to install and maintain
- Lead covered cables terminate in compound filled pot heads inside breaker.

*“Get in touch with Condit”*

CONDIT ELECTRICAL MFG. CORPORATION

*Manufacturers of Electrical Protective Devices*

BOSTON, MASS.

*Northern Electric Company*

LIMITED

Distributor for the Dominion of Canada

SPECIFICATIONS: 400 amperes, 15,000 volts. Estimated interrupting capacity 60,000 Kv-a.

# CONDIT

# Classified Advertiser's Index for Buyers—Continued

## RHEOSTATS

General Electric Co., Schenectady  
Sundh Electric Co., Newark, N. J.  
Westinghouse Elec. & Mfg. Co., E. Pitts-  
burgh

## ROPE, WIRE

American Steel & Wire Co., Chicago  
Roebling's Sons Co., John A., Trenton, N. J.

## SCREWS

*Drive Hardened Metallic*  
Parker-Kalon Corp., New York  
*Self-Tapping Hardened*  
Parker-Kalon Corp., New York  
*Sheet Metal, Hardened Self-Tapping*  
Parker-Kalon Corp., New York

## SEARCHLIGHTS

General Electric Co., Schenectady  
Westinghouse Elec. & Mfg. Co., E. Pitts-  
burgh

## SLEEVE TWISTERS

Kearney Corp., Jas. R., St. Louis

## SLEEVES, SPLICING

Memco Engg. & Mfg. Co., L. I. City, N. Y.

## SOCKETS AND RECEPTACLES

General Electric Co., Schenectady  
Westinghouse Elec. & Mfg. Co., E. Pitts-  
burgh

## SOLENOIDS

Acme Wire Company, New Haven, Conn.  
Belden Mfg. Co., Chicago  
Dudlo Mfg. Co., Ft. Wayne, Ind.  
Electric Controller & Mfg. Co., Cleveland  
General Electric Co., Schenectady  
Roebling's Sons Co., John A., Trenton, N. J.  
Sundh Electric Co., Newark, N. J.  
Westinghouse Elec. & Mfg. Co., E. Pitts-  
burgh

## SPRINGS

American Steel & Wire Co., Chicago

## STARTERS, MOTORS

Condit Electrical Mfg. Corp., Boston  
Electric Controller & Mfg. Co., Cleveland  
General Electric Co., Schenectady  
Roller-Smith Co., New York  
Sundh Electric Co., Newark, N. J.  
Westinghouse Elec. & Mfg. Co., E. Pitts-  
burgh

## STOKERS, MECHANICAL

Westinghouse Elec. & Mfg. Co., E. Pitts-  
burgh

## SUB-STATIONS

Delta-Star Electric Co., Chicago  
General Electric Co., Schenectady  
Memco Engg. & Mfg. Co., L. I. City, N. Y.  
Westinghouse Elec. & Mfg. Co., E. Pitts-  
burgh

## SWITCHBOARDS

Allis-Chalmers Mfg. Co., Milwaukee  
Bull Dog Electric Products Co., Detroit  
Condit Electrical Mfg. Corp., Boston  
General Electric Co., Schenectady  
Metropolitan Device Corp., Brooklyn, N. Y.  
Westinghouse Elec. & Mfg. Co., E. Pitts-  
burgh

## SWITCHES

*Automatic Time*  
General Electric Co., Schenectady  
Minerallac Electric Co., Chicago  
Sundh Electric Co., Newark, N. J.  
Westinghouse Elec. & Mfg. Co., E. Pitts-  
burgh

*Disconnecting*  
Burke Electric Co., Erie, Pa.  
Condit Electrical Mfg. Corp., Boston  
Delta-Star Electric Co., Chicago  
General Electric Co., Schenectady  
Kearney Corp., Jas. R., St. Louis  
Matthews Corp., W. N., St. Louis  
Memco Engg. & Mfg. Co., L. I. City, N. Y.  
Pacific Elec. Mfg. Corp., San Francisco  
Roller-Smith Co., New York  
Westinghouse Elec. & Mfg. Co., E. Pitts-  
burgh

*Fuse*  
Bull Dog Electric Products Co., Detroit  
General Electric Co., Schenectady  
Kearney Corp., Jas. R., St. Louis  
Matthews Corp., W. N., St. Louis  
Metropolitan Device Corp., Brooklyn, N. Y.

*Knife*  
Condit Electrical Mfg. Corp., Boston  
Electric Controller & Mfg. Co., Cleveland  
General Electric Co., Schenectady  
Matthews Corp., W. N., St. Louis  
Westinghouse Elec. & Mfg. Co., E. Pitts-  
burgh

*Oil*  
Condit Electrical Mfg. Corp., Boston  
General Electric Co., Schenectady  
Pacific Elec. Mfg. Corp., San Francisco  
Roller-Smith Co., New York  
Westinghouse Elec. & Mfg. Co., E. Pitts-  
burgh

*Remote Control*  
Condit Electrical Mfg. Corp., Boston  
General Electric Co., Schenectady  
Roller-Smith Co., New York  
Sundh Electric Co., Newark, N. J.  
Westinghouse Elec. & Mfg. Co., E. Pitts-  
burgh

## TELEPHONE CONNECTORS

Kearney Corp., Jas. R., St. Louis

## TESTING LABORATORIES

Electrical Testing Labs., New York

## TRANSFORMERS

Allis-Chalmers Mfg. Co., Milwaukee  
American Transformer Co., Newark, N. J.  
Duncan Elec. Mfg. Co., Lafayette, Ind.  
Electric Service Co., Cincinnati  
Ferranti, Ltd., Hollinwood, England  
Ferranti, Inc., New York  
Ferranti Electric, Ltd., Toronto, Ont.  
General Electric Co., Schenectady  
Kuhlman Electric Co., Bay City, Mich.  
Moloney Electric Co., St. Louis  
Sangamo Electric Co., Springfield, Ill.  
Wagner Electric Corp., St. Louis  
Westinghouse Elec. & Mfg. Co., E. Pitts-  
burgh

*Factory*  
American Transformer Co., Newark, N. J.  
Kuhlman Electric Co., Bay City, Mich.  
Moloney Electric Co., St. Louis  
Wagner Electric Corp., St. Louis

*Furnace*  
Allis-Chalmers Mfg. Co., Milwaukee  
American Transformer Co., Newark, N. J.  
Moloney Electric Co., St. Louis  
Westinghouse Elec. & Mfg. Co., E. Pitts-  
burgh

*Metering*  
American Transformer Co., Newark, N. J.  
Ferranti, Ltd., Hollinwood, England  
Ferranti, Inc., New York  
Ferranti Electric, Ltd., Toronto, Ont.  
Roller-Smith Co., New York  
Sangamo Electric Co., Springfield, Ill.

*Radio*  
American Transformer Co., Newark, N. J.  
Ferranti, Ltd., Hollinwood, England  
Ferranti, Inc., New York  
Ferranti Electric, Ltd., Toronto, Ont.

*Street Lighting*  
Kuhlman Electric Co., Bay City, Mich.

## TRANSFORMERS, USED

Electric Service Co., Cincinnati

## TROLLEY LINE MATERIALS

General Electric Co., Schenectady  
Ohio Brass Co., Mansfield, O.  
Westinghouse Elec. & Mfg. Co., E. Pitts-  
burgh

## TURBINES, HYDRAULIC

Allis-Chalmers Mfg. Co., Milwaukee

## TURBINES, STEAM

Allis-Chalmers Mfg. Co., Milwaukee  
General Electric Co., Schenectady  
Westinghouse Elec. & Mfg. Co., E. Pitts-  
burgh

## TURBO-GENERATORS

Allis-Chalmers Mfg. Co., Milwaukee  
Westinghouse Elec. & Mfg. Co., E. Pitts-  
burgh

## VALVE CONTROL, ELECTRIC

Bristol Company, The, Waterbury, Conn.

## VALVES, BRASS

*Gas, Water, Steam*  
Ohio Brass Co., Mansfield, O.

## VARNISHES, INSULATING

General Electric Co., Bridgeport, Conn.  
Mica Insulator Co., New York  
Minerallac Electric Co., Chicago  
Westinghouse Elec. & Mfg. Co., E. Pitts-  
burgh

## WASHERS, LOCK

Shakeproof Lock Washer Co., Chicago

## WELDING MACHINES, ELECTRIC

General Electric Co., Schenectady  
Ohio Brass Co., Mansfield, O.  
Westinghouse Elec. & Mfg. Co., E. Pitts-  
burgh

## WELDING WIRES & RODS

American Steel & Wire Co., Chicago  
Ohio Brass Co., Mansfield, O.

## WIRES AND CABLES

*Aluminum S. C.*  
Aluminum Co. of America, Pittsburgh

*Armored Cable*  
American Steel & Wire Co., Chicago  
Belden Mfg. Co., Chicago  
General Electric Co., Schenectady  
Kerite Ins. Wire & Cable Co., New York  
Okonite Company, The, Passaic, N. J.  
Roebling's Sons Co., John A., Trenton, N. J.  
Simplex Wire & Cable Co., Boston  
Standard Underground Cable Co., Perth  
Amboy, N. J.

*Asbestos Covered*  
American Steel & Wire Co., Chicago  
Belden Mfg. Co., Chicago  
General Electric Co., Schenectady  
Rockbestos Products Corp., New Haven  
Conn.  
Rome Wire Company, Rome, N. Y.

## WIRES AND CABLES—Continued

*Automotive*  
American Steel & Wire Co., Chicago  
Belden Mfg. Co., Chicago  
General Electric Co., Schenectady  
Kerite Ins. Wire & Cable Co., New York  
Roebling's Sons Co., John A., Trenton, N. J.  
Rome Wire Company, Rome, N. Y.  
Simplex Wire & Cable Co., Boston  
Standard Underground Cable Co., Perth  
Amboy, N. J.

*Bare Copper*  
American Steel & Wire Co., Chicago  
Anaconda Wire & Cable Co., New York  
Belden Mfg. Co., Chicago  
Roebling's Sons Co., John A., Trenton, N. J.  
Rome Wire Company, Rome, N. Y.  
Standard Underground Cable Co., Perth  
Amboy, N. J.

*Copper Clad*  
Belden Mfg. Co., Chicago  
Standard Underground Cable Co., Perth  
Amboy, N. J.

*Copperweld*  
Copperweld Steel Co., Glassport, Pa.

*Flexible Cord*  
American Steel & Wire Co., Chicago  
Belden Mfg. Co., Chicago  
General Electric Co., Schenectady  
Okonite Company, The, Passaic, N. J.  
Roebling's Sons Co., John A., Trenton, N. J.  
Rome Wire Company, Rome, N. Y.  
Simplex Wire & Cable Co., Boston  
Standard Underground Cable Co., Perth  
Amboy, N. J.

*Heavy Duty Cord*  
American Steel & Wire Co., Chicago  
Belden Mfg. Co., Chicago  
Okonite Company, The, Passaic, N. J.  
Rome Wire Company, Rome, N. Y.  
Simplex Wire & Cable Co., Boston

*Fuse*  
American Steel & Wire Co., Chicago  
General Electric Co., Schenectady  
Roebling's Sons Co., John A., Trenton, N. J.  
*Lead Covered (Paper and Varnished Cambric Insulated)*

American Steel & Wire Co., Chicago  
Anaconda Wire & Cable Co., New York  
General Electric Co., Schenectady  
Kerite Ins. Wire & Cable Co., New York  
Okonite Company, The, Passaic, N. J.  
Okonite-Callender Cable Co., The, Inc.,  
Passaic, N. J.  
Roebling's Sons Co., John A., Trenton, N. J.  
Rome Wire Company, Rome, N. Y.  
Simplex Wire & Cable Co., Boston  
Standard Underground Cable Co., Perth  
Amboy, N. J.

*Magnet*  
Acme Wire Company, New Haven, Conn.  
American Steel & Wire Co., Chicago  
Anaconda Wire & Cable Co., New York  
Belden Mfg. Co., Chicago  
Dudlo Mfg. Corp., Fort Wayne, Ind.  
General Electric Co., Schenectady  
Roebling's Sons Co., John A., Trenton, N. J.  
Rome Wire Company, Rome, N. Y.  
Standard Underground Cable Co., Perth  
Amboy, N. J.

*Rubber Insulated*  
American Steel & Wire Co., Chicago  
Belden Mfg. Co., Chicago  
General Electric Co., Schenectady  
Kerite Ins. Wire & Cable Co., New York  
Okonite Company, The, Passaic, N. J.  
Roebling's Sons Co., John A., Trenton, N. J.  
Rome Wire Company, Rome, N. Y.  
Standard Underground Cable Co., Perth  
Amboy, N. J.

*Tree Wire*  
Okonite Company, The, Passaic, N. J.  
Roebling's Sons Co., John A., Trenton, N. J.  
Simplex Wire & Cable Co., Boston

*Trolley*  
American Steel & Wire Co., Chicago  
Anaconda Wire & Cable Co., New York  
Copperweld Steel Co., Glassport, Pa.  
Roebling's Sons Co., John A., Trenton, N. J.  
Rome Wire Company, Rome, N. Y.  
Standard Underground Cable Co., Perth  
Amboy, N. J.

*Weatherproof*  
American Steel & Wire Co., Chicago  
Anaconda Wire & Cable Co., New York  
Copperweld Steel Co., Glassport, Pa.  
General Electric Co., Schenectady  
Kerite Ins. Wire & Cable Co., New York  
Okonite Company, The, Passaic, N. J.  
Roebling's Sons Co., John A., Trenton, N. J.  
Rome Wire Company, Rome, N. Y.  
Simplex Wire & Cable Co., Boston  
Standard Underground Cable Co., Perth  
Amboy, N. J.



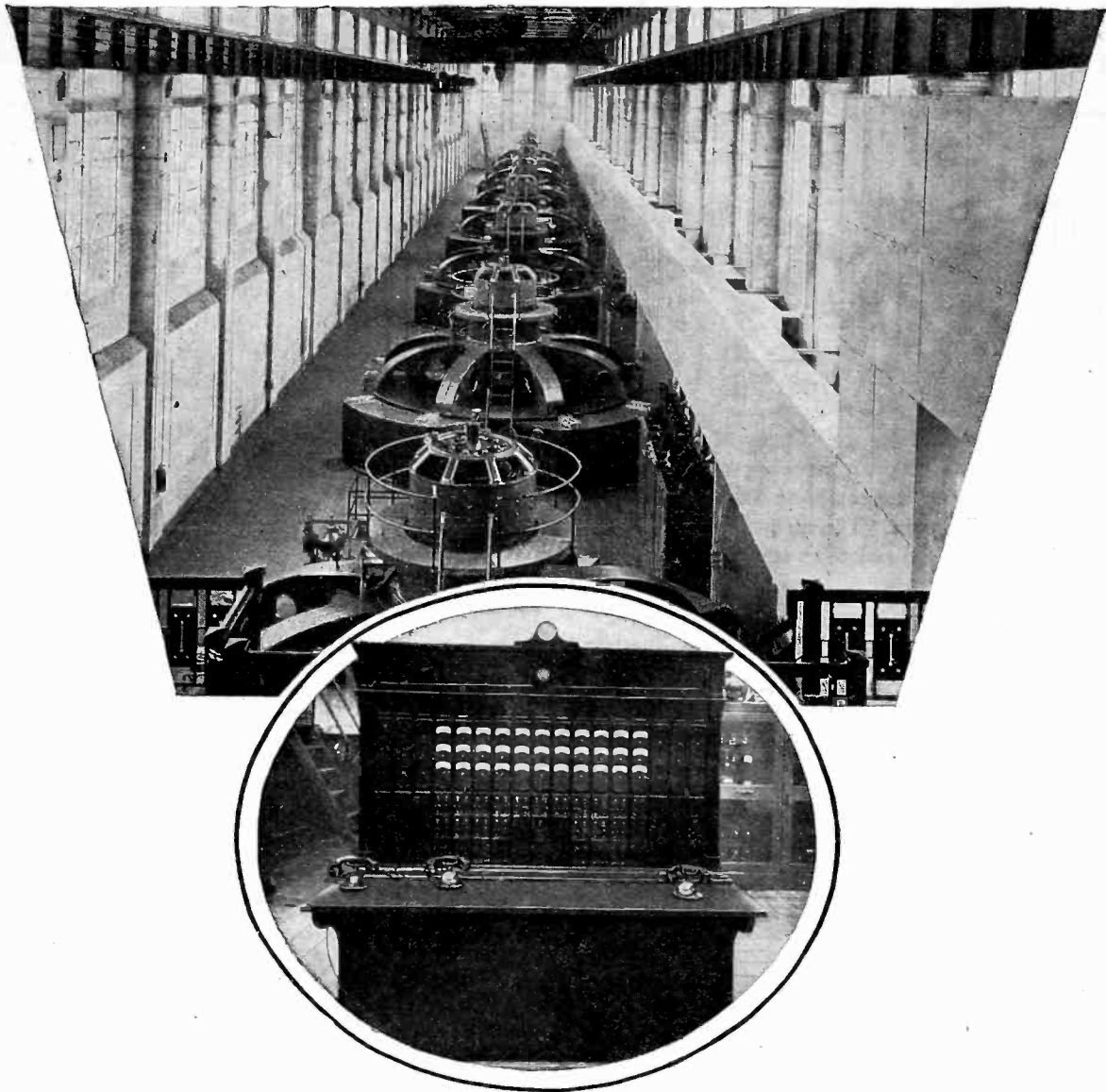

## Concentrated Control with Miniature Switchboards

A concentration of control in a power station can now be accomplished with a miniature switchboard. Much lower voltages and smaller currents are utilized at the control board, and the size of the control equipment is reduced.

By locating the relays close to the controlled apparatus, heavy currents need not be brought to the switchboard. Installation costs are decreased, and a few multi-conductor telephone cables replace the conventional conduit and wiring.

Important features of the miniature switchboard:

Control board can be placed where convenient because it requires but little floor space.

Control wiring and conduit is greatly reduced. Economical operation is obtained by one-man control.

Remote control by low-voltage circuits provides safe operation.

Other advantages also add to the satisfactory, safe, and economical operation of G-E miniature switchboards. For further information, write to the nearest G-E office.



JOIN US IN THE GENERAL ELECTRIC HOUR, BROADCAST EVERY SATURDAY AT 8 P.M., E.S.T. ON A NATION-WIDE N.B.C. NETWORK 460-42

# GENERAL ELECTRIC

GENERAL ELECTRIC COMPANY, SCHENECTADY, N. Y., SALES OFFICES IN PRINCIPAL CITIES

Please mention the JOURNAL of the A. I. E. E. when writing to advertisers.

a simple  
piece of  
copper  
that

**RECTIFIES**



KUPROX is the rectifier of the age. Its rectifying action is simplicity itself. It does not depend upon pressure or chemical reaction. In fact, each individual disc in a complete Kuprox rectifier is a capable and efficient rectifier in itself. The application of the Kuprox principle to commercial rectification two years ago was new. Since that time it has become the standard accepted rectifier on most of our railroads, in telephone, telegraph, and many other industrial uses. It has proved its absolute dependability, its efficiency, and long, trouble-free life.

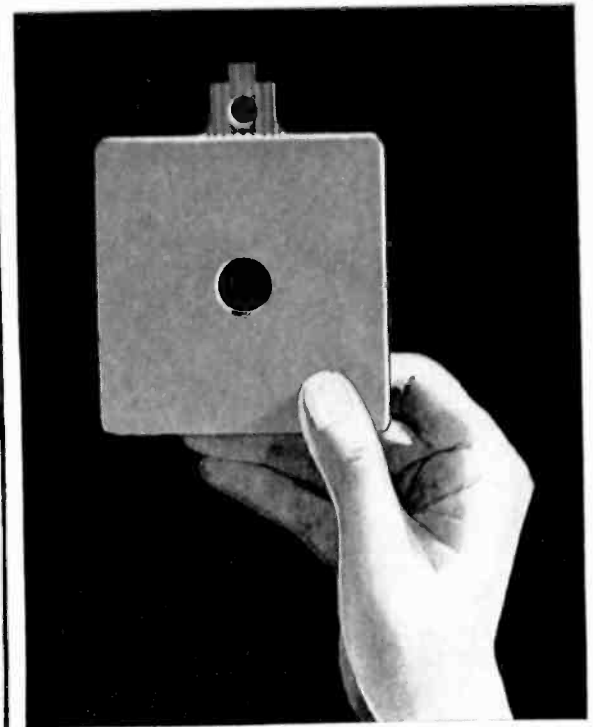

Kuprox Dry Copper Oxide Rectifiers are offered in many standard installations. But they can be built to handle any requirements wherever rectifiers of any kind are used. If you are interested in knowing more of these actual installations, we have compiled a complete treatise on Kuprox in our Bulletin No. 3678. It will be sent free on request.

THE KODEL ELECTRIC & MFG. CO.  
CINCINNATI, OHIO

# KUPROX

## DRY COPPER OXIDE RECTIFIERS

### ALPHABETICAL LIST OF ADVERTISERS

	PAGE		PAGE		PAGE
Acme Wire Company	38	Engineering Directory	48, 49	National Carbon Company	33
Allis-Chalmers Manufacturing Co.	30	Exposition Electrical Industries, National	42	Neall, N. J.	48
Aluminum Company of America	19			Neiler, Rich & Company	48
Ambursen Construction Company, Inc.	48	Fennesy, David V.	48	Norma-Hoffmann Bearings Corporation	28
American Lava Corporation	36	Ferranti, Incorporated	17		
American Pencil Company	38	Fibroc Insulation Company	36	Ohio Brass Company	11
American Steel & Wire Company	39	Ford, Bacon & Davis, Inc.	48	Okonite Company, The	Third Cover
American Telephone & Telegraph Co.	16	Fowle & Company, Frank F.	48	Okonite-Callender Cable Co., Inc.	Third Cover
American Transformer Company	25	Frey Engineering Company	48	Ophuls & Hill, Inc.	48
Anaconda Wire & Cable Company	6			Osgood, Farley	48
Bakelite Corporation	26	G & W Electric Specialty Company	45	Pacific Electric Mfg. Corporation	46
Barstow & Company, Inc., W. S.	48	General Electric Company	8, 9, 35, 55	Parker-Kalon Corporation	38
Batthey & Kipp, Inc.	48	General Radio Company	43		
Belden Manufacturing Company	41			Rochester Electric Products Corp.	40
Black & Veatch	48	Hoosier Engineering Company	48	Rockbestos Products Corporation	27
Bull Dog Electric Products Company	5			Roebing's Sons Company, John A.	46
Burke Electric Company	44	International Nickel Company, The	10	Roller-Smith Company	42
Burdny Engineering Company, Inc.	44	International Resistance Company	3	Rome Wire Company	2
Burt, Dr. Robert C.	48	I-T-E Circuit Breaker Company	22		
Byllesby Engineering & Management Corp.	48			Sanderson & Porter	48
				Sangamo Electric Company	23
Cambridge Instrument Company	42	Jackson & Moreland	48	Sargent & Lundy, Inc.	49
Canadian Porcelain Company, Ltd.	46			Scofield Engineering Company	4
Century Electric Company	29	Kearney Corporation, James R.	46	Shakeproof Lock Washer Company	4
Chicago Mica Company	36	Kerite Insulated Wire & Cable Co., Inc.	1	Simplex Wire & Cable Company	45
Classified Advertisements	40	Kidde & Company, Inc. Walter	Fourth Cover	Standard Underground Cable Company	14
Clement, Edward E.	48	Kodel Electric & Mfg. Co.	56	Stevens, John A.	49
Condit Electrical Manufacturing Corp.	53	Krpse, Robert S.	48	Stevens & Wood, Inc.	49
Condit Electrical Manufacturing Corp.	44	Kuhlman Electric Company	21	Stockbridge & Borst	49
Copperweld Steel Company	24			Stone & Webster, Inc.	12
Corning Glass Works	24	Lapp Insulator Company, Inc.	7	Sundh Electric Company, Inc.	40
		Locke Insulator Corporation	13		
Danne, Harold A.	48			Texas Company, The	57
Delta-Star Electric Company	47	Manufacturers' & Inventors' Elec. Co.	40	Thomas, Percy H.	49
Dossert & Company	20	Mathews Corporation, W. N.	15	Thomas & Sons Company, The R.	46
Dudlo Manufacturing Company	51	Memco Engineering & Mfg. Co.	46		
		Metropolitan Device Corporation	58	Wagner Electric Corporation	18
Electric Contoller & Mfg. Co., The	31	Mica Insulator Company	37	West Va. Pulp & Paper Company	36
Electric Service Company, Inc., The	49	Minerallac Electric Company	44	Western Electric Company	34
Electric Specialty Company	40	Moloney Electric Company	47	Westinghouse Elec. & Mfg. Company	32
Electrical Testing Laboratories	49	Morganite Brush Company, Inc., The	50	Weston Electrical Instrument Corp.	43
Electro Dynamic Company	40			White Engineering Corp., The J. G.	49
				Wireless Specialty Apparatus Company	46
				Wray & Company, J. G.	49

(For classified list of Advertisers see pages 50, 52 and 54)

Please mention the JOURNAL of the A. I. E. E. when writing to advertisers.



## “Troubles just do not exist”

FOR ten years, Texaco Ursa oil has been the *one* oil used in the Diesel engines of a well-known mid-west public service company. And for ten years Texaco Ursa Oil has given the most satisfying service, maintaining a low and even temperature and remarkable freedom from carbon.

Results have been better than with any other oil used prior to the use of Texaco Ursa Oil, according to the chief engineer, who says “we know at all times that troubles just do not exist.”

There has never been a shut-

down attributable to the oil during the entire 10 years.

Texaco Ursa Oil has the ideal combination of qualities which make it the exceptional Diesel lubricant. It is clean, clear golden — pure — which means freedom from carbon. It has the correct viscosity, the ability to seal compression perfectly—and is *always uniform*.

More than that—Texaco Lubrication Service — experienced — active in your behalf is constantly alert to help you in the correct use of every Texaco Lubricant. It is the combination for completely effective lubrication.

# TEXACO LUBRICANTS

THE TEXAS COMPANY  
17 Battery Place, New York City  
*Offices in principal cities*

THERE IS A TEXACO LUBRICANT FOR EVERY PURPOSE

Please mention the JOURNAL of the A. I. E. E. when writing to advertisers.

# A LIGHT, STRONG, INEXPENSIVE LADDER RIG FOR STREET LIGHTING WORK

## TYPE PS LIGHT LADDER

Developed, tried and tested by a large Eastern Public Utility.

May be mounted on a Ford, Chevrolet or other commercial vehicle.

Entire ladder assembly weighs only 200 pounds.

Height from ground to top when ladder is fully extended is 24 feet.

Will safely carry 600 pounds at the top when fully extended.

May be mounted on vehicle of your own choice in one hour.

Your copy of Bulletin No. 200, describing Type PS Light Ladder in detail, now ready,—write for it.

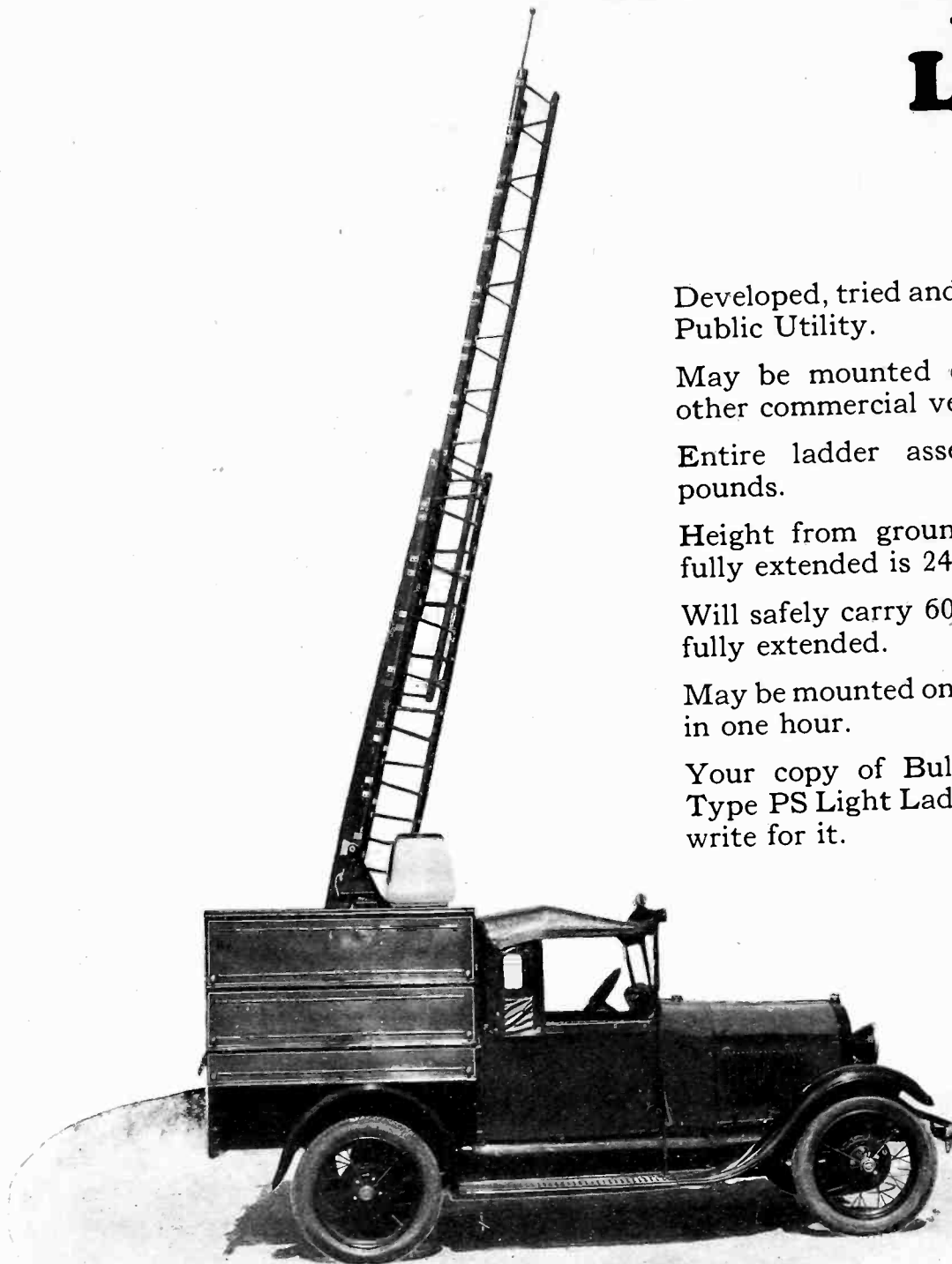

**Metropolitan Device Corporation**  
1250 Atlantic Avenue, Brooklyn, N. Y.

Please mention the JOURNAL of the A. I. E. E. when writing to advertisers.



# The Most Helpful Thing In Overhead Plant

## OKONITE TREE WIRE

Affords the Minimum  
of Maintenance Per Dollar  
of Investment

"Wires burned off in a tree" is a familiar call to the trouble desk. How unwelcome, too, meaning either interrupted work in the daytime or a difficult job in the dark.

The cost of just the repairs: men, truck, materials, may be small in a single case, but the total expense piles up to a large amount in a year; large enough to show that the lower *first* cost of ordinary line wire is not a *saving*.

This abnormal maintenance and all the discomfitures attending such troubles can be avoided by using OKONITE TREE WIRE in the places where tree wire is the needed thing.

Nothing successfully takes the place of a real tree wire. Operators who use Okonite know that. Those who will decide to use it have a wonderful revelation awaiting them.

OKONITE TREE WIRE is *service-proved*. Its years and years of tested performance under the severest conditions assure a new era of economical and comfortable operation to the user.

The Okonite Company has made extensive field studies of tree wire applications. Our booklet "Tree Wire" has been prepared with an exceptional practical knowledge of the subject. It will be mailed upon request.

*Okonite Products*  
OKONITE INSULATED  
WIRES AND CABLES  
VARNISHED  
CAMBRIC CABLES  
OKONITE  
INSULATING TAPE  
MANSON and DUNDEE  
FRICTION TAPE  
OKONITE CEMENT  
OKOCORD OKOLOOM

*Okonite-Callender  
Products*  
IMPREGNATED  
PAPER CABLES  
SUPER-TENSION  
CABLES  
SPlicing  
MATERIALS

## THE OKONITE COMPANY

Founded 1878

THE OKONITE-CALLENDER CABLE COMPANY, INC.

Factories: Passaic, N. J.

Paterson, N. J.

SALES OFFICES: NEW YORK CHICAGO PITTSBURGH ST. LOUIS  
ATLANTA BIRMINGHAM SAN FRANCISCO LOS ANGELES DALLAS SEATTLE BOSTON

Novelty Electric Co., Philadelphia, Pa.  
F. D. Lawrence Electric Co., Cincinnati, O.

Canadian Representatives:

Engineering Materials, Limited, Montreal

Cuban Representatives: Victor G. Mendoza Co., Havana





# SMOTHER OUT the FLAMES—

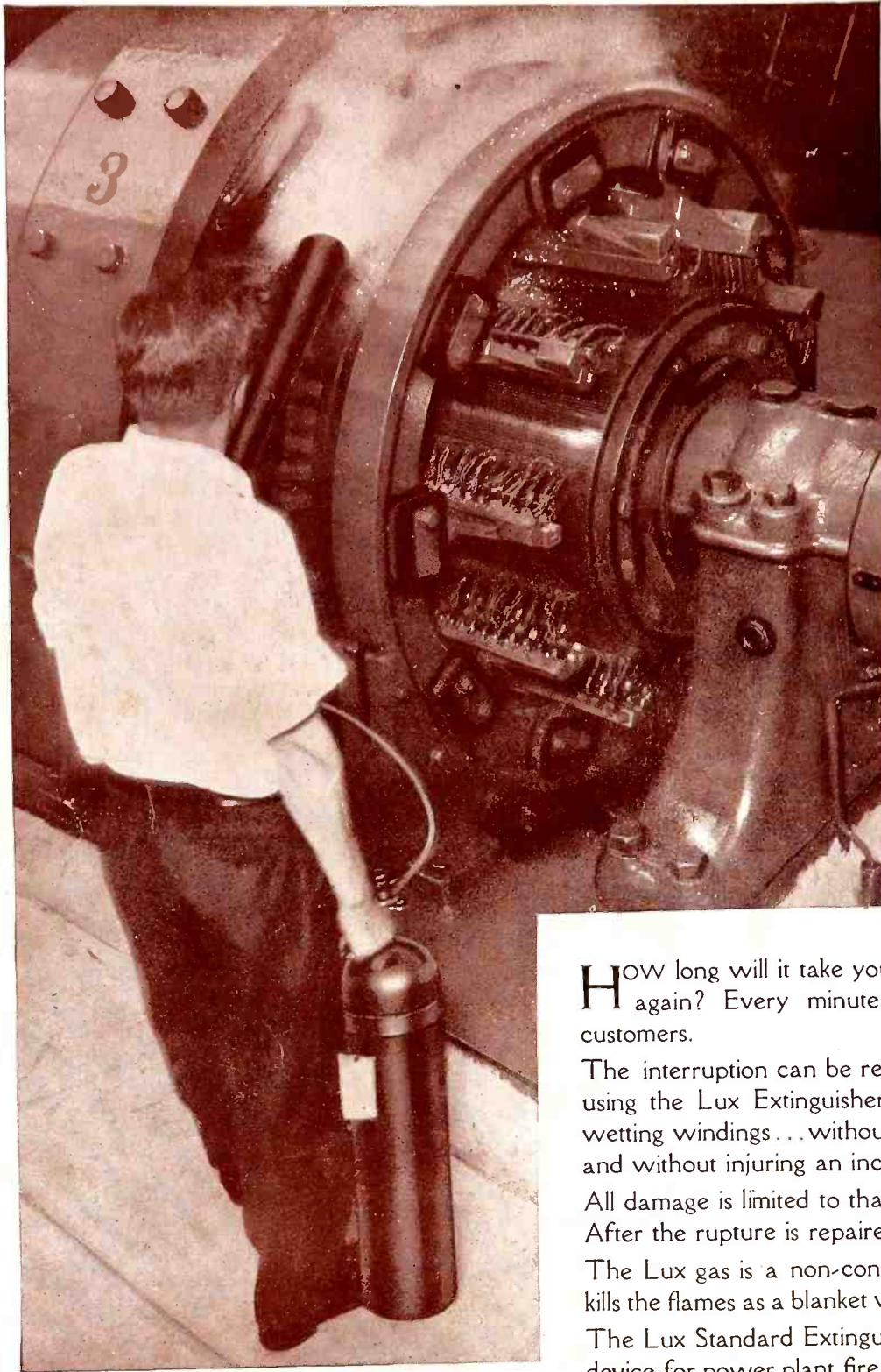

—Then the  
**INTERRUPTION**  
is  
**CUT IN THIRD**

**H**OW long will it take you after a fire to get a machine in service again? Every minute lost may mean inconvenience to your customers.

The interruption can be reduced from days to hours however, by using the Lux Extinguisher. For Lux smothers the flames without wetting windings . . . without dirtying the machine with chemicals . . . and without injuring an inch of insulation.

All damage is limited to that by the fire at the point of breakdown. After the rupture is repaired, the machine is ready for service again. The Lux gas is a non-conductor—dry, clean, and non-corrosive. It kills the flames as a blanket would—instantly and without after effects. The Lux Standard Extinguisher is rated higher than any other hand device for power plant fire hazards. The Underwriters' Laboratories have classified it B-1, C-1.

A request will bring you complete information.

**Walter Kidde & Company, Inc.**  
140 Cedar Street  
New York

