

JOURNAL OF THE A. I. E. E.

SEPTEMBER 1927



PUBLISHED MONTHLY BY THE
AMERICAN INSTITUTE OF ELECTRICAL ENGINEERS
33 WEST 39TH ST. NEW YORK CITY

PACIFIC COAST CONVENTION NUMBER

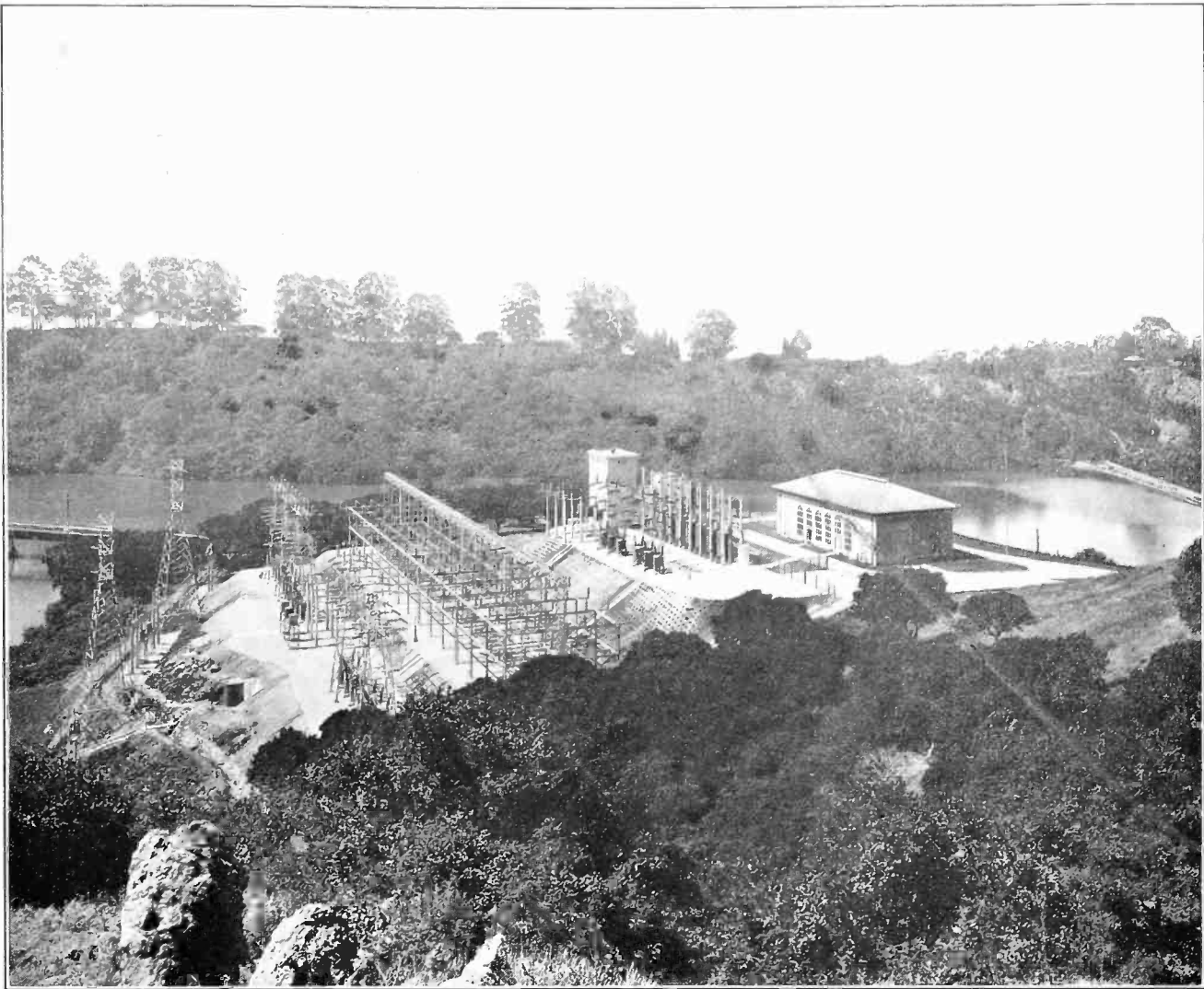

CLAREMONT SUBSTATION OF THE PACIFIC GAS & ELECTRIC CO.

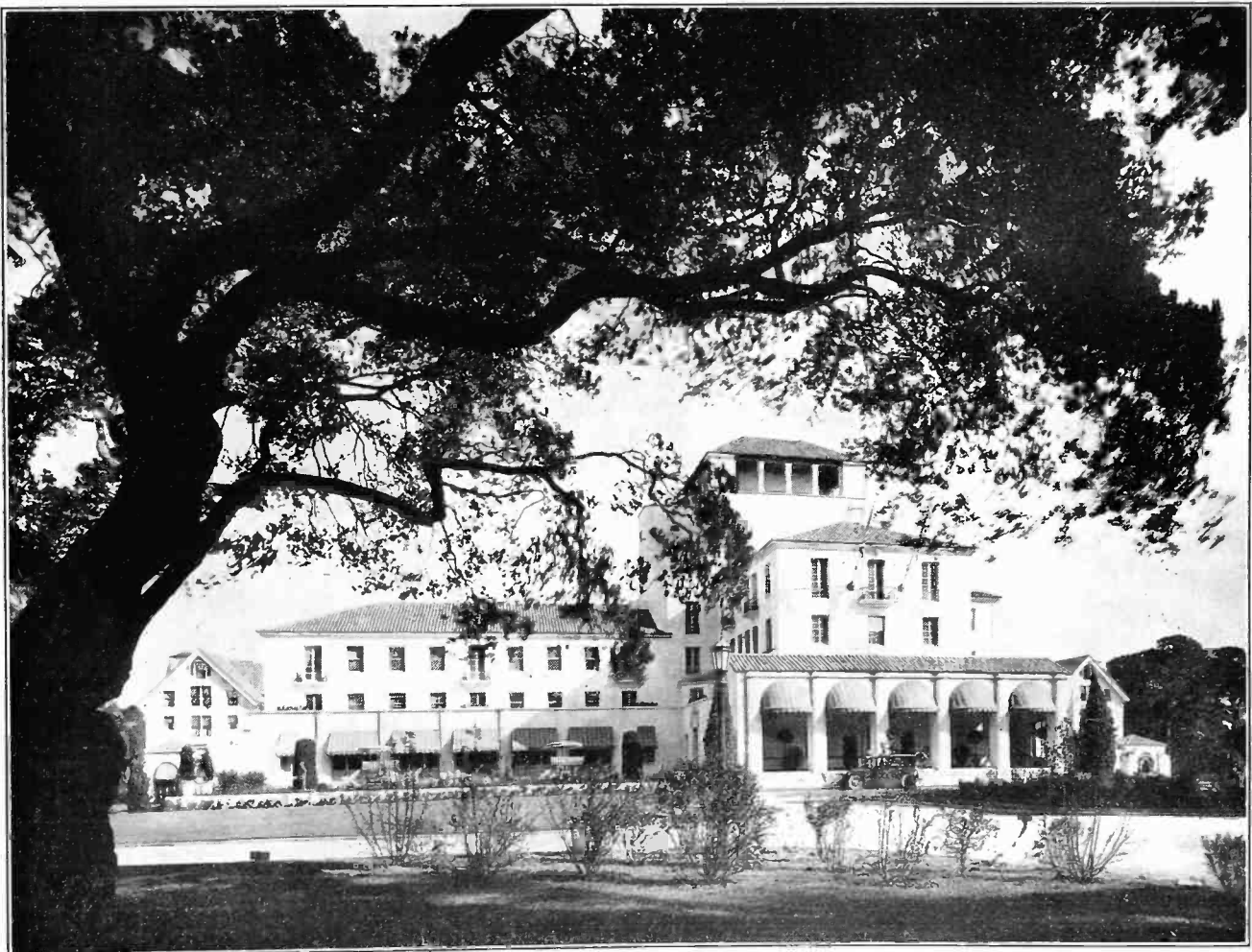

HOTEL DEL MONTE—A. I. E. E. HEADQUARTERS FOR PACIFIC COAST CONVENTION

JOURNAL

OF THE

American Institute of Electrical Engineers

PUBLISHED MONTHLY BY THE AMERICAN INSTITUTE OF ELECTRICAL ENGINEERS
33 West 39th Street, New York

Subscription. \$10.00 per year to United States, Mexico, Cuba, Porto Rico, Hawaii and the Philippines, \$10.50 to Canada and \$11.00 to all other countries. Single copies \$1.00.

Entered as matter of the second class at the Post Office, New York, N. Y., May 10, 1905, under the Act of Congress, March 3, 1879. Acceptance for mailing at special rate of postage provided for in Section 1103, Act of October 3, 1917, authorized on August 3, 1918.

Vol. XLVI

SEPTEMBER, 1927

Number 9

TABLE OF CONTENTS

Papers, Discussions, Reports, Etc.

<p>Notes and Announcements..... 857</p> <p>Lightning Protection for Oil Storage Tanks and Reservoirs, by R. W. Sorensen, J. H. Hamilton, and C. D. Hayward..... 859</p> <p>Electric Oscillations in the Double-Circuit, Three-Phase Transmission Line, by Y. Satoh..... 868</p> <p>Equipment for 220-Kv. Systems, by J. P. Jollyman..... 877</p> <p>Electricity on U. S. Trunk Line..... 880</p> <p>Application of Electricity in Cement Mills, by W. E. North..... 881</p> <p>Recent Developments in Electric Drives for Rolling Mills, by L. A. Umansky..... 885</p> <p>Reduction of Transformer Exciting Current to Sine-Wave Basis, by G. Camilli..... 892</p> <p>Mechanical Forces Between Electric Currents and Saturated Magnetic Fields, by V. Karapetoff..... 897</p> <p>Portable Lamps Demonstrate Desirability of Shaded Lights..... 903</p> <p>The Most Economical Power Factor, by H. S. Litchfield..... 904</p> <p>Experimental Measurement of Mechanical Forces in Electric Circuits, by J. W. Roper..... 913</p> <p>Railroad Report Shows Long Life of Electric Locomotives..... 915</p> <p>Report of Committee on Power Generation, W. S. Gorsuch, Chairman..... 916</p> <p>A Non-rotary Regenerative Telegraph Repeater, by A. F. Connery..... 933</p> <p>The Influence of Residual Air and Moisture in Impregnated Paper Insulation (Abridged), by J. B. Whitehead and F. Hamburger, jr.... 939</p>	<p>Discussion at Winter Convention</p> <p style="padding-left: 20px;">The M. M. F. Wave of Polyphase Windings (Graham)..... 948</p> <p style="padding-left: 20px;">Combined Light and Power Systems for A-c. Secondary Networks (Richter)..... 949</p> <p>Discussion at Kansas City Meeting</p> <p style="padding-left: 20px;">Development of Railway Signaling (Stevens). 954</p> <p>Discussion at Pittsfield Meeting</p> <p style="padding-left: 20px;">Substitution Method for the Determination of Resistance of Inductors and Capacitors at Radio Frequencies (Burke)..... 955</p> <p style="padding-left: 20px;">Condenser Shunt for Measurement of High-Frequency Currents of Large Magnitude (Nyman)..... 957</p> <p style="padding-left: 20px;">High-Frequency Measurement of Communication Apparatus (Shackelton and Ferguson)..... 957</p> <p style="padding-left: 20px;">A New Thermionic Instrument (Hoare)..... 958</p> <p style="padding-left: 20px;">The Oscilloscope, A Stabilized Cathode Ray Oscillograph with Linear Time Axis (Bedell and Reich)..... 959</p> <p style="padding-left: 20px;">Empirical Analysis of Complex Electric Waves (Horton)..... 960</p> <p style="padding-left: 20px;">Sensitivity Characteristics of a Low-Frequency Bridge Network (Edwards and Herrington)..... 960</p> <p style="padding-left: 20px;">Mechanical Forces in Transformers (Clem) .. 961</p> <p style="padding-left: 20px;">High-Voltage Measurements on Cables and Insulators (Kasson)..... 963</p> <p style="padding-left: 20px;">Sparking in Air (Sah)..... 965</p> <p style="padding-left: 20px;">Non-harmonic Alternating Currents (Bedell) 965</p> <p style="padding-left: 20px;">A Theory of Imperfect Solid Dielectrics (Malti) 965</p>
--	---

Institute and Related Activities

<p>Program for Pacific Coast Convention at Del Monte, Sept. 13-16..... 968</p> <p>Regional Meeting in Chicago, November 29-30.. 969</p> <p>First National Fuels Meeting..... 970</p> <p>Seventy-fourth Meeting of the American Chemical Society..... 970</p> <p>Sixteenth Annual Safety Congress of the National Safety Council..... 970</p> <p>A. I. E. E. Directors Meeting..... 970</p> <p>Report on Standard Definitions..... 970</p> <p>New Oil-Electric Car Operated in Canada..... 970</p> <p>Utility Inquiry May Be Pressed..... 971</p> <p>Seventeen Companies Accept Radio Telegraph Conference Invitation..... 971</p>	<p>Would Coordinate University Studies Throughout World..... 971</p> <p>Value of Timber as Protection to Water Shed... 971</p> <p>Gasoline Engine Temperatures..... 971</p> <p>Personal Mention..... 971</p> <p>Obituary..... 972</p> <p>Past Section and Branch Meetings..... 972</p> <p>Engineering Societies Library..... 973</p> <p>Engineering Societies Employment..... 975</p> <p>Membership and Applications and Transfer... 976</p> <p>Officers of A. I. E. E..... 978</p> <p>Local Honorary Secretaries..... 978</p> <p>Sections and Branches..... 981</p> <p>Digest of Current Industrial News..... 982</p>
---	--

A REQUEST FOR CHANGE OF ADDRESS must be received at Institute headquarters at least ten days before the date of issue with which it is to take effect. Duplicate copies cannot be sent without charge to replace those issues undelivered through failure to send such advance notice. With your new address be sure to mention the old one, indicating also any changes in business connections

Copyright 1927. By A. I. E. E.

Printed in U. S. A.

Permission is given to reprint any article after its date of publication, provided proper credit is given.
(The Journal of the A. I. E. E. is indexed in Industrial Arts Index.)

Current Electrical Articles Published by Other Societies

Journal of the Western Society of Engineers (July 1927)

Hydro-Electric Generators, by R. B. Williamson

The Institute of Radio Engineers, Proceedings (July 1927)

Telephone Communication Over Power Lines by High Frequency Currents,
by C. A. Boddie

Measurements of Radio Frequency Amplification, by Sylvan Harris

Journal of the A. I. E. E.

Devoted to the advancement of the theory and practise of electrical engineering and the allied arts and sciences

Vol. XLVI

SEPTEMBER, 1927

Number 9

Engineering Education

The second report of the Board of Investigation and Coordination of the Society for the Promotion of Engineering Education, issued in June, is based upon the results of a general investigation "directed to a study of the objects of engineering education and the fitness of the present-day curricula," which has been conducted by the Society during the past three and one-half years. It deals with the following two distinct but related issues:

"I. Engineering Education—A Unified *vs.* a Divided Process."

"II. The Question of a Longer Engineering Curriculum."

The following paragraphs are quoted from the "Summary of Issues and Conclusions" and "Conclusion".

Part I. "A unified educational process implies a curriculum in which humanistic, scientific and technological studies are combined into an orderly whole, constituting a complete and self-contained branch of higher education under unity of supervision. A divided process implies a distinct pre-engineering curriculum under separate auspices and an engineering curriculum set up on purely technical lines, a plan corresponding to the present educational scheme in law, medicine and dentistry.

"The Board is of the opinion that the engineering colleges in general may best fulfill their purpose by providing under their own auspices an educational program which is complete in itself and which may be entered direct from the secondary schools; that this type of program supplies the norm in engineering education; but that facilities should be afforded for the admission to advanced standing of students who desire a more extended general academic training before entering upon the study of engineering."

Part II. "The issue concerning the length of the curriculum grows out of the accepted principle that more than four years of preparation are needed to equip men for creative leadership in the engineering profession. The alternative lies between a longer prescribed program, to be pursued in full or in part by all students, and a normal undergraduate program as a base with a variety of supplementary programs to fit different needs and preferences.

"The Board is of the opinion that it is advisable to preserve the usual distinction between undergraduate and post-graduate programs and that the undergraduate

program should be self-contained and lead to a degree. Opportunity should be afforded and encouragement given to students of promise to extend their formal training by means appropriate to their aptitude, ability and choice of a career, such as the voluntary election of additional humanistic studies, the pursuit of post-graduate study in a fully qualified institution, or through orderly studies pursued in conjunction with engineering experience. Four years is regarded as the normal length of the undergraduate program. In many cases this program may be divided advantageously into two stages under the same supervision and both reasonably self-contained, in order to provide an intermediate goal and facilitate a selective process of admission to the upper years."

Conclusion. "In conclusion, it seems fitting to outline the Board's conception of the place and function of the engineering colleges in the educational scheme and to indicate some of its ideals for their future progress.

"It is the Board's belief that engineering education is so broad in its aims and that its methods are so truly educative as fully to justify its established position as one of the major complete branches of higher education. The engineering college is conceived to be coordinate in organization and status with the college of liberal arts, in both undergraduate and post-graduate divisions. There is a clear-cut distinction, however, in their purposes and their methods of work, which invests the engineering colleges with a professional character. The undergraduate engineering curriculum properly combines humanistic, scientific and technological studies into a coherent and integral program which is set off from a loose grouping of scientific studies by a well-marked professional orientation. The professional element in the curriculum becomes increasingly important in the upper years of the program and dominates the more specialized work of the post-graduate years.

"The Board recognizes the need to develop, broaden and enrich engineering education, in view of the constantly enlarging responsibilities of engineers in society and the increasing exactions of professional practise. It holds, however, that this development should proceed from within, by enhancing the distinctive qualities of engineering education, rather than by adding to it unrelated elements from without; that the preservation of a unified program better lends itself to this end; that it is desirable to give a more generous place to distinctly humanistic studies in the curriculum and to

give these studies a form and content¹ which will enrich the student's conception of engineering and its place in social economy; that it is desirable to give the student a more connected and better grounding in engineering principles; that a greater effort should be made to develop the student's capacity for self-directed work; and that these ends should be gained, wherever need be, at the expense of unrelated studies on one hand and of detailed technical training on the other. The Board holds that detailed training in engineering technique should be more adequately provided for in both post-graduate and post-scholastic courses.

"The Board holds that its principal efforts for the improvement of engineering education must take the direction of a simpler and better balanced curriculum, better selection of students, better qualified teachers, better teaching methods, better subject matters and more adequate provision for advanced training, rather than changes in the scheme of educational organization."

For a list of publications dealing with various phases of this investigation and a brief summary of the first report of the Board, see page 83 of the JOURNAL for January, 1927. The following more recent publications are now available:

Second Report of the Board of Investigation and Coordination. 15 cents.

Bulletin No. 10. A Study of Engineering Curricula. 40 cents.

Bulletin No. 11. A Study of Evolutionary Trends in Engineering Curricula. 20 cents.

Bulletin No. 12. A Study of the Cooperative Method of Engineering Education. 30 cents.

Copies may be obtained from The Lancaster Press, Inc., Price and Lemon Streets, Lancaster, Pennsylvania.

Some Leaders of the A. I. E. E.

John White Howell, Member of the Institute since 1887 (Fellow 1912) and Edison Medalist for 1924, was born at New Brunswick, New Jersey, December 22, 1857. His preliminary education was followed by a year and a half at the College of the City of New York, whence he went to Rutgers for a year's study in engineering, following it by a special course at Stevens Institute of Technology, which he completed in 1881. Later, in 1899, he was given the honorary degree of Electrical Engineer by Stevens.

On July 6, 1881, he joined the Edison Lamp Works at Menlo Park. The lamp industry was then in its infancy with no machinery and no established methods of procedure. In fact for several years, Mr. Edison himself supervised the work personally, but gradually, as Mr. Howell became more experienced, this supervision was passed on to him until he was finally in full charge. His contributions by important inventions and much constructive literature have been representative factors in the improvement and enlargement of the incandescent lamp developments.

Two of his earliest achievements were the production of a portable voltmeter and the Wheatstone Bridge type of potential indicator now widely used in central stations and electric light plants to compensate for

temperature. Later on, the comparative indicator, a novel system for giving the voltage at each feeder end by comparison with one standard indicator, was also originated by him.

In 1886, he determined for the first time in the history of the incandescent lamp the relation between its life and its candle power. This has since been applied to all forms of incandescent lamps. The next year he introduced a carbonaceous paste clamp, which greatly decreased the cost of clamping and filament, at the same time greatly increasing the efficiency and quality of the lamp. And when, in 1890, he was made Technical Advisor to Manager of Works, he introduced certain changes in the exhaust which, while increasing the speed of the exhaust, still further improved the quality of the lamp. It was in 1892 that the Edison Lamp Works became a part of the General Electric Company, and Mr. Howell was appointed Engineer and Assistant Manager of the Lamp Works. Continuing his experimental investigations, he organized the Edison Lamp Works Engineering Department, improving upon the Thomson-Houston method of treating carbon filaments and developing a treating machine which completely revolutionized the most important processes of current lamp production. He also introduced the squirted cellulose filament, thereby reducing the number of operators required in this specific department from 350 to 12. As engineer, manager, inventor, Mr. Howell has ever been an ever moving force in the development of the lamp industry. It would be difficult in fact to even catalogue his many technical achievements; his patents are numerous and cover a wide field in parts, processes and the machinery used in the evolution of the electric lamp.

To devote more time to the more congenial occupation of his engineering duties, Mr. Howell, in 1895 resigned from his assistant managership. He investigated and reported favorably upon the Malignani methods of exhaust, afterward introduced into the works at an enormous increase of production. With W. R. Burrows, he designed and patented the first stem-making machine which was a great innovation at that time and is still in use. Various filament inventions were investigated by him and he assisted Doctor Whitney in the development of the metallized filament. During 1906 much of his time was spent in Europe for the purpose of studying the Tungsten lamp and acquiring their American rights. Today he is the most distinguished pioneer in incandescent lamp field, in the evolution and development of which he has rendered inestimable service. His work of research has been of universal value, and the general public as well as the entire electrical industry have derived many benefits from his labors. Mr. Howell is also a member of the American Society of Mechanical Engineers, the National Electric Light Association, the Association of Edison Illuminating Companies, Illuminating Engineering Society, Franklin Institute and Past-president of the Edison Pioneers.

1. It is the expectation that the Board will deal with the form and content of the humanistic studies of the engineering curriculum in a later section of its reports.

Lightning Protection for Oil Storage Tanks and Reservoirs

BY ROYAL W. SORENSEN*
Fellow, A. I. E. E.

JAMES HUGH HAMILTON†
Non-Member

CLAUDE D. HAYWARD‡
Non-Member

Synopsis.—This paper outlines work done in connection with planning a protection scheme for the oil storage tank farms of the General Petroleum Corporation of California. The work shows that the average annual number of storms at a given location is a constant. The dielectric property of oil has no influence in causing lightning or inducing it to strike oil in storage.

Tests show that excellent protection can be obtained by towers

properly installed, but they do not indicate absolute immunity against hits.

The work done also shows that an extensive field program, supplemented by such laboratory work as required for understanding and assisting the field program, should be carried out to extend our knowledge of lightning phenomena and protection.

* * * * *

INTRODUCTION

IN California, the production of great quantities of oil has made necessary the development of storage capacity for millions of barrels of oil of varying degrees of inflammability.

Three types of storage containers have been used; all steel tanks, tanks with steel walls and roofs of some other material, and large concrete basin-like structures commonly known as reservoirs.

Previous to 1926, on California oil properties, fires resulting from lightning were scattered as to time and place. Also, insurance rates for damage to these properties by lightning were sufficiently reasonable to make such insurance more economical than the employment of protective measures for oil or oil products against induced and direct-hit ignition by lightning.

Three major fires which occurred during April 1926, resulting in the loss of several lives and almost \$20,000,000 worth of property, immediately caused a large increase in insurance rates and entirely changed the aspect of the problem in emphasizing the fact that insurance can never compensate for the economic loss involved in the destruction of large quantities of oil.

The average number of thunderstorm days per year for a given geographical location is, according to Weather Bureau statistics, a constant which has not changed during the period covered by their records (Fig. 1).

In different parts of the United States, the number of such days varies from less than 5 to 95 per year. Small areas within the divisions represented by the reports may have a greater or less number of such days.

The probability of damage by lightning in any given area is largely a function of the number of storms occurring within that area, the amount of the area occupied by life and property, the character of structures or materials included therein, and the absolute humidity—which determines the percentage of lightning discharges that will occur as strokes to ground.

*Prof. of Elec. Engg., California Institute of Technology.

†Graduate Student, California Inst. of Tech.

‡Graduate Student, California Inst. of Tech.

To be presented at the Pacific Coast Convention of the A. I. E. E., Del Monte, Calif., Sept. 13-16, 1927.

Each year adds to the portion of any given region occupied by life and property and increases accordingly the probability of loss of life and damage to property. For this reason, not only the petroleum industry but also other industries should consider means of protection for the future in addition to those required at present, and should make it possible for engineers and scientists to plan and execute a thorough program of field researches on the character of lightning discharges,

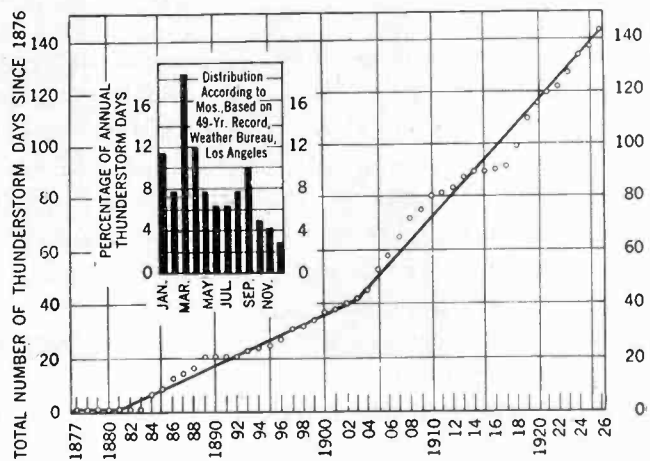

FIG. 1—NUMBER OF THUNDERSTORM DAYS IN LOS ANGELES SINCE 1876

Cumulative chart from records of the Weather Bureau. In this form a straight line indicates a constant thunderstorm frequency. It should be noted that in 1903, an alteration was made in station regulations equivalent to changing the official definition of a thunderstorm from "thunder with rain" to "thunder with or without rain." This explains the increase in thunderstorms recorded since 1903. (From Marion E. Dice, "Lightning Hazards," *Oil Bulletin*, 13, 27, Jan. 1927.)

supplemented by such laboratory work as may be required for the development of the apparatus for these tests and interpretation of the results obtained in the field.

Directly following the 1926 oil fires, several oil companies using the laboratories at the California Institute of Technology as a base, independently or in cooperation with members of the Institute staff, undertook the problem of designing protection for their oil storage properties. The most extensive of these programs was conducted for the General Petroleum Corporation by Marion E. Dice of their Consulting Engineer's Depart-

ment and the California Institute of Technology High-Voltage Laboratory staff. It forms the basis of this paper.

EFFECT OF LOCATION ON LIGHTNING HAZARD

Given a geographical section within which certain industrial operations are to be carried on, are there spots within that area which vary as to the probability of a lightning discharge?

A study of contributing causes for lightning, such as the breaking of water drops in upward currents of air¹ at the required velocity, showed that much can be done in reducing the lightning hazard by proper location with respect to thunderstorm paths.

Lightning damage may be caused by direct stroke or by ignition from secondary or induced discharges. As the energy in discharges caused by induced charges is relatively small, oil fires from this means can result only by such discharge acting as ignition systems. The obvious method for guarding against such effects is to reduce to a minimum the storage of highly combustible oils or gases given off by oils, and to keep well guarded against spark discharges the oils that are the more highly inflammable or give off gases which, with air, form explosive mixtures.

The well-known impossibility of producing differences of potential between two objects within a completely closed conducting envelope by influences exerted without the envelope indicates the proper solution for the problem of induced discharges. In practise, therefore, the desired protection from induced effects has been obtained by storing readily inflammable oils or oils which will give off explosive gases in all metal tanks, with well screened and properly designed vents or by the use of wire networks over wooden roofs. Floating roof construction, which reduced to a minimum the free gas space above oil in a tank, is an aid to this form of conservation. Tanks constructed in this way are costly and it is therefore not practicable to use them as general storage for the millions of barrels of oil now stored. Fortunately a great percentage of the oil can be reduced to a heavy residuum of low volatility for storage. This heavy residuum can be safely stored in the large reinforced concrete reservoirs, used so extensively in California, or in metal tanks with non-metal, non-floating roofing, providing such reservoirs or tanks are protected from direct hits.

Before discussing methods of guarding against direct hits, the authors wish to present some data bearing upon the possibility of any special phenomena related to lightning which may be directly chargeable to the influence of the oil itself.

COLLECTION OF CHARGES ON OIL SURFACES

It was suspected at one time that certain oil fires of unaccountable origin might have been due to ignition from sparks caused by independent charges accumu-

lating on parts of a large oil surface and then coming near enough to each other to have their charges equalized by a spark between them. The apparatus shown in Fig. 2 was used to make tests relating to this possibility. With voltage applied to the pan and terminal above it as electrodes, charges could be detected at the surface of the oil only while such voltage was applied. Also, during the application of voltage, the oil was always in circulation, the rapidity of circulation being a function of the potential gradient through the oil. Bits of cork or other insulating material in the oil would show a rather definite circulation path from the strong field under the rod above the pan out to the weaker field. Frequently particles of insulation material in the oil, because of some peculiarity of shape or color, could be singled out and watched. Many of these particles were seen to act as though they were in the business of carrying charges from the surface of the oil to the pan at the bottom; that is, with a rate of motion entirely apart from the rate of circulation of oil, these particles would come to the oil surface, move down until they touched the pan at the bottom, and then come to the surface again to repeat the operation. As a further check, a charged electroscope was con-

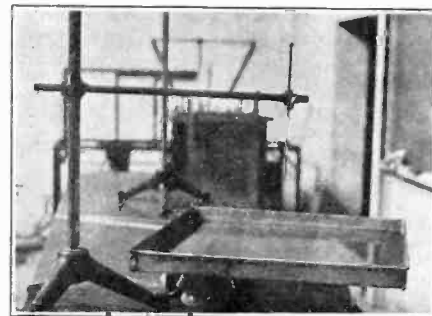

FIG. 2

nected to a conductor which was allowed to touch the surface of the oil. In every case the electroscope was very quickly discharged. Also, it was found that the electroscope could not be charged above the potential drop through the oil so long as it was kept connected to the surface of the oil. These tests showed, as did similar earlier² ones, that oil cannot accumulate charges at points on its surface. Thus, there need be no fear of isolated or local charges on the surface of oil building up or approaching each other, and igniting the gas above the oil by spark discharges.

INFLUENCE OF OIL ON SPARK DISCHARGE

In planning protection for oil storage, one is confronted with the question; does oil have to be considered as a special problem because of characteristics which have influence, different from those of other substances, in directing the path of a lightning discharge between a charged cloud and the earth, or because of

1. For all references see Bibliography.

2. Loc. cit.

any special phenomena relating to the accumulation of charges on the surface of a body of oil.

It is a known fact that when a high potential direct current is applied to two electrodes insulated from each other, a dielectric, such as glass or mica, placed near the positive one materially lowers the voltage required to give arc-over between the two terminals.³ At the suggestion of E. R. Wolcott of the Union Oil Company of California, oil, being a dielectric, was examined for such an effect with negative results. There was found no evidence that spark-over voltage between two charged electrodes was changed by placing oil on the positive one. This is fortunate, for if oil in a reservoir on the ground could act to lower the discharge voltages, there would be a great hazard for the oil, whenever a negative cloud formed in the region of storage.

This absence of any influence of the oil to cause it to

insulation over the pan), was increased, and no arc from upper electrode to pan took place. Also, when the oil film was not punctured, there was no arc discharge from the upper electrode, the discharge around this electrode being limited to the corona discharge; that is, an arc does not strike from a conductor to an insulator unless the potential gradient over the insulator is great enough to either puncture the insulator or carry the arc around it through the medium surrounding the insulator. This is a fact of which one sometimes loses sight in thinking of the action of two insulators having different dielectric constants when placed in series in an electric field. When voltage is applied to such an arrangement, while it is true that the greater stress is upon the insulator with the smaller dielectric constant, it is also true that in order to obtain an arc there must be complete breakdown of both dielectrics by puncture or

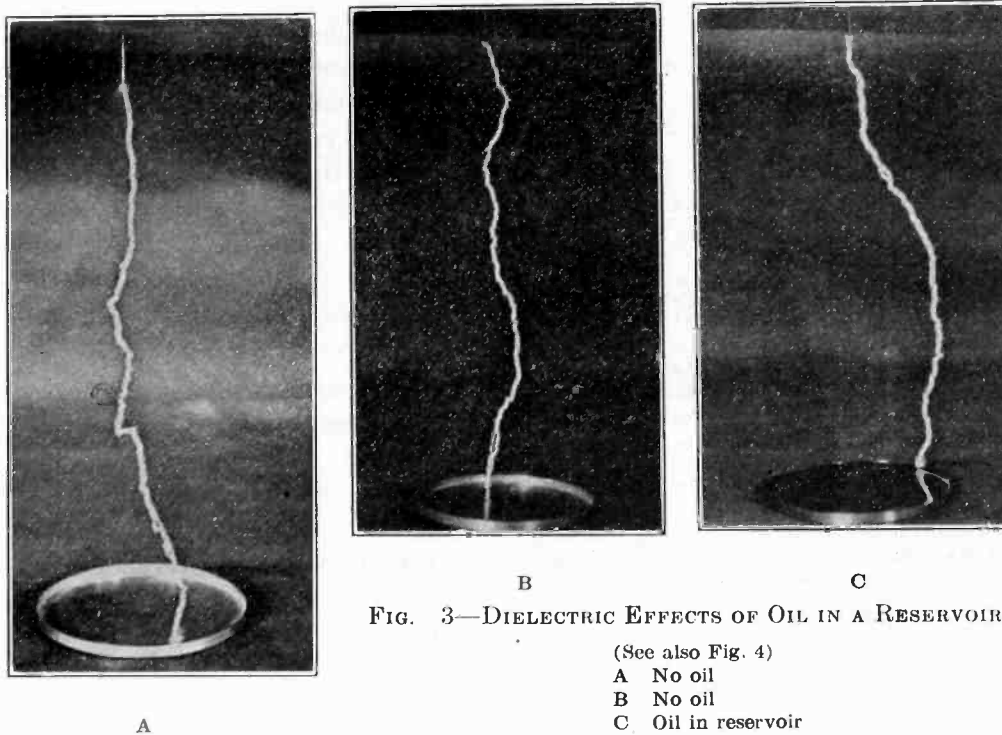

FIG. 3—DIELECTRIC EFFECTS OF OIL IN A RESERVOIR

(See also Fig. 4)

- A No oil
- B No oil
- C Oil in reservoir

be a more probable target for spark discharges was also checked by the use of the piece of apparatus shown in Fig. 2. This apparatus consisted simply of a large shallow pan partly filled with oil. With an electrode above the pan, (as shown), connected to one terminal of the source of direct current supply and the pan connected to the other many tests were made. These tests show that as the voltage was increased, the oil was agitated more and more violently until, as the voltage approached that required for arc-over, the oil was hollowed out under the upper electrode, as though blown away, and when the depth of oil directly under the electrode was sufficiently small, the arc struck through the oil to the pan. If the voltage was kept constant and the oil level in the pan raised by adding more oil, the depth of oil (or, in other words, the thickness of

arc-over, as the arc cannot strike through one dielectric to the other as a terminal.

As a further check upon the inability of oil in a vessel to cause the discharge to take place more readily, many tests were made with smaller pans, dimensions of which were proportional to those of reservoirs. These were placed on the floor below the electrode used to represent a cloud, the other terminal of the power supply being grounded to the floor. With oil in the pan, the discharges missed the pan altogether or struck the edge; without oil in the pan, the discharges would hit in the pan or at the edge indiscriminately as shown by Figs. 3 and 4.

LIGHTNING STROKES

There are three possible ways of guarding against direct hits; *viz.*, to prevent the occurrence of lightning discharges between clouds and earth, to construct

3. Loc. cit.

the tanks or reservoirs in such a way as to provide immunity to damage from such hits, or to direct the hits elsewhere to conductors which will harmlessly carry a discharge occurring between cloud and earth until all energy of the discharge is dissipated. All of these suggested solutions were discussed shortly after Franklin's invention of the lightning rod in 1752, were revived and again thrashed out about 100 years later when Sir W. Snow Harris devised lightning conductors for ships of the English Navy, and more than 50 years since were reduced to scientific analysis by Sir Oliver Lodge.

To prevent lightning discharges between clouds and earth, it is necessary to provide a means of preventing the accumulation of sufficient charge on cloud and earth to

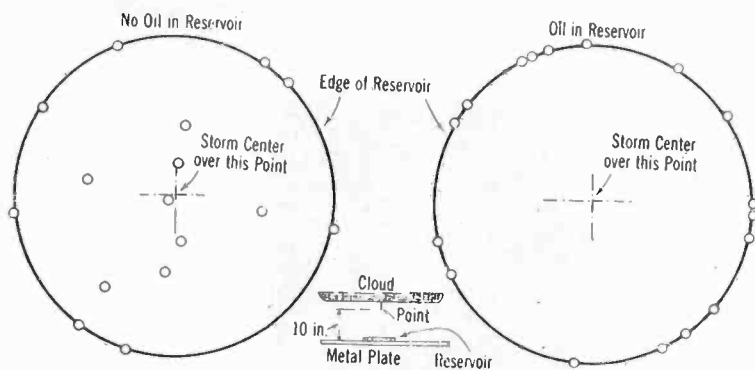

FIG. 4—DIELECTRIC EFFECT OF OIL IN A RESERVOIR WITH GROUNDED WALLS

These records show that the presence of oil in a reinforced concrete or metal reservoir tends to direct electrical discharges, which would otherwise strike into the body of the reservoir, to the edge. At the same time, the presence of a body of oil of the proportions of a reservoir in a thunderstorm field does not affect the number of discharges which fall within that area. Oil does not attract or repel lightning. In the tests, discharges from the surge generator were directed into a scale model of one of the 500,000-bbl. Wilmington reservoirs when empty and when full of oil (13 deg. residuum). The storm center was over the center of the reservoir at an elevation of 1000-ft. (actually 10-in.). The small circles show the location of hits.

Point Struck	Results	
	Reservoir Empty	Reservoir full of Oil
Edge.....	8	17
Inside.....	8	0
Outside.....	4	3
	20	20

cause a discharge to take place between them. There are no known records of this having been accomplished in such a way as to make available any data on energy discharge from structures erected for this purpose, though there have been many schemes suggested⁴. These schemes rely for the most part upon the use of points attached to earth as a means of discharging the charges produced. Tests to determine the value of such a scheme should be made on actual tower and point installations in a district subject to many lightning storms. Not having available such an equipment, tests were made with laboratory apparatus as shown in Fig. 5. This apparatus was constructed to scale and

4. Loc. cit.

tests made for several conditions involving different actual dimensions.

In these laboratory tests, steady unidirectional fields were used, because, had alternating fields been used, the total current measured would be the resultant of an energy current in phase with the voltage and the charging current leading the voltage 90 degrees. Lack of a proper wattmeter for use under such small current,

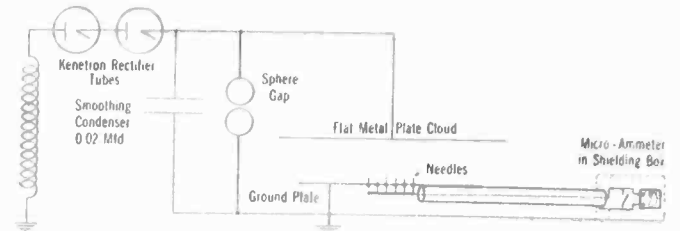

FIG. 5—DIAGRAM OF TESTS ON DISSIPATION OF ELECTRIC CHARGE BY NEEDLE POINTS

high-voltage conditions would make the separation of these components very difficult. There are also other difficulties with alternating fields, such as distorted waves having greater peak value on the positive half cycle than on the negative half cycle, which make the separation of energy current from total current practically impossible. With direct current, these complications are avoided and the conduction current between points and the upper plate has a steady value for any given voltage.

The apparatus (Fig. 5) consisted of two parallel flat metal plates, mounted horizontally and insulated from each other. The upper plate represented the thunder cloud and by means of the kenotron and condenser equipment shown in the figure, could be charged to a maximum potential of 100 kv. The lower plate was connected to ground and represented the earth surface under the thunder cloud. A number of steel needles,

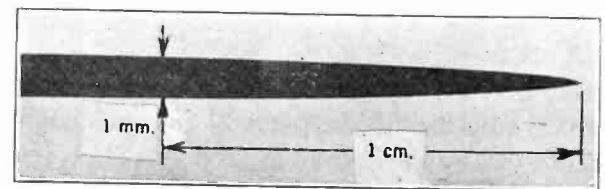

FIG. 6—DIMENSIONS OF NEEDLES USED IN FIG. 5

(Fig. 6), projected through holes in the grounded plate. Each needle was insulated from the plate by means of a small piece of glass tubing and all the needles were connected together at their ends by a third, smaller, flat metal plate which in turn was connected to ground through a micro-ammeter. The connecting lead was carefully shielded against induced charges by a grounded metal tube which surrounded it, and the micro-ammeter itself was placed inside a grounded screen wire cage.

For each set of readings, the upper plate was set at a

given distance above the lower one, the points were raised above this plate 1/12 the distance between plates, and the needles were separated a distance of four times the needle height. The sphere-gap was set for a desired value and voltage was applied, slowly increasing until the gap sparked over, at which time the micro-ammeter was read.

Results of some of the tests made are shown in Fig. 7. Each curve demonstrates the relation between the average voltage gradient between the plates and the conduction current from the points. The curves give no constant relation between conduction current and gradient, but indicates so many variables as to make it impossible to draw many conclusions from the data at present available.

On the other hand, the curves show that the con-

and from other investigations, may be of interest in this connection.

C. T. R. Wilson⁵ shows that a probable charge of 50 coulombs is neutralized by a lightning flash. Simpson⁶ states the total charge to be of the order of 100 coulombs. Norinder⁷ found the time required for building up charges preceding lightning flashes to vary between large limits, the short intervals being only about three or four seconds and the longer ones, several minutes. Apparently a large number of them are built up in 10 sec. or less. Assuming for our calculations, a time of 10 sec. allowed for the accumulation of a charge of 50 coulombs, resulting in a gradient of 100 kv. per ft., if it is assumed that the gradient builds up at a uniform rate during 10 sec. of applied voltage the average current would be approximately 2.5 micro-amperes flowing for eight seconds, if it takes a gradient of 20 kv. per ft. to start the current as shown by Curve I (+), Fig. 7. The number of points required to give out this conduction current would be

$$\frac{50}{8 \times 2.5 \times 10^{-6}} = 2.5 \times 10^6$$

points, each of which must be 1/12 of the cloud height. For clouds 2400 ft. high, this requires 2,500,000 200-ft. towers spaced 800 ft. apart. Conceding these calculations to be largely in error, there is, nevertheless, little indication that lightning may be prevented by conduction currents from points. For cases of more rapid charge accumulation, the number of towers required would be correspondingly greater.

TANKS

The use of tanks for oils which are dangerously inflammable has been discussed in relation to induced discharges. These same tanks made entirely of metal can be made to furnish, unaided except by good grounds, protection to contents for direct hits. They need no further discussion.

LIGHTNING RODS

Franklin when he gave instructions that conductors used for lightning rods should terminate at the upper extremity, with one or more points, and extend downward until they met permanently moist earth possessed of good powers of electric conduction showed knowledge of the fundamentals of lightning rod protection far beyond that of his associates. These fundamentals are, however, insufficient for the whole solution of the problem, and must be supplemented by knowledge of lightning phenomena developed since the time of Franklin, such as was reported by Sir Oliver Lodge⁸ and added to by the engineers and physicists of today.

In fact, with all our knowledge of these phenomena, such as side flashes, back strokes, electrical inertia, and the effect of location, ground conditions, etc., there

5, 6, 7. Loc. cit.
8. Loc. cit.

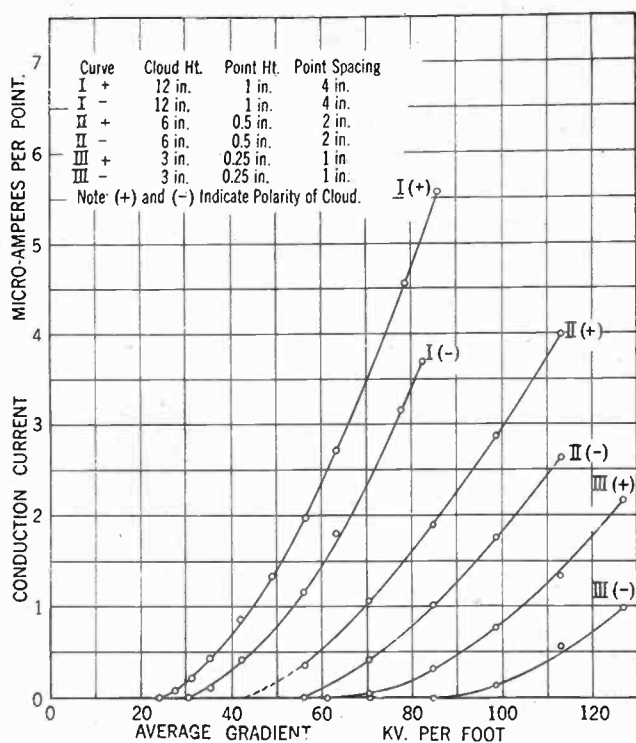

FIG. 7—DISSIPATION CURRENTS OF NEEDLE POINTS DISCHARGING AN ARTIFICIAL CLOUD

duction current is practically zero (less than 10⁻⁸ amperes) up to a certain critical gradient in each case. From this point, as the gradient is increased, points are obtained according to some regular law (which permits them to be plotted as points in a curve). They also show that the current is influenced by the actual size of the apparatus within the range available in the laboratory at the present time, but it is inconceivable that the same order of increase of current with increase of scale will be maintained up to the scale of clouds and lightning towers in actual use.

If conduction current great enough could be obtained, there would be a possibility of keeping the potential between earth and clouds down to a value too low for the discharge by lightning. Some calculations based on the data obtained from the tests just described,

seem to be no general rules which can be applied to all places to be protected, and these rules are sufficiently comprehensive to make unnecessary a special study of practically each location for which protection is desired.

For oil in storage, it seems best to have the rods take the form of high towers, placed as far from the reservoirs and as far apart as practical, being at the same time near enough to each other to make almost impossible any hits to objects between them. Each tower so erected should be grounded at its base to the water plane below the tower, to all piping around the base of

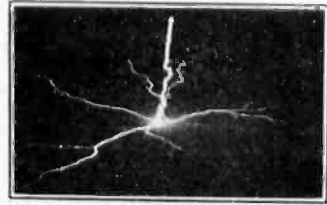

FIG. 8—SPREAD OF DISCHARGE CURRENT OVER A CONCRETE FLOOR

the tower, and to the reservoirs for which protection is being provided.

To avoid so far as practical, any danger from side flashes which might ignite the oil, the towers are erected at some distance from the reservoir they are to protect. Good grounds directly under the towers also assist in reducing the possibility of side flash. Fig. 8 shows a current of electricity that appears to spatter all over the surface of a concrete floor with no special provision for good grounding when a condenser is discharged into the

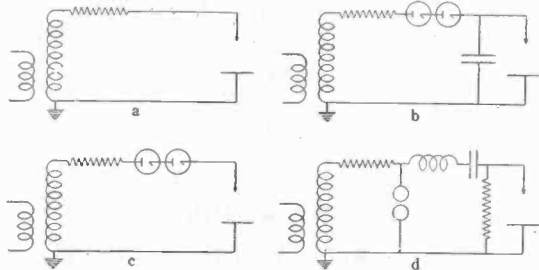

FIG. 9—DIAGRAMS OF CONNECTIONS FOR FURNISHING DISCHARGES

- a. A-c. 50 cycles
- b. D-c. with condenser
- c. D-c. pulsating
- d. Surge generator

floor. There is no evidence of this flow of current over the floor surface when it is well grounded.

Having decided to consider high towers well grounded, the next step was the making of many experiments to determine the protection area about rods as single units and in groups, as set up on models in the high voltage laboratory. In making these experiments, many tests were made with a-c., 50-cycle sparks, d-c. sparks with and without condensers both for grounded positive and grounded negative terminals, and for dis-

charges from a surge or lightning generator.⁹ Connections used are shown in Figs. 9A, B, C and D.

Results of the tests made for all types of discharge used show no absolute immunity for any area around a rod. The tests were made on models having the storm centers two and four rod heights off center. Considered from a statistical viewpoint, the number of hits within a circle having one rod height as a radius and with its center at the rod was practically nil, but there was an occasional hit even within this area which was not taken by the rod.

As the area under consideration is increased by considering larger boundary circles drawn about the rod,

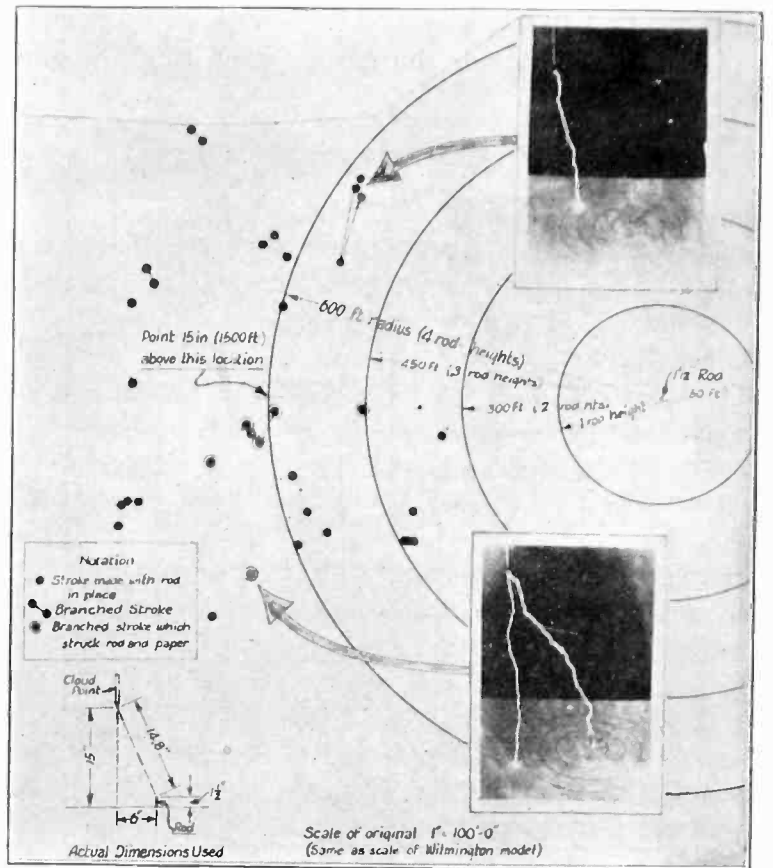

FIG. 10—DISTRIBUTION OF HITS FROM DISCHARGE NEEDLE OVER POINT FOUR ROD HEIGHTS AWAY FROM ROD AND TEN ROD HEIGHTS ABOVE SURFACE

the number of hits which can strike within a given area is increased until, at a distance of four times rod height from the rod, a circle may be drawn as indicative of the fact that beyond this point the rod furnishes little or no protection.

Results of some typical tests are shown in Fig. 10 and Tables I, II, and III. These tests show the statistical protection values for single rods for areas enclosed by circles having radii of one, two, three, and four rod heights. All tests of this type were made with apparatus set up to scale, the rod in each case being considered as 150 ft. high. The actual rods used varied in height from 1/4 in. to two in., with actual sparking distances varying from about two in. to almost 27 in.

Having determined in the laboratory what one rod

9. Loc. cit.

TABLE I. PROTECTION AFFORDED BY SINGLE RODS FOR AREAS SURROUNDING THE RODS
 These results are from tests made with surge-generator discharges from a point representing a cloud center located at various distances above the plane and at a horizontal distance of 4 h from the center line of the rod whose height is h, equivalent to 150 ft.
 The areas in which strokes were recorded are circles of which the rod is the center and whose radii were respectively h, 2 h, 3 h, and 4 h.

Scale	Rod height	Point (cloud) height		No. of strokes with rod and without rod	Circle with radius = 4 h			Circle with radius = 3 h			Circle with radius = 2 h			Circle with radius = 1 h			Strokes to rod		
		Actual in.	To scale, ft.		With rod	Without rod	Per cent. protection	With rod	Without rod	Per cent. protection	With rod	Without rod	Per cent. protection	With rod	Without rod	Per cent. protection			
1 in. = 300 ft.	1/2 in. = 150 ft.	1 2/3	1000	50	6	35	83	2	2	0	0	0	0	0	0	?	21		
		2 1/3	1500	50	10	25	60	1	11	91	0	3	100	0	1	100	?	20	
		3 1/3	2000	50	7	16	56	4	8	50	1	3	67	0	0	?	30		
		5	3000	50	7	19	63	2	11	82	0	2	100	0	0	?	15		
		6 2/3	4000	50	2	16	87	1	10	90	0	7	100	0	3	100	?	0	
		8	4800	50	1	18	95	0	15	100	0	3	100	0	0	?	21		
		10	6000	50	0	14	100	0	9	100	0	2	100	0	0	?	23		
		1 in. = 400 ft.	1/3 in. = 150 ft.	2 1/3	1000	50	12	24	50	1	9	11	0	0	0	0	0	?	15
				3 1/3	1333	50	8	20	60	2	6	67	0	1	100	0	0	?	22
				5	2000	50	14	20	30	3	11	73	0	5	100	0	1	100	?
6 2/3	2667			50	8	23	65	2	14	86	1	6	83	0	1	100	?	9	
8	3200			50	1	19	95	1	12	92	0	7	100	0	1	100	?	33	
10	4000			50	2	19	89	0	14	100	0	6	100	0	2	100	?	26	
1 in. = 300 ft.	1/2 in. = 150 ft.			3 1/3	1000	50	17	33	48	5	5	0	0	0	0	0	0	100	9
				5	1500	50	13	32	59	1	14	93	1	5	80	0	1	100	11
				6 2/3	2000	50	11	19	42	4	9	56	0	6	100	0	1	100	11
				8	2400	50	4	38	88	1	19	95	0	6	100	0	2	100	33
		10	3000	50	2	12	83	1	4	75	0	2	100	0	0	?	26		
		1 in. = 200 ft.	1/3 in. = 150 ft.	5	1000	50	26	27	4	4	60	0	0	?	0	0	?	3	
				7 1/2	1500	50	24	25	4	6	57	0	2	100	0	0	?	6	
				10	2000	50	10	21	52	1	5	80	0	0	?	0	?	26	
				12 1/2	2500	50	7	18	61	1	14	93	0	3	100	0	0	?	14
				15	3000	50	7	21	67	0	14	100	0	8	100	0	2	100	19
1 in. = 150 ft.	1/4 in. = 75 ft.			6 2/3	1000	50	29	18	0	7	4	0	0	?	0	0	?	0	
				10	1500	50	21	22	5	8	39	0	3	100	0	0	?	15	
				13 1/3	2000	50	10	19	47	1	9	89	0	3	100	0	0	?	21
				16 2/3	2500	50	6	26	77	1	17	94	0	10	100	0	1	100	22
				20	3000	50	1	16	94	0	10	100	0	5	100	0	2	100	30
		1 in. = 100 ft.	1/8 in. = 150 ft.	10	1000	50	21	32	34	5	5	0	0	0	0	0	?	8	
				15	1500	50	14	29	52	4	14	71	0	1	100	0	0	?	15
				20	2000	50	4	14	71	1	4	75	0	0	?	0	0	?	8
				25	2500	50	11	26	81	2	11	82	0	0	?	0	0	?	32
				1 in. = 75 ft.	1/16 in. = 150 ft.	13 1/4	1000	50	22	29	24	7	6	0	0	?	0	0	?
20	1500					50	29	23	39	3	9	67	1	1	0	0	?	14	
26 2/3	2000					50	7	21	67	0	12	100	0	3	100	0	0	?	35

TABLE II
PROTECTION AFFORDED BY SINGLE ROD

Summary of laboratory tests with various sources of potential when storm center is four times the rod height from a vertical line through the rod. On the scale used, the rod height is 150 ft. and the average cloud height is 2578 ft. With each source of potential 900 strokes were made with the rod and 900 without the rod. One rod height = h .

		D. C. (Pulsat- ing)	A. C. 50 Cyc.	D. C. with Con- denser	Surge Gen- erator
Circle with Radius = $4h$	Hits with rod	227	256	261	125
	Hits without rod	401	386	415	397
	Per cent protection	43	34	37	69
Circle with Radius = $3h$	Hits with rod	74	76	67	31
	Hits without rod	198	168	148	183
	Per cent protection	63	55	55	83
Circle with Radius = $2h$	Hits with rod	15	7	2	3
	Hits without rod	77	63	47	65
	Per cent protection	83	89	96	96
Circle with Radius = h	Hits with rod	0	0	0	0
	Hits without rod	19	19	12	14
	Per cent protection	100	100	100	100
No. of strokes to rod		278	181	333	345
Per cent of 900 strokes to rod		31	20	36	38

TABLE III
PROTECTION OF A SINGLE ROD

Summary of laboratory tests when the storm center is twice the rod height from a vertical line through the rod. On the scale used, the rod height is 150 ft. and the average cloud height is 2578 ft. With each source of discharge used 900 strokes were made with the rod and 900 strokes without the rod. One rod height = h .

		D. C. (Pulsat- ing)	A. C. 50 Cyc.	D. C. with Con- denser	Surge Gen- erator
Circle with Radius = $4h$	Hits with rod	208	192	147	61
	Hits without rod	721	662	774	650
	Per cent protection	71	71	81	92
Circle with Radius = $3h$	Hits with rod	129	108	134	16
	Hits without rod	562	501	614	495
	Per cent protection	77	76	78	97
Circle with Radius = $2h$	Hits with rod	39	26	45	3
	Hits without rod	318	263	332	264
	Per cent protection	88	90	86	99
Circle with Radius = h	Hits with rod	1	0	0	0
	Hits without rod	94	66	81	74
	Per cent protection	99	100	100	100
No. of strokes to rod		584	615	710	675
Per cent of 900 strokes to rod		65	68	79	75

will do, combinations of rods using 2, 3, 4 and 6 rods set on the circumference of circles were tried. Many tests were made with the rods grounded and connected to one side of the circuit, and an electrode above the center of the circle, on the circumference of which the rods were located. The rods took a large share of the hits, but it was entirely possible to make a portion of them strike the area within the circle when that circle had a radius of 4 rod heights. For smaller circles the number of hits inside was less. Also the protection factor increased with increase in sparking distance, or height of point above the plane of the rods.

Data about cloud height showed thunder clouds for Southern California to have a height of 2000 to 6000 ft.

above the earth.¹⁰ The preliminary work while far from complete suggested as a probable safe spacing of protective towers such that no portion of the area to be protected would be more than $2\frac{1}{2}$ times a tower height from a tower.

To check this hypothesis, a model of one of the important storage farms to be protected was made to the scale of one inch equals 100 ft.

In making the protection plan, the model was tested first with towers only, the towers being adjusted as to location and height until it was practically impossible to make any discharges hit the miniature reservoirs. It was considered unnecessary to make it impossible to get a discharge to structures representing steel tanks. After the reservoirs were thus fully protected, some connecting cables were added at the 150 ft. level and another group of tests was made to test their effect. As a further precaution, each cable has, at the middle point of the span between towers, a vertical cable extending downward from the aerial cable to the ground cable.

Each tower at its base, is grounded by means of a well drilled to permanent water and is also tied in to the water pipe system which is installed in such a way as to form a complete loop around each reservoir. The reinforcing steel of each reservoir is also connected to this grounding system.

In conclusion, it may be said that the authors feel that very good protection has been provided for the oil reservoir farms of California. It is urged, however, that more knowledge of lightning phenomena be gained as rapidly as possible. As a step in this direction many towers which have been erected are being equipped with fusible tips and klydonograph attachments to make it possible to get records of hits to towers.

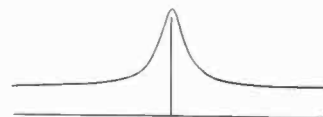

FIG. 11—EQUIPOTENTIAL LINE AROUND A CONDUCTING ROD UNDER A CLOUD

This plot was obtained by the formula of H. V. Ingersoll. The potential of any point (x, y) on the line is 5. The potential of the cloud is 100 and the potential of the earth is 0. The height of the cloud above ground is 6.69 and the height of the rod is 1.22. In the plot the vertical scale is $2\frac{1}{2}$ times the horizontal scale.

Appendix

Inasmuch as grounded conducting towers do act as lightning rods, it would be natural to expect that some law of influence of a rod in space upon the electric field about that rod may be found. A search of literature for results of such studies and a series of tests to determine the effect of conducting rods upon an adjacent electric field were planned. The tests have not been completed and results which can be considered

10. Loc. cit.

conclusive have not been obtained as yet, but a large number of tests and two equations found in a thesis of H. V. Ingersoll, indicate something worthy of attention.

The equations are

$$\Phi = \frac{\Phi_2 - \Phi_1}{l \sqrt{2}}$$

$$\sqrt{(y^2 - x^2 - d^2) + \sqrt{(y^2 - x^2 - d^2)^2 + 4x^2y^2}} + \Phi_1$$

and

$$v = \frac{v_2 - v_1}{h \sqrt{2}}$$

$$\sqrt{(y^2 - x^2 - h^2) + \sqrt{[-(y^2 - x^2 - d^2)]^2 + 4x^2y^2}}$$

The first of these equations was developed at the

California Institute of Technology, whereas the second one is taken from a paper by Dr. Charles H. Lees published in the proceedings of the Royal Society of London, 1915.

In the first equation the following symbols are used:

- Φ = potential at a point (x, y)
- Φ_2 = potential at a cloud
- Φ_1 = potential at ground
- l = height of cloud above ground
- d = height of rod.

In the second equation the symbols used are:

- v = potential at a point (x, y)
- h = height of rod

$$\frac{\alpha \pi}{h} = \text{vertical potential gradient at point } (x, y).$$

If the vertical potential gradient is constant over the

whole area then $\frac{\alpha \pi}{h} \frac{v_2 - v_1}{l}$

where

- v_2 = potential of cloud
- v_1 = potential of ground
- l = distance between cloud and ground.

The equation now is

$$v = \frac{v_2 - v_1}{\pi l \sqrt{2}}$$

$$\sqrt{(y^2 - x^2 - h^2) + \sqrt{[-(y^2 - x^2 - h^2)]^2 + 4x^2y^2}}$$

With Φ_1 and v_1 taken as zero and Dr. Lees' equation

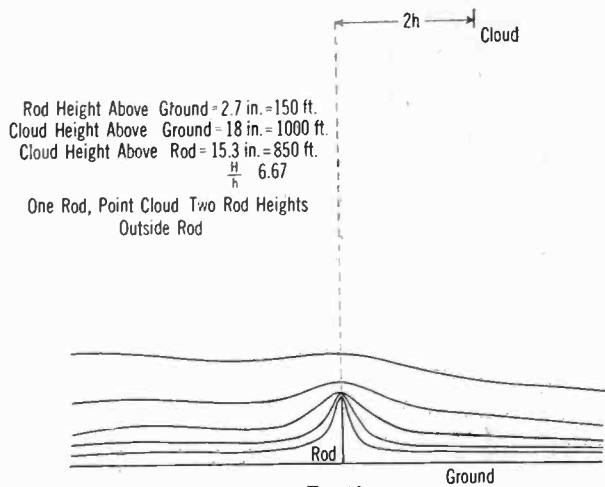

FIG. 12

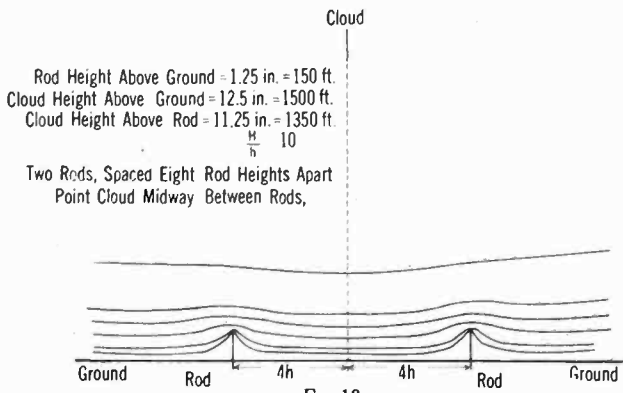

FIG. 13

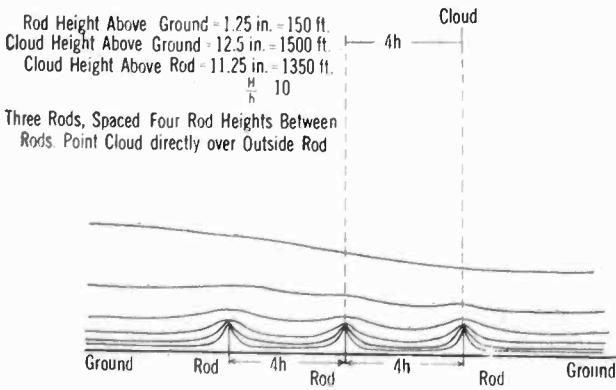

FIG. 14

FIGS. 12, 13 AND 14—EQUIPOTENTIAL LINES BETWEEN CLOUDS AND GROUND WITH DIFFERENT ARRANGEMENTS OF RODS

Charts plotted from tests made with salt tray shown in Fig. 15

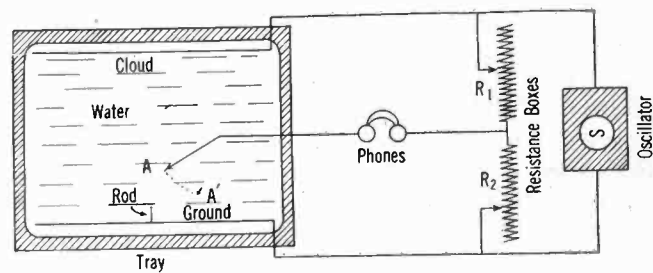

FIG. 15—DIAGRAM OF TESTS TO DETERMINE EQUIPOTENTIAL LINES WITH VARIOUS ROD ARRANGEMENTS

multiplied by π to get both equations in the same system of units the equations are identical.

Fig. 11 shows a curve plotted by use of these equations.

Figs. 12, 13, and 14 show charts obtained by means of a salt tray with one, two, and three rods respectively.

The salt tray used was 21 in. by 25 in. in size.

The bottom was a true plane kept level and then covered to a depth of $\frac{1}{4}$ in. with tap water.

Fig. 15 shows the arrangement used in making the tests.

An attempt was made to get from men with several years of experience at industrial plants, such as smelters with high stacks, located in places subject to considerable lightning reports of hits with relation to tall stacks equipped with lightning rods.

The reports are somewhat in disagreement and do not furnish material from which positive conclusions may be drawn, but there are a number of cases of reports backed by competent and careful observations which state that lightning often hits close to high stacks properly equipped with good lightning rods, without striking the rod.

Bibliography

1. Lenard Meterol, Zeitschen, Vol. 21, 249, 1904, G. C. Simpson *Phil. Mag.* (6) Vol. 30, 1, 1915. *Phil. Trans, Roy. Soc.*, A Vol. 209, pp. 379-413, 1909. *Proc. Roy. Soc.*, A Vol. 82, pp. 169-172, 1909. *Proc. Roy. Soc.*, A Vol. 83, pp. 394-404, 1910.
2. Marion E. Dice and Hallen N. Marsh, Investigations of Static and Atmospheric Electricity, 1925; (unpublished document of the General Petroleum Corp.)
3. Spark Length of an Electrical Influence Machine, as Modified by a Small Spark from the Negative Side, W. J. Humphreys, *Phys. Rev.*, Vol. 10, pp. 311-16, 1900. Mentions effect of solid dielectrics in anticipation of:
Spark Length as Modified by Solid Dielectrics, W. J. Humphreys, *Phys. Rev.*, Vol. 11, pp. 79-83, 1900. Spark length increased as much as 50 per cent when glass (rods, tubes, or fibers), sealing wax, ebonite, sulfur, rubber tubes, wood, or silk threads were placed near the positive terminal. No effect near negative.
- Conditions which Influence the Sparking Potential Values, B. A. Ekern, *Sibley Jl. Engg.*, June 1904. Sparking potential for a given gap and pressure is variable quantity depending on

the shape of the electrodes and the proximity of solid dielectrics to the electrodes. Effect explained by distortion of electrostatic field.

Decrease of Sparking Voltage when a Piece of Mica, Sulfur, Glass, Ebonite, etc., is Placed near the Positive Electrode, Dr. Dawson, *Proc. Roy. Soc.*, Edin., Vol. 29, p. 414, 1900.

Spark-gap Phenomena, J. McWhan, *Electrician*, London, Vol. 65, p. 249, 1910. Within certain limits for the dimensions of a dielectric, sparking may often be induced by placing it near or against the positive pole. Opposite effect at negative pole.

Effects of Dielectrics on the Sparking Voltage, E. R. Wolcott, *Phys. Rev.*, N. S. Vol. 12, p. 284, 1918. Spark length increased by presence of solid dielectrics near positive pole. Author concluded that dielectric must be able to retain a charge in order to show the effect. When made conducting, as by a film of moisture, the effect was lost. Also essential that surface of dielectric be discontinuous, having an edge or a hole. Explains effect by ionization of air between electrodes due to presence of dielectric.

4. *Lit. Digest*, Oct. 27, 1917.

5. C. T. R. Wilson, *Proc. Roy. Soc.*, London, A Vol. 92, pp. 555-574, 1916.

6. C. C. Simpson, *Proc. Roy. Soc.*, London, A Vol. 111, pp. 56-67, May, 1926.

7. H. Norinder, *Elect. World*, Feb. 2, 1924. H. Norinder, *Tekniska Tidskrift Electrotechnic*, Oct. 6, 1923.

8. Sir Oliver Lodge, *Lightning Conductors and Lightning Guards*, 1892.

9. F. W. Peek, A. I. E. E. TRANSACTIONS, Vols. 34, 38, 42, 43.

10. Marion E. Dice, *Engineering News-Record*, July 7, 1927.

Electric Oscillations in the Double-Circuit Three-Phase Transmission Line*

BY Y. SATOH¹

Enrolled Student, A. I. E. E.

Synopsis.—This paper, after referring to the results of a previous study of the electric oscillations on the three-phase aerial line obtained by Dr. Bekku, describes the additional work done by the writer concerning the electric oscillations in the double-circuit, three-phase transmission line, and shows that there are three kinds of

traveling waves. The nature of these waves, and some of the important results of the induced transients, are described. In the appendixes, it is shown briefly how these results were derived and how to calculate the line constants from the construction data of the lines. A few numerical examples are given.

IN 1923, Dr. S. Bekku deduced the theory of electric oscillations in the three-phase aerial line² and showed that, when the three phases are symmetrical, there arise two kinds of traveling waves having different surge impedances and, in general, different propagation velocities. He showed also that when the conductivity of earth is infinity, the propagation velocities of the two waves become equal to that of light.

Referring to his paper, the writer has discussed the oscillations in the double-circuit, three-phase transmission line which are of practical interest and has pointed out some of the important points obtained in studies of these oscillations.

*With supplementary discussion by H. G. Brinton.

1. Graduate student, Stanford University.

2. *Jl. of Japanese Inst. of E. E.*, Feb., 1923.

To be presented at the Pacific Coast Convention of the A. I. E. E., Del Monte, Calif., Sept. 13-16, 1927.

NATURE OF WAVES ON THE SINGLE- AND DOUBLE-CIRCUIT LINES

When a single conductor is running parallel to a boundary plane of a perfect conductor, the oscillation therein as is well known, consists of one kind of traveling wave having a propagation velocity equal to that of light. If, however, several conductors closely parallel one another, as in the case of ordinary transmission lines, there exist various kinds of traveling waves, due to mutual inductive effects. It was shown in Dr. Bekku's paper that in the three-phase line, if the three conductors are balanced, *i. e.*, if the transposition is complete, there are two varieties formed and there are two kinds of traveling waves. The first kind has currents and voltages the sums of which in the three conductors are zero, while the currents and voltages of the second are equal for three conductors. The first

is a wave between conductors and the second is a wave between the group of conductors as one side and the ground as the other. The same theory applies to both aerial lines and underground cables.

If another three-phase circuit of the same electrical characteristics is closely coupled to the former circuit, as in the case of ordinary double-circuit, three-phase power lines, and if we assume that each conductor of one circuit is in the same position with respect to the conductors of the other circuit, then the oscillations therein are the superposition of three kinds of traveling waves, as follows: (The above assumption is not satisfied unless a special method of transposition is used, however, according to the numerical calculations for the actual lines, the assumed conditions are practically realized.)

1. The wave whose sums in voltages to ground and currents of the three conductors of each circuit are zero.
2. The wave whose voltages to ground and currents are equal for all of the six conductors.
3. The wave whose voltages to ground and currents are equal for the three conductors of one circuit and equal but opposite in sign for the three conductors of the other circuit.

Each of the above three kinds consists of two component waves traveling in opposite directions, and each current wave is accompanied by the corresponding voltage wave in the ratio of surge impedance; that is, each kind acts by itself as does the ordinary wave in the case of a single conductor.

The three kinds of waves may be stated as follows:

1. The first kind consists of two waves;
 - a. The wave between conductors of the first circuit,
 - b. The wave between conductors of the second circuit,
 2. The second is the wave between the group of six conductors as one side and the ground as the other side.
 3. The third is the wave between the group of three conductors of one circuit as one side and the group of three conductors of the other circuit as the other side.
- The three kinds are illustrated as in Fig. 1.

Thus we see that a wave can never exist on one conductor only, but it is always accompanied by its companion waves on the other conductors. The surge impedances and the propagation velocities of these waves can be expressed as follows:

For the first kind,

$$Z_1 = \sqrt{(L - L_1)/(K - K_1)}, \tag{1}$$

$$v_1 = 1/\sqrt{(L - L_1)(K - K_1)}, \tag{1a}$$

For the second kind,

$$Z_2 = \sqrt{(L + 2L_1 + 3L_2)/(K + 2K_1 + 3K_2)}, \tag{2}$$

$$v_2 = 1/\sqrt{(L + 2L_1 + 3L_2)(K + 2K_1 + 3K_2)} \tag{2a}$$

For the third kind,

$$Z_3 = \sqrt{(L + 2L_1 - 3L_2)/(K + 2K_1 - 3K_2)}, \tag{3}$$

$$v_3 = 1/\sqrt{(L + 2L_1 - 3L_2)(K + 2K_1 - 3K_2)} \tag{3a}$$

in which

L = Self inductance per unit length of a conductor with ground return,

L_1 = Mutual inductance per unit length between conductors of the same circuit with ground return.

L_2 = Mutual inductance per unit length between conductors of the different circuits,

K = Coefficient of capacity per unit length of a conductor,

K_1 = Coefficient of static induction per unit length between conductors of the same circuit,

K_2 = Coefficient of static induction per unit length between conductors of the different circuits.

As is clear from the above expressions, the surge impedances and the propagation velocities of the three kinds of waves are different. If the conductivity of the earth is assumed to be infinity, the three velocities become equal to that of light.

The relative magnitudes of the three waves entering into the oscillation are determined by the initial conditions. For example, if equal charges are thrown

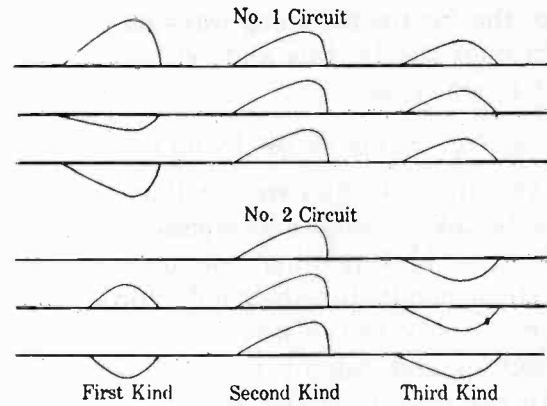

FIG. 1—ILLUSTRATION OF THREE KINDS OF WAVES

on the conductors, as might be the case in a lightning stroke, only the second wave comes in. In three-phase switching operations there will exist only the first wave.

REFLECTIONS AND REFRACTIONS

If the waves meet an irregularity, the reflections and refractions occur as in the case of a single conductor. If the irregularity is the same for the six conductors, each kind of wave independently obeys the same laws of reflection and refraction as in the single conductor. If, however, the irregularity is different in the various conductors, interference and splitting-up occurs among the different kinds of waves; *i. e.*, although the incoming wave is one kind, the reflected and refracted waves consist, in general, of three kinds. If the irregularity is the same for the conductors of the same circuit, the first wave acts separately from the other waves, being reflected without splitting-up, while there is splitting-up between the second and the third waves. For example, if the ends of the six conductors are grounded equally through the resistance R , then all waves obey the law, $G = -F(R - Z)/(R + Z)$, in which F and G

are the incoming and reflecting current waves of one kind and Z is the surge impedance corresponding to that kind. From the above formula, we see that when the six conductors are equally grounded with the resistance equal to the surge impedance of a certain kind of wave, the reflection is zero when the incoming wave is of that kind, but this is not the case for the incidence of the other waves.

When the line having the surge impedances Z_1, Z_2, Z_3 , for the three kinds of waves is connected to another double-circuit, three-phase line of surge impedances Z_1', Z_2', Z_3' , then

$$G = F (Z - Z') / (Z + Z')$$

$$H = F \cdot 2 Z / (Z + Z')$$

for each kind of waves, in which H is the refracted current wave, that is, H is the current wave that travels on past or through the irregularity.

When the conductors of the same phase of two circuits are tied together at the end of the line, as in the case of a paralleling bus, this end acts as an insulated end for the second wave and as a grounded end for the third wave, while for the first wave, there occurs no reflection; that is, the incoming wave on the first circuit passes through the tie bus and returns on the second circuit and vice versa.

SOME OF THE EFFECTS OF INDUCED TRANSIENTS

From the above results we see that any oscillation in one conductor is always accompanied by corresponding oscillations in the other conductors. If, in the case of a single conductor, the conductor is grounded or broken on the way of the wave, the wave undergoes total reflection and cannot pass through the faulty point. In the case of three-phase lines, however, due to the inductive effects of the sound conductors, the waves do pass through such faulty points. Sound conductors must also stand the high voltage of waves due to induced transients from the nearby faulty conductor. The sound circuit must sometimes stand almost as much voltage as the faulty one. Waves starting on a single-circuit line will induce large transients in a sound circuit that may parallel the faulty circuit, even though the place of fault is some distance away from the point where the two circuits come together. This will be important because low-voltage lines often parallel high-voltage lines.

Since the sums of currents and voltages of the first and the third waves in six conductors are zero, they do not give inductive disturbances in adjacent lines. Inductive disturbances are caused only by the second kind of wave. The induced voltage resulting from the second kind of wave is obtained by multiplying by six the voltage induced by the individual conductor.

EFFECT OF LOSSES

Due to the energy losses in the circuits, the waves gradually die out. In this case also each wave acts independently of the other waves and the whole theory

obtained for the wave in the case of a single conductor can be applied to the individual wave. For example, each wave has its own attenuation constant and its wave front gradually flattens out just as if the other waves were absent.

EXAMPLES

Applying the theory outlined above to several cases one obtains the following results: In these examples, the following values of surge impedances were assumed: $Z_1 = 400$ ohms, for the first wave, $Z_2 = 1000$ ohms, for the second wave, $Z_3 = 500$ ohms, for the third wave. (These are typical values obtained for existing high-voltage lines.) When there is only one three-phase circuit having the same construction as one of the above double-circuit lines, Z_1 is the same as for the

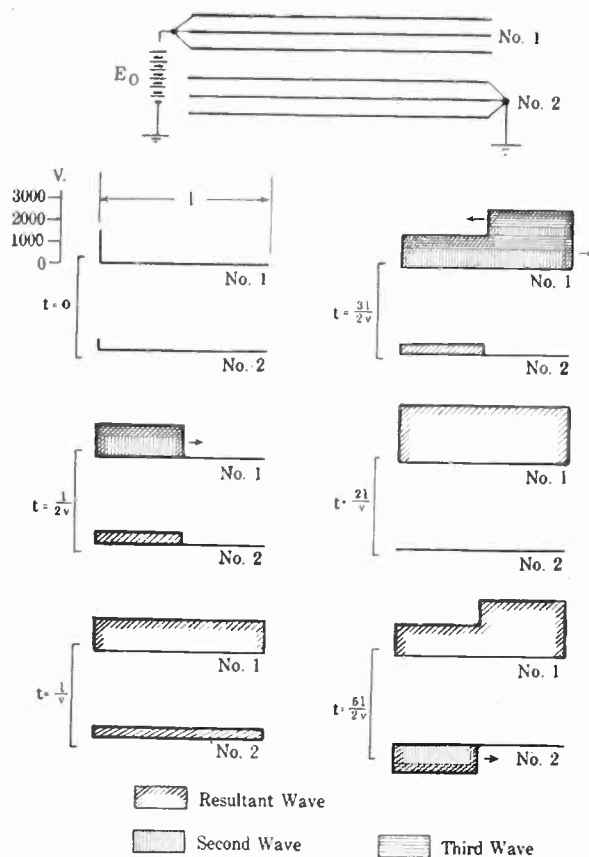

FIG. 2—VOLTAGE WAVES OF EX. 1

double-circuit case, while Z_2 is different and has the typical value $Z_2' = 800$ ohms.

1. When the voltage source is suddenly connected to one of the circuits having the end conditions as shown in Fig. 2.

The propagation and reflection of voltage waves when the source voltage is 1500 volts d-c. are shown in Fig. 2. The calculation of this example is shown in Appendix III.

In this figure, as well as in those that follow, the different kinds of waves are distinguished by different shadings so far as the clearness of the figures allows. As seen in Fig. 2, two kinds of waves are produced and the voltage wave of 1500 volts on No. 1 circuit is accompanied by the corresponding induced wave on

No. 2. When these waves reach the right end, they are reflected. If this end of No. 2 circuit were insulated, or if No. 2 were absent, the maximum voltage in No. 1 would be twice the source voltage, but, affected by the grounding of the right end of the former, the maximum voltage in the latter is 1.8 times. The voltage of 0.85 times the source voltage is induced in No. 2 circuit.

2. When the wave comes from a single circuit. (See Fig. 3.)

Fig. 3 shows how the voltage waves split up and give a disturbance in a parallel circuit when waves of 100 kv. between conductors and ground (second kind of wave), come equally on three conductors of a single circuit. This case might arise from a lightning stroke on No. 1 circuit producing voltage waves that travel to a point where No. 1 parallels with No. 2. If the latter is the low-voltage circuit, the induced voltage may be sufficient to cause a flash over even though the trouble originated in No. 1.

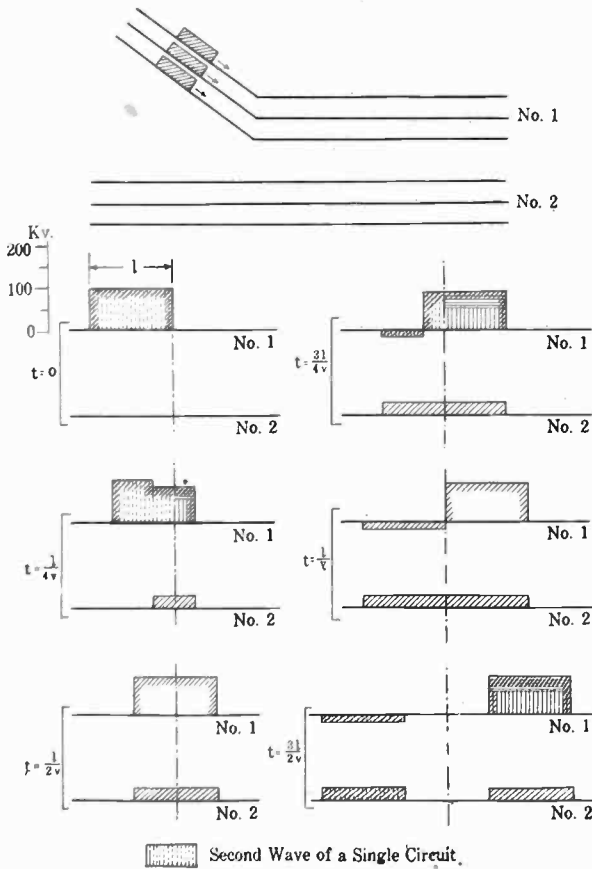

FIG. 3—VOLTAGE WAVES OF EX. 2

3. When one of the conductors is broken and grounded on the way of waves.

The state of reflections and refractions of voltage waves when the incoming wave is of the second kind of 100 kv., is shown in Fig. 4. As shown in Fig. 4, a considerable voltage wave passes the point at which the conductor is broken and grounded due to the inductive effect of the other conductors, and the fault in one of the conductors causes reflections on all of them.

4. When the two circuits are tied together at one end, phases *a* and *a*₁ charged to 100 kv., and phases *b* and *b*₁, *c* and *c*₁ to -50 kv., then the other end of phase *a* is suddenly grounded, as the result of an insulator failure. (The state of oscillation is shown in Fig. 5.)

An oscillation of this type could arise, if, in the double-circuit lines charged by a three-phase alternator through transformers, the distant end of a conductor is

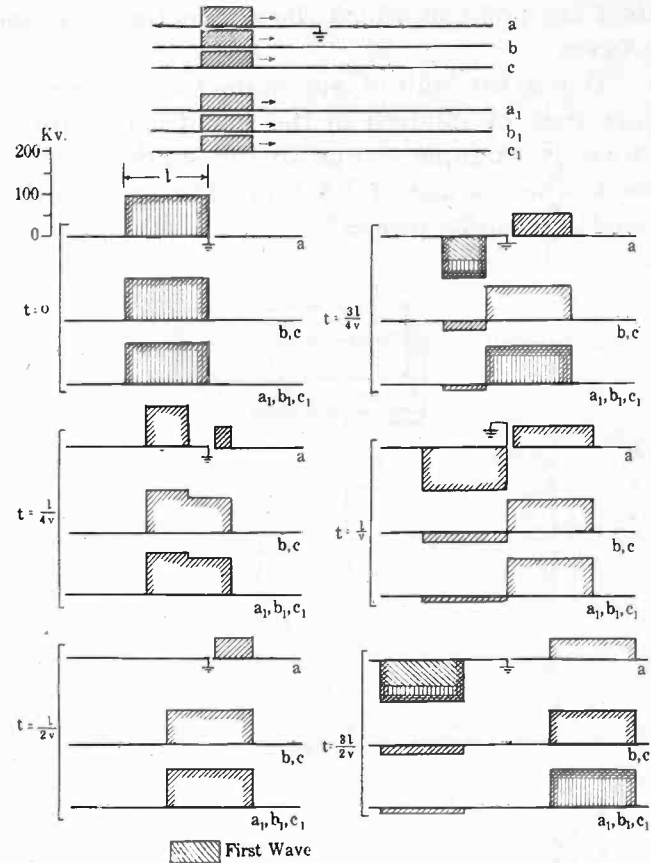

FIG. 4—VOLTAGE WAVES OF EX. 3

grounded at the instant when the voltage of this phase is maximum. The first few oscillations are represented approximately in Fig. 5 provided the length of the line is not large. This is because the impedances of the transformers are large for the high-frequency oscillation so that the phases may be considered approximately insulated from one another for a short time interval. As seen from Fig. 5, the voltage of 1.8 times the initial value is induced in phases *b*, *c*, *b*₁ and *c*₁ due to the sudden ground of phase *a*.

CONCLUSIONS

1. The oscillation in the double-circuit, three-phase transmission line in general consists of three kinds of waves.
2. As the result of the existence of three kinds of waves, there are three kinds of surge impedances.
3. In a single conductor, reflecting waves can be made zero by grounding the end with a resistance equal to the surge impedance of the line. However, when there are three kinds of surge impedances, even if the

six conductors are equally grounded with a certain resistance, the reflection may sometimes be zero, or sometimes otherwise.

4. When the waves meet an irregularity of the line, one kind of wave splits up into three kinds.

5. In a single conductor, if the conductor is grounded or broken on the way of traveling waves, total reflection occurs and the waves cannot propagate beyond that point. But, in three-phase lines, due to the inductive effects of the other wires, the waves do propagate beyond the point at which the conductor is grounded or broken.

6. Due to the fault of one conductor, an appreciable voltage may be induced in the sound conductors; for instance, in example 4, due to the sudden ground of phase *a*, the voltage of 1.8 times the initial value is induced in the other phases.

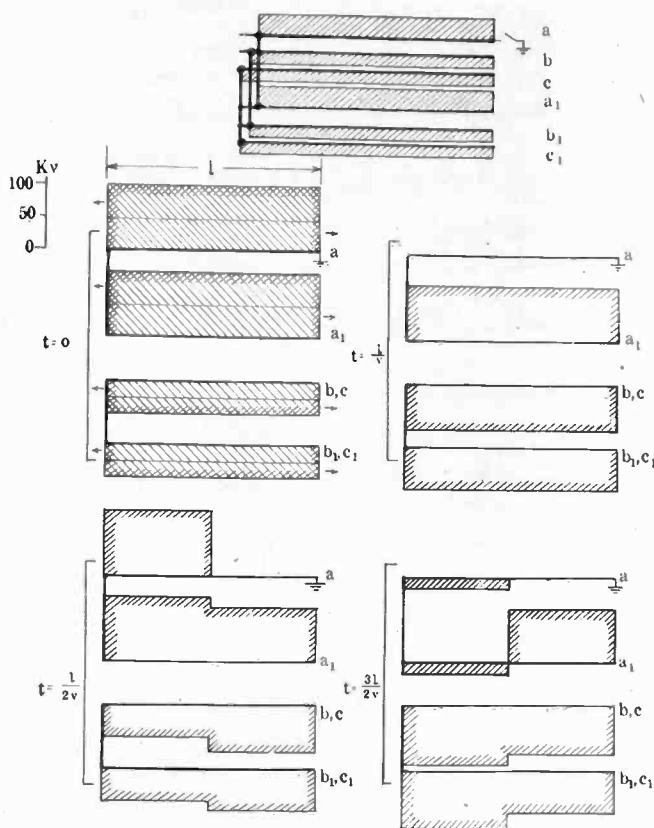

FIG. 5—VOLTAGE WAVES OF EX. 4

7. Inductive interference to neighboring telephone circuits from the transmission lines is caused only by the second kind of wave and can be easily calculated.

The writer wishes to acknowledge the assistance rendered by Dr. F. E. Terman of Stanford University when this paper was prepared.

Appendix I

DERIVATION OF EQUATIONS AND THE METHOD OF SOLUTION

The following assumptions are made:

1. The characteristics of the two circuits are electrically the same.
2. The conductors in each circuit are in the same

position with respect to one another and to the ground, *i. e.*, the transposition of each circuit is complete.

3. The conductors in one circuit are in the same position with respect to the conductors in the other circuit.

All the energy losses shall be neglected. Let L, L_1, L_2, K, K_1 and K_2 have the same meanings as in the main text. Let

- q = electric charge per unit length of a conductor,
- ϕ = magnetic flux interlinkage per unit length of a conductor,
- E = voltage to ground of a conductor,
- I = current of a conductor,
- t = time,
- x = distance along the conductor, (take positive directions of x and I the same.)

Denote the three conductors of one circuit by a, b, c , and those of the other circuit by a_1, b_1, c_1 . Then we have, $\phi_a = L I_a + L_1 I_b + L_1 I_c + L_2 (I_{a_1} + I_{b_1} + I_{c_1})$, and if we neglect the voltage drop in earth,

$$-\partial E_a / \partial x = \partial \phi_a / \partial t,$$

or

$$-\frac{\partial E_a}{\partial x} = L \frac{\partial I_a}{\partial t} + L_1 \frac{\partial I_b}{\partial t} + L_1 \frac{\partial I_c}{\partial t} + L_2 \left(\frac{\partial I_{a_1}}{\partial t} + \frac{\partial I_{b_1}}{\partial t} + \frac{\partial I_{c_1}}{\partial t} \right), \tag{4}$$

and exactly similar equations are obtained for conductors b, c, a_1, b_1, c_1 .

We have further,

$$q_a = K E_a + K_1 E_b + K_1 E_c + K_2 (E_{a_1} + E_{b_1} + E_{c_1}), \tag{5a}$$

and

$$I_a = \frac{\partial}{\partial t} \int q_a dx,$$

or

$$-\frac{\partial I_a}{\partial x} = \frac{\partial q_a}{\partial t},$$

so that,

$$-\frac{\partial I_a}{\partial x} = K \frac{\partial E_a}{\partial t} + K_1 \frac{\partial E_b}{\partial t} + K_1 \frac{\partial E_c}{\partial t} + K_2 \left(\frac{\partial E_{a_1}}{\partial t} + \frac{\partial E_{b_1}}{\partial t} + \frac{\partial E_{c_1}}{\partial t} \right), \tag{5}$$

and exactly similar equations are obtained for conductors, b, c, a_1, b_1, c_1 .

The above equations are the fundamental equations of the electric oscillations in the double-circuit, three-phase transmission line, and since they are twelve simultaneous partial differential equations of the first order and of the first degree having the twelve unknown quantities, $I_a, I_b, I_c, I_{a_1}, I_{b_1}, I_{c_1}, E_a, E_b, E_c, E_{a_1}, E_{b_1}$ and E_{c_1} ,

it is seen that their general solutions are twelve indeterminate functions.

To solve the above equations, let us make the following transformations of the variables:

$$\left. \begin{aligned} I_a &= i_a + i_2 + i_3, & I_{a1} &= i_{a1} + i_2 - i_3, \\ I_b &= i_b + i_2 + i_3, & I_{b1} &= i_{b1} + i_2 - i_3, \\ I_c &= i_c + i_2 + i_3, & I_{c1} &= i_{c1} + i_2 - i_3, \\ i_a + i_b + i_c &= 0, & i_{a1} + i_{b1} + i_{c1} &= 0. \end{aligned} \right\} \quad (6)$$

$$\left. \begin{aligned} E_a &= e_a + e_2 + e_3, & E_{a1} &= e_{a1} + e_2 - e_3, \\ E_b &= e_b + e_2 + e_3, & E_{b1} &= e_{b1} + e_2 - e_3, \\ E_c &= e_c + e_2 + e_3, & E_{c1} &= e_{c1} + e_2 - e_3, \\ e_a + e_b + e_c &= 0, & e_{a1} + e_{b1} + e_{c1} &= 0. \end{aligned} \right\} \quad (8)$$

Though the right-hand sides of the equations (6) and (8) contain 16 variables, since there are 4 relations of (7) and (9) among them, they are essentially 12 independent variables. If these component currents and voltages are known, the currents and voltages of the six conductors are obtained by combining them according to equations (6) and (8). Hence, we shall now obtain these components.

Substitute (6) and (8) into the fundamental equations (4) and (5). By adding all the six equations of (4) and dividing by (6), we get,

$$-\partial e_2 / \partial x = (L + 2L_1 + 3L_2) \cdot \partial i_2 / \partial t, \quad (10)$$

treating (5) the same as above,

$$-\partial i_2 / \partial x = (K + 2K_1 + 3K_2) \cdot \partial e_2 / \partial t. \quad (10a)$$

By adding the three equations of a, b, c of (4) and subtracting from it the three equations of a_1, b_1, c_1 , and dividing by 6, we get

$$-\partial e_2 / \partial x = (L + 2L_1 - 3L_2) \cdot \partial i_3 / \partial t, \quad (11)$$

treating (5) the same as above,

$$-\partial i_3 / \partial x = (K + 2K_1 - 3K_2) \cdot \partial e_3 / \partial t. \quad (11a)$$

By subtracting (10) and (11) from the first equation of (4),

$$-\partial e_a / \partial x = (L - L_1) \cdot \partial i_a / \partial t, \quad (12)$$

by subtracting (10a) and (11a) from the first equation of (5),

$$-\partial i_a / \partial x = (K - K_1) \cdot \partial e_a / \partial t. \quad (12a)$$

Exactly the same equations as (12) and (12a) are obtained for $e_b, i_b, \dots, e_{c1}, i_{c1}$.

Equations (10), (11), (12), (10a), (11a), and (12a) have the following forms:

$$-\partial e / \partial x = L \cdot \partial i / \partial t, \quad (13)$$

$$-\partial i / \partial x = K \cdot \partial e / \partial t. \quad (13a)$$

They are essentially the equations of oscillations in a single conductor having a self inductance per unit length L and a capacitance per unit length K , the solutions of which are, as well known, two traveling waves propagating in the opposite directions and can be expressed as follows:

$$i = F(x - vt) + G(x + vt), \quad (14)$$

$$e = Z \cdot F(x - vt) - Z \cdot G(x + vt), \quad (14^1)$$

$$v = 1/\sqrt{LK} = \text{propagation velocity}, \quad (15)$$

$$Z = \sqrt{L/K} = \text{surge impedance}. \quad (16)$$

$F(x - vt)$ is a wave traveling in the positive direction of x , and $G(x + vt)$ in the negative direction of x . The forms of functions F and G can be determined from the boundary conditions.

If we apply the above results to equations (10), (12)¹, we get at once the solutions of component currents and voltages:

$$i_2 = F_2(x - v_2t) + G_2(x + v_2t), \quad (17)$$

$$e_2 = Z_2[F_2(x - v_2t) - G_2(x + v_2t)], \quad (17)^1$$

$$i_3 = F_3(x - v_3t) + G_3(x + v_3t), \quad (18)$$

$$e_3 = Z_3[F_3(x - v_3t) - G_3(x + v_3t)], \quad (18)^1$$

$$\left. \begin{aligned} i_a &= F_a(x - v_1t) + G_a(x + v_1t), \\ i_b &= F_b(x - v_1t) + G_b(x + v_1t), \\ &\dots \dots \dots \end{aligned} \right\} \quad (19)$$

$$\left. \begin{aligned} e_a &= Z_1[F_a(x - v_1t) - G_a(x + v_1t)], \\ e_b &= Z_1[F_b(x - v_1t) - G_b(x + v_1t)], \\ &\dots \dots \dots \end{aligned} \right\} \quad (19)^1$$

in which $Z_1, v_1, Z_2, v_2, Z_3, v_3$ are as expressed by (1), (1)¹, (2), (2)¹, (3) and (3)¹, and

$$\left. \begin{aligned} F_a + F_b + F_c &\equiv 0, & G_a + G_b + G_c &\equiv 0, \\ F_{a1} + F_{b1} + F_{c1} &\equiv 0, & G_{a1} + G_{b1} + G_{c1} &\equiv 0. \end{aligned} \right\} \quad (20)$$

By combining the above results according to equations (6) and (8), we get the general solutions of the oscillation: (omitting $(x - vt)$ and $(x + vt)$),

$$\left. \begin{aligned} I_a &= (F_a + G_a) + (F_2 + G_2) + (F_3 + G_3), \\ I_b &= (F_b + G_b) + (F_2 + G_2) + (F_3 + G_3), \\ I_c &= (F_c + G_c) + (F_2 + G_2) + (F_3 + G_3), \end{aligned} \right\} \quad (21)$$

$$\left. \begin{aligned} I_{a1} &= (F_{a1} + G_{a1}) + (F_2 + G_2) - (F_3 + G_3), \\ I_{b1} &= (F_{b1} + G_{b1}) + (F_2 + G_2) - (F_3 + G_3), \\ I_{c1} &= (F_{c1} + G_{c1}) + (F_2 + G_2) - (F_3 + G_3), \end{aligned} \right\} \quad (22)$$

$$\left. \begin{aligned} E_a &= Z_1(F_a - G_a) + Z_2(F_2 - G_2) + Z_3(F_3 - G_3), \\ E_b &= Z_1(F_b - G_b) + Z_2(F_2 - G_2) + Z_3(F_3 - G_3), \\ E_c &= Z_1(F_c - G_c) + Z_2(F_2 - G_2) + Z_3(F_3 - G_3), \end{aligned} \right\} \quad (21a)$$

$$\left. \begin{aligned} E_{a1} &= Z_1(F_{a1} - G_{a1}) + Z_2(F_2 - G_2) - Z_3(F_3 - G_3), \\ E_{b1} &= Z_1(F_{b1} - G_{b1}) + Z_2(F_2 - G_2) - Z_3(F_3 - G_3), \\ E_{c1} &= Z_1(F_{c1} - G_{c1}) + Z_2(F_2 - G_2) - Z_3(F_3 - G_3). \end{aligned} \right\} \quad (22a)$$

All F waves travel in the positive direction of x and all G waves in the negative direction of x . By comparing the above equations with the description in the main text, it is seen that the first two terms of the above equations represent the first kind of wave, the second two terms the second kind of wave and the third two terms the third kind of wave. The equations when the losses are considered can be treated in the same way and resolved into three sub-equations as above.

The forms of functions F 's and G 's are determined from the initial conditions. Let the distributions of currents and voltages on the six conductors at the instant at which the oscillation begins (when $t = 0$) be $J_a(x), J_b(x), \dots, J_{c1}(x)$ and $V_a(x), V_b(x), \dots, V_{c1}(x)$. Then we have,

$$J_a(x) = (F_a + G_a) + (F_2 + G_2) + (F_3 + G_3),$$

$$V_a(x) = Z_1(F_a - G_a) + Z_2(F_2 - G_2) + Z_3(F_3 - G_3),$$

from which

$$F_a = (1/6) (2 J_a - J - J_o) + (1/6 Z_1) (2 V_a - V_b - V_c),$$

$$G_a = (1/6) (2 J_a - J_b - J_o) - (1/6 Z_1) (2 V_a - V_b - V_c),$$

and all other functions F and G can be obtained in similar forms. If we put $x - vt$ instead of x in all the F functions and $x + vt$ instead of x in all the G functions and combine them according to (21), (22a), we get the equations of oscillation.

Appendix II

CALCULATION OF LINE CONSTANTS

Assuming that the earth is a perfect conductor, the current in the earth is confined to its surface and the

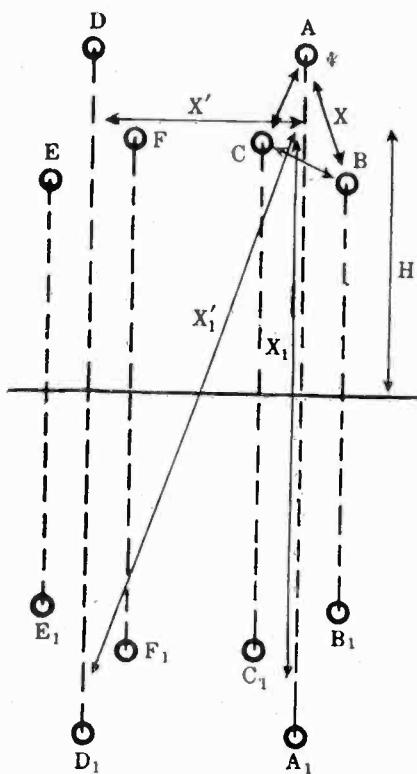

FIG. 6—DIMENSIONS OF LINES

principle of electric image holds. Let the configuration of the lines be as in Fig. 6.

(In Fig. 6,

$$H = (1/2) \sqrt{A A_1 \cdot B B_1 \cdot C C_1}.$$

$$X = \sqrt{A B \cdot B C \cdot C A}.$$

$$X_1 = \sqrt{A B_1 \cdot B C_1 \cdot C A_1}.$$

$$X' = \sqrt{(A F)^2 \cdot (B F)^2 \cdot (B D)^2 \cdot A D \cdot B E \cdot C F}.$$

$$X_1' = \sqrt{(A F_1)^2 \cdot (B F_1)^2 \cdot (B D_1)^2 \cdot A D_1 \cdot B E_1 \cdot C F_1}.$$

r = radius of conductor.)

Then we get,

$$L = ((1/2) + 2 \cdot \log \cdot (2H/r)) \times 10^{-9} \text{ henry per cm. (23)}$$

$$L_1 = 2 \cdot \log \cdot (X_1/X) \times 10^{-9} \text{ henry per cm. (24)}$$

$$L_2 = 2 \cdot \log \cdot (X_1'/X') \times 10^{-9} \text{ henry per cm. (25)}$$

Let

P = coefficient of potential per unit length of a conductor,

P_1 = coefficient of potential per unit length between conductors of the same circuit,

P_2 = coefficient of potential per unit length between conductors of the different circuits,

then we have, from the ordinary electrostatics,

$$\left. \begin{aligned} E_a &= P \cdot q_a + P_1 \cdot q_b + P_1 \cdot q_c + P_2(q_{a1} + q_{b1} + q_{c1}), \\ E_b &= P_1 \cdot q_a + P \cdot q_b + P_1 \cdot q_c + P_2(q_{a1} + q_{b1} + q_{c1}), \end{aligned} \right\} (26)$$

where

$$P = 2 \cdot \log \cdot (2H/r) \times 9 \times 10^{11} \text{ daraf per cm. (27)}$$

$$P_1 = 2 \cdot \log \cdot (X_1/X) \times 9 \times 10^{11} \text{ daraf per cm. (28)}$$

$$P_2 = 2 \cdot \log \cdot (X_1'/X') \times 9 \times 10^{11} \text{ daraf per cm. (29)}$$

Equations (26) can be rearranged as follows:

$$\left. \begin{aligned} q_a &= K \cdot E_a + K_1 E_b + K_1 E_c \\ &\quad + K_2(E_{a1} + E_{b1} + E_{c1}), \\ q_b &= K_1 \cdot E_a + K \cdot E_b + K_1 \cdot E_c \\ &\quad + K_2(E_{a1} + E_{b1} + E_{c1}), \end{aligned} \right\} (30)$$

(see (5a) of Appendix I),

in which

$$K = \frac{(P + 2 P_1) (P + P_1) - 6 P_2^2}{(P - P_1) (P + 2 P_1 + 3 P_2) (P + 2 P_1 - 3 P_2)}, (31)$$

$$K_1 = - \frac{(P + 2 P_1) P_1 - 3 P_2^2}{(P - P_1) (P + 2 P_1 + 3 P_2) (P + 2 P_1 - 3 P_2)}, (32)$$

$$K_2 = - \frac{P_2}{(P + 2 P_1 + 3 P_2) (P + 2 P_1 - 3 P_2)}, (33)$$

which are the required coefficients of capacity and induction. It is also seen that,

$$K - K_1 = 1/(P - P_1), \dots (34)$$

$$K + 2 K_1 + 3 K_2 = 1/(P + 2 P_1 + 3 P_2), \dots (35)$$

$$K + 2 K_1 - 3 K_2 = 1/(P + 2 P_1 - 3 P_2), \dots (36)$$

From these results, the surge impedances and propagation velocities can be calculated. In this case, if we neglect the effect of magnetic flux inside the conductor, (if we drop 1/2 in the expression of L), we get $P/L = P_1/L_1 = P_2/L_2 = 9 \times 10^{20}$, so that $v_1 = v_2 = v_3 = 3 \times 10^{10}$ cm. per sec.

Appendix III

CALCULATION OF EX. 1.

From the symmetry of the line, we see that the first kind of wave is zero, and all G waves are zero since, at first, only outgoing waves are present. Put E_o = voltage of the source, $E_a = E_b = E_c = E$, $E_{a1} = E_{b1} = E_{c1} = E_1$, $I_a = I_b = I_c = I$, $I_{a1} = I_{b1} = I_{c1} = I_1$, then, $E = Z_2 F_2 + Z_3 F_3$, $E_1 = Z_2 F_2 - Z_3 F_3$, $I = F_2 + F_3$, $I_1 = F_2 - F_3$, (see (21), (22), (21a), (22a) and at $x=0$, $E=E_o$, $I_1=0$, whence, $F_2=F_3=E_o/(Z_2+Z_3)$, and thus the outgoing waves are obtained.

When these waves reach the right end, the reflection occurs. Let G_2 and G_3 be reflected waves. Then

$$E = Z_2 (F_2 - G_2) + Z_3 (F_3 - G_3),$$

$$E_1 = Z_2 (F_2 - G_2) - Z_3 (F_3 - G_3),$$

$$I = (F_3 + G_2) + (F_3 + G_3),$$

$$I_1 = (F_2 + G_2) - (F_3 + G_3),$$

and at the right end

$$E_1 = 0, I = 0,$$

from which,

$$G_2 = F_2 (Z_2 - Z_3) / (Z_2 + Z_3) - F_3 \cdot 2 Z_3 / (Z_2 + Z_3),$$

$$G_3 = -F_2 \cdot 2 Z_2 / (Z_2 + Z_3) - F_3 \cdot (Z_2 - Z_3) / (Z_2 + Z_3).$$

When the G waves reach the left end, they are reflected. The left end of No. 1 acts as a grounded end, hence the reflection is the same as at the right end except No. 1 and No. 2 are interchanged. The oscillation at any instant can be found by superposing all these outgoing and reflected waves.

Discussion

H. G. Brinton: The paper by Mr. Satoh is rather mathematical and has been somewhat difficult to understand. It is based on a previous paper presented in Japan by Dr. Bekku, and perhaps Mr. Satoh assumes that the reader will look up the previous paper and so gives very little explanation himself. The writer has found it possible to understand the paper by first making an analysis from a physical standpoint and then checking Mr. Satoh's equations. As we have no other literature on this phase of the subject it appears desirable to give here a discussion of waves on several parallel wires.

The case to be discussed is that of two parallel three-phase lines. The three wave currents in the three wires of one line are I_a, I_b and I_c . The three wave currents in the three wires of the other line are I_a', I_b' and I_c' . The corresponding potentials of wires to earth are E_a , etc. Thus we have in general six traveling waves of different potential and current on six parallel wires. If we have only one wave on an isolated wire we would calculate the current and energy from the values of voltage and surge impedance, and we would calculate the changes in voltage due to reflection, etc. at points where the circuit constants changed. In the case of several waves on several adjacent wires, the problem is complicated by the magnetic and electrostatic interactions between the various waves. If we have six waves of different potential to consider, then there are six different surge impedances, or ratios of potential to current, to determine; and the surge impedance for each wave is affected by each of the different currents in the five other wires. Thus we have quite a complicated set of interactions and it is necessary to find a method evaluating them.

We shall first explain how it is possible to consider these six currents as the resultants of certain components and thus simplify the problem because of the simpler relations between these theoretical components. Consider first the three wave currents I_a , etc., in the three wires of one three-phase line. If we add these currents, taking account of direction, and then divide by three, we shall have the average value of current in these three wires. The actual current in each wire differs from the average. We shall call these differences I_1, I_2 and I_3 . We know that the sum of these differences from the average value must be zero, because otherwise there would be an average difference from an average value which is impossible. Thus we see that the three unequal actual currents are composed of three equal components each having the average value and three unequal components whose sum is zero. In the same way we see

that the three unequal currents in the other line are composed of similar components. We can now take the average of the three equal currents of one line plus the three equal currents of the other line. Let this value be called I . This value must be greater than the average value of one line by a certain amount, and less than the average value of the other line by the same amount which we shall call I' . Then the value of the three equal components in one line is $I + I'$ and the value of the three equal components in the other line is $I - I'$. Thus we have reduced the six unequal wave currents in the six wires to the following components. In the three wires of each line there are three unequal components whose sum is zero. In the six wires there are six equal components called I flowing in the same direction. In the three wires of one line there are three equal components called I' flowing in one direction; and in the three wires of the other line there are three equal components $-I'$ flowing in the opposite direction to I' in the first line. A further simplification is obtained by considering the three unequal currents of each line whose sum is zero as equivalent to two equal and opposite currents. For example, if we wish to consider the surge impedance Z_1 of the wire in which I_1 is flowing, we can consider the two currents I_2 and I_3 as equivalent to a current $-I_1$ flowing in the opposite direction to I_1 .

Then in considering the various components we have only equal currents to consider. When considering equal currents there is only one value of surge impedance to calculate. Thus we have reduced the problem to three sets of components and three surge impedances to be determined.

Before discussing these components further, it is well to state briefly the known relationships in the case of a single wire. In that case, if the wave potential at a given point is known, the wave current is found by dividing the potential by Z_1 the surge impedance. Z is calculated from the formula

$$Z = \sqrt{\frac{L}{C}} \text{ but } v = \frac{1}{\sqrt{LC}} = \text{velocity of light}$$

$$\therefore Z = \frac{1}{cv} \quad L = \frac{1}{Cv^2}$$

C is the capacitance to earth of a unit length of the wire and is twice the capacitance from the wire to its image.

If there is another wave of equal voltage and current on a second wire; then the capacitance of the first wire to earth is reduced or increased by the presence of the charge on the second wire, being reduced by a charge of the same sign and increased by a charge of the opposite sign. The capacitance will then be C instead of C per unit length. The inductance of the first wire is also affected by the current in the second wire, but if the waves travel with the velocity of light the product of capacitance and inductance remains constant and it is only necessary to calculate the capacitance as in the simple case of one wire. In the case of two wires the capacitance is then αC and the

inductance is $\frac{1}{\alpha C v^2}$ and the surge impedance is

$$Z_1 = \frac{1}{\alpha C v}$$

This is the formula for surge impedance in the case of the component current I_1 and its opposite $-I_1$ in the first line, and also in the case of I_1' and $-I_1'$ in the second line. If we assume, as Mr. Satoh does, that the two equal but opposite currents of one line would have zero resultant affect on the other line, then this formula for Z_1 holds true when these particular current components are flowing in the two lines at the same time. The voltage components corresponding to these current components are

$$E_1 = I_1 Z_1 \quad E_1' = I_1' Z_1$$

$$E_2 = I_2 Z_1 \quad E_2' = I_2' Z_1$$

$$E_2 = I_2 Z_2 \quad E_1' = I_1' Z_1'$$

There is only one value of surge impedance for these components because the three wires of each line are assumed to be under the same influences. These assumptions do not correspond exactly to any conditions existing in practise, but they are satisfactory for the purpose of aiding us to obtain a fair general conception of the wave relationships.

We may next consider the current and voltage components in the case of the six equal components in the same direction in the six wires. In this case the capacitance of each wire to earth is reduced. If we assume, as Mr. Satoh does, that each wave is equally affected by the other five, then the capacitance of each wire is reduced by the same factor which we may designate as B . Then in the same way as above we see that the surge impedance of each wire is

$$Z_2 = \frac{1}{B C v}$$

We then have for each wire

$$E = Z_2 I$$

The third set of components to be considered are those consisting of three equal currents I in one direction in the three wires of one circuit and three equal currents $-I$ in the opposite direction in the other circuit. In this case the capacitance to earth of one wire is γC instead of C . Assuming each of the six wires is under the same influences, this value C applies to each wire. The corresponding value of surge impedance is

$$Z_1' = \frac{1}{\gamma C v}$$

In the above we have started with six waves of given current. In the same way we can start with six waves of given voltage and then calculate the wave currents after determining the surge impedances. For example, we would first find the average value E for the six waves. The average value for one circuit would be $E + E'$ and for the other circuit $E - E'$. The differences E_1 and E_1' could then be determined, knowing the total voltages E_a and E_a' . After determining the various surge impedances $Z_1 Z$ and Z_1' , the current components could be calculated and the total current in any wire would then be the sum of the components in that wire.

In order to determine the various surge impedances, it is necessary to calculate C and the factors α , β and γ which depend upon the amount that the capacitances are affected by the presence of the other charges. There are several ways of doing this. One way is to work with unit quantities and determine how much the potential at one wire is affected by the presence of the charges on the other wires. For example, in the case of Z_1 we have to consider two wires oppositely charged. The effect of the unit charge of one wire is to make it have the potential,

$$4.6 \log \frac{2h}{r}$$

where h is the elevation of the wire and r is its radius. The opposite charge on the second wire decreases the potential of the first wire by the amount,

$$4.6 \log \frac{r_2}{r_1}$$

where r_1 is the distance to the second wire and r_2 is the distance to its image. Therefore the potential of the first wire is decreased by the factor

$$\frac{\log \frac{2h}{r} - \log \frac{r_2}{r_1}}{\log \frac{2h}{r}}$$

Since in the case of unit given charge the voltage is inversely proportional to the capacity we can say that the capacity of the wire is increased by the factor

$$\alpha = \frac{\log \frac{2h}{r}}{\log \frac{2h}{r} - \log \frac{r_2}{r_1}}$$

The factor β is determined in the same way, remembering that the charges are all of the same sign in this case and that there are six charges to be considered. Mr. Satoh uses an average value for the distance of the three wires of one circuit to one wire of the other circuit. Calling this distance r_1' and the distance to its image r_2' we see that the factor is

$$\beta = \frac{\log \frac{2h}{r}}{\log \frac{2h}{r} + 2 \log \frac{r_2}{r_1} + 3 \log \frac{r_2'}{r_1'}}$$

The factor γ is calculated in the same way. Remembering that in this case the three charges of one circuit are opposite in sign to those of the other circuit, we see that

$$\gamma = \frac{\log \frac{2h}{r}}{\log \frac{2h}{r} + 2 \log \frac{r_2}{r_1} - 3 \log \frac{r_2'}{r_1'}}$$

Mr. Satoh does not use the above factors because he adds to or subtracts something from C to take account of the effect of the other charges instead of multiplying C by a factor. We have used the factor method for the sake of simplicity.

Mr. Satoh gives some interesting diagrams showing rectangular waves on parallel wires and the effect of certain changes in circuit constants. He gives the calculations for the case of three equal waves on three wires of one circuit due to an impressed d-c. voltage and three equal but smaller voltage waves on three wires of a parallel circuit due to induction from the first circuit. However, he apparently omits the calculation of the values of the induced wave which are the really important unknowns; and in the diagram the induced charges in the second circuit are incorrectly shown as having the same sign as the charges in the first circuit. These specific cases will require some further study and it therefore seems best to consider them separately. One point of interest to us is the fact that when waves of about equal voltage arrive at a station on the three wires of a circuit, which perhaps is the usual occurrence, the surge impedance is greater by a considerable percentage than in the case of a single wire, and so the wave current and energy is correspondingly less.

Electric power is entering more deeply into the steel industry every month. Steam power is now being entirely replaced in the main plant of the Youngstown Sheet and Tube Co. at a cost of about \$6,000,000. The boiler plants whose clouds of smoke have hung over the mill region every working day for years together with the blast furnace and large Bessemer steam power houses will be scrapped and replaced. For 20 years electricity has been advancing into steam's stronghold—the steel industry—and today some of the most powerful motors in the world are used there. Motor ratings of 7000 horse power are now familiar in some mills.

Equipment for 220-Kv. Systems

BY J. P. JOLLYMAN¹

Member, A. I. E. E.

Synopsis.—This paper discusses the characteristics of equipment which have been found most suitable for use on 220-kv. systems or on extensive lower voltage systems. Consideration is given to general system design, governors of prime movers, generators, excitation the systems, transformers, high-voltage oil circuit

breakers, transmission line and the equipment of substations. The result of four years' operation of a 220-kv. system have proven it to be as reliable as a 110-kv. system. The economies of 220-kv. transmission have been realized.

* * * * *

EXPERIENCE gained from the operation of a pioneer project confirms the wisdom of the original choice of equipment or shows where improvements can be made. This paper will discuss briefly the characteristics of equipment found most suitable for a 220-kv. system in the light of four years of operation. While the statements apply particularly to 220-kv. 60-cycle systems with long lines, they also apply to lower voltage systems if due allowance is made for the differences in magnitude.

The 220-kv. transmission systems are required for three principal purposes: (1) for long distances and considerable power; (2) for short distances with large amounts of power; and (3) as a part of an ultimate network. The requirements of equipment for the three types of systems are essentially the same. The systems having long transmission lines are the most difficult to operate on account of the very large charging kv-a.'s that must be supplied. The system with large power but with short transmission is less difficult to operate but imposes very severe duty on the oil circuit breakers.

GENERAL SYSTEM DESIGN

When planning a transmission system for 220-kv. operation, the entire system with its connected equipment must be considered as a whole or as a part of the whole of the ultimate system. The sections of transmission circuits which must be handled as a unit have to be determined, since the kv-a. required to bring these sections of transmission to normal voltage decides the size of generating units and of synchronous condenser units.

Experience has very definitely established the necessity for operating 220-kv. transmissions as well as lower-voltage transmissions containing a considerable amount of transmission mileage with the transformer neutrals solidly grounded not only at the generating stations but also at all substations. All transformer banks should be equipped with delta-connected windings for the purpose of stabilizing the relation between the separate phases as well as improving relay operation. In the case of transformers at generating stations, the delta winding becomes the low-voltage winding of the transformer bank. In the case of

transformers at substations, the delta windings can frequently be used to supply the necessary synchronous condensers.

Due consideration must be given to the supply of charging current, and this supply must take into account the fact that the generators, when carrying load, must operate at a high power factor if stability is to be maintained. These requirements will generally make it necessary to operate a high-voltage transmission with a drop in voltage in the direction of the flow of power. The effect of this operation will be to necessitate supply of charging current from the receiving end of the line, leaving the generators free to operate at a high power factor.

Under heavy loads, it is possible to supply sufficient boost at the receiving end of the transmission section to bring its voltage to an equality with the sending end of the same section without causing a leading current in the generators at the sending end. In very extensive networks where the flow of power may be reversed, operation at the same voltage at all points may become necessary.

Should this be essential, definite provision for a supply of charging current at some of the generating stations will have to be made.

Some flashovers of line insulators seem inevitable. Interference from external sources cannot always be avoided, nor has any insulation yet been found which will withstand the effects of all kinds of lightning. When a failure does occur, the section of line involved in the failure must be disconnected from the system with the least possible delay. While the arc resulting from a flashover may be extinguished by dropping the system voltage, this operation will nearly always result in the loss of synchronism between the generating stations and the load. It therefore seems better to cut out the section of line on which trouble has occurred.

Experience shows that this can be done in the majority of cases without loss of load, provided the sections of line remaining in service have sufficient capacity to carry the total load. To disconnect a section of line on which trouble has occurred requires the use of automatic relays. Excellent satisfaction has been experienced with the use of directional overload and directional residual relays. It is possible to connect the directional residual relays to the system in such a manner as to secure inverse time operation. With

1. Pacific Gas & Electric Co., San Francisco, Calif.

To be presented at the Pacific Coast Convention of the A. I. E. E., Del Monte, Calif., September 13-16, 1927.

such a system of connections, it has been found possible to relay out one of two parallel lines even though the trouble was within one per cent of the total distance from one end of the section. To attain this result from the balanced system of relays is extremely difficult, if not impossible.

GENERATING STATIONS

The prime movers of generators employed on high-voltage systems will usually be steam turbines or waterwheels of the reaction or impulse type. The only special requirement of prime movers for such systems is that their governors should hold the speed very close to normal without hunting at no-load. This requirement must be met if quick operating is to be attained.

In the case of certain types of hydroelectric plants where pulsations in penstock pressures tend to cause the waterwheels to hunt when running at no-load, this is not an easy requirement to meet. The use of a load limiting device on the governors which will permit a convenient adjustment of the output of the prime movers has been found very useful. Especially in hydroelectric plants it is frequently desirable to limit the output of many of the units and permit only a few units to govern. The load limit device permits of such operation in the most advantageous manner.

The generating units may be called upon to build up the voltage on transmission line sections for the purpose of tests or for the purpose of bringing up a section to put it in service. In either event the generator must be first connected to the line with little or no field current. The fact that no terminal voltage, or a very low terminal voltage, would exist on the generator prior to the time the line is brought to full voltage prohibits the use of electric drive governors. The later types of mechanical drive for governors have proved so satisfactory that there seems little reason to desire the electric form of drive.

From the standpoint of the function which they must serve in connection with the operation of this system, generating units connected to high-voltage systems fall in two classes: (1) Those units which must be of sufficient capacity to handle designated sections of the transmission lines; (such units will generally be of fairly large size); and (2) smaller units having insufficient capacity to handle any part of the high-voltage system whose function is merely to feed in a certain amount of power but which must be cleared from the system in case of trouble or in case of line test.

The larger or control units should have fairly high short circuit ratios so that they may have good stability during system disturbances and be able to carry charging kv-a. at least equal to rated capacity without exceeding rated terminal voltage. Such generators should also stand occasional overvoltages of the order of 50 per cent since switching operations may occur at any time which will result in high over-voltage.

A smaller generator should have a sufficiently high short-circuit ratio for stable operation and should have

the ability to operate with considerable overvoltage at least for brief periods.

EXCITATION SYSTEMS

Excitation systems for generators supplying high-voltage lines must be automatic as to their voltage control and must operate with the highest practicable speed, especially in a case where direct-connected exciters are used. If this is not done, the generator voltage will vary far too much with the changes in power factor resultant from the changes that occur, especially in case of line trouble. The automatic voltage regulators should be direct-connected to the generators and not to the station bus. The generators are thus protected from protracted overvoltage in the event of their being tripped off the bus.

The use of direct-connected exciters, which is desirable from nearly every standpoint, presents an additional problem because of their being affected by generator speed. Hence, on such an increase of generator speed as will be occasioned by sudden loss of load, the terminal voltage of the generator tends to increase with the square of the increase of speed. To avoid this compounding effect, the automatic control of the excitation system must have a very quick response.

Sudden loss of full load, with large hydroelectric units driven by reaction turbines, results in a speed increase of the order of 30 per cent. In the case of impulse wheels, this speed increase can be reduced somewhat provided governor action in less than two sec. is permissible. With excitation systems having fairly high speed response, it has been found possible to hold the generator terminal voltage to a rise which is not greater than the per cent rise in speed.

In order that each main generating unit may be as independent as possible, the use of direct-connected exciters, with a voltage regulator for each unit, has been found very satisfactory.

TRANSFORMERS

Modern high-voltage transformers have given very good service in high-voltage systems. The reactance of these transformers should be kept as low as can be reasonably obtained. If this is not done, the transformers will contribute to bad voltage regulation of the system especially when lines are being tested or sections of lines placed in service.

The short-circuit current through transformers connected to long distance hydroelectric systems tends to be limited by the generating capacity or the line impedance rather than by transformer impedance. It does not seem necessary to introduce any additional reactance in the transformers for such systems to protect them from damage from short circuits.

In the case of transformers fed from large steam turbine generating units, great care must be exercised to provide for their safety under a short circuit on account of the higher momentary short-circuit currents of steam turbine units as compared with water-wheel

units. Like the generators, the transformers must stand considerable overvoltage. However, as transformers designed for an induced potential test of 2.73 times normal voltage have given perfect results on solidly grounded neutral systems, it does not appear necessary that for such systems they should be designed to stand a higher test voltage.

For generating station transformers with low voltages of 11 kv. or 13 kv., the core-type transformer has much to commend it from the standpoint of the simple form of major insulation. For auto-transformers or for transformers having high low-tension voltages the shell type of design permits of a better control of the characteristics of the transformers.

HIGH-VOLTAGE OIL CIRCUIT BREAKERS

To lessen the effects of short circuit or grounds on high-voltage system and to reduce the amount of energy which must be dissipated within a high-voltage oil circuit breaker, such circuit breakers should operate with very high speed. The total time of operation for an opening stroke should be well under one-half second. Any longer time than this may result in serious effects in the transmission network.

Admittedly, this requirement is a difficult one to meet. However, it is agreed that the problem of attaining still higher operating speeds in large circuit breakers is one of the most important confronting the transmission industry. In times of peace, some of the mechanical skill which has been applied to the design of instruments of warfare could very profitably be devoted to the refinement of the mechanical design of oil circuit breakers.

An incidental requirement for the satisfactory operation of an oil circuit breaker is that it must be mechanically trip free. This trip-free function must be so arranged that a minimum time is consumed between the instant that a short circuit is encountered and the instant that the circuit breaker will be opened.

With the establishment of 220-kv. systems with considerable lengths of line, leading currents of some magnitude are made available and it has been found that the rupture of such currents creates lengths of arcs within oil circuit breakers very much greater per ampere of leading current than per ampere of short-circuit current of a lagging power factor. In fact, the length of arc drawn within oil circuit breakers is of the same order of magnitude for the charging current of a 200-mi. section of 220-kv. line as for a short circuit close to the oil circuit breaker.

TRANSMISSION LINE

The transmission line as a mechanical structure has given excellent service. Reasonable factors of safety were employed on the structures, the design of which is subjected to test to destruction. Low stringing tensions were employed for the conductors, primarily for economy in cost of the towers. No trouble has been encountered from conductor vibration. It is felt that

the low stringing tensions contribute to this desirable result.

No difficulty or evidence of undue depreciation has been encountered in the insulators used. The mechanical loads imposed on the insulators are rather moderate. With a material of the character of porcelain, it seems wise to proceed with caution in regard to the loading imposed. While high strengths have been developed for test load conditions in comparatively small porcelain suspension insulators, it is felt that the best way to employ this strength is to increase the factor of safety rather than to increase the initial load on such units.

In the case of the system with which the writer is familiar, accumulated evidence appears to point very directly toward the benefits to be derived from the use of an amount of line insulation which gives high flash-over values. In the case of 110-kv. lines it is definitely known that even a comparatively small increase in the length of insulator strings secures a marked reduction in the number of the cases of flashovers experienced. There seems no reason to doubt that the same will be true in higher-voltage systems. This statement is made for a territory where lightning is a comparatively minor factor. In territory where lightning is a frequent source of trouble, caution should be used to see that the flashover value of the line insulation is not so high as to cause failures in the insulation of switches of transformers. However, if there is any question of the ability of the apparatus to stand the flashover voltages developed by the line insulation, it would be better to increase the breakdown values of the apparatus insulation rather than to decrease the flashover values of the line insulation.

One of the most trying problems, and one concerning which there is no certain solution in sight, is the question of maintaining sufficient insulation in sections where conditions permit of excessive surface leakage of line insulators. This problem is particularly acute in California in districts close to the ocean where the combination of the western trade winds and the ocean fogs results in a rapid accumulation of dirt on the insulator surfaces which are frequently wet by the fogs. The only method thus far discovered for securing high continuity of service in these sections is by artificial cleaning of the insulators during the months in which rain does not fall.

Some device for suppressing corona discharge of the conductor and wire clamps at the insulators appears highly desirable, since such a device tends to offset the distortion of electrostatic field at the points of support. It is not so certain that devices are required to improve the grading of the voltage impressed on the several units of long suspension strings. Apparently, as good results have been obtained in operation with devices for suppressing corona that have little or no grading effect as have been obtained with devices for suppressing corona that are arranged for considerable grading effect.

An insulator string is most likely to fail when wet by

a fog. At this time the distribution of voltage is undoubtedly determined by leakage currents rather than by the condenser effect of the unit. Obviously, grading devices are ineffective at the very time an insulator string is most likely to fail.

It is believed that the conductors of high-voltage circuits should be transposed so that the electrical characteristics of each phase wire may be as nearly like the characteristics of the other phase wires as possible. Additional reasons for transposing each circuit occur where two parallel circuits are used. In this case, transpositions should be so arranged that one circuit is transposed with respect to the other. In this way, inductive effects of trouble on one circuit upon the other circuit are minimized.

The use of double-circuit towers appears to be permissible where no sleet is encountered. This construction is a very distinct economy compared with the use of two separate single-circuit lines.

SUBSTATIONS

The requirements of equipment for substations are similar to those of generating stations in practically all respects. The main transformers may be auto-transformers if the ratio of voltage transformation is not more than 2:1. In such transformers, delta-connected windings should be employed and may be used for synchronous operation if desired.

Synchronous condensers must work over the complete range from full boost to as much buck as they are designed to supply. Some economy of cost can be had if the bucking capacity of the synchronous condensers is not more than 60 per cent of their boosting capacity.

Where very long sections of transmission line must be handled, it will be found necessary to employ a synchronous condenser in addition to a large generator in order to supply the charging kv-a. for bringing the circuit up to full voltage. For this operation, the condenser may be attached to the circuit with little or no field excitation and the generator may be used to secure the desired voltage.

In certain substations, control being a number of outgoing circuits which it would be desirable to test by building up rather than by cutting into the bus, the use of a driving motor on a synchronous condenser, permitting the operation of the condenser as a generating unit, will be found very convenient. At first thought it seems best to make these driving motors of the induction type. However, it is believed that a synchronous drive motor will serve the purpose equally well and will have the advantage of operating with a greater air-gap. The synchronous driving motor should have the same speed as the synchronous condenser. The unit should be started in the usual way, using the main condenser.

When the main condenser has reached synchronism, the driving motor can be cut in to carry the unit while

the main condenser is being used as a generator for test purposes.

A flexible switching scheme should be used for main substations so that the various operations may be conducted with the utmost dispatch. The arrangement should be such that access to any oil switch may be had without material loss of switching flexibility because oil switches require considerable maintenance.

In closing, it may be said that four years of operation have proved that a 220-kv. system can be expected to give as good service as can be had from a 110-kv. system. With four times the kilowatt capacity at approximately twice the cost per mile the 220-kv. system affords a very distinct economy in the cost of transmission where the amount of power is sufficient to justify the use of the higher voltage.

The success that has attended the operation of the pioneer 220-kv. systems proves that the economies of these systems can be realized and can be applied to increasing the transmission radius at a given cost or for decreasing the cost for a shorter radius.

ELECTRICITY ON U. S. TRUNK LINES

Although less than 2000 miles of railroad have been electrified in this country the present development of the new way of running trains is affecting a considerable proportion of the nation's train service because it is used mainly on heavily traveled lines such as those of the New York Central, the New York, New Haven and Hartford and the Pennsylvania running in and out of New York City. Ninety per cent of the total railroad traffic of the United States is handled over a bare 10 per cent of the trackage and electricity is making itself felt on this 10 per cent.

Economies have been effected and operating conditions improved under a wide range of situations by electrification. The Norfolk & Western, The Virginian, the Great Northern and the Chicago, Milwaukee & St. Paul have demonstrated that electric motive power is both economical and provides greater capacity than steam in their operations over sections wherein heavy grades are encountered, according to Britton I. Budd, chairman of the National Electric Light Association's committee on electrification of steam railroads.

The Long Island, Pennsylvania, Erie, New York Central, Southern Pacific and the New Haven have secured many benefits from electrification in congested terminals. Most of these railroads, as well as the Baltimore & Ohio, Michigan Central, Grand Trunk and Boston and Maine have obtained more satisfactory operation through tunnels since changing over from steam to electric motive power therein. The electrified portion of the Chicago, Milwaukee & St. Paul has the longest section of its kind in the world—about 800 miles—and approaches more nearly to the conditions that would obtain were the large trunk line railroads electrified throughout their entire length.

Application of Electricity in Cement Mills

BY W. E. NORTH¹

Associate, A. I. E. E.

Synopsis.—The advantages of electric drive for cement mills are enumerated in this paper and general pointers on installing electrical equipment are given. The electrical installation recently made in a modern cement plant is described.

NO single factor has contributed more to the present design and efficient operation of a modern cement mill than the application of electricity as its motive power.

The older cement plants were designed to operate on steam power and since this necessitated the use of long line shafts to accommodate the numerous pulleys required to drive the many small manufacturing units then in use, these plants were practically built around an engine room. For this reason it was not possible to arrange the machinery used for the manufacture of cement in such a way as to insure maximum efficiency, nor could the elevating and conveying systems be installed so as to give the best flow of materials through the mill.

The first application of electric motors in cement mills was the use of d-c. motors to drive auxiliary machinery requiring from 1 to 50 h. p. It was, for example, most inconvenient to transmit power from the line shafts to elevator heads and overhead conveyors, and tests showed that from 50 to 90 per cent of the power was lost in transmission, due to speed reductions usually accomplished with long chain and sprocket drives. Electric motors in such places proved an immediate success. They not only cut the transmission losses but it was soon found possible to install an astonishing amount of connected load in motor horse power, on a generator set of much less rated capacity. This was due to the fact that such drives are usually over-motored due to the high ratio of the maximum to the average power required by the individual motors. In one case known to the writer a total of 375 h. p. in rated motor capacity was carried by generators rated at 150 kw. with only occasional interruptions in service due to opening of circuit breakers. This constituted such a radical and valuable change from the old line transmission practise that small generator units driven by special high-speed engines of from 100 to 500 h. p. became a feature of every cement plant.

The electrification of the cement plants in the Lehigh Valley was started on a larger scale when the Lehigh Navigation Electric Company built its plant at Hauto and offered attractive power rates to the cement manufacturers, most of whom were operating with steam power plants that were either in poor condition or badly overloaded due to increased production demands. The

work of changing over these mills consisted primarily of replacing the old line shaft drives by individual motors, and in most cases the general layout of the cement machinery was not changed to any great extent to get greater advantages of the use of electric motors. One of the plants installed 2200-volt and 220-volt induction motors, two plants used 550-volt induction motors, and one plant installed d-c. motors.

The advantages of the electrification were realized very soon. At the Coplay Cement Manufacturing Company's plant the production was increased from 2600 barrels per day to over 3000 barrels per day without the addition of a single grinding unit and since the meters on the various feeder circuits gave accurate records of power consumption, causes of trouble and faulty operation could be detected easily and the unit cost of manufacture was decreased.

The use of electrical machinery in a modern cement mill is necessary for the following reasons:

1. It makes it possible to design a plant to meet manufacturing conditions without being restricted by conditions imposed when using other forms of power.
2. Increasing cost of labor necessitates the use of labor saving devices that are not practical except when driven by electric motors.
3. Saving in operating efficiency on account of not running idle machinery.
4. Necessity of keeping accurate daily cost data which is greatly aided by proper use of electric meters.
5. Greater flexibility in making repairs and adjustments to various parts of mill without interfering with other operations.
6. General trend toward larger manufacturing units.

One of the most important points to consider in the operation of a cement mill is the continuous operation of the various departments according to a prearranged schedule. The schedule of operation depends mostly upon local conditions, for, although it is necessary to run the kilns without shut-down, it is sometimes advisable to shut down certain departments over the week ends. The quarrying and packing operations are in many cases discontinued on Sundays except during periods of maximum shipping requirements.

The manufacturing departments of a dry process cement mill may be divided as follows:

1. Coplay Cement Mfg. Co., Coplay, Pa.

Presented at the Regional Meeting of District No. 2 of the A. I. E. E., Bethlehem, Pa., April 21-23, 1927.

Quarrying,
 Stone Crushing and Drying,
 Raw Material Grinding,
 Kilns,
 Coal Crushing and Grinding,
 Clinker Grinding,
 Stocking and Packing.

It is seen easily that if a mill is designed with sufficient storage capacities between these departments, any department except the kilns and possibly the coal department may be shut down for repairs or other reasons without interfering with the other operations.

In a cement plant as outlined above, the electrical feeders should be so arranged as to supply one department only. If this rule is followed, repairs and adjustments to electrical apparatus and mill machinery can be made without interfering seriously with the operation of the mill. Such a feeder layout will not always meet with approval from an electrical viewpoint since the power requirements of the various departments vary within wide limits, which means that the feeder panels and the distribution feeders will not be the same size, but the advantages gained from a manufacturing standpoint offset its disadvantages when considered simply as an electrical installation.

The advantage of flexibility of operation and the readiness with which repairs and adjustments may be made without interference have been explained. Another advantage is derived from a cost accounting standpoint. Compared with other industries, the ratio of the cost of power to the total value of the product manufactured is great, varying from 15 to 20 per cent of the total cost, depending upon cost of power and efficiency of operation. To keep accurate and reliable account of the power costs is therefore of utmost importance and if each manufacturing department is provided with its own feeder panel and necessary metering devices, accurate data as to power cost can be obtained daily. Since the power consumption is an indication of the efficiency of general operating conditions, other troubles are easily located and corrected before serious trouble is caused or costs increased. The safety factor is also improved as any department not in operation can be cut off entirely from the feeder system.

The plans under way for the installation of new 60-cycle motors and for remodeling the mills of the Coplay Cement Manufacturing Company at Coplay, Pa. are based on the above principles; that is, the electrical equipment simply supplies a means to drive the machinery and in no way influences the layout of the mill.

When the improvements in the mill are completed, sufficient storages will be supplied between all departments to allow for flexible and economical operation and the electrical system has been installed so as to meet all of the requirements of operation of the mill.

The power for the electrical machinery is purchased

from the Pennsylvania Power and Light Company, 60 cycles at 66,000 volts. Due to dusty conditions, and to insure as far as possible freedom from interruptions in power service, all of the 66,000-volt equipment was installed indoors, and the installation was designed to combine the greatest possible protection affording safe and continuous operation with the greatest simplicity of arrangement of equipment.

The transformer house is built of concrete with a cement tile roof supported on steel trusses. The concrete work was erected by the use of sliding forms. The pitched roof (six in. per ft.) with ventilators was used to secure the maximum amount of ventilation for the self-cooled transformers without the use of fans. A tunnel extends through the building under the switchboard and contains cable racks, steam, water, and compressed air service pipes and a concrete tank of sufficient capacity to hold the transformer oil in case it is necessary to empty the transformer tanks for any reason.

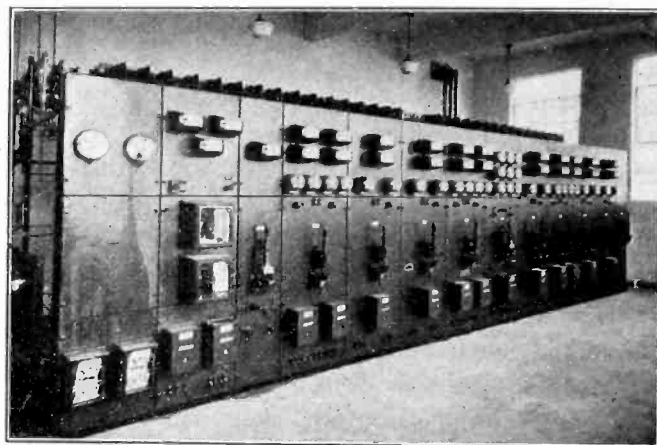

FIG. 1—DISTRIBUTION SWITCHBOARD

The building was erected and all of the equipment installed by the construction forces of the company.

The transformer house and arrangement of the electrical machinery is shown in Figs. 1, 2, and 3, and the schematic wiring diagram of the whole system in Fig. 4.

The incoming feeders enter the building through 110,000-volt wall entrance bushings and the equipment is protected by oxide film lightning arresters. The main line oil circuit breakers have manually operated closing mechanism and are equipped with bushing type current transformers and have d-c. trip coils operated by induction type overload and reverse power relays.

The rupturing capacity of these switches is sufficient to interrupt the current due to a short circuit on any part of the system. The transformers are self-cooled, three-phase, 66,000-2200 volts, 5000-kv-a. capacity with four 2½-per cent taps below 66,000 and are equipped with conservator tanks, thermometers and temperature indicators connected to coils in the windings. They are mounted on trucks and provision is made for a hoist beam for repairs.

The disconnecting switches between the oil circuit breakers and the bus are three-pole, gang-operated and

are mechanically interlocked so that it is impossible to operate them when the oil breaker is closed. The bus tie switch and the transformer bank switches are three-pole, gang-operated air break switches and are used for breaking the parallel operation and the magnetizing current of the transformers.

It will be noted, Figs. 2-4, that when operating on one transformer bank, one side of the station can be entirely disconnected, making safe repairs and adjustments possible.

The operating switchboard is in a separate room, and

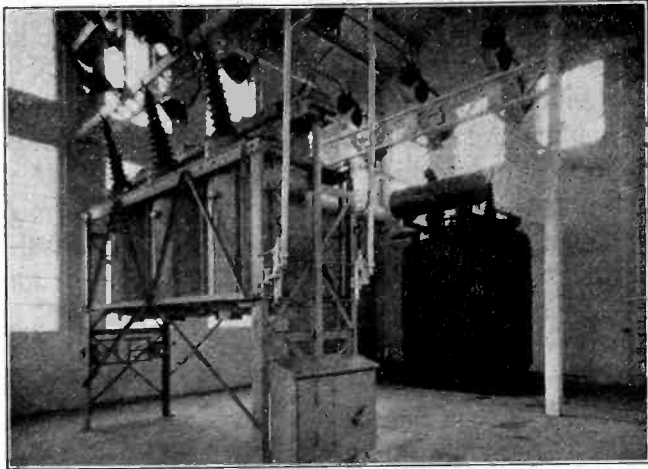

FIG. 2—5000-KV-A., 66,000/2200-VOLT, THREE-PHASE TRANSFORMER WITH AIR BRAKE SWITCH AND MAIN LINE OIL SWITCH

consists of two transformer panels, two totalizing meter panels, feeder panels and a bus tie panel.

The bus tie switch is operated by an instantaneous overload relay and is used to sectionalize the bus in case of a dead short circuit on one of the feeders to reduce the rupturing capacity required by the feeder circuit



FIG. 3—TRANSFORMER HOUSE

breakers which have d-c. trip coils operated by inverse time limit relays. This combination operated successfully on two occasions when short circuits occurred on feeder cables during the construction period.

The totalizing panel is equipped with watthour meters, printometers, ammeter, voltmeter, curve drawing wattmeter, power-factor indicator, and wattless

component indicator to be used with watthour meter in computing the average power factor.

The feeder panels are equipped with oil circuit breakers, disconnecting switches, ammeter, wattmeter, and watthour meters and with a complete set of testing

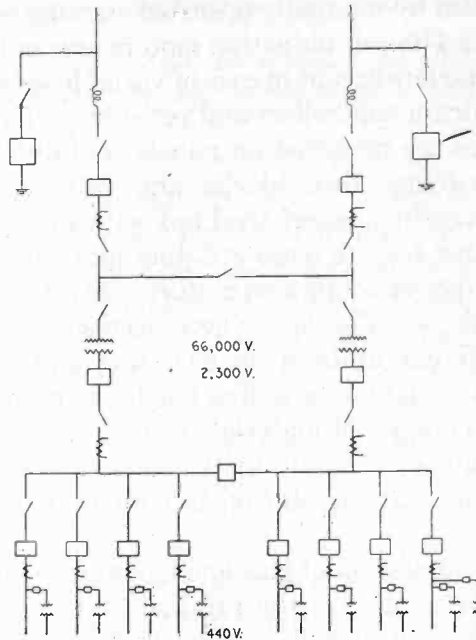

FIG. 4—SCHEMATIC WIRING DIAGRAM OF SYSTEM

studs on the front of the board for testing meters and relays.

All of the feeder circuits to the various departments are of armored lead covered varnish cambric insulated cable. These cables are run underground to the various departments and when located out of doors are buried about three ft. underground and spaced several inches

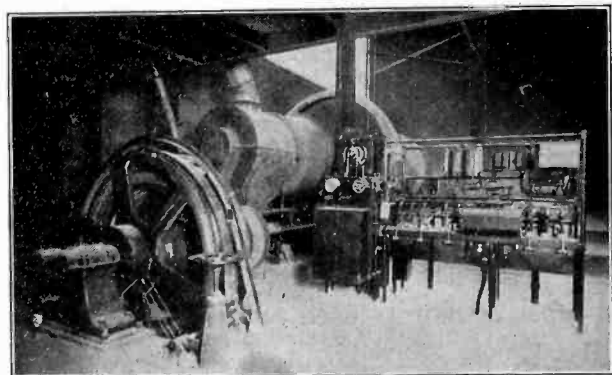

FIG. 5—600-H. P., THREE-PHASE, 2200-VOLT SUPER-SYNCHRONOUS MOTOR DRIVING TUBE MILL

apart. Boards are placed about six in. above the cables as a protection against injury by workmen making excavations.

Where the cables are located in buildings having concrete floors, the ditches in which the cables are laid are filled with earth and covered with a 2-in. concrete slab marked to show location of cables and to allow the concrete to be broken out easily, if necessary.

The starting equipment for the various motors con-

ected to a feeder circuit is in most cases arranged in a group at the termination of the feeder. Since 440-volt motors are used for all sizes under 50 horse power, small distribution transformers are connected to each feeder to take care of these motors.

The 2300-volt induction motors with few exceptions are controlled by manually operated starting compensators and the 440-volt induction motors are controlled by magnetic starters except in case of variable speed motors that have drum controllers and resistors. These starting switches are mounted on panels containing disconnecting switches, fuse blocks and testing jacks all mounted in a single sheet steel box with safety catches.

The motors for the main grinding units are 600- and 200-h. p. super-synchronous motors controlled by automatic panels; see Fig. 5. Where necessary, all motors driving different units of an elevating and conveying system serving a main grinding machine are interlocked to prevent choking of materials in case of stoppage of one of the units. All automatic starters are equipped with but one starting station but many have several stop stations.

With the exception of gasoline locomotives operating in the quarries and on the railroad and two gasoline-engine-operated well drills used for prospecting at points distant from our feeder circuits, all power applications in the mill are motor driven.

The distribution of the motor load may be classified as follows:

Pumps.....	260 h. p.
Air Compressors.....	170 h. p.
Blowers.....	315 h. p.
Well Drills.....	50 h. p.
Electric Shovels (M-G Set).....	240 h. p.
Quarry Hoists.....	125 h. p.
Bridge Crane (M-G Sets).....	200 h. p.
Elevators and Conveyors.....	1055 h. p.
Crushers.....	615 h. p.
Dryers.....	110 h. p.
Kilns.....	240 h. p.
Grinding Machinery.....	4950 h. p.
Packing Machinery.....	140 h. p.
Machine Tools and Miscellaneous Applications.....	288 h. p.
Total.....	8758 h. p.

The types of motors used are as follows:

D-c. Motors, 220-volt..... (Electric Shovels, Cranes, Etc.)	374 h. p.
Squirrel-Cage Induction Motors, 440-volt.....	1886 h. p.
Variable-Speed Induction Motors, 440-volt.....	280 h. p.
Squirrel-Cage Induction Motors, 2300-volt.....	3100 h. p.
Hoist Duty Induction Motors, 2300-volt.....	125 h. p.
Synchronous Motors, 2300-volt.....	3340 h. p.
Total.....	9105 h. p.

With the exception of comparatively few motors with characteristics suitable for the operation of electric

shovels, cranes, and other labor saving machinery, most of the motors used in the cement industry are of standard design and construction and since the general practice in the installation of this equipment is to make the starting operation as automatic as practicable, specialized mechanics are not required for the operation of the motors and few skilled men are required for their maintenance.

An installation such as described above would be expected to operate 24 hr. a day for 360 days per year, and would have a yearly load factor (ratio of average demand to maximum demand) of 80 per cent and a monthly load factor of 88 per cent with an average power factor of 90 per cent, making it a desirable load from a power generating standpoint.

The tendency in cement mill work is toward larger grinding units and the most efficient electrical apparatus obtainable, standardization in sizes and speeds of the general purpose motors, and distribution of the motor load into circuit so as to best meet the manufacturing requirements of the mill so as to be an aid to more efficient operation.

The recent development of synchronous motors of high starting torque, with either mechanical or magnetic clutches, has caused the installation of more direct-connected units, eliminating many expensive belts and pulleys and resulting in great saving in space and in efficiency and safety of operation.

In many instances, ball and roller bearings have been used in extremely dusty places with good results, but a modern cement mill can be made to be so free from dust that when proper attention is paid to the condition of the equipment, motors with standard habbited bearings can be operated with as little trouble as when installed on similar machinery in other industries.

The use of belts and chains on countershafts for speed reduction necessary to drive elevators and conveyors has been almost universally replaced by the use of gear reduction units direct connected to motors through flexible couplings mounted on common bases. Reducers of these types can be built for speed reductions ranging from 4 to 1 up to 8000 to 1 when power does not exceed 500 h. p. and therefore cover the entire range of cement making machinery except in case of the larger grinding units. Rock crushers and heavy machinery subject to severe shock are still usually belt driven to provide flexibility and reduce the strains on the motor bearings and coils.

In addition to the above described motor applications, electricity is used in cement mills for magnetic separators, rivet heaters, arc and spot welders, pyrometers and various other application of electricity, all of which have become most satisfactory features in operating cement plants, and as is the case in other industries, electric power has become one of the greatest factors in production, and from raw material to the finished product the responsibility of uninterrupted manufacture rests primarily upon the electric motor.

Recent Developments in Electric Drives for Rolling Mills

BY L. A. UMANSKY¹

Associate, A. I. E. E.

Synopsis.—The application of electric power in the steel industry introduced many radical changes and improvements in rolling-mill layout and practise. The electric drives, of capacities larger than encountered elsewhere, are usually designed to fit individual cases.

Special machines or special combinations of them are frequently used.

Several representative cases are outlined, and some methods of solving the encountered problems are analyzed.

INTRODUCTION

THE iron and steel industry is the largest single consumer of electric power. In 1924 this industry used more than 6,000,000,000 kw-hr., which is about 20 per cent of the total power consumed by all industries in the United States. It is of interest to note that the combined output of all central stations in the country equalled 54,413,403,000 kw-hr. during the same year.

A modern steel plant, starting with an iron ore as a raw product, produces at its blast and open hearth furnaces and at the coke ovens a large amount of waste gas or heat. Electricity gives means of conveniently converting and transmitting this potential power to the centers of its consumption. This explains the rapid growth of power generating plants in the steel mills; one steel plant has an installed capacity of over 100,000 kw.; a number of plants have a demand in excess of 50,000 kw. In 1926 alone the steel industry purchased for its use a 30,000-kw. turbo generator and three others each rated at 20,000 kw., not counting many other units of 15,000-kw. capacity and less.

So great is the demand for power in the steel industry that even plants having their own blast furnaces often purchase additional power from public utilities. Many other plants, deprived of the use of blast furnace gas, run almost exclusively on purchased power. The latter amounted in 1924 to 39 per cent of the total power consumed.

The bulk of this vast amount of energy goes for the work of shaping the steel; the rolling mill drives are the principal outlets of the generated power. Here the electric drive predominates. Hardly any new mills are being equipped with anything but electric motors; older steam driven mills are being gradually electrified, for purely economic reasons.

Many electrical engineers, not connected directly with the steel industry, may not fully realize the profound, almost revolutionary changes which the electric drive brought about in the rolling mills. It is not merely the question of performing the operations in a better, more efficient, or more reliable manner than

otherwise possible; but the point, which is sometime lost sight of, is that many operations and processes, now in wide use, are practically impossible without the agency of electric power. Rolling mill designers have taken advantage of the possibilities of electric drives and have built mills on radically new principles, exceptionally advantageous for steel plants, but not practical, were it not for the presence of electrical motors. On the other hand, the electrical engineers have developed new machines, or new combinations of machines, primarily, if not exclusively, for rolling mill application. Thus the new rolling mill has become closely tied to its drive and is unthinkable without it; the influence between the electrical and mechanical equipments is now not only great—it is also mutual. Many new problems were brought up and were solved more or less successfully.

There will be outlined in this paper, in a necessarily short space, those solutions offered by electrical engineers for a few of these problems. A brief sketch of the types of new rolling mills will give the necessary background.

CONTINUOUS ROLLING AND CONTINUOUS MILLS

It has been generally recognized that for a large tonnage output a continuous rolling mill possesses decided advantages. Such a mill, see Fig. 1, consists of a number of two-high stands, arranged in tandem and conventionally driven through a line shaft and gears by a single motor or engine. The hot bloom or bar passes in succession through all stands, as indicated by the arrow. Each pair of rolls reduces the cross-section of the bar until the latter leaves the last stand as a finished product of the desired shape. The layout is compact; little heat is lost between stands; the metal is rolled at a high temperature and with a relatively low power consumption; the steel requires little, if any, handling; the labor costs per ton are reduced to a minimum.

The bulk of the country's steel output passes through a continuous mill of one kind or another.

To maintain the high tonnages and to keep the cost of handling down, the rolled bars are usually of considerable length; a finished length of several hundred feet is quite common. In order to save floor space the stands are located close to each other. This means that

¹ Industrial Engg. Dept., General Electric Co., Schenectady, N. Y.

Presented at the Regional Meeting of District No. 2 of the A. I. E. E., Bethlehem, Pa., April 21-23, 1927.

the metal is in several stands at the same time. It is obvious that with such an arrangement the speed of each consecutive pair of rolls is increased in proportion to the reduction of the cross-section area. For a given mill the speed relation between stands is fixed and is determined by ratio of the several gears; hence the reductions per pass, or the so-called drafts, are also more or less fixed. Thus, a continuous mill of the outlined type, capable of producing large tonnages of a

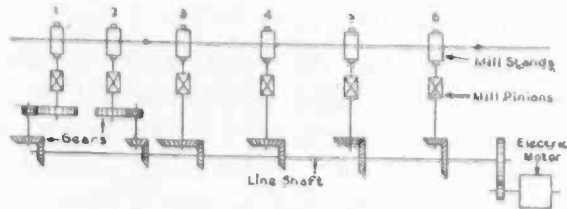

FIG. 1—ELEMENTARY DIAGRAM OF A CONTINUOUS MILL WITH A SINGLE DRIVE

certain class of sections, is not quite flexible when it comes to rolling of a diversified line of products.

Individual drives for several stands of a continuous mill give it the necessary flexibility, at the same time maintaining its inherent advantages.

For instance, the mill, Fig. 2, has its first three roughing stands driven by one motor, the next two stands by another motor, and the last three, or finishing, stands are each provided with a separate drive. If all motors, or several of them, are of the adjustable

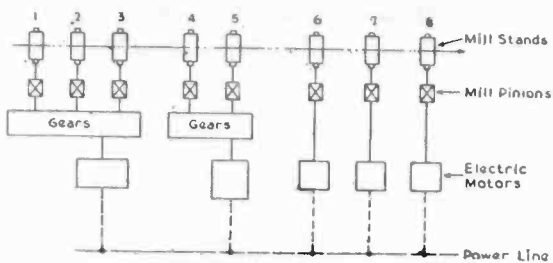

FIG. 2—ELEMENTARY DIAGRAM OF A MULTI-DRIVE CONTINUOUS MILL

speed type, then the speed ratio between the stands may be readily changed. A wide variety of products may be then successfully rolled, each at its proper speed, each with the most suitable reductions at the several stands.

Mills, designed and built on this principle, are springing up all over the country. Hot strip, rods, merchant and certain structural shapes are being rolled on such mills. They are believed to be economical, flexible and tonnage producing. In many cases one mill of this type takes the place of two or three less modern mills.

Such layouts would be hardly feasible were it not for the application of the electric motor. We are usually accepting it as a matter of fact, and are apt to forget that there is no other device which can concentrate a large bulk of power in a limited space, which is efficient

even in small units and which is capable of speed adjustment, yet will closely maintain its speed, once it has been adjusted.

It is outside the scope of the present paper and outside the competence of the writer to offer a thorough analysis of mill layouts from the standpoint of rolling mill operations. It was not intended to convey the idea that, for instance, a continuous mill with individual drives is the best combination or layout for all applications; such a mill was merely discussed in order to illustrate the profound influence of electricity on rolling mill engineering and practise.

TYPES OF ELECTRIC DRIVES

It will be shown presently how the electrical engineers are providing suitable drives for mills of the kind just described. While no radically new machine was

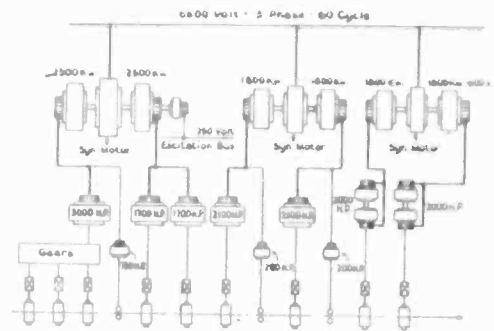

FIG. 3—LAYOUT OF A LARGE CONTINUOUS MILL DRIVEN BY D-C. MOTORS. THE GENERAL VIEW OF THE MOTOR ROOM IS SHOWN ON FIG. 4

invented nor introduced, some new combinations of machines were conceived and were successfully applied.

D-c. Drives. When a mill requires a number of adjustable speed drives it is the simplest and, in many



FIG. 4—GENERAL VIEW OF THE MOTOR ROOM AT THE 14-IN. MERCHANT MILL OF THE JONES AND LAUGHLIN STEEL CORPORATION, WOODLAWN, PA.

The elementary diagram of connection is shown on Fig. 3

cases, the best way to make each drive a d-c. motor and to furnish power to them from motor-generator sets or from synchronous converters.

Figs. 3 and 4 give the schematic layout and the general view of the motor room of one of the most modern mills of this type.

A 3000-h. p., 200 360-rev. per min. motor drives

the roughing train of three stands; two 1700-h. p., 90/204-rev. per min. motors and two 2100-h. p., 150/460-rev. per min motors are individually driving the next four stands; the two finishing stands are each driven by double-unit, 2000 h. p. motors, consisting of two 1000-h. p. armatures which can be connected either in series or in multiple, and operating up to 800 rev. per min. Three smaller edging roll stands are also electrically driven.

All motors are 600-volt, d-c. machines and the power to them is furnished from three large synchronous motor-generator sets, aggregating 12,200 kw. (40 deg. cent. continuous capacity). Practically each motor has a corresponding generator, as is shown on the diagram. Ward-Leonard control is used for starting, and the combination of generator voltage and motor field control gives a very wide speed range (as wide as 4:1 and 5:1) to each drive.

Another interesting example of a modern mill with

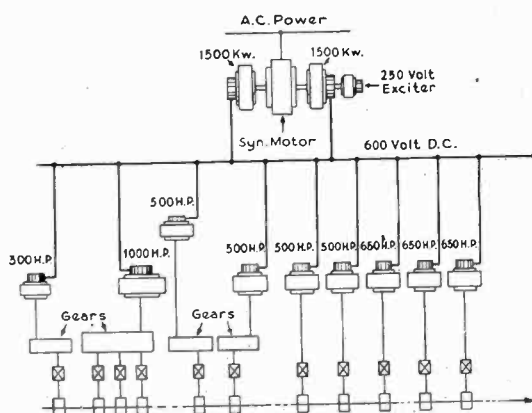

FIG. 5—TYPICAL ARRANGEMENT OF A MODERATE SIZED CONTINUOUS MILL DRIVEN BY D-C. MOTORS

stands individually driven by d-c. motors is represented by the layout in Fig. 5. The capacity of each drive is indicated on the diagram. The power to the motors is supplied from a 3000-kw., 600-volt, three-unit motor-generator set. Ward-Leonard control is used for starting, and motor field control for speed adjustment.

D-c. Versus A-c. Drives. When a mill requires a number of adjustable speed drives, especially of the average or of less than the average capacity, then it is usually more economical to make them of the d-c. type, as just described. When a speed range larger than 2:1 is necessary, the use of direct current becomes almost imperative. The speed regulating control is quite simple, usually consisting of one or several field rheostats. The use of direct current may also reduce the cost of the high voltage switching equipment.

On the other hand, the necessity of converting the full amount of electrical power three times from the available a-c. line to the mill coupling, greatly reduces the over-all efficiency of the drive and increases the running light losses. Assuming an efficiency of a d-c. motor at 92 per cent and that of a motor-generator set at 88 per cent, the over-all efficiency of the drive at full load is

only 81 per cent. When the d-c. machines are operating at reduced voltage (*i. e.*, when part of the speed range is covered by Ward-Leonard control) their efficiency goes down quite appreciably. The actual over-all efficiency and the power consumption (in terms of kilowatt-hours used per ton of rolled material) are still further unfavorably affected by the fact that the average mill load is usually much less than the rating of the drives.

Thus, much as a straight d-c. system may seem attractive, in many cases, from the operating standpoint, it would be a fallacy to consider it as a standard for any multi-drive mill.

With alternating current universally adopted in all steel mills for power generation and distribution, the engineers should always analyze whether the available a-c. power could not be more directly used for driving the mills. When large amounts of energy and large tonnages are involved, the possible improvement of 5 or 6 per cent, or more, in over-all efficiency, presents an attractive goal worth striving for. Say, a mill rolls 50,000 tons of steel per month, consuming approximately 40 kw-hr. per ton, or 2,000,000 kw-hr. per month; a saving of 5 per cent at, say, 0.9 cent per kw-hr. will net over \$10,000 per year. Such economy alone would justify an additional investment as high as \$50,000 if it were required. But, if it is obtainable without any additional outlay, or even with a lower first cost than with a d-c. drive, then the application of a-c. drives becomes vital and their possibilities should be most carefully studied.

A-c. Drives. The art of engineering thus far knows of but one way to build adjustable speed, a-c. drives, of such capacities as are involved in steel mill work. This is to use a slip-ring induction motor and to regulate its speed by acting on its secondary circuit in one or another well known manner. These methods were described in great detail, at various times, before this Institute or before other engineering societies, and the most representative of them are diagrammatically shown on Fig. 6.

Broadly speaking, all these methods have one thing in common. An induction motor, running at a sub-synchronous speed, delivers at its shaft, as mechanical energy, only that portion of the power transmitted to the rotor which is proportional to the speed; the balance of this power, proportional to the slip, is available at the slip-rings and is usually called the slip energy; it is of a frequency and voltage proportional to the slip. This energy is either converted into mechanical power and is returned to the main motor shaft, see 6B, 6D, 6F, or is converted into electric power of the line frequency and voltage and is returned to the a-c. system; see Figs. 6A, 6C, 6E. In the first case the drive is of a "constant horse power" type, as approximately the same amount of power (neglecting conversion losses) is available at the motor coupling at all operating speeds; in other words, larger torque is

permit the shutting down of one motor-generator set, thereby reducing the running light losses. Although it is hard to estimate with any degree of accuracy the resultant saving in power, it is evident that any such saving is a net gain. It may be truly said in this connection that in steel mill drives, which are usually liberally motored to take care of the maximum load conditions, the low running light losses are just as big a factor in conservation of power as the high efficiency.

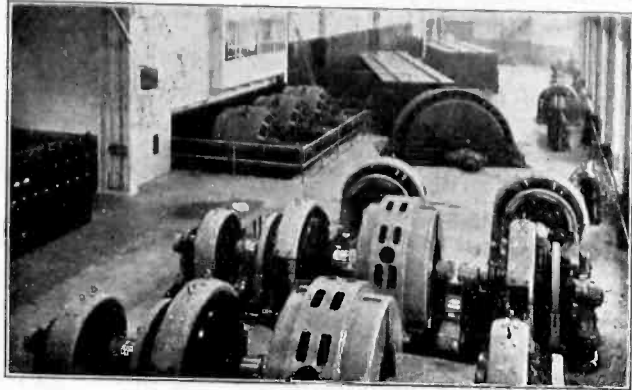

FIG. 8—GENERAL VIEW OF THE MILL MOTOR ROOM CONTAINING THE ELECTRICAL EQUIPMENT ARRANGED AS SHOWN ON FIG. 7

Two out of three synchronous motor generator sets and two synchronous converters are seen in the foreground; three 2000-h. p. d-c. motors are located next to the wall, with the 7500-h. p. Kraemer drive seen to the right of them. The 3600-h. p. Kraemer drive is located back of the gear cases and is not shown on the photograph

The motor room of the mill just described is illustrated by Figs. 8 and 9.

Another continuous mill, now being built for a large eastern steel manufacturer, will be equipped with electric drives embodying to a smaller extent the same

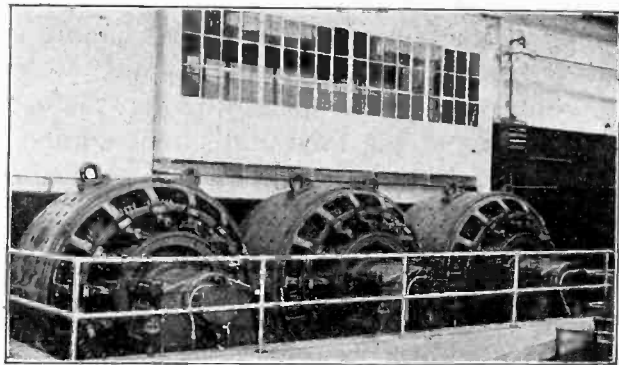

FIG. 9—CLOSE-UP VIEW SHOWING THREE 2000-H. P., D-C. MOTORS, EACH DRIVING A FINISHING STAND OF A CONTINUOUS MILL

See Figs. 7 and 8

principle; several new features of a different nature will make a brief review of this equipment rather interesting.

In this case the mill will have a number of stands arranged in tandem, as shown diagrammatically on Fig. 10. The rolling requirements being different, the first several stands will be driven by constant speed motors. The power supply is 6600-volt, 25-cycle.

The roughing train will take a 4000-h. p., 83.3-rev. per min. motor, *A*, the intermediate train will be driven by a 6500-h. p., 187.5-rev. per min. motor, *B*. The following group of stands will be jointly driven through a train of gears by an adjustable speed equipment, *C*, developing 6700 h. p. at 500 rev. per min. and 3350 h. p. at 250 rev. per min.

The last finishing stand will take a separate direct-connected drive, *D*, with an output of 2600 h. p. at a speed of 275 rev. per min.; constant horse power output will be maintained for speeds above 275 rev. per min., and reduced output on constant torque basis, for speeds below this value.

These drives will never be required to start their respective mills with metal in the rolls. Mill friction on a cold winter day, after a prolonged shut-down, would be the most severe starting condition. Several tests have shown that a torque of about 25 or 30 per

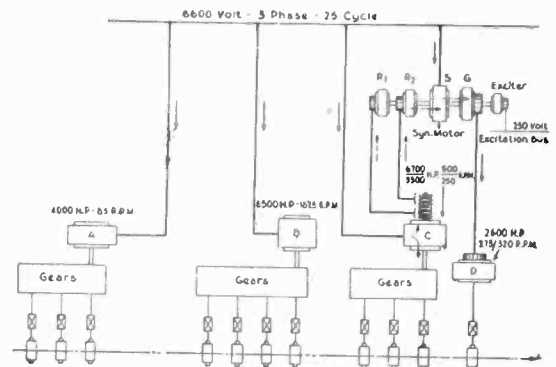

FIG. 10—ARRANGEMENT OF ELECTRIC DRIVES FOR A LARGE CONTINUOUS MILL

Two synchronous motors, one Scherbius equipment and one d-c. motor aggregating approximately 20,000 h. p. continuous capacity will be used for driving this mill

cent normal will start a continuous mill under most adverse conditions.

Actual experience with a 9000-h. p., 107-rev. per min., synchronous motor, driving since the summer of 1926 a large continuous rolling mill at the McKinney Steel Company, Cleveland, Ohio, has proved conclusively that a synchronous drive is quite applicable for mills of this nature. This synchronous motor, shown on Fig. 11, is capable of developing a starting torque of 265 per cent normal if started on full voltage; it is usually started on a low voltage tap of an auto-transformer, developing the starting torque actually required with considerably less than normal line kilovolt-ampere input.

Under circumstances it has been decided to build the drives *A* and *B* as synchronous motors and to take advantage of their leading kilovolt-amperes for power factor correction of the steel plant.

The large adjustable speed drive, *C*, will consist of a 5000-h. p., 375-rev. per min. slip-ring induction motor, the speed of which will be adjusted up to 33 per cent above, and up to 33 per cent below, synchronism

(i. e., from 500 rev. per min. to 250 rev. per min.) by means of the two Scherbius regulating machines R_1 and R_2 . With this constant torque layout, the capacity of the drive will be 6700 h. p. at 500 rev. per min. and 3300 h. p. at 250 rev. per min. An a-c. drive of such capacity and speed can be built more economically and with a much higher efficiency than any combination of d-c. machines. The fact that the power supply was 25-cycle gave the Scherbius system an advantage over the Kraemer drive.

The last finishing mill drive, D , will have a wider speed range, is of smaller capacity and runs at a lower speed than the drive C . While a Scherbius equipment for the drive, D , would be fully competitive in first

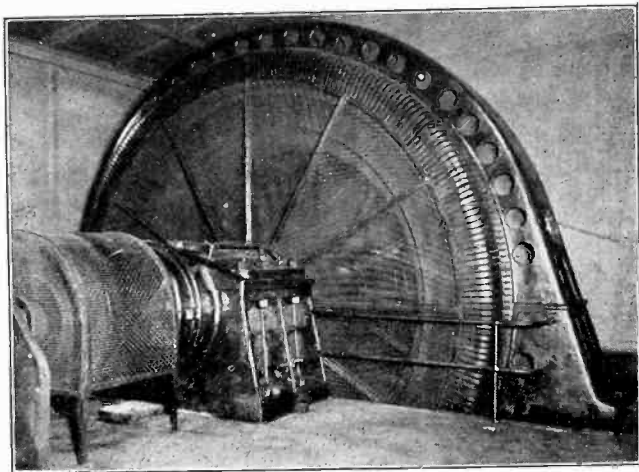

FIG. 11—9000-H. P.-107, REV. PER MIN. 6600-VOLT, 25-CYCLE, SYNCHRONOUS MOTOR DRIVING A LARGE CONTINUOUS ROLLING MILL

cost, the difference between it and that of a d-c. drive was not as wide as in the case of the drive C . For the sake of greater flexibility of control it was decided to make the drive D of the d-c. type.

A 500-rev. per min. synchronous motor, S , will drive a 2300-kw., d-c. generator G (furnishing power to the motor D) and the two 650-kv-a. Scherbius speed regulating machines R_1 and R_2 used for adjusting the speed of the induction motor C . When the motor C runs below its synchronous speed, the slip energy flows to the machines R_1 and R_2 ; the latter run as motors and assist the synchronous motor S in driving the generator G . In other words, the slip energy does not have to be returned as electric power to the incoming line; instead of this, it may be used for driving, wholly or in part, the finishing mill D . The flow of power is indicated by arrows. This is another application of the same principle which was illustrated on Fig. 7.

When the drive C is running above synchronism, the slip energy becomes negative and arrows shown by the dotted lines, see Fig. 11, will be reversed. The machines R_1 and R_2 act then as generators, and derive their power from the synchronous motor S .

A direct-connected exciter provides the necessary 250-volt excitation to the synchronous motors A , B and S , and to the d-c. machines G and D .

The use of two regulating machines R_1 and R_2 for controlling the speed of the motor C presents some interesting features. The maximum amount of the slip energy to be handled by the speed regulating equipment is 1700-h. p.; it is not practicable to build an a-c. commutator machine of such capacity and to run at 500 rev. per min.; a lower speed like 375 rev. per min. or 300 rev. per min. would be required. With the proposed layout such reduced speed would considerably increase the cost of the d-c. generator G and of the motor S . It would be still more expensive to provide a separate low speed drive for the regulating machines R_1 and R_2 , and to drive the generator G by another 500-rev. per min. motor. It was quite advantageous, therefore, to split the capacity of the regulating equipment in two units and to run them at 500 rev. per min.

The connections of the regulating machines to the secondary winding of the induction motor are shown on the Fig. 12. The 5000-h. p. motor is equipped with six slip-rings, with both ends of each phase of the rotor

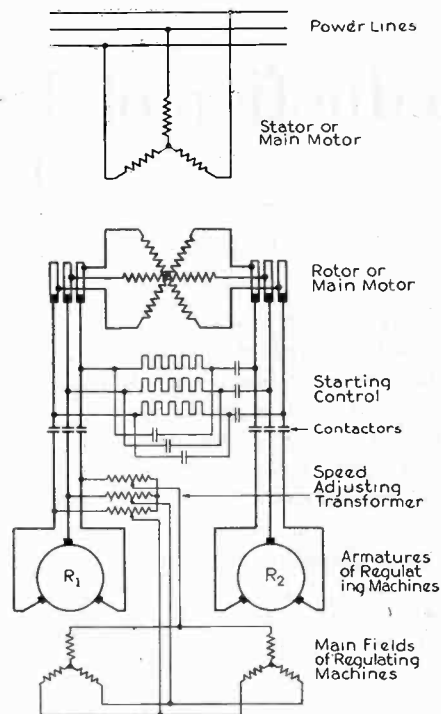

FIG. 12—ELEMENTARY DIAGRAM OF ELECTRICAL CONNECTIONS OF A SCHERBIUS ADJUSTABLE SPEED DRIVE WITH TWO REGULATING MACHINES CONNECTED IN SERIES

brought out. Each set of three slip-rings is connected electrically to the commutator of the regulating machines R_1 and R_2 , which thus forms the two Y-points of the secondary circuit. In other words, the two machines R_1 and R_2 act as if they were connected in series with each other, their e. m. fs. added together. The shunt fields F_1 and F_2 are adjusted simultaneously by a common speed control apparatus.

By disconnecting one regulating machine and by short-circuiting the corresponding set of slip-rings, it is still possible to operate the drive with the other regulating machine; full torque of the drive will be obtainable, but the speed range will be cut in half;

i. e., it will be in this case approximately 312/437 rev. per min.

CONCLUSION

None of the several electrical layouts described on the preceding pages should be considered as anything more than what they were originally intended for:— a good combination of electrical machines to fit a set of given requirements. Certain principles may be used again in some future drives; the whole combination may never be repeated. Electric drives for modern large rolling mills can hardly be standardized. They rather are and may rightly be called "custom made."

Many single mills require up to, or over, 20,000 h. p. in electric drives; investment runs into several hundred thousands of dollars; the cost of power consumed in a year may approach the same figure. This alone justifies a thorough engineering study and a preparation of an individual layout for each case. Machines of special design need not necessarily be built for any new

drive, but there is usually a broad field for working up a good new combination of apparatus.

It was the author's intention to point out, by means of the several illustrated schemes, that such an opportunity is present in most cases and that the electrical engineers seldom let such opportunities slip by.

Bibliography

1. "Adjustable Speed Drives for Rolling Mills" by L. A. Umansky, *Iron and Steel Engineer*, September, 1924.
2. "Methods of Varying the Speed of A. C. Motors" by Gus A. Maier, *TRANSACTION A. I. E. E.*, 1911, page 2455.
3. "The Economical Speed Control of A-c. Motors Driving Rolling Mills" by F. W. Meyer and Wilfred Sykes, *TRANSACTION A. I. E. E.*, 1912, page 2067.
4. "Application of Synchronous Motors to Continuous Mills" by F. O. Schnure, *Iron and Steel Engineer*, May 1925.
5. "The Application of Synchronous Motors to Steel Mill Main Roll Drives" by H. A. Winne, *General Electric Review*, June 1926.
6. "Theory of Speed and Power Factor Control of Large Induction Motors by Neutralized Polyphase A-C. Commutator Machines" by John I. Hull, *TRANSACTION A. I. E. E.*, 1920, page 1135.

Reduction of Transformer Exciting Current to Sine-Wave Basis

BY G. CAMILLI¹

Associate, A. I. E. E.

Synopsis.—As a sequel to an earlier investigation and development of a method for the reduction of core-loss measurement to sine-wave basis, this paper describes two methods developed for the reduction of exciting current to sine-wave basis.

The first method consists of making two measurements at wave shapes as widely different as possible, setting the voltage in each case by means of the flux voltmeter. The current corresponding to sine-wave voltage is obtained by extrapolation from the observed values of currents and form factors. Although the method might be considered to some extent empirical, it is found to yield an accuracy within one per cent even under extremely unfavorable conditions.

The second method utilizes as before the flux voltmeter for setting

the voltage but uses a "crest ammeter" (developed for this purpose) for reading the instantaneous maximum values of the corresponding currents. Measurements are made at 100 per cent, 86.6 per cent and 50 per cent voltages. These data determine the fundamental, third and fifth harmonics of the exciting current corresponding to sine-wave voltage and hence the exciting current itself, because these harmonics are the only important components in determining the effective value of the exciting current.

Theory of the crest ammeter is given, and its applicability (in conjunction with the flux voltmeter) to the determination of d-c. saturation curves by means of a-c. tests in magnetic investigations is indicated.

INTRODUCTION

It is well known that the no-load losses, that is, the iron loss and exciting current, of a transformer are dependent upon the wave shape of the excitation voltage. While the Institute rules provide that the efficiency rating of transformers must be based on sine-wave operation, it is known how difficult it is to obtain sine-wave voltage on a commercial scale for the testing of transformers. Some scheme that will reduce core loss

and exciting current tests to a sine-wave basis is therefore a necessity, much more important now than it was some years ago, due primarily to the increased kv-a. capacity of transformers. This may be seen better by considering the fact that while the kv-a. capacity of transformer units has steadily increased, the kv-a. capacity of generating units used for testing them has not increased proportionately, and therefore the core-loss load on generators in testing departments is a much larger percentage of the generator capacity than was formerly the case, with the consequence that wave distortion is much larger.

In a paper presented to the Institute a year ago,² the writer described a new and accurate method for the reduction of transformer core-loss measurements to sine-wave basis, utilizing a flux voltmeter developed for

1. General Transformer Engineering Department, General Electric Company Pittsfield Mass.

2. See G. Camilli, *A Flux Voltmeter for Magnetic Tests*, *JOURNAL A. I. E. E.*, October 1926.

3. See Discussion by Mr. R. L. Sanford, *JOURNAL A. I. E. E.*, October 1926, p. 1014.

Presented at the Regional Meeting of District No. 1 of the A. I. E. E., Pittsfield, Mass., May 25-28, 1927.

that purpose by the writer. The accuracy of the meter and method was checked and endorsed by the Bureau of Standards,³ and it is understood that a number of research laboratories besides the Bureau of Standards have already adopted the scheme.

Since the successful solution of the problem of the reduction of the core-loss component of the no-load loss measurements to sine-wave basis, the writer studied the problem of the reduction of the exciting current component of the no-load measurement to sine-wave basis.

Two different methods were developed for the reduction of exciting current measurements to sine-wave basis, as follows:

Method I. In core-loss measurements, setting the voltage by the flux voltmeter,² the maximum flux density and therefore the maximum value of the exciting current are those corresponding to sine-wave voltage regardless of the wave shape of the test voltage. The effective value of the exciting current, however, will be variable with the wave shape of the test voltage.

To apply a wave-shape correction to the observed effective value of the exciting current, it would be necessary to have some applicable measure of wave distortion. Now, form factor is one kind of a measure of wave-shape distortion and is given in a simple way by the flux voltmeter, and therefore it occurred to the writer that some simple relation might exist between form factor and effective value of the exciting current. Thus, indicating the values of form factors by F , and the values of the exciting current by Y , we may write as a general equation between these two variables:

$$Y = a + bF + cF^2 + dF^3 + \dots + fF^n$$

Equations of this type are frequently used in engineering problems and are very convenient whenever it is found that the terms above the first or second power are negligible. Tests were therefore made to determine what approximation could be used, and it was found that all terms above the first power could safely be ignored; that is, the exciting current corresponding to sine-wave form factor may be extrapolated as a straight line function of the form factor.

$$\text{form factor} = 1.11 \times \frac{\text{A-c. Voltmeter reading}}{\text{Flux Voltmeter reading}}$$

In a dozen test cases, the error was not more than 1 per cent. With no correction applied, the error would have been up to 20 per cent, making the exciting current that much too high.

Method II. In the foregoing, it was mentioned that in using the flux voltmeter the maximum flux density and therefore the maximum value of the exciting current are determined. Consequently, if a transformer is tested at various voltages, observing the voltage on a flux voltmeter and the current on a crest ammeter (to be described below), points of the $B-H$ curve of the transformer are obtained. Having

the $B-H$ curve, the effective current corresponding to sine-wave voltage can be calculated.

It may appear at first as though this would be a very laborious method, but it is extremely simple. Three readings, *viz.*: one taken at full voltage, one at 86.6 per cent voltage, and one at 50 per cent voltage, (by the flux voltmeter), enable us to determine the fundamental, third-harmonic and fifth-harmonic components of the exciting current corresponding to sine-wave voltage, and, since these are the only important harmonics, their resultant gives the total effective current for sine-wave voltage. In this method, the higher harmonics are not entirely neglected, because they appear partially in the first, third and fifth harmonics by modifying their values. For greater accuracy, a larger number of readings and correspondingly larger number of harmonics may be included, but this appears to be hardly necessary. When a large number of points is

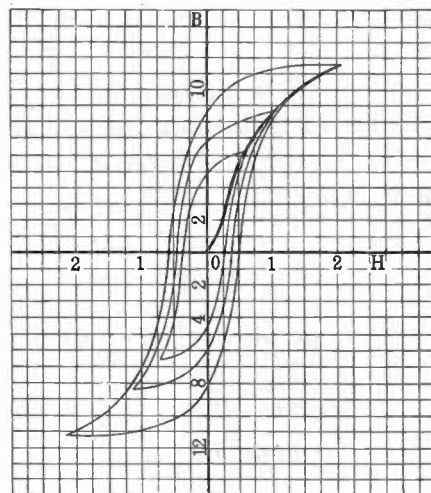

FIG. 1—H-B CURVE BY MEANS OF THE CREST AMMETER

taken, it becomes unnecessary to bring in the harmonics at all, as the r. m. s. value of the exciting current for sine-wave voltage may be calculated by taking points equi-distant in time. The harmonic idea is useful in obtaining a greater accuracy from a few points than would otherwise be possible.

The $B-H$ curve obtained by observing simultaneous values of B_{max} and I_{max} will be recognized to be the locus of the tips of the symmetrical hysteresis loops for various densities, as shown by the heavy line in Fig. 1, and therefore, intermediate between the ascending and descending branches of the loop for maximum (normal density). The error which this introduces into the exciting current calculation is that of ignoring the power component of exciting current corresponding to hysteresis loss, which ordinarily may be neglected in the value of the exciting current. The exciting current thus obtained lacks, therefore, the hysteresis loss component; and therefore, if desired, this component may be added to it as determined by the core-loss test. This refinement, however, appears to be hardly necessary, because tests show that exciting currents obtained

that the exciting current is a function of the form factor and increases with it.

Method II. In using this method, a given transformer is tested at three different voltages: *viz.*, 50 per cent, 86.6 per cent and 100 per cent (set by the flux voltmeter), and value of the current corresponding to each voltage is measured by the crest ammeter. With the help of these data the effective value of the exciting current is calculated. (See Appendix B.)

As a check to the value of the current obtained by this method, six transformers were tested also with the best wave shape available, and the results are compared below.

ACKNOWLEDGMENT

The writer is indebted to Mr. Boyajian for his personal interest and consultation in this investigation.

Let B be the value of I_{max} corresponding to 50 per cent voltage.

Let C be the value of I_{max} corresponding to 86.6 per cent voltage.

Then

$$\text{3rd harmonic} = \frac{A - 2B}{3} = I_3$$

$$\text{5th harmonic} = \frac{A - (I_3 + 1.15C)}{2} = I_5$$

$$\text{1st} = A - (I_3 + I_5) = I_1$$

From which

$$I_{\text{effective for sine wave}} = \sqrt{\frac{I_1^2 + I_3^2 + I_5^2}{2}}$$

Item	Rating	Exciting current by crest ammeter	Exciting current by conventional method, a-c. ammeter	Exciting current at sine-wave voltage	Error of conventional method, per cent	Error of crest ammeter method, per cent
(1)	H-60-2000-C-73,000-2520	79	93	78.3	19	0.9
(2)	H-60-667-C-33,000-2300/4000 Y	7.97	8.9	8.03	11	0.85
(3)	H-60-3333-C-13,200 Y-2300/4000 Y H 480	61.8	65.1	61.5	6	0.5
(4)	H-60-2000-C-69,300-2400/4160 Y-K D H	47.7	48.0	47.3	1.4	0.8
(5)	H-60-2000-C-2300-23,000	23.3	23.5	23.5	0	0.85
(6)	H-60-4000-C-23,000-4200/7260 Y	16	17.8	16	10	0

APPENDIX A

In using Method I, instead of graphical extrapolation, calculation may be made by slide rule as follows:

Calling the value of current I_1 at form factor F_1 (for instance, the higher form factor), and I_2 at form factor F_2 (the smaller form factor), the value of exciting current I at sine wave may be expressed by:

$$I_{\text{sine wave}} = I_1 - \frac{(I_1 - I_2)(F_1 - 1.11)}{F_1 - F_2}$$

APPENDIX B

In using Method II (the crest ammeter method), the effective value of the exciting current is found from the peak values of the exciting current corresponding to 50 per cent, 86.6 per cent and 100 per cent rated voltage of the transformer. The following method gives in a simple way the fundamental, third and fifth harmonics by means of which it is possible to calculate the effective value of their resultant. Example:

Let A be the value of I_{max} corresponding to 100 per cent voltage.

FARM ELECTRIFICATION IN ITALY

Agriculture in Italy is under the handicap of either too much or too little water. In some districts the seasonal rains would be quite sufficient if the water could be used to benefit the crops, but instead it flows away leaving the soil dry. In other places, the land is swampy and the excess of water must be removed before it can be efficiently utilized. As a result, even under the most favorable conditions, Italy, which is a wheat-consuming nation, is obliged to supplement its own wheat production by heavy imports. The wheat crop sometimes varies as much as 40 per cent, having produced 4,400,000 tons in 1922 and 6,120,000 tons in 1923, although the area under cultivation remained practically unchanged.

In northern Italy, where the water supply is better than in other parts, the greatest progress has been in the use of electricity. A network of transmission exists and the availability of electric energy is greater during the summer months when agricultural activity is also greatest. In this section of the country electricity has been applied to many purposes including pumping of water, plowing, harrowing, threshing, and fodder cutting.—*Commerce Reports.*

Mechanical Forces Between Electric Currents and Saturated Magnetic Fields

BY VLADIMIR KARAPETOFF¹

Fellow, A. I. E. E.

Synopsis.—The general case considered is that of N independent electric circuits placed in a medium of variable permeability and subject to saturation, in parts or as a whole. The problem is to determine the component (in a given direction) of the mechanical force acting upon one of the electric circuits, upon a group of circuits, or upon a group of circuits with part of the magnetic medium rigidly attached to them. It is believed that the problem has not been solved in this general form heretofore.

Use is made of the expression for the stored electromagnetic energy, W , of the system, assuming all the electric circuits to be originally open and then closed one by one. Such a treatment necessitates a number of partial saturation curves, giving the linkages with each individual electric circuit when some of the remaining circuits are closed and the rest are open. A virtual displacement,

δs , is then given to the part of the system under consideration, keeping either the linkages or the currents constant, and the mechanical force, F , is determined from a comparison of the work done, $F \cdot \delta s$, with the change in the stored energy, δW .

It is shown that the familiar reciprocal relationship for the mutual inductance, $M_{12} = M_{21}$, which holds true in a medium without saturation, can be generalized to a more involved integral expression for a saturated medium.

In order to connect the general treatment with the simpler cases previously solved in the literature of the subject, some intermediate cases of one and two circuits are considered, especially those of importance in applications. The substance of the general method used was presented before the American Physical Society, at the Philadelphia Meeting, in December, 1926.

INTRODUCTION

CONSIDER a system of stationary linear electric circuits in each of which a steady direct current is maintained by a suitable source of energy. Let these circuits be sufficiently close to each other to influence each other's magnetic fields. For the sake of generality, assume the medium to be of variable permeability; that is, let the permeability at a point be a scalar function of the position of the point. Moreover, let the medium be subject to saturation; that is, let the permeability be a function of the resultant flux density at that point.

Generally speaking, the system can be maintained in its given position only by some external mechanical forces or constraints, preventing the individual circuits from moving into a more stable position in the direction of maximum stored energy. The problem is to find the values of these mechanical forces for any individual circuit or part of the system. Since each circuit may require a force and a couple to hold it stationary, the problem may be formulated thus: To find the magnitude of the projection of the force (or of the turning couple) with which a given circuit tends to move along (or to rotate about) a given axis.

In its most general form, with variable permeability and saturation, the solution of the problem leads to quite complicated equations. Moreover, many less general cases are of greater importance in actual applications, and a physical interpretation of more general cases is facilitated by a previous study of simpler combinations. For these reasons, the treatment in this article follows the order "from specific to general," even though a treatment in the opposite order might have been somewhat shorter. The notation and the

units are those used in the writer's "Magnetic Circuit," (McGraw-Hill Book Co.), and the references are to the pages of that book, unless stated otherwise.

IA. A SINGLE CIRCUIT IN A MEDIUM OF CONSTANT PERMEABILITY

Consider the coil shown on page 178. The electromagnetic energy stored in it is expressed by equation

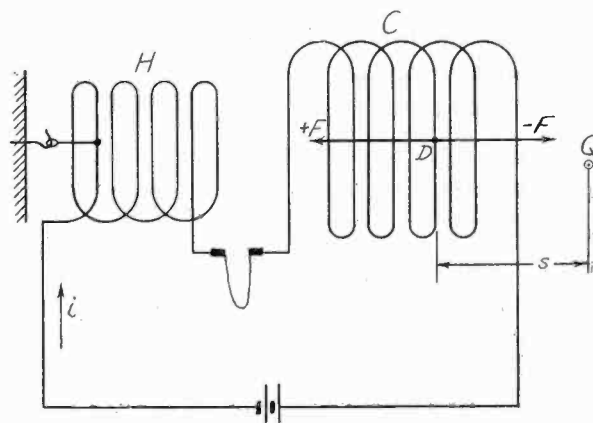

Ba
FIG. 1

(102a), and from this expression, together with the definition

$$W = 0.5 L i^2 \quad (1)$$

follow equations (105) and (106) for the coefficient of self-inductance. The same expressions hold true, in a medium of constant permeability, for an electric circuit of any form, not necessarily a coil.

Let a circuit, Fig. 1, be of such a shape that its movable part, C , tends to approach the stationary part, H , with a force, F , unless held in place by an external force, $-F$. It is shown on page 251, equation (182), that

$$F = 0.5 I^2 \delta L / \delta s \quad (2)$$

where s is the distance from an arbitrarily chosen

1. Professor of Electrical Engineering, Cornell University, Ithaca, N. Y.

Presented at the Regional Meeting of District No. 1 of the A. I. E. E., Pittsfield, Mass., May 25-28, 1927.

fixed origin Q to some point D on the part C of the circuit. In other words, s is a coordinate which determines the position of C , and s increases when the two parts of the circuit come closer together².

If left to itself and not stopped by H , the part C of the circuit will finally come into a position in which $F = 0$, and since in this position there is no force tending to move C any farther, the motion will stop. The condition $F = 0$ means $\delta L / \delta s = 0$, or $L = \text{max}$. Thus, a circuit tends to assume a position of maximum inductance, or, with a constant current, that of maximum stored energy.

With a non-linear deformable conductor, such as a bath of mercury or of molten metal, the mechanical forces tend to modify the shape of the body of the liquid for a maximum of stored electromagnetic energy, consistent with the shape of the container. The tendency is to increase the length and to contract the cross-section³. In some cases this tendency for maximum flux linkages results in a continuous motion, as in a homopolar motor. With liquid conductors, such a motion has been utilized for automatically stirring molten metal in an electric furnace⁴. The writer fully recognizes the value of the late Dr. Hering's ingenious experiments and of his work on electric furnaces; he only does not see the necessity for a new "law" to interpret the observed phenomena. As has been pointed out by several persons in the discussion of the above paper, the relationship expressed by eq. (2) is sufficient to interpret the observed forces and motions.

IB. A SINGLE CIRCUIT IN A MEDIUM WHOSE PERMEABILITY VARIES FROM POINT TO POINT, BUT IS INDEPENDENT OF THE FLUX DENSITY

In such a medium, magnetic lines of force obey the law of refraction (page 119). With the same exciting circuit, the magnetic field has a shape different from that in a medium of constant permeability. Nevertheless, all the flux densities are proportional to the exciting m. m. fs., and the field retains its general shape as the m. m. f. is increased. Consequently, eqs. (1) and (2) still hold true, but values of L have to be determined for the actual elementary permeances as they enter in eq. (105) or (106).

As a simple example, consider the lifting magnet shown on page 243. Let the reluctances of all the iron parts be constant and let their sum be denoted by \mathcal{R}_1 . Then, if the length of the air-gap is a , the total reluctance of the magnetic circuit is

$$\mathcal{R} = \mathcal{R}^{-1} = \mathcal{R}_1 + (a/\mu) (S_1^{-1} + S_2^{-1}) \quad (3)$$

and

2. In this investigation, the variation sign δ is used to indicate a change with respect to s . The differential sign d is reserved to indicate a change with respect to the current.

3. For some ingenious experiments illustrating spontaneous adaptation of various circuits to a shape of maximum energy storage, see Carl Hering, *TRANS. A. I. E. E.*, 1923, Vol. 42, p. 321.

4. *Ibid.*, Bibliography on p. 326.

$$\begin{aligned} \delta \Phi / \delta s &= - \delta \Phi / \delta a = - \delta (\mathcal{R}^{-1} / \delta a) \\ &= \mathcal{R}^{-2} (S_1^{-1} + S_2^{-1}) / \mu \end{aligned} \quad (4)$$

Hence, disregarding the change in the partial linkages, eq. (2) gives

$$F = 0.5 I^2 n^2 \mathcal{R}^{-2} (S_1^{-1} + S_2^{-1}) / \mu \quad (5)$$

But $I n \mathcal{R}^{-1}$ is the total flux of complete linkages and $I n \mathcal{R}^{-1} S_1^{-1}$ is the corresponding flux density in the inner air-gap. Hence, eq. (5) may also be written in the form

$$F = 0.5 B_1^2 S_1 / \mu + 0.5 B_2^2 S_2 / \mu \quad (6)$$

which agrees with eq. (169), and is the usual formula for the supporting force of a lifting magnet.

IC. A SINGLE CIRCUIT IN A COMPOSITE MEDIUM, PART OF WHICH IS SUBJECT TO SATURATION

Let now a coil or an electric circuit of any kind be placed in a position where the magnetic lines of force are partly in the air, partly in iron, the latter being somewhat saturated at the assumed values of electric current. To determine the mechanical force F between some two parts of the magnetic circuit, we shall assign to these parts a virtual relative displacement δs in the desired direction s , and let this displacement occur at a constant current.

If δs has a component in the direction of the longitudinal tension along the lines of force, the flux and the stored energy will be greater in the final than in the initial position. We then have for the final position:

$$e I \delta t = F \delta s + \delta W \quad (7)$$

where $-e$ is the voltage induced in the circuit during the displacement, and $+e$ is the voltage applied from an external source to keep the current constant; δt is the interval of time during which the displacement occurs, and δW is the increase in the stored electromagnetic energy.

In Fig. 2, let OA be the saturation curve of the circuit in the initial position and OA' that in the final position. The current, i , is plotted as abscissas and the corresponding flux linkages, ϕ , as ordinates. By ϕ is meant the sum of the fluxes linking with the individual turns. For example, if the circuit consists of three turns, and the actual fluxes linking with these turns are 3, 2.5, and 2.7 kilolines respectively, then $\phi = 8.2$ kilolines. The actual value of the current at which the force F is to be determined is I and the corresponding sum of the linkages is Φ .

Since the magnetic flux is a function of both the current i and the position s , it is necessary to distinguish between two increments of ϕ , which in Fig. 2 are denoted by $d\phi$ and $\delta\phi$ respectively. The increment $d\phi$ is the increase in the linkages, at a constant s , when the current increases from i to $i + di$. The increment $\delta\phi$ is the increase in the linkages, at a constant current i , when s is changed to $s + \delta s$. If $d\phi$ be called the differential of ϕ , then $\delta\phi$ is the variation of ϕ . In equation (7)

$$e = \delta \Phi / \delta t \quad (8)$$

the symbol δ signifying that the current I is kept constant while s varies.

To find an expression for the stored magnetic energy, it is necessary to compute the electric energy put into the circuit to establish the current I in the position s . During the process of building up the current, let the linkages increase by $d\phi$ when the current increases from i to $i + di$. This is shown by the lengths cg and gh in Fig. 2. The induced voltage is $-d\phi/dt$ and the electric energy supplied by the external source is

$$i (d\phi/dt) dt = i d\phi \tag{9}$$

This energy is represented in Fig. 2 by the strip $abhc$. The total stored energy in the position s is

$$W = \int_0^I i d\phi \tag{10}$$

and is proportional to the area $CNOcC$. The energy

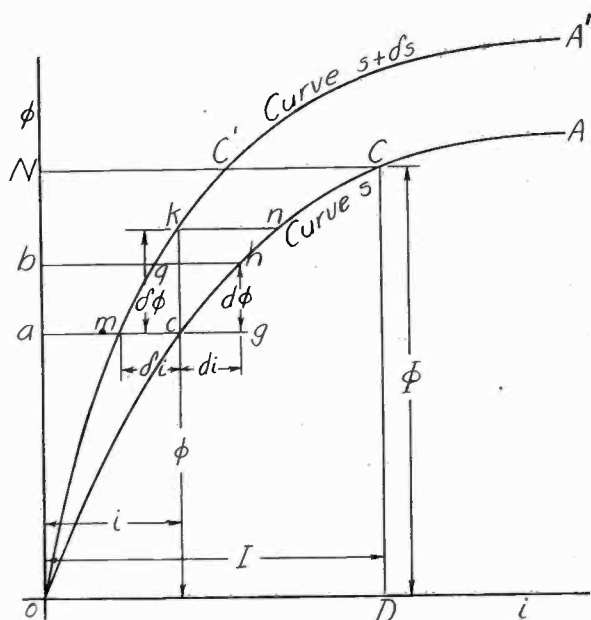

FIG. 2

in the position $s + \delta s$, at the same current I , differs from W by the amount

$$\delta W = \int_0^I i \delta d\phi \tag{11}$$

which is obtained from eq. (10) by partial differentiation with respect to s .

It is permissible in this case to put the variation symbol δ under the integral sign, since the limits of integration are independent of ϕ or i .

Substituting now the expressions (8) and (11) in eq. (7), we get

$$I \delta \phi = F \delta s + \int_0^I i \delta d\phi \tag{12}$$

or, solving for F ,

$$F = I (\delta \phi / \delta s) - \int_0^I i d (\delta \phi / \delta s) \tag{13}$$

In this expression, the symbols δ and d are interchanged under the integral sign, in accordance with the fundamental theorem of the Calculus of Variations;

namely, that the variation of a differential is identically equal to the differential of the variation⁵. Using on the right hand side of eq. (13) the familiar transformation

$$\int x dy = xy - \int y dx \tag{13a}$$

we finally obtain

$$F = \int_0^I (\delta \phi / \delta s) di \tag{14}$$

Equation (14) can also be proved by assuming the virtual displacement to occur at constant linkages, that is, under the condition

$$\delta \phi = 0 \tag{14a}$$

With this assumption there is no interchange of energy between the electric source and the magnetic circuit, so that the mechanical work is done at the expense of the stored magnetic energy. We therefore have

$$F \delta s + \delta W = 0$$

or

$$F \delta s + \int_0^I i d \delta \phi = 0 \tag{14b}$$

Integrating in parts, this becomes

$$F \delta s + I \delta \phi - \int_0^I \delta \phi di = 0 \tag{14c}$$

According to eq. (14a), the middle term is equal to zero. Solving for F , eq. (14) is obtained⁶.

The area of the strip $C'Oc$ may be thought of as consisting of elementary parallelograms, such as $mghc$. The area of this parallelogram is $-\delta i \cdot d\phi$, the minus sign being necessary because δi is a negative quantity. Hence, according to formula (44) in the Appendix, we have

$$F = - \int_0^\Phi (\delta i / \delta s) d\phi \tag{14d}$$

This is a useful modification of formula (14).

If ϕ is given as a function of both i and s , all the operations on the right hand side of eq. (14) may be performed, at least approximately, and the value of F determined. When the force is a simple tension in a small air-gap, as in Fig. 58, it is not necessary to use eq. (14). The force can be computed according to eq. (169) even though the core is saturated. Some inaccuracy is introduced, however, in those lines of force which are not normal to the faces of the air-gap.

When saturation is negligible, eq. (14) becomes identical with eq. (2) because in this case

$$\phi = iL \tag{15}$$

so that

$$\delta \phi / \delta s = i \delta L / \delta s \tag{16}$$

5. In this particular case, the truth of this statement may be seen directly from the fact that $d^2\phi/di ds = d^2\phi/ds di$, the value of the second derivative being independent of the order of differentiation.

6. See Appendix.

Thus eq. (14) becomes

$$F = \int_0^I (\delta L / \delta s) i di.$$

Without saturation, L is independent of i , so that $\delta L / \delta s$ may be taken outside the integral sign. The result is

$$F = 0.5 I^2 (\delta L / \delta s) \quad (17)$$

which is identical with eq. (2).

IIA. TWO CIRCUITS IN A COMPOSITE MEDIUM WITH CONSTANT PERMEABILITIES

Let there be two separate circuits, 1 and 2, each supplied with a constant direct current from a separate source. Let the medium be partly air and partly iron, the permeability of the latter being assumed to be constant for all flux densities, from zero to the highest for which the mechanical force is to be computed.

The first step is to determine the magnetic energy stored in the system. Let the circuit 2 be in place, excited with the final value of its current, I_2 , and let the circuit 1 be initially open. When the switch of the circuit 1 is closed, let the voltage of the source 2 be so regulated that the current I_2 remains constant while the current in the circuit 1 rises from zero to its final value I_1 . Let M_{12} be the sum of the flux linkages in circuit 2, due to one ampere in circuit 1. Then the instantaneous voltage induced in the circuit 2, when the current in circuit 1 increases from some value i_1 to $i_1 + di_1$, is $-M_{12} di_1 / dt$. Hence, the total energy furnished by the source 2 to keep the current I_2 constant, is

$$W_{12} = I_2 \int_0^{I_1} M_{12} (di_1 / dt) dt = M_{12} I_1 I_2 \quad (18)$$

Therefore, the total stored energy of the system is

$$W = 0.5 I_1^2 L_1 + M I_1 I_2 + 0.5 I_2^2 L_2 \quad (19)$$

In this expression, the subscript of M has been omitted because $M_{12} = M_{21}$; that is, the coefficient of mutual inductance (or the sum of mutual magnetic linkages per unit current) is the same for both circuits. This follows from the symmetrical form of eq. (19). Had we started with the current I_1 at its full value and increased I_2 from zero to its final value, we would have obtained an identical formula, with M_{21} in place of M_{12} . But, without hysteresis, the phenomenon is reversible, and the total stored energy cannot depend on the manner in which the system has been established, so that W is the same in both cases; consequently $M_{12} = M_{21}$, and can be simply denoted by M .

Let now a part of the system be given a virtual displacement δs , while the rest of the system is kept stationary. Both currents are to be kept constant during the motion. The displaced part may include one of the coils and some iron, or only one of these. If a coil and an iron part are moved, they are supposed to be mechanically joined together, and the force F is that necessary to move the combination. Generally speak-

ing, such a displacement will modify the values of L_1 , L_2 , and M , since the position of the coils with respect to the iron masses will be changed and the flux distribution will be different. The energy furnished by the electrical source 1 during the displacement will be

$$I_1 (I_1 \delta L_1 + I_2 \delta M),$$

while that furnished by the source 2 will be

$$I_2 (I_2 \delta L_2 + I_1 \delta M).$$

The increase in the stored energy, according to eq. (19), is

$$0.5 I_1^2 \delta L_1 + I_1 I_2 \delta M + 0.5 I_2^2 \delta L_2.$$

Hence, we have

$$F \delta s + (0.5 I_1^2 \delta L_1 + I_1 I_2 \delta M + 0.5 I_2^2 \delta L_2) \\ = I_1 (I_1 \delta L_1 + I_2 \delta M) + I_2 (I_2 \delta L_2 + I_1 \delta M) \quad (20)$$

or, after reduction,

$$F = 0.5 I_1^2 \delta L_1 / \delta s + I_1 I_2 \delta M / \delta s + 0.5 I_2^2 \delta L_2 / \delta s \quad (21)$$

This is a generalized form of Kelvin's law, to the effect that (with constant currents and constant permeabilities) the energy supplied by the electric sources during a displacement is divided into two equal parts. One half is converted into mechanical work; the other half increases the stored magnetic energy of the system. Conversely, if mechanical work is done on the system, pulling it apart, the energy returned to the sources is equal to twice the mechanical work done, the other half coming from the reduction in the stored magnetic energy.

When all media are of the same permeability, a relative motion of the coils does not alter their self-inductances, and the preceding equation is simplified to

$$F = I_1 I_2 \delta M / \delta s \quad (22)$$

which is the one usually given in treatises on physics.⁷ If the coil 1 is displaced without moving the iron parts, the last term in eq. (21) is equal to zero. The same is true if an iron part is so moved as to leave the value of L_2 unchanged.

IIB. TWO CIRCUITS; PART OF THE MEDIUM SUBJECT TO SATURATION

This is an extension of the case treated under IC above. The equations of stored energy, corresponding to eq. (19), are

$$W = \int_0^{I_1} i_1 d\phi_{12} + I_2 (\Phi_{21} - \Phi_{20}) + \int_0^{I_2} i_2 d\phi_{20} \quad (23)$$

$$W = \int_0^{I_2} i_2 d\phi_{21} + I_1 (\Phi_{12} - \Phi_{10}) + \int_0^{I_1} i_1 d\phi_{10} \quad (24)$$

In eq. (23), it is assumed that in the circuit 2 the current is first brought up to its full value, I_2 , while the circuit 1 is open. The last term on the right-hand side expresses the energy stored in the circuit 2 under these conditions, this term being identical with eq. (10).

7. See, for example, J. C. Maxwell, *Electricity and Magnetism*, Vol. II, p. 151; J. H. Jeans, *Electricity and Magnetism*, edition of 1920, p. 495; Alex. Russell, *Alternating Currents*, Vol. I, p. 40.

The subscript 20 (read two-o) means "linkages of the circuit 2 when the current in circuit 1 is zero." When the current in the circuit 1 is increased from zero to its final value, I_1 , the flux linkages of the circuit 2 are changed from Φ_{20} to Φ_{21} , where the subscript 2 again indicates circuit 2, and the subscripts 0 and 1 indicate the initial and the final values (0 and I_1) of the current in circuit 1. Since the change in the linkages occurs at a constant current I_2 , the amount of energy furnished by the source 2 is $I_2 (\Phi_{21} - \Phi_{20})$. This is the middle term on the right-hand side of eq. (23). The energy stored in the circuit 1 is given by the first term on the right-hand side. During the interval of time when the flux linking with this circuit is being built up, the current I_2 remains constant, as indicated by the double subscript 12. Eq. (24) is obtained from eq. (23) by interchanging the subscripts 1 and 2. On the supposition that the phenomenon is reversible and the value of the total stored energy is the same, no matter which circuit is closed first, the left-hand sides of both equations are denoted by the same symbol W .

Equating the right-hand sides of eqs. (23) and (24), we obtain the following "reciprocal" relationship:

$$\int_0^{I_1} i_1 d \Delta \phi_1 + I_2 \Delta \Phi_2 = \int_0^{I_2} i_2 d \Delta \phi_2 + I_1 \Delta \Phi_1 \quad (25)$$

where

$$\Delta \phi_1 = \phi_{12} - \phi_{10} \quad (26a)$$

and

$$\Delta \phi_2 = \phi_{21} - \phi_{20} \quad (26b)$$

The symbol Δ in application to ϕ_1 stands for the increase in the linkages of circuit 1 due to an increase in the current i_2 from 0 to I_2 , the current i_1 remaining constant. In application to ϕ_2 the symbol Δ stands for the increase in the linkages of circuit 2 at a constant current i_2 , when i_1 is changed from 0 to I_1 .

Applying the transformation (13a) to the two integrals in eq. (25), we obtain after reduction

$$\int_0^{I_1} \Delta \phi_1 d i_1 = \int_0^{I_2} \Delta \phi_2 d i_2 \quad (27)$$

Eq. (27) is a generalized form of the relationship $M_{12} = M_{21}$, when saturation is to be taken into consideration. Four saturation curves must be thought of in connection with eqs. (25) and (27), namely,

- between i_1 and ϕ_1 when $i_2 = 0$
- between i_1 and ϕ_1 when $i_2 = I_2$
- between i_2 and ϕ_2 when $i_1 = 0$
- between i_2 and ϕ_2 when $i_1 = I_1$

Eq. (25) or (27) gives a necessary physical condition which these four curves satisfy.

Without saturation, $\Delta \phi_1 = M_{12} I_2$, and $\Delta \phi_2 = M_{21} I_1$. Eq. (27) simply becomes: $M_{12} I_2 I_1 = M_{21} I_1 I_2$, or $M_{12} = M_{21}$.

Using the value of δW from eq. (23), the condition expressed by eqs. (7) and (20) can now be generalized as follows:

$$F \delta s + \int_0^{I_1} i_1 \delta d \phi_{12} + I_2 (\delta \Phi_{21} - \delta \Phi_{20}) + \int_0^{I_2} i_2 \delta d \phi_{20} = I_1 \delta \Phi_{12} + I_2 \delta \Phi_{21} \quad (28)$$

Cancelling $I_2 \delta \Phi_{21}$ on both sides of this equation, and using the transformation (13a), we get

$$F = \int_0^{I_1} (\delta \phi_{12} / \delta s) d i_1 + \int_0^{I_2} (\delta \phi_{20} / \delta s) d i_2 \quad (29)$$

In eq. (28), expression (23) for W is used. If eq. (24) be used instead, the subscripts 1 and 2 in eq. (29) would become interchanged, and we should get

$$F = \int_0^{I_2} (\delta \phi_{21} / \delta s) d i_2 + \int_0^{I_1} (\delta \phi_{10} / \delta s) d i_1 \quad (30)$$

Eqs. (29) and (30) are the general expressions for the mechanical force between two electric circuits in a medium subject to saturation. Since eq. (30) may be obtained by combining eqs. (29) and (27), expressions (29) and (30) are identical.

As a special case, and as a check on these formulas, consider the condition of no saturation. Then

$$\phi_{12} = L_1 i_1 + M I_2 \quad (31)$$

and

$$\phi_{20} = i_2 L_2. \quad (32)$$

Hence,

$$\delta \phi_{12} / \delta s = i_1 \delta L_1 / \delta s + I_2 \delta M / \delta s \quad (33)$$

$$\delta \phi_{20} / \delta s = i_2 \delta L_2 / \delta s \quad (34)$$

Substituting these values in eq. (29), and remembering that L_1, L_2, M , are independent of i_1 and i_2 , we get

$$F = (\delta L_1 / \delta s) \int_0^{I_1} i_1 d i_1 + I_2 (\delta M / \delta s) \int_0^{I_1} d i_1 + (\delta L_2 / \delta s) \int_0^{I_2} i_2 d i_2 \quad (35)$$

After integration, this expression becomes identical with eq. (21).

In order to perform the operations indicated in eq. (29), ϕ_{12} and ϕ_{20} must be given as functions of the distance s and of the currents i_1 and i_2 . Such saturation curves, for different values of s , can either be estimated by computation or obtained from test. The value of F can then be determined graphically to a desired degree of accuracy. Or else, ϕ_{12} and ϕ_{20} may be expressed as empirical functions of s, i_1 , and i_2 , and the integrations performed analytically.

III A. N SEPARATE CIRCUITS IN A COMPOSITE MEDIUM WITH CONSTANT PERMEABILITIES

This is a generalization of the Case IIA. The first step is to compute the total stored electromagnetic energy. Let the circuit 1 be closed first, then the circuit 2, etc. With two circuits, the total stored energy is expressed by eq. (19). When the circuit 3 is closed, its own stored energy, $0.5 I_3^2 L_3$, is added, and more energy must be furnished by the sources 1 and 2 in order to keep the corresponding currents constant

during the transient period. These latter amounts of energy are equal to $I_1 I_3 M_{13}$ and $I_2 I_3 M_{23}$ respectively. Thus, the total stored energy of the three circuits is

$$W = 0.5 I_1^2 L_1 + 0.5 I_2^2 L_2 + 0.5 I_3^2 L_3 + M_{12} I_1 I_2 + M_{23} I_2 I_3 + M_{31} I_3 I_1 \quad (35a)$$

Extending the same process to N circuits, we may write

$$W = 0.5 \sum I_k^2 L_k + \sum I_k I_u M_{ku} \quad (36)$$

In this expression, k and u have all the integer values from 1 to N inclusive, and in the second summation the subscripts correspond to *combinations*, and not to permutations. This means that if, for example, the values of $k = 2$ and $u = 5$ have been used in a term, the values $k = 5$ and $u = 2$ cannot be used any more.

Let now some of the circuits be combined into a subsystem, and be given a common virtual displacement, δs , with respect to the remaining circuits, all the currents being kept constant. For the sake of generality, assume that this displacement causes a change not only in the coefficients of mutual inductance, but in those of self-inductance as well. The energy furnished by the electric source in the k th circuit is

$$\delta W_k = I_k [I_k \delta L_k + \sum I_v \delta M_{kv}] \quad (37)$$

Here v denotes any circuit except the k th; that is, v has all the integer values from 1 to $k - 1$ and from $k + 1$ to N . Eq. (20) becomes

$$F \delta s + 0.5 \sum I_k^2 \delta L_k + \sum I_k I_u \delta M_{ku} = \sum I_k^2 \delta L_k + \sum \{I_k \sum I_v \delta M_{kv}\} \quad (38)$$

The last summation on the right-hand side of this equation contains the same terms as the last summation on the left-hand side, only each term enters twice, because each source of voltage is here considered separately. Thus, we find that Kelvin's law holds true also in this case, and by analogy with eq. (21) we may write

$$F = 0.5 \sum I_k^2 \delta L_k / \delta s + \sum I_k I_u \delta M_{ku} / \delta s \quad (39)$$

Depending on the particular circuit or circuits for which the force F is sought, the derivatives $\delta L / \delta s$ and $\delta M / \delta s$ have different values. Thus, it may be required to determine the mechanical force acting on a winding alone, or on a winding with the corresponding iron core, etc. In each case a virtual displacement must be assumed to take place for the part or parts under consideration, with respect to the rest of the system.

IIIB. N CIRCUITS; PART OF THE MEDIUM SUBJECT TO SATURATION

This is an extension of the case treated under IIB. The method is the same, only the subscripts become more numerous and involved. For this reason, it has been deemed sufficient to show the deduction of the final formula in application to three circuits only, since with N circuits each flux ϕ would have a subscript consisting of N numbers of different order. An extension of the reasoning given below to four or more circuits is quite evident, and the final formula for N circuits is written directly.

To compute the stored energy, we shall assume that the circuit 1 is closed first, then circuit 2, and finally circuit 3. By analogy with eq. (24), changing somewhat the order of the terms, we may write the following expression for the total stored energy corresponding to the final values of the currents:

$$W = \int_0^{I_1} i_1 d\phi_{100} + \int_0^{I_2} i_2 d\phi_{210} + \int_0^{I_3} i_3 d\phi_{312} + I_1 (\Phi_{123} - \Phi_{100}) + I_2 (\Phi_{213} - \Phi_{210}) \quad (40)$$

In this expression, the first integral represents the energy stored in circuit 1 when $i_2 = i_3 = 0$. The subscript 100 (read one-o-o) means "flux linkages in circuit 1, when the currents in the other two circuits are equal to zero." The second integral represents the energy stored in circuit 2 when the current in the circuit 1 has already reached its full value, while that in circuit 3 is still equal to zero. This is indicated by the subscript 210. The third integral represents the energy stored in circuit 3, and the subscript 312 indicates that the currents i_1 and i_2 have reached their maximum values.

The term $I_1 (\Phi_{123} - \Phi_{100})$ represents the energy furnished by the source 1 in order to keep the current I_1 constant when the currents in the other two circuits are being increased from zero to their final values. Similarly, the last term gives the energy furnished by the source 2 when the circuit 3 is closed.

Let now a virtual displacement, δs , be allowed to occur in one part of the system with respect to the other, keeping all the currents constant. The energy furnished by the three sources is equal to

$$I_1 \delta \Phi_{123} + I_2 \delta \Phi_{213} + I_3 \delta \Phi_{312}.$$

Writing an equation similar to eq. (28), and using the transformation (13a), we get, by analogy with eq. (30) with a reversed order of terms:

$$F = \int_0^{I_1} (\delta \phi_{100} / \delta s) d i_1 + \int_0^{I_2} (\delta \phi_{210} / \delta s) d i_2 + \int_0^{I_3} (\delta \phi_{312} / \delta s) d i_3 \quad (41)$$

In order to determine F from this equation, the flux linkages ϕ_{100} , ϕ_{210} , and ϕ_{312} must be given as functions of s and of the corresponding currents. In practical cases, advantage may be taken of certain simplifications due to the arrangement of the circuits or to the particular shape of the saturation curves. Since the total stored energy is independent of the order in which the circuits are closed, certain "reciprocal" relationships must hold true. These may be deduced by analogy with eqs. (25) and (27).

Extending now the formula (41) to N circuits, we get

$$F = \sum_0^{I_k} (\delta \phi_q / \delta s) d i_k \quad (42)$$

This expression consists of a sum of N integrals corresponding to the values of k from 1 to N . The subscript q is as follows:

$$q = k(k-1) \dots 21000 \dots \quad (43)$$

This means that for the k th circuit the saturation curve between i_k and ϕ_k , used in eq. (42), must be the one which obtains with the currents $I_k, I_{k-1}, I_{k-2}, \dots, I_2, I_1$ at their full values, while the currents $i_{k+1}, i_{k+2}, \dots, i_n$, are all equal to zero.

Literature References. Comparatively little has been done on the general theory of mechanical forces in magnetic circuits, especially taking saturation into account. Some recent articles, of applied nature, are listed below. References to earlier contributions will be found in these articles.

Doherty and Park, *Mechanical Force between Electric Circuits*; Am. Inst. Elec. Engrs., TRANS., 1926, Vol. 45, p. 240.

Lehmann, *The Calculation of Magnetic Attraction*; Ibid., p. 383.

Hague, "Forces Acting on Conductors Near Iron;" *World Power*, 1926, Vol. 5, pp. 124 and 205.

Hak, "Calculation of Mechanical Stresses in Reactance Coils;" *Elek. u. Masch.*, 1924, Vol. 42, p. 17.

Liénard, *Revue Gen. de l'Elec.*, 1923, Vol. 14, p. 563.

Appendix

It is shown in connection with eq. (10) that the magnetic energy stored in a saturated circuit (Fig. 2) is represented by the area $CNOcC$. Similarly, the stored magnetic energy, after the displacement, δs , has taken place, is proportional to the area $C'NOmC'$. When this displacement occurs at constant linkages ϕ , the mechanical work is done entirely at the expense of the stored magnetic energy. Consequently, the curved infinitesimal strip $C'OC$ represents the work done, $F \delta s$, so that

$$F = (\text{area of strip } C'OC) / \delta s \quad (44)$$

This expression permits the visualization of the relations and also the solution of some special cases. Consider, for example, a saturated electromagnet with a small air-gap (a lifting magnet). Within a certain range of small values of air-gap, the lines of force in the gap may be assumed to be straight lines, normal to the iron surfaces, and the flux in the iron parts may be considered to follow the same paths and to have the same leakage, independent of the magnitude of the gap. In other words, within a certain range of gaps, the same saturation curve may be used for the iron, and only the exciting ampere-turns for the air-gap changed. With this limitation, the area of the strip $C'OC$ may be obtained from the air characteristic alone. For the air-gap we have

$$IT = (\phi/T) (s_o - s) / (\mu A) \quad (45)$$

where IT are the exciting ampere-turns; s_o and s are some distances whose difference gives the length of the air-gap; A is the cross-section of the magnetic path in the air-gap, and μ the absolute permeability of the air. T being the number of turns, the linkages ϕ divided by T give the actual flux. From eq. (45)

$$T \delta I = - (\phi/T) \delta s / (\mu A) \quad (46)$$

With the foregoing assumptions, the strip $C'OC$ becomes a triangle, so that

$$\text{area } C'OC = - 0.5 \delta I \cdot \phi. \quad (47)$$

The minus sign is necessary because δI is a negative quantity. Substituting this expression in eq. (44), and using for δI its value from eq. (46), we get

$$F = 0.5 A B^2 / \mu \quad (48)$$

where B is the flux density in the air-gap. Expression (48) is the usual formula for the lifting force of an electromagnet.

The same result may be obtained from eq. (14d). With the limitations stated above, the saturation curve for the whole electromagnet may be written in the form

$$Ti = \psi(\phi) + (\phi/T) (s_o - s) / (\mu A) \quad (49)$$

where the function $\psi(\phi)$ is the m. m. f. required for the iron parts. At a constant ϕ ,

$$\delta i / \delta s = - (\phi/T^2) / (\mu A) \quad (50)$$

Substituting in eq. (14d) and integrating, will give eq. (48).

PORTABLE LAMPS DEMONSTRATE DESIRABILITY OF SHADED LIGHT

It has taken certain branches of the electrical industry interested in lighting a long time to learn that more and better lighting involves proper shading and diffusing of light. For example, lighting fixtures have been designed and sold without shades. Even some "modern electrical homes" have been opened to the public without demonstrating the desirability of shades on certain brackets and ceiling fixtures. After years of effort on the part of certain exponents of good lighting the electrical industry is beginning to awaken and bestir itself to the commercial possibilities of better lighting. The homes of this country need more light, but this cannot be sold easily and permanently unless the principles of good lighting are used as a vehicle.

The public is not alone in its ignorance and indifference. Many persons in companies which are in a position to aid the better lighting activity in the residential field are not conscious of the value of shaded light. To these the portable lamp conveys a convincing message. Many millions of these are entering the homes yearly. They have combined decorative and utilitarian value. The public has accepted them without much effort on the part of organizations promoting better lighting. Would they be acceptable if they were not equipped with shades?

Every dealer or salesman who is not convinced that shaded light is of primary importance should take the shades off the portable lamps in his home. How unbearable would he find this condition of glaring light! Then he might try to sell portable lamps without shades. Again he would learn a lesson.—*Electrical World*.

The Most Economical Power Factor

A Practical Design Formula for Distribution Circuits

BY H. S. LITCHFIELD¹

Associate, A. I. E. E.

Synopsis.—The use of power factor corrective devices on distribution circuits is justified, under certain conditions, by rather substantial savings in investment charges and by a reduction in the power losses of the system. The object of the present paper is to develop a practical working formula for calculating the most economical corrected power factor for a distribution circuit. Most economical conditions are assumed when the total of such annual circuit costs as are directly affected by a change in power factor, is a minimum.

The usual methods for computing separately, the saving in $I^2 R$ losses and the decrease in investment charges due to power factor improvement, are inadequate. Particularly in the design of new circuits and extensions has the need for a more accurate method for calculating optimum power factor and conductor sizes been expressed.² Since these equations were originally worked out, two other solutions for the most economical corrected power-factor angle have been published, each having been obtained independently of the other. Menjelou³ obtained his formula in the form:

$$\alpha \sin \theta = 1 - \beta \tan \theta$$

in which θ is the power-factor angle and α and β are constants computed from the circuit costs. Stevenson⁴ obtained a similar expression:

$$\sin \theta = \delta - \eta \tan \theta$$

the difference lying in the constants to be evaluated.

The equation developed in this paper reduces to the simple form:

$$\sin \theta = \text{unit cost ratio}$$

That is, the sine of the most economical corrected power-factor angle is determined by the ratio of the annual cost of condenser capacity per reactive kilovolt-ampere of correction to the annual cost (fixed charges plus value of losses) per kilovolt-ampere delivered, of that portion of the supply circuit which is directly affected by the change in power factor. When the unit cost ratio is greater than the sine of the original power-factor angle, it is found that no investment in corrective equipment is economically justified.

The equation is set up in such a form that solutions are readily obtained for the most economical size of conductor as determined by the Kelvin law, and for the required kilovolt-ampere rating of the transformers and condensers. A method is suggested for including generating station costs with those of the individual circuit under consideration.

In evaluating circuit costs, the effects of load factor and the shape of the typical daily load curve upon capital investment and power losses have been worked out after the methods used by Gear and Williams⁵ and by Reyneau and Seelye⁶.

Equations for evaluating the circuit constants are included in the appendix. Several illustrative examples are worked out.

SO long as each community was served by its own generating station, the generator was the most convenient and, in some cases, the most economical source of magnetizing current. But with the elimination of small stations and with the growth of interconnection, the shunting of large blocks of reactive power from one point on the system to another has introduced serious operating complications. Low system power factor limits the availability of installed capacity, adds to the $I^2 R$ line losses, and increases the conductor sizes required to maintain proper voltage regulation. The kilowatt-hour losses on circuits operated at low power factor may run as high as 20 to 30 per cent of the annual input. For a switchboard cost of eight mills, a reduction in line losses from 25 to 15

per cent is nearly equivalent to a saving of one mill per kilowatt-hour at the stations. The economical utilization of the modern generating station is dependent not only upon a favorable base load but also upon the cost of distributing this lower cost power to the consumer. The full value of modern refinements in station design and operation cannot be realized unless there be a commensurate increase in the efficiency of the system of distribution. Certainly, industry cannot hope to obtain full advantage of low cost power made possible by the modern generating station so long as generators, bus structure, cables, substations, lines and transformers must be designed to carry excessive, inductive loads.

Considerable improvement in system power factor usually may be obtained through a more scientific application of the individual induction motor to its load. When loaded continuously between three-fourths and full load rating, a good induction motor should operate at a power factor of from 0.80 or 0.85 to 0.92 or 0.94 lagging, depending on size and speed. The prospective increase in high power-factor heating load will tend to raise the average of the system power factor.

For further improvement, rather substantial investment in corrective devices is necessary. Prices range from six to sixty dollars per reactive kilovolt-ampere of correction. If such large expenditures are to be made in unproductive equipment, it is necessary to know that the largest possible savings are to be effected. How much money can be invested profitably in such improvement? What is the most economical corrected

1. Electrical Distribution Engineer, 30 Beckwith St., Auburn, R. I.

2. Serial Report No. 25-104, "Power Factor Improvement," p. 1; *Electrical Apparatus Committee of the National Electric Light Association*.

This reference contains a complete bibliography.

3. *Rev. Generale de l'Electricite*, September 26, 1925. Article entitled "Rapid Calculation of Optimum Power Factor in Industrial Networks" by Rene Menjelou.

4. *General Electric Review*, August, 1926, p. 574. Article entitled "The Economic Limit of Power Factor Correction," by A. R. Stevenson, Jr.

5. Gear and Williams, "Electric Central Station Distribution Systems," Chap. XIII. Van Nostrand.

6. Reyneau and Seelye, "Economics of Electrical Distribution," McGraw-Hill.

Presented at the Regional Meeting of District No. 1. of the A. I. E. E., Pittsfield, Mass., May 25-28, 1927.

power factor? The term "most economical" is here used to indicate an economic balance in circuit design for which the total annual cost of supplying a standard power service is a minimum.

In the analysis that follows, a circuit cost equation is set up with θ , the corrected power-factor angle, as a variable. The minimum value is found by equating the first derivative to zero. The general equation includes only the variable circuit costs that are directly affected by a change in power factor. It does not include what may be termed fixed costs that are not reduced by an improvement in the power factor of the circuit. The mathematical correctness of the solution is not changed by the elimination of the fixed costs, since all constant terms drop out in the differentiation.

The equation is developed subject to the following conditions:

a. The value of generating station and outside plant capacity released through power factor correction depends upon its availability for carrying additional profitable kilowatt load. In the design of new circuits, smaller conductors and transformers may be used for a given kilowatt load.

b. The cost⁷ of line losses per kilowatt-hour includes fuel cost at the generating station and demand charges prorated over the kilowatt-hour losses for the year.

c. Load is figured in terms of maximum kilowatt demand.

d. Power factor is measured at the time of maximum kilowatt demand at the point where the condenser is to be installed. It is defined as the ratio of kilowatt demand to coincident kilovolt-amperes. The term "power-factor angle" is used as a convenient mathematical convention rather than as a true instantaneous vector relationship.

e. It is assumed that the distribution voltage has been determined by conditions affecting the system as a whole. Existing standards usually determine in a general way the types and ratings of equipment.

f. Construction standards on overhead distribution systems are usually such that the cost of the supporting structure is the same for each of the several possible wire sizes which could be chosen for a given circuit.

g. The cost of spare condenser equipment is not included. This is offset by the reduction in spare transformer and line capacity required for emergency service.

h. Capacity rating of condensers determined by economical considerations: Synchronous condensers to be operated normally at full excitation to obtain maximum corrective effect during working hours, and shut-down during off-peak hours. Static condensers act as a constant capacity connected across the line with losses practically constant. When installed in accessible locations these are usually disconnected

during off-peak hours. Annual condenser losses are determined by the number of hours connected.

i. Partial voltage control with capacity rating of synchronous equipment determined by economical formula: In this case condenser and circuit losses should be computed for the actual duty cycle of the condenser throughout the year.

j. Constant voltage control: The rating of the synchronous condenser in this case is determined by the constants of the circuit and by the generator and receiver voltages. The economical power-factor formula does not apply to this condition.

The equation is developed for an overhead line supplying power through a single bank of transformers. The power factor of the load is $\cos \theta_{or}$, lagging. A condenser is to be installed on the low voltage side of the distribution transformer. Kilowatt demand is known, as is also the required full load receiver voltage. It is assumed that the rating of the transformer will be just equal to the resultant kilovolt-ampere demand at the corrected power factor and that the size of the line conductors will be just sufficient to carry the resultant full load amperes at the most economical current density. The annual fixed charges on the investment and the cost of losses for the primary line conductors, transformers, and the condenser are to be set up in an algebraic equation in which the variable is θ , the corrected power-factor angle.

The following symbols are used:

Q_1	Annual fixed charges on the most economical line conductors per kilovolt-ampere delivered,
Q_2	Annual cost of line losses per kilovolt-ampere delivered,
Q_3	Annual fixed charges on transformers per kilovolt-ampere delivered,
Q_4	Annual cost of transformer iron losses per kilovolt-ampere,
Q_5	Annual cost of transformer copper losses per kilovolt-ampere,
K_1	Annual fixed charges on the condenser per reactive kilovolt-ampere of correction,
K_2	Annual cost of energy losses in the condenser per reactive kilovolt-ampere of correction,
P	Power in kilowatts delivered to the load at the time of maximum demand,
p	Kilowatt loss in the condenser at full load voltage and excitation,
$\cos \theta_{or}$	Power factor of the load, at the maximum demand,
$\cos \theta$	Corrected power factor at maximum load,
M	Cir. mils per ampere at full load for most economical line-current density in the conductor,
Y	Annual cost of the circuit, including the condenser; it includes only those costs which are directly affected by an improvement in power factor.

In the appendix will be found a list of additional

7. See reference 6, Chap. IV, for a method of computing the cost of energy losses at any point on the system.

symbols and a detailed mathematical development of the equations for evaluating the K and Q terms, to which reference is made in the following paragraphs.

By the Kelvin⁸ law, that wire size is assumed most economical for which the annual fixed charges on the investment in the conductors are just balanced by the yearly cost of $I^2 R$ energy losses. Assuming a current of one ampere, the most economical circular mils per ampere, designated by the symbol M , may be calculated by formula (6) in the appendix. The value of M depends on the cost of copper, the shape of the typical daily load curve, and the cost of energy. It is independent of the ampere load, voltage, phase, spacing and the length of line. The size of the most economical conductor is then equal to M times the resultant amperes per wire. Multiplying by the length of line and by the unit weight of copper, and by the cost per pound, the cost of one conductor is obtained as in (7). The resultant current may be expressed in terms of kilowatt load, voltage, and power factor. Substituting for the current terms in (7) and multiplying through by the number of conductors and by the annual fixed charge rate yields expression (8). It represents the annual fixed charges on the most economical size of conductors expressed as a function of the resultant power-factor angle θ . The coefficient Q_1 is obtained in expression (9).

The energy loss in the most economical conductor at full load is $I^2 R$ watts. The resistance may be represented by the resistivity per cir. mil ft. times the length of the conductor divided by the area of the conductor in cir. mils. The cross-sectional area equals M times resultant amperes, as in the previous paragraph. Multiplying by the cost of energy and by the number of conductors, expression (10) gives the hourly cost of losses at constant full load.

The actual $I^2 R$ losses of a fluctuating load may be evaluated in terms of loss at full load by means of a special "loss factor" computed from typical daily load curves of the circuit under consideration. The loss factor is found by dividing the sum of the squares of the hourly ordinates of a typical daily load curve by 24 times the square of the annual peak. Descriptions of the method are given in the references⁸. The loss factor multiplied by 8760 hours gives the "equivalent hours" per year that it would be necessary for the annual peak load to continue in order to yield the same energy loss as that given by the actual fluctuating load throughout the year.

The annual cost of losses in the conductors is then obtained by multiplying expression (10) by the equivalent hours. The current term is expressed in terms of kilowatts, voltage and power factor as before, yielding expression (11). The simplicity of the final result

8. For Kelvin law, "loss factor" and "equivalent hours," see reference 5; reference 6, Chaps. V. VI; also *Standard Handbook for Electrical Engineers*, Sec. 12, Par. 235-238; Section 13, Fig. 14.

8. loc. cit.

depends in part upon the fact that, by this method of setting up the equation, the cost of losses is expressed as a function of the power-factor angle to the first power rather than to the usual square.

Transformer costs apply to the nearest standard size required for the resultant kilovolt-ampere load. In cost analyses of this sort, where the unit cost varies inversely with the size, it is sometimes desirable to plot the cost per kilovolt-ampere against kilovolt-ampere rating and to obtain the equation of the line passing through the desired points. Under the conditions of the present problem, however, it is simpler to use the unit cost of the nearest standard size. A first approximation may be used and a second value substituted later, if necessary.

The evaluation of the transformer cost coefficients, Q_3 , Q_4 and Q_5 is given in expressions (13) (14) and (15). Transformer copper losses are found by multiplying the loss at full load by the equivalent hours defined above. The iron losses are approximately constant and may be represented by loss at the manufacturer's rating times 8760 hr. in a year.

As in the case of the transformers, the unit cost of the condenser is that of the nearest standard size. For static condensers in groups of 30 kv-a., the unit cost does not vary greatly. In the larger sizes of synchronous condensers, the cost per kilovolt-ampere is fairly constant. For the smaller sizes of both types the unit price increases rapidly and it may be necessary to try one or two approximate values. The annual fixed charge rate includes interest, depreciation and taxes. Where special attendance is required, as with synchronous equipment, the extra expense may be added to the fixed charge rate. Condenser losses are evaluated by multiplying the rated loss at full load voltage and excitation by the hours per year that the equipment is connected to the line. The evaluation of terms K_1 and K_2 is given in expressions (16) and (17).

THE CIRCUIT COST EQUATION

The kilovolt-ampere delivered by the transformers at the corrected power factor are

$$\frac{P + p}{\cos \theta} = (P + p) \sec \theta$$

The annual cost of line conductors and transformers at the resultant power factor is then:

$$(Q_1 + Q_2 + Q_3 + Q_4 + Q_5) (P + p) \sec \theta \quad (1)$$

The condenser capacity required to raise the original load power factor from $\cos \theta_{or}$ to $\cos \theta$ is shown graphically by the familiar condenser diagram, Fig. 1. The reactive kilovolt-amperes in leading quadrature to be carried by the condenser are given by the vertical line $D - F$. For static condensers and for synchronous condensers without mechanical load, the losses are comparatively small so that the quadrature difference is usually taken as the approximate condenser capacity required. This quadrature difference, or reactive

...olt-amperes of correction, may be expressed algebraically as

$$P \tan \theta_{or} - (P + p) \tan \theta$$

...the annual cost of condenser capacity as

$$(K_1 + K_2) P \tan \theta_{or} - (K_1 + K_2) (P + p) \tan \theta \quad (2)$$

...is the maximum kilowatt load and is assumed constant. The energy loss, p , in static condensers is small, about 0.5 per cent, and is often neglected in calculating the power polygon. For synchronous

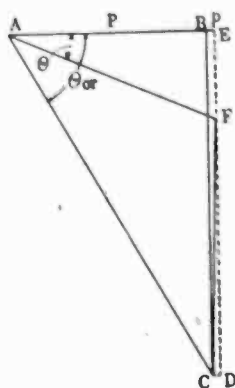

FIG. 1

- P Kilowatt load
- p Kilowatt loss in condenser
- $A C$ Kv-a. at original load power factor
- $A F$ Kv-a. at corrected power factor
- $D F$ Reactive kv-a. correction

For 3 per cent condenser loss, the error in using $D F$ for $C F$ is less than 0.1 of one per cent

probable value of θ , to assume a fixed value⁹ for p . The first approximation may be corrected later if necessary. θ_{or} is a constant, and θ the only variable.

The annual cost of the circuit, including condenser, for any power factor, $\cos \theta$, is

$$Y = (Q_1 + Q_2 + Q_3 + Q_4 + Q_5) (P + p) \sec \theta + (K_1 + K_2) P \tan \theta_{or} - (K_1 + K_2) (P + p) \tan \theta \quad (3)$$

The minimum point on the cost curve is found by equating to zero the first derivative of Y with respect to θ , and solving

$$\frac{dY}{d\theta} = 0 = (Q_1 + Q_2 + Q_3 + Q_4 + Q_5) (P + p) \tan \theta \sec \theta - (K_1 + K_2) (P + p) \sec^2 \theta \quad (4)$$

and

$$\sin \theta_{ec} = \frac{K_1 + K_2}{Q_1 + Q_2 + Q_3 + Q_4 + Q_5} \quad (5)$$

The graphical representation of these cost functions

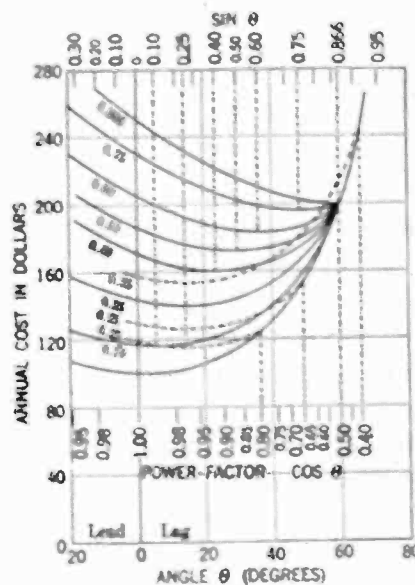

FIG. 3—COMPARISON OF Y-COST CURVES
The number on each curve is the unit cost ratio

in Fig. 2 indicates the variation in total cost as the condenser capacity is increased. The conditions for a minimum¹⁰ are that the sum of the K terms be less than the sum of the Q terms; that the sum of the K terms be positive or equal to zero, and that the sum of the Q terms be positive and greater than zero.

If the sum of the K terms be zero, that is, if condenser capacity could be obtained at no extra expense, $\cos \theta_{ec} = 1.00$ and correction to unity power factor would be justified.

If the ratio of the K terms to the Q terms be equal to the sine of the original power-factor angle, then $\sin \theta_{ec} = \sin \theta_{or}$, and the original power factor is the most economical one. This is illustrated graphically by the upper curve in Fig. 3 marked 0.866. If the unit cost ratio is greater than $\sin \theta_{or}$, the mathematical minimum

9. For percentage error in assuming p constant see appendix B.
10. For test for minimum point see appendix B.

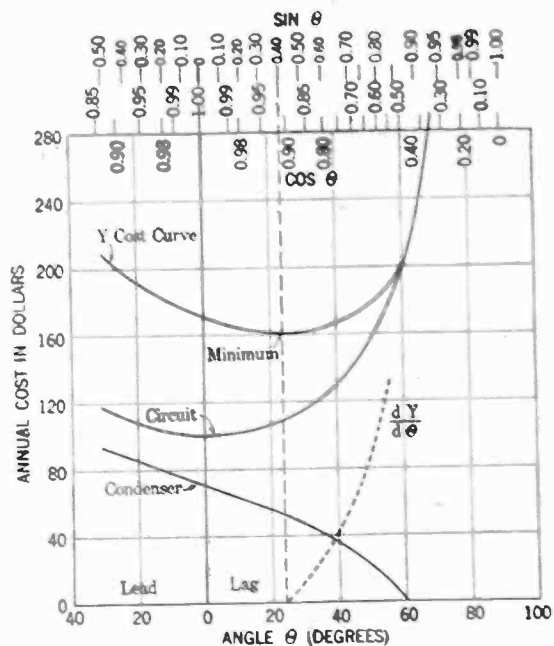

FIG. 2—ANNUAL COST OF CIRCUIT WITH CONDENSER

Drawn for a unit cost ratio of 0.40 and a load power factor 0.50. The minimum point on the Y curve occurs at $\sin \theta_{ec} = 0.40$. Corresponding to a corrected power factor $\cos \theta_{ec} = 0.916$

condensers, losses will be about 1.7 to 3.5 per cent of rating for the larger machines and higher for the smaller units. If p is expressed as a function of θ , the equation becomes unnecessarily complicated. It is simpler, and sufficiently accurate within a limited range of the

lies in the area of negative values of the condenser cost curve. The physical interpretation of the curves for values of the unit cost ratio greater than $\sin \theta_{or}$ is that condenser correction is not economical. The lagging power-factor angle is taken as positive.

The conditions under which equation (5) may be used in practical problems are that the sum of the Q terms be positive and greater than zero, that the sum of the K terms be positive or equal to zero, and that the ratio of the K terms to the Q terms lie between zero and $\sin \theta_{or}$. Within these limits, the following conclusions are warranted.

A. The sine of the most economical corrected power-factor angle is determined by the ratio of unit annual condenser costs per reactive kilovolt-ampere of correction, to unit annual cost per kilovolt-ampere delivered, of that portion of the supply circuit directly benefited by the improvement.

B. Correction to unity is economically justified only if corrective capacity can be obtained at no additional expense.

C. If the unit cost ratio is found to be equal to, or greater than, the sine of the original load power-factor angle, investment in corrective equipment is not economically justified.

D. For a given unit cost ratio, the most economical power factor is the same, irrespective of the power factor of the load.

Conclusion *D* is illustrated by the dotted curves in Fig. 3 where each of the four total cost curves drawn at a unit cost ratio of 0.25, for load power factors 0.80, 0.65, 0.50, and 0.40, has its minimum value at $\sin \theta_{ec} = 0.25$ corresponding to the corrected power factor, $\cos \theta_{ec} = 0.986$.

Conclusion *D* is based on a constant unit cost ratio within the range of values considered. This condition is met in the case of a distribution substation with supply lines, built to a standard maximum current rating. Local power load is served, up to the limit of circuit capacity, by radiating branch feeders either at the same or at reduced voltage. The circuit cost per kilovolt-ampere of its capacity is known, and the average unit price of the static condensers, to be located at the load ends of the radiating branches, is fixed by the manufacturer's quotation. The unit cost ratio is therefore practically constant and a common most economical power factor for the circuit as a whole is determined by equation (5). Sufficient condenser capacity is installed at the end of each branch, whatever its original power factor, to raise the corrected power factor to the most economical value. This result, based on economic considerations, is in agreement with the best operating characteristics of the circuit. If all the condenser capacity be placed at the ends of the branches, but each corrected to a different power factor, circulating currents will be set up between the branches which tend to offset the desired savings.

GENERAL APPLICATION

In the design of a circuit to serve a definite kilowatt load, the unit cost ratio tends to decrease as the size of the condenser is increased, and the required line and transformer capacity becomes less. This is due to the variation in cost per kilovolt-ampere of condensers and transformers with a change in size. The correct relationship is given by the unit cost ratio at the minimum point on the total cost curve. In the usual case, standard sizes of equipment will not agree exactly with the most economical sizes of conductors, transformers, and condensers as calculated by the formula. The flatness of the cost curve near the minimum point, however, indicates that this value is not critical. With static condensers, it is quite practicable to install just the capacity required, since these are built up in small units.

The formula has been derived for the particular case of an overhead feeder. Similarly, it may be developed for distribution circuits in general, both overhead or underground, by introducing appropriate Q terms. The criterion for including a given cost is whether or not a saving can be effected in that particular item by improving power factor. The cost of the supporting structure should be included in the case of parallel circuits, when a reduction in the number of paralleled conductors can be effected after correction, due to the reduced ampere capacity required to supply the same kilowatt load. This applies also to the cost of ducts in an underground system, when fewer cables will be required after correction. The cost of stringing wire or running cable should be included if the labor charge for the larger size is materially higher than for the smaller. The unit annual costs per kilovolt-ampere of circuit capacity applying to cables, switches, bus structure, and substation electrical equipment in general should be evaluated as Q terms if an actual saving can be made. In including cost at the sending end, such as step-up transformers, the cost per kilovolt-ampere should be increased by a factor covering per cent line loss between that point and the condensers.

The sine relationship between unit condenser and circuit costs may be used also in making power factor improvement calculations in industrial plants. The method of computing optimum rating of static condensers within the consumer's plant is the same as for outside feeders. Where over-excited synchronous¹¹ motors or internal corrective motors of the synchronous-induction¹² type¹³ are used, the power, p , consumed by the motor is included as a part of the useful load, P . The cost² properly chargeable to power factor improvement is the difference between the price of the synchronous

11. *Electric Journal*, March 1926, p. 99.

12. H. Weichsel, *A New Alternating-Current General-Purpose Motor*, presented at the Midwinter Convention of the A. I. E. E. New York, February, 1925.

13. Underhill, "Power Factor Wastes," McGraw-Hill. *JOURNAL of the A. I. E. E.*, October 1926, p. 949.

motor and that of a lower priced induction motor of equivalent rating. The correction in reactive kilovolt-ampere is the sum of the power component in leading quadrature of the synchronous motor and the lagging component of the equivalent induction motor. The cost per reactive kilovolt-ampere of correction, term K_1 in the equation, is thus determined. Further correction may be justified when the rate schedule contains a special power factor clause.

In making a basic cost study of the power factor problem on a utility system preparatory to working out new power rate schedules, the use of the sine formula is suggested as a means for determining the optimum consumer power factor upon which the schedule of penalties or bonus is based. In this case the cost of correction at the motor is credited with savings on the central station system back to the generator, in addition to savings within the industrial plant. Direct comparison may be made between the over-all savings obtained by consumer correction and those resulting from the use of condensers on the lines of the central station.

GENERATING STATION COSTS

Excess generating station costs chargeable to low lagging power factor include (a) fixed charges on generating capacity which could be released for profitable kilowatt load, (b) excess electrical losses due to increased excitation requirements and the reactive current component in station bus and transformers, and (c) lower steam economy due to the necessity for operating turbines below normal power rating or for floating spare units on the line as condensers. Figures for determining excitation losses are usually obtainable from the manufacturer's design data. Other losses must be worked out for each individual station from daily operating data and special tests.

The evaluation of station costs is not within the scope of the present paper. The following method is outlined for segregating that portion of the station costs directly affecting the distribution circuits.

Case I: Generating capacity insufficient to supply kilowatt demand at existing power factor, necessitating the purchase of a new generator or additional power from an outside source. It may be assumed that it would be cheaper to release existing generator capacity up to the limit of the horse power rating of the turbines by installing a large synchronous condenser at the station. The larger units have the lowest cost per kilovolt-ampere. Let the annual fixed charges, including routine maintenance, be K_3 and the cost of losses K_4 dollars per reactive kilovolt-ampere per year.

The problem is to determine how much of this corrective capacity could be installed more profitably at the load end of the distribution circuit. The annual unit cost of the load end condenser has been evaluated as $(K_1 + K_2)$ dollars per reactive kilovolt-ampere per year and is greater than $(K_3 + K_4)$. Due to load diversity between feeders, additional capacity is

required at the load end than at the station. Let D = the ratio of coincident reactive kilovolt-ampere demand at the station peak to the sum of the reactive demands of the individual feeders. One reactive kilovolt-ampere of condenser correction out on the line saves $D(K_3 + K_4)$ dollars per year in station condenser costs, at the same time releasing generating capacity for profitable kilowatt load. The difference in the annual unit costs of the two condensers, representing the additional cost of load end correction, applies to the distribution circuit. Equation (5) in its general form is then:

$$\sin \theta_{ec} = \frac{(K_1 + K_2) - D(K_3 + K_4)}{Q_1 + Q_2 + Q_3 + Q_4 + Q_5 + Q_6 + \dots} \quad (5a)$$

the additional Q terms representing cost of cables, substations, et cetera, as previously noted.

Case II: Spare generator capacity available, station economy reduced by inefficient operation at low power factor. It is assumed that the expense of a station condenser is not justified. Term K_3 is not included since no immediate saving in annual fixed charges on generating equipment will be made. The excess cost of operating the station at low power factor, compared with the cost of generating the same kilowatt-hours in saleable energy at unity power factor, represents the cost of using station generators as condensers. The excess cost throughout the year divided by the reactive power component at the station peak demand gives K_4 , the annual cost per reactive kilovolt-ampere of correction at the station. The numerator of equation (5a) is then $(K_1 + K_2) - DK_4$.

The method does not apply to distant hydroelectric or steam stations operating at leading power factor. The sine formula does not apply to transmission lines¹⁴ of such length and voltage that charging current, corona loss, conductor material, tower spacing and other special factors enter into the problem. The correct rating of condensers for long lines is usually determined by the requirements for voltage control and system stability.

The sine formula may be used in the design of the individual distribution circuits of the network supplied by a transmission line, as in Case I for the generators. Thus, if it is found economical to correct the power factor at the load ends of the individual circuits of the distribution network from 0.70 to 0.90, the size of the synchronous condenser required to control transmission line voltage is considerably reduced.

The annual saving at the most economical power factor depends upon the power factor of the load and the unit cost ratio. In Figs. 2 and 3, the difference in the height of the ordinate to the total cost curve at the original power factor, and the ordinate at the minimum

14. Kirsten and Loew, *The Line of Maximum Economy*, presented at the Pacific Coast Convention of the A. I. E. E., September, 1925.

point indicates the saving effected. For a load power factor of 0.50 and a unit cost ratio 0.4, the saving at the economical power factor, 0.916, is about 20 per cent, but would be only about 15 per cent if corrected to unity. For a unit cost ratio of 0.5, there would be a saving of 14 per cent if corrected to 0.866, but only 7 per cent at unity power factor. The percentage annual saving at the most economical corrected power factor has been plotted against unit cost ratio in Fig. 4. These curves show in a general way the conditions

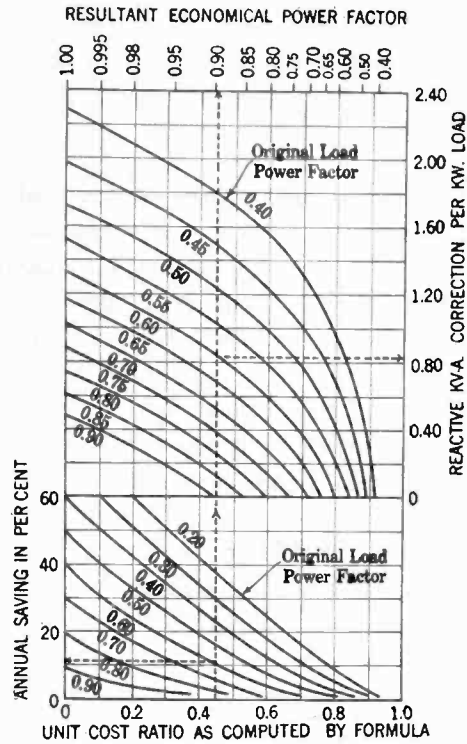

FIG. 4—WORKING DIAGRAM FOR USE IN PRELIMINARY CALCULATIONS

Calculate unit cost ratio from K and Q terms. The dotted projection lines indicate use of chart. Final figures should be worked out accurately for the actual prices and ratings of equipment used.

under which substantial savings may be expected.

The upper set of curves in Fig. 4 gives the required correction in reactive kilovolt-amperes for any power factor.

CONCLUSION

An annual cost equation has been developed for an overhead distribution circuit supplying a lagging power factor load partially corrected by a condenser. An economic balance in circuit design is obtained when the sine of the corrected power factor angle equals the ratio of the unit annual cost of correction to the unit annual cost of that portion of the supply circuit in which an actual saving is effected by power factor improvement. For this value of θ_{ec} , the total annual cost of the circuit is a minimum, and $\cos \theta_{ec}$ is the most economical corrected power factor. Comparison is made on the basis of the most economical conductor sizes and transformer ratings equal to the resultant load. If the unit cost ratio is equal to, or greater than, the original load power-factor angle, correction is not economically justified.

Application of the formula may be extended to distribution circuits in general, both overhead and underground. A method has been outlined for working out the comparative advantages of power factor correction at the generating station and at substations, feeder load ends, and the motors. This requires a careful study of load diversity and of the effect of each type of condenser upon the shape of the load current curve and therefore upon $I^2 R$ losses.

The equations and methods here given have the definite advantage that they may be applied equally as well to the design of new circuits and extensions as to the selection of optimum condenser ratings for existing circuits.

Although the present discussion has been limited to the cost element of the power-factor problem, it should be understood throughout that applications to specific cases should always be made in accord with practical operating requirements, and with those more intangible attributes connoted by the term "electric service."

Appendix A

Supplementary List of Symbols and Working Formula.

In addition to the symbols already defined, the following list is given for use in evaluating the K and Q terms. It represents circuit design data ordinarily available to the distribution engineer.

- C_{cu} Cost of conductor in dollars per lb. of actual copper, actual price of bare wire. For insulated wire, multiply charging out price by ratio of weight per 1000 ft. insulated wire to weight 1000 ft. bare wire of same size A. W. G.
- C_e Cost in dollars per kilowatt-hour of generating and distributing energy to supply losses.
- C_{con} Cost of condenser equipment in dollars per kilovolt-ampere.
- C_T Cost of nearest standard size of transformer to carry the resultant load, in dollars per kilovolt-ampere.
- g Rate of annual fixed charges; includes interest, depreciation, insurance, and taxes.
- U_{TFe} Decimal ratio of watts iron loss in transformer to the volt-ampere rating.
- U_{TCu} Decimal ratio of watts copper loss in transformer at full load to the volt-ampere rating.
- U_{con} Decimal ratio of kilowatts required to operate the condenser at full load to the kilovolt-ampere rating.
- l Length of line in feet, one way.
- N Number of conductors with respect to relative size.
- N' Number of conductors carrying full current.
For 3-phase, 3-wire . . . $N = 3, N' = 3$
- w Weight of conductor in lb. per 1000 cir. mil ft.
For copper, $w = 0.00303$ lb.
- ρ Resistivity of conductor per cir. mil ft.
- H 8760 hr. in a year.
- f Load factor.
- fH Hours use of demand, yearly.

F Loss factor⁸, computed from typical daily load curve

$$F = \frac{\text{sum of squares of hourly ordinates}}{24 \times (\text{peak load})^2}$$

FH Equivalent hours⁸ per year at constant full load to produce the same kilowatt-hours in $I^2 R$ line losses as occur with the actual fluctuating load. Analogous to "hours use of demand."

h Hours per year that condenser is connected to the line.

E Receiver voltage, phase voltage at full load.

I_{ec} Amperes per wire at full load at the resultant economical power factor, for a 3-phase line,

$$I_{ec} = \frac{1000 (P + p)}{\sqrt{3} E \cos \theta_{ec}}$$

$$\frac{l w I_{ec} M}{1000 \text{ ft.}} = \text{Weight of one conductor.}$$

$$\frac{\rho l}{I_{ec} M} = \text{Resistance of one conductor.}$$

The *K* and *Q* terms are set up for a 3-phase, delta-connected line. Similar expressions may be worked out for 3-phase, 4-wire and 2-phase, 3- or 4-wire circuits. The economical circular mils for one ampere are calculated from the Kelvin law.⁸

$$M = 5500 \sqrt{\frac{F C_e}{g C_{cu}}} \quad (6)$$

The area in circular mils of the economical size of conductor is $I_{ec} M$. If the line drop for this size proves too great, calculate *M* from the allowable regulation.

$$\text{The cost of one conductor} = \frac{C_{cu} l w M I_{ec}}{1000} \quad (7)$$

The annual fixed charges on *N* conductors, substituting for *I_{ec}*,

$$\begin{aligned} &= \frac{g C_{cu} N l w M}{1000} \times \frac{1000 (P + p)}{\sqrt{3} E \cos \theta_{ec}} \\ &= \frac{g C_{cu} N l w M (P + p) \sec \theta_{ec}}{\sqrt{3} E} \quad (8) \end{aligned}$$

and

$$Q_1 = \frac{g C_{cu} N l w M}{\sqrt{3} E} = \frac{0.00525 g C_{cu} l M}{E} \quad (9)$$

$$Q_1 \text{ per mile} = \frac{27.72 g C_{cu} l M}{E} \text{ dollars per mile per year} \quad (9a)$$

The $I^2 R$ losses in kilowatt at full load, for one conductor

$$= I_{ec}^2 \frac{\rho l}{I_{ec} M} \times \frac{1}{1000}$$

The cost of losses in *N'* conductors at *C_e* dollars per kilowatt-hour

$$= \frac{C_e \rho l N'}{1000 M} \times I_{ec} \quad (10)$$

dollars per hour at constant full load. When the load fluctuates, the $I^2 R$ losses vary as the square of the current. The annual cost of loss for a fluctuating load may be approximated by multiplying loss at full load by the "equivalent hours," *FH*, defined above. The annual cost of line losses

$$\begin{aligned} &= \frac{C_e \rho l N' F H}{1000 M} \times I_{ec} = \frac{C_e \rho l N' F H}{1000 M} \\ &\quad \times \frac{1000 (P + p)}{\sqrt{3} E \cos \theta_{ec}} \\ &= \frac{C_e \rho l N' F H}{\sqrt{3} E M} (P + p) \sec \theta_{ec} \quad (11) \end{aligned}$$

and

$$Q_2 = \frac{C_e \rho l N' F H}{\sqrt{3} E M} = \frac{160826 C_e l F}{E M} \quad (12)$$

$$Q_2 \text{ per mile} = \frac{849.16 C_e F 10^6}{E M} \text{ dollars per mile per year} \quad (12a)$$

Transformer prices and losses are those of the nearest standard capacity actually required at the resultant power factor

$$g C_T (P + p) \sec \theta_{ec} \quad (13)$$

and

$$Q_3 = g C_T$$

Transformer iron losses may be assumed as practically constant through the year. Transformer iron loss

$$\begin{aligned} &= U_{TFe} C_e H (P + p) \sec \theta_{ec} \quad (14) \\ Q_4 &= 8760 U_{TFe} C_e \end{aligned}$$

Transformer copper losses vary as the square of the current. Annual losses in kilowatt-hours may be approximated by multiplying loss at full load by the "equivalent hours," *FH*. The annual cost of copper losses in the transformer

$$= U_{TCu} C_e F H (P + p) \sec \theta_{ec} \quad (15)$$

and

$$Q_5 = 8760 U_{TCu} C_e F$$

Annual condenser costs are divided into fixed charges and cost of losses. The unit fixed charges are

$$K_1 = g C_{con} \quad (16)$$

For synchronous condensers, an estimated percentage should be added to the annual fixed charges, *g*, to cover the cost of routine maintenance.

The yearly losses may be approximated by multiplying loss at full load excitation by the hours use = $U_{con} h$ per kv-a. The unit annual cost of losses will be

$$K_2 = U_{con} C_e h \quad (17)$$

Appendix B

Test for Minimum. If a root of the first derivative of Y with respect to θ yields a positive result when substituted in the equation of the second derivative, a minimum is indicated at that point.

Let K = sum of K terms and Q = sum of Q terms. Taking the second derivative of (3) and substituting the value of θ from (5)

$$\frac{d^2 Y}{d \theta^2} = \frac{Q^2}{\sqrt{Q^2 - K^2}}$$

The expression is real and positive when Q is positive and > 0 , K is positive or $= 0$, and $Q > K$. Negative values of K and Q terms have no physical significance in the present problem. Lagging power factor is taken as positive.

Accuracy of Results. For the purpose of calculating the power polygon in equations (3) and (4), the value of p , kilowatt loss in the condenser, was assumed a constant. The error thus introduced is practically negligible. In a typical numerical example, for a load of 1000 kw., the loss in the condenser required to correct the power factor from 0.50 to 0.85 was 3 per cent, or 33 kw. The assumption that the condenser loss would be the same for corrected power factors ranging from 0.75 to 0.95 introduced a maximum error of less than 0.9 of one per cent of the total kilovolt-amperes. Since plus errors in calculating condenser kilovolt-amperes offset minus errors in required transformer kilovolt-amperes, even these small errors tend to cancel out in evaluating the total cost, Y .

In equations (1), (2) and (3) and in Figs. 2 and 3, a constant unit cost per kilovolt-ampere is assumed for transformers and condensers. In the usual case, however, the unit price of the larger sizes tends to decrease with increase in rating. If necessary, this condition could be expressed mathematically by plotting cost per kilovolt-ampere against kilovolt-ampere rating and writing the equation of a line passing through the required points. Introducing these expressions into equation (3) would tend to complicate the problem unnecessarily. The location of the minimum point of the Y cost curve is all that is required, and this can be determined accurately from the simple formula in one or two trials. No error is involved when the conditions of formula (5) are satisfied.

In the application of the formula to practical problems, it may be desirable to design the circuit for a corrected power factor slightly above or below the calculated value in order to make the most advantageous use of standard sizes of wire, cable, transformers and condensers. In the design of new circuits, probable growth in load may dictate the use of larger wires and transformers than are immediately required. Where static condensers are used, provision may be made for adding additional units as required, thus maintaining economical operation during the period of growth and increasing the ultimate kilowatt capacity of the circuit.

HOW SHOULD CAPACITIES OF WATER POWER SITES BE STATED?

There is probably more confusion with respect to proper units and bases for expressing the capacity of water-power sites than with respect to almost any other resource which vitally affects the prosperity of peoples and nations. A decade ago, when water power was used primarily in connection with local industries, the widespread necessity for uniformity in describing it did not exist. As a result, however, of the great increase in the development of water power, resulting largely from improvements in the art of transmitting electric energy, there are now relatively few homes that do not use electric energy that has been generated in part by falling water.

Moreover, questions regarding water power are rapidly becoming of paramount political importance, as illustrated by activities in cities of the West Coast and elsewhere in connection with municipal ownership; in New York, in connection with the utilization of St. Lawrence River; and throughout the nation, in connection with the power plant already constructed at Muscle Shoals on the Tennessee River and with the proposed development in Boulder Canyon of the Colorado River.

In order that these various questions may be clearly understood, it is extremely desirable that there be some uniformity in the terms used so that engineers, laymen, and politicians can state their views in terms which have a definite meaning that is understood by all.

This is one of the problems that is now being considered by the American Engineering Standards Committee by means of a Sectional Committee composed of about forty engineers who are prominent in the hydro-electric industry, representing twenty-eight organizations. The work is being carried out under the official leadership of the U. S. Geological Survey, with Nathan C. Grover, M. Am. Soc. C. E., and W. G. Hoyt, Assoc. M. Am. Soc. C. E., as Chairman and Secretary, respectively, of the Sectional Committee.

After giving these and many other question consideration for more than a year the Committee has tentatively decided that the kilowatt should be used instead of the horse power as the unit for expressing the capacity of water-power sites; that the capacity shown should express the theoretical potential power without deductions for the losses, which are sure to occur in water-wheels, generators, transformers, etc.; and that the capacity should be stated for two rates of flow—one called the 90%-of-time flow, corresponding to a flow available 90% of the time, and the other called the 50%-of-time flow, corresponding to the flow available one-half the time.

It is the desire of the Committee to have these tentative rules discussed fully and frankly by every one interested in hydraulic development in this country, to the end that they may be so modified that as finally adopted they will represent the best American opinion.

Experimental Measurement of Mechanical Forces in Electric Circuits

BY J. WALTER ROPER¹

Associate, A. I. E. E.

Synopsis.—This paper presents a simple laboratory method of measuring the mechanical forces exerted on the parts of a complete circuit due to current flowing in the circuit.

Tests, using the method, show that the "classic" methods of

computing such forces are reliable. Curves are included which show the comparison between the theoretical and measured forces. Tests were made on a rectangular circuit, representing a disconnecting switch, and on a circle of round wire.

CIRCULAR CIRCUITS

THE expression derived in the companion paper by Dr. H. B. Dwight for the tension acting in a circular circuit has been checked experimentally by the apparatus shown in Fig. 1 and described below. These measurements were made in the Electrical Engineering Department of the Massachusetts Institute of Technology.

A circle of copper wire 0.249 cm. (0.098 in.) in diameter was made, having a centerline diameter of 40.2 cm.

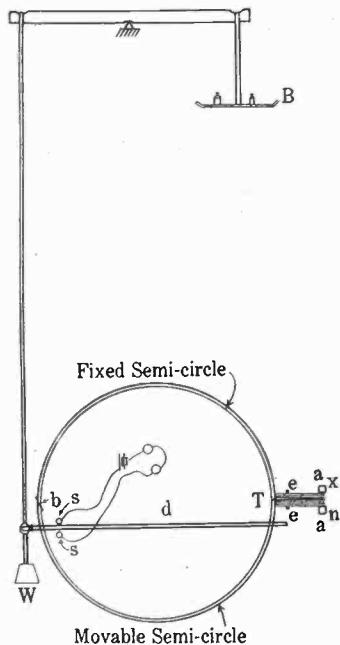

FIG. 1—THE CIRCULAR CIRCUIT

(15.81 in.). The circle was divided into two equal parts the upper half of which was fixed by being fastened to a semicircle of wood. The current was led in and out of the circle by means of flexible leads which were clamped at *a*, about four inches from the terminals *T* of the circle. An elastic rubber band at *e*, one inch from *T*, provided a support for the end of the circle. The other joint of the circle was made at *b* by means of a slanting or tapered joint. A thin mercury film was used to insure good contact between the halves of the circle. The tapered joint was suggested by the late

Dr. Carl Hering, and is a useful device. As shown later, a mercury cup gave approximately the same results as a tapered joint.

The lower half of the circle was braced by a wooden rod *d* in order to maintain the dimensions of the circuit when current was flowing and to provide a place to attach the measuring device. The motion of the semicircle was limited to 1/16 in. at the joint by a set of stops at *s*. The upper stop was fitted with a contact which touched a contact on the brace. These contacts were connected by means of very flexible leads with a dry cell and telephone headset. The force was measured by means of a lever arm and scale pan, connected to the brace by a copper rod a little over a yard in length. To offset the weight of the scale pan *B*, the auxiliary weight *W* was fastened to the brace as shown in Fig. 1.

The vertical support above *W* was one inch horizontally from *b*. The moment of the force acting through this support about *e* was balanced by the moments of the electromagnetic forces at *b* and *T* about the same point *e*. Since the distances *Wb* and *Te* were each equal to one inch, the force in the vertical support was taken equal to the force at *b*. If the leads *ea* were comparatively stiff so that the semicircle moved about *T* as a hinge, however, then the observed forces should be multiplied by the ratio of the lever arms which would be about 17 to 16. This may partly account for the fact that the observed forces are less than the calculated values in Fig. 2.

The initial position of the lower semicircle was determined by the upper stop which was visually adjusted so that the circuit was circular. In order to have an absolute measurement of the force exerted when current was flowing, it was necessary to determine the zero of the circuit, that is, the weight on the scale pan *B* which just held the contacts of the indicating circuit closed. This was done by placing weights on the scale pan *B* until the removal of a small weight, as carefully as possible, just closed the indicating circuit. If care was taken in placing and removing weights, this determination could be made to within 0.05 gram. The average of several trials gave a good determination of the zero position.

With the zero determined, points were obtained for a curve. The procedure was to add weights by tenths

¹ Massachusetts Institute of Technology,
Presented at the Regional Meeting of District No. 1 of the
A. I. E. E., Pittsfield, Mass., May 25-28, 1927.

of grams to the scale pan *B*, and for each increment of weight to send current through the circle. As the current was increased the value of current at which the indicating circuit opened was noted, and as the current was reduced, the value at which it closed was also noted. The average of the two readings was taken as the one which eliminated errors due to friction in the joint and in the flexible leads. Several readings were taken

this were the case, the test curve should lie to the left of the calculated curve, since less current would be required for a given force if "pinch" effect aided the separation. It does not seem reasonable, either, to ascribe the difference to mercury tension or friction because these forces should remain constant over the range taken, and should give a constant error and consequently a continually decreasing percentage error, instead of a percentage error which is practically constant.

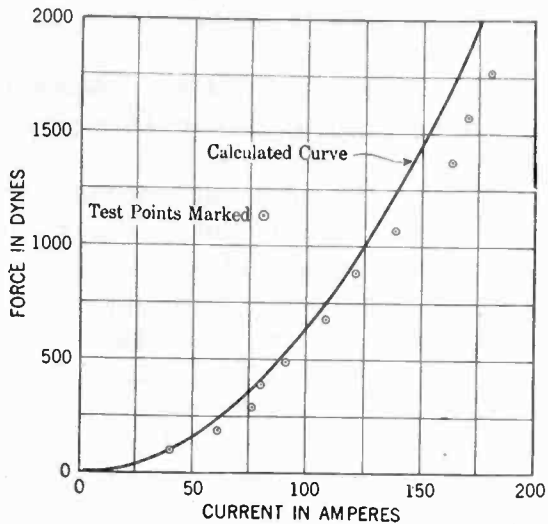

FIG. 2—CURVE SHOWING THE RELATION BETWEEN FORCE AND CURRENT IN THE CIRCUIT OF FIG. 1

at each point and the results averaged to give the current required for a given force. The curve of Fig. 2 shows the variation of force in dynes against averaged currents. The maximum value of current which could be used was 180 amperes, for with this current the mercury film blew out, probably due to heating.

The test results were compared, Fig. 2, with the curve

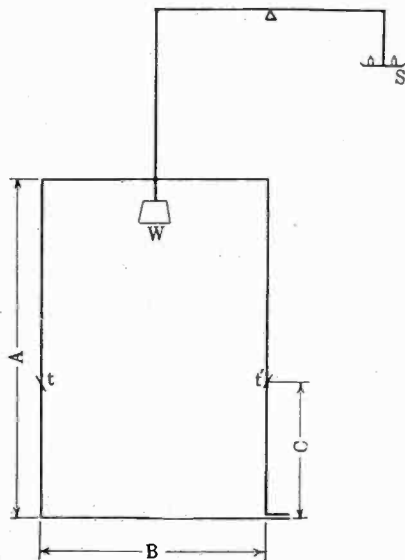

FIG. 3—DIAGRAMMATIC SKETCH OF A RECTANGULAR CIRCUIT calculated from equation (4) of the companion paper which for the dimensions used reduces to

$$F = 0.0641 I^2 \text{ dynes} \quad (1)$$

where *I* is the current in amperes. This comparison indicates an agreement of approximately 10 per cent. The so called "pinch" effect of the mercury in the joint cannot be reasonably blamed for the divergence. If

RECTANGULAR CIRCUITS

In connection with the tests concerned with the mechanical forces acting on a conductor due to current flowing in other parts of the same circuit, of which the tests on the circular circuit just described were a part, experiments with rectangular circuits were performed using the same method. A diagrammatic sketch of the set-up is shown in Fig. 3. In this case two separations, at *t* and *t'*, were made and the force measured in the center of the top cross-piece, thus measuring

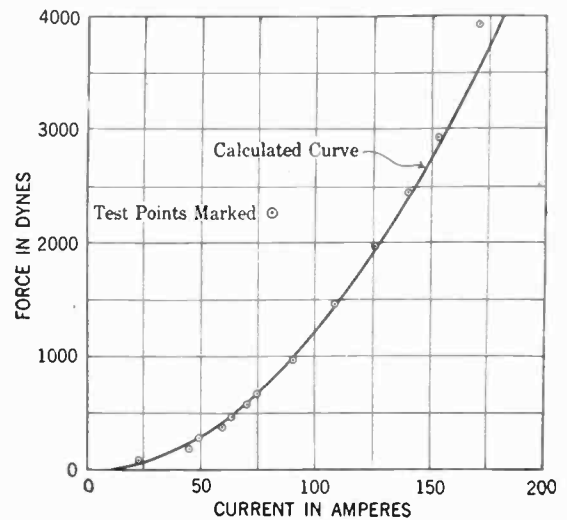

FIG. 4—CURVE SHOWING RELATION BETWEEN FORCE AND CURRENT IN RECTANGULAR CIRCUIT

Length—89.6 cm.
Width—40.0 cm.
Diameter of Wire—0.249 cm.

the total force acting. Several different lengths of rectangle were tested and the results for the longest and the shortest are given. According to theory, it should make no difference where the cuts *t* and *t'* are made. In the case of the longest rectangle, 89.6 cm. long, the distance from the bottom of the rectangle to the cut was 40 cm. This is dimension *C* in Fig. 3. In the case of the shortest rectangle, 30.0 cms. long, the distance was 20 cm. At first it was deemed inadvisable to use mercury cups for the joint and the tests were made with the tapered joint previously described. A trial with mercury cups was made later and the results were found to agree quite closely when compared with those obtained by use of the tapered joint. This comparison is shown in Fig. 5.

The results of the tests for the two sizes of rectangle are given in Fig. 4 and Fig. 5. They are compared with curves calculated from formulas (20) and (21) given in a

paper, *The Calculation of the Magnetic Force on Disconnecting Switches*, by H. B. Dwight, TRANS. A. I. E. E., 1920, page 1337. This paper has been referred to frequently in several recent articles, but up to the present time there has been no experimental verification of the formulas derived in it. The formulas as given are for a disconnecting switch, of which a diagrammatic sketch is

force in dynes acting on the blade of a disconnecting switch is

$$i^2 \left[\logh \frac{2A}{r} - \frac{2}{3} - \frac{1}{2} \frac{A}{B} - \frac{1}{6} \frac{c^2}{A^2} + \frac{3}{20} \frac{r^2}{A^2} + \frac{1}{24} \frac{A^3}{B^3} + \frac{1}{24} \frac{A c^2}{B^3} + \frac{B}{S} \right] \quad (2)$$

and where A is greater than B , the force is

$$i^2 \left[\logh \frac{B}{r} + \frac{1}{3} - \frac{B}{A} + \frac{1}{4} \frac{B^2}{A^2} + \frac{3 r^2}{20 A^2} - \frac{1}{32} \frac{B^4}{A^4} + \frac{B}{S} \right] \quad (3)$$

where i is the current in abamperes, r is the radius of the section of wire QP , and $RT, 2c$ is the width of the blade and A, B , and S are the dimensions shown in Fig. 6.

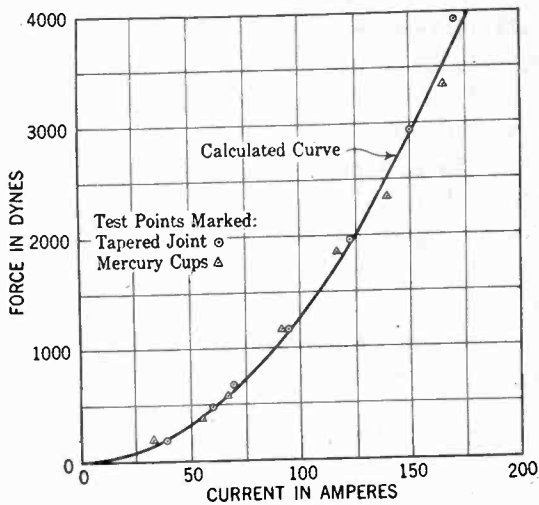

FIG. 5—CURVE SHOWING RELATION BETWEEN FORCE AND CURRENT IN RECTANGULAR CIRCUIT WITH AND WITHOUT MERCURY CUPS

Length—30.0 cm.
Width—40.0 cm.
Diameter of Wire—0.249 cm.

given in Fig. 6. This circuit reduces to a rectangle when S is made equal to A , so that the section $N'P'$ coinciding with NP will cancel the effect of NP , as it should for a rectangle, since this part does not exist. The section $T'V'$ cannot be made to coincide with TV since it is necessary to lead current in and out of the rectangle, but the effect of these parts will be reduced to a negligible amount if they are placed very close together. In the disconnecting switch the section QR

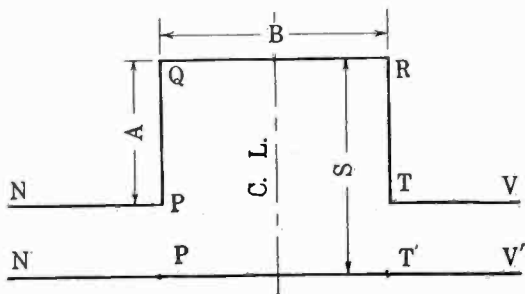

FIG. 6—DIAGRAM OF TYPICAL DISCONNECTING SWITCH

was considered to be a flat strap, but in the tests made round wire was used throughout. Another point to be noted is that the disconnecting switch formula gives the force tending to open the blade at Q , and consequently only half the total force acting on QR .

The formulas are given in the form of a convergent series and for convenience will be repeated here. Two cases are considered. Where B is greater than A , the

RAILROAD REPORT SHOWS LONG LIFE OF ELECTRIC LOCOMOTIVES

Electrified railroading, the latest phase in the transportation business of the country, gets a thorough checking-up in a report that has just been issued on the first 20 years of electric power on the New York, New Haven and Hartford Railway. That company which now has 145 route miles electrified from New York to New Haven and to Danbury, Conn. and which has the heaviest main line traffic of any electrified railroad of its length in the world, reveals that even though electrification is costly to install, its locomotives never seem to go to the scrap heap. They do an astonishing amount of work year in and year out.

Forty-one passenger locomotives have now been in service for the full 20 years. They average about 170 miles a day though many of them, especially of late, have consistently run over 400 miles a day and the total mileage for each locomotive thus far in its life is about 1,250,000 miles. The 36 original freight locomotives have averaged 46,000 miles a year and the original switchers 37,000 miles a year. This record is astonishingly good in a world of railroading that is accustomed to the wear and tear on steam engines.

This report of unusual locomotive longevity moves *Railway Electrical Engineer* to remark editorially that, remarkable as these locomotive performances are on the dense-traffic New Haven railroad, "Not all the best operating records of electric locomotives are confined to the heavy traction lines of this country as may be seen in the very satisfactory results obtained on the St. Gothard Railroad in Switzerland. In 1924 this road succeeded in transporting 19,000 tons of merchandise in a single day—a record which was not expected to be broken. Nevertheless, on February 25, 1927, a total of 23,000 tons was moved by means of electric equipment. Had steam traction still been in use 138 locomotives would have been required, but under electric operation only 84 were needed."

Progress in Power Generation¹

Annual Report of Committee on Power Generation*

To the Board of Directors:

A meeting was held shortly after the appointment of the present chairman in February, to formulate plans for the committee's activities during the remainder of the administrative year.

The question of taking up certain subjects for special study and investigation was given particular consideration, but it was not thought advisable to attempt any work of this kind, because of the limited time available in which to prepare the annual report. There were presented at the meeting three subjects which the committee therefore recommends for investigation by its successors; *viz.*, Interconnection—its relation to station and unit capacity, reliability and economy; Oil Circuit Breakers of Large Capacity—with particular reference to reliability, economy of space and costs; and Comparison of American and European Power Station Practice.

At the invitation of the Standards Committee a "contact officer" was appointed for prompt cooperation with that committee on any matter of standardization in which the Committee on Power Generation may be concerned. In this connection the Standards Committee has been asked to cooperate with the A. S. M. E. in the preparation of a section on "Measuring the Output of a Generator" for inclusion in the A. S. M. E. Test Code for Steam Turbines. A subcommittee of your Committee on Power Generation has been appointed to assist the Standards Committee in this work.

There has been secured by the committee for presentation at the Summer Convention in June, two papers dealing with the design and operation of Power Stations, one by F. A. Allner on *Holtwood Steam Plant, Design and Operation in Coordination with Water Power*, and one by J. W. Anderson and A. C. Monteith on *Auxiliary Power at Richmond Station*.

Many important developments in power generation during the past year have been extensively reviewed and the following resumé and bibliography are presented to show the progress made and the trend in the art.

Resumé of the Year's Progress in Power Generation

One of the outstanding features in power development is the tremendous increase in the so-called ultimate station capacity over that anticipated at the time of the

*Committee on Power Generation:

W. S. Gorsuch, Chairman		
J. T. Lawson, Vice-Chairman		
Vern E. Alden,	H. A. Kidder,	F. A. Scheffler,
H. A. Barre,	W. H. Lawrence,	R. F. Schuchardt,
E. T. Brandon,	F. T. Leilich,	Arthur R. Smith,
N. E. Funk,	James Lyman,	Nicholas Stahl,
C. F. Hirshfeld,	W. E. Mitchell,	B. Tikhonovitch,
Francis Hodgkinson.	I. E. Moulthrop,	W. M. White.
	M. M. Samuels,	

1. Complete report except bibliography omitted.

Presented at the Summer Convention of the A. I. E. E., Detroit, Mich., June 20-24, 1927.

initial installation. In some cases, the ultimate capacity will probably be more than double that originally expected. What has brought this about is the unprecedented increase in system loads and the introduction of units of much larger capacity than those first installed. In the eternal quest for greater and yet greater economies in power stations, notable technical achievements have been brought about in practically every line of the industry. Such developments during the past year have been so many and so varied that it is possible in a brief survey to touch on only a few of the most noticeable tendencies.

In this resumé, the committee does not attempt to predict the future of the art in power generation, but simply points out the trend as indicated by the important developments that have taken place or are now under construction.

STEAM TURBINE GENERATOR UNITS

Capacity. Turbines and generators of unprecedented size have been designed and completed during the year and still larger ones are now under construction. Less than two years ago the largest turbine being built was under 100,000 kw. The largest turbine to date is the 208,000-kw. unit now under construction and one of the manufacturers has offered a machine in excess of 300,000 kw. The largest single-cylinder turbine yet built in this country is a 65,000-kw. normal pressure unit. Without extensive interconnection it would not be wise or economical to install such large generating units.

The motive for these huge machines is not so much better fuel economy as it is reduced plant investment and the desire to keep the total plant capacity in reasonably few units. Experience with large units has demonstrated that they can be operated almost as continuously and easily as smaller machines. We may expect therefore, that the construction of huge generating sets will continue, although to what final limit it is difficult to predict.

As an indication of the trend toward larger units, it has recently been decided that throughout Chicago and adjacent territory no turbine will be installed in the future of less than 50,000 kw. capacity.

Type. The combination of turbines and generators to make up a single generating unit is quite varied. Tandem compound and two- and three-element cross-compound formations offer numerous means of providing generating units in excess of 60,000 or 70,000 kw. capacity. The actual formation depends to a large extent on local conditions to be met and the ideas of the turbine manufacturer and the plant designer as to the best means of accomplishing the results desired. It is likely that turbines of the compound type will be

used for the very large capacities. There appears however, to be a marked tendency on the part of many engineers toward still larger turbines of the single-cylinder design.

There are now under construction four outstanding turbine units each of a different type and the largest of its kind on record. The sizes and types of these units are; 208,000-kw. cross compound, three elements; 160,000-kw. cross compound, two elements; 94,000-kw. tandem compound; and 65,000-kw. single-cylinder.

Speed. The trend toward higher speed is evidenced by the fact that there are now on order a number of large turbines which are to operate at 1800 rev. per min. The prevailing turbine generator speeds are 1500 rev. per min. for 25 and 50 cycles and 1800 rev. per min. for 60 cycles. Smaller units up to as high as 10,000-kw. capacity have been made for operation at 3600 rev. per min. The largest 1800-rev. per min. generator designed to date is the 89,412-kv-a. machine for the high-pressure element of a triple-shaft unit now under construction, and the largest 1500 rev. per min. generators on record have a capacity of 100,000 kv-a. An indication of the rapidity of the development of the art is furnished by the fact that a little more than a year ago a 60,000-kw. generator was regarded as a conservative maximum limit of capacity in 1800-rev. per min. units.

It has been suggested by eminent authority on turbine design that some economies might be effected by a system of standardization, which would limit the number of sizes of machines built. The greatest economy in first cost is obtained by using the highest possible rotative speed, and the most profitable machine for builder and user alike is that of the greatest capacity at the given speed. It would be an advantage from the standpoint of investment to concentrate upon a relatively few standard capacities of large machines for 1800-rev. per min., 60-cycle service, and 1500-rev. per min., 25- and 50-cycle service. A larger number of standard capacities would be required in 3600-rev. per min. turbines of capacities of 10,000 kw. and lower for manufacturing requirements. In a growing power system having a number of interconnected stations, a new unit of large capacity added to the system may be operated within quite a range of its capacity without greatly affecting the efficiency of operation of the system, and therefore it would seem desirable to choose the largest standard machine to secure the advantage of lowest investment per kilowatt.

Pressure. The desire to secure high efficiencies in steam power plants has resulted in rapid increase in pressure and temperature to a maximum of 1400 pounds and 750 deg. fahr. in this country. In the United States, the boiler pressures in large steam power plants have been confined to three classes of approximately 1400 pounds, 600 pounds, and 400 pounds, the steam pressure at the turbine throttle

being about 1200 pounds, 550 pounds, and 350 pounds respectively. These pressures represent about the average conditions, some may be 5 per cent or 10 per cent above or below. There appears to have developed three schools of engineering for the above pressures and each is apparently convinced that the pressure which it has adopted is the most economical one. From the turbine designer's standpoint no insurmountable problems have been presented up to the highest pressures so far considered.

The 1400- and 1200-pound boilers and turbines have continued to operate satisfactorily and the results in at least one station have justified the installation of additional high pressure units. For large stations, 500 pounds to 600 pounds has become more or less standard pressure. Stations with these pressures have given satisfactory service with no unusual difficulties. In fact, many of the expected serious difficulties with pipe joints and other details have so far failed to materialize. It may therefore be said that the way is clear for a general increase in the steam pressures of all new plants.

An investigation of the properties of steam was started about five years ago and it is expected that this work will be completed in the near future. These data will be of great value in designing high-pressure stations and will help us to analyze the results obtained in actual operation. As to the most economical pressure, some engineers maintain the following: "From our present knowledge it is not likely that steam pressures will very much exceed 400 pounds for all the main units of stations with average load factors and 650 pounds for all the main units of stations carrying what is commonly known as base load." A 400-pound steam pressure plant is probably the most economical installation for a small load factor or low price fuel. Furthermore, this pressure is very well adapted to the superimposition of a high-pressure steam cycle or a mercury cycle at a later date when warranted by an increased load factor or price of fuel. The experience at the Edgar Station of The Edison Electric Illuminating Company of Boston and the Lakeside Station of the Milwaukee Electric Railway and Light Company indicates that a boiler pressure of 1400 pounds per square inch is economically justified. Care must be taken, however, not to draw general conclusions from any particular installation for the local conditions are a big factor in determining what pressure is the most economical one for any contemplated station. A careful study must be made before a decision can be reached as to the proper boiler pressure for any new station. We must keep constantly in mind that the base load station of today will be the peak load station of tomorrow, and this fact should not be overlooked when figuring the investment warranted.

Temperature. The total temperature of steam has, in the last few years, been limited to 750 deg. fahr. for all pressures, while most of the plants are operating at temperatures varying from 700 deg. fahr. to 725 deg.

Progress in Power Generation¹

Annual Report of Committee on Power Generation*

To the Board of Directors:

A meeting was held shortly after the appointment of the present chairman in February, to formulate plans for the committee's activities during the remainder of the administrative year.

The question of taking up certain subjects for special study and investigation was given particular consideration, but it was not thought advisable to attempt any work of this kind, because of the limited time available in which to prepare the annual report. There were presented at the meeting three subjects which the committee therefore recommends for investigation by its successors; *viz.*, Interconnection—its relation to station and unit capacity, reliability and economy; Oil Circuit Breakers of Large Capacity—with particular reference to reliability, economy of space and costs; and Comparison of American and European Power Station Practice.

At the invitation of the Standards Committee a "contact officer" was appointed for prompt cooperation with that committee on any matter of standardization in which the Committee on Power Generation may be concerned. In this connection the Standards Committee has been asked to cooperate with the A. S. M. E. in the preparation of a section on "Measuring the Output of a Generator" for inclusion in the A. S. M. E. Test Code for Steam Turbines. A subcommittee of your Committee on Power Generation has been appointed to assist the Standards Committee in this work.

There has been secured by the committee for presentation at the Summer Convention in June, two papers dealing with the design and operation of Power Stations, one by F. A. Allner on *Hollywood Steam Plant, Design and Operation in Coordination with Water Power*, and one by J. W. Anderson and A. C. Monteith on *Auxiliary Power at Richmond Station*.

Many important developments in power generation during the past year have been extensively reviewed and the following resumé and bibliography are presented to show the progress made and the trend in the art.

Resumé of the Year's Progress in Power Generation

One of the outstanding features in power development is the tremendous increase in the so-called ultimate station capacity over that anticipated at the time of the

*Committee on Power Generation:

W. S. Gorsuch, Chairman		
J. T. Lawson, Vice-Chairman		
Vern E. Alden,	H. A. Kidder,	F. A. Scheffler,
H. A. Barre,	W. H. Lawrence,	R. F. Schuchardt,
E. T. Brandon,	F. T. Leilich,	Arthur R. Smith,
N. E. Funk,	James Lyman,	Nicholas Stahl,
C. F. Hirshfeld,	W. E. Mitchell,	B. Tikhonovitch,
Francis Hodgkinson,	I. E. Moulthrop,	W. M. White.
	M. M. Samuels,	

1. Complete report except bibliography omitted.

Presented at the Summer Convention of the A. I. E. E., Detroit, Mich., June 20-24, 1927.

initial installation. In some cases, the ultimate capacity will probably be more than double that originally expected. What has brought this about is the unprecedented increase in system loads and the introduction of units of much larger capacity than those first installed. In the eternal quest for greater and yet greater economies in power stations, notable technical achievements have been brought about in practically every line of the industry. Such developments during the past year have been so many and so varied that it is possible in a brief survey to touch on only a few of the most noticeable tendencies.

In this resumé, the committee does not attempt to predict the future of the art in power generation, but simply points out the trend as indicated by the important developments that have taken place or are now under construction.

STEAM TURBINE GENERATOR UNITS

Capacity. Turbines and generators of unprecedented size have been designed and completed during the year and still larger ones are now under construction. Less than two years ago the largest turbine being built was under 100,000 kw. The largest turbine to date is the 208,000-kw. unit now under construction and one of the manufacturers has offered a machine in excess of 300,000 kw. The largest single-cylinder turbine yet built in this country is a 65,000-kw. normal pressure unit. Without extensive interconnection it would not be wise or economical to install such large generating units.

The motive for these huge machines is not so much better fuel economy as it is reduced plant investment and the desire to keep the total plant capacity in reasonably few units. Experience with large units has demonstrated that they can be operated almost as continuously and easily as smaller machines. We may expect therefore, that the construction of huge generating sets will continue, although to what final limit it is difficult to predict.

As an indication of the trend toward larger units, it has recently been decided that throughout Chicago and adjacent territory no turbine will be installed in the future of less than 50,000 kw. capacity.

Type. The combination of turbines and generators to make up a single generating unit is quite varied. Tandem compound and two- and three-element cross-compound formations offer numerous means of providing generating units in excess of 60,000 or 70,000 kw. capacity. The actual formation depends to a large extent on local conditions to be met and the ideas of the turbine manufacturer and the plant designer as to the best means of accomplishing the results desired. It is likely that turbines of the compound type will be

used for the very large capacities. There appears however, to be a marked tendency on the part of many engineers toward still larger turbines of the single-cylinder design.

There are now under construction four outstanding turbine units each of a different type and the largest of its kind on record. The sizes and types of these units are; 208,000-kw. cross compound, three elements; 160,000-kw. cross compound, two elements; 94,000-kw. tandem compound; and 65,000-kw. single-cylinder.

Speed. The trend toward higher speed is evidenced by the fact that there are now on order a number of large turbines which are to operate at 1800 rev. per min. The prevailing turbine generator speeds are 1500 rev. per min. for 25 and 50 cycles and 1800 rev. per min. for 60 cycles. Smaller units up to as high as 10,000-kw. capacity have been made for operation at 3600 rev. per min. The largest 1800-rev. per min. generator designed to date is the 89,412-kv-a. machine for the high-pressure element of a triple-shaft unit now under construction, and the largest 1500 rev. per min. generators on record have a capacity of 100,000 kv-a. An indication of the rapidity of the development of the art is furnished by the fact that a little more than a year ago a 60,000-kw. generator was regarded as a conservative maximum limit of capacity in 1800-rev. per min. units.

It has been suggested by eminent authority on turbine design that some economies might be effected by a system of standardization, which would limit the number of sizes of machines built. The greatest economy in first cost is obtained by using the highest possible rotative speed, and the most profitable machine for builder and user alike is that of the greatest capacity at the given speed. It would be an advantage from the standpoint of investment to concentrate upon a relatively few standard capacities of large machines for 1800-rev. per min., 60-cycle service, and 1500-rev. per min., 25- and 50-cycle service. A larger number of standard capacities would be required in 3600-rev. per min. turbines of capacities of 10,000 kw. and lower for manufacturing requirements. In a growing power system having a number of interconnected stations, a new unit of large capacity added to the system may be operated within quite a range of its capacity without greatly affecting the efficiency of operation of the system, and therefore it would seem desirable to choose the largest standard machine to secure the advantage of lowest investment per kilowatt.

Pressure. The desire to secure high efficiencies in steam power plants has resulted in rapid increase in pressure and temperature to a maximum of 1400 pounds and 750 deg. fahr. in this country. In the United States, the boiler pressures in large steam power plants have been confined to three classes of approximately 1400 pounds, 600 pounds, and 400 pounds, the steam pressure at the turbine throttle

being about 1200 pounds, 550 pounds, and 350 pounds respectively. These pressures represent about the average conditions, some may be 5 per cent or 10 per cent above or below. There appears to have developed three schools of engineering for the above pressures and each is apparently convinced that the pressure which it has adopted is the most economical one. From the turbine designer's standpoint no insurmountable problems have been presented up to the highest pressures so far considered.

The 1400- and 1200-pound boilers and turbines have continued to operate satisfactorily and the results in at least one station have justified the installation of additional high pressure units. For large stations, 500 pounds to 600 pounds has become more or less standard pressure. Stations with these pressures have given satisfactory service with no unusual difficulties. In fact, many of the expected serious difficulties with pipe joints and other details have so far failed to materialize. It may therefore be said that the way is clear for a general increase in the steam pressures of all new plants.

An investigation of the properties of steam was started about five years ago and it is expected that this work will be completed in the near future. These data will be of great value in designing high-pressure stations and will help us to analyze the results obtained in actual operation. As to the most economical pressure, some engineers maintain the following: "From our present knowledge it is not likely that steam pressures will very much exceed 400 pounds for all the main units of stations with average load factors and 650 pounds for all the main units of stations carrying what is commonly known as base load." A 400-pound steam pressure plant is probably the most economical installation for a small load factor or low price fuel. Furthermore, this pressure is very well adapted to the superimposition of a high-pressure steam cycle or a mercury cycle at a later date when warranted by an increased load factor or price of fuel. The experience at the Edgar Station of The Edison Electric Illuminating Company of Boston and the Lakeside Station of the Milwaukee Electric Railway and Light Company indicates that a boiler pressure of 1400 pounds per square inch is economically justified. Care must be taken, however, not to draw general conclusions from any particular installation for the local conditions are a big factor in determining what pressure is the most economical one for any contemplated station. A careful study must be made before a decision can be reached as to the proper boiler pressure for any new station. We must keep constantly in mind that the base load station of today will be the peak load station of tomorrow, and this fact should not be overlooked when figuring the investment warranted.

Temperature. The total temperature of steam has, in the last few years, been limited to 750 deg. fahr. for all pressures, while most of the plants are operating at temperatures varying from 700 deg. fahr. to 725 deg.

fahr. There probably will be some endeavor to resort to higher steam temperatures in the future, but whether the increase in temperature will be in decided steps by using special alloy steels, or whether there will be a gradual increase in steam temperature from year to year, cannot be predicted at present. Much research has been and is being conducted on the physical characteristics of materials at high temperatures, a feature being the tests carried out under continued stress and temperature. The general results will give opportunities for securing greater reliability under the maximum temperatures which obtain today in power plant operation in this country. It is reported that there are plants in Europe operating on the straight steam cycle at temperatures higher than 750 deg. fahr. but the general adoption of higher temperatures for this cycle will depend upon the results of the research work now in progress.

Bleeding and Reheating. Stage bleeding for heating

separate drip return pumps for the two low-pressure heaters and for the evaporator condenser. It will be noted that the drains from the 5th stage heater are passed to the shell of the 10th stage heater, from which point the combined drains of these two heaters enter the flash tank, which cooperates with the evaporator condenser. This generating set will have a very high use-factor so the heaters have been chosen with close terminal temperature differences. The evaporators and heaters are of Griscom-Russell design with removable tube bundles.

Reheating of the steam after it has completed a portion of its expansion, has proved satisfactory and successful where applied. Reheating in the boiler room however, requires large piping to and from the reheating boiler and also involves some loss in pressure which partially offsets the gains from reheating. This year has brought out a new development largely overcoming these objections and it is now proposed to

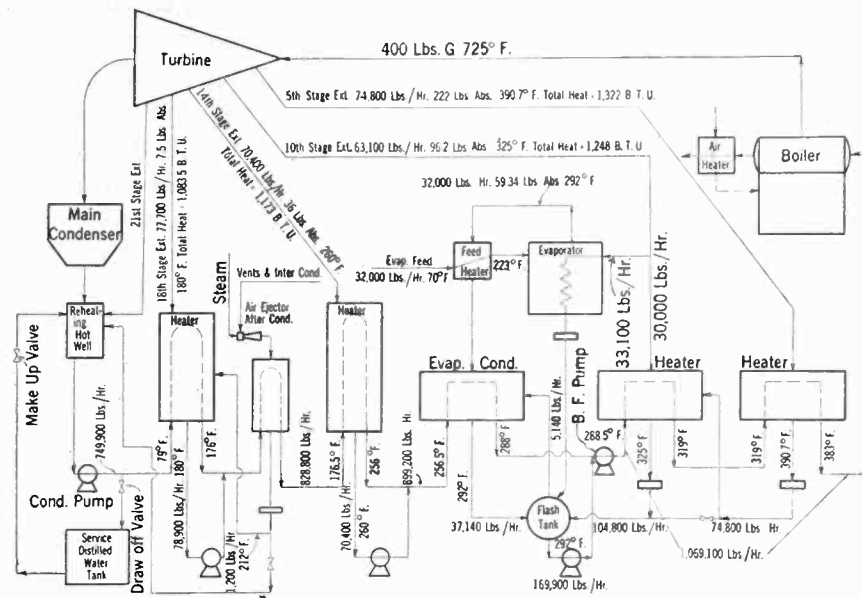

FIG. 1—APPROXIMATE HEAT DIAGRAM. SOUTHERN CALIFORNIA EDISON CO., LONG BEACH STEAM PLANT NO. 3—NO. 10 UNIT

the boiler feed water and evaporating the make-up water has become almost standard practise and in most of the large plants constructed recently, the bleeding is done in three or four, and in some cases five, separate stages.

One method extensively used is bleeding in which the feed water heating is done entirely by steam extracted from the main units. Such a scheme, in which a four-stage extraction heating system contributes a final feed temperature of 383 deg. fahr., has been adopted for the 94,000-kw. turbine in Long Beach Power Station, and is shown in Fig. 1. The evaporator and its separate condenser are interposed between the 10th and 14th stage extractions, which is a thermally efficient disposal of this apparatus, by virtue of the fact that there is no external heat degradation from the 10th stage to the 14th stage. It is economically advisable in a set of this size to employ

reheat the steam at or near the turbine using high pressure live steam.

Voltage. With the increase in size of steam turbine-driven generators, which today have reached a maximum of 100,000 kv-a., an increase in the generator voltage is desirable. It is well-known that this higher voltage will, by decreasing the current, effect a considerable reduction in the cost of busses, switches, cables, etc., and probably before very long many generators of 50,000 kv-a. and upward will be wound for higher voltages than have prevailed heretofore. As an illustration of this trend, there are now under construction a 100,000-kv-a. generator for 16,500-volt operation, the generators for a 208,000-kw. cross-compound three-element unit to be operated at 22,000 volts, and also a single-shaft generator of 61,765 kv-a. that will operate at 22,000 volts.

Generator Cooling and Fire Protection. It is almost

universal practise to employ the closed system of air circulation with surface air coolers for machines above 6000 kw. and quite common practise on smaller machines. The possibility of using an inert gas continuously has been suggested, but the predicted advantages have not been considered sufficient to warrant its introduction. The use of hydrogen, because of its lower density and higher specific heat promises many advantages, and provision is being made for its use at a later date in some machines now under construction.

The introduction of the enclosed machine has resulted in the installation of a number of CO₂ fire extinguishing systems. Where this protection is used on generators and similar rotating electrical machines the CO₂ is injected in the intake air duct and a predetermined concentration is maintained until the machine comes to a stand still. Leakage during deceleration is compensated for by introducing additional gas at necessary intervals. This application of course is particularly adapted to closed recirculating ventilating systems.

The following are some of the outstanding turbine and generator installations recently completed or now under construction:

Single Cylinder Turbine Units. The outstanding single cylinder turbine unit installations during 1926 were the 60,000-kw. General Electric units at the Charles R. Huntley (formerly River) Power Station of the Buffalo General Electric Company and at the East River Power Station of the New York Edison Company. The machine installed at Buffalo is supplied with steam at 250 lb. gage and 656 deg. fahr. The speed is 1500 rev. per min. and the generator is rated at 66,667 kv-a. At the East River Station the two 60,000-kw. 100 per cent power factor units are also General Electric machines which are supplied with steam at 375 lb. gage and 700 deg. fahr. The turbines are twenty-stage impulse type units operating at 1500 rev. per min. and are bled at three points for feed water heating.

The record size single cylinder installation of 1926, however, will be exceeded by the addition now being installed in the Edgar Station of the Edison Electric Illuminating Company of Boston. This installation will include a 65,000-kw. single-cylinder General Electric turbine, which will run at 1800 rev. per min. and drive a 75,000 kv-a. main generator and a 6250 kv-a. auxiliary generator. This turbine will operate on steam at 350 lb. gage and 725 deg. fahr. In addition to the 65,000-kw. normal pressure unit, a 10,000-kw. 1200-lb. unit will be installed which will exhaust through reheaters into the 350-lb. steam header. The feed water will be heated with steam bled from three points of the 65,000-kw. unit and also from the exhaust of the 10,000-kw. high-pressure unit.

Tandem-Compound Turbine Units. The largest tandem-compound (single-shaft) units in operation in 1926 are the two 50,000-kw., 20-stage, impulse type, General Electric units at the Richmond Station of the Phila-

delphia Electric Company, and the two 50,000-kw., reaction type, Westinghouse units at the Hudson Avenue Station of the Brooklyn Edison Company. The Richmond Station units operate at a steam pressure of 385 lb. and 675 deg. fahr. total temperature. The speed is 1800 rev. per min. and the generators are rated at 62,500 kv-a., furnishing power at 14,000 volts, 60 cycles. The generators are cooled by two motor-driven external fans, solidly connected to the generator leads through transformers. Recent tests indicate, however, that the Richmond Station units can be given a higher rating, which has been tentatively and probably will be finally fixed at 60,000 kw., 0.85 power factor, *i. e.*, 70,600 kv-a. The machines at the Hudson Avenue Station are supplied with steam at 265 lb. and 611 deg. fahr. total temperature. The speed is 1200 rev. per min. and the generator capacity is 62,500 kv-a.

The 50,000-kw., tandem-compound, Allis-Chalmers turbine generator unit recently placed in operation at the Waukegan Station of the Public Service Company of Northern Illinois is also a notable installation, in that the steam pressure will be 600 lb. gage and the total steam temperature 725 deg. fahr. The generator is rated at 58,800 kv-a., the speed being 1800 rev. per min. The exciter will be direct-connected to the shaft. The turbine will be provided with five extraction nozzles.

The Southern California Edison Company will install at its new Long Beach Power Station No. 3, a 94,000-kw., 1500-rev. per min. single-shaft, tandem-compound, turbine generator unit. This will be a 21-stage, impulse type, General Electric unit, and will be the largest single-shaft turbine on record. The turbine will have two cylinders with complete double flow of the steam in the low-pressure cylinder. The steam pressure at the turbine will be 400 lb. gage and 725 deg. fahr. total temperature, and there will be four extraction points for heating feed water to a total temperature of 383 deg. fahr. The turbine will be direct connected to a 100,000-kv-a., 16,500-volt, 50-cycle generator with a 5000-kv-a. auxiliary generator and 60-kw. exciter for the auxiliary generator on the same shaft.

Cross-Compound Turbine Units. The largest cross-compound turbine generator unit placed in operation in 1926 was the 80,000-kw. Westinghouse unit at the Hudson Avenue Station of the Brooklyn Edison Company. This consists of one high-pressure and one low-pressure cylinder operating at 1800 rev. per min., each driving a 45,000-kv-a. generator, with the exciter direct-connected to the high-pressure element. Steam is supplied at 375 lb. and 700 deg. fahr. total temperature. The high-pressure element is a combination impulse reaction turbine, while the low-pressure element is a double flow reaction turbine.

All previous records of turbine sizes will be exceeded by the remarkable cross-compound units now in course of construction—the 104,000-kw. Westinghouse unit for the Crawford Avenue Station of the Commonwealth Edison Company, the 108,700-kw. Westinghouse unit

for the Hudson Avenue Station of the Brooklyn Edison Company, the 160,000-kw. American Brown Boveri unit for the Hell Gate Power Station of the United Electric Light and Power Company, the 165,000-kw. General Electric unit for the Philo Power Station of the Ohio Power Company and the 208,000-kw. General Electric unit for the State Line Power Station of the Commonwealth Edison system.

The 104,000-kw. Westinghouse unit (Fig. 2), for the Crawford Avenue Station is unique in that it was designed as a base load unit. The leaving loss of this unit is reduced to a minimum and is approximately 1 per cent at the economical load and $1\frac{3}{4}$ per cent at the maximum load, in both cases when steam is being bled at four extraction points for heating its own feed water. To secure this low leaving loss, the triple-flow, low-pres-

sure principle is employed. The speed of each of the two lines of shafting will be 1800 rev. per min. and there will be two main generators.

The reheating of the exhaust steam from the high-pressure element by means of live steam from the high-pressure header is a new departure that is also being installed for the 91,500-kw. unit under construction for this station.

After the 104,000-kw. and 91,500-kw. units are installed, and including the 77,000-kw. unit recently placed in operation, the total installed generating capacity of the Crawford Avenue Station will be 432,500-kw.

The Brooklyn Edison Company has just closed an order for a Westinghouse 108,700-kw., 80 per cent power factor (136,000 kv-a.), 60-cycle, three-phase, 13,800-volt, cross-compound, two-element steam generating

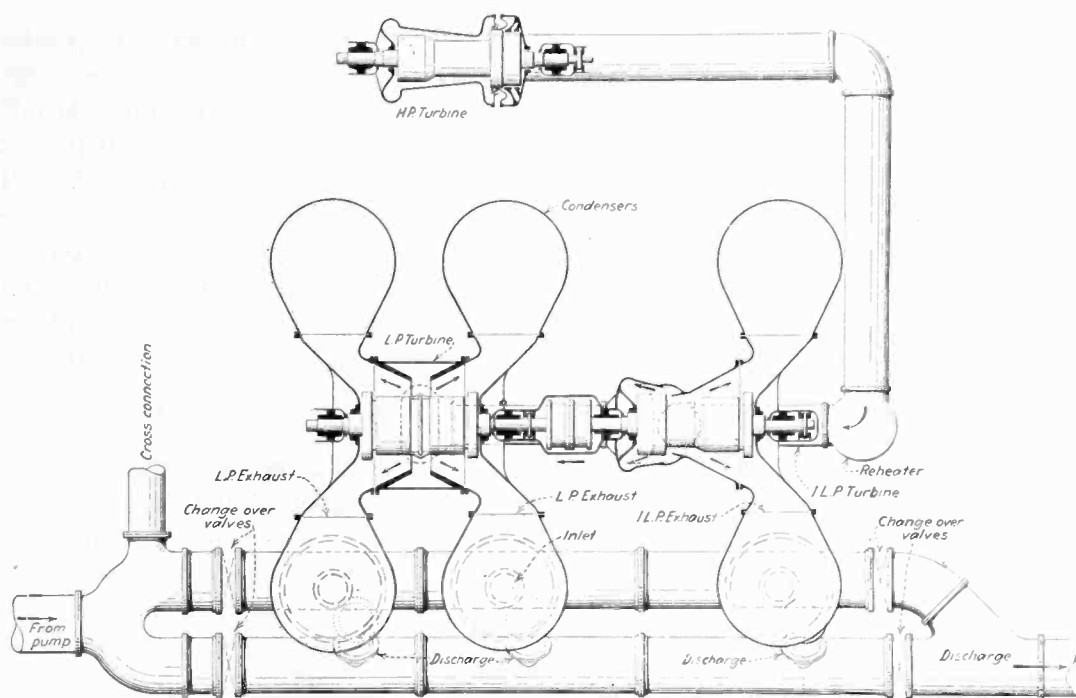

FIG. 2—ARRANGEMENT OF TURBINES FOR 104,000-KW. WESTINGHOUSE UNIT FOR CRAWFORD AVENUE STATION OF COMMONWEALTH EDISON COMPANY

The circulating-water piping shown for three of the condensers is duplicated for the other three.

sure principle is employed. The steam is supplied to the high pressure element at 550 lb. gage and 725 deg. fahr. and expanded to about 40 lb. absolute. It is then reheated, by means of a live steam reheater to 500 deg. fahr. the steam then entering the double flow intermediate element. One-third passes in one direction and is completely expanded, while two-thirds of it passes in the opposite direction expanding to 8 lb. absolute. It is then passed to the double-flow, low-pressure element which is in the same line of shafting as the intermediate element. By this arrangement, steam is exhausted to the six vertical condensers at three points, two condensers being at one end of the intermediate element and two condensers at each of the two ends of the double-flow, low-pressure element. Any one of the six condensers can be opened at the water end while the unit is in service with no other effect than a reduction

unit. The turbines are to be of the parallel-flow type and drive two 68000-kv-a., 1800-rev. per min. generators. The exciter is direct connected to the high pressure generator shaft. The machine will use a steam pressure at the throttle of 375 to 400 lb. per sq. in. at 700 deg. total temperature. It will heat the condensate in four stages of feed heating. Two interesting features of the design of the turbines are the five governor control valves in two steam chests and the stainless steel blading. The generators are arranged with internal fans, and generator air coolers are being supplied with the unit. The main generator fields will be alike so that they may be used on either stator, and the shaft ends will be alike for this purpose.

In deciding upon the size of the Hell Gate unit, the special problem arose of providing a turbine of the greatest possible output in the space available, which is

25½ feet by 69 feet. Owing to the limited floor space, the turbine was designed as a two-cylinder machine with two lines of shafting (cross-compound) and it is a pure reaction turbine. The high-pressure element has a capacity of 75,000 kw. at 1800 rev. per min., and the low-pressure element can deliver 85,000 kw. at 1200 rev. per min. Steam will be supplied to the high-pressure element at 265 lb. and 600 deg. fahr. total temperature. There will be extraction at two stages for heating feed water, one at the low-pressure element inlet and one at about the middle of the low-pressure element. The alternators are built for a continuous output of 188,200 kv-a. at 13,800 volts and 60 cycles, the capacities of the generators driven by the high- and low-pressure turbines being 88,200 kv-a. and 100,000 kv-a., respectively. This unit will be required at present for a normal service of 50,000 to 100,000 kw., but in the event of one or more of the existing units failing, it must be able to take over 160,000 kw. continuously. In spite of the large overload, it was therefore necessary for the unit to have a high efficiency at a small load and it was designed with a flat efficiency curve.

The 165,000-kw. unit at the Philo Station will consist of one high-pressure and two low-pressure elements, each element having a speed of 1800 rev. per min. the high-pressure element having a capacity of 49,000 kw. and each low-pressure 55,000 kw. There will be in addition to the main generators, two 3000-kw. direct-connected auxiliary generators. Alternating current will be delivered at 11,000 volts, 60 cycles. The main generators will have a capacity of 57,647 kv-a. and 64,706 kv-a. each for the high- and low-pressure turbines respectively, and the auxiliary generators 4286 kv-a. each. Steam will be delivered to this machine at 600 lb. 725 deg. fahr. total temperature and there will be five extraction points for feed water heating, the highest point having a pressure of 360 lb. absolute, and the lowest 6.15 lb. absolute. The initial steam pressure for the low-pressure element will be 126 lb. absolute 725 deg. fahr. total temperature after reheating.

The largest unit on record anywhere, is the 208,000-kw. three-element machine now under construction for the State Line Plant, a plan of which is shown in Fig. 3. It will consist of a 76,000-kw. high-pressure element and two 62,000-kw. low-pressure elements, all elements operating at 1800 rev. per min. Each of the two low-pressure turbines also operate a 4000-kw., direct-connected, auxiliary generator. The main generators will be wound for the remarkably high voltage of 22,000, the frequency being 60 cycles. The generator driven by the high-pressure turbine will have a capacity of 89,412 kv-a., the two generators driven by low-pressure turbines, 72,941 kv-a. each, and the auxiliary generators 5333 kv-a. each. The high pressure element will be supplied with steam at a pressure of 600 lb. and a total temperature of 730 deg. fahr., and the steam will be reheated between the high- and low-pressure elements to 500 deg. fahr., the pressure being 110 lb.

absolute. The exhaust steam from the high-pressure element will be reheated with live steam from the high-pressure header. Eight Allis-Chalmers condensers having a surface of 22,000 sq. ft. each will be used with the 208,000-kw. unit. There will be five extraction points, including the cross-over, from a maximum of 380 lb. absolute to a minimum of 9.4 lb. absolute.

An interesting four-cylinder compound turbine generator unit has been reported in the technical press as being under construction by the Allgemeine Elektrizitäts Gesellschaft for a new superpower station in the suburbs of Berlin. The unit will have a maximum rating of 85,000 kw. A high-pressure and an intermediate cylinder are arranged in tandem, driving a single generator and there are two low-pressure cylinders in tandem driving a second generator, the speed of both generators being 1500 rev. per min. The initial steam pressure and temperature are 500 lb. absolute and 750 deg. fahr., respectively. In the first stage a small Curtis wheel is installed and the remainder of the high

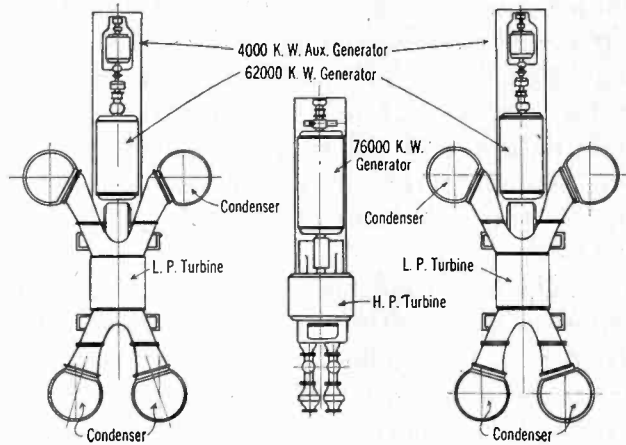

FIG. 3—ARRANGEMENT OF 208,000-KW. GENERAL ELECTRIC TURBINE GENERATOR UNIT FOR THE STATE LINE POWER STATION OF THE COMMONWEALTH EDISON SYSTEM

pressure and intermediate-pressure bladings consist of 30 stages of simple pressure compounded, impulse type. The two low-pressure turbines have 24 stages of reaction blading in each, and the steam flows through the two casings in opposite directions in order to eliminate the axial thrust.

CONDENSERS

The factors governing the performance of a condenser are coming to be better understood. With increased knowledge of condenser performance and its relation to the cost of producing electrical energy, much attention has been paid in the last few years to increasing the efficiency of this apparatus. Condensers are now chosen on a capitalized basis, wherein initial cost, vacuum, power consumed by auxiliaries, and reliability are all given monetary value.

Condensers as measured by steam capacity have kept pace with the growth of turbine sizes. Although still larger units can be built, there is a tendency because of construction and installation difficulties, toward the

use of divided units for very large sizes. As an indication of this trend, the largest turbine on record to date will have eight condensers which will handle a total of 1,600,000 lb. of steam per hour.

There has been a marked reduction in the ratio of square feet of condenser surface to kw. capacity of the turbine. This has been brought about because of a more intelligent arrangement of tubes in providing lanes that give a proper direction of the steam flow, bleeding of turbines and improved turbine water rates. An investigation regarding condenser installations in modern power plants shows that, among forty of the most prominent power stations completed within the last two years, only two have a ratio of condenser surface to kilowatt of normal turbine capacity under 1.0. This ratio for the different stations varies considerably, one being as high as 2.75, and the average for all stations being 1.396. This year however, has seen a further reduction in the amount of condensing surface per kilowatt of normal turbine capacity. Considering the condensers of appreciable size now under construction, 50 per cent of them have a ratio of less than 1.0, the four largest ones averaging 0.86, the lowest one of the four being 0.77. The problem of selecting a condenser for a particular unit is essentially one of an economic nature, and the ratio recommended by the different manufacturers may vary considerably according to the condenser design of the individual manufacturer.

The single-pass condenser has been gaining in favor whereas up to within the last two years the two-pass condenser was almost universally used. There appears to be a decided tendency toward the use of both vertical and horizontal single-pass condensers. The first single-pass vertical condensers to be built are now under construction for the Long Beach Station and will be installed early in 1928. There is also under construction, vertical bottom inlet, single-pass condensers for the 104,000-kw. and the 208,000-kw. units to be installed in the Chicago district.

A recent unique development in tube sheet construction which is claimed to eliminate leakage, will be applied to several condensers now being built. These condensers will have a floating tube sheet at one end with a rubber expansion joint between the tube sheet and the condenser shell. With this arrangement the tubes are expanded into both tube plates rigidly, the movement of expansion and contraction being taken up in the floating tube head.

Tube cleaning still presents a considerable field for investigation. During the past year experiments were conducted on a large condenser in one of the plants in the Chicago district operating on very foul circulating water, to show the effect of velocities on keeping tubes clean and decreasing the rapidity of slime formation. The results of approximately a month's run showed that the higher the velocity, the cleaner the average condition of the tubes. Also that flushing these tubes period-

ically at relatively higher velocities for short periods tended to return the efficiency of the tubes to their original condition at the start of the run.

Condensers built with divided water boxes and provided with two circulating pumps are becoming increasingly popular, as it permits cleaning one-half while the other half is in service.

Improvements have been made in the construction of hot-wells, so as to cause violent ebullition of the condensate before discharging into the suction of the pump. In one form of construction the condensate is exposed to a lower absolute pressure before discharging to the pump and in another form the drips from the bleeder heaters are led into the comparatively cool condensate. The resulting ebullition in each case has been found to be particularly successful in effecting deaeration. This construction may eliminate the necessity for deaerators.

Motor-driven auxiliaries are in the majority and there is a tendency toward the use of duplicate units. The prevailing practise seems to limit the number of circulating pumps to two per condenser, providing for each an independent source of power supply.

In a number of cases, condensers and piping have been arranged in such a manner as to permit the reversal of flow of the circulating water through the condenser tubes. This arrangement makes it possible to wash the trash out from the tube ends and water boxes, and it is particularly justified economically in cases where the water carries a considerable amount of trash most of the time.

An interesting development which has recently been applied to large power stations is a vertical screw impeller type of circulating water pump having high efficiency at low heads which is so designed that the pump may be located in a pit below the intake water level. It is therefore always primed and presents the advantage of being able to deliver water to the condenser without the necessity of priming suction and discharge lines.

The following are some of the outstanding condensers now under construction or recently placed in operation:

The 208,000-kw. turbine unit for the State Line Station of the Commonwealth Edison system will have eight Allis-Chalmers condensers of 22,000 sq. ft. cooling surface each or a total of 176,000 sq. ft., two condensers serving each of the low-pressure ends of the two double-flow, low-pressure turbines. The condensers will be of the vertical, single-pass type, the circulating water entering the lower water box, passing upward through the tubes, and discharging downward through two over-flow pipes contained in the condenser shell. With a circulating water rate of 360,000 gallons per minute, it is capable of condensing 1,600,000 lb. of steam per hour. There will be four vertical circulating pumps placed in a crib house outside the generating station.

At the Crawford Avenue Station of the Commonwealth Edison Company, the 104,000-kw. unit will be served by a total of 90,000 square feet of condensing surface composed of six 15,000-sq. ft. vertical Westinghouse condensers of the single-pass, radial flow design, which will be capable of condensing a total of 730,000 lb. of steam per hour. Circulating water will be sent up through a center pipe and down through the tubes at a rate of 180,000 gallons per minute, two vertical pumps being used.

In the condensers for the 94,000-kw. unit for the Long Beach Station of the Southern California Edison Company, provision will be made for reversing the flow of circulating water in order to clean the tubes. There will be four Ingersoll-Rand condensers for this unit and they will be of the vertical, single-pass type having 20,000 sq. ft. of cooling surface each, or 80,000 sq. ft. in all. Two motor-driven pumps will supply approximately 150,000 gallons of circulating water per minute.

An instance of the trend toward a decreasing ratio of condensing surface to turbine capacity is the 25,000-sq. ft., single-pass, Wheeler condenser for the 31,500-kw. unit to be installed at the Cabin Creek, W. Va., Power Station of the Appalachian Power and Light Company. The ratio of condensing surface to turbine capacity will be 0.793 sq. ft. per kw. Provision will be made for reversing the flow of circulating water and an external 1500-sq. ft. air cooler will be used.

The 50,000-sq. ft., single-pass, Wheeler condenser for the 55,000-kw. unit being constructed for the Pekin Power Station of the Super Power Company of Illinois will also have provision for reversing the flow of circulating water. Specially built-in valves in the water chambers will be provided for this purpose, and there will be a 5000-sq. ft. external air cooler.

The unique development in design of using a "floating" tube sheet will be applied in the case of the 25,200-sq. ft. single-pass, Wheeler condenser for the 30,000-kw. unit for the Virginia Electric and Power Company at Norfolk, Va. A storage hotwell will also be provided for this condenser and there will be a 2000-sq. ft. external air cooler.

Another instance of the trend of decreasing ratio of condenser surface to turbine capacity is the two pass, vertical, twin type Worthington condenser for the 91,500-kw. unit being constructed for the Crawford Avenue Station of the Commonwealth Edison Company. The total condensing surface will be 70,520 sq. ft., or 0.77 sq. ft. per kw.

One of the largest condensers being built is that for the 41,250-kw. turbine for the Colfax Station of the Duquesne Light Company. It is a Westinghouse radial flow, two pass type with divided water boxes, having a tube surface of 62,500 sq. ft. Steam will be condensed at the rate of 412,000 lb. per hour when using 72,500 gallons of circulating water per minute.

BOILERS, SUPERHEATERS AND ECONOMIZERS

Boiler development has been influenced by the trend toward larger units, higher pressures, higher operating ratings, new furnace designs exposing the maximum surface to the radiant heat of the fire, automatic combustion control, reduced plant investment and operating cost.

The boiler will grow in size with the rest of the industry. One new station has been designed so that one boiler can readily generate all the steam needed to carry the main turbine, and a capacity of over 35,000 kw. has been developed with ease. It is reported that one boiler has already developed sufficient capacity to generate all the steam required for a 50,000-kw. unit. This has come about through operation at very high evaporative rates made possible by substituting water cooled walls for those refractory lined. The use of water-cooled furnace walls and bottoms, resulting in a large percentage of the heat absorption taking place in the furnace at heat transfer rates in the neighborhood of 60,000 B. t. u. per sq. ft. per hour, requires a readjustment of the boiler heating surface involving a reduction in that portion receiving heat solely by convection. This change caused higher boiler outlet gas temperatures which were reduced to very low values before entering the stack, by the extensive use of air preheaters and the adoption of water heating surface in the form of integral steaming economizers of relatively low cost as compared with water heating surface in the boiler proper. The use of economizers has been stimulated by the use of higher steam pressures permitting higher feed water temperatures so that in some cases both air heaters and economizers may prove economically justifiable.

That boiler designs are not only being modified and extended to huge proportions but also are being radically altered, is evidenced by the advent of the so-called Combustion Steam Generator. This equipment, utilizing pulverized fuel, is a recent product of the International Combustion Engineering Corporation and reflects the trend toward higher ratings, completely water-cooled furnaces, reduction of convection heating surface, and intense turbulence of the furnace gases. Twelve of these units have been contracted for, some of which are ready to go into service, and others are in course of erection. Considerable interest is being manifested in this development and the performance of the equipment will be closely watched.

The benefits of highly preheated air both for stokers and for powdered coal firing are becoming more generally realized. Developments in air preheaters have been rapid. It is probable that new stations will install air preheaters of such a capacity that the flue gases will be cooled to relatively low temperatures.

There have been no unusual developments in the design of superheaters during the past year except that manufacturers are ready to offer superheaters to furnish steam at a maximum of 900 deg. fahr. The preferential

location of the superheater for high temperature seems to be in the inter-deck position, although a few installations have been made of the combination convection-radiant type. A novel arrangement in the Fordson Plant consists of placing the superheater tubes in the side walls of the furnace and behind a protecting screen of water tubes.

Owing to the rapid development in the utilization of high-pressure and high-temperature steam, it has frequently been found advisable, when constructing additions to existing stations, to select a higher steam pressure and temperature for the new part, than is used in the old part of a station. The benefits secured, from the standpoint of economy, generally outweigh the complications introduced when operating sections of a station at different pressures and temperatures. This is one satisfactory answer to the question, "What is to be done with old steam generating stations?" The steam connection necessary between the two sections of a plant so operated must contain, of course, reducing valves and desuperheating equipment. Reliable and economical operation has been aided by adapting automatic control equipment to regulate the flow of steam through this apparatus.

An installation embodying a desuperheater and reducing valves, operated automatically by a system using compressed air, is that at the Hudson Avenue Station, between its high- and low-pressure sections. The regulating valve of the desuperheater is controlled primarily by the flow of superheated steam through the desuperheater and secondarily by the temperature of the outgoing steam. The steam is desuperheated by passing through tubes surrounded by water at a controlled level. Inasmuch as the pressure of the water is such that the saturation temperatures of steam and water are not very different, it is not likely that the desuperheated steam will ever become wet.

STOKERS AND FURNACES

The inherent nature of the combustion problem necessarily obviates any spectacular accomplishments in the stoker field and limits the gains to what might be termed detailed refinements.

The insistent demand for constantly increasing steam output with high efficiency is characteristic of present day practise. So far, the boiler units have increased in horse-power rating at a greater ratio than in width. This has called for stokers of constantly increasing length with longer time-interval for the burning of the fuel and added complications in its distribution over such a length of grate surface.

Two factors have contributed in large measure, to the successful application of long stokers—means for the exact control of the movement of the fuel throughout the retort and regulation of the air to unit sections of the stoker according to the condition of the fuel bed at each individual section.

Up to the present time, boiler and stoker equipment

has generally been selected without much reference to the heat exchanges of the plant as a whole. The development of such heat reclaiming devices as water-walls, preheaters and economizers is gradually bringing about a tendency to consider the heat exchanges of the entire plant in the selection of the fuel burning equipment. There is also evidence indicating that joint selection of steam generating and fuel burning equipment is preferred to separate selection of the former without regard to its influence in the selection of the latter.

The recent developments in stokers for use with preheated air, have resulted in an appreciable reduction in furnace volume and an improvement in performance. There are under construction very large stokers which will be regularly operated with air preheated to about 400 deg. fahr. These stokers are being arranged for operation with air preheated to a maximum of approximately 600 deg. fahr., for the purpose of obtaining information as to their operating characteristics under such conditions. When air is preheated to high temperatures, it is necessary, because of its relatively large specific volume, that it pass through the fire bed at high velocities in order to maintain high rates of combustion per square foot of grate surface. There are some who maintain that there will be a considerable agitation of fuel on the grates with high air velocities and therefore the use of air preheated to a high temperature will result in reduced rates of combustion in stoker fired furnaces when air velocities are held down to rates that are not excessive.

As an indication of the trend toward the great increase in fuel burning capacity per foot of furnace width, stokers with 45 tuyeres that will underfeed coal for a distance of 16 ft. are being installed in furnaces 19 feet 5-11/16 inches from the inside of front wall to the rear breaker apron of the clinker grinders, in extensions to the Edgar Station. Stokers of the same length will be installed in the Saginaw River Station of the Consumers Power Company in Michigan. Also in the Hudson Avenue Power Station there were installed, during the past year, stokers with 39 tuyeres underfeeding coal for a distance of 15 ft. A stoker for a furnace 19 ft. 1 in. from face of bridge wall to face of front wall has just been ordered by the Stamford (Conn.) Gas & Electric Company.

For the purpose of showing the recent marked improvement in underfeed stoker development, Fig. 4 is given which compares the performance of underfeed stokers only three years old, with that which is claimed by one manufacturer, for a unit on the present basis of design up to 700 per cent of boiler rating.

Probably the most radical change in any phase of central station design is in the furnace. It is significant that water-cooled walls with certain amounts of exposed refractory surface have been installed to an increasing extent during the past year, particularly in stoker installations such as at Richmond, Hudson

Albany and Edgar Stations. However, engineers have not yet reached any final conclusion in regard to the proper proportion of refractory surface to install in such furnace walls.

In the proposed addition to the boiler house at Karny, to be stoker fired as is the original installation, all four walls will be water cooled by tubes with slight refractory material showing between tubes. Powdered fuel furnaces, such as are installed at Calumet, Fordson, Kops Bay, East River and Charles R. Huntley plants, apparently lend themselves more readily to complete water cooling than do stoker-fired furnaces.

The introduction of water walls has made possible the increasing of capacity of boilers to a point never even dreamed of three years ago. Before water walls were developed it was impossible to operate boilers continuously at high ratings owing to the limitations of refractory materials used. Now it is apparently only a question of the amount of fuel which can be burned within the furnace walls.

Furnace cooling by water walls has stimulated the use of air preheaters and it can be said these two pieces of equipment go hand in hand. The regenerative cycle

Turbulence accomplished in one way or another, to secure agitation and rapid mixing of air and carbon, greatly accelerating and improving combustion, has obviated the need for large combustion chambers formerly thought necessary to accomplish the same result. Preheated air and water cooled walls have also played a part in the reduction of furnace volume. All of these factors have either permitted or dictated that less excess air be introduced in the furnace thus allowing a smaller combustion space.

PULVERIZED FUEL

A striking feature in the expansion of pulverized fuel firing is the introduction of this form of combustion into a number of large outstanding steam generating stations during the past year. When it is recalled that the first major installation was made in connection with a 40,000-kw. plant in 1921, the development of burning pulverized fuel becomes impressive when it is considered that six years later it has been adopted for the power station which will have the largest generating unit on record.

In a comparatively short period of rapid growth it is perhaps natural that the best method of utilizing this system of combustion has not yet been defined generally. For example, turbulence is accomplished in several ways, each way requiring radically different furnaces; dryers of different types are installed in some cases and not in others. Further, quite a number of installations of unit pulverizers have been made in the last two years, but there is still a difference of opinion among engineers in regard to the question of unit mills as compared to the storage or central system. At the present time, each individual case must be studied at length, giving full consideration to operating conditions, price and kind of fuel, operating costs and fixed charges. Results from unit system installations are becoming available and the characteristics of this type of firing show many peculiarities which should be carefully considered, particularly in central station application. These results no doubt will permit of a better comparison relative to lower combined operating costs and fixed charges when considering stokers or the storage system of pulverized fuel.

Considerable progress has been made in the last year in improvements of apparatus directly connected with pulverized fuel, and there seems to have been a radical departure from many previous methods of applying this system of firing to the steam boiler.

Four factors of primary importance are, the preliminary preparation of coal including drying, fineness of pulverization, turbulence in burning and furnace volume, all of which have been and are still being intensely studied. One of the most important single factors in the combustion of pulverized fuel is mixing of the air and coal streams. The intimate mixing of the secondary air with the primary air and coal immediately upon leaving the burners produces a turbulence which

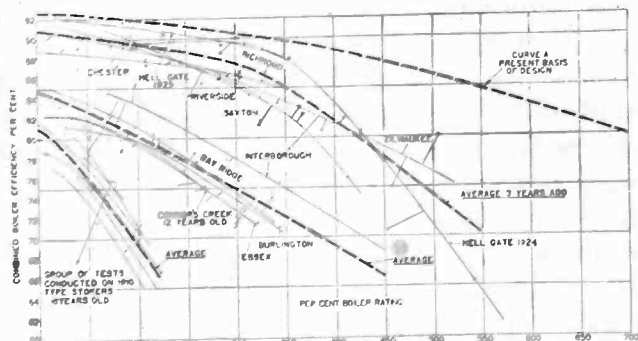

FIG. 4—DEVELOPMENT OF BOILER AND STOKER PERFORMANCES DURING THE PAST 17 YEARS

with its high temperature feed water coming to the boiler room, minimizes the absorption of heat from the flue gases by an economizer unless it be of the steaming type. The ability of the preheater under these conditions to lower the flue gas temperature below the temperature possible to obtain with an economizer alone, has frequently dictated the installation of the preheater rather than an economizer.

With brick walls it was impossible to take full advantage of the benefits of the air preheater, as higher furnace temperatures resulted in excessive maintenance of the refractory walls. With water cooled walls the limits to the degree of preheat are fixed by the character of the fuel when burned on stokers, the material used in the manufacture of the preheater, or the highest velocity of the air through the tuyeres, that will not blow the coal off the grates. In some cases it has been necessary to install an economizer before the air heater in order to hold down the temperature of the gases.

The size of pulverized fuel furnaces for a given amount of heat liberated is definitely on the decline.

persists throughout the zone of flame activity, thereby completing combustion in a minimum of time and space. In order to keep the dimensions of the furnace within reasonable limits, it is likely that the tangential system of introducing the fuel will be most favored, as greater use of furnace volume can be secured. The importance of the intense turbulence is generally recognized and designers of coal burning equipment have endeavored to obtain this in various ways.

If a forecast can be made of developments, these will include turbulent firing, simplified storage systems, methods of drying of the fuel and mills of greatly increased capacity. Through these developments still greater advantages will be realized by the use of pulverized fuel in central station practise. The opinion has been expressed that powdered fuel firing will probably be the standard method of the future as it will be impossible to burn sufficient coal per square foot on a stoker to develop the capacities which will be required. However no clear cut supremacy has as yet been demonstrated and the fact must not be lost sight of that stoker development has proceeded at a brisk pace with no indications of a diminution.

The rapid introduction of pulverized fuel into steam generating stations is indicated by the fact that at the present time 40 public utility plants in the United States either partially or fully operate with pulverized coal, the aggregate generator capacity so fired being 2,200,000 kw. This is exclusive of several installations in steam heating plants. In addition to this there are now under construction five new plants and extensions to two old plants, having together a total capacity of 440,000 kw., all of which will be operated with pulverized coal. The significance of these figures can better be appreciated from the following tabulation:

PULVERIZED COAL INSTALLATIONS		
	No.	Capacity, kw.
Installations in operation	40	2,200,000
Installations under construction	7	440,000
Total	47	2,640,000
Installations in operation and under construction, entirely operated with pulverized coal	27	1,700,000
Plants with 40,000 kw. capacity or more, operated with pulverized coal	27	2,250,000

AUTOMATIC COMBUSTION CONTROL

Considerable progress has been made in the development and application of automatic combustion control equipment to stoker firing, pulverized fuel and oil burning. Engineers are giving increased attention to this equipment which, judging from the number of installations in operation at the present time, is apparently well advanced from the development stage and should assume a major role in the process of converting the heat in the coal to heat in steam in the most economical manner possible.

Complete automatic combustion control has been in operation for some time in several of the outstanding

power stations in the east, and the companies report satisfactory performance of the equipment. Results show that daily operating efficiencies are maintained within 2 per cent of test efficiencies.

The following are some of the outstanding installations of boiler room equipment recently completed, or under construction:

The second boiler in this country to generate steam at a pressure of more than 1000 pounds went into operation late in 1926 at the Lakeside Station. This is a single three drum Stirling boiler built for a working pressure of 1390 pounds and contains 28,532 sq. ft. of heating surface. The drums are forged steel 41 ft. 6 in. long, 40 in. inside diameter and 5 in. thick. The walls of the furnace are formed, by radiant heat superheaters on the sides designed to give an ultimate temperature of 720 deg. fahr., by a radiant heat resuperheater on the rear wall designed to reheat the steam from 447 deg. fahr. at 317 pounds pressure to approximately 720 deg. fahr., and by fin cooling tubes on the front wall. Pulverized coal equipment is used with a plate air heater of 20,160 sq. in., designed to preheat the air to 650 deg. fahr. at maximum load.

Four additional high-pressure boilers are planned, two being under construction, for the Edgar Station. The two units are B. & W. boilers built for a working pressure of 1400 pounds, with a heating surface of 15,090 sq. ft. each, the drums being 4 $\frac{5}{8}$ in. thick, 48 in. inside diameter and 38 ft. 4 in. long. Each unit is equipped with a primary superheater designed to give an ultimate temperature of 725 deg. fahr., and a reheater unit to give an ultimate temperature of 750 deg. fahr., both at an output of 200,000 pounds of steam per hour. The economizers are the wrought steel return bend type with 5596 sq. ft. of heating surface each, and the tubular air heaters each contain 33,032 sq. ft. The boilers are fired with Taylor underfeed stokers having 16 retorts and 45 tuyeres, the largest of their type ever built. These stokers, using preheated air, are capable of burning 37,700 pounds of coal per hour, and are provided with means for manually regulating the supply of air to various parts of the fire according to the condition of the fuel bed at each part. The furnace will be equipped with Bailey side and rear walls, and a ventilated Bigelow hung front wall.

An ultra high-pressure boiler and turbine installation is planned for the Northeast Power Station of the Kansas City Power and Light Company, but has not yet assumed definite enough form to warrant publication of any details.

European manufacturers are experimenting with ultra high pressure steam generation. It is reported that an installation of 18,000 kw. capacity is near completion and that the boiler in which water is evaporated by superheated steam will supply steam at a pressure of 1500 to 1700 pounds. The boiler setting contains only a superheater and economizer.

The redesigning and rebuilding of No. 2 boiler and furnace unit at the Fordson Plant, illustrates the tendency to secure the maximum capacity from a single unit. This unit is a Ladd boiler of originally 26,470 sq. ft. of heating surface with a furnace designed to burn pulverized coal, blast furnace gas, oil, tar and coke oven gas, either singly or in combination. At the time of installation this boiler and three more of identical pattern in the Fordson Plant were the largest ever built. By adding 12 per cent of the total water-heating surface in the form of water screens in the bottom of the furnace, equipping the side walls with fin tubes and radiant superheaters, protecting the arches with water tubes besides doubling the number of burners and installing air preheaters the actual steaming capacity was increased 100 per cent. A peak output of 500,000 pounds of steam has been attained, which is said to be a record for a single unit.

There are being installed in the Stanton Power Station of the Pennsylvania Power & Light Company, six standard and two reheater B. & W. cross drum boilers built for a working pressure of 732 pounds and to be operated at approximately 650 pounds pressure. The standard boilers contain 17,962 sq. ft. of heating surface each and are equipped with superheaters designed to give an ultimate temperature of 750 deg. fahr. at an output of 150,000 pounds of steam per hour. The reheater units contain 5978 sq. ft. of heating surface each, and are equipped with primary superheaters to give 740 deg. fahr. at an output of 81,000 pounds of steam per hour, and with reheater elements designed to reheat the low pressure steam to 730-740 deg. fahr. The boilers will be fired by B. & W. chain grate stokers 24 feet by 22 feet burning anthracite slush with preheated air.

An experimental powdered coal installation has been in service in the Calumet Station since November 15, 1926. The heating surface of the unit is divided as follows:

Boiler Heating Surface.....	5,938 sq. ft.
Furnace Heating Surface.....	2,460 sq. ft.
Steaming Economizer Surface...	8,365 sq. ft.
<hr/>	
Total Water Surface.....	16,763 sq. ft.
Air Heater Surface.....	41,700 sq. ft.

This boiler has been operated for short intervals at a rate of 300,000 pounds of steam per hour, but this rate could not be maintained for longer periods because of the lack of pump capacity. This rate corresponds to an evaporation per square foot of total water surface of 17.9 pounds or an evaporation of 35.7 pounds per sq. ft. on the basis of combined boiler and furnace heating surface.

The operation of this Calumet boiler equipment has proven to be so satisfactory that orders have been placed for five similar units for the State Line Generating Company, State Line, Ind. The entire arrangement of these units will be similar to the Calumet equipment as to boilers, superheaters, economizers, air heaters,

Bailey furnaces, Calumet burners and Fuller-Lehigh unit mill pulverized coal equipment, with the exception that the boilers will be built for a working pressure of 800 pounds to operate at about 600 pounds pressure. The individual units, however, will be much larger than the Calumet unit, the boiler drums being 52 inches in diameter, 3¼ in. thick and forged instead of riveted.

Satisfying the demand for still larger units, there is being installed in station "C", for the Pacific Gas & Electric Company, two B. & W. cross-drum boilers which are the largest of their type yet built. These boilers have a heating surface of 35,500 sq. ft. each, and are built for a working pressure of 460 lb. They are equipped with tubular air heaters of 51,232 sq. ft. each and superheaters designed to give 725 deg. fahr. ultimate temperature at an output of 350,000 lb. of steam per hour. The furnaces are to be oil fired and equipped with water-cooled walls. For the Long Beach station of the Southern California Edison Co., there are now under construction three cross drum units of the same type having 34,162 sq. ft. each and built for a working pressure of 450 lb. each with steam at 713 deg. fahr. The furnaces are designed to burn oil when the plant is first put into operation and pulverized coal at some future date, the furnace walls and floor being of water cooled construction.

A notable installation to go into service was the six (6) 1590 h. p. Springfield boilers in the East River Plant of the New York Edison Company. The boilers are pulverized coal fired and furnish steam at 375 lb. pressure and 700 deg. fahr. Each boiler is capable, on continuous overload, of producing 250,000 lb. of steam per hour. No brickwork or refractory material is used, the furnace being completely enclosed by Murray fin tubes, backed up by plastic coating about 6 in. thick consisting of diatomaceous earth, cement and a painted hard outside finish.

Another outstanding installation is the addition to the Hudson Avenue station, consisting of four 2292-h. p. boilers furnishing steam at approximately 400 pounds per square inch and 700 deg. fahr. These units have the rear and side walls cooled by water tubes which are protected at the firing line by cast iron and carborundum blocks respectively. The front wall is lined with carborundum blocks. These boilers are fired by Westinghouse 14 retort, 39 tuyere, 18 ft. long under-feed stokers. The stokers use preheated air and provide an actual grate surface of 460 sq. ft. or 427 sq. ft. of projected area.

At the Kearny station a fifth row of three boilers will be added. They will be Springfield cross-drum units of 23,640 sq. ft. of heating surface, similar to the original units but with water-cooled rear, side and front walls composed of tubes backed up by refractory tile, a layer of insulating material and a finished casing of transite board. Cast iron blocks will be bolted to the wall cooling tubes just above the fire line to protect

them and reduce heat absorption. Preheated air will also be employed in combustion. It is expected that with these two features of water cooled walls and preheated air, not possessed by the boilers in the original installation, much higher ratings will be secured. Riley superstokers of about the same huge dimensions as the original units in this station will be installed under these boilers.

The installation of four boilers, burning pulverized coal, at the Charles R. Huntley Station of the Buffalo General Electric Company is unique in several respects. These boilers have 12,515 sq. ft. of heating surface, well-type furnaces tangentially fired, and Bailey water walls on four sides. The wells in three of the furnaces are as wide as the furnace in each case and about two-thirds its length. Tap holes are provided for removing the ash as molten slag. The unit system of pulverizing is employed. These boilers can be operated at outputs of from 60,000 to 250,000 pounds of steam per hour.

Two Combustion Steam Generators furnishing steam at 825 pounds pressure and fired by unit pulverizers using preheated air, are being installed in the Syracuse N. Y. plant of the Solvay Process Company. Another such unit is being installed in the Calumet Station, a brief description of which is as follows:

Water-heating surface		
Rear bank of tubes.....	3,637 sq. ft.	
Side Walls.....	1,710 sq. ft.	
Roof.....	254 sq. ft.	
Bottom Bank of tubes.....	1,171 sq. ft.	
<hr/>		
Total Water-heating surface....	6,772 sq. ft.	
Superheating surface.....	3,000 sq. ft.	(Approx.)
Economizer.....	5,250 sq. ft.	
Air heating surface.....	25,200 sq. ft.	
Steam pressure.....	360 lb. gage	
Effective Combustion space....	5,000 cu. ft.	
Normal Capacity of unit.....	125,000 lbs. per hr.	
Peak Capacity of unit.....	150,000 lbs. per hr.	

Cheap water power, for industries using large amounts of steam for process work, has encouraged the development and use of electric steam boilers. At the beginning of 1927, an aggregate of 750,000 kw. of these units was installed in Canada and the U. S. Three of such boilers having a capacity of 42,000 kw. each and operating at 6600 volts, were installed in 1926.

ULTRA-HIGH PRESSURE STEAM TURBINE GENERATOR INSTALLATIONS

Considerable progress has been made during the last few years in the development of turbines, boilers and other equipment operating at the ultra-high pressures, from the pioneer stage into an important commercial development. At the Edgar Station of the Edison Illuminating Company of Boston, the original high-pressure installation in this country, a 3150-kw. unit has given remarkably satisfactory results for nearly two years. Upon the basis of this experience a 10,000-kw. 1200-lb. unit is now being installed and a second 10,000-kw. unit is contemplated. The Mil-

waukee Electric Railway and Light Company has also installed a 7000-kw., 1250-lb. unit in its Lakeside power station. It has been reported in the technical press that a third installation is contemplated for the Northeast Power Station of the Kansas City Power and Light Company. This installation will consist of a 1400-lb. boiler with a 10,000-kw. high-pressure turbine exhausting to the main steam header of the station.

The problem of the use of both high pressures and high temperatures is very difficult, particularly in the design of the boilers and superheaters, where the stresses in the tubes are increased by the temperature differences between the outside and inside surfaces. The difficulty of the use of both high temperatures and high pressures is due to the fact that at high temperatures the strength and stability of the materials normally used are seriously reduced. The question of materials for use in high pressure turbine construction is somewhat less troublesome than in boiler work, because of the fact that small high-speed units are used with temperatures fairly uniform at any section, and therefore the stresses can be controlled so as to prevent high unit-stresses in high temperature zones.

The advantage of using ultra-high pressure turbines in connection with normal pressure units is not only the increased fuel economy, but also the fact that the space required is nearly the same for the high and normal pressure installation combined as for the normal pressure alone. The increased capacity is therefore a net gain, which approximately balances the increased cost of the equipment, so that the improved thermal efficiency represents very nearly a corresponding economic gain.

The entirely satisfactory operating results and full realization of expected gains of the ultra-high-pressure installations now in operation in this country shows that they are of unquestionable commercial value and proves by actual test the advisability of improving the efficiency of existing "normal pressure" stations as well as new stations by the convenient addition of high pressure equipment instead of more low pressure apparatus. This is especially the case in stations having a low load factor where the equipment operating on the high pressure cycle can be installed sufficient to supply the base load only.

Edgar Station. The high-pressure plant now in operation at the Edgar Station consists of one high-pressure boiler and a 3150-kw. turbine. Based on its successful operation for nearly two years, an addition is now being constructed which includes two 15,090-sq. ft. cross-drum Babcock & Wilcox boilers, a 10,000-kw., 3600-rev. per min. General Electric high-pressure turbo-generator together with the 65,000-kw. normal-pressure turbo generator. The boilers will generate steam at approximately 1400 lb. pressure and 700 deg. fahr. It will be expanded in the 10,000-kw. turbine, which has 16 impulse stages, to 375 lb. per sq. in. and returned to the reheating superheaters which

form part of the new boilers. After being reheated to approximately 725 deg. fahr., the steam will be discharged into the main 350-lb. steam header and together with steam from the normal pressure boilers will supply the two existing 32,000-kw. turbo generators and the new 65,000-kw. turbo generator.

Each high-pressure boiler will be equipped with a 5596-sq. ft. economizer operating at approximately 1500 lb. water pressure and with a 33,032-sq. ft. air preheater, and will be fired by a 16 retort, 45 tuyere underfeed stoker. The side and rear furnace walls will consist of refractory-faced, cast-iron blocks, bolted to boiler tubes which will be connected to the boiler.

The next high pressure extension contemplated will include two additional 15,090-sq. ft. boilers and one 10,000-kw. turbine. At that time, the four high-pressure boilers will serve the two 10,000-kw. turbines and the steam from those two high pressure turbines will be sufficient to operate the 65,000-kw., 350-lb. pressure turbine.

Before entering the economizers, the feed water will be heated to 420 deg. fahr., by means of steam bled from three points of the 65,000-kw. turbine and from the exhaust of the 10,000-kw. turbine at a pressure of 375 lb. It is of interest to note that feed water has never before been heated to this high temperature by bled steam. This high-feed temperature is of particular interest in view of the fact that the feed water will pass through an economizer after leaving the high pressure heater and before entering the boiler.

Three boiler feed pumps of interesting design are being installed. Two will be motor-driven at 1800 rev. per min. and will be used for normal operation and the third will be turbine-driven at 3600 rev. per min. and will be used for emergency only. Each motor-driven pump will consist of three pumps in series, two five-stage volute pumps and one six-stage turbine pump. One five-stage volute pump of each unit will be driven by a separate motor and will pump through two closed feed water heaters, delivering water at 500 lb. per sq. in., 420 deg. fahr., to the suction of the second five-stage volute pump. The second five-stage volute pump and the six-stage turbine pump will be piped in series, driven by one motor and will discharge at a maximum pressure of 1600 lb. per sq. in. All motors will be adjustable speed and will be automatically regulated. The turbine-driven pump will also be a six-stage turbine pump and will develop the full 1600 lb. per sq. in. in the one casing. This pump is designed for automatic starting when the pressure in the 1600-lb. boiler feed header drops below a safe limit.

The coal consumption per kilowatt-hour at the Edgar Station is approximately 1.02 lb. when only the present 30,000-kw. normal pressure turbines are operating. When about one-third the output of the station is generated by steam from the high-pressure boilers and turbines, the coal rate is approximately 0.98 lb. per kw. hr., an improvement of 4 per cent. For a complete

1200-lb. installation it is estimated that the gain should be approximately three times this figure or 12 per cent.

Lakeside Station. Prior to the installation of the 1300-lb. boiler and the 1250-lb., 720 deg. fahr. turbine, the capacity of the Lakeside Station was 160,000 kw., made up of two 20,000-kw. and four 30,000-kw. machines. The boiler room capacity was 1,600,000 lb. of steam per hour with a throttle pressure of 285 lb. per sq. in. and a temperature of 700 deg. fahr.

The new high pressure boiler is a Babcock and Wilcox-Stirling type boiler and is the largest of its kind. Its nominal rating is 2853 b. h. p. and it is capable of delivering 240,000 lb. of steam per hour. Pulverized coal is burned in a 30,100 cu. ft. Lopulco type furnace. The high-pressure turbine unit is a 7000-kw. General Electric machine and its speed is 3600 rev. per min. It exhausts to the reheater at 310 lb., the temperature of the steam after reheating being approximately 720 deg. fahr.

The high pressure installation has been in service since October 1926. It was in continuous operation from January 29th to March 19th, 1927, a period of 50 days. During this period, the kw-hr. output of the high pressure turbine was about 7.5 per cent of the total station output, while the kw-hr. generated by both the high-pressure (1250-lb.) turbine unit and the normal pressure units from the steam originating in the high pressure boiler only, was about 34.3 per cent of the total station output. The load factor of the load (in this case equal to the capacity factor) on the high-pressure turbine was approximately 90 per cent, the load being less than maximum at times due to the fact that the total station load on Sundays is below the capacity of the high-pressure boiler.

Operating results showed a coal saving on the entire station of about 4 per cent due to the operation of the high-pressure cycle since this cycle was approximately 12 per cent more efficient than the 300-lb. cycle and furnished 34 per cent of the station output.

The high pressure boiler installation has shown several remarkable operating features. Ability to average 16½ per cent CO₂ over long periods without CO losses and with unusually low carbon losses has been obtained in the operation of the high-pressure installation. This CO₂ average represents use of 12 per cent excess air, and as such establishes a record in economy of fuel burning. Automatic and instantaneous stoppage of coal feed and by-passing of 1200-lb. steam to 300-lb. pressure has been utilized in service several times when the high-pressure turbine tripped from service. Not a safety valve opened under these conditions.

MERCURY VAPOR INSTALLATION

After some four years of experience with the mercury vapor installation in its Dutch Point Station, the Hartford Electric Light Company has ordered mercury vapor equipment, including a 10,000-kw. turbine, to be

installed and to go into operation early in 1928 in its South Meadow Plant. This will be a strictly commercial application of the mercury-steam cycle and will be representative of the size and design of equipment to be placed on the market.

The commercial success of this process provides a means of effecting marked economies in power production, made possible by being able to go to higher temperatures of a working substance than when using steam alone. The very moderate pressures required permit using the higher temperatures with our present materials. In effect, the mercury is used to convey heat from the furnace to the steam boiler acting as a mercury condenser; before reaching the condenser some of the heat is developed into electrical energy by the mercury-turbine generator.

It is claimed that the remarkable record of 27 per cent efficiency, attained by the Columbia Plant, operating on a straight steam cycle, could be increased to 36 per cent in a similar plant arranged to operate on the mercury-steam cycle. The savings in fuel consumption for less efficient plants will be even greater. Of course, from a commercial viewpoint, the cost of plant must be studied with relation to capacity factor.

The original single-stage 1800-kw. unit operating at 35 pounds pressure, installed at Dutch Point in 1923, developed about 60 per cent of the available energy in the mercury. This was supplanted by a three-stage machine, developing 70 per cent of the available mercury energy, that went into operation late in 1926. The unit to go into the South Meadow Plant, estimated to develop 75 per cent of the available mercury energy, will be a five-stage 10,000-kw. machine receiving mercury vapor at about 70 pounds pressure and exhausting it at one pound absolute to two mercury condensers. In these condensers 125,000 pounds of steam per hour will be generated at 250 to 350 pounds pressure and superheated by the mercury-boiler furnace flue gases to an ultimate temperature of 700 deg. fahr. It is expected that about 10,000 kw. will be obtained from the steam generated by the condensed mercury.

The present boiler at Dutch Point, of different design from the original one, generates mercury vapor at 70 pounds pressure and 884 deg. fahr. The new boiler consists of a group of drums, each carrying dead-ended tubes six feet long, giving the unit the appearance of a huge coarse brush. There will be required for the entire installation 135,000 pounds of mercury, the cost of which will represent a substantial portion of the plant investment. In the process of generating energy the mercury will be circulated in the system eight or nine times an hour. An experimental boiler in the Schenectady G. E. Plant has been operated at 110 pounds pressure, generating vapor at 940 deg. fahr., at a rate more than twice that planned for the South Meadow unit with no difficulties whatsoever. It is expected that this Hartford unit will operate indefinitely without interruptions.

The approximate fuel saving, at an estimated figure of 11,000 B. t. u. per kw-hr. output developed from mercury and steam from the mercury condenser, based on a conservative use factor, is expected to be about \$200,000 a year. While the maximum saving is obtained when carrying base load, under light load conditions the savings are material. The operating company reports that in its Dutch Point Station it has been able to obtain as good a coal economy on 5 per cent capacity factor as the entire station is capable of doing on a 60 per cent load factor.

As a means of increasing the capacity and the economy of existing stations or even planning new base load high-economy stations, this system of power generation is competitive with the ultra-high pressure generation and utilization of steam with its attendant steam reheating complications and relatively large auxiliary power consumption.

The supply of mercury is expected to be ample although price disturbances may occur until the industry adjusts itself to the increased demands to be ultimately made upon it.

HYDROELECTRIC DEVELOPMENT

While the increase in electrical energy generated during 1926 by steam plants of public utilities was only about 9 per cent over that generated in 1925, the increase for waterpower plants was approximately 17 per cent. Furthermore, the aggregate capacity of waterwheels and generators produced was greater than for the preceding year. However, except for the trend toward larger units, there have not been any radical changes in turbine types or general form or design, but certain details of design and special features have shown development or improvement.

During the past year a large number of power companies for whom hydroelectric units were installed, adopted electric drives for the governors. This form of drive is becoming increasingly popular for hydroelectric installations. The driving motors are of the induction type and operate in close synchronism with the frequency of the generator unit which it is required to regulate. This provides a simple and convenient drive and has been found to give extremely smooth and quiet operation free from operating troubles.

Another interesting development in hydraulic turbine design was the introduction of a water-lubricated guide bearing with a rubber lining. It may be of interest to note that bearings of this type have recently been adopted for use with four turbine installations in which the shaft diameters range from 9 to 24 in. The chief advantage of the rubber lined bearing is the great durability and the long life obtainable.

In the past year a number of hydraulic turbine units have been built, equipped with plate steel casings of the volute type. Engineers are becoming increasingly interested in the possibilities of welding instead of caulking the plate steel joints for these casings, and it

may be of interest to note that the welding of these casing joints will actually be undertaken in connection with one or more of the largest and most recent turbine installations.

Hydroelectric plants automatically operated and controlled established another record during the past year. In one instance, two units of 28,500 h. p. each have been installed in a station designed to operate automatically. New methods of applying automatic control to both a reaction and impulse type of unit are being developed. This equipment is of particular advantage in connection with steam-operated plants as supplementary sources of power.

In one of the outstanding major hydraulic developments under construction where the contracts for both the turbines and generators have been split between two companies, it was found economical to have one manufacturer build all of the oil pumping system. Also, in general, the design of all the main turbine parts which are subject to wear and replacement are made interchangeable. The generators are being built with the same degree of cooperation between the manufacturers, to insure interchangeability of some of the important mechanical parts.

There has been a tendency towards the closed circuit for air circulation with surface coolers, similar to the method of cooling commonly employed for steam turbine generators. This arrangement simplifies the construction of air ducts and permits the use of an inert fire extinguishing gas if desired. A number of machines have been constructed for the closed system of circulation.

Some of the Hydroelectric Developments of exceptional interest recently completed or now under construction are given below:

Conowingo Development. The outstanding hydraulic turbine development in 1926 was the seven 54,000-h. p. 89-ft. head, 81.8-rev. per min. single-runner vertical-shaft hydraulic turbines for the Susquehanna Power Company's Conowingo Development. Three of the turbines are of I. P. Morris manufacture and four are Allis-Chalmers. The runners are made of cast steel in three sections and represent a very difficult problem in casting. The total weight of the runner will be approximately 200,000 lb. and outside diameter 179 in. The division of the runner into three parts was necessitated by shipping limitations which seem to be one of the principal factors now limiting the size of hydraulic equipment. The sections of the runner are bolted together by flange joints and in addition have steel bands mounted on the crown of the runner and the discharge ring. The spiral casing is made up of riveted steel plate sections and has an inlet diameter of 27 ft. The butterfly valve housing is joined to both the penstock and turbine casing by riveted connections. The feature of particular interest incorporated in the design of the butterfly valves is the installation of a rubber tube fitted into an annular recess in the valve body

around the circumference of the gate when the valve is in closed position. This rubber tubing is designed to expand and hold tightly against the outer circumference of the gate when pressure is admitted to the inside of the tube when the gate is closed. This characteristic of the valve will insure unusual tightness against leakage. An innovation was used in the design of the pit ring which extends from the speed ring to the generator base in that this ring was built entirely of structural steel. After repeated tests, the hydracone draft tube was accepted as the best design of tube offered for the conditions and as a result the hydracone and the Moody spreading tube were used for the entire development. The draft tubes will be equipped with cast steel stay vanes at the lower ends, designed to carry the weight of the draft tube above, in addition to the weight of the unit and its portion of the station structure, this having been found to give greater economy in construction costs than to strengthen the concrete reinforcements which would otherwise be necessary. The center concrete cones for these tubes will extend all the way up to the turbine runner.

Each water-wheel unit will be direct connected to a 40,000 kv-a. 90 per cent power factor, 81.8-rev. per min., 13,800-volt, 60-cycle generator, four of which will be of General Electric manufacture and three of which will be Westinghouse machines. These alternators are notable, not only because they are the largest in physical dimensions, of any electrical machines ever built, but also because of the fact that they are to supply power to the first 200-kv. transmission line in the eastern part of the United States. The outside diameter of the stator frame is 38 feet. The largest capacity thrust bearings ever built will be required for these generators, their capacity being the total load of 750 tons. Mounted upon each 40,000-kv-a. generator will be a 715-kv-a. auxiliary generator and above the auxiliary generator will be the 41-kw. exciter set.

By a large degree of cooperation between the manufacturers of turbines and generators, it has been possible to obtain similarity in characteristics and appearance and the interchangeability of some of the important mechanical parts.

The Conowingo units will be required to operate, in most cases, on the peak loads with unusual conditions, and will be shut down during the low load portions of the day in order to store water to the greatest possible extent. For this reason it is important to avoid leakage when the units are shut down and consequently the large pivot valves will be installed in the turbine casing rather than have head gates at the upper ends of the penstock, thus insuring quick closure and reducing the loss of water to a minimum. It is expected that this plant will show a world's record performance from the standpoint of efficiency and reliability of operation.

Automatic Hydroelectric Stations. During 1926, two 28,500-h. p., I. P. Morris turbines driving 25,000-kv-a.,

60-cycle, 11,000-volt Westinghouse generators at 300 rev. per min. were placed in operation in the Wallenpaupack Power Station of the Pennsylvania Water & Light Company. These units operate under a head of 300 ft. and the station is designed for carrier-current type of automatic control. These are the largest units on record that will be controlled automatically.

A 17,500-h. p. Pelton Water Wheel driving a 13,333-kv-a., 60-cycle, G. E. generator is under construction for the Glines Canyon Power Station of the Northwestern Power & Light Company. This unit which will operate under a head of 190 ft. will be controlled by the operator of the Elwha River Plant, seven miles away by means of selector supervisory control. In addition to the main unit, the 62.5-kv-a. auxiliary water wheel and the motor driven oil pump will also be controlled by the automatic equipment.

The largest plant built up to date for full automatic control is the Louisville hydroelectric installation now under construction which will consist of eight 13,500 h. p., Allis-Chalmers turbines. The generators are 12,500-kv-a., 14,000-volt, 100-rev. per min. vertical General Electric machines which will have a self-contained ventilating system because of the high air temperatures during the summer time when they will carry the heaviest loads.

High Head Impulse Wheels. The largest capacity impulse wheels ever constructed are the two 56,000-h. p. turbines which are under construction for the Big Creek No. 2-A plant of the Southern California Edison Company. These machines will operate under a head of 2300 ft., one being an Allis-Chalmers machine and the other will be made by the Pelton Water Wheel Company. Both machines will be of the double overhung type, having separate governor control for each nozzle. The main shaft bearings of these units will be 30 in. in diameter and the total weight carried on each bearing will be 230,000 lb. The present speed of the units will be 250 rev. per min. for 50 cycles, but the machines are designed for 60-cycle operation at 300 rev. per min. The jet diameter for each overhung impulse wheel will be 8½ in. Each bucket will weigh 900 lb. and in case of the runaway of the unit, the combined forces on the bucket bolts will be approximately 300 tons per bucket.

The Westinghouse generators for these units will have a capacity of 45,000 kv-a. at 11,000 volts, 250 rev. per min. but will have a capacity of 50,000 kv-a. at 12,500 volts when operating at a speed of 300 rev. per min.

A 40,000 h. p. Allis-Chalmers double overhung impulse wheel has been placed in operation at the Kings River Plant of the San Joaquin Light & Power Corporation for operation under a head of 2243 ft. The generator will be a General Electric 33,000-kv-a., 13,200-volt, 360-rev. per min. machine. Two exciters are provided, each of which is of sufficient capacity to excite the main generator. Each exciter is driven by a single-jet, single-overhung impulse wheel.

Two Pelton Water Wheels of 40,000 h. p. capacity each have been installed at Santos, Brazil for operation under an effective head of 2450 ft. The General Electric alternators are of the horizontal type with a capacity of 33,000 kv-a. at 11,000 volts and 360 rev. per min.

The turbines to operate under the highest head up to the present time will be the units for the Bucks Creek Plant of the Feather River Power Company. These will be of the double overhung impulse type Pelton Wheels with a capacity of 30,000 h. p. The head will be 2548 ft. and the turbines will drive 25,000-kv-a., 11,000-volt, 450-rev. per min. General Electric generators.

Propeller Type Turbines. There are being installed in the Great Falls Plant of the Manitoba Power Company, one 28,000-h. p., Moody and one 31,500-h. p. Bell type turbines driving General Electric generators. These units are the largest propeller type units now being installed and will operate under a head of 56 ft. at 138 rev. per min.

POWER STATION AUXILIARIES

The prevailing practise seems to be motor driven auxiliaries, with the added protection of having certain auxiliaries steam driven. The chief reasons for this are the extensive adoption of the regenerative cycle for feed water heating and the rapid development of motors suitable for auxiliary drive. The electric drive is very efficient and reliable and it is probable that in most cases a station using electrically driven auxiliaries will show on the average, a better thermal efficiency and a lower cost per unit of output including fixed charges, than if steam driven auxiliaries were used.

Steam drive, however, is still most favored for boiler feed pumps. It is interesting to note that a large station recently constructed in the East has adopted steam drive for all of its essential auxiliaries, but this is largely a local condition peculiar to its system. The refinements of design details, and improvements developed for large turbines have been extended to smaller capacities so that manufacturers are prepared to furnish turbines for auxiliary service having very much improved water rates.

There are still many opinions in regard to the best source of electric power for auxiliaries. On account of the higher efficiency of the main units, there has been a tendency to put all the station load on these machines. There are not so many house turbine generators being installed as in the past. The house generator in tandem with and being direct connected to the main generator shaft, appears to be gaining in favor and is extensively used.

POWER PRODUCTION ECONOMIES

A record for thermal efficiency was attained at the Columbia Station of the Columbia Power Company in Ohio. For a period of one month this station was operated on a heat consumption of approximately

12,462 B. t. u. per kw-hr. net output, which is the lowest figure obtained by any steam plant to date. The following figures, for two consecutive months, are of particular interest:

	December 1926	January 1927
Kw-hr. net output.....	44,998,400	42,547,900
Load factor.....	65.7%	60.7%
B. t. u. per kw-hr. net output.....	12,495	12,462
B. t. u. per lb. coal as fired.....	13,838	14,002
Coal factor, lb. per kw-hr. net Output.....	903	890
Station water rate.....	7.76	7.85
Standard Boilers;		
Average efficiency.....	87.06%	87.54%
Average Rating.....	216 %	233 %
Reheat Boilers:		
Average efficiency.....	90.7%	90.92%
Average Rating.....	408 %	422 %
Auxiliary power consumption....	5.27%	5.41%

The results in many other stations put into operation during the last year have also been very reassuring and in some cases have exceeded the expectations of their designers. High pressures, high temperatures, water walls, regenerative cycle, reheat cycle, air preheaters, improved combustion due to better stokers or pulverized fuel, reduction in exit gas losses by economizers and preheaters, use of electrical drives for auxiliaries, and

improvements in turbine and condenser design have all contributed to improve the thermal efficiency of power plants so that the reduction of operating costs have more than kept pace with the increased price of fuel and increased operating labor rates.

The marked improvement in utilization of fuel by public utility power plants is revealed by figures given in the Geological Survey Report, which shows that in 1926 the average large generating plant turned out a kw-hr. on 1.94 pounds of coal as compared with 2.07 in 1925. These figures include coal, oil and gas fired plants and represent the equivalent coal consumption. It is interesting to note that since the world war, using 1919 as a basis, the equivalent coal consumption per kw-hr. has been reduced 40 per cent.

ACKNOWLEDGMENT

In attempting to present a resumé of the outstanding technical achievements brought about during the past year in a complex industry like that of power generation, every effort was made to obtain from many sources, as complete and reliable information as possible of the existing conditions in the field. The committee is indebted to those engineers and manufacturers who so splendidly assisted in this work and wishes to express its appreciation of their cooperation.

W. S. GORSUCH, *Chairman.*

A Non-Rotary Regenerative Telegraph Repeater

BY A. F. CONNERY¹

Associate, A. I. E. E.

Synopsis.—Rotary regenerative repeaters have made multiplex printing telegraphy possible over long distances. This paper gives a

brief description of some types of rotary repeaters and then proceeds to describe in more detail a non-rotary regenerative repeater.

INTRODUCTION

THE use of multiple-channel printing telegraph systems in the United States and Canada has resulted in many problems in connection with their operation over long circuits.

Practically all circuits are duplexed and the usual practise is to repeer them at intervals of 250 to 350 mi. A printer circuit operated between New York and San Francisco may have as many as 12 repeaters.

An ordinary relay telegraph repeater can never repeat signals as perfectly formed as those sent out by the originating transmitter since the signals always arrive somewhat out of shape and the repeating apparatus itself contributes a further modification.

Most overhead telegraph circuits use a ground return

and some distortion of the signals is inevitable in addition to the distortion caused by the repeaters and imperfections in the duplex balance.

To operate a transcontinental multiplex printing telegraph circuit equipped throughout with ordinary relay repeaters, a very high grade of line and repeater maintenance is required. Accurate duplex balances are essential at repeater and terminal stations. The most direct routes must be used and line conductors chosen which have a favored location on the pole line so as to reduce the cross-fire from other conductors.

Even with high grade maintenance, the signal received at the terminal station is somewhat distorted and much time is consumed in balancing and adjusting. It is apparent that even a slight distortion of the signal in each line section results, in the aggregate, in an extremely distorted signal being received at the terminal station. The speed of operation is very slow as compared with the shorter circuits and the traffic capacity is low.

¹ Telegraph Engineer, Postal Telegraph Cable Co., 253 Broadway, New York, N. Y.

Presented at the Summer Convention of the A. I. E. E., Detroit, Mich., June 20-24, 1927.

By the use of a regenerative type of repeater, the received distorted signal in passing through the repeater is regenerated and sent on to the next line section in perfect shape. The invention of the regenerative repeater is old and is attributed to Baudot of France.

A regenerative repeater for duplex working usually consists of electrically driven tuning forks controlling synchronous motors, rotary distributors driven by the synchronous motors, a plurality of storing relays together with the line relays and relays used in the synchronizing circuit. The synchronizing circuit maintains the distributor in step with the received signals.

Fig. 1 indicates a simple form of regenerative repeater. The sent, received and regenerated signals are shown in addition to the two rings, R_1 and R_2 , of the rotary distributor. The received signals operate line relay LR . Transmitting relay TR can only be operated by LR during the period that brush BR has joined R_1 to a segment of R_2 . The only part of the received signal utilized for retransmission is that marked S . Any distortion occurring outside

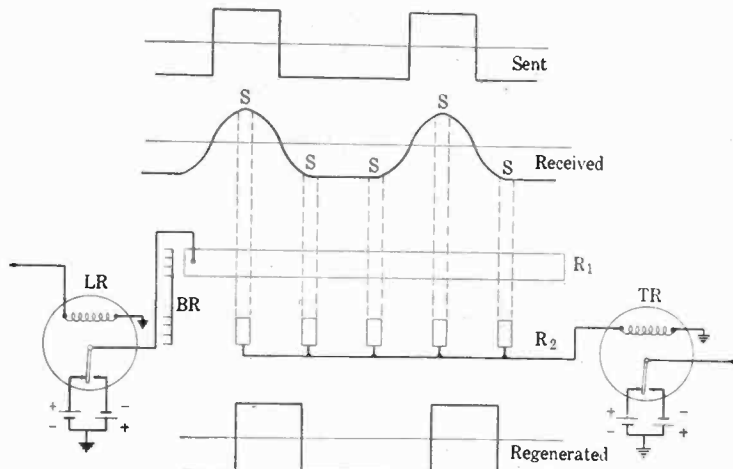

FIG. 1

of S will have no effect on the retransmitted signal. With this type of repeater, a slight distortion may be present in the retransmitted signals if the received signals are so badly distorted that they infringe upon S . Reducing the length of the segments R_2 increases the ability of the repeater to regenerate badly distorted signals, but, if the segments are too short, the operating impulse to transmitting relay TR may become too short to properly actuate the relay. The brushes BR must be driven at such a speed that the time required for the brush to pass from the start of one segment to the start of the next segment is the same as the time occupied by the shortest signal element.

Fig. 2 indicates a form of regenerative repeater which was invented by P. M. Rainey. Only a portion of the distributor face is shown. Line relay LR is actuated by signals received over line 1. Brush BR_1 connects successively the receiving segments of R_2 to R_1 . The storing relays, SR_1 to SR_5 , are operated whenever the line relay tongue is touching its marking contact at

the same instant that the brush makes contact with the respective segments of R_2 . Each storing relay, when operated, locks up through the left contact and tongue and the right contact applies the proper polarity of battery to the transmitting segments R_4 . Transmitting brush BR_2 , which is angularly displaced with respect to BR_1 , connects line 2 to the successive transmitting segments. When the transmission is

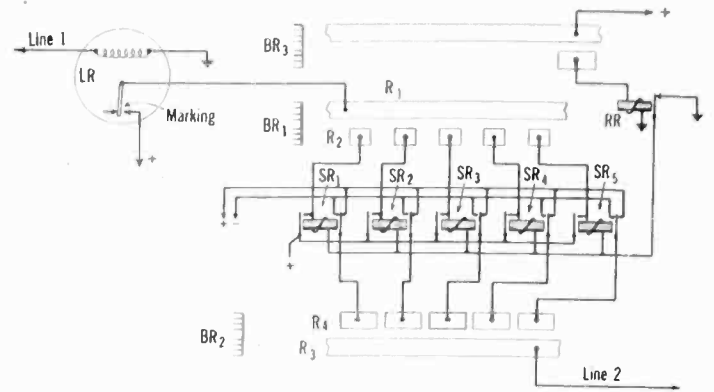

FIG. 2

completed, the restoring relay RR is actuated by BR_3 . This unlocks the storing relays and they are ready for the next revolution of the brushes.

Fig. 3 illustrates still another form of regenerative repeater. The polarized storing relays SR_1 and SR_2 are connected to alternate segments on the sending and receiving rings. While a signal from line 1 is being

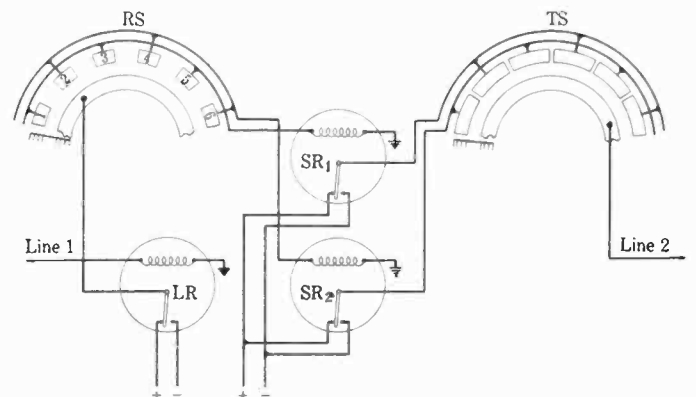

FIG. 3

stored in one relay, the stored signal in the other relay is being transmitted to line 2.

There are two main types of synchronizing systems used to maintain phase relation between the distributor brush arms and the received signals. One type, which has been termed "shift the hands" correction, shifts the brush arms to maintain synchronism while the other type maintains synchronism by altering the natural period of the driving fork.

In one example of the "shift the hands" correction, the rotary distributor is arranged to run slightly faster and a mechanism controlled by the received signals steps back or "corrects" the distributor brushes when they gain a certain amount over the brushes of the

sending distributor. Several opportunities for correction are available during each revolution. While this correcting scheme has been used to a considerable extent on rotary regenerative repeaters, it is open to some objections. The many opportunities for correction in each revolution make it possible for a few badly distorted signals to considerably alter the phase relations and several seconds are required for the distributor to work around to the proper phase. When several repeaters of this type are used in tandem on a long circuit, difficulty may be experienced in holding synchronism.

In the writer's opinion, it is preferable to use, in a regenerative repeater, a correction which alters the natural period of the driving fork because the correcting action is gradual and an occasional badly distorted signal will not seriously alter the phase relations.

NON-ROTARY REGENERATIVE REPEATER

The main object of this paper is to describe a new type of regenerative repeater which has no rotating parts. It should be realized in this connection that the rotating feature of the repeaters previously described in this paper has for its object the control of electrical contacts at uniform time intervals which agree with the rate at which signals are being sent over the line circuit. An electrically operated tuning fork adjusted to vibrate at a uniform rate and controlling electrical contacts, can be used, therefore, for timing purposes for regenerative telegraph repeaters and rotating members eliminated. A repeater for one-way repetition consists

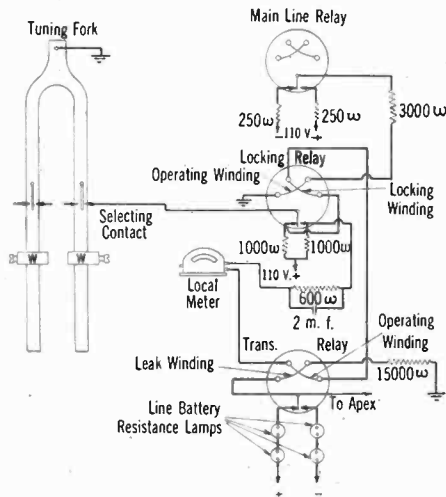

FIG. 4

essentially, therefore, of an electrically operated tuning fork, a line relay, a locking relay, a transmitting relay and a correcting or synchronizing circuit with relays. It has been found possible in practise to make use of the same type of tuning fork as is now used with multiplex printing telegraph terminal sets.

SELECTING CIRCUIT

Fig. 4 shows the selecting and locking circuits. The locking relay is normally under the influence of the main line relay which controls the direction of the current through the operating winding. The current through

the locking winding of the locking relay is stronger than the current in the operating winding and as long as the fork is touching its selecting contact the armature of the locking relay is prevented from moving. During the period that the fork is not touching the selecting contact, no current flows through the locking winding of the locking relay, and it therefore is under the influence of the tongue of the main line relay. The polarity of the signal transmitted by the transmitting relay depends upon the position of the tongue of the locking relay at the moment the fork engages its selecting contact. A long duration of engagement of the fork with the selecting contact does not injure the repeated

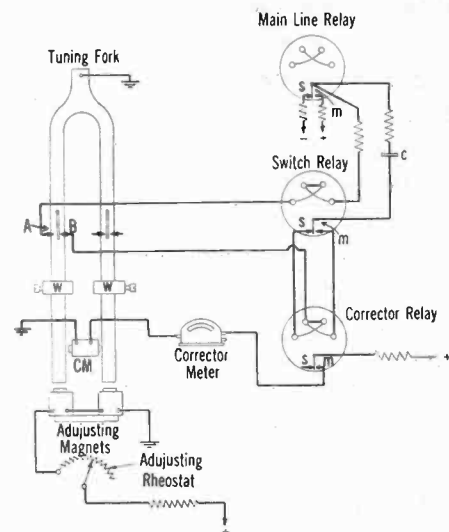

FIG. 5

signals. The locking up of the locking relay while the transmitting relay is operated prevents any clipping of the signals sent out from the transmitting relay. The shunted condenser permits a quick rise and fall of current in the locking winding. A leak current through one of the windings of the transmitting relay tends to hold the relay tongue to whichever contact it may be touching. The current in the leak winding is small and does not interfere with the operation of the relay. The local meter is used as a guide in checking speed and detecting breakups.

CORRECTION CIRCUIT

The means used to hold the fork in synchronism with received signals is an adaptation of the Picard system. Fig. 5 shows the correction circuit.

By means of the weights *W* and the adjusting rheostat, the rate of vibration of the fork is set so that, with no current flowing through the corrector magnet *CM*, it makes slightly less than a complete cycle of vibration for each unit length of line signal. With current flowing through the corrector magnet, the fork speed increases so that it makes slightly more than a complete cycle of vibration for each unit length of line signal. In actual operation, the current through the corrector magnet occurs at irregular intervals due to the action

of the correction circuit and the fork is held in step with the received signals. When the fork falls behind the signals, current flows through the corrector magnet and causes the fork speed to increase. When the fork gains on the signals, the current is cut off the corrector magnet and the fork speed is reduced.

Assume, for example, that the speed has been matched and the repeater is in operation. If the tongue of the main line relay moves from one of its contacts to the other at the instant the fork is touching contact *A*, Fig. 5, the tongue of the switch relay *SR* is moved to correspond with the position of the tongue of relay *MLR*. When the fork makes contact with *B*, a short impulse of current flows through condenser *C* and one winding of the corrector relay and the tongue of relay *CR* is moved to the marking contact and current flows through the corrector magnet and increases the speed of the fork. As long as the movements of the tongue of the main line relay *MLR* occur at the instant that the fork is touching contact *A*, the relay *CR* remains in the marking position. If, for example, the movement of the tongue of relay *MLR* is from *S* to *M*, the tongue of relay *SR* is moved to contact *M* and the current impulse through the condenser and the windings of relay *CR* which occurs when the fork touches contact *B* goes through one winding of relay *CR* from right to left and the tongue is thrown to the right. If, however, the movement of the tongue of relay *MLR* is from *M* to *S*, the tongue of relay *SR* is moved to contact *S* and the current impulse which occurs when the fork touches contact *B* is in a reverse direction, but goes through the other winding of the relay *CR* from right to left and the tongue still tends to be thrown to the right.

The tongue of relay *CR* being on contact *M*, a current flows, through the corrector magnet which increases the speed of the fork. In a short time the movements of the tongue of relay *MLR* occur when the fork is on contact *B*. The impulse through the condenser occurs just as soon as the tongue of relay *MLR* moves and as the relay *SR* is not affected since the fork is on contact *B*, the impulse through the condenser moves the tongue of relay *CR* to the left and the current is cut off the corrector magnet.

In reviewing the action of the correction circuit, it is apparent that if the operation of the tongue of relay *MLR* occurs when the fork is touching contact *A*, the switch relay tongue is moved and the impulse through the condenser which takes place when the fork moves to contact *B* throws the tongue of relay *CR* to the right and the fork speed increases. If the operation of the tongue of relay *MLR* occurs when the fork is touching contact *B*, the impulse through the condenser occurs immediately and since relay *SR* has not been operated, the impulse moves the tongue of the relay *CR* to the spacing or left-hand position. This breaks the current through the corrector magnet and the fork speed will reduce again. In actual

operation, the fork corrector contact is moving from *A* to *B* or about to move when the tongue of relay *MLR* operates.

REGENERATIVE ACTION

The correction circuit, as explained, holds the tuning fork in step with the line signals. The fork makes a complete cycle of vibration during the time of the shortest signal element. If, for example, the signals over the line are the equivalent of alternating current

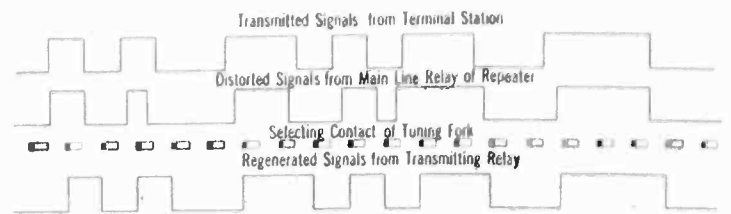

FIG. 6

at a frequency of 25 cycles or 50 signal units per sec., the fork vibrates at 50 cycles.

The received signals operate the main line relay which in turn operates the locking relay. The fork engages the selecting contact once for each unit length of received signal. The instant that the signal reverses on the transmitting relay is defined by the vibration of the fork into a contact with the selecting contact. The tuning fork maintains a constant rate of vibration and the repeated signals reverse at properly timed intervals.

Fig. 6 shows in a graphic form the transmitted, received and regenerated signals. The comparatively

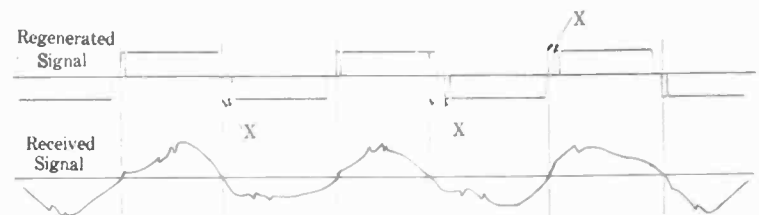

FIG. 7

long time during which the fork engages the selecting contact insures that the transmitting relay will be reliably operated and will tend to minimize chatter. Fig. 7 is a tracing from an oscillogram of some distorted received signals and their reconstruction by the repeater. The received signals were in the form of continuous reversals or alternating current. The variation in the distance between the points marked *X* would be the amount of distortion retransmitted by an ordinary relay repeater. The initial part of each regenerated signal shows a slight bounce or chatter of the transmitting relay contacts. Improved relays are now available, the use of which will reduce the chatter effect.

The range of speed of the repeater using a standard tuning fork is from 15 to 30 cycles line frequency or 30 to 60 words per min. per channel of a two-channel, five-unit code printer circuit.

In the early development of this regenerative

repeater, means were provided for varying the selecting or pickup point, thus giving the equivalent of orienting the contact segments of a rotary distributor. The correcting system which was adopted, however, proved to be very stable and it was found that the orienting feature could be dispensed with. Within the 15- to 30-cycle line frequency range, the point of selecting under all conditions is as close to the central portion of the signal as could be desired. In this connection it should be pointed out that an orienting feature is of less

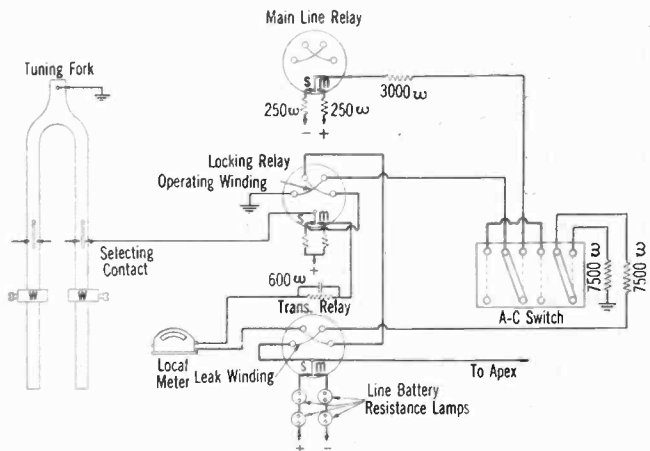

FIG. 8

value at a regenerative repeater station where no printer record is available than on a printer terminal set. Valuable time is often lost in making futile adjustments of the orientation when another remedy is required.

ALTERNATING CURRENT FOR BALANCING

One advantage of regenerative repeaters is the possibility of reducing the time required for balancing. If, for example, a long line circuit is equipped with a regenerative repeater at a central point, a readjustment or lineup of the balances of the relay repeaters on one side of the regenerative station may be conducted at the same time as the lineup on the other side. The regenerative repeater, however, must be equipped with a means of transmitting alternating current to either line, and it should preferably be of nearly the same frequency as that at which the working signals are transmitted.

Fig. 8 shows how this is accomplished on the non-rotary repeater without the need for additional equipment with the exception of the a-c. switch.

In the normal right-hand position of the a-c. switch, the operating winding of the locking relay is connected to the tongue of the main line relay and the leak winding of the transmitting relay goes to ground through 15,000 ohms. When the levers of the a-c. switch are thrown to the left, the operating winding of the locking relay is connected through the leak winding of the transmitting relay to the tongue of the same relay, through a 7500-ohm resistance. This leak current through the operating winding of the locking relay normally holds the tongue of the locking relay in a position opposite to

that of the transmitting relay. When the fork engages the selecting contact, the tongue of the transmitting relay moves in the usual manner to a position corresponding with that of the locking relay. When the tongue of the transmitting relay operates, the current through the operating winding of the locking relay reverses but the locking relay is not operated immediately because the stronger current in its locking winding prevents its operation. When the fork moves away from the selecting contact, the locking current ceases to flow and the locking relay tongue, under the influence of the leak current from the transmitting relay, moves to the opposite contact.

From the foregoing, it is apparent that when the fork engages its selecting contact, the transmitting relay tongue moves to a similar position to that of the locking relay and when the fork disengages the selecting contact, the locking relay tongue moves to a dissimilar position to that of the transmitting relay. The alternating current generated in this manner is practically the same frequency as the alternating current from the terminal multiplex distributor.

CONVERSION TO PLAIN REPEATER

The repeater is equipped with cords and jacks by the use of which the regenerative action can be cut out and the set will function as a non-regenerative repeater.

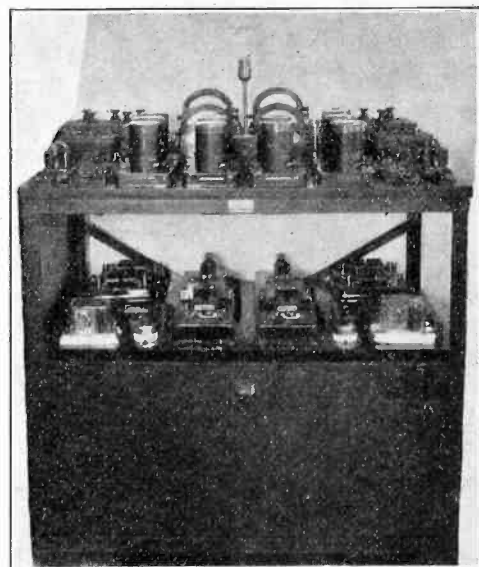

FIG. 9

FLOOR SPACE AND POWER REQUIREMENTS

The complete duplex repeater is shown in Fig. 9

The repeater table is shipped completely wired for duplex operation. It is merely necessary to connect to power, lines and ground and attach the forks and relays, etc., to the table. The floor space required is 43 in. by 27 in. The height of the table is 42 in.

The tuning fork, which is similar to those used on the terminal multiplex sets, is shown in Fig. 10.

The local power may be either 110 or 160 volts. The local current required for the duplex table is approximately one-half ampere and it has been found possible

to install these repeaters in most telegraph offices without adding to the generator plant.

OPERATING EXPERIENCE IN POSTAL TELEGRAPH-CABLE SYSTEM

More than 50 of these repeaters are in use.

No difficulty has been experienced in operating several repeaters in one printer circuit.

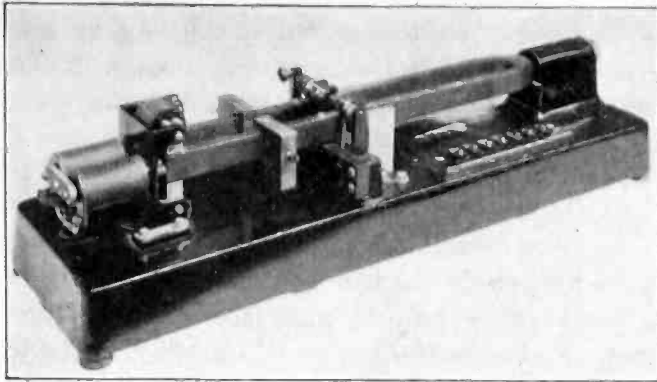

FIG. 10

Before regenerative repeaters were used, it was necessary to assign the best line wires to the overland circuits so that the overall distortion of the signal would be kept at a minimum. The present practise is to use a sufficient number of regenerative repeaters so that almost any line wire, provided it is electrically intact

One or more regenerative repeaters are used in practically every printer circuit over 800 mi. in length with consequent reduction in lost circuit time and increase in speed of operation.

CONCLUSION

This regenerative repeater was developed to provide a simple and compact form of repeater which would give equivalent results to those obtained from the rotary regenerator without the expense of the rotary distributors and their synchronous motors.

The design eliminated the necessity for special types of distributors which otherwise would have had to be built to regenerate the multiplex circuits in use on the lines of the Postal Telegraph-Cable Company.

The completed non-rotary regenerative repeaters have certain economies and improvements over the rotary forms considered and among these were:

The first cost is less because the expensive distributors and synchronous motors with accessories are eliminated.

The maintenance cost is lower because there are no distributor parts to require attention and renewal and less local current is needed.

The required amount of floor space is reduced.

The regeneration of the signals being accomplished directly by the fork eliminates the loss in margin caused by the tendency of the distributors to hunt.

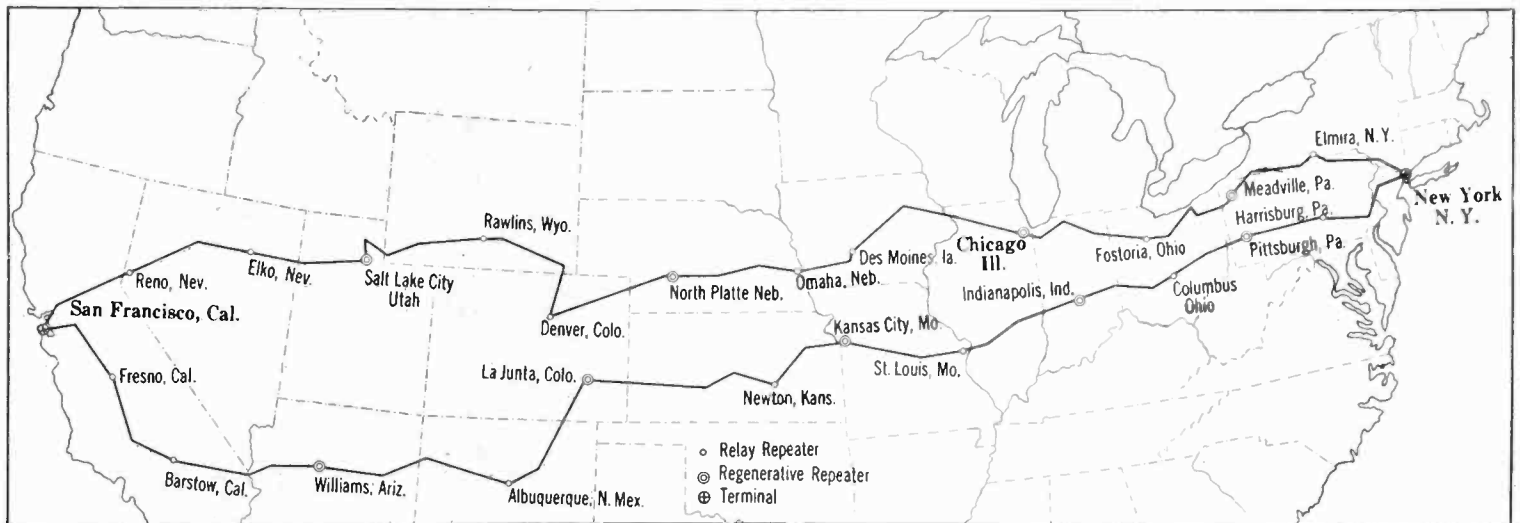

FIG. 11

and free from swings, may be used in the overland circuits.

In several instances, wire routes which were unsuitable for use in overland circuits because of the long distances between repeater stations and which had insufficient wires to justify opening up additional repeater stations, have been made suitable for printer operation by the installation of regenerative repeaters adjacent to or near the long sections.

Fig. 11 shows the layout of two typical overland circuits. The speed of operation is approximately 50 words per min. per channel and the spacing between the regenerative repeaters is short enough to reduce lineups to minimum.

A short interruption of the local power supply does not necessitate the attention of a repeater attendant. The tuning forks are self-starting and when the power supply is resumed the repeater starts up automatically.

Bibliography

"Printing Telegraph Systems and Mechanisms," H. H. Harrison, Longmans, Green.

"Les Systems De Telegraphie and Telephonie," E. Montoriol. *Printing Telegraph Systems*, J. H. Bell, TRANS. A. I. E. E., 1920.

"Baudot Printing Telegraph System," H. W. Pendry, Pitman & Sons.

"Regenerative Telegraph Repeaters," H. H. Harrison, *Electrician*, Jan. 7th, 14th, 21st, 1927.

The Influence of Residual Air and Moisture In Impregnated Paper Insulation

BY J. B. WHITEHEAD¹ and F. HAMBURGER, Jr.²

Synopsis.—The paper describes experiments in study of the separate influence of residual air and moisture in impregnated paper as used for the insulation of high voltage cables.

Some sixty similar samples are prepared, dried, evacuated, and impregnated under the same program, except as regards the pressure of evacuation and impregnation. In groups of three the samples were evacuated at various absolute pressures between 2 mm. and 76 cm. Hg.

The samples were brass tubes 2.54 cm. in diameter, 122 cm. long, with 25 layers of wood pulp paper applied in the usual lapping spirals. Each sample was equipped with outside test and guard electrodes.

Throughout their entire history, i. e., before and after impregnation

observations were made on the samples of their dielectric absorption and their final conductivity. These studies have led to the conclusions as to the influence of moisture.

After impregnation, the samples are studied as to power factor and dielectric loss over the range of electric stress 20 to 300 volts per mil, and of temperature 20 deg. cent. to 80 deg. cent. These studies have led, principally, to the conclusions of the influence of residual air. They show clearly the importance of thorough impregnation, and the conditions under which it may be accomplished. The causes of rising power-factor—voltage curves and methods of avoidance are clearly indicated.

The principal results and conclusions are given at the end of the paper.

THE sharp rise in the power-factor—voltage curve of impregnated paper insulation such as found in high-voltage cables is commonly attributed to the ionization of entrapped air or gases. The present investigation was undertaken with a view to studying the influence of different amounts of entrapped air in such insulation. The general plan adopted was to construct a large number of samples as nearly identical as possible, to impregnate them under similar conditions except as regards the air pressure, and to follow the electrical behavior of the samples as closely as possible throughout their entire history. In addition to the results of the study of the influence of entrained air, other interesting data on impregnated paper insulation have also been obtained.

THE TEST SAMPLES

Each test sample consisted of a brass tube 2.54 cm. (1 in.) in diameter and 121.9 cm. (4 ft.) long. Each tube was cleaned and polished and then received its wrapping of cable paper. The wood pulp paper furnished by a prominent manufacturer, was 0.01016 cm. (0.004 in.) thick, and 2.54 cm. (1 in.) wide. The tube was put in a lathe and a leather friction grip mounted on the carriage of the lathe fed the paper on to the tube spirally in the usual manner. In each layer the successive turns lapped slightly, the lap varying from 0.08 cm. (1/32 in.) down to a close butt contact. The laps or joints in successive layers were displaced successively by approximately 0.635 cm. (1/4 in.). The tension on the paper during wrapping was between 3.5 and 5 lb. The greater number of samples were wrapped with 25 layers of paper, a few having 40

layers. At each end of the paper wrapping additional layers built up the thickness to twice that over the body of the sample. These ends were secured with a wrapping of linen thread.

Each sample was provided with a test electrode of sheet lead 0.04 cm. (1/64 in.) thick, and 71.12 cm. (28 in.) long placed equidistant from the two ends. Guard electrode 5.08 cm. (2 in.) wide were mounted on either end of the test electrodes. The electrodes were cut from sheet lead, carefully smoothed out and wrapped on in single pieces with a longitudinal opening of about 0.08 cm. (1/32 in.) at the butt joint. The electrodes were firmly held in place and in close contact with the paper by a continuous band of linen thread wound over the outside.

There were 60 test samples in all, divided into 20 groups of 3 each. The 3 samples in each group received the same treatment throughout. The treatment of the several groups differed only as regards the air pressure at which impregnation took place.

POWER FACTOR MEASUREMENTS

The method of measurement of power factor was a modified form of Schering bridge. A schematic diagram of connections is shown in Fig. 5. As is well known this method requires an air condenser in one arm of the high-voltage side. The low arms of the bridge are resistances, one arm being shunted by an adjustable air condenser by means of which final balance is obtained. When the bridge is balanced the following relations exist:

$$\rho_1 = \frac{C_3}{C_2} Q; C_1 = \frac{S}{Q} C_2 \quad (1)$$

Whence, power factor $\approx \tan$ (phase difference)

$$= \omega C_1 \xi_1 = \omega S C_3 \quad (2)$$

The accuracy of the method was carefully checked

1. Dean of School of Engineering, The Johns Hopkins University, Baltimore, Md.

2. Research Assistant, Johns Hopkins University.

Presented before the Baltimore Section of the A. I. E. E. December 16, 1926.

for values of power factor above and below that which were usually encountered during the work. The records also show many examples of agreement between the values of loss measured for three samples in parallel and the sum of the values taken on the three samples individually.

PROGRAM OF TEST

Following is a general statement of the preparation, treatment and test of the various groups of samples. As a general thing the three samples of one group were carried together through the entire process.

The three samples of each group, equipped with test electrodes and guard electrodes, were first placed in the drying box in which the temperature was slowly raised to 105 deg. cent. A slow draft of air passed through the box. The condition of the samples was observed by absorption and conductivity measurements at 1500 continuous volts. The samples remained in the drying box until there was no further change in their electrical

samples were completely immersed the temperature was maintained for two hours at 80 deg. cent. the pressure remaining unchanged. Air was then admitted to the impregnating chamber and absorption and conductivity measurements made on the samples at atmospheric pressure and 80 deg. cent. The chamber was then allowed to cool over night and the absorption and conductivity measurement repeated at atmospheric pressure and room temperature.

The impregnating chamber was then heated to about 45 deg. cent., the compound drained, and the samples quickly transferred to the high-voltage test box. During this transfer the specimens were in the open air for about five minutes. In the high-voltage test box the samples were immersed in compound. The compound was completely changed for each two groups of samples, three-quarters the compound being removed for each group, and the fresh compound being that in which the group had been impregnated. In the high-voltage box, measurements were made of total dielectric loss, power factor, and charging current, over a range of temperature from that of the atmosphere to 80 deg. cent., and over a range of voltage of 1.5 to 30 kv., corresponding generally to the range 15 to 300 volts per mil. Usually all three samples were measured in parallel with occasional check measurements on single samples to insure that they were of uniform characteristics.

Following the power measurements, the samples were dipped in paraffin and set aside for further possible tests.

EXPERIMENTAL OBSERVATIONS

The Influence of Moisture in Cable Paper. We discuss first the influence of different amounts of absorbed moisture on the electrical properties of unimpregnated cable paper. The fact that each set of test samples had to be carefully dried out under exactly similar conditions afforded easy opportunity for studying the progressive change in the absorption and final resistance at different stages throughout the drying period. Provision was made for applying continuous voltage up to 1500 volts to the samples while in the drying box, and for measuring both charge and discharge currents to the test electrode in the usual manner. A Weston D'Arsonval galvanometer of sensitivity of 1.5×10^{-10} amperes per division, was used.

The behavior of each group of three samples was much the same throughout the drying period. Individual samples differed in considerable amount in the initial stage, but the shapes of the current-voltage curves, and the types of changes with temperature showed little or no variation among the various sets. The following description and curves refer to test sample 1-A.

The three samples of group 1, equipped with paper and electrodes, were dried and tested in the impregnating chamber. On test sample 1-A the current through

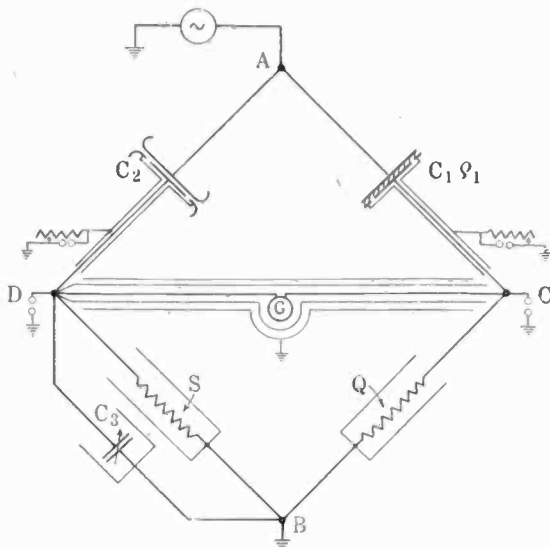

FIG. 5—SCHERING BRIDGE WITH ELECTROSTATIC SCREENING

characteristics over a period of 24 hours. As a rule this required a total elapsed time of about 72 hours. The samples were then transferred while hot to a rack and immediately lowered into the impregnating chamber already heated to 105 deg. cent. The chamber was then sealed, the vacuum pump started, and the pressure reduced to that at which the samples were to be impregnated. In certain cases the pressure was reduced to a minimum of between 1 to 2 mm. Hg. absolute pressure and afterwards allowed to rise to the value for impregnation. The impregnating chamber was kept at the desired pressure and at 105 deg. cent. for two hours and then left to stand over night; usually about fifteen hours. The pressure was readjusted next morning to the proper value and the temperature allowed to fall to 80 deg. cent. The compound already heated to the same temperature was then slowly admitted to the impregnating chamber, the air pressure being maintained approximately constant. After the

the insulation to the test electrode at 110 volts continuous, and at 20 deg. cent. rose continuously for an hour and a half after the first application of voltage, and had not yet become constant. After discharging and charging a second time at the same temperature the second curve begins abruptly at approximately the value at which the first curve left off. Much the same effect is observed for a further period of short circuit and charge. After reversal of polarity the current starts at a lower value and seems to decrease slowly. These results indicate that the continuous application of

of the residual charge also increases through this range, the 30-sec. value reaching 9.2 centimeters at 55 deg. cent. It is still very small as compared with the charging current at the corresponding interval and absorption is as yet not great enough to show itself in the form of the charging current curve. The samples were allowed to stand over night at 75 deg. cent. It was then found that the charging current curve was nearly flat and considerably below that at 65 deg. cent. Thus in this temperature region time enters as a factor. Somewhere between 65 deg. and 75 deg. the conductivity of the sample stops rising and decreases (see Fig. 11). The curve of current on discharge is also correspondingly lower, thus indicating a relation between absorption and moisture content. It should be noted, however, that the absorption is of negligible magnitude as compared with conduction, up to 75 deg. cent.

At 85 deg. cent. the charging current curves rise slightly at the beginning and then fall off. They are still quite flat, but the decrease, although slow, seems to indicate that absorption begins to play its part in the shape of the curve. After standing over

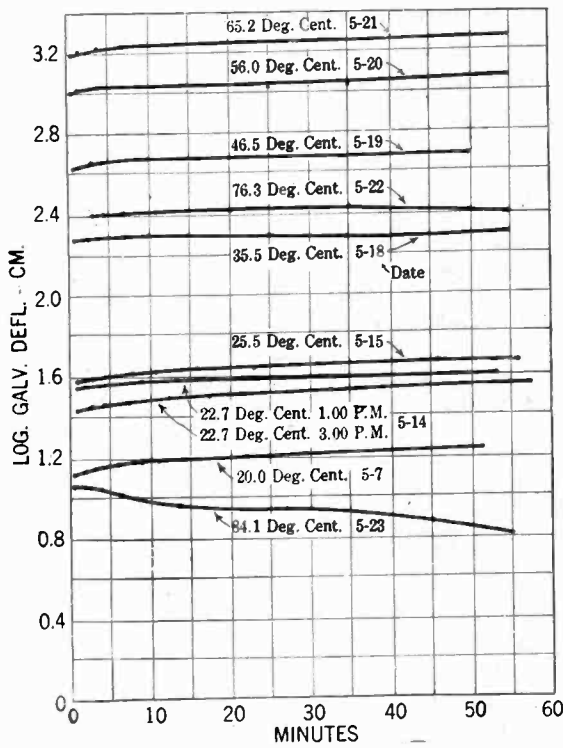

FIG. 10—CURRENT—TIME CURVES

Cable paper specimen 1A—At various temperatures and 120 volts d-c Not impregnated

voltage gives a progressive increase in conductivity, and therefore shows the conspicuous presence of the well-known Evershed effect. All three samples in the group give approximately the same shape of curves, but their ordinates differ amongst themselves. At this temperature (20 deg. cent.) there is only an extremely small indication of residual charge for any of the samples, the 30-sec. reading on discharge for 1-A being 5-mm. galvanometer deflection, which may be compared with the corresponding deflection of 40 cm. on charge.

The temperature of the samples was then raised in steps of approximately 10 deg. and allowed to come to a steady electrical state at each temperature. The changes in the electrical characteristics follow very closely the changes in temperature. During the process of temperature change it is easily possible to follow the change in the value of the charging current. Up to 65 deg. cent. there is a steady and rapid increase of the values of the currents, the curves, however, tending to become flatter (see Figs. 10 and 11). The value

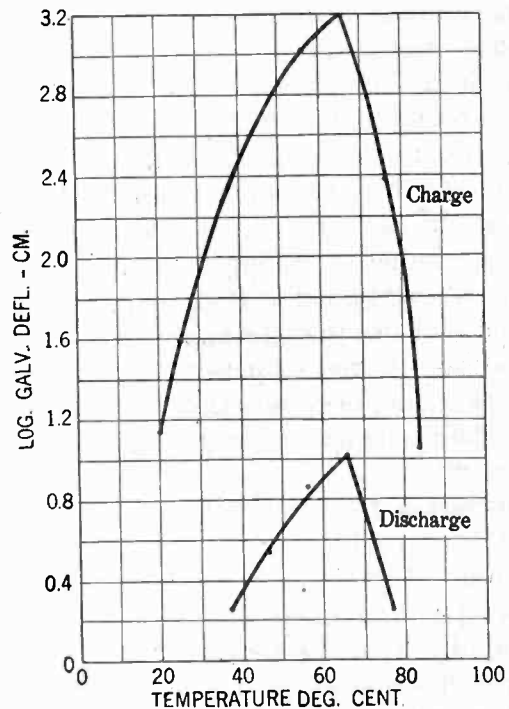

FIG. 11—CHARGE AND DISCHARGE CURRENTS AT INCREASING TEMPERATURE. UNIMPREGNATED PAPER

night at 90 deg. cent., the initial rise in the charging current curve disappears and a typical absorption curve takes its place. In this condition, however, the paper is still extremely sensitive to temperature change. For example, starting at 94 deg. cent., the initial limb of the absorption curve is readily observed but as the temperature is gradually raised to 103 deg. cent. over a period of two and one-half hours, the current is seen to rise and become steady contemporaneously with the temperature. For temperatures above 104 deg. cent. the curves are all of typical absorption type, with little

change in shape up to 125 deg. cent. Both absorption and final conductivity continue to decrease in this range suggesting the continued elimination of moisture. Above 85 deg. cent. measurements were made at 500 volts, 1200 volts, and 1500 volts continuous. In all cases, the galvanometer gave deflections in proportion to the voltage and all the curves repeated their shapes.

The general conclusion from these studies is that the paper contains large amounts of moisture which are driven off rapidly at 75 deg. cent. or above. Up to this point its conductivity masks the usual dielectric properties. At 105 deg. cent. the paper seems to reach a fairly definite condition. It appears as a dielectric having marked absorption and relatively high resistivity. On further elevation of temperature more moisture is driven off with consequent improvement of dielectric properties, although the changes are neither as marked nor as rapid as in the earlier stages. The properties are quite definite at any one temperature, although there are differences of from 50 to 100 per cent as amongst successive samples tested.

Influences of Impregnation on Absorption Characteristics. In preparing the samples for impregnation they were maintained at a temperature of 105 deg. cent. in the drying chamber until they reached a steady state as regards absorption and conduction. Immediately after impregnation at 80 deg. cent. the absorption current values were found to have increased from 40 to 70 times depending upon the sample, although the relative positions of the three curves of the samples of each set remained about the same. These increases in absorption and in conductivity decrease slowly with time if the sample is maintained at high temperature. There is also some evidence that the application of alternating voltage causes further reductions. The samples apparently reach a uniform condition after one or two days of test. These changes offer an interesting problem for future study.

The conclusion from our observations is that the conductivity of cable paper is greatly increased on impregnation. There is also a corresponding increase in the dielectric absorption. The increased conductivity falls off rapidly with the temperature and at 20 deg. cent. approaches that of the dry unimpregnated paper. The conductivity thus introduced by the compound seems to be constant in character at any one temperature and to possess the irreversible character often observed in liquid dielectrics. A further study is planned of the characteristics of paper and compound separately and in combination, under different conditions of impregnation.

The Influence of the Air Pressure at Impregnation. The first purpose of our experiments has been the study of the influence of the air pressure at which impregnation takes place, on the shape of the power-factor-voltage curve. The sharp break often observed in this curve is generally attributed to the presence of air in thin layers, which breaks down to cause increased

loss, when the voltage gradient rises above a certain value. It does not appear to be clearly determined, however, whether or not these air layers are generally distributed through the successive layers of paper. If so a variation of the air pressure at which impregnation takes place might have an influence on the shape of the power factor curve. It may be said here that the evidence from our experiments indicates that the break in the power-factor curve is far more often to be traced to a definite air layer between insulation and a loose fitting sheath, rather than to air films distributed through the body of the insulation.

The air pressure at impregnation apparently plays a more important role in its action in facilitating the driving off of still further residual moisture, after the

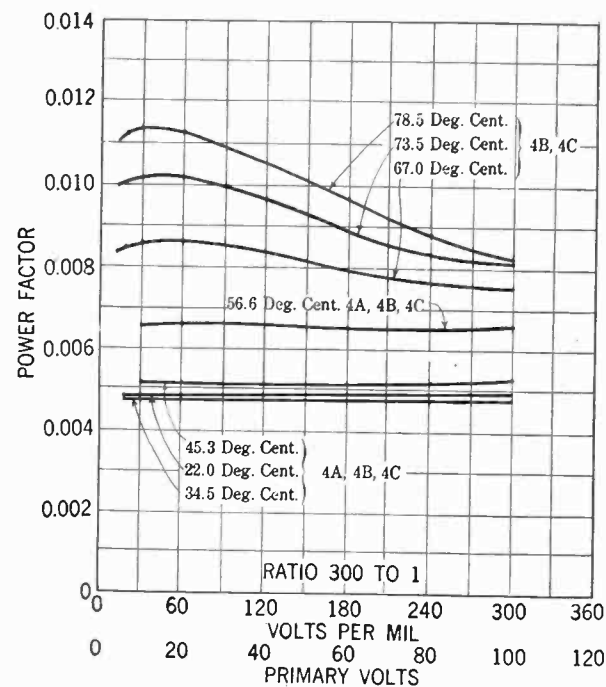

FIG. 20—POWER-FACTOR—VOLTAGE CURVES—SPECIMENS 4A, 4B AND 4C—IN PARALLEL

Conductor diameter = 1 in. Insulation = 0.10 in. wall, impregnated at 2-mm. pressure

Conductivity in dried state = 4A—3.40 cm.
4B—3.45 cm.
4C—2.55 cm.

greater part has been driven off under preliminary temperature drying. It appears to be impossible to completely expel all moisture from cable paper. Final temperature and air pressure, and the time during which they are applied are the principal factors determining the ultimate state of the paper. Extending the ranges of these factors well beyond the values used in cable manufacture we have had no difficulty in obtaining power-factor-voltage curves which appear greatly superior to those encountered in cables as manufactured. We have obtained these results by methods of drying evacuating, and impregnating which certainly are more careful and prolonged than those to be observed in many cable factories. On the other hand none of the methods we have used involves special difficulty, and with one possible exception, that of the method of

obtaining a tight fitting sheath, it appears that it should be possible to approximate them in the factory production of cables. They would, however, entail more complex equipment than that commonly used, and more time, thus increasing costs considerably. One manufacturer has stated that he can duplicate our flat power-factor curves in cables for the market if the purchaser will stand for the additional price.

The results of our study of the influence of the air pressure at impregnation are shown in the series of curves of Fig. 20 to 38. The range of pressure studied is from 2 mm. to 76 cm. Hg. absolute pressure, extending well beyond the range used in manufacture, in both directions.

There are several striking results to be noted from this series of curves:

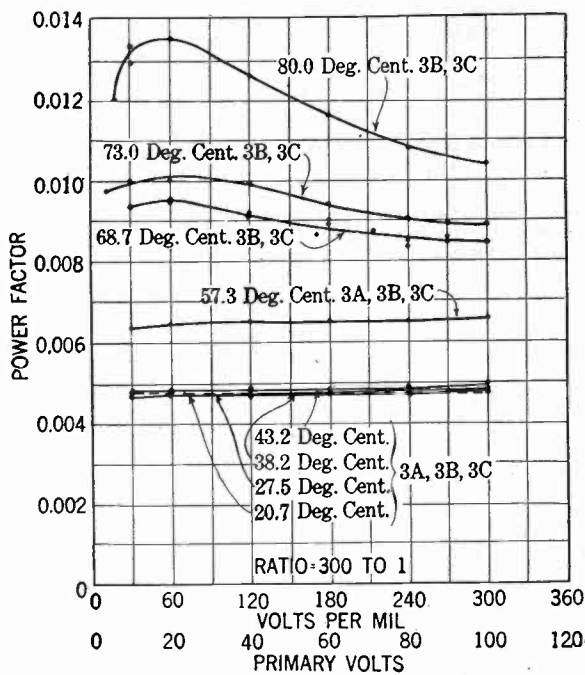

FIG. 22—POWER-FACTOR—VOLTAGE CURVES—SPECIMENS 3A, 3B AND 3C IN PARALLEL

Conductor diameter = 1 in. Insulation —0.10 in. wall, impregnated at 5-mm. pressure
 Conductivity in dried state = 3A—0.65 cm.
 3B—0.63 cm.
 3C—0.57 cm.

Characteristics of Thorough Impregnation. The characteristic type of the power-factor-voltage curve for complete impregnation is exemplified in Fig. 20 for 2 mm. impregnating pressure. Up to 56 deg. cent. the power-factor curves are perfectly flat over the range 30 to 300 volts per mil. At higher temperatures the curves show increasing maxima in the neighborhood of the relatively low gradient 40 volts per mil and apparently tending to become flat towards the upper range. Although the values of the power factor may vary from one set of curves to another this typical shape is remarkably well preserved over the range of pressure 2 mm. to 10 cm.

Pressure Range for Thorough Impregnation. Over the range of pressure 2 mm. to 10 cm. Hg. pressure the flat power factor curve of the lower range of tempera-

ture appears throughout. There is no evidence within the range of air pressures mentioned of a break followed by sharply rising values in the power-factor-voltage curve. This seems to indicate that with sufficient

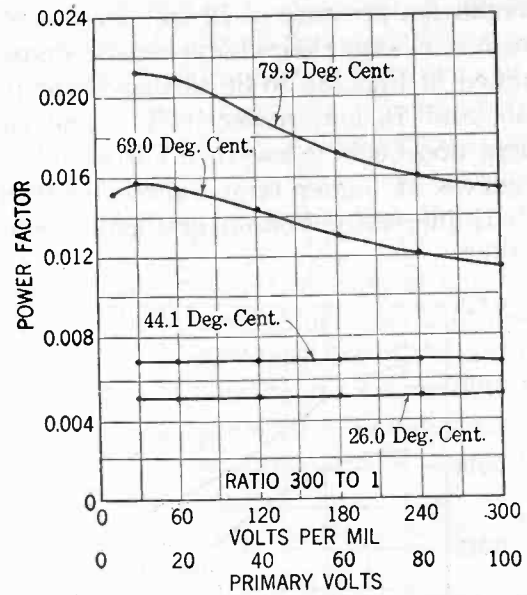

FIG. 26—POWER-FACTOR—VOLTAGE CURVES—SPECIMENS 11A, 11B AND 11C IN PARALLEL

Conductor diameter = 1.0-in. Insulation 0.10-in. wall, evacuated and impregnated at 3 cm. pressure
 Conductivity of dried specimens about three times normal due to high humidity
 Conductivity in dried state = 11A—8.7 cm.
 11B—4.6 cm.
 11C—6.2 cm.

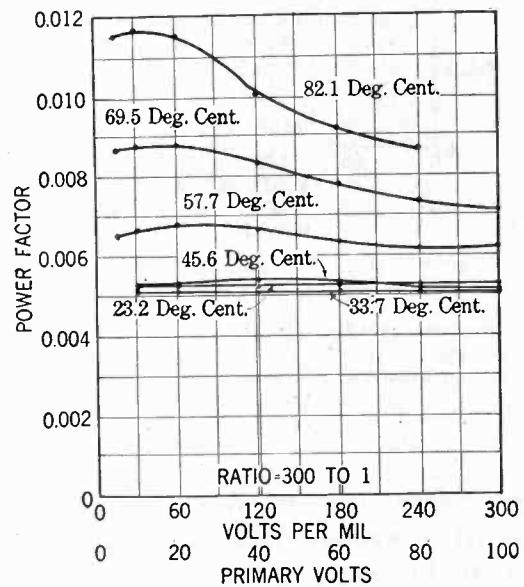

FIG. 27—POWER-FACTOR—VOLTAGE CURVES—SPECIMENS 8A, 8B AND 8C IN PARALLEL

Conductor diameter = 1-in. Insulation = 0.10 in. wall, evacuated to 2-mm. pressure
 Impregnated at 5-cm. pressure
 Conductivity in dried state = 8A—4.00 cm.
 8B—2.70 cm.
 8C—1.80 cm.

care to obtain thorough drying, impregnation, and close fitting sheath, internal gaseous ionization may be eliminated and good power factor curves obtained without the necessity of an evacuation pressure lower than 10

cm. Hg. Or stated more briefly, complete impregnation of cable paper, without resulting gaseous ionization, or rising power-factor-voltage curve, may be obtained at air pressures of impregnation up to 10 cm. Hg.

Internal Gaseous Ionization. Above an evacuation and impregnation pressure of 10 cm. the power-factor-curves begin to change their characteristic shape. This is exemplified in Figs. 35 to 38 inclusive, for pressures 15, 25, 40, and 76 cm. respectively. The curves at low temperatures begin to lose their horizontal character and the curves at higher temperatures instead of decreasing with increasing voltage gradient now show the

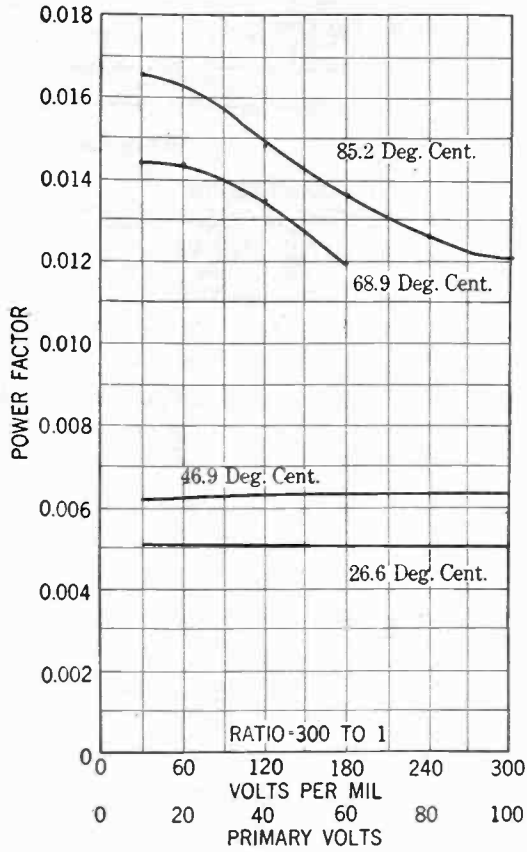

FIG. 28—POWER-FACTOR—VOLTAGE CURVES—SPECIMENS 14A, 14B AND 14C IN PARALLEL

Conductor diameter = 1-in. Insulation 0.10-in. wall, evacuated and impregnated at 5-cm. pressure
 Conductivity in dried state = 14A—2.30 cm.
 14B—1.75 cm.
 14C—1.35 cm.

characteristic sharp upward turn, due to the ionization of the internal air spaces. Within this region there is also evidence that the degree of impregnation changes over a considerable period of time. This is illustrated in the curves of Fig. 36. The order in which the curves are taken is indicated and clearly shows that a temperature cycle results in a change of internal condition. This period seems to extend over several days, after which time there is some suggestion that the specimens reach a steady and improved condition. Some of the specimens in this range have been stripped and all show the presence of copious air spaces.

We show elsewhere that a layer of air between insulation and sheath is a very probable cause of gaseous

ionization. It may be seen, therefore, that even with thorough impregnation of the insulation, gaseous ionization may still exist between the insulation and

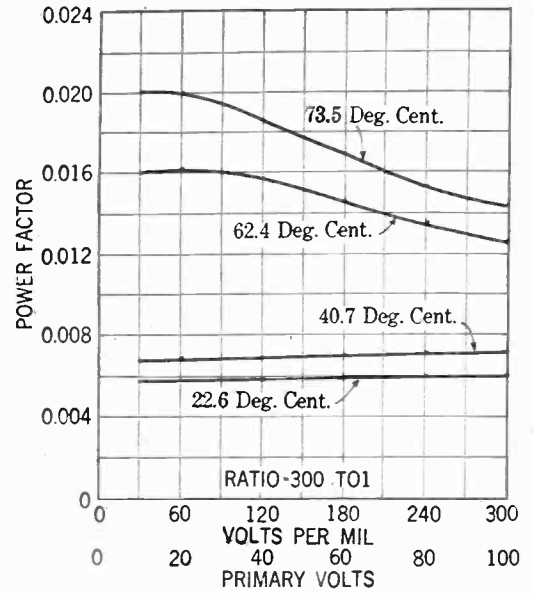

FIG. 33—POWER-FACTOR—VOLTAGE CURVES—SPECIMENS 13A, 13B AND 13C IN PARALLEL

Conductor diameter = 1-in. Insulation, = 0.10-in. wall
 Evacuated and impregnated at 10-cm. pressure
 Conductivity in dried state = 13A—3.60 cm.
 Drying period—192 hrs. 13B—3.85 cm.
 13C—3.25 cm.

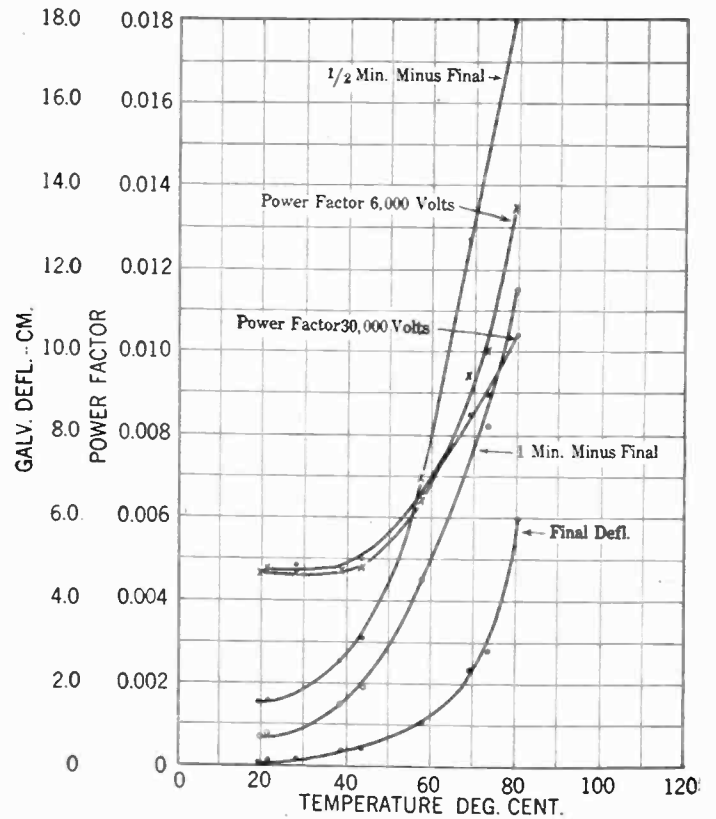

FIG. 34—POWER FACTOR AND ABSORPTION—TEMPERATURE—SPECIMENS 3B AND 3C

Conductor diameter = 1-in. Insulation = 0.10-in. wall
 Evacuated and impregnated at 5-mm. pressure

sheath and reflect itself in the characteristic upward break in the power-factor-voltage curve.

Influence of Residual Moisture. Although as already

noted the power-factor-voltage curves have a typical shape for all pressures, up to 10 cm., it will be observed that some of the specimens show very much higher values of power factor than others, as for example, sets Nos. 11 and 13, Figs. 26 and 33. These differences are apparently due to excess amounts of residual moisture. As stated in the earlier part of the paper a definite program of drying and evacuation was determined and followed, with the idea that it would

spheric pressure,—is very thorough. The subsequent treatment as regards evacuation has relatively small influence up to 10-cm. evacuation pressure. The power-factor-voltage curves all retain their shape. Such differences as appear are principally in the absolute values of power factor at the higher temperatures. These increases are always to be explained either by high atmospheric humidity or higher values of pressure at evacuation. These increases in power factor never assumed serious proportions. For example, as regards pressure of evacuation, the difference between 2 mm. and 5 cm. is reflected in an increase of the maximum power-factor from 0.012 to 0.017. At 10-cm. evacuation the power factor is of the order of 0.02. Another indication of the thoroughness of the preliminary drying was found in a comparison of the absorption of one set of samples taken before evacuation and after evacuation to 4-mm. pressure. The dielectric absorption and residual conductivity was about the same before and after evacuation.

Influence of Absorption and Conductivity. Through-

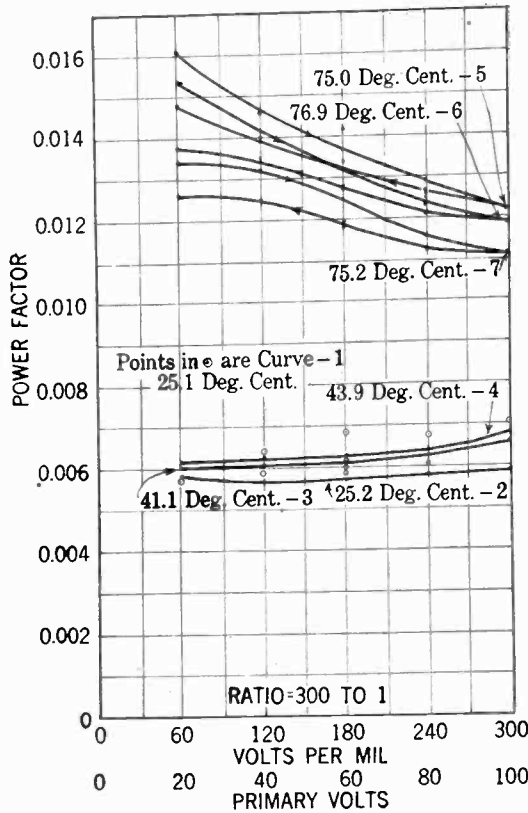

FIG. 35—POWER-FACTOR—VOLTAGE CURVES—SPECIMENS 19A, 19B AND 19C IN PARALLEL

Conductor diameter = 1 in. Insulation, 0.10-in. wall
 Evacuated and impregnated at 15 cm. pressure
 Conductivity in dried state = 19A—2.00 cm.
 19B—1.50 cm.
 19C—3.60 cm.

bring all the specimens to the same initial condition. A quite different result was found which is chiefly caused by the variation in the atmospheric humidity. In the drying period the specimens are heated in the presence of a slow draft of air, as already described. At very high values of atmospheric humidity, during the summer months, it was impossible even in prolonged periods of drying to reduce the conductivity below the very high values indicated by specimens Nos. 10, 11, and 12. The curves of specimens Nos. 10, 11, and 12 especially seem to indicate that residual moisture will cause higher values of power factor without materially changing the shape of the curve. If, however, the pressure is carried down sufficiently low, say to 1 cm. Hg., this may offset the imperfect drying conditions and result in a power factor curve of normal shape and value. It appears evident that our preliminary drying period,—72 hours at 105 deg. cent. in a slow draft of air at atmos-

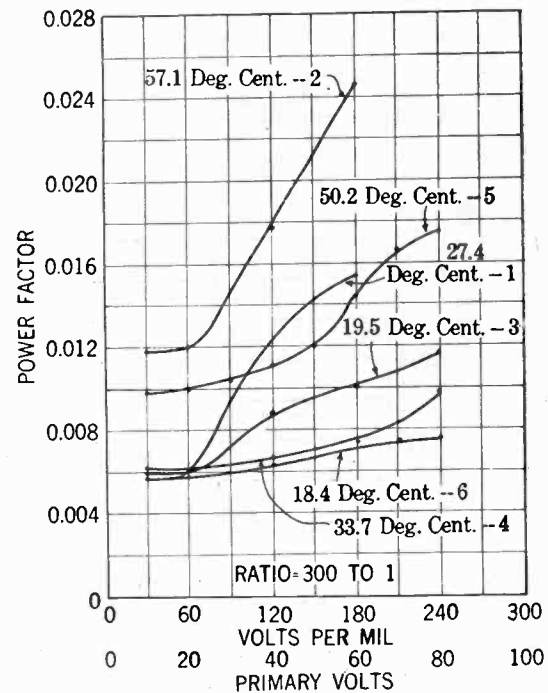

FIG. 36—POWER-FACTOR—VOLTAGE CURVES—SPECIMENS 17A 17B AND 17C IN PARALLEL

Conductor diameter = 1 in. Insulation = 0.10-in. wall
 Evacuated and impregnated at 25-cm. pressure
 Conductivity in dried state = 17A—2.25 cm.
 17B—1.60 cm.
 17C—1.55 cm.

out our measurements, we have taken closely parallel readings of power factor and of conductivity and dielectric absorption at 1500 volts continuous. The curves of Fig. 34 specimens 3-B and 3-C, show the variation with temperature of the power factor, of the final conductivity, and of absorption, as indicated by the one-half minute and one minute readings of the charging current curve. The similarity of form of the power factor and absorption curves is very striking. It has been recognized since the early work of

Hopkinson, Rowland, and Hess and from subsequent refined laboratory studies that there is an intimate connection between the dielectric loss and dielectric absorption. The curves of Fig. 34 emphasize this relationship in a very striking manner. They suggest that it should be possible to control the losses and power factor in cable insulation by means of studies of the property of absorption of the insulating materials. Such studies may be carried out at moderate values of continuous potential. Work in this direction is now under way by the authors. The decreasing values of power factor with increasing voltage gradients, always found in well impregnated specimens, is of interest in this connection. In our study of absorption we have shown the close importance between the absorption of impregnated paper and the conductivity of impregnating oil. It is known that good liquid dielectric often evidence a saturation current that has a decreasing conductivity with increasing voltage. It appears probable that in our experiments, the impregnating oil, being liquid at the higher temperatures,

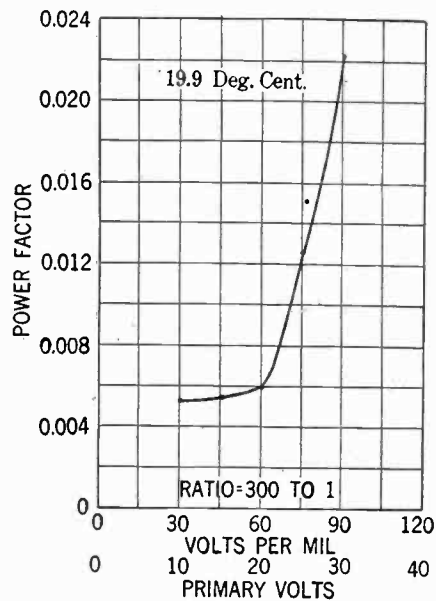

FIG. 38—POWER-FACTOR—VOLTAGE CURVES—SPECIMENS 15A, 15B AND 15C IN PARALLEL

Conductor diameter = 1 in. Insulation, = 0.10-in. wall
Evacuated and impregnated at 76-cm. pressure
Conductivity in dried state = 15A—1.95 cm.
15B—3.25 cm.
15C—4.25 cm.

possesses this decreasing conductivity with increasing voltage, thus accounting for a lower absorption, lower losses, and lower power factor.

Influence of the Closeness of the Fit of the Lead Sheath. One of the striking results of our investigation has been the marked flatness of the power-factor curve at temperatures up to 60 deg. cent., throughout the entire range of voltage gradient 30 to 300 volts per mil, and for specimens impregnated at all air pressures up to 10 cm. Hg. An example of these curves is shown in Fig. 22.

In looking for possible causes of the marked dif-

ferences between our specimens constructed in the laboratory and those taken from cables manufactured by commercial methods, we noticed the relatively loose fit which the sheathing of the commercial cables makes with the underlying cable paper insulation. This condition was perhaps accentuated by the cutting and stripping of the lead in order to provide test electrodes necessary in samples of short lengths. In our methods of test the electrodes, which correspond to the lead sheath, were applied to the cable before impregnation. It thus appeared desirable to study the question as to the influence of air lying between the outer wall of

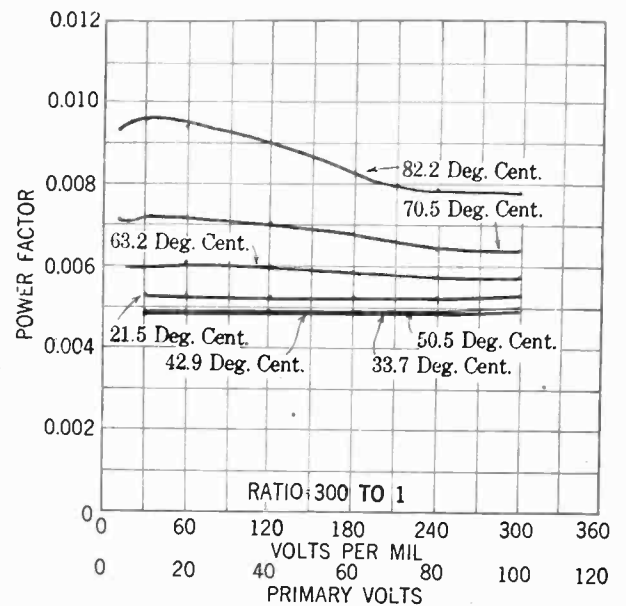

FIG. 40—POWER-FACTOR—VOLTAGE CURVES—SPECIMENS 5A, 5C IN PARALLEL

Conductor diameter 1 in. Insulation, = 0.1-in. wall
Impregnated at 1-cm. pressure

insulation and the lead sheathing. With this purpose in view, samples A and C of set No. 5 of our series were equipped with electrodes before impregnation in the regular manner. Sample B was impregnated before the electrodes were applied. The electrodes were applied first loosely and afterwards tightly.

Fig. 40 shows the observations on 5-A and 5-C and Fig. 41 shows the observations on specimens 5-B; the observations being taken under compound. It will be noted that there is a pronounced influence of the loose electrode in causing the power-factor curves to turn upward at all temperatures. By far the most striking indication of the influence of a loose application of the sheath after impregnation is shown by the observations on 5-B taken in the air, that is, not under compound, and with varying degrees of tightness of the sheath. These are shown in Fig. 42. These curves were taken with conditions approximating as closely as we were able, the conditions that are met in manufacture. There is no question of the great importance of the layer of air between the lead sheath and the wall of insulation. It should be noted that with test electrodes applied as tightly as possible after im-

pregnation there is still present the rising tendency of the power-factor-voltage curves.

The several measurements, described above, all seem to indicate clearly the influence on the power-factor

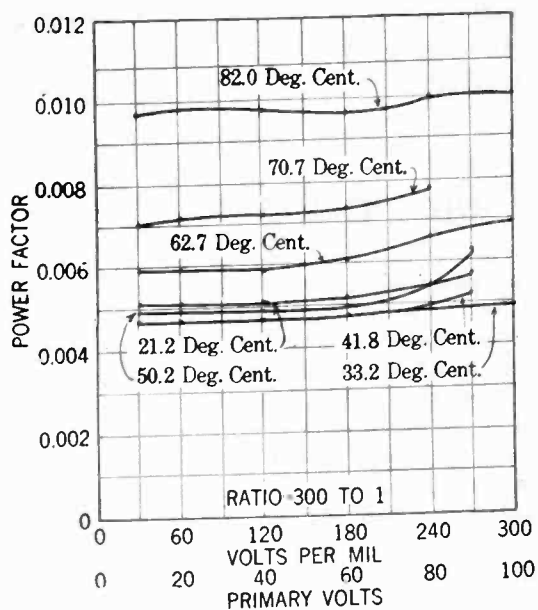

FIG. 41—POWER-FACTOR—VOLTAGE CURVES—SPECIMEN 5B—LOOSE SHEATH APPLIED AFTER IMPREGNATION TESTS UNDER COMPOUND

Conductor diameter = 1 in. Insulation, = 0.1-in. wall Impregnated at 1-cm. pressure

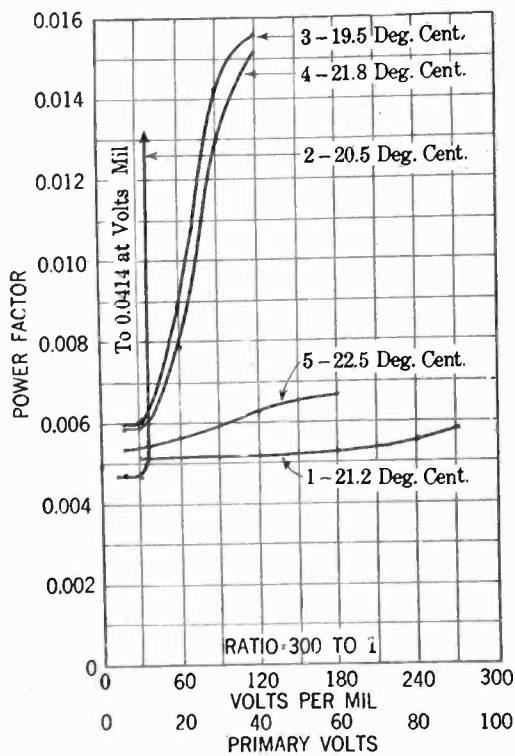

FIG. 42—POWER-FACTOR—VOLTAGE CURVES—SPECIMEN 5B—INFLUENCE OF TIGHTNESS OF SHEATH

curve of an air layer between lead and paper. This does not necessarily mean that deeper lying films of air may not play their part. On the contrary, it indicates that if such layers are present they, too, must necessarily cause a rising break in the power-factor curve.

Thanks are due to Dr. William B. Kouwenhoven for much helpful cooperation throughout the course of the work which was done in the School of Engineering, The Johns Hopkins University, at the request of the Subcommittee on Impregnated Paper Insulated Cable Research, of the National Electric Light Association, D. W. Roper, Chairman. Further studies under the same auspices are continuing.

SUMMARY AND CONCLUSIONS

1. In the drying of cable paper at atmospheric pressure the great proportion of absorbed moisture is given off between 75 deg. and 80 deg. cent. At lower temperatures, the electrical conductivity under the continued application of voltage increases with time in accordance with the Evershed effect. At higher temperatures the paper takes on the characteristics of a highly absorbent dielectric.

2. In drying by elevation of temperature the final steady state of the paper depends on the temperature, the time, and on the relative humidity of the atmosphere. Similar examples carried through the same drying process but at different times may have widely different residual moisture and electrical properties. A drying period of 72 hours at 105 deg. cent. in a dry atmosphere renders cable paper an excellent insulator, although it still contains moisture and shows high dielectric absorption.

3. The evacuation process following that of temperature drying is principally important as removing still further residual moisture. It is not, however, so important in this particular as the initial drying period. Differences in the humidity of the initial drying period show themselves through subsequent evacuation periods at 1, 2, and 3 cms. Hg. pressures, and above.

4. After impregnation, the conductivity and absorption are greatly increased at the higher temperatures, but near atmospheric temperature the values are approximately the same as for the dry unimpregnated paper. The differences are apparently due to the conductivity of the impregnating compound.

5. Using a drying and evacuating and impregnating period of four days we have found for all pressures of impregnation up to 10 cm., and for temperatures up to 50 deg. power-factor-voltage curves which are perfectly flat over the range 20 to 300 volts per mil, at values in the neighborhood of 0.005. At higher temperatures, the curves are higher and show maxima near 45 volts per mil, the power factor decreasing steadily thereafter with increasing stress.

6. Up to 10 cm., impregnating pressure differences in the original state of the samples as regards moisture reflect themselves in small changes in the values of final power factor without material influence on the shape of the curves. High moisture content increases the power factor.

7. Up to 10 cm. Hg., the pressure of impregnation causes no tendency of the power-factor curve, to break

and rise, usually attributed to gaseous ionization. Above 10 cm. pressure rising power-factor curves appear, reaching the typical ionization shape at 25 cm. pressure.

8. Typical gaseous ionization curves have been obtained and controlled by variations in the tightness of the lead sheath or test electrodes. It appears that the rising power-factor curves found in cables are in all

probability due either to loose fitting sheaths or to imperfect impregnation, causing extended layers of air rather than to original entrained air as dependent on the evacuation pressure.

9. Power factor and dielectric absorption follow similar curves and the latter is suggested as a promising method for the predetermination of the properties of cable insulation.

Discussion at Winter Convention

THE M. M. F. WAVE OF POLYPHASE WINDINGS¹

(GRAHAM)

NEW YORK, N. Y., FEBRUARY 7, 1927

P. L. Alger: This paper raises questions whose discussion might be carried to great lengths, since the ramifications of the effects of harmonics on various characteristics of the motor are very extensive. I will confine myself, however, to making two comments on this paper and then giving a few things from my own experience.

In the first place, Mr. Graham develops a formula for the magnitude of any particular harmonic, which contains the coefficient $\sqrt{1 - \cos nB}$. That, to my mind, is very hard to visualize, and it is much better to replace it by the exactly

equivalent expression $\sqrt{2} \sin \frac{nB}{2}$. When this is done, the

magnitude of each harmonic is seen to be proportional to the pitch factor for that particular harmonic. As the pitch factor is a very familiar thing to all designers, this expression tells the relative magnitudes of different harmonics almost by inspection.

In the second place, it appears obvious to me from physical considerations that with a perfectly balanced winding, every phase being like every other phase, the other phases can only introduce purely reactive voltages in the first phase, similar to the voltages induced by that phase in itself. That is, if you have a perfectly balanced arrangement, the currents in each phase being displaced in time by the same angle as they are in space position, there cannot be produced any two harmonic waves of the same order but opposite directions of rotation. So the n th pulsating harmonic made by phase 1 alone will either be converted into a revolving field of amplitude $3/2$, due to the three phases, or else will be cancelled out altogether. For that reason, it is clear that Graham's equations showing a phase difference between the various harmonic voltages in a single phase must be wrong. There is no phase difference because all of them are purely reactive voltages.

Once we have admitted the existence of these harmonics and shown they are present and undesirable, the really interesting thing is how to avoid them. That Mr. Graham did not touch upon at all.

By rearranging the windings in various groupings, a great many effects can be produced. There are a number of arrangements possible for any particular winding, all of which give balanced phase voltages, but which have different characteristics. Systems of distribution can be worked out to give minimum vibration, minimum reactance or minimum load losses, or to meet other conditions, and some of those other arrangements have distribution factors so little different from the one that we ordinarily use, that they are more desirable than the ordinary arrangement.

An interesting case illustrating these possibilities is that of a 1000-h. p. induction motor, with 14 poles and $4 \frac{2}{7}$ slots

per pole per phase, which I had the opportunity of observing in 1923. When the motor was tested the first time, it developed a very severe load vibration, similar to that Mr. Graham observed on his motor. We determined the vibration to be of twice line frequency, and due to the 10-pole field produced by the irregular winding arrangement. By reconnecting the winding to the arrangement giving a minimum 10-pole field, the trouble was remedied without any mechanical change. In general, unbalanced magnetic pull occurs whenever two fields of nearly the same numbers of poles exist together, and so the way to avoid vibration is to arrange the winding to minimize that particular harmonic whose number of poles is nearest the fundamental.

The study of the best winding arrangement, taking into account all the factors, is very fascinating, but it is quite difficult to make a complete analysis of the problem. I have been working on this matter for some time, and I hope ultimately to be able to say for any given number of fractional slots per pole per phase what arrangement gives the best combined characteristics, taking into account noise, fundamental distribution factor, reactance and losses.

C. A. Nickle: I agree with Mr. Alger that in a rotor with uniform permeance, reactive voltages other than 90 deg. out of phase with the currents cannot be obtained. When such voltages exist, we must have reluctance torques in the machine, we must have consumption of power, and we cannot have reluctance torques in a uniform-permeance machine.

The author has made calculations of the leakage reactance introduced by sub-harmonics and he gets a value of approximately 1 per cent. Of course, if we add reactance voltages vectorially, we shall get a much smaller voltage than if we add them arithmetically. If all these reactance voltages were added in time phase, the total reactance voltage might be considerably greater, and I think might be worth investigating.

W. V. Lyon: Mr. Graham has applied the principles of harmonic analysis to an interesting and not uncommon problem, the most important aspects of which I believe are the extra losses and vibration which may occur when these irregular windings are employed. He has clearly shown how the problem may be attacked.

In the spring of 1926, apparently at about the time when Mr. Graham was preparing this paper, I analyzed the same problem with a class of graduate engineers at the General Electric Works at Lynn. Curiously enough the illustrative problem that we worked through was the same that Mr. Graham has chosen, *viz.*, one in which there are $6 \frac{3}{4}$ slots per pole. Also the winding arrangement was the same in both cases. The only difference was that ours was a stator having 54 slots and wound for 8 poles. We found no particular difficulty in obtaining a resultant n th harmonic reduction factor for this winding which was a combination of the ordinary pitch and breadth factors. We did not, however, determine the criteria for the existence of the n th harmonic nor for its direction of rotation.

One point that Mr. Graham has made is well worth emphasize-

1. A. I. E. E. JOURNAL, February, 1927, p. 118.

ing. When a uniform air-gap is acted upon by a magnetizing winding there will in general be produced component sinusoidal flux distributions which have two poles, four poles, six poles, eight poles, etc. By properly arranging the winding, certain of these distributions can be completely or partially eliminated. If, for example, a symmetrical three-phase winding having an integral number of slots per pole per phase and wound for 4 poles is used there will be no components except the 4-polar, 20-polar, 28-polar, 44-polar, 52-polar, etc. Again in the 20-pole winding that Mr. Graham cites there will be 10-polar, 20-polar, 30-polar, 40-polar, 50-polar, 70-polar, etc., distributions.

I should like to add a little to what Mr. Graham has said about vibration. If the stator and rotor were perfectly rigid the internal stresses between them due to the magnetic field could cause no vibration. Actually, however, both the stator and rotor have a certain amount of flexibility and thus these internal stresses may produce serious vibration. There are two distinct types of internal stress. One is due to the action of a single sinusoidal flux distribution and the other is due to the joint of two sinusoidal distributions of different wave lengths. If there is a single sinusoidal component of flux in the gap, the rotor will be acted upon by balanced radial forces which can cause no vibration in the rotor if its laminations are rigidly connected to the shaft. On the other hand the rotation of the flux distribution will produce a harmonic variation in the magnetic force between the stator and rotor in any fixed radial direction of such a frequency that it will go through one cycle while the magnetic field is moving one pole pitch. If the stator frame is flexible in a radial direction this harmonically varying force may set up serious vibration. This is apparently the case that Mr. Graham cites.

The other cause of vibration may, I believe, be equally important. If there are in the gap two component distributions of different wave lengths the radial forces acting on the rotor may be unbalanced. Two polar distributions that differ by a single pair of poles will produce this effect. This unbalanced force on the rotor may be either constant or variable. If the distributions are moving properly with respect to each other the unbalanced force acting on the rotor will vary harmonically and serious vibrations may result.

Quentin Graham: Mr. Alger has suggested the substitution of $\sqrt{2} \sin \frac{n\beta}{2}$ for the expression $\sqrt{1 - \cos n\beta}$ which

I have used. I agree that this change would aid in visualizing the magnitude of the harmonics.

Mr. Alger and Mr. Nickle have both pointed out the error contained in the last paragraph of Appendix B and also in the body of the paper where it is stated that the reactance voltages of the various harmonics are not in phase. I am giving below a number of corrections in the mathematics, changing the final equation on which this false conclusion was based. I am indebted to Mr. Nickle for having pointed out the particular points which were in error. The corrections are as follows:

Equation (6) should read

$$n \theta_n = - \tan^{-1} \frac{\sin n\beta}{1 - \cos n\beta}$$

which can be simplified to

$$n \theta_n = \frac{n\beta}{2} - \frac{\pi}{2}$$

Using this value for $n \theta_n$ equation (30) may be simplified so that the quantity in the parenthesis becomes $\left(\omega t - n\psi - \frac{\pi}{2} \right)$

The statement following equation (31) should give the displacement angle as $-n\psi$ instead of $n\psi$.

With this correction the quantity in the parenthesis in equations (32), (33) and (34) will be, $\left(\omega t - \frac{\pi}{2} \right)$. It is clear then

that the final paragraph, following equation (34), is in error and that the reactance voltage components of the various harmonics must be in phase.

I have experimented to some extent with the rearrangement of windings, as Mr. Alger suggests, for the purpose of reducing some particular harmonic. This is usually accomplished at the expense of increasing some other harmonic but, as he says, the total result may be beneficial.

Mr. Lyon's discussion of the vibration problem is very interesting and his conclusions appear to agree with Mr. Alger's experience.

COMBINED LIGHT AND POWER SYSTEMS FOR A-C. SECONDARY NETWORKS

(RICHTER)

NEW YORK, N. Y., FEBRUARY 9, 1927

D. K. Blake: Mr. Richter's paper does not attempt to take sides. He tried very hard to avoid that. Some years ago, together with others, I made a similar study and obtained similar results, showing that the 115/199-volt system had the lowest cost, the 120/208 next, and then the two-phase system.

Of course this problem will not be settled in this meeting. It will have to be settled by the N. E. L. A., the Power Club and the N. E. M. A., but I would like to state my positive convictions along these lines.

I believe, based upon my discussion with various operating engineers and knowing the manufacturers' conditions, that the 115/199-volt system will be the solution to our problem. I am just going to make three statements, without attempting to prove them as to why I believe so. They are by no means all of the reasons.

The first is because of the lower cost. The second is because of the large number of consumers unaffected by retaining the 115-volt standard. When I stop and think of the data that were given in the *Electrical World* showing that we have somewhere around 14,000,000 domestic customers, about 2,000,000 commercial lighting customers, and about a half-million power customers, I think that in view of our attempts at good public relations, it is by far better to change things that affect the least number of consumers even though they may have more kilowatt demand and about an equivalent revenue.

The third thing is that I recognize the work that has already been done by the N. E. L. A. in attempting to make the 115-volt system a standard. Now of course if that is the answer, if the committee's work proves that 115/199-volt system is preferable, it means two lines of polyphase induction motors. I know positively that no manufacturer recommends the use of 220-volt motors on systems rated nominally 199 volts.

Now I want to say a word about the practise of using 220-volt motors on 208-volt systems. Suppose you decide on a 120/208-volt system, and use the old arguments of lower power factor and over-motoring, etc., to justify utilizing the 220-volt motor. You then have a system that 110-volt single-phase devices do not fit. I think those arguments are perfectly valid for existing conditions, and during the period of change-over, but I think it is wrong to continue to grow throughout the years without having a system supplying devices that do not fit the system voltage.

Therefore I can see no other answer than two lines of motors.

Now the manufacturers in the past have always, to the best of my knowledge, built additional lines of devices whenever there was a sufficient demand. I have no doubt in my own mind that they will do so in case it is the general opinion that two lines of motors would be desirable.

P. H. Chaser Mr. Richter's paper covers a very broad field and has so many angles both from the manufacturing point of view and also from the central-station public-relations and economic points of view, that it is difficult to make an adequate analysis.

I would like to take the liberty at this time of discussing a few of his assumptions and points of view. His paper, as I understand it, first presents a statement that the expense incurred in suitable utilization equipment may range from \$75,000,000 to \$150,000,000 even under the unlikely condition of a single combined scheme adopted universally.

Mr. Elden's remarks on voltage standardization¹ could well be read into the record on this paper. It is open to serious question whether we ever can get to a single, universally adopted standard, because each operating company has its own local public-policy, financial and construction conditions to meet. It may be true that one system compared with other systems theoretically may show an economic advantage a few per cent better. When that situation is reduced to terms of the existing system, as many of us have done, a change to another system may impair the quality of service, damage public relations, decrease flexibility and involve expensive change-over costs for at best a small saving, which may not even be realized. This leads one to question whether a figure of \$75,000,000 to \$150,000,000 spread over a ten-year transition period is really important, compared with the expense that must be incurred to effect the change and with the hazards involved.

Now this figure of \$75,000,000 to \$150,000,000 on a ten-year transition period means \$7,500,000 to \$15,000,000 a year. That is compared with what other plan or plans? The paper does not give any figures showing what it will cost to continue with the present standards so far as the utilization of equipment is concerned. In other words, we have no base line with which to compare these figures. It seems to me that there should be further analysis to draw up a bill of the costs of continuing with a diverse standard basis. Certainly it will not be necessary to spend this \$75,000,000 to \$150,000,000 if the present standards are kept.

Possibly the central-station companies may have to spend money in continuing with the development of existing systems which may not be quite so efficient theoretically as one universal system might be. However, those operating systems will have avoided the very heavy costs, which this paper does not pretend to deal with, of changing over to some other system than the one they now have. The paper does not deal with the extra operating expenses that will exist during the transition period which, on a ten-year basis, are very appreciable. There is also extra investment during transition.

To come back again to this \$75,000,000 to \$150,000,000, are those gross figures, or are they net figures, after allowing for the expected manufacturing economies that would come from the adoption of a single standard? If these are gross figures, then they are misleading. If they are net, the public in one way or another must pay what seems like a high price for standardization unless it is assumed that in the overall problem there are marked savings over the present diversity of systems.

The paper is admittedly written from the manufacturers' point of view. The magnitude of the potential savings to the operating company of any proposed system over the existing system gets down to a very elaborate analysis. Let us take the X. Y. Z. Electric Light and Power Co. operating in a metropolitan area, covering suburban areas and some rural areas. As has been brought out, by far the largest number of customers are the residence customers, and all their needs can be supplied by single-phase, three-wire service. Power loads may be three-phase, three-wire; three-phase, four-wire; two-phase, four-wire, and so on.

Most of its distribution plant and most of the load is not in the dense portion of the territory. Also, possibly the dense portion

of the territory requires underground construction; possibly the local conditions require only 10 or 15 per cent of the low-voltage load to be underground.

Such a company will not determine its system for all its territory from conditions pertaining to a small fraction of the load. Can it afford to start out on a policy that involves asking its customers to have a different type of motor in different portions of its territory? Is that company going to consider seriously, without a great deal of study, changing its miles and miles of aerial secondary distribution and its hundreds of thousands of services to residence customers to conform to a system that may be slightly advantageous from a theoretical point of view only for this central densely loaded area?

I think, as has been mentioned by Mr. Blake, this whole subject deserves and must have extended study by the N. E. L. A. and the Power Club before there can be an overall answer.

H. L. Wallau: Mr. Richter has pointed out to us the enormous expense to be charged against the electrical industry due to the redesigning of utilization equipment if any of the present a-c. low-tension network schemes is adopted. The tentative figures set up by him are appalling.

In Cleveland for over ten years we have been using the three-phase, 230-volt system with the four-wire lighting neutral (Fig. C-2 of his paper) with radial feed. This system was first installed in a new underground district. Later, a similar system was used to replace a three-phase, four-wire, 115/199-volt system, then at least 15 years old. This system has the advantage of using lamps, appliances, motors, control equipment, etc., as now standardized.

Can this system be modified slightly and become suitable for network use? I believe it can, but do not recall that the following scheme has ever been suggested. Referring to the accompanying diagram you will note three primary feeders which may issue from one or more substations and are supposed to have the customary over-current protection at the substation end. I have shown these connected to merely one transformer bank each. The transformer banks are shown connected delta-delta but might be Y-connected on the primary. A network protector is assumed cut into the secondary leads between the transformers and the network. Cut-outs, etc., have not been indicated. The cables forming the three-phase, 230-volt mains are continuous and the transformer banks consist of three units of equal capacity, or of one three-phase unit. The lighting neutrals carrying the out-of-balance current are *discontinuous*, there being one section per transformer bank. Between a pair of 230-volt phase wires there is connected a balance coil at each bank location, each successive balance coil being rotated so as to be across the next successive phase. The middle points of these balance coils are respectively connected to the lighting neutral of their particular section. We now have a system having 230 volts between any two-phase wires and 115 volts between any neutral and its corresponding phase wires. There is also a difference of potential of 115 volts between any two lighting neutrals, hence these neutrals should preferably remain discontinuous but could be made continuous by the insertion of a suitable iron-cored reactance between the junction points. So far we have not grounded this system. A ground is provided by means of a star-connected auto-transformer, wound with 133-volt coils, the common junction point of which is grounded. This provides a difference of potential of 133 volts between phases and ground and $66\frac{1}{2}$ volts between neutrals and ground. If the secondary, three-phase mains are to be arranged for sectionalization at times, it would be desirable to have a grounding transformer for each section. If not so arranged, fewer might be used but at least two should be provided in case of failure of one. The total number would depend somewhat upon the extent of the interconnected network. The balance coils used need be only large enough to carry safely the maximum unbalanced load of any section. They would probably be standardized for

network as of the maximum size required, due to local conditions. In certain specific cases where a large amount of lighting load was connected to one section, as compared with adjacent sections, it would be advisable to select certain buildings and connect their lighting load across phases other than that normally supplying that section, additional balance coils being located either in the street or in the buildings selected.

The lighting neutral should be fused preferably to at least twice the value of the phase wires at both service entrance and in all base circuit panel boards, in order that internal faults might not cause the neutral to open, thereby unbalancing the voltage across the three-wire lighting system. Should a ground develop on a neutral within a building, the neutral fuse would, of course, blow. No ground should be installed on any of the house or service wires but the grounding transformers should preferably have their neutral leads securely bonded to the nearest water system in some adjacent building. I assume that the present network protectors may be used as now designed or with some slight modification; possibly a zigzag, instead of a star-connected grounding transformer, would be required to obtain certain necessary phase relations for relay operations.

Before this system could be adopted, certain changes in the code would probably have to be agreed upon, such as over-sizing a lighting neutral in order that the neutral wire size need not be increased. There may be others.

I advance this scheme as being worthy of study at this time when standardization is still in the embryo. If feasible, I believe that the cost to the industry of additional equipment required, in the way of balance coils and grounding transformers, would be many millions lower than Mr. Richter's lowest estimate of the cost of the required changes in present equipment using the most favorable of the schemes at present contemplated. Perhaps Mr. Richter could contribute a comparative estimate later.

In the time at my disposal between the conception of this idea and the present, I have not thought of any vital objection to it.

It may have some very vulnerable features which make it impractical. It should, therefore, be thoroughly checked for any such faults and if none can be pointed out, given serious consideration before being thrown into the discard.

A. H. Kehoe: I disagree with the conclusions which would be inferred from reading the paper, and claim that the 120/208-volt system is the preferable one to adopt. In discussions before the Institute on voltage standardization, it has been stated that 110-, 115-, and 120-volt systems are each being operated successfully throughout the country on a single-phase, three-wire basis. One unfamiliar with conditions might readily think in reading the paper that 120/240-volt supply existed only on some of the older d-c. systems. It should also be noted that items of cost are included for changes in single-phase equipment that is regularly sold by the manufacturers, who guarantee its successful operation for the same service which in the paper is indicated as requiring these heavy redesign expenses. Such single-phase equipment, today, as in the past, is designed to operate successfully on 110-, 115-, and 120-volt services. It is difficult to understand how any charges for changes in these conditions will be incurred in time to affect the economics of the situation here under consideration.

The paper states in the qualitative treatment of the 120/208-volt system that there is a possibility of using either a 5-per cent or a 10-per cent maximum allowable voltage variation. The 10-per cent variation is ignored in the quantitative results. This omission is made regardless of the fact that it has been many times stated that the 120/208-volt system operating with a maximum terminal voltage variation of 5 per cent is the only one of the combined balanced light and power systems which can supply all of the standard utilization equipment within the limits covered by existing agreements at which the equipment is guaranteed to operate successfully. Needless to say, such a system is the only one which will avoid the expense which in the paper is estimated in the millions.

It is questionable whether third-leg protection on some motor circuits should be included in the costs, as the industry now uses this and will have to do so with any of the combined systems. Watthour meter costs, on the other hand, are not mentioned, presumably because the meters have been developed and are required in practice today. However, the watthour meter charge is an important one to consider in any three-phase case, and should not be overlooked when considering costs. A fact to note, in this connection, is that for the moment three-element meters cost more than three separate single-element meters.

I am not in accord with most of the statements made on public relations. It is paramount for good public relations that a customer never be inconvenienced from the viewpoint of our service to him, and that equipment which he wishes to buy, sell, or use can be readily utilized. Universal use covers more than equipment; it means service availability as well, on the fifth or fiftieth floor, if need be, without major reconstruction of the system while the consumer waits. The principal objection to the 115/199-volt system is due to public relations, in that it is impossible to guarantee delivery of a terminal voltage at which standard equipment is sold to operate successfully within its rating.

From time to time it has been stated that a special motor of 200 volts will be produced. Such a motor should not be produced unless it can be designed for universal application. However, if one is produced, it will be possible to operate it successfully on a well-regulated 120/208-volt system.

I am of the opinion that no single combined light and power system will be used for some time to come; but if one system should be generally adopted in the next few years, it will be the 120/208-volt, three-phase, four-wire with a maximum variation of 5 per cent in terminal voltage.

W. B. Kirke: I heartily agree with Mr. Kehoe on what he has to say in regard to the 120-volt versus the 115-volt system; I also am definitely on the 120-volt side.

If we look ahead to the future and consider possibly a 10- or 15-year period, we might make the assumption that in that time there will be a possible 10,000,000-kw. demand on network systems. If we ascribe a figure of \$20 or \$25 a kilowatt to the cost of secondary mains and subways, if it represents an underground system, we shall have a capital investment of \$250,000,000. A comparison of the kilowatt capacity of the 115-volt system with that of the 120-volt system has to be based primarily upon voltage regulations, and in round figures one is 10 per cent greater than the other. Ten per cent of \$250,000,000 is \$25,000,000 which you can add as a credit on the 120-volt system. That makes up the difference in cost between \$75,000,000 and \$100,000,000 as represented in the Table X, on the assumption that the other figures are correct. I seriously question the values as given.

L. L. Elden: In discussing this paper I must confess my inability to analyze some of the prospective savings which are computed for certain types of network systems. In some estimates which were presented recently it appeared that in a single system the cost of extensions during the next ten years was estimated to total something like \$100,000,000 for distribution equipment if present methods of construction and supply were followed.

It was suggested that the adoption of the network system would mean a saving of approximately \$7,000,000. I wonder if there is anybody here—engineer, commercial man, or otherwise—who will guarantee that over a period of ten years his estimate for such construction will fall within 7 per cent of the actual cost.

Such an estimate must take into consideration the future developments in the art, obsolescence of equipment, changing rates of interest, taxes, and many other contingencies. It is doubtful if anyone here would undertake such responsibility.

It has become increasingly evident that in the maintenance of favorable public relations, we must consider everything that we do primarily from the standpoint of the user and for that reason

must carefully review any investment and its effect upon future operating and maintenance costs.

An important feature of the networks under discussion is the propriety of operating motors at subnormal voltages as appears necessary through the adoption of any four-wire, three-phase secondary networks where the lamp voltages range from 110 to 120 volts.

Manufacturers' data on motor operation show very conclusively that operation at the subnormal voltages referred to results in a reduction of efficiency if the motors are operated at anywhere near full load. This method of operation takes advantage of the 10-per cent tolerance factor provided by the manufacturers in their guarantees. From this point of view it may appear that our utilities are within their rights in providing for operating such motors at lower than normal voltages.

As this tolerance factor, however, is not intended to be used in such a manner since it is well known that there will be variations in almost any system voltage below normal voltage, it must be that in most cases the motor will be operated under conditions unfavorable to the customer.

It is unfortunate that this situation has arisen but while it is desirable to construct motors which are capable of operating within a 10-per cent range of voltage plus and minus from normal, it does not appear desirable to recommend the construction of systems on that basis as has been suggested in the consulting engineer's paper presented on this subject.

Considerable time has been spent upon a study of the motor situation in the hope that some development might be suggested to the manufacturers which would provide motors adapted to network operation and at the same time not require a change in present standards.

It appears that the bulk of the requirements will naturally fall in the 115/199-volt class, so that unless some special scheme can be developed, there appears to be a logical need for another motor possibly rated at 200 volts as Mr. Blake has suggested.

An extension of motor windings has been suggested with taps which may be utilized for either 200- or 220-volt operation as a possible solution. Motors are moved from one part of a system to another so that a motor arranged with a combination of taps as above suggested would be suitable for use in any location. If this method of construction is feasible, and I have been told by one designer that there is nothing to prevent such an arrangement being incorporated in motor construction except a slight additional cost, it may be the way out of the situation with which we are contending.

Mr. Blake has very definitely stated that manufacturers do not approve of the operation of 220-volt standard motors on 199-volt service. It appears, however, that manufacturers' representatives are guaranteeing such motors for operation on the lower voltages without hesitation. This appears to be a most undesirable procedure and in the end will be very destructive of any efforts which may be made to secure a definite standardization of motor ratings.

It is to be hoped that out of this situation something will be developed in the form of a motor product which will be universal in application and leave us free to develop networks at will without detriment to other interests.

D. K. Blake: It is by no means out of the question to have a motor that will operate successfully, a universal motor, on 199 or 220 volts. It may be a little difficult to do, but it seems that a great deal can be accomplished by a combination of parallel-Y and series-delta. I would merely suggest something like perhaps parallel-Y 195 volts, series-delta 225 volts. Not all motors can be built that way easily, but a large number can.

P. H. Chase: I would like to ask whether a motor of that type will run into considerable extra expense? It means heavier coil cost and it may affect the frame.

D. K. Blake: It is my understanding that it will not run into a very heavy expense except on some sizes and speeds. I can't

say definitely because that has not been pursued far enough, but there is that hope.

W. B. Kirker: I would like to add one more point. In Brooklyn we have the 120-volt service standard. We attempt to keep that voltage within the limits of 116 to 124 volts.

Our complaints on utilization equipments connected from line to neutral due to 120-volt standard are practically nil. It may have some bearing upon the costs which Mr. Richter has given on rewinding of 120-volt parallel-connected or 220-volt series-connected motors. The network system that we intend to install will take care of loads up to 10-kw. demand from line to neutral. This will take care of the great majority of small motors. Above that capacity we expect to serve on a four-wire basis.

Our distribution transformers are operating above the 120-volt maximum rating. I would say 60 per cent of them are operating close to 124 volts or above, or rather 60 per cent are operating above 120 volts, and 40 per cent are operating below.

I would like to make one other reference to Fig. 4 showing the proportion of lamp sales. I believe the figures for 1926 on the 120-volt group are about 35 per cent, and on the 115-volt group approximately 47 per cent. This shows an increase of approximately 4 per cent during the past year at 120 volts and closer to a 3-per cent gain on 115 volts.

The parallelism is, therefore, converging, and there seems to be a very good economic justification for the increase in 120-volt service.

P. H. Chase: I would like to ask one specific question. These figures of \$75,000,000 to \$150,000,000 stick in my mind very definitely. Mr. Richter explained that those figures were the net figures. In a ten-year period there would accumulate \$75,000,000 to \$150,000,000 deficit that somebody has got to pay. I don't imagine that the manufacturing companies will absorb that kind of a deficit out of profit and loss account. It will be passed on.

How many years after that ten-year transition period will it take to make up that deficit? In other words, I am asking in another way, what is the gross figure? After we have spent the \$150,000,000, there must be some economies resulting at the end of the transition period that are going to pay back, we would hope very shortly, the money we spent.

I am much interested in that figure and how long it is going to take. If it is 25 years we must have a great deal of hope.

M. T. Crawford (by telegraph): I suggest for discussion that consideration be given to the delta system, Fig. 2c, as it permits the supply of full normal voltage to all utilization equipment which will become more necessary with increased use of heating devices. Seattle has had multiple primary feed low-voltage networks in operation six years with success, using this delta system for combined light and power on recent work. We have no difficulty in balancing phase loads on primary feeders.

H. P. Seelye (by letter): One cannot help but agree that the adoption of one system as a standard would be very desirable, if possible. It usually occurs, however, that standardization follows considerably behind utilization and is accomplished for the purpose of bringing order out of chaos but after the chaos is pretty well established. It would appear somewhat doubtful if the use of combined secondaries has yet reached such a point as to make a general agreement on a single standard possible, no matter how desirable it may be. A comparatively small percentage of the industry is using such secondaries as yet although consideration is being given to the subject quite universally. A satisfactory generally accepted standard cannot be impressed on such a situation but will come only after a wide experience with all the variations points to one type as most desirable.

The present trend seems to be quite generally toward the adoption of a Y-connected, 4-wire, three-phase scheme at either 120/208 volts or 115/199 volts. There seem to be enough arguments in favor of both these voltage combinations to make it quite certain that neither one will be universally accepted for

some time. Companies will probably choose the voltage which corresponds best with their present standards and those which they will use elsewhere on the system (the combined secondaries will in most cases form only a part of the total secondary system). This might point to the adoption of one as a standard and the other as an accepted departure, as Mr. Richter suggests, but aside from the probable controversy as to which will be the standard and which the departure, can the desired result be gained by such a standardization? The two voltages are far enough apart so that most of the changes noted by Mr. Richter for both systems would be necessary. The manufacturer would be bound to furnish apparatus both for the standard and the accepted departure. A possible solution might be a compromise between the two, say 117.5/203.5 volts for apparatus which would be only about 2 per cent away from either utilization voltage.

Regardless of which voltage might be accepted as standard, there will no doubt be a demand by motor users for motors in the 200-volt range. This demand will probably not be entirely satisfied by 220-volt motors either with or without supplemental ratings or understandings as to reduced allowable voltage variation. It will be met by some manufacturer by 200-volt motors. It would seem the best practicable solution to accept the fact that there probably will be systems at both 115/199 and 120/208 volts (as well as at 115/230 volts) and to develop a line of apparatus, if possible, which will be suitable for both voltages with satisfactory rating and guarantees.

H. Richter: The question was raised by Mr. Chase as to whether the diverse conditions in the various distribution systems will allow the application of any standard for combined light and power secondaries. I wish to call attention to the fact that when standardization of frequencies was suggested many years ago, and of lamp voltages more recently, similar doubts were raised. Time has shown that in the general good of the industry the numerous local objections were relinquished. Basically, the conditions treated in the paper are the same as were those of the frequency and lamp-voltage problems.

There seems to be a doubt that the cost of continuing the present unstandardized conditions would exceed the total of \$75,000,000 to \$150,000,000. An approximate analysis made a short time ago gave a sum greatly in excess of \$150,000,000. The assumptions included the usual process of developing equipment exactly fitted to each of the different systems.

The total expenditures given in Table II, incidentally, are net. In pointing out that the paper omits consideration of increase in investment and operating costs due to incidentals during the ten-year transition period, Mr. Chase lends support to those parts of the conclusions that suggest a comprehensive study by the leading men of the industry. His question as to how soon the huge totals against the combined system may be cancelled by economies introduced by this system can also be answered properly only by such a study.

I fail to see wherein there would be undue difficulty in standardizing on one combined scheme for secondary networks because of objections to operating in the congested area of a city a system differing from that in the remainder of the city or to changing the rest of the distribution system to conform with the network. What of the numerous d-c. underground systems now surrounded by extensive a-c. overhead systems? At least, with the Fig. 2F scheme, many of the motors can be used interchangeably on both radial and network systems. In one large city there are 120/240 volts direct current; 120/208 volts, three-phase, four-wire; 115/230 volts radial alternating current; and 115/230 volts, two-phase, five-wire. Of course, this is ideal but it shows what is done in practise for expediency.

Mr. Wallau's suggestion, like J. C. Parker's translator system, is another of those admirable attempts to derive a combined scheme for three-phase networks which I hope will eventually result in eliminating compromises with existing standards. It should be given due consideration, but already I see some of the

vulnerable features that he seemed to feel impending as he closed his remarks. The necessity of leaving the neutral wires ungrounded does not meet the National Electrical Safety Code requirement to ground the neutrals at all services. The advantage of a thoroughly grounded solid neutral network over the entire system is also lost. Similar to the translator scheme, Mr. Wallau's suggestion involves that added complexity in the distribution system due to auxiliary apparatus which is directly opposed to the simplicity of the Fig. 2F scheme and may therefore be undesirable to the operating companies.

Mr. Kehoe objects to those assumptions in the paper that provide for changes in phase-to-neutral apparatus to suit the 120/208-volt system. Surely we cannot ignore the fact that on a nominal 120-volt system the apparatus must be guaranteed for at least 120 volts plus or minus 5 per cent. It is incorrect to think that the guarantees on all standard equipment are covered at these limits, which are 126 to 114 volts. This would ignore the electric heating devices rated at 115 volts plus or minus 5 per cent, or 121 volts maximum; miscellaneous apparatus, including fan motors, rectifiers, static condensers, etc., with the same rating; and distribution transformers rated at 110/115/120 volts, that is, 120 volts maximum.

It was even considered necessary to assume 10 per cent plus or minus for the limits on small motors, general-purpose motors and motor-control equipment. The reason was that this is the only standard that has been definitely agreed upon. It can be readily understood that such limits may not suit metropolitan network systems maintaining very close regulation at utilization devices. But the guarantees are formulated according to the requirements of the majority of the systems in the country. For years the apparatus connected to radial systems in large cities has similarly had the same limitations as equipment for outlying towns and villages.

Likewise, it is probable that the combined secondary scheme acceptable to the majority of companies operating networks may not be applicable to skyscraper services as well as to small stores and apartment houses, without some modification.

Mr. Kirke claims that the 5-per cent economic advantage of 120 volts over 115 volts will cancel the difference between the \$100,000,000 expenditure for the 120/208-volt system and the \$75,000,000 for 115/199 volts. In view of the decision of the industry to standardize on 115 volts for lamps and the indications that this decision is being put into effect, it would seem that the sum total of the disadvantages of going to 120 volts for phase-to-neutral apparatus must outweigh all the advantages.

In neglecting to be governed by this gain of 5 per cent, important consideration was apparently given to the condition illustrated by some figures published in the *Electrical World*. These state that the application of 110, 115 and 120 volts to residential customers is in the approximate ratio of 76 to 37 to 17.

The Europeans appear to be swayed by this economic factor and not only carry the process to its logical conclusion by using the 220/380-volt combined system but also point to the undue conservatism of our 115/230-volt separate light and power system.

Mr. Kirke thinks that the 1926 lamp sale totals will cause the 115- and 120-volt curves in Fig. 4 to converge further. It may be too early to make this prediction, as it is quite possible that there will be no further convergence. Furthermore, the 120-volt curve is not conclusive. No effort has been made to differentiate between the lamps on d-c. systems and those on a-c. I have obtained data from a reliable source that show that as of January 1, 1926, the percentage of domestic lighting customers using direct current to those served with alternating current was: for 110 volts—0.33 per cent; for 115 volts—0.25 per cent; and for 120 volts—25 per cent. Applying these corrections to the curves in Fig. 4 results in dropping the 120-volt curve considerably below the position shown. It is thus apparent that 115 volts is decidedly the standard at the present time.

must carefully review any investment and its effect upon future operating and maintenance costs.

An important feature of the networks under discussion is the propriety of operating motors at subnormal voltages as appears necessary through the adoption of any four-wire, three-phase secondary networks where the lamp voltages range from 110 to 120 volts.

Manufacturers' data on motor operation show very conclusively that operation at the subnormal voltages referred to results in a reduction of efficiency if the motors are operated at anywhere near full load. This method of operation takes advantage of the 10-per cent tolerance factor provided by the manufacturers in their guarantees. From this point of view it may appear that our utilities are within their rights in providing for operating such motors at lower than normal voltages.

As this tolerance factor, however, is not intended to be used in such a manner since it is well known that there will be variations in almost any system voltage below normal voltage, it must be that in most cases the motor will be operated under conditions unfavorable to the customer.

It is unfortunate that this situation has arisen but while it is desirable to construct motors which are capable of operating within a 10-per cent range of voltage plus and minus from normal, it does not appear desirable to recommend the construction of systems on that basis as has been suggested in the consulting engineer's paper presented on this subject.

Considerable time has been spent upon a study of the motor situation in the hope that some development might be suggested to the manufacturers which would provide motors adapted to network operation and at the same time not require a change in present standards.

It appears that the bulk of the requirements will naturally fall in the 115/199-volt class, so that unless some special scheme can be developed, there appears to be a logical need for another motor possibly rated at 200 volts as Mr. Blake has suggested.

An extension of motor windings has been suggested with taps which may be utilized for either 200- or 220-volt operation as a possible solution. Motors are moved from one part of a system to another so that a motor arranged with a combination of taps as above suggested would be suitable for use in any location. If this method of construction is feasible, and I have been told by one designer that there is nothing to prevent such an arrangement being incorporated in motor construction except a slight additional cost, it may be the way out of the situation with which we are contending.

Mr. Blake has very definitely stated that manufacturers do not approve of the operation of 220-volt standard motors on 199-volt service. It appears, however, that manufacturers' representatives are guaranteeing such motors for operation on the lower voltages without hesitation. This appears to be a most undesirable procedure and in the end will be very destructive of any efforts which may be made to secure a definite standardization of motor ratings.

It is to be hoped that out of this situation something will be developed in the form of a motor product which will be universal in application and leave us free to develop networks at will without detriment to other interests.

D. K. Blake: It is by no means out of the question to have a motor that will operate successfully, a universal motor, on 199 or 220 volts. It may be a little difficult to do, but it seems that a great deal can be accomplished by a combination of parallel-Y and series-delta. I would merely suggest something like perhaps parallel-Y 195 volts, series-delta 225 volts. Not all motors can be built that way easily, but a large number can.

P. H. Chase: I would like to ask whether a motor of that type will run into considerable extra expense? It means heavier coil cost and it may affect the frame.

D. K. Blake: It is my understanding that it will not run into a very heavy expense except on some sizes and speeds. I can't

say definitely because that has not been pursued far enough, but there is that hope.

W. B. Kirke: I would like to add one more point. In Brooklyn we have the 120-volt service standard. We attempt to keep that voltage within the limits of 116 to 124 volts.

Our complaints on utilization equipments connected from line to neutral due to 120-volt standard are practically nil. It may have some bearing upon the costs which Mr. Richter has given on rewinding of 120-volt parallel-connected or 220-volt series-connected motors. The network system that we intend to install will take care of loads up to 10-kw. demand from line to neutral. This will take care of the great majority of small motors. Above that capacity we expect to serve on a four-wire basis.

Our distribution transformers are operating above the 120-volt maximum rating. I would say 60 per cent of them are operating close to 124 volts or above, or rather 60 per cent are operating above 120 volts, and 40 per cent are operating below.

I would like to make one other reference to Fig. 4 showing the proportion of lamp sales. I believe the figures for 1926 on the 120-volt group are about 35 per cent, and on the 115-volt group approximately 47 per cent. This shows an increase of approximately 4 per cent during the past year at 120 volts and closer to a 3-per cent gain on 115 volts.

The parallelism is, therefore, converging, and there seems to be a very good economic justification for the increase in 120-volt service.

P. H. Chase: I would like to ask one specific question. These figures of \$75,000,000 to \$150,000,000 stick in my mind very definitely. Mr. Richter explained that those figures were the net figures. In a ten-year period there would accumulate \$75,000,000 to \$150,000,000 deficit that somebody has got to pay. I don't imagine that the manufacturing companies will absorb that kind of a deficit out of profit and loss account. It will be passed on.

How many years after that ten-year transition period will it take to make up that deficit? In other words, I am asking in another way, what is the gross figure? After we have spent the \$150,000,000, there must be some economies resulting at the end of the transition period that are going to pay back, we would hope very shortly, the money we spent.

I am much interested in that figure and how long it is going to take. If it is 25 years we must have a great deal of hope.

M. T. Crawford (by telegraph): I suggest for discussion that consideration be given to the delta system, Fig. 2c, as it permits the supply of full normal voltage to all utilization equipment which will become more necessary with increased use of heating devices. Seattle has had multiple primary feed low-voltage networks in operation six years with success, using this delta system for combined light and power on recent work. We have no difficulty in balancing phase loads on primary feeders.

H. P. Seelye (by letter): One cannot help but agree that the adoption of one system as a standard would be very desirable, if possible. It usually occurs, however, that standardization follows considerably behind utilization and is accomplished for the purpose of bringing order out of chaos but after the chaos is pretty well established. It would appear somewhat doubtful if the use of combined secondaries has yet reached such a point as to make a general agreement on a single standard possible, no matter how desirable it may be. A comparatively small percentage of the industry is using such secondaries as yet although consideration is being given to the subject quite universally. A satisfactory generally accepted standard cannot be impressed on such a situation but will come only after a wide experience with all the variations points to one type as most desirable.

The present trend seems to be quite generally toward the adoption of a Y-connected, 4-wire, three-phase scheme at either 120/208 volts or 115/199 volts. There seem to be enough arguments in favor of both these voltage combinations to make it quite certain that neither one will be universally accepted for

Sept. 1927

some time. Companies will probably choose the voltage which corresponds best with their present standards and those which they will use elsewhere in the system (the combined secondaries will in most cases form only a part of the total secondary system). This might point to the adoption of one as a standard and the other as an accepted departure, as Mr. Richter suggests, but aside from the probable controversy as to which will be the standard and which the departure can the desired result be gained by such a standardization? The two voltages are far enough apart so that most of the changes noted by Mr. Richter for both systems would be necessary. The manufacturer would be bound to furnish apparatus both for the standard and the accepted departure. A possible solution might be a compromise between the two, say 117.5/205 volts for apparatus which would be only about 2 per cent away from either utilization voltage.

Regardless of which voltage might be accepted as standard, there will no doubt be a demand by motor users for motors in the 200-volt range. This demand will probably not be entirely satisfied by 220-volt motors either with or without supplemental ratings or understandings as to reduced allowable voltage variation. It will be met by some manufacturer by 200-volt motors. It would seem the best practicable solution to accept the fact that there probably will be systems at both 115/199 and 120/208 volts (as well as at 115/230 volts) and to develop a line of apparatus, if possible which will be suitable for both voltages with satisfactory ratings and guarantees.

H. Richter: The question was raised by Mr. Chase as to whether the diverse conditions in the various distribution systems will allow the application of any standard for combined light and power secondaries. I wish to call attention to the fact that when standardization of frequencies was suggested many years ago, and of lamp voltages more recently, similar doubts were raised. It has shown that in the general good of the industry the numerous local objections were relinquished. Basically the conditions treated in the paper are the same as were those of the frequency and lamp-voltage problems.

There seems to be doubt that the cost of continuing the present unstandardized conditions would exceed the total of \$75,000,000 to \$150,000,000. An approximate analysis made a short time ago gave a sum greatly in excess of \$150,000,000. The assumptions included the usual process of developing equipment exactly fitted to each of the different systems.

The total expenditures given in Table II, incidentally, are net. In pointing out that the paper omits consideration of increase in investment and operating costs due to incidentals during the one-year transition period, Mr. Chase lends support to those parts of the conclusions that suggest a comprehensive study by the leading men of the industry. His question as to how soon the huge totals against the combined system may be cancelled by economies introduced by this system can also be answered properly only by such a study.

I fail to see wherein there would be undue difficulty in standardizing on one combined scheme for secondary networks because of objections to operating in the congested area of a city a system differing from that in the remainder of the city or to changing the rest of the distribution system to conform with the network. What of the numerous d-c. underground systems now surrounded by extensive a-c. overhead systems? At least, with the Fig. 2r scheme many of the motors can be used interchangeably on both radial and network systems. In one large city there are 120/240 volts direct current; 120/208 volts, three-phase, four-wire; 115/200 volts radial alternating current; and 115/230 volts, two-phase, five-wire. Of course, this is ideal but it shows what is done in practise for expediency.

Mr. Wallau's suggestion, like J. C. Parker's translator system, is another of those admirable attempts to derive a combined scheme for three-phase networks which I hope will eventually result in eliminating compromises with existing standards. It should be given due consideration, but already I see some of the

vulnerable features that he seemed to feel impending as he closed his remarks. The necessity of leaving the neutral wires ungrounded does not meet the National Electrical Safety Code requirement to ground the neutrals at all services. The advantage of a thoroughly grounded solid neutral network over the entire system is also lost. Similar to the translator scheme, Mr. Wallau's suggestion involves that added complexity in the distribution system due to auxiliary apparatus which is directly opposed to the simplicity of the Fig. 2r scheme and may therefore be undesirable to the operating companies.

Mr. Kehoe objects to those assumptions in the paper that provide for changes in phase-to-neutral apparatus to suit the 120/208-volt system. Surely we cannot ignore the fact that on a nominal 120-volt system the apparatus must be guaranteed for at least 120 volts plus or minus 5 per cent. It is incorrect to think that the guarantees on all standard equipment are covered at these limits, which are 126 to 114 volts. This would ignore the electric heating devices rated at 115 volts plus or minus 5 per cent, or 121 volts maximum; miscellaneous apparatus, including fan motors, rectifiers, static condensers, etc., with the same rating; and distribution transformers rated at 110/115/120 volts, that is, 120 volts maximum.

It was even considered necessary to assume 10 per cent plus or minus for the limits on small motors, general-purpose motors and motor-control equipment. The reason was that this is the only standard that has been definitely agreed upon. It can be readily understood that such limits may not suit metropolitan network systems maintaining very close regulation at utilization devices. But the guarantees are formulated according to the requirements of the majority of the systems in the country. For years the apparatus connected to radial systems in large cities has similarly had the same limitations as equipment for outlying towns and villages.

Likewise, it is probable that the combined secondary scheme acceptable to the majority of companies operating networks may not be applicable to skyscraper services as well as to small stores and apartment houses, without some modification.

Mr. Kirke claims that the 5-per cent economic advantage of 120 volts over 115 volts will cancel the difference between the \$100,000,000 expenditure for the 120/208-volt system and the \$75,000,000 for 115/199 volts. In view of the decision of the industry to standardize on 115 volts for lamps and the indications that this decision is being put into effect, it would seem that the sum total of the disadvantages of going to 120 volts for phase-to-neutral apparatus must outweigh all the advantages.

In neglecting to be governed by this gain of 5 per cent, important consideration was apparently given to the condition illustrated by some figures published in the *Electrical World*. These state that the application of 110, 115 and 120 volts to residential customers is in the approximate ratio of 76 to 37 to 17.

The Europeans appear to be swayed by this economic factor and not only carry the process to its logical conclusion by using the 220/380-volt combined system but also point to the undue conservatism of our 115/230-volt separate light and power system.

Mr. Kirke thinks that the 1926 lamp sale totals will cause the 115- and 120-volt curves in Fig. 4 to converge further. It may be too early to make this prediction, as it is quite possible that there will be no further convergence. Furthermore, the 120-volt curve is not conclusive. No effort has been made to differentiate between the lamps on d-c. systems and those on a-c. I have obtained data from a reliable source that show that as of January 1, 1926, the percentage of domestic lighting customers using direct current to those served with alternating current was: for 110 volts—0.33 per cent; for 115 volts—0.25 per cent; and for 120 volts—25 per cent. Applying these corrections to the curves in Fig. 4 results in dropping the 120-volt curve considerably below the position shown. It is thus apparent that 115 volts is decidedly the standard at the present time.

If a standard combined system were chosen in conjunction with a recognized departure, Mr. Seelye believes the development of apparatus with guarantees for the departure would come about. I think this unlikely. At present, 120 volts is a recognized departure from 115 volts, yet the majority of electric heating devices, distribution transformers and those devices listed in the paper as miscellaneous are still rated at 115 volts plus or minus 5 per cent.

In the discussion of standardization of transmission voltages,² mention was made that there had been omitted a review of the

conditions that had brought about certain of the off-standard voltages. With these voltages so firmly entrenched, it certainly appears to be a difficult task to choose a series of transmission voltage standards satisfactory to the majority of systems. This situation is one more eloquent plea that the small differences here and there in the combined light and power secondary problem be reconciled as quickly as possible. There will thus be no past history to reveal the huge expenditures that might have been prevented by the adoption of a standard system at this time.

Discussion at Kansas City Meeting

DEVELOPMENT OF RAILWAY SIGNALING¹

(STEVENS)

KANSAS CITY, MO., MARCH 17, 1927

F. E. Snell: Though continued development of the semaphore and light type of signals resulted in the production of a highly efficient unit, it yet has some serious drawbacks as pointed out by Mr. Stevens. These unfavorable conditions, attendant on wayside signals, which could not be remedied by electrical means, naturally resulted in the development of a cab signal. The cab type of signal may also offer a solution to one of the problems with which we are confronted in Cleveland, and which, no doubt, affect other operators of rapid transit lines in metropolitan areas, where a portion of the right-of-way is through the less polite residential sections. I refer to the malicious destruction of signal equipment by trespassers, particularly small boys who throw stones, using the wayside signal light lenses as targets.

It would be interesting to hear, not only of the problems presented by the inductive effects of adjacent power lines of the same frequency as the signal current, but also something regarding the ability of the engine equipment to function properly under severe conditions to which it is no doubt subjected. In other words, do vibrations, bumps, etc., cause excess relay or lamp failures when compared with the wayside type of signal?

Wishing to give the traveling public the greatest possible protection, signal engineers have experimented with, and developed, various forms of automatic train control, the ultimate success of which, Mr. Stevens states, is debatable. Our company has had no occasion, of course, to consider such a system, but from the wonderful progress made in the signal field in a comparatively short time, as well as in other branches of the electrical industry, I can see no reason why continued experimenting and future developments will not soon result in more efficient and reliable methods of signaling and automatic control of trains.

O. S. Major: As presented by Mr. Stevens, the cab-signal system appears to be comparatively simple, but when one digs into the problem a little deeper and considers various traffic conditions to be contended with and traffic reversal as used on the Santa Fe, situations sometimes arise which are extremely complicated.

Other general types of automatic train control not taken up by Mr. Stevens include the intermittent inductive, intermittent contact (ramp type), continuous two-speed and continuous stop; they are all intended to accomplish the same general purpose, namely, enforcing of obedience to, or cognizance of, signal indications.

In the intermittent contact or ramp type, ramps are placed at intervals along the roadway which make contact with a shoe on the locomotive. The ramp is energized or deenergized, depending upon track conditions ahead or wayside signal indication;

the shoe, on passing over the ramp, completes electrical circuits on the locomotive which in turn control relays and valves, causing a reduction of brake pipe pressure under certain conditions.

In the intermittent inductive types, several methods are used to impart an electrical impulse to the locomotive circuits through an air-gap to a receiver mounted on the locomotive which in turn controls electropneumatic valves causing a reduction of brake-pipe pressure under certain conditions of track and signal indications.

The track element, or inductor, in one device consists of permanent magnets and electromagnets, placed adjacent to one another in such a manner that when energy is applied to the electromagnets, the field of the permanent magnet is suppressed or flattened out to the extent that the locomotive receiver or valve in passing over it will not receive an impulse, which would be the condition set up for a clear block. The energy supplying the electromagnets is selected through certain relays and contacts in such a manner that if the track ahead is *not* clear, this circuit will be open, the field of the permanent magnet will not be suppressed and the locomotive receiver or valve on passing through this field is subjected to the effects of these lines of force. The action of the locomotive receiver or valve is purely magnetic, embodying the principles of north and south poles bucking and helping one another. An air valve with pressure on one side working against a magnet on the other side vents pressure to atmosphere when the magnetic effect on the valve is diminished or neutralized on account of passing over the extended field of the track element.

Another type of intermittent inductive train control uses an inert track element or inductor which imparts an impulse to a receiver mounted on the locomotive when the receiver passes over it. The inductor consists of a laminated iron core around which wire is wound. The receiver consists of a primary and secondary winding on a laminated U-shaped core. The primary is constantly energized from the headlight generator, thereby forming an electromagnet. If the leads to the track element or inductor are closed, as in clear block conditions, the engine circuits are not materially disturbed when the receiver passes over the inductors. However, if the winding on the inductor is open, as in the caution or stop block condition, the reactance of the inductor is changed as well as the reluctance of the magnetic circuit, between receiver, air and inductor, and a current is induced in the secondary circuit of the receiver, opposite in polarity to and larger than the normal holding current of engine-control relay, which drops this relay and causes an electropneumatic valve to function resulting in a reduction of pressure. Acknowledging and forestalling devices can be provided on most of the devices which enable the engineman to forestall an automatic application of the brakes, providing he is sufficiently alert to perform a certain duty in a specified length of time at a certain place.

The Chicago & Northwestern has installed a system of continuous control which is rather unique in many respects, in that

2. A. I. E. E. JOURNAL, July 1927, p. 717.

1. A. I. E. E. JOURNAL, July, 1927, p. 689.

the operating mechanism controlling the speed of the train in a yellow or caution block is a function of both speed and distance. The mechanism is driven from the axle. A lever or arm, working on a sliding governor, opens and closes certain contacts at various speeds and when a yellow block is entered, another arm or lever engages a worm gear which operates the arm to open and close certain other contacts at predetermined intervals of space or distance, the worm gear being also axle-driven. Another set of arms or levers combines the speed and distance features and operates still another set of contacts. The combination speed and distance contacts provide a means for compelling the engineman to control the speed of his train in conformity with a predetermined tapered speed curve, and require that the speed of his train be below a certain low speed at a particular point. If the speed of this train is not below the low-speed limit at a particular point or place, he will be penalized with an automatic application of the brakes which he cannot release until his train has come to a stop. Cab signals are also provided in this installation, but I believe the old wayside signals, which are of the disk type, are still in service.

In the systems of continuous control, I find that some roads reverse the polarity of the loop circuit and some reverse the track circuit in order to get the normal, neutral and reversed positions of the engine train-control relay.

The device Mr. Stevens refers to as the "Coder Device" which he states the Santa Fe is testing should fill a long-felt need if it proves satisfactory. It eliminates the loop circuit and renders the locomotive apparatus immune to picking up stray alternating currents of commercial frequencies.

I am rather inclined to agree with Mr. Stevens that in the last analysis continuous control is the end to which we should work as it paves the way for the ultimate elimination of wayside signals and provides a continuous check on the integrity and continuity of the track as well as the engineman.

An automatic train-control device using radio frequencies has been under development and test for some time on the P. M. Railway with encouraging results, but I am not advised as to the present status of this device. Considering the rapid progress and development in radio in the past few years, it is not entirely impossible to conceive of automatic continuous radio train control.

A. Herz: Mr. Stevens has made it clear that the locomotive signals depend on the magnetic field impulse transmitted through several inches of space, usually six in. or more over each rail, making a total air-gap of over one ft. The train control signal current used by the railroad is weak, in fact, not over one ampere. The power interests transmit large quantities of current over wires often located adjacent to railroad tracks, since the conditions of supply and demand make this necessary. These power wires are located at a distance making an air-gap many times greater than that used by the railroad interests in sending the train control impulse through space from rail to locomotive. However, it is quite impossible to transmit these large currents without setting up the usual magnetic fields around the conductors, which will in many instances cut the railroad tracks and thus create a very weak current flow along these tracks quite similar to that made use of by the railroad for this train control. This is especially pertinent and has a great bearing on the whole problem, since in some instances the railroad makes use of 60-cycle current and since the receiving devices and the whole set-up is such as to respond to the impulses from a 60-cycle magnetic field, so that the normal magnetic field liberated by the power wires may also influence the signals in the same manner, and very often in an undesirable manner.

That this is actually the case has been demonstrated in various localities. Some recent experimental work on a parallel between a continuous inductive type of train control installation and a power line along the edge of the right-of-way demonstrated that a comparatively small current, I believe it was on the order

of seven amperes, carried on the power lighting circuit, produced enough current in the rails actually to set up a false clear signal on the locomotive. The almost obvious reason for such a failure, of most dangerous nature, is the simple fact that the field of the power line had the same frequency as the field used in the track circuit to transmit the signals.

I want to draw attention to the obvious danger of having these devices set up so that they are responsive to the normal stray fields of the commercial power systems which are today almost universal. If the magnetic field made use of by the train control signal employs a materially different frequency, such interference can be absolutely prevented. This has been proven and is practically self-evident. As a matter of fact, some train control systems now being installed and also some now in use operate at 100 cycles, instead of 60 cycles. Some will go so far as to use 100 cycles plus mechanical tuning, that is, to employ an interrupted 100-cycle current, the rate of interruption being such that a mechanically resonant relay will respond to it and none other. This will provide a double element of safety or protection against possible interference from commercial power systems. However, there is probably a good deal of experimental work which must be done before the continuous inductive train control system is really perfected for general adoption.

T. S. Stevens: The relays for controlling automatic block signals on electrically operated railroads are designed so that they can be operated not only on direct-current operated railroads by alternating currents but on alternating-current propulsion railroads by the use of relays of a different frequency, centrifugal relay, sensitive to a different frequency from that used for propulsion. So the complete track circuit is used in that way.

Mr. Snell spoke of operating cab signals on electrically operated railroads and it is rather interesting because this is probably the most interesting electrical development of the age.

I don't want to start a discussion about frequency because it is too deep. The effects of the use of any frequency, whether it happens to be a different frequency from that of the power companies or the same, are not thoroughly known. What corrections can be made with the same frequency and still provide safe operation, are still doubtful. Whether the 100 cycles will not lead us into other difficulties is not known. A device of some kind which involves only very, very low frequency may be developed in the future, but we are pioneering.

I want to say in favor of Mr. Herz that he has been and we also have been working along amicably toward a settlement of this problem and no doubt will get to the solution of it some time.

Discussion at Pittsfield Meeting

SUBSTITUTION METHOD FOR THE DETERMINATION OF RESISTANCE OF INDUCTORS AND CAPACITORS AT RADIO FREQUENCIES¹

(BURKE)

PITTSFIELD, MASS., MAY 25, 1927

T. E. Shea: This paper offers an opportunity to call attention to certain equivalent networks, due to Dr. O. J. Zobel, which do not seem to have become generally absorbed into the literature to the extent that they deserve.

In the design of wave filters, of equalizers, or of balancing networks for simulating telephone lines, these equivalents have two values. In the first place, they simplify a great many formulas and give a better picture of what is going on in the circuit. In the second place, more desirable inductance, capacity and resistance values are often obtainable.

Now consider the network represented in Fig. 2 of the present

1. A. I. E. E. JOURNAL, May, 1927, p. 487.

paper. We are all familiar with the various relationships of equivalent T and π networks (for example, those made up of capacitors) where there are three terminals for each network. Nobody would ever question, if he had one mesh and it were more convenient to substitute another in a circuit and get a better picture of what was going on or get a more easily calculated circuit, the validity of using the second mesh. If he obtained more desirable capacity values, or a more convenient arrangement of capacities, he might even substitute the one mesh physically in place of the other.

In the case of two-terminal networks, that is, impedances in which there is only one main current path, there are a large number of similar equivalents. In the case of Fig. 2, the corresponding equivalent two-terminal network is in the form of capacity in series with a parallel combination of resistance and capacity. Likewise there are equivalent two-terminal meshes using inductance and resistance, and inductance and capacity, respectively, and for any number of component impedance elements.

If in this present case, for example, one wishes to investigate the matter of selectivity—the change in sensitivity of the device as the frequency is slightly changed—I suggest that it can be done very much more readily by means of equivalent networks, although, of course, the formulas in the paper ultimately simplify down to give the same results.

Two-terminal equivalent networks are discussed in many places in the literature; for example, in Zobel's papers on "Wave Filters," R. S. Hoyt's paper on "Design of Networks to Simulate Smooth Lines," and R. M. Foster's paper on "A Reactance Theorem," and in K. S. Johnson's book "Transmission Circuits for Telephonic Communication."

J. G. Ferguson: I would like to point out the small modification necessary in a circuit of this type to transform it into a bridge network and thus eliminate the necessity of measuring the current in the circuit in order to determine the point of resonance.

In Fig. 1 of the paper, we have a resonant circuit consisting of the three inductances, the variable capacitance, and the variable resistance, all connected in series. In order to measure resistance, as described in the paper, it is necessary to adjust the circuit for resonance. The resistance is determined by adjusting R to give the same current reading with the test coil or condenser in and out of the circuit. The difference in the reading of R then gives the value of resistance required.

Now the e. m. f. applied to this circuit is induced in Coil L_A . If we place across this coil in series, two equal resistances, we do not change the circuit in any way except to introduce a shunt across the generator coil. By connecting a detector from the midpoint of the two added resistances to ground, we transform the circuit into a bridge network, having two equal resistance arms, a third arm containing the resistance R , and a fourth arm containing L_o , L_x , and C in series. If we balance this bridge by adjusting R and C to give zero current through the detector, then L_o and L_x in series must be in resonance with C , and the total resistance of this arm must be equal to R .

This method is practically identical with the method described, except that it is unnecessary to measure the current, or even to hold it constant. Consequently, we do not have the same requirement of stability in the oscillator.

The general method described is really a substitution one, the assumption being made that the change in the capacitance of C may be made without changing the loss in the circuit. The usual assumption made is that if the dielectric loss is known or negligible, there are no other losses to be considered. However, at radio frequencies this is by no means the case, as in certain designs of capacitors we may have considerable eddy-current loss. Consequently one of the chief limitations of the method is in the determination of the loss in the standard capacitor. Knowing the loss in the standard, the method consists simply of

substituting the unknown for the known, keeping other conditions the same and reading the change in the setting of the variable resistor R .

Probably the only absolute way of determining the loss in a standard capacitor is the calorimeter method, and there are so many difficulties to be overcome in a measurement of that type, that a high degree of accuracy can be obtained only by use of extraordinary precautions.

In conclusion, there is just one other point which makes a bridge method preferable to an indicating method. If the detector is a heterodyne type or some type which allows us to discriminate between the frequency at which we wish to make the measurement and other frequencies, it is possible to balance the bridge for one frequency only, that is, for the fundamental. Any indicating method such as described in the paper which is dependent on a current measurement, measures the total current in the circuit including all of the harmonics, and the result obtained becomes a function of wave shape.

A. Nyman: I was rather amused on the question of nomenclature and particularly as applied to condensers. The company I am connected with is making millions of condensers every year, and I believe if we started changing the name to capacitor we would find ourselves in difficulty; people wouldn't know what we were talking about.

In connection with the measurement of condensers in Mr. Burke's paper, particularly at radio frequency, we worked out a method of measuring condensers at radio frequency which I believe is very accurate and quite simple.

The accompanying figure shows the construction of this test set. It consists of two independent oscillating circuits both with adjustable capacities. By arranging the capacities close to the same values, a beat note is formed between the two oscillating circuits, and this beat note can be brought very close to 1000 cycles by introducing in the circuit a 1000-cycle note from a

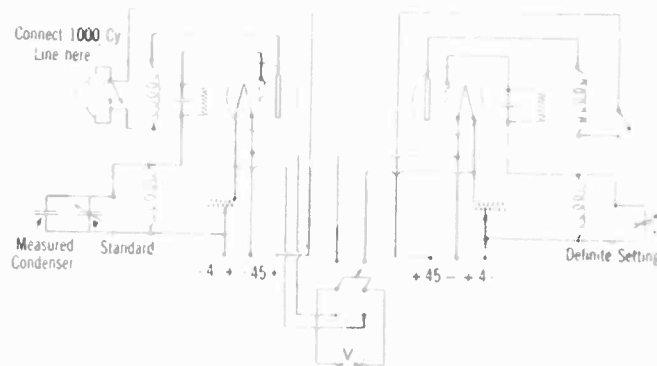

FIG. 1—PRECISION CAPACITY MEASUREMENT

tuning fork. Thus, on the left-hand side of the diagram, a standard condenser is adjusted alone until the 1000-cycle beat note tunes in with the 1000-cycle note from the tuning fork. Then a condenser to be measured is inserted in parallel with the standard and the standard readjusted to get the same condition.

It is of course necessary to watch that this beat note is always on the same side of the resonance curve. This will be the condition if the resonance is always approached from the same side, say, reducing the condenser in each case. Since the frequency of the circuit is now the same as it was before, the total capacity is the same as it was originally.

It has been found that it is possible to gage the frequency of the beat between the two 1000-cycle notes to within one cycle every two or three sec. With a million cycles on each oscillating circuit, this would give an accuracy of comparison of condensers of one in a million. Of course, this accuracy is a good deal higher than is required under any practical circumstances. Moreover, the actual accuracy is limited by the construction of the standard

condenser. With a General Radio type 222 standard condenser, this accuracy is not more than one in 25,000.

This method of measurement has been found quite reliable and is not affected by any outside circumstances. Since the two measurements are made on the same oscillating circuit, and the measured condenser is generally considerably smaller than the standard, the load conditions on each tube are practically identical and there is no tendency to upset the frequency relations of the two circuits. Moreover, the coupling between these two circuits is so loose that any change in one circuit does not affect the oscillation in the other circuit until approximate resonance (beat note of about 25 to 60 cycles) is reached. Thus, at the 1000-cycle beat note, the effect of one circuit on the other is entirely negligible.

C. T. Burke: In regard to the points raised by Mr. Ferguson, the condenser is the weakest link in the circuit. We have found in fact that on very high frequencies of the order of 50,000 kilocycles or thereabouts, the use of a condenser of the soldered-plate type does show a noticeable improvement over the usual stacked-plate type.

In connection with the other question as to the effect of harmonics, since this circuit is tuned to the fundamental of the oscillator, the magnitude of harmonics in the circuit should be rather small, and as the actual value of current is not used in the computation but is only used to reset the circuit, harmonics in the circuit should not affect the accuracy of the method unless the magnitude of the harmonic differs between the two tunings, and there does not seem to be any reason for expecting this to occur.

As to the other point raised in the matter of nomenclature, the terms "capacitor" and "condenser" do refer to the same thing.

CONDENSER SHUNT FOR MEASUREMENT OF HIGH-FREQUENCY CURRENTS OF LARGE MAGNITUDE¹

(NYMAN)

PITTSFIELD, MASS., MAY 25, 1927

B. E. Lenehan: It is not apparent why the capacity of a condenser can be assumed to be constant up to frequencies as high as 6000 kilocycles. Two conductors spaced approximately 10 times their diameter will have an inductive drop at 50 amperes 6000 kc. of about 345 volts per ft. The mutual inductance between the meter and shunt circuit can hardly be disregarded as only 1 per cent coupling would introduce errors of around 50 per cent.

The method is a very good practical way of making high-frequency measurements after its accuracy has been established, but it can hardly be classed as a standard. The well known difficulties of shielding high-frequency circuits are evident due to the high resistance of all materials. This effect accounts for the use of only moderately high frequencies in induction furnaces.

We must remember that no method of demonstrated accuracy exists for measurement of currents above 1000 kc. Resistances and inductances are all affected by the proximity of the return conductor of a circuit if any exists and the usual effects by which one makes measurements are complicated by the fact that the usual "constants" of a circuit are not constant.

Alexander Nyman: Concerning the statements of Mr. Lenehan, with regard to the voltage drop on leads at 6000 kc. and 50 amperes, it is not clear what size of lead he is contemplating, as of course the bigger the lead the less would be the drop per unit length. It is of course also true that the leads to condenser shunt are short from the junction point of the small condenser and these leads are so arranged as to confine the magnetic field to a small space and for this reason the voltage drop is practically negligible.

The inductive effect of these leads is again reduced by their

mutual shielding arrangement, and by the fact that the leads to the thermo-couple are very short. This inductive effect can of course be determined by connecting the small condenser element to the large, in which case it will be found that no current passes through the thermo-couple. In other words, the mutual inductance which Mr. Lenehan mentions is much less than 1 per cent and probably could not be readily determined.

With regard to the second paragraph, the writer is fully aware of the difficulties of shielding as this factor had been carefully studied in the design of the condenser shunt. The shortness of leads, the construction which encloses the incoming lead by outgoing leads, and a complete separation in a metallic container are the essential features which were found necessary for shielding. In other words, if the construction is such that there is no external field except in close proximity to the conductors, then the magnetic effect evidently is much easier to shield than than for an exposed conductor.

HIGH-FREQUENCY MEASUREMENT OF COMMUNICATION APPARATUS¹

(SHACKELTON AND FERGUSON)

PITTSFIELD, MASS., MAY 25, 1927

J. R. Craighead: Will the authors kindly clarify the definition of a crosstalk unit? The definition of a unit as a "relation" is not easy to use for measurement purposes.

N. E. Bonn: Messrs. Shackelton and Ferguson have mentioned a vacuum-tube oscillator the frequency of which they can keep constant to within one part in 250,000 under ordinary variations in external conditions. If this is meant to include variations in plate voltage and filament current, the statement would appear to be at variance with universal experience which indicates that the frequency of vacuum-tube oscillators is profoundly affected by changes in tube impedance. In view of the importance of the subject will the authors please discuss the particular features of their circuit that make it so stable?

W. E. Shackelton: We are very glad to have had Mr. Craighead's comment on the matter of crosstalk. I will not attempt to redefine the crosstalk unit, but will simply try to explain what is meant by it, and then you can make your own definition.

If we have two circuits which, due to some undesired coupling, are so related that the current flowing in one of the circuits causes a current to flow in the second circuit, and if the current so induced (I am assuming that these circuits have the same impedance) is one-millionth part of the current in the circuit causing the disturbance, we say that the relation between the two circuits is such that one unit of crosstalk exists. If the induced current is twice as much the relation is such that we have two units of crosstalk. We don't have two relations, but you see we do have a different relation from that in the first case.

Mr. Bonn has raised some questions regarding the 1000-cycle oscillator. I think he assumed the statement that I made regarding the smallest division of the capacity element of the oscillating circuit to indicate the frequency stability of the oscillator as a whole. I said that the condenser could be set to one part in 250,000, but we do not claim that to represent the stability of the oscillator. We consider that to be, with respect to variation of filament current or plate potential, about one part in 100,000. I will ask Mr. Ferguson to explain in a general way how it is that we are able to obtain that degree of stability.

J. G. Ferguson: The frequency variations of the current in any oscillating circuit are due to a number of causes. One of the principal causes of variation would be variations of load. This is taken care of in this particular case by the use of one tube for an oscillator and a second tube as the amplifier. The load taken by the amplifier does not affect appreciably the oscillating circuit.

¹ A. I. E. E. JOURNAL, May, 1927, p. 487.

¹ A. I. E. E. JOURNAL, May, 1927, p. 487.

A second cause of variation is the variation in the level of oscillation in the oscillating circuit itself. In this case, we have to deal with only a single frequency, and it is possible to design the circuit so that the best conditions prevail for that frequency, that is, the degree of coupling controlling the level of oscillation is such that variations of plate potential, or of filament current, have the minimum effect on the frequency.

This is not so easily accomplished when we have an oscillator that covers a wide range of frequency, but in this case, for a single-frequency oscillator, it is comparatively easy to design the circuit so that the variations are very small due to changes in the level of oscillation.

Aside from these variables, the oscillating circuit itself, that is, the tuned circuit, is the greatest cause of variation, and this has been taken care of as described already by having the temperature variation due to the condenser equal and opposite to the temperature variation due to the coil and placing the whole tuned circuit in a separate assembly which is arranged so that any temperature changes take place very slowly, and the coil and condenser can be considered always to be at the same temperature.

Another way in which the characteristics are improved is to have a large capacity in the tuned circuit. In this particular case, the capacity is approximately $\frac{1}{4}$ microfarad. This means that variations in stray capacity and other variations which would cause frequency variations in the circuit if the circuit capacitance were small are reduced to a minimum.

The actual characteristics of this particular oscillator may be of interest. The frequency variations are less than 0.001 per cent with changes of B battery from 125 to 135 volts, the nominal voltage being 130 volts, and for current variations from 1.9 to 2.1 amperes, total current through the two-tube filaments in parallel.

The variation of the oscillator over a period of six months is less than 0.02 per cent. Such variations with respect to time, can be taken care of by recalibration. Over a period necessary to make a measurement or a series of measurements the stability is better than 0.001 per cent.

A NEW THERMIONIC INSTRUMENT¹

(HOARE)

PITTSFIELD, MASS., MAY 25, 1927

N. E. Bonn: Mr. Hoare's instrument will undoubtedly be found very useful for certain special applications. For general laboratory work and as a detector in ordinary bridge and potentiometer circuits its value is very much limited by the exceptionally high internal impedance. True, it can be made to give a full-scale deflection while drawing only 0.1 microampere from the circuit, but it takes fully 0.3 volt to do so, and such high voltage is not available when one measures temperatures by means of thermocouples or in ordinary Wheatstone bridge and potentiometer circuits.

Throughout the paper the instrument is referred to a number of times as a microammeter. Now a microammeter is a current-measuring device the impedance of which must be much lower than the impedance of the circuit in which it is being used. To express the sensitivity of an instrument having an internal impedance in excess of 3 million ohms, in terms of microamperes is somewhat misleading. This instrument is strictly a voltmeter, but not a microammeter in the accepted meaning of the term.

B. W. St. Clair (communicated after adjournment): Vacuum tube thermionic instruments are by no means new. There have been a number of different instruments on the market for several years. There are certain differences between the schemes proposed by Mr. Hoare and those that have been used

heretofore and it is to the differences in these various instruments that this discussion is dedicated.

The biggest difference between this instrument and the more ordinary type of thermionic or vacuum-tube voltmeter is in the elimination of all auxiliary equipment with the exception of one exciting battery. Heretofore vacuum-tube instruments have required either B batteries or C batteries, or auxiliary ammeters or voltmeters in addition to the A battery required by this instrument. In several of the schemes the accuracy of the final measurement is determined by a setting of an auxiliary instrument.

Another very real difference between this instrument and the older ones lies in the type of scale that results and also in the position of the electrical zero. In few of the previous schemes do the electrical and mechanical zeros coincide. Mr. Hoare's instrument is the only commercial one I know of that has coincident mechanical and electrical zeros. Most of the instruments proposed heretofore have scales that depart very seriously from a uniform law. The departure from a linear law of the scales of these instruments is not very serious. In fact, the scale can easily be read with about the same linear accuracy at any part of its length. This is not true in the older commercial instruments we are familiar with as they have scales that correspond more to reciprocal laws than to straight line laws. For many test purposes the uniform type of scale is very much to be desired.

S. C. Hoare: Under ordinary conditions, I doubt if many will object to the resistance of these thermionic microammeters since when measuring current values of the order of 20 to 1

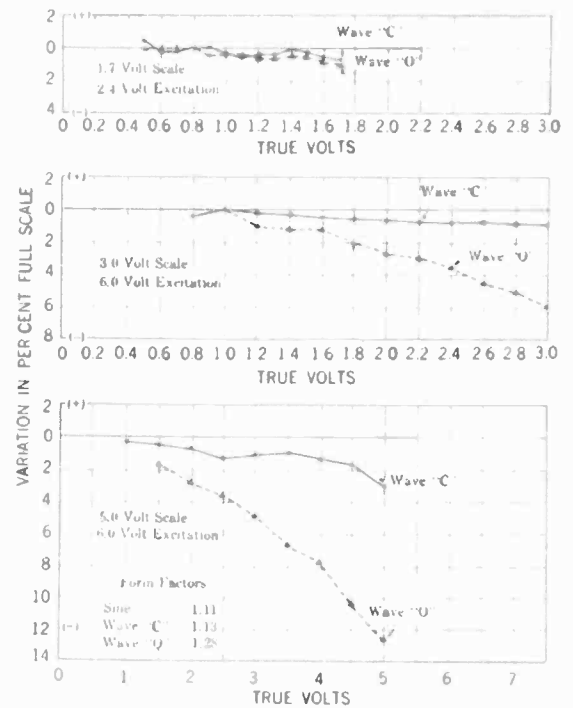

FIG. 1—ALTERNATING-CURRENT THERMIONIC VOLTMETER VARIATION WITH WAVE FORM. GIVEN IN TERMS OF SINE-WAVE INDICATIONS TESTED AT 60 CYCLES

microamperes or less, the resistance of the circuit is so many times that of the instrument that 3 megohms would not be serious. A common use of these instruments is for photoelectric cell photometry where the circuit resistance is many times that of the instrument. In such work the instrument resistance can be considered almost insignificant.

Errors due to irregular wave-forms are inherent in those types of thermionic instruments in which the grid is worked at positive potentials. The errors become smaller with the reduction in

1. A. I. E. E. JOURNAL, May, 1927, p.487.

	FOR DIRECT CURRENT			FOR ALTERNATING CURRENT	
	Thermionic Type	d'Arsonval Type	d'Arsonval Type	Thermo-couple Type	Electrodynamic Type
Ampere, full scale.....	0.000001	0.0005	0.010	0.002	0.010
Resistance between terminals (ohms).....	3,300,000	800.0	100.0	600.0	5000.0
Drop at full scale (volts).....	0.33	0.4	1.0	1.2	2.8
Torque full scale (mm-g.).....	0.9	2.2	1.9	—	2.8

positive grid potentials, and are quite negligible in those instruments in which the grid is kept always at a negative bias.

The accompanying characteristic curves illustrate the magnitude of wave-form errors with different conditions of grid-biasing. The upper set are typical of an instrument in which the grid is never permitted to become positive. In this type the current consumption in the input circuit is practically nil. The lower set represents the other extreme, wherein the grid is permitted to become appreciably positive. This type draws about 100 microamperes in the input circuit.

Waves *C* and *O* are badly distorted, *C* containing prominent fifth and seventh harmonics and *O* containing third and seventh harmonics.

I doubt if Mr. Bonn appreciates the magnitude of the voltage drop necessary in an instrument for the measurement of very small currents. Alternating-current instruments especially require quite an appreciable drop when the current range approaches milliamperes or microamperes. In the brief tabulation above are given some values for ordinary d-c. instruments and for a-c. instruments. It is there seen that the drop across the thermionic microammeters is not excessive when compared with some of the more ordinary types of test instruments.

THE OSCILLOSCOPE, A STABILIZED CATHODE-RAY OSCILLOGRAPH WITH LINEAR TIME AXIS¹

(BEDELL AND REICH)

PITTSFIELD, MASS., MAY 25, 1927

K. B. McEachron: It seems to me that the material in this paper will be of considerable value to all of us who are interested in the study of recurrent phenomena of a character that requires a measuring device which takes little or no energy from the circuit.

The paper describes a very interesting and ingenious scheme for securing two or three sets of measurements all on the screen at the same time by the use of the distributor. Also, a method is given for getting a linear time axis by the use of the so-called Schroeter valve which I believe is perhaps better known abroad than in this country.

I do want to say something, however, regarding the statement made in the first few paragraphs of this paper with reference to linear time axes of other investigators and to say something about the work which we have been doing ourselves along that line.

Some two years ago² Mr. Wade and myself showed a group of cathode-ray oscillograms having a linear time axis.

It is well known that for a few degrees either side of zero, the current of a sine wave will vary directly with the time and the linear time axis shown in the paper referred to was obtained by using such a portion of a sine wave of current in the oscillograph deflecting coils. Thus when the current is zero the electron stream impinges on the middle of the photographic film, the synchronous switch usually being so arranged that the unknown transient occurs at this moment.

For taking volt-ampere curves, it has been necessary to develop a special form of motion in which the spot moves at a uniform rate to the middle of the film where it undergoes deflection¹ by

reason of the transient being studied and then resumes its uniform motion, thus carrying the spot off the film.

For transients of very short duration it is necessary to use as a time scale a high-frequency wave which gives an approximately linear axis only near the middle of the film. With such a time scale either end is very much condensed.

It should be remembered that the oscillograph which is used by Professor Bedell and Mr. Reich is quite different from that used by ourselves, since the transients we study occur but once, while with the oscilloscope they must necessarily be recurrent to obtain satisfactory records. For our work it is necessary to place the photographic film within the vacuum chamber which is not necessary with the oscilloscope.

P. A. Borden: What I have to say in discussing Professor Bedell's paper on the oscilloscope may appear irrelevant; but I take this opportunity to press the plea that I have always put forward for better standardization in engineering nomenclature.

In this connection I want to call attention to the word "oscilloscope." There was a device produced in England a few years ago by a Mr. Elverson, designed for visualizing the movements of rapidly oscillating mechanisms. It is purely mechanical and optical in its nature and is now generally known as the Elverson *oscilloscope*. Now Professor Bedell shows us a new and valuable application of the cathode-ray oscillograph, which has been styled the "oscilloscope;" and while on a basis of technical exactitude, his right to use this term would appear to be quite as great as that of Mr. Elverson, I cannot but feel that this double use of the term does not serve to clarify our technical nomenclature. I am of the opinion that we need among our standards committees some "inter-technical" body which will endeavor to oversee the naming of new developments in different branches of science and thus prevent such overlapping as I have cited, without the formality of having terms registered in the Patent Office.

H. M. Turner: Professor Bedell explained how it is possible by means of a distributor to observe on the screen of the cathode-ray oscillograph several curves at the same time. I have obtained a similar result with considerable success by using a device called the transient visualizer which was described in the A. I. E. E. JOURNAL of June, 1924, which permits photographic records to be made of certain types of phenomena as well as visual observations on the cathode-ray oscillograph.

By means of the transient visualizer associated with the General Electric oscillograph we have taken as many as twelve separate exposures on a single film which makes it convenient for comparing curves taken under different conditions.

F. Bedell: I wish to express my keen appreciation of the wonderful work done by Mr. McEachron and others in this country and by various workers in Europe in developing so successfully that type of cathode-ray oscillograph wherein a photographic plate is placed inside the cathode tube, so that the cathode rays impinge directly upon it. I admire the skill and patience of those who have done this work. In the hands of an expert, if expenditure of time and money be neglected, certain results can be thus obtained that can be obtained in no other way. Our object, however, has been to develop a simple instrument, fool-proof and portable, useful even for the man in the street with limited time and limited money, who wishes an instrument he can take where he will, as he would a voltmeter, observe the wave-form and get immediate results. He wants

1. A. I. E. E. JOURNAL, May, 1927, p. 487.

2. A. I. E. E. TRANS., Vol. 44, 1925, p. 832.

the results then and there, and does not want to wait until next week.

I am quite in sympathy with the desirability of uniformity in nomenclature. The oscilloscope is for viewing oscillations; the name is both descriptive and correct. If, as Mr. Borden points out, an instrument for viewing oscillations has already been termed an oscilloscope, all the more reason for retaining the name when a new instrument, even though operating on a different principle, is developed for performing this function.

Prof. Turner's remarks emphasize the desirability of visualizing several curves simultaneously.

EMPIRICAL ANALYSIS OF COMPLEX ELECTRIC WAVES¹

(HORTON)

PITTSFIELD, MASS., MAY 25, 1927

N. E. Bonn: The last method described in Mr. Horton's paper and the one which he evidently prefers, involves the use of a sine-wave oscillator of variable frequency. Now a sine-wave oscillator, especially one whose frequency may be varied over a large range without disturbing the wave form, would make a very valuable adjunct to many a laboratory. Will Mr. Horton please state what method he uses to make certain of the purity of the wave form?

A method of wave analysis not mentioned by Mr. Horton, but somewhat similar to the one referred to above, was described in a well known French publication a little over a year ago by R. Thornton Coe (*Revue de Electricite*, XIX, 203-207, February, 1926). This method makes use of an astatic electro-dynamometer. A sinusoidal current of adjustable frequency is passed through the stationary coil, while the moving coil carries the current whose wave form is sought. The deflection of the dynamometer at unity power factor is a direct measure of the amplitude of the particular harmonic, since the instrument will respond only to that component of the complex wave the frequency of which is equal to the frequency of the current passing through the fixed coil. As the method appears very simple, I should like to hear from Mr. Horton whether it received consideration and whether, in his opinion, it could be used at audio or carrier frequencies.

J. W. Horton: The first question concerns the purity of wave shape of the oscillator. I presume this refers to the oscillator used in the substitution method. As a matter of fact most measurements do not require an abnormally high degree of purity in this oscillator. For example, should the total harmonics aggregate, say, 5 per cent of the fundamental, the only error introduced is that the current used in the substitution method as measured by the thermocouple will appear to be about 5 per cent higher than the correct value. In other words, the absolute value of the component measured will be in error by the amount of the harmonics. These harmonics may, however, be determined by other measurements and a correction applied to take account of their presence.

In the actual oscillator used, the total amount of harmonics under normal conditions, that is, the square root of the sum of the squares of all components other than the fundamental, is less than 4 per cent of the total amplitude of the current as measured by a thermocouple. If the measurements demand that greater purity be obtained it is generally most economical to do it by using a low-pass filter in the output of the oscillator. There have been provided for certain measurements a series of such low-pass filters, the cut-off of one filter being approximately twice the cut-off of the other. With any filter of the series it is possible to obtain a current free from harmonics over the frequency range extending from just above one-half the cut-off frequency to just below the cut-off frequency. The several filters are so chosen that these ranges overlap.

1. A. I. E. E. JOURNAL, May, 1927, p. 487.

The second question refers to the dynamometer method for measuring individual components. I have had no experience with that method. From what little I know of it I should imagine it might possibly be somewhat cumbersome to apply in cases where the component to be measured is of the order of 0.0001 of the fundamental components in the circuit. I should also imagine that it might not be very accurate in cases where the components are so small that a considerable amplification is required to bring them to the point where they could be made to give a reliable reading on some indicating device, or where the frequencies are so high that distributed capacities within the dynamometer become effective.

SENSITIVITY CHARACTERISTICS OF A LOW-FREQUENCY BRIDGE NETWORK¹

(EDWARDS AND HERRINGTON)

PITTSFIELD, MASS., MAY 25, 1927

I. M. Stein: It seems to me that the method and apparatus described accomplish two things. First, the bridge circuit and the type of detector used permit of a great precision of balance; that is, the quantity being measured may be measured precisely enough to give the accuracy desired in locating the open circuit. Then, having a set-up which gives the desired precision, we have two options. One is to chart each long cable by putting "opens" at certain known places and making measurements; the other is to get rid of the non-linear characteristic so that no charting is necessary.

The second method is the one which has been chosen, and the desired result has been accomplished by lowering the frequency enough to give a linear relation between the measured quantity and the length of cable to the "open."

So that there are two steps. First, a precision of setting enabling an accurate measurement of the capacitance; and second, the use of a frequency low enough to eliminate certain errors, thus obtaining a linear relation between capacitance and distance.

I should like to ask if I have a correct understanding of the matter.

B. W. Kendall: The need for the development of this modification of Wheatstone-bridge methods arose in connection with the large growth of toll-cable plant within the last few years. The convenient distance between cable-testing stations is set by the use of telephone repeaters at about a 50-mi. spacing, and it was therefore desirable to be able to locate opens in the cable conductors over distances of this order. Because of the difficulty in getting access to the individual wires along the cable it was important that the location of the fault be as accurate as possible.

The terminal impedance as measured between a defective (open) wire and ground is a hyperbolic function of the distance from the measuring point to the broken end of the defective wire. In this method, the testing frequency is so chosen as to make this relation approach a reciprocal function so that the capacity measured is directly proportional to the distance. This choice is a matter of convenience in testing. It would be possible to use a higher frequency and then by means of tables of hyperbolic functions to determine the distance to the break. In the paper the deviation of the measured capacity from direct proportionality with the distance is spoken of as an "error." This is, of course, an error which would be made if a higher frequency were used for the measurement and it were then assumed that the measured capacity and the distance were in direct proportion. By using so low a measuring frequency the error that would thus be incurred is made negligible and the measuring technique is thereby simplified.

The other notable feature of this paper is the use of bridge and galvanometer currents of different phases for determining the settings of the two adjustable resistances of the bridge. It should

1. A. I. E. E. JOURNAL, May 1927, p. 487.

be understood that the balance so obtained is correct for any phase of measuring current and that this method is applied simply to obtain a larger deflection of the galvanometer for a given unbalance of the bridge, thereby facilitating the measurement. This method was developed for measuring opens in cable circuits, which have certain definite and uniform characteristics, and I would like to ask Mr. Edwards or Mr. Herrington what experience they have had with the use of the same apparatus in locating faults in open wire in which the impedances would have different characteristics from those of cable circuits.

This paper shows what can be accomplished in the development of a special bridge method for readily making tests of circuits which are uniform in character. At other frequencies and in other arts where a large number of quantities which differ little among themselves are to be measured, the exercise of equal skill and ingenuity can develop methods to simplify and expedite the determinations.

S. P. Shackelton: An important phase of the work of an engineer involves the application to practical everyday problems of the results of pure scientific investigation and research. The contribution of Edwards and Herrington constitutes such a practical application to a problem which has been studied for many years. It occupied the minds of communication engineers before the advent of the telephone. The particular arrangements described do not disclose any new principles but rather represent the utilization of known characteristics of lines and networks to a useful purpose.

The bridge network used was described in 1891. An approximate utilization of transmission-line low-frequency characteristics has been in common use for open locations. Alternating-current galvanometers have been well known although their use as detectors in the balancing of bridge circuits has not been so common. The shifting of the phase in the bridge to assist in obtaining a balance had been treated prior to the work under discussion. The present work however, affords a convenient tool for the field man whether he be technical or not, to apply technical methods to his common problems of plant maintenance.

Specifically, the problem was one of adapting the technical methods to rather trying limitations imposed by plant conditions. A low-frequency measurement was desired with positive indications of balance and with a minimum adjustment of variables. A method was required which would afford a rather high degree of accuracy considering the precision of the apparatus and the possible errors outside the control of the operator. All this was combined in space limitations which necessitated rather careful detail design.

The authors have not specified any requirements as to wave shape although stressing the phase relations required in the different portions of the bridge network. The effect of phase angle on balance is noted and, of course, for any given length of line and frequency there is a best value of phase shift. It may be interesting to know the relative importance of this and its effect on other lengths of line.

C. R. Fischle: There is one phase of the subject presented by Messrs. Herrington and Edwards that it would seem warrants discussion, and that is the means employed to apply the principles brought out in the paper to practical telephone work.

In order to facilitate the application of these principles by the test-board forces, the Bell System has established routines outlining in a simple and orderly manner the procedures to be followed in determining the location of cable faults in toll cables. The engineering forces, as a rule, prepare in advance for each testing point, data such as temperature-correction curves and records giving information as to cable distances, loading, gage of conductors, cable make-up, etc., for the cables to be tested from the respective points. Work sheets are supplied to the test-board men on which the results of the electrical tests made at the time of a fault location are entered, together with values selected from the data mentioned above. By following the sequence of cal-

culations set up on this work sheet, the fault location is quickly arrived at. These calculations are of a simple order and do not involve hyperbolics.

By administering the work in this manner the test-board men can expeditiously arrive at accurate fault locations, thus materially aiding in the dispatch of repair forces to the fault and in securing the restoration of defective circuits in the least possible time.

P. G. Edwards: One question which has arisen in connection with the low-frequency bridge is that of wave form. A square wave is used with results agreeing very closely with theoretical values based on calculations involving a sinusoidal wave shape. This is made possible by the fact that the bridge network employed is symmetrical. With a square wave and a network involving both inductance and capacitance sinusoidal methods of treatment probably would not be applicable.

A question has been brought up by Mr. Kendall—that of errors with frequencies other than 4 cycles. In earlier designs higher frequencies were used and a family of correction curves was plotted for each class of conductors, from which a correction was read for each capacitance ratio. This correction in per cent when applied to the capacitance ratio gave the true length ratio. On toll cables of average length and with a frequency of 8 cycles this correction reached values as high as 1 per cent.

In connection with the subject of correction curves, the question has arisen as to the practicability of plotting curves for individual conductors or classes of conductors. Mr. Stein's analysis of the situation in this respect is quite correct. Due to the large number of circuits involved, as well as classes of circuits, the number of combinations possible renders this procedure quite unwieldy and expensive. The problem has been treated rather by means of fundamental design. As pointed out by Fischle records of actual measurements, however, are filed and are accessible to the tester.

In regard to phase adjustment, as has been brought out in the paper, there is an optimum phase adjustment for each measurement. In the apparatus as outlined an adjustment has been selected which gives a desirable set of sensitivity characteristics for the type of work for which the apparatus was designed. The equipment arrangements are such that the phase relation of bridge potential and field potential can be adjusted where desirable. This is not done, however, in the normal routine of locating opens.

Mr. Kendall has brought up the question of open-wire impedances. The equipment as outlined has been tried out on exposed aerial lines with success. The chief departure from the problem of locating opens in cables is the presence of a leakage component in the line impedance. Toll cables are almost entirely free from this characteristic. This leakage component happily involves no modification in design, but is observed in the balancing of the bridge as an increase in the value of the resistance component of the condenser arm of the bridge and does not, over a considerable range of leakage, affect the ratio-arm setting, or in consequence, the actual fault location.

MECHANICAL FORCES IN TRANSFORMERS¹

(CLEM)

PITTSFIELD, MASS., MAY 25, 1927

W. S. Moody: The problem of taking care of mechanical forces in transformers became a really difficult one for the practical designing engineer some fifteen or twenty years ago. Previous to that, the power available in case of a short circuit and the size of transformers were not sufficient to require much more than good judgment on the part of the engineer to provide the necessary mechanical support. But with the increase in size, and more particularly with the increase in the available power, the necessity of accurate calculation of these forces

¹ I. A. I. E. JOURNAL, August, 1927, p. 814.

arose. Ever since, therefore, we have welcomed most cordially the assistance of the ablest mathematicians and physicists who have shown interest in this difficult problem.

Time and again we have felt that the problem was fully solved, that one's design might be assuredly safe in every respect; but with the ever increasing complexity of transformer designs, now seldom consisting of two simple windings, but with three and even four complex windings, with many taps and the consequent inability to distribute equally the ampere-turns in all cases, new features have arisen showing that the previous study of the subject had not been on a broad enough gage to include all the variables in such complex designs.

So we still welcome such assistance as we have so generously received from our mathematical and physical friends.

After formulas have been developed to calculate accurately the mechanical forces resultant from all possible combinations of ampere-turns (if that time ever does come) we shall still have the interesting problem of making those formulas practical for use in "every-day" calculations. Such formulas as have been talked about in this paper are excellent for the general study of transformer design but when it comes to every-day designs, which must be produced promptly and cheaply, one can see that these formulas are very burdensome and that there is necessity for short-cut methods giving equal accuracy. For this we must use special mathematical calculating machines, such as specially designed slide-rules and other forms of calculating machinery that make it possible to use the principles of these fundamental formulas in the daily routine of productive design.

F. H. Kierstead: There are often simplifications of difficult circuits that may be made in the calculation of the forces between these circuits. I wish to illustrate such a case.

Many times it is necessary to calculate the forces between two conductors (carrying currents) which have such a form that no standard formula applies. Usually time does not permit of deriving an accurate formula for the special case.

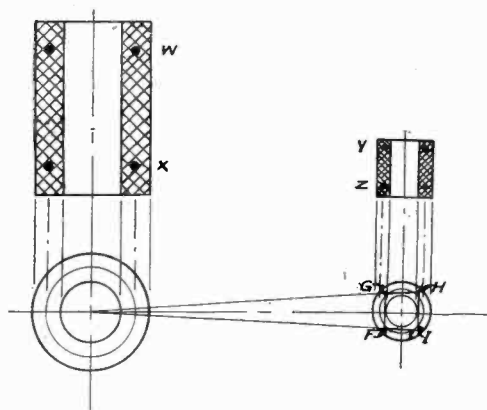

FIG. 1—DIAGRAM REPRESENTING THE EQUIVALENT FILAMENTS USED IN CALCULATING THE FORCES BETWEEN A LARGE AND A SMALL REACTOR

Approximate calculations which are generally accurate enough can be made by replacing the actual circuits by equivalent ones to which the standard formula applies. As an example to illustrate this method let us take the case of the forces between a large and a small reactor with parallel but not co-axial axes.

The accompanying figure shows the position of the reactors relative to each other. From the standpoint of forces the reactors can be replaced by the circular filaments W , X , Y and Z and the forces calculated between these filaments are the forces between the reactors. It is, however, difficult to calculate the force between two parallel unequal circles not coaxial. To facilitate this calculation the smaller circle can be replaced by the arcs of circles $G-F$ and $H-I$ (which are co-axial with the circular fila-

ments of the larger reactor) and the radial lines $G-H$ and $F-I$.

Standard formulas are available for calculating the force between co-axial circles and, therefore the forces between the filaments of the large reactor and circles of which arcs $G-F$ and $H-I$ form a part are easily calculated. The forces between the filaments of the large reactor and arcs $G-F$ and $H-I$ bear the same relation to the forces between the complete circles that the length of the arcs bear to length of the complete circles. Since that part of the equivalent circuit represented by $G-H$ and $F-I$ is radial to the filaments of the large reactor, there is no force between it and the filaments of the large reactor. Since the current in the arc $G-F$ is in opposite direction to that in arc $F-I$ the forces are in opposite directions.

H. B. Dwight: Mr. Clem's paper is an interesting example of a case where it is desirable to have both an inductance formula and a force formula, not only because a knowledge of the inductance is useful, but because the inductance is more easily measured than the force.

Mr. Kierstead's trapezoid solution of the special problem is interesting to me personally. In 1917, I was asked to make an estimate of the force between two air-core reactors which were mounted side-by-side with parallel axes. As I had no formulas that I could use at that time for two circles, I used the device of representing one of the circles by a trapezoid, the same as Mr. Kierstead has described. I had not seen it published before, and perhaps Mr. Kierstead can say if there was a previous announcement of it. My publication of this was in the *Electrical World* of June 16, 1917.

Later, I was able to calculate the repulsion between circular coils with parallel axes, and in the *TRANS. A. I. E. E.*, 1919, page 1678, Fig. 2, there is given a comparison between the circular-coil solution and the trapezoid solution. The curves lie very close together.

There is a formula in Gray's "Absolute Measurements" which may be of interest. If the axes of two coils meet in a point, a calculation is given by which the mutual inductance and repulsion can be obtained.

F. W. Grover (communicated after adjournment): Mr. Clem has developed a new formula for the mutual inductance of coaxial solenoids, which offers some points of interest.

The Rosa formula for the mutual inductance of a solenoid and coaxial circular filament (*Bull. Bureau of Standards* 3, p. 209; 1907, formula (56) *Sci. Paper*, Bureau of Standards) is made the starting point. This formula, although very convergent for a wide range of cases, involves certain polynomials X_{2n} which, for long solenoids, may assume values so large as to cast doubt upon the degree of convergence. By a simple algebraic substitution Clem eliminates these polynomials, and obtains a transformation of the Rosa equation in which appear as variables only the ratios of the radii to the radius vector from the center of the circle to the circumference of the end turn of the solenoid. Since these variables lie in value between zero and unity as limits, this expression of Clem's is better adapted to tabulation than is that of Rosa. It is worthy of note that, making the proper changes to reduce to the same system of nomenclature, Clem's expression is seen to be identical with that derived by Lorenz, (*Wied. Ann.* 25, p. 1, 1885. Also (53) *Sci. Paper* 169, Bureau of Standards).

The derivation of Clem's formula for the mutual inductance of coaxial solenoids from this formula for a solenoid and circle is straightforward and may readily be extended to obtain further terms of the series, if desired. The resulting new expression is readily used, and for practical calculations is much superior to the related formula of Gray, (*Abs. Meas.* 2, Part I, p. 274, or (40) *Sci. Paper* 169, Bureau of Standards) which has heretofore been the only formula available for this case, except the absolute complicated elliptic integral formulas. For example, the solution of Example 41, *Sci. Paper* 169, Bureau of Standards, by Clem's formula gives as a result 1086.2, the true value by the

absolute formula being 1086.55. Using Gray's formula directly the result is 1092.3, and to obtain an accuracy equal to Clem's it is necessary to subdivide the coils and to sum the results for the different pairs of sections.

Although Clem's derivation is for the case where the coils are separated axially, it applies also to the case of overlapping coils. For the important case where the coils are *concentric*, only two main terms have to be calculated instead of four. For this case Clem's formula compares very well with the accurate formula of Searle and Airey, (*Lon. Electrician*, 56, p. 318, 1905, or (43) *Sci. Paper Bur. of Stand.*) which is the special form taken by Gray's general formula for the concentric case.

One precaution in using Clem's formula should be mentioned. When the coils are far apart, the main terms $(r_1 + r_4) - (r_2 + r_3)$ give the result as the relatively small difference of two larger numbers. However, these quantities may readily be calculated by a calculating machine to a sufficient number of places. Another obvious method is to expand them in series, but this is advantageous only for very distant coils.

HIGH-VOLTAGE MEASUREMENTS ON CABLES AND INSULATORS

(KASSON)

PITTSFIELD, MASS., MAY 27, 1927

W. B. Kouwenhoven: I am very glad that Mr. Kasson has pointed out again the necessity of using shields and guards in making high-voltage measurements on cables. I pointed out at the Mid-Winter Convention of 1926 that unless shields and guards are employed the results may be widely in error.

It is not only important to shield specimens properly from all electrostatic fields but in case of the a-c. measurements of loss, it is also necessary that the voltage of a shield be the same as the voltage of the conductor it protects. It is therefore essential to place in series between the shield and ground an impedance that is the same as the impedance of the measuring instrument used. Unless this is done the difference in potential between the shield and its shielded conductor will cause an error in results. This point, I am afraid, is often overlooked.

Mr. Kasson's curves in Fig. 3, showing the effect of temperature on d-c. insulation resistance, do not conform with the law that we have found for some of our cable samples. This law states that the logarithm of the conductivity is equal to a constant divided by the temperature, plus another constant. When the logarithm of the conductivity is plotted against the temperature the curve is a straight line, although, some of our specimens give this straight line relation, there are others that are exceptions to the rule.

There is one other point which I would like to mention in regard to Mr. Kasson's work and that is his method of procedure. The time of charge must be considerable to obtain accurately the conductivity of specimens. It may take several hours before the final leakage current is reached, owing to the presence of the absorbed charge, and unless the test is continued over a long period of time you cannot be sure that the current measured is actually the final leakage current, corresponding to the conductivity of the sample.

One method that we have used at Johns Hopkins in this work, and which will shorten the time somewhat, is to take a charging run for about 45 min. and then immediately throw the cable in discharge and measure the absorbed charge coming out for the same period of time. The difference between these two curves represents the final leakage current.

Another difficulty that arises when measuring the conductivity or leakage current at several different voltages is the superposition of the curves. If, for example, you apply 5000 volts for a certain length of time and take a reading of the conductivity, and then raise the voltage to 10,000 volts the second curve is superimposed on top of the first and you cannot be sure of the

results. If possible, it is best to discharge the cable between each run.

I should like to ask Mr. Kasson what method of measuring he used in determining his a-c. losses.

If, as pointed out by Mr. Kasson, it is possible to tell from the shape of the d-c. resistance curve plotted between resistance and voltage whether a cable is getting old and deteriorating, or whether it is in good condition, we have a very important aid with which the operating companies can determine the condition of their cables. We have been endeavoring to determine some such relation in our research work at Johns Hopkins but to date have not been able to find any definite relation.

Herman Halperin (by telegram): In Mr. Kasson's paper, Fig. 1, shows, for cable with 7/16 in. insulation to sheath, the maximum insulation resistance occurs at 13 kv., which using the d-c. to a-c. ratio of 2.4 corresponds to about 5-kv. a-c. This indicates electrical action in the cable at a potential of only about half the operating voltage of this old cable. A-c. ionization tests made on several samples of old 12-kv. three conductor cables, removed from the system of the Commonwealth Edison Company have shown practically flat power-factor voltage characteristics up to 10- or 15-kv. three-phase. As the insulation on these cables was considerably less than on Mr. Kasson's cable, the stresses at which ionization took place in our cables would be approximately three times as much as the stress at which a change occurred in his d-c. tests. Perhaps by means of these tests he has discovered a new characteristic of the insulation in connection with the effect of shielding. In Fig. 8 he shows a metal box around the entire reel of cable. If the shielding is to take care of ionization near the end of the cable, I am wondering whether a metal box over each end of the length of cable would not be sufficient. Referring to the paragraph regarding the nonuniformity of cables, our testing has shown that cables with poor quality of insulation are liable to be more irregular in their quality than the cables of high quality which checks Mr. Kasson's statement. For instance poor cables would develop several hot spots in accelerated life tests and fail in rather short times. In some accelerated life tests at 2.5 rated voltage we took several 50-ft. samples from various sections of one make of a given size of high-tension cable which was giving trouble in service and shown to be irregular in factory tests. One sample failed, after a total of 26 hr., while another sample developed hot spots without failure after 405 hr. and a third sample withstood the test for 596 hours without any failure or hot spots.

S. J. Rosch: Several theories have been brought forward in explanation of dielectric phenomena, and I believe that the probabilities are that each theory may be correct as relating to the behavior of the particular dielectric under consideration. Our error in the past has been chiefly, in trying to make one theory or one set of laws govern the behavior of all dielectrics. That is why we have failed up to the present in solving the dielectric problem and in my estimation if we commence to study each dielectric individually, we shall come nearer to obtaining a truer picture of the laws governing its behavior.

Even in a general dielectric such as a paper cable, Dr. Kouwenhoven brought out the point that he has only been able to substantiate some of the results obtained by Mr. Kasson on some samples of cable, but not on others. Undoubtedly the observations made by Dr. Kouwenhoven that were not in accordance with those by Mr. Kasson, were made on samples of cable which although equally good as far as quality was concerned, nevertheless as dielectrics possessed characteristics obeying entirely different laws. We must establish the accuracy of this fact before we can hope to go further in solving the laws of dielectrics.

Mr. Halperin in his discussion, has stated that if we took the results of d-c. measurements as established by Mr. Kasson and converted them to the equivalent a-c. voltage, by using as a

divisor the factor 2.4, the values thus obtained would be much lower than those obtained by Mr. Halperin. Here again we must question why we should use 2.4 when the work of Hayden, Eddy, and Dolon has definitely proven that the ratios of d-c. to a-c. vary all the way from unity to 2.6 depending again upon the type of dielectric used. It may be that in the case of the cables tested by Mr. Kasson the ratio for that particular dielectric should have been about 1.4 in which case the results would have been comparable with those obtained by Mr. Halperin.

I believe that before rejecting any of the theories propounded in the past, we ought first to establish definitely whether or not they are applicable in the case of some particular class of dielectrics.

E. S. Lee: Mr. Kasson has shown with great certainty the need for proper shielding to prevent the end loss of cable samples from being included with the measured loss. Wherever the end loss is high compared with the measured loss, then more perfect shielding becomes necessary. This is particularly the case with measurements on cables made with high direct voltages.

The variation of insulation resistance with voltage has been obtained at various times as shown in Figs. 3 to 6, though it has never been possible to justify with certainty the rapid decrease of the resistance with increase in voltage after passing the maximum point. It is quite gratifying to have Mr. Kasson point out that this variation is not true but has been obtained because of a faulty measurement.

It is pertinent that the end loss is also present in a-c. measurements of dielectric power loss, and it behooves us to investigate these particular measurements as they are being variously made, to be assured that the end losses are not included with the measured loss to vitiate the results.

P. T. Graff: With reference to the shielding of cables in making tests on cables for dielectric loss, we found that on short samples the power factors showed up rather high, and a method of test was devised which gave results on short samples, without resorting to shielding, that compared very well with the values for long lengths of cables.

The method used is shown in Fig. 1 herewith. Current and

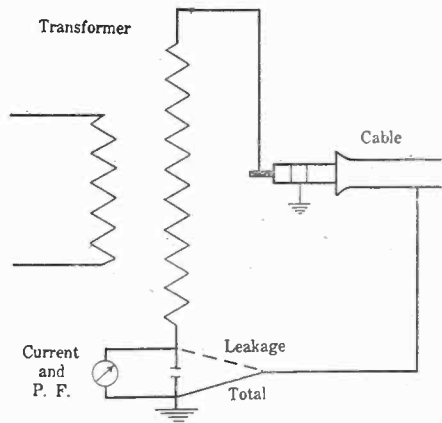

FIG. 1

power-factor values for leakage and leakage plus cable losses are read. By the vector subtraction shown in Fig. 2 herewith the cable current and its phase angle with respect to the applied voltage are obtained. That figure shows relatively what is typical of actual cases. The effect of a small leakage current can be considerable in taking the apparent cable power factor.

Because hot spots are found where cables eventually breakdown on voltage tests, it cannot be construed that Mr. Malti is mistaken in not accepting the pyroelectric theory. That is based on weak microscopic filaments whereas hot spots may be due to imperfect "imperfect dielectric." No cable is uniform in its entirety and it is rather hard to apply a theory to such a dielectric. The electrophysicists are better able to handle such

theories, and as engineers we should concentrate on making perfect "imperfect dielectrics."

C. L. Kasson: In regard to Mr. Halperin's comment on the difference between his results and those we obtained in Boston, I might say that perhaps the cable we used was different from the cable he used, and this point has been brought out by several other speakers. Fig. 1, to which Mr. Halperin referred, gives the

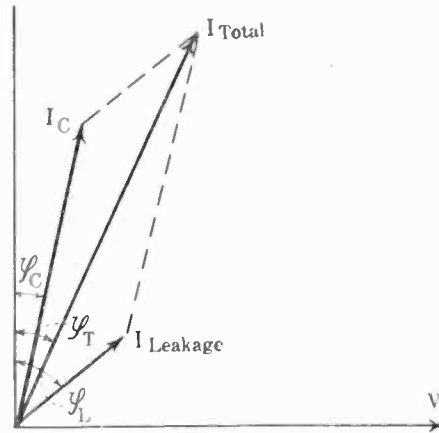

FIG. 2

results for very old rosin-oil cable that has failed repeatedly in service.

I believe that shields must be tried by a good many others before we can be sure of the results. I tried to bring out here simply the work of one group of engineers which must be checked by others before it can be accepted.

In regard to Professor Kouwenhoven's remarks, absorption curves were made in all cases and carried out until they became practically flat. The values of leakage current used were those

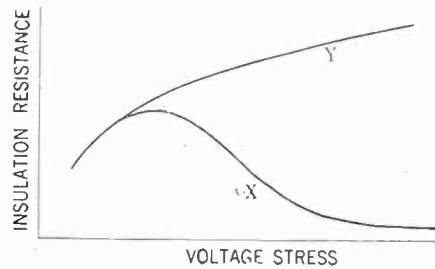

FIG. 3

taken from the flat portion of the curve. It usually required about 15 min. for the curve to become reasonably flat.

Professor Kouwenhoven asked in respect to the instrument used to measure the a-c. losses. A dynamometer with series resistance was used for this purpose.

In closing, I would like to show typical insulation-resistance voltage-stress curves. We plot insulation resistance and d-c. voltage stress on a short length of cable unshielded and obtain a curve something like X in Fig. 3 herewith. On the same cable, with shields, we obtain a curve like Y. Y is a very different curve from X, and it is apparently due to the fact that curve X is influenced by the ionization of the external air, and perhaps in some of the results in the past we have been talking about ionization of external air at the ends of the cable, rather than ionization of air within the cable.

In all nature we are interested in stress on one hand and in resistance on the other hand. To every stress there is resistance; to every resistance there is stress. Therefore, a resistance stress curve of a dielectric, *i. e.*, the resistance reaction of the dielectric against the stresses placed upon it, should be an important thing, and in order to obtain what we believe is a true curve, we must resort to shielding or at least some equivalent method.

SPARKING IN AIR

(SAH)

PITTSFIELD, MASS., MAY 27, 1927

W. B. Kouwenhoven: In Mr. Sah's paper I find no reference to the effect of humidity. At the Johns Hopkins University we have been conducting an elaborate research upon the effect of humidity on the corona-forming voltage; this research is being carried out under our direction at the Bureau of Standards at Washington.

A few weeks ago I received a letter from E. S. Lee of the General Electric Company, saying that he had found that humidity affected his air condenser, and during the same week we obtained our first definite information that this was actually the case. The presence of humidity in the air has an effect on the corona-forming voltage. On perfectly clean surfaces the presence of moisture in the atmosphere raises the corona-forming voltage slightly, the maximum increase we have found is of the order of 1.2 per cent. In order to detect this effect it was necessary to refine our method of measuring and check everything very carefully. At the Bureau of Standards in the research to which I referred a moment ago, they are measuring the wave shape of the voltage directly in the high-voltage side of the circuit and have taken every precaution to insure accuracy. I feel that their results are accurate to at least one part of a 1000, if not better.

We have found also that humidity causes a lowering of the voltage when a corona forms on dirty or dusty surfaces. This lowering of the corona-forming voltage may amount to 5 per cent. In future work with the spark-gap it may be necessary to use correction tables for correcting for the amount of humidity in the air at the time of the test.

A. P. T. Sah: The influence of humidity on sparking voltages has been raised. Our experiments show that it is very small. It is true that humidity has a very pronounced effect on the sparking voltages when corona precedes a spark-over, for instance in the case of the needle gap. But for spherical and cylindrical electrodes, spaced at less than twice the radius of the smaller electrode, corona does not precede a spark-over. Thus in such cases the effect of humidity is negligible as our experiments show.

NON-HARMONIC ALTERNATING CURRENTS

(BEDELL)

PITTSFIELD, MASS., MAY 27, 1927

A. Boyajian: Professor Bedell is a pioneer in the theory of alternating currents, and his early book is still a classic on the subject. A few years ago I listened with great fascination to Professor Bedell narrating his early experiences in the fundamental theory of alternating currents. He said in the course of his narrative that when he analyzed the flow of currents in condensers, resistances and inductances due to sine-wave voltage, his mathematical analysis showed him that the current of the condenser should be 90 deg. ahead of the voltage, the current of the inductors 90 deg. behind, and in a resistance in phase with the voltage. Up to that time nobody knew anything about phase relationship and this was very puzzling. It was peculiar how in a condenser you could get current ahead of voltage, like having an effect precede the cause instead of following the cause. They made some tests, plotted oscillograms, verified the mathematical analysis and everybody was happy.

What he had done at that time for sine-wave voltages he has later done for non-harmonic voltages, and his paper puts together a lot of developments since that time.

One feature, or one problem, discussed in his paper which interested me a great deal was the subject of losses due to mixed frequencies. He emphasizes very strongly the fact that if we have two currents of different frequencies, the losses do not correspond to the square of the arithmetic sum of the currents,

but that the losses for each current are independent of the other with the implication that it might be possible to take advantage of this fact and increase the capacity of conductors for transmission of power.

A few years ago I had occasion to examine the possibility of increasing the transmission capacity of a line by the superposition of different frequencies, and I was sorry to come to the conclusion that such a thing was impossible. For given kilowatts to be transmitted at a given r. m. s. voltage, the $I^2 R$ line losses are the same regardless of whether this is done at a single frequency or mixed frequencies. The truth of this statement may be more easily seen considering the fact that "mixed frequencies" is another name for a distorted voltage. Is there any fundamental copper economy in transmitting power at a distorted voltage instead of sine-wave voltage? In any scheme of superposed frequencies, it will be found that any $I^2 R$ loss economy is due to raising the r. m. s. voltage of the lines.

The only fundamental benefit to be gained by the use of mixed frequencies for transmission appears to be one of convenience. In some cases the advantage in convenience may be so great as to lead indirectly to an economy in copper. For instance, if one can transmit 40 telephone conversations over the same pair of wires simultaneously, instead of over 40 separate pairs of wires, there would be a distinct economy in copper. But this is not due to a fundamentally lower $I^2 R$ loss, but due to increased transmission voltage and more effective utilization of the circuit. If one telephone message were to stress the line insulation to its limit, it would be impossible to superpose 40 messages; but telephone voltages are very small, and insulation stress is not the limiting feature.

Frederick Bedell: As Mr. Boyajian has clearly pointed out, there is no copper economy in the joint transmission of currents of different frequencies when the two currents supply a common receiver. There may, however, be a saving in certain cases, as discussed in references 16-22, when the two currents, transmitted jointly, supply separate receivers.

A THEORY OF IMPERFECT SOLID DIELECTRICS

(M. G. MALTI)

PITTSFIELD, MASS., MAY 27, 1927

S. J. Rosch: In considering the total loss in a dielectric, Mr. Malti claims to have been able to separate that particular loss due to hysteresis and he gives an expression $W_h = W_d - I^2 R$. In justification of this expression he states that as the frequency of the test voltage is increased, the loss per cycle decreases until some value of frequency is reached after which the loss per cycle remains a constant.

In order to accept this equation, we must assume that the loss due to hysteresis is constant at the lower frequencies. That is, something we have not as yet been able to substantiate and until its accuracy has been deduced as the result of experimental work in connection with different dielectrics, I would counsel caution in the acceptance of this expression.

Nevertheless, as a working hypothesis, the point is well taken and it would certainly be a worth-while fact for some of the research engineers to establish as a step toward the better understanding of the behavior of an imperfect solid dielectric.

E. S. Lee: The mechanism of dielectric breakdown is still unknown to us. Mr. Malti suggests the occurrence of certain internal phenomena in the dielectric to account for external phenomena as observed. While these internal conceptions may possibly be helpful, he does not make it clear how they may be made useful for prediction of phenomena not as yet observed. If this might be done, his work would have greater value.

Mr. Malti indicates the absence of crucial research on the phenomenon of breakdown. This is the dielectric property of greatest interest. There surely ought to be recognition of the large amount of work of high caliber which has been carried on and

published relative thereto, which, if it has not been crucial research, has nevertheless given us considerable insight into the phenomena involved and the magnitude of their extent.

F. M. Clark: In discussing Mr. Malti's paper I am thinking more of the oil-treated cellulose material than I am of the type such as mica and glass.

Mr. Malti is to be congratulated in attacking the electronic phase of dielectric failure. I think, however, that he has perhaps fallen out of the frying pan into the fire when he endows his electrons with a degree of mentality. He has three or four different types of electrons. Free electrons, we can dispense with by the statement that they are there. If we want to increase them we subject the insulation to ionizing radiation, but when we come to electrons of various degrees of viscosity ranging all the way from elastic to viscous electrons, I am rather doubtful as to the source of those electrons themselves.

In view of the fact that he admits as everyone does that the electrons are practically identical with regard to charge and mass, it is hard to see how two electrons under the same conditions can one of them choose to be elastic and the other one choose to be rather viscous.

I want to suggest an idea on which we are working in the laboratory of the General Electric Company; that is, the consideration of the dielectric problem from the standpoint of molecular moment. If we have a molecule in which the center of mass gravity corresponds to the center of electrical gravity, we say it has no moment. That molecule ought to be inert chemically and a very good dielectric. If, on the other hand, we have the center of mass gravity not corresponding with the center of electrical gravity, then we have a molecule which is endowed with electric moment. With this fundamental idea, one can explain most dielectric behavior very similarly to the way Mr. Malti has done in adopting different viscosities for electrons.

I can illustrate one point very simply in following out that idea. I hope we shall soon have our data ready to present before the Institute. Mr. Malti discusses polarization. If you adopt the polar molecule you will get the same sort of a diagram as Mr. Malti has obtained. But immediately you raise the question that in some molecules, preferably with paraffin material, the electric moment is almost negligible. In that case if there is no electric moment we are compelled to admit then that we do not get orientation in the electric field.

Therefore, we have approached pretty close to what we might consider as a perfect dielectric. But even then we should have to explain the perfect dielectric as being not only of no electrical moment, but of having infinite affinity for its electrons, because as we raise the voltage we should get electron displacement and eventually should get electrons knocked off with resulting ionization.

It must be remembered, too, that in the ordinary type of solid insulation—and I mentioned oil-treated cellulose—the material is colloidal in character. If it is not a true colloid, it is colloid-like and subject to colloidal laws. Colloids in the electrical field, of course, will assume a charge, and for all intents and purposes we have then a polar molecule, even though inherently it is of no moment.

From that definition then, we would conclude that the perfect dielectric would be a molecule of no electrical moment and with infinite affinity for its electrons.

I shall not try to apply that idea to all of Mr. Malti's work, but I want to say that with such an idea, d-c. breakdown is subject to entirely different fundamental laws from a-c. breakdown. Only in a case of what we have defined as a perfect dielectric would the d-c. and a-c. breakdowns be subject to the same characteristics or laws.

Passing over to d-c. breakdown, Mr. Malti mentions the fact that d-c. breakdown is subject to time, is a function of insulation thickness and is therefore subjected to the mode of voltage

application, and logically following these conclusions, is subject to a fatigue effect.

We have done considerable work in fatigue effect under a-c. potential, and we have been able to trace it out pretty well. However, we have never been able, under carefully controlled conditions, to trace out a fatigue effect under d-c. potential. If the experiment is carefully controlled, the d-c. breakdown appears almost independent of the thickness. The rate of voltage application is not markedly effective. The time-voltage curve is almost flat. Those ideas fit in very nicely with the suggestion of molecular moment which I am offering.

Mr. Malti is led to the conclusion that the pyroelectric theory is to be rejected. That conclusion I think, should be carefully considered before it is generally accepted. For example, Mr. Malti's two reasons which he gives for this conclusion are of interest. We recognize that there are two types of breakdown perhaps—the instantaneous type and the so-called long-time type. To my idea the weakness of the pyroelectric theory has not been that it is wrong. It is apparently true, as far as I can see, that insulation failure is a heat phenomenon if you exclude the instantaneous type of breakdown. However, the pyroelectric theory begs the question almost entirely on the fundamental cause of that heat and it is hard to see why Mr. Malti can adopt his own ideas of viscous electrons and still retain the pyroelectric theory. If the heat theory is to be rejected on his ideas, what would he say is the direct cause of insulation failure? The motion of electrons is bound to create heat, and heat itself, from the second paragraph of his first reason, does exert an effect.

Mr. Malti also rejects the idea of pyroelectric theory because of measurements on glass. This is one place where I want to emphasize what Mr. Lee has said. It is the present tendency to give up the study of oiled solids and pass over to the study of what are thought to be perfect dielectrics such as glass and salt crystals. In doing that you must remember that as we pass from cellulose materials to salt crystals, we are passing from the organic to the inorganic realm. Whatever the molecular attraction may be in the organic realm, there seems to be considerable doubt that it is electrostatic. In the inorganic series, it is pretty certain that the attraction between atoms in the molecule is electrostatic.

In going from the organic to the inorganic, from cellulose materials to glass, we are passing to a material which has all the appearances of being an electrolytic conductor. With salts such as silver sulphide, it has been shown conclusively that the conductivity is partly electrolytic and partly metallic in character.

The dielectric characteristics of an inorganic insulator are probably affected by laws which do not apply to an organic molecule. I do not see how we can make any marked progress in obtaining a theory of insulation failure (by insulation meaning oiled organic material), by going over into a crystalline structure where in most cases we are dealing with inorganic materials showing either electrolytic or metallic conduction, or both.

Herman Halperin (by telegram): It would obviously be of very great assistance to the art if Mr. Malti would conduct a series of experiments to verify some of his theories and statements especially in regard to Fig. 9 showing the variation of dielectric strength with the thickness of dielectric and to his disagreement with the pyroelectric theory. In connection with the pyroelectric theory, it has been found in a series of tests at various voltages on several hundred samples of impregnated paper insulated cables of various voltages and sizes that about 75 per cent of the failures in accelerated life tests occur at points along the cable sheath which were considerably warmer previous to the failure than the adjacent sheath. This percentage increases with the thicker insulations. Further data on this point are given in the paper on the quality rating of high-tension cables by Mr. Roper and myself.¹

1. A. I. E. E. TRANSACTIONS, 1926, Vol. 45, p. 528.

M. G. Malti: In answer to Mr. Halperin's telegram and to the various speakers as to my attitude on the pyroelectric theory of breakdown, I would like to refer to the following statement on the tenth page of my paper:

"Undoubtedly, for very prolonged potential application, the phenomenon of heat does exert an effect on the rupturing voltage by raising the temperature of the sample. However, a theory built *wholly* on this effect is of necessity erroneous."

Again, referring to the appendix (Column T) it will be noted that I am aware of at least seven references which confirm the view that the dielectric strength decreases with an increase in temperature. The question is really much deeper than would appear. It is this: *For very short time of potential application is heat the result or the cause of breakdown?* My answer is that for short time intervals heat is both a result and one of the weakest contributing factors of breakdown.

The reason I assert that heat is a *result*, in the case of instantaneous breakdowns, is that the phenomenon of breakdown is nothing more than the tearing up of the electrons from their orbits. The energy dissipated due to the consequent electronic oscillations, vibrations and friction appears in the sample as heat.

Answering Mr. Lee, I fully recognize the large amount of work of high caliber which has been carried on and published relative to dielectric breakdown. However, I beg to repeat that none of it appears to be crucial. If he finds opportunity to do some research I would suggest the following: take a group of samples of the same insulation all of the same thickness and all made by the same process of manufacture and as uniform in quality as can be had. Let these samples be tested under the following conditions:

1. Continuous potential (time of potential application S_1 seconds, breakdown potential applied in one step).

a. Flat plates of the same material (plates not touching the insulation),

b. Flat plates of the same material (plates touching the insulation),

c. Flat plates of the same material (plate forming intimate contact with insulation),

d. Increase and decrease size of plates and repeat tests a, b, c,

e. Use spheres of varying diameters and repeat tests a, b, c,

f. Use needle points and repeat tests a, b, c,

g. Use a, b, c, d, e, and f in various combinations,

h. Change material of plates and repeat tests a to g,

i. Use plates of two different materials under various combinations and repeat tests a to g,

j. Repeat tests a to i with various sources of continuous potential (*e. g.*, kenotron tube, d-c. generators, induction machines, etc.).

2. *Alternating potentials* (time of potential application S_1 , seconds, full potential applied in one step): Repeat all tests listed for continuous potentials with alternating potentials of pure *Sine waves* or of waves whose form is definitely known. Use ranges of frequency varying from 1 cycle per sec. to as high as laboratory facilities permit.

3. Repeat tests 1 and 2 for a breakdown of $S_2, S_3 \dots S_n$ seconds.

4. Repeat tests 1, 2, and 3 with potential gradually increased to breakdown. This series of tests should be made under the same conditions of temperature, humidity, etc.

5. Change the thickness of the dielectric and repeat tests 1 to 4.

6. Change the temperature of the sample and repeat tests 1 to 4 for various thicknesses.

7. This suggested research should give some *crucial* results as regards only that one material. Therefore, repeat it for other materials.

8. Give a very detailed description of the physical and chemical properties of the samples used.

I know of no published work that has strictly followed this procedure. If this research can be made with the required material and *high-class labor*, the results will shed a bright light on the mechanism of breakdown.

I do not know that phenomena Mr. Lee refers to when he says "prediction of phenomena not yet observed." Each of the phenomena mentioned in my paper is an entity. They are all well known and have been observed for ages.

Mr. Rosch takes exception to my definition of hysteresis loss appearing in Eqs. (37a) and (37b) on the ground that, these expressions would be correct if, and only if, the hysteresis loss remained constant at various frequencies. He further suggests that some research engineers should establish this fact.

Unfortunately both hysteresis and viscosity are so intimately connected together that they cannot be experimentally separated. In order to affect their separation we have to discover a dielectric that possesses one but not the other property. Paraffin ozokerite closely approaches this ideal. It would be indeed well worth while if an experimental research engineer would establish or refute my equations. I wish to thank Mr. Rosch for this suggestion.

Mr. Clark seems to infer, from the simile I give between the electrons and a crowd in a theater, that I endow the electrons with a degree of mentality. This simile is drawn only to help one's imagination as to what goes on when a potential is impressed on a dielectric. He cannot see how, if all the electrons are of the same nature, some of them can be viscous, others elastic and still others free. I beg to refer him to part I section B of my paper and to state that the terminology used there might help him. I refer there to these electrons as *free elastically bound* and *viscously bound*.

According to the modern electron theory of matter electrons are assumed to revolve in orbits of various diameters and various eccentricities about the proton. The picture is similar to our solar system with the proton corresponding to the sun and the electrons corresponding to the various planets.

Now from the fundamental laws of electrostatics, $F = \frac{q_1 q_2}{r^2}$

where q_1 and q_2 correspond to the charges on the proton and the electron and r to the distance and F , is the force of attraction between the electron and proton².

It can be easily seen from this equation that the greater the distance between an electron and a proton, the less the force of attraction. Therefore, we may introduce, on this basis, the following definitions of the three types of electrons: 1. Free electrons are those which lie in the outermost orbit or orbits,

2. Viscously bound electrons are those lying in orbits nearer to the proton than those of the free electrons, and

3. Elastically bound electrons are those which occupy the innermost orbits.

Mr. Clark refers to the old Maxwellian conception of molecular moments. However, in the light of modern developments the old Maxwellian views are known and have been proven to be very crude and incorrect.

In regard to fatigue with d-c. potential Mr. Clark would probably be interested in the experiments of Professor Langsdorf and others. They have found fatigue. I shall be glad to supply a complete bibliography on the subject of fatigue which will not only be of interest to him but will probably suggest different modes of procedure from those he has been following in an effort to determine insulation fatigue.

As to the cause of insulation failure, I beg to refer Mr. Clark to my answer of Mr. Halperin's and Mr. Lee's discussions.

2. This definition is known not to be true for atomic structure but it is approximately true to illustrate my point.

JOURNAL OF THE American Institute of Electrical Engineers

PUBLISHED MONTHLY BY THE A. I. E. E.
33 West 39th Street, New York
Under the Direction of the Publication Committee

BANCROFT GHERARDI, *President*
GEORGE A. HAMILTON, *National Treasurer* F. L. HUTCHINSON, *National Secretary*

PUBLICATION COMMITTEE

L. F. MOREHOUSE, *Chairman*
F. L. HUTCHINSON E. B. MEYER
DONALD McNIGOL I. E. MOULTROP
GEORGE R. METCALFE, *Editor*

Subscription: \$10.00 per year to United States, Mexico, Cuba, Porto Rico, Hawaii and the Philippines; \$10.50 to Canada and \$11.00 to all other countries. Single copies \$1.00. Volumes begin with the January issue.

Changes of advertising copy should reach this office by the 15th day of the month for the issue of the following month.

The Institute is not responsible for the statements and opinions given in the papers and discussions published herein. These are the views of individuals to whom they are credited and are not binding on the membership as a whole.

Program for Pacific Coast Convention at Del Monte, Sept. 13-16

All arrangements have been made for the opening of the Pacific Coast Convention of the Institute which will be held in Del Monte, Calif., September 13-16, with headquarters at the Hotel Del Monte.

A change in the order of the technical sessions has been made since the announcement of the Convention was published in the August issue of the JOURNAL. The present schedule is shown in the accompanying program which leaves open Thursday afternoon, September 15, for recreation and trips.

The technical program contains fifteen papers of high quality on such subjects as application of intermediate synchronous condensers to transmission lines, carrier-current relaying, high-voltage circuit breakers, carrier-current communication on power lines, oscillographic recording of transients, corona space charge, the sphere-gap voltmeter at high frequencies, transients and oscillations in transmission lines, toll-call telephony and lightning protection for oil tanks.

A Student technical session, as well as conferences of Branch Counselors and Chairmen, will be held on the first day of the Convention, September 13.

Inspection trips will be made to many of the plants and lines in this part of the state, including a visit to the Ryan High-Voltage Laboratory at Stanford University.

A convention banquet will be held on Thursday evening, September 15, at which there will be a number of interesting addresses.

There will also be a number of entertainment and sporting events. The sports will include the annual golf tournament for the Fisker cup, as well as tennis, swimming and boating. For the ladies, special arrangements have been made for card parties, trips and sports.

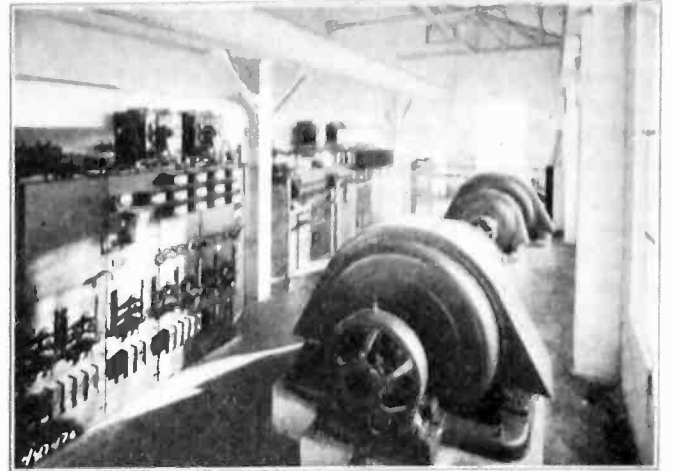

INTERIOR OF RYAN HIGH-TENSION LABORATORY, STANFORD UNIVERSITY

Special hotel rates are being offered to those attending the convention as follows:

HOTEL DEL MONTE DAILY RATES INCLUDING MEALS

Room	No. of persons	Price per person
Single, without bath	1	\$ 8.00
Double, without bath	2	7.50
Single, with bath	1	10.00
Double, with bath	2	9.00
Two singles, bath between	2	9.50
Two doubles, bath between	4	8.50

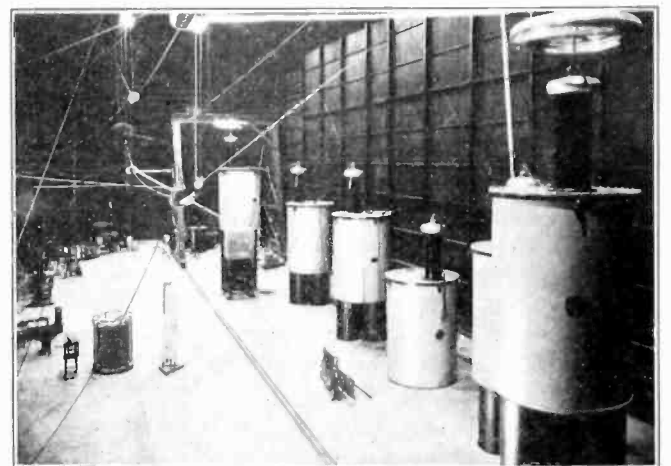

INTERIOR OF RYAN HIGH-TENSION LABORATORY, STANFORD UNIVERSITY

The general committee which has arranged all plans for the convention is as follows: P. M. Downing, Chairman; D. I. Cone, Vice Chairman; G. H. Hagar, E. A. Crellin, W. L. Winter, W. R. VanBokkelen and A. G. Jones.

TENTATIVE PROGRAM

TUESDAY, SEPTEMBER 13

Morning Registration
12:00 m. Student Branch Counselors' and Leaders' Luncheon.
2:00 p. m. Student Branch Conference.
3:00 p. m. Student Technical Meeting.
Evening Open.

WEDNESDAY, SEPTEMBER 14

9:30 a. m. Technical Session.

Advance Planning of the Telephone Toll Plant, J. N. Chamberlain, Pacific Tel. & Tel. Co.

Tandem System of Handling Toll Calls in and About Los Angeles, E. Jacobsen, American Tel. & Tel. Co., and F. O. Wheelock, So. California Telephone Co.

Coupling Capacitors for Carrier-Current Communication over Power Lines, T. A. E. Belt, General Electric Co.

A Carrier-Current Pilot System of Transmission-Line Protection, A. S. Fitzgerald, General Electric Co.

1:30 p. m. Technical Session.

The Relation between Frequency and Spark-Over Voltage in a Sphere-Gap Voltmeter, L. E. Reukema, University of California.

Afternoon Recreation, Sports and Trips.

7:00 p. m. Banquet.

FRIDAY, SEPTEMBER 16

9:30 a. m. *Oscillographic Recording Apparatus for Transmission-Line Studies*, J. W. Legg, Westinghouse Elec. & Mfg. Co.

High-Voltage Oil Circuit Breakers for Transmission Networks, Roy Wilkins and E. A. Crellin, Pacific Gas & Elec. Co.

Lightning Protection for Oil-Storage Tanks and Reservoirs, R. W. Sorensen, J. H. Hamilton and C. D. Hayward, California Institute of Technology.

Lightning Protection for the Oil Industry, E. R. Schaeffer, Johns-Manville, Inc.

Friday afternoon and Saturday—open for recreation and trips.

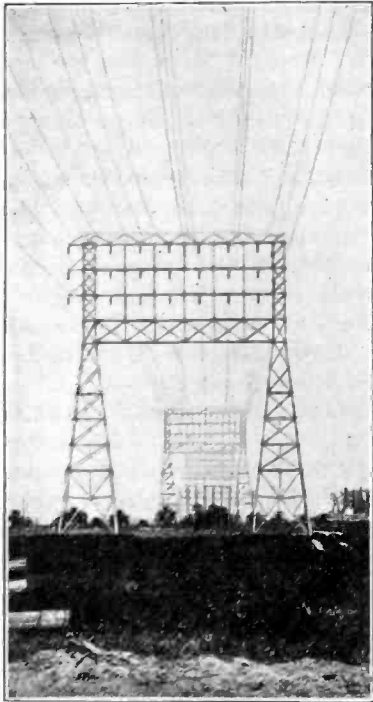

EIGHT-CIRCUIT TOWERS NEAR LIGHTPIPE SUBSTATION, SOUTHERN CALIFORNIA EDISON CO.

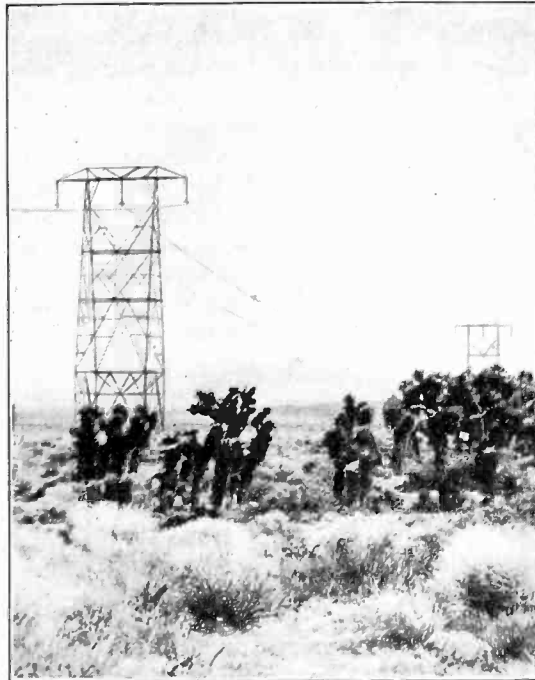

NEW 220,000-KV. VINCENT TRANSMISSION LINE OF THE SOUTHERN CALIFORNIA EDISON CO.

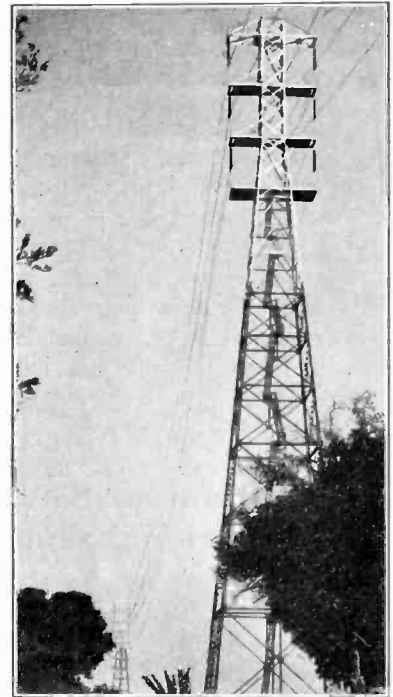

SPAN OVER SACRAMENTO RIVER, WORLD'S LONGEST SPAN AND HIGHEST TOWERS

The Space Charge that Surrounds a Conductor in Corona, J. S. Carroll and J. T. Lusignan, jr., Stanford University.

Electric Oscillations in the Double-Circuit Three-Phase Transmission Line, Y. Satoh, Stanford University.

8:00 p. m. General Meeting.

Address by President Bancroft Gherardi.

Address by Dr. H. J. Ryan on Phases of Future Electrical Development.

THURSDAY, SEPTEMBER 15

9:30 a. m. Technical Sessions.

Transients Due to Short Circuits, R. J. C. Wood and F. L. Hunt, Southern California Edison Co., and S. B. Griscom, Westinghouse Elec. & Mfg. Co.

Equipment for 220-Kv. Systems, J. P. Jollyman, Pacific Gas and Elec. Co.

Static Stability Limits and the Intermediate Condenser Station, R. D. Evans and C. F. Wagner, Westinghouse Elec. & Mfg. Co.

Synchronous Condensers, P. L. Alger, General Electric Co.

The General Convention Committee which is handling this meeting consists of P. M. Downing, chairman; D. I. Cone, vice-chairman; A. G. Jones, secretary; and the members of the following committees as shown: *Papers*—D. I. Cone, chairman S. J. Lisberger, Paul Lebenbaum; *Publicity*—G. H. Hagar, chairman; G. R. Henninger; *Entertainment*—E. A. Crellin, chairman; W. B. Sawyer, A. V. Thompson, W. P. L'Hommedieu, J. S. Thompson; *Registration and Transportation*—W. L. Winter, chairman; M. S. Barnes, P. B. Garrett, C. F. Benham, A. J. Swank, B. D. Dexter; *Arrangements*—W. R. Van Bokkelen, chairman; J. M. Buswell, A. M. Bohnert.

**Regional Meeting in Chicago
November 29-30**

A three-day regional meeting is being planned by the Great Lakes District of the Institute, to be held in Chicago, November 28, 29 and 30.

For the technical program of the meeting, it is proposed to have papers on such timely subjects as cables, control systems, circuit breakers and other topics.

A definite program has not yet been completed but the October issue of the JOURNAL will contain a more complete announcement of the plans.

First National Fuels Meeting

A meeting of exceptional importance to American engineers and executives has been arranged by the Fuels Division of the American Society of Mechanical Engineers, to be held in St. Louis, October 10-13, 1927. The meeting should appeal to any one interested in any phase of the production, transportation or application of fuels. Men of international reputation will present papers on industrial practices, power plants and smoke abatement, as well as on more general subjects. All papers will be preprinted and presented in abstract form, giving plenty time for discussion.

While the interest in fuel has been quite general, there has been no centralized agency for development and dissemination of sound information on proper and efficient use of fuels. It is essential, if the problem of fuels is to be properly taken care of, that all engineers—regardless of membership or even non-membership, technical as well as practical—be put in contact with one another and this is precisely the purpose of the First National Fuels Meeting.

Seventy-Fourth Meeting of the American Chemical Society

The Seventy-Fourth Meeting of the American Chemical Society will convene at the Hotel Statler, Detroit, Mich., on Sept. 5th, the Council of the organization holding a meeting that afternoon in the Henry II Room. An elaborate program has been planned to extend over a period of five days. A great number of papers will be presented as well as several lectures with lantern slides and numerous inspection trips will be made to points of interest. Informal dances and receptions, group dinners and banquets have been arranged for the evening hours. A large attendance is expected.

Sixteenth Annual Safety Congress of the National Safety Council

Arrangements have been completed for the Sixteenth Annual Safety Congress of the National Safety Council which will take place in Chicago, September 26th to 30th. The numerous meetings will be in the Hotel Stevens where there will also be held several entertainments and an interesting Safety Exhibit. The newest equipments for accident, fire and health protection, as well as first aid and sanitary supplies, will be shown at this Exhibit. The railroads have granted reduced rates for people attending the Congress; certificates may be secured from the National Safety Council offices at 108 East Ohio Street, Chicago. All members of the A. I. E. E. are cordially invited to attend the meetings.

A. I. E. E. Directors Meeting

The first meeting of the Board of Directors of the Institute for the administrative year beginning August 1, was held at Institute headquarters, New York, on Tuesday, August 9, 1927.

There were present: President Bancroft Gherardi, New York; Vice-Presidents B. G. Jamieson, Chicago, G. L. Knight, Brooklyn, N. Y., A. E. Bettis, Kansas City, J. L. Beaver, Bethlehem; Managers H. A. Kidder, New York, E. C. Stone, Pittsburgh, I. E. Moulthrop, Boston, F. J. Chesterman, Pittsburgh, E. B. Meyer, Newark, N. J., H. P. Liversidge, Philadelphia, F. C. Hanker, Pittsburgh; National Secretary F. L. Hutchinson, New York.

On the recommendation of the Board of Examiners, the following actions were taken upon pending applications: six Students were ordered enrolled; 70 applicants were elected to the grade of Associate; two applicants were reinstated in the grade of Associate; four applicants were elected to the grade of Member; one applicant was transferred to the grade of Member.

The Board ratified the action of the Finance Committee in approving for payment monthly bills amounting to \$21,445.08.

Announcement was made of the appointment, by the president of the Institute, of committees and of representatives of the Institute, on various bodies, for the administrative year commencing August 1, 1927; a list of the committees and representatives appears elsewhere in this issue.

In accordance with the by-laws of the Edison Medal Committee, the Board confirmed the appointment by the president, for terms of five years each, of the following members of the Edison Medal Committee: Messrs. E. B. Craft, Paul M. Lincoln, and C. E. Skinner. Also, as required by the committee's by-laws, the Board elected the following from its own membership to serve on the Edison Medal Committee for terms of two years each: Messrs. H. P. Liversidge, E. B. Meyer, and I. E. Moulthrop.

The following Local Honorary Secretaries were reappointed for the two-year term beginning August 1, 1927: Axel F. Enstrom for Sweden; T. J. Fleming, for Argentina; C. le Maistre, for England; P. H. Powell, for New Zealand; Guido Semenza, for Italy.

Upon request of the American Engineering Standards Committee, approval was given of the admission of the Portland Cement Association as a Member Body of the A. E. S. C.

An invitation to be represented at the Southern Appalachian Power Conference, Chattanooga, Tennessee, October 13-15, 1927, was referred to the president of the Institute and to the vice-president of the Southern District, with power.

Consideration was given to a request from the American Society of Mechanical Engineers for cooperation in the First National Fuels Meeting, St. Louis, October 10-13, and the matter was referred to the president with power.

A request from the South West District for authority to hold a regional meeting in St. Louis, March 21-23, 1928, was referred to the Committee on Coordination of Institute Activities for consideration in connection with other contemplated regional meetings and for recommendation to the Board.

Other matters of importance were discussed, reference to which may be found in this and future issues of the JOURNAL.

Report on Standard Definitions

A report on *Standard Definitions* which has been in preparation for some time by a subcommittee of the A. I. E. E. Standards Committee, is now available. This report is No. 2 in the series of A. I. E. E. Standards and was compiled under the guidance of a representative Working Committee with John B. Taylor as chairman. The report is now issued in the belief that it has reached a stage where it should be circulated widely in order to obtain all possible criticism and suggestions before final adoption.

The definitions assembled in this report have been taken largely from the latest approved sections of the A. I. E. E. Standards. A few definitions are included from the 1922 Edition, but comprise only those which have not as yet been replaced in the work of revision. Copies of the pamphlet may be obtained without charge from H. E. Farrer, Secretary, A. I. E. E. Standards Committee, 33 West 39th Street, New York, N. Y.

New Oil-Electric Car Operated in Canada

The U. S. Trade Commissioner at Toronto has made a report on the development and successful operation of a new oil-electric car recently placed in service by the Canadian National Railways. The car recently ran from Montreal to Toronto in five hours and thirty minutes, two hours and twenty minutes less than the time made by the International Limited, the regular train which has been covering this route.

The new car is about 74 feet long and is divided into four com-

partments: the engine, baggage, smoking and general passenger rooms.

The engine conforms to a modified Diesel-cycle of the solid injection four-stroke cycle type, six cylinders in a line. Each cycle has an $8\frac{1}{4}$ inch bore and a 12-inch stroke and develops 300 H. P. at 750 rev. per min. The combined weight of the engine and fly-wheel is 6900 pounds. The engine runs a generator from which the electrical energy is secured to operate the car.

Utility Inquiry May be Pressed

Persistent reports in the Capital indicate that every effort will be made to bring about a senatorial investigation of the growth and capitalization of public utility companies as soon as the 70th Congress convenes.

It is reliably reported that Senate Resolution 371 of the last Congress which failed of passage will be reintroduced. This provided a committee of five members of the Senate with power to "inquire into the growth of the capitalization of public utility corporations supplying either electrical energy in the form of power or light or both, however produced, or gas, natural or artificial, and of corporations holding the stocks of such corporations, the method of issuing and the price realized or value received for the various security issues of both classes of corporations named, including the bonds and other evidences of indebtedness thereof, as well as the stocks of the same, the extent to which additions or extensions to the property of the operating companies have been made, and the value or detriment to the public of holding companies owning the stock or otherwise controlling such operating companies immediately or remotely, with the extent of such ownership or control and particularly what legislation, if any, should be enacted by Congress to correct any abuses that may exist in the organization or operation of such companies."

This elaborate investigation as proposed in the Senate would again go into detailed study of the subjects recently fully reported upon by the Federal Trade Commission.

Seventeen Companies Accept Radio Telegraph Conference Invitation

Seventeen cable and wireless companies have accepted the invitation of the United States to attend the International Radiotelegraphic Conference to be held in Washington, October 4, according to an announcement August 12 by the Department of State.

The list of companies includes those from the United States, Great Britain, France, Germany, Denmark, Japan, the Netherlands, the Philippines and Haiti.

Would Coordinate University Studies Throughout World

The University Subcommittee of the Committee on Intellectual Cooperation of the League of Nations has planned for coordination of university studies and will discuss further details of the plan at its next meeting. Recommendations of the subcommittee, however, have been well formulated.

As regards the coordination of university studies in its relation to the creation of an international university, the subcommittee consider that the first efforts in this domain should bear on coordination according to nationality, and to this end decided to convene another special committee of experts.

Value of Timber as Protection to Water Shed

The Department of Agriculture recently announced results of a study just completed on an 112-acre farm in Tennessee showing that a relatively small amount of timber has a decided influence in reducing the rate of run-off of rainfall on water sheds.

The experts that conducted this study point to its value in determining the part that farm forestry can play in a program of controlling erosion and diminution of floods. The Department has long contended that proper forestation is an important item in flood control and has emphasized its importance as the result of the Mississippi flood disaster.

Gasoline Engine Temperatures

The U. S. Bureau of Standards recently reported on the result of warming the intake manifold and water jackets in the speed and acceleration of gasoline engines. The statement follows:

Recent tests show that a considerable difference in jacket water temperatures has but slight effect on car acceleration, but warming the intake manifold does help the engine's ability to pick up speed very materially.

One of the current problems of the co-operative fuel research sponsored by the National Automobile Chamber of Commerce, the American Petroleum Institute, and the Society of Automotive Engineers, which is being conducted at the Bureau is a general study of engine acceleration. This investigation will be followed later by a study of engine performance during the "warming up" period.

Tests thus far have been made in the laboratory on a 1926 six-cylinder passenger car engine. These tests show considerable difference between the performance obtained with different carburetors at normal temperatures.

PERSONAL MENTION

ELMER A. SMITH, a Member of the Institute since 1924, was recently unanimously elected to life membership in the *Academie Latine des Sciences, Arts et Belles-Lettres* in Paris, France.

GEO. W. IREY, formerly production superintendent of the Ohio Public Service Company, has been appointed to a similar position with the Empire District Electric Company at Joplin, Mo.

JOHN F. VAUGHAN, member of the firm of Vaughan Engineers, formerly of 185 Devonshire St., Boston, has announced the opening of new offices in the Waterman Building, 44 School St., Boston.

EDWARD J. WHITE has established an electrical contracting business with offices at 39 Division St., Newark, N. J. He had been Secretary and Treasurer of the Harris Wright Co., Inc., of Newark.

THEODORE BERAN, commercial vice-president of the General Electric Company in charge of activities in the New York district, sailed for Europe on August 20th. He will attend the exercises of the International Electric Technical Commission.

ALBERT R. ASKUE, Associate of the Institute, who has been employed by the Cleveland Electric Illuminating Company for the past nineteen years, has recently resigned to take up a position as construction superintendent with the A. J. Penote Co., a contracting firm specializing in underground conduit construction.

E. D. TREANOR has been appointed managing engineer of the distribution transformer department at the Pittsfield, Mass., works of the General Electric Company. As managing engineer of that department, Mr. Treanor will also have general supervision of the engineering on distribution transformers manufactured at the Fort Wayne, Ind., and Oakland, Cal., works of the company.

FRANCIS HODGKINSON, consulting mechanical engineer at the South Philadelphia Works of the Westinghouse Electric and Manufacturing Company, sailed for Europe on Saturday, August 6th. Mr. Hodgkinson has planned an extensive business trip in Europe and while there he will attend the sessions of the International Electric Technical Commission, of which he is a member, held at Bellagio and Rome, Italy.

T. C. RÜHLING left his position as superintendent of underground construction with the Kansas City Power & Light Com-

pany on June first, to enter the sales field. He is now in the organization of the Charles L. Ward Company in the Dallas office. Mr. Ruhling will handle the products of Schweitzer & Conrad, G and W Electric Specialty Company, Electric Service Supplies Company and Franklin Porcelain Company.

C. E. WISE, who represents Ward Leonard Electric Company, of Mount Vernon, New York, in the Detroit district, has announced that Mr. Leroy Braisted has been admitted as a partner in the former firm of C. E. Wise. The new name of the concern is Wise & Braisted, the address being 2-133 General Motors Building, Detroit, Michigan. Mr. Braisted has been associating with C. E. Wise for some years, and the recent partnership is the logical result of their association.

Obituary

Dr. Alexander Crombie Humphreys, President of Stevens Institute of Technology, Hoboken, N. J., for twenty-five years and nationally known water-gas engineer, died August 14th of a general breakdown at his home in Morristown, N. J. He was in his seventy-seventh year.

Dr. Humphreys was born in Edinburgh, Scotland, on March 30, 1851, a son of Dr. Edward R. and Margaret McNutt Humphreys. He was brought to this country by his parents at the age of 8.

He obtained his first job at the age of 14. A short time later he passed the entrance examinations of the United States Military Academy at West Point, but was rejected as a student because he was not 16. In 1872 he became Secretary of the Bayonne and Greenville Gas Light Company. His ability was so conspicuous that he was promoted soon to superintendent, though he was without technical training.

At the age of 26 he entered Stevens Institute as a student, having obtained from his employers permission to stay at the institute two mornings a week, provided he worked at night to make up the lost time. Four years later he was graduated and began an engineering career which gained him international fame.

From 1881 to 1885 Dr. Humphreys was chief engineer of the Pintsch Lighting Company of New York. He then became general superintendent and chief engineer of the United Gas and Improvement Company of Philadelphia, serving it until 1894. Meantime he had become senior partner in the firm of Humphreys & Glasgow of New York and London, to which he devoted himself until 1908, when he retired from the London branch. In 1910 he reorganized the New York office as Humphreys & Miller, Inc.

Despite his heavy personal work, Dr. Humphreys accepted the presidency of Stevens Institute and of its Board of Trustees in September, 1902, at the urging of trustees, Faculty and students.

The success which had come to him professionally followed him as head of Stevens. Under his administration the institution had a period of great expansion.

Dr. Humphreys was a Fellow of the American Institute of Electrical Engineers and was a former president of the American Institute of Consulting Engineers, the American Society of Mechanical Engineers, the American Gas Institute, the Canadian Society of New York, the American Gas Light Association, the Engineers' Club and the St. Andrews Society and was a member of the United Engineering Society, the National Society for the Promotion of Industrial Education, the American Association for the Advancement of Science, the British Association for the Advancement of Science, the Society for the Promotion of Engineering Education, the American Society of Mining and Metallurgical Engineers, the American Society of Civil Engineers, the Institution of Civil Engineers of Great Britain, the Lotus Club, the Century Club, the Lawyers' Club, the Union League Club, the University Club and the Church Club of New York.

His wife and a daughter, Mrs. Henry S. Loud, survive him. Two sons died.

Paul Spencer, widely known expert in the electric light and power industry, died Aug. 9th at his home, 2125 Cypress St.,

Philadelphia, Pa. Mr. Spencer was electrical engineer for The United Gas Improvement Company and had charge of that important branch of the U. G. I.'s business in 28 states. He had been with The United Gas Improvement Company for 27 years.

Mr. Spencer was born in East Orange, N. J., March 19, 1866, the son of George Gilman and Caroline (Arnold) Spencer. He was graduated from Yale in 1887 with the degree of A. B. and from Stevens Institute of Technology in 1891 with the degree of M. E. Mr. Spencer married Frances Margaret Durbin, of Montclair, N. J., April 25, 1894. He is survived by Mrs. Spencer and two children, Frederick Gilman Spencer of Philadelphia and Mrs. Archibald G. Robertson of Richmond, Va.

Mr. Spencer entered the employ of the Field Engineering Company of New York in 1891. He was connected with the Stanley Electric Manufacturing Company, Pittsfield, Mass., from 1894 until 1897. He was general superintendent of the People's Light & Power Co., Newark, N. J., from 1897 until 1900, when he became connected with The United Gas Improvement Company as electrical engineer.

He served in 1916 as an associate member of the Naval Consulting Board in connection with the preparation of an inventory of the industrial resources of the country, being one of the state directors from Pennsylvania.

Mr. Spencer joined the Institute in 1897 as an Associate and in 1912 was transferred to Grade of Fellow. He had served on numerous committees of the Institute and also as Manager from 1906-1909 and Vice-President in 1919. He was a member of the National Electric Light Association, of which he had been manager; Illuminating Engineering Society and Franklin Institute. He was a member of the Delta Kappa Epsilon Fraternity. Among his clubs were: Engineers, (Phila.); University, (Phila.); University and Yale Engineering, (New York); Merion Cricket and Graduate (New Haven).

Past Section and Branch Meetings

PAST SECTION MEETINGS

Cleveland

Inspection trip to Ohio Bell Telephone Company. August 3. Attendance 220.

Rochester

Motion picture entitled "From Mine to Consumer" was shown. The following officers were elected: Chairman, R. D. DeWolfe; Vice-Chairman, W. H. Reichard; Secretary-Treasurer, C. C. Eckhardt. Joint meeting with A. A. E., A. S. C. E., A. S. M. E., I. R. E., R. S. A., R. S. T. D. and A. C. S. May 6. Attendance 390.

Toledo

Annual Picnic. July 16. Attendance 250.

Vancouver

Impressions of a Recent Visit to Eastern Cities, by R. L. Hall, B. C. Electric Railway Co. July 28. Attendance 19.

PAST BRANCH MEETINGS

Lewis Institute

Business Meeting. The following officers were elected: President, L. F. Masonick; Secretary-Treasurer, G. M. Berg. June 17.

Engineering School of Milwaukee

Prof. J. D. Ball, Counselor, gave a short resumé of his experiences with the General Electric Co. Arrangements for the Student Convention to be held in Chicago in November were discussed and passed upon. The following officers were elected: Chairman, Joseph Havlick; Vice-Chairman, V. C. Nye; Secretary, H. F. Brundage; Treasurer, Joseph Cacciola. July 12. Attendance 12.

University of Pennsylvania

Business Meeting. The following officers were elected: President, W. H. Hamilton; Vice-President, A. L. Pugh; Secretary, S. R. Warren, jr.; Treasurer, R. S. Palmer. May 6. Attendance 44.

Engineering Societies Library

The library is a cooperative activity of the American Institute of Electrical Engineers, the American Society of Civil Engineers, the American Institute of Mining and Metallurgical Engineers and the American Society of Mechanical Engineers. It is administered for these Founder Societies by the United Engineering Society, as a public reference library of engineering and the allied sciences. It contains 150,000 volumes and pamphlets and receives currently most of the important periodicals in its field. It is housed in the Engineering Societies Building, 29 West Thirty-ninth St., New York.

In order to place the resources of the Library at the disposal of those unable to visit it in person, the Library is prepared to furnish lists of references to engineering subjects, copies or translations of articles, and similar assistance. Charges sufficient to cover the cost of this work are made.

The Library maintains a collection of modern technical books which may be rented by members residing in North America. A rental of five cents a day, plus transportation, is charged.

The Director of the Library will gladly give information concerning charges for the various kinds of service to those interested. In asking for information, letters should be made as definite as possible, so that the investigator may understand clearly what is desired.

The library is open from 9 a. m. to 10 p. m. on all week days except holidays throughout the year except during July and August when the hours are 9 a. m. to 5 p. m.

BOOK NOTICES (JULY 1-31, 1927)

Unless otherwise specified, books in this list have been presented by the publishers. The Society does not assume responsibility for any statement made; these are taken from the preface or the text of the book.

All books listed may be consulted in the Engineering Societies Library.

ALTERNATING-CURRENT RECTIFICATION AND ALLIED PROBLEMS.

By L. B. W. Jolley. 2nd edition. N. Y., John Wiley & Sons, 1927. 472 pp., illus., diags., tables, 9 x 6 in., cloth. \$6.00.

The aim of this book is to describe the methods available for obtaining unidirectional currents for power and for laboratory use and to present the mathematical analysis with numerical examples where they are possible. The author has tried to make the book as complete as possible within itself, and to accomplish this has assumed an acquaintance with the general theories of electricity and magnetism, transformers, crystallography, etc. He has also largely omitted questions of design and manufacture.

Chapters on the installation of thermionic rectifiers, on radio supplies and on inverters have been added to this edition. Bibliographies are given for each chapter.

ARCHITECTURAL CONSTRUCTION, v. 2, Book 2; Steel Construction.

By Walter C. Voss & Edward A. Varney. N. Y., John Wiley & Sons, 1927. 564 pp., illus., diags., tables, 12 x 9 in., cloth. \$10.00.

This publication is one section of an elaborate treatise on architectural construction, intended primarily for the architect but also full of interest for the structural engineer. Its purpose is to promote closer cooperation between architect and engineer, in the design of modern buildings requiring the services of both, by helping each to understand the architectural and structural limitations that are to be surmounted.

In this section the authors show, by numerous examples, best modern practise in steel construction. Each principle of design is analyzed so that its practical application is evident, and its relations to the entire building and to those architectural and structural details that control it, is considered. The book is copiously illustrated and replete with practical details which adapt it admirably for reference as well as for study.

DIE BERECHNUNG ELEKTRISCHER LEITUNGSNETZE IN THEORIE UND PRAXIS.

By Josef Herzog. 4th edition, revised by Clarence Feldmann. Berlin, Julius Springer, 1927. 554 pp., diags., tables. 9 x 6 in., boards. 38.-r. m.

The principal change in this edition is the separation of the treatment of direct-current circuits from that of alternating-current circuits. This change will make the book more suitable for use as a textbook, the author believes. The subject matter has also been revised wherever necessary.

The book gives a detailed mathematical discussion of the design of distributing networks for power and light, including railroad networks.

CALCULUS OF VARIATIONS.

By A. R. Forsyth. Cambridge, Eng., University Press; (N. Y., Macmillan Company), 1927. 656 pp., 11 x 8 in., cloth. 50s.

Dr. Forsyth's treatise on the calculus of variations is the first in English for many years. While it makes no pretensions to an encyclopedic range, it covers the subject more fully than any of its predecessors and gives a systematic exposition of it by a uniform composite process. The book is based upon the work of Moigno and Lindelöf, and of Weierstrass, but much of its material is novel, and a large part is due to independent work by the author.

DESCRIPTIVE GEOMETRY.

By C. H. Schumann, jr. N. Y., D. Van Nostrand Co., 1927. 249 pp., 9 x 6 in., cloth. \$2.50.

This textbook is the outcome of the author's experience in teaching descriptive geometry at Columbia University, where it has been used in abbreviated form. Efforts have been made to present the subject from the students' viewpoint and to describe the problems so clearly that little explanation by the instructor will be necessary. Over 1300 exercises and practical problems, covering mining, civil, mechanical, and electrical engineering, are given.

DIESEL MASCHINEN, III. Sonderheft der Zeitschrift des V. D. I.

Berlin, V. D. I. Verlag, 1927. 99 pp., illus., diags., 12 x 8 in., paper. 4,50 r. m.

This book contains the papers upon Diesel engine construction which appeared in the Zeitschrift des Vereines Deutscher Ingenieure during 1926, and which are here reprinted in convenient form for reference. The twelve papers are the work of leading experts; taken collectively, they form a good survey of the present position of the Diesel engine industry.

ELEKTRISCHE BAHNEN.

By A. Schwaiger. Ber. u. Lpz., Walter de Gruyter & Co., 1927. 116 pp., illus., diags., 6 x 4 in., cloth. 1,50 r. m.

A brief account of the present situation in railroad electrification, especially full with respect to conditions in Germany. Electric locomotives are discussed.

ELEKTRISCHE FORDERMASCHINEN.

By W. Philippi. 2d edition. Leipzig, S. Hirzel, 1927. (Elektrizität in industriellen betrieben, bd. 6). 310 pp., illus., diags., 10 x 7 in., paper. 20.-Mk.

A practical treatise on the construction and operation of electric mine hoists, intended for the mining engineer. The author describes the mechanical and electrical machinery and the control and safety devices, and discusses the advantages of electric hoists, giving special attention to their safety and economy. A number of typical installations are described and a list of references is given.

ELEMENTS OF PHYSICS.

By Alpheus W. Smith. 2d edition. N. Y., McGraw-Hill Book Co., 1927. 660 pp., illus., diags., 9 x 6 in., cloth. \$3.50.

A textbook for students who are primarily interested in the practical applications of physics, which aims to include those

topics which touch our everyday life most closely. By using a large number of illustrations of the applications of physics to engineering, agriculture and other familiar subjects, the author endeavors to stimulate the student to recognize the universality of physical laws and to find in them an explanation of common experiences and observations. The text is of college grade. Formerly published under the title of "Elements of Applied Physics."

ELEMENTS OF RADIO-COMMUNICATION.

By O. F. Brown. Lond. & N. Y., Oxford Univ. Press, 1927. 216 pp., diags., 9 x 6 in., cloth. 10s 6d. (Gift of American Branch).

Electrical engineers who have not studied radio-communication and students of science who wish a theoretical knowledge of radio will find this book a good introduction to the theory of wireless communication and to the principles upon which receiving and transmitting apparatus rests. The author avoids mathematics successfully.

After a discussion of the theory of alternating currents, the book describes and compares the various methods of producing radio waves, tells how they are propagated through space, and gives the probable causes of the variation in their strength and direction. Methods of reception and of conversion into audible waves are explained, and the book closes with a chapter on atmospherics.

ERGEBNISSE DER AERODYNAMISCHEN VERSUCHSANSTALT ZU GÖTTINGEN, Lieferung 1-3. edited by L. Prandtl & A. Betz. Mün. & Ber., R. Oldenbourg, 1923-1927. 3 pts., illus., diags., tables. 11 x 8 in., paper. Pt. 1, 8,-mk.; pt. 2, 6,-mk.; pt. 3, -14, 50 mk.

The first three numbers of a publication to be issued at irregular intervals by the Aerodynamical Experiment Station at Göttingen. The publication is intended to make the most important results of the experimental work at the Institute more conveniently available to engineers and manufacturers than hitherto, when they have only appeared in summaries in periodicals.

The first number contains a description of the Institute and of the directions which its investigations had taken before 1920, accompanied by the results. It also includes an introduction into the study of the resistance of the air, in which the basic laws of aerodynamics are explained. The later numbers, issued in 1923 and 1926, contain, in addition to theoretical studies, reports of many investigations of interest not only to aeronautical engineers but also to students of wind resistance in connection with railroads, bridges and other fields.

ESTIMATING BUILDING COSTS.

By Frank E. Barnes. 2nd edition. N. Y., McGraw-Hill Book Co., 1927. 592 pp., illus., tables, 7 x 5 in., fabrikoid. \$5.00.

This book is intended to assist the contractor or estimator in determining the amount of labor required for various building operations, to furnish prices of labor and material by which he may check his estimates and to give full data on the present costs of replacing various types of existing buildings.

The new edition has been thoroughly revised to conform with the present efficiency of building labor and present prices of material. Certain data easily obtainable elsewhere have been omitted and replaced by other material of value.

FESTIGKEITSUNTERSUCHUNGEN ZUR NORMUNG DER STAHL-ALUMINIUM-SEILE.

By Verband Deutscher Elektrotechniker. Berlin, V. D. I. Verlag, 1927. (Forschungsarbeiten auf dem gebiete des ingenieurwesens, heft 293). 12 pp., tables, 11 x 8 in., paper. 0,80 r. m.

The Commission on Overhead Lines of the Association of German Electrical Engineers presents this report on the strength of aluminum-steel cables. It contains the results of tests of the elasticity and tensile strength of these cables and of the coefficients of thermal expansion and the strains resulting therefrom. The results are tabulated and their use in practical calculations is illustrated.

FOUR-FIGURE TABLES.

By C. Godfrey and A. W. Siddons, Cambridge Univ. Press, 1927. (American agents, Macmillan Co.) 40 pp., 9 x 6 in., cloth. \$.80.

A convenient collection of the usual mathematical tables of logarithms, natural and logarithmic trigonometrical functions, squares, square roots, reciprocals, and radians. The tables are clearly printed on good paper and are well adapted to the needs of students.

FUNDAMENTALS OF ELECTRICAL DESIGN.

By A. D. Moore. N. Y., McGraw-Hill Book Co., 1927. 353 pp., illus., diags., tables, 9 x 6 in., cloth. \$4.00.

This course in design is not intended to teach the student how to design electrical machinery. Real knowledge and skill in that art can only be acquired, in the author's opinion, through actual experience in professional work. Instead of attempting the impossible, Professor Moore offers a course which directs attention to a mastery of certain fundamental subjects which are basic to much professional electrical design, among which are the electromagnetic system, fields and field mapping, attraction, and the thermal problems of heat storage, heat flow, heat radiation, heat dissipation, and rise in temperature. In the latter part of the book the application of this knowledge is illustrated by applying it to the problems of direct-current machinery.

HOCHSPANNUNGSTECHNIK.

By Arnold Roth. Berlin, Julius Springer, 1927. 534 pp., illus., diags., tables, 9 x 6 in., cloth. 31,50 r. m.

Attempts to give a comprehensive survey of modern high-tension practise, based on recent advances in our knowledge of the physics of electrical phenomena in materials, and of the importance of high-tension phenomena in practise. Discusses at length the important solid dielectrics, oil and air; electromagnetic surge phenomena; practical requirements for dielectrics; testing-room equipment; arcing; and high-tension apparatus for alternating-current and direct-current systems. The author was formerly in charge of apparatus and transformer testing for Brown, Boveri & Co. A good bibliography is included.

HYDRAULICS.

By Ernest W. Schoder and Francis M. Dawson. N. Y., McGraw-Hill Book Co., 1927. 371 pp., illus., diags., tables, 9 x 6 in., cloth. \$3.50.

This work does not attempt to treat exhaustively any phase of hydraulics nor to offer a short course on any one of the professional fields of hydraulic engineering. It aims rather to be a basic course in the hydraulics of engineering, which may serve both as an introduction to more specialized studies and as a text and reference book on everyday problems.

The treatment has four stages: first, description of the physical phenomena; second, development of the fundamental laws into useful formulas; third, presentation of examples showing good form in the analysis and good methods in the solutions of problems; fourth, typical problems drawn from practical cases. The course is long enough for usual college requirements.

THE IRON INDUSTRY IN PROSPERITY AND DEPRESSION.

By Homer Bews Vanderblue and William Leonard Crum. Chicago & N. Y., A. W. Shaw Co., 1927. 193 pp., diags., tables, 11 x 8 in., cloth. \$7.50.

Presents the results of investigations designed to apply to a single industry certain statistical methods for the analysis of recorded data, and undertaken in part with the aim of developing a method of forecasting conditions in that industry. The topics considered are prices and production, the regional production of pig iron, and the forecasting of conditions in the industry. The book does not attempt to be an exhaustive analysis of all the material bearing on the iron and steel industry, but it gives a sufficiently full view of the problem to be helpful in understanding conditions in it, and also to point the way to similar analyses of other industries.

KRÜMMUNGEN ZYLINDRISCHER KESSELTEILE WAHREND DES BETRIEBES.

By P. Rönne. Berlin, V. D. I. Verlag, 1927. (Forschungsarbeiten auf dem gebiete des ingenieurwesens, heft 292). 43 pp., diags., 11 x 8 in., paper. 5,-r. m.

Gives the results of an investigation of the strains caused in cylindrical boilers by differences of temperature within the plates and between the plates. The causes of these strains, their size, the failures that they cause and the prevention of such failures, are discussed. The changes of shape caused by differences in temperature were measured for boilers of various types, and formulas derived for calculating the resulting strains. The study shows how differences of temperature may cause failures, and what steps must be taken in construction and operation to prevent them.

LAW OF RADIO COMMUNICATION.

By Stephen Davis. N. Y., McGraw-Hill Book Co., 1927. 206 pp., 9 x 6 in., cloth. \$3.00.

In the study upon which this book is based, the aim of the author was to determine the basic legal rules of the relationships

between those engaged in radio communication and the government, the public, and other operators. Attention is paid to such important questions as the right to engage in radio communication, federal and state jurisdiction, conflicting rights in reception and transmission, broadcasting copyright matter, libel and slander. At the present stage of development, the work is of necessity largely speculative: an endeavor to foresee the direction that statute law and judicial decisions will take.

DER SCHIFFSMASCHINENBAU, v. 2.

By G. Bauer. Mün. & Ber., R. Oldenbourg, 1927. 455 + 175 pp., illus., diags., tables, 11 x 8 in., paper. 54.-r. m.

The second volume of Dr. Bauer's great treatise on marine engines is devoted to steam turbines and reducing gear. The theory of the turbine is discussed first, after which the design of the turbine is treated at length. Turbine construction is then taken up, followed by sections on reducing gear, on turbine operation, and on the installation of turbines in ships. A suggestive section on land turbines concludes the book, except for 168 pages of appendixes, in which many matters in the first volume are brought up to date. A third volume, on internal-combustion engines, is promised.

The work is a valuable record of European practise in design and construction, of interest to every marine engine builder.

SIR ISAAC NEWTON; a brief account of his life and work.

By S. Brodetsky. Lond., Methuen & Co., 1927. 161 pp., Port. map, diags., 8 x 5 in., cloth. 5s.

An attempt to present the main features of Newton's life and his chief contributions to knowledge in a manner that will be understood by a reader who possesses a very moderate grounding in the elements of science. The author successfully tells all that the average inquirer will wish to know of Newton and of his influence on scientific thought.

STANDARD CONSTRUCTION METHODS.

By G. Underwood. N. Y., McGraw-Hill Book Co., 1927. 407 pp., illus., tables, 9 x 6 in., fabrikoid. \$5.00.

In spite of the extensive literature upon construction, little is available upon the methods of construction actually in use. Mr. Underwood's book, in which he presents standard methods, will therefore be decidedly interesting to superintendents of construction, contractors and others engaged in building. The subject is treated comprehensively. The methods advocated are described simply and precisely.

STREAM GAGING.

By William Andrew Liddell. N. Y., McGraw-Hill Book Co., 1927. 238 pp., illus., diags., tables, 9 x 6 in., cloth. \$3.00.

This volume presents briefly the theories of stream flow which bear on stream gaging, considers practical methods for applying these theories to the measurement of flow, examines the characteristics of the various measuring devices, and outlines methods for analyzing stream-flow data. The book provides a ready working knowledge of the general nature of stream flow and of practical methods for determining the rate of discharge.

VERSUCHE UBER DEN EINFLUSS NIEDERER TEMPERATUR AUF DIE WIDERSTANDSAHIGKEIT VON ZEMENTMORTEL UND BETON. (Deutscher Ausschuss für Eisenbeton, heft 57). Berlin, Wilhelm Ernst & Sohn, 1927. 44 pp., illus., diags., 11 x 8 in., paper. 5,20 r. m.

The investigations described in this pamphlet were undertaken to ascertain the extent to which the well-known retardation of the setting of cement at low temperatures affects the later hardening of cement and concrete. Tests were made of cements laid at or below the freezing-point of water and maintained at low temperatures for one to two weeks, of the effect of additions of calcium chloride, of the effect of frost upon partially set cement, and of the effect of repeated freezing and thawing upon cement and concrete. Conclusions are drawn of practical importance.

Engineering Societies Employment Service

Under joint management of the national societies of Civil, Mining, Mechanical and Electrical Engineers cooperating with the Western Society of Engineers. The service is available only to their membership, and is maintained as a cooperative bureau by contributions from the societies and their individual members who are directly benefited.

Offices:—33 West 39th St., New York, N. Y.,—W. V. Brown, Manager.

53 West Jackson Bl'v'de., Room 1736, Chicago, Ill., A. K. Krauser, Manager.

57 Post St., San Francisco, Calif., N. D. Cook, Manager.

MEN AVAILABLE.—Brief announcements will be published without charge but will not be repeated except upon requests received after an interval of one month. Names and records will remain in the active files of the bureau for a period of three months and are renewable upon request. Notices for this Department should be addressed to **EMPLOYMENT SERVICE, 33 West 39th Street, New York City**, and should be received prior to the 15th day of the month.

OPPORTUNITIES.—A Bulletin of engineering positions available is published weekly and is available to members of the Societies concerned at a subscription rate of \$3 per quarter, or \$10 per annum, payable in advance. Positions not filled promptly as a result of publication in the Bulletin may be announced herein, as formerly.

VOLUNTARY CONTRIBUTIONS.—Members obtaining positions through the medium of this service are invited to cooperate with the Societies in the financing of the work by nominal contributions made within thirty days after placement, on the basis of \$10 for all positions paying a salary of \$2000 or less per annum; \$10 plus one per cent of all amounts in excess of \$2000 per annum; temporary positions (of one month or less) three per cent of total salary received. The income contributed by the members, together with the finances appropriated by the four societies named above will it is hoped, be sufficient not only to maintain, but to increase and extend the service.

REPLIES TO ANNOUNCEMENTS.—Replies to announcements published herein or in the Bulletin, should be addressed to the key number indicated in each case, with a two cent stamp attached for reforwarding, and forwarded to the Employment Service as above. Replies received by the bureau after the positions to which they refer have been filled will not be forwarded.

POSITIONS OPEN

PERMANENT POSITION in South America is open for an energetic graduate civil engineer who speaks Spanish and is qualified to successfully sell and promote materials entering into modern street and road construction. Remuneration commensurate with ability. Submit complete statement of experience and training and a recent photograph. Applications will be treated with strict confidence. X-2353 C-8.

ELECTRICAL DESIGN ENGINEER, competent to redesign existing line of A-C. motors and assume responsible control of induction motor engineering section. Location, Buffalo District. Apply by letter. X-3138-C.

MEN AVAILABLE

ELECTRICAL ENGINEER, sixteen years' experience including specialization in underground distribution of design and construction, overhead transmission, railway electrification, also general electrical construction. M. I. T. graduate; member A. I. E. E. and N. E. L. A., two years' experience in committee work with the latter; N. Y. State license. Desires position as transmission and distribution engineer, location United States. A-2024.

COMMERCIAL ENGINEER, graduate 1908, thoroughly experienced in power sales for large industrial operations, invites correspondence with holding company who require executive to

organize actively department for negotiations of larger power contracts and to build up power load. A successful record and highest type of reference as to character; ability of accomplishment and personality offered. B-4221.

PUBLIC UTILITY EXECUTIVE, 47, technical graduate, twenty-five years' experience in all kinds of public utility work. Ten years' experience in construction, engineering and operation of steam and hydro-electric systems, including generation, transmission and distribution. Fifteen years' experience in executive capacity, covering appraisals, rate structures and adjustments, public service commission controversies, new business campaigns. Experienced in the management of

electric, artificial gas and steam heating. Now engaged in winding up affairs of large public utility. C-3304.

DRAFTSMAN, with fifteen years' experience in laying out electrical systems. Available September 15th. Construction work preferred. Salary \$300 a month. C-28.

TRANSMISSION LINE ENGINEER, university graduate, over ten years' experience in design of transmission lines. Formulation and application of safety codes, design of structures, standardization, sag and tension investigations, etc. At present in charge of transmission line design in large organization. C-2014.

TECHNICAL GRADUATE, 25, married, experienced in polyphase and single phase meter work, also some experience in construction, maintenance and general testing. B-7464.

SALES ENGINEER, 27, single, who gained his commercial experience in the real estate field, wishes to connect with reputable firm. Has been for years on substation electrical design with big utility in New York City. Westinghouse experience on wiring, assembling and designing of switchboards. Practical experience on substation electrical construction, house wiring and machine shop work. Speaks German. Location immaterial. C-2522.

ELECTRICAL AND MECHANICAL ENGINEER, 42, married, twenty years' experience in supervising and directing engineering, designing of power and substations, industrial plants, pulverized fuel systems and electric transmission. Made power studies, prepared reports, specifications and costs of construction and operation of

various plants. Unquestionable references furnished. B-3054.

TECHNICAL GRADUATE, 28, with seven years' experience in testing and service work on many types of industrial electrical apparatus, wishes position with medium sized concern on sales and service proposition. Northern New Jersey preferred. References. C-3020.

INDUSTRIAL ENGINEER, M. I. T., six years, chemistry, physics, mechanical engineering. Experienced technician, designer, executive, practical economist. Now industrial engineer on industrial and financial investigations, production and labor analyses, plant and equipment layout, costs, systematizing, standardization, routing. Desires position Philadelphia, New York, as assistant to executive or industrial engineer where profits must be increased. B-9030.

MEMBERSHIP — Applications, Elections, Transfers, Etc.

ASSOCIATES ELECTED AUGUST 9, 1927

ADAMS, WILLIAM E., Service Engineer, Elliott Engineering Co., Inc., 215 Washington St., Binghamton, N. Y.

BENDER, LESLIE L., Sales Engineer, Morganite Brush Co., 3302 Anable Ave., Long Island City, N. Y.; res., Lansdowne, Pa.

BERG, GUNNAR, Assistant Sales Engineer, Westinghouse Electric International Co., 150 Broadway, New York, N. Y.

BERUMEN, JOSE ABRAHAM, Electrical Engineer, 924 Morelos Ave., Torreon, Coahuila, Mex.

BRINKLER, JOHN STANLEY, Draftsman, General Electric Co., Lynn, Mass.

BROWNE, PATRICK J., Distribution Division, Engineering Dept., Commonwealth Edison Co., 72 W. Adams St., Chicago, Ill.

CANNON, DOYLE L., Safety Engineer, Carolina Power & Light Co., Raleigh, N. C.

COLLETT, CHARLES S., Central Office Maintenance, Avalon Telephone Co., Ltd., St. Johns, Newfoundland.

CORONADO, CHARLES ARTHUR, Member of Electrical Engineering Staff, Compania Petrolera Lobitos, Restin, Peru, So. Amer.

CUNNINGHAM, J. A., Instructor, Electrical Engineering Dept., Iowa State College, Ames, Iowa.

DAVIS, WILLIAM JOHN, Substation Operator, Commonwealth Edison Co., 362 W. Ohio St., Chicago, Ill.

***DEVINE, PERLE ALFRED**, Graduate Assistant, Electrical Engineering Dept., Iowa State College, Ames; res., Des Moines, Iowa.

DUCOTÉ, CHARLES HUESMANN, Electrical Engineer, Stone & Webster, Inc., 49 Federal St., Boston, Mass.

EVANS, ROBERT LESLIE, Consumers' Engineering Assistant, Shanghai Municipal Electricity Department, Shanghai, China.

FILLMORE, JAMES M., Contractor, 23 Spring St., Norwich, Conn.

FRANCA, ABILIO, Survey Tracer, Brooklyn Edison Co., Inc., 360 Pearl St., Brooklyn, N. Y.

GEIS, HAROLD WILLIAM, Switchman, New York Telephone Co., 121 W. 73rd St., New York, N. Y.

GOODWIN, HAROLD FRANK, Engineer, Jackson & Moreland, Park Square Bldg., Boston, Mass.

GRAY, WILLIAM H., Foreman, Electrical Construction, Columbia Steel Co., Elyria, Ohio.

***GREEN, CECIL H.**, Research Engineer, Raytheon Manufacturing Co., Kendall Sq. Bldg., Cambridge; res., Allston, Mass.

GROSS, FELIX P., Electrical Engineer, Central Public Service Co., 209 S. La Salle St., Chicago, Ill.

GROVE, ARTHUR WILSON, Assistant, Engineering Dept., Gibbs & Hill, Penna. Station, New York, N. Y.; res., Yerkes, Pa.

HEALY, KENT TENNEY, Speen St., Natick, Mass.

HUKINO, SHIGEZO, Chief Signal Engineer & Maintenance of Overhead Line Construction, Hanshin Kyuko Dentetsu, Osaka, Japan.

HOKANSON, CARL GUSTAV, JR., Electrical Service Inspector, Bureau of Power & Light, 207 S. Broadway, Los Angeles, Calif.

HOLLY, GEORGE S., Chief Engineer, Newcombe-Hawley, Inc., St. Charles, Ill.

JEFFREY, ELMER F., Maintenance Supervisor, Western Union Telegraph Co., 606 Sloan Bldg., Cleveland, Ohio.

JONES, CHARLES NELSON, Mechanical & Electrical Engineer, Brown & Bailey Co., 410 N. Franklin St., Philadelphia, Pa.

KEENE, ROY, Superintendent of Substations, Mississippi Power & Light Co., Jackson, Miss.

KELLY, FRED GRIFFEN, JR., Electrical Engineer, Westinghouse Elec. & Mfg. Co., East Pittsburgh; res., Wilkesburg, Pa.

LANNING, H. R., Chief Operator of Hydro Plants, Light Department, City of Seattle, Nisqually Power Plant, La Grande, Wash.

MacFARLANE, JOHN MacDONALD, Head of Electrical Dept., State Trade School, New Britain, Conn.

***MacGUFFIE, CHARLES IRVING**, Data Engineer, General Electric Co., Schenectady, N. Y.

MARKS, MILTON MAURICE, Electrical Engineer, Crane Co., South Ave., Bridgeport, Conn.

MASKILLEYSON, LEV, Asst. Professor, High-Tension Laboratory, Electrotechnical Institute, Pesotschnaya 5, Leningrad, Russia.

McCALEB, THOMAS S., Radio Engineer, Liberian Government, Monrovia, Liberia, West Africa.

McGILL, CHESTER WILLIAM, Electrical Engineer, Edison Electric Illuminating Co., 39 Boylston St., Boston, Mass.

McLEAN, TRUE, Instructor, Electrical Engineering Dept., Cornell University, Franklin Hall, Ithaca, N. Y.

MEALY, EARL GRANVILLE, Electrical Engineer, Ohio Boxboard Co., Rittman, Ohio.

MELLETT, PERCIVAL McDONALD, Electrician, Mountain Park Collieries, Ltd., Mountain Park, Alta., Can.

MILLER, SAM OLIVER, Merchandising Engineer, Mine & Smelter Supply Co., El Paso, Texas.

MILLS, BRENT, Manager, Chicago Office, Lapp Insulator Co., 140 S. Dearborn St., Chicago, Ill.

NIERLICH, GOTTFRIED, E. Frederics, Inc., 49-57 W. 37th St., New York, N. Y.

NYE, HAROLD EDWIN, Electrician, Warner Bros. Pictures Corp., 5842 Sunset Blvd., Hollywood, Calif.

QUALLINS, GEORGE ANDREW, Appraisal Engineer, New York Edison Co., 130 E. 15th St., New York, N. Y.; res., Westwood, N. J.

RAJU, M. G., Principal, Government School of Handicrafts, Assam, Sylhet, India.

RICKARD, ERIC MARTYN, Salesman, Wedjit Tie Co., Grand Central Office Bldg., New York, N. Y.

***RUDGE, WILLIAM JEROME, JR.**, Student Engineer, Lightning Arrester Dept., General Electric Co., Pittsfield, Mass.

SALERNO, MARCUS JOSEPH, 141 W. 75th St., New York, N. Y.

SALVATORE, MICHAEL, Draftsman, Electric Locomotive Works, The Baldwin Locomotive Works, Philadelphia, Pa.

SCALES, GEORGE BURTON, Electrical Operating Engineer, New England Structural Co., Second St., Everett; res., Cambridge, Mass.

SCHAD, ALFRED E., Sales Engineer, Westinghouse Elec. & Mfg. Co., 121 E. Baltimore St., Baltimore, Md.

***SCHWARZ, EDWIN**, 289 North Second St., Pittsfield, Mass.

SKAAR, EINAR, Electrical Engineer, Skandinavisk Kabel & Gummifabriker, Nordal, Aker, Norway.

SMITH, BENJAMIN DAY, Eastern Manager, Sterling Varnish Co., 147 Headley Terrace, Irvington, N. J.

SNELL, EDWARD JUSTUS, Laboratory Helper, Public Service Electric & Gas Co., Durham Ave., Metuchen, N. J.; res., Brooklyn, N. Y.

STRADLING, HOWARD MICHNER, Electrical Contractor, 311 N. Alabama St., Indianapolis, Ind.

SVELA, OLA JANASSEN, Electrical Designer, New York Edison Co., New York; res., Brooklyn, N. Y.

TAYLOR, PHILIP LEONARD, Laboratory Assistant, Westinghouse Elec. & Mfg. Co., East Pittsburgh; res., Wilkesburg, Pa.

TELMO, PEDRO M., Assistant Electrical-Naval Engineer, Public Utility Commission, Manila, P. I.

UNGERER, FRED A., 2038 72nd St., Brooklyn, N. Y.

WALKER, A. S., Superintendent of Distribution, New England Power Co., 35 Harvard St., Worcester; res., Millbury, Mass.

WEIR, PAUL LATIMER, Byllesby Engineering & Management Corp., 435 Sixth Ave., Pittsburgh; res., Wilkesburg, Pa.

WILSON, IRVING CLIFFORD, Assistant Electrician, Lane Hospital, 1334 24th Ave., San Francisco, Calif.

YOUNG, ROBERT A., Sales Manager, Petroleum Engineering Corp., E. Main St., Bradford, Pa.

Total 65.

*Formerly enrolled Students.

ASSOCIATES REELECTED AUGUST 9, 1927

CARSWELL, HOWARD LAMPREY, Electrical Engineer, Service Dept., A. B. See Electric Elevator Co., 52 Vesey St., New York; res., Brooklyn, N. Y.

HOPKINS, HENRY DEMING, Designer, Commonwealth Edison Co., 72 W. Adams St., Chicago, Ill.

PAWSON, HERBERT EDWIN, Assistant Commercial Manager, Southern Canada Power Co., Ltd. & Power Corp. of Canada, Ltd., 330 Coristine Bldg., Montreal, Que., Can.

PEACOCK, WORTH C., Service Engineer, Air Reduction Sales Co., 342 Madison Ave., New York, N. Y.

SPERLING, R. H., Factory Manager, Canadian Celanese Ltd., Drummondville, Que., Can.

ASSOCIATES REINSTATED AUGUST 9, 1927

BADGLEY, ARTHUR DAVISON, Designing Engineer, General Electric Co., 1 River Road, Schenectady, N. Y.

BRU, EDMUND H., Charge of Elec. & Mech. Maintenance, Schlage Lock Mfg. Co., Bay Shore, San Francisco; for mail, Mountain View, Calif.

MEMBERS ELECTED AUGUST 9, 1927

CHOJECKI, STEPHEN L., Lecture, High Tension Laboratory, Electrotechnical Institute; Member of Committee, State Patent Office, Fontanka 76/78, Leningrad, (U. S. S. R.) Russia.

DIXON, W. R., General Supt., Florida Public Service Co., 100 E. Central Ave., Orlando, Fla.

OLESEN, HAROLD L., Radio Engineer, Fansteel Products Co., Inc., North Chicago; res., Highland Park, Ill.

VIBBARO, EDWARD L., Bell Tel. Laboratories, Inc., 463 West St., New York, N. Y.

TRANSFERRED TO THE GRADE OF MEMBER AUGUST 9, 1927

WARNER, EARLE E., Industrial Engg. Dept., General Electric Company, Schenectady, N. Y.

RECOMMENDED FOR TRANSFER

The Board of Examiners, at its meeting held July 19, 1927, recommended the following members for transfer to the grade of membership indicated. Any objection to these transfers should be filed at once with the National Secretary.

To Grade of Member

BODEN, WALTER A., Sales Engineer, Ward Leonard Electric Co., Mt. Vernon, N. Y.

BROWN, FREDERIC S., Assistant Electrical Engineer, Bylesby Engg. & Mgt. Corp., Pittsburgh, Pa.

BUGBEE, RALPH L., Electrical Designer, Stone & Webster, Inc., Boston, Mass.

CALL, LLOYD L., Chief Engineer, Victor X-Ray Corp., Chicago, Ill.

CANARIS, SVEND A., Senior Engineer, Duquesne Light Co., Pittsburgh, Pa.

CHU, FU I., Electrical Engineer, Chinese Govt. Tel. Adm., Shanghai, China.

CONKLING, DEWITT C., Electrical Machinist, The Panama Canal, Balboa, Canal Zone.

DAVIS, WILLIAM S., Meter and Wiring Engineer, Public Service Electric & Gas Company, Newark, N. J.

DAZA, GABRIEL A., Supervising Engineer and Assistant General Manager, Visayan Electric Co.—Assistant General Manager, Visayan Electrical Supply Co., Cebu, P. I.

ELDREDGE, WILLIAM S., Testing Engineer in charge of Generating Stations, Commonwealth Edison Co., Chicago, Ill.

ELLIOTT, EDWARD B., Engineer, Stone & Webster, Inc., Boston, Mass.

FARON, FRANK A., Electrical Engineer, Railway Engg. Dept., General Electric Co., Schenectady, N. Y.

FLEMISTER, S. A., Transmission and Protection Engineer, Southern Bell Tel. & Tel. Co., Atlanta, Ga.

GEORGE, ROBERT B., Electrical Engineer, Westinghouse Elec. & Mfg. Co., Sharon, Pa.

GOODALE, J. ELMER, Assistant Electrical Engineer, N. Y. & Queens Elec. Lt. & Pr. Co., Flushing, N. Y.

GOODMAN, LYNN S., Assistant Supt., Statistical Bureau, Edison Electric Illuminating Co. of Boston, Boston, Mass.

HERBST, WILLIAM B., Assistant Electrical Engineer, Dept. of City Transit, Philadelphia, Pa.

HIGGINS, D. D., Electrical Assistant to Supt., Generating Stations, Commonwealth Edison Co., Chicago, Ill.

HOLBEN, WILMER P., Distribution Design-Section Engineer, Bylesby Engg. & Mgt. Corp., Pittsburgh, Pa.

KYLE, GEORGE L., Electrical Engineer, U. S. L. Battery Corp., Niagara Falls, N. Y.

LANGSTAFF, HAROLD A. P., Relay Engineer, West Penn Power Co., Pittsburgh, Pa.

LANSIL, CLIFFORD E., Assistant Prof. of Electrical Engineering, Massachusetts Institute of Technology, Cambridge, Mass.

LAURENCOT, HENRY J., Assistant System Engineer, Brooklyn Edison Co., Brooklyn, N. Y.

LEUREY, LOUIS F., Consulting Electrical Engineer, 58 Sutter St., San Francisco, Calif.

LOSHING, CLEMENT K., Electrical Engineer, Cleveland Electrical Illuminating Co., Cleveland, Ohio.

LUICHINGER, MARTIN J., Foreign Wire Relations Engineer, Indiana Bell Telephone Co., Indianapolis, Indiana.

MACRAE, FRED G., Sales Engineer, Electric Service Supplies Co., Chicago, Ill.

MERLIN, HOWARD R., Electrical Research Engineer, Interborough Rapid Transit Co., New York, N. Y.

NORMAN, HORACE M., Design Engineer, Westinghouse E. & M. Co., East Pittsburgh, Pa.

PERLEY, FRANK G., Industrial Power Engineer, Connecticut Power & Light Co., Norwalk, Conn.

PFEIFFER, CONRAD L., Engineer, Western Electric Co., Chicago, Ill.

QUIRK, WILLIAM G., Supervising Chief Inspector, City of New York, Municipal Bldg., New York, N. Y.

ROSEVEAR, MORRIS B., Engineer, American Brown Boveri Electric Corp., Camden, N. J.

ROSS, LINDSLEY W., Secretary of Employment and Training, Pacific Telephone & Telegraph Co., Seattle, Washington.

RUPP, WELLINGTON, Chief Engineer, Dept. of Public Works of Washington, Olympia, Wash.

RUSSELL, EDWARD G., Electrical Engineer, Dept. of Water & Power, Los Angeles, Calif.

SAALBERG, WILLIAM H., Underground Engineer, The Ohio Power Co., Canton, Ohio.

STAMM, OTTO E., Chief of Planning Bureau, Distribution Dept., N. Y. Edison Co., New York, N. Y.

STEELE, GEORGE F., Consulting Engineer, General Electric Co., Boston, Mass.

STEPHENS, HOWARD O., Engineer, Transformer Dept., General Electric Co., Pittsfield, Mass.

SWENSON, GEORGE W., Assistant Professor, University of Minnesota, Minneapolis, Minn.

SWOBODA, H. O., Consulting Engineer, 3400 Forbes St., Pittsburgh, Pa.

THOMAS, JOSEPH E., Supt. of Operation, West Penn Power Co., Pittsburgh, Pa.

VOGDES, FRANCIS B., Research Laboratory, General Electric Co., Schenectady, N. Y.

WAGNER, CHARLES F., Transmission Engineer, Westinghouse E. & M. Co., East Pittsburgh, Pa.

WICKERSHEIM, LYLE W., Engineer, Southern Calif. Telephone Co., Los Angeles, Calif.

WILSON, WILLIAM, Head Switchgear Development Dept., General Electric Co., Witton, Birmingham, England.

WRIGHT, EARL L., Transformer Specialist, General Electric Co., Philadelphia, Pa.

APPLICATIONS FOR ELECTION

Applications have been received by the Secretary from the following candidates for election to membership in the Institute. Unless otherwise indicated, the applicant has applied for admission as an Associate. If the applicant has applied for direct admission to a higher grade than Associate, the grade follows immediately after the name. Any member objecting to the election of any of these candidates should so inform the Secretary before September 30, 1927.

Abraham, G. P., Philadelphia Electric Co., Philadelphia, Pa.

Alderman, H. L., Electric Bond & Share Co., New York, N. Y.

Allen, A. J., (Member), American Tel. & Tel. Co., New York, N. Y.

Armour, W., Windsor Hydroelectric System, Windsor, Ont., Can.

Barnhart, C., Cooper Corp., Findlay, Ohio

Blowes, W. J., E. L. Phillips & Co., Far Rockaway, N. Y.

Buchman, A. R., East Ohio Gas Co., Cleveland, Ohio

Court, W. E., Lake Buntzen Pr. Plant, Vancouver Pr. Co., Burrard Inlet Floating P. O., Lake Buntzen, B. C.

Derenkowsky, P., 904 Tiffany St., New York, N. Y.

Downer, J. B., City of Seattle Water Dept., Seattle, Wash.

Garroway, D. C., Locke Insulator Corp., St. Louis, Mo.

Heap, J. G., General Electric Co., St. Louis, Mo.

Hilton, E. J., Scranton Electric Co., Scranton, Pa.

Hollister, J. W. A., Trinidad Electric Trans., Ry. & Gas Co., Trinidad, Colo.

Hooper, D. B., Canadian Pacific Railway, Alberta, Can.

Jefferson, H. D., Matson Navigation Co., S. S. Malolo, San Francisco, Calif.; for mail, New York, N. Y.

Johnson, O. E., Puget Sound Power & Light Co., Seattle, Wash.

Kelley, F. E., Products Protection Corp., New Haven, Conn.

Kennedy, J. T., Cutler-Hammer Mfg. Co., Milwaukee, Wis.

E. 1927-1928

ERARDI
 (Term expires July 31, 1929)
C. C. CHESNEY

ENTS
 (Terms expire July 31, 1929)
 Ferguson (District No. 6)
NORTHMORE (District No. 8)
BEAVER (District No. 2)
COOPER (District No. 10)
BICKELHAUPT (District No. 4)

S
 (Terms expire July 31, 1930)
E. MOULTROP
C. DON CARLOS
J. CHESTERMAN
 (Terms expire July 31, 1931)
C. HANKER
B. MEYER
P. LIVERSIDGE

NATIONAL SECRETARY
 (1928-1929)
L. HUTCHINSON
GENERAL COUNSEL
ARKER & AARON
 Broad Street, New York

1884-1927
FRY G. STOTT, 1907-8.
IS A. FERGUSON, 1908-9.
IS B. STILLWELL, 1909-10.
ALD C. JACKSON, 1910-11.
O DUNN, 1911-12.
PH D. MERSHON, 1912-13.
. MAILLOUX, 1913-14.
L. M. LINCOLN, 1914-15.
N J. CARTY, 1915-16.
V. BUCK, 1916-17.
7. RICE, JR., 1917-18.
FORT A. ADAMS, 1918-19.
VERT TOWNLEY, 1919-20.
F. BERRESFORD, 1920-21.
LIAM MCCLELLAN, 1921-22.
NK B. JEWETT, 1922-23.
RIS J. RYAN, 1923-4.
LEY OSGOOD, 1924-25.
. PUPIN, 1925-26.
C. CHESNEY, 1926-27.

SECRETARIES
 res, Argentina, S. A.
 Co. Ltd., Cathcart House,
 tralia.
 S. W. I, England.
 France.
 y House, Bombay, India.
 ilan, Italy.
 ch, New Zealand.
 olm, Sweden.
 rg, Transvaal, Africa.

Committees

COMMITTEES

MITTEE
 York, N. Y.
 I. E. Moulthrop,
 E. C. Stone.

FINANCE COMMITTEE

H. A. Kidder, Chairman, 600 W. 59th Street, New York, N. Y.
 G. L. Knight, E. B. Meyer.

MEETINGS AND PAPERS COMMITTEE

H. P. Charlesworth, Chairman, 195 Broadway, New York, N. Y.
 E. H. Hubert, Secretary, 33 W. 39th St., New York, N. Y.
 E. E. F. Creighton, J. E. Macdonald, L. W. W. Morrow,
 A. E. Knowlton, E. B. Meyer, H. S. Osborne,
 A. M. MacCutcheon, C. E. Skinner.
 Chairman of Committee on Coordination of Institute Activities, *ex-officio*.
 Chairmen of technical committees, *ex-officio*.

PUBLICATION COMMITTEE

E. B. Meyer, Chairman, 80 Park Place, Newark, N. J.
 H. P. Charlesworth, F. L. Hutchinson, L. F. Morehouse,
 Donald McNicol.

COMMITTEE ON COORDINATION OF INSTITUTE ACTIVITIES

G. L. Knight, Chairman, Pearl & Willoughby Sts., Brooklyn, N. Y.
 C. O. Bickelhaupt, F. L. Hutchinson, W. B. Kouwenhoven,
 H. P. Charlesworth, H. A. Kidder, E. B. Meyer.

BOARD OF EXAMINERS

E. H. Everit, Chairman, Southern New England Telephone Co.,
 New Haven, Conn.
 H. C. Don Carlos, Harold Goodwin, F. V. Magalhaes,
 H. W. Drake, S. P. Grace, L. W. W. Morrow,
 F. M. Farmer, Erich Hausmann, W. I. Slichter,
 Charles D. Knight.

SECTIONS COMMITTEE

W. B. Kouwenhoven, Chairman, Johns Hopkins University, Baltimore, Md.
 J. L. Beaver, H. H. Schoolfield, Harold B. Smith,
 D. M. Simons,
 Chairmen of Sections, *ex-officio*.

COMMITTEE ON STUDENT BRANCHES

J. L. Beaver, Chairman, Lehigh University, Bethlehem, Pa.
 C. E. Magnusson, Charles F. Scott, W. H. Timbie,
 R. W. Sorensen,
 Student Branch Counselors, *ex-officio*.

MEMBERSHIP COMMITTEE

E. B. Merriam, Chairman, General Electric Co., Schenectady, N. Y.
 R. B. Bonney, J. J. Frank, S. H. Mortensen,
 G. O. Brown, F. R. George, L. J. Stacy,
 E. S. Code, M. B. Hastings, George J. Yundt,
 George M. Keenan,
 Chairmen of Section membership committees, *ex-officio*.

HEADQUARTERS COMMITTEE

G. L. Knight, Chairman, Pearl & Willoughby Sts., Brooklyn, N. Y.
 F. L. Hutchinson, H. A. Kidder.

LAW COMMITTEE

C. O. Bickelhaupt, Chairman, Southern Bell Telephone &
 Telegraph Co., Atlanta, Ga.
 H. H. Barnes, Jr., E. B. Merriam, W. I. Slichter,
 R. F. Schuchardt.

PUBLIC POLICY COMMITTEE

H. W. Buck, Chairman, 49 Wall Street, New York, N. Y.
 Gano Dunn, John W. Lieb, M. I. Pupin,
 F. B. Jewett, William McClellan, Harris J. Ryan.

STANDARDS COMMITTEE

J. F. Meyer, Chairman, Bureau of Standards, Washington, D. C.
 H. E. Farrer, Secretary, 33 W. 39th St., New York.
 H. A. Kidder, H. S. Osborne, C. E. Skinner,
 A. M. MacCutcheon, F. L. Rhodes, W. I. Slichter,
 F. D. Newbury, L. T. Robinson, R. H. Tapscott,

Ex-Officio

Chairmen of Working Committees.
 Chairmen of delegations on other standardizing bodies.
 President of U. S. National Committee of I. E. C.

COMMITTEE ON AWARD OF INSTITUTE PRIZES

Worth, Chairman, 195 Broadway, New York, N. Y.

COMMITTEE ON COLUMBIA UNIVERSITY SCHOLARSHIPS

Chairman, Columbia University, New York, N. Y.

Francis Blossom, H. C. Carpenter.

COMMITTEE ON SAFETY CODES

Chairman, 130 E. 15th St., New York, N. Y.

ts, H. B. Gear, W. T. Morrison,
F. C. Hanker, R. H. Nexsen,
H. W. Leitch, Farley Osgood,
M. G. Lloyd, H. R. Sargent,
Wills MacLachlan, W. H. Sawyer,
R. W. E. Moore, H. S. Warren.

SPECIAL COMMITTEES**LICENSING OF ENGINEERS**

om, Chairman, 52 William Street, New York, N. Y.

Gano Dunn, E. W. Rice, Jr.
L. E. Imlay,

COMMITTEE TO THE MUSEUMS OF THE PEACEFUL ARTS

Chairman, 130 E. 15th Street, New York, N. Y.

Randolph H. Nexsen, George K. Thompson.

TECHNICAL COMMITTEES**AUTOMATIC STATIONS**

enberg, Chairman, 6901 Elmwood Ave., Philadelphia, Pa.

io, Joseph Hellenthal, E. W. Seeger,
S. J. Lisberger, W. R. Smith, Jr.,
G. H. Middlemiss, E. C. Stone,
W. H. Millan, L. J. Turley,
O. Naef, F. Zogbaum.

COMMUNICATION

Chairman, Western Union Telegraph Co., 195 Broadway,

N. Y.

D. H. Gage, F. A. Raymond,
S. P. Grace, Chester W. Rice,
P. J. Howe, C. A. Robinson,
F. H. Kroger, J. K. Roosevelt,
R. H. Manson, H. A. Shepard,
S. R. Parker, J. F. Skirrow,
R. D. Parker, H. M. Turner,
H. S. Phelps, K. L. Wilkinson,
F. A. Wolff.

EDUCATION

Chairman, Franklin Hall, Cornell University, Ithaca, N. Y.

J. P. Jackson, W. L. Robb,
John Mills, R. W. Sorensen,
H. H. Norris, J. B. Whitehead,
Harold Pender, W. R. Whitney,
W. E. Wickenden.

ELECTRICAL MACHINERY

y, Chairman, Westinghouse Elec. & Mfg. Co., East Pittsburgh, Pa.

W. J. Foster, A. M. MacCutcheon,
H. M. Hobart, V. M. Montsinger,
B. G. Jamieson, J. C. Parker,
A. H. Kehoe, E. C. Stone,
R. B. Williamson.

ELECTRIC WELDING

Chairman, Lincoln Electric Co., Coit Road & Kirby Ave.,
Ohio.

Alex. Churchward, Ernest Lunn,
O. H. Eschholz, J. W. Owens,
F. M. Farmer, William Spraragen,
H. M. Hobart, H. W. Tobey,
C. J. Holslag, Ernest Wanamaker,
C. L. Ipsen.

ELECTROCHEMISTRY AND ELECTROMETALLURGY

Chairman, Bureau of Standards, Washington, D. C.

icks, E. B. Dawson, J. A. Seede,
on, F. A. J. Fitzgerald, Magnus Unger,
on, W. E. Holland, John B. Whitehead,
ark, F. A. Lidbury, J. L. Woodbridge,
lby, C. G. Schluederberg, J. L. Yardley.

ELECTROPHYSICS

f, Chairman, Cornell University, Ithaca, N. Y.

y, J. F. H. Douglas, R. A. Millikan,
y, C. L. Fortescue, C. A. Nickle,
ge, A. Hund, J. Stepien,
son, Carl Kinsley, Irving B. Smith,
W. B. Kouwenhoven, J. B. Whitehead,
K. B. McEachron.

Liaison Representatives of American Physical Society

W. F. J. Swann, A. P. Willis.

APPLICATIONS TO MARINE WORK

W. E. Thau, Chairman, Westinghouse E. & M. Co., 150 Broadway,

New York, N. Y.

Edgar C. Alger, J. S. Jones, Wm. H. Reed,
R. A. Beekman, A. Kennedy, Jr., Edgar P. Slack,
H. C. Coleman, J. B. Lunsford, H. M. Southgate,
E. M. Glasgow, E. B. Merriam, C. P. Turner,
H. Franklin Harvey, Jr., I. H. Osborne, Oscar A. Wilde,
Wm. Hetherington, Jr., G. A. Pierce, J. L. Wilson,
H. L. Hibbard, R. L. Witham.

APPLICATIONS TO MINING WORK

W. H. Lesser, Chairman, Madeira Hill & Co., Frackville, Pa.

F. N. Bosson, A. B. Kiser, W. F. Schwedes,
Graham Bright, Carl Lee, E. D. Stewart,
M. M. Fowler, John A. Malady, F. L. Stone,
E. J. Gealy, C. H. Matthews, W. A. Thomas,
L. C. Ilsley, F. C. Nicholson, E. B. Wagner,
G. M. Kennedy, H. F. Pigg, J. F. Wiggert,
R. L. Kingsland, L. L. Quigley, C. D. Woodward,
Herbert S. Sands.

GENERAL POWER APPLICATIONS

A. M. MacCutcheon, Chairman, 1088 Ivanhoe Road, Cleveland, Ohio.

D. H. Braymer, P. C. Jones, D. M. Petty,
C. W. Drake, G. A. Kositzky, H. W. Price,
J. F. Gaskill, A. C. Lanier, H. L. Smith,
Harry Grant, Austin Lloyd, A. H. Stebbins,
Clyde D. Gray, W. R. Maddocks, E. C. Stone,
E. Francis Harding, N. L. Mortensen, W. H. Timbie,
C. W. Henderson, K. A. Pauly, F. M. Weller,
H. D. James, W. C. Yates.

POWER GENERATION

W. S. Gorsuch, Chairman, 600 W. 59th Street, New York, N. Y.

N. E. Funk, Vice-Chairman.

Vern E. Alden, H. A. Kidder, I. E. Moultrap,
F. A. Allner, G. L. Knight, Marion Penn,
Robert Baker, W. H. Lawrence, F. A. Scheffler,
E. T. J. Brandon, W. S. Lee, W. F. Sims,
Paul M. Derry, F. T. Leilich, M. L. Sindeband,
James H. Fowning, James Lyman, A. R. Smith,
C. F. Hirshfeld, William McClellan, T. H. Soren,
Francis Hodgkinson, W. E. Mitchell, William M. White.

POWER TRANSMISSION AND DISTRIBUTION

Philip Torchio, Chairman, 124 E. 15th St., New York, N. Y.

R. E. Argersinger, C. L. Fortescue, P. Sporn,
R. W. Atkinson, C. D. Gibbs, E. C. Stone,
P. H. Chase, C. D. Gray, R. H. Tapscott,
W. S. Clark, K. A. Hawley, P. H. Thomas,
R. N. Conwell, J. P. Jollyman, W. K. Vanderpool,
M. T. Crawford, A. H. Kehoe, Theodore Varney,
W. A. Del Mar, A. H. Lawton, H. L. Wallau,
H. H. Dewey, D. W. Roper, H. S. Warren,
L. L. Elden, A. E. Silver, F. R. Weller,
F. M. Farmer, M. L. Sindeband, R. J. C. Wood,
Harland C. Forbes, H. R. Woodrow.

PROTECTIVE DEVICES

F. L. Hunt, Chairman, Turners Falls Power & Electric Co., Greenfield, Mass.

R. E. Argersinger, F. C. Hanker, W. H. Millan,
A. C. Cummins, E. A. Hester, R. C. Muir,
H. W. Drake, J. Allen Johnson, J. M. Oliver,
W. S. Edsall, R. L. Kingsland, A. H. Schirmer,
L. E. Frost, M. G. Lloyd, H. P. Sleeper,
James S. Hagan, K. B. McEachron, H. R. Summerhayes,
Herman Halperin, A. H. Sweetnam.

RESEARCH

F. W. Peek, Jr., Chairman, General Electric Co., Pittsfield, Mass.

H. D. Arnold, W. P. Dobson, E. W. Rice, Jr.,
Edward Bennett, V. Karapetoff, D. W. Roper,
V. Bush, A. E. Kennelly, C. H. Sharp,
E. H. Colpitts, S. M. Kintner, C. E. Skinner,
W. F. Davidson, M. G. Lloyd, R. W. Sorensen,
W. A. Del Mar, C. E. Magnusson, J. B. Whitehead.

TRANSPORTATION

J. V. B. Duer, Chairman, Pennsylvania Railroad, Altoona, Pa.

Renier Bueuwkes, H. A. Kidder, N. W. Storer,
E. R. Hill, John Murphy, H. M. Vandersluis,
W. K. Howe, W. S. Murray, Richard H. Wheeler,
D. C. Jackson, W. B. Potter, Sidney Withington.

DIGEST OF CURRENT INDUSTRIAL NEWS

NEW CATALOGUES AND OTHER PUBLICATIONS

Mailed to interested readers by issuing companies

Recording Ammeters.—Catalog 1502, ammeter section, 28 pp. Describes the Bristol line of recording ammeters for a wide variety of applications. The Bristol Company, Waterbury, Conn.

Switching and Protective Equipment.—Bulletin 32-B, 48 pp. Devoted to high-tension disconnecting switches, fuse mountings and choke coils. Delta-Star Electric Company, 2400 Block, Fulton Street, Chicago, Ill.

Static Condensers.—Bulletin 20286A. Describes static condensers for power factor correction on motor circuits, and contains descriptions and illustrations of the various types of condensers. Westinghouse Electric & Manufacturing Company, East Pittsburgh.

Electric Sign, Poster Panel and Bulletin Lighting.—Bulletin LD 131B, 36 pp. Illustrations show interesting applications of electric lighting to advertising signs. **Lighting for the Modern Store.**—Bulletin LD 132B, 44 pp. Describes and illustrates correct illuminating principles for stores. Edison Lamp Works of General Electric Company, Harrison, N. J.

Electricity in the Coal Mine.—Bulletin 1782, 16 pp. Touches upon such problems as cutting, loading, conveying, haulage, hoisting, ventilation, tippie and breaker drive, pumping and power distribution. Westinghouse Electric & Manufacturing Company, East Pittsburgh.

Wires and Cables.—Bulletin 67, 28 pp. Describes the complete line of Hazard standard wires and cables. Includes specifications covering insulation, and gives the application of these electrical wires and cables to railroad, municipal, mine, industrial and public service operations, as well as other valuable data. Hazard Manufacturing Company, Wilkes-Barre, Penn.

Ohmmeters and Circuit Testers.—Bulletin 300, Supplement 1, 4 pp. Describes the COM ohmmeter, a small, compact resistance measuring instrument with capacity from .5 ohm to 50,000 ohms. The HTD circuit tester, also described, is new and was developed for the purpose of providing a small and reliable device for circuit testing and approximate resistance measurements. Roller-Smith Company, 12 Park Place, New York.

Flywheel Effect Recommendations for Compressors.—Bulletin 500, 16 pp., entitled "Flywheel Effect Recommendations for NH₃ and CO₂ Compressors Based on Ideal Synchronous Motor Drive." It is stated that this is the first time graphic curves have been published showing the relation between current pulsations and flywheel effect for ammonia and CO₂ compressors of all different types of construction. The Ideal Electric & Manufacturing Company, Mansfield, Ohio.

Instrument Current Transformers.—Bulletin 14. Describes the new type OA instrument current transformers. It is stated that these transformers were originally produced for installation within tanks of Pacific Electric oil circuit breakers, and their success under severe operating conditions created a demand for the transformer arranged for individual mounting and for installation other than within circuit breaker tanks. The transformers are oil immersed. One of the features is that the tap leads are brought out to the entrance bushing terminal so that the ratio may be varied without disturbing the mounting or oil tank. Pacific Electric Manufacturing Company, 5815 Third Street, San Francisco, Cal.

NOTES OF THE INDUSTRY

Corning Glass Works, Corning, N. Y., has appointed Howard D. Steele as New England representative, with headquarters at 79 Milk Street, Boston, to handle the sale of Pyrex power insulators.

The Maring Wire Company, Muskegon, Michigan, manufacturers of magnet wire, has announced that contracts have been let for a branch factory containing about 25,000 square feet floor space, to be constructed at Anderson, Indiana. Executive offices will be maintained at Muskegon.

The Delta-Star Electric Company, Chicago, has purchased the Electric Connector Company of Minneapolis, manufacturers of solderless rigid stud compression connectors. These connectors will now be made in the Chicago factory and the lines greatly extended.

H. O. Swoboda, Inc., Pittsburgh, announce that they will represent the Heavi Duty Electric Company of Milwaukee, Wis., manufacturers of electric furnaces for industrial, laboratory and other purposes, and are prepared to furnish complete information and engineering advice pertaining to this line.

Additional Compensation to G-E Workers.—General Electric supplementary compensation totalling \$1,403,723.14 was distributed in August to 31,436 factory and office employees of the General Electric Company who have been in the employ of the company for five years or more. Payments represent five per cent of the employees' earnings for six months ending June 30, 1927 and were made in bonds or cash, as the employee desired.

New Portable Watthour Meter.—A new type OB portable watthour meter has recently been placed on the market by the Westinghouse Company for which several advantages are claimed, the outstanding one being the compensation for temperature errors at both unity power factor and low power factor. This compensation is inherently permanent for both the electromagnets and the permanent magnets and does not depend on the movement of mechanical parts with the variation in temperature. Superior accuracy is obtained along with a decrease in size and weight. These latter features are important considerations in a portable meter, especially where a great many meters are to be tested at widely separated points. The micrometer adjustments have been simplified and the electromagnets are of the one piece OB type. A zero reset is provided by which both pointers can be set on zero. Potential settings are changed by means of a small switch, and three current binding posts are used, so that the meter may be connected for either 1 or 10 ampere capacity.

C. M. & St. P. Electrified to Seattle.—With the opening of a ten-mile extension to the western terminal of the Chicago, Milwaukee & St. Paul Railroad, Seattle is now a terminal of the longest electrified railroad in the world. In recognition of this event, the mayor of Seattle, Mrs. Bertha K. Landes, piloted the 260-ton electric locomotive hauling the first train into Seattle from Black River Junction, where it formerly had been necessary to change to a steam-driven locomotive.

All trains, including the two through passenger trains, the Olympian and Columbian, as well as the Ranier Park Special between Seattle and Tacoma, are now drawn by General Electric 260-ton gearless electric locomotives into either Tacoma or Seattle. This extension brings the total electrification of the St. Paul road to 655 miles. This extends from Harlowton, Mont., to Avery, Idaho, a distance of 440 miles, and from Othello, Wash., to Seattle and Tacoma, a distance of 215 miles. Five mountain ranges are crossed.

The first step in the electrification of the Chicago, Milwaukee & St. Paul Railroad was inaugurated in 1915 over the Rocky Mountain division between Three Forks and Deer Lodge. In 1916 this was extended to Harlowton and westward to Alberton, and to Avery in the spring of 1917. So successful did this stretch of 440 miles prove that a few years later the Cascade division between Othello and Tacoma was electrified, leaving a gap of only 220 miles between the two electrified zones between the Cascade and Rocky Mountain ranges.

From the Early Period
of the Telegraph to the present
remarkable development in the field of Electricity

KERITE

has been continuously demonstrating the
fact that it is the most reliable and
permanent insulation known

**KERITE INSULATED
WIRE & CABLE COMPANY**

NEW YORK CHICAGO



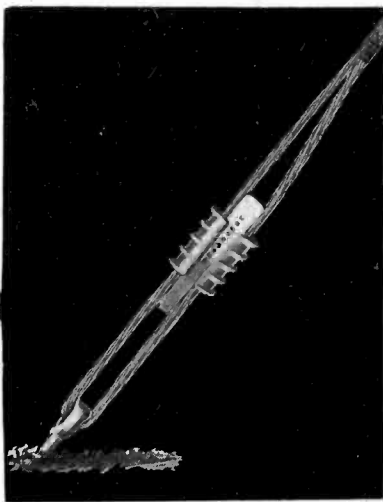
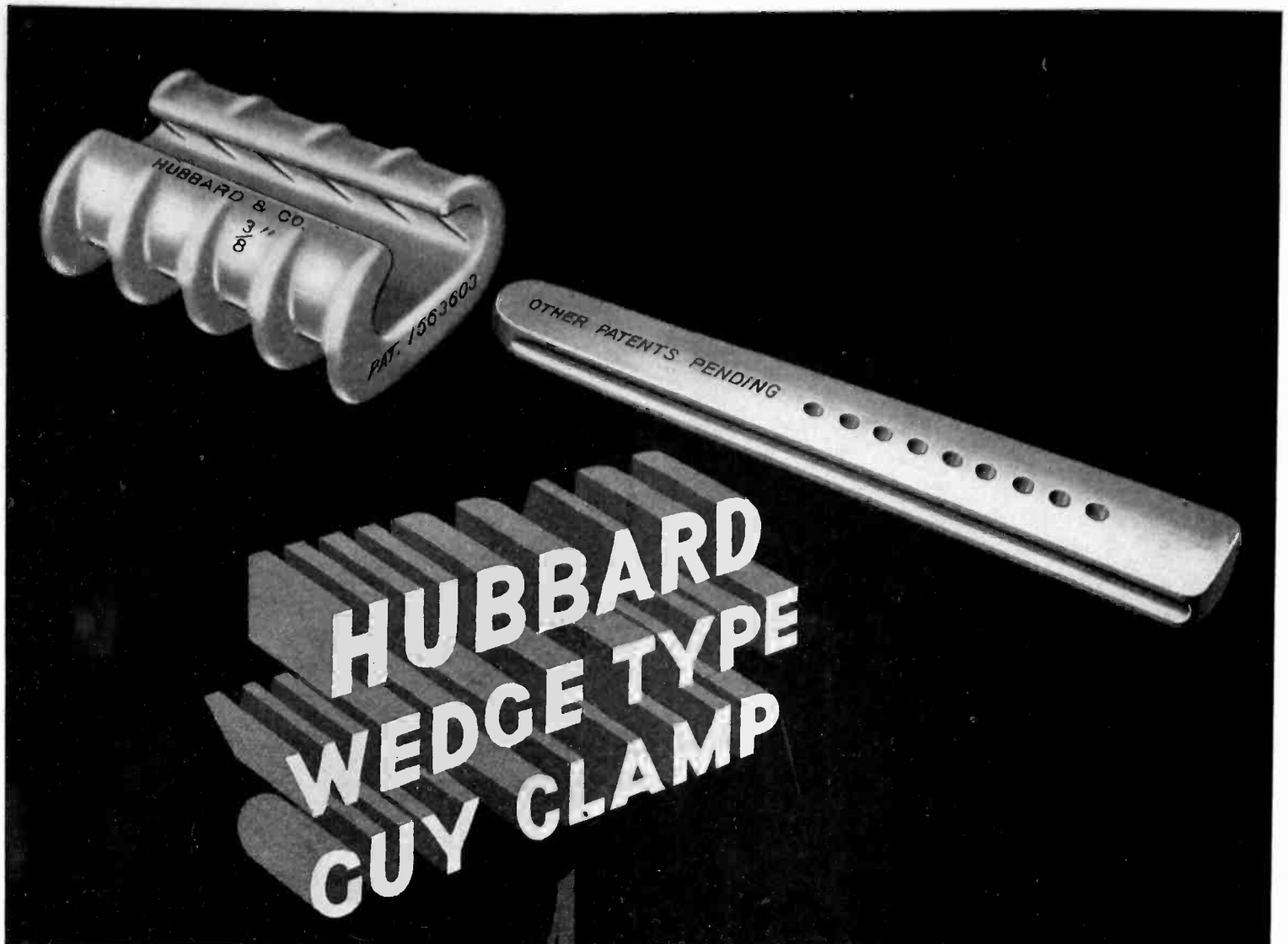

At last!

A Wedge Type Guy Clamp That Holds!

The Hubbard Wedge Type Clamp is a development from the logging camps of the far West. The great derricks with which the giant logs are handled are guyed with 1½-inch plow steel cables. Subject as they were to sudden severe strains, bolt clamps constantly slipped on these cables. The Wedge Type Clamp was evolved and for four years has proved its efficiency in this exacting service.

Hubbard and Company have obtained the patent rights for the electrical field.

The Clamp holds when applied in either direction. The springy sides of the body readily adjust to elongation of the strand when the strain is applied.

In a great number of tests the lowest strain at which the Clamp has slipped was 9000 pounds. It has the great advantage of being applied in much less time than a Three-Bolt Clamp and there is less likelihood of its not being correctly applied to hold the maximum strain. Under ordinary working conditions on ¾-inch strand it will hold as much as two Three-Bolt Clamps and can be applied in one-fourth the time.

Both parts are drop forged special alloy steel. Hot-dip galvanized. Stock number complete No. 7476.



These Guy Clamps are carried in stock and sold exclusively through the leading Electrical Jobbers.

Hubbard and COMPANY

PITTSBURGH & OAKLAND, CAL. & CHICAGO

Please mention the JOURNAL of the A. I. E. E. when writing to advertisers.

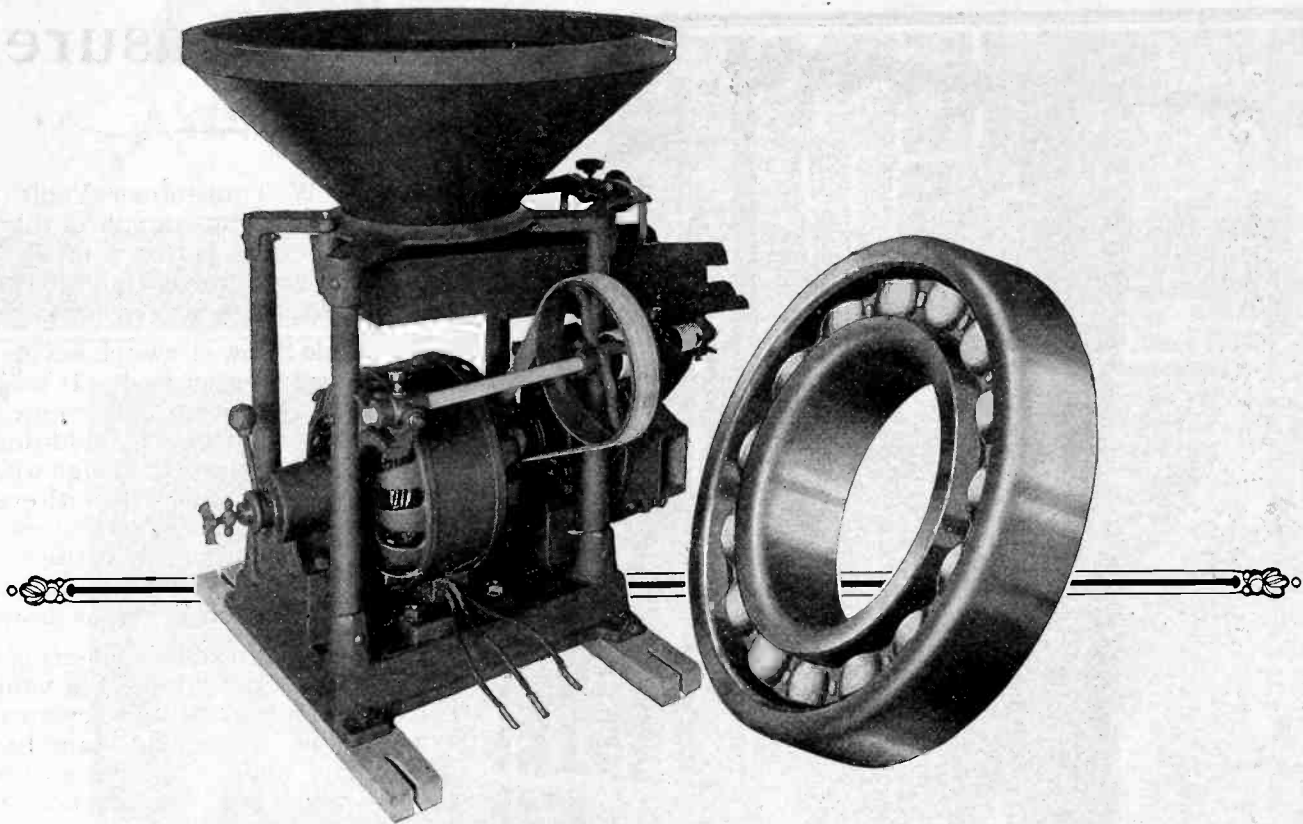

Ball Bearings Simplify Design, Construction and Maintenance

YOU can simplify construction and design compact mechanisms that will have longer life with New Departure Ball Bearings because of their inherent capacity to resist the combined radial and thrust loads of driving and driven parts with only a minimum amount of attention to lubrication and no need of readjustment.

These advantages enable you to build at less cost more efficient machines of which the Vessot Motor Driven Ball Bearing Grinder, shown here, is an example.

Lubrication is simplified because New Departures require re-lubricating only once in nine to twelve months and can be effectively sealed against dust, dirt and lubricant leakage, saving lubricant and reducing depreciation.

Added to these advantages is precision of manufacture because rotating parts mounted on New Departures remain permanently in alignment and are rigidly held without friction and without measurable wear.

Thus, where efficiency and maintenance are factors New Departure Ball Bearings are most effective and more economical than any other type of bearing. The New Departure Mfg. Co., Bristol, Conn., Chicago and Detroit.

Write for engineering data on ball bearing application. Valuable, authoritative information mailed you on request. Personal consultation with resident representatives quickly arranged by addressing the Bristol office.

New Departure Quality Ball Bearings

Maximum Continuity of Service With a Full Measure of Safety—

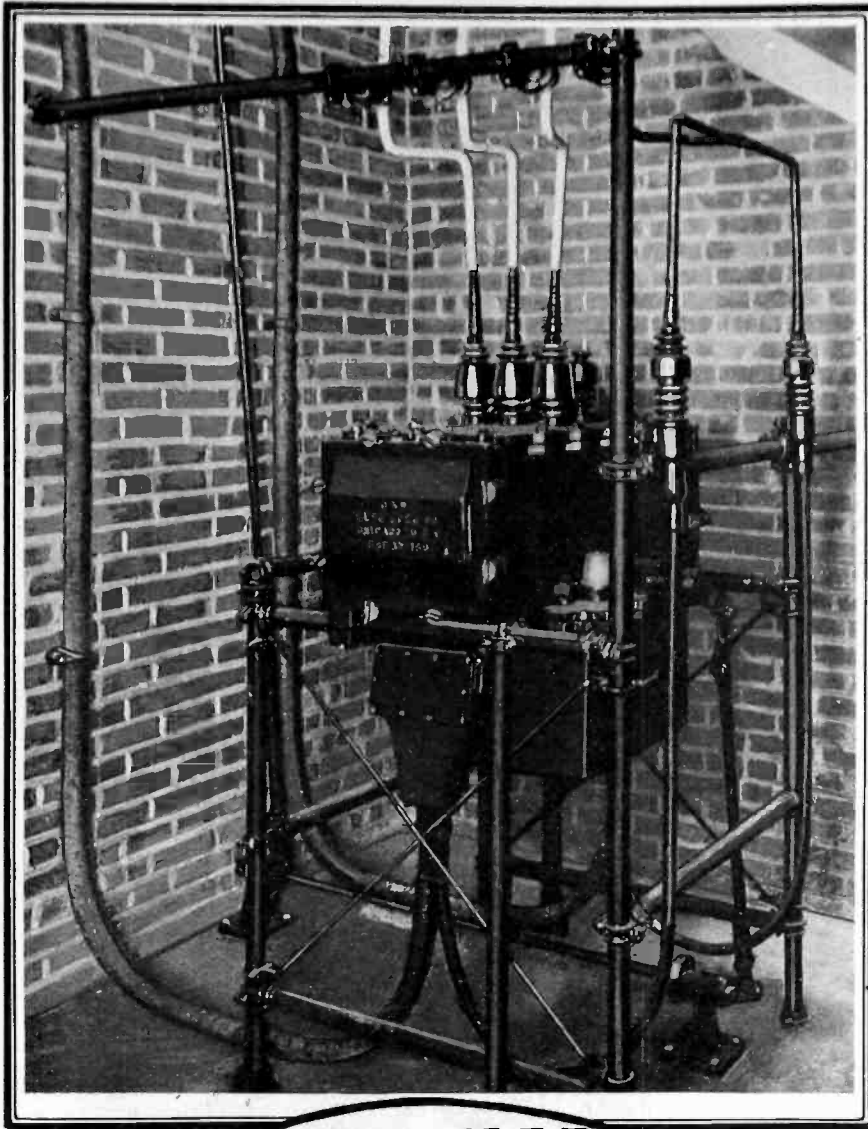

G & W TRANSFORMER VAULT UNIT

The G & W Transformer Vault Unit is another outstanding example of this organization's efforts to better your service—to bring about greater operating economy and to effect most satisfactory customer relations.

It is a double throw oil switch having on and off positions for either feed. It is operated by the house electrician thru remote manual or electrical control. In addition it is equipped with by-passes through which load may be carried on either feed with every part of the oil switch dead. These by-pass connections can also serve as a tie between the two feeds, the tie and the load feeding through or by-passing the oil switch as desired.

There are also two additional sets of disconnects on the load side of the vault unit. Thus it accommodates two separate transformer banks or one important bank and one primary main supplying a number of services which are also important. The house electrician at the "important bank" will be available to operate the unit. Two separate branches of a primary main supplying important services could also be controlled in the same manner.

Installation time is considerably reduced. The unit is not dismantled for installation of feed and load cables.

It is a space saver. Two potheads, an oil switch, air-break by-pass disconnects and two sets of load disconnects are all combined in one compact unit. It is placed in line with the transformers, effecting further space economy and economy of supporting and wiring materials.

This Unit now is being successfully used by power companies for many of their important loads.

Equipped with the G & W Automatic Master Control and combined with good engineering, it permits a low outage factor at half net work cost.

Investigate the possibilities of this unit now.

ARRANGED FOR EITHER AUTOMATIC OR
REMOTE MANUAL CONTROL

G & W designs and manufactures practically every device for the end of a cable. See our Catalog.



Exactly
what
you
want

Potheads	Underground Boxes
Series Cutouts	Conduit Bells
Primary Cutouts	Ground Pipe Caps
Oil Fuse Cutouts	Ground Pipe Points
"Oil and air break" disconnecting devices.	
Vault Units with and without automatic control.	
Oil Disconnects.	

G & W EQUIPMENT Provides for the emergencies

G & W ELECTRIC SPECIALTY CO.
7780 Dante Ave., Chicago

More than Protection **G & W** for the Cable Ends
POTHEADS AND BOXES

Please mention the JOURNAL of the A. I. E. E. when writing to advertisers.



Always associated with the best

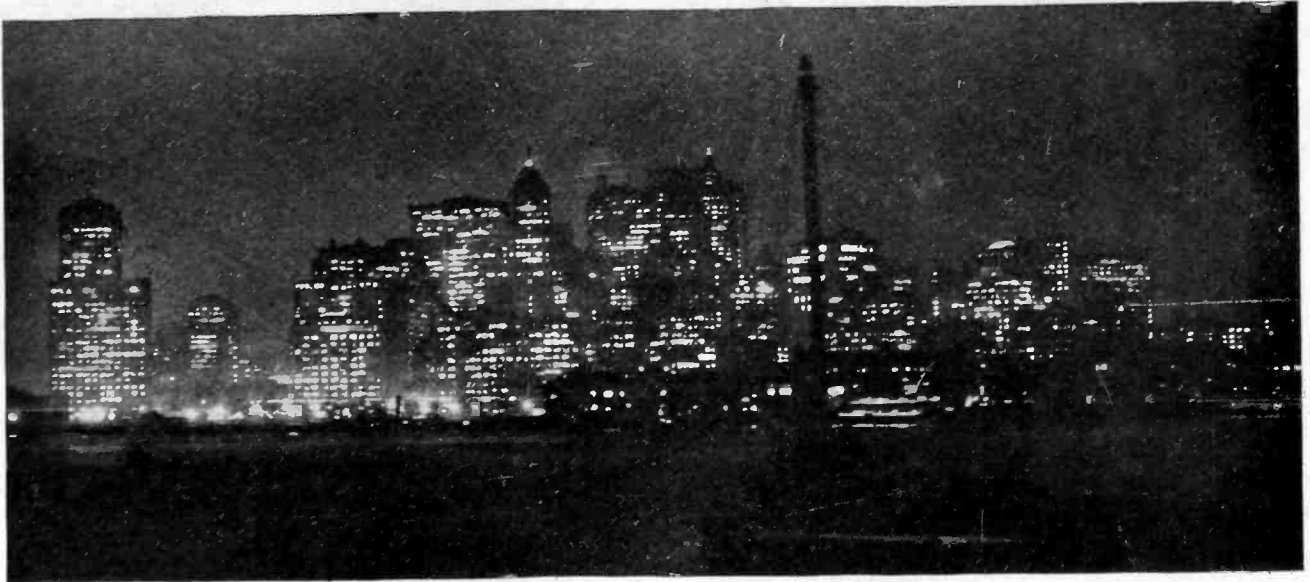

The 8th wonder of the world—

A world-famed traveler when asked what scene in all the world he enjoyed best, answered: "The New York skyline at night from the Brooklyn Bridge." True, he admitted that New York was home to him. Yet his choice is a picture that Kings, Princes, Presidents and Potentates have marveled at.

Much of New York's lighting depends upon Habirshaw Cable and Wire. Here in New York as elsewhere in many remote sections of the world, Habirshaw's long experience in wire and cable making has proved its worth.

Habirshaw success began and continues in the making of good wire. For more than thirty-five years the electrical industry has used Habirshaw cable and wire. Upon the sound foundation of a "quality first" policy an engineering and manufacturing organization known for its dependability, has been solidly built.

HABIRSHAW CABLE AND WIRE CORPORATION

10 East 43rd Street, New York City

Plants: Yonkers, N. Y.—Bridgeport, Conn.—Nepperhan, N. Y.

HABIRSHAW

PROVED BY THE TEST OF TIME

Paper Insulated Cable — Varnished Cambric Insulated Cable — Armored Cable — Rubber Insulated Cable

Please mention the JOURNAL of the A. I. E. E. when writing to advertisers.

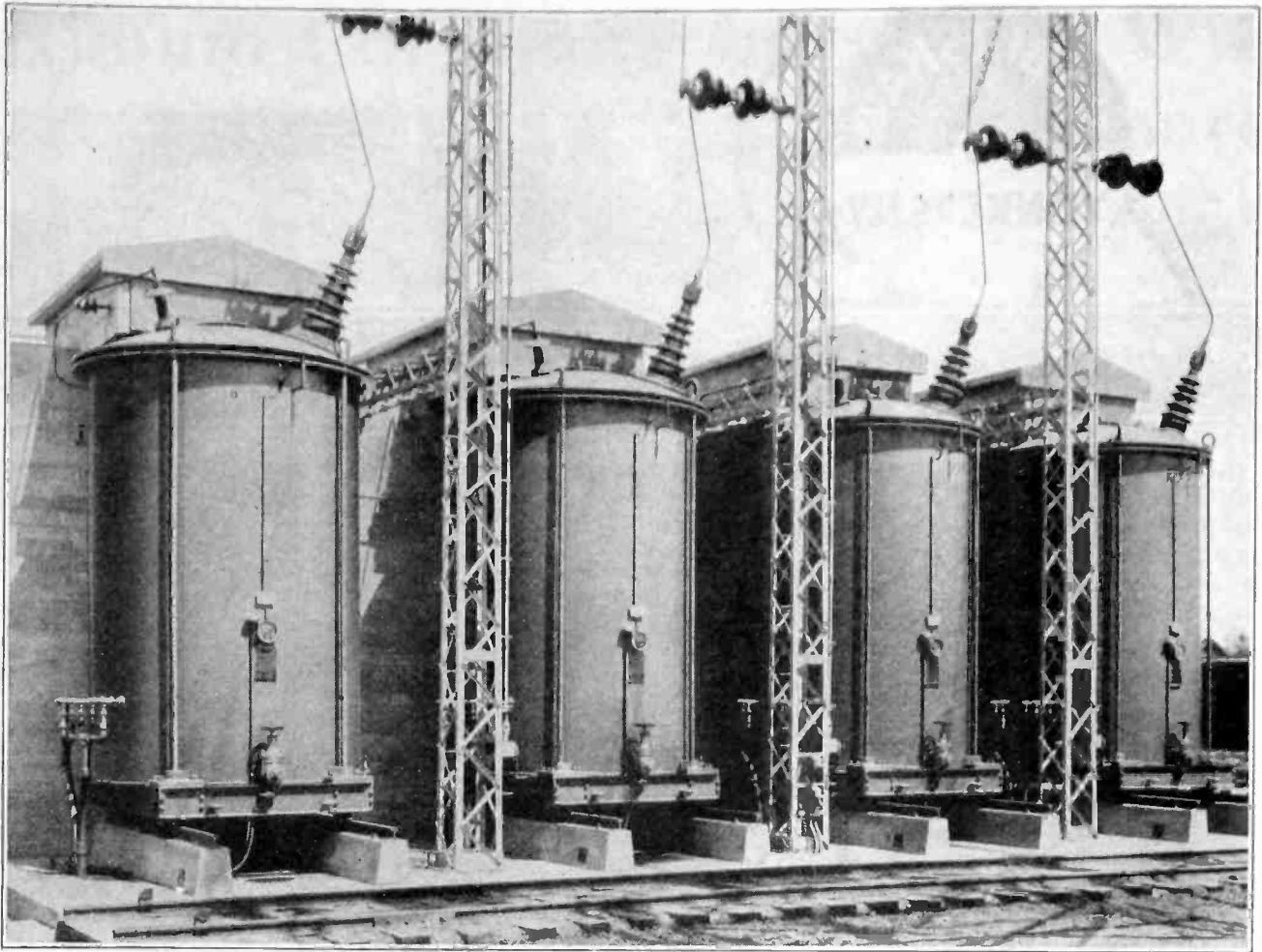

4—10,000 KV-A., 108,000 Volt H. V., 12,450 Volts L. V.
Tertiary voltage, 5,000 KV-A., 6600 volts, O.I.W.C.O.
Transformers

Power Transformers

The above installation shows the 4—10,000 KV-A. Allis-Chalmers, oil-insulated, water-cooled, outdoor type Transformers installed in the San Jose Substation of the Pacific Gas & Electric Company. This is a recent installation and one that is proving highly successful.

Allis-Chalmers power transformers are giving continuous uninterrupted service in many of the large generating and substations of the country.

ALLIS-CHALMERS MANUFACTURING CO.
MILWAUKEE, WIS. U.S.A.

District Offices in All Principal Cities

Please mention the JOURNAL of the A. I. E. E. when writing to advertisers.

BURNDY

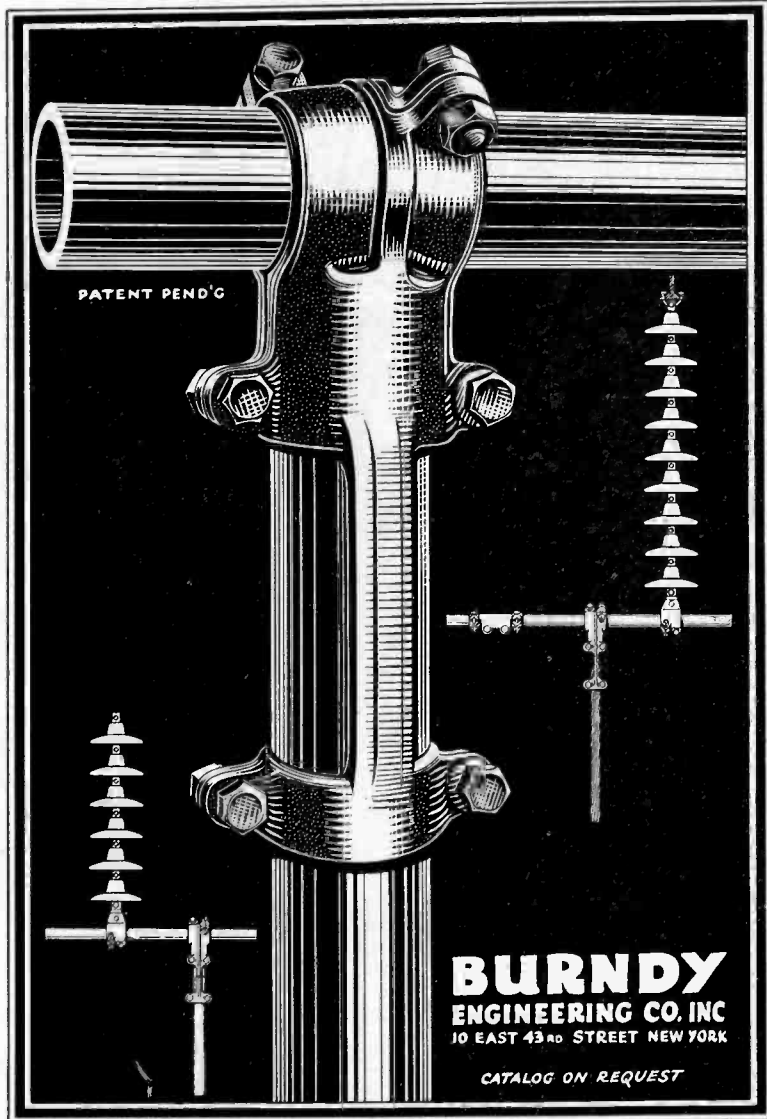

FOR
TUBING

FOR
CABLE

CONNECTORS

Catalog, Details and Prices supplied you by —

San Francisco

H. M. Thomas Co., 589 Howard St.

Los Angeles

Bell & Slimmon, 443 E. 3rd St.

Seattle

R. H. Ballock, 71 Columbia St.

New York

10 E. 43rd St.

Kansas City

Utilities Service Co.,
204 Baltimore Bldg.

Birmingham

W. H. Neville, Age-Herald Bldg.

Toronto

Canadian Line Materials, Ltd.

Please mention the JOURNAL of the A. I. E. E. when writing to advertisers.

From coast to coast you



- | | |
|-------------------|------------------------|
| 1—Duluth, Minn. | 9—New Castle, Ind. |
| 2—Hammond, Ind. | 10—Toledo, O. |
| 3—St. Louis, Ill. | 11—El Paso, Tex. |
| 4—St. Louis, Mo. | 12—Minneapolis, Minn. |
| 5—Dallas, Tex. | 13—Charlotte, N. C. |
| 6—Malden, Mass. | 14—Los Angeles, Cal. |
| 7—Denver, Colo. | 15—Far Rockaway, N. Y. |
| 8—Cincinnati, O. | 16—Gary, Ind. |



GENERAL ELECTRIC COMPANY, SCHENECTADY, N. Y.

Please mention the JOURNAL of the A. I. E. E. when writing to advertisers.

will find G-E Regulators

- *preventing loss of revenue*
- *providing good service*
- *promoting line efficiency*

These are three important results of maintaining constant voltage at centers of distribution.

The large operating companies everywhere—determined to control changes in voltage—are installing G-E induction regulators in increasing numbers.

The G-E regulator continues to demonstrate the value of its special features and to verify all the claims made as to its superior operation and reliability.

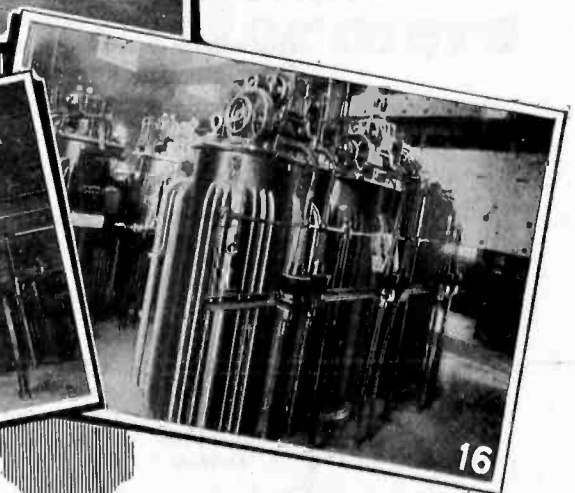
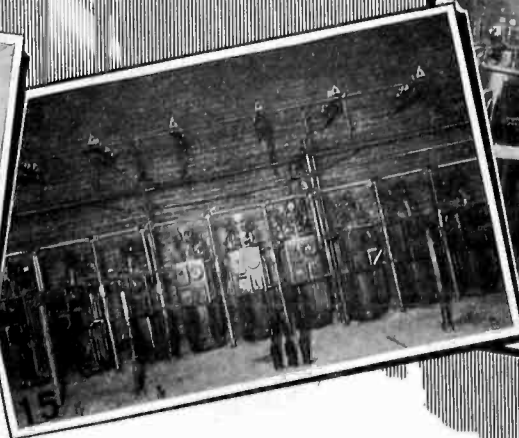
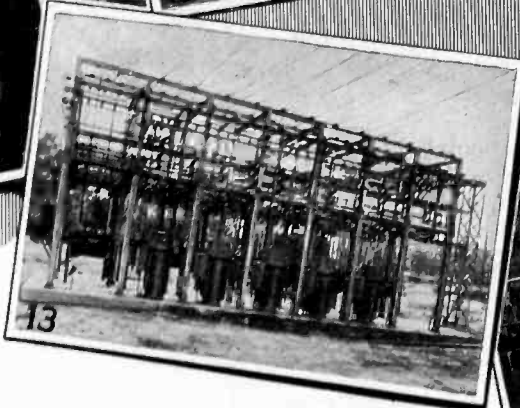
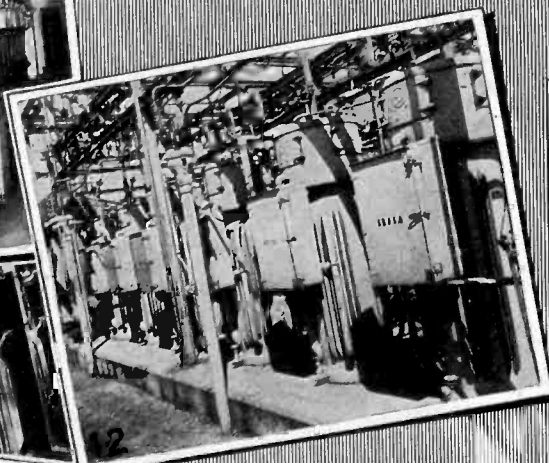
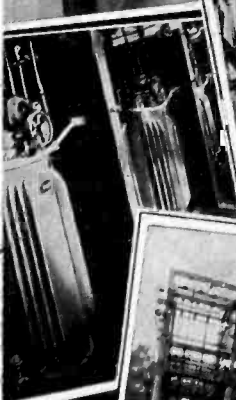
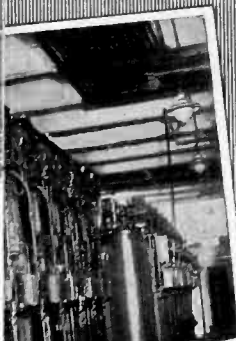

ELECTRIC

SALES OFFICES IN PRINCIPAL CITIES

430-2

Please mention the JOURNAL of the A. I. E. E. when writing to advertisers.

G-E Relays

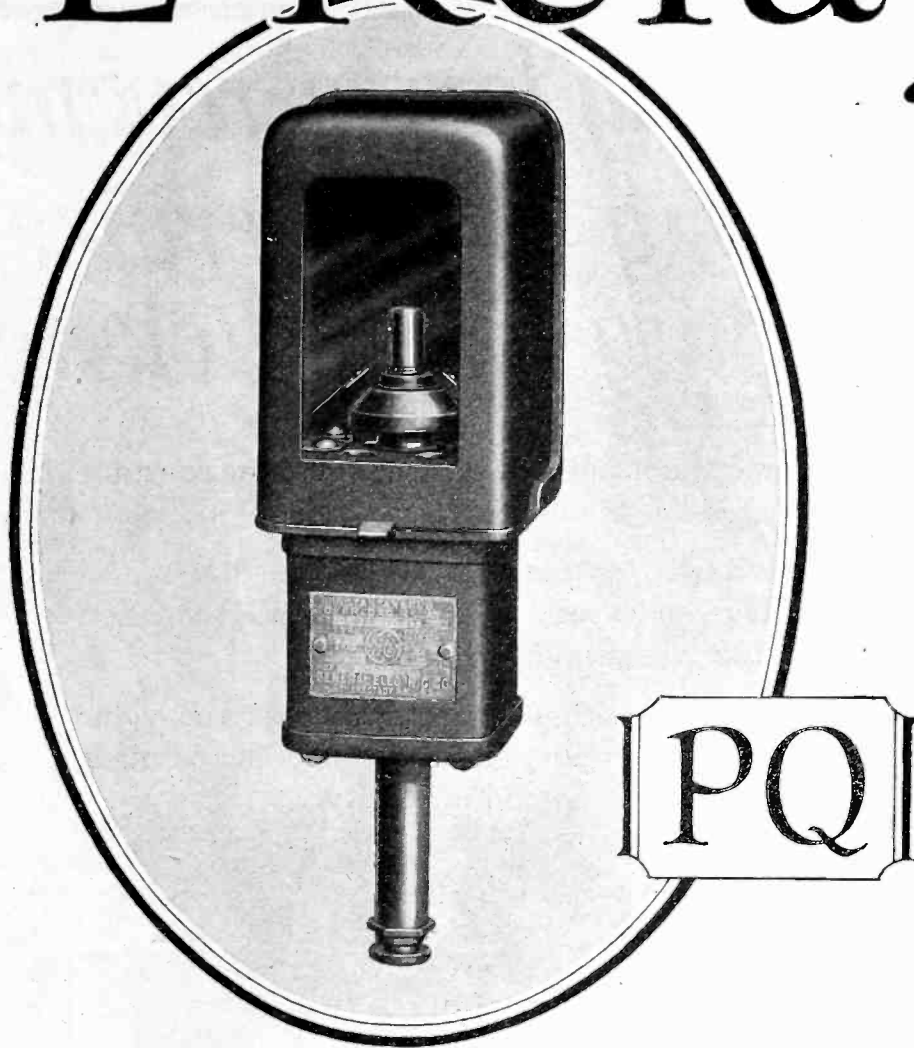

Plunger Type

The Type PQ relays operate on the solenoid principle and are used for various applications.

A-c and d-c service	Single- and multi-circuit control
Over-current and under-current	Instantaneous, definite, and inverse
Over-voltage and under-voltage	Locking, trip-free, signal, and auxiliary
	Hand-reset and self-reset contacts

PQ relays are only part of the contribution which G-E relay specialists have made to the protection of equipment and the control of distribution systems. The service of these specialists is available to protection engineers in the solution of relay problems.

G-E SWITCHBOARD EQUIPMENT

Air Circuit Breakers
Stationary Switchboards
Outdoor Station Equipment
Switchboard Accessories and
Devices



Relays
Oil Circuit Breakers
Truck-type Switchboards
Automatic Switching Equipment
Switches

GENERAL ELECTRIC

GENERAL ELECTRIC COMPANY, SCHENECTADY, N. Y., SALES OFFICES IN PRINCIPAL CITIES

Please mention the JOURNAL of the A. I. E. E. when writing to advertisers.

American Transformer

Power bills for industrials depend upon correctness of current transformers

The totalizing watt meter tells the correct amount of energy used in factory, industrial plant or mill—only if the current transformers at the customer's entrance switch are correct. In case these transformers are incorrect—the consumer is billed too much or too little.

Best practice by central stations calls for periodical testing of all current transformers at customer's entrance. By this practice, disputes are avoided. Also the relations between the large consumer and utility are made more pleasant.

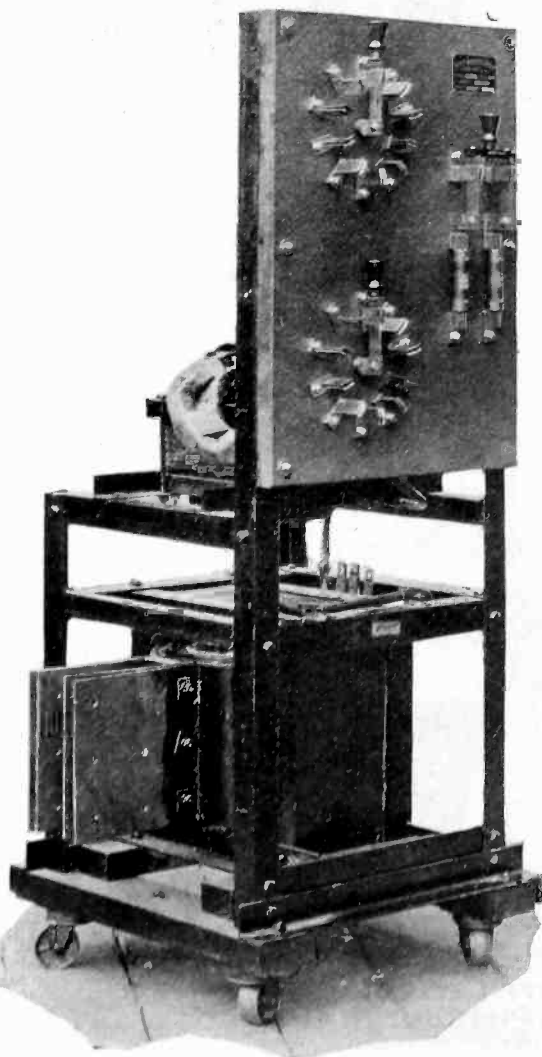
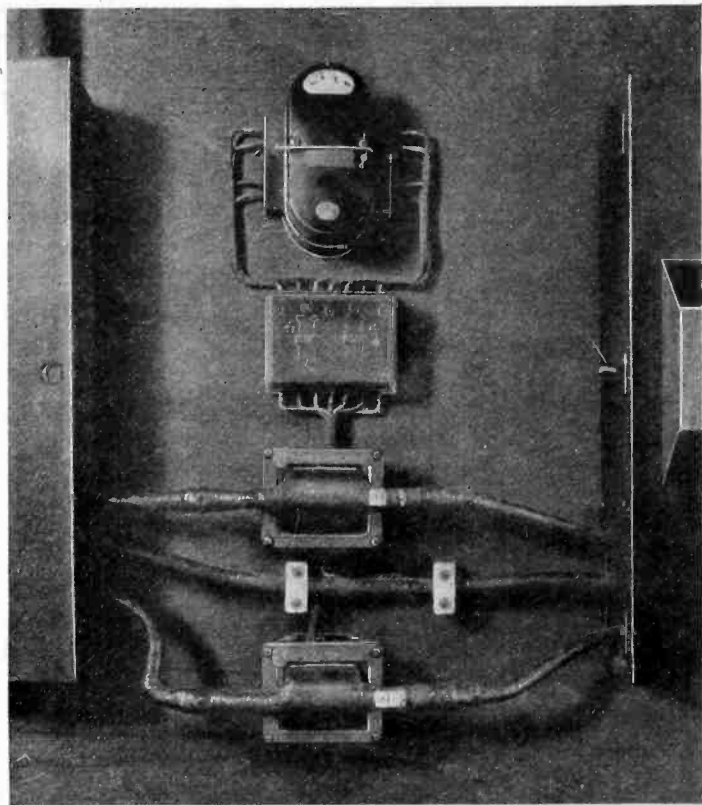

TS-14 Set for testing current transformers

Here is a high current, low voltage testing transformer complete with primary regulating switch, mounted on a swivel castor truck. It is used principally for testing current transformers and can be made for any convenient current range. The control on the primary is obtained by means of an auto transformer with 1% and 10% taps. The taps are connected to two ten point switches. The current can be controlled in 1% steps from zero to 100%.

Whatever your problem, consult us. Transformer problems exclusively have been our business for more than 25 years. Write for Bulletins 1025-J, 1030-J, 1035-J and 1040-J.

AMERICAN TRANSFORMER CO.

176 Emmett St., Newark, N. J.

Please mention the JOURNAL of the A. I. E. E. when writing to advertisers.

TRANSMISSION POLES

For use where right-of-way conditions limit the size



THE use of narrow base poles for high tension transmission lines is necessarily expensive but their use is required where the right of way is limited.

Where they are used as a part of or comprise a main trunk line, it is of great importance that the design and details be correct in every respect.

The illustrations show a few of the lines on which narrow base poles have been used.

We have designs of standard poles of various heights, and voltages up to 66,000. The higher voltages usually require special designs. The lower right hand photograph illustrates a 120,000 volt line.

All of these poles, by reason of their design, offer resistance to torsional loads.

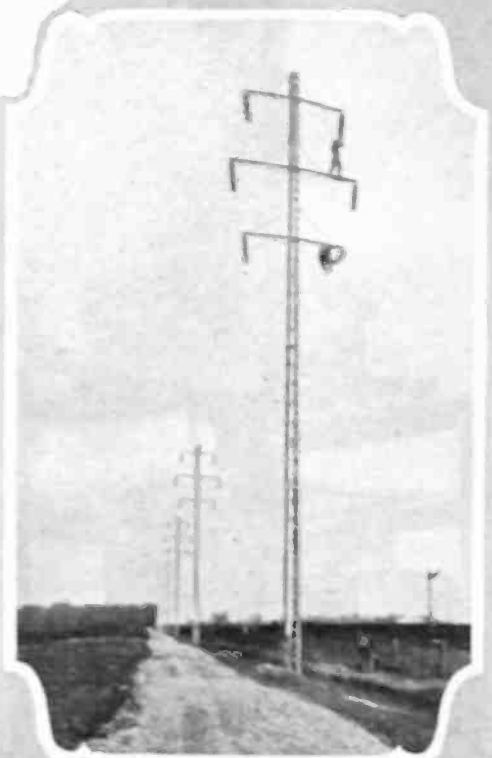

AMERICAN BRIDGE COMPANY

EMPIRE BUILDING, 71 BROADWAY - NEW YORK, N.Y.

Selling Offices in Principal Cities

Tower Department - Frick Building - Pittsburgh, Pa.



Low cost in rural distribution is now possible with HITENSO "BB" TRANSMISSION WIRE

HITENSO "BB" Wire was developed to permit the use of long span construction with light poles in order to cut the cost of transmission lines.

It is a high strength, high conductivity wire. Size for size it has 77% of the conductivity of hard drawn copper, and 30% greater strength. Compared with hard drawn copper of equivalent conductance it has 60% greater strength.

Since the initial investment for poles and line hardware is generally greater than the cost of conductors, the use of longer spans

made possible by Hitenso "BB" helps to lower the cost of rural installations.

Hitenso "BB" is also an important factor in the reduction of maintenance expense. It is highly resistant to abrasion and the effects of arcing. Its small diameter for a given strength reduces the surface exposed to sleet and wind and lessens the danger of line failure.

An Engineering Department is maintained to assist electrical engineers in the design of cables for special conditions. You are invited to make use of this service.

ANACONDA COPPER MINING CO.—THE AMERICAN BRASS COMPANY

Rod, Wire and Cable Products

General Offices: 25 Broadway, New York

Chicago Office: 111 W. Washington St.

ANACONDA COPPER
BRASS  **BRONZE**

I. P. Morris Corporation

New York Office:
100 Broadway

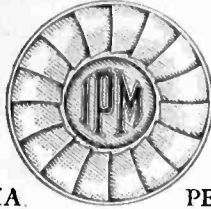

Birmingham Office:
American Trust Building

PHILADELPHIA PENNSYLVANIA

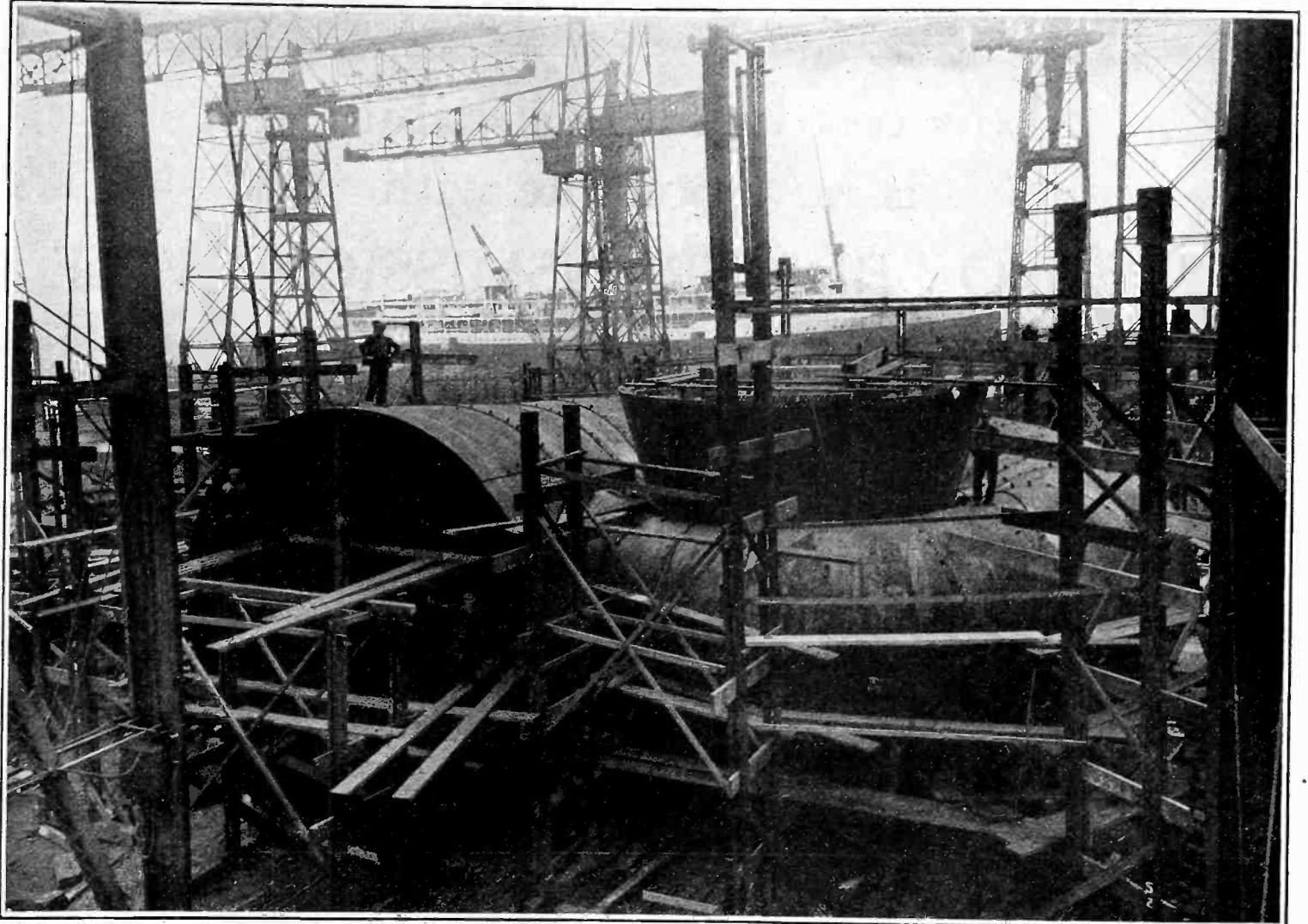

PLATE STEEL VOLUTE CASING FOR ONE OF THE 54,000 HORSEPOWER
TURBINES TO BE INSTALLED IN THE SUSQUEHANNA POWER
COMPANY'S CONOWINGO DEVELOPMENT

HEAD 89 FT.

SPEED 81.8 R.P.M.

Largest plate steel casing ever built.

Casing intake diameter 27 ft. 0 in.

Maximum overall width 63 ft. 0 in.

Complete assembly of entire casing prior to shipment insures accurate fitting of all plates and greatly facilitates erection at site.

Designers and Builders of the Johnson Hydraulic Valve and the Moody Spiral Pump

ASSOCIATED COMPANIES

THE PELTON WATER WHEEL CO., San Francisco and New York
DOMINION ENGINEERING WORKS, LTD., Montreal. Canadian Licensees

Please mention the JOURNAL of the A. I. E. E. when writing to advertisers.

"MODERN" PLANTS

True as in 1894

S TONE & WEBSTER, Inc., built a station in 1894. An account, "A Modern Power Plant," contains these words:

A complete mechanism, every part designed to work with every other part . . . in case of accident to any member, some other can perform its duty . . . energy put on the line surely and cheaply . . . must be no shutdowns, either steam or electrical . . . every device and arrangement a good investment . . . constructed and equipped under constant supervision and care.

Written when 2000 kw. was an important installation, this remains a good description of Stone & Webster power work. It shows the sound early foundation on which rests the experience offered Stone & Webster clients today.

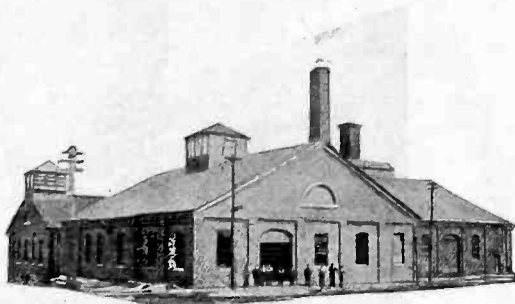

INDUSTRIAL IMPROVEMENT COMPANY
OF BOSTON
OLD ALLENTOWN, PA., PLANT

SOUTHERN CALIFORNIA
EDISON COMPANY
LONG BEACH PLANT No. 2

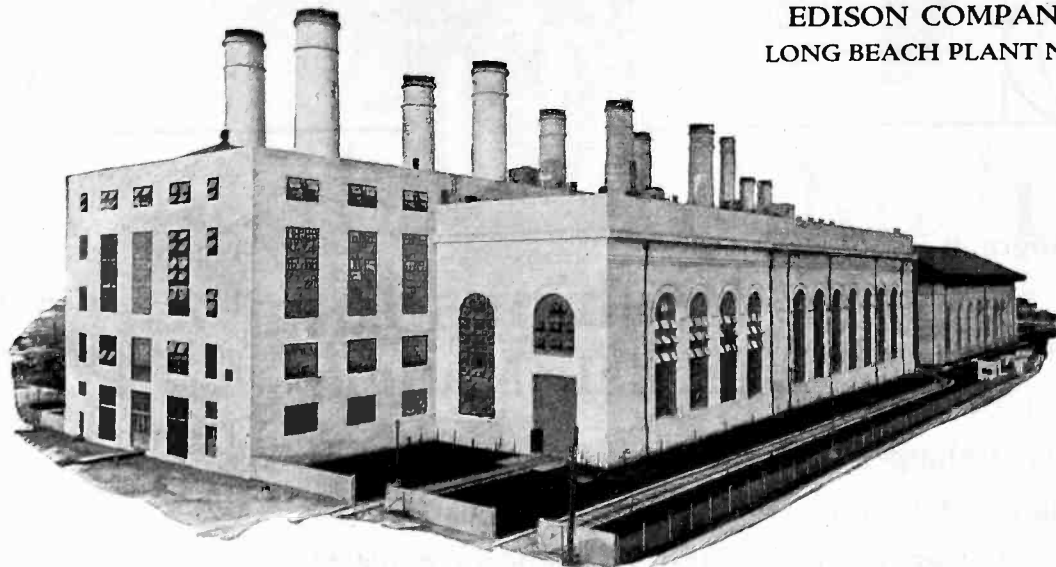

STONE & WEBSTER

INCORPORATED

BOSTON, 49 Federal Street
NEW YORK, 120 Broadway
CHICAGO, First National Bank Bldg.



PHILADELPHIA, Real Estate Trust Bldg.
SAN FRANCISCO, Holbrook Bldg.
PITTSBURGH, Union Trust Bldg.

Please mention the JOURNAL of the A. I. E. E. when writing to advertisers.

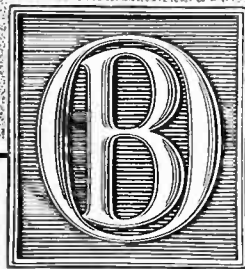
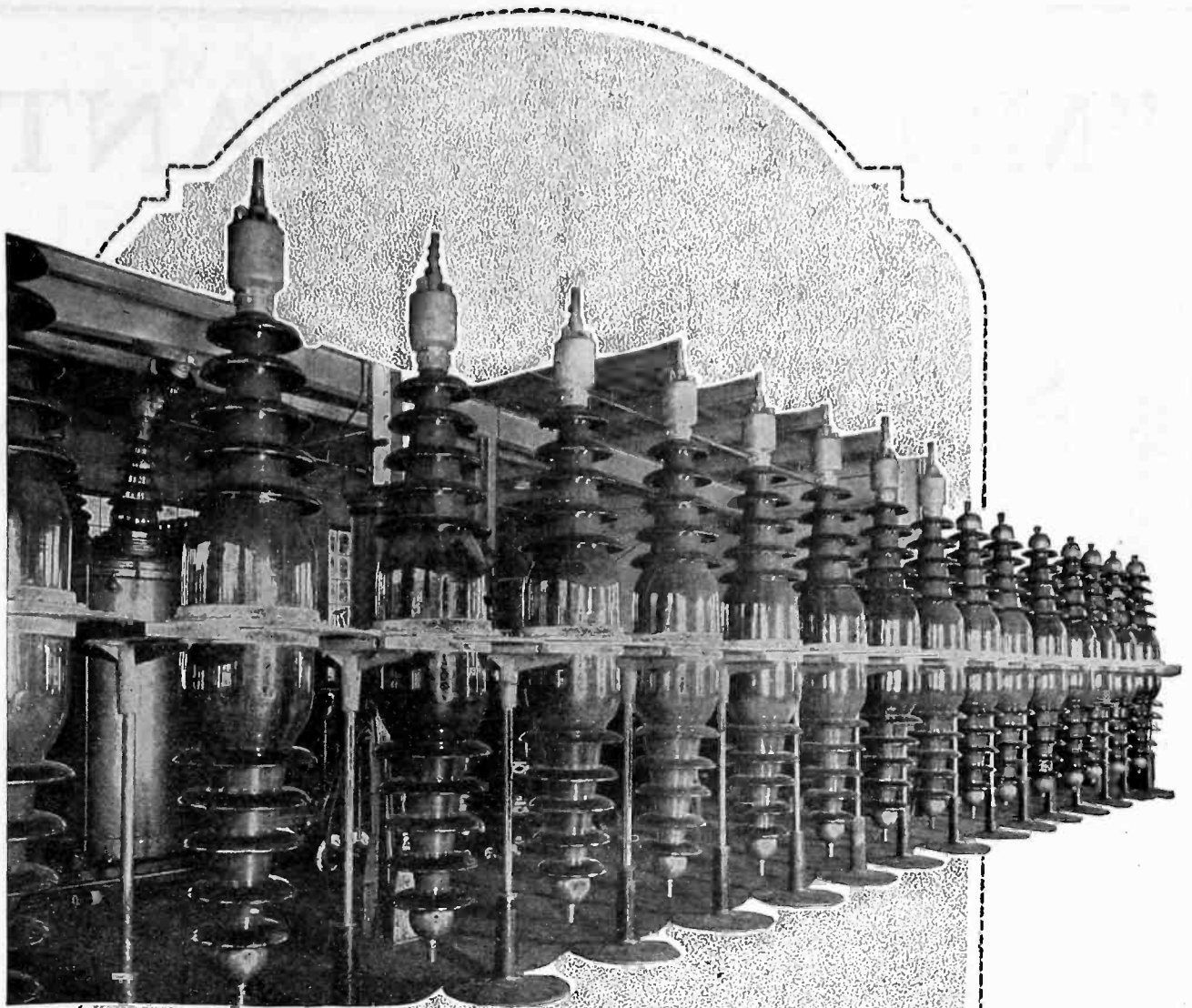

THIS photograph of nine roof and seven wall entrance O-B bushings on test was taken just before these huge pieces were shipped to the Isle Maligne Station of the Duke-Price Power Company, situated on the Saguenay River in the

Bushings for the Isle Maligne

Province of Quebec.

They are splendid examples of the technique in porcelain manufacture which finds its

Ohio Brass Company, Mansfield, Ohio
Dominion Insulator & Mfg. Co., Limited
Niagara Falls, Canada

458H

highest expression in large high tension bushings and potheads of this type.

These large oil-filled bushings measure about 11 ft. over-all and weigh approximately 1200 lbs. each. Bushings of this type are manufactured for voltages up to 220 kv. or more.

Ohio Brass Co.

SALES OFFICES: NEW YORK CHICAGO



PHILADELPHIA PITTSBURGH CLEVELAND
SAN FRANCISCO LOS ANGELES

PORCELAIN INSULATORS
LINE MATERIALS
RAIL BONDS
CAR EQUIPMENT
MINING MATERIALS
VALVES

Please mention the JOURNAL of the A. I. E. E. when writing to advertisers.

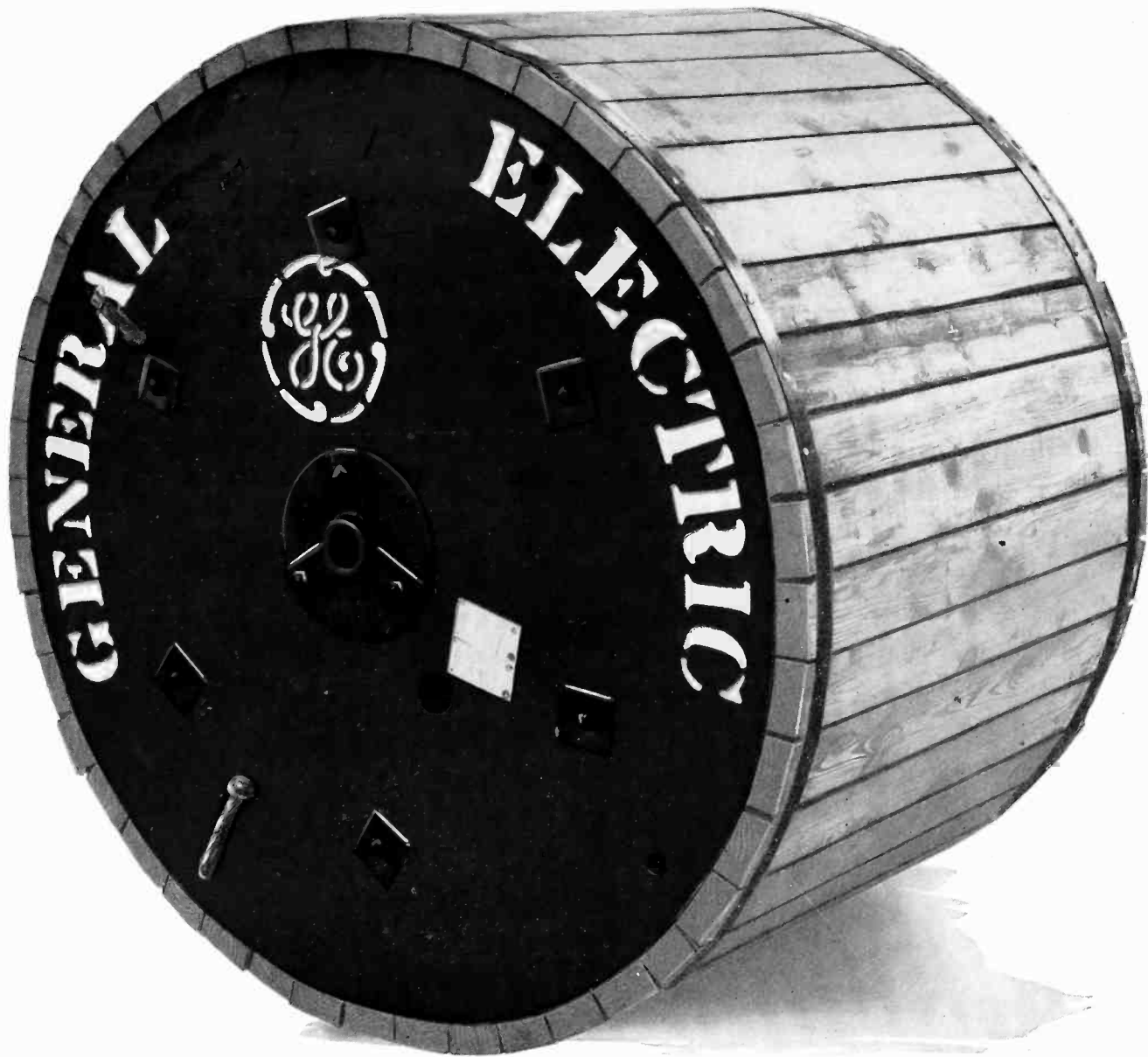

Cable of Quality



Cable for
—any voltage
—any capacity
—any service

When a reel of G-E Cable leaves the factory it represents more than so much copper and covering. It combines scientific selection of many materials, fabrication of these into a perfect whole, and a rigid test that has stamped the product with G-E approval. To the user it carries full assurance of long and satisfying service.

810-4

GENERAL ELECTRIC

GENERAL ELECTRIC COMPANY, SCHENECTADY, N. Y., SALES OFFICES IN PRINCIPAL CITIES

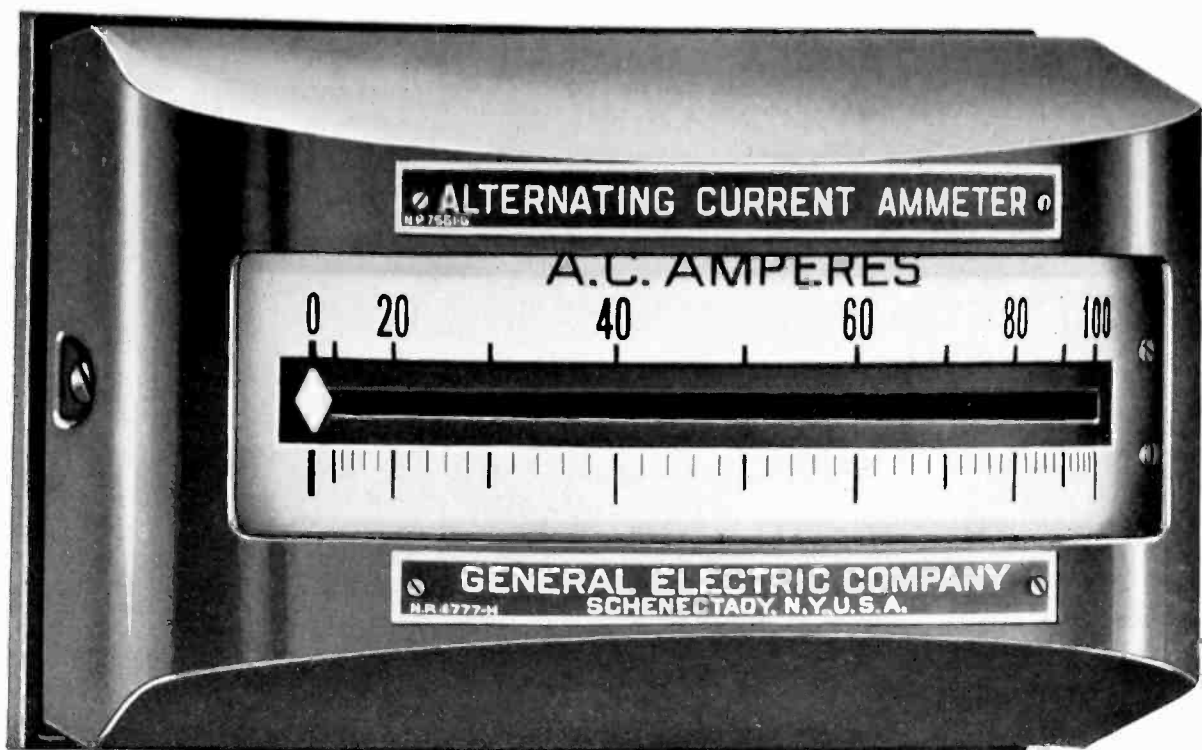

A Quarter Century of Dependable Service

For more than 25 years, G-E horizontal edgewise instruments have maintained their superiority in both a-c. and d-c. switchboard service.

Refinements include:

Reversed position of jewels and pivots to facilitate renewal of the latter.

Resistors mounted inside the instrument case (voltmeters and wattmeters) to simplify wiring and conserve panel space.

Improved coil design. Improved insulation.

Anti-parallax construction of pointer and scale.

Non-corrodible finish on case, frame, magnets, screws, etc.

Strip-wound magnetic shield surrounding electric element.

The vertically mounted moving element, which is the distinctive feature of these instruments, continues to be the most significant advance ever made in the design of G-E switchboard instruments.

GENERAL ELECTRIC ⁶¹⁰⁻²⁰

GENERAL ELECTRIC COMPANY, SCHENECTADY, N. Y., SALES OFFICES IN PRINCIPAL CITIES



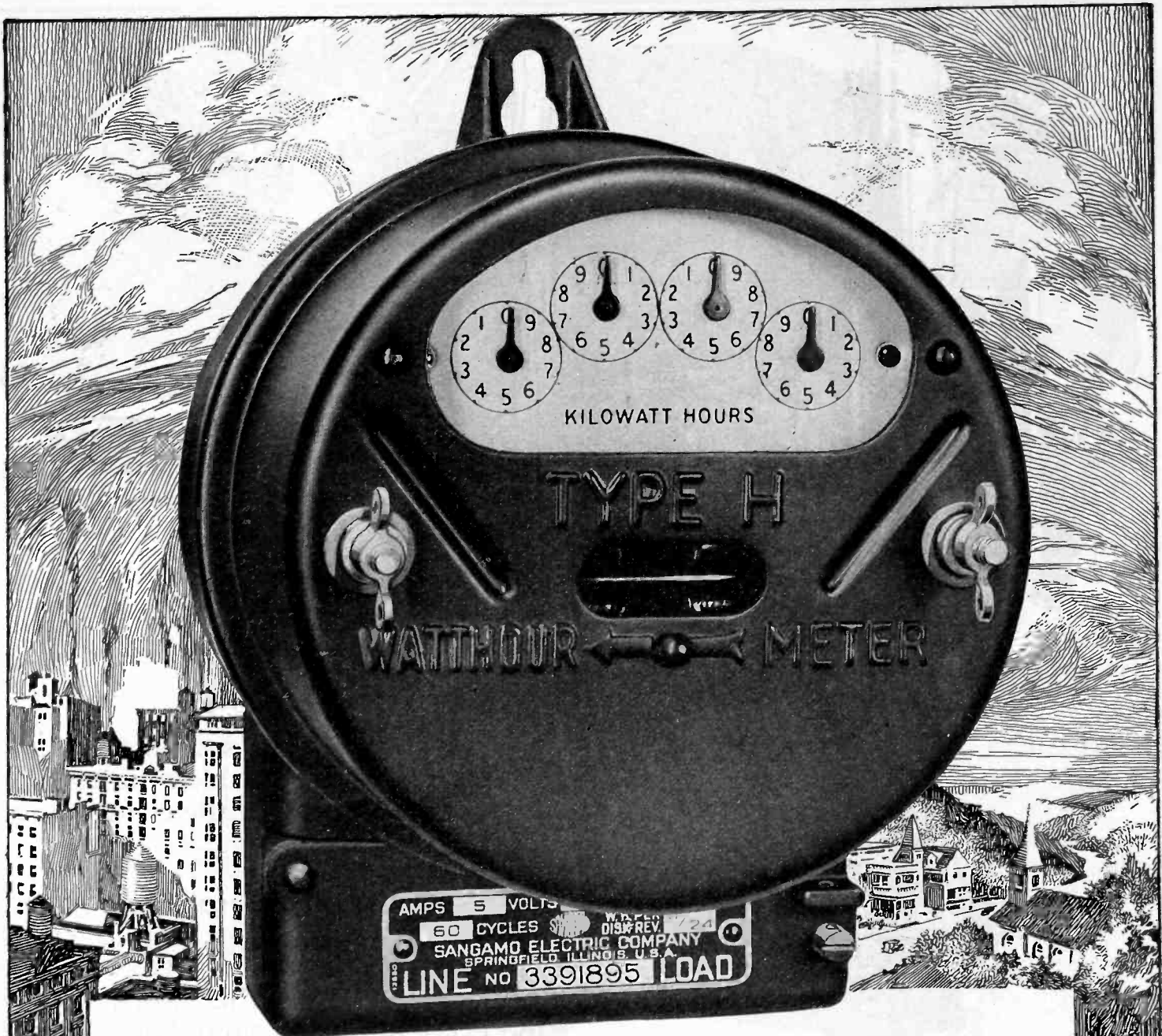

Nearly 3,500,000

NEARLY 3,500,000 Sangamo Type "H" Meters are installed on the Central Station lines of the various countries of the world.

If the monthly billing of service type meters alone averaged only \$3.00 per meter, it would mean an annual total of nearly \$126,000,000. And Sangamo meters last for many years. Of course, it must be remembered that domestic customers furnish about 30 per cent of the income of the Electric Light and Power industry of the United States, and therefore the Sangamo meters

installed to measure factory loads will add a great deal to this figure.

These figures imply merit on one hand and confidence on the other. And such confidence on the part of the Central Station industry has been a material factor in the growth of the Sangamo organization.

Every 12 seconds of every working day a Sangamo meter is installed.

SANGAMO ELECTRIC COMPANY
Springfield, Illinois

SANGAMO METERS

FOR EVERY ELECTRICAL NEED

8137-1



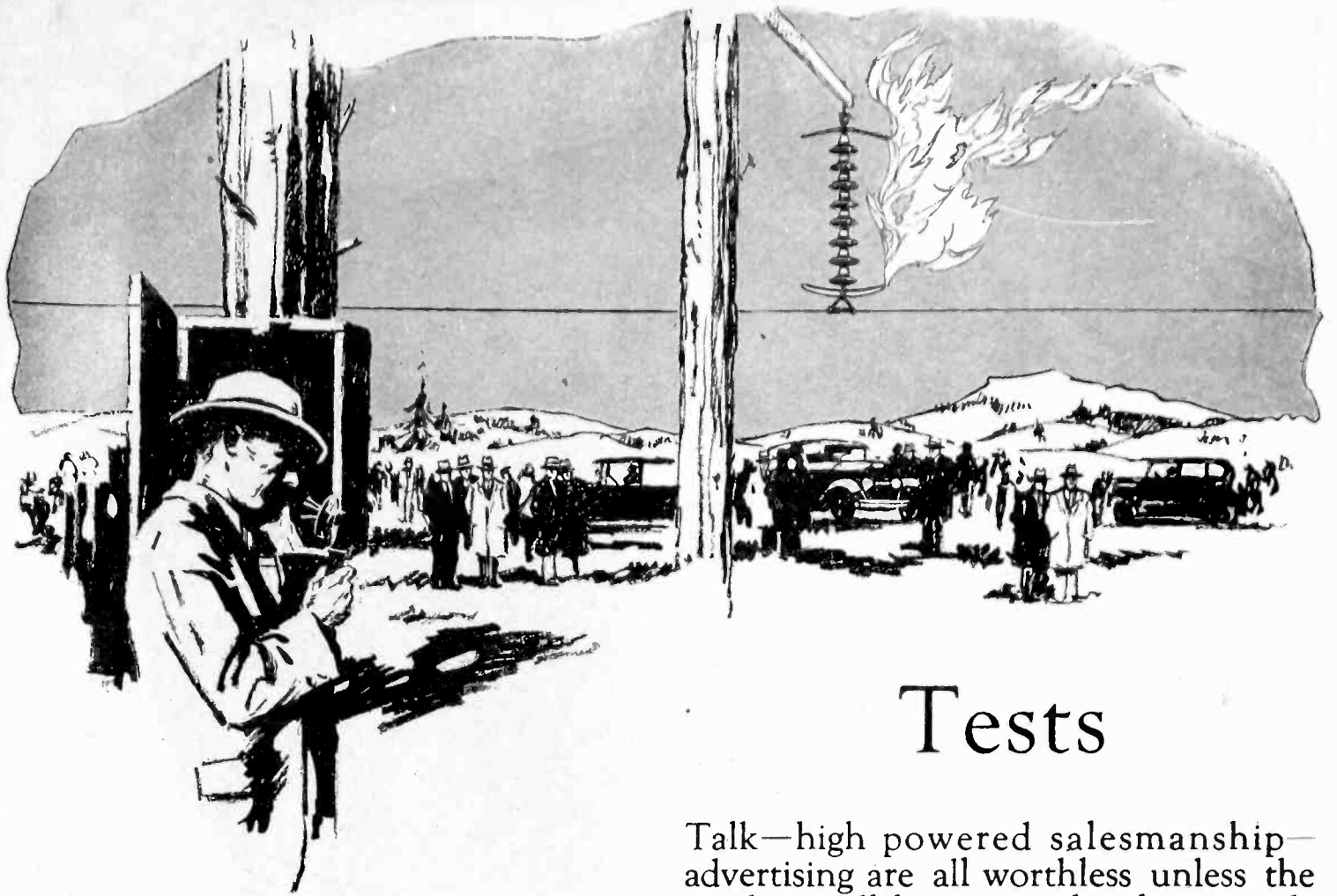

Tests

Talk—high powered salesmanship—advertising are all worthless unless the product will live up to the claims made for it.

We are always pleased to send you test results because we want you to know what we already know—that Locke Insulators will prove their worth by any and every test. On your lines—where service really counts—they will aid the perfect operation you want.

Whether in the laboratory or on the line, Locke Insulators and Locke Grading Shields fully justify every claim made for them.

LOCKE INSULATOR CORPORATION
BALTIMORE MARYLAND



The service which Locke Insulators and Locke Grading Shields are rendering operating companies is splendid corroboration of laboratory and field tests.

You can specify LOCKE for every insulator requirement with the assurance of complete satisfaction.



LOCKE PORCELAIN



LOCKE QUALITY

LOCKE SERVICE

Please mention the JOURNAL of the A. I. E. E. when writing to advertisers.

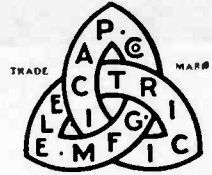
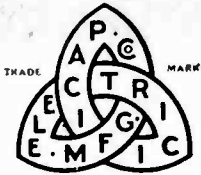

Pacific Type MW Oil Circuit Breaker Control

(Patented)

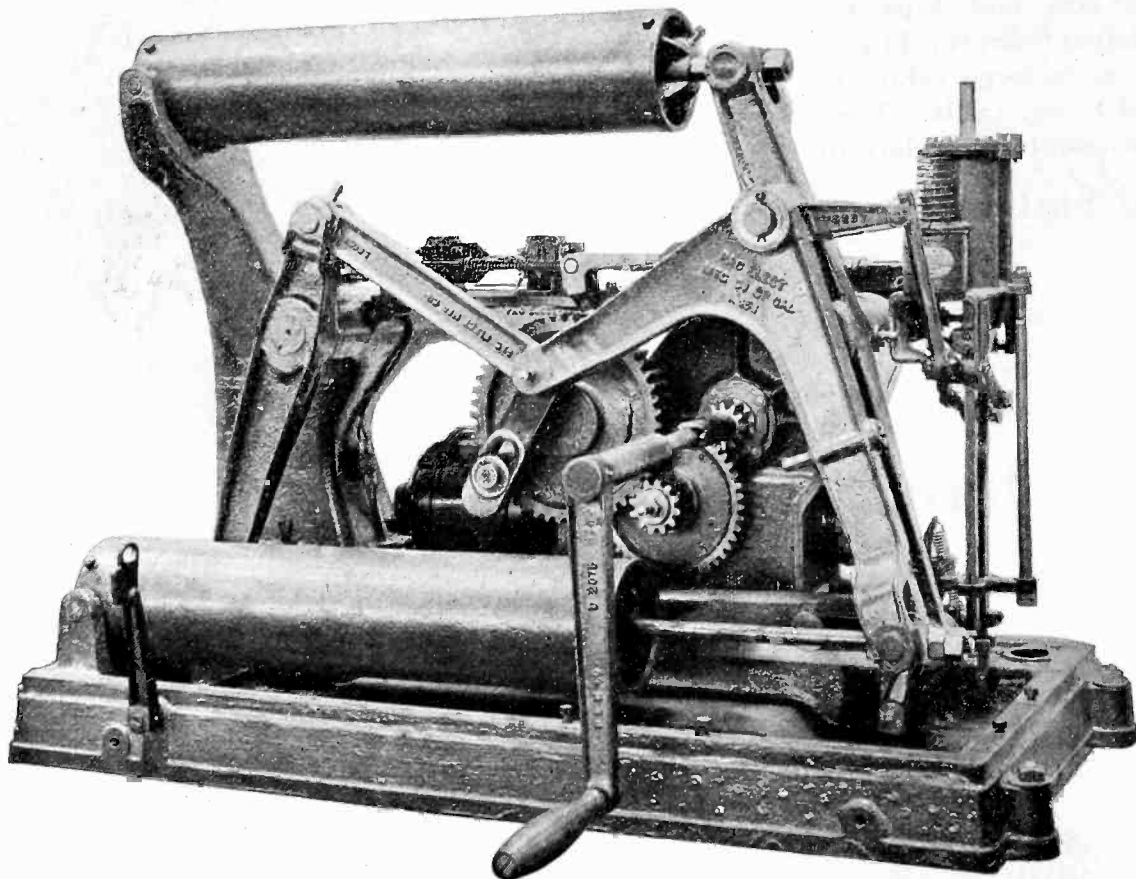

Type MW-3 Motor-wound Spring-actuated Control Mechanism with Housing removed.

Made in Various Sizes for either A.C. or D.C. Motor, Closing and Tripping Coils. Removable Crank permits Hand Operation

The Essential of an Oil Circuit Breaker is Speed

12 Cycles (20/100 second) Current Flow Duration per OCO Test is Speed. This Type of Control Makes This Speed Possible

Bulletin 11 fully describes its features.

Pacific Electric Manufacturing Co.

The only Manufacturer of Horizontal Rotary Break Oil Circuit Breakers in the U. S. A.

5815 THIRD STREET, SAN FRANCISCO, CALIF.
and ST. LOUIS, MO., U. S. A.

Representatives in Principal Cities



DOSSERT

Solderless Connectors

are furnished in every required size and type for conductors from No. 14 B & S gauge, to large cables of 3,000,000 cir. mils. They are the adopted standard in

Central Station Practice



DOSSERT

Solderless Connectors

Tests which have been made from time to time by users of Dossert connectors show that the connectors run at as low temperature as enabled by the wires connected to them.

Send for Catalog Twenty

Dossert & Company

H. B. LOGAN, President
242 West 41st Street, New York



Please mention the JOURNAL of the A. I. E. E. when writing to advertisers.

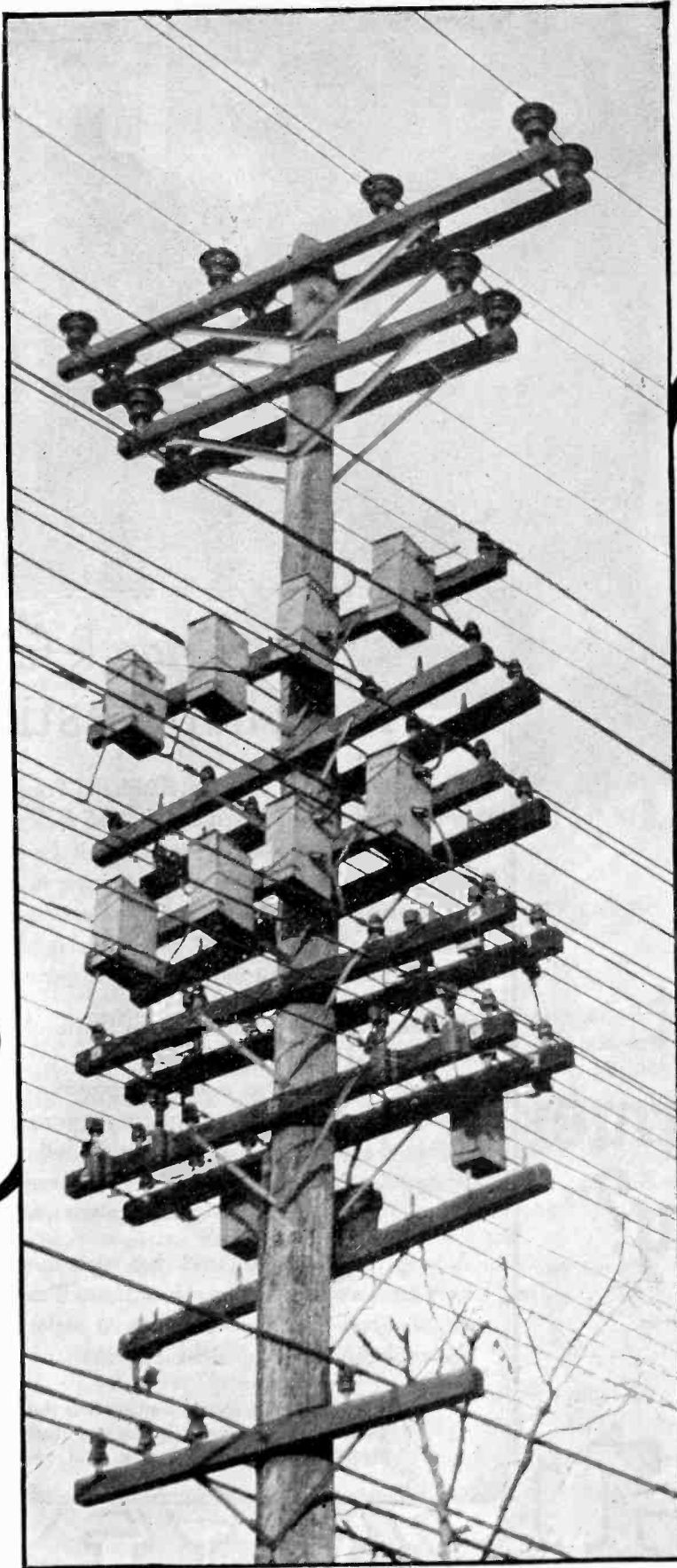

The H. Q. Socket Type Matthews Disconnecting Switch can be quickly converted to a Fuswitch by simply replacing disconnect blade with fuse cartridge. The housing is made of genuine Tidewater Cypress and guaranteed for a period of ten years against warpage or weather cracks that would make the box unserviceable.

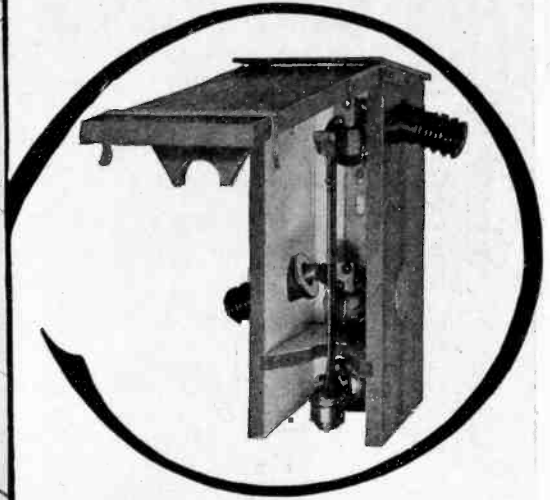

Good Construction

The engineering eye commends the neatness of this construction—commends, too, the choice of Matthews Disconnecting Switches as here used for sectionalizing purposes. These switches are recognized as having very definite advantages—namely, large contact areas, high dielectric strength, large clearances, safety in operation, ease of installation, maximum efficiency, long life and with all, low cost. As a result, complete, standardization of Matthews Fuswitches and Disconnecting Switches is rapidly developing. Write for 50-page Bulletin No. 502 and learn more about Matthews Fuswitches and Disconnecting Switches.

Your nearest Electrical Distributor will be glad to serve you on Matthews Products.

W. N. Matthews Corporation
3706 Forest Park Blvd. • St. Louis, U.S.A.



MATTHEWS FUSWITCHES

and DISCONNECTING SWITCHES
INTERCHANGEABLE



Please mention the JOURNAL of the A. I. E. E. when writing to advertisers.



***“Do you test every transformer so carefully?”**

*Answering R.C.**
Re: Shop Testing

The tests on these 833 Kva. Kuhlman Transformers that you have just witnessed are typical. Before leaving our shops, each transformer—whether it be a large power transformer, a distribution transformer or a small series multiple street lighting transformer—is subjected to rigid and complete tests that prove it will satisfy the highest standards of reliability and operating economy.

We regard each transformer as if the continuation of our 34-year-old record for building trustworthy transformers depended on it alone. Inspection of individual parts and operations are equally thorough. We have a highly skilled organization, but this policy is an added precaution to keep it “in step.” It also serves as a continuous check upon the quality of the materials we use.

A long time ago we found that such thorough inspection and testing of every Kuhlman Transformer was mighty good business—our annual expense for repairs and replacements is considerably less than 1/8 of 1 per cent.

This is one of a series of answers to important questions frequently asked us regarding transformer design, construction and operation.

KUHLMAN TRANSFORMERS

KUHLMAN ELECTRIC CO., Bay City, Michigan

- | | | | |
|---------------------------------------|---|--------------------------------------|--|
| Akron.....High and Barges Sts. | Dallas.....Unit 2, Santa Fe Bldg. | Minneapolis.....1004 Marquette Ave. | Salt Lake City.....134 West 2d South St. |
| Atlanta.....411 Glenn Bldg. | Denver.....1843 Wazee St. | New York.....Graybar Bldg. | San Francisco.....Call Bldg. |
| Boston.....69-71 High St. | Detroit.....3-260 Gen. Motors Bldg. | Oklahoma City.....1013 Braniff Bldg. | Seattle.....314 Seneca St. |
| Buffalo.....280 Carolina St. | Greensboro, N. C.....333 S. Davie St. | Omaha.....923 W. O. W. Bldg. | Toledo.....424 Spitzer Bldg. |
| Chicago.....844 Rush St. | Indianapolis.....202 Indiana Ter. Whse. | Philadelphia.....1700 Walnut St. | Washington.....1328 New York Ave. |
| Cincinnati.....1308 Union Trust Bldg. | Los Angeles.....316 American Bank Bldg. | Pittsburgh.....839 Oliver Bldg. | N. W. |
| Cleveland.....627 Union Trust Bldg. | Milwaukee.....1031 Clybourn St. | Saint Paul.....1479 Blair St. | York, Pa.....335 W. Market St. |

Please mention the JOURNAL of the A. I. E. E. when writing to advertisers.

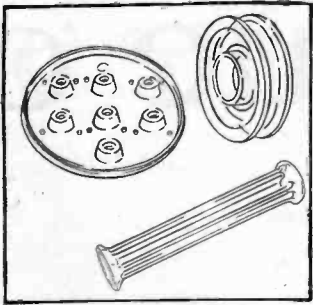

Smooth, hard, non-porous.
PYREX Industrial Glass Products

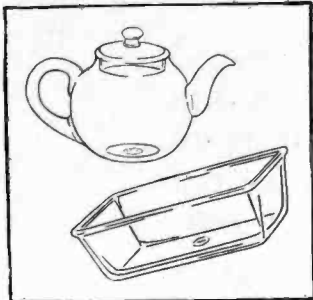

Resistant to thermal change
PYREX Ovenware

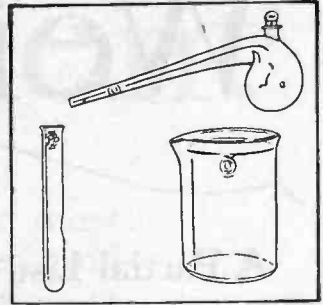
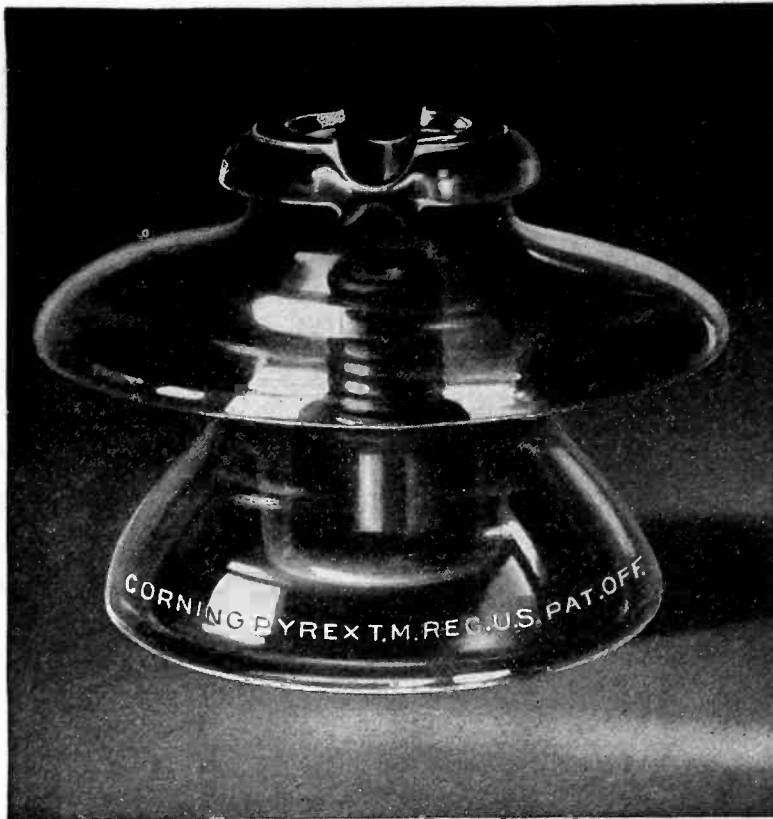

Chemically stable
PYREX Laboratory Glassware

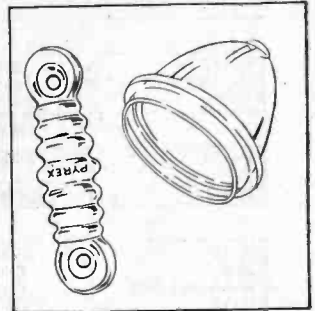

High dielectric strength—low
dielectric loss.
PYREX Radio Insulators

Another Surprising Development

• • PYREX Power Insulators

T. M. Reg. U. S. Pat. Off.

THE natural properties of *PYREX Products have made them increasingly valuable for countless specialized uses—in industry, in homes, in laboratories and in radio stations.

Chemically stable — resistant to thermal change—high in dielectric strength and resistance—low in dielectric loss,—transparent, smooth, hard and non-porous—these glasses sold under the PYREX trade mark are as different from ordinary glass as mahogany from white pine, or tempered steel from lead.

And now PYREX Glassware has been applied in the electric power field.

Already, PYREX Power Insulators are establishing new standards of low maintenance cost and uninterrupted service.

The following characteristics of these insulators will explain *how* and *why*:

High wet and dry flash-over values — strong puncture strength—unusual resistance to power arcs—indifference to hot and cold weather, salt fogs, fumes—low absorption of solar heat—transparency—one-piece design—accurate pin-fit—*permanence*.

Write for complete catalog, Dept. R, Corning Glass Works, Corning, N. Y.!

See our exhibit at the Eleventh Exposition of Chemical Industries, Grand Central Palace, New York, Sept. 26th to Oct. 1st, 1927

SALES OFFICES

369 Lexington Avenue,
New York, N. Y.

79 Milk Street,
Boston, Mass.

Candler Building,
Atlanta, Ga.

211 I. W. Hellman Bldg.,
Los Angeles, Calif.

Polson Building,
Seattle, Wash.

193 Second Street
San Francisco, Calif.

PYREX

T. M. Reg. U. S. Pat. Off.

POWER INSULATORS



A PRODUCT OF CORNING GLASS WORKS

*Trade-mark Reg. U. S. Pat. Off.

Please mention the JOURNAL of the A. I. E. E. when writing to advertisers.

Weigh the value of

A Partial List of G-E Oil Circuit Breakers

TYPE	Voltages	Current-Carrying Capacities	Interrupting Capacities (Amps. at rated volts)
INDUSTRIAL TYPES			
FP-115	110 to 550	50	400 to 500
FP-110	110 to 550	50	400 to 500
FK-20	2500	60 to 300	1300 to 1650
MANHOLE AND POLE TYPES			
FP-104	7500	200	240
FP-7	4500 to 15000	100 to 200	240 to 400
FKO-37	15000 to 37000	400 to 600	1000 to 1500
SWITCHBOARD TYPES			
FK-13	3300	200	1750
FK-5	600 to 7500	200 to 800	1400 to 15000
FK-35 and 35Y	600 to 7500	400 to 800	1700 to 20000
FK-12	15000	300 to 800	1000
FK-12B	4500	1500	4000
FK-132A and B	7500 to 15000	400 to 1200	1500 to 5300
FK-32C	7500 to 15000	600 to 1200	3600 to 8300
STATION TYPES			
FK-34A	4500	2000	6500
FK-25	600 to 2500	3000 to 5000	7200 to 30000
FK-53B	15000 to 25000	400 to 2000	2200 to 4600
FK-54	7500	600 to 1600	10500
FH-103, 203	7500 to 35000	500 to 4000	4700 to 32000
FH-206, 209	7500 to 35000	500 to 4000	6700 to 69000
FHD-17	15000	600 to 5000	32000
FHD-21	15000	600 to 4000	50000
FK-230A	15000 to 25000	600 to 3000	10700 to 30000
FHK-230B	15000 to 37000	600 to 3000	18500 to 60000
FK(O)-136A	25000 to 110000	400 and 800	1200 to 2300
FK(O)-236A	15000 to 73000	400 and 800	2000 to 7000
FHK(O)-236B	15000 to 88000	600 to 1200	3300 to 14000
FK(O)-39A	110000 to 154000	800	2600 to 3300
FHK(O)-39B	15000 to 220000	600 to 2000	2600 to 30000
FHK(O)-39C	15000 to 220000	600 to 2000	3900 to 3800

There's a G-E Breaker for every application



Oil Circuit Breakers

—part of the complete line of General Electric equipment to control and protect power generating and distributing apparatus.

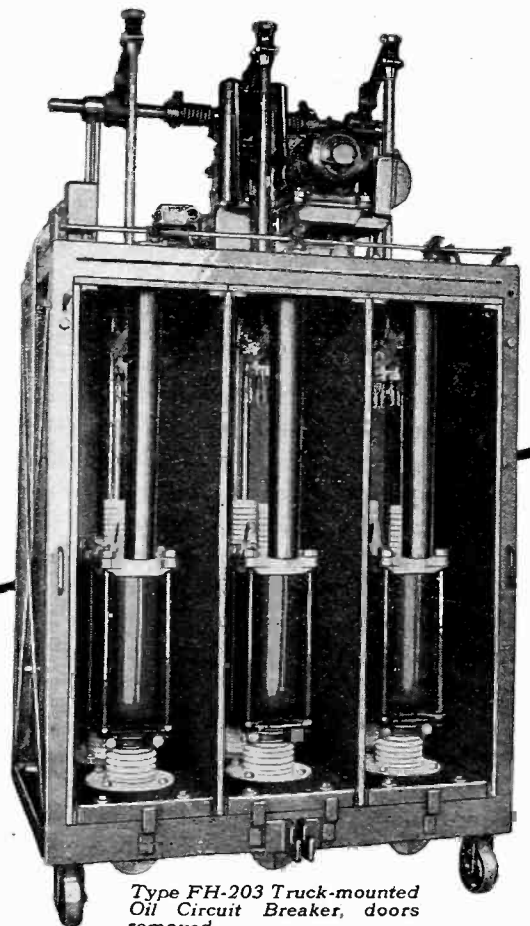

Type FH-203 Truck-mounted Oil Circuit Breaker, doors removed

GENERAL

GENERAL ELECTRIC COMPANY, SCHENECTADY, N. Y.

Please mention the JOURNAL of the A. I. E. E. when writing to advertisers.

Testing Equipment

The successful development of oil circuit breakers to meet the new requirements set up by higher voltages and heavier currents depends upon a balanced combination of experience, engineering ability, and information from operation and test.

General Electric's experience began in 1895 with the building of the first commercial oil circuit breaker in America; its engineering ability is recognized; its testing equipment, in use several years, has provided much valuable information that could not be obtained otherwise.

Before selecting a breaker for any installation, consider the three requisites of successful oil circuit breaker engineering and weigh the value of General Electric's complete testing equipment.

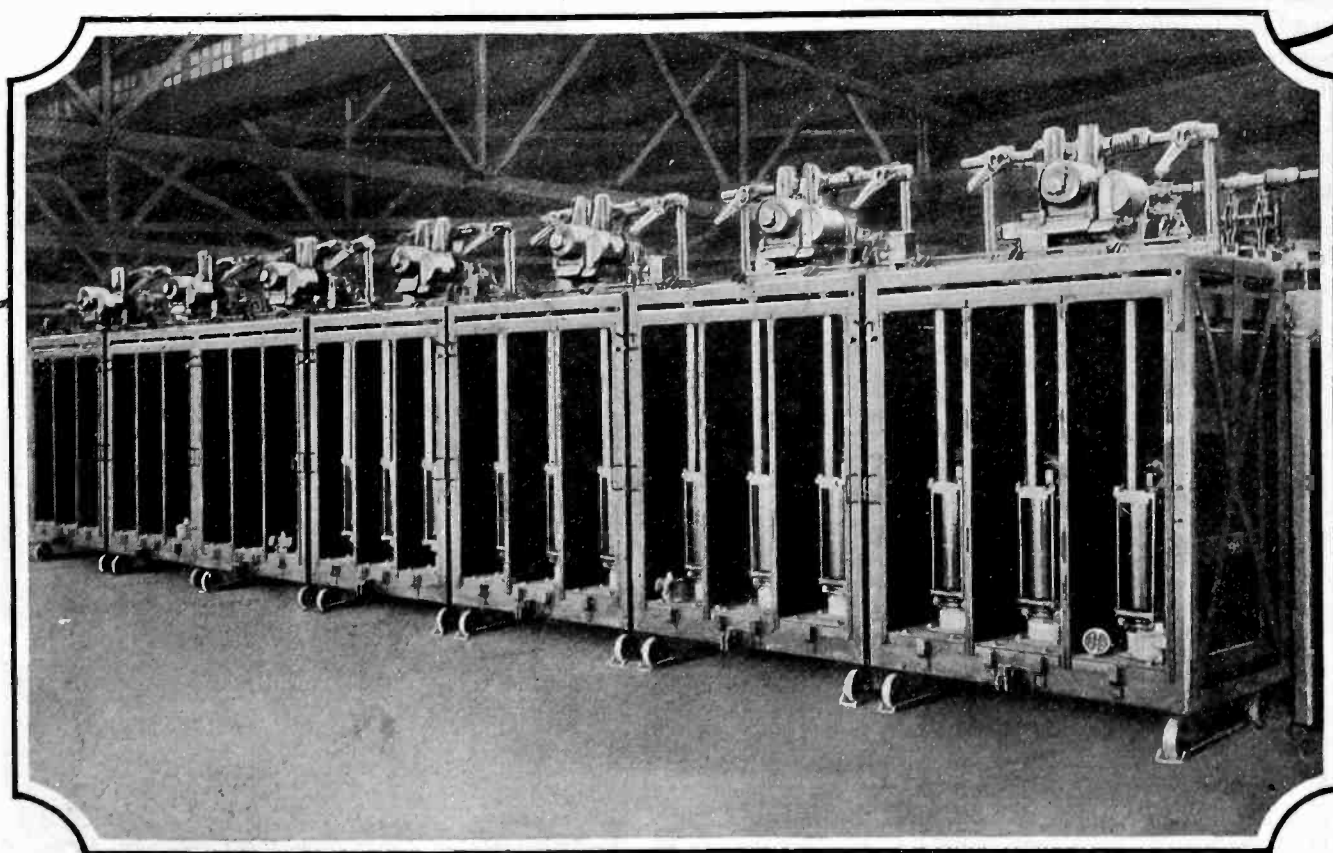

Type FH-203 Truck-mounted Oil Circuit Breakers (doors removed) in New Power House of Central Illinois Light Company, Peoria, Ill.

470-3

ELECTRIC

SALES OFFICES IN PRINCIPAL CITIES

Please mention the JOURNAL of the A. I. E. E. when writing to advertisers.

Roosevelt Dam and Reservoir System

Great American Reservoirs

THE Roosevelt Dam stores up a huge reservoir of water which can be drawn upon as needed. The thirty-five Western Electric distributing houses store up reserves of telephone apparatus and supplies to be drawn on as needed by the telephone companies in constructing lines and maintaining service.

Western Electric with this outstanding national distribution system, does this work at substantial economies for the telephone companies and the telephone-using public.

In time of emergency this service, because of its flexibility, aids your telephone company in quickly repairing the ravages of storm, fire or flood.

Distribution thus plays an important part along with manufacturing and purchasing—the three Western Electric responsibilities—in supplying the needs of the Bell System.



Western Electric Distributing System

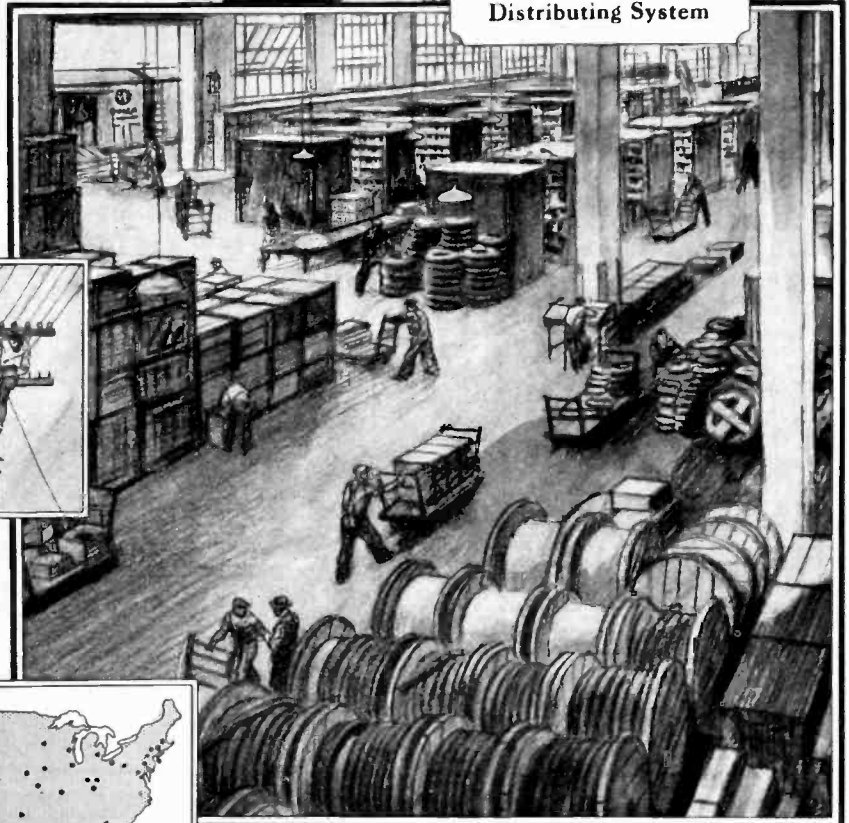

After the storm Western Electric stocks enable telephone service to be restored promptly.

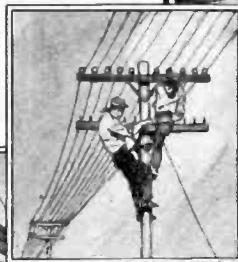

Western Electric quickly supplies everything needed inside the telephone exchange too.



A nationwide service of supply. Western Electric maintains stocks at 35 important points.

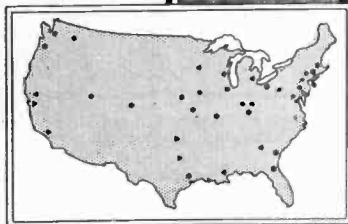

Back of your telephone

Western Electric

SINCE 1882 MANUFACTURERS FOR THE BELL SYSTEM
Please mention the JOURNAL of the A. I. E. E. when writing to advertisers.



TYPE AF-3 \$12.00
 Ratio: 3½ to 1
 Dimensions 2¼" x 3" x 3¾"
 Weight 1 lb. 14 oz.

AUDIO

FREQUENCY TRANSFORMERS

High amplification ratio with flat curve.

High primary inductance maintained under normal operating conditions.

Low leakage reactance resulting in uniform amplification at high frequencies.

Primary winding of ample cross section to withstand continuously, plate currents resulting from all usual operating conditions.

No compound or fibrous material used in construction, therefore low self and mutual capacity with durability and long life.

Core of specially tested material of ample cross section. Laminations thoroughly insulated and assembled to produce an efficient magnetic circuit.

Primary shunted with built in condenser of correct capacity.

Every transformer subjected to ten tests to insure uniformity product.

Tested to one thousand volts between primary and secondary, and between primary and secondary and ground; therefore specially suited for use with power tubes requiring high plate voltages.

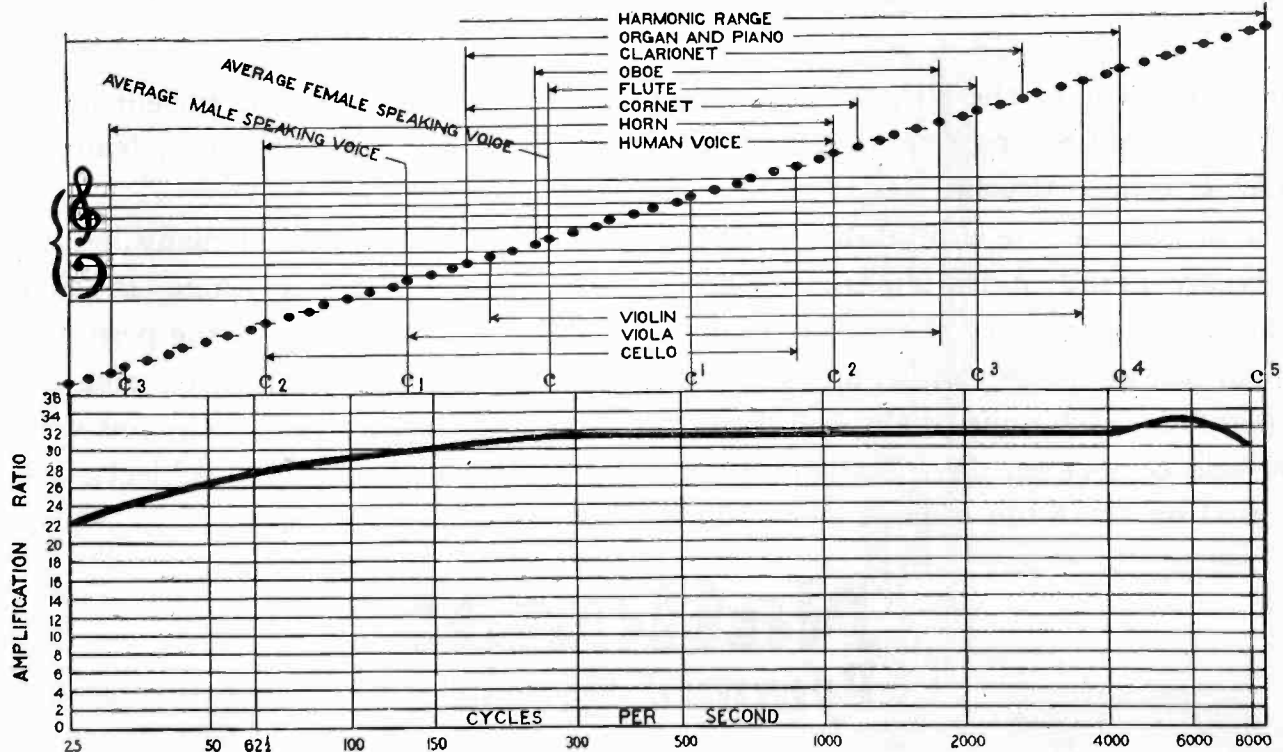

Tube amplification 9.1. Tube resistance 10,500 ohms. Tube UX 112
 A 5 volts. B 68 volts. C 3 volts.

FERRANTI Ltd.
 Hollinwood, England

FERRANTI Inc.
 130 West 42nd Street, New York, N. Y.

FERRANTI ELECTRIC Ltd.
 Toronto, Ontario, Canada

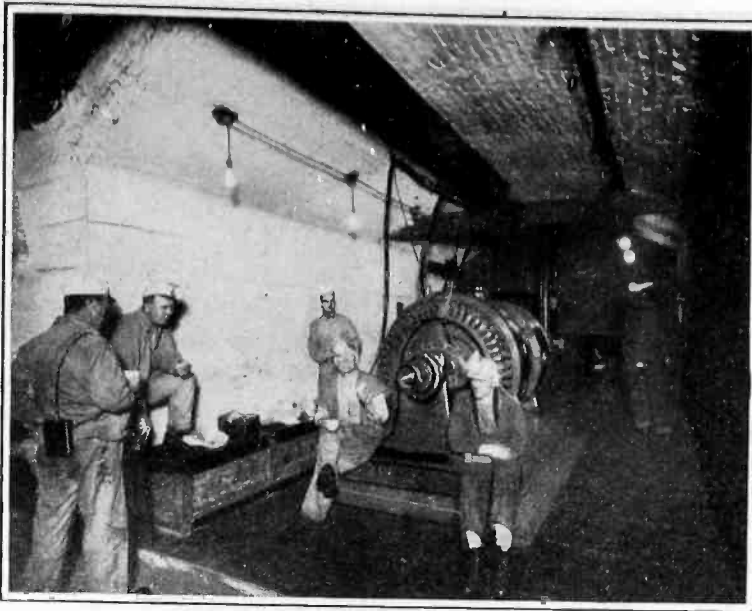

On all mine equipment —NCC Brushes

ALL the equipment of the Virginia and Sayre Mines of the Gulf States Steel Company uses National Pyramid Brushes, and we are as proud of this fact as the Gulf States Company is deservedly proud of its mines. For these mines are modern in every respect, thoroughly electrified, safe as mines can be, and economically operated. Each mine produces from 1000 to 1200 tons of coal per day. National Grade 401 is used on the 6-ton electric locomotives,

which are supplied with current at 250 volts. On the motor generator sets, National Grade 255 is employed.

In the show places of many industries you will find National Pyramid Brushes, doing their part in maintaining the perfection of the whole. Our Sales Engineers, men of diverse experience, are eager to help you with advice on brushes and correlated subjects. Ask about our Data Sheet Service.

National Pyramid Brushes

NATIONAL CARBON COMPANY, INC.
Cleveland San Francisco

*Unit of Union Carbide and Carbon Corporation
Emergency Service Plants*

CHICAGO, ILL.
551 West Monroe St.
Phone: State 6092

PITTSBURGH, PA.
7th Floor, Arrott Power Bldg. No. 3
Barker Place. Phone: Atlantic 3570

NEW YORK, N. Y.
357 West 36th St.
Phone: Lackawanna 8153

BIRMINGHAM, ALA.
1824 Ninth Ave., N.
Phone: 3-6091

HONESTY OF MANUFACTURE

Some transformer manufacturers claim to provide more insulation than their competitors. Other manufacturers claim a better quality of insulation.

But after a transformer has been designed and the material for making it has been purchased, the next step is to fabricate the transformer. If the workmen who build it are not honest then the efforts of

the engineers and the purchasing department are nullified.

Wagner is noted for the honesty of its manufacture. Whatever is specified by its engineers and only such material as is passed by its inspection department goes into the transformer—exactly as designed and specified.

6737-1

Wagner Transformers

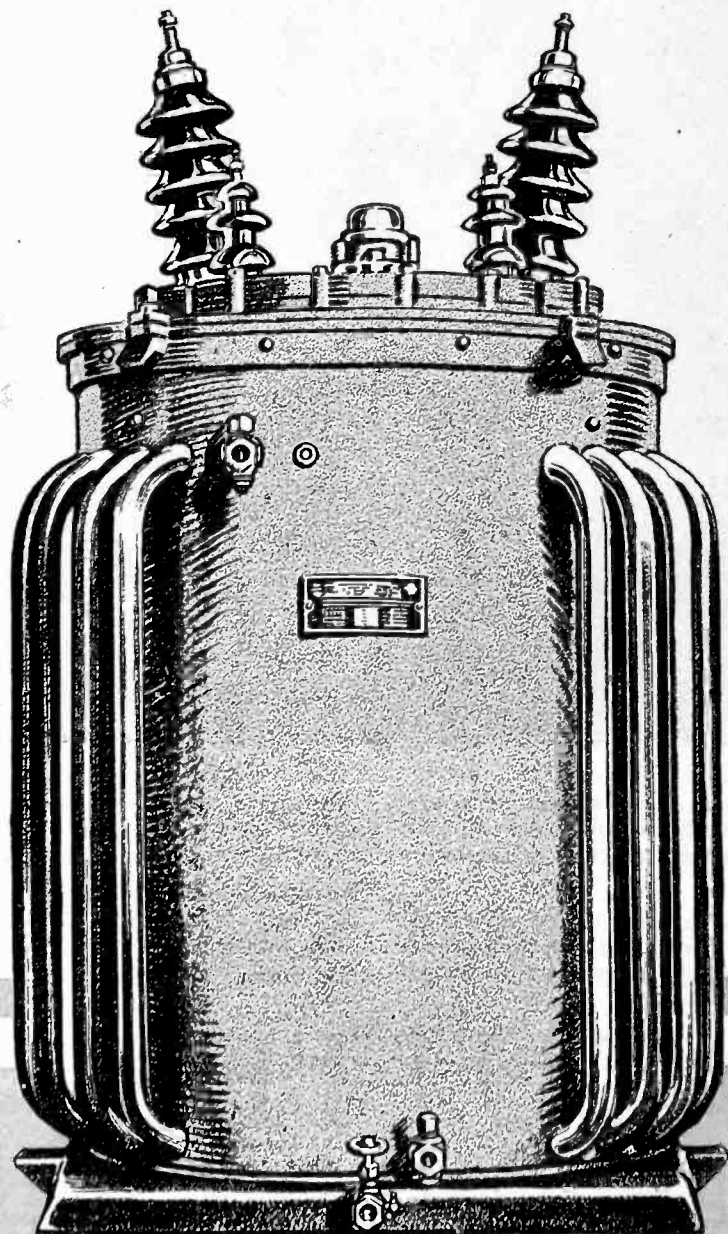

Type HE Transformer, 200 kva., single-phase, 60-cycle, 33,000 to 2,300 volts.



FYNN-WEICHSEL MOTORS

POWER TRANSFORMERS

SINGLE-PHASE MOTORS

POLY-PHASE MOTORS

FANS

INSTRUMENT TRANSFORMERS

DISTRIBUTION TRANSFORMERS

WAGNER ELECTRIC CORPORATION, 6400 PLYMOUTH AVENUE, ST. LOUIS, U. S. A.

Please mention the JOURNAL of the A. I. E. E. when writing to advertisers.

"ONE THING WELL DONE"

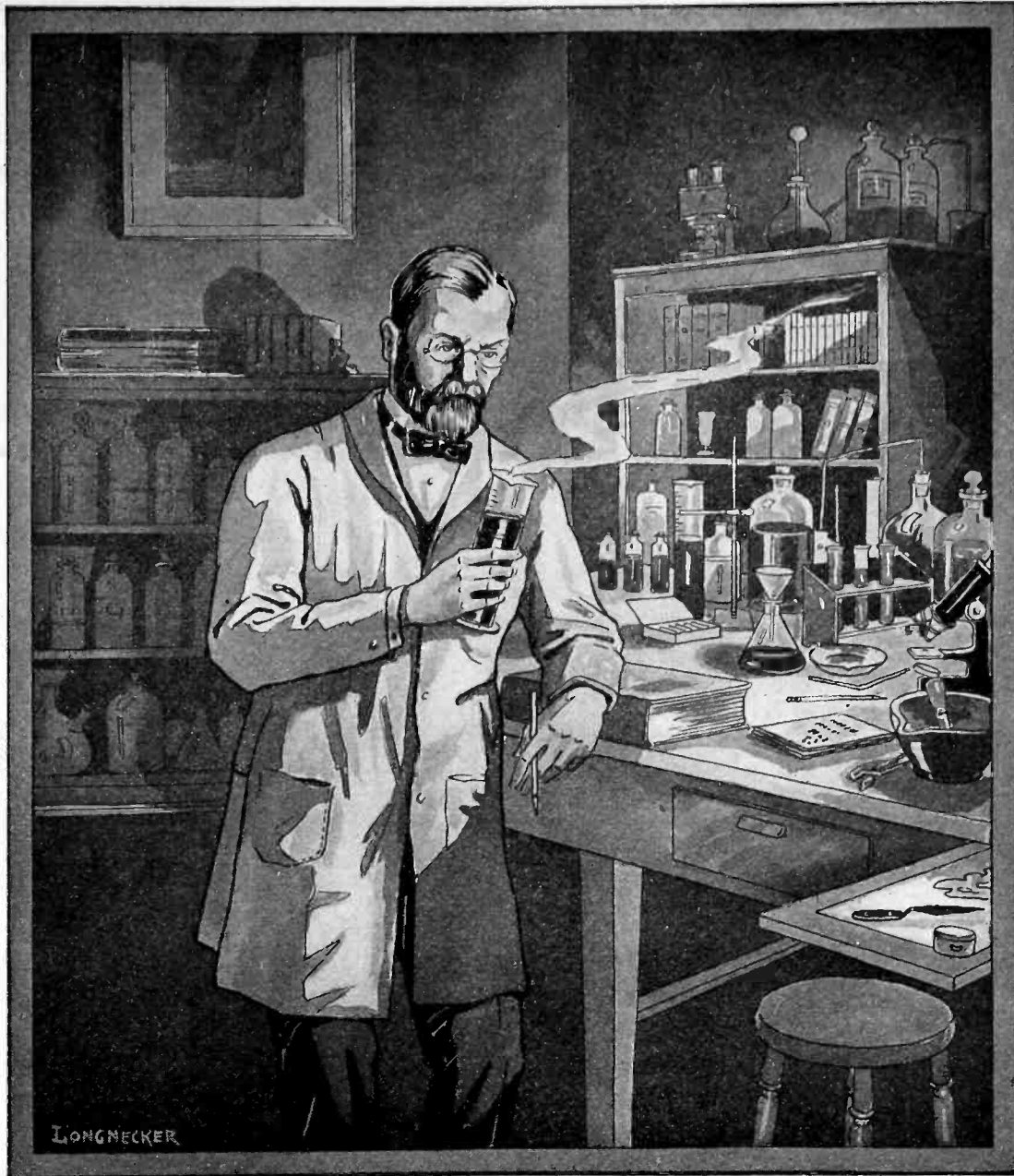

LOUIS PASTEUR (1822-95)—founder of the science of bacteriology and genius in preventive medicine—set before himself one all-important purpose in life: the protection of humanity by elimination of disease.

"Protection" has likewise been the watchword of Cutter Engineers for almost forty years—protection to life and property by accurate control of electric power—protection against

destructive "shorts", overloads and single phasing—protection against costly repairs and crippled production—protection to men, motors, machines and minutes.

In every industry, for every purpose, in circuits not exceeding 600 volts A. C. or D. C., I-T-E Circuit Breakers—sturdy, dependable, unlimited in rupturing capacity—have set the standard by which electrical protection is measured.

CUTTER

A 6000 Ampere, 250 volt, 2-pole overload, solenoid operated I-T-E Air Circuit Breaker installed in the Chicago steel district. Equipped with Auto-Ite, or mechanical non-closable-on-overload feature, to protect equipment and employees and to guard against production delays.

THE CUTTER COMPANY, EST. 1888

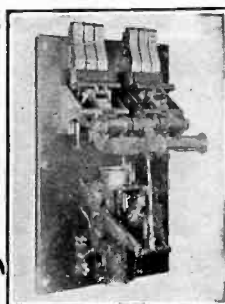

The "Handbook of the I-T-E Circuit Breaker"—with its 263 pages of text, tables, charts and illustrations on electrical protection—is worth having. Your copy will be mailed free on request, by mentioning your company's name.

505 N. 19th STREET—PHILADELPHIA

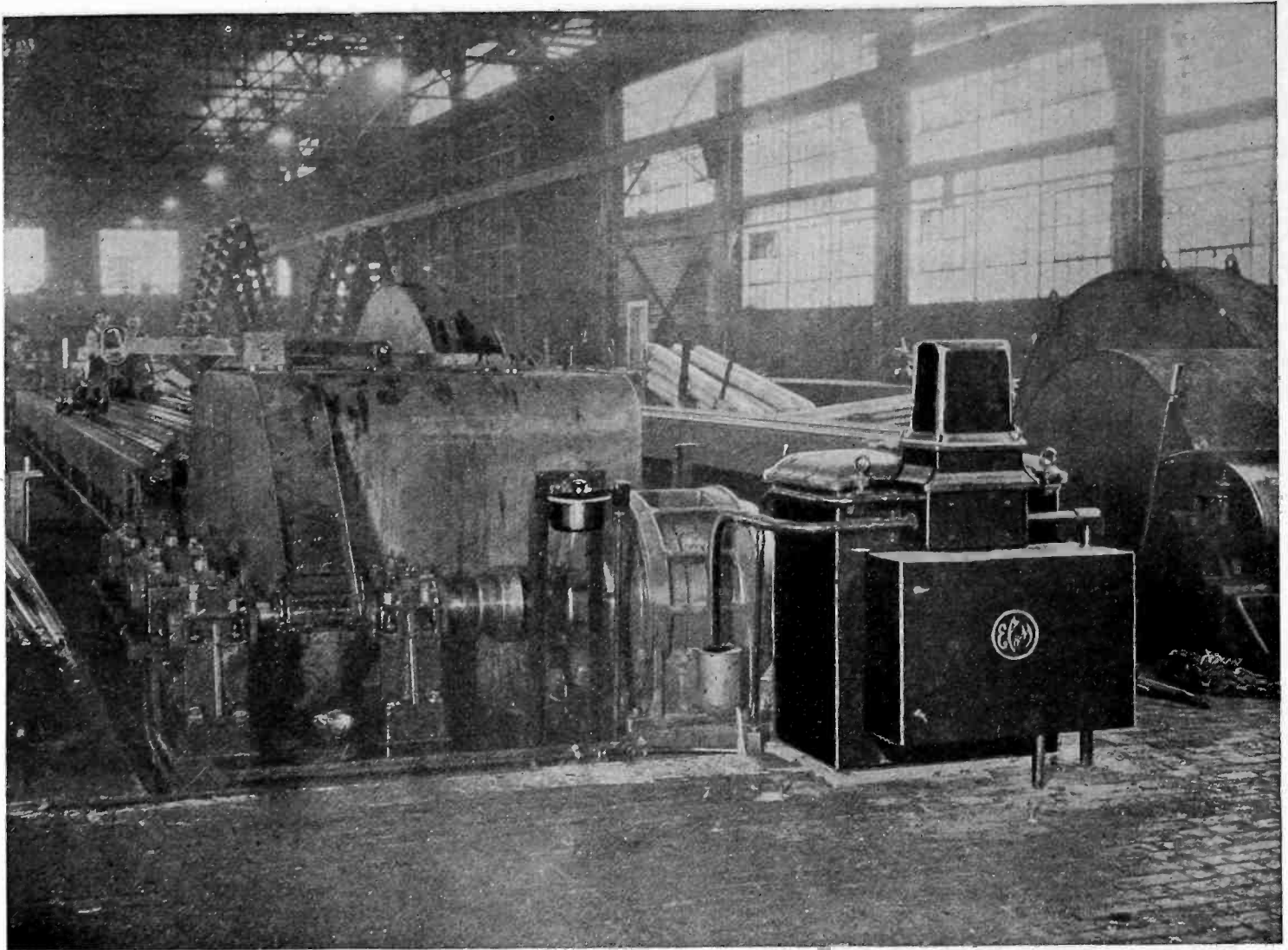

EC&M Synchronous Motor Starters can be placed out in the mill

The illustration shows an EC&M Oil-immersed Automatic Starter for a 100 HP, 2300 volt Synchronous Motor driving a Tube Draw Bench.

Consider the saving in cost of installation when using this self-contained, dust-proof EC&M Control as compared with switch-board type of apparatus. Expensive control houses are dispensed with and locating the Controller right by the motor reduces the cost of wiring.

Write for Bulletin 1047



THE ELECTRIC CONTROLLER & MFG. CO.

BIRMINGHAM - BROWN-MARX BLDG.	CLEVELAND, OHIO	PHILADELPHIA - WITHERSPOON BLDG.
CHICAGO - CONWAY BLDG.		PITTSBURGH - OLIVER BLDG.
CINCINNATI - NATIONAL BANK BLDG.	MONTREAL - DRUMMOND BLDG.	SAN FRANCISCO - CALL BUILDING
DETROIT - DIME BANK BLDG.	LOS ANGELES - AMERICAN BANK BLDG.	SEATTLE - 570 COLMAN BLDG.
NEW YORK - 50 CHURCH ST.	SALT LAKE CITY - 228 W. SO. TEMPLE	TORONTO - REFORD BLDG.



Please mention the JOURNAL of the A. I. E. E. when writing to advertisers.

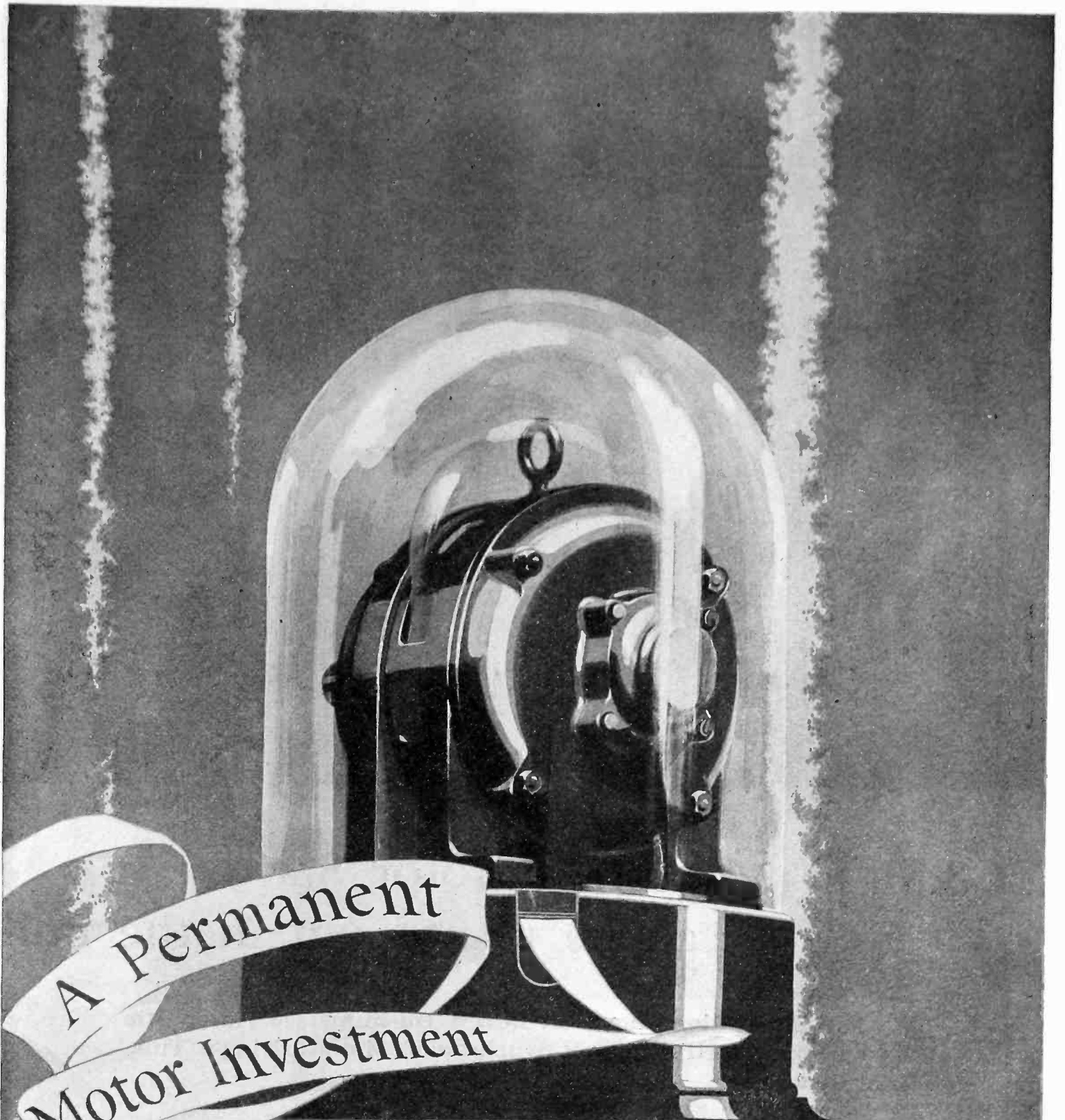

A Permanent
Motor Investment

FRICTION-ELIMINATION is merely one factor in prolonging motor life. Ending all possible friction, Timken Tapered Roller Bearings raise endurance in many other ways, also.

Timken load capacity greatly increases rigidity. Timken tapered design renders thrust harmless. Timken *POSITIVELY*

ALIGNED ROLLS add to speed possibilities. Timken-made electric steel is shock-proof. So far as bearing life is concerned, Timken-equipped motors are a permanent investment, producing continuous returns in the form of lubricating economy, reduced power consumption, space saving, and insurance against shutdown.

THE TIMKEN ROLLER BEARING CO., CANTON, OHIO

Compression Resistance Starters Are Superior to Compensators

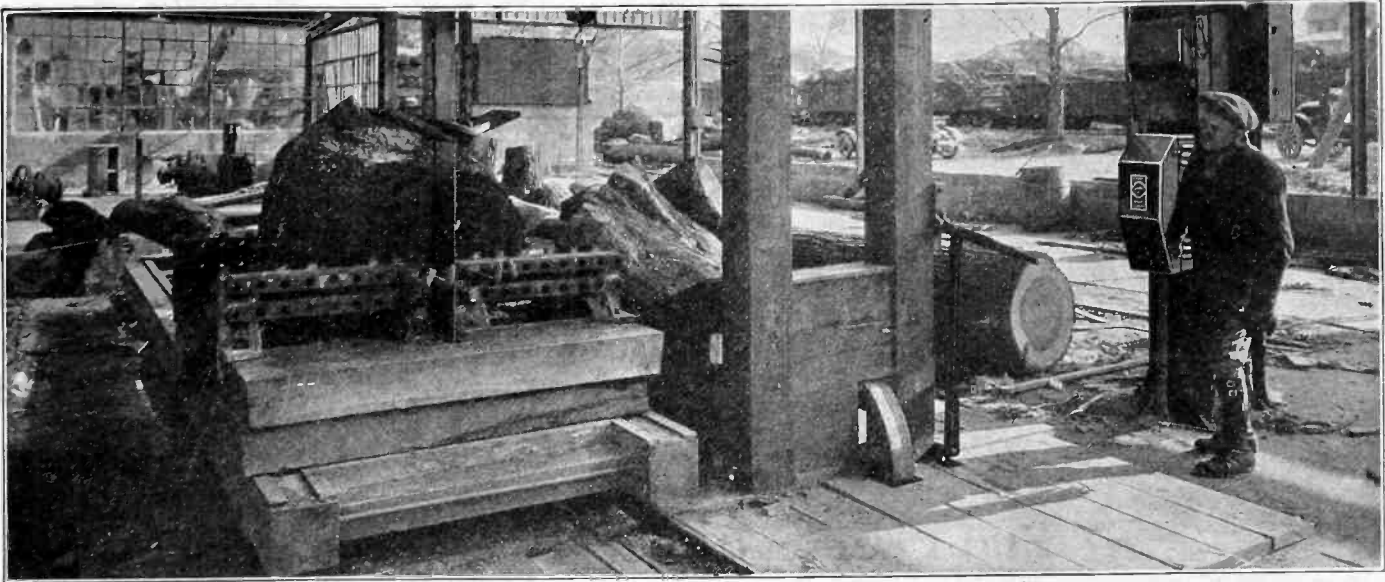

There's No Starting Job Too Tough for the Compression Resistance Starter

THE real advantage of the compression resistance starter for squirrel-cage motors shows up best under severe starting loads. For example, heavy band saws must be brought up to high speed quickly, but without jerks. If a compensator is used for such duty, the motor picks up its load with a jerk that often breaks the highly-tempered saw. In other cases the sudden starting jolt causes slippage that burns or breaks belt drives and also increases wear and tear on the driven machinery.

When the Allen-Bradley starter handle is lifted, line voltage is ap-

plied to the starter, and current flows to the motor. The current is steplessly increased by further lifting of the handle until the motor starts, and the motor then is gradually brought up to full speed. Finally a magnetic switch automatically closes, which throws the motor on the line without opening the motor circuit, and it also cuts the resistors from the circuit. At no time does the motor draw an excessive starting current, and no violent in-rushes take place, which are so characteristic of the starting compensator.

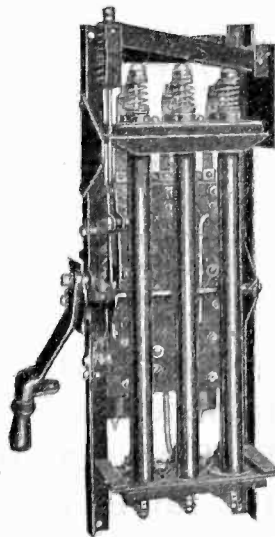

Write for full information concerning Allen-Bradley hand-operated and automatic compression resistance starters; mail the coupon for a new technical bulletin on "Compensators vs. Resistance Starters."

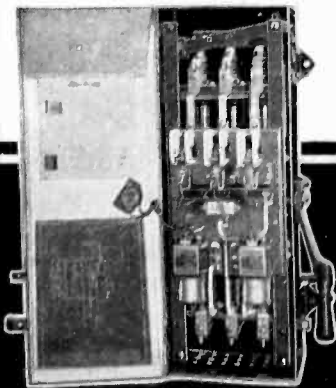

Allen-Bradley
Graphite Compression
RESISTANCE STARTERS
for Squirrel-Cage Motors

ALLEN-BRADLEY CO.,
494 Clinton St., Milwaukee, Wis.

Please send me engineering bulletin with oscillograph test of squirrel-cage motor starters.

Name

Company

Address

Prizes for Thinking

Who Will Win Them?

1st Prize	-	-	\$10,000
2nd Prize	-	-	\$ 5,000
3rd Prize	-	-	\$ 2,500

THE Lincoln Arc Welding Prizes for 1927 are offered to stimulate thought along the line of new applications of arc welding. These prizes will be won by men who demonstrate how arc welding can be made of greater benefit to humanity.

In all probability the successful contestants will show how this revolutionary process can be utilized on the very jobs **WITH WHICH THEY ARE FAMILIAR.**

Study **YOUR** manufacturing problems. Do you manufacture from iron or steel? If so, arc welding can undoubtedly be utilized to reduce manufacturing costs. In general, the cost of machinery can be reduced 20% or more by this process.

Determine what the total annual saving would be if everyone in your line should adopt arc welding. Then you have the basis of a paper to submit for the arc welding prizes. The winners of these prizes will reap rewards far in excess of the amounts of the awards, for they will be brought to the attention of every mechanical engineer and manufacturer in the United States.

A booklet containing complete information regarding this contest can be secured from The American Society of Mechanical Engineers who will judge the papers. Address them at 29 West 39th St., New York City, or write direct to The Lincoln Electric Company, Cleveland, Ohio.

"NORMA" Precision Ball Bearings and "HOFFMANN" Precision Roller Bearings, on the motor shaft, enable this high-speed Router—made by R. L. Carter at Phoenix, N. Y.—to operate continuously at speeds up to 12000 R.P.M.

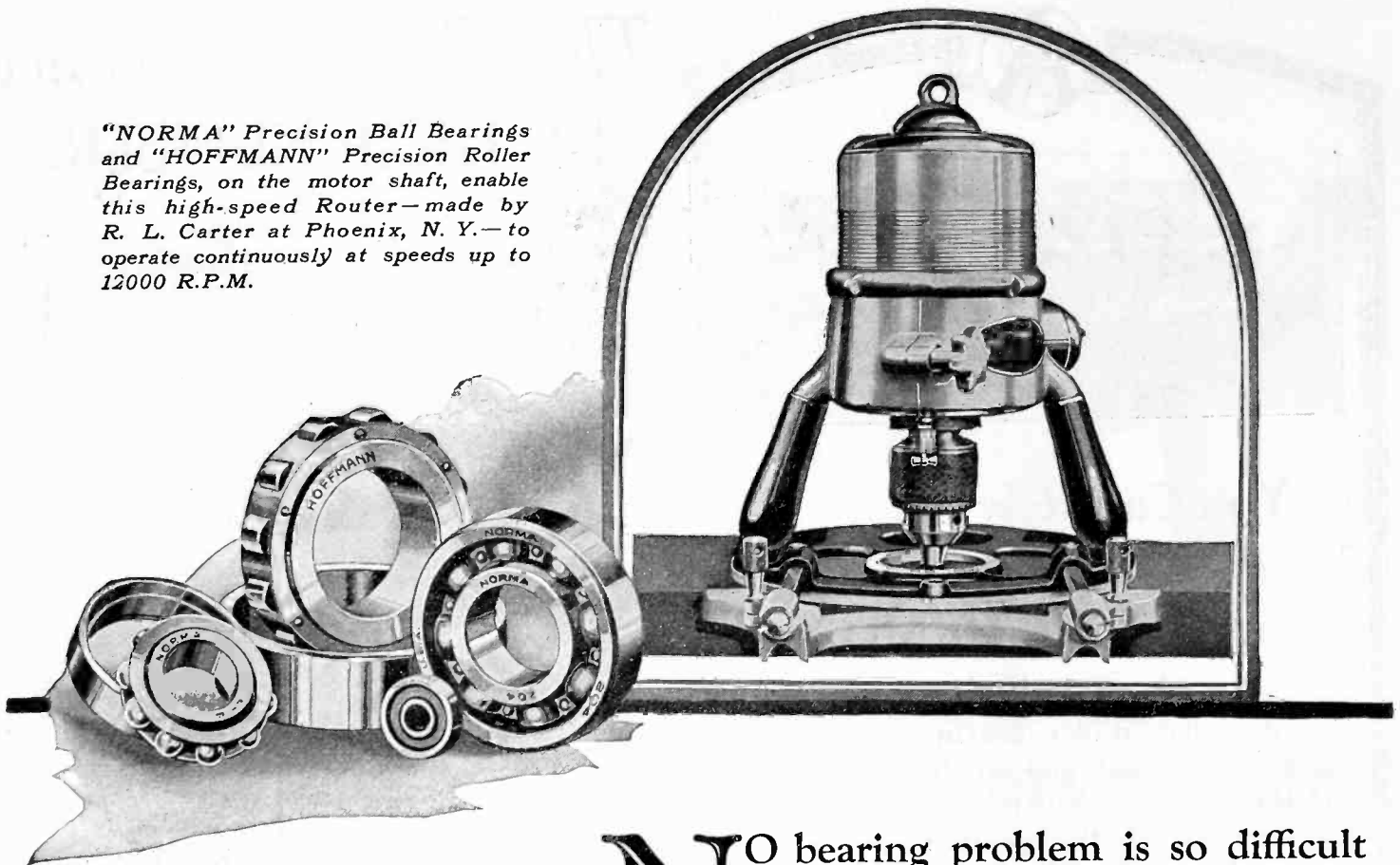

NO bearing problem is so difficult or so complex that it cannot be completely and economically solved either by "NORMA" Precision Ball Bearings, by "HOFFMANN" Precision Roller Bearings, or by the two in combination. All conditions of load and speed are today being met successfully by these Precision Bearings. They are daily demonstrating their dependability, in the tests of hard service.

Catalogs 904, 905 and 917—describing the "NORMA-HOFFMANN" line—will be sent on request

NB-879

NORMA-HOFFMANN BEARINGS CORPORATION
STAMFORD, CONN. . . . U. S. A.

**There Is No Substitute
For Experience**

Let our engineers work with you, placing freely at your disposal the mastery of bearing problems which they have gained in long years of specialized bearing engineering. You incur no obligation in seeking their counsel.

**- NORMA -
HOFFMANN
PRECISION BEARINGS**

Please mention the JOURNAL of the A. I. E. E. when writing to advertisers.

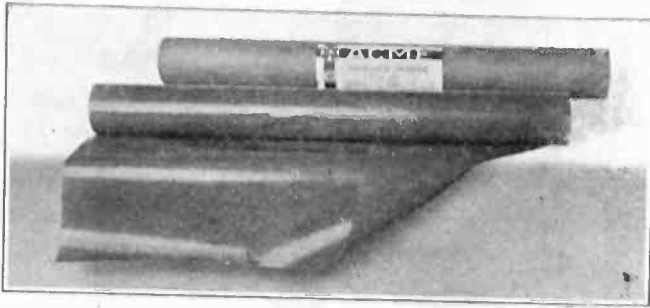

You Can Rely on Acme UNIFORMITY

Uniformity in varnished insulations has direct bearing on the price you pay and on the state of the finished product. If the thickness exceeds the specification, the yardage will fall short and the finished job will be over-size.

Acme Varnished Cambrics are of long-staple cotton, specially finished for smoothness and uniformity, then coated with pure vegetable oil varnish, under accurate heat control. The silks and papers are produced under similar care. And *all* must undergo the severest physical and electrical tests.

The Code Numbers in the Acme Catalog are absolutely reliable for all electrical calculations.

Acme Varnished Insulations are furnished in Cambrics, Silks and Papers, in all standard colors, finishes and sizes; also in Tubing and Slot Insulations.

Our Catalog 3A gives the details. It should be in your files. Let us send you a copy.

ACME WIRE PRODUCTS

THE ACME WIRE CO.
Main Office and Plant, New Haven, Conn.
Branches at
New York, 52 Vanderbilt Ave. Chicago, 427 West Erie Street
Cleveland, Guardian Bldg.

Their Task is Lightened BY THEIR NUMBERS

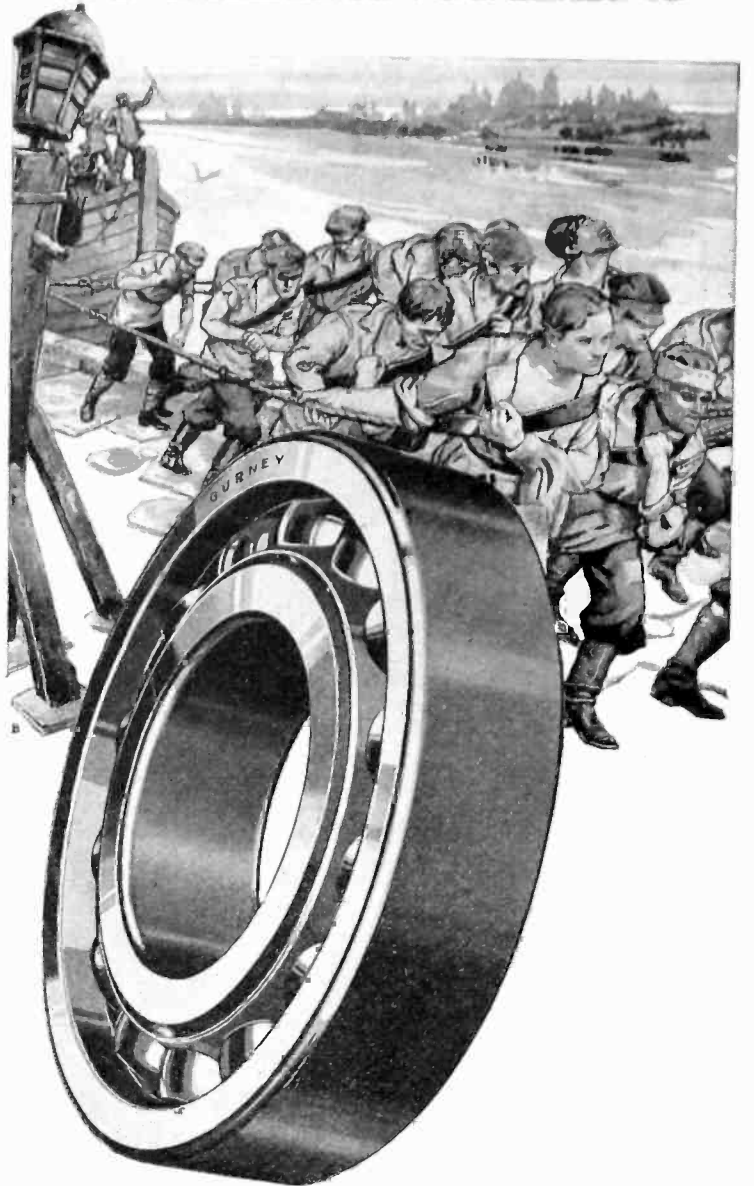

Divide a task among ten men and each does one-tenth of the work. Give the same job to fourteen men and the work of each is correspondingly reduced.

The Gurney Maximum Type Bearing functions in much the same manner. More balls of tough, wear-resisting Molybdenum Steel reduce the load on each ball with consequently greater capacity and longer life.

Reason enough for specifying Gurney in your equipment. Our Engineering Department will gladly help you.

MARLIN - ROCKWELL CORPORATION
Gurney Ball Bearing Division
Jamesstown, N. Y.

GURNEY

BALL BEARINGS

BETTER STEEL · BIG BALLS · MORE OF THEM



**Every DUDLO Coil
must be O. K. in every respect**

—number of turns

—no short circuits

—dimensions

—resistance

—output

Complete satisfaction is assured to Dudlo customers because each individual coil is thoroughly tested and accurately checked in every way possible.

Dudlo coils must be up to specifications. There is no passing mark short of perfection.

Here in the world's coil headquarters has been developed the most complete testing apparatus in the industry. Special methods and equipment have been developed that would be impossible with any but the largest volume.

Unlimited volume, deliveries on schedule and exact adherence to specifications make Dudlo the logical source of supply for magnet wire and windings.

DUDLO

DUDLO MANUFACTURING CORPORATION, FORT WAYNE, INDIANA

56 EARL STREET
NEWARK, N. J.

160 NORTH LA SALLE STREET
CHICAGO, ILL.

4153 BINGHAM AVE.
ST. LOUIS, MO.

274 BRANNAN ST.
SAN FRANCISCO, CALIFORNIA

Please mention the JOURNAL of the A. I. E. E. when writing to advertisers.

I-N BOARD West Virginia Fibre Board

For Electrical Insulation

Tested and approved by the Underwriters' Laboratories.

High tensile and dielectric strength. Used successfully by many of the large electrical manufacturers.

A decided factor for economy.

Pulp Products Department

**West Virginia
Pulp & Paper Company**

200 Fifth Avenue, New York, N. Y.
505 Dime Bank Bldg. Detroit, Mich. 732 Sherman Street Chicago, Ill.
503 Market Street, San Francisco, Cal.

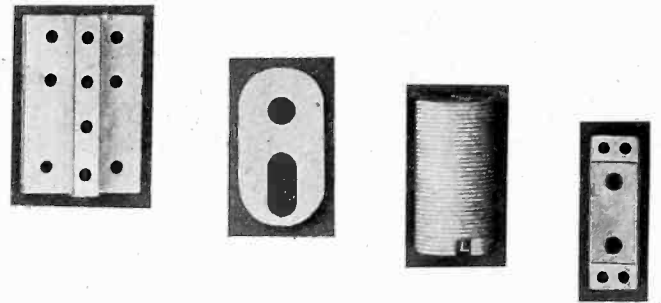

INSULATORS

made of

LAVA

Made to special design Lava insulators, accurate, uniform and dependable, are important parts when incorporated in electric appliances.

AMERICAN LAVA CORPORATION
27-67 Williamson St.,
Chattanooga Tennessee
Manufacturers of Heat Resistant Insulators

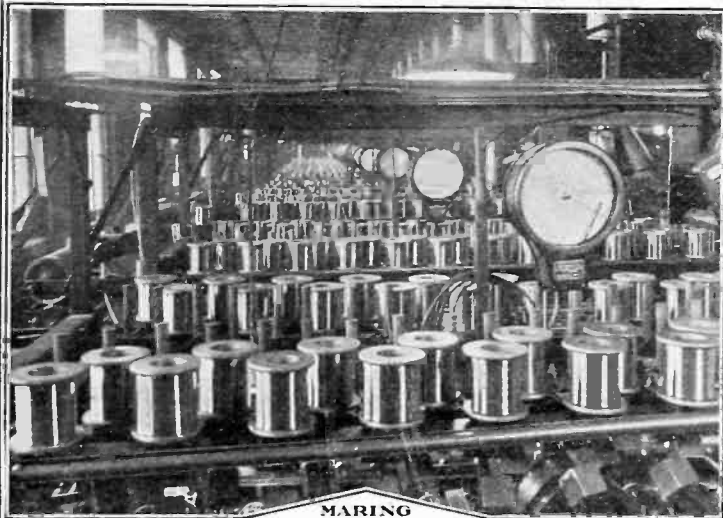

MARING PROCESS

A "Sea" of Spools—View of Maring Fine Wire Enameling

JUST one row of ovens enameling MARING Process Fine Magnet Wire. Note the line of charts that faithfully register the temperature of the electrically-heated enameling ovens.

These ovens, Maring-designed and Maring-built represent the finest enameling process. Their construction has drawn upon a wide experience of nearly twenty years devoted exclusively to magnet wire manufacture. "MARING" rapidly established a reputation for superior magnet wire, constantly improved and perfected. This reputation is becoming a standard because of a policy to make only one product, but make it the best.

Write us for data and prices. Our branch managers are ready and eager to help you solve your magnet wire problems. New free catalog sent on request.

MARING WIRE COMPANY
Muskegon, Mich., U. S. A.
Branch Offices in Principal Cities

MARING

"The Nation's Finest Value in Magnet Wire"

"IRVINGTON" PRODUCTS

Black and Yellow

Varnished Cambric Varnished Paper
Varnished Silk
Flexible Varnished Tubing
Insulating Varnishes and Compounds
"Cellulak" Tubes and Sheets

IRVINGTON VARNISH & INSULATOR CO.
Irvington, New Jersey.

Sales Representatives

Mitchell-Rand Mfg. Co., New York
E. M. Wolcott, Rochester
I. W. Levine, Montreal
A. L. Gillies, Toronto
Consumer's Rubber Co., Cleveland
Martin Woodard, Seattle
Prenter Brothers, Inc., Chicago
White Supply Co., St. Louis
Clapp & La Moree, Los Angeles

**NATIONAL
VULCANIZED
FIBRE**

**SHEETS
RODS
TUBES
SHAPES**

*Graded to
your requirements*

*Paper base
Canvas base*

PHENOLITE
Laminated BAKELITE

**SHEETS
RODS
TUBES
SHAPES**

**PEERLESS
INSULATION**

NATIONAL VULCANIZED FIBRE CO.
WILMINGTON DEL., U. S. A.
Offices in principal cities

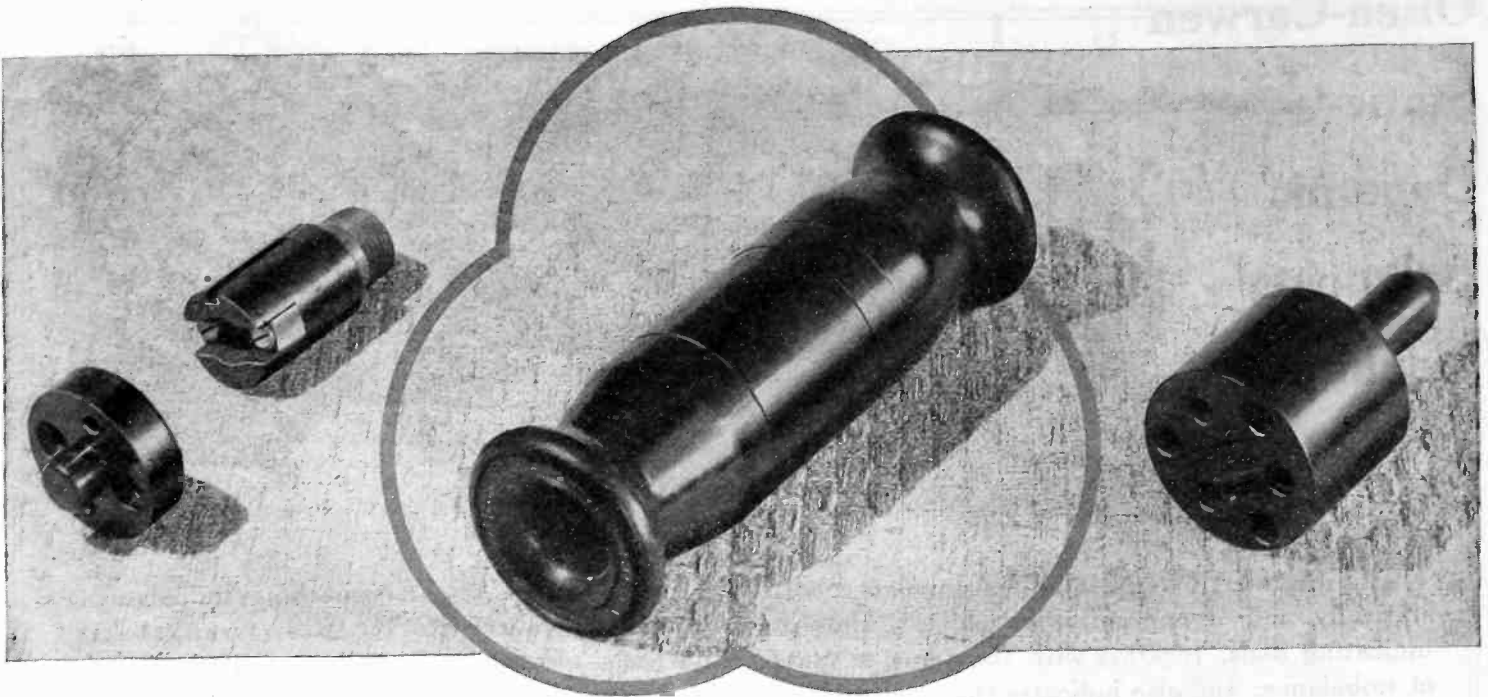

Cable connector and plugs of Bakelite Molded. Made by Russell & Stoll Co., New York.

Heavy duty wiring devices *formed of Bakelite Molded*

CONNECTORS and plugs for circuits of 60 amperes 250 volts must be formed of a material that provides mechanical strength as well as superior insulation, and both properties are combined in Bakelite Molded.

The cable connector shown above is a typical example of the advantages of Bakelite Molded for this type of device. Four close fitting molded parts are used, each formed in a single operation with all necessary lugs and holes and relief let-

tering of rating and manufacturer's name. The high lustre of Bakelite Molded and its permanent color give an unusually handsome appearance to these parts.

The steadily increasing use of Bakelite Molded for wiring devices of every sort proves that it possesses many advantages for this, and similar, classes of work. We invite you to enlist the cooperation of our engineers and research laboratories in adapting Bakelite Molded to your own particular needs. Write for Booklet No. 3.

BAKELITE CORPORATION

247 Park Ave., New York, N. Y., Chicago Office: 635 West 22nd St.

BAKELITE CORPORATION OF CANADA, LTD., 163 Dufferin St., Toronto, Ontario, Can.

BAKELITE

REGISTERED U. S. PAT. OFF.



THE MATERIAL OF A THOUSAND USES

The registered Trade Mark and Symbol shown above may be used only on products made from materials manufactured by Bakelite Corporation. Under the capital "B" is the numerical sign for infinity, or unlimited quantity. It symbolizes the infinite number of present and future uses of Bakelite Corporation's products.

Please mention the JOURNAL of the A. I. E. E. when writing to advertisers.

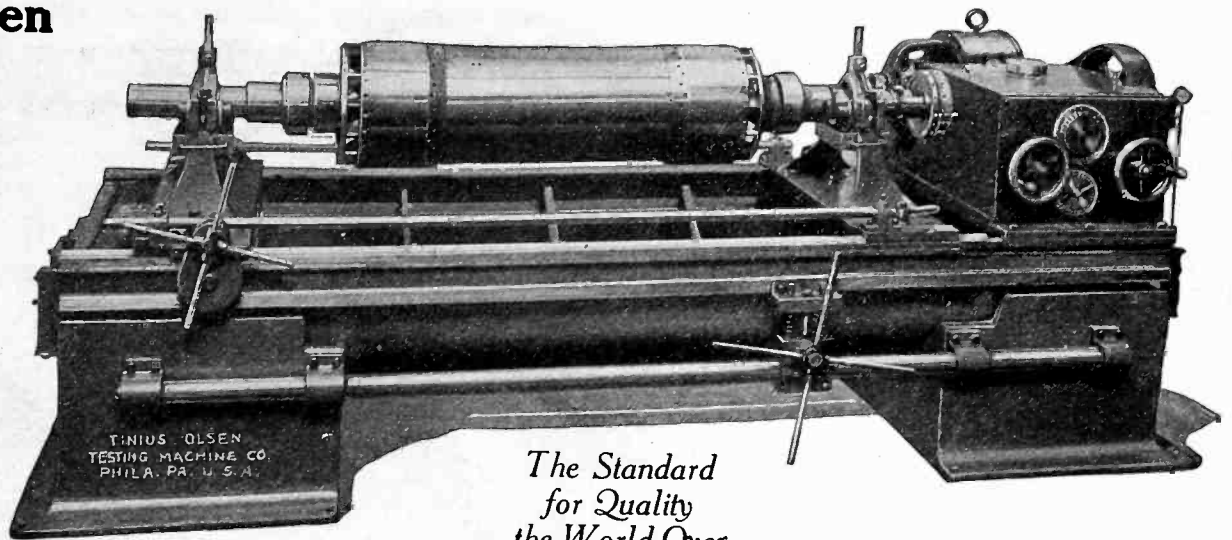
Olsen-Carwen**Static-
Dynamic
Balancing
Machine**

*The Standard
for Quality
the World Over*

The OLSEN-CARWEN indicates unbalance both statically and dynamically in ounce inches on indicating dials, together with the angle or plane of unbalance; and also indicates the axial rotation of the static unbalance along the length of the rotor.

The OLSEN-CARWEN is built in many sizes to take in all types and weights of rotors.

Special OLSEN-CARWEN machines for balancing Armatures, Turbine Rotors, Crankshafts, Flywheels, Pulleys, Propeller Shafts, Cutter-Heads, etc.

To ELIMINATE VIBRATION and secure perfect balance with speed and economy use THE OLSEN-CARWEN.

Sole Manufacturers

TINIUS OLSEN TESTING MACHINE COMPANY

500 North Twelfth Street, PHILADELPHIA, PA., U. S. A.

THE PIONEER MANUFACTURER OF Interpole & Ball Bearing Motors

½ to 1000 H. P. D. C. and A. C.



Type "S" Ball Bearing Motor
with base and pulley

ELECTRO DYNAMIC COMPANY

Established 1880

BAYONNE, N. J.

Sales Offices in Principal Cities

Sturtevant Electric Motors

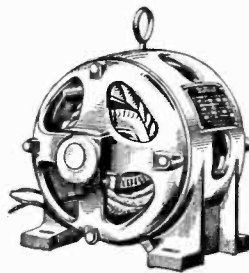

—A. C. and D. C.; single and polyphase—built in sizes from small fractional to 250 horse-power—designed to operate under a constant full load where uninterrupted service is demanded.

B. F. STURTEVANT COMPANY
HYDE PARK, BOSTON, MASS.

Star Ball Bearing Motors

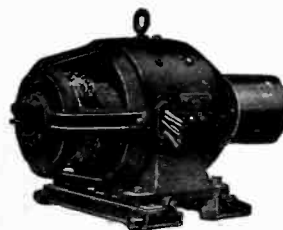

For
Hard
Usage
—
A. C.
and
D. C.

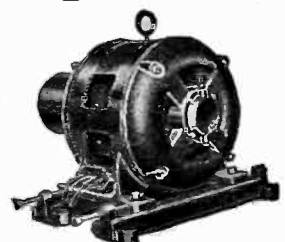

Complete line of standard motors and generators,
all sizes up to 75 h. p. and 50 kw. respectively.
Our Engineering Department at your service for all special applications

STAR ELECTRIC MOTOR CO.
NEWARK, NEW JERSEY

Please mention the JOURNAL of the A. I. E. E. when writing to advertisers.

“They Keep a-Running”



*2 Horse Power Century Type RS Repulsion Start
Induction Single Phase Motor*

Safe Operating Temperature

The safe operating temperature of Century Type RS Repulsion Start Induction Single Phase Motors is one point of *the difference* that contributes to their long life and makes them “Keep a-Running” indefinitely.

- 1 Temperature rise is not more than 40° Centigrade in, the hottest spot under constant full-load operation.
- 2 This low temperature preserves the insulation, upon which the sustained operating life of the motor depends.
- 3 Well ventilated end brackets and symmetrical open spaces between field coil ends permit free circulation of air through and around all vital parts.

“Keep a-Running” ability plus high starting torque and low starting current makes Century Type RS Repulsion Start Induction Single Phase Motors particularly suitable for operating such apparatus as domestic and commercial refrigerators, pumps, compressors, oil burners, etc. Built in all standard sizes from $\frac{1}{8}$ to 40 horse power.

*There is a difference—use and specify Century Type RS Repulsion Start
Induction Single Phase Motors*

CENTURY ELECTRIC COMPANY

1806 Pine St.

St. Louis, Mo.

*33 Stock Points in the United States
and More Than 50 Outside Thereof*

$\frac{1}{8}$ to 40 H. P.



$\frac{1}{8}$ to 40 H. P.

Please mention the JOURNAL of the A. I. E. E. when writing to advertisers.

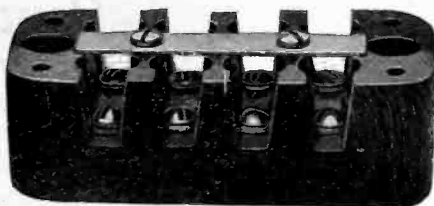

**CONTROLEAD TERMINAL BLOCKS
WITH INTERCHANGEABLE SWITCH PARTS**

Sample and Bulletin furnished on request

BURKE ELECTRIC CO., ERIE, PA.

MARTINDALE MOTOR MAINTENANCE EQUIPMENT

Effective September 1, 1927, we are taking over the exclusive sale and distribution of Industrial Types of Commutator Undercutters manufactured by The Hullhorst Micro Tool Co.

Write us for copy of new Undercutter Catalog.

Martindale Electric Co.
1254 West 4th St., Cleveland, O.

MARTINDALE MOTOR MAINTENANCE EQUIPMENT

Trade "ESCO" Mark

ELECTRIC SPECIALTY CO.

Engineers and Manufacturers

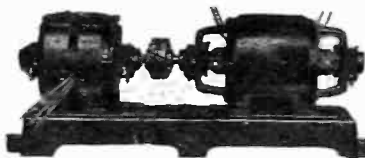

DESIGN —
DEVELOP —
PRODUCE —

Small Motors, Generators, Dynamotors,
Motor Generators, Rotary Converters, Etc.
FOR SPECIAL PURPOSES—Send Us Your Problems
222 South Street, STAMFORD, CONN., U.S.A.

TRUMBULL

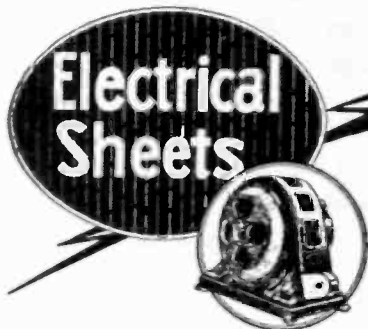

for years have stood the most exacting tests of scores of the largest motor, dynamo, generator, and radio builders in the United States.

Our Engineering Department is at your service. Write us concerning your requirements.

THE TRUMBULL STEEL COMPANY
WARREN Mills, Laboratories and General Offices OHIO

MODELS

for

MANUFACTURING STANDARDS
SALES DEMONSTRATION AND DISPLAY
USE IN LITIGATION

Experimental Development under Client Supervision
MANUFACTURERS' & INVENTORS'
ELECTRIC CO.

(Smith Building)
228 West Broadway, N. Y. City
Incorporated 1897



Here's a new starter!

Completely oil-immersed

Dust tight—Gas tight—Weatherproof

Write for complete details of this new across-the-line starter.

ROWAN CONTROL
THE ROWAN CONTROLLER CO., BALTIMORE, MD.

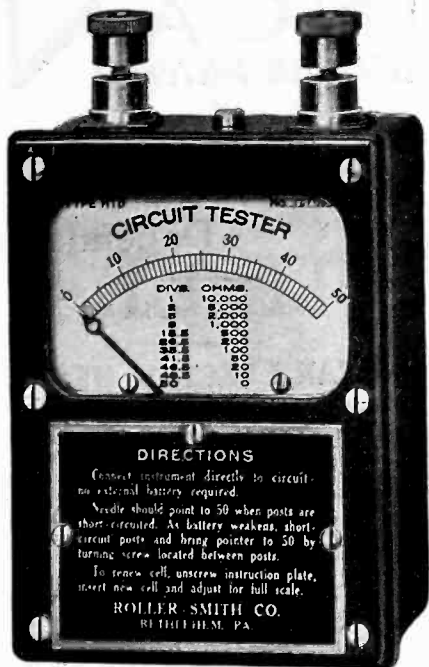

ROLLER-SMITH announces A New and Very Much Needed Instrument TYPE HTD CIRCUIT TESTER

The new Type HTD Circuit Tester is an instrument that everyone has been waiting for. With it one can instantly locate open circuits in coils and circuits of all kinds. Not only that but it shows directly the approximate resistance of the coil or circuit up to a range of 10,000 ohms.

It is small, compact, rugged and thoroughly dependable. The small, standard flashlight cell is self-contained. The price is very low for such an instrument. The many other features of interest are given in new Supplement No. 1 to Bulletin No. AE-300. Send for your copy.

"Over thirty years' experience is back of Roller-Smith"

ROLLER-SMITH COMPANY

Electrical Measuring and Protective Apparatus

MAIN OFFICE
12 Park Place, NEW YORK

WORKS
Bethlehem, Penna.

Offices in Principal Cities in U. S. A. and Canada.
Representatives in Australia, Cuba and Japan.

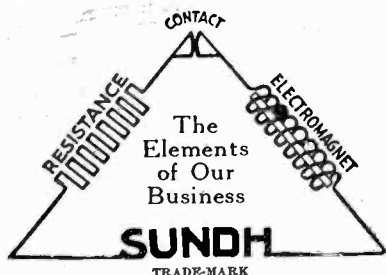

SUNDH

Alarm, High and Low Liquid Level.....	Bulletin 3610-3615	Pressure Regulator Panels (See Panels, Special). Regulator, Pressure (See Pressure Regulator). Regulators, Speed (See Speed Regulators). Relay, Tumbler.....	Bulletin 7250 7100
Automatic Fire Pump Panels, Combined Hand and (See Panels, Fire Pump).		Remote Controlled Lighting Panels.....	
Automatic Starters (See Starters, Automatic).	5600	Remote Controlled Speed Regulators (See Speed Regulators).	
Automatic Transfer Switches.....	9920	Remote Liquid Level Indicator.....	3625
Brakes, Magnetic.....	3800-3815	Remote Switches (See Switches, Remote, also Switches, Magnet).	
Circuit Breakers.....		Self Starters (See Starters, Automatic).	
Contactors (See Switches, Magnet).	9000	Solenoids (See Magnets).	5700
Control, Machine Tool.....	9999	Solenoid Operated Valves.....	
Controllers, Elevator.....	9999	Special Panels (See Panels, Special).	
Elevator Controllers.....		Speed Regulators.....	8500-8520
Fire Pump Panels (See Panels, Fire Pump).	3600-3625	Starters, Automatic, A. C.....	5800-6200
Float Switches.....		Starters, Automatic.....	5300-5350
Hand and Automatic Fire Pump Panels, Combined. (See Panels, Fire Pump).	3600	Starters, Hand.....	8320
Hand Operated Switches.....		Starters, Manual (See Starters, Hand).	
Hand Starters (See Starters, Hand).	3610-3615	Sump Switches (See Switches, Float).	3600-3627
High and Low Liquid Level Alarm Switches.....	3625	Switches, Float.....	3604
Indicator, Level, Liquid, Remote.....	3610-3615	Switches, Hand Operated.....	3610-3615
Level, High and Low Liquid, Alarm Switch.....	3625	Switches, High and Low Liquid Level Alarm.....	7600
Level, Indicator, Remote.....	7100	Switches, Magnet, A. C.....	7600
Lighting Panels, Remote Control.....	3610-3615	Switches, Magnet, D. C.....	7200-7250
Low Levels, High and, Alarm Switches.....	9000	Switches, Remote (See also Switches, Magnet).	
Machine Tool Control.....	5700	Switches, Sump (See Switches, Float).	
Magnetic Brakes (See Brakes, Magnetic).	7600	Switches, Tank (See Switches, Float).	
Magnet Operated Valves.....	7500	Switches, Time.....	6900
Magnet Switches, A. C.....	6500	Switches, Transfer, Automatic.....	5000
Magnet Switches, D. C.....		Tank Switches (See Switches, Float).	
Magnets.....		Terms.....	300
Manual Fire Pump Panels (See Panels, Fire Pump).		Time Switches.....	6900
Manual Starters (See Starters, Hand).	8800-8830	Transfer Switches, Automatic.....	5000
Panels, Fire Pump.....	7100	Tumbler Relay.....	7250
Panels, Lighting, Remote Control.....		Valve Control.....	5700
Panels, Pressure Regulator (See Pressure Regulator, also Panels, Special).	5400-5423	Valve, Magnet Operated.....	5700
Panels, Special.....	4900-4902	Valve, Remote Controlled.....	5700

Write for Catalog

SUNDH ELECTRIC COMPANY, 4 Ave. C, NEWARK, N. J.

Branch Offices: Chicago, New York

Sales Representatives:

Boston Cleveland Minneapolis Philadelphia St. Louis Baltimore Buffalo
Cincinnati Detroit Los Angeles New Orleans Pittsburgh San Francisco Toronto, Can.

Please mention the JOURNAL of the A. I. E. E. when writing to advertisers.

There can be
no compromise—

Executives concerned with important applications of electrostatic condensers are content only with capacitors of proven dependability.

There are several hundred distinct Faradon units in regular production on which data is available upon mention of the required application. Faradon engineers are always ready to assist in effecting a solution of any special capacitor problem.

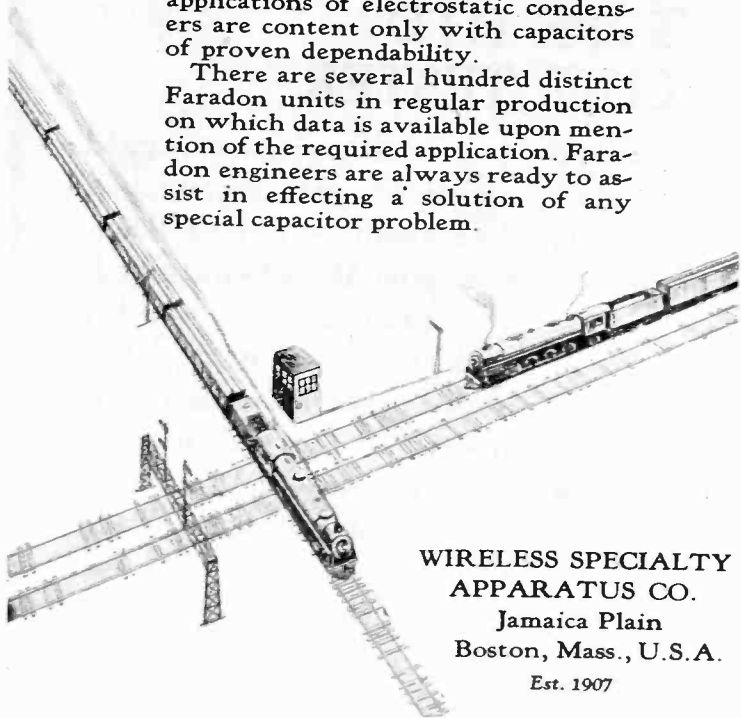

WIRELESS SPECIALTY
APPARATUS CO.
Jamaica Plain
Boston, Mass., U.S.A.
Est. 1907

Faradon

1136

DUNCAN

Watthour Meters

Accurate
and
Dependable



Model M2.

Write for bulletins

DUNCAN ELECTRIC MFG. CO.
Lafayette, Ind.

KEARNEY

MANUFACTURERS OF

- Preheated Certified Malleable Iron Screw Type Anchors
- Outdoor Type Fuse Switches, Disconnecting Switches, Choke Coils, and Combinations, 7500 and 15000 volts
- Aluminum, Copper, and Galvanized Iron Guy Wire Clips
- Extension Sleeve Twisters with Interchangeable Dies
- Solderless Service Connectors
- Expulsion Porcelain Plug Cutouts
- Tap Off Clamps

Write for Catalog

JAMES R. KEARNEY CORPORATION
4220 Clayton Avenue ST. LOUIS, MO.



SAUTER Electric TIME SWITCHES

These "astronomic" time switches are carried in stock for circuits of
250 Volts: 10, 25, 40, 60, 100, 200, 300 Amps.
4600 Volts: 25 and 50 Amps.
8000 Volts: 25 and 50 Amps.

Ask for new catalog S-1.

R. W. CRAMER & COMPANY, INC.
136 Liberty St. New York City

JEFFERSON

is equipped to design or build
Special Small Transformers to order.

Special Transformers

Submit your problem without obligation.

Jefferson Electric Mfg. Co.

546 50 GREEN ST CHICAGO, ILL. U.S.A.

Pittsburgh Transformer Company

Largest Manufacturers of Transformers exclusively
in the United States

Pittsburgh, Pennsylvania



BETTER INSTRUMENTS

Jewell "Master" portables give to the electrical industry the utmost in modern instrument design.

The cases are of uniform size of moulded black bakelite. As supplied for direct current, the pattern No. 171 weighs 3 $\frac{3}{4}$ lbs. A D'Arsonval movement of refined design is used which contains the finest materials available for instrument construction. The movement is sufficiently sensitive to permit its use with microammeters and high resistance voltmeters where desired. Highly polished pivots bear in selected sapphire jewels.

Hand drawn scales, 17% longer than heretofore supplied in portable instruments of these overall dimensions, and backed by mirrors to prevent parallax errors, allows closer determination of indicated values.

Extremely large scale openings are closed by non-shatterable glass for the first time in a portable instrument and with obvious advantages.

Pattern No. 171 is truly a master instrument

Write for descriptive circular No. 1111.

Jewell Electrical Instrument Co.

1650 Walnut St., Chicago

"27 Years Making Good Instruments"

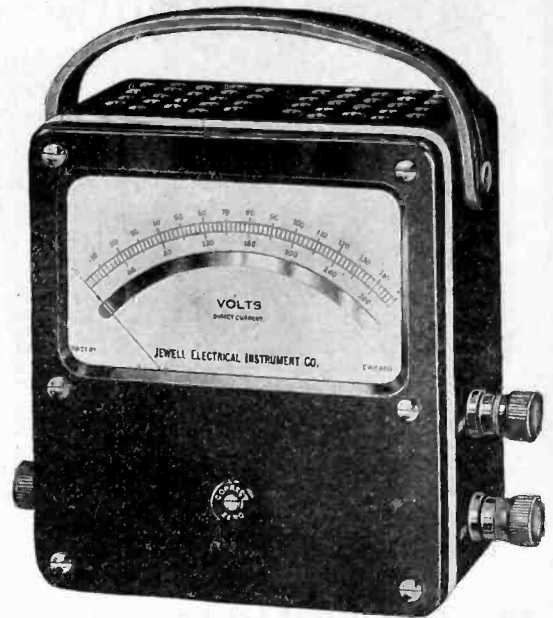

Pattern No. 171 Direct Current "Master" Portable

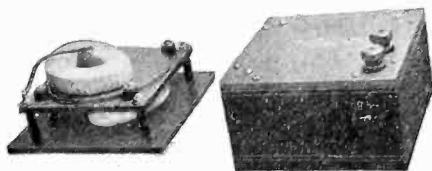

Standards of Inductance

Type 106

Inductance Standards suitable for use in bridge measurements. The astatic form of winding reduces external fields to a minimum. Adjustment is to one-tenth per cent.

Available in 0.1, 1.0, 10 and 100 millihenry sizes.

Price, \$24.00.

Described in bulletin 307-E.

GENERAL RADIO COMPANY

30 State Street

CAMBRIDGE, MASSACHUSETTS

Bristol's
Recording
Wattmeter
Strip Chart
type;



for
single,
two or
three
phase
current.

Records in Kilowatt Hours

made by Bristol's Recording Wattmeters provide a continuous check on feeder lines: showing how heavily they are loaded, together with the time and extent of load changes which occur during the day's run.

The Electrical Engineer who desires SERVICE in an instrument may well consider the enthusiastic approval accorded the "Bristol's" in thousands of installations. A simple, rugged design insures freedom from trouble and continued accuracy.

Write us for further information.

The Bristol Company Waterbury, Connecticut





Holabird & Roche, Chicago, Architects
 George A. Fuller Co., Chicago—New York, General Contractors
 J. Livingston & Co., Chicago, Electrical Contractors

The STEVENS HOTEL, Chicago
 Wired Throughout with
American Steel & Wire
 Company's
Rubber Covered Wire

TWO million feet of rubber covered wire were used to completely wire all of the 29 floors, 3000 guest rooms, several kitchens, ballrooms, banquet and meeting rooms, hallways, reception parlors, lobbies and other parts of this magnificent new hotel recently completed on Michigan Boulevard, Chicago. Only the very finest material and the most rigid specifications were approved for this great building. The selection, therefore, of our wire to meet these demands expresses most forcefully the uniform and dependable quality of the product, and further gives striking evidence as to the standing with leading architects and contractors.

Let us send you our indexed catalog and handbook of electrical wires and cables. Estimates furnished promptly from any of our offices in all of the principal cities.

SALES OFFICES

- | | | | |
|-----------------------|-------------------------------|---------------|---------------------------------------|
| CHICAGO | 208 So. La Salle Street | NEW YORK | 30 Church Street |
| CLEVELAND | Rockefeller Building | BOSTON | 185 Franklin Street |
| DETROIT | Foot of First Street | PITTSBURGH | Frick Building |
| CINCINNATI | Union Trust Building | PHILADELPHIA | Widener Building |
| MINNEAPOLIS--ST. PAUL | Merchants Nat'l Bank Bldg. | ATLANTA | 101 Marietta Street |
| ST. LOUIS | 608 Olive Street | WORCESTER | 87 Grove Street |
| KANSAS CITY | 417 Grand Avenue | BALTIMORE | 32 So. Charles St. |
| OKLAHOMA CITY | First Nat'l Bank Bldg. | RUFFALO | 670 Ellicott Street |
| BIRMINGHAM | Brown-Marrs Bldg. | WILKES-BARRE | Miners Bank Bldg. |
| MEMPHIS | Union and Planters Bank Bldg. | SAN FRANCISCO | Rialto Bldg. |
| DALLAS | Praetorian Building | LOS ANGELES | 2087 E. Slauson Ave. |
| DENVER | First National Bank Bldg. | PORTLAND | 6th and Alder Sts. |
| SALT LAKE CITY | Walker Bank Bldg. | SEATTLE | 4th Ave. So., & Conn. St. |
| | | | *United States Steel Products Company |

FIBREX TREE WIRE

Where trees must not be trimmed



A typical Fibrex installation in New England

Where hazards are greatest - places where trees must not be trimmed and where wires are rubbed and chafed by swaying limbs - splice in a piece of Fibrex Tree Wire.

Central Stations find that Fibrex creates good will by eliminating the short circuits and swinging grounds that interfere with the maintenance of steady voltage.

Short pieces of Fibrex spliced into the line will afford ample protection where overhead lines must run through trees.

Fibrex consists of a rubber insulated copper conductor protected by successive layers of tape, tarred jute, non-metallic Fibrex armor and a wear-resisting weatherproof braid.

An immediate check-up along the line and the early installation of Fibrex at danger points will save the repair gang many annoying and expensive emergency calls.

SIMPLEX WIRE & CABLE CO

MANUFACTURERS

201 DEVONSHIRE ST., BOSTON

CHICAGO SAN FRANCISCO NEW YORK
 CLEVELAND JACKSONVILLE

Please mention the JOURNAL of the A. I. E. E. when writing to advertisers.

Reduce Operating Expenses and Improve Service Qualities.

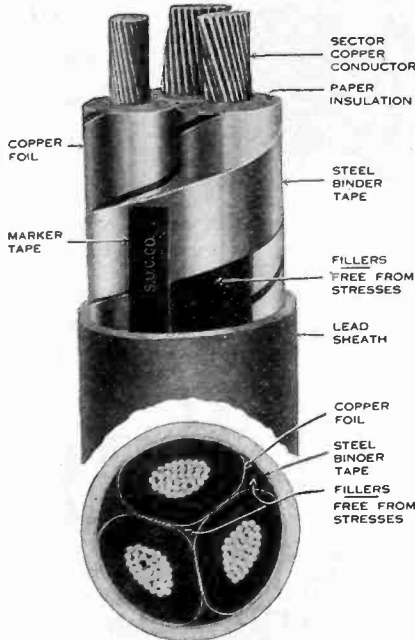

TYPE H 35 Kv. CABLE

These are the problems which engineers, central station managers and other cable users are striving to solve when planning their electric transmission systems. A solution of these problems is a high voltage cable with added assurance of long life and greater dependability, when compared with other cables. Such a cable is that known to the trade as

Type H Cable

(Pat. No. 1,199,789, dated Oct. 3, 1916)

The weak spots in the usual types of cables are avoided in the Type H construction by the use of thin metallic tapes over the insulation grounded to the lead sheath, thus shielding the fillers and the inevitable voids therein from stresses, relieving the conductor insulation from the most dangerous stresses, and reducing the operating temperature.

If you have problems of this kind write our nearest office

Standard Underground Cable Co.

General Office: Pittsburgh, Pa.

BOSTON
NEW YORK
PHILADELPHIA

WASHINGTON
ATLANTA
PITTSBURGH

CHICAGO
DETROIT
ST. LOUIS

KANSAS CITY
SEATTLE
LOS ANGELES

SAN FRANCISCO

For Canada

STANDARD UNDERGROUND CABLE CO. OF CANADA, LIMITED, HAMILTON, ONT.

We manufacture Electric Wires and Cables of all kinds, also Cable Accessories.

HAZARD

for
BOREHOLES



for
MINE SHAFTS

POWER CABLES

The heavy layers of Hazard Standard Insulation are tough and elastic offering absolute insurance against current leakage.

The lead sheath, two layers of asphalted jute, galvanized steel armor wires and two layers of asphalted jute over all insure protection against mechanical injury, and provide strength for suspension in borehole or shaft.

HAZARD MANUFACTURING CO.

Wilkes-Barre, Pa.

NEW YORK
333 Canal St.

CHICAGO
32 S. Clinton St.

PITTSBURGH
1st Nat'l. Bk. Bldg.

DENVER

BIRMINGHAM

PHILADELPHIA

LOS ANGELES

Can you afford to ignore the costly replacement and damage losses caused by rusting? Minimize them by using

NON-RUSTING "COPPERWELD"

The strength and life of the guy and messenger wires are frequently the determining factors in the reliable and uninterrupted operation of an overhead system.

When a guy or messenger rusts, its strength and life are decreased. Its protective value is lessened. It is no longer a safeguard, but a menace.

"It costs less to prevent Rust than to endure it."

Copperweld Steel Company

MAIN OFFICE & MILLS: BRADDOCK P. O., RANKIN, PA.
30 CHURCH ST., NEW YORK. 129 S. JEFFERSON ST., CHICAGO.
403 RIALTO BLDG., SAN FRANCISCO.

In Canada: Northern Electric Co., Ltd.

MANUFACTURERS OF INSULATORS

For 2,200 to 220,000 Volts
HIGH VOLTAGE PORCELAIN

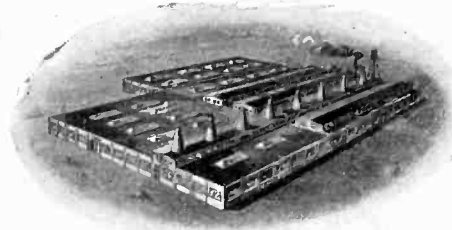

Catalog
on request

CANADIAN PORCELAIN COMPANY
Limited

HAMILTON — ONTARIO — CANADA

Cable Address "PORCELAIN," Hamilton, Ontario

Roebbling

Electrical Wires and
Cables. High in Con-
ductivity and Reliability.

John A. Roebbling's Sons Co.
Trenton, New Jersey



MINERALLAC INSULATING COMPOUNDS

For filling Cable Joints
and Potheads
on High-Voltage lines

"A safe specification"

High dielectric
Strength

Approved
physical
properties

MINERALLAC ELECTRIC COMPANY

1045 Washington Blvd.
CHICAGO ILL.

WIRE PRODUCTS For Varied Applications

We manufacture many types of wires, cords and cables for specific uses. Among them are:

Rubber Covered Wire—Solid Conductor, Stranded Conductor, Flexible Conductor, Extra Flexible Conductor. Lamp Cords, Reinforced Cords, Heater Cord, Brewery Cord, Canvasite Cord, Packinghouse Cord, Deck Cable, Stage Cable, Border Light Cable, Flexible Armored Cable, Elevator Lighting Cable, Elevator Operating Cable, Elevator Annunciator Cable. Switchboard Cables, Telephone Wire, Flameproof Wires and Cables, Railway Signal Wires, High Voltage Wires and Cables. Automobile Ignition Cables, Automobile Lighting Cables, Automobile Starting Cables, Automobile Charging Cables. Moving Picture Machine Cable.

Boston Insulated Wire & Cable Co.

Main Office and Factory:

Dorchester District Boston, Mass.

Canadian Branch, Office and Factory, Hamilton, Ont.

Engineering Societies Library

A reference library for engineers—contains 150,000 volumes—receives over 1,300 technical journals and periodicals on all branches of engineering.

Searches are made upon engineering subjects, translations from foreign publications, photostats made, etc.

Books may be borrowed by members of the A. I. E. E. For information address, The Engineering Societies Library, 33 West 39th St., New York.

At Your Service

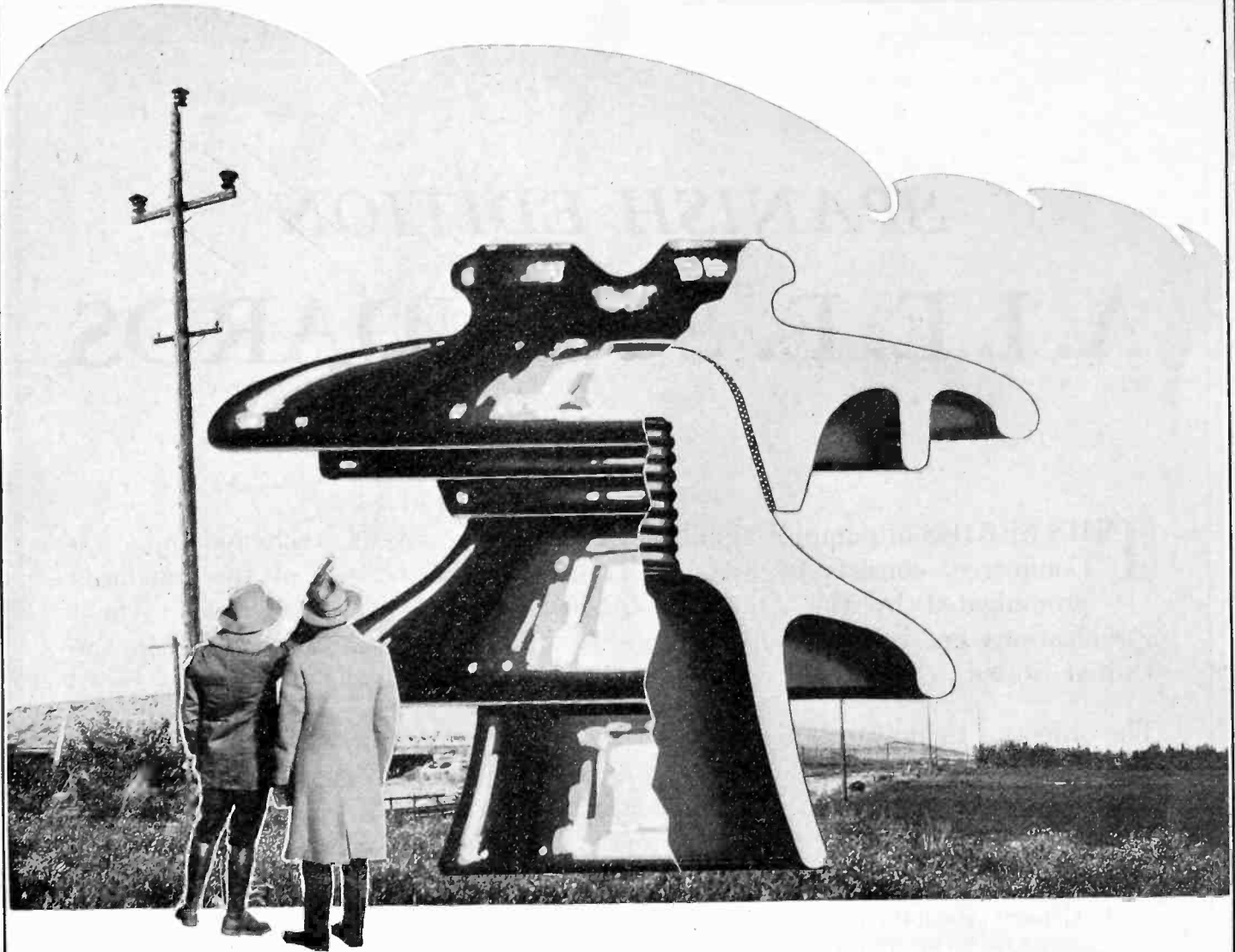

“Look at Those Sections”

THAT'S what makes the “Thomas Quality” pin-type insulator No. 2126 so dependable—ample thickness of porcelain at the right place, in the vital spots of the insulator. And that is what counts when lightning strikes or when abnormal surges ride your line. And while studying the No. 2126 insulator, just note the graceful lines of the design, the long leakage path, the rolled edges that permit mechanical abuse without breakage, the open-faced construction of shells that insures thorough ventilation and freedom from gaseous accumulation, and at the same time provides easy access for field testing. Next, study the drooping curve of the

head or top shell. This you know, is a point well worth considering especially when planning mountainous construction. Then, note the long rugged porcelain lip that follows the line of cement, a notable protection against cracking. The “sure-hold” cable grooves should likewise come in for some attention; they are generously formed and are well shaped for either the conductor or tie-strands. All of these things, really important features, may prove of considerable value to you in the future, especially if your lines ever fail to give steady uninterrupted service. So a close study of this reliable insulator should be in order now.



THE R. THOMAS & SONS CO.

Established 1873

East Liverpool, Ohio

New York

Boston

Chicago

London

Graybar Electric Co., Inc., on the Pacific Coast

Northern Electric Co., Ltd., in Canada



Please mention the JOURNAL of the A. I. E. E. when writing to advertisers.



SPANISH EDITION

A. I. E. E. STANDARDS



THIS SERIES of pamphlets, published by the Bureau of Foreign and Domestic Commerce, consists of Spanish Translations of certain of the standards promulgated by the American Institute of Electrical Engineers. These specifications are commercially acceptable and represent good practice in the United States.

The object of their translation and publication is to develop a broader knowledge and use of the standards and to facilitate trade in electrical products between the United States and Spanish-speaking countries.

AVAILABLE PAMPHLETS

- | | |
|--|--|
| 1. General principles upon which temperature limits are based in the rating of electrical machinery and apparatus. | 13. Transformers, induction regulators, and reactors. |
| 5. Direct-current, rotating machines, generators, and motors. | 14. Instrument transformers. |
| 7. Alternators, synchronous motors, and synchronous machines in general. | 15. Industrial control apparatus. |
| 8. Synchronous converters. | 16. Railway control and mine locomotive control apparatus. |
| 9. Induction motors and induction machines in general. | 19. Oil circuit breakers. |
| 10. Direct and alternating current fractional horse-power motors. | 22. Disconnecting and horn gap switches. |
| 11. Railway motors. | 30. Wires and cables. |
| | 37. Illumination. |
| | 41. Insulators. |

For convenience in filing or binding, the form and size of the English edition have been followed.

The price of each bulletin available is 10 cents,
except No. 1 and No. 14, which are 5 cents.



For sale by the
Superintendent of Documents, Government Printing Office, Washington, D. C.,
or any district office of the Bureau of Foreign and Domestic Commerce

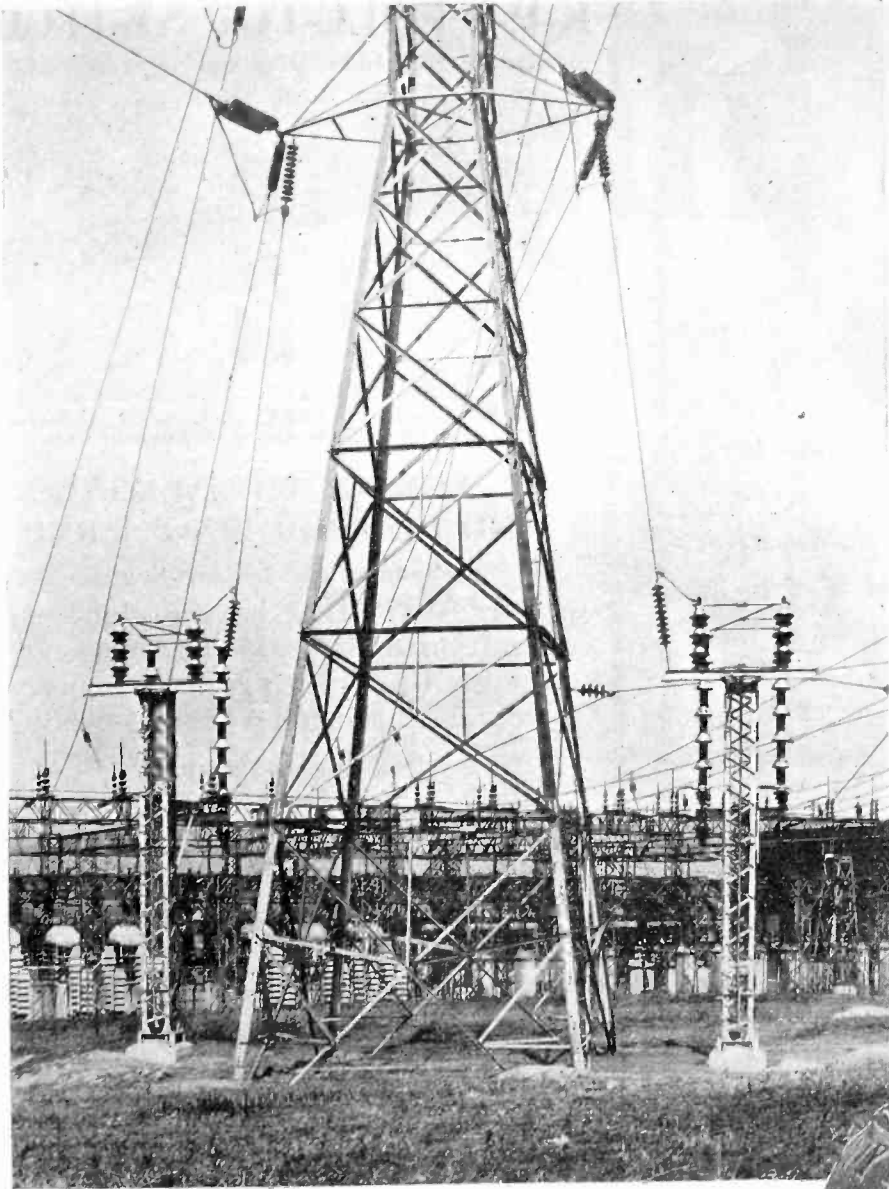

Sunnyside Sub-station, Ohio Power Co., Canton, Ohio, one of the properties of the American Gas and Electric Co. Installed on their 132,000 volt circuit between Canton, Ohio and Philo, Ohio March 1925. This installation consists of two columns, six 22,000 volt units in series per phase.

Condenser Coupling for Power Line Telephony

Condenser coupling for power line telephony carrier current systems affords a reliable and efficient method of conveying telephone conversation direct to the power line.

Condenser coupling does not require the difficult and expensive changes to power lines and tower structures which were necessary to effect an ideal antenna arrangement. This coupling system operates with a minimum radiation of the telephone energy to other power lines.

Dubilier type 670 condenser units, designed for this purpose, can be arranged in series—multiple combination for any line voltage or coupling capacity.

For particulars address

Dubilier Condenser Corporation
4377 Bronx Boulevard, New York City



*Type No. 670
Condenser built
in capacities of
.001 to .003
Mfd. for line
voltage of
22,000 volts, 60
cycles, A.C.*

Dubilier

CONDENSERS

IF YOU WANT
PICTURES OF 8
LABORATORIES
with TESTING
FACILITIES
FROM
500,000 TO
3,000,000
VOLTS

TWO
MILLION



TWO
MILLION

Ask for
our special
publication
Vol. 4, No. 2.

... the first time
that the leading
laboratories have
been shown in one
publication.

Delta-Star  **Electric Co.**

2400 Block, Fulton St. Chicago, Illinois

K-P-F POLE-TOP SWITCHES

Reduce Your Installation and Maintenance Costs

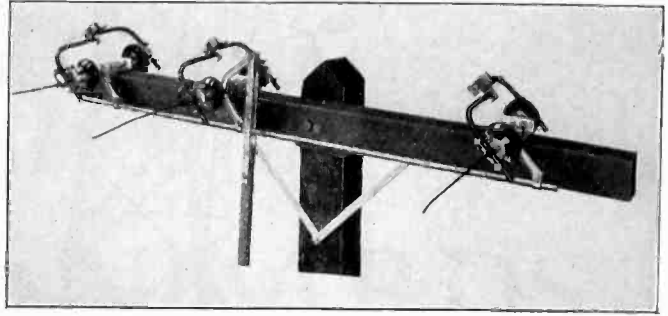

K-P-F type L-115—4500-V. Bolts to the cross-arm.
Line wires can be dead-ended directly to it.

FOR SECTIONALIZING AND DISTRIBUTING SERVICE

Manufactured For Any Voltage

K-P-F SWITCHES have established their
reputation for dependability, efficiency and
economy through a period of many years
of actual service under varying conditions.

Extra deadends not required. Switch
bolts to a single cross-arm. Shipped
completely assembled—ready to install.

Bulletin #106 covers this equipment in detail

K-P-F ELECTRIC CO.

855-859 Howard St.

San Francisco, Cal.

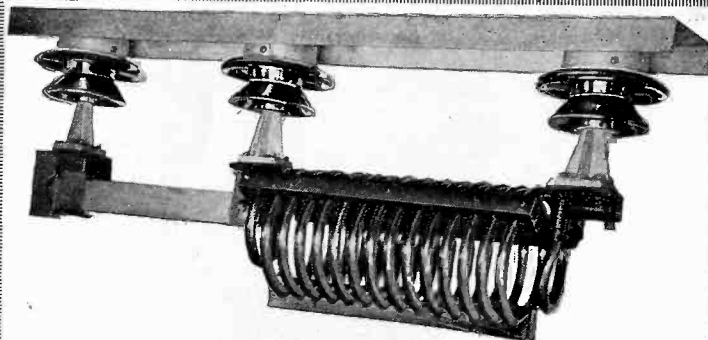

THE THONER & MARTENS

*underslung outdoor
disconnecting switch*

THE standard T & M underslung outdoor
disconnecting switch, 800 amp., is now
equipped with choke coil.

Working pressure is 22,000 volts, dry flush
is over 88,000 volts and wet flush over
55,000 volts.

Other T & M features are the Bolt type
lock and new sleet cover.

Write for further details

THONER & MARTENS

463 Commercial St., Boston, Mass., U. S. A.

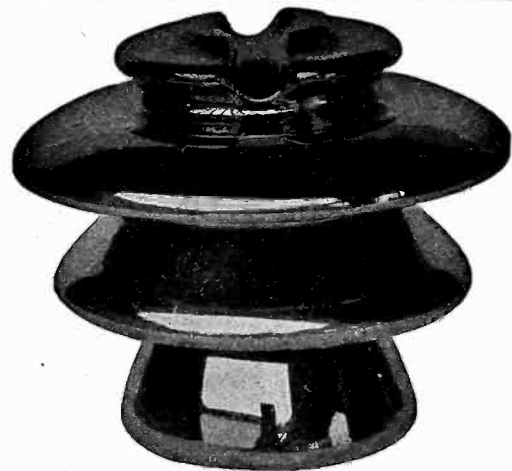

**Lapp Insulators
do not fail!**

LAPP INSULATOR CO., Inc.
LE ROY, N. Y.

Sales Representatives

BIRMINGHAM, ALA., Industrial Supply Co., 239 Brown-Marx Bldg.
BOSTON, Van Rosen Co., Statler Building
CHARLOTTE, N. C., J. W. Fraser & Co., Commercial Bank Bldg.
CHICAGO, Transelectric Co., Inc., 140 So. Dearborn St.
COLUMBUS, O., Engineering Merchandising Syndicate, 600 Joyce Realty Bldg.
DALLAS, TEX., J. K. Webb, 1521 Commerce St.
DENVER, The O. H. Davidson Equip. Co., 130 W. 14th Ave.
INDIANAPOLIS, W. D. Hamer Co., 518 Trac. Terminal Bldg.
KANSAS CITY, MO., Power Machinery Co., 301 Dwight Bldg.
LOS ANGELES, S. Herbert Lanyon, 210 Transportation Bldg.
MINNEAPOLIS, J. E. Sumpter Co., 515 Security Bldg.
NEW YORK CITY, Shield Electric Co., 149 Broadway.
PHILADELPHIA, Harris & Butler, Real Estate Trust Bldg.
PITTSBURGH, Henry N. Muller Co., 2204 First National Bank Bldg.
SAN ANTONIO, TEX., L. G. Bassett, 723 Navarro St.
SAN FRANCISCO, S. Herbert Lanyon, 509 New Call Bldg.
SYDNEY, AUSTRALIA, Chas. M. Terry.
WELLINGTON, NEW ZEALAND, A. C. Thomas.

Announcing

**Condit
Type E-20
with
Thermal
Control**



**Condit again
blazes the trail!**

The Condit Type E-20 equipped with thermally operated overload time lag unit represents an important advance in the design and construction of oil circuit breakers of 400 ampere, 2500 volt size.

Other important features include trip free automatic mechanism, exceptionally heavy panel steel frame, vibration-proof latch and easy access to automatic attachment through convenient cover plate.

Send for bulletin.

CONDIT ELECTRICAL MFG. CORP.
Manufacturers of Electrical Protective Devices
Boston, Mass.
Northern Electric Company
LIMITED
Sole Distributor for the Dominion of Canada

SPECIFICATIONS:

Standard capacity up to 400 amperes at 2500 volts, wall mounting, manually operated, non-automatic, and automatic.

CONDIT



VENUS PENCILS

The Largest Selling Quality Pencils in the World

The Lead is absolutely free from grit or even the slightest coarseness; remarkably smooth and long-lasting.

Each of the 17 degrees are uniform with every pencil of that degree—always.

The wood is specially selected cedar, of the best quality obtainable.

Their perfection makes them economical as they can be used down to the last inch.

The distinctive watermark finish avoids substitution—known and recognized throughout the world.

UNIQUE THIN LEAD COLORED PENCILS

Make fine lines for figuring, checking, sketching, blueprints, etc.

Blue	Purple	Pink
Red	Brown	Lt. Blue
Green	Orange	Lt. Green
White	Yellow	Maroon

\$1.00 per doz.

17 Black Degrees
3 Copying

For bold heavy lines 6B-5B-4B-3B
For writing, sketching 2B-B-HB-F-H
For clean fine lines 2H-3H-4H-5H-6H
For delicate, thin lines 7H-8H-9H

Plain Ends—per doz. \$1.00
Rubber “ —per doz. \$1.20

At Stationers and Stores throughout the World

American Lead Pencil Co.
204 Fifth Ave., New York

MANUAL OF ENDURANCE OF METALS UNDER REPEATED STRESS

Heretofore popularly called

Fatigue of Metals

A little book for the practical use of Designing, Inspecting, Testing and Operating Engineers. Compiled at the request of Engineering Foundation.

By H. F. MOORE, D. Sc.

Research Professor of Engineering Materials,
In Charge, Investigation of Fatigue of Metals,
University of Illinois.

With the cooperation of the directors of other important investigations in this field.

In 60 pages of clear statements, tables and diagrams, Professor Moore has condensed much of the usable information gotten by researches occupying several years of work by a score or more of investigators and many advisers, and costing in the aggregate a few hundred thousand dollars.

Bound in cloth, with stiff boards 5x7 inches.

Price \$1.00, postpaid.

Orders and remittances should be sent to

ENGINEERING FOUNDATION
29 West 39th Street New York

RECOMMENDED PRACTISE FOR Electrical Installations on Shipboard

(MARINE RULES)

SECTION No. 45, A. I. E. E. STANDARDS

A new edition of "Recommended Practise for Electrical Installations on Shipboard" (Marine Rules) is now available. This pamphlet of eighty-four pages is published as Section 45 of the A. I. E. E. Standards at a cost of \$1.50 (50% discount to members of the A. I. E. E.)

These rules have been drawn up to serve as a guide for the equipment of merchant ships with electrical apparatus for lighting, signaling, communication, power and propulsion. They indicate what is considered good engineering practise with reference to safety of the personnel and of the ship itself, as well as reliability and durability of the electrical apparatus.

American Institute of Electrical Engineers

33 West Thirty-ninth Street, New York

Model 322 for Laboratory and Industrial Use

This instrument is widely used in experimental laboratories and in industry for the measurement of exceedingly small electrical quantities, and for various temperature control operations.

As used in Pyrometry, it is calibrated as a D. C. Millivoltmeter, and also in degrees in connection with the E. M. F. of thermo-couples. It is also used in similar work as an A. C. Milliammeter in connection with vacuum thermo-couples. It is a most valuable instrument wherever high temperatures must be maintained with great accuracy, as in steel hardening operations, and in the manufacture of alloys.

Model 322 is also furnished as a Microammeter for the measurement of minute currents as in experimental radio work, telephony, and the testing of insulating materials. Accuracy, $\frac{1}{2}$ of 1%. Full description in Bulletin 501, mailed upon request.

WESTON ELECTRICAL INSTRUMENT CORPORATION
48 Weston Ave. Newark, N. J.



Balkite Trickle Charging— *standard for* Emergency Lighting Units

The portable emergency light shown, made by a well-known manufacturer, employs a Balkite Trickle Charger as standard equipment.

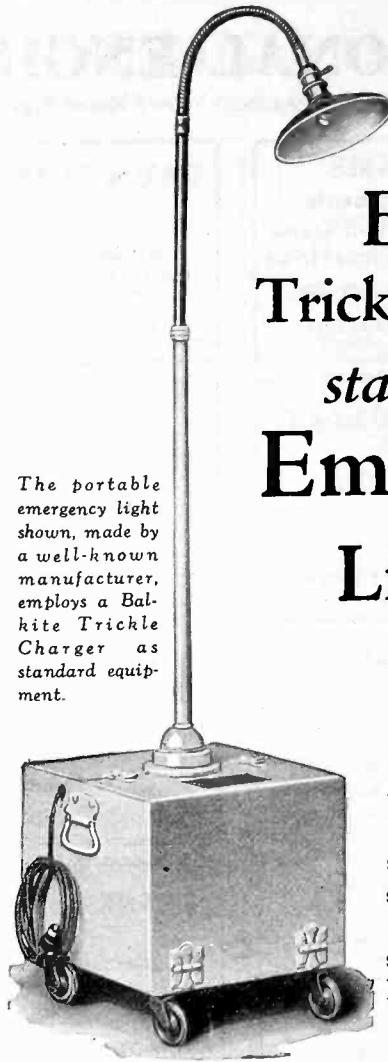

In operating rooms, at theatre exits, in stores and banks—light must not be subject to failure. The simplest way of providing unfailing light is with a storage battery and Balkite Trickle Charger.

Most installations are based on the same principle as that used in the portable light shown above. The base of this light contains a storage battery, a Balkite Trickle Charger and an automatic switch.

The charger charges the battery continuously, at a rate high enough to keep the battery always at full power. Normally the lamp burns directly from the alternating current line. Should the alternating current fail, however, the switch temporarily connects the lamp to the battery, and the lamp continues to burn, uninterrupted.

Because the Balkite Trickle Charger is unfailing in operation and requires a minimum of attendance it has become standard for portable emergency lighting use. Write for the booklet describing the system completely

FANSTEEL PRODUCTS COMPANY, Inc., North Chicago, Ill.

FANSTEEL Battery Balkite Chargers

FANSTEEL PRODUCTS COMPANY, Inc., North Chicago, Illinois
Gentlemen: Please send me a copy of Balkite Trickle Charging.

Name _____

Company _____

Address _____

Position _____

A. I. E. E. - B-27

Please mention the JOURNAL of the A. I. E. E. when writing to advertisers.

PROFESSIONAL ENGINEERING DIRECTORY

For Consultants in the Fields of Engineering, and Related Arts and Sciences

AMBURSEN DAMS
Hydroelectric Developments
Water Supply and Irrigation Dams
DAMS ON DIFFICULT FOUNDATIONS
AMBURSEN CONSTRUCTION CO.
Incorporated
Grand Central Terminal, New York
Kansas City, Mo. Atlanta, Ga.

DAY & ZIMMERMANN, Inc.
Engineers
Power Plants, Sub-Stations,
Transmission Lines, Industrial Plants
Examinations and Reports, Valuations,
Management of Public Utilities
1600 WALNUT ST., PHILADELPHIA
New York Chicago

HOOSIER ENGINEERING CO.
Erectors of
Transmission Lines and Substations
325 South New Jersey Street
INDIANAPOLIS INDIANA

W. S. BARSTOW & COMPANY
Incorporated
Financial and Operating
Managers of
Public Utilities
50 Pine Street New York

DAVID V. FENNESSY
Consulting Power Engineer
MILLS BUILDING EL PASO, TEXAS

Dugald C. Jackson
Edward L. Moreland
JACKSON & MORELAND
CONSULTING ENGINEERS
31 St. James Ave. Boston, Mass.

BATTEY & KIPP
Incorporated
ENGINEERS
Complete Industrial Plants
Power Plants & Electrical Installations
Engineering Reports, Analyses & Appraisals
231 South LaSalle Street CHICAGO

FORD, BACON & DAVIS
Incorporated
ENGINEERS
115 Broadway, New York
Philadelphia Chicago San Francisco

E. S. LINCOLN
Consulting Electrical Engineer
Designs Investigations Reports
Electrical Research Laboratory
Graybar Building
420 Lexington Avenue NEW YORK

BLACK & VEATCH
Consulting Engineers
Water, Steam and Electric Power Investiga-
tions, Design, Supervision of Construction,
Valuation and Tests.
Mutual Building KANSAS CITY, MO.

FRANK F. FOWLE & CO.
Electrical and Mechanical
Engineers
MONADNOCK BUILDING CHICAGO

MCCLELLAN & JUNKERSFELD
Incorporated
Engineering and Construction
Power Developments—Industrial Plants
Electrifications—Examinations
Reports—Valuations
NEW YORK
68 Trinity Place
Chicago St. Louis

BYLLESBY
ENGINEERING AND MANAGEMENT
CORPORATION
231 S. La Salle Street
CHICAGO
New York San Francisco

FREY ENGINEERING COMPANY
Industrial Electric Power
Generation—Application—Purchase
Combustion Engineering
Electric Furnace Installations
CHICAGO PHILADELPHIA
310 South Michigan Ave. 1500 Chestnut St.

John Minton I. G. Maloff
JOHN MINTON, PH. D.
Consulting Engineer
For Developing, Designing & Manufacturing
of Radio Receivers, Amplifiers, Transformers,
Rectifiers, Sound Recording & Reproducing
Apparatus.
Radio & Electro-Acoustical Laboratory.
8 Church Street White Plains, N.Y.

WALTER G. CLARK
Consulting Engineer
Electrical, Mining and Industrial
Reports
Supervision of Organization and Arrange-
ments for Financing
LOS ANGELES NEW YORK
1211 Insurance Exch. Bldg. 40 Wall St.

A. BARNETT GREEN
Writing — Editing — Compiling
Engineering Matter
1328 BROADWAY NEW YORK

N. J. NEALL
Consulting Engineer
for
Electrical and Industrial Properties
12 PEARL STREET BOSTON, MASS.

EDWARD E. CLEMENT
Fellow A. I. E. E.
Attorney and Expert
in Patent Causes
Soliciting, Consultation, Reports,
Opinions
McLachlen Bldg. Washington, D. C.
700 10th St., N. W.

AUGUSTUS M. HENRY
COUNSELOR AT LAW
(Patents and Patent Causes)
WOOLWORTH BLDG. NEW YORK

NEILER, RICH & CO.
Electrical and Mechanical
Engineers
Consulting, Designing and
Supervising
431 So. Dearborn St. — — — Chicago

HAROLD A. DANNE
LIGHT AND POWER
41 PARK ROW NEW YORK

Card space limited
to 1"x2" for each
advertiser.

OPHULS & HILL, Inc.
Formerly Ophuls, Hill & McCreery, Inc.
CONSULTING ENGINEERS
112-114 WEST 42nd ST., NEW YORK CITY
Ice Making and Refrigeration
Investigations and Reports

PROFESSIONAL ENGINEERING DIRECTORY

For Consultants in the Fields of Engineering and Related Arts and Sciences

FARLEY OSGOOD
 Consultant
 Design, Construction, Operation
 Inter-Connection
 of
PUBLIC UTILITIES
 National Bank of Commerce Building
 31 Nassau Street, New York, N. Y.
 Tel.: Rector 7878 Cable Address: Fargood

SCOFIELD ENGINEERING CO.
 Consulting Engineers
 Power Stations Gas Works
 Hydraulic Developments Electric Railways
 Examinations & Reports Valuations
 Philadelphia

STONE & WEBSTER
 Incorporated
DESIGN AND CONSTRUCTION
EXAMINATIONS REPORTS
APPRAISALS
INDUSTRIAL AND PUBLIC SERVICE
PROPERTIES
 New York Boston Chicago

I. S. PRENNER
 Mem. A. I. E. E.
 Lawyer—Engineer
 Patent Practice
 Liberty Trust Bldg.
 Broad and Arch Sts. PHILADELPHIA

J. E. SIRRINE & COMPANY
 Engineers
 Textile Mills; Hydro-Electric Develop-
 ments; Tobacco Products Plants; Cotton,
 Tobacco and General Warehousing; Indus-
 trial Housing; Steam Power Plants; Steam
 Utilization.
 General Offices: Greenville, South Carolina
 Branches
 Chattanooga, Tenn. Birmingham, Ala.

PERCY H. THOMAS
 Consulting Engineer
ELECTRIC POWER
 Generation—Transmission
 Applications
 120 BROADWAY NEW YORK

PUBLIC SERVICE
PRODUCTION COMPANY
 Engineers and Constructors
 Design and Construct: Power Plants,
 Transmission Lines, Industrial Plants,
 Highways, Railroad Shops and Terminals,
 Gas Plants, Commercial Buildings
 Make: Examinations, Reports and Valuations
 80 PARK PLACE NEWARK, N. J.

JOHN A. STEVENS
 CONSULTING POWER ENGINEER
 16 Shattuck Street
 LOWELL MASSACHUSETTS

THE U. G. I. CONTRACTING CO.
 Engineers & Constructors
 Power Developments, Industrial Plants, Gas
 Plants, Transmission Systems, Appraisals
 Broad & Arch Sts., PHILA., PA.
 421 Peoples Gas 928 Union Trust
 Bldg., Chicago, Ill. Bldg., Pittsburgh, Pa.

SANDERSON & PORTER
ENGINEERS
PUBLIC UTILITIES & INDUSTRIALS
 Design Construction Management
 Examinations Reports Valuations
 Chicago New York San Francisco

STEVENS & WOOD
 INCORPORATED
 Engineers and Constructors
 120 BROADWAY, NEW YORK
 Youngstown, O.

THE J. G. WHITE
ENGINEERING CORPORATION
 Engineers—Constructors
 Oil Refineries and Pipe Lines,
 Steam and Water Power Plants,
 Transmission Systems, Hotels, Apartments,
 Offices and Industrial Buildings, Railroads
 43 EXCHANGE PLACE NEW YORK

SARGENT & LUNDY
 Incorporated
 Mechanical and Electrical
 Engineers
 1412 Edison Bldg., 72 West Adams Street
 CHICAGO ILLINOIS

STOCKBRIDGE & BORST
 Patent Law
 41 PARK ROW NEW YORK CITY

J. G. WRAY & CO.
 Engineers
 J. G. Wray, Fellow A.I.E.E. Cyrus G. Hill
 Utilities and Industrial Properties
 Appraisals Construction Rate Surveys
 Plans Organization Estimates
 Financial Investigations Management
 576 First National Bank Bldg., Chicago

YOUR CARD in each issue of this publication—12 times a year, will keep your name and specialized service constantly before the electrical industry.
 Qualified advertisers in the Engineering Directory are invited to send for rates.

ELECTRICAL TESTING LABORATORIES

80th Street and East End Ave.
 NEW YORK

Inspections — Tests — Research

Tests may be used by the purchaser for the following purposes:

- (1) To determine the quality of competing samples. This enables the purchase of the best quality for the money.
- (2) To make sure that shipments comply with specifications. This makes possible the assurance to the customer that shipments match buying samples.
- (3) To furnish an impartial decision in case of disputes between purchaser and manufacturer.

Testing places the whole buying problem on a sound basis.

Please mention the JOURNAL of the A. I. E. E. when writing to advertisers.

Classified Advertiser's Index for Buyers

Manufacturers and agents for machinery and supplies used in the electrical and allied industries.

Note: For reference to the Advertisements see the Alphabetical List of Advertisers on page 66.

- AIR COMPRESSORS**
Allis-Chalmers Mfg. Co., Milwaukee
General Electric Co., Schenectady
Western Electric Co., All Principal Cities
- AIR WASHERS**
Sturtevant Co., B. F., Boston
- AMMETER COMPENSATING COILS**
Minerallac Electric Co., Chicago
- AMMETER, VOLTMETERS**
(See INSTRUMENTS, ELECTRICAL)
- ANCHORS, GUY**
Hubbard & Co., Pittsburgh
Kearney Corp., Jas. R., St. Louis
Matthews Corp., W. N., St. Louis
- ARMS FOR STREET LIGHTING**
Hubbard & Co., Pittsburgh
- BALANCING MACHINES, STATIC DYNAMIC**
Olsen Testing Mach. Co., Tinius, Philadelphia
- BATTERY CHARGING APPARATUS**
Allen-Bradley Co., Milwaukee
Electric Specialty Co., Stamford, Conn.
Fansteel Products Co., Inc., North Chicago
General Electric Co., Schenectady
Wagner Electric Corp., St. Louis
Western Electric Co., All Principal Cities
Westinghouse Elec. & Mfg. Co., E. Pittsburgh
- BEARINGS, BALL**
Gurney Ball Bearing Division of Marlin-Rockwell Corp., Jamestown, N. Y.
New Departure Mfg. Co., The, Bristol, Conn.
Norma-Hoffmann Bearings Corp., Stamford, Conn.
Standard Steel & Bearings, Inc., Plainville, Conn.
- BEARINGS, ROLLER**
Timken Roller Bearing Co., The, Canton, O.
- BLOWERS**
Sturtevant Co., B. F., Boston
- BOXES, FUSE**
General Electric Co., Schenectady
Kearney Corp., Jas. R., St. Louis
Metropolitan Device Corp., Brooklyn, N. Y.
Western Electric Co., All Principal Cities
Westinghouse Elec. & Mfg. Co., Pittsburgh
- BOXES, JUNCTION**
G & W Elec. Specialty Co., Chicago
Metropolitan Device Corp., Brooklyn, N. Y.
Standard Underground Cable Co., Pittsburgh
- BRACKETS AND PINS, METAL**
Hubbard & Co., Pittsburgh
- BRUSHES, COMMUTATOR**
Carbon
Morganite Brush Co., Inc., L. I. City, N. Y.
National Carbon Co., Inc., Cleveland
Westinghouse Elec. & Mfg. Co., E. Pittsburgh
Copper Graphite
Morganite Brush Co., Inc., L. I. City, N. Y.
National Carbon Co., Inc., Cleveland
Westinghouse Elec. & Mfg. Co., E. Pittsburgh
- BUS BAR FITTINGS**
Burndy Engineering Co., Inc., New York
Delta-Star Electric Co., Chicago
General Electric Co., Schenectady
Ohio Brass Co., Mansfield, O.
Westinghouse Elec. & Mfg. Co., E. Pittsburgh
- BUSHINGS, PORCELAIN**
Ohio Brass Co., Mansfield, O.
- CABLE ACCESSORIES**
Delta Star Electric Co., Chicago
Dossert & Co., New York
G & W Electric Specialty Co., Chicago
General Electric Co., Schenectady
Minerallac Electric Co., Chicago
Standard Underground Cable Co., Pittsburgh
Western Electric Co., All Principal Cities
- CABLE RACKS**
Hubbard & Co., Pittsburgh
Metropolitan Device Corp., Brooklyn, N. Y.
- CABLES**
See WIRES AND CABLES
- CABLEWAYS**
American Steel & Wire Co., Chicago
Roebling's Sons Co., John A., Trenton, N. J.
- CAMBRIC, VARNISHED**
Belden Mfg. Co., Chicago
General Electric Co., Bridgeport, Conn.
Irvington Varnish & Ins. Co., Irvington, N. J.
Westinghouse Elec. & Mfg. Co., E. Pittsburgh
- CARRIER CURRENT TELEPHONE EQUIPMENT**
Dubilier Condenser Corp., New York
Western Electric Co., All Principal Cities
Wireless Specialty Apparatus Co., Boston
- CIRCUIT BREAKERS**
Air—Enclosed
Allen-Bradley Co., Milwaukee
Cutter Co., The, Philadelphia
Roller-Smith Co., New York
Sundh Electric Co., Newark, N. J.
Western Electric Co., All Principal Cities
Oil
Condit Electrical Mfg. Corp., Boston
General Electric Co., Schenectady
Pacific Elec. Mfg. Co., San Francisco
Westinghouse Elec. & Mfg. Co., E. Pittsburgh
- CLAMPS, GUY & CABLE**
Burndy Engineering Co., Inc., New York
Hubbard & Co., Pittsburgh
Kearney Corp., Jas. R., St. Louis
Matthews Corp., W. N., St. Louis
- CLAMPS, HOT LINE**
Hubbard & Co., Pittsburgh
Kearney Corp., Jas. R., St. Louis
- CLIPS, CABLE**
Hubbard & Co., Pittsburgh
Kearney Corp., Jas. R., St. Louis
- CLOCKS**
Cramer & Co. Inc., R. W., New York
- COILS, CHOKE**
Burke Electric Co., Erie, Pa.
General Electric Co., Schenectady
Kearney Corp., Jas. R., St. Louis
Westinghouse Elec. & Mfg. Co., E. Pittsburgh
- COILS, MAGNET**
Acme Wire Co., New Haven, Conn.
Belden Mfg. Co., Chicago
Dudlo Mfg. Corp., Ft. Wayne, Ind.
General Electric Co., Schenectady
Westinghouse Elec. & Mfg. Co., E. Pittsburgh
- COMMUTATOR SLOTTERS**
Martindale Electric Co., The, Cleveland
- COMMUTATOR STONES**
Martindale Electric Co., The, Cleveland
- CONDENSATION PRODUCTS**
Bakelite Corporation, New York
- CONDENSERS, COUPLING**
For Carrier Current Telephone
Dubilier Condenser Corp., New York
Wireless Specialty Apparatus Co., Boston
- CONDENSERS, RADIO**
General Radio Co., Cambridge, Mass.
Wireless Specialty Apparatus Co., Boston
- CONDENSERS, STEAM**
Allis-Chalmers Mfg. Co., Milwaukee
General Electric Co., Schenectady
Westinghouse Elec. & Mfg. Co., E. Pittsburgh
- CONDUIT, UNDERGROUND FIBRE**
Western Electric Co., All Principal Cities
- CONNECTORS, SOLDERLESS**
Dossert & Co., New York
Kearney Corp., Jas. R., St. Louis
Western Electric Co., All Principal Cities
Westinghouse Elec. & Mfg. Co., E. Pittsburgh
- CONNECTORS AND TERMINALS**
Belden Mfg. Co., Chicago
Burke Electric Co., Erie, Pa.
Burndy Engineering Co., Inc., New York
Dossert & Co., New York
G & W Electric Specialty Co., Chicago
Western Electric Co., All Principal Cities
Westinghouse Elec. & Mfg. Co., E. Pittsburgh
- CONTACTS, TUNGSTEN**
Fansteel Products Co., Inc., North Chicago
General Electric Co., Schenectady
- CONTROLLERS**
Allen-Bradley Co., Milwaukee
Electric Controller & Mfg. Co., Cleveland
General Electric Co., Schenectady
Rowan Controller Co., Baltimore
Sundh Electric Co., Newark, N. J.
Western Electric Co., All Principal Cities
Westinghouse Elec. & Mfg. Co., E. Pittsburgh
- CONVERTERS—SYNCHRONOUS**
Allis-Chalmers Mfg. Co., Milwaukee
Electric Specialty Co., Stamford, Conn.
Wagner Electric Corp., St. Louis
Westinghouse Elec. & Mfg. Co., E. Pittsburgh
- COPPER CLAD WIRE**
Belden Mfg. Co., Chicago
Copperweld Steel Co., Rankin, Pa.
Standard Underground Cable Co., Pittsburgh
Western Electric Co., All Principal Cities
- CROSS ARMS, STEEL**
Hubbard & Co., Pittsburgh
- CUT-OUTS**
Condit Electrical Mfg. Corp., S. Boston
General Electric Co., Schenectady
G & W Electric Specialty Co., Chicago
Kearney Corp., Jas. R., St. Louis
Metropolitan Device Corp., Brooklyn, N. Y.
Wagner Electric Corp., St. Louis
Western Electric Co., All Principal Cities
Westinghouse Elec. & Mfg. Co., E. Pittsburgh
- DRAWING INSTRUMENTS**
Cramer & Co., Inc., R. W., New York
- DYNAMOS**
(See GENERATORS AND MOTORS)
- DYNAMOTORS**
Burke Electric Co., Erie, Pa.
Electric Specialty Co., Stamford, Conn.
- ELECTRIFICATION SUPPLIES, STEAM ROAD**
General Electric Co., Schenectady
Ohio Brass Co., Mansfield, Ohio
Westinghouse Elec. & Mfg. Co., E. Pittsburgh
- ENGINEERS, CONSULTING AND CONTRACTING**
(See PROFESSIONAL ENGINEERING DIRECTORY)
- ENGINES**
Gas & Gasoline
Allis-Chalmers Mfg. Co., Milwaukee
Sturtevant Company, B. F., Boston
Oil
Allis-Chalmers Mfg. Co., Milwaukee
Sturtevant Company, B. F., Boston
Steam
Allis-Chalmers Mfg. Co., Milwaukee
Sturtevant Company, B. F., Boston
- FANS, MOTOR**
Century Electric Co., St. Louis
General Electric Co., Schenectady
Star Electric Motor Co., Newark, N. J.
Sturtevant Company, B. F., Boston
Wagner Electric Corp., St. Louis
Western Electric Co., All Principal Cities
Westinghouse Elec. & Mfg. Co., E. Pittsburgh
- FARM LIGHTING GENERATORS**
Western Electric Co., All Principal Cities
Westinghouse Elec. & Mfg. Co., E. Pittsburgh
- FIBRE**
Belden Mfg. Co., Chicago
National Vulcanized Fibre Co., Wilmington, Del.
- FLOW METERS**
General Electric Co., Schenectady
- FURNACES, ELECTRIC**
General Electric Co., Schenectady
Westinghouse Elec. & Mfg. Co., E. Pittsburgh



Is your name on our mailing list for bulletins and catalog?

Morganite Brushes

Morganite Brush Co., Inc.
3302-3320 Anable Ave.,
Long Island City,
N. Y.

Please mention the JOURNAL of the A. I. E. E. when writing to advertisers.



REDUCING THE PROFITLESS ENERGY

THE energy supplying the losses of a distribution system is a considerable item in the operating cost of a central station—and it earns no profit.

The problem of transformer losses in addition to keeping all losses to a minimum, involves also the balance of design—the selection of the proper ratio of copper-loss to iron-loss to give the best economy for existing load conditions. Extreme reduction in iron-loss can be made only at an increase in the copper-loss and vice versa.

With the increasing use of heating appliances and the resulting improved load factor, a low copper-loss is becoming increasingly important and this fact has been given its proper consideration in the Westinghouse design.

Westinghouse Distribution Transformers are designed to give the lowest operating cost with the present-day average load conditions. They keep to a minimum the energy that earns no profit.

Westinghouse Electric & Manufacturing Company
Sharon Works Sharon, Pa.

Sales Offices in All Principal Cities of
the United States and Foreign Countries

Westinghouse

X90028

Please mention the JOURNAL of the A. I. E. E. when writing to advertisers.

Classified Advertiser's Index for Buyers—Continued

FUSES

- Enclosed Refillable*
General Electric Co., Schenectady
Western Electric Co., All Principal Cities
Westinghouse Elec. & Mfg. Co., E. Pittsburgh
- Enclosed Non-Refillable*
General Electric Co., Schenectady
Western Electric Co., All Principal Cities
- Open Link*
General Electric Co., Schenectady
Metropolitan Device Corp., Brooklyn, N. Y.
Western Electric Co., All Principal Cities
- High Tension*
Delta-Star Electric Co., Chicago
Metropolitan Device Corp., Brooklyn, N. Y.
Western Electric Co., All Principal Cities
- ### FUSE PULLERS
- Kearney Corp., Jas. R., St. Louis
- ### GEARS, FIBRE
- General Electric Co., Schenectady
- ### GENERATORS AND MOTORS
- Allis-Chalmers Mfg. Co., Milwaukee
Burke Electric Co., Erie, Pa.
Century Electric Co., St. Louis
Chandeysson Electric Co., St. Louis
Electric Specialty Co., Stamford, Conn.
Electro-Dynamic Co., Bayonne, N. J.
General Electric Co., Schenectady
Lincoln Electric Co., The, Cleveland
Star Electric Motor Co., Newark, N. J.
Sturtevant Company, B. F., Boston
Wagner Electric Corp., St. Louis
Western Electric Co., All Principal Cities
Westinghouse Elec. & Mfg. Co., E. Pittsburgh
- ### GENERATING STATION EQUIPMENT
- Allis-Chalmers Mfg. Co., Milwaukee
Burke Electric Co., Erie, Pa.
General Electric Co., Schenectady
Western Electric Co., All Principal Cities
Westinghouse Elec. & Mfg. Co., E. Pittsburgh
- ### GROUND CONNECTIONS
- Hubbard & Co., Pittsburgh
- ### GROUND RODS
- Copperweld Steel Co., Rankin, Pa.
Hubbard & Co., Pittsburgh
Western Electric Co., All Principal Cities
- ### HEADLIGHTS
- Ohio Brass Co., Mansfield, O.
- ### HEATERS, INDUSTRIAL
- General Electric Co., Schenectady
Western Electric Co., All Principal Cities
Westinghouse Elec. & Mfg. Co., E. Pittsburgh
- ### IGNITION SYSTEMS, AUTOMOBILE
- Wagner Electric Corp., St. Louis
- ### INDICATORS, SPEED
- Bristol Co., The, Waterbury, Conn.
Roller-Smith Co., New York
- ### INDICATORS, REMOTE, WATER LEVEL
- Bristol Co., The, Waterbury, Conn.
Cramer & Co., Inc., R. W., New York
- ### INSTRUMENTS, ELECTRICAL
- Graphic*
Bristol Co., The, Waterbury, Conn.
Ferranti, Ltd., Hollinwood, England
Ferranti, Inc., New York
Ferranti Electric, Ltd., Toronto, Ont.
General Electric Co., Schenectady
Westinghouse Elec. & Mfg. Co., E. Pittsburgh
- Indicating*
Bristol Co., The, Waterbury, Conn.
Ferranti Ltd., Hollinwood, England
Ferranti, Inc., New York
Ferranti Electric, Ltd., Toronto, Ont.
General Electric Co., Schenectady
Jewell Elec. Instrument Co., Chicago
Roller-Smith Co., New York
Westinghouse Elec. & Mfg. Co., E. Pittsburgh
Weston Elec. Inst. Corp., Newark, N. J.
- Integrating*
Duncan Elec. Mfg. Co., Lafayette, Ind.
Ferranti, Ltd., Hollinwood, England
Ferranti, Inc., New York
Ferranti Electric, Ltd., Toronto, Ont.
General Electric Co., Schenectady
Roller-Smith Co., New York
Sangamo Elec. Co., Springfield, Ill.
Western Electric Co., All Principal Cities
Westinghouse Elec. & Mfg. Co., E. Pittsburgh
- Radio*
General Radio Co., Cambridge, Mass.
Jewell Elec. Instrument Co., Chicago
- Repairing and Testing*
Electrical Testing Laboratories, New York
Jewell Elec. Instrument Co., Chicago
- Scientific, Laboratory, Testing*
General Electric Co., Schenectady
Jewell Elec. Instrument Co., Chicago
Metropolitan Device Corp., Brooklyn, N. Y.
Roller-Smith Co., New York
Western Electric Co., All Principal Cities
Westinghouse Elec. & Mfg. Co., E. Pittsburgh
- Telegraph*
Weston Elec. Inst. Corp., Newark, N. J.
Western Electric Co., All Principal Cities

INSULATING MATERIALS

- Board*
General Electric Co., Bridgeport, Conn.
West Va. Pulp & Paper Co., New York
- Cloth*
Acme Wire Co., New Haven, Conn.
General Electric Co., Bridgeport, Conn.
Irvington Varnish & Ins. Co., Irvington, N. J.
Minerallac Electric Co., Chicago
Westinghouse Elec. & Mfg. Co., E. Pittsburgh
- Composition*
American Lava Corp., Chattanooga
Bakelite Corporation, New York
Belden Mfg. Co., Chicago
General Electric Co., Bridgeport, Conn.
Westinghouse Elec. & Mfg. Co., E. Pittsburgh
- Compounds*
General Electric Co., Bridgeport, Conn.
Minerallac Electric Co., Chicago
Standard Underground Cable Co., Pittsburgh
Western Electric Co., All Principal Cities
Westinghouse Elec. & Mfg. Co., E. Pittsburgh
- Fibre*
General Electric Co., Bridgeport, Conn.
National Vulcanized Fibre Co., Wilmington, Del.
West Va. Pulp & Paper Co., New York
- Lava*
American Lava Corp., Chattanooga, Tenn.
Chicago Mica Co., Valparaiso, Ind.
- Mica*
Chicago Mica Co., Valparaiso, Ind.
Westinghouse Elec. & Mfg. Co., E. Pittsburgh
- Paper*
Acme Wire Co., New Haven, Conn.
General Electric Co., Bridgeport, Conn.
Irvington Varnish & Ins. Co., Irvington, N. J.
Westinghouse Elec. & Mfg. Co., E. Pittsburgh
- Silk*
Acme Wire Co., New Haven, Conn.
General Electric Co., Bridgeport, Conn.
Irvington Varnish & Ins. Co., Irvington, N. J.
- Tape*
Belden Mfg. Co., Chicago
General Electric Co., Bridgeport, Conn.
Minerallac Electric Co., Chicago
Okonite Co., The, Passaic, N. J.
Western Electric Co., All Principal Cities
Westinghouse Elec. & Mfg. Co., E. Pittsburgh
- Varnishes*
Acme Wire Co., New Haven, Conn.
General Electric Co., Bridgeport, Conn.
Irvington Varnish & Ins. Co., Irvington, N. J.
Minerallac Electric Co., Chicago
Westinghouse Elec. & Mfg. Co., E. Pittsburgh
- ### INSULATORS, HIGH TENSION
- Composition*
General Electric Co., Schenectady
- Glass*
Hemingray Glass Co., Muncie, Ind.
- High Voltage Glass*
Corning Glass Works, "PYREX," Corning, N. Y.
- Porcelain*
Canadian Porcelain Co., Ltd., Hamilton, Ont.
General Electric Co., Schenectady
Hubbard & Co., Pittsburgh
Lapp Insulator Co., Inc., LeRoy, N. Y.
Locke Insulator Corp., Baltimore
Ohio Brass Co., Mansfield, O.
Thomas & Sons Co., R., East Liverpool, O.
Western Electric Co., All Principal Cities
Westinghouse Elec. & Mfg. Co., E. Pittsburgh
- Post Type*
Delta-Star Electric Co., Chicago
Ohio Brass Co., Mansfield, O.
- ### INSULATORS, TELEPHONE & TELEGRAPH
- Hemingray Glass Co., Muncie, Ind.
Ohio Brass Co., Mansfield, O.
Western Electric Co., All Principal Cities
- ### INSULATOR PINS
- Hubbard & Co., Pittsburgh
Ohio Brass Co., Mansfield, O.
Thomas & Sons Co., R., East Liverpool, O.
- ### LAMP GUARDS
- Matthews Corp., W. N., St. Louis
Western Electric Co., All Principal Cities
- ### LAVA
- American Lava Corp., Chattanooga
- ### LIGHTNING ARRESTERS
- Delta-Star Electric Co., Chicago
General Electric Co., Schenectady
Hubbard & Co., Pittsburgh
Western Electric Co., All Principal Cities
Westinghouse Elec. & Mfg. Co., E. Pittsburgh
- ### LOCOMOTIVES, ELECTRIC
- General Electric Co., Schenectady
Westinghouse Elec. & Mfg. Co., E. Pittsburgh
- ### LUBRICANTS
- Texas Co., The, New York
- ### MAGNETIC SEPARATORS
- Electric Controller & Mfg. Co., Cleveland
- ### METERS, ELECTRICAL
- (See INSTRUMENTS ELECTRICAL)

METER SEALS

- Metropolitan Device Corp., Brooklyn, N. Y.
- ### MICA PRODUCTS
- Chicago Mica Co., Valparaiso, Ind.
Westinghouse Elec. & Mfg. Co., E. Pittsburgh
- ### MICA UNDERCUTTERS
- Martindale Electric Co., The, Cleveland
- ### MOLDED INSULATION
- Bakelite Corporation, New York
Belden Mfg. Co., Chicago
Burke Electric Co., Erie, Pa.
Westinghouse Elec. & Mfg. Co., E. Pittsburgh
- ### MOLYBDENUM
- Fansteel Products Co., Inc., North Chicago
- ### MOTORS
- (See GENERATORS AND MOTORS)
- ### OHMMETERS
- Jewell Elec. Instrument Co., Chicago
Martindale Electric Co., Cleveland
Roller-Smith Co., New York
Weston Elec. Instr. Corp., Newark, N. J.
- ### OIL SEPARATORS & PURIFIERS
- Sharples Specialty Co., The, Philadelphia
Westinghouse Elec. & Mfg. Co., E. Pittsburgh
- ### PANEL BOARDS
- (See SWITCHBOARDS)
- ### PATENT ATTORNEYS
- (See PROFESSIONAL ENGINEERING DIRECTORY)
- ### PLUGS
- Delta-Star Electric Co., Chicago
General Electric Co., Schenectady
Western Electric Co., All Principal Cities
Westinghouse Elec. & Mfg. Co., E. Pittsburgh
- ### POLE LINE HARDWARE
- Hubbard & Co., Pittsburgh
Ohio Brass Co., Mansfield, O.
- ### POLES, STEEL
- American Bridge Co., Pittsburgh
Western Electric Co., All Principal Cities
- ### POLES—TIES, WOOD
- Western Electric Co., All Principal Cities
- ### POTHEADS
- G & W Electric Specialty Co., Chicago
Ohio Brass Co., Mansfield, O.
Standard Underground Cable Co., Pittsburgh
Western Electric Co., All Principal Cities
- ### PROTECTIVE DEVICES
- Metropolitan Device Corp., Brooklyn, N. Y.
Western Electric Co., All Principal Cities
- ### PULLERS, SLACK
- Matthews Corp., W. N., St. Louis
- ### PUMPS
- Allis-Chalmers Mfg. Co., Milwaukee
- ### PUMPS, SPIRAL
- Morris Corporation, I. P., Philadelphia
- ### RADIO LABORATORY APPARATUS
- General Radio Co., Cambridge, Mass.
Westinghouse Elec. & Mfg. Co., E. Pittsburgh
- ### RAILWAY SUPPLIES, ELECTRIC
- General Electric Co., Schenectady
Ohio Brass Co., Mansfield, O.
Western Electric Co., All Principal Cities
Westinghouse Elec. & Mfg. Co., E. Pittsburgh
- ### REACTORS
- General Electric Co., Schenectady
Metropolitan Device Corp., Brooklyn, N. Y.
- ### RECTIFIERS
- Fansteel Products Co., Inc., North Chicago
General Electric Co., Schenectady
Wagner Electric Corp., St. Louis
Western Electric Co., All Principal Cities
Westinghouse Elec. & Mfg. Co., E. Pittsburgh
- ### REELS, PAYOUT AND TAKEUP
- Matthews Corp., W. N., St. Louis
- ### REGULATORS, VOLTAGE
- Burke Electric Co., Erie, Pa.
General Electric Co., Schenectady
Western Electric Co., All Principal Cities
Westinghouse Elec. & Mfg. Co., E. Pittsburgh
- ### RELAYS
- Cramer & Co., Inc., R. W., New York
Electric Controller & Mfg. Co., Cleveland
General Electric Co., Schenectady
Westinghouse Elec. & Mfg. Co., E. Pittsburgh
- ### RESISTOR UNITS
- Allen-Bradley Co., Milwaukee
General Electric Co., Schenectady
- ### RHEOSTATS
- Allen-Bradley Co., Milwaukee
General Electric Co., Schenectady
Sundh Electric Co., Newark, N. J.
Ward Leonard Electric Co., Mt. Vernon, N. Y.
Western Electric Co., All Principal Cities
Westinghouse Elec. & Mfg. Co., E. Pittsburgh
- ### ROPE, WIRE
- American Steel & Wire Co., Chicago
Roebling's Sons Co., John A., Trenton, N. J.

Please mention the JOURNAL of the A. I. E. E. when writing to advertisers.

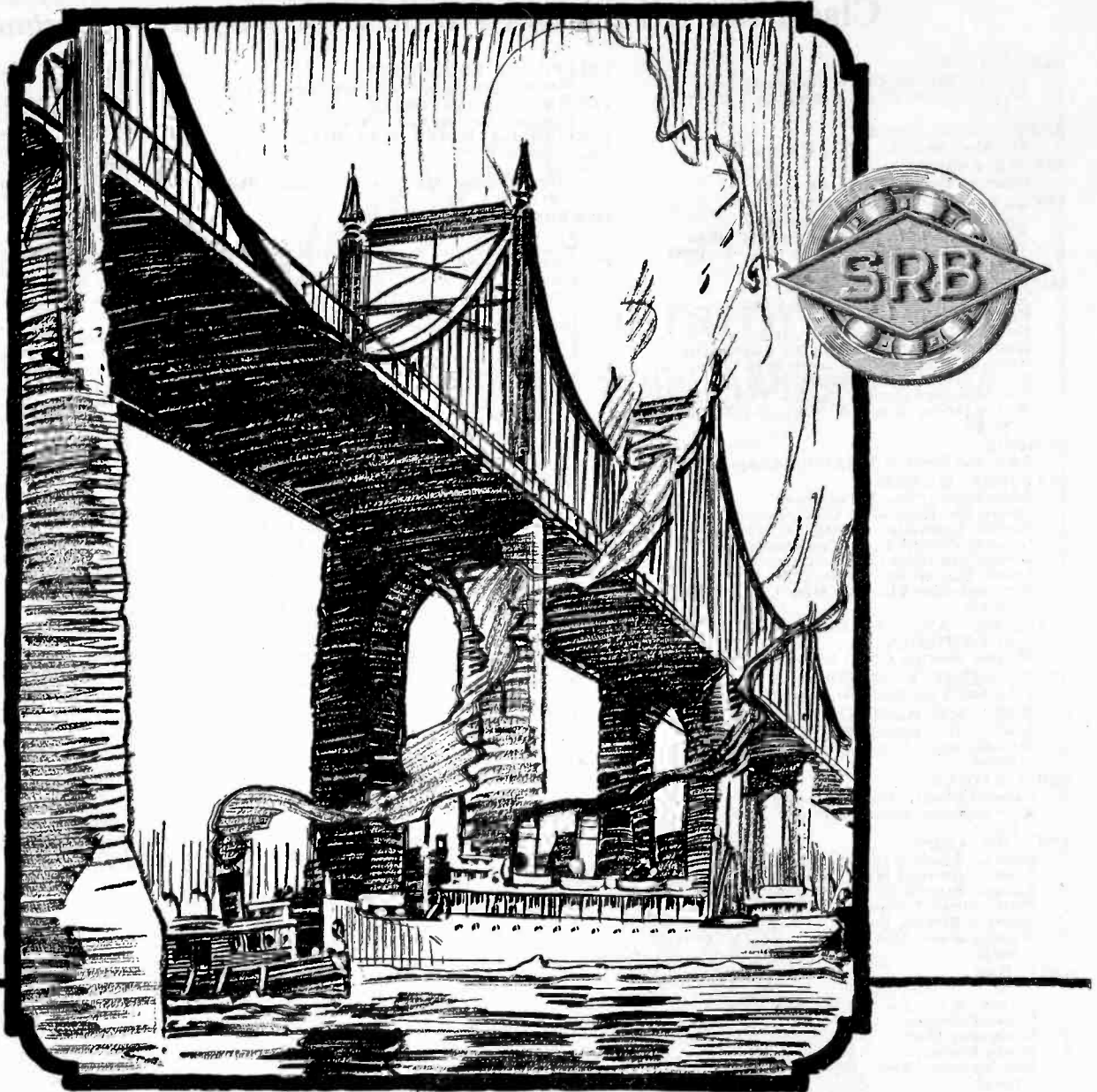

They may never need all the "Extra Strength" built into a bridge any more than you may need the "25% Extra Life" built into an SRB Bearing, but—IMPORTANT! It's there to be called upon!

Extra SRB years of service cost no more

You are a good business man! Then isn't it good business to take this extra long-life feature when it can be had at no extra cost? Isn't it good business to buy a ball bearing that has the highest factor of safety...not so much because you think you will need it... but because it will be there if you do need it?

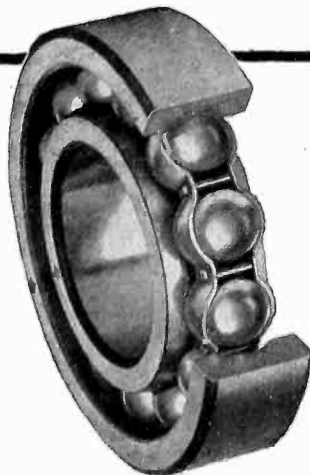

SRB took its long-life features of deep grooves and maximum number of large size balls, and increased life still further by hot forging these balls from Molybdenum Steel.

Only the combination of these SRB features makes such long-life possible at no extra cost.

STANDARD STEEL AND BEARINGS INCORPORATED
PLAINVILLE CONNECTICUT

USE SRB BALL BEARINGS—*First!*
—they'll last!

Please mention the JOURNAL of the A. I. E. E. when writing to advertisers.

Classified Advertiser's Index for Buyers—Continued

- SEARCHLIGHTS**
General Electric Co., Schenectady
Westinghouse Elec. & Mfg. Co., E. Pitts-
burgh
- SHEETS, ELECTRICAL**
Trumbull Steel Co., The, Warren, O.
- SLEEVE TWISTERS**
Kearney Corp., Jas. R., St. Louis
- SOCKETS AND RECEPTACLES**
General Electric Co., Schenectady
Western Electric Co., All Principal Cities
Westinghouse Elec. & Mfg. Co., E. Pitts-
burgh
- SOLENOIDS**
Acme Wire Co., New Haven, Conn.
Belden Mfg. Co., Chicago
Dudlo Mfg. Co., Ft. Wayne, Ind.
Electric Controller & Mfg. Co., Cleveland
General Electric Co., Schenectady
Sundh Electric Co., Newark, N. J.
Ward Leonard Electric Co., Mt. Vernon, N. Y.
Westinghouse Elec. & Mfg. Co., E. Pitts-
burgh
- SPRINGS**
American Steel & Wire Co., Chicago
- STARTERS, MOTOR**
Allen-Bradley Co., Milwaukee
Condit Electrical Mfg. Corp., Boston
Electric Controller & Mfg. Co., Cleveland
General Electric Co., Schenectady
Rowan Controller Co., Baltimore, Md.
Sundh Electric Co., Newark, N. J.
Westinghouse Elec. & Mfg. Co., E. Pitts-
burgh
- STARTING AND LIGHTING SYSTEMS, AUTOMOBILE**
Wagner Electric Corp., St. Louis
- STEEL, SHEET & STRIPS**
Trumbull Steel Co., The, Warren, O.
- STOKERS, MECHANICAL**
Sturtevant Company, B. F., Boston
Westinghouse Elec. & Mfg. Co., E. Pitts-
burgh
- SUB-STATIONS**
General Electric Co., Schenectady
Westinghouse Elec. & Mfg. Co., E. Pitts-
burgh
- SWITCHBOARDS**
Allis-Chalmers Mfg. Co., Milwaukee
Condit Electrical Mfg. Corp., Boston
General Electric Co., Schenectady
Metropolitan Device Corp., Brooklyn, N. Y.
Western Electric Co., All Principal Cities
Westinghouse Elec. & Mfg. Co., E. Pitts-
burgh
- SWITCHES**
Automatic Time
Cramer & Co., Inc., R. W., New York
General Electric Co., Schenectady
Minerallac Electric Co., Chicago
Sundh Electric Co., Newark, N. J.
Westinghouse Elec. & Mfg. Co., E. Pitts-
burgh
Disconnecting
Burke Electric Co., Erie, Pa.
Condit Electrical Mfg. Corp., Boston
Delta-Star Electric Co., Chicago
General Electric Co., Schenectady
Kearney Corp., Jas. R., St. Louis
K-P-F Electric Co., San Francisco
Matthews Corp., W. N., St. Louis
Pacific Elec. Mfg. Co., San Francisco
Thoner & Martens, Boston
Fuse
General Electric Co., Schenectady
Kearney Corp., Jas. R., St. Louis
Matthews Corp., W. N., St. Louis
Metropolitan Device Corp., Brooklyn, N. Y.
Thoner & Martens, Boston
Knife
Condit Electrical Mfg. Corp., Boston
Cramer & Co., Inc., R. W., New York
Electric Controller & Mfg. Co., Cleveland
General Electric Co., Schenectady
Matthews Corp., W. N., St. Louis
Western Electric Co., All Principal Cities
Westinghouse Elec. & Mfg. Co., E. Pitts-
burgh
Magnetic
Allen-Bradley Co., Milwaukee
Oil
Condit Electrical Mfg. Corp., Boston
General Electric Co., Schenectady
Pacific Elec. Mfg. Co., San Francisco
Western Electric Co., All Principal Cities
Westinghouse Elec. & Mfg. Co., E. Pitts-
burgh
Remote Control
Condit Electrical Mfg. Corp., Boston
Cramer & Co., Inc., R. W., New York
General Electric Co., Schenectady
Rowan Controller Co., Baltimore
Sundh Electric Co., Newark, N. J.
Western Electric Co., All Principal Cities
Westinghouse Elec. & Mfg. Co., E. Pitts-
burgh
- TANTALUM**
Fansteel Products Co., Inc., North Chicago
- TELEGRAPH APPARATUS**
Western Electric Co., All Principal Cities
- TELEPHONE CONNECTORS**
Kearney Corp., Jas. R., St. Louis
- TELEPHONE EQUIPMENT**
Western Electric Co., All Principal Cities
- TESTING LABORATORIES**
Electrical Testing Labs., New York
- TESTING MACHINES, MATERIAL**
For Tension, Compression, Ductility, Endurance
etc.
Olson Testing Machine Co., Tinius, Phila-
delphia
- TOWERS, TRANSMISSION**
American Bridge Co., Pittsburgh
Western Electric Co., All Principal Cities
- TRANSFORMERS**
Allis-Chalmers Mfg. Co., Milwaukee
American Transformer Co., Newark, N. J.
Duncan Elec. Mfg. Co., Lafayette, Ind.
Ferranti, Ltd., Hollinwood, England
Ferranti, Inc., New York
Ferranti Electric, Ltd., Toronto, Ont.
General Electric Co., Schenectady
Jefferson Elec. Mfg. Co., Chicago
Kuhlman Electric Co., Bay City, Mich.
Moloney Electric Co., St. Louis
Pittsburgh Transformer Co., Pittsburgh
Wagner Electric Corp., St. Louis
Western Electric Co., All Principal Cities
Westinghouse Elec. & Mfg. Co., E. Pitts-
burgh
Factory
American Transformer Co., Newark, N. J.
Kuhlman Electric Co., Bay City, Mich.
Moloney Electric Co., St. Louis
Pittsburgh Transformer Co., Pittsburgh
Wagner Electric Corp., St. Louis
Western Electric Co., All Principal Cities
Furnace
Allis-Chalmers Mfg. Co., Milwaukee
American Transformer Co., Newark, N. J.
Moloney Electric Co., St. Louis
Pittsburgh Transformer Co., Pittsburgh
Metering
American Transformer Co., Newark, N. J.
Ferranti, Ltd., Hollinwood, England
Ferranti, Inc., New York
Ferranti Electric, Ltd., Toronto, Ont.
Pittsburgh Transformer Co., Pittsburgh
Mill Type
Pittsburgh Transformer Co., Pittsburgh
Radio
American Transformer Co., Newark, N. J.
Ferranti, Ltd., Hollinwood, England
Ferranti, Inc., New York
Ferranti Electric, Ltd., Toronto, Ont.
Jefferson Elec. Mfg. Co., Chicago
Street Lighting
Kuhlman Electric Co., Bay City, Mich.
Western Electric Co., All Principal Cities
- TROLLEY LINE MATERIALS**
General Electric Co., Schenectady
Hubbard & Co., Pittsburgh
Ohio Brass Co., Mansfield, O.
Western Electric Co., All Principal Cities
Westinghouse Elec. & Mfg. Co., E. Pitts-
burgh
- TURBINES, HYDRAULIC**
Allis-Chalmers Mfg. Co., Milwaukee
Morris Corporation, I. P., Philadelphia
- TURBINES, STEAM**
Allis-Chalmers Mfg. Co., Milwaukee
General Electric Co., Schenectady
Sturtevant Company, B. F., Boston
Western Electric Co., All Principal Cities
Westinghouse Elec. & Mfg. Co., E. Pitts-
burgh
- TURBO-GENERATORS**
Allis-Chalmers Mfg. Co., Milwaukee
Westinghouse Elec. & Mfg. Co., E. Pitts-
burgh
- VALVES, BRASS**
Gas, Water, Steam
Ohio Brass Co., Mansfield, O.
- VALVE CONTROL, ELECTRIC**
Bristol Company, The, Waterbury, Conn.
- VALVES, JOHNSON HYDRAULIC**
Morris Corporation, I. P., Philadelphia
- VARNISHES, INSULATING**
General Electric Co., Bridgeport, Conn.
Irvington Varnish & Ins. Co., Irvington, N. J.
Minerallac Electric Co., Chicago
Westinghouse Elec. & Mfg. Co., E. Pitts-
burgh
- WELDING MACHINES, ELECTRIC**
General Electric Co., Schenectady
Lincoln Electric Co., The, Cleveland
Ohio Brass Co., Mansfield, O.
Westinghouse Elec. & Mfg. Co., E. Pitts-
burgh
- WELDING WIRES & RODS**
American Steel & Wire Co., Chicago
Lincoln Electric Co., Cleveland
Ohio Brass Co., Mansfield, O.
- WIRES AND CABLES**
Armored Cable
American Steel & Wire Co., Chicago
Belden Mfg. Co., Chicago
Boston Ins. Wire & Cable Co., Boston
General Electric Co., Schenectady
Habirshaw Cable & Wire Corp., New York
Hazard Manufacturing Co., Wilkes-Barre, Pa.
Kerite Ins. Wire & Cable Co., New York
Okonite Company, The, Passaic, N. J.
Roebbling's Sons Co., John A., Trenton, N. J.
Simplex Wire & Cable Co., Boston
Standard Underground Cable Co., Pittsburgh
Western Electric Co., All Principal Cities
Asbestos Covered
American Steel & Wire Co., Chicago
Belden Mfg. Co., Chicago
General Electric Co., Schenectady
Automotive
American Steel & Wire Co., Chicago
Belden Mfg. Co., Chicago
Boston Ins. Wire & Cable Co., Boston
General Electric Co., Schenectady
Habirshaw Cable & Wire Corp., New York
Kerite Ins. Wire & Cable Co., New York
Roebbling's Sons Co., John A., Trenton, N. J.
Simplex Wire & Cable Co., Boston
Standard Underground Cable Co., Pittsburgh
Western Electric Co., All Principal Cities
Bare Copper
American Steel & Wire Co., Chicago
Anaconda Copper Mining Co., Chicago
Belden Mfg. Co., Chicago
Copperweld Steel Co., Rankin, Pa.
Hazard Manufacturing Co., Wilkes-Barre, Pa.
Roebbling's Sons Co., John A., Trenton, N. J.
Standard Underground Cable Co., Pittsburgh
Western Electric Co., All Principal Cities
Copper Clad
Copperweld Steel Co., Rankin, Pa.
Standard Underground Cable Co., Pittsburgh
Western Electric Co., All Principal Cities
Flexible Cord
American Steel & Wire Co., Chicago
Belden Mfg. Co., Chicago
Boston Ins. Wire & Cable Co., Boston
General Electric Co., Schenectady
Hazard Manufacturing Co., Wilkes-Barre, Pa.
Okonite Company, The, Passaic, N. J.
Roebbling's Sons Co., John A., Trenton, N. J.
Simplex Wire & Cable Co., Boston
Standard Underground Cable Co., Pittsburgh
Western Electric Co., All Principal Cities
Heavy Duty Cord
American Steel & Wire Co., Chicago
Belden Mfg. Co., Chicago
Hazard Manufacturing Co., Wilkes-Barre, Pa.
Okonite Company, The, Passaic, N. J.
Simplex Wire & Cable Co., Boston
Ruse
American Steel & Wire Co., Chicago
General Electric Co., Schenectady
Roebbling's Sons Co., John A., Trenton, N. J.
Western Electric Co., All Principal Cities
Lead Covered (Paper and Varnished cambric insulated)
American Steel & Wire Co., Chicago
Anaconda Copper Mining Co., Chicago
General Electric Co., Schenectady
Habirshaw Cable & Wire Corp., New York
Hazard Manufacturing Co., Wilkes-Barre, Pa.
Kerite Ins. Wire & Cable Co., New York
Okonite Company, The, Passaic, N. J.
Okonite-Callender Cable Co., The, Inc.,
Passaic, N. J.
Roebbling's Sons Co., John A., Trenton, N. J.
Simplex Wire & Cable Co., Boston
Standard Underground Cable Co., Pittsburgh
Western Electric Co., All Principal Cities
Magnet
American Steel & Wire Co., Chicago
Belden Mfg. Co., Chicago
Dudlo Mfg. Corp., Fort Wayne, Ind.
General Electric Co., Schenectady
Maring Wire Co., Muskegon, Mich.
Roebbling's Sons Co., John A., Trenton, N. J.
Standard Underground Cable Co., Pittsburgh
Western Electric Co., All Principal Cities
Rubber Insulated
American Steel & Wire Co., Chicago
Belden Mfg. Co., Chicago
Boston Ins. Wire & Cable Co., Boston
General Electric Co., Schenectady
Habirshaw Cable & Wire Corp., New York
Hazard Manufacturing Co., Wilkes-Barre, Pa.
Kerite Ins. Wire & Cable Co., New York
Okonite Company, The, Passaic, N. J.
Roebbling's Sons Co., John A., Trenton, N. J.
Simplex Wire & Cable Co., Boston
Standard Underground Cable Co., Pittsburgh
Western Electric Co., All Principal Cities
Tree Wire
Hazard Manufacturing Co., Wilkes-Barre, Pa.
Okonite Company, The, Passaic, N. J.
Simplex Wire & Cable Co., Boston
Trolley
American Steel & Wire Co., Chicago
Anaconda Copper Mining Co., Chicago
Copperweld Steel Co., Rankin, Pa.
Roebbling's Sons Co., John A., Trenton, N. J.
Standard Underground Cable Co., Pittsburgh
Western Electric Co., All Principal Cities
Weather proof
American Steel & Wire Co., Chicago
Anaconda Copper Mining Co., Chicago
Copperweld Steel Co., Rankin, Pa.
General Electric Co., Schenectady
Kerite Ins. Wire & Cable Co., New York
Okonite Company, The, Passaic, N. J.
Roebbling's Sons Co., John A., Trenton, N. J.
Simplex Wire & Cable Co., Boston
Standard Underground Cable Co., Pittsburgh
Western Electric Co., All Principal Cities

Please mention the JOURNAL of the A. I. E. E. when writing to advertisers.

Chandeysson

Generators 25 to 25,000 Amperes

Direct Connected to



Motors

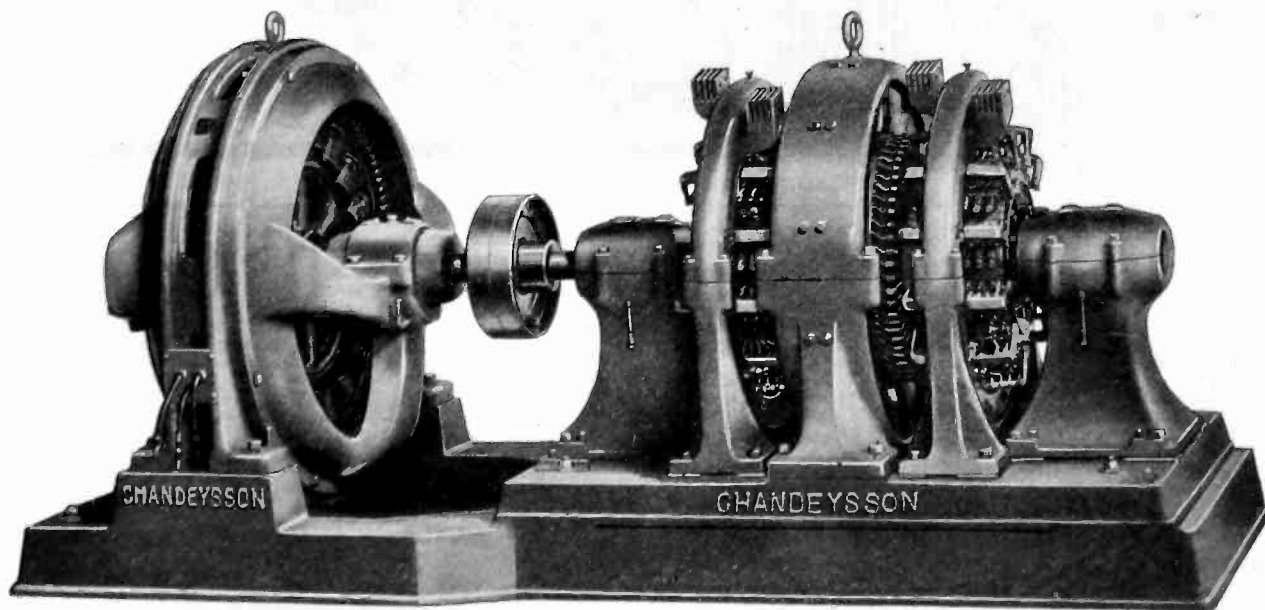

G-E Motor, 60 h.p., 3 phase,
60 cycle, 440 volt

Generator 6000/3000 Amp.,
6/12 volts, 360 r.p.m.

Two 6000-Ampere Units

added May 1926 to the

4 Units

operating at the Bridgeport Works of the

GENERAL ELECTRIC COMPANY

Installed 1923

CHANDEYSSON ELECTRIC CO., St. Louis, U. S. A.

Please mention the JOURNAL of the A. I. E. E. when writing to advertisers.

Moloney Transformers

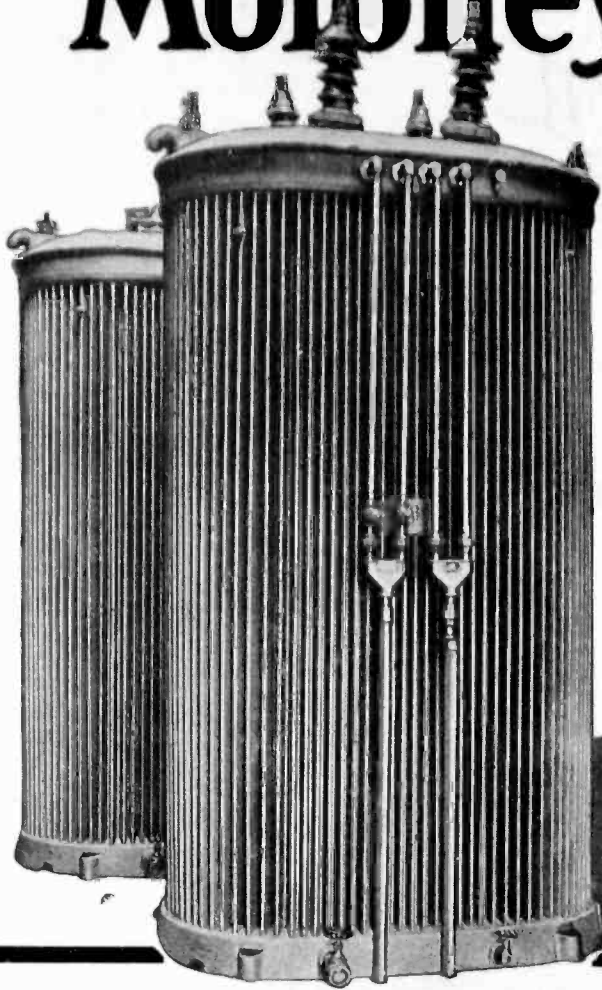

Moloney Transformers can be had in all types and sizes from the small distribution unit to the larger power sizes.

There are five Moloney factories devoted exclusively to the manufacture of transformers. Let us furnish you with complete details.

Moloney Electric Company

Main Office and Factories
St. Louis, Mo.
Sales offices in all principal cities

ALPHABETICAL LIST OF ADVERTISERS

	PAGE		PAGE		PAGE
Acme Wire Company, The	38	Fowle & Company, Frank F.	58	Ohio Brass Company, The	16
Allen-Bradley Company	35	Frey Engineering Company	58	Okonite Company, The	3d Cover
Allis-Chalmers Manufacturing Co.	6	G & W Electric Specialty Company	4	Okonite-Callender Cable Co., Inc.	3d Cover
Ambursen Construction Company, Inc.	58	General Electric Company	8, 9, 10, 17, 18, 26, 27	Olsen Testing Machine Company, Tinius	42
American Bridge Company	12	General Radio Company	47	Ophuls & Hill, Inc.	58
American Lava Corporation	40	Green, A. Barnett	58	Osgood, Farley	59
American Lead Pencil Company	56	Gurney Ball Bearing Div. M. R. Co.	38	Pacific Electric Mfg. Company	21
American Steel & Wire Company	43	Habirshaw Cable & Wire Corporation	5	Pittsburgh Transformer Company	46
American Transformer Company	11	Hazard Manufacturing Company	49	Prenner, I. S.	59
Anaconda Copper Mining Company	13	Henry, Augustus M.	58	Public Service Production Company	59
Bakelite Corporation	41	Hoosier Engineering Company	58	Roebbling's Sons Company, John A.	50
Barstow & Company, Inc., W. S.	58	Hubbard & Company	2	Roller-Smith Company	45
Battey & Kipp, Inc.	58	Irvington Varnish & Insulator Company	40	Rowan Controller Company, The	44
Belden Manufacturing Company	Back Cover	Jackson & Moreland	58	Sanderson & Porter	59
Black & Veatch	58	Jefferson Electric Mfg. Company	46	Sangamo Electric Company	19
Boston Insulated Wire & Cable Co.	50	Jewell Electrical Instrument Company	47	Sargent & Lundy, Inc.	59
Bristol Company, The	47	Kearney Corporation, James R.	46	Scotfield Engineering Company	59
Burke Electric Company	44	Kerite Insulated Wire & Cable Co., Inc.	1	Simplex Wire & Cable Company	48
Burdny Engineering Co., Inc.	7	K-P-F Electric Company	54	Sirrine & Co., J. E.	59
Byllesby Engineering & Management Corp.	58	Kuhlman Electric Company	24	Standard Steel & Bearings, Inc.	63
Canadian Porcelain Company, Ltd.	50	Lapp Insulator Company, Inc.	54	Standard Underground Cable Company	49
Century Electric Company	43	Lincoln, E. S.	58	Standards A. I. E. E. (Spanish)	52
Chandeysson Electric Company	65	Lincoln Electric Company, The	36	Star Electric Motor Company	42
Clark, Walter G.	58	Locke Insulator Corporation	20	Stevens, John A.	59
Clement, Edward E.	58	Manufacturers' & Inventors' Elec. Co.	44	Stevens & Wood, Inc.	59
Condit Electrical Manufacturing Corp.	55	Marine Rules A. I. E. E.	56	Stockbridge & Borst	59
Copperweld Steel Company	50	Maring Wire Company	40	Stone & Webster, Inc.	15, 59
Corning Glass Works	25	Marlin-Rockwell Corporation	38	Sturtevant, B. F., Company	42
Cramer & Co., Inc., R. W.	46	Martindale Electric Co., The	44	Sundh Electric Company	45
Cutter Company, The	32	Matthews Corporation, W. N.	23	Texas Company, The	67
Danne, Harold A.	58	McClellan & Junkersfeld, Inc.	58	Thomas, Percy H.	59
Day & Zimmermann, Inc.	58	Metropolitan Device Corporation	68	Thomas & Sons Company, The R.	51
Delta-Star Electric Company	54	Minerallac Electric Company	50	Thoner & Martens	54
Dossert & Company	22	Minton, John	58	Timken Roller Bearing Company	34
Dubilier Condenser Corporation	53	Moloney Electric Company	66	Trumbull Steel Company, The	44
Dudlo Manufacturing Corporation	39	Morganite Brush Company, Inc., The	60	U. G. I. Contracting Company, The	59
Duncan Electric Manufacturing Co.	46	Morris Corporation, I. P.	14	Wagner Electric Corporation	31
Electric Controller & Mfg. Co., The	33	National Carbon Company, Inc.	30	West Va. Pulp & Paper Company	40
Electric Specialty Company	44	National Vulcanized Fibre Company	40	Western Electric Company	28
Electrical Testing Laboratories	59	Neall, N. J.	58	Westinghouse Elec. & Mfg. Company	61
Electro Dynamic Company	42	Neiler, Rich & Company	58	Weston Electrical Instrument Corp.	57
Engineering Directory	58, 59	New Departure Manufacturing Co., The	3	White Engineering Corp., The J. G.	59
Engineering Foundation	56	Norma-Hoffmann Bearings Corporation	37	Wireless Specialty Apparatus Company	46
Engineering Societies' Library	50			Wray & Company, J. G.	59
Fansteel Products Company, Inc., The	57				
Fennessy, David V.	58				
Ferranti, Incorporated	29				
Ford, Bacon & Davis, Inc.	58				

(For classified list of Advertisers see pages 60, 62 and 64.)

Please mention the JOURNAL of the A. I. E. E. when writing to advertisers.

Check up

Try to form a mental picture of the company which is selling you lubricants. Check items on blank below.

Yes No

- 1. Is it entirely dependable?
- 2. Has it a wide choice of crude?
- 3. Does it control every process of refining, handling and manufacture?
- 4. Has it adequate and efficient shipping facilities?
- 5. Does it handle products from well to purchaser?
- 6. Has it thousands of tank cars on all the railroads of the country?
- 7. Does it maintain warehouses at all important centers?
- 8. Has it a fleet of motor vehicles for local delivery?
- 9. Has it huge stocks of lubricants of all kinds on hand at all times all over the country?
- 10. Are the oils of high grade, of constant quality, fully able to meet your varying requirements?
- 11. Can the seller supply all your lubricating needs, and also your burning oils?
- 12. Can the seller supply you with unstinted engineering service through experienced and capable lubricating engineers?

If your checks show all "Yes's" you are buying from a "good" Company.

If there are a number of "No's" it will pay you to investigate what The Texas Company offers—for the above is a skeleton of some of the things which are earning a very high regard for Texaco lubricants in the Electric Street Railway field.

When do you want to take it up with us?



THE TEXAS COMPANY

Texaco Petroleum Products

Dept. W9—17 Battery Place, New York City

Offices in principal cities



**Joints
on
26,400
Volt
Cable**

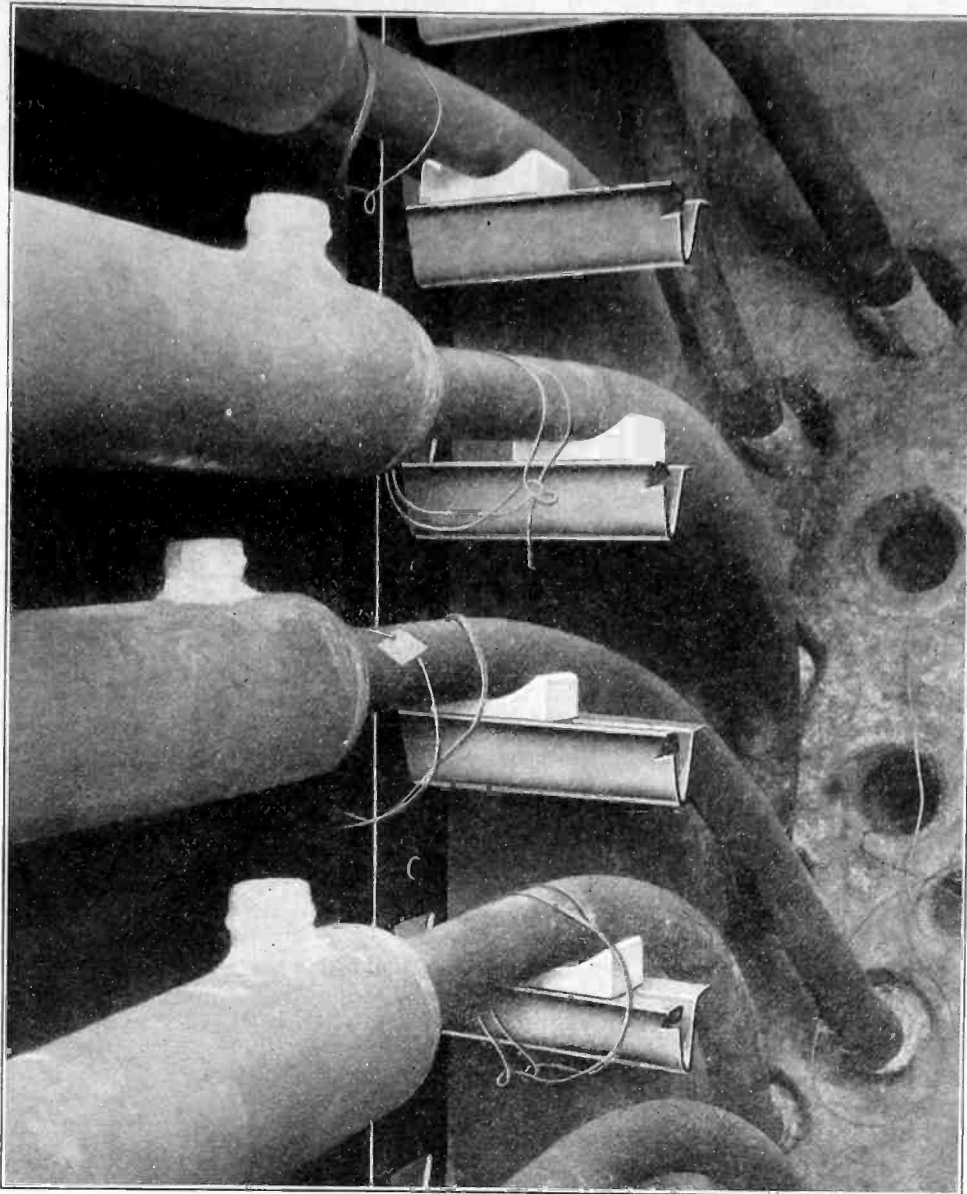

**Rack with
Insulator
That
Protects
Cable**

“Good Generation Deserves Good Distribution”

Metropolitan

SUPER TENSION JOINT

Splice with the Metrolatum filled joint and watch your cable troubles vanish.

This joint for 26,400 volt cable will withstand for 8 hours 160,000 volts. This factor of safety should interest you. Thousands of these joints have been in service from 10 to 15 years. For full information write for our 16-page booklet.

SUBWAY CABLE RACK

When you use this rack for mounting cables, you can be assured of the fullest measure of protection. Metropolitan Racks will outlive the cable. They are heavy and durable. The porcelain saddle affords a smooth surface over which cable may creep. It is a vital barrier against trouble from cables which receive or discharge stray currents. Our 16-page booklet gives full details. Write for it today.

Metropolitan Device Corporation
1250 Atlantic Ave., Brooklyn, N. Y.

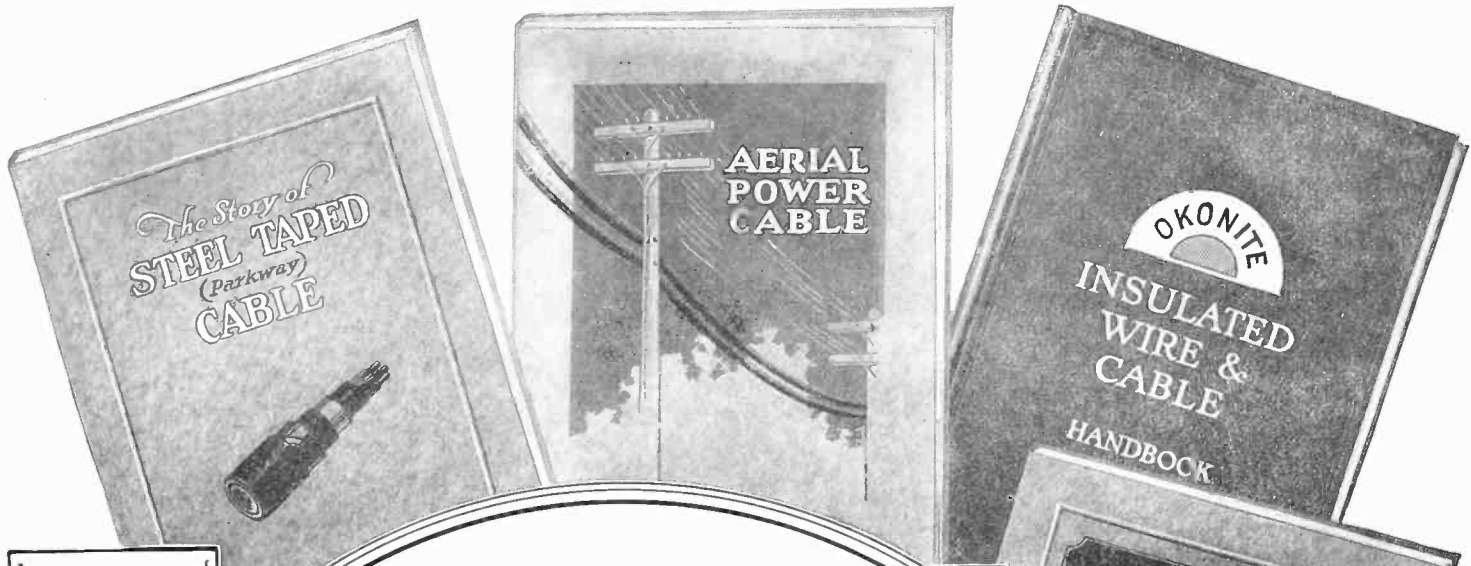

Okonite Products

- OKONITE INSULATED WIRES AND CABLES
- VARNISHED CAMBRIC CABLES
- OKONITE INSULATING TAPE
- MANSON & DUNDEE FRICTION TAPES
- OKONITE CEMENT
- OKOCORD
- OKOLOOM

Okonite-Callender Products

- IMPREGNATED PAPER CABLES
- SUPER-TENSION CABLES
- SPLICING MATERIALS

There's Information You can Use in each of these Booklets!

AERIAL POWER CABLE— Completely covers the subject. Thirty-two pages of specific data on this type of construction,—Where Used—How to Install, (with detailed Directions)—Finely Illustrated.

HANDBOOK: OKONITE INSULATED WIRE AND CABLE— A real Handbook of 100 pages on the subject treated. Also tells how carefully Okonite Products are made, covers each principal kind of wire and cable, and explains each step in their manufacture. Profusely illustrated.

THE STORY OF STEEL-TAPED CABLE— Its development, purpose and advantages. Construction of Okonite Steel-Taped Cable, Typical installations for Ornamental Street Lighting, Police and Fire Alarm Systems, Railroad Signals, etc. Complete "Specifications" and Tables for service up to 7,000 volts.

SPLICING AND TAPES FOR RUBBER INSULATED WIRES— The Importance of a Perfect Splice; The Important Properties of Tape; How to Recognize These Properties; How to Make a Perfect Splice; "Okonite", "Manson", and "Dundee" "A" and "B" Tapes. Fully illustrated.

TREE WIRE— This little book will help you solve many a line construction problem. Contains the latest information available on Tree Wire,—Why Needed—How used (with Directions for installing)—How Made. Also Specifications. Twenty-four pages; many interesting illustrations.

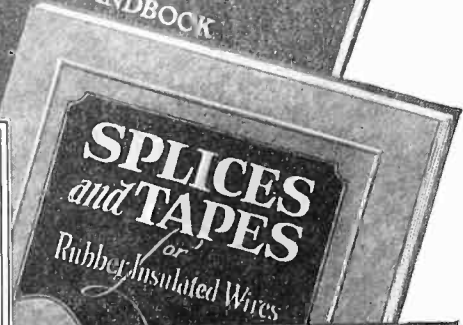

**THE OKONITE COMPANY
THE OKONITE-CALLENDER CABLE COMPANY, INC.**

FACTORIES: PASSAIC, N. J. PATERSON, N. J.

SALES OFFICES: NEW YORK . CHICAGO . PITTSBURGH . ST. LOUIS . ATLANTA
BIRMINGHAM SAN FRANCISCO LOS ANGELES SEATTLE

Pettingell-Andrews Co., Boston, Mass.

Novelty Electric Co., Philadelphia, Pa. F. D. Lawrence Electric Co., Cincinnati, O.

Canadian Representatives: Engineering Materials Limited, Montreal

Cuban Representatives: Victor G. Mendoza Co., Havana



CHECK THE BOOKLETS YOU WANT AND MAIL COUPON TODAY.

THE OKONITE COMPANY, PASSAIC, N. J. Please send me booklets as marked below:

J. A. C. E. E.

Name

Street Number..... City and State.....

Official Position..... with.....

OKONITE HANDBOOK AERIAL POWER CABLE TREE WIRE SPLICES & TAPES "PARKWAY" CABLE



One of the twenty-five Special Boeing Planes equipped with Belden Wire that have handled the Western Division of the Air Mail since July 1st

Belden's Contribution to Aviation Progress

BELEDEN engineers have given intensive time and effort to the development of airplane electrical wiring practically since its inception. It is significant that Belden Wire has been used on practically every American plane which has made a phenomenal success.

Belden Wire was adopted by the U. S. Army Air Corps for the DH-4; it was used on Lt. MacReady's American High-Altitude flight plane. The four American Around-the-World flight planes used Belden Wire; Byrd's Polar flight plane used Belden Wire; Lindbergh and

Chamberlain used the Earth Inductor Compass wound with Belden Wire; Maitland's Pacific flight plane and the big Fokker used by Byrd on his Trans-Atlantic flight were more than 90% equipped with Belden Wire. In view of the rigid inspection and tests of materials used in these special planes, the selection of Belden Wire is a strong testimonial to its quality.

Belden engineers are as glad to help you solve your wiring problems as they are to solve the wiring problems of aviation. Write them about your requirements.

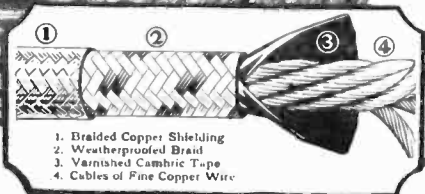

1. Braided Copper Shielding
2. Weatherproofed Braid
3. Varnished Cambric Tape
4. Cables of Fine Copper Wire

BELDEN PRODUCTS

*Beldenamel and Textile
Magnet Wire
Coil Windings
Beldenmold
(Molded Bakelite Products)
Automotive Wires and Cables
Airplane Assemblies
Radio Wires, Cords
and Cables
Rubber Covered Wires
Armored Cables
Flexible Armature Wires
Motor Lead Wires
Braided and Stranded
Copper Cables
Cotton Sleaving*

Belden Manufacturing Company
2316B South Western Avenue Chicago, Illinois

*Specify
Belden*