

MEETINGS

of the

American Institute of Electrical Engineers

(See Announcements This Issue)

PACIFIC COAST CONVENTION, Del Monte, Calif.,
September 13-16



MEETINGS OF OTHER SOCIETIES

American Chemical Society Conferences, Pennsylvania State
College, State College, July 4-29

National Electric Light Association

East Central Division, Cedar Point, Ohio, July 12-15

New England Division, New London, Conn., Sept. 12-15

Annual Convention Illuminating Engineering Society, Edgewater
Beach Hotel, Chicago, October 11-14

JOURNAL

OF THE

American Institute of Electrical Engineers

PUBLISHED MONTHLY BY THE AMERICAN INSTITUTE OF ELECTRICAL ENGINEERS
33 West 39th Street, New York

Subscription. \$10.00 per year to United States, Mexico, Cuba, Porto Rico, Hawaii and the Philippines, \$10.50 to Canada and \$11.00 to all other Countries. Single copies \$1.00.

Entered as matter of the second class at the Post Office, New York, N. Y., May 10, 1905, under the Act of Congress, March 3, 1879. Acceptance for mailing at special rate of postage provided for in Section 1103, Act of October 3, 1917, authorized on August 3, 1918.

Vol. XLVI

JULY, 1927

Number 7

TABLE OF CONTENTS

Papers, Discussions, Reports, Etc.

Notes and Announcements	665	Report of Committee on Electrical Communication, H. P. Charlesworth, Chairman	712
Mercury Arc Rectifier Phenomena, by D. C. Prince	667	Giant Power Systems Are Getting Numerous	716
Fifty Years Artificial Lighting	674	Discussion at Winter Convention	
Catenary Construction for Chicago Terminals, by J. S. Thorp	675	Papers on Voltage Standardization (Summerhayes and Hanker, Argersinger, Silver and Harding, Gear, Scholz, Eberhardt and Jones, Minor, Huber-Ruf)	717
Calculation of High-Voltage Transmission Lines (Correspondence)	680	Maxwell's Theory of the Layer Dielectric (Murnaghan)	727
A 10-Kw., 20,000-Cycle Alternator, by M. C. Spencer	681	Transverse Reaction in Synchronous Machines (Douglas)	731
Cab Signals for Railway Signaling, by T. S. Stevens	687	Discussion at Kansas City	
Standby Storage Battery	690	Testing, Inspecting and Maintaining Stations (Lichtenberg)	734
Report of Committee on Transmission & Distribution, P. Torchio, Chairman	691	Electricity for Oil-Well Drilling (Murphy)	737
Mechanical and Magnetic Properties of Steel	697	Would Simplify Headlamp Focusing	737
Tests on High- and Low-Voltage Oil Circuit Breakers, by P. Sporn & H. P. St. Clair, (Abridged)	698	Illumination Items	
Circuit Breaker Development, by R. M. Spurek	707	Photoelectric Rating Incandescent Lamps	738
		Lighting and Contrast	738

Institute and Related Activities

The Detroit Summer Convention	739	Addresses Wanted	743
Pacific Coast Convention	739	Past Section Meetings	744
American Chemical Society Conferences	739	Students Activities	
New York Electrical Society	739	Joint Branch Meeting in Milwaukee	745
Report on Standards for Measurement of Test Voltage	740	Annual Spring Engineers' Day, Univ. of Col.	745
Standards for State Adoption	740	Conference Student Activities at Pittsfield, Mass.	745
New Edition of "Recommended Practise for Electrical Installations"	740	Student Convention of Northeastern District	746
Revised Edition of A. I. E. E. Standards No. 9	740	Columbus Section and Ohio State Branch Joint Meeting	746
Degrees Conferred Upon Six Scientists	740	Engineering Open House at University of North Carolina	746
Guggenheim School Opens	740	Award of National Best Branch Paper Prize	746
Air Activities of the Federal Government	741	Branch Meetings	746
Work Started on Federal Buildings	741	Engineering Societies Library	748
Loan Funds Proposed for Aviation	741	Employment Service	751
Patent Office Improvements	741	Membership	
Washington Award Presented to Orville Wright	741	Applications, Elections, Transfers, etc.	752
Electrical Safety Conference Dissolves	741	Officers of A. I. E. E.	758
500th Anniversary of University of Louvain	741	List of Sections	758
Summer School for Engineering Teachers	742	List of Branches	759
Personal Mention	742	Digest of Current Industrial News	760
Obituary	743		

A REQUEST FOR CHANGE OF ADDRESS must be received at Institute headquarters at least ten days before the date of issue with which it is to take effect. Duplicate copies cannot be sent without charge to replace those undelivered through failure to send such advance notice. With your new address be sure to mention the old one, indicating also any change in business connections.

Copyright 1927. By A. I. E. E.

Printed in U. S. A.

Permission is given to reprint any article after its date of publication, provided proper credit is given.
(The Journal of the A. I. E. E. is indexed in Industrial Arts Index.)

Current Electrical Articles Published by Other Societies

Engineers & Engineering (May 1927)

Molding Rubber with Electricity, (Research Narrative No. 125)

Institute of Radio Engineers (Proceedings May 1927)

Loud Speaker Testing Methods, by I. Wolff and A. Ringel

High Angle Radiation of Short Electric Waves, by S. Uda

Notes on Radio Receiver Measurements, by T. A. Smith and G. Rodwin

The Tuned Grid Tuned-Plate Circuit Using Plate-Grid Capacity for Feed-Back, by J. B. Dow

Selectivity of Tuned Radio Receiving Sets, by K. W. Jarvis

Radio Phenomena Recorded by the University of Michigan Greenland Expedition 1926, by P. C. Oscanyan

Puncture Damage Through the Glass Wall of a Transmitting Vacuum Tube, by V. Kusunose

Iron & Steel Engineers, (June 1927)

Application of Synchronous Motors in Steel Mills, by H. A. Winne

Developments in Electric Heat, by G. H. Schaeffer

Electrical Developments in the Iron and Steel Industry, by W. H. Burr

Safe Practices in Connection with the Operation of High Tension Power, by T. E. Hughes

Safe Practices in Connection with the Operation of High Tension Power, by A. N. Cartwright

Journal of the Franklin Institute (June 1927)

Unusual Engineering Features of the Conowingo Dam and Power Plant, by N. E. Funk

National Electric Light Association (Bulletin June 1927)

Hydroelectric Power Era, by W. H. Onken, Jr.

Journal of the A. I. E. E.

Devoted to the advancement of the theory and practise of electrical engineering and the allied arts and sciences

Vol. XLVI

JULY, 1927

Number 7

The Work of the Board of Examiners

The Board of Examiners of the Institute considers the qualifications of applicants for election to membership and for transfer to higher grades of membership, and reports its recommendations to the Board of Directors for action. One meeting is held every month and occasionally extra meetings of the entire Board or of subcommittees are necessary. The growth in membership of the Institute has naturally increased the work of the Board of Examiners; accordingly its personnel was increased at the beginning of this year to twelve, all Fellows of the Institute. The recent amendment to the Constitution, increasing the dues of Associates after the first six years of membership to the same amount as is paid by Members, has also had its effect in increasing the number of transfers to the higher grades.

During the year ending April 30, 1927, the Board of Examiners was in session an aggregate of over forty-five hours and considered and referred to the Board of Directors a total of 4080 applications for admission and transfer. While most of these applications are for Student enrolment and admission to the Associate grade, about one-eighth of the total are for admission and transfer to the higher grades. These latter cases require the major attention of the Board. During the year thirty-two were recommended for admission or transfer to the grade of Fellow, and 386 were recommended for admission or transfer to the grade of Member. Corresponding recommendations for the five preceding years are as follows:

Year ending April 30,	Recommended for grade of	
	Fellow	Member
1926	37	302
1925	13	138
1924	26	170
1923	28	197
1922	22	242

While the work of the Board of Examiners may be considered largely of a routine nature, many difficult problems arise in the gaging of applicants for Member or for Fellow grade. These problems vary greatly because of the necessarily diverse nature of the applicants' experience and the lack of any definite standard for judgment. The work of the Board of Examiners

would be greatly simplified if applicants for admission or transfer to either of the higher grades of membership would keep in mind, in filling out their applications, the three following points:

1. A statement of experience in sufficient detail to give a clear idea of the exact nature of the applicant's professional work, particularly during the period on which the application is based.
2. A concise statement of the degree of responsibility which has been involved in the execution of that work.
3. Supporting references from the required number of Members and Fellows who are sufficiently familiar with the applicant's professional record to enable them to express a definite opinion as to his eligibility.

It is the latter point on which it seems desirable to enlarge. The Examiners naturally are inclined to place more weight on the statements of Member or Fellow references who have been associated with an applicant than they are on any opinion reached from a reading of a submitted record. Where it is not possible to name a sufficient number of such references, the Constitution provides that the Board of Examiners may accept other references preferably professional engineers of standing. The Examiners feel that, in general, persons eligible for Member or Fellow grade should have had sufficient contact with fellow engineers to enable them to secure the endorsements of proper grade from our own members. If it is necessary to take advantage of the Constitutional provision with respect to references they should be professional engineers of standing.

During the last few years, many applications for Associate grade have been received from men who have but recently arrived in this country and have no professional contacts here. Similarly long time residents of this country are sometimes so located as to be in the same position. Often these applicants offer as references individuals who are not members of the A. I. E. E. nor of any other professional engineering society. Since the reliability of such references is difficult to verify, the admission of these applicants might result in an injustice to members of the Institute. The Examiners therefore are inclined to ask such applicants to wait until they make reliable contacts in the engineering profession.

ERICH HAUSMANN, *Chairman,*
Board of Examiners.

the slow movement of the heavy ions. An electron has a mass of 9×10^{-28} g. and carries a charge of 1.59×10^{-19} coulombs, while an ion carrying the same charge has a mass of 3.3×10^{-22} g. Their velocities are inversely proportional to the square roots of their masses, so that the electron velocity is about 600 times that of the mercury ion in the same field.

The ionization potential of mercury vapor is 10.4 volts; however, all this energy need not be imparted at one collision. A molecule may be activated by receiving 4.7 volts in which condition its free electrons are in an outer position from which they are more easily detached. The nine-volt cathode drop is presumably a weighted average of the various possibilities. 0.44 ampere, the positive portion of each cathode ampere, falling through nine volts, delivers 3.96 watts to the cathode. On entering the mercury, the ions are neutralized by combination with electrons, and this releases further energy equal to 3.1 watts. The total energy is thus 7.06 watts per ampere. This energy is consumed as follows:

Consumption of energy by electrons leaving the mercury.....	2.20 watts
Evaporation of mercury in the cathode spot.....	2.20 watts
Conducted away by the mercury.....	2.68 watts
	7.08 watts

The heat conducted away by the mercury may evaporate mercury outside of the cathode spot or may be conducted to the outside of the rectifier. The electrons passing out through the nine-volt cathode drop acquire energy represented by $0.56 \times 9 = 5.04$ watts which is used in making ionizing collisions, but 3.1 watts is returned to the mercury by the positive ions. The difference, 1.94 watts, passes into the ionized space but must be added to the 7.08 to make up the total cathode drop. $7.08 + 1.94 = 9.02$ volts.

CONDUCTION IN SPACE

Once free of the cathode, the gas expands to a low pressure, which will be considered later. In this space the electrons travel in the general direction of the anodes but they are diverted by collisions with vapor not violent enough to ionize, and this adds heat to the vapor. Some electrons recombine with ions, giving off energy as radiation which is lost. Electrons and ions combine on the surface of the vessel giving up their energy as heat. These losses must be made up by a potential drop along the arc path. Data have been published giving this loss as 0.1 to 0.4 volts per cm. of arc length. It is thus quite variable and depends upon a variety of factors, such as temperature and geometry of the rectifier. In any given volume of ionized vapor there will tend to be equal numbers of electrons and ions at any instant. A surplus of either sign of charge will attract charges of the opposite sign until the balance is restored. Since for equal energy the electrons move

600 times as fast, the conducted or drift current will be carried by electrons and positive ions in the ratio of about 600 to one. The walls of the rectifier, if at space potential, would receive 600 times as many electrons as ions. They could therefore remain at space potential only if a large current were drawn from them. Actually the walls are usually allowed to charge themselves negatively until a balance is reached. This balance occurs when the walls are negative about five volts with respect to the space potential or about four volts positive with respect to the cathode. The cathode drop was thus long supposed to be the difference between the wall or sounding electrode potential and the cathode³.

ANODES

The deflection of electrons and ions from the straight path by collisions gives rise to random velocities which may considerably exceed the velocity of drift toward the anode. Langmuir³ has found that the density of electrons striking a test electrode is from $1\frac{1}{2}$ to 4 times the drift current through the rectifier, depending upon the temperature. It is thus possible for an anode to collect all its current merely by picking up electrons which naturally strike it. These electrons give up their energy upon falling into the anode surface so that the anode is heated even though there is, strictly speaking, no anode drop.

Theoretically, a large enough anode might collect its entire current while at a potential negative with respect to the space. A metal tank rectifier employing the whole tank as an anode will show a drop as low as eight volts for considerable currents. The total drop is thus less than the cathode drop alone. Such an arrangement would be more or less impracticable for an operating rectifier but serves to show the nature of the anode loss.

Most practical rectifiers are arranged to have enough anode area so that the entire current is random current at ordinary loads and working temperatures. This is accomplished by making the anode area not less than $\frac{2}{3}$ of the cross section of the arm in which it is located. The anode is then required to dissipate only the energy of recombination of the electrons; that is, the work function which is 3.7 volts for iron and 4.1 for graphite. This energy may be conducted away in anodes with cooled stems or radiated where small solid stems are employed.

If, due to insufficient anode area or a cold tank, the random current is too low, the anode must surround itself with an electric field to draw additional electrons in. This field accelerates the electrons which reach the anode at high velocity and cause excessive heating. It is not uncommon for the anodes in a cold tank suddenly loaded to become incandescent or melt, giving a failure before the apparatus has time to warm up.

3. Langmuir, *G. E. Review*, Nov., 1923, and July, Aug., Sept., Nov., and Dec., 1924.

TOTAL ARC-DROP

The total arc-drop from anode to cathode of a rectifier is easily investigated. Fig. 1* gives the arc-drop of a small glass tube under various conditions. The lower curves are taken with a tube having short straight anode arms. With natural air cooling, direct current was first collected by one anode and then by two in parallel using a resistance to divide the current. The curves are the same within the limits of experimental error. Also it is impossible to make two anodes divide current without some external means, for even though the drop increases with slow increase of current, it seems to drop with instantaneous increases.

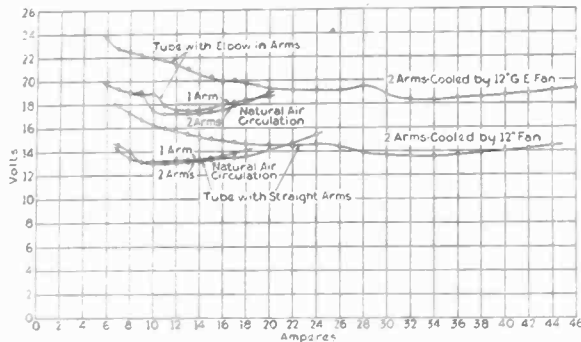

FIG. 1—ARC-DROP FOR 20-AMPERE GLASS TUBE

The upper curves are for a precisely similar tube with bent anode arms which are necessarily longer. The point of minimum drop is perhaps the best to take for comparison between different sizes. Table I gives an idea of the erratic connection between length of arc and total drop.

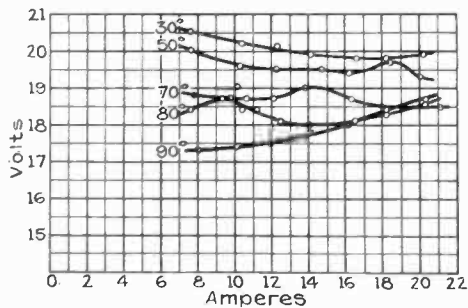

FIG. 2—EFFECT OF TEMPERATURE ON ARC-DROP OF 20-AMPERE GLASS TUBE

TABLE I
MINIMUM ARC-DROP FOR VARIOUS RECTIFIERS

Glass	Size	Minimum drop
	10 ampere	16
	20 "	17.1
	30 "	15
	50 "	15
	250 "	17.2
Steel	15 inch	14.1
	30 "	14.8

*Figs. 1, 3, 11, 12, 13, 14, 16, 18, 19, 20 are reproduced from "Mercury Arc Rectifiers and Their Circuits," by Prince and Vogdes, through the courtesy of the McGraw Hill Book Co.

Fig. 1 also shows the effect of fan cooling the same two tubes. The point of minimum drop is moved to a considerably higher current but the minimum drop itself is larger. The temperature effect is clearly shown in Fig. 2. For small currents the drop is much lower at high temperatures.

The drop as a function of time is shown in Fig. 3. A rectifier was operated under oil at carefully controlled temperature and a record made of current and arc-

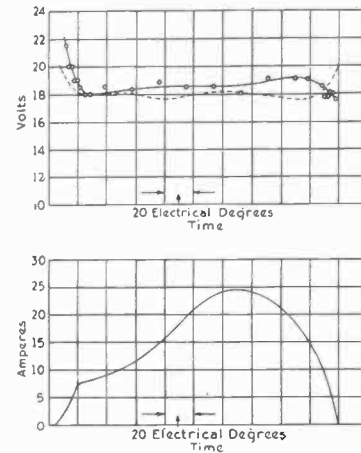

FIG. 3—INSTANTANEOUS ARC-DROP VARIATIONS

drop. The arc-drop measurements at the same temperatures and currents obtained from d-c. measurements are shown dotted and check quite closely except at the transfer points where two anodes were exchanging current.

The effect of fan cooling in Fig. 1 suggests that even more current could be carried by more intensive cooling. Fig. 4 shows the effect of additional cooling on the same tube. Additional current possible with water

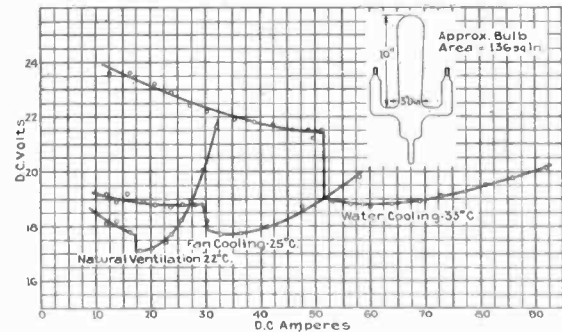

FIG. 4—EFFECT OF COOLING ON ARC-DROP OF 20-AMPERE GLASS TUBE

cooling is accompanied by a considerable rise in arc drop. The connection between the increased minimum and tube shape is shown by comparing Fig. 4 with Fig. 5. The two tubes have almost the same external area but the one of larger cross section not only carries more current with natural cooling but allows an almost indefinite increase in current without much increase in drop under forced cooling. The sudden changes in drop attract attention, but we are not

prepared to offer an explanation for them. It is associated with the anode conditions. When the drop is high, the whole anode is covered with glow. When it is low, the anode tip appears to receive most of the current.

When the vacuum is extremely poor, excessive arc-drops are obtained. The additional drop appears to be

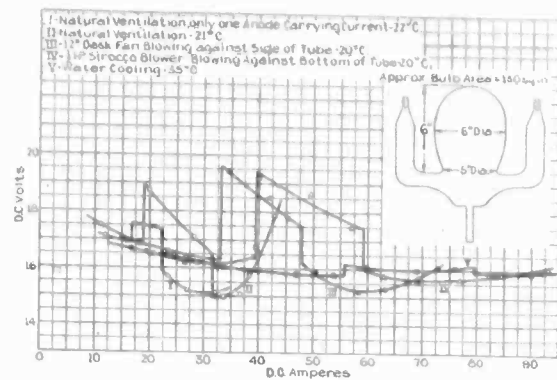

FIG. 5—ARC-DROP IN GLASS TUBE OF LARGE CROSS SECTION

in the arc stream which contracts and becomes very hot, even melting glass or iron where it comes in contact at turns in the passage. The anode is also likely to be heated locally. A voltage breakdown or arc-back, however, will usually occur in operation long before this state is reached.

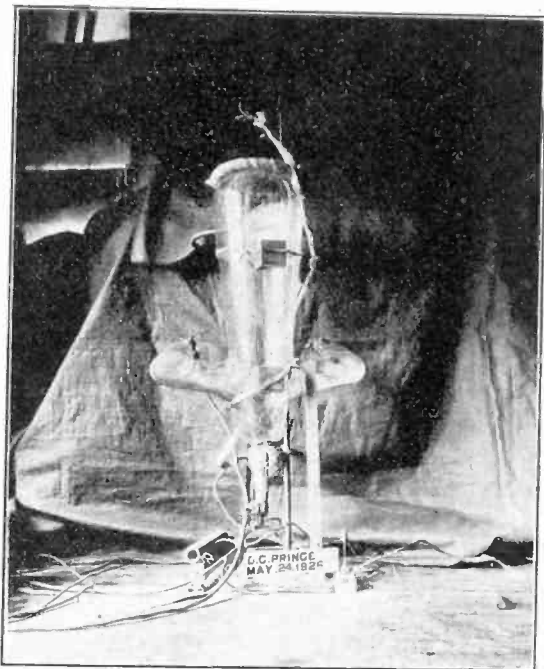

FIG. 6—50-AMPERE TUBE ARRANGED FOR VAPOR PRESSURE MEASUREMENTS

PRESSURE MEASUREMENTS

It seems as though there should be some connection between arc drop and the pressure in the vessel. Certain difficulties interfere with direct measurements of these pressures. A gage connected to the outside will measure the pressure of fixed gasses plus some mercury vapor pressure. If a MacLeod gage is used, the mercury vapor will practically all condense under

compression. If the hot wire type of gage is used, connected by a small tube, the mercury may not all be condensed, but an indeterminate part will be condensed so that the reading is of doubtful value as far as indicating the total pressure in active zones in the rectifier. The hot wire gage cannot be introduced into the arc stream because recombination will then take place on its surface and the heat of recombination may more than offset the convection due to the gas on which the pressure indication depends. Similar difficulties prevent reliable measurements of temperature inside a rectifier. Investigators have thus been more or less in the dark as to the actual conditions in the arc stream and condensing chamber.

At the suggestion of Dr. Langmuir, a new method has been worked out for measuring pressures and temperatures within a mercury arc rectifier. Small copper

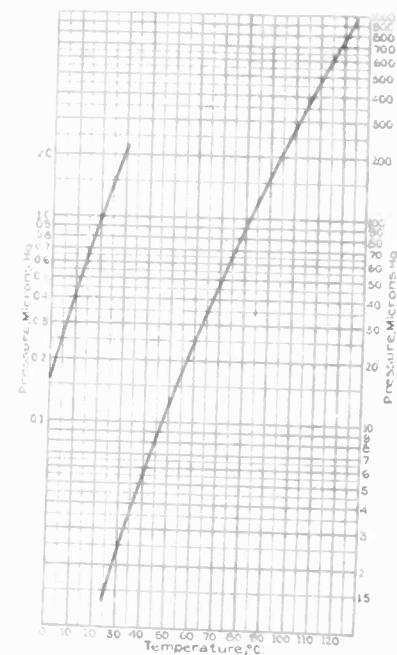

FIG. 7—TEMPERATURE AND PRESSURE OF SATURATED MERCURY VAPOR

thermometer wells are attached to the sides of a rectifier, as shown in Fig. 6. By heating and cooling these wells, the temperature is found at which the mercury just condenses or just evaporates from the inside surface. These temperatures are within one or two degrees of each other. At the balance temperature, the amount of mercury condensing must be equal to the amount of mercury evaporating. The mercury evaporating must evaporate in a saturated state, so that by consulting a saturation pressure temperature curve for mercury, the pressure of evaporating mercury is known. The pressure of the condensing mercury vapor can only be different from this due to superheat. If a calorimetric measurement were made on the thermometer well, the heat represented by superheat could be determined. To do this the temperature is measured at a point where there is a natural balance between evaporation and condensation. From information on the heat loss of surfaces, the energy passing through

the glass can be calculated. The superheat at this point is found to be about 20 deg. cent., so that at most points in the condensing chamber the degree of superheat is probably negligible. In the regions of high ionization density, the recombination on measuring surfaces would produce the same indication as superheat.

The relation between saturated mercury vapor pressure and temperature is given in Fig. 7., and the observed vapor pressures for a 20-ampere glass tube

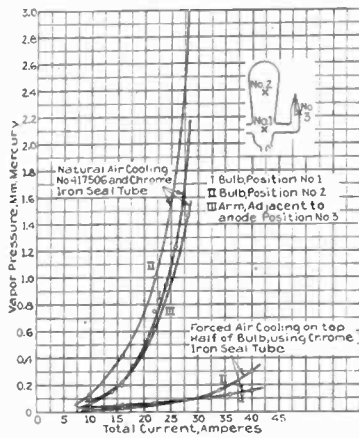

FIG. 8—VARIATION OF VAPOR PRESSURE WITH CURRENT IN GLASS RECTIFIER

are given in Fig. 8 and Fig. 9. By comparison with Fig. 1, it appears that minimum arc-drop corresponds to about 0.1-mm. pressure for either natural or fan cooling, using the pressures obtained for the neighborhood of the anode arms. Other things being equal, the greatest efficiency will be obtained with a vapor pressure of approximately 0.1 mm. or corresponding to a temperature for saturated vapor of 82 deg. cent.

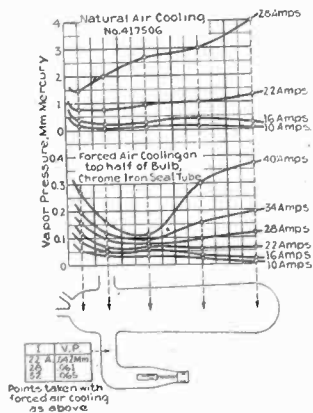

FIG. 9—VARIATION OF VAPOR PRESSURE WITH LOCATION IN GLASS RECTIFIER

Fig. 2 shows a slightly lower arc drop at 90 deg. cent. and a lower current. The tube had to be heated to secure this temperature at a current of six to eight amperes whereas the 90-deg. curve is higher than the 80-deg. curve under full load conditions.

Similar pressure measurements can be made on iron tank rectifiers by providing them with glass windows on which condensation and evaporation can be observed. The difficulty in this case is to secure the

proper location for the windows but valuable information is likely to be secured in any case.

In running such pressure tests, it has been observed that the condensing chamber may run 20 deg. to 30 deg. cooler than the saturation temperature. Several obvious explanations for this phenomenon do not seem to apply. For instance, a temperature gradient might exist in iron or glass. But such a gradient is calculable from the known loss per unit of area and heat conductivity and calculations indicate fractions of a degree. There is always a loss at a boundary where heat is transferred from one material to another. The amount of this drop is known and small for the conditions employed, since heat need only be conveyed to a thermometer well. The amount of mercury vapor condensing and evaporating from the surface is several times the amount required to deliver heat by condensation and raise the parts in question to the temperature of the interior.

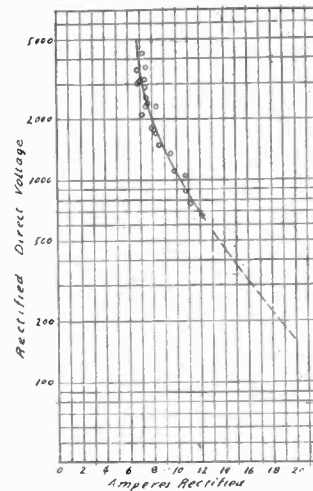

FIG. 10—ARC-BACK CURVE FOR 10-AMPERE 200-VOLT GLASS RECTIFIER—NATURAL AIR CIRCULATION

The most reasonable explanation appears to be that the fixed gas which evacuation has failed to remove from the rectifier is entrained by the mercury vapor and carried to the walls of the condensing chamber. Since these gasses cannot condense, they remain as a cushion of dead gas through which the mercury vapor must diffuse before it can condense. By assuming a reasonable small value for residual gas pressure and calculating how thick a film this gas would make if compressed against the condensing surfaces at the pressure of the mercury vapor, a value is obtained which is of the proper order of magnitude to account for the observed temperature drop from the mercury vapor to the condensing surface.

ARC-BACK

The mechanism of conduction has been developed in advance of the mechanism of failure since the failure is merely conduction at the wrong time. Before setting up what is believed to be the correct theory, some of the observed facts may be described.

OBSERVED ARC-BACK DATA

Fig. 10 is an arc-back curve of a standard 10-ampere, 200-volt mercury arc rectifier. Previous tests had been made of the dotted low voltage portion. The curve

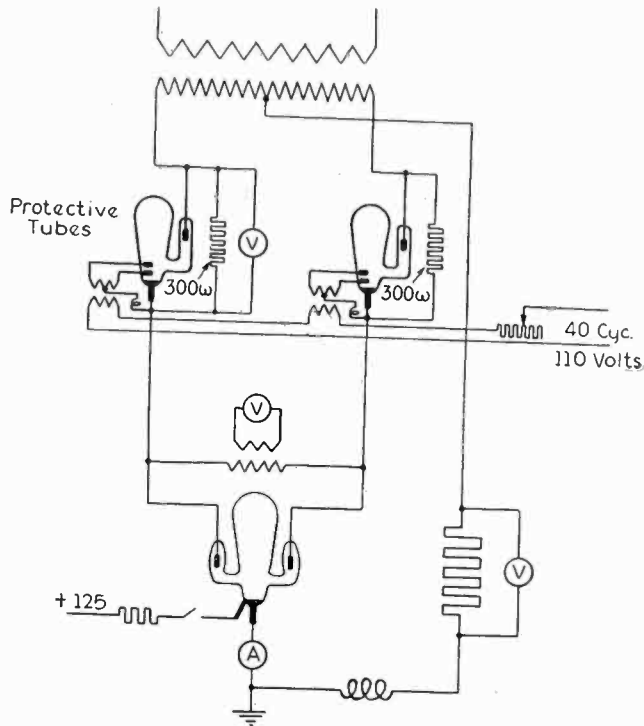

FIG. 11—ARRANGEMENT OF RECTIFIERS FOR ARC-BACK TESTS

therefore represents actual test results up to 4300 volts. Other tests were made to 10,000 volts, but extraneous factors prevented consistent results. The method of making such tests is to connect three rectifiers, as shown

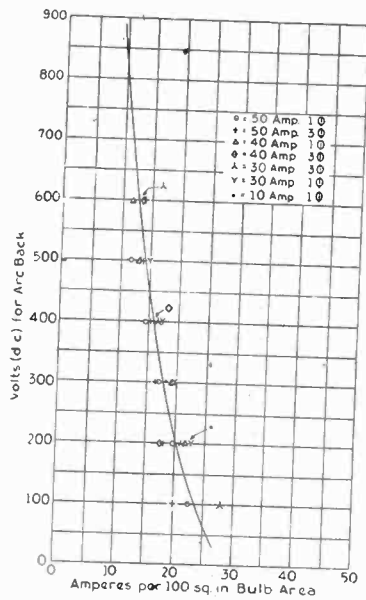

FIG. 12—COMPOSIT ARC-BACK FOR GLASS TUBES NATURAL AIR-COOLED

in Fig. 11. Two are used for protective purposes and have auxiliary anodes from which a cathode spot is continuously maintained. The circuit to each anode of the tube under test is carried through the protective tube shunted by resistance. As long as the protective anode is practically perfect, there is little current through the resistances and the full burden is

under test. If a failure to rectify occurs, the reversal current flows through the shunt resistance which limits it to such a value that the rectifier under test is not in-

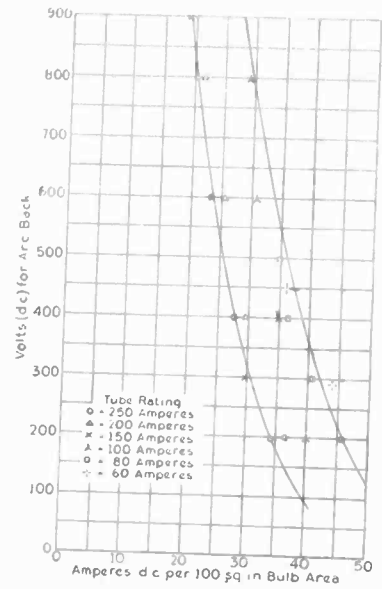

FIG. 13—COMPOSIT ARC-BACK CURVE FOR GLASS TUBES FAN-COOLED

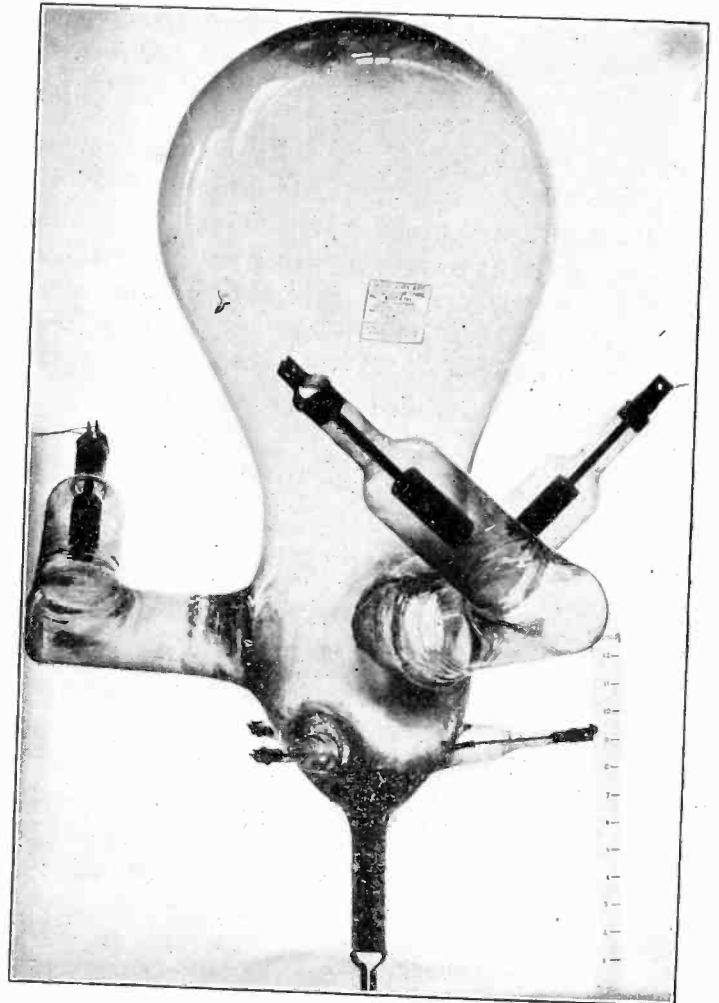

FIG. 14—250-AMPERE, THREE-PHASE 500- TO 600-VOLT MULTIPLE MERCURY ARC RECTIFIER TUBE

stantly destroyed. The protective tubes are larger and better cooled than the tube under test and so do not give way. Such tests are most readily made on glass tubes because in the past they have been the only ones that could be depended upon to repeat themselves.

Fig. 12 gives the arc-back curve of a whole series of tubes of similar shape reduced to the performance per 100 sq. in. of bulb area. Fig. 13 gives similar data for tubes cooled by a fan. Two forms are represented. The left-hand curve is for tubes having a

Curves are not available because of the larger power required since the tubes were actually loaded up to the point where failure occurred and only 50 kw. were available for the tests.

DERIVED ARC-BACK CURVES

Of course it is not very satisfying to know the limitations of a given rectifier without knowing the reasons, because it is always possible that some insignificant change might multiply the output several fold with no increase in cost of manufacture. In searching for

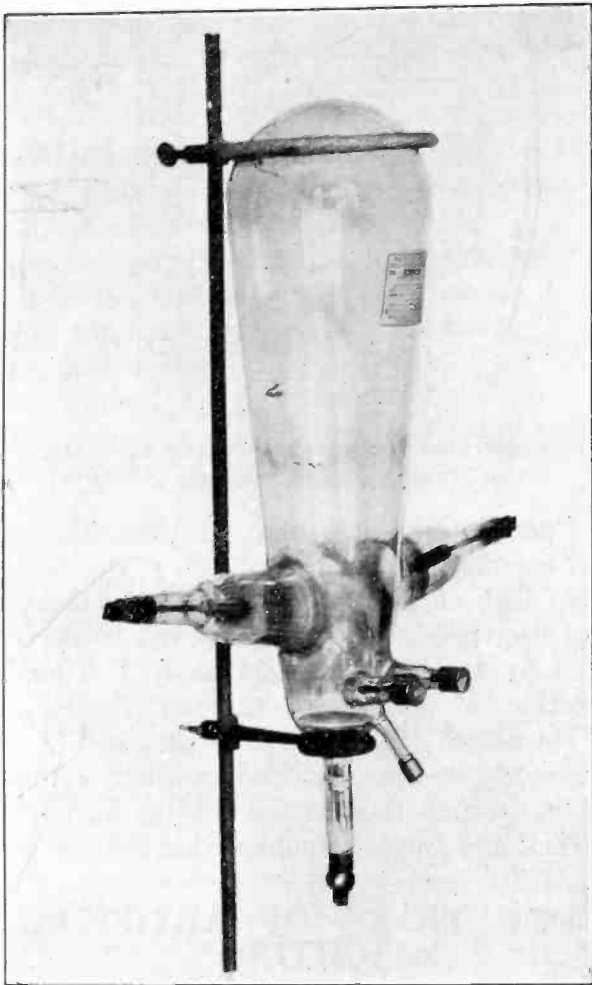

FIG. 15—150-VOLT MERCURY ARC RECTIFIER TUBE

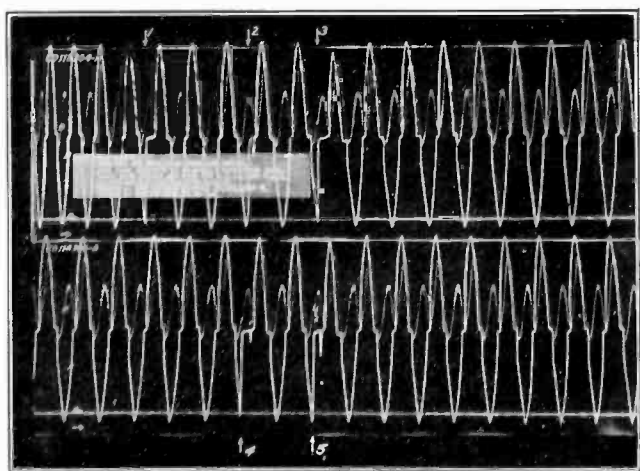

FIG. 16—OSCILLOGRAM OF ARC-BACK TAKING PLACE

modified hour glass form, such as Fig. 14. The right-hand curve is for straight sided tubes such as Fig. 15.

As in the arc-drop measurements, a tube of greater section gives superior results. More intense cooling gives a further shift of the arc-back curve to the right.

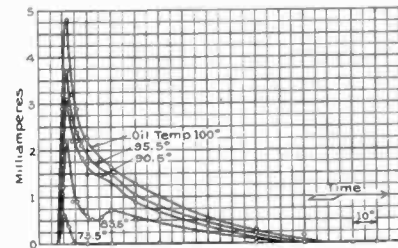

FIG. 17—INVERSE CURRENTS IN A GLASS MERCURY ARC RECTIFIER

reasons, the first steps were naturally empirical, feeling the way. Rectifiers were operated with varying amounts of inductance in the a-c. circuits. These failed at a lower d-c. output voltage which corresponded to nearly the same voltage on the a-c. lines; that is, the peak inverse voltage was the same. Two tubes connected like the protective tubes in Fig. 11, but without the shunting resistance, carried more load than two tubes each rectifying both half waves. These bits of evidence tended to show that the failure occurred

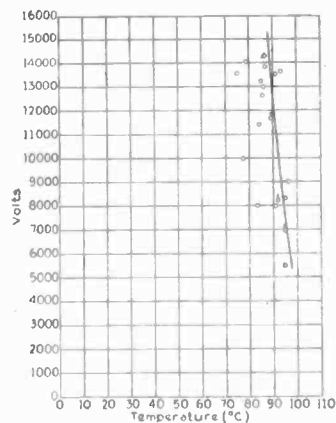

FIG. 18—BREAKDOWN OF RECTIFIER WITHOUT ARC AS FUNCTION OF TEMPERATURE

at the inverse voltage peak, but conclusive evidence of this was wanting until one tube came under test which arced so consistently that it could be caught in the act by an oscillograph. Fig. 16 is a record of actual arc-back taking place. It appears that the failure occurs at or near the voltage peak so that conditions at that time should yield the explanation for arc-back.

Fig. 17 is a record of inverse currents at different points in the inverse half-cycle, and shows that at the

negative inverse peak there is practically no ionization present, even at temperatures a good deal higher than those used in operating rectifiers. It should therefore be possible to test for breakdown in a tube not operating at all, provided the pressure conditions are duplicated,

The width of the envelope is a measure of vacuum technique. The relation between pressure and temperature of the cooling medium is a matter of thermodynamic technique. It is predicted that within five years there will be less mystery about the design of a

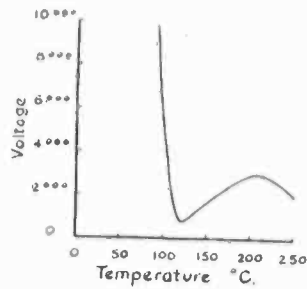

FIG. 19—BREAKDOWN OF MERCURY VAPOR

and have the results apply to an active rectifier. Fig. 18 shows the breakdown voltages for a considerable variety of tubes as functions of temperature. Fig. 19 produces Fig. 18 to higher temperatures. Fig. 20 gives corresponding data for a special tube having movable electrodes. From these figures it appears that a

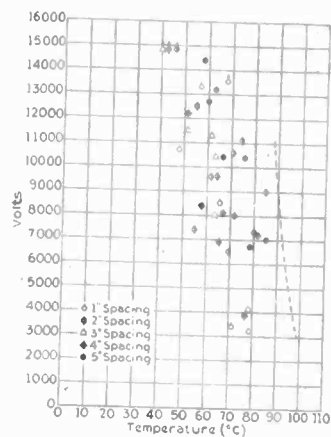

FIG. 20—BREAKDOWN OF MERCURY VAPOR FOR VARIABLE ELECTRODE SPACING

considerable variety of rectifiers break down at almost exactly the same voltage and temperature. Within these limits the electrode spacing is immaterial. The special movable electrode tube could not be exhausted so well as the others and it accordingly breaks down at lower temperatures, but as perfection is approached the points of failure approach a common curve.

If these breakdown data are significant, it should be possible to check the breakdown curve by means of the current voltage arc-back curves reduced to pressure temperature abscissa by means of the pressure temperature measurements which have been described. Fig. 21 shows such a comparison. An envelope is formed by curves A and B which enclose the breakdown points obtained with no arc in the tube. The other curves are the actual observed arc-back curves for three sizes of tubes reduced to a pressure basis.

The envelope in Fig. 21 is rather a wide one but at least the elements of constructive design are present.

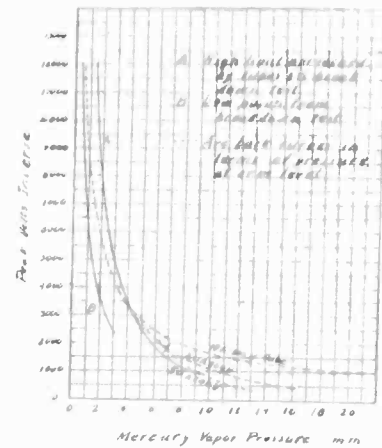

FIG. 21—COMPARISON OF BREAKDOWN AND ARC-BACK CURVES FOR MERCURY ARC RECTIFIER TUBES

mercury arc rectifier than now enshrouds the limitations of commutating machinery.

NOTE: The physical mechanism of the breakdown between electrodes at low pressures has been roughly indicated by such investigators as J. J. Thompson, "Conduction of Electricity through Gasses," and J. L. Townsend, "Electricity in Gasses." A more detailed study of what happens when a cathode is formed on a conducting surface is being made by Dr. I. Langmuir and should be published in the near future.

FIFTY YEARS OF ARTIFICIAL LIGHTING

The last 50 years is the epoch of electric lighting, says *Electrical World* editorially, for this kind of lighting began only half a century ago. It is commonplace to remark that the cost of light today from tungsten-filament lamps is only a small portion of the cost of the same quantity of light fifty years ago; but how many grasp the enormous difference? If the unskilled laborer of a half century ago had used as much light as is now used daily in the average home in this country, he would have had to work two and one-half hours daily to pay his gas-lighting bill alone, as compared with approximately ten minutes daily for the average unskilled laborer to pay his present electric lighting bill.

Of course, this great difference is due to the decreased cost of light, since the unskilled laborer now receives approximately \$3.22 per day as compared with \$1.43 fifty years ago. At the present time the average family is spending seven cents a day for electric light in the home. On the same basis of comparison, if the laborer a half century ago had used tallow candles to supply as much light in his home as he uses now, he would have been able to purchase nothing but light, and he would have had to labor almost twenty-four hours a day to pay for that.

Catenary Construction for Chicago Terminal Electrification of Illinois Central Railroad

BY J. S. THORP¹
Non-Member

Synopsis.—The object of this paper is to give briefly the procedure followed by the Illinois Central engineers in the layout, design and erection of the catenary system. Brief reference also

will be made to the principal items of material entering into the construction and to methods of maintenance.

* * * * *

THE Illinois Central decided upon the 1500-volt d-c. system of electrification with catenary construction for pantograph operation.

The electrified suburban trackage includes about:

- 4 route mi. of single main line track,
- 20 route mi. of double main line track,
- 1½ route mi. of 3 main line tracks,
- 8 route mi. of 4 main line tracks,
- 5 route mi. of 6 main line tracks, and about
- 20 track mi. of yards and sidings.

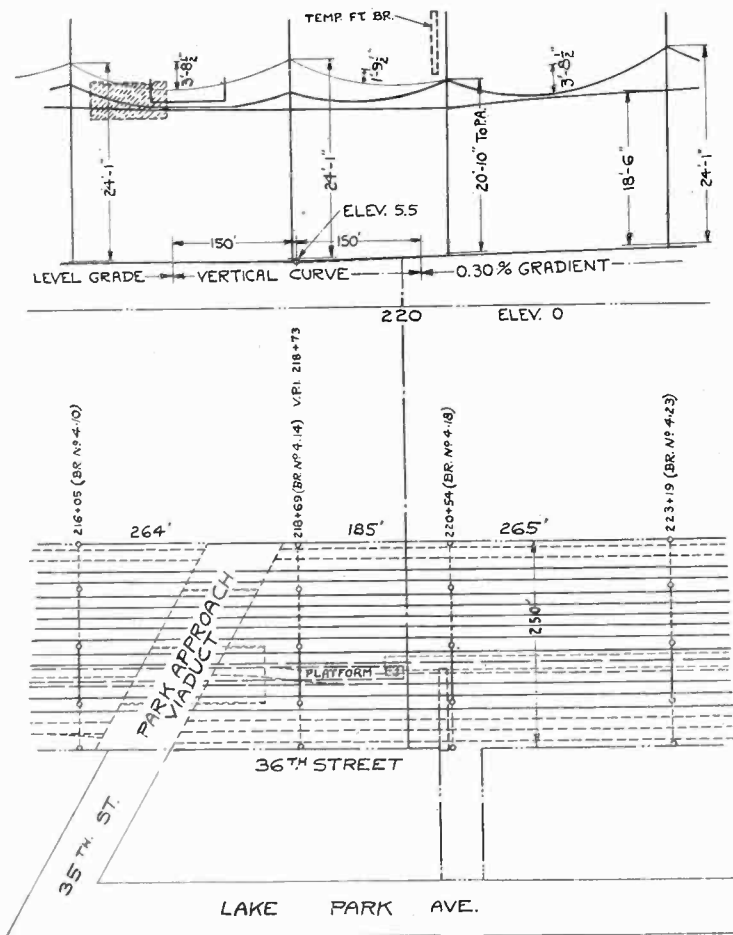

FIG. 1—TYPICAL TRACK PLAN

PLANS

Track plans were prepared showing the existing tracks and the proposed track arrangement to ultimately

1. Distribution Engineer, Illinois Central Railroad.

Presented at the Summer Convention of the A. I. E. E., Detroit, Mich., June 20-24, 1927.

develop the right-of-way. Fig. 1 shows a typical section of the track plan in the vicinity of 36th Street.

The catenary structures were located tentatively on the track plans, adhering to the normal tangent spacing of 300 ft. as far as possible and reducing the spacing according to Fig. 2, where the span is wholly or partly on

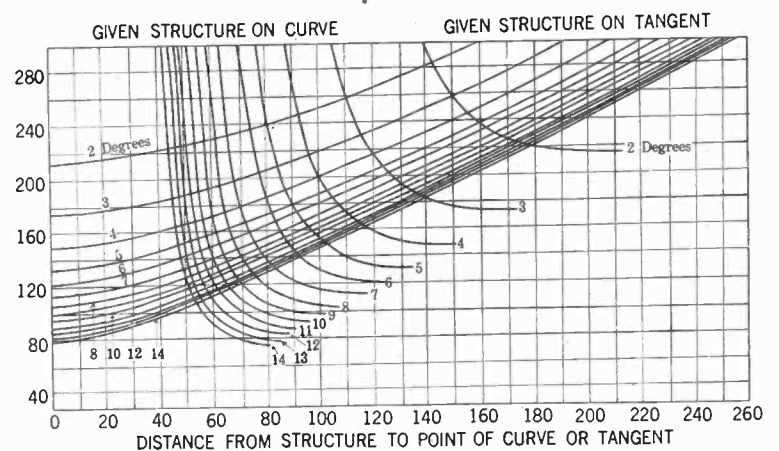

FIG. 2—SPACING CHART FOR STRUCTURES ON CURVES

a curve, or the normal spacing maintained and pull-off-poles interposed as found desirable. These locations were given to the field engineer who first made a check to see if any shifting would be necessary due to physical obstructions not shown on the plans, and then when the structures were definitely located, he made cross-

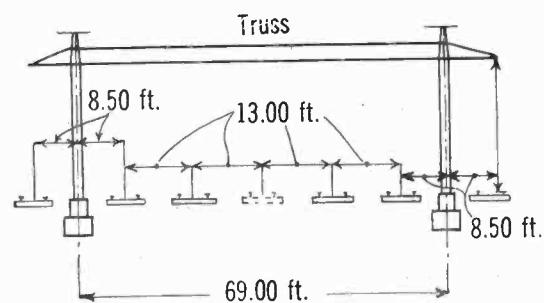

FIG. 3—TYPICAL ERECTION DIAGRAM

sections of the entire right-of-way at each location. From the track plans and cross-sections, erection diagrams as shown in Fig. 3 were prepared and the catenary structures designed. The height of the structure is determined by the catenary profile which is drawn on the track plans.

CATENARY STRUCTURE FOUNDATIONS

The foundations of all permanent structures were concrete. Where the space between the ties was less than the across-track dimension of the foundation, "side-bearing" footings were used. These "side-bearing" footings were designed in accordance with the chart shown in Fig. 4.

Gravity type footings were installed where track shoring was not necessary, and this type was designed

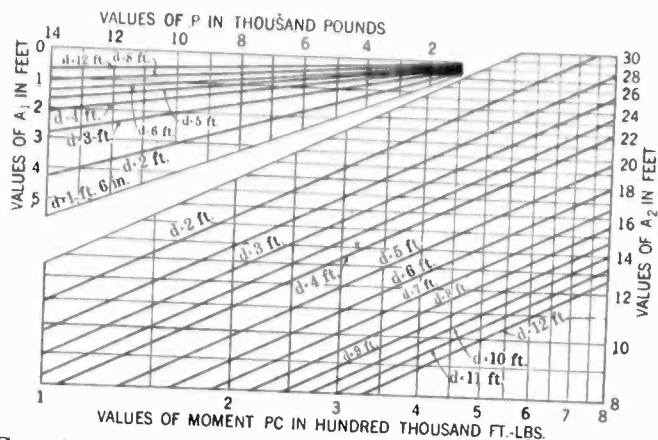

FIG. 4—CHART USED IN THE DESIGN OF SIDE-BEARING FOUNDATIONS

$$A = \frac{3P}{\delta d} + \sqrt{\frac{12PC}{\delta d}} = A_1 + A_2 \quad A_1 = \frac{3P}{\delta d} \quad A_2 = \sqrt{\frac{12PC}{\delta d}}$$

Earth pressure $\delta = 5000$ lb./sq. ft.

by reference to the chart shown in Fig. 5. In addition to the determination of the bearing pressure under the footing, these foundations were checked against overturning, using a factor of $1\frac{1}{2}$.

In staking out the foundations for construction, two stakes were set on each center line and grade was referenced from the top of an adjacent tie. The concrete was poured from a mixing plant mounted on flat cars and handled in a work train. An inspector

supervised all operations of the concrete pouring outfit which placed as much as 140 cu. yd. per eight-hr. day where traffic conditions were favorable to the use of the track.

CATENARY STRUCTURES

The catenary structures for the suburban electri-

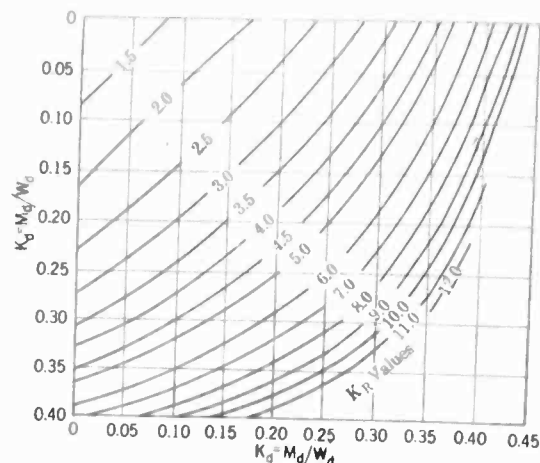

FIG. 5—CHART USED IN THE DESIGN OF GRAVITY FOUNDATIONS CURVES GIVE VALUES OF MULTIPLIER K_R

Reduce moments to equivalent moments at base of pier.
 M_d = moment due to force P_d ft = lb.
 M_b = moment due to force P_b ft = lb.
 W = total vertical load at base of pier, lb.
 b = width of pier ft.
 d = length of pier ft.
 Moments in Two Directions.—Read K_R at intersection of K_b and K_d
 Moments in One Direction.—Read K_R in the same manner as described above except that either K_d or K_b is zero.

$$\text{Maximum Toe Pressure} = \frac{W}{bd} K_R \text{ lb. per sq. ft.}$$

fication were designed so as to permit extensions to include the remainder of the right-of-way. In some instances this means an ultimate structure of 200 ft. or more in length, made up of several spans. A reference to Fig. 1 will show the suburban catenary structures in heavy line, proposed extension to the east for

TABLE I
LOADING OF CATENARY SYSTEM

Loadings of each Catenary System are shown in the following table:

	Equiv. Conductivity cir. mils	Tension still air at 60 deg. fahr.	Tension at 0 deg. fahr. Ice and wind	Factor of safety	Dead weight	Dead weight with ice	Hori-zontal wind load. No ice 20 lb. wind	Hori-zontal wind load with ice 8 lb. wind
Suburban catenary system 70th-North								
0.81-in. diameter composite messenger.....	370,000	7,750 lb.	12,350† lb.	2.55	1.51	2.32	1.35	1.21
0.512-in. diameter. Copper aux. messenger.....	200,000	800	1,555	5.82	0.61	1.25	0.85	1.01
Two 3/0, 80 per cent conductivity. Bronze trolley wire Hangers.....	268,900	4000	7,020	2.85	1.02	2.20	1.08	1.43*
Total.....	838,900	12,550	20,925	..	0.11	0.22	0.14	0.13
Suburban catenary system 70th-South, So. Chicago and B. I. R. Rs.								
0.81-in. diameter composite messenger.....	370,000	7,720 lb.	12,325 lb.*	2.55	1.51	2.32	1.35	1.21
0.375-in. diameter aux. messenger.....	105,500	800 lb.	1,555 lb.	3.55	0.32	0.87	0.63	0.92
wo 4/0 hard-drawn copper grooved trolley wires.....	423,200	4,000 lb.	7,020 lb.	2.2	1.28	2.51	1.21*	1.48*
Hangers.....	0.15	0.27	0.18	0.15
Total.....	898,700	12,520 lb.	20,900 lb.	..	3.26	5.97	3.37	3.76

NOTE. *Wind on double trolley wires figures at one and one-half times the wind on one wire.
 †Wind on messenger and one-half wind on hangers assumed as acting at point of support of messenger, remaining wind on catenary system assumed as acting at steady wire.

through passenger and freight tracks, and further extensions to the east and west, shown in dotted lines, to include the entire right-of-way which at this point has

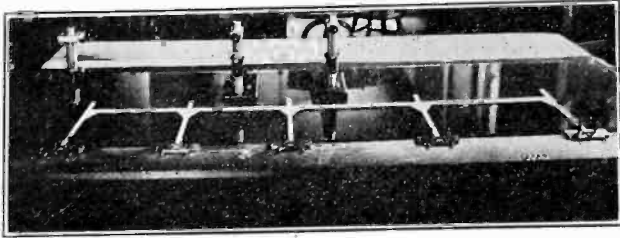

FIG. 6—BEGGS' APPARATUS AS APPLIED TO THE MODEL OF A 5-COLUMN STRUCTURE

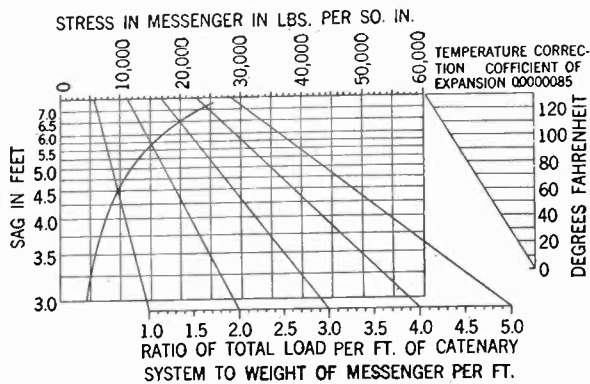

FIG. 7—MAIN MESSENGER DEFLECTION CURVE

a width of 250 ft. This provision necessitated calculations of the stresses in the complete structure and a check of the stresses in the initial structure. To reduce

the labor and time required for such troublesome calculations, it was decided to adopt the Beggs method for the mechanical determination of statically indeterminate stresses. This method proved very satisfactory and greatly facilitated the work. Fig. 6 shows an application of the Beggs apparatus to a five column structure.

The structures were erected, painted and the base plates grouted by the railroad forces, very expeditiously and with little interruption to the regular traffic.

CATENARY SYSTEM

Table I shows the loadings of the catenary system and Fig. 7 shows a very convenient and easily workable chart for a determination of the tensions and sags in the messenger for any assumed condition of temperature or loading. The curves shown on Fig. 12 were prepared from this chart.²

About the time when the make-up of the catenary system was being considered, the General Electric Company was carrying out some tests of double trolley wire construction at Erie, Pennsylvania. Illinois Central representatives were invited to witness some of these tests and were favorably impressed with the practically arcless collection of heavy current at high speed, and shortly the decision was reached to adopt the double trolley system. At the same time it was decided not to use parallel feeders but to equip each track with a catenary system of sufficient current-carrying capacity to keep the voltage drop within the prescribed limit,

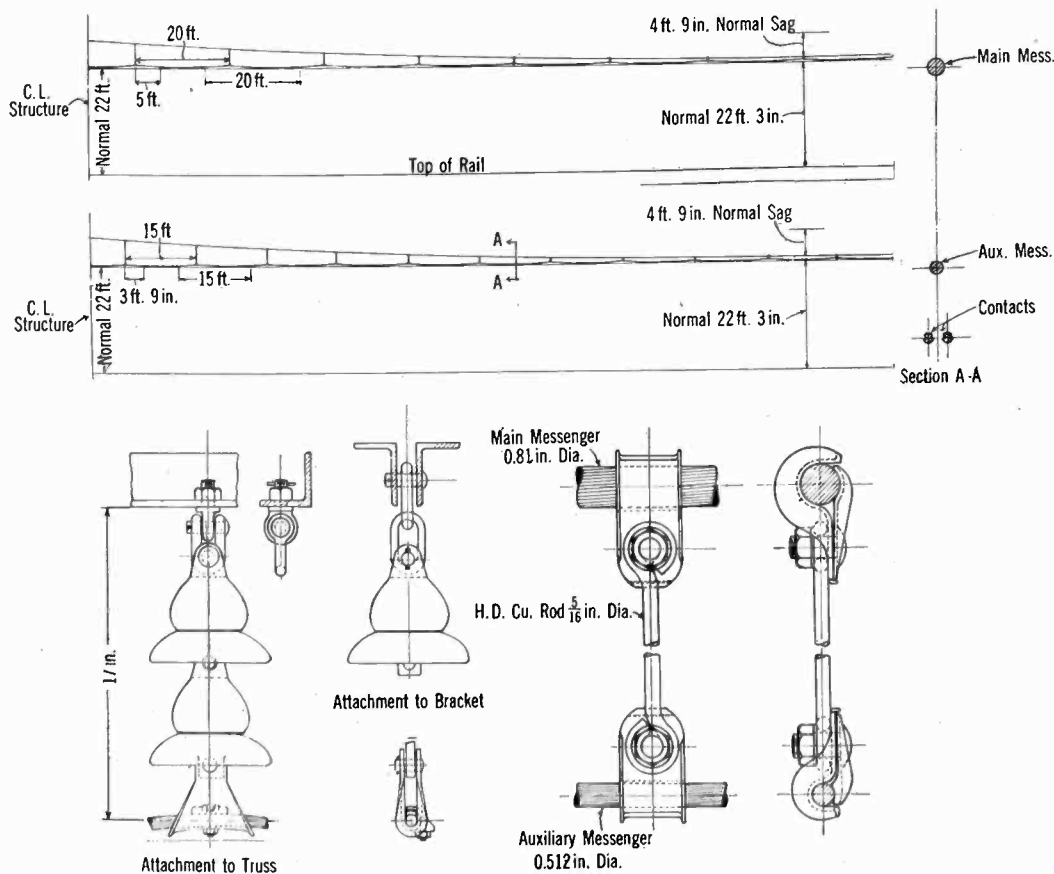

FIG. 8—MAIN LINE CATENARY SYSTEM

2. The method of constructing this chart was published in the A. E. R. A. *Proceedings* for 1925.

when normally in parallel with other tracks at sub- and tie-stations.

After these decisions were made it was a simple matter to select the main and auxiliary messengers to make up an adequate catenary system. Fig. 8 shows the main line catenary assembly. On the main line 4/0 copper trolley wires were used south of 70th Street and on the South Chicago Railroad and the Blue Island Railroad. Bronze trolley wires were selected for use north of 70th Street where the traffic is most dense. To compensate for the lower conductivity of the 3/0 bronze as com-

The auxiliary messenger is made up of 19 strands of hard-drawn copper and has a normal tension of 800 lb. which gives a little sag between hangers and increases the flexibility of the trolley wire supporting structure.

The catenary hangers are simple, consisting of bronze clamps for main and auxiliary messenger connected with a 5/16-in. diameter hard-drawn copper rod with an eye in each end. To simplify the determination of the hanger lengths and to aid in the spacing of the hangers in the field, a diagram was prepared to divide the span lengths into four series. Fig. 9 shows the arrangement for the system having a normal hanger spacing of 15 ft. This diagram was laid out on a tabletop to full vertical scale and to 1/4 in. equaling one foot horizontal scale. The eye-to-eye lengths of the hangers were measured from points on the curve to a line representing the normal position of the eye of the hangers. In cases

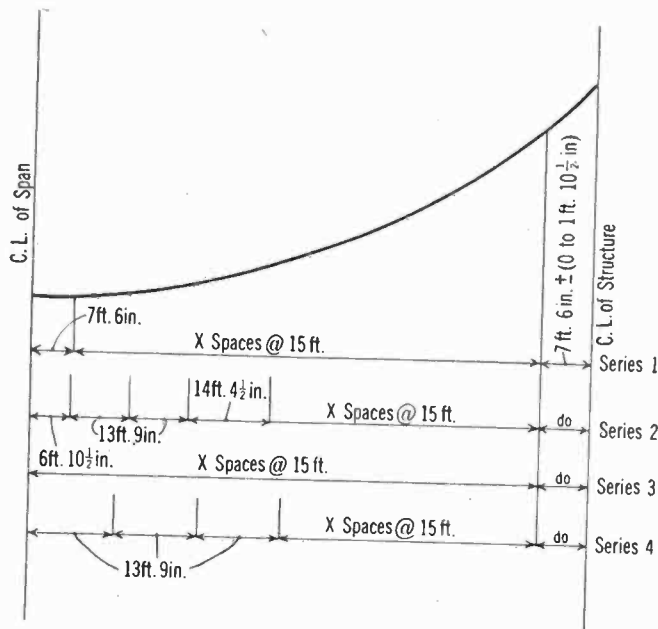

FIG. 9—CATENARY HANGER CHART

pared with the 4/0 copper trolley wires, the auxiliary messenger was increased in size. A 0.375-in. auxiliary was used with the 4/0 trolley and a 0.512-in. auxiliary with the 3/0 trolley.

The main messenger cable is of composite construction made up of seven Copperweld wires forming the core around which are stranded 12 hard-drawn copper wires. This cable is 0.81 in. in diameter and has an ultimate strength of 31,500 lb., which allows a sag of 4 ft., 9 in. in a 300-ft. span at 60 deg. Fahr., giving a factor of safety of 2 1/2 under the maximum assumed loading of the system.

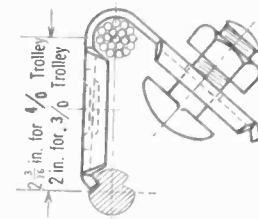

FIG. 10—TROLLEY WIRE CLIP

where the position, with reference to the messenger, of the trolley wires is other than normal, a straight edge was adjusted to represent this change and the hanger lengths measured to it. The clips between the auxiliary messenger and the trolley wire are unique in that they are formed of one piece of stock as shown in Fig. 10. The manufacturer delivered these clips with the T-head bolts and nuts assembled as shown.

Double insulation to ground was used throughout, the standard suspension unit being two seven-in.-disk, 8000-lb., M. & E., cap and pin insulators attached to the structure by means of either a galvanized eye-bolt-and-clevis or a double-link, depending upon the type of structure to which the attachment was made.

The suspension or saddle clamp is U-shaped to which the messenger is clamped by means of one J-bolt and keeper. Tests made on this clamp showed that the

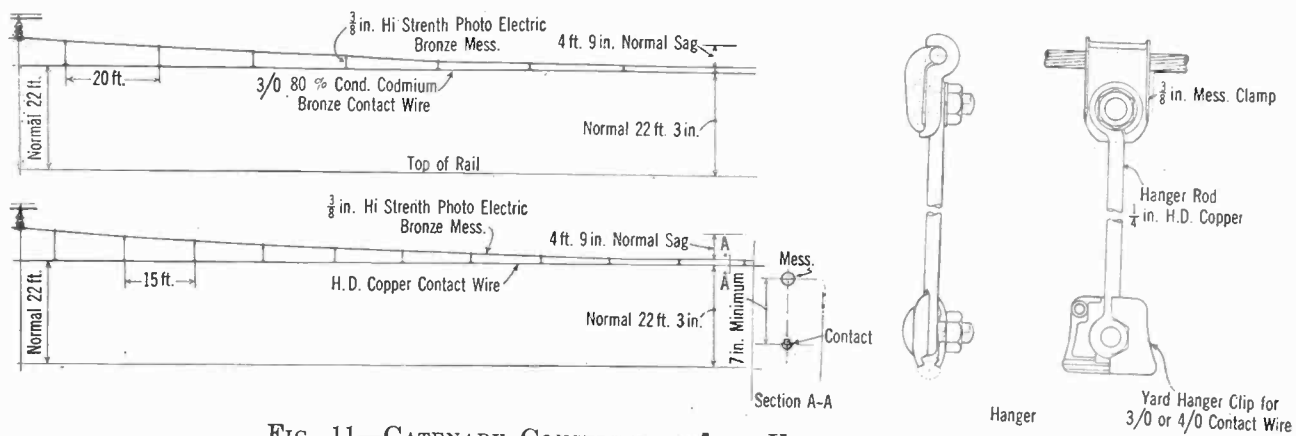

FIG. 11—CATENARY CONSTRUCTION FOR YARDS AND SIDINGS

messenger would slip at an unbalanced tension of about 1000 lb. In the structure design, a broken wire load of

The fittings used for splicing and terminating the main messenger were developed after considerable experimenting and testing. These fittings consist of a combined chuck and poured socket so arranged that the the poured zinc button will follow against and keep tight the cone-shaped chuck. These fittings will develop the full rated strength of the composite messenger cable.

The seven-in-disk insulators used for suspension were also used in steady- and pull-off-strand construction to insulate from structure and to insulate separate sections.

For terminating the main line catenary system a very sturdy type of double strain insulator was used, one set for the main messenger and one set for the two trolley wires and auxiliary messenger combined.

The yard construction is shown on Fig. 11. Only a single trolley wire of either 3/0 or 4/0 gage was used. All yard catenary was supported from steel structures except Weldon Yard where some cross-span construction was used.

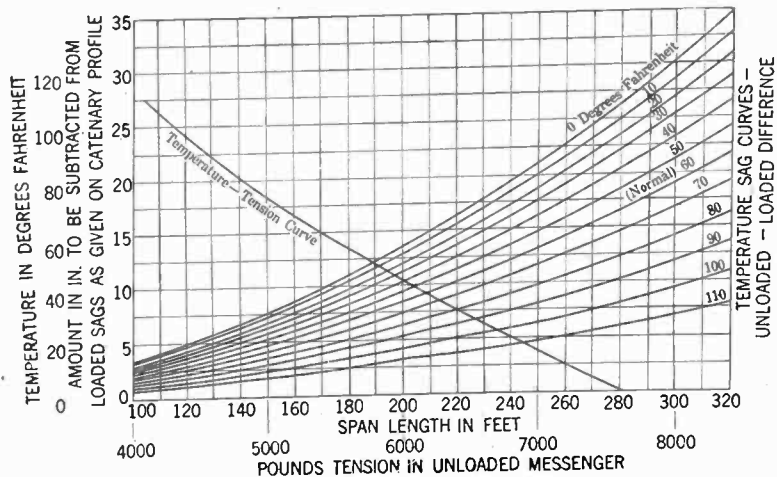

FIG. 12—TEMPERATURE—SAG CURVE

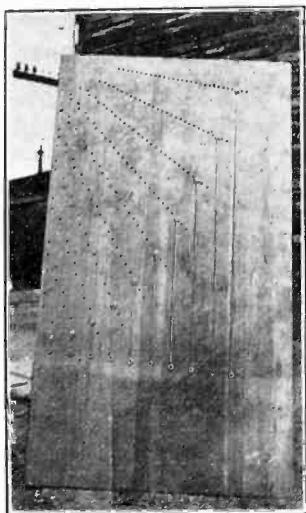

FIG. 13—HANGER BOARD WITH HALF SPAN OF HANGERS CUT TO LENGTH

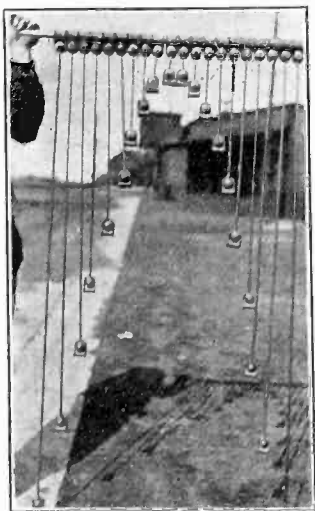

FIG. 14—COMPLETE SPAN OF HANGERS ASSEMBLED ON PIPE

1000 lb. was allowed for. This broken wire load was figured for only one track per structure.

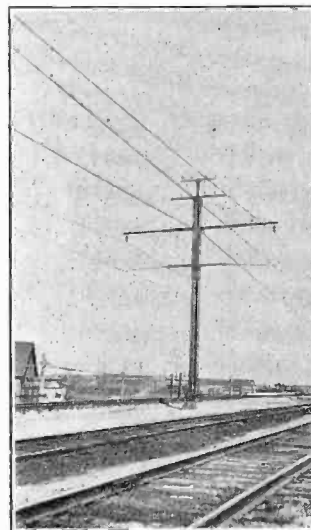

FIG. 15—TYPICAL 2-TRACK BRACKET CONSTRUCTION

CATENARY CONSTRUCTION

All of the wires were strung and the remainder of the main line work practically completed from work trains. The yard work, except wire stringing, was completed from push-tower-car and ladders. The heavy equipment for construction consisted of reel cars with special shafts and brake rigging, tower cars with winch operated platforms adjustable from 15 ft., 6 in. to 19 ft., 6 in. above top of rail, and box cars fitted with work benches, shelves and bins for tool cars.

The typical train for wire stringing consisted of a locomotive, reel car, tool car, and one or more tower cars. Only one main messenger was strung at a time, but the auxiliary messenger and the two trolley wires were strung together. The main messenger was tensioned by means of a sight rod and surveyor's level. The auxiliary messenger and trolley wires were tensioned with a dynamometer. These wires were all erected and tensioned in roller bearing rollers, the

proper sag for the main messenger being determined from curves shown in Fig. 12.

The hanger chart described above was used in the material depot to check the length of the hangers as they were assembled on a piece of $\frac{1}{2}$ -in. pipe, three ft. long. After the hangers were assembled on the pipe, a linen tag was attached showing the location of the span and the series number of the hanger. See Figs. 13 and 14.

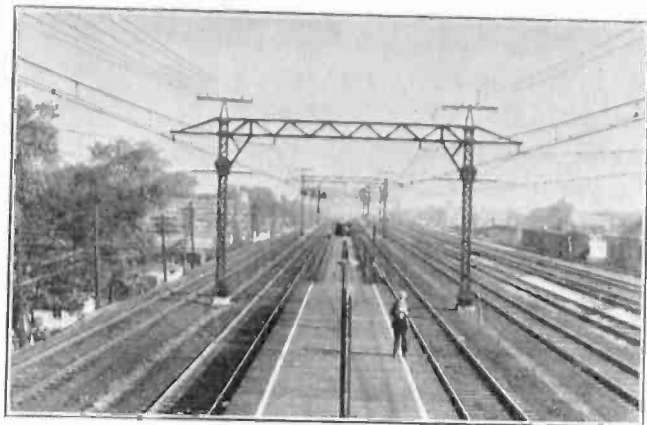

FIG. 16—TYPICAL 4-TRACK CONSTRUCTION

In erecting the hangers, the contractor used a steel tape, one side of which was marked in span lengths and the other marked with the recurring figures 1 to 4 inclusive, representing the four series of spacings. These figures were spaced as on the hanger board, but to full scale. This tape was stretched alongside the messenger, adjusted to the span, and the hangers were placed opposite the series figure.

MAINTENANCE

The maintenance of the catenary system is handled by the Maintenance of Way Department, using one 1-ton and one $1\frac{1}{4}$ -ton motor trucks equipped with special bodies for hand tools, supplies and ladders. These trucks are used for all light repair work as it is possible to approach the right-of-way in the electrified zone on paved or hard surface streets or roads. For heavy repair work two construction trains, each consisting of reel, tool and tower car, are located at points on the terminal where a steam locomotive is readily available.

Soon after the start of the electric operation, trouble was experienced due to the pantographs striking the insulators which form part of the air-gap construction and either damaging the gap or so damaging the pantograph as to result in line trouble elsewhere. During the severe cold weather, some trouble was caused by failure of faulty fittings or by poor workmanship and to pantographs fouling the steady arms. The latter trouble was due to the fact that the trolley wires, at very low temperatures, lifted higher at the structures than was anticipated.

Main line construction was sectionalized by means of air-gaps, but wood section insulators were used in cross-overs where high speed is not attained. These insulators were originally equipped with two bronze

gliders to give continuous feed. It was later found desirable, however, to install four gliders, two on each side of the wood stick to prevent the insulator rocking when the pantograph passed.

Occasionally the gliders of a wood section insulator

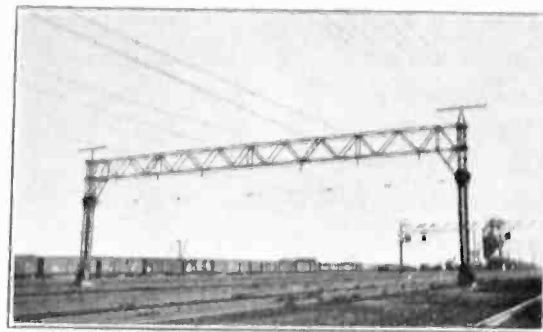

FIG. 17—TYPICAL 6-TRACK CONSTRUCTION

will burn in two when a pantograph bridges a live and a grounded section, and on two occasions a trolley wire has burned in two at an air-gap due to the same cause.

The chief troubles were mentioned above and there have been minor failures but on the whole the operation has been highly satisfactory.

CORRESPONDENCE

CALCULATION OF HIGH-VOLTAGE TRANSMISSION LINES

To the Editor:

It was with great interest that I read the article on *The Circle Diagram of a Transmission Network*, by F. E. Terman, in the December, 1927 issue of your JOURNAL. In the year 1923, I made an extensive study regarding transmission phenomena. The investigation was utilized by the "Elektrizitätsaktiengesellschaft formerly W. Lahmeyer & Co.", Frankfurt-on-the-Main, Germany, for the purpose of planning and calculating the first German 220-kv. transmission (approximately 300 miles). In the meantime the line has been completed, parts of which are now provisionally operating at 110 kv.

Above all, I would point out that there is not the least doubt regarding the independence of Mr. Terman's investigation. Mr. Terman arrives in a quite different manner at his formulas which apparently are so different from mine, that at first sight it is impossible to recognize any resemblance. There is, however, such a complete conformity that one can, step by step, mutually "translate" the formulas of both researches—an interesting example of how to arrive at the same results by different ways.

I have compiled my researches in a book which will be published, by Springer, Berlin, under the title "Theorie der Wechselstromübertragung (Fernleitung und Umspannung)"—"Theory of A-c. Transmission (Long-Distance Conducting and Transforming.)"

HANS GRUNHOLZ,
Charlottenburg, Germany,

March 3, 1927

A 10-Kw. 20,000-Cycle Alternator

BY M. C. SPENCER¹

Synopsis.—This paper briefly discusses the advantages and limitations of the inductor and reaction types of alternators when designed for generating alternating currents of very high frequency. A new design for a reaction type alternator is described in which some of the limitations of the usual type of reaction alternator have been overcome in a way which enables such alternators to be designed for a higher frequency and greater output. The complete specification

of a 10-kw., 20,000-cycle alternator of the new type are given and its operating characteristics, as determined by test, shown by a series of curves. A method is developed by means of which the various losses in the alternator may be separated and the complete operating characteristics of the alternator under any condition of load predetermined from the no-load tests.

* * * * *

IN attempting to design alternators of the usual type for very high frequencies, it is found that the difficulties encountered increase rapidly with the frequency. Alternators of the ordinary inductor type can readily be designed for a frequency of 500 cycles per sec. A moderate increase in frequency above this value can be obtained by increasing the peripheral velocity of the rotor up to the maximum safe limit. Any further increase in frequency requires an increase in the number of rotor poles and stator slots, which so decreases the size of the slots and the amount of copper which can be placed in them that the output of the alternator is reduced.

The general construction of the inductor type alternator is shown in Fig. 1A. At the instant shown, the rotor teeth line up with the stator teeth which are enclosed by the stator armature coils. The magnetic flux set up by the field winding (not shown) passes from the stator core into the rotor core through the stator armature coils. An instant later, when the rotor has moved ahead one-half a rotor slot pitch, the rotor teeth line up with the stator teeth which are between the stator coils. The magnetic flux passing through the stator coils is then a minimum. This pulsation of the magnetic flux, passing through the armature coils as

remains practically constant and merely shifts back and forth from one stator tooth to the next.

A somewhat higher frequency can be obtained with the reaction or variable reluctance type of alternator as this type requires only one-half as many stator slots as the inductor type. The general construction of the reaction type of alternator is shown in Fig. 1B. At the instant shown, the rotor teeth line up with the

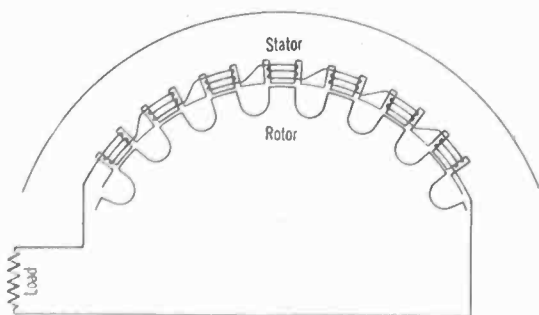

FIG. 1A—INDUCTOR TYPE ALTERNATOR

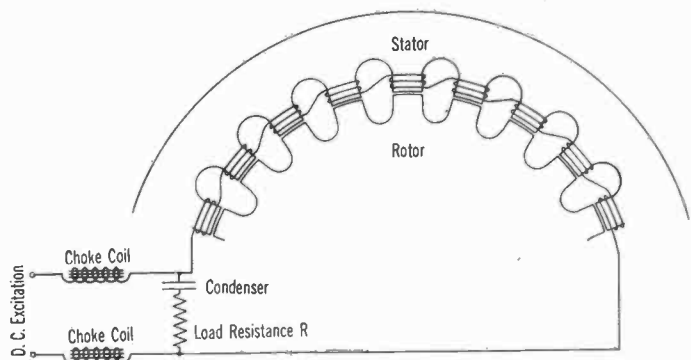

FIG. 1B—REACTION TYPE ALTERNATOR

stator teeth and the magnetic flux set up by the direct current flowing through the stator coils is a maximum. An instant later, when the rotor has moved ahead one-half a rotor slot pitch, the rotor teeth line up with the stator slots and the magnetic flux is a minimum. This pulsation of the magnetic flux through the stator coils generates in them an alternating electromotive force which is superimposed on the d-c. excitation voltage. This alternating electromotive force is prevented from sending current back through the excitation lines by means of choke coils and is made use of to cause high-frequency current to flow through the load resistance through a condenser, as shown. The magnetic flux in the reaction type of alternator pulsates through the entire magnetic structure as the rotor revolves and does not simply shift back and forth from one stator tooth to another as in the case of the inductor type alternator. The reaction type of high-frequency alternator requires but a single stator winding, as the same winding can be made to serve both as a field winding and as an armature winding by inserting choke coils in the excitation circuit. The output of the high-frequency type of reaction alternator is, however, relatively small, due not only to the small amount of copper which it is

the rotor revolves, generates in them a high-frequency, alternating, electromotive force. The total magnetic flux passing through the field structure and from the stator core to the rotor core of such an alternator

¹ Electrical Engineer, Crocker-Wheeler Electric Mfg. Co., Ampere, N. J.

possible to place in the narrow stator slots, but also to the fact that this copper must carry not only the load current but also the excitation current.

It has been found possible, however, to overcome the principal limitations of the reaction type of alternator and greatly increase its output by a type of construction shown in Fig. 1c. Instead of placing a stator coil

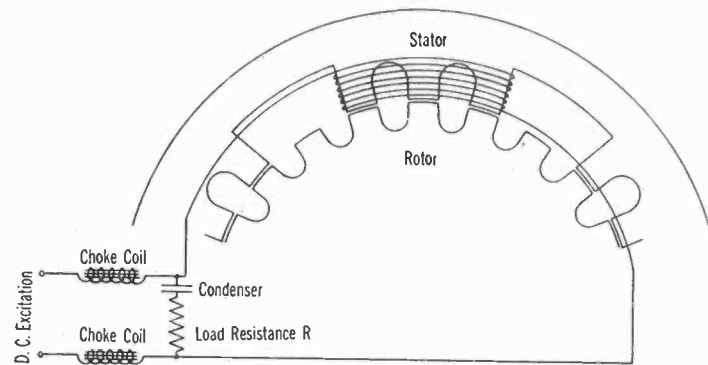

FIG. 1c—IMPROVED REACTION TYPE ALTERNATOR

around each of the stator teeth, as is done in the case of the usual type of reaction alternator, a single stator coil is placed around a whole group of stator teeth. Plenty of space is provided for the stator coils by cutting away groups of stator teeth at equally spaced intervals around the stator core as indicated in Fig. 1c and Fig. 2. By this means the number of stator coils is greatly reduced and the size of the conductor increased so that

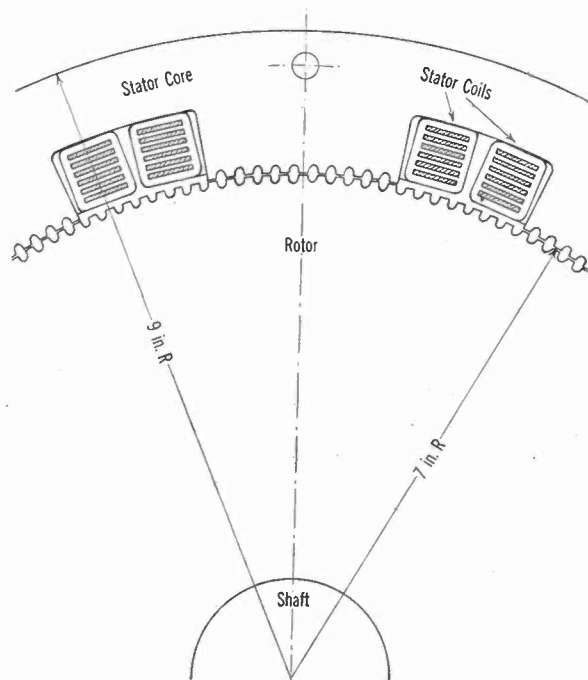

FIG. 2—SECTIONAL VIEW OF ALTERNATOR

the output of the alternator is no longer limited by the current carrying capacity of the stator winding.

The principle of operation of this type of alternator is evident from Fig. 1c. Direct-current for the excitation of the alternator is passed through the stator coils and sets up a magnetic flux the magnitude of which depends upon the reluctance of the magnetic circuit.

At the instant shown in Fig. 1c, the rotor teeth line up with the stator teeth, the reluctance of the magnetic circuit is a minimum, and the flux passing through the stator coils is a maximum. A moment later when the rotor has moved into a position where the rotor teeth line up with the stator slots, the reluctance of the magnetic circuit is a maximum and the magnetic flux a minimum. This pulsation of the magnetic flux passing through the stator coils as the rotor revolves generates in these coils in an alternating electromotive force having a frequency depending upon the number of teeth on the rotor and its speed of rotation only and is not in any way dependent upon the span of the stator coils. This construction makes it possible to provide for any desired amount of winding space without in any way affecting the frequency of the current generated.

SPECIFICATIONS OF 10-KW. ALTERNATOR

In order to determine the actual operating characteristics of an alternator of this type, an experimental alternator designed for an output of 10 kw. was built and tested. The general specifications for this alternator were as follows:

10 kw., 20,000 cycles, single-phase, 6670 rev. per min. Principal dimensions:

Frame $20\frac{3}{4}$ in. outside diameter, $6\frac{1}{4}$ in. frame length. Stator core, 18 in. outside diameter, 14 in. inside diameter, $1\frac{5}{8}$ in. core length. Single air-gap 0.025 in.

The stator frame was provided with a hollow section through which cooling water could be circulated while the alternator was in operation. Water cooling was made necessary by the high core loss due to the high frequency of the flux pulsations.

The rotor core was built up of very thin steel laminations with 180 slots cut in its periphery, thus leaving 180 teeth or pole projections. The stator core was also built up of thin steel laminations. The 180 slots, having approximately the same dimensions as the slots in the rotor core, were cut in the stator core, leaving 180 teeth corresponding to the 180 teeth on the rotor. At ten equally spaced points groups of seven teeth were cut away to provide room for the stator winding.

The stator winding consisted of ten coils each having six turns of flat copper strip wound on edge. A coil was placed around each one of the ten groups of stator teeth. These ten coils were connected in series in the same manner as the ten field coils of an ordinary ten-pole d-c. generator. These coils constituted the only winding in the alternator and served both as a field winding for exciting the alternator and as an armature winding for collecting the alternating current generated by the alternator. This double use of the single winding makes particularly effective use of the copper as, due to skin-effect, the alternating component of the stator current is confined more or less to the surface of the conductor while the direct current, or non-pulsating component of the current, makes

effective use of the copper in the center of the conductor. Thus the effective a-c. resistance of the stator winding is low, due to the relatively large surface of the conductor and is obtained without the complication and expense of stranding the conductor.

CIRCUIT CONNECTIONS AND METHOD OF OPERATION

Direct current for excitation is passed into the alternator to its single winding, through two choke coils as indicated in Fig. 3. This current sets up a magnetic

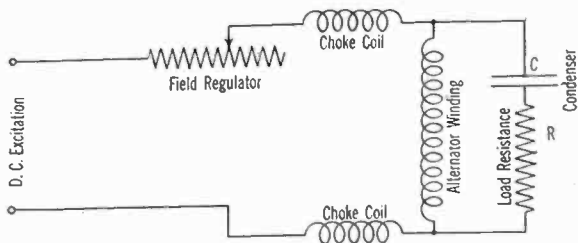

FIG. 3—CONNECTION DIAGRAM

flux in the alternator similar to the magnetic flux in a ten-pole d-c. generator. As the rotor revolves, the rotor teeth cause a pulsation in this flux, which generates an electromotive force in the stator coils. This electromotive force goes through a complete cycle every time the rotor moves one rotor tooth pitch. Therefore, since there are 180 rotor teeth, the generated electromotive force goes through 180 complete cycles for each revolution of the rotor or the frequency of the current generated at 6670 rev. per min. is 20,000 cycles per second.

The load circuit, represented by the resistance, *R*, (Fig. 3), is connected to the terminals of the stator winding through a condenser as indicated. This condenser serves two purposes; in the first place, it prevents direct current from the excitation mains from passing through the load circuit, and in the second place, it serves to neutralize the self-inductance of the alternator winding and thus render available for the external load nearly the full internal generated voltage of the alternator. The high-frequency current generated by the alternator is prevented from passing back through the d-c. excitation mains by the two choke coils which are connected in these lines.

OPERATING CHARACTERISTICS AS DETERMINED BY TEST

The characteristics of this alternator when operating on a non-inductive load of 57.4 ohms are as shown by the curves of Fig. 4. The data for these curves was taken after the alternator had been operated at an output of 10 kw. for a sufficient length of time for it to assume a constant temperature. The non-inductive load resistance was located in the circuit as shown in Fig. 3 by the resistance *R*. The capacity *C* (Fig. 3) had a value of 0.0782 microfarad. This value of capacity was selected as being the value required to neutralize the self-inductance of the alternator winding and thus adjust the

power factor of the complete circuit to unity with a current of from 10 to 15 amperes flowing. The exact value of capacity required varies somewhat with the current. This value was taken as a fair average value.

As seen from the output curve of Fig. 4, this alternator had a maximum output of about 15.4 kw. when operating on a load resistance of 57.4 ohms. It might be stated here, (although it will be shown by actual tests later), that, up to a certain point, the maximum output of an alternator of this type increases as the load resistance decreases although at the same time the efficiency decreases. The value of the effective load resistance to be selected in any particular case is therefore a compromise between high maximum output and high efficiency. This value of 57.4 ohms was selected as giving a reasonable overload capacity (50 per cent) and a fair value of efficiency, at the rated load of 10 kw., of 65.3 per cent.

As measured by thermometer immediately after shutdown, after a run of about one hour by which time the alternator had attained a constant temperature, the temperature rise of this alternator, when operated at an output of 10 kw. on a load resistance of 57.4 ohms, was as follows: rotor 65.5 deg. cent., stator winding 47 deg. cent. and stator core 36.5 deg. cent.

EXCITATION

The efficiency values given in this paper do not

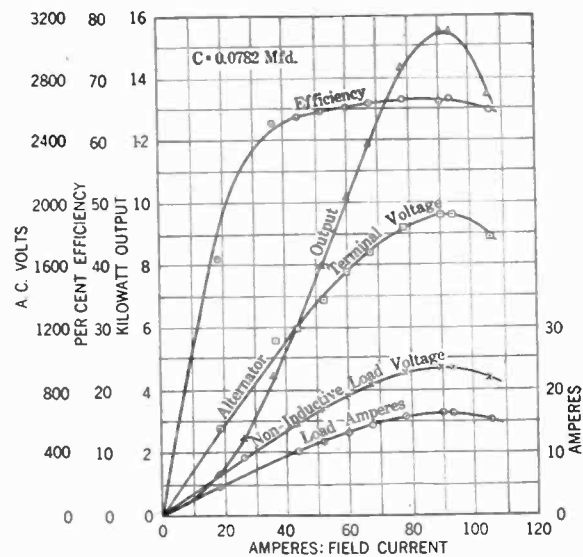

FIG. 4—CHARACTERISTICS WITH A NON-INDUCTIVE LOAD RESISTANCE OF 57.4 OHMS, WITH ALTERNATOR HOT

include the power required for excitation. The reason for this is that the power required depends almost entirely upon the amount of copper in the choke coils placed in the excitation lines. The resistance of the alternator winding was 0.025 ohms at the full load operating temperature. The normal field current, as indicated by the curves of Fig. 4, was 60 amperes, therefore, the actual power required for excitation, exclusive of the power lost in the choke coils, was only $(60)^2 \times 0.025 = 90$ watts.

MAXIMUM OUTPUT

From the curve of Fig. 4, it is seen that when the field current of this alternator is increased beyond a certain value, the output actually decreases. This is caused by a decrease in the generated voltage of the alternator due to the relative increase in the leakage flux between the teeth as the teeth begin to saturate. A no-load

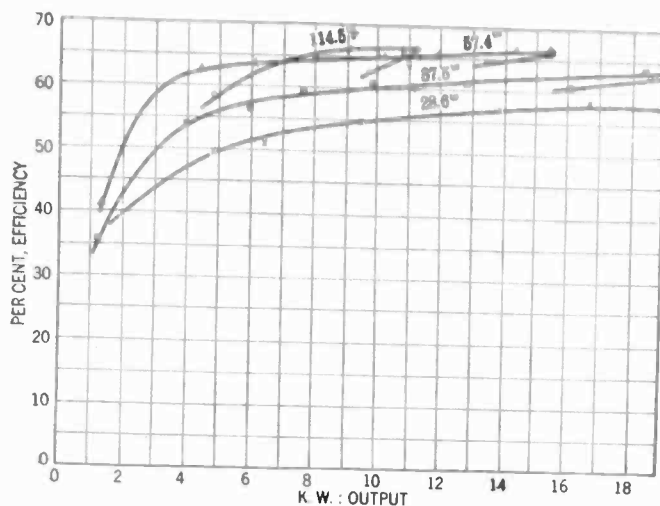

FIG. 5—VARIATION OF EFFICIENCY (EXCLUSIVE OF POWER REQUIRED FOR EXCITATION) WITH OUTPUT AND LOAD RESISTANCE

saturation curve would have a similar shape and show this same decrease in voltage at the higher field currents.

EFFECT OF LOAD RESISTANCE ON EFFICIENCY AND MAXIMUM OUTPUT

The curves of Fig. 5 show that at least up to a certain point the efficiency increases as the load resistance

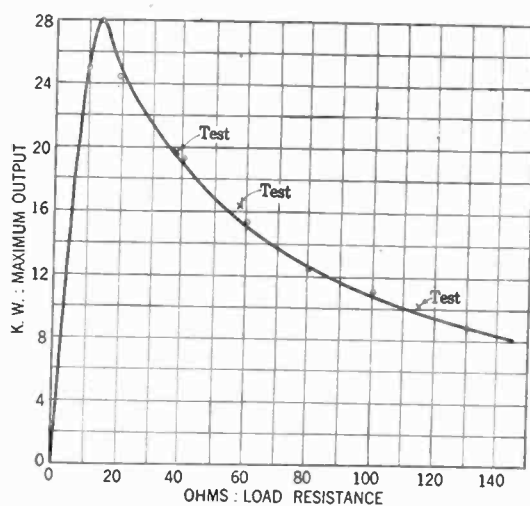

FIG. 6—VARIATION OF MAXIMUM POSSIBLE OUTPUT WITH LOAD RESISTANCE

increases. Data for these curves were obtained by gradually increasing the field current up to, and then somewhat beyond, the field strength which gave maximum output for each particular value of load resistance. It is evident from these curves that high efficiency obtained by means of high load resistance is obtained at

the expense of high maximum output; that is, at the expense of overload capacity.

The effect of the value of the load resistance on the maximum output is perhaps best seen from the curve of Fig. 6. Three points, as indicated on this curve, were obtained by actual tests by adjusting the field current to give maximum output. Too strong a field current, as explained above, actually reduces the generated voltage and therefore the output. Other points on this curve were obtained by calculation by a method to be explained later in this paper.

The characteristics of this alternator over a wide range in load resistances is of particular interest in connection with the possible use of this type of alternator as a source of power for electric furnaces of the induction type. The effective resistance of such a furnace load varies greatly with the nature and quantity of the material in the furnace. The curves of Fig. 7

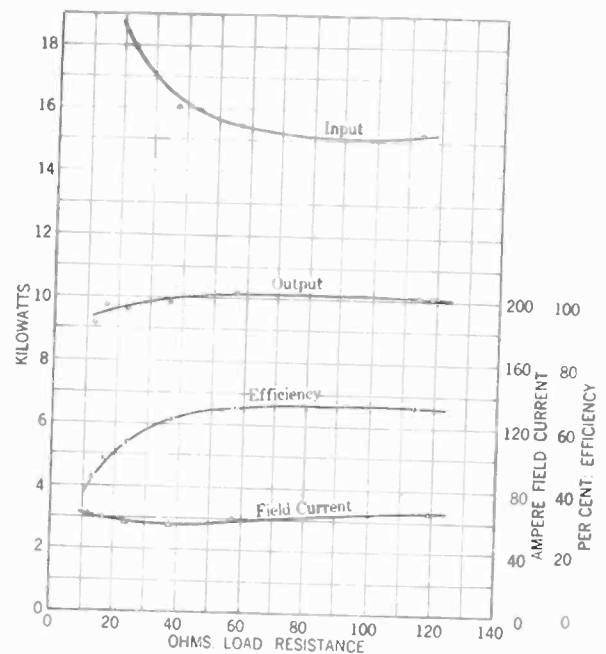

FIG. 7—CURVES SHOWING THE POSSIBILITY OF OPERATING AT CONSTANT OUTPUT OVER A WIDE RANGE IN LOAD RESISTANCE BY ADJUSTING THE FIELD CURRENT.

indicate that by adjusting the field current it is possible to maintain the output of the alternator constant at about 10 kw. over a range in effective load resistance from 12 to about 120 ohms. The curves of Fig. 8 were obtained under conditions similar to those for Fig. 7 except that the field current was held constant at 50.2 amperes.

SEPARATION OF LOSSES

Windage and Friction. The windage and friction loss for this alternator, as determined by the same method used for the standard type of alternators, was found to be 1400 watts at its normal speed of 6670 rev. per min.

Copper Loss. The resistance of the stator winding, with the alternator hot, was equal to 0.025 ohms, as measured with direct current. The copper losses

at normal load are therefore approximately as follows:

$$(60)^2 \times 0.025 = 90 \text{ watts loss due to field current,}$$

$$(13.2)^2 \times 0.025 = 4.4 \text{ watts loss due to load current.}$$

This simple method of determining the copper losses is, of course, not strictly correct as it does not take into account the increase in the effective resistance of the winding due to skin-effect at the high frequency of the load current or the fact that both excitation and load currents flow through the same winding. These losses are so small as compared with the core loss, however,

nished directly by the mechanical torque of the shaft. Hence, these losses do not affect the available voltage of the alternator or its maximum output. The energy for core loss c is supplied electrically in a manner somewhat similar to that of the core loss of a transformer. This core loss has the effect of increasing the effective resistance of the alternator winding, increasing the internal voltage drop and therefore decreases the available voltage and limits the maximum output of the alternator.

In a low-frequency alternator of the usual type the type c losses, or as they are usually called, the stray or load losses, are relatively small and in no way affect the rating of the alternator, which is determined by other considerations such as regulation, as determined mainly by the reactance of the winding, and the heating rather than by the maximum possible output. In the case of a reaction type alternator, such as the one which is the subject of this paper, the rating is determined by the maximum possible output which is limited mainly by the type c core loss. As the inductance of the armature winding is neutralized by the capacity of the condenser in series with the load, it does not reduce the available voltage, as in the case of the usual type of low-frequency alternator. Also, any desired amount of space can readily be provided for the armature winding so that the rating of the alternator need not be limited by the heating of the winding.

In order to predetermine the characteristics of this type of alternator, it is necessary to find some means of separating core loss c from core losses a and b and of determining just what effect this core loss has on the available voltage of the alternator.

The combined core losses of types a and b can be obtained by the method used for determining the core

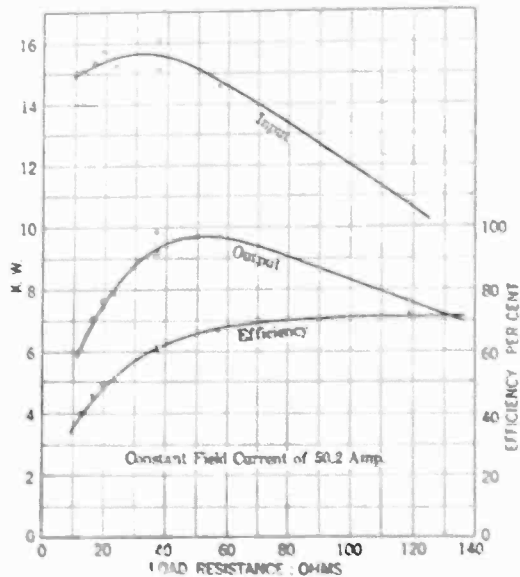

FIG. 8—CURVES SHOWING VARIATION IN INPUT, OUTPUT AND EFFICIENCY WITH CHANGE IN LOAD RESISTANCE WITH CONSTANT FIELD EXCITATION OF 50.2 AMPERES.

that for most practical work they may be neglected entirely.

Core Loss. The core loss in any high-frequency alternator is very large compared with that of a standard low-frequency alternator. Therefore in order to predetermine the operating characteristics of a high-frequency alternator, it is necessary to be able to determine the core loss with considerable accuracy. The methods usually used in determining the core loss of a low-frequency alternator do not give satisfactory results when applied to a high-frequency alternator when it is operated as a resonance alternator. The following method of determining the core loss has, however, been found to give satisfactory results.

The core loss of a high-frequency alternator of the reaction type may be divided into three parts as follows:

a. Core loss in the rotor due to its rotation in the non-pulsating or leakage portion of the magnetic flux set up by the d-c. field excitation.

b. Core loss in both rotor and stator cores due to the high-frequency pulsations in the magnetic flux caused by the rotation of the rotor teeth past the stator teeth.

c. Core loss in both rotor and stator cores caused by the circulation of the armature, or load current, through the stator winding.

The energy for supplying core losses a and b is fur-

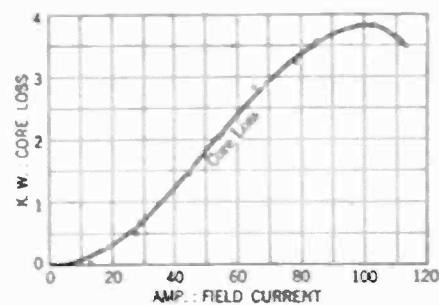

FIG. 9—COMBINED CORE LOSS OF TYPES A AND B

loss of the standard type of alternator by operating the alternator on open circuit and measuring the power required to drive it. Fig. 9 shows the combined core losses of types a and b for this alternator as a function of the field current. This curve shows a falling off in the core loss at the higher values of excitation due to the saturation of the rotor and stator teeth with the consequent reduction in the pulsations in the flux.

The core loss of type c can be obtained by short circuiting the alternator through a condenser and using

low field excitation. The value of the condenser should be such that its capacitive reactance is just equal to the self-inductive reactance of the alternator winding. The input to the alternator, under this condition, after deducting the windage and friction and $I^2 R$ loss, may, for most practical purposes, be taken as a measure of the type c core loss, corresponding to the particular value of alternating current which was flowing through the alternator. Under this condition, there is a small core loss of types a and b . This may be corrected for if desired but at the low excitation required for this short-circuit test, it is so small in comparison with the rest of the core loss that it usually need not be considered.

The core loss due to the armature current as determined by the above condenser method is shown in Fig. 10 as a function of the armature current. Since this core loss is a function of the armature current it is convenient in studying the operating characteristics of this alternator to consider this core loss as an increase in the effective resistance of the armature. The

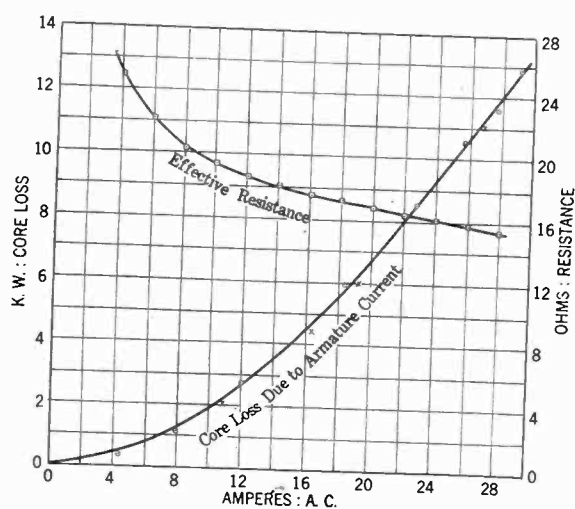

FIG. 10—CORE LOSS OF TYPE C

equivalent value of increase in resistance for any particular value of armature current is obtained by dividing the core loss in watts by the square of the armature current at which the loss was determined. The second curve of Fig. 10 shows the effective resistance, corresponding to the type c core loss, as a function of the armature current. This value of effective resistance is not constant but varies with the current due to magnetic saturation in the stator and rotor cores.

The total core loss for any given condition of operation might at first be thought to be the arithmetical sum of core losses of types a , b and c . Such, however, is not the case. The reason for this is that the pulsations in the core flux due to the armature current are out of phase; that is, out of time phase with the pulsations in the flux due to the rotation of the rotor teeth past the stator teeth. A study of the vector diagram for a reaction type alternator shows that the pulsations in the core flux due to the armature current are 90 deg. out of phase with the pulsations caused by the rotation of the rotor, when the alternator is operating as a reso-

nance alternator. Since these two forces tend to cause pulsations in the same flux the actual pulsations in the flux are proportional to their resultant. It is this resultant pulsation which causes the total core loss of the alternator. The core loss due to this resultant flux pulsation under load conditions may, with sufficient accuracy for most practical purposes, be obtained from the individual core losses by the following formula.

$$\text{Total core loss} = \sqrt{(a + b)^2 + c^2}$$

This formula is approximate only, as it depends upon the assumption that core losses vary directly with the flux density, while actually core losses vary as the 1.6 to 2.0 power of the flux density. Also it is not strictly correct to add core loss a to core loss b in the above formula. This is necessary, however, since it is not practical to separate core loss a from core loss b . In any case core loss a is very small in comparison with core loss b and its addition to core loss b does not introduce any serious error. This formula has been found to give reasonably good results in actual practice and has proved more satisfactory than the method, usually used in designing low-frequency, single-phase alternators, of arbitrarily using one-third or some other fixed percentage of the load loss as determined on a short-circuit test.

PREDETERMINATION OF OPERATING CHARACTERISTICS

The complete operating characteristics of an alternator of this type under any condition of load can be predetermined from the following data:

1. Windage and friction at operating speed.
2. Armature resistance at operating temperature.
3. No-load saturation curve.
4. Combined core losses of types a and b as a function of the field current.
5. Core loss of type c as a function of the load current.

In order to illustrate the method let it be required to determine the efficiency of this alternator when operating at an output of 10 kw. on a non-inductive load resistance of 57.4 ohms.

By substitution in the formula

$$W = I^2 R$$

$$10,000 = I^2 \times 57.4$$

$$I = 13.2 \text{ amperes load current.}$$

From Fig. 10 the core loss of type c , corresponding to a current of 13.2 amperes is found to be 3200 watts, and its effective resistance 18.3 ohms.

Assuming the alternator to be tuned to resonance by means of a series condenser, which is its normal condition of operation as a resonance alternator, the required total generated voltage will be equal to

$$(57.4 + 18.3) \times 13.2 = 992 \text{ volts}$$

(The very small armature resistance drop may be neglected.)

The field current corresponding to 992 volts should be obtained from the no-load saturation curve. As a voltmeter suitable for use at 20,000 cycles was not

available, a no-load saturation curve could not be taken for this alternator. For the purpose of illustration let it be assumed that such a curve indicated a value of 60 amperes.

With this value of field current of 60 amperes the sum of the core losses of types *a* and *b* is found to be 2420 watts from the curve of Fig. 9.

Hence the total effective core loss equals

$$\sqrt{(2420)^2 + (3200)^2} = 4020 \text{ watts.}$$

Armature copper loss = $(13.2)^2 \times 0.025 = 4.4$ watts which may be neglected.

Windage and friction = 1400 watts.

Hence

Windage and friction	=	1400	watts
Core loss	=	4020	"
Output	=	10000	"
<hr/>			
Input	=	15420	"
<hr/>			
Efficiency	=	$\frac{10000}{15420}$	= 64.8 per cent

The efficiency of this alternator when operating at 10 kw. output on a load resistance of 57.4 ohms, as determined by test by the input-output method was found to be 65.3 per cent.

The maximum output of the alternator when operating on any particular value of load resistance may

readily be determined by the cut-and-try method. A value of load current is found, by trial, which when multiplied by the sum of the load resistance and the effective resistance of the type *c* core loss for the same current, equals the maximum generated voltage of the alternator as indicated by the no-load saturation curve. This value of current squared and multiplied by the load resistance gives the value of the maximum possible output of the alternator when operating on this particular load resistance under resonance conditions. The maximum output curve of Fig. 6 was obtained by this method for outputs beyond the capacity of the driving motor used for the test. It is seen from Fig. 6 that values obtained by this method check very well with the values obtained by actual test. Therefore this is a good check on the method used to determine the effect of core loss of type *c* on the available voltage of the alternator.

CONCLUSIONS

The results of the tests made on this 10-kw. alternator seem to indicate that this improved type of reaction alternator is well suited for the generation of alternating currents of frequencies up to at least 20,000 cycles. The operating characteristics of this alternator are such as would seem to render it suitable as a source of power for high frequency induction type electric furnaces and other applications which require relatively large amounts of a-c. power at high frequencies.

Cab Signals for Railway Signaling

BY T. S. STEVENS¹

Synopsis.—There is described in this paper a system of continuous signals operating within the cab of a railway locomotive. This system was developed in an effort to provide more reliable and safer signals than the common semaphore or light signals. The

particular type of system is called the three-speed, continuous-control signal system. It has been adopted quite extensively by the Atchinson, Topeka and Santa Fe Railway System.

* * * * *

PROBABLY every signal engineer has worried about the difficulty of placing wayside signals on a railroad so that they can be seen and the indication properly read at a sufficient distance for proper control of the train. There are two forms of wayside signals; the semaphore and daylight light signal. The first displays its indications by a movable arm attached to a mast. The second displays its indications by colored lights which, by virtue of special lenses, can be seen in ordinary day light at sufficient distance. Particularly with semaphores, the question of background is very essential. It is not quite so essential in connection with light signals, but even with these devices it is often difficult to place signals on a crooked piece of track so that there will be sufficient view of

them. Fog is another agent which interferes to a great extent with a view of semaphores and with a view more or less of light signals; although in a fog, a light signal can be seen much the farther.

Then again any form of wayside signal is only intermittent in its indication. A train arrives at a signal which is displaying a certain indication. It passes it and the indication is lost except in the memory of the the engineman.

Thus, many years ago, we dreamed of the possibility of having a signal right ahead of the engine which would change under changing conditions or continuously display the same indication if the condition did not change. Much research work was accomplished and ultimately it was found possible, through means of practically wireless circuits, to provide a signal in the cab of the engine which would keep the engineman informed continuously of the condition ahead regardless of whether he was moving or standing still.

1. Signal Engineer, Atchinson, Topeka & Santa Fe Railway System.

Presented at the Regional Meeting of District No. 7 of the A. I. E. E., at Kansas City, Mo., March 17 and 18, 1927.

The type of cab signaling adopted by the Santa Fe is generally called *Three-speed continuous control*. It employs no wayside signals and all information is obtained from the signals in the engine cab.

Fig. 1 indicates a train proceeding along the track receiving a high-speed indication from the track ahead. Directly at the rear of the train, a zone of low-speed control is set up and just behind that, a zone of medium-speed control, so that a train following will receive a medium-speed indication and then a low-speed indica-



FIG. 1—AUTOMATIC TRAIN CONTROL

tion over sufficient length of track so that it can easily be brought to rest before getting within dangerously close proximity of the first train.

The three-speed, continuous control system necessarily requires the establishment of three different

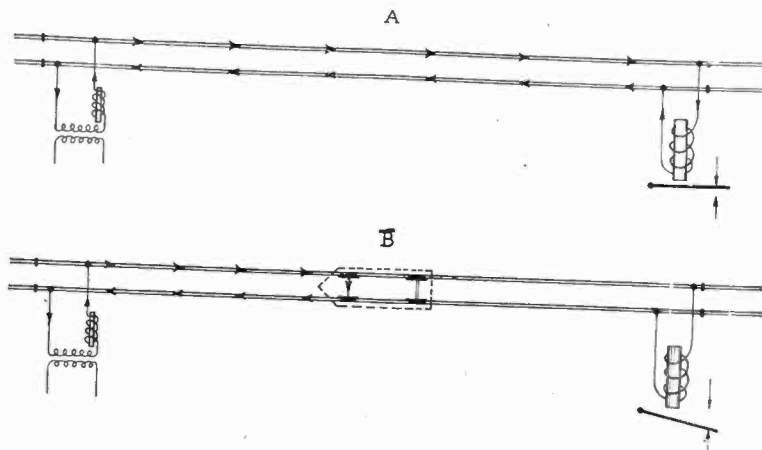

FIG. 2—ALTERNATING CURRENT TRACK CIRCUIT

electrical conditions in order to provide the three controls. These three conditions are brought about by the proper control of a-c. circuits in the rails which establish magnetic fields around the rails and affect receiving apparatus mounted at the front and rear of the locomotive. The energy picked up by these receivers is am-

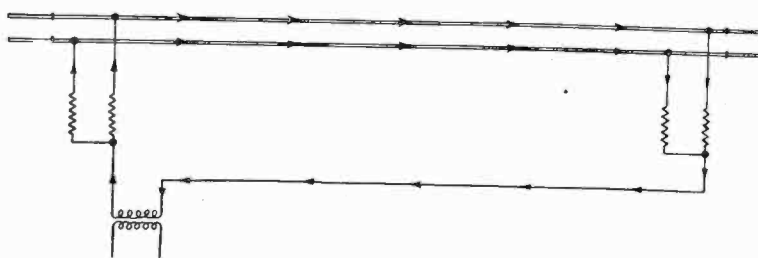

FIG. 3—LOOP CIRCUIT

plified in two stages and used to operate the engine relay on the locomotive.

The railroad tracks are divided into track sections, or "blocks," by insulated joints located approximately

4000 ft. apart. Each section is equipped with an individual set of controlled circuits, two separate circuits being used as follows:

Fig. 2 shows the circuits mentioned above. A is the "Track Circuit" in which a small transformer feeds current into the rails, and this is received at a track relay at the other end of the section. The current in the track circuit flows through a limiting impedance coil to the track, down one rail, through the track relay or the axles of any train which may be in that particular section, and back through the other rail. Incidentally, quite a large part of the total current may leak from rail to rail through the ground.

B shows the same track circuit occupied by a train moving from right to left, and it will be noted that the current is shunted away from the relay by the axles of the train so that the armature of the relay drops by gravity on the back contacts instead of the front contacts. These contacts are used to control circuits in such a way as to indicate the presence or non-presence of a train on the particular track section concerned.

Fig. 3 is the "Loop Circuit" in which current travels down both rails in the same direction. It leaves the

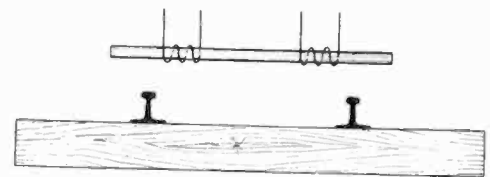

FIG. 4—ENGINE RECEIVER

loop transformer at one end of the circuit, divides through two resistance coils and flows down both rails in both directions under the train. At the end of the track section it is again brought together through two resistance coils and returns over a wire installed on the pole line.

Fig. 4 shows in a diagrammatic way the engine receiver, of which one is mounted in front of the first pair of wheels on the locomotive and another at the rear of the tender with a vertical clearance of about six in. above the rail. This is a structure of laminated iron with coils mounted thereon in such a manner as to pick up energy from the magnetic field around the rails. The "Track Receiver" being at the front of the locomotive picks up track energy before it is shunted by the wheels. The coils on the track receiver are connected in such a manner that the voltages induced in them are additive when the current is passing through the two rails in a direction opposite from that indicated for the track circuit in Fig. 1.

The "Loop Receiver" being mounted on the rear end of the tender is out of the zone of track circuit current because this has been shunted through the wheels of the locomotive. The coils of the loop receiver are connected in such a manner that the voltages induced in them are additive for currents passing through both

rails in the same direction. Thus they pick up energy from the loop circuits which is shown in Fig. 2.

The "High-Speed" indication is established when the track is unoccupied for a specified distance ahead. It is brought about by energization of both the track circuit and the loop circuit with the normal direction of current flowing in each circuit.

The "Medium Speed" indication is established when the track is occupied at a specified distance ahead. This is brought about by energization of both the track and the loop circuits with the current in the latter circuit reversed.

The "Slow Speed" indication is established when the track is occupied at a specified shorter distance ahead. This is brought about by de-energization of either the track circuit or the loop circuit.

The method of controlling the track circuit and loop

both of these contacts and closes another. In order to accomplish this, suitable means are provided to reverse the relative polarity of the current in the loop circuit.

Fig. 5 shows the circuit used on the locomotive. Directly under the train control relay is shown the contacts which bring about the display of the different lights in the cab signal. The letter in the indicator used on the Santa Fe means *low*, *medium* and *high* describing the speeds which are authorized. In this same connection, the relay controls two electropneumatic valves designated as "Control Magnets," which, in turn, set up conditions through which the speed of the train is actually controlled automatically regardless of the action of the engineer.

The author does not intend to give a full description of this automatic control, but it is interesting to a mechanical engineer and the author will be glad to arrange for

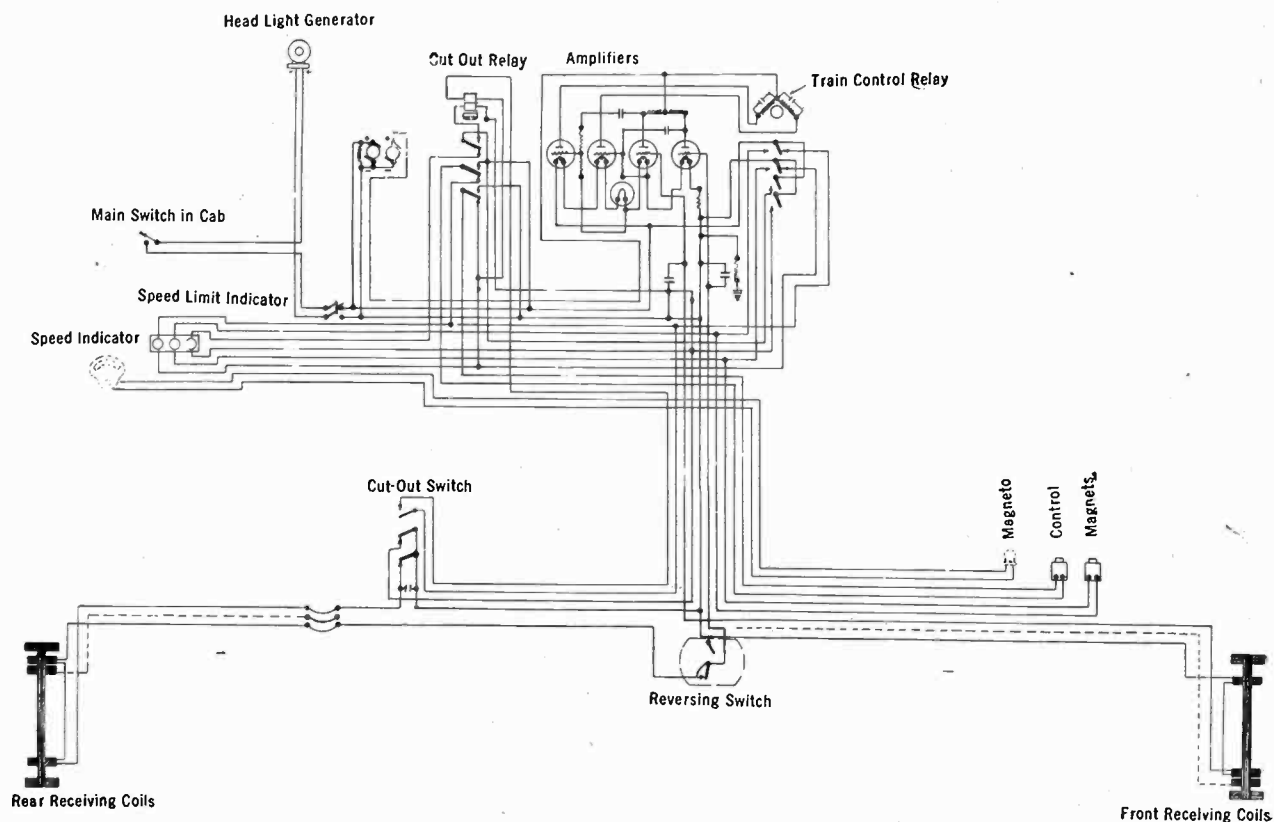

FIG. 5—CIRCUIT DIAGRAM AUTOMATIC TRAIN CONTROL

circuit automatically by the presence of a train on the track will be explained in detail a little later.

The train control engine relay is a two element affair, one element of which is energized by induction from current in the track circuit shown in Fig. 1 except when this current is shunted away from it by the wheels and axles of a train. The other element is energized by induction from current in the loop circuit shown in Fig. 2. The operating part of the relay is a vane somewhat similar to that used in a watt-hour meter. In order to obtain three indications, it is necessary to provide a means for this disk to be operated in two directions in order to close different contacts. It must also be actuated by gravity to a point where it opens

answers to any questions which may be asked.

Fig. 6 illustrates in greater detail than Figs. 1 and 2, the circuits used on the roadway. In this connection, it will be noted that a three-phase line is used to energize the system. This line is very nearly balanced by using one of the three phases for a five-mi. stretch, the next phase for the next five miles and the third phase, for for the next five miles. It will be noted also that the secondaries of the line transformers are divided into two circuits, each of 110 volts, in order to provide a convenient way for reversal of current polarity in the loop circuit without a complicated pole changing device.

Now, as to the circuits on the roadside which bring about the different indications: In the following

discussion, the current which is permanently applied to the rails will be designated as the "track circuit current" and that which is controlled through contacts will be called "loop current."

In order to provide a high-speed indication, both of these currents must be present, and the loop current must be of the proper relative polarity. To provide a medium-speed indication, both of these currents must be present and the relative polarity of the loop current must be reversed. There are two ways of providing the slow-speed indication: One is shown between locations 1 and 2, where the current is shunted away from the relay by the train. Under these conditions, if another train enters this section, there will be no track circuit current available. The other is shown at location 2. At this point contact *A* is open and therefore no energy is applied to the primary of loop transformer *B*. In either case, one element of the engine relay is de-energized and its rotor drops by gravity to the low-speed contact.

The method of providing a medium-speed indication

was very interesting. The real reason for all the above was to provide a means of controlling a train automatically regardless of the carelessness of the engineer or the fact that he might become incapacitated due to sudden illness or death, but it has lead several railroads to consider the desirability of providing signals in the cab of the engine rather than on the wayside and in this sense has had a good effect.

Whether the automatic control of a train will ultimately be successful is debatable, but at present it looks as if it is a factor in railway operation which has come to stay.

There are various other schemes now in use which are very interesting from a technical standpoint, but all of these involve intermittent controls. None of them provides an adequate means for the use of cab signals without the addition of wayside devices. They simply provide for a check on the engineer should he disobey a signal indication. They are not self checking, as is the device described above, and therefore as a means of adding to the efficiency as well as safety of

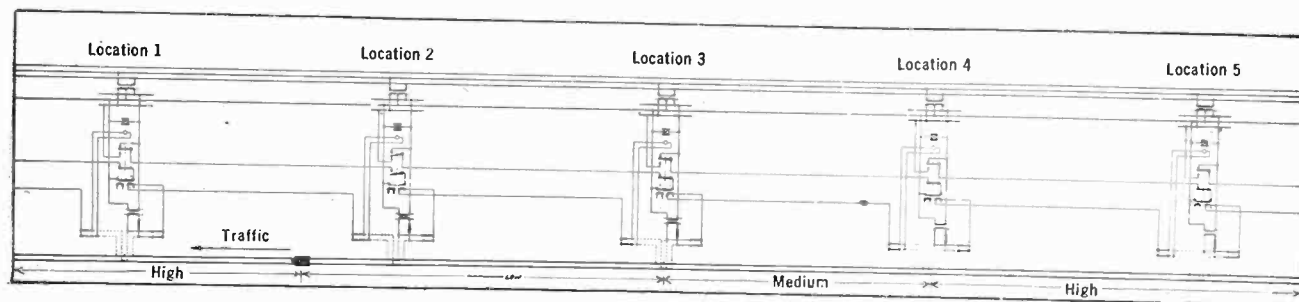

FIG. 6—TYPICAL TRAIN CONTROL ROADWAY CIRCUITS

is shown at location 2. It will be noted at location 1 that contact *C* is connected to wire *B X* which, in turn, is connected to the line transformer on the relatively plus side. At location 2, the corresponding contact at *D* is dropped and is now connected to wire *N X* which is connected to the relatively minus side of the transformer. In this way, the relative polarities between the track circuit current and the loop current have been reversed, which in turn reverses the engine relay.

The trade name of the particular scheme as described is "Continuous Control" because of its continuous indications. It seems easy as here described, but a great many years were spent in research work before a simple description of this kind became possible.

Various new problems confronted us when we had the opportunity to study the problem in connection with an actual installation. Very interesting studies have been made about the various paths which a current will take when a conductor is grounded as all steam railroad rails must be grounded more or less through the ties and ballast. The problem of providing safe operation, with due consideration for the inductive effects of adjacent power lines of the same frequency

train movements they seem incomplete. Only time will show whether this idea is correct or not.

"STAND BY" STORAGE BATTERIES

The people of every city make sudden heavy demands upon their electric light company. The approach of storms and resultant daytime gloom is one of the commonest causes of this. To meet such demands and to guard against power failures many companies maintain immense storage batteries to handle the load during the few minutes that are sometimes required to bring the generating machinery up to speed. These batteries usually are the largest to be found anywhere—some weighing over three tons each. A few electric light plants keep as much as 500 tons of batteries always standing ready for service.

There are some eighteen cities in the United States and Canada in which "stand by" batteries are employed in this way. In five representative cities of this class, there are 125 "stand by" storage batteries aggregating in capacity 675,000 amperes at the one hour discharge rate on the 250-volt bus. These batteries would, therefore, carry the load of 2,700,000 60-watt incandescent lamps for one hour or about twice that many for 20 minutes.

Transmission and Distribution

Annual Report of Committee on Power Transmission and Distribution*

To the Board of Directors:

FOREWORD

In presenting the annual report of the Committee on Power Transmission and Distribution it has seemed best to largely confine its scope to a discussion of the progress that has been made in those branches of the art with which the Committee has been actively concerned during the year. Several of the members have collaborated in the preparation of the report and it represents the consensus of opinion of the Committee as a whole.

It is felt that the coordination of effort which has been secured through the medium of the Committee has resulted in a very substantial stimulus to the advancement of the state of knowledge regarding those problems which have been particularly studied and if this report in presenting a resume of the progress made also succeeds in indicating profitable fields for further study and research its purpose will have been accomplished.

LIGHTNING ON TRANSMISSION LINES

With the growing tendency toward interconnection of large power systems and the increasing dependence on high-tension transmission lines for the service of large communities, the question of continuity of service for such lines has become very important.

Inasmuch as lightning has been responsible for most of the interruptions to service over transmission lines a subcommittee was appointed whose duties were to investigate lightning and its relation to transmission lines.

The work assigned to the sub-committee was of considerable magnitude and importance. The various lightning difficulties that had been encountered on transmission lines in the past two years were discussed,

*Committee on Power Transmission and Distribution:

Philip Torchio, Chairman
P. H. Chase, Vice-Chairman
R. N. Conwell, Vice-Chairman
R. H. Tapscott, Vice-Chairman
R. W. Atkinson,
A. O. Austin,
F. G. Baum,
R. D. Booth,
J. A. Brundige,
V. Bush,
George F. Chellis,
Wallace S. Clark,
Edith Clarke,
John C. Damon,
W. A. Del Mar,
Herbert H. Dewey,

L. L. Elden,
R. D. Evans,
F. M. Farmer,
C. L. Fortescue,
C. D. Gray,
K. A. Hawley,
J. F. Jollyman,
A. H. Kehoe,
C. H. Kraft,
A. H. Lawton,
E. A. Loew,
W. E. Meyer,
W. E. Mitchell,

C. R. Oliver,
F. W. Peek, Jr.,
D. W. Roper,
O. E. Schwenger,
A. E. Silver,
M. L. Sindeland,
H. C. Sutton,
Percy H. Thomas,
W. K. Vanderpoel,
Theodore Varney,
H. S. Warren,
R. J. C. Wood.

Presented at the Summer Convention of the A. I. E. E.,
Detroit, Mich., June 20-24, 1927.

as well as the various data that had been gathered in connection with these difficulties.

The following are the subjects taken into consideration in the discussion of the general problem.

Klydonograph Tests. Inasmuch as the transients due to lightning are of extremely short duration it was very difficult to determine their characteristics until the advent of the klydonograph. By means of the klydonograph it has been possible to obtain information regarding the operation of transmission lines of voltages ranging from 6.6 kv. to 220 kv. The nature of the tests and the inherent variation of the physical conditions under which lightning occurs necessitated a great amount of data to determine the facts definitely. However, the data secured is sufficiently extensive to indicate the following important conclusions.

1. The most important voltage surges on overhead transmission lines are those produced by lightning.

2. On 120- to 140-kv. lines surges of 1200 to 1400 kv. and on 220-kv. lines surges of 1800 to 2000 kv. can be established.

3. Majority of lightning surges were positive.

4. Highest surges were negative, which would indicate that they were direct strokes and that the clouds causing these surges were negative.

5. While very high positive surges were recorded, they were few in number and only slightly over 1000 kv.

6. The number of surges per storm at a given point is not great.

7. When a surge above the flashover of the insulation is induced, the insulator flashover relieves the energy and limits further rise of voltage.

8. The steeper the rate of application, the higher is the voltage reached before flashover, and when no flashover occurs, the insulators must withstand the surge for its entire duration.

9. High-voltage surges do not travel far. Such surges are damped below the corona voltage in a relatively few miles, while low-voltage surges travel many miles.

10. Lightning strokes are unidirectional or at most highly damped oscillations.

Lightning Strokes. What is the amount of current that can be encountered in a lightning stroke?

It is fairly definitely known that in the case of a direct stroke, currents of the order of 10,000 to 100,000 amperes can be encountered, whereas in the case of an induced lightning stroke this current is probably of the order of 3000 amperes.

A point also to be taken into consideration is that when a lightning stroke does take place the number of insulator units that are likely to be spilled will depend

to a large extent on the resistance of the principal unit paths, the resistance consisting of the tower and the ground resistances. To amplify: if the resistance of the lightning path at a particular string is of a high enough value, the effect of the current going through it will be to raise the potential of the conductor at that point above the flashover value of the string in question and a wave above the spillover value of the string will travel on to the next string to be spilled over and so on until it reaches the point where the flashover of a string is in excess of its crest in which case it will travel on until it is dissipated in some other manner and so disappears.

This, of course, shows clearly that the ground resistance plays a considerable part in the determination of how the lightning flashover will act over the line. With a low value of ground resistance, it will take fewer strings to dissipate a particular impulse or stroke. On the other hand, with a low value of ground resistance, the amount of power current to be handled at any particular string will be greater and therefore the possible arc damage will also be greater.

There is another point to be taken into consideration in determining the value of ground resistance, and that is the question of short circuit current required for the successful operation of relays. It is essential that the relays controlling transmission lines operate very quickly under lightning disturbances in order to minimize the damage of the power arc to the insulator string and the conductor.

Some data were available as to what value of ground resistance was encountered in practise. Some companies had made measurements of ground resistance on towers and found that the average resistance was between 15 and 25 ohms, while some towers, however, showed a resistance as low as 2 ohms, others as high as 100 ohms and the highest encountered was in the neighborhood of 300 ohms.

The question as to what is, therefore, a correct mean value of a ground resistance is one that is of considerable importance and it would be highly desirable to obtain some data both from a theoretical and experimental standpoint to establish that value definitely.

Lightning Discharges. The question of lightning discharges under power and the power arcs which follow brings with it another question and that is whether it is definitely known that in all cases a power arc follows the lightning discharge.

One or two cases were cited in which reports had been received from observers who claimed that they had seen a lightning discharge on a string of insulators with no accompanying power follow-up arc, but the Committee agreed that the amount of data available on this was meagre and in all probability what was available was highly unreliable. It is conceivable that a lightning discharge could take place and yet if the amount of lightning current were small enough, sufficient ionization of the atmosphere would not take place to render

a power arc possible. However, just what is the amount of current necessary to do this is not known and it is a problem for further investigation.

It has been estimated that the duration of dangerous lightning impulses encountered on transmission lines is of the order of a fraction of a micro-second to ten micro-seconds.

Ground Wire. The value of the ground wire as a protection against lightning has been a much mooted question. In the past where the maximum operating voltages were in the neighborhood of 66 kv., the consensus of operating opinion has been that interruptions to service by lightning were as frequent on the transmission lines equipped with ground wire as those that were not equipped with ground wire. In addition a great deal of mechanical trouble was encountered with the ground wire which was often accompanied by interruptions to service.

Very little attention in the past has been paid to the erection of the ground wire both from a mechanical and electrical standpoint and it is believed that the chief objection to the ground wire on transmission lines has been as a result of this lack of attention. It is believed that the ground wire conductor should have a layer of non-magnetic conducting material. Some operating companies have used aluminum steel reinforced or copper clad conductors for ground wires and other companies are using copper and high-strength copper alloy conductors.

As to the value of ground wire for reducing the induced lightning voltage data obtained on a 132-kv. line operated without ground wire was studied, and charts prepared in which the various flashovers that occurred were plotted on a profile on which tower locations had been indicated by two different sets of coordinates. In one set, the coordinate consisted of distance from the station and average height above ground of the bottom conductor of the span on side of tower away from the station and in the other case, the coordinate consisted of distance from the station and elevations of the bottom conductors on the towers.

On this chart all the flashovers which occurred were spotted opposite each tower. A careful examination of the chart showed very markedly that the flashovers were concentrated on the high spots and were generally absent from the low spots on the line. It also indicated very clearly that the great majority of the trouble was on the top conductor.

There were three stations located on that line and while the line was literally peppered with lightning at other points, these stations were apparently free from trouble. The chart showed that the line was particularly low for a distance of two or three miles from the stations and this explains at least partially the absence of trouble at the stations.

The number of flashovers during the 1925 season was approximately 88. In the early spring of 1926 a ground wire was installed on this line and the corre-

sponding number of flashovers during the lightning season of 1926 was only about 8 or 10. This with other evidence that is available clearly shows the value of the ground wire.

Effect of Tower Design. The question of the effect of the tower itself on the electro-static field surrounding a conductor and what effect this has on the flashover value of the insulator units, was considered.

It was the opinion of the Committee that any affect which the tower may have on the field is of relatively little importance in determining whether a flashover will or will not occur. The fact that some semi-flexible towers are known to have less lightning trouble than some of the other towers of the square type is undoubtedly due to the fact that in the first place they are very much lower lines, the spans being comparatively short and, second, they invariably are equipped with ground wires since the structures themselves are generally not self-supporting and the ground wire which is put in for mechanical reasons serves, of course, the additional function of giving them lightning protection at the same time.

It was considered advisable that all the points on which the committee was in agreement should be set down to serve in the nature of principles for guidance in the design of high-tension transmission lines.

It is the opinion of the Committee that these principles have sufficient theoretical background for their conclusions and generally also a considerable amount of actual experience to further back up the theory.

The following are the principles referred to:

1. Under any given set of conditions, the lightning voltage which can be picked up by a line is a function of the height of the line, being directly proportional to the height and is further a function of the ground wire arrangement but is independent of the power voltage.

2. The lightning voltage under any set of conditions on a line is limited by the insulator flashover for the particular wave in question. It should be pointed out, however, that this is only true where the ground resistance and the tower resistance are comparatively small. If this resistance is high, the total voltage may then be appreciably higher than that corresponding to the flashover of the insulator string.

3. In any line design, it is desirable first to hold down the lightning voltage. This can be done by

(a) Keeping the line as low as is economically feasible, and

(b) By the proper use of ground wires, again within economical limits. Failing to do this, the next best thing is to prevent the power arc following the lightning flashover. Unfortunately we are not at present in a position to state how this can be done.

4. The higher you go in transmission voltage, the more beneficial as a rule, is the ground wire. This may be seen by the following simple example:

Assume two lines built with the same type of structure, the same conductor, with one built for operation

at 66,000 volts, say the other for operation at 132,000 volts. Assume that the 66,000-volt line utilizes 5 ordinary suspension units and that the 132,000 volt line utilizes 10 suspension units. The lightning flashover of the first is in the neighborhood of 600,000 volts and of the second in the neighborhood of 1,200,000 volts. Assume that the average lightning voltage that you can get on the 66,000-volt line is 2,000,000 volts. Then if the ground wire has the effect of reducing that by 50 per cent, the lightning voltage with the ground wire will still be 1,000,000 volts which is 400,000 volts in excess of the flashover value of the 5 unit string. Therefore, under these conditions, a flashover will take place.

In the case of the 132-kv. line, the height, the conductor and everything else being the same it follows that the voltage with or without the ground wire would be the same as before and therefore with the string having a lightning flashover of 1,200,000 volts no flashover will occur.

A similar example could be employed to show that a 220-kv. line where with 14 standard suspension units the lightning flashover of the insulators may be expected to reach values of the order of 1,800,000 volts would hold and not flash.

5. The design of substations should be co-ordinated with that of transmission lines as there is a great tendency to over insulate the line and thereby tend to transfer the trouble to substation equipment.

A great deal of attention is being paid at the present time in specifications for electrical apparatus to the impulse strength of apparatus.

The manufacturers are working on the problem of impulse strength of apparatus. There is considerable evidence to show that there is a fairly definite ratio between the impulse strength and the 60-cycle strength of the apparatus. If this is demonstrated to be true, it will be possible to design a complete system, including the transmission line and connected apparatus, with a relation of insulation values that will give the greatest efficiency and continuity of service consistent with minimum cost.

Future Work. For the lightning season of 1927, several power companies are arranging for future klydonograph tests which will give us more information on the value of the ground wire and on the amount of attenuation of traveling waves. We also hope to obtain data to determine the following points:

1. Wave fronts of lightning surges
2. Duration, of energy of lightning surges
3. Maximum voltages induced on continuous transmission lines
4. Maximum field gradients.

Arrangements are also being made to determine attenuation, potentials at stations, and at short distances therefrom, potentials on adjacent sections of line with and without ground wires, potential on both

sides of choke coils, and discharge currents of lightning arresters.

LIGHTNING PROTECTION OF DISTRIBUTION CIRCUITS

For a number of years studies in lightning protection for 4000-volt, four-wire, three-phase circuits have been made in Chicago, and the results have been reported to the Institute.* During this period, several new types of arresters have been placed on the market, and the most promising of these arresters have been installed in Chicago.

In attempting to analyze the records obtained during the past few years on the various types of lightning arresters and determine their relative efficiency in protecting transformers from damage by lightning, some very discordant results were observed. The results obtained from the service records were not in accord with the theories, nor with the results of laboratory tests.

To make a more comprehensive study of the situation, the engineers of manufacturers whose lightning arresters were under investigation in Chicago accepted the invitation to join in a conference for determining the cause of these discrepancies. The investigations resulting from this conference will probably require at least a year before definite results can be secured. The indications are that, by giving more attention to the details of line construction and perhaps making some alterations, it will be possible to make a considerable further improvement in lightning protection on distribution circuits.

Many of the factors which affect lightning arrester performances are not constant and alike for all installations, and it appears from the data that a large share of the transformer failures, are due to limitations in protection which are imposed by conditions outside the arrester, of which good examples are, high ground resistance, currents from several circuits through ground connections of moderate resistance and entrance through the secondary. Before a conclusion is made that the arrester has failed to function properly, the variables must be thoroughly considered. A list of these variables is as follows:

1. Ground resistances
2. Transformer history
3. Primary exposure
4. Secondary exposure
5. Shielding
6. History of immediate territory
7. Lightning entrance.

These variables are quite well known to engineers who have studied lightning arrester performances. In attempting to determine their individual importance on each failure, they are studied somewhat as follows:

1. *Ground Resistance.* Ground resistances are mea-

asured on the nearest three arrester installations in each direction from the failure. This assists in determining the ability of the arresters to relieve the line. Resistance above 20 ohms should be considered inadequate, and lower values are in doubt, that is, the value of resistance to be considered as dangerous must be in relation to the amount of current which the ground connection may be expected to carry and the maximum strength of the insulation which is being protected.

2. *Transformer History.* The transformer history includes the make, size, age, connected load, previous failures, previous fuse failures, and the type of installation, whether it be power or light. Of these factors, the first two affect failures, inasmuch as some transformers may be more susceptible to damage than others. Windings of the older transformers are quite apt to be of a lower insulating value, transformers operating with an overload and previous fuse failures may also weaken this insulation. Transformers which have previously failed are repaired and re-installed on the lines. The rewinding of the transformer coils may result in the transformer being more susceptible to damage by lightning. Lightning transformer installations are grounded, and also one power transformer, of a power bank installation, is grounded. This factor—whether the transformer be grounded or not grounded—also may affect the failures.

3. *Primary Exposure.* The height, length, number of primary wires, number of arresters, and the underground cable connecting to the overhead conductors are features which are studied in connection with the primary conductors. The height of mains connected to the transformer failure are of importance, the charge induced increases as the distance from the earth, or the point of zero potential, increases. The length of these wires is important, since the increased exposure increases the charge on the line. The number of arresters discharging, and the length of the line relieved by each arrester, should be considered. Long lengths of underground cables connected to overhead conductors at distances of 100 feet or so from the failure aid in reducing the induced potential, and are a variable factor.

4. *Secondary Exposure.* The length and height of secondary phase wire and the length of secondary neutral exposure is of importance. The secondary neutral is grounded on some systems and ungrounded on others. The grounded secondary neutral furnishes shielding of considerable value.

5. *Shielding.* Structure shielding is quite low unless the structure is of steel adjacent to and higher than the line. Frame and brick structures, unless extending two or more stories above the line and adjacent to it, furnish little shielding. Trees extending above the line and adjacent to it, and telephone cables on the same pole as the primary conductors, furnish good shielding and must be considered.

6. *History of Immediate Territory.* Transformers burned out and fuses blown due to lightning in the

*Studies in Lightning Protection on 4000-volt Circuits. TRANS. A. I. E. E., Vol. XXXIX, page 1895; Vol. XXXV, page 655.

adjacent areas of approximately one square mile should be considered to determine the severity of lightning within that area. Certain areas may be more susceptible to lightning disturbances than others; this susceptibility may be due to geographical conditions, or the character of the structures within the area.

7. *Lightning Entrance.* A study of the transformers burned out should be made and an attempt to determine the lightning entrance, whether it be over the phase or neutral primary, or over the secondary wires. Evidences of arcing on the case, bushings and pole should be noted and the extent and nature of the burns on the windings of the transformer. Any damage to customer's equipment should be studied as evidence of lightning entrance over the secondary side of the transformer.

These are the factors which should be studied in connection with each case of failure, whether it be transformers, underground cables, or secondary equipment. After this study, one of the factors may be found to be almost entirely responsible for the failure, and with sufficient data covering a period of years, an attempt can be made to eliminate these factors as much as possible and better the protection.

The Commonwealth Edison Company now installs 2300-volt arresters on primary phase, and 300-volt arresters on the primary neutral; and as a result of their studies of the seven factors listed, the advisability of arrester installation on the secondary side of the transformer is being considered as a means of further reducing interruptions of service due to lightning burnouts.

VOLTAGE STANDARDIZATION

Several excellent papers dealing with transmission and distribution voltage standardization have been presented to the Institute during the past year and undoubtedly have contributed much toward clarifying the status of this problem. The ultimate solution, however, is still somewhat obscure. With the present tendency toward interconnection of systems the standardization of voltages becomes of increasing importance and it seems urgent to push the studies in this field.

STABILITY AND LOAD LIMITATIONS OF POWER SYSTEMS

During the past year, the most significant development has been the engineering studies of several of the power companies which have led them to adopt special means to improve operating conditions and minimize the probability of outage. The stability studies have led to the adoption of synchronous machines of low reactance and high short-circuit ratio provided with quick-response excitation. The first installation of this kind will be in California followed quickly by similar installations in Pennsylvania and Alabama. The inclusion of these features in specifications for these installations shows the importance that the engineers of large utilities are attaching to the subject of stability.

An important advancement in the transmission art is the development by Frank G. Baum of "A Transmission System." Broadly, the principle of this system consists in supplying to the line at each point the reactive kv-a. required for transmitting the power over the line at that point, irrespective of whether power is taken in or given out there and incorporating in the devices used for this purpose the necessary characteristics to enable them to supply the reactive power required for stability under all conditions of operation. Practically, this means the installation of synchronous condensers of proper characteristics at intermediate points of long distance transmission line, in order to increase the amount of power that may be transmitted over that line as compared with the same line without the condensers.

Sustained attention is being given to the design and construction of machines having characteristics appropriate for long-distance power transmission. It is recognized that the desirable characteristics in synchronous machines from the standpoint of stability are low leakage reactance and high short-circuit ratio. The better performance thus obtained may be utilized to increase the amount of power transmitted rather than the margin of stability. Generators of low reactance were decided upon by the Southern California Edison Company for its Big Creek 2-A power plant and for the motor end of the frequency changer set at Farmersville located at an intermediate point on their Big Creek transmission system. Maintenance of stability is essential not only for long-distance transmission lines but also for comparatively short systems of large capacity and high standard of service. For example, in the case of the Conowingo development of the Philadelphia Electric Company, it was found that the use of generators having special characteristics would increase the reliability of the system.

Quick-response excitation which has been introduced commercially during the past year, maintains a high average value of voltage in synchronous machines at time of changes in circuit or load conditions thus improving the stability of operation. In some cases it will be desirable to use quick-response excitation in addition to special characteristics in the synchronous machines. The speed of response of the excitation system is obtained by the use of multiple-connected field windings in the exciters and separate excitation. Motor-driven exciters have been employed instead of direct-connected exciters for low-speed generators, because quicker response can be obtained with exciters of higher rotational speed and smaller air gaps which are possible with motor-driven units. To obtain the advantages of the quick response excitation system it must be controlled by a suitable voltage regulator capable of acting promptly and keeping its contacts closed until the system voltage has approached normal value. In order to secure correct operation of the voltage regulator under all conditions of operation, two

potential transformers with a positive phase sequence network are employed instead of the single potential transformers normally used. Quick-response excitation systems have been ordered for each of the plants described above, and in addition for the Lock 18 and Tallassee plants of the Alabama Power Company.

In last year's report mention was made of the theory of artificial stability which had been previously advanced and which had been substantiated by actual calculations and to some extent by experimental tests. Further experimental data not only confirms the laboratory data previously obtained but establishes the fact that artificial stability can be obtained on commercial power systems. While it is not expected that systems would normally be operated in the range of artificial stability it is undoubtedly desirable to take advantage of this increased limit as a margin. It should of course be appreciated that the real advantages of quick response excitation systems lie in the increased power limits under transient conditions.

Going further in the development of voltage sustaining devices, successful experiments with a small inherently compensated synchronous condenser have been carried out. The compensating current responds not only to a change in the magnitude of the load current but also to a change of the load power factor. It is necessary to keep in mind that this response to change of angle is quite important during transient conditions.

An important development during the past year has been the increased interest in the recording of systems data useful from the stability standpoint. The most suitable instruments for this purpose are of the oscillographic type arranged to operate automatically on the occurrence of system trouble. For instance, on the occurrence of a fault to ground, a ground relay places the automatic recording apparatus in operation and after the record had been obtained, auxiliary relays automatically disconnect the apparatus and prepare it for a subsequent operation. Particular mention should be made of the instantaneous watt elements, a sample of which was displayed to the Committee during the year. Such a watt element is particularly useful in stability studies.

These instruments should be very valuable to enable operating engineers to obtain data on the performance of their systems during transients. This data will be useful also in planning future extensions, ties and interconnections.

Another point, mentioned in last year's report as being incomplete, is the matter of fault resistance. The effective value of the fault resistance at the time of a flashover cannot in general be measured directly. A new indirect method has been used successfully which consists in making a chart of calculated values of ground currents for various fault locations and for arbitrary values of fault resistance. Lines of constant resistance on this chart are used as parameters of

reference and the actual fault current, as measured by the above mentioned oscillographic recording device, is plotted on this chart; its position with reference to the constant-resistance lines gives the actual fault resistance. In this way fault resistance, when comparable to the reactance of the system, can be obtained with a fair degree of accuracy, and since only the order of magnitude of fault resistance is important, this accuracy is adequate.

During the past year progress has been made in increasing our technical knowledge on the subject of transmission stability. One paper on this subject was presented by Mr. O. E. Shirley and another by Mr. H. V. Putman. Mention should also be made of the paper by Messrs. Doherty and Nickle on the *Theory of Synchronous Machine*, which gave consideration to the stability characteristics of machines. Noteworthy progress in the general understanding of the stability problem has been facilitated to a considerable degree by the use of the mechanical analogy due to Mr. S. B. Griscom, and presented before the Transmission Committee and several Section meetings.

UNDERGROUND CABLES

A pronounced drift toward the use of single-conductor cables and three-conductor metal-sheathed unbelted cables is making itself felt. More data are being secured as to the relative merits of these two types of cables as well as the ordinary belted three-conductor cable. Aside from any difference in dielectric strength the belted three-conductor cable is at a disadvantage due to the fact that faults frequently are from phase to phase instead of being confined to ground as is usually the case with the single-conductor or metal-sheathed three-conductor cables.

Where the duct size permits, three single-conductor cables may be installed in one duct thereby avoiding the necessity of having an individual duct for each cable which in many cases would make the subway cost prohibitive. This practise is being followed to a large extent on the system of The New York Edison-United Companies with very satisfactory results.

Progress is continually being made in the development of super-voltage cables. The 66-kv. Cleveland cable has been in service for about three years and the Philadelphia cable which was rated at 75 kv. but operated at 66 kv. has been in service for about one year. While some failures have occurred the operation in general has been satisfactory.

The Commonwealth Edison Company has in service two 75-kv. lines each consisting of three single conductor 750,000-cir. mil cables with 24/32-in. insulation and is installing additional circuits of this size and insulation which will go into service this Fall.

One of the encouraging features has been the highly successful operation of the oil-filled joints.

While short time tests indicate that the 24/32-in. insulation is liberal and that the cables might have a

somewhat higher voltage rating, the deterioration rate of insulation stressed on this basis is not yet accurately determined.

Trial installations are being made on 66-kv. cables of joints which incorporate a means of insulating the intervening section of sheath. By suitably connecting the insulated sections the sheath currents may be minimized and the carrying capacity of the cables thereby increased.

The past year has seen considerable development in the use of oil reservoirs of various types on high-tension cable splices. The oil supplied by these reservoirs no doubt reduces or possibly eliminates voids, especially near the joints. This is of considerable importance as it has been found that the cable itself absorbs large quantities of oil for weeks or even months after installation. The indications are that the oil absorption by the line bears a direct relation to the temperature range through which the line is worked, the greater the temperature range the greater the oil absorption. Considerable attention should be given to the volume capacity of the oil reservoirs as the temperature changes also produce appreciable variations in the volume of the insulation for which it is desirable to compensate. The use of such oil-filled joints makes it possible that satisfactory single conductor cables of the usual type of construction may be obtained for operation at 110-kv., three-phase.

A clear distinction should be made between this type of cable and the 132-kv. cable now being installed in New York and Chicago. The latter has a hollow core filled with an oil which is fluid at all operating temperatures and this central space is connected at suitable intervals with large oil reservoirs capable of compensating for volumetric changes in both oil and cable whether due to temperature changes or other causes. No experience has yet been had with these 132-kv. installations but it is expected that their operating record during the next few years plus the further experience with the lines operating at 66 kv. will indicate whether or not the usual type of cable can be made to operate satisfactorily at over 75 kv. and also show whether the hollow core, oil filled type and its several accessories are good for 132 kv. or possibly more.

Voltage Surges on Underground Cable Systems. In the course of the studies which have been made of high voltage transients on underground cable systems klydonographs have been installed on 16 cable systems for the purpose of obtaining operating records of transients on these systems. The highest voltage recorded was 4.6 times normal. Nearly 99 per cent of all the surges recorded were under three times normal and 92 per cent of the total were unidirectional and therefore of brief duration. As the highest surges are of the same order as the commonly specified test voltage of the cable, but last only a small fraction of a second, it is probable that they have no effect on the cable insulation.

USE OF TEMPERATURE INDICATORS ON DISTRIBUTION TRANSFORMERS

Experience which has been obtained from the use of temperature indicators on distribution transformers in Boston has indicated that material savings may be accomplished due to a better loading of the transformers. Some operating companies, however, feel that temperature indicators are not a satisfactory substitute for load tests but in any case it is probable that under cool weather conditions where the ambient temperature is materially below 40 deg. cent. which usually corresponds to the peak-load season in Northern cities the transformers can be safely loaded to values considerably in excess of their rating. An important reduction in transformer investment may thereby result.

PHILIP TORCHIO, *Chairman.*

MECHANICAL AND MAGNETIC PROPERTIES OF STEEL

The Department of Commerce has made public a statement on an investigation of the magnetic and mechanical properties of iron and steel. The full text of the statement follows:

The results of a recent investigation of the relationship which exists between the magnetic and mechanical properties of iron and steel do not lead to the conclusion that there is no relationship between the magnetic and the mechanical properties of those metals but only that the algebraic expression of magnetic properties, generally known as Kennelly's law, or the reluctivity relationship, does not truly represent the magnetic properties, according to R. L. Sanford, chief, Magnetic Section, Bureau of Standards. For this reason, states Mr. Sanford, we cannot expect to develop such relationship as may exist between the magnetic and mechanical properties in terms of the constants in the reluctivity equation.

In the light of the result of many researches carried out independently by several investigators, there can be no doubt that there is a very close connection between the magnetic and mechanical properties of steel, according to Mr. Sanford. It would be of considerable advantage therefor if these relationships could be worked out on a quantitative basis and the investigation under discussion was undertaken primarily for the purpose of discovering whether or not the reluctivity relationship could be used as the basis of such a quantitative correlation. The fact that the relationship cannot be so used should not by any means be construed as meaning that the correlation does not exist. It is very desirable that fundamental investigation looking toward the establishment of definite laws of correlation should be carried on since only through a knowledge of the underlying principles involved can the advantages of magnetic analysis be realized to the fullest possible extent.

Abridgment of Tests on High- and Low-Voltage Oil Circuit Breakers

BY PHILIP SPORN¹

Member, A. I. E. E.

and

HARRY P. ST. CLAIR¹

Associate, A. I. E. E.

Synopsis.—Data from a large number of tests on several types of oil circuit breakers are given in this paper. The tests were made on breakers with the following ratings: (a) 150 kv., 1,500,000 kv-a.; (b) 35 kv., 250,000 kv-a.; (c) 7000 volts, 75,000 kv-a.; (d) 132 kv.,

1,250,000 kv-a., and (e) 132 kv., 750,000 kv-a. These tests were made on power systems having sufficient connected capacity to make the tests conclusive. Complete data are tabulated and oscillograms are shown. Some valuable conclusions resulted from the tests.

INTRODUCTION

THE American Gas and Electric Company has carried out a number of tests on high- and low-voltage oil circuit breakers, these tests falling into three principal groups which are as follows:

1. The first group of tests was brought about by the purchase from the Brown Boveri Company of a number of 150-kv. and 35-kv. breakers, the acceptance of which was made conditional upon the results of rupturing capacity tests. The 150-kv. breaker, described and illustrated more fully in later paragraphs, is of the round tank multiple break type equipped with oil filled 150-kv. bushings. A total of 10 breaks per pole is employed using simple ball type butt contacts.

Although it was not possible to obtain sufficient

particular point being a substation, any short circuit placed on the system there would be divided between the various generating stations on the interconnected system through the intervening lines between Sunnyside Substation and the generating stations.

The 35-kv. breaker was of the plain break type, two breaks per pole, with all three poles in one rectangular tank. Several of these switches had been purchased subject to the results of tests to be made at 22 kv.

2. The second group of tests, conducted at Schenectady, using the regular testing equipment of the General Electric Company, was made on one unit of the Reyrolle compound filled switchgear, type C-1-ORD, rated at 7000 volts, 400 amperes, and having a guaranteed rupturing capacity of 75,000 kv-a. As in the case of the Brown Boveri breakers a number of these units had been purchased subject to satisfactory performance under short-circuit tests.

3. The third group of tests was made on two General Electric Company breakers, the breakers selected being two 132-kv. breakers, one of them an FHKO-39-B and the other an FHKO-136-B. The first, that is, the FHKO-39-B, had a rated rupturing capacity of 1,250,000 kv-a. This breaker, as is well known, is of the round tank, explosion chamber type. The other, the FHKO-136-B, is rated at 750,000 kv-a. and is of the oval tank explosion chamber type. It was felt that a short-circuit test on this breaker at the Sunnyside Substation, where a capacity practically equal to the breaker rating was available, would serve as an excellent check on the design principles embodied in other high-voltage breakers of the same type.

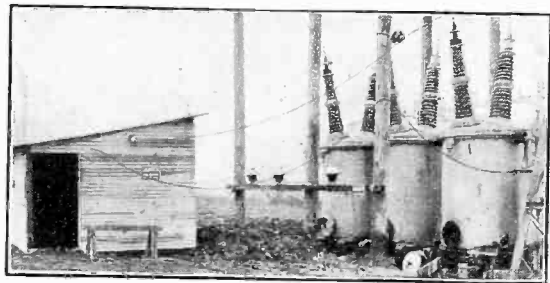

FIG. 1—BROWN BOVERI 150-KV. BREAKER IN POSITION FOR TEST WITH SHELTER FOR CURRENT TRANSFORMERS AND TRIPPING RELAYS

short-circuit current at any point on the interconnected 132-kv. system of the American Gas and Electric Company to test the breaker at its full rated interrupting capacity of 1,500,000 kv-a., it was felt, nevertheless, that a series of tests at the maximum capacity available, approximately 750,000 kv-a., would serve to indicate whether the breaker would be acceptable for the intended service. The Sunnyside Substation of the Ohio Power Company at Canton, Ohio, was selected as the logical place to carry out the tests, since not only was it possible to obtain a maximum concentration of short-circuit capacity at that point, but also because the

1. Both of the American Gas and Electric Co., 30 Church St., New York, N. Y.

Presented at the Winter Convention of the A. I. E. E., New York, N. Y., February 7-11, 1927.

TESTS ON THE BROWN BOVERI TYPE² A F 24/1 A 150,000-VOLT OIL CIRCUIT BREAKERS

The general appearance of the 150-kv. Brown Boveri breaker is shown in Fig. 1. This illustration also shows the method of mounting the breaker and of bringing the leads on the short-circuit side to a small shelter in which were placed the 2500-ampere current transformers and the relays used in tripping the breaker. The foundation for the breaker consisted

2. See also *Electrical World* of May 9, 1925.

of heavy timbers placed directly on the ground as shown.

The breaker tanks have a diameter of 65½ in. and a height of 8 ft. 10 in. from the truck wheel to the center line of the horizontal operating shaft. The ball type contacts are shown in Fig. 2.

The results of typical tests are summarized in the Table I. (abridged).

Beginning with a standard duty cycle of 2-OCO shots with a two-minute interval and with a system set-up calculated to give approximately 225,000 kv-a., the duty on this breaker was increased by steps until on Tests No. 16 to No. 26 the full system capacity available was applied.

After the fifth shot on which approximately 300,000 kv-a. was interrupted, the oil was drained from one tank and the contacts examined before proceeding further. Tests were continued without dressing the contacts

oil was in very good condition and tested an average of 24 kv.

During the interval between Test No. 15, the final test on March 8, and Test No. 16, the contacts were removed and dressed and fresh oil supplied to the breaker.

For Tests No. 16 to No. 26 inclusive, the full system set-up was calculated to give approximately 745,000 kv-a. with five generators at Windsor and approximately 725,000 kv-a. with four generators at Windsor.

While no current records were obtained on Tests No. 16 and No. 17, so that the exact value of ruptured kv-a. cannot be given, with the five generators at Windsor (only four available for Tests No. 18 to No. 26) and with a somewhat higher voltage, it is estimated that the duty on these two shots was approximately 700,000 kv-a.

On Test No. 17 which was the second shot of a standard 2-OCO duty cycle, No. 1 pole gave off considerable

TABLE I (Abridged)
RESULTS OF TESTS ON 150-KV. BROWN BOVERI OIL CIRCUIT BREAKER

Duty cycle and system set-up	Test number	Test voltage	Recovery volts		Current			Duration of short, ½ cycles		Short-circuit kv-a.		Remarks
			Peak value line 2-3	Per cent initial	Closing		Initial in arc R.M.S.	*Total	Arcing	Closed	Opened	
					Peak	R.M.S.						
2-OCO 2-min. system as in Fig. 4 except Cleveland off and 22,000-kv-a. gen. only at Akron. 4 gen. at Windsor...	14	134,000	134,000	70.7	Could not be read		2340	40	14	..	534,000	Opened O. K. Some smoke, slight oil throw. Noticeable jumping of all three tanks.
	15	134,000	111,000	58.5	6920	4000	2180	38	13	930,000	505,000	
7-OCO 1-min. interval. System same as Test 18.....	20	132,000	262,000	140.0	8000	4680	2830	34	14	1,070,000	645,000	Opened O. K. Some smoke. Considerable jumping.
	21	132,000	164,000	87.0	7930	4580	2800	37	16	1,040,000	640,000	
	22	132,000	No record	..	†7750	†4480	2830	No record		1,020,000	645,000	Ditto
	23	132,000	180,000	96.5	6660	4020	2830	40	17	926,000	645,000	
	24	132,000	No record	..	†7000	†4150	2860	No record		946,000	652,000	Ditto
	25	132,000	144,000	77.0	Could not be read		2920	39	16	..	666,000	
26	132,000	217,000	116.0	8450	4900	2920	34	13	1,120,000	666,000	Ditto	

*Estimated from current and voltage record.
†Estimated, record cut off.

which were only slightly burned, and without changing the oil in the other two tanks.

The series of eight shots comprising Tests No. 6 to No. 13 inclusive, presents an unusual and interesting test in that the eight shots were given as rapidly as the breaker could be closed, the interval averaging approximately 10 sec. The short-circuit kv-a. opened on this series averaged approximately 330,000 or approximately one-fourth of the rated capacity of the breaker.

Oil samples taken after this series tested 27 kv. as compared with a test of 28 kv. on the oil originally supplied to the breakers, and showed only slight discoloration.

Tests No. 14 and No. 15 represent a standard 2-OCO duty cycle to which was applied the full system capacity calculated to give a short circuit of approximately 525,000 kv-a.

Oil samples taken at this time showed slightly more discoloration than those taken after Test No. 5, but the

smoke and threw a small quantity of oil from the vent indicating more distress than on any of the other shots during the entire series. Nine shots at full system capacity were applied after this test without any repetition of this apparent distress so that the reason for it on this shot is not at all clear. An examination of the barrier between the individual breaks in tank No. 1 after the completion of the tests showed that one of them had been somewhat charred on both sides opposite the breaks. This barrier was of a material different from that furnished with the original breaker, as it had been obtained locally and placed in the breaker to replace one of the originals which had become broken in assembly. Subsequent examination failed to reveal any puncture, however, so that the distress shown is still unexplained unless it was simply due to the generation of more than the usual amount of gas and smoke caused by the burning of this barrier.

After Tests No. 18 and No. 19, which comprised

another standard duty cycle of 2-OCO shots, a final series of 7-OCO shots at one-minute intervals was applied. On all of the shots at the higher values of kv-a. a considerable movement of the tanks was observable due, it is believed, at least partly to the resilient character of the timber foundations. This last series was intended to consist of eight shots instead of seven, but, on account of the instability of the timber foundations causing considerable movement each time

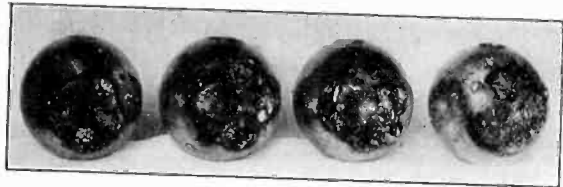

A

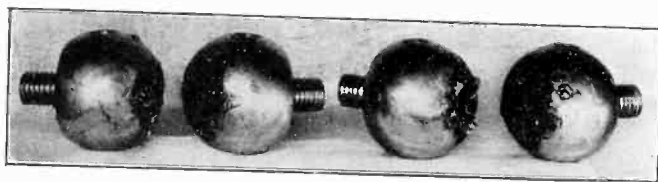

B

FIG. 7—(A) CONTACTS OF BROWN BOVERI 150-KV. BREAKER AFTER COMPLETION OF TESTS
(B) SIDE VIEW OF SAME CONTACTS

the breaker opened, it was agreed that between each of the shots the test breaker would be given a blind shot; that is, it would be closed and opened with the back-up breaker open so as to make sure that the tanks had not been thrown out of alignment to such an extent as to prevent tripping. This proved to be a wise precaution as the breaker failed to trip on the blind shot made after Test No. 26 and no further tests were made.

The contacts taken from this breaker after Test

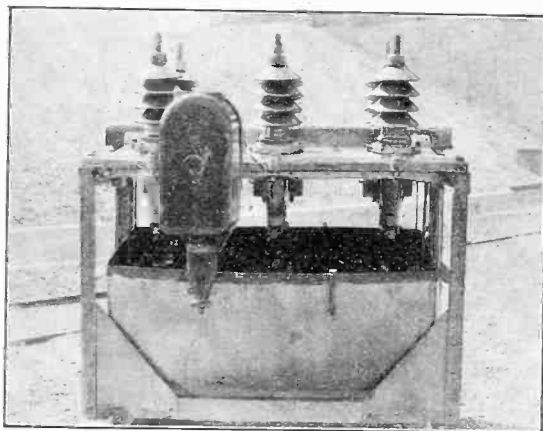

FIG. 10—FRONT VIEW OF 35-KV. BREAKER AFTER TEST. NOTE CRACK IN COVER AND RIVETS SHEARED OFF AROUND TOP OF TANK

No. 26 are shown in Fig. 7. Although considerably burned, there was nothing, in the authors' opinion, in the condition of these contacts which would prevent the breaker from continuing in service even without any dressing of the contacts. The oil was considerably

discolored, but tested an average of 25 kv. as compared with 30 kv. for the fresh oil supplied to the breaker before Test No. 16.

TESTS ON THE 35-KV. BROWN BOVERI TYPE A F 12/36 OIL CIRCUIT BREAKER

This breaker, which is of the plain break type with spring mounted arcing contacts, is particularly distinctive due to all three poles being placed in one rectangular tank with internal barriers only for separation between poles.

It was planned to give the breaker an initial standard duty cycle at about 175,000 to 200,000 kv-a. and then increase in one or two steps to the full rating of 250,000 kv-a. The short-circuit kv-a. for the first test as calculated from the system set-up was approximately 180,000 kv-a. at 0.2 seconds and approximately 200,000 kv-a. at 0.1 sec. Tests on the over-all time required to trip the breaker from the closing of the trip circuit until the breaker contacts separated indicated that the duration of the short circuit would be between 0.1 and 0.2 sec.

The planned series of tests was carried out, however, only to the extent of the first shot, as this resulted in a failure accompanied by the oil catching fire. Unfor-

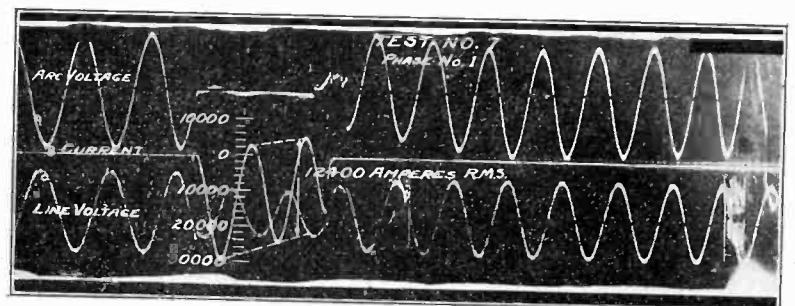

FIG. 15—OSCILLOGRAMS TAKEN ON TEST No. 7

tunately, due to a mishap on the oscillograph, no record was obtained of the current and voltage values on this shot. As stated above, however, calculations indicate that the short circuit was probably in the neighborhood of 190,000 kv-a. Fig. 10 shows how the breaker tank was dropped on this shot, leaving the contacts exposed to the air. In this view is also shown the break in the cover casting as well as the two halves of the rivets which hold the tank to the angle iron ring at the top and which were sheared off, thus allowing the tank to drop. The arcing at the exposed contacts of course immediately turned into a short circuit, igniting the oil and causing the back-up breaker to open. Although not visible in the picture the lower half of one of the bushings was stripped of porcelain by the arc.

It is regrettable that no determination was possible as to the amount of capacity the breaker could actually interrupt or as to whether the design could be reinforced sufficiently within economic limits to give it a rupturing capacity of 250,000 kv-a. It was definitely determined, however, that the breaker was not up to its rating.

TESTS ON REYROLLE TYPE C 1-ORD-7000-VOLT OIL CIRCUIT BREAKER

The Reyrolle armor clad compound filled switchgear, is shown in Fig. 16. The upper enclosed compartment contains the bus while the lower compartment just beneath the bus contains the built-in current transformers.

This breaker was purchased subject to meeting the guaranteed rupturing capacity of 75,000 kv-a. at 2300 volts. To determine this, arrangements were made to

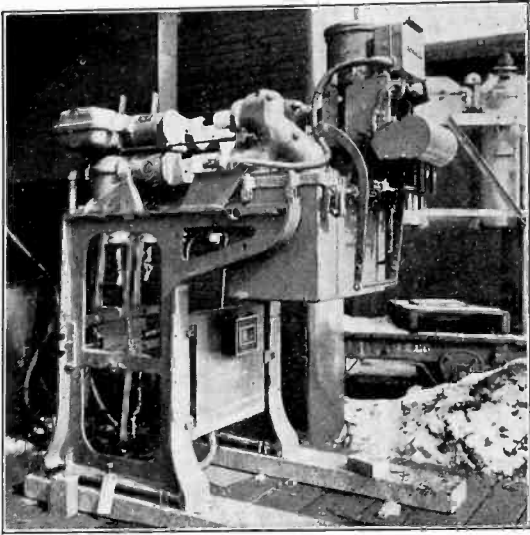

FIG. 16—REYROLLE TYPE C1-ORD—7000-VOLT COMPOUND FILLED SWITCHGEAR SET-UP FOR TEST. SWITCH RACKED OUT

test one of these units at the factory of the General Electric Company at Schenectady using the regular testing equipment consisting of the 26,700-kv-a., 25-cycle test generator and auxiliary equipment.

It was planned to give this breaker 2300-volt tests consisting of standard duty cycles at 40,000 kv-a., 60,000 kv-a., and 75,000 kv-a., followed by 6600-volt tests at 75,000 kv-a. and 100,000 kv-a. On the first duty cycle in which the breaker opened 39,200 kv-a. no distress was evident beyond the hissing sound of escaping oil and gas.

The second duty cycle on which 58,000 kv-a. and 45,700 kv-a. respectively were obtained on the two shots, was handled by the breaker apparently as easily as the first duty cycle. Upon lowering the tank, however, it was found that the wooden barriers separating the three poles were broken from their fastenings and displaced, the screws fastening these barriers to the tank lining at the side and at the bottom having been torn out of the wood. Also considerable burning was disclosed on this test, both on the arcing contacts and somewhat on the main contacts.

On the final duty cycle at 2300 volts the breaker successfully cleared a short circuit of 100,000 kv-a. on the first shot and 64,300 kv-a. on the second shot. Before these two tests were made the wooden barriers, found broken after the last test, were repaired and replaced and new oil was supplied to the breaker.

The oscillograms for this duty cycle show that on test No. 5 the total duration of current was only about $1\frac{1}{3}$ cycles as against $3\frac{1}{2}$ cycles for test No. 6. The reason for the short duration and consequent high value of current on test No. 5 was the fact that the d-c. time delay relay used as part of the regular station testing equipment for tripping the test breaker was not reset after the last test, resulting in energizing the trip circuit of the test breaker as soon as the auxiliary contacts closed. This relay was properly reset before test No. 6 so that the normal duration of short circuit and the smaller value of current were obtained.

The wooden barriers found broken after test No. 4 and repaired prior to test No. 5 were again found completely broken from their fastenings and displaced after test No. 6. As before, the arcing contacts, both upper and lower, were quite badly burned and considerable burning was also evident on both the upper main contacts and on the lower contact bar.

Before proceeding with the test at 6600 volts it was decided, due to the badly burned condition of the arcing contacts after the preceding six shots at 2300 volts, that new arcing contacts, both upper and lower, should be made up and installed, that the main contacts should be carefully dressed, and that new wooden baffles should be made up and fastened in the tank. New oil of course was supplied.

Based on a duration of short circuit of seven or eight cycles for which the time delay relay was set, the generator circuits were arranged to give a calculated value of 75,000 kv-a. for test No. 7. However, the short circuit lasted only $2\frac{1}{2}$ cycles instead of seven or eight,

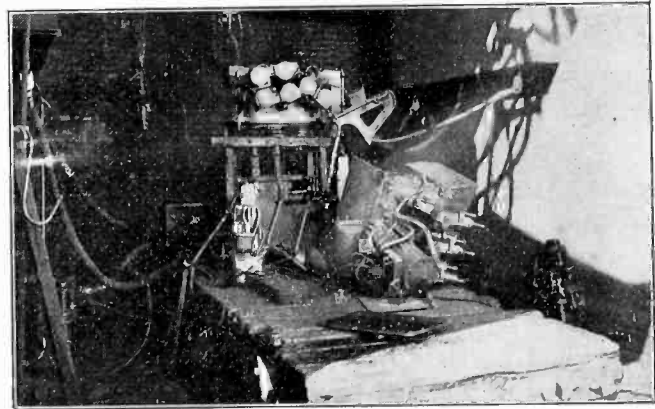

FIG. 17—REYROLLE SWITCHGEAR AFTER TEST NO. 7

and the kv-a. which the breaker attempted to open was 122,000. The oscillogram shown in Fig. 15 bears evidence that the short circuit actually was cleared for a period of seven cycles after which complete failure and blow-up of the breaker took place. Apparently the breaker cleared the short circuit but the gas pressure was so great that the tank was completely ruptured, one side being thrown against the exposed 6600-volt temporary terminals underneath the current transformer chamber causing a short circuit which immedi-

ately set fire to the oil. The appearance of the breaker after the fire had been put out is shown in Fig. 17. The force of the explosion which ruptured the tank was so great that the tank was split not only along the welded seams but on two edges where the steel had been bent but not welded.

The rupturing capacity of this switch was exceeded by more than 60 per cent on test No. 7 at which value the result obtained might well have been expected. On test No. 5, on the other hand, the breaker successfully opened 100,000 kv-a. at 2300 volts, which, aside from the breaking of the barriers and rather extensive burning of the arcing contacts (the contacts tested were not designed for 2300 volt service), ought certainly to be considered a creditable performance.

Although the breaker more than met its guaranteed rupturing capacity, certain design features which were standard with the manufacturers on breakers of heavy duty were incorporated in the breakers actually installed, the principal ones being those of increasing the thickness of the tank from $\frac{1}{4}$ in. to $\frac{5}{16}$ in., increasing

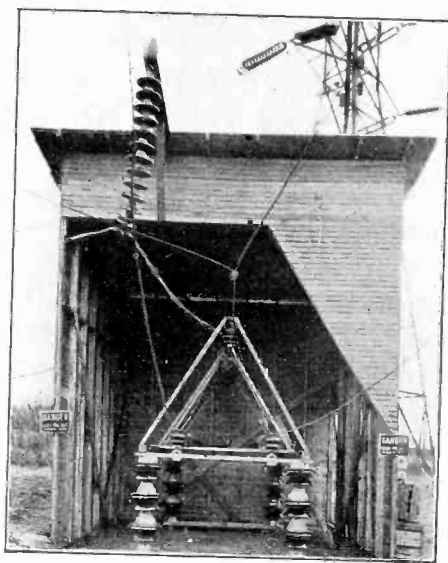

FIG. 18—HOUSE BUILT FOR SHELTERING THE GENERAL ELECTRIC OSCILLOGRAPH SHUNTS AND PROF. DYCHE'S CURRENT TRANSFORMER

the depth of the tank two in., and the substitution of a much heavier butt type-arcing contact and the employment of steel barriers over which is placed a wooden lining instead of wooden barriers fastened to the tank lining.

TESTS ON GENERAL ELECTRIC 132-KV. OIL CIRCUIT BREAKERS

Tests on the FHKO-39-B 132-kv. Breaker. For these tests three oscillographs were furnished by the General Electric Company, one of which was mounted on a platform insulated for 132,000 volts, so as to permit recording three line currents from shunts placed directly in the line for both grounded and ungrounded short circuits. In addition to these three oscillographs a fourth machine, Professor Dyche's, was provided in order to obtain parallel records of

voltages and current, the latter by means of the same current transformer used in the previous Brown Boveri tests. The method of mounting the shunts on an insulated triangular frame work, is shown in Fig. 18.

In an attempt to duplicate as nearly as possible on the FHKO-39-B the tests carried out on the Brown Boveri 150-kv. breaker, the program for testing consisted of a preliminary trial shot followed by a series of eight shots in rapid succession at approximately one-fourth the rating of the breaker, a standard duty cycle at full system capacity, a special duty cycle consisting of 2-CO shots with two-minute interval to obtain a shorter duration of short-circuit current, and finally several special duty cycles including a series of 7-OCO shots, also with full system capacity. Most of these tests were to be made with the short-circuit point grounded, permitting the taking of records both on the shunts and on the current transformer with its limited insulation.

Table III (abridged) gives the results of tests on the 39-B breaker, including data from both the General Electric Company oscillographic equipment and Professor Dyche's equipment.

During all of the tests on this breaker no inspections of the contacts were made at any time. After the completion of tests 10 and 11 which were the first tests using the full capacity of the system, oil samples were drawn from the middle of each tank and from the bottom of tank No. 1. Dielectric tests on these samples gave for tank No. 1, 24.5 kv. average; for tank No. 2, 21.3 kv.; for tank No. 3, 27.6 kv.; and for the oil drawn from the bottom of tank No. 1, 11 kv. No change was made in the oil.

The special duty cycle of seven shots at one-minute intervals was then successfully carried out as shown under test Nos. 14 to 20 inclusive in the table. All of the shots were cleared by the test breaker with no evidence of distress, with no throwing of oil, and with very little smoke visible, except on test No. 17 when No. 3 tank gave off quite a puff of smoke. This tank, however, as well as the other two tanks, did not give off more than a small amount of smoke on any other tests and the inspection following the completion of the tests did not reveal any unusual condition in No. 3 tank.

In order to obtain a higher value of current by decreasing the total duration of the short circuit, a duty cycle consisting of 2-CO shots was made as covered by test Nos. 21 and 22. While this type of duty cycle did decrease the total duration of short circuit to approximately 30 one-half cycles, the increase in ruptured kv-a. was not very large.

All of the shots up to and including test No. 22 were made with the short circuit grounded. The remaining four shots, tests 23 to 26 inclusive, were then made with the short circuit ungrounded, so that it was necessary to disconnect the current transformer supplying Professor Dyche's oscillograph and confine further

oscillographic records to the General Electric equipment, the current recording oscillograph being mounted on a platform insulated for 132,000 volts.

At the conclusion of the tests the oil was immediately drained from the tanks and the contacts from phase 3, which had given off the puff of smoke on test No. 17, were removed from the tank. It was found that the burning was confined almost entirely to the arcing ring below the current-carrying segments and that the burning of the rod was confined to the arcing tip and was such that no beads or pits were left which might cause the rod to stick in the contacts. It was quite

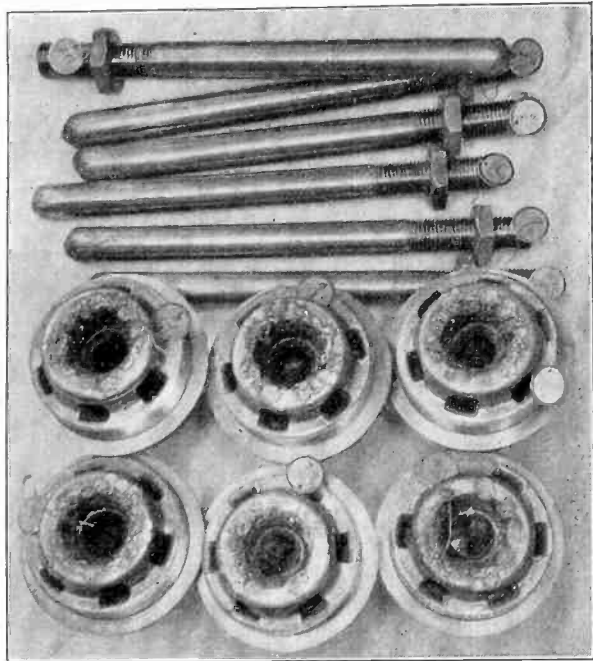

FIG. 22—FULL SET OF CONTACTS FROM FHKO-39B BREAKER AFTER COMPLETION OF TEST NOS. 1 TO 26

evident that the contacts were in sufficiently good condition so that without any dressing at all the breaker could have been kept in service and carried its rated current even though 26 short circuits had been interrupted, 17 of them at full system capacity.

Fig. 22 shows all six contacts and contact rods taken from the FHKO-39 breaker after the completion of the tests. A comparison of one of these rods with a new rod showed that the arcing had burned away only a small part of the arcing tip and that the burning was fairly smooth and without beads. The average test on the oil taken from this breaker after the completion of the tests was 19.25 kv.

Tests on the FHKO-136B 132-kv. Breaker. After the completion of the tests on the FHKO-39B breaker, tests were made on the 136B which, as previously mentioned, was connected in series with the 39B, the latter then being used as a back-up breaker.

On account of the difficulties encountered in testing the 136 breaker, these tests were spread out over a considerable period of time and divided into three series, the first taking place on December 6, 1925,

the second on January 10, 1926, and the third on May 23, 1926.

It was planned to subject this breaker to a series of eight OCO shots in rapid succession at approximately one-fourth of the breaker rating followed by one or more standard duty cycles at the full system capacity, and then to carry out one or more special duty cycles, such as four shots at full system capacity with one-minute intervals.

The first attempt to carry out the above tests on this breaker was made on December 6, 1925. After subjecting the breaker to a trial shot and three of the proposed series of eight shots at approximately one-fourth of the breaker rating, the breaker failed by splitting open along the welded seam at the bottom of the middle tank, permitting the oil in that tank to escape. The character of this failure is clearly shown in Fig. 25 in which the tank is suspended and the view is from below.

While there was no conclusive evidence to show whether the electrical puncture encountered on the throat bushings during the test of December 6 was caused by mechanical failure or was the cause of the mechanical failure, at the same time there is a slight preponderance of evidence, especially after an analysis of the tests of May 23, that would show that mechanical failure preceded electrical failure. Following out this theory a new assembly for the explosion chamber parts, including the insulating shield, was worked out. The principal new features are, first, that the insulating cylinder is supported at the bottom again by means of fibre screws but tapped directly into the steel pot and kept quite separate from the explosion throat. Further, although not shown in the sketch, the number of these

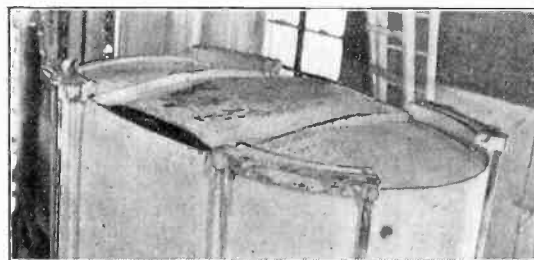

FIG. 25—MIDDLE TANK OF 136 B AFTER TEST NO. 31 SHOWING ACTUAL OPENING WHERE WELDED SEAM FAILED

supporting screws was increased from six used originally, to 12 in the new assembly. Second, an entirely new part was installed consisting of two wooden rings, one at the top of the steel pot and the other at the bottom, exactly filling the space between the inner insulating cylinder and the steel at these two points, thus taking all cantilever strain off from the lower end of the cylinder. These two upper and lower wooden rings are joined together by several connecting wooden uprights making a rigid structure.

With these changes carried out the third series of tests on the 136B breaker was arranged for May 23, 1926.

TABLE III (Abridged)
RESULTS OF TESTS ON GENERAL ELECTRIC TYPE FHKO-39B, 135-KV. BREAKER

Duty cycle and system set-up	Test number	Test voltage	Recovery volts across pole 2				Current				Arc length inches	Duration of short 1/2 cycles	Short-circuit kv-a.		Remarks		
			G. E. Co.		Dyche		Closing		Initial in arc r. m. s.				Closed G. E. Co.	Opened Dyche			
			Peak volts	Per cent initial	Peak volts	Per cent initial	G. E. Co. Peak R.M.S	Dyche Peak R.M.S	G. E. Co.	Dyche							
													Total	Arcing			
7-000 1-min. interval except between No. 17 and No. 18-2 min. to change film. Full system†	14	132,000	66,700	62.5	74,700	69.3	7550	4375	8920	4900	2220	2360	2290	1,080,000	538,000	640,000	Opened O. K.
	17	132,000	78,000	73.0	No. Dyche film	..	7025	4180	2780	2960	2840	965,000	675,000	..	Opened O. K. Puff of smoke Tank No. 3.
	20	132,000	*81,000	75.5	90,000	83.5	5700	3740	7890	4570	2780	2980	2870	970,000	680,000	789,000	do
4-000 2-min. interval full system† short circuit ungrounded.....	23	132,000	*63,700	59.5	No Dyche film	..	5700	3580	2625	2840	2740	1,100,000	650,000	..	do
	26	132,000	*86,700	80.6	Do	..	7170	4220	3010	3010	..	965,000	690,000	..	do

*Obtained from line voltage (arc voltage record N. G.)
†"Full System" means the set-up shown in Fig. 4 minus the 22,000-kv-a. generator at Akron.

TABLE V (Abridged)
RESULTS OF TESTS ON GENERAL ELECTRIC TYPE FHKO-136 B-135-KV. BREAKER, MAY 23, 1926

Duty cycle and system set-up	Test number	Test voltage	Recovery volts across pole 2				Current				Arc length inches	Duration of short 1/2 cycles	Short-circuit kv-a.		Remarks		
			G. E. Co.		Dyche		Closing		Initial in arc r. m. s.				Closed G. E. Co.	Opened Dyche			
			Peak volts	Per cent initial	Peak volts	Per cent initial	G. E. Co. Peak R.M.S	Dyche Peak R.M.S	G. E. Co.	Dyche							
													Total	Arcing			
2-000 2-min. interval. Full system.....	50	173,000	95,000	85.0	118,200	105.0	6550	3800	4840	3140	2440	2590	2590	901,000	615,000	582,000	Cleared easily. Moderate jar.
	51	137,000*	82,000	73.0	98,700	86.3	*4570	3040	5620	3270	2440	2540	2540	780,000	602,000	592,000	Ditto
2-00 2-min. interval. Full system ungrounded short circuit.....	64	5500	3160	2590	2640	2640	765,000	625,000	..	Opened O. K. Slight smoke.
	65	4450	3010	2590	2640	2590	772,000	625,000	..	Opened O. K. Some smoke.

*Values obtained from CT in series with shunt in line No. 2.
†No arc voltage record, values assumed.

The testing arrangements on this series were the same as on the last, with the exception that the system capacity available was somewhat less, the calculated value of short circuit available at 0.16 sec. after the beginning of the short circuit being reduced from 775,000 kv-a. to 685,000.

The results of this final series of tests on the 136B breaker, made on May 23, 1926, are summarized in Table V (abridged).

The program for testing was laid out in the same manner as that which had been attempted for the two preceding series. After making the preliminary trial shot to determine whether all oscillographic equipment was functioning properly, the series of 8-OCO shots at approximately one-fourth the breaker rating in rapid succession was begun. No distress was apparent on any of the shots, only a slight trace of smoke being visible and no oil being thrown.

The next test was a standard duty cycle of 2-OCO shots with a two-min. interval at the full system capacity available. Following this a duty cycle consisting of 2-CO shots with a two-minute interval was given to the breaker with the idea of obtaining a somewhat higher current due to decreased time between the beginning of the short circuit and the first half cycle of arcing. This procedure did result in increasing the current from approximately 2300 to approximately 2500 amperes. On both of these duty cycles, which include tests 48 to 51, the short circuit was cleared without signs of distress on the part of the breaker.

As a special duty cycle with a larger number of shots at closer intervals, the breaker was subjected to 4-CO shots at one-min. intervals with the maximum system capacity available. These four shots which averaged 600,000 kv-a. interrupted were handled without any distress by the breaker.

After these tests a number of additional shots were taken with the short circuit ungrounded. An attempt was made also to further increase the short-circuit current by means of CO shots on which the test breaker was tripped through an auxiliary switch on the KO39 back-up breaker, thus decreasing the total duration of the short circuit. The first series made in this manner consisted of 4-CO shots at one-min. intervals. It was found, however, that the adjustment of the auxiliary switch trip on the back-up breaker did not speed up the tripping of the test breaker as much as had been anticipated.

The next series of tests consisted of 4-OCO shots at one-min. intervals at full system capacity, all of which were opened easily.

In a final attempt to approach nearer to the rating of the FHKO-136B test breaker a further adjustment was made on the auxiliary switch of the 39B back-up breaker so as to speed up considerably the tripping of the test breaker. With this adjustment and with the system still ungrounded a final duty cycle consisting of 2-CO shots at two-min. intervals was carried out. The

attempt to speed up the tripping was quite successful in this case as the total duration of short circuit was reduced to approximately 31 half-cycles and the interrupted kv-a. was increased to 625,000, a larger value than on any of the previous shots. These shots were handled by the breaker with no distress, only a small amount of smoke being given off and no oil being thrown.

After the completion of the tests, samples of oil were drawn from the middle of the tanks and tested for dielectric strength, averaging 15 kv. as against approximately 30 kv. obtained for the original oil. Upon draining the oil and inspecting the interior of the tanks



FIG. A

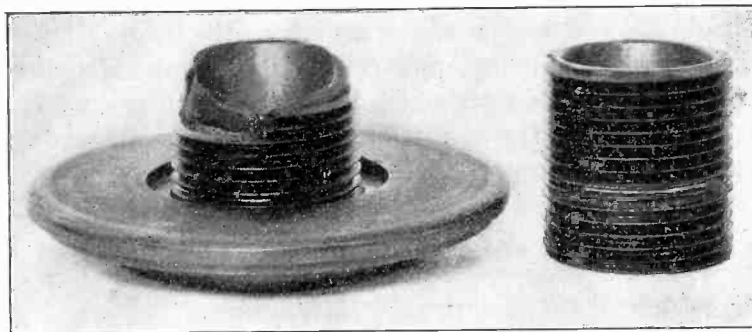

FIG. B

FIG. C

FIG. 26—(A) THROAT BUSHING AND INSULATING COLLARS TAKEN FROM 136B BREAKER AFTER FAILURE ON TEST NO. 31

(B) SAME THROAT BUSHING WITH ONE COLLAR REMOVED SHOWING WHERE PUNCTURE OCCURRED

(C) THROAT BUSHING FROM OPPOSITE SIDE OF SAME POLE SHOWING BURNING

it was found that all of the insulating cylinders around the explosion chambers were in place and that no damage had been done to any of the throat bushings. The burning of the contacts which is shown in Fig. 34 was found to be confined almost entirely to the arcing tips of the contact rods and to the arcing bell of the explosion chamber, the contact segments themselves being in a very clean condition.

The tests were discontinued of course for that day and the tanks opened to permit examination of the contacts.

It was found that one of the insulating cylinders normally surrounding the explosion chambers had broken from its fastenings and was lodged on the cross-

head. The other insulating cylinder in this pole had not fallen down but was partially broken from its fastening. It was apparent also that the explosion chamber insulation had failed, permitting the arc to cut through the throat bushing to the lower edge of the steel explosion chamber. Fig. 26A shows the broken throat with insulating collars in place. Marks on one of the fibre rings show evidence of burning by the arc. Fig. 26B shows the same throat bushing with one collar removed, revealing the place where the arc punctured through.

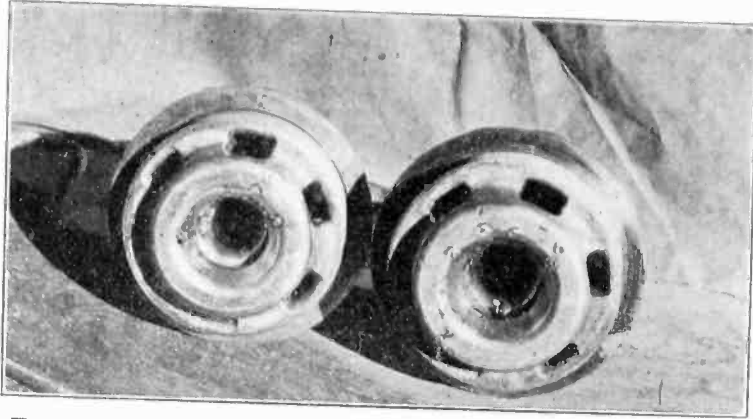

FIG. 27—CONTACTS FROM 136B BREAKER AFTER TEST NO. 31

Another throat bushing also bearing evidence of puncture is shown in Fig. 26C. The steel explosion chamber itself showed marks of the arcing on the inside edge of the bottom opening, and retained the imbedded half of the six fibre screws which were broken off and which, together with the explosion chamber throat bushing, were used to support the insulating cylinder around the explosion chamber. The contacts taken from this

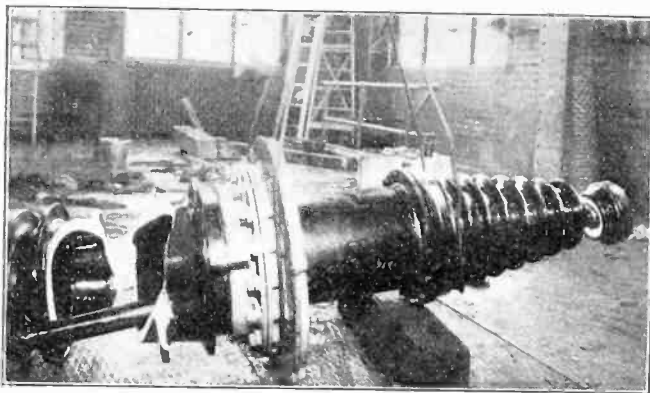

FIG. 30—BUSHING FROM POLE NO. 3 OF 136B BREAKER AFTER TEST NO. 35. NOTE BREAK AT LOWER END

breaker, two of which are shown in Fig. 27, indicated by the small amount of pitting that the actual short-circuit duty was very light.

In going over such evidence as was available as to the cause of the breaker failure, two things were apparently certain; first, it seemed established beyond a doubt that material used in the throat bushing was inadequate from the standpoint of dielectric strength and perhaps also from a mechanical standpoint; and second, the tank, and particularly the weld, seemed to be weak. The

first, that is, the faulty bushing, through its electrical breakdown, probably caused the mechanical breakdown which in turn ruined the explosion chamber assembly and at the same time allowed open arcing with the result that there was created a pressure sufficiently high to open a weld which was none too strong in the first place.

The tanks were returned to the factory and rewelded, a stronger weld being employed in the new set-up. New types of throat bushings slightly different in design but principally different in the employment of new material, supposedly stronger from a mechanical and electrical standpoint, were also supplied. The breaker, embodying these changes, but no others, was submitted to a second series of tests on January 10, 1926.

The results of this series of tests, proved to be almost an exact repetition of the results obtained on the previous series, with the exception that the failure on the third shot of the proposed series of eight was evidenced by the breaking of a 132-kv. bushing on the high side



FIG. 34—ARCING BELL COMPARISON OF NEW AND USED CONTACT ROD, AND EXPLODED VIEW OF CONTACT SEGMENTS TAKEN FROM ONE POLE OF 136B BREAKER AFTER TESTS 36 TO 65

of the breaker, permitting oil to leak out, and by a sharp report with fire issuing from the vents on pole 3.

The second series of tests being thus ended, the oil was immediately drained from the tanks and the interior examined. As in the case of the failure on December 6, it was found that the insulating cylinders on both the explosion chambers in No. 3 tank (the one on which the bushing was broken) were broken from their fastenings and both were down on the cross head. It was noted also that this tank showed considerably more bulging than the other two. Upon removing the explosion chambers from all of the tanks it was found that throat bushings were again broken in both No. 2 and No. 3 tanks. In this case, however, the breaks were such that it did not seem possible that they were caused by electrical puncture. The manner in which the high-voltage bushing was broken is illustrated in Fig. 30, the break at the lower end of the bushing not being discovered until the bushing was taken apart.

The final explanation adopted as the reason for the failures of December 6 and January 10, and the one which served as the basis for the changes that were made prior to the tests of May 23, was as follows:

The fairly long insulated cylinder placed over each explosion chamber was supported only and entirely at

the bottom, partly by means of a number of fibre screws tapped into the bottom of the steel explosion chamber and partly by the explosion chamber throat itself. When the breaker opened on short circuit the generation of gas caused some internal pressure, throwing oil against the flat sides of the tank and springing these sides out to a certain extent. On the rebound the oil was made to exert force in the opposite direction causing considerable thrust against the insulating cylinders over the explosion chambers. Since these long insulating tubes were supported only at the bottom, the cantilever strength was insufficient to withstand this shock and the supports had to give way, thus breaking the explosion chamber throat and allowing the cylinder to drop.

The authors desire to acknowledge the great assistance and cooperation they have received in the carrying out of these tests, and without which the tests would have been impossible, from the Cleveland Electric Illuminating Company, The Northern Ohio Power and Light Company, The Ohio Public Service Company and the West Penn Power Company whose systems

were either tied in with the test circuit or through whose cooperation in carrying a certain portion of the load it was possible to make available the capacity gathered together for the tests.

The authors also wish to acknowledge the great help received from the American Brown Boveri Corporation and from the Reyrolle Company in furnishing the switches and assisting in the tests and to the General Electric Company for their cooperation in the making of the Reyrolle tests and for furnishing the switches, the test equipment and operators, and for other assistance rendered in connection with making the tests on their breakers. Finally, acknowledgment is due to the operating department of The Ohio Power Company and Professors H. E. Dyche and E. R. Rath for their great help in making and recording the tests.

The complete paper gives many additional illustrations, including typical oscillograms, schematic diagrams of test setups, complete one-line diagram of system setup for tests, unabridged tables of results of all tests, as well as considerable additional descriptive data and discussion of the results of the test.

Circuit Breaker Development

BY R. M. SPURCK¹

Associate, A. I. E. E.

Synopsis.—This paper tells of (1) conditions which govern the design of a breaker of a given interrupting capacity, (2) the standardization that has been accomplished in rating breakers, and

(3) trends in the design of breakers constructed to meet operating requirements.

* * * * *

GENERAL

THE title of this paper might be construed to limit it to a discussion of detailed design improvements of a particular line of breakers. A somewhat broader view of the situation has been taken, however, it being intended to discuss in general, first, oil circuit breaker design problems; second, the standardization that has been accomplished; and third, the general trend of design and design activities to meet operating requirements.

The oil circuit breaker design problem has been discussed many times and various phases of it have been analyzed. In order to provide an introduction to the standardization discussion and to form a background for the description of the design details and design trend, it is proposed to summarize some of the more important features that are considered in the successful designs of oil circuit breakers that are now available.

DESIGN PROBLEMS

Of all the design problems of oil circuit breakers,

1. Switchboard Engg. Dept., General Electric Co., Schenectady, N. Y.

Presented at the Regional Meeting of District No. 2 of the A. I. E. E., Bethlehem, Pa., April 21-23, 1927.

including insulation, current-carrying ability and the like, the one relating to interrupting capacity ratings is probably of most interest. The standardization rules of the A. I. E. E. state:—"The interrupting rating of an oil circuit breaker is a rating based on the highest r. m. s. current at normal voltage the breaker can interrupt under the operating duty specified. The current value taken shall be that existing during the first half-cycle of arc between the contacts during the opening stroke." This specifies the basis on which ratings shall be made. It is the designers' problem to determine what features and to what extent those features contribute to the production of interrupting ability and to combine those features in an economical design in such a way that the specified interrupting performance will be the result.

The economical attainment of interrupting ability of an oil circuit breaker is fundamentally a question of control of the gas formed during specified conditions of circuit interruption. Broadly, when contacts are separated under oil, gas is formed in varying quantities until the circuit is interrupted. It is this gas formation that produces pressures in the breaker structure; so we must first use all the principles at our command to re-

duce the amount of gas formed and then provide adequate means for handling the gas that results. It is also an accomplishment from a design standpoint to make use of the gas as it is generated to produce some beneficial result in interrupting the circuit and to limit the amount of formation, under particularly specified conditions, to a small variation.

In order to expand some of the principles laid down in the preceding paragraph, and to lay the foundation for further discussion, a short summary will be given of a conception of how an oil circuit breaker functions in interrupting an alternating current.

As contacts separate under oil, an arc is formed. This arc stream is considered to have dielectric strength or, stating it more simply, a certain number of volts per inch of length is required to cause current to flow. Obviously, then, the total voltage required to cause current to flow through the arc path will increase with the length of that path; that is, it will increase as the contacts continue to separate. Interruption will finally occur when the contacts have separated to such an extent that the arc path has sufficient insulation strength to resist the voltage tending to reestablish the arc as the current wave passes through zero. The only place where this reestablishing voltage actually appears on an oscillogram, as ordinarily taken, is during the first half-cycle after the current has been interrupted.

If such a description of the principles of arc interruption under oil is accepted, it would be expected, of course, that the circuit would be interrupted or the current wave would disappear only at some zero point or at some point closely approximating zero. That is exactly what does happen except in some very unusual cases, and in view of this fact, it is obviously of interest to learn more about the reestablishing voltage, particularly at those instants when the current wave passes through zero.

The studies that have been made during the last few years have resulted in a determination of the conditions that give maximum reestablished voltage. The conditions which produce the maximum voltage are those occurring during a phase-to-phase short circuit, not involving ground and in which the voltage tending to reestablish is 90 deg. ahead of or behind the current. This does not consider over voltages of a transient nature at frequencies materially different from the normal frequency of the current. Such a short circuit can be obtained on any type of system whether grounded or ungrounded.

It will be seen, therefore, that it is essential to introduce insulation into the arc path as rapidly as possible. It is furthermore necessary to have the maximum contact separation such that the insulation introduced in the arc path is of such a value that the circuit will be interrupted by the insertion of this insulation before the contacts reach the maximum open position.

It has already been stated that gas is formed by an

arc under oil. This gas, which is a mixture of hydrogen, methane, and other gases, remains in the form of gas and does not condense. In order to prevent oil throw, breaker structures must be closed. It is necessary, therefore, to provide air space in the structure above the oil to accommodate the gases until they can be permitted to escape through openings provided for them. At this time, it may be proper to explain that the formation of gas during circuit interruption is so rapid that no reasonable openings would permit the gas to escape as rapidly as formed. Hence the need of having an air space as a reservoir for the gas to accumulate in, during the period that the gas is generated, at a rate which exceeds the rate at which it can be released from vents of a practical size.

It develops, then, that after having determined the break distance required, it is necessary, in order to produce a proper design, to have data on the amount and rate of gas formation so that the air reservoir and breaker structure can be designed with strength sufficient to resist the pressure resulting from the gas formation.

Such data are determined experimentally by many tests under varying conditions in order to establish the maximum values. With such data, the structure can be designed to resist the forces that will result.

The preceding discussion shows that a great deal of experimental data must be obtained in order to arrive at design constants accurate enough to be used in the design of a breaker which will meet the interrupting ratings assigned to it. Much of the developmental work of the company with which I am associated has been along these lines. A factory testing equipment has been in use continuously for a number of years. In addition, field tests have been made on systems of the American Gas and Electric Company, Duquesne Light Company, Alabama Power Company, and the Northern States Power Company, at voltages ranging from 13,000 volts to 132,000 volts. These field data have been very useful in checking the factory data.

STANDARDIZATION

Through the efforts of the Electric Power Club, the National Electric Light Association, and the American Institute of Electrical Engineers, the following standard interrupting capacities have been agreed upon.

Standardization of this kind which limits designs to a reasonable number of steps of interrupting capacity has already done a great deal toward eliminating types and varieties and will do much more as new designs are brought out. Breakers which meet the A. I. E. E. interrupting rule and have the above mentioned interrupting ratings are available. Quotations have been made on designs of somewhat higher ratings, although the desirability from an operating standpoint of designing systems with such large short-circuit currents, especially at the moderate voltages, has been questioned.

In breakers of moderate and high interrupting ratings,

INDOOR BREAKER

Voltage rating	Interrupting rating Amperes at rated volts	Approximate kv-a.
4,500	2,500	20,000
7,500	2,000	25,000
15,000	1,500	40,000
"	2,500	65,000
"	3,500	90,000
"	5,000	125,000
"	7,000	175,000
"	10,000	250,000
"	14,000	350,000
"	20,000	500,000
"	30,000	750,000
"	40,000	1,000,000
"	60,000	1,500,000
"	100,000	2,500,000
25,000	1,200	50,000
"	3,000	125,000
"	8,000	350,000
"	12,000	500,000
"	17,000	750,000
"	24,000	1,000,000
"	36,000	1,500,000

OUTDOOR BREAKER

Voltage rating	Interrupting rating Amperes at rated volts	Approximate kv-a.
25,000	3,000	125,000
"	8,000	350,000
"	*12,000	*500,000
"	17,000	750,000
"	23,000	1,000,000
37,000	2,000	125,000
"	5,500	350,000
"	12,000	750,000
"	16,000	1,000,000
50,000	1,400	125,000
"	5,800	500,000
"	12,000	1,000,000
73,000	1,200	150,000
"	4,000	500,000
"	8,000	1,000,000
"	12,000	1,500,000
88,000	1,650	250,000
"	6,500	1,000,000
110,000	1,300	250,000
"	2,600	500,000
"	5,500	1,000,000
"	8,000	1,500,000
132,000	3,300	750,000
"	6,500	1,500,000
154,000	2,800	750,000
"	5,500	1,500,000
187,000	3,100	1,000,000
"	5,400	1,750,000
220,000	3,300	1,250,000
"	5,200	2,000,000

*Temporary standard step.

both indoors and outdoors, most operating companies recognize the desirability of having the breakers which do not throw oil. Breakers with this feature fully tried out are available. This characteristic is obtained by making the entire breaker structure pressure-tight and providing an opening through a baffle or separating chamber for the emission of the gas from the air space or gas reservoir, after interruption of the circuit has taken place. One type of separating chamber that has proved very effective is that consisting of a tube filled with small quartz pebbles. This tube containing the pebbles is the only opening from the air space to the outer air. To escape, therefore, the gas must pass around the pebbles. The gas as it flows around the pebbles is cooled and any oil that may be carried with it

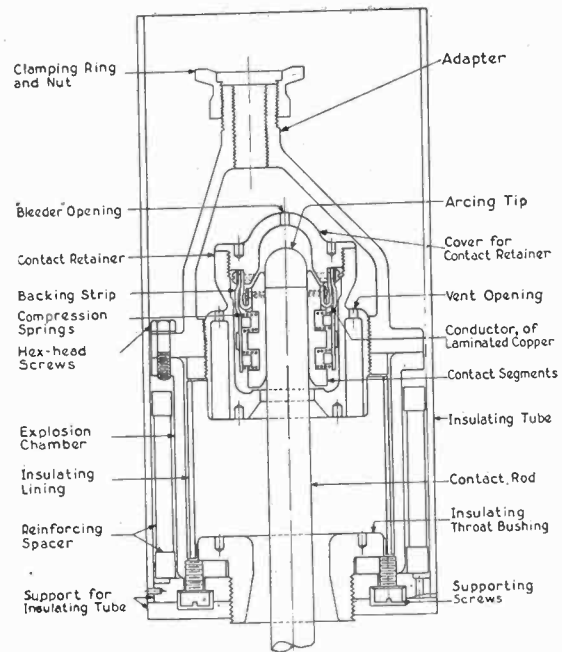

FIG. 1—CROSS SECTION OF AN EXPLOSION CHAMBER FOR OIL CIRCUIT BREAKER

is separated from the gas and eventually drains back into the breaker.

In addition to the study given to fundamental data and standardization, detail improvements have been made in the design, particularly in those features which reduce and control the gas formation.

The explosion chamber has been used on oil circuit breakers for a number of years. It consists of a steel chamber surrounding the stationary contact which is at the top of the chamber. The bottom of the chamber has an opening for the entrance of the movable contact. The outside and inside of the chamber, with the exception of the stationary contact, is insulated. This chamber and the contacts are so arranged that the arc started by the separation of the contacts when current is flowing is for a time entirely surrounded by the steel chamber. This arrangement has proved very effective in reducing the arc duration, controlling the gas formation, reducing the variation in gas formation under specified interrupting conditions, and finally in relieving

the pressure on the main tank. It is of interest that such advantages come from the use of the gas pressure in such a way that the insulation of the arc stream is artificially increased during the arcing period. The many tests that have been made on explosion chamber breakers have shown ways to still further increase their effectiveness.

A major improvement in the operation of the explosion chamber results from the addition of openings in the top of the chamber, for venting purposes. Such a chamber is shown in Fig. 1. The proportions of the chamber, area of vents, and size of opening at the

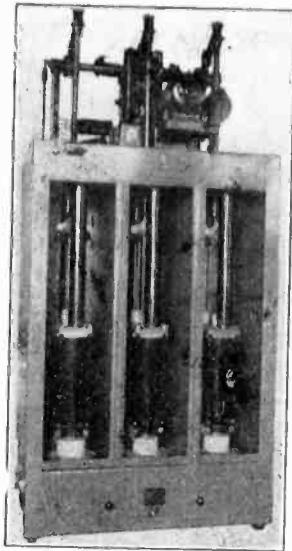

FIG. 2—INDOOR OIL CIRCUIT BREAKER TRUCK TYPE, 15,000 VOLTS.

Front view with doors removed.

bottom, are designed to give the maximum effect of the useful characteristics of the explosion chamber.

Where heavy current must be controlled, a segmental type contact for use in explosion chambers has been designed. The feature of this contact is that each segment is supported independent of the others. The pressure of the individual segmental contacts on the moving contact rod is obtained by heavy compression springs acting on these contacts. A contact of this type is shown in connection with the explosion chamber in Fig. 1. Here again factory and field tests have demonstrated the improvement in operation.

The improvements mentioned above have been included in the designs of breakers now being supplied. In the interest of brevity, however, no attempt will be made to show the entire details of all breakers now offered, but the general construction of some representative types will be shown. These will be of the moderate or high interrupting types. All are designed to be pressure-tight and are provided with separating chambers.

In the class of station breakers of the upward-break, two-break-per-phase type, no radical changes have been made since the type designed to prevent oil throw was introduced. Many of the details have been modified in order to give better operation. Also some

larger sizes having higher interrupting ratings have been produced. The standard line includes interrupting ratings from 14,000 to 30,000 amperes at 15,000 volts, or in round figures, 350,000 kv-a. to 750,000 kv-a. A breaker of this type, adapted to truck mounting, is shown in Fig. 2. This illustration shows a breaker mounted in a steel enclosing structure carried on a truck. The truck is provided with interlocks to prevent removal or replacement of the truck when the breaker is in the closed position. Additional interlocks for special purposes are also included.

Another type of station breaker is the tank type. Such breakers in the 15,000-volt ratings are available for interrupting ratings of 16,000 amperes to 60,000 amperes, or generally 400,000 to 1,500,000 kv-a. A typical design of a single-pole unit is shown in section in Fig. 3. The units are designed to be

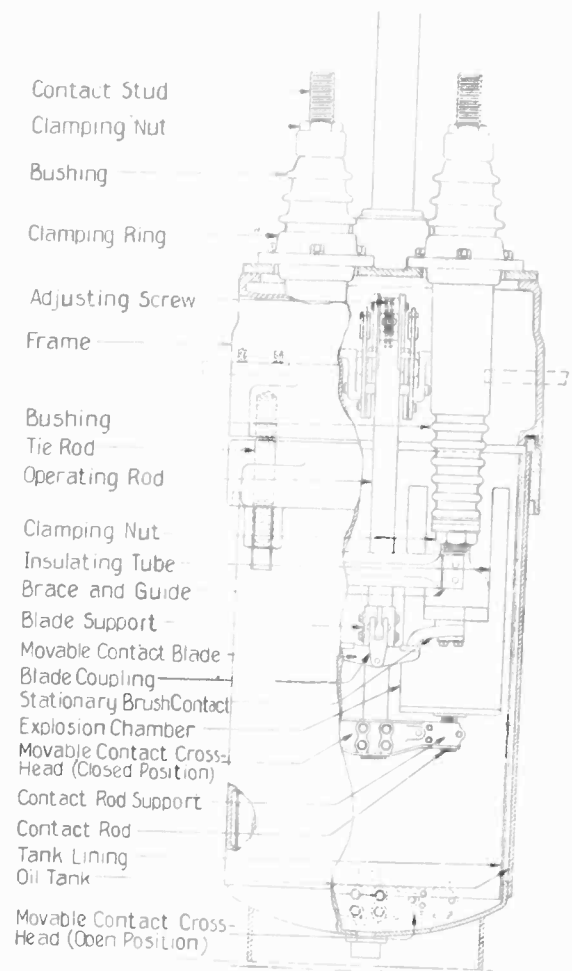

FIG. 3—SECTION OF ONE POLE OF THE BREAKER

adaptable to cell mounting for adjacent phase arrangement or for the vertical or horizontal isolated phase arrangements.

The 37,000-volt framework is mounted on a truck. The bushing current transformer leads are brought out in separate conduits to outlet boxes and then to a common box where they terminate at a terminal board.

The 154,000-volt breaker is of the floor mounted type, but trucks have been provided. The floor mounting applies to breakers of voltage ratings above 73,000 volts. The mounting is typical of all designs of

outdoor breakers, up to and including voltage ratings of 220,000 volts. Such breakers are available in all the standard interrupting ratings.

Operating mechanisms for all types of breakers have been improved in the mechanical details and their

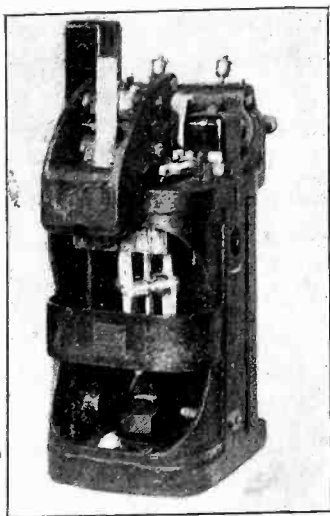

FIG. 4—CENTRIFUGAL TYPE MOTOR OPERATING MECHANISM FOR OIL CIRCUIT BREAKERS

reliability much increased. Some of the important features are the addition of rust-resisting finish to exposed metal parts, and the use of non-rusting metals for parts, such as bearings or latches, subject to excessive wear. Also, the line of centrifugal operating mechanisms has been extended so that mechanisms of this type are now available in sizes and capacities capable of operating the largest outdoor breakers,

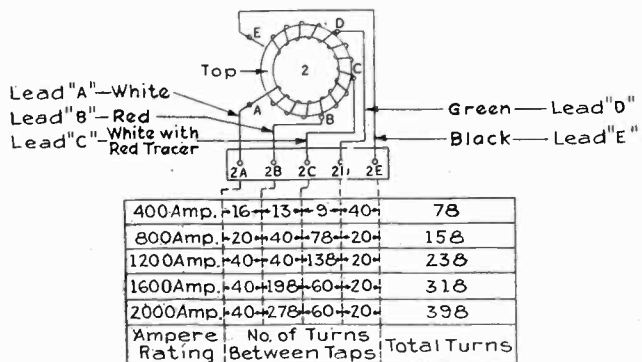

FIG. 5—DIAGRAM OF WINDINGS OF MULTI-TAP BUSHING CURRENT TRANSFORMER

including the 220,000-volt size, or indoor breakers of large size in the isolated phase arrangements. Fig. 4 is a representative design of a centrifugal operating mechanism.

One development that warrants description is the multiple-tap bushing transformer. In earlier designs, bushing transformer secondaries consisted of only one winding, although sometimes a tap was provided at the midpoint for some special purpose. With only one winding, it was necessary for the customer to give the manufacturer a great deal of data relating to ratios required and volt-ampere burdens to be used, before the

winding could be designed. To eliminate this difficulty transformers having a single winding with three taps, or five leads in all, were designed. The main problem involved was to proportion the number of turns so that when the characteristics of the transformer were considered, a wide range of ratios in moderate steps would be available. A schematic diagram of this transformer is shown on Fig. 5. By using various combinations of the taps a number of ratios are obtainable in transformers of this kind, as shown herewith.

Inasmuch as all five leads are brought out to one terminal board, it is very easy to select the ratio that is desired without resorting to the difficult task of removing the transformer and changing the winding.

As a summary, improvements in oil circuit breakers have been made on the basis of design obtained from many tests, and standardization of interrupting ratings has been accomplished. Breakers of the non-oil-throwing type, having reliable interrupting ratings, can be supplied in interrupting capacities required by operating companies. Accessories, such as operating mechanisms, have been made more reliable and better adapted to the service required of them. Bushing transformers of great flexibility in ratio and application have been designed. All these represent progress but indicate only briefly the results of a great deal of work.

BUSHING TRANSFORMER RATIOS

Trans. rating	Sec. turns	*Leads	Nominal ratio five ampere sec.	Max. V. A. burden	
400 Amperes	9	C-D	
	13	B-C	80	
	16	A-B	100	25	
	22	B-D	125	25	
	29	A-C	160	35	
	38	A-D	200	40	
	49	C-E	250	50	
	62	B-E	320	50	
	78	A-E	400	50	
	800 Amperes	20	A-B	120	25
40		B-C	210	40	
60		A-C	310	50	
78		C-D	400	50	
98		C-E	500	50	
118		B-D	600	50	
138		A-D	700	50	
158		A-E	800	50	
1200 Amperes		20	D-E	120	25
		40	A-B	210	40
	80	A-C	410	50	
	138	C-D	700	50	
	158	C-E	800	50	
	178	B-D	900	50	
	198	B-E	1000	50	
	218	A-D	1100	50	
	238	A-E	1200	50	
	1600 Amperes	198	B-C	1000	50
238		A-C	1200	50	
258		B-D	1300	50	
278		B-E	1400	50	
298		A-D	1500	50	
318		A-E	1600	50	
2000 Amperes	278	B-C	1400	50	
	318	A-C	1600	50	
	338	B-D	1700	50	
	358	B-E	1800	50	
	378	A-D	1900	50	
	398	A-E	2000	50	

*See Figure 5

Electrical Communication

Annual Report of Committee on Communication*

To the Board of Directors:

During the past Institute year, notable progress has been made in many branches of the art of electrical communication. The committee has selected for its report the items which were considered to be of most general interest and these are described under the various subheadings below.

TELEGRAPHY

In the field of printing telegraphy, there has been a considerable extension during the year in the use of the simplified tape printers on branch office circuits and in private offices of business houses.

Additional installations have been made of the automatic tape transmission system for telegraphic tickers mentioned in the 1926 report, and direct service and full market quotations have been extended through the southwest.

For trans-ocean traffic, a notable example among the permalloy-loaded cables laid during the year is the New York-Bay Roberts-Penzance cable. Multi-channel operation for direct traffic between New York and London is now in effect on this cable.

In the larger telegraph central offices, a system for automatically dispatching carriers in pneumatic tube lines is displacing manual dispatching. Space at the routing center is conserved, efficiency of operation is improved, and savings are effected in operating costs. In this system, a tube clerk drops a carrier containing telegrams for transmission to a branch office into the proper one of a group of open-end gravity tubes located in front of the working position. The gravity tubes lead to the floor below where the automatic sending inlets are located. The inlet contains a rotor which oscillates on a horizontal axis through an arc of about 70 deg. at the rate of about six times a min. The carrier enters a pocket in the rotor when it is in alignment with the gravity tube at one end of the rotor's travel. At the other end of the arc, the pocket containing the carrier is in alignment with the end of the outgoing tube. The rotors of a group of sending inlets are driven by one motor through reducing gears and crank mechanisms. Interlocking devices feed one

carrier at a time into each rotor and a visible signal is provided to indicate failure of any inlet to perform its function. Automatic sending inlets act as spacing devices in the transmission of carriers and eliminate trouble from overloading which occurs with manual sending on busy tubes. The average transit time from the main to the branch office is therefore generally decreased.

The great development of message telegraph systems involves interesting traffic problems, including layout of wires, traffic routing, office layout, operator assignment, etc. These problems were discussed in an interesting paper entitled, *Telegraph Traffic Engineering*, by Messrs. H. Mason and C. J. Walbran, which was presented at the Winter Convention.

Another very important telegraph subject which was discussed at the Winter Convention is the measurement of telegraph transmission (*Measurement of Telegraph Transmission*, by Messrs. H. Nyquist, R. B. Shanck, and S. I. Cory.) This subject has been of growing importance for a number of years, partly because of the advent of telegraph circuits having a large number of sections and partly on account of the increasing importance of accurately determining the effect on telegraph transmission of various amounts of interfering currents and of changes in individual circuit elements.

DIAL TELEPHONY

The rapid application of dial telephone systems has continued. During the year about 500,000 dial telephone stations were installed, bringing the total in service in this country, as of the first of January 1927, to approximately 2,400,000.

A means has been developed for remotely operating small magneto telephone plants where this is desirable. The name applied to this means is the semi-automatic magneto exchange. In a system of this type the subscribers' stations are equipped with magneto telephones. Connections are switched remotely by means of automatic telephone apparatus under the control of an operator, who employs a dial trunk from a control center into the exchange area. Any number of such exchanges may be controlled from the operating center.

TOLL TELEPHONE SERVICE

Further progress has been made in the development and application of methods for increasing the speed of toll telephone service. The plan, the so called A-B method, of handling the large volume of messages between nearby points in a manner quite similar to that used in handling local traffic, has been considerably extended. The improvement of service has progressed to a point where even at the longer hauls it is now possible in many cases to complete a toll call while the

*Committee on Communication:

H. P. Charlesworth, Chairman	D. H. Gage,	F. A. Raymond,
F. L. Baer,	S. P. Grace,	Chester W. Rice,
L. W. Chubb,	P. J. Howe,	J. K. Roosevelt,
J. L. Clarke,	F. H. Kroger,	H. A. Shepard,
Charles E. Davies,	Ray H. Manson,	J. F. Skirrow,
H. W. Drake,	R. D. Parker,	E. B. Tuttle,
Major P. W. Evans,	H. S. Phelps,	K. L. Wilkinson,
R. D. Evans,	Lt. Comdr. B. B. Ralston,	F. A. Wolff,
E. H. Everit,		C. A. Wright,
L. F. Fuller,		

Presented at the Summer Convention of the A. I. E. E.,
Detroit, Mich., June 20-24, 1927.

calling subscriber remains at the telephone. An important factor in this improvement is the development of a method of operation combining the work of the line and recording operators so that if the number of the called telephone is given the recording operator, she can proceed at once with the handling of the call.

A new type of toll switchboard has been made available for toll centers having sufficient traffic to require separate toll and local switchboards. The signaling equipment which was previously located in the cord circuits has been transferred to the line and trunk circuits and use has been made to a considerable extent of common positional equipment.

TELEPHONE TOLL CABLES

The year witnessed the opening on December 15, 1926, of a new long distance cable link between Chicago and St. Louis, insuring for the future the best possible storm protection for communication through from New York to St. Louis as well as between intermediate points. This cable forms a part of the network of cables connecting Chicago, Detroit, Toledo, Cleveland, Pittsburgh, and other cities with the cities on the Atlantic seaboard, and contains circuits for both very long-haul and short-haul telephone business. The longest circuits of the network are about 1500 mi. in length, but even this does not represent the maximum distance over which circuits of this type can be operated. Telephone repeaters on these circuits are spaced at intervals of approximately 50 mi. Echo suppressors are used to permit operating with volume efficiencies comparable with other long distance telephone circuits. Automatic regulators are employed to compensate for the effect of temperature in changing the attenuation of the cable conductors by suitable changes in the amplification of repeaters in the circuit.

The new link is 344 mi. in length. It provides more than 250 telephone circuits, and over 500 telegraph messages can also be sent simultaneously, making it the equivalent of 10 heavy pole lines of open wire.

The increasing development of toll cable networks is of extreme importance in the protection of telephone service from interruptions due to sleet storms. During the year 1926, about 2000 mi. of such cables were put in service in various parts of the country, adding more than 400,000 mi. to the telephone circuits of the nation.

CARRIER-CURRENT SYSTEMS

An interesting example of the rapidity with which new developments are finding their way into practical use is to be found in the extensive application of carrier-current telephony and telegraphy to the long distance open wire telephone circuits of the country. There are now of the order of 100,000 mi. of long distance telephone facilities provided by carrier methods and some 250,000 mi. of telegraph facilities so provided.

The recent growth in carrier-current circuits results from the progress which has been made in perfecting the

performance of the apparatus itself and in the development and standardization of methods for coordinating a large number of carrier systems upon the wires of a pole line.

During 1926, an interesting application of carrier telephony was made on one of the two Catalina Island telephone cables. Because of the relatively short length of these cables and of their transmission stability, it has been possible to obtain in this way as many as six additional two-way circuits, making a total of seven telephone channels and one telegraph channel on a single-conductor cable. The apparatus employed in this system is similar to that used on open wire lines. By an arrangement of this character, the loss of one of the cables would temporarily reduce the number of telephone circuits only from eight to seven. This system was described in a paper by Mr. H. W. Hitchcock which was presented at the Pacific Coast Convention in September.

The use of carrier-current telephony for communication on power transmission lines has increased appreciably. The power circuits involved vary from those of 22 kv. to 220 kv. and the distances communicated over vary from a few miles to those in the order of 300 mi.

The coupling to the transmission lines which in the earlier stages of the art was effected in some cases by means of parallel wires is now being accomplished very largely by coupling condensers or capacitors which are now available in several types for voltages up to and including 220 kv. Considerable progress has been made in the development of by-pass apparatus, repeater stations, portable equipment and various other supplementary pieces of apparatus. With the increased application of this form of communication, the demand is rapidly increasing for multiple communication channels, particularly in connection with the more extensive individual power systems where load dispatching is divided into districts and in the case of the rapidly growing number of transmission line interconnections between the large power systems.

TRANSCONTINENTAL TELEPHONY

An important event during the year was the completion of a new transcontinental telephone and telegraph route. The new route connects Chicago with Seattle by way of Minneapolis, Bismarck, Billings, Helena and Spokane. The through circuits comprise at the present time three telephone circuits and 14 superposed telegraph channels. The repeaters in use on these circuits represent the very latest development in this field.

There are now three transcontinental telephone routes in service, the others being routed, one through Omaha, Denver, Salt Lake City, and Sacramento, and one via St. Louis, Dallas, El Paso, Phoenix, and Los Angeles. A discussion of some of the more interesting transmission problems and other considerations which

are important factors in determining the design of these facilities was presented at the Pacific Coast Convention at Salt Lake City last September in a paper by Messrs. H. H. Nance and O. B. Jacobs entitled *Transmission Features of Transcontinental Telephony*.

LOADING OF TELEPHONE CIRCUITS

An outstanding development in loading coil design which has been put into commercial use in the past year is the use of permalloy in compressed powdered form in the cores of some types of these coils. The application of this desirable magnetic material has resulted in material reductions in both the size and cost of loading coils. The lower cost of loading resulting from this and the other improvements in loading coils referred to in last year's report is, together with the large installations of toll cable in this country, bringing about a very large increase in the use of loading coils.

ELECTRICAL AMPLIFICATION

In the development and application of amplifiers, there is sometimes occasion for amplifying extremely weak signals. Considerable interest attaches to the question of what limitation, if any, is imposed on the strength of the signals that can be amplified. Recent researches have shown that the limit of amplification may be set not by noises coming from the vacuum tubes or the batteries supplying them, but instead from the internal characteristics of the electrical conductors comprising the circuit whose minute currents are to be amplified. In any electrical conductor, minute electromotive forces are continuously produced by the thermal agitation of the electrons and atoms. This is true whether or not external electromotive forces are connected to the conductor. When an electrical conductor is connected to the input of a carefully built amplifier of sufficiently high amplification, readily audible sound may be heard in a telephone receiver connected to the output of the amplifier. The fact that the noise does not come from the amplifier can readily be proved by cooling the conductor by means of liquid air, when the noise heard in the receiver immediately diminishes in intensity, the reduction in noise being due to the reduced thermal agitation in the conductor. The laws underlying this phenomenon were determined experimentally by Mr. J. B. Johnson and presented in a paper at the December 1926 meeting of the American Physical Society at Philadelphia. These laws were later deduced from thermodynamical considerations and presented by Mr. H. Nyquist at the February 1927 meeting of the American Physical Society at New York.

CHARACTERISTICS OF SPEECH

The continued researches in the characteristics of speech and hearing and the nature of vocal and musical transmission have continued to give results of great importance for the improvement of telephone service,

and have also led to many noteworthy developments in allied fields. A very important development based on these researches is the combination of improved phonographic recording devices and high quality reproduction synchronized with motion pictures.

A paper by C. F. Sacia and C. J. Beck entitled "The Power of Fundamental Speech Sounds" published in *The Bell System Technical Journal* of July 1926 describes the continuing work in the study of speech power by means of the oscillograph. Sounds are considered individually on the basis of instantaneous and mean power. In earlier analyses, the principal emphasis was placed upon the power in speech as a whole.

RADIO TELEGRAPHY

Long distance radio telegraph communication is rapidly changing from long waves or low frequencies generated by alternators or Poulsen arcs to short waves or high frequencies generated by thermionic tubes. Within the last 18 months, transmitters up to 40-kw. capacity operating on frequencies of 10,000 to 20,000 kc., 30 to 15 meters, have been produced and put into service. These are replacing arc generators up to 500-kw. and alternators of 200-kw. capacity. Reliable continuous daylight communication has been obtained by using wave lengths around 15 meters, notably between New York and Buenos Aires. During hours of darkness, wavelengths from 25 to 75 meters have been in use in both transatlantic and transpacific services. The greater reliability of the short waves is the result of almost complete immunity to summer static, and the new system is much more economical because of the low power consumption compared to that used for long wave transmission.

The scope of international radio service was further extended during the year by the opening of direct radio circuits for duplex operation between the United States and Brazil.

An analytical study entitled *Behavior of Radio Receiving Systems to Signals and to Interference*, made by Professor L. J. Peters, was reported by him at a Regional Meeting of the Institute at Madison, Wisconsin, in May 1926. This paper discusses methods for studying transient effects of current in radio systems, the degree to which interference can be mitigated by frequency selection methods and the factors determining the interference caused by transmitting stations of various types and by static.

TRANSATLANTIC RADIO TELEPHONY

An event of outstanding importance in the progress of international electrical communications occurred early in the present year with the opening of transatlantic telephone service between the United States and England. This first telephonic bond between America and Europe was opened to the public on January 7, 1927, following an exchange of brief greetings

between Mr. W. S. Gifford, President of the American Telephone and Telegraph Company, and Sir Evelyn Murray, Secretary of the General Post Office of Great Britain.

Although the service was at first limited to the metropolitan areas of New York and London, during the months following, service was extended successively to greater areas until it has included most of the British Isles on the European end and the United States and Cuba on the American end. No attempt has been made to give 24-hr. service, but service has been available daily for the period which includes the overlapping portions of the business day at the two ends, and is being extended.

The principal features of the system added since the description given in last year's report of this committee are that arrangements were perfected whereby both the east-bound channel and the west-bound channel are transmitted in the same frequency band. Thus, the entire two-way system occupies only 3 kc. (58.5 to 61.5 kc.). One thing which contributed materially to this accomplishment is the employment at both terminals of voice-current operated switching devices which function to cut the transmission path to and fro from west-bound to east-bound automatically in accordance with the flow of conversation between the two speakers.

RADIO BROADCASTING

The results of investigations carried out during the last few years in ascertaining the service area for which broadcast transmitting stations are effective were summarized in a paper entitled *Radiobroadcast Coverage of City Areas* presented at the New York Regional Meeting last November by Mr. Lloyd Espenschied and printed in the January issue of the JOURNAL. This is a subject that is receiving considerable attention. These investigations raise questions regarding the desirable power levels to be used for radio broadcasting.

ELECTRICAL TRANSMISSION OF PICTURES

During the year the scope of the commercial tele-photograph service which has been given for two years between New York, Chicago, and San Francisco was materially enlarged by the extension of the network to Boston, Cleveland, St. Louis, Los Angeles, and Atlanta. Several important developments have taken place during the year, notably the arrangement of the circuits for two-way operation, the installation of phase-correctors on the New York-Boston and Chicago-St. Louis telephone cables to make these circuits suitable for picture transmission, and the fitting of the southern transcontinental route to make it available for service to Los Angeles and San Francisco.

TELEVISION

On April 7, 1927, a successful demonstration was given of electrical television by wire circuit between

Washington, D. C., and New York, and by radio from an experimental station at Whippany, N. J., to New York.

Television employs many of the principles and some of the apparatus of telephony. The object of television is to reproduce a scene with action, and to do this a series of essentially instantaneous views must be transmitted and reproduced at a rate, 15 or more per second, such that an observer will detect no discontinuity of action. In its present form, the sending apparatus is adapted to obtaining for one participant in a telephone conversation a continuous view of the face of the other participant. The receiving apparatus recreates this view on a picture plane about two by two and one-half in.; or, with a alternative form of apparatus, on a plane about two ft. sq. for observation by more than a single person.

At the sending end a narrow beam of light, or rather a rapid succession of beams scan the subject to be transmitted, illuminating at one time an area about a quarter of an inch square and sweeping over the entire scene in less than one-fifteenth of a sec. This scanning process is repeated continuously. A group of large photoelectric cells responds to each change in the reflected light.

At the receiving station, a glass tube filled with rarified neon gas and provided with electrodes responds with a brilliancy corresponding to the current received from the photoelectric cell. The high potential requisite to the operation of the neon tube is obtained by the use of vacuum tube amplifiers in the connecting circuit. All parts of the neon tube have the same brilliancy at any instant but the observer views only a small portion at a time, which is uncovered by the synchronizing apparatus provided to insure that the light shall appear to the observer at each instant in the same position on a picture plane as that occupied by the beam-illuminated spot of the distant scene.

In the production of the larger image, a very long neon tube is folded back and forth to form a grid. This tube is provided with 2500 electrodes along its length. Each electrode corresponds to a single elemental area of the picture plane which is scanned by the light beam of the transmitting apparatus. As the current corresponding to each area reaches the receiving station, it is distributed through contacts to the appropriate electrode and so causes a flash of light similar in location and intensity. The speed of operation causes the observer to see not a series of flashes but a picture as a whole.

NEW RECTIFIERS

A new type of rectifier suitable, among other uses, for charging batteries used in communication circuits was described in a paper by Messrs. L. O. Grondahl and P. H. Geiger presented at the Winter Convention. The rectifier consists of partially oxidized disks of copper. The rectification appears to take place at the

junction between the copper and the oxide without observable physical or chemical change, and is similar in character to rectification by the hot cathode type of rectifiers.

MANUFACTURE OF COPPER WIRE

The developments of the past few years have led to great improvements in the methods of drawing copper wire, particularly in the speed of the process. Some of the outstanding features in these developments, together with a description of a copper rod and wire mill designed to meet the new requirements and a brief survey of the copper rolling and wire drawing art, are included in the paper entitled *Developments in the Manufacture of Copper Wire*, by J. R. Shea and Samuel McMullan which was presented at the Winter Convention of the Institute.

WOOD PRESERVATION

During the past year, a large amount of research work has been continued in improvements in methods of preserving wood poles, crossarms and other timber. As a result of studies which have been made by the Western Union Telegraph Company, they are placing in service a treatment by which a solution of zinc and arsenic is forced into the poles. Their investigations indicate that on exposure of the treated wood to the atmosphere, chemical changes take place which deposit in the wood zinc arsenite, a toxic material which is practically insoluble and permanent, and that this will constitute a very effective method of preservation against decay.

FIRE-ALARM AND POLICE SIGNAL SYSTEMS

The past year has seen some further refinements in alarm signaling devices. These were chiefly along the lines of simplification and increased reliability of recording devices, improved insulation for street fire-alarm boxes, and improved protective devices for circuits entering buildings. The early fire-alarm devices were insulated against other signaling circuits only; circuits entering buildings had only the comparatively simple lightning arresters then known to the electrical telegraph art. Now, with fire-alarm circuits on the same pole lines with 2300- and 4300-volt circuits, a high grade of insulation of the associated apparatus has become necessary. Recent improvements in boxes have been made to provide this necessary protection.

There has been a considerable increase in the use of electric sirens as fire-alarms in smaller communities where the expense of maintaining normally closed telegraph circuits for this purpose would be felt as a burden. The sirens are generally operated on normally open circuits actuated from the public power supply.

In April, the seventy-fifth anniversary of the opening of the first electrical fire-alarm system in the United States and the first successful one anywhere was celebrated. An exhibition was held at the new fire-alarm office in the Fenway, Boston.

There has been a general tendency toward the adoption of the red-amber-green cycle of signals for the regulation of traffic; red to stop, amber to warn of change and permit clearing of intersections, and green to go. This three-light cycle gives opportunity for control or stopping of all wheeled traffic in congested sections while foot traffic is permitted to proceed, and for stopping all traffic during the passage of fire apparatus, police cars, ambulances, etc. There has also been a widespread tendency toward synchronizing signals along a street or throughout a district. In the town or small city, the business district is frequently concentrated along a main street. Hence it becomes comparatively easy to synchronize signals along this street so that traffic may move fairly continuously for certain intervals, during the long intervals along the main street, during shorter intervals across the main street, with still shorter intervals between these while the light shows amber to clear the traffic from intersections. In some places this control obtains only during the period of heavy traffic; at other times only flasher or caution lights are shown at certain intersections. In the larger cities, this synchronizing may cover a large congested section so that by due attention to the time intervals between signals points, traffic moving at an average rate may proceed with little or no stopping. The possible saving in traffic police and in consequent expense due to carefully planned signals of this type is evident.

H. P. CHARLESWORTH, *Chairman.*

GIANT POWER SYSTEMS ARE GETTING NUMEROUS

Electric power companies have grown to such a size in the United States that there are now eighteen whose annual output of energy exceeds one billion kilowatt-hours annually. At the head of the list is the Buffalo, Niagara and Eastern Power Corporation, whose output in 1926 was 4,464,000,000 kw-hrs. This immense volume of power was generated principally by the falling water of Niagara Falls. The Commonwealth Edison Co. of Chicago is second and the Edison United and allied companies of New York City third. The Southern California Edison Co. is fourth and the Pacific Gas & Electric Co. fifth. There are no less than 126 systems in the United States, each of which is generating more than 100 million kilowatt-hours a year.

Between 1919 and 1925 the mechanical power used in American industry increased 30 per cent per worker employed and the value of production per wage earner rose from \$2751 to \$3193, according to the last U. S. Census of Manufacturers.

Discussion at Winter Convention

PAPERS ON VOLTAGE STANDARDS

(SUMMERHAYES AND HANKER¹, ARGERSINGER², SILVER AND HARDING³, GEAR⁴, SCHOLZ, EBERHARDT AND JONES⁵, MINOR⁶, HUBER-RUF⁷)

NEW YORK, N. Y., FEBRUARY 9, 1927

B. G. Jamieson: This discussion was organized for the purpose of presenting this voltage question in such a broad light that it may arouse a unity of purpose and a spirit of compromise so that following this presentation there may be substantial progress towards either a settlement of the question or a definite statement that perhaps we are too far apart ever to settle it.

A few references may be made to previous work. This subject was recognized as preeminently important by the Electrical Apparatus Committee of the N. E. L. A. about 1921 and 1922, with particular reference to one of its several aspects, namely transformers. As a result the 1922 standard of the Electrical Apparatus Committee for the transformers was compiled and approved.

In 1924 the manufacturers began to complain that less than 50 per cent of the power transformers were being ordered in accordance with these standards, and an investigation by the Transformer Committee of the N. E. L. A. revealed that not only was a revision of the 1922 transformer standards necessary but that any such revision should take into account the whole system from the generator to the consuming device.

In 1926 the International Electro-Technical Commission held a meeting in New York, at which time standard system voltages was a major topic in the program, and it became evident that the United States was unable to present anything like a nationally endorsed schedule of system voltages. The recognition of this dilemma brought about a serious committee activity which has crystallized into this symposium.

As I said in the beginning, it is but an expression of a very earnest endeavor to bring about some unity of sentiment on this subject.

President Chesney in his address⁸ on February 7 stressed the topic of standardization and the Institutes obligation in this work. In the appreciative responses to his appeal, a suggestion was offered, and that particular suggestion seemed to me to be particularly worth our consideration. The substance of it was that we accomplish our ends (meaning the greater efficacy in our work of attempts at so-called standardization) by a somewhat diminished stressing of that term. That is to say, instead of stressing the word "standard," let's see if we can't use some other word perhaps that will help in bringing about what we desire.

If, for example, we can convey to engineers that what we really are seeking is not in the nature of the absolute which the word "standard" always suggests nor of that fixed character, nor a futile academic ideal, but the ideal that engineers as economists all really appreciate, namely, that we ought to unify and thereby simplify our practise, perhaps this avowed concession to contemporaneous practise and, of course, fixed capital, will attract and soften some of the irreconcilable elements now preventing the desired unification. Operating practise will change with the development of the art, but we should, of course, maintain its orderly direction.

M. D. Cooper: Since the focal point of all endeavor along lines of voltage standardization is the ultimate service voltage,

it may be interesting to review briefly the development of the present program of standardization in reference to lighting voltages and incandescent lamp demand.

The original Edison central stations practically all operated at 110 volts. The inherent spread in voltage encountered in the manufacture of carbon lamps induced a corresponding spread in voltage on the part of central station lighting companies so that in the early years of the century lamps were supplied in a large number of voltages between 100 and 130 volts. After the advent of the drawn-wire tungsten filament, the spread in voltage in lamp manufacture ceased. The outstanding voltages of greatest demand were 110, 115 and 120 volts, wherefore the lamp manufacturers started a movement to centralize the lamp demand on these three voltages.

The original 110 volts continued to be the favorite voltage until 1919, when the percentage of demand at this voltage was exceeded by that at 115 volts.

In 1923 the National Electric Light Association put forth the recommendations in reference to standardization of service voltage as quoted in the paper by Messrs. Hanker and Summerhayes¹.

The percentage of total lamp demand at 115 volts has risen continuously, and for 1926 stands at 47 per cent. For the last seven years there has been a steady decrease in the demand for

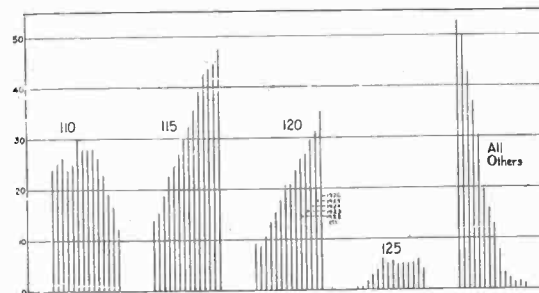

FIG. 1

110-volt lamps. This decrease has been accelerated in recent years by the increasing favor of the 3-phase, 4-wire network, which gives an undesirably low-power voltage when operated at 110 volts for lighting. In 1926 the demand for 110-volt lamps was only 12 per cent of the total.

There will always be a theoretical advantage in operation at 120 volts in preference to 115 volts. With growing load, however, it will be increasingly difficult to work line apparatus at sufficiently high voltages to maintain 120-volt service at peak load.

With the added impetus which will be given to operation of the new network system at 115/200 volts by the probable standardization of a line of 200-volt motors in the near future, we can anticipate an increase in percentage of the total demand at 115 volts at the expense of all other voltages.

It is often difficult to place any cash value upon any one particular step in a program of standardization. If we go back far enough in the history of the art, however, and draw a comparative picture between conditions then and now, we cannot fail to see the great advantage of standardization. For example, in the year 1900 standardization was just beginning to be felt in the matter of incandescent lamps. At that time there were 5 principal sizes of lamps ranging from 2 to 32 candle power and in most of these types there were available 4 types of filament construction, 3 different efficiencies of lamp, 3 different finishes of bulbs, 30 different voltages and 13 different bases. Multiplying all these factors together we find that there were more than 50,000 types of lamps in current demand. At the present time, with

1. A. I. E. E. JOURNAL, May, 1927, p. 438.
2. A. I. E. E. JOURNAL, February, 1927, p. 115.
3. A. I. E. E. JOURNAL, March, 1927, p. 242.
4. A. I. E. E. JOURNAL, April, 1927, p. 344.
5. A. I. E. E. JOURNAL, March, 1927, p. 223.
6. A. I. E. E. JOURNAL, February, 1927, p. 167.
7. A. I. E. E. JOURNAL, March, 1927, p. 257.
8. *Electrical Standardization*, address by C. C. Chesney, A. I. E. E. JOURNAL, March, 1927, page following p. 214

much greater range of size, viz.,—10 to 1000 watts— with one standard efficiency, base, filament construction and bulb for every size of lamp—one type of bulb finish for the majority of the sizes—and only 3 voltages, the number of lamp types for general lighting has decreased from 50,000 to 54. The completion of the voltage standardization as recommended by the National Electric Light Association will still further reduce this number of types to only 18.

The writer had occasion to see what standardization means in ordinary business on a recent European trip. In Vienna there was a lamp manufacturer who maintained a factory stock of about 3,000,000 lamps. The biggest single item (lamps of the same description) in this stock was one of 3000 lamps. This condition resulted from a lack of standardization with its resultant complication in requirements of different voltages, style of lamp, bulb finish, bases, etc. In a factory stock in this country of approximately the same total size the largest single item was 40-watt, 115-volt lamps of which there were 198,000, or about 70 times as great a stock of the most popular item as could be maintained under the European conditions of non-standardization. The greater availability of the product under conditions of standardization makes, for much more convenient commercial service as well as greatly decreased cost of warehousing, less investment in stocks, less delay, duplication of shipments, etc.

No one needs to speak to the electrical industry in this country on the advantages to be gained by standardization, and I draw this parallel to emphasize more fully the advantages that can accrue to us by a thorough standardization from the lamp back to the generator.

C. E. Skinner: It seems to be well established that we need national industrial standardization. In the electrical field, there has been considerable effort, particularly through the work of the I. E. C. to bring about international standardization, especially with regard to fundamentals, such as the basis of rating. This effort has been continued for a number of years and further progress was made at the meeting of the I. E. C. in New York, April 1926, where this general question of voltage standards was considered.

Unfortunately, international accord seems difficult, due to the fact that in Europe they have been inclined to use the even thousands, while we in America have in general adopted voltages which are multiples of eleven. The lack of voltage standards is responsible for much of the confusion and non-standardization in international electrical trade. For example, a manufacturer of incandescent lamps doing a truly international business, is forced to manufacture something over 70,000 sizes, types and varieties. This makes mass production, as we understand it, impossible.

International standardization is of importance to everyone having anything to do with international trade and in trying to arrive at national standards we should continuously keep in mind the desirability of international accord wherever this may be at all possible.

A. H. Kehoe: I assume it to be generally accepted that the "mean lamp voltage" is the proper basis to use in any standardization of voltages. Some of the papers fail to indicate that standardization has not been rigorously adopted but is still on a tentative basis with three recognized lamp voltages, namely, 110, 115, and 120 volts. It appears that the immediate practical result to be sought is simplification or unification of practise, rather than hard and fast standardization which is likely to be too narrow to be suitable for future requirements. Last year's *Electrical World* statistics recorded over 50 per cent of the residential customer being supplied with 110 volts. Data presented today indicate 120-volt lamp use to be 35 per cent of this class of lamp. With these conditions existing it appears evident that simplification, particularly of the lower voltages, may be possible, but standardization of voltages or equipment unless broad enough

to cover such conditions would be standardization in name only, similar to former cases mentioned in the papers.

I differ with statements in certain of the papers which indicate that adopted standards are endowed with properties whereby it becomes a moral duty to adopt them. It is recognized that contractual obligations, in the absence of other specifications, are controlled by existing standards, and the responsibility for the operation of apparatus outside of standards when not covered by specifications places a responsibility on the operator which would not otherwise be present. In practise, probably most of the departures are covered by specification, and I hold the real concern should be for the blind follower of standards regardless of their value for his conditions. For instance, consider the systems equipped with the present standard transformer—this group of papers indicates how inadequate they are for proper operating conditions. I disagree with the statement in the Hanker-Summerhayes paper that "The design of electrical systems contemplating the use of apparatus under conditions more severe than sanctioned by the A. I. E. E. standards should be discouraged." In certain instances, equipment is (and, in my opinion, should be) purchased with insulation in excess of the values which are standard at present, and if conditions warrant the use of apparatus with less than standard values, I see no moral reason why it should not be done. To discourage such action is merely to retard progress temporarily. When variations from standards become of economic importance, changes in standards should be considered. These cases do not have the hazards of a steam boiler, and are not incorporated in the safety requirements of the industry.

It appears possible to me for present conditions to be covered by modifying minor details of the proposals made in the different papers so that a large percentage in the industry can adopt a unified practise. To do this it will be necessary to recognize that we have three "lamp base" voltages, that important economic results are to be obtained by unification, and that the standards are very likely to require changes from time to time as developments in the art change the economics of the situation. If the first step is comprehensive, further simplification at a later date will doubtless be possible. What the future simplification is likely to be should be indicated only in a general way so that future progress will not be delayed if new conditions require changes from what is indicated at present.

W. F. Dawson: This standardization of voltages means much to all of us, but it appears that in starting out for standardization, existing practise has been ignored.

It is now proposed to make standard voltages 5 per cent higher than heretofore and to permit an operating leeway between plus 5 per cent or minus 5 per cent. Previously the plus or minus margin of 5 per cent was permissible but with the understanding that standard temperature guarantees did not apply; in other words, the departure from standard voltage was assumed to be an overload condition. Now apparently, it is proposed that in addition to raising the standard voltages 5 per cent, we are also to guarantee standard temperatures with 5 per cent margin, which is equivalent to raising the voltage standard 10 per cent. Many operators have come to consider dynamo-electric machinery as capable of overloads and special operating conditions much beyond the specifications. They found apparatus rather generously rated, but overlooked the fact that competition has been gradually driving manufacturers to adjust ratings more nearly in accordance with performance ability.

We are prepared to meet these new proposals, but venture the hope that one year, or five years from now, we shall not be confronted with another new "standardization" which will not be standardization, but actually "destandardization."

Many of the smaller turbine alternators are built in advance on stock orders and when special requirements are insisted upon, it means that these standardized and stock machines cannot be utilized. Special requirements mean that machines must be

built to order, and involve special development which adds greatly to the cost. The time required for building the apparatus is also increased substantially.

J. H. Foote: Perhaps it is all right to standardize the voltages on the basis of utilization voltage. But we don't want to forget that the correct basis for apparatus design is not the utilization voltage or multiples thereof. In my opinion, the correct basis is the maximum voltage to which the apparatus will be subjected under the maximum load.

For instance, we may say that the correct utilization voltage is 115 volts in terms of a distribution system with 20-to-1 ratio transformers. We can say that the nominal for the distribution voltage is 2300 volts. That is fine, but don't buy 2300-volt generators and don't buy 2300-volt secondary transformers to feed a 2300-volt system, or you are in just the same trouble that you are in now.

That is what caused all this trouble—a generator which has a voltage rating and which was designed to supply that voltage at full load. That means that the generator will probably be a 2500-volt generator. The paper of Messrs. Silver and Harding bring that out very nicely.

Their paper seems to recognize the actual voltage situation more than the other papers in that they figure out what the voltage should be, but apparently have not the courage to say that voltage is impossible and, therefore, they will change the transformer ratio. To jump from the 2300-volt class to the 6600-volt class, a 6600-volt system is just three times a 2200-volt system. Therefore on the same basis on which we say a 2500-volt generator would be needed for a 2300-volt system, a 7500-volt generator would be needed for a 6600-volt system.

Just double that and you have instead of a 13,200-volt generator a 15,000-volt generator.

You say, "That is impossible." Well, it is done. Much 13,200-volt equipment is now operating under full-load conditions at potentials largely in excess of 14,000 volts, and the only reason they don't operate at 15,000 volts is that the machines would probably burn up if operated at that voltage at full load—and some of them do burn up once in a while. The temperatures run to excessive degrees, and the operators change the ratio of their distribution transformers from the 120-to-1 ratio, to a lower ratio by dropping down on the 5 per cent tap.

That means that in place of using the taps in our transformers for line regulation or for transformer regulation, we have to use that range because of the inability of the generator to produce adequate voltage.

Now that is the fundamental picture that comes to me when I think of this transformer standardization. I always have to think of the starting from the utilization voltage. Most of us are led astray in these profiles by starting at the generating end of the transmission system. We should start with the motor and the lamp and see what the voltage must be to supply their requirements adequately.

Now there are some more complications that make the present situation, I believe, besides this tenacious hold on the 11-multiple and the like. One is that most of us are using standard distribution transformers which are of straight ratio. Five or six years ago the Transformer Committee changed the ratio of the transformer stepping down to primary voltages from standard to a little off standard at that time. For instance, they changed from 13,200/2200 volts, which was the former standard, to 13,200/2300 volts, giving us 100 volts boost and helping out the situation somewhat.

Now we have all those transformers and we have the present generators and we have a situation. The solution that we must arrive at is something which will utilize as much of this equipment as possible, and I do not think that the solutions as proposed generally take adequate care of that situation.

There is another reason for our difficulty. We have without thought for many years brought transformers with either four

2½ per cent taps, or two 5 per cent taps, because it was standard and because the manufacturers found it convenient to limit the tap range to 10 per cent. Ten per cent has been shown in any number of transmission systems to be an inadequate range.

This is brought out in one or two of the papers, and most of us who operate systems involving ups and downs and transmission distances know that 10 per cent is not enough. The remainder of the required range is taken out by over-voltage apparatus.

We have found in the systems I am connected with, that a tap range of 16 to 17 per cent seems to be indicated as necessary in an interconnected system for transmission transformers. That does not mean distribution transformers. It is our opinion that distribution transformers should be without taps; that is, the generator voltage is adequate, and straight-ratio transformers and proper feed regulators are used, but there is no necessity for taps in a straight distribution transformer.

Another difficulty is that due to following present standards we have been using not only generator voltages but also transformer secondary voltages, which are too low to supply adequate voltage to the distribution systems.

Perhaps the last difficulty, which has not been really brought out in this meeting, is that in the years that have passed, people have adopted two different schemes of raising the voltage on their system. One is to use multiples of two. For instance, a man who had a 6600-volt system, some day when he needed it doubled his voltage, and then he had 13,200. The other man bought the 6600-volt transformer, and instead of doubling his voltage he y -connected it and got 11,400 or thereabouts.

Then a third man adopted 11,000 volts as his voltage. And so there are at least three voltages all in the same range and we wonder why they aren't the same.

Any new standard which we may adopt, which will displace those three lines of transformers or unify them must have a sufficient range of taps so that it will take care of the situation adequately and in following these proposed standards, limiting the taps to 10 per cent or so, that is impossible of solution.

In the solutions which are offered, I note a dread to change the name of the voltage. Instead of that we change the ratio of the transformer. I seriously question that we should do that. Transformers are rather flexible. We have thousands of them already installed and in supplying the new standard transformers to operate on the same system they must, of course, have approximately the same ratio. I think that, that has been brought out by Mr. Kehoe in his discussion.

There is another matter that seems to complicate the situation. That is, that all the new standards are proposed to be nominally rated. This was started four or five years ago and is a reversion to the old standard of rating at the receiving end and applying certain factors to take care of the drops and the like. It gets us into trouble.

For instance, take the 132,000-volt class of transformers. A voltage of 132,000 is largely a nominal voltage and means absolutely nothing. If a man buys a 132,000-volt transformer, we would not know what he was talking about unless he specified whether it would have one 5 per cent tap, or two 5 per cent taps in an extended winding supposedly to hold voltage under load.

That would mean that the extreme ratio of the transformer would give a no-load voltage of about 145,000 volts. If we rate that a maximum-rate transformer it would be a 145,000-volt transformer, and according to the present A. I. E. E. standards would be subject to a considerably higher test than a 132,000-volt transformer.

Therefore the proponent of the nominal rating says that it is to our advantage to rate apparatus nominally and supply over-voltage specifications in order that the A. I. E. E. test be not increased and, therefore, the expense of the equipment.

I think that, that is a subterfuge. If the A. I. E. E. test at 132,000 volts is adequate for a transformer with a top-tap ratio giving 140,000 volts, then the thing to do is to change the

standards. Instead of making them twice normal plus 1000, make them 1.9 normal plus 1000 or anything else. But why try to fool ourselves about this situation?

Another difficulty is that by nominally rating equipment, the manufacturer rates his insulated apparatus, such as the lightning arresters and oil circuit breakers and other apparatus, at that nominal rating. This means that any engineer who is desirous that the apparatus be adequate as regards test voltage must go into the next class if he is honest with himself and specifies a transformer at the maximum rating.

It seems to me that such apparatus should have the division point half-way between one class and the other class. This is particularly true of lightning arresters, because the performance of the arrester is absolutely dependent upon the actual voltage. Rating a lightning arrester at a maximum of 138,000 volts and a minimum of 126,000 or something like that, which is established practise, means that a system having 140,000 volts must either have special apparatus, or else must go into the next class which is 154,000.

If the division point between the 132,000 volts and the 154,000 volts were made at something around 147,000 volts just about half-way between, then the range of apparatus would fit the standard more adequately.

As I see it, the result, if we go ahead on any such basis as has been proposed, namely to change the distribution transformer ratios in order to keep the names correct, not a present standard and a present special, but a new standard, an old standard and a present special. We are going to have three sets of transformers in a few years instead of two, and I should like to emphasize that in my opinion any new standard must be decidedly broader in scope than anything that has been offered yet, in order that it may not only include the present standard of transformers, but may also absorb as many of these present specials as possible.

This circuit-voltage rating is something I should like to mention. This A. I. E. E. definition, I believe, should be clarified, the definitions for the purpose of fixing a value to be used in designing and testing electrical apparatus. The rated voltage is defined as the highest rated voltage of the apparatus. That means that if you rate a machine at anything less than maximum voltage that is the rated voltage. That keeps the test down and cheapens the apparatus without changing the test definition, but the A. I. E. E. says, "This voltage rating applies to all parts of the circuit. The actual operating voltage may vary from the rated circuit voltage but should not exceed it."

We are proposing in these new standards to exceed the voltage. If that is all right, the A. I. E. E. rule should be changed. I think the A. I. E. E. rule is all right except that it should say, "It must not exceed it," instead of "should." I think we should bring the ratings of our systems up to what they really are.

To summarize the situation, as I see it: Adequate standards must be technically correct, or else engineers who really think they have worked out the solution adequately will continue as they are at present to buy so-called special apparatus. These new standards must include as much as possible of the present special standard apparatus. They must be based upon premises which will avoid the mistakes of the past, and I think the present standards are merely trying to make standard equipment which has been proved to be inadequate in the past.

They must recognize transformers as ratio machines only, with a certain maximum voltage rating. They must have an adequate tap range, which inter-connected systems find is at least 15 per cent, although full capacity is not necessarily required above 10 per cent.

Generators particularly must be rated at maximum voltage in order that injurious heating will not be experienced. Transformers should be rated at maximum voltage in order to clarify the situation and work in accordance with the present A. I. E. E. installation standards.

Finally, the general apparatus names should be such as to

place the nominal rating of the apparatus midway between the maximum and minimum ratings of the new standard itself.

F. L. Hunt: It is not difficult to pick out details in the various papers which have been presented with which we disagree, but I believe, if possible, this discussion should be confined to the general features of the question before us.

I am willing to express my opinion as to one of the general points under discussion, and that is that we should base our standardization on the idea that power will flow in two directions on most of our important circuits. In general terms, I like the idea that Mr. Argersinger has proposed.

H. C. Sutton: In my opinion, generators should be designed to deliver full rated output throughout a range of 10 per cent above or below rated voltage. The manufacturers' proposal of 5 per cent voltage range does not give sufficient flexibility for operation.

There is one other point that I particularly want to stress, and that is, the difficulty due to the present rating of apparatus for voltages above 66 kv. For instance, step-down transformers have a voltage rating in multiples of 11.5 up to 69,000 volts. This same rate should apply for the higher voltage ratings. There is no logical reason for changing the multiple to 11 when the figure of 6900 volts is exceeded.

N. B. Ames: It seems to me that we have overlooked the main point in this proposition entirely. After all, is it a matter of the particular voltage to use or is it a matter of regulation? That seems to me to be the answer to the question. There are two very practical theories in conflict here, of course, (1) whether we shall have excessive reactance in our transformers and generators producing poor regulation and ample protection, or (2) whether we shall reduce this reactance and get better regulation and depend upon our protective devices to give us the protection.

Eugene Vinet: To my mind the essential thing to decide as a first step is what planes or levels of voltages we want to take as standards. That is to say, do we want to take, say, 33,000 volts as a standard or do we want to take 44,000 volts? Whether it is 33,600 or 31,500, etc., is only a matter of fluctuation or regulation as a result of the usual operation. What we have to decide are the planes of voltages that we want to use.

One thing which strikes me in these proposed voltages is that there are too many of them. The purpose of standardization is to reduce to a minimum. My feeling is that we should suggest only approximately 7 or 8 voltages. I speak from personal experience with the organization with which I am connected. Some two years ago we felt that there was a necessity for a standardization of voltages, as, owing to the growth of loads, a good many of the transformers became obsolete, and when we wanted to do some interchanging of transformers we were hindered because the voltages were too varied. We found on a survey of our conditions that we had 21 different voltages.

We have standardized on seven, which is a considerable reduction, and have tried to make everything as simple as possible. That was two years ago. Now every one is fairly well agreed that it has simplified matters considerably and has been of very great help in operation and interchangeability of material, not to mention the saving in money.

It seems to me that it might be well to make a definite issue of certain voltages, and debate them and see whether we can agree on them. For instance, some people favor 11,400, others 13,200. In our own case we have standardized on 11,400 volts star. The reason for that is, because we have a great many rural lines which are growing all the time. We felt that the thing to be considered first was the distribution in preference to the generation, because we have got to give service and that should be the dictating factor.

In the case of rural distribution, very often the loads did not warrant voltages of 13,200. We can start at 6600 volts very often single-phase; then we make it three-phase, and then as the load grows we star it and get 11,400. That suits our purpose

very nicely. We also standardized on 33,000 volts. It was a question whether we should go up directly to 66,000 volts, but for economical reasons we felt that it was advisable to make a step between 11 kv. and 66 kv. We have situations where we have relatively small towns to reach for service. In scattered communities we may have a town of 5000 people or thereabout to serve. We may have to build 20 or 25 mi. of line to reach that town with smaller places to be served from such a line. It would not be economical to build a 66,000-volt line. We can't build it at 11,000 volts because it won't give the service. Therefore 33 kv. is a very nice intermediate step. That was one reason for our 33 kv. Then we go up to 66 kv. and 132 kv.

The lower voltages are 115, 230, and 460. Then we have 2300 delta or 4000 star. Those are the only standard voltages which we have. We take care of voltage variations by means of taps.

I am mentioning these voltages because they may offer some ground for discussion. We have been very happy with these few voltages so far. I might mention in connection with the 6600 volts 11,400 star that it might be a good thing to go up to 6900 volts or 12,000 volts star. It occurs to me at this time that it might be a way of compromising with the advocates of 13,200 volts. There isn't any doubt that there will have to be compromises.

So far as we are concerned, we feel so much the importance and the benefit of standardization in voltages, that we certainly will do everything we can to cooperate in this movement and help get it over if possible.

E. C. Stone: It seems to me that there are certain fundamental principles brought out in this discussion that we can all well recognize. The first one is that standardization will start at the utilization voltage. We have heard there were three utilization voltages—110, 115, 120. I wonder if it means that we have to start with three different standards and build up.

The second point is that we must recognize the voltage regulation or drop in the transmission system. This varies widely on different systems, being small on some and large on others, but in any event, in the general problem of voltage standardization, the voltage drop in the various parts of the transmission distribution system must be recognized.

That means, I think, fundamentally that the old set-up of 10-to-1 ratios for transformers and multiples of 10-to-1 ratios is no longer acceptable, and we must break away from that system of ratios to something else.

The suggestion that I wish to offer for immediate consideration is that the essential mechanical features of power transformers be standardized. This is done to a considerable extent at the present time but might be carried further. By mechanical features I mean the core, bushings, end frames, tanks, terminal boards, terminal arrangements, number of taps, number and arrangement of outgoing leads. With these elements standardized, the actual number of turns in the winding, the ratios, and the exact location of taps in the winding might be left as the lowest-cost flexible link in the transmission system, to be worked out to meet to best advantage the local conditions which are peculiar to any particular system. It hardly seems reasonable to install on the system which has very low voltage drops, transformers which are designed with perhaps 15 per cent and 20 per cent full-capacity taps, to meet conditions on systems having long overhead transmission and correspondingly high-voltage drops.

B. G. Jamieson: Mr. Stone has enumerated some fundamentals that apply particularly to transformers, and there are others applying to transformers which will probably make the wisdom of such standardization apparent, as we find ourselves requiring exciting transformers and series transformers and tap changers and phase shifters and various other auxiliaries, that are now coming to be recognized as necessities with large transformers in the larger and more complex systems.

Of course there are standards to be considered in connection with generators. It is proposed by one of the authors that a simple way to get more flexibility without greater complication is to increase the range of generator voltage. That is something that might be discussed profitably. If, for example, we assume that generators will be built to deliver energy on the busses at 25,000 or 30,000 volts in the near future, perhaps we have more to think about in that connection than we now have when we are generating at pressures below 15,000.

It is quite a simple matter to specify any voltage and get any voltage in a generator so long as you stay below 15,000 volts, but before very long on account of general desirability of a lower current in these large machines, we shall probably see higher-voltage generators, and then it may not be so easy to get the 10 or 15 per cent range suggested by the simple device of varying the voltage.

There are other fundamentals in this problem. There is the general question of means of limiting the necessary voltage range, such as is accomplished in part by the use of synchronous condensers. The Pacific Coast companies are using 17½ or 20 per cent tap ranges partly because the use of the devices really makes it possible for them to keep within that range.

We need to know whether we must allow our systems to respond to this upward urge or trend of voltage that seems to be so evident. We need to know, in order to meet that, on what basis a gradation of steps in system voltages is to be founded. We need to know whether they are to be on a Y-delta basis or on a preferred-number basis or on the basis of approximation of our old standards or whatnot.

We need to know whether those steps can be met by apparatus having sufficient flexibility without being out of the pale of the standard class, or whether we must allow in our contemplated schemes for a very extended number of steps which will give us a minimum in flexibility requirements of individual apparatus forming part of the system.

We need to know whether or not the problem of high voltage resulting from open circuits is something that can be successfully taken care of.

In connection with the fundamentals of this matter, the Committee has made a survey and has been able to get almost universal assent to the basic acceptance of the principle of utilization voltage as a standard of reference in connection with any standard-voltage system. That point has been, we consider, gained and we hope it won't be upset, though of course if it need be, it will be I presume.

Another point referred to by Mr. Jones, namely the question of rated circuit voltage or, as he put it, the system voltage, was fixed by the Committee and approved by the Institute. Now it would be possible to undo that also, if necessary, but I mention that as another achievement of the Committee so that you will understand that at least two of the fundamentals necessary in consideration of a standard system voltage have been, we think, sufficiently settled so the discussion may proceed on that assumption.

C. E. Skinner: At the meeting of the International Electro-technical Commission in New York last spring, some of our European friends brought to us the term "voltage zones" and it seems to me that this is a very apt term in connection with certain features of our standardization program. By "voltage zone" is meant a certain range of voltages between which all dielectric tests for apparatus are to be the same. This would be of distinct advantage in allowing manufacturers to stock such parts as outlet bushings and other features of design which have a definite limit due to the dielectric test. In many cases, it would probably be cheaper to take an outlet bushing, for example, from the next zone than to manufacture one for a specific purpose which happened to fall just beyond the particular zone. I would suggest that this question of voltage zones be kept in mind in connection with this standardization proposition, especially with regard to the application of dielectric tests.

R. K. McMaster: An important point is the breaking away from any attempt to have transformers of a single ratio suitable for use on both the 6600- and the 7200/12,470-volt systems. There should be a ratio of 2-to-1 between the voltage ratings of transformers for the 6600- and 13,200-volt systems and a ratio of 3-to-1 for the 2400/4150- and 7200/12,470-volt systems.

In the paper by Messrs. Silver and Harding the recommendation is made that 120 volts be the accepted secondary voltage for transformers of the service class. This is quite a step forward, and also will do much toward the consolidation of the 12,470- and 13,200-volt systems. There is only 6 per cent difference between these two voltages. It would be quite possible to have a tap at about that point, or even to use one of the standard taps for 13,200-volt transformers. In the same paper it is recommended that the voltage ratings of motors for use on 6600- and 13,200-volt systems should be reduced. This is a good idea and will go a long way toward avoiding step-by-step increases above these voltages.

One of the disadvantages of the 13,200-volt system is that twice this voltage, namely 26,400, is not standard. Might it not be that the real purpose of standardization would be served by adopting 16,500 volts as a standard voltage, this being half of 33,000 volts?

It is very important to maintain the ratio of 2-to-1 between 66,000 and 132,000 volts and between 69,000 and 138,000 volts, allowing the use of series-parallel transformer connections without complications due to a little lower ratio.

In the paper by Mr. Huber-Ruf voltage ratios based on the star-delta arrangement of motor and transformer connections are advocated. In some cases this is advantageous for motors. It is not, however, advantageous for high-voltage systems; not alone for the reason that there are already at least approximately standard voltages which do not allow for this, but also because of the grounding of the neutral which should be provided for at certain stations necessarily and at others as practicable to provide alternate points of grounding.

Regarding transformer taps in general the percentages of taps should be standardized, rather than the number of taps, so that transformers having a non-standard range of taps will parallel with standard transformers. Simple figures are desirable for tap voltages. An example of this would be the use of 64,500-, 63,000-, 61,500- and 60,000-volt taps for 66,000-volt transformers. There will be a readjustment of parallel operating conditions in any event in connection with standardization of percentages of reactance as well as standardization of voltages.

It is also desirable to give considerable attention from a standardization viewpoint to the phase angle between lines of all voltages, in the higher ranges to facilitate interconnections which are not thought of at the present time, and in the lower ranges to facilitate networks supplied from systems of more than one voltage.

For transformers of all ratios, with the exception of those involving 120 volts and small multiples thereof, it should be recognized that a zero phase angle is permissible, at least under certain conditions. The cases where a 30-deg. angle is desirable or permissible should be standardized so that there will not be more than a minimum possibility of a 30-deg. angle existing between systems of the same voltage in the same vicinity. It is also important to have the 30-deg. angle in the same direction wherever it occurs between systems of any two voltages operating under similar conditions.

Mr. Minor's paper mentions the use of transformers having a ratio suitable for connection directly between the phase wires of 4150-volt systems, permitting the omission of the fourth wire. Such transformers should be used wherever practicable, not only to eliminate the need for running the fourth wire, but also to facilitate the use of the combined light and power system with service voltages of 115 and 199.

P. H. Chase: I should like to ask what the manufacturers

consider is the relative influence on transformer cost of standardization of reactance, also of such things as insulation of the neutral lead for full-line potentials as against treating it as a fully grounded neutral lead? On lower-voltage distribution transformers, such as those for subway installation, what is the influence of standardization on the number of phases? There are also certain dimensional and other manufacturing standardization points that, to my mind, must influence cost to a degree commensurate with the influence of voltage, as such.

H. L. Wallau: The point has been raised about reducing the number of voltage standards in use. I think that is something we can all consider. The figure mentioned by one of the previous speakers was a reduction from 21 to 7. I might say that in our own system we are gradually tending to 5, if we consider the 2300-4600 volt class as one. Five might be plenty for most of us. It may not be enough for all of us.

Messrs. Harker and Summerhayes have enumerated five principles to which any proposed system of voltage standards should conform. These will not be challenged.

Undoubtedly the definition of "rated circuit voltage" will meet with general approval, and it is obvious that equipment should be tested in conformity with the maximum line to line voltage to which it may be subjected.

The A. I. E. E. test, for transformers, Rule 6356, is twice line-to-line voltage plus 1000. An exception, Rule 6363 for "Transformers with Graded Insulation" is very vague. The manufacturers' present practice is to test at 2.73 times the voltage from line to ground. What test is proposed for this class of insulation? I quote in part "Such a rule . . . would definitely set the rated voltages of apparatus, their *test voltages* and maximum operating voltage."

If test voltages are to meet Rule 6356 even though induced in the windings must we not sacrifice graded insulation and its resultant economy? Should not the A. I. E. E. Standards Committee provide for a definite test voltage for transformers of this class?

Among low-voltage distribution systems of today are some involving transformers with windings for 2080/4160 and 2300/4600 volts delta. The proposed standards recognize only the 2300-volt class.

Cleveland, Detroit and, I believe, Chicago, have thousands of kilowatts of transformers connected of the above off-standard voltages. Too much is involved to discard these. By building transformers of this general class with coils for series or parallel connection, we establish the 4600-volt standard from the 2300-volt standard and by providing a 10 per cent tap, we can obtain 2070/4140 volts from these, which probably would be acceptable to operators.

For new systems the 11,500-volt standard may be abandoned in favor of the 13,800-volt. For many existing systems it must be maintained and transformers for both 6600 volts and 11,500 volts delta connection are required. The former group has been entirely eliminated.

To me, another grave defect in these proposed standards is the lack of reversibility of power transfer, due to the use of different turn ratios for step-up and step-down transformers. With interconnections growing apace, if full benefit is to be realized from them, power should be able to flow in the direction reverse from normal and the voltage delivered under this condition closely approximate the normal sending voltage.

Mr. Argersinger has most clearly indicated this disadvantage and suggested a remedy. It merits close study. His proposed voltage standards retain the values made familiar to us by long usage and his 5 per cent over-voltage tap automatically brings his system into practical agreement with the manufacturers'. However, he omits the 88- and 154-kv. ratings and adds a 176-kv. rating.

These changes would, I believe, be inadvisable because of considerable mileage in 88- to 90-kv. and of 140- to 154-kv. lines.

Also the 176-kv. standard would necessitate the design of a complete new line of equipment and there is a permissible argument that a project requiring at least 176 kv. should be developed at 220 kv. at the outset.

I am in general agreement with his views which, though differently expressed, result in standards not far different from those proposed, except for an additional $2\frac{1}{2}$ per cent of over-voltage operation suggested and the omission of the emergency limitation. What constitutes an emergency and how long does it last? Mr. Argersinger's proposal is the more clear-cut.

Two taps per winding as suggested by him may not prove enough for certain long transmissions. It should be simple to provide others at a slight increase in cost, when required.

All power transformers should be equipped with externally operated ratio adjusters.

Referring to maximum voltage rated "apparatus," when standards are agreed upon, cannot this apparatus be derated to fit, that is, name plate data changed and equipment left as is?

F. C. Hanker: In considering the subject of voltage standardization an effort has been made to investigate the possibility of developing a practical system of voltages that will meet the needs of a large percentage of electricity supply systems.

There has been a tendency in the discussion to cite certain specific needs that appear of paramount importance for a particular district. Where there is sufficient justification for certain values they should unquestionably be adopted but we should carefully scrutinize these suggestions to be sure that they are not an expedient to care for a temporary condition. We should be sure that they conform to a logical plan.

The Pacific Coast has a condition where they are meeting distribution requirements with transformers arranged for 11,000-volt star connection and 6600-volt delta connection. The decision that we burden the entire industry with costs of a 6600-volt transformer that will be satisfactory for operation on 11,000 volts can only be determined by a survey to see whether the cost is justified. In the lower voltages the difference is not as great as it would be in the higher classes. It is very possible if the demand is sufficient that it would be justified. That same condition exists I feel throughout this standardization. We should study the conditions and where there is justification it should be recognized by being included in a standard line. Obviously it would be agreeable to everyone concerned if standards could be made flexible enough to meet all conditions. Unfortunately this cannot be done without increasing costs and only those that are suitable for general use would be included.

The objection to the star-delta proposal is greater for the higher voltages. For example if you take a transformer suitable for delta connection on 66,000 volts and star connection on 114,000 volts you must of necessity design the insulation for the higher voltage service. This means in the first place that the apparatus will cost from 35 to 40 per cent more for the star-delta combination than would be the case if it was designed for the 66,000-volt service. The design must be satisfactory for insulation to ground and insulation between turns when operated on the higher voltage. This adds to the expense of those transformers that are equipped only for the 66,000-volt service. In addition to higher cost you have a lower performance. In view of these disadvantages it does not seem desirable that the entire capacity of 66,000-volt apparatus should be burdened with the greater expense for the possible benefit to those systems that would use the transformers at the higher voltage.

It is generally recognized that the greatest return from standardization is in those classes where quantity production is a possibility. Every effort should be made to reach an agreement on the lower voltages applying to utilization equipment, distribution transformers, substation transformers and possibly some of the lower transmission voltages that are generally used.

In the higher voltage classes it may not be possible to secure a general agreement on the requirements. The range that has

been suggested by several of the groups varies from 5 per cent proposed by the manufacturers to a maximum of 25 per cent for those cases where reversal of power flow may be necessary. There are undoubtedly cases where a greater range than 5 per cent is necessary. We would suggest that a survey be made to establish the capacity of equipment that would come outside the proposed 5 per cent range. This study could be based on equipment already in service. It is probable that the curve would be somewhat similar to the "use-factor curve" showing the time generating apparatus is required to meet load conditions on a particular system. These curves show that the capacity required to care for the peak loads is in use only a relatively few hours during the year representing a high investment cost for these increments of load. If we establish the capacity of transformers operating at normal voltage and at voltages up to 25 per cent above normal, and determine a corresponding cost for transformers with different voltage ranges, we would then be able to establish the total cost to the industry that would result from the adoption of different zones. At the present time the range is based on opinion. Before a final decision is made it is recommended that a study similar to that proposed would be of value in establishing the most satisfactory range.

On the higher voltage transformers it is not the actual turn ratio that is so important as a standardization of the voltage classes. Such a standardization would minimize the number of designs necessary for the manufacturers and result in a reduction in development costs. With such a standardization the mechanical construction of the core, insulation structure, tanks and terminals could be standardized and advantage taken of this condition.

Ernest Pragst: I should like to comment on these papers and the discussion largely from the point of view of the manufacturer.

A number of years ago, the operators of public utilities and the manufacturers of electrical apparatus undertook to standardize the voltages of apparatus. Out of this work a set of standards finally emerged which were sponsored and issued by the National Electric Light Association.

The fact now seems to make itself apparent that when the standards were adopted, little or no consideration was given to the system as a whole. Each type of apparatus was standardized as to voltage with little or no consideration given to its operation in connection with other types of apparatus. Because of these oversights, we now find ourselves with an inoperative set of standards.

Now, the manufacturer has accepted the standards and has a number of standard lines of generators, transformers and motors. When he attempts to sell this standard apparatus, he discovers that his customer cannot operate it in a system without exceeding the limits for which it has been designed and guaranteed.

The operators of public utilities realized some time ago that the standards as adopted could not be used successfully, so they simply abandoned them. Each has sought his own solution in his own way, with the result that but little uniformity of practise now exists.

After listening to the many diverse opinions expressed I find myself in a quandary when I try to reconcile them. Some might have been led to believe that the manufacturers seeking a new set of standards will be next asking the discarding of present equipment. Nothing like this is contemplated. Moreover, nothing particularly radical is being asked.

In preparing the standards proposed by the manufacturers and presented by Messrs. Summerhayes and Hanker, I am sure every effort was made to depart as little as possible from the present standards. A comparison of the proposed standards with the present standards as issued by the National Electric Light Association will reveal the close similarity between the two. Generator voltages are such that the old can be paralleled with the new; transformer ratios are such that through the use of taps

parallel operation of old with new transformers will usually be possible; motor voltages are to remain the same.

I am convinced that greater benefits will accrue to the operator than to the manufacturer through standardization and that the manufacturers are seeking only a workable set of standards that will meet an appreciable part of the requirements of the operating companies. With such diverse views as now exist (most of which are not without merit) an agreement will be reached only if we can realize the necessity of compromise and practise it to the utmost.

L. L. Elden: It is believed that an analysis of the value and quantities of equipment which have been found unsuited for operation under the voltage standards referred to, will be found to be only a relatively small percentage of the units in service and that such difficulties as have developed in this direction will be largely found in high-tension equipment.

The discussion which I will present is one in which Mr. Oliver of the New England Power Company and the writer have collaborated to some extent to present very briefly some views covering our experience in New England. One of us is operating a system utilizing moderate voltages in supplying a compact area, with interconnections to several adjacent systems. The other is operating an extensive transmission system reaching into five states and utilizing voltages of 66,000 and 110,000. The present transformer standards have been entirely satisfactory to the former, and with the addition of standard feeder regulators, high grade, efficient and reliable service has been maintained.

For the second system existing transformer standards have been found unsatisfactory, and apparatus has been purchased which does not conform to A. I. E. E. standards in order to meet operating requirements. Power-factor correction equipment has been found necessary at several points to insure a proper degree of regulation, with the result that substantially uniform voltage conditions are maintained throughout the system. In passing it may also be said that the voltage standards proposed by the manufacturers would still be unsatisfactory for this system.

In this discussion we have refrained from presenting any table of values, believing that the determination of final values applicable to the entire industry cannot be effected at this time. If broad principles applicable to the situation can be agreed upon, much will have been accomplished.

Any undertaking aiming to standardize voltages is bound to meet with many difficulties in view of the many interests affected. Many of the conditions to be met are not fully appreciated. On this phase of the question we may refer to the proposed basis of standardization outlined in the manufacturers' paper.

An analysis of the hypothetical system shown therein discloses the fact that as between full- and no-load conditions, an overall uncontrolled regulation of about 30 per cent would be developed, an amount which could at best only be divided between the generator and receiver if any load be served from, or near the generating station.

If the system is expanded and becomes an interconnected network with additional generating stations, difficulties immediately develop. For example, a second generating station connected to the 69,000-volt section of the system must experience voltage or reactive-power difficulties with changing load conditions on the main system. It is, of course, granted that the addition of regulating apparatus may obviate some of these difficulties.

The system described is hardly sufficiently comprehensive to illustrate the needs of practical application. Even if such a simple system exists, it may be short-sighted to design it so with no provision for expansion. If transmission systems or lines are interconnected, it is questionable whether a considerable difference of potential can be allowed to exist between any two parts. Probably it would always be found desirable to regulate the voltage very closely by power-factor control.

Even if not, a step-down transformer may be installed close (electrically) to a step-up transformer, so close that the voltages at the two points are practically identical, and in this case also the proposed standards become inadequate. Some of these difficulties would be eliminated by the following suggested changes in the proposed transformer standards.

STEP-UP TRANSFORMERS

Adhere to proposed secondary voltage ratings and provide one 5 per cent tap above normal rating to maintain secondary rated voltages under load.

Provide two 5 per cent (each) reduced-voltage full-capacity taps.

Taps should preferably be located in the high-voltage windings (low-voltage taps in large transformers involve difficulties, particularly in regard to ratio-adjuster design on account of high current densities).

STEP-DOWN TRANSFORMERS

Increase proposed primary voltage ratings 5 per cent (which raises this voltage rating to agree with the rating of step-up transformers at zero regulation).

Provide three 5 per cent (each) reduced-voltage full-capacity taps.

Transformers should be designed to operate under emergency conditions at 5 per cent over-voltage (over-excited). Emergency conditions should be defined as existing a considerable length of time, perhaps several days.

Standardization to be effective must recognize that present-day developments indicate that interconnected systems covering large areas, with many sources of power supply are to be more and more important features of transmission and distribution practise in the near future and that voltage requirements in such systems must be studied from all points of view.

It is believed that standardization of voltages cannot be effective if based upon conditions assumed in any radial system. At least one of the papers has presented the question from the network point of view with favorable results.

Conservation of existing investments is no small portion of the main problem and any new standards must be devised to protect such investments.

Progress, however, has been made and agreement seems quite general upon certain items. Generators and transformers should be capable of operating at least 5 to 10 per cent above rated voltage.

Step-up and step-down transformers should be identical in operating characteristics and be equipped with similar taps ranging from 5 per cent above to 15 per cent below rated voltage. The definition of "rated voltage" is logical and acceptable. Certain other features require further study.

The point at which "system voltages" should be standardized must be agreed upon. European practise recognizes receiver voltage as most desirable. American opinion is divided upon this point, and before national progress can be made, agreement must be reached.

There is much to be said in favor of receiver voltage as it is at receiver locations that constant and normal conditions are expected to prevail. Elsewhere wide variation may exist. A difference of opinion exists between Mr. Oliver and myself on account of the difference in the practise of our respective interests.

Standards should be on same basis throughout the full range of systems and not change from receiver to sending values above 66,000 volts as proposed by the manufacturers.

In connection with test voltages applicable to apparatus specified under rated voltages, it is suggested that apparatus should be reclassified for test purposes. Apparatus including windings, for example transformers, should be tested substantially in accordance with present standards as such apparatus has proved most reliable. Oil switches, disconnecting switches,

lightning arresters, high-tension bushings, etc., should be subjected to higher tests than at present. The many failures which occur in this apparatus justify this recommendation.

Further support to this theory is afforded from the data submitted in papers on surge investigations presented at this convention.

In general it is contended the switch ratings in the higher voltage classes (66,000 and over) are much too close to the operating voltages. The added cost of a higher voltage switch is sometimes considered prohibitive and as cost is too often a controlling element, the factor of safety secured is sometimes insufficient. Studies of dimensional data for switches in adjacent classes frequently show but small differences, which leads to the constructive suggestion that costs to the user might be lower all around if the manufacturers would eliminate certain classes of switches and utilize possibly 5 or 6 classes to cover the entire range of usage.

The following groupings are suggested:

For System Voltages of the Kv. Below	Use Switches of the Kv. Below
220 to 154.....	220
132 to 110.....	132
88 to 66.....	88
44 to 22.....	44
15 to 6.6.....	13.2

Substantial savings in manufacturing costs would result. Substantial savings would accrue to users through more general interchangeability, reduction in stock of parts, etc.

There never has appeared to be any justification for development of 33,000-volt switches as a separate class between 22,000 and 44,000 volts, or for certain other intermediate classes.

All switches should be designed with ample factor of safety in service at voltages 50 per cent above rated voltage. Puncture and flash-over tests should be based upon the 50 per cent excess voltages to enable apparatus to meet known impulse and surge values to be encountered under service conditions.

The net result of this proposal should be a better and safer product at no higher, if not actually less, cost than at present. This proposal is not out of line with present practise in other branches of the industry, namely, one size of tank for several transformer sizes, one motor frame for several different motor capacities, etc.

The suggested elimination of certain classes of switches leads to the further suggestion that certain system voltages might also be eliminated from the standards, for example, 4600, 11,000, 33,000, and 88,000. These might be considered exceptions and no new construction be undertaken for these voltages.

The responsibility for the present situation rests upon all interests; users and manufacturers, utilities, consulting engineers, designing engineers, and owners of projects, all of whom have contributed to present conditions. Much construction has been created in which through lack of foresight, knowledge or appreciation of future requirements, great sums have actually been wasted. Even today construction is going forward which is limited in its future usefulness and as designed represents substantial waste.

Failure to supply conductors of adequate capacity and suitable operating facilities leads to ultimate losses which are enormous when compared with the small additional investment required for an adequate arrangement. Isolated construction is frequently noted which involves factors preventing the use of any standard apparatus.

It may well be that certain interests delay or obstruct standardization in recommending that motors be designed for operation for 90-110 per cent of normal voltage and then operate at the lower value contrary to the intent of the present standard. Systems should not be designed for 20 per cent variation in

voltage at receiver end as suggested. In short, responsibility for some of these matters must rest where it belongs.

Standardization of voltages has been and is really being impeded to a great extent by manufacturing interests who, for competitive purposes, create new classifications in design of apparatus which might well be eliminated through liberality in existing designs. Users' specifications may be responsible for certain of this undesirable effort, but a brief review of the many types of similar equipment which are offered from year to year is most convincing. Cooperative effort such as is being considered here should eliminate many of these conditions.

Assuming that standardization is really effected, will costs be reduced? We believe not, at least so they can be distinguished since it appears that in high-voltage construction, for example, most equipment is non-standard and is usually designed to meet requirements of individual systems, hence if such methods are to continue there is little opportunity for cost reduction. With years of progress in present switch design, rising prices are encountered.

On the other hand a review of many transactions involving purchases of apparatus under highly competitive conditions, manufacturing prices seem to have no anchor. Possibly we are really saving as much now as would be represented by increases in cost of higher rated apparatus which seems so necessary. It has been suggested that the cost of non-standardization in matters of voltages may total \$150,000,000 to \$200,000,000.

This is really not an excessive expenditure to be incurred in the development of a \$10,000,000,000 industry, it being only 2 per cent of the total. What industry can show equal efficiency through an extended development period? We are really not so badly off as might appear from some of the comparisons which have been made.

Finally, if standardization is actually accomplished, the following queries suggest themselves:

(a) Will prescribed standards be followed by all? We believe the answer is "no," that special construction will still continue as controlled by the acts of individuals, and that there will always be special classes outside of the standards which we may create.

(b) Will not special voltages still be selected for certain projects as best harmonizing with local conditions, such as load, distance, preferred sizes and types of conductors, economic conditions to be met, etc.? We believe the answer is "yes."

It is common knowledge that many projects are designed and built as isolated units, to meet certain local conditions with no thought of future connection with other systems. Where is this condition more prevalent than in industrial plants where every standard is sometimes sacrificed to make a sale. In many more important undertakings operating conditions are seriously affected by economical limitations, imposed by investment restrictions supposedly to meet some theoretical or calculated load cycle to the entire disregard of future requirements.

P. H. Chase: It seems to me that Mr. Elden's remarks reflect the well-reasoned attitude of the central station man considering the problem from the broad point of view, looking forward to the day when we will have more interconnection, when the voltage regulation must be taken care of by voltage regulating means for power flow in both directions.

W. R. Bullard (by letter): Messrs. Silver and Harding have presented a comprehensive picture of a rational and practical method of assigning voltage ratings to different types of apparatus, so as to maintain the proper voltage levels at different points in the system. Under this method, the starting point for assigning voltage ratings is the lamp socket. This is as it should be, since the lamp-socket voltage is fixed by service requirements and the values of other voltages are very largely dependent upon the necessity for holding this voltage practically constant at its nominal value. Therefore, in connection with the general problem of voltage standardization, it is highly desirable that a single lamp-socket or utilization voltage standard be ultimately

established, and a brief discussion of this phase of the problem may not be out of place.

A lamp-socket voltage standard of 115 volts was assumed by Messrs. Silver and Harding in building up the tentative assignment of voltage ratings. Of the two remaining voltages in general use—namely, 110 and 120 volts,—the popularity of the lower voltage is on the decline; 110 volts can therefore probably be eliminated from consideration as far as eventual standards are concerned. This leaves the choice of the ultimate standard between 115 and 120 volts, if the selection is to be made from existing standards.

Of these two voltages the latter has the advantage of providing a slightly higher copper efficiency in the low-voltage distribution circuits, while the former has the advantage of conforming, on the whole, more nearly to existing voltage standards of utilization and distribution devices and apparatus, as will be seen from the following:

Incandescent lamps are short-lived and are now furnished at the same cost and efficiency for both voltages. The selection of either 115 or 120 volts as a universal standard would therefore involve no difficulties as far as the manufacture of lamps is concerned.

In the case of motors and devices of the 220-volt class, existing designs are not entirely suitable for delta-connected distribution systems of either 115 or 120 volts at the lamp socket. They are, however, more suitable for the former than for the latter voltage in delta systems, since 240 volts, the delta voltage for the 120-volt standard, is nearly 10 per cent high for equipment rated at 220 volts.

Delta-connected distribution systems will doubtless continue to be used for many years. However, low-voltage systems of the 4-wire Y-connected type are rapidly coming into use in connection with underground distribution in business districts of both medium-sized and large cities, and therefore the relation of motor voltage standards to this type of system must be carefully considered. In Y-connected systems, the delta voltage corresponding to the 120-volt standard, or 208 volts, conforms more nearly to existing 220-volt apparatus designs than does the delta voltage corresponding to the 115-volt standard, or 199 volts. However, actual operating experience obtained in connection with several underground distribution systems of the 4-wire network type has demonstrated that 220-volt motors, both of ancient vintage and of present design, will with very few exceptions, function satisfactorily at 199 volts, in much the same manner as they will function satisfactorily at 240 volts in a 120/240-volt delta system.

In order to meet the demands of both delta and Y-connected systems and at the same time avoid developing two lines of motors and devices of the 220-volt class, the logical solution of this phase of the problem is to make slight changes in the future designs of this apparatus so as to make them conform to an intermediate voltage value between those of the two types of systems with the necessary tolerance above and below this value. This would be advantageous not only from the manufacturer's viewpoint but also from that of the customer, since the latter would be enabled to use his motors interchangeably in both types of systems. Assuming this procedure, there is little to choose between 115 or 120 volts as a universal standard as far as this class of apparatus is concerned. In one case the mean value between the delta voltages of the two types of systems would be 214.5 and in the other case, 224. Neither of these values conforms exactly to the present 220-volt rating, but the relation is so close in each case that the necessary changes would be slight.

The situation is slightly different with respect to appliances of the 115-volt class. Many of the existing standard lines are designed to apply to a voltage range from 110 to 120 volts. This of course makes them entirely satisfactory for 115-volt distribution and in some measure out of line for a universal standard of 120 volts. Consequently, it seems fair to assume that the

adoption of 120 volts as a single utilization standard would eventually bring about some general changes in the design of appliances whereas a 115-volt standard would almost exactly fit existing designs.

The most serious phase of the situation is encountered in the case of 2300-volt distribution transformers. The present voltage rating in this case, namely 115 230 2300 volts,—is primarily suitable for use in systems having nominal 110 lamp-socket voltage. In 115-volt systems, it is quite generally necessary to over-excite these transformers by some 5 per cent or more in order to maintain 115 volts at the lamp socket. This is working out fairly well in practice, particularly since present transformer designs are probably liberal as to the allowable upper limit of operating voltage. However, a lamp-socket voltage of 120 would in many cases require an overexcitation of more than 10 per cent and even then it would be difficult in many systems to maintain normal voltage at the lamp socket with generators and station transformers of present voltage ratings.

It can of course be assumed that these difficulties would eventually be taken care of by some comprehensive method of voltage ratings in the future design of system apparatus. However, the number of standard distribution transformers of present ratings in service, and the present capital investment represented by other apparatus involved in the question of system voltage levels, are so great that existing equipment in this case must be given serious consideration.

On the other side of the picture is the fact that the 120-volt standard would provide a slightly higher copper efficiency in the low-voltage distribution circuits. The difference would indeed be slight in the case of a-c. systems, since it would represent only some 10 per cent of the secondary copper losses or, in usual types of a-c. distribution systems, a fraction of 1 per cent of the delivered energy. In d-c. systems the situation is somewhat more serious, and it is worthy of note in this connection that the d-c. systems provide a very large portion of the present market for 120-volt lamps and appliances. This suggests that a satisfactory solution to the problem might be the general adoption of 115 volts for a-c. systems and 120 volts for d-c. systems. This, however, has the serious disadvantage that in cities having both a-c. and d-c. distribution it would be necessary either to maintain two utilization voltage standards, or to depart from the standard voltage in one of the two systems. In practically all except the very largest cities, d-c. systems are being converted into or merged with a-c. systems, and the importance of establishing standards which will facilitate this process can easily be appreciated. Furthermore, although lamps and appliances are now furnished for both voltages, and would have little influence upon the question of which voltage should be selected, nevertheless a considerable simplification of manufacture and stocking of these articles would be brought about by the establishment of a single standard.

The ultimate solution of the problem must of course be based upon a very careful weighing of all the factors involved, and it will no doubt be a difficult matter to bring about, in any reasonable length of time the complete application of a single lamp-voltage standard. Nevertheless, in view of the large ultimate saving which would accrue to the industry, it can hardly be doubted that a well coordinated effort to fix upon such a single standard should be made in the near future.

The general problem of standardization of apparatus voltage ratings is largely dependent upon the establishment of such a single standard. Messrs. Silver and Harding have suggested a schedule of standard voltage ratings that is entirely practicable if the ultimate lamp-voltage standard is to be 115 volts. If, however, 120 volts should ultimately be selected it would seem from the foregoing that a change from the existing standard voltage ratings of distribution transformers would be necessary. The logical form for this change to take would be a change in ratio. For instance, the ratio of 18-to-1 might be adopted, this

being an existing commercial rating in use in a number of systems. For a 120-volt standard this ratio would permit operating the distribution transformers at a more favorable excitation voltage than does the present standard 20-to-1 ratio in connection with 115-volt systems. Furthermore, with this one change in the schedule of voltage ratings suggested by Messrs. Silver and Harding, this schedule would apply as well to the 120-volt standard as it does in its present form to the 115-volt standard.

M. T. Crawford (by telegraph): I can endorse general plan of voltages proposed by Messrs. Silver and Harding as our distribution installations recent years conform thereto. There is considerable investment in 6600-volt/11,00-volt-Y systems in the northwest, which are very economical for rural distribution. I doubt the possibility of their eventual elimination. I suggest careful consideration in the discussion of Mr. Argersinger's scheme combining step-up and step-down types by adding taps.

H. Carl Wolf, (communicated after adjournment): Voltage standardization has been discussed from practically every viewpoint except that of the public, and in the final analysis we all fall into this latter classification. Speaking broadly and collectively, the consumer wants standardization of voltages and wants it to begin at, what is to him the most tangible point, his equipment. From data presented on the sales of lamps, it appears that lamp voltages will very soon be standardized at 115 or 120, either one of which provides a reliable starting point.

The consumer is interested in service and is willing to pay the price to get the very best service obtainable. He is also interested in flexibility, simplicity, sturdiness and universality of equipment. Simplification of practise as to voltages is the most effective means of accomplishing these ends. A great deal of stress has been laid in discussions on this subject on the need for transformer taps in order to keep the voltage up during loads. Greater stress should, in my opinion, be laid on the regulation of voltage, thus necessitating more care in the design of lines and equipment in order to reduce voltage drop to the lowest point commensurate with the economics of the situation. With the development of equipment for changing taps under load, a larger number of taps might be justified, but until such time the other engineering features of the system should be stressed.

If we are to have simplified practise, the fewer the number of voltages agreed upon, the nearer will be attained the goal. It should not be forgotten that the electric industry is still in its infancy and present investment is still only a fraction of what will ultimately obtain. The present medley of voltages and practises should not be permitted to stand too much in the way of adoption of standards for the future. After all, this question of voltage standardization is nothing more than the preparation of a voltage budget within the limits of which good practise can move. Present equipment and present standards should not be rendered obsolete over night, but the industry should be given a goal toward which to work.

In selecting the voltages to be concentrated on and in considering the relative merits of the delta-Y or other systems of connections, the telephone situation should not be lost sight of. Joint construction is very desirable in a large number of cases and any standardization adopted should conform as far as possible to that operating practise which will reduce to a minimum inductive interference.

MAXWELL'S THEORY OF THE LAYER DIELECTRIC¹
(MURNAGHAN)

NEW YORK, N. Y., FEBRUARY 9, 1927

Vladimir Karapetoff: The phenomenon of absorption in a composite dielectric, each layer of which separately shows no absorption, has been graphically explained by Grünwald². Referring to the accompanying sketch, consider the simplest case of two slabs $A B C D$ and $C D E F$, of equal thickness and of equal insulation resistance to direct current. Let the material

I be of much lower permittivity than the material II . Let $A B$, $C D$, $E F$, represent very thin layers of metal foil, to insure the positions of equipotential surfaces. Assume the metal sheet $A B$ grounded at G and a d-c. potential of value $N F$ suddenly applied to the surface $E F$. The instantaneous distribution of potential may then be represented by the broken line $H K F$. The permittivity of the layer I being lower, a major portion, $S K$, of the total voltage is applied across it, and a minor portion, $K C$, across II . The slopes of the two lines are inversely as the permittivities, or directly as the elasticities of the two materials.

At the first instant, there can be no electric charge on the the surface $C D$, and the displacements of electricity through both dielectrics must be equal to each other. The line $P R$ indicates this condition, the ordinate $H P$ representing the displacement of electricity or the charge on the plates. It will be seen that the positive and negative charges on the plate $C D$ cancel each other, leaving equal and positive charges on $A B$ and $E F$.

Now, let the same voltage remain applied indefinitely, causing a conduction current through the dielectrics. Since, by assumption, the resistivities of the two materials are equal, the final distribution of potential will be represented by the straight line $H L F$. The voltage gradient in the material I has been reduced in the ratio of $L S$ to $K S$, and consequently the displacement of electricity will be reduced in the same ratio, say

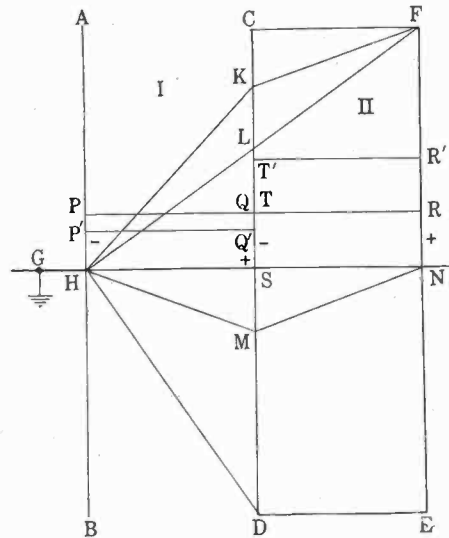

FIG. 1

from $H P$ to $H P^I$. The potential gradient in II has been increased from $C K$ to $C L$, and the displacement increased in the same ratio, say from $N R$ to $N R^I$. Thus, the middle plate $C D$ receives a positive charge $S Q^I$ and a negative charge $S T^I$, or a net negative charge $Q^I T^I$. An electroscope connected to $C D$ would indicate this charge, corresponding to the difference $K L$ in the voltages at the first instant and under steady-state conditions.

Let the potential $N F$ be suddenly removed and the plate $E F$ immediately grounded. The new distribution of potential will then be represented by the line $H M N$, the potential of the middle plate being negative because it carries a negative charge. Numerically, $S M = L K$. The charge on $C D$ will be equal to $-Q^I T^I$, and that on each of the grounded plates $+0.5 Q^I T^I$. Should the plate $E F$ be left grounded indefinitely, the charge $Q^I T^I$ would ultimately leak to the ground in both directions.

Let the plate $E F$, however, be grounded for an instant only, and then an equal and opposite voltage, $N E$, applied to it.

1. A. I. E. E. JOURNAL, FEBRUARY, 1927, p. 132.
2. Arch. für Elek., 1923, Vol. 12, p. 98.

The new instantaneous distribution of potential will be $H D E$, where $M D = S K$. In other words, the new distribution of potential may be considered as a result of superposition of the distribution $H K F$ in the neutral state and of the distribution $H M N$ due to the accumulated charge on $C D$.

It will thus be seen that the new distribution involves a greater stress in the material I than without absorption. Moreover, the absorbed charge can reach $C D$ only through conduction which involves heat loss. The materials themselves have no property of absorption, but because the ratio of their conductivities is different from that of the permittivities, a residual charge, alternately positive and negative, accumulates on the dividing surface as the applied voltage its sign. This graphical interpretation may be carried further, to include more layers or layers of different thicknesses and different resistivities. Some years ago, the writer designed a kinematic model to show dielectric absorption according to Grünwald's representation. Certain linkages were connected through a spring and a dash-pot. At the first instant, as the point N on the linkage was suddenly raised to F , the linkage assumed the shape $H K F$. Then the spring gradually moved point K to L , overcoming the resistance of the dash-pot. Moving the point F suddenly to E gave the configuration $H D E$. Some parts of the model were made but the work was never completed due to a pressure of other investigations.

While Maxwell's theory of absorption has considerable methodological value, its practical usefulness is limited by the fundamental assumption that the layers which constitute a dielectric possess no absorption when tested separately. This may be true of such pure materials as white paraffin and xylol, but dielectrics used in practise show considerable absorption even in their constituent parts, such as paper, oil, mica leaves, etc. It is, therefore, not clear how to apply Maxwell's theory to a given case of say molded insulation, built-up mica, paper and oil, etc.

For this reason, it seems necessary for the present to assume the existence of the phenomenon of absorption in a given piece of insulation as a fact, and simply try to express mathematically the observed behavior, having made plausible assumptions about the shape of the functions expressing variations of current and flux density with the time. This method is used in the writer's paper on the subject presented at the 1926 Winter Convention.³

D. W. Roper: I should like to comment upon the necessity for such fundamental research. The industry at the present time is forging ahead of the science in cable dielectrics, particularly in high-voltage cables, and in this country that means paper-insulated cables. We are not yet able to test a cable and predetermine with reasonable accuracy its operating characteristics. A cable which has passed all of the requirements of the specifications agreed upon by the manufacturers and committees of the various associations will fail in service, and sometimes within a few months after being placed in service. Two instances of that sort have occurred within the last year. They were not confined to any one operating company, nor to any one manufacturer. In each case, after one or two failures had occurred, the manufacturers looked over their factory records and found evidence which caused them to be suspicious of certain other sections of cable that had been sent out from their factories, so they arranged with their customer to remove and replace certain other sections that had not yet failed, but which the manufacturers thought would probably fail, and the expense of the change was borne by the manufacturers. Now there is perfectly definite evidence that the manufacturer, from his factory records, can tell something about the cable that was not shown by any test that we know how to make, either in the factory or after it is placed in service.

We can make life tests on cable, and if we do, we get a fairly

3. (A. I. E. E. JOURNAL, 1926, Vol. 45, p. 236.)

definite line between the voltage and the time. If we plot the logarithm of the kilovolts against the logarithm of time, we obtain a straight line, and for the types of cables that we are getting nowadays the kilovolts vary inversely as the seventh root of the time. Now, if you test that cable for a part of its life, there is no way of which we know at the present time to determine what fraction of that life has been spent, except by looking at the clock and the voltmeter. There is no electrical test that can be made to determine deterioration.

The lower part of that curve is of great interest because if you simply extend that curve, you get a finite time for zero voltage; but we know that if you get the voltage low enough, the time becomes infinitely long.

We have that problem before us continually. As a company increases in size and builds new generating stations, it scatters them about the territory which it supplies, so as to reduce the transmission distances, among other things, and that means that every time a new station is built, it is necessary to take out of service some cable which is no longer of value in its original location and remove it to some new location. As the voltages increase and we operate a little closer to the limit, there is every prospect that we shall, at some future time be taking out of service cable which has lost so much of its life that it would hardly pay to reinstall it in a new location, but there is no way of telling that except to go ahead and install it and then replace it if it fails.

There is one other point: In connection with the cable failures in Chicago and the determination of their cause, we found it expedient to train some of our younger engineers in methods of systematic and careful inspection and analysis of cable in the vicinity of the failure and at points on the same section remote from the failure, so as to tell whether the cause of the trouble was one which existed throughout the entire length or which was local. A local case of trouble might for example, be due, to irregular impregnation,—spotty impregnation, as the manufacturers call it. As these young engineers have competent supervision and instruction, you might say that their ability is proportional to their experience, and along certain lines, the circumstances have been such that they had ample experience.

A few years ago we had some trouble with the joints on 33-kv. 3-conductor cables, and we had to remake the joints so as to use a different joint-filling compound. The one used was unsuitable for the purpose. In remaking these joints, we carefully examined the ends of the factory insulation in the joint, in some cases cutting back a few inches or a few feet, if necessary, and in a few cases replacing entire sections, because examination disclosed the evidence of ionization, and when those evidences of ionization were sufficiently definite and numerous throughout the insulation at one point, we removed that cable either by cutting it back in the manhole or by replacing the entire section. That gave us a very good opportunity for getting an average idea of the insulation of the entire line and from the evidence so gathered, the engineers making the inspection predicted the failure of the line very shortly from ionization. They reported that the life had been well spent at the operating voltage. The prediction was verified within six months.

The point to which I wish to call attention is that we can get this evidence and this prediction from a *visual examination*, but we cannot make any tests whatever, that we know now how to make, which will warrant the same prediction. We are now making, I believe, all the tests that we know how to make, on the data that we have available, and apparently what we need is more fundamental research that will enable us to make more tests and determine some of these features that we can now determine by visual examination or other methods which are not electrical tests.

Joseph Slepian: I should like to raise the question as to how much actual information about dielectrics such mathematical investigations can give. Essentially, Dr. Murnaghan shows,

following Maxwell, that if a dielectric is composed of n layers of dielectric with different dielectric constants and resistivities the relation between voltage and current is one which satisfies an n th order differential equation and hence there must be a certain final relation between current and voltage. But it does not follow that if for any particular dielectric the voltage and current do satisfy such a relationship that the dielectric must be composed of n layers.

They are infinitely many hypothetical structures of the dielectric which will give the same relationship between voltage and current. For example, if we insist on explaining the behavior of the dielectric by inhomogeneities, we will have equally great success by imagining the inhomogeneities to be in the form of little spheres. Wagner, I believe, has carried out a mathematical investigation of such a dielectric. A year ago Professor Karapetoff also considered the mathematical theory of a dielectric with what he called particles, each particle having dielectric properties expressed by means of a first order of differential equations.⁴ By suitable hypotheses as to the distribution of these particles, any relationship between voltage and current satisfying the principle of superposition may be derived.

The fact that an actual dielectric has voltage-current relationships which correspond to the results obtained by such analyses throws no light upon the structure of the dielectric itself at all, since all these hypotheses lead to the same results. By merely measuring voltage and current no information can be obtained which permits one to decide which hypothesis, if any, is the actual truth.

Hence I want particularly to point out the need of other kinds of information than relations between current and voltage. Before we can attach importance to any inhomogeneity theory, we must somehow show by other means the existence of the inhomogeneities which the theory postulates. In this connection I am glad to mention the work of Professor Joffé of Leningrad, whom I was fortunate enough to hear not long ago in Pittsburgh. Professor Joffé described some experiments upon crystals of rock salt in which, a priori, you wouldn't expect any inhomogeneity at all. In spite of this apparent homogeneity Professor Joffé did observe absorption, and after voltage had been applied to the crystal long enough for the absorption current to die down to nearly its zero value, he investigated the distribution of the potential through the crystal. By a very skillful technique which consisted of shaving away with insulated knives exceedingly thin layers of the dielectric he found that the distribution of potential through this dielectric consisted of a very small gradient through the body of the material with almost all of the potential concentrated in thin layers immediately next to the electrodes. Thus he showed the actual existence of a layer, next to the one electrode which had such different characteristics from the rest of the dielectric as to cause the voltage to be highly concentrated on that layer. The most significant thing about Joffé's experiment is that the layer in question had its peculiar properties only because of its relation to the electrode. If after the layer was cut off voltage was applied to the remaining crystal a concentration of potential upon the layer next to the electrode would again be obtained. The inhomogeneity which is active here is not in the material to begin with. It is an inhomogeneity which is produced by the electric current itself. For an understanding of the phenomena in dielectrics, it is not sufficient to treat the dielectric as if it had a simple ohmic conductivity. The nature of the carriers of current must be considered and account taken of the space charges which these carriers produce as a result of the flow of current.

In the absence of evidence other than the voltage-current relationships, the layers of Maxwell, spheres of Wagner, particles of Karapetoff, must be considered as mathematical fictions or conveniences, or simply individual preferences as to the manner

of describing the phenomenon that is going on. Personally, I prefer to say that the homogeneous dielectric has its own complex properties rather than to assume a hypothetical complex heterogeneous structure, built up of parts having hypothetically simple dielectric properties.

Donald Bratt: In regard to the physical conditions of the problem, it is well to remember that Maxwell's idea was nothing more than to show that there is no such thing as "absorption" of charge in a dielectric. He did show, that the phenomena known as "absorption" are the result of lack of homogeneity and confined himself to the simple case of two plane condensers in series, subjected to a sudden application of a d-c. voltage. He further indicates, that the nature of these phenomena remains the same even if the dielectrics assume a geometrical shape other than plane. The proof of this statement could, perhaps, be given in strict mathematical language, there is nothing however to make one believe that the phenomena in physics should change their nature by changing the geometrical configuration of the boundaries. In all problems where phenomena obey for instance the well-known Laplace differential equation a purely mathematical transformation exists, which will refer any boundary to the cubical dement on which we base our physical laws, as well as our calculus. Maxwell did not, apparently, consider it necessary to emphasize this.

It is not safe to base an extended analysis on Maxwell's work, for the further reason that Maxwell omitted the magnetic permeability from this problem to get a simpler analysis of the initial displacements due to a suddenly impressed d-c. voltage. He found these displacements all equal initially. Had Maxwell wanted to go a little further, it would have been necessary for him to emphasize that there cannot be any such thing as a displacement until the wave starting from one end of the dielectric has had time to reach the other end.

The idea of a wave does not, of course, occur unless magnetic permeability is introduced.

The term "dielectric absorption" is doubtless derived from a supposed analogy with heat. It was this idea Maxwell tried to refute by showing how different were the laws governing dielectric phenomena from those governing the flow of heat. On page 458 (Vol. I) in his work Maxwell says (referring to his above-mentioned analysis): "The object of the investigation is merely to point out the true mathematical character of the so-called electric absorption and to show how fundamentally it differs from the phenomena of heat which seem at first sight analogous."

To give a general solution of a stratified condenser, consider first the conventional picture of a dielectric: a non-inductive resistance in parallel with an ideal condenser. Should a d-c. voltage be suddenly impressed on such a condenser, the initial rush of current would be infinite. The same would happen if several such condensers were connected in series. To avoid this difficulty it is necessary to make certain restricting assumptions on the form of the impressed voltage, as will be shown below.

Take, now, Dr. Murnaghan's equation (7)

$$\left[\frac{\alpha_1}{D + b_1} + \dots + \frac{\alpha_n}{D + b_n} \right] u = E$$

which I prefer to solve for the current, writing, symbolically

$$i = \frac{E(t)}{\frac{1}{g_1 + p c_1} + \frac{1}{g_2 + p c_2} + \dots + \frac{1}{g_n + p c_n}}$$

where i is the total charging current at any time t $E(t)$ is the external voltage impressed, and may for the moment be assumed to be perfectly unrestricted.

g_k and C_k are the conductance and capacity of the k th condenser.

p is the differential operator $\frac{d}{dt}$ (Heavisides notation)

4. *Theory of Absorption in Solid Dielectrics*, by V. Karapetoff, A. I. E. E. JOURNAL, March 1926, p. 236.

Re-arranging, we obtain an expression

$$i = \frac{A(p)}{B(p)} E(t)$$

where A and B are algebraic polynomials in p ; A being 1 degree higher than B .

To reduce still further, perform the division $\frac{A(p)}{B(p)}$; we get

$$\frac{A(p)}{B(p)} = M p + \frac{G(p)}{H(p)}$$

where M is a constant directly obtained by the division, G and H are polynomials in p of the same degree (i. e. $(n - 1)$ if there are n condensers in series.)

According to the Heaviside Expansion Theorem, we now have

$$\frac{G(p)}{H(p)} = K_0 + K_1 \frac{p}{p - p_1} + \dots + K_{n-1} \frac{p}{p - p_{n-1}}; \text{ where}$$

$$K_0 = \frac{G(0)}{H(0)}$$

p_1, p_2, \dots, p_{n-1} are the roots of $H(p) = 0$ which are all negative and real, no two roots being alike, by assumption.

$$K_r = \frac{1}{p_r} \cdot \frac{G(p_r)}{\left[\frac{\partial}{\partial p} H(p) \right]_r}$$

so that

$$i = \left[M p + K_0 + K_1 \frac{p}{p - p_1} + \dots + K_{n-1} \frac{p}{p - p_{n-1}} \right] E(t)$$

The operation $\frac{p}{p - p_r}$ performed on $E(t)$ gives a solution

$$\frac{p}{p - p_r} E(t) = E(t) + e^{p_r t} p_r \int_0^t e^{-p_r u} E(u) du$$

Further

$K_0 E(t)$ means nothing but $K_0 E(t)$ since K_0 is a constant

$M p E(t)$ means $M \cdot \frac{d E(t)}{d t}$

so that the solution can be written

$$i = M d \frac{E(t)}{d t} + E(t) \left[K_0 + \sum_1^{n-1} K_r \right] + \sum_1^{n-1} e^{p_r t} p_r \int_0^t e^{-p_r u} E(u) du$$

The displacement f_r of the r th condenser would be,

$$f_r = \frac{i}{A \left[\frac{1}{r_r} + p \cdot \frac{1}{4 \pi k_r} \right]}$$

which solves into

$$f_r = \frac{4 \pi k_r}{A} e^{-\frac{4 \pi k_r}{r_r} t} \int_0^t e^{-\frac{4 \pi k_r}{r_r} u} i du$$

and can be calculated when i is known.

It should be noticed, that these solutions for i and f , are perfectly general, inasmuch as the voltage $E(t)$ has not been subject to any restrictions.

Our immediate concern, as physicists, would now be to check the theory by experiment. It would then be a question of the

best form to adopt for the test voltage $E(t)$, and particularly the form of $K(t)$ near $t = 0$.

There are three principal forms that may occur:

(1) D-c. voltage is entirely inadmissible, as it would introduce wave motion that has not been considered above.

(2) Alternative (sine-wave) voltage is better, but gives a finite value of current for $t = 0$ in the formula above, and is therefore not recommended.

(3) Voltage, possessing zero derivative at $t = 0$ should be used, for instance $E(t) = E_0 (1 - \cos \omega t)$

In other words: an a-c. voltage super-imposed on a d-c. voltage so as to produce a gradual smooth rise of voltage at the first moments would probably be the best to use when testing the theory.

To sum up: The weak spots in any theory of the dielectric omitting the magnetic permeability will be found around discontinuous points in the external voltage-curve or its first derivative. In particular it seems inadmissible from a physical standpoint to base a general solution on the solution for a suddenly impressed d-c. voltage.

Vladimir Karapetoff: I am glad that Mr. Bratt brought up the question of discontinuity in the current at the first instant. This discontinuity is not confined to Dr. Murnaghan's paper; any problem on a combination of resistances and capacitances leads to a similar inconsistency if you omit the magnetic flux. The system then has no inertia, and theoretically the current rises instantly from zero to a finite value.

W. B. Kouwenhoven: We are carrying on an investigation of Maxwell's theory at Johns Hopkins University under the auspices of the Engineering Foundation. We are endeavoring to obtain two or more perfect dielectrics having no absorption but different conductivities and dielectric constants. We will then make a mixture of these two dielectrics and if Maxwell's theory is correct the resulting mixture will show absorption. This work is still in its early stages and we are not ready to report any results as yet, but simply to say that we are making progress.

A. F. Puckstein (communicated after adjournment): Dr. Murnaghan uses the concepts of the physicist rather than those of the engineer. Would it not have been easier for the engineering reader if the set-up had been based on the idea of capacitances instead of electric intensities and displacements?

On this basis, the same value of current passes through all of the dielectrics, then for a two-layer arrangement

$$i_1 = i_2 \tag{1}$$

Since each layer may be regarded as a condenser shunted by a resistance we have the relations,

$$i_1 = c_1 \frac{d e_1}{d t} + \frac{e_1}{r_1} \tag{2}$$

$$i_2 = c_2 \frac{d e_2}{d t} + \frac{e_2}{r_2} \tag{3}$$

in which e_1 and e_2 are the potential drops across the different layers; r_1 and r_2 are the insulation resistances; and c_1 and c_2 are the capacitances of the condensers formed by each layer.

In addition, the total potential drop e is the sum of the several drops, and this sum is at all times equal to the internal voltage E of the supply source minus its internal $i r$ drop. It is assumed that the system is initially uncharged. From this we have

$$e = e_1 + e_2 = E - i r \tag{4}$$

At this point, the theory here given diverges from that of Dr. Murnaghan in that he assumes the displacements at the first moment to remain finite, with no further restriction, except that initially $\Delta f_1 = \Delta f_2$, while here a limit is set by the $i r$ drop in the supply source. The letter f stands for displacement.

There is an obscurity of statement where we read, " * * * the polynomial ϕ degree $n - 1$ has all its zeros real and negative and that they lie in the intervals between the negative values of

b 's. Let us denote these zeros by $(-\beta_1, -\beta_2, \dots, -\beta_{n-1})^{***}$. This may be correct, but it carries no meaning to one not initiated into its mysteries.

To solve the above equations, equate (2) and (3), combine (2) and (4), use D in place of $\frac{d}{dt}$, and solve for e_1 when

$$e_1 = \frac{E}{r} \frac{c_2 D + \frac{1}{r_2}}{\frac{1}{r} \left(c_1 D + \frac{1}{r_1} \right) + \left(c_2 D + \frac{1}{r_2} \right) \left(c_1 D + \frac{r_1 + r}{r r_1} \right)} \tag{5}$$

Equation (5) may be solved by the rules of operational calculus or by the rules for solving simultaneous equations. The latter method is used here. We may solve for both or either e_1 and e_2 , and obtain the other by interchanging the subscripts. This last is the simplest and will be used here.

If we put

$$a = r c_1 c_2, \tag{6}$$

$$b = c_1 \left(1 + \frac{r}{r_2} \right) + c_2 \left(1 + \frac{r}{r_1} \right) \tag{7}$$

$$c = \frac{r + r_1 + r_2}{r_1 r_2} \tag{8}$$

then equation (5) becomes, since E is independent of time,

$$e_1 = \frac{E/r_2}{a d^2 + b D + c} \tag{9}$$

The roots of the denominator in (9) are

$$m_1 \text{ and } m_2 = -\frac{b}{a} \pm \sqrt{\left(\frac{b}{2a} \right)^2 - \frac{c}{a}} \tag{10}$$

and the solution,

$$e_1 = A e^{m_1 t} + B e^{m_2 t} + \frac{E}{r_2 c} \tag{11}$$

where A and B are the constants of integration. To determine these, we notice that e_1 is zero when t is zero, then from (11)

$$0 = A + B + \frac{E}{r_2 c} \tag{12}$$

Also, when t is zero, from (2) and (4),

$$i = i_1 = \frac{E}{r} = c_1 \frac{d c_1}{d t} \tag{13}$$

Substituting e_1 from (11) in (13),

$$\frac{E}{c_1 r} = A m_1 + B m_2 \tag{14}$$

Solving (12) and (14),

$$A = \frac{E (r_2 c - m_2 r c_1)}{r_1 r_2 c c_1 (m_2 - m_1)} \tag{15}$$

$$B = -\frac{E}{r_2 c} \left\{ \frac{r_2 c - m_2 r c_1}{r_1 c_1 (m_2 - m_1)} + 1 \right\} \tag{16}$$

To obtain e_2 , interchange all subscripts 1, 2, except those of m_1 and m_2 .

This theory is easily extended to the case of n layers and to alternating currents, though the solutions are more complicated.

F. D. Murnaghan: I have been very interested in the various comments on my paper but shall confine myself here to some remarks on Mr. Puchstein's communication since it is almost entirely mathematical in character. His idea of allowing for

the internal resistance in the supply source is quite interesting and may be at once cared for by the general method of my paper. The E in equation (7) is now to be replaced by $E - r u$ so that our fundamental equation for the current is

$$\left[\frac{\alpha_1}{D + b_1} + \frac{\alpha_2}{D + b_2} + \dots + \frac{\alpha_n}{D + b_n} + r \right] u = E$$

It is now of the n th order instead of the $(n - 1)$ th as before. In the case of two layers the determining equation for the exponents is

$$r D^2 + D \{ r (b_1 + b_2) + \alpha_1 + \alpha_2 \} + r b_1 b_2 + \alpha_1 b_2 + \alpha_2 b_1 = 0$$

Our α 's are the reciprocals of Mr. Puchstein's c 's while our b 's are the reciprocals of the product of his c 's and r 's, i. e.,

$$b_1 = \frac{1}{c_1 r_1} \text{ etc. This equation checks, on substitution of these}$$

values, with his results (6), (7), (8). The same method takes care of the general case of n layers.

TRANSVERSE REACTION IN SYNCHRONOUS MACHINES¹

(DOUGLAS)

NEW YORK, N. Y., FEBRUARY 7, 1927

H. V. Putman: I have been intensely interested in Professor Douglas' paper because in my own work I use Blondel's two-reaction theory exclusively for calculating the performance of salient-pole machines.

His method of measuring the phase angles between the terminal voltage, current and the pole axis by the use of two wattmeters is extremely interesting, but I do not see clearly how this same method could be applied to 3-phase machines (the machines he used were 2-phase machines), because in the 3-phase machine there would be no way to check the current by getting the zero reading on the wattmeter, to get it in phase with the pole axis. Maybe there is some way, and I should like to ask Professor Douglas if he has some similar way worked out for the 3-phase machine.

Professor Douglas has called attention to the fact that the transverse synchronous reactance decreases with increasing saturation. He also states that it is a mistake to build a two-reaction theory on the basis of an unsaturated magnetic circuit. We must not forget in this connection that not only the transverse synchronous reactance but also the direct synchronous reactance decreases with the saturation. Actually, I believe the direct synchronous reactance decreases more rapidly with increased saturation than does the transverse. Dr. Berg defines the direct synchronous reactance as the sum of the real armature reactance plus the reactance equivalent of the armature reaction, and he expresses it in this form:

$$X + \frac{m}{c} \text{ where } X \text{ is the reactance, } m \text{ is the coefficient of}$$

armature reaction and c is the factor that depends on the saturation.

If one expresses m in percentage based on the no-load excitation of the machine, as is usually done, then c is unity for a condition of saturation that corresponds to no-load excitation. Under short circuit, where there is no saturation in the machine, c is less than unity, and at higher saturations it is much greater than unity. So that the synchronous reactance for high saturation is considerably less than one would measure from the short-circuit test. One should certainly not use the same value of synchronous reactance measured at full load under a condition of normal saturation. Nor would one use the same value for a condition of load at a leading power factor where there is a high degree of saturation present. Consequently, Professor Douglas should not calculate orthogonal lines for those shown in his Fig. 2.

1. A. I. E. E. JOURNAL, February, 1927, p. 109.

It is always necessary to determine first, the point on the saturation curve corresponding to the condition under investigation. c is then known and consequently one can calculate the correct values of synchronous reactance to be used in Blondel's theory.

It is all right to have a theoretical structure based on the assumption of no saturation, provided it can be made to give the right answer, and I think this is true of Blondel's theory. It may not give the pull-out torque absolutely correct, but I feel sure that it will give it closer than 30 per cent when handled correctly. In his discussion he referred to the work of Mr. Doherty and now I wonder if he meant the sudden pull-out, which of course would be higher than calculated for the steady-state condition.

Professor Douglas says that in order to make an experimental study of the transverse reaction it is necessary that the load be placed so that the effect shall be wholly transverse; that is, the armature currents shall attain their maximum values when opposite a pole axis. I think this is at least interesting, but Blondel pointed out that this is not necessary. In his book on "Synchronous Motors and Converters" he gives the equation for the angular displacement of a synchronous motor as follows:

$$\tan \delta = \frac{I X_s' - E_0 \sin \theta}{E_0 \cos \theta - I r}$$

δ is the angle between the current and the pole axis. The angle of displacement is this same angle plus the power-factor angle of the machine. I is the current and θ is the power-factor angle of the machine between the terminal voltage and the current. X_s' is the transverse synchronous reactance.

Notice that nowhere in this equation is the direct synchronous reactance involved at all, and Blondel called particular attention to this point: The angular displacement of a machine, under any condition of load and power factor, depends not at all on the direct synchronous reactance but only on the transverse synchronous reactance. So that it is only necessary to measure the angular displacement at any load and power factor whatever, and then substitute in this formula and calculate backwards to get the transverse synchronous reactance. Of course, this does not assume the validity of the general theory that Blondel bases his diagram on and that superposition is possible. If however, one denies the validity of the Blondel diagram, he would say that this is also invalid.

However, the common use of Blondel's theory is in the calculation of characteristics which depend on the displacement. If, by intelligent comparison of calculations with test results, it is possible to determine the constants in such manner that they give the correct displacement characteristics, the theory fulfills its purpose.

There is one point in connection with Professor Douglas' experimental set-up which is not clear to me. I understood from his description that the terminal voltage of machine *B* is supposed to correspond in phase position to the pole axis of machine *A*. This would be true if the rotors and stators of the two machines were lined up; that is, if the rotors were in line on the shaft, and the stators were in line on the floor, and if there were no load on machine *B*. But machine *B* was loaded with 5 amperes. If *B* is also rated 15-kv-a. (which, incidentally, he did not state), this 5 amperes would produce a displacement of three or four electrical degrees. Was this corrected for by adjusting the hand-wheel, and if so, how could it be done without an oscillograph to show when the terminal voltage of machine *B*, when loaded on the rheostat, was in line with the no-load voltage of machine *A*?

Professor Douglas refers to the great confusion of statements on the subject of transverse reaction.

In 1918 we were discussing the subject of armature reactance and reaction at zero power factor. The problem then was simply to divide the reactance flux from the armature reaction flux.

The total flux or interlinkages were known directly from the short-circuit test.

Now we are discussing the armature reactance and reaction at unity power factor referred to the pole axis. The problem is twofold. It is first necessary to find out the total interlinkages corresponding to the transverse synchronous reactance and then to divide this total into reactance and armature reaction. The first part of the problem can be handled experimentally by measuring the angular displacement. As I pointed out, that will give the value of the transverse synchronous reactance. It will give the total flux in the transverse field. So the accuracy with which the transverse synchronous reactance can be known will depend on how accurately the angular displacement can be measured. The second part of the problem, that is, the division of this flux, I think is not of great importance. It is usually only necessary to know the total transverse reaction for most problems, not the component parts of it. It will, however, be desirable to make the separation in order to understand more clearly the nature of the transverse synchronous reactance and also to settle the question about the magnitude of the transverse reactance. This question is perhaps the one on which there is more difference of opinion than on any other relating to Blondel's theory.

Blondel himself considered the transverse reactance equal to the direct reactance. At least, he used only a single value of reactance in his diagram.

Dr. Steinmetz and Dr. Berg both used a transverse reactance much larger than the direct reactance. Dr. Berg states definitely in his "First Course in Electrical Engineering" that the direct reactance is only about 60 per cent of the transverse. That means that if an ordinary synchronous machine had 30 per cent reactance, for instance, the transverse reactance would be in the neighborhood of 50 per cent—not reaction but reactance.

Professor Karapetoff is also of the same opinion, if one may judge from his paper on "Variable Leakage Reactance." While he does not state definitely how much larger the transverse reactance is than the direct reactance, if one may scale his diagrams, he would agree substantially with Dr. Berg.

Professor Arnold, on the other hand, holds that the transverse reactance is considerably smaller than the direct. He says that when a phase belt is above a pole face, only that flux which links the phase belt without entering the pole iron is reactance flux. This means that there is practically no tooth-tip leakage in this position.

Personally, I never could see why, because a line of flux in trying to get around a phase belt found it convenient to enter a friendly pole face for a part of its journey, it had to have its name changed from "reactance" to "reaction." So I agree with Dr. Berg and not with Professor Arnold.

Messrs. Doherty and Nickle, after a thorough and elaborate investigation, conclude that the transverse and direct reactances are practically equal, differing by not more than 1 or 2 per cent.

And now Professor Douglas concludes that the transverse reactance is zero, or at least negligible.

C. A. Nickle: I am inclined to agree with Mr. Putman that the effect of saturation upon quadrature reactance is not quite as great as concluded in this paper.

I think that one question might be raised. The author points out that "The voltage E_n ," that is, the voltage in the direct axis "is not a function of the field current alone." This is true. This merely means that due to pole-tip saturation, instead of the quadrature and direct axes being in their geometric position, they have been slightly shifted, so that the quadrature current now has a mutual component with the field winding and reduces the flux in that circle. I think on that basis that it is reasonable to say that the curve in the main field winding, under these conditions, will have a mutual effect on the quadrature axis. If the quadrature axis has a mutual effect on the direct, it should work the other way. If such is the case,

we would expect the values as measured to be much lower than the true values. If the transverse-current magnetomotive force produces a certain transverse flux and in addition to that flux we have another component which is 180 deg. out of phase, this flux being actually produced by the main field winding, the total flux that we measure in the quadrature axis is not the flux produced by the quadrature curve but is a composite flux. I think that quadrature reactance should at least be defined by the flux produced by the quadrature curve. Before we can say what transverse reactance is, we must separate the two components of flux so as to get that component of flux which is due to the main field winding.

It is found when the pole-tip saturates, we have the effect of having removed a small amount of iron from the tip of this pole. The two direct axes are no longer the geometric direct axes but have been shifted slightly to the left. Therefore, since the fluxes in the main field winding, especially at the right-hand end of this curve, are very high compared to the fluxes in the quadrature axis, it requires but a 1- or 2-deg. shift of the two axes so that the main field winding will give a component of flux in the quadrature path which is probably 50 percent as large as the flux that exists there due to the current alone. I think when this is taken into account, we shall find that quadrature reactance is not affected so vitally by saturation as we would be led to believe from these tests. Large numbers of tests have been made in the past and the angles, pull-out torques, and so forth have checked very well.

R. E. Doherty: Prof. Douglas has offered something for us to think about though there are some things in the paper that are not altogether clear and the results are not what most of us who study these matters might have anticipated.

I would like to mention one point which Prof. Douglas has made, namely, the necessity of distinguishing between a rational method of analysis and one which is largely empirical. The theory of superposition applies only when no saturation is present. If saturation is present, it may be negligible to such an extent that one may apply a theory based on no saturation and get approximate results, or he may, as Mr. Putman has mentioned, shade the constants to take care of it and assume that it can be used; and then interpret the results accordingly.

So this is the point: If those pictures of saturation curves and methods referred to by Professor Douglas are intended to represent a philosophy underlying a method of making such calculations, it must be considered as a relic of the past, because I am pretty sure that nowadays not very many informed engineers so regard them. However, very many calculations on important machines are made according to a theory which, strictly, does not apply—let us say Potier's diagram applied to salient-pole synchronous machines. Why? Because it gives results that are as close, practically, as you can test them. It gives practically correct results in magnitudes of excitation, but not in phase angle. But it is an engineer's privilege to use such tools as he sees fit, so long as he gets results that he can depend upon. Thus, if you can compute the magnitude of excitation under load on a salient-pole machine, when some saturation exists, by using Potier's diagram, that is a perfectly justifiable procedure so long as you recognize its limitations and understand why it gives practically the same magnitude as Blondel's method, which of course is theoretically more sound.

I might say that the reasons why Potier's diagram will give practically the same magnitude of excitation as Blondel's treatment are explained fully in the literature.²

Mr. Putman mentioned the different opinions regarding reactance. It is not a question of difference of opinion regarding reactance, but difference of definition; that is, Dr. Berg and Dr. Steinmetz are right; and Blondel is right. Also Doherty and Nickle, Professor Karapetoff and Professor Douglas may be right. The only person who is wrong is one who, not clearly understanding the definition and physical significance of some

particular value of reactance, uses it where it is not applicable. In the case of a synchronous motor, for instance, there are a number of different reactances which must be known separately in order to calculate the various operating characteristics. It is therefore meaningless merely to refer to the "reactance" of a synchronous machine.

Going a step further, there may be a legitimate difference in view regarding the segregation of armature leakage reactance into its components. According to the usual view, armature leakage reactance comprises three components: (a) *slot reactance*, about which there is little or no question; (b) *end-winding reactance*, that is the reactance due to leakage flux around the ends of the coils, about the nature of which there is very little question; and (c) *zigzag or tooth-tip reactance*, about which there has been considerable question and discussion. Now if one can build up a consistent theory, using only (a) and (b) as comprising armature reactance, it would be a logical thing to do, provided everybody who used the theory understood that. On the other hand, since it is more in keeping with the established view of things to include all three of these terms in *armature reactance*, and include the remainder reactance effects of the armature current as the effective reactance of armature reaction, this point of view was taken in our paper on *Synchronous Machines—I*.² And we believe it is a comprehensive and logical treatment of the problem. It is a question of definition, as I stated at the outset, and if we wish to discuss the particular term which Professor Karapetoff treated, then let us discuss it as such, and not be confused by comparing its value with the whole, of which it is only a part.

Vladimir Karapetoff: To me, the principal value of Professor Douglas' paper lies in a novel experimental method which permits to obtain partial data in addition to the usual load data. It seems to me that further progress should lie not in juggling any more with vector diagrams and introducing more factors, but primarily in devising new experimental ways whereby we could get not only "bulk data," that is, the terminal voltage, current and power factor, but partial data as well. A synchronous machine is a comparatively complex aggregate of physical phenomena and if one provides a sufficient number of arbitrary factors, one can usually duplicate the performance of the machine with a sufficient degree of accuracy. However, the progress of the art requires checking those individual factors and not the final performance alone.

I judge from Professor Douglas' paper that he is familiar only with Blondel's early work. Since 1918 Blondel has done a considerable amount of work on synchronous machines. I refer in particular to the investigation, of which the purpose was checking the individual fluxes and voltage drops in the machine, rather than the final performance. Special, rather complicated experimental means were devised for that purpose.³ Besides, Blondel presented several papers before the French Academy of Sciences, discussing several advanced phases of the theory of synchronous machines. In the third edition of Vol. II of my *Experimental Electrical Engineering* (1927) there is a fairly complete bibliography on the subject, and I hope that Prof. Douglas' paper will create a new stimulus for attacking the problem with modern experimental means and coordinating the results with a more rational theory.

J. F. H. Douglas: Mr. Putman mentioned the test of the 3-phase machine. We did not make such a test although we saw some simple modifications by which it could be done. We submit that the line voltage, perpendicular to the Y voltage, would give us the two reference axes necessary. For convenience, we chose the 2-phase connection which was available on the machine.

Mr. Putman mentioned that the direct synchronous reactance was also a variable. With this we agree. For this reason I advocated following Prof. Karapetoff's idea in this respect,

2. JOURNAL A. I. E. E., October, 1926, p. 974.

treating it in a magnetomotive force diagram, where it will be a constant. My paper has no reference to sudden pull-out or suddenly applied torques. When I alluded to Mr. Doherty's paper, it was to a formula included which applied to steady-state conditions. This formula has a term which includes $\sin 2\delta$ and consequently makes use of a transverse coefficient different from the direct coefficient.

With reference to the formula advocated by Prof. Blondel quoted by Mr. Putman, I did not mean to imply that the transverse coefficient could not be computed unless the action were wholly transverse, but rather that under those conditions, having one system of causation present, the effect would be less subject to constant or systematic error. As a matter of fact, Mr. Nickle called our attention particularly to the fact that direct demagnetizing current might have an effect on transverse conditions. We foresaw that possibility and for that reason the tests were made as nearly as possible with the current fully transverse in its action.

And again, if we refer to Fig. 2 in the paper, we were looking for a demagnetizing effect of transverse reaction, and consequently if we had a large demagnetizing current present, we would not have been able to separate it with accuracy from that produced by the cross-magnetizing current.

With reference to the question raised as to how we lined up the two machines without knowledge of how the coupling between them was adjusted, I would say that, when we said that we brought the two machines so that the pole axes were in the same line, it was simply a short way of saying that we lined up the reference voltage with the no-load voltage of the machine tested. The machine *B* was loaded to the 5-ampere load, which was used, before the hand-wheel was turned, and so it was the terminal voltage under load that was adjusted to the same phase as the no-load voltage of machine *A*.

I will not respond further to Mr. Putman's and Mr. Doherty's remarks on reactance than to say that my attitude is entirely empirical. It is a question of how you define reactance. If you define reactance as including non-synchronous revolving fluxes, then undoubtedly the reactance will be larger under transverse than under demagnetizing condition. I think that for the purposes of calculation, the most useful division of the effect between the e. m. f. and the m. m. f. diagrams is that one giving factors which remain fairly constant. If we define reactance as due to those flux components unaffected by saturation, and if all flux components are affected by saturation in a given condition, as we found in the case of transverse reactance condition, we can say that the transverse reactance is zero. This same attitude is taken when we use the zero per cent power-factor characteristic to find the direct reactance and reaction components, although it is well known that the reactance thus determined is considerably larger than what can be computed with rational formulas.

Mr. Nickle's remarks deserve a better discussion than I can give. Pole-tip saturation should be important. I am not at all sure that his analysis is not correct. The case seems to me to be an exact analog of the corresponding case in d-c. machines. The treatment given in Prof. Karapetoff's Magnetic Circuit for d-c. machines could be applied almost bodily to the synchronous machines. In this theory there is a demagnetizing effect produced by transverse reaction but no cross-magnetizing effect produced by demagnetizing reaction. The loci of our e. m. f. vectors were parabolas proving the existence of a demagnetizing component of cross-reaction. However, on the m. m. f. diagram the loci were approximately straight lines. In other machines this result may not prove to be true. Since writing the paper, the writer and his students have used three other different methods, and have tested one other machine the results being the same; the transverse effect is a constant only when placed wholly in the m. m. f. diagram. The question whether the transverse reactance is unaffected by saturation or whether it is constant in the m. m. f. diagram should be easily verified, since

at say 50 per cent over voltage the pull-out torques predicted by the two theories are quite different.

I am heartily in accord with what Prof. Karapetoff has said and it means that there is still a lot of work to be done on the subject.

In particular the writer has assumed a reasonable active layer characteristic for the machine tested, and has by calculation been able to check the curves shown quite closely.

Discussion at Kansas City

TESTING, INSPECTING AND MAINTAINING STATIONS'

(LICHTENBERG)

KANSAS CITY, MO., MARCH 17, 1927

Caesar Antoniono: There is no question in my mind that the success of the automatic substation depends entirely upon inspection and maintenance. We were pioneers in this field, having installed the first automatic substation in the latter part of 1917 and to date, we have operated 17 complete automatic substations and two that are under way, in varying sizes of 300, 500, 1000 and 1500 kw. including one mercury arc rectifier.

The automatic substation is nothing but a combination of electrical-mechanical equipment, and it requires, like any other mechanical device, a certain amount of attention. We have attempted several methods of inspection. The North Shore Line which runs between Chicago and Milwaukee, is attempting to run first-class service, and any interruption of any one of these substations will cause objectionable delay.

At first we thought that daily inspection was best, but daily inspections have not proved to be what they should be, for the reason that a man is left alone with no definite method of procedure. Ordinarily, he takes care of that which he thinks he should, and usually the most important part, the part that should be investigated, is passed over and there is where the trouble begins.

So we have changed somewhat, more for experimental purposes than for anything else, and we have applied to one station the idea of going to a longer and better inspection and forgetting the time in between. We have taken a 500-kw. station and made a thorough inspection. We went over every part of the equipment, the setting of the relays, the contacts, (which are largely what cause trouble), the condition of the contacts, burning, and things of that kind. After this inspection was completed, we kept away from making any further inspection at all. A man goes in every day to take readings on the watt meters and each device is equipped with counting devices that register the operations. Some of these devices must check with each other. By taking these, whoever attends the station may see whether or not there is any failure in the sequence of operation.

After that inspection is made, we don't do anything to the station for a month, not even to attempt to clean the contacts, outside of proper cleaning of the equipment. That shows that there is something to periodical and better inspection. Another thing in support of our contention is this: As a rule when putting a new station into operation, you watch that station until it functions properly all the way through. After this is done, you need do nothing to that station for three or four weeks.

There is another reason we think that long periodical inspection is better than daily inspection. The equipment, as Mr. Lichtenberg stated, is designed to give service. I want to take one station that we installed in 1917. That equipment was put into service under unusual conditions. It was a 500-kw. station but it was doing the work of a 1000-kw. station for a number of years. In this station, up to 35,000 operations, the number of failures were 1.1 per thousand. We measure a failure by means

of the counting devices on the equipment. We considered a failure the attempt the station was making to complete a cycle, and to close in on the d-c. line. There are times when the station makes an attempt to come in on the line but, due to bad contact or things of that kind, it fails, and then there is a shut down, so that the delay is the time it takes the station to make another complete sequence of operation. We counted this a failure. From 35,000 to 85,000 operations the number of failures was 1.5 per thousand.

This station was too small for the location so we removed the equipment and put it into another place where it is in service now and in that new place we made another 35,000 operations, a total of 120,000 operations for this equipment, and all it was necessary to do to that equipment was to change some of the plungers on the overload relays and air bellows that eventually dried out and broke loose.

On the running contactor of that equipment, we changed two sets of contact points which burned out during these operations. On the starting contactor we changed one set, and on the d-c. contacts, three sets. The first load-limiting, resistance-shunting contactor has made, in over two years, from 100 to 300 operations per day, which proves what this equipment does.

Sometimes we may assume that some devices do not require attention. We assume they function properly. Take the case of a bearing thermostat. It is generally assumed that a bearing thermostat will prevent bearing troubles. In our experience it does not. I will tell you why. Due to the open locations of these stations, the temperatures in the buildings are such that the oil does not flow through the bearing as quickly some times as at other times—the difference between winter and summer. On a large bearing, the thermostat is in the lower part of the bearing as close to the shaft as possible, within half an inch or so. It seems as though that should take care of the babbitt, but it does not.

We had a case where the temperature in the station dropped to zero during the night when there was no demand for the station to run, and the station was closed down for something like six hours. We found in the morning that it was around zero, but during the night, the outside temperature was lower and therefore we assumed that the temperature in the building was lower.

The station started up and the oil was of the consistency of glycerin. In about fifteen minutes it developed enough heat to ruin the skin surface of the babbitt, and naturally, in that time, the thermostat took it off. Nevertheless there was damage done. The thermostat was not so effective as some of us assumed it should be. It was necessary to take the bearing apart and scrape it before the machine could be put into operation. You have to use common sense *with* the device. The device won't do everything.

There is another thing I want to mention: Ordinarily, on the North Shore, the machine is assumed to carry 150 per cent load for two hours. We have set the first load-limiting resistance to be cut in at from 165 to 175 per cent load.

I raised the point some years ago with the manufacturers, what would happen if there should be a condition like a loading down at a distant point on the road where, due to the resistance of the feeders, it would give a load above the rating of the machine but still below the setting of the first step of resistance—what would happen then? The machine may burn out. It may overheat.

Later, a relay was introduced to take care of that condition, assuming that the machine would carry the 150 per cent load for the two hours. This relay is naturally set to operate within that, or lower if you want it. But the point is that sometimes, in practise, this assumption does not hold good.

This relay was installed on this particular machine and, as stated, the equipment made 120,000 operations. But there has never been a demand for the relay to operate, although the station

was carrying, during a 15-min. period, 300 per cent load through resistance. This relay never did operate.

We had two armature breakdowns; one due to lightning, (a puncture of the armature) and the other apparently to old age. This armature was in service for sixteen years before it was put in there and broke down apparently through old age.

Going into Mr. Stewart's supervisory control, I want to mention that we have on the North Shore supervisory control, not the latest type, but the three-wire type. Nine of the stations are now under supervisory control. Five stations are on one group of wires, two stations on another group, and another on the third group. We have divided them into groups so that if for any reason—trouble in the equipment or on the lines,—one group should go out of service, it does not cripple the whole system. Dividing into groups gives more flexibility in controlling the stations.

It seems that on a system of our kind, the supervisory control has to be installed for the operation of the station. We have a string of automatic stations, one succeeding the other and as many as nine on one side, and if one goes down, nobody would know it unless by indications in the supervisory control system. So it seems to be necessary to have supervisory control on any great system.

W. H. Millan: I appreciate Mr. Lichtenberg's cautions on the subject of caring for automatic equipment, and also his suggestion that we must not get the idea that automatic equipment will run forever without care.

We have four d-c., automatic substations. The four stations' total embodies six converting units, three of which are synchronous converters; the remaining being motor-generator sets.

In 1916 all of the stations involved had been seasoned; that is, at least three of four months had elapsed after the initial installation, during which time everyone knows a certain amount of trouble is to be expected.

In this year, there were 165 failures, 135 of which were actual failures of devices themselves, such as circuit breakers, oil switches, contactors, relays, etc., out of that 135, 31 failures had to do with d-c. circuit breakers.

As we have't many of these devices, from our tabulation it appears that that type of device will bear close watching.

The remaining 30 failures were classified as being brought about by failure of the human element; that is, they were due to carelessness, improper assembly, improper adjustment and wiring defects.

Out of these 30, carelessness was responsible for five; in other words, one-sixth was due to our own men actually doing something wrong. There was none chargeable to improper assembly, but to improper adjustment, there were 18, to lack of factory inspection five, to wiring defects two.

You will see that the major portion of all failures is really due to the devices themselves.

As to the cost of these 165 failures, in real outage hours we had a total outage of 337 machine-hours. It is interesting to note that that represents 24 machine-hours outage per year per thousand kw. of capacity. We do not think that is high.

I might mention that there were 2796 hours of inspection actually spent on these six machines and their equipment in that year's time.

We assume from the results that we are not overdoing our inspection schedules; by that, I mean to say that while we did not have sufficient outages or damages to equipment to make us feel that we should scrutinize our equipment still more closely, the situation is not so rosy as to give us the idea that we might do with less inspection.

Our inspection schedule on these stations is roughly this:

A tester of rather high caliber and a helper go to every unit once a week. In one month's time they have gone through a complete cycle of inspection of each unit. This means that at no one of his four visits per month does he make a complete

inspection but rather that he does it in four steps. The reason for this is that certain of the equipment and devices are actually tested oftener than once a month, some every alternate inspection day; others every inspection day. One of his inspection periods, however, covers a complete sequence test of the entire machine control.

This inspection schedule brought out during the year the significant fact that of these 165 total failures, 85 were discovered during test or inspection before they had an opportunity to cause an outage. To my mind this is an extremely important point and again justifies a high caliber of inspection and test.

G. K. Thomas: The subject of automatic substations is quite interesting to railway signal engineers because it is essential that we have continuity of power. Mr. Stevens explained the operation of the track circuit. The track relay is energized from current flowing down one track rail into the relay and back through the other rail. When a train occupies the track in that particular section, it short-circuits this current and de-energizes the relay and this in turn controls the signals, causing them to the most restrictive indications.

It follows, therefore, that power failure will cause the same operation. The relay will become de-energized and the signal will indicate "Stop."

When we get into automatic train control, continuity of power is even more essential because, whether the train is approaching a signal or not, it will be delayed if power is cut off the train-control system.

Automatic train control is installed on the Santa Fe between Fort Madison, Iowa, and Coal City, Illinois. It is in official operation over a little more than 100 mi. and the total distance over which circuits are completed at the present time is about 195 mi. We have power connections at approximately 50-mi. intervals. The power system is three-phase 6600-volt.

The substations are so arranged that if power should fail at one point, it will automatically come on at the other end of the line, and so keep the train-control system in operation. A test which we made recently showed that by tripping the circuit breaker at one of these stations when the volt-meter needle was standing at 6600 volts, (the voltage of the line), the other station came in so quickly that the volt-meter needle only had time to drop to 3000 volts before it came back to indicate normal voltage. This rapid operation is very essential to prevent application of the brakes on trains.

At Chillicothe the station is purely an emergency connection and on that account we installed automatic contactors at both sides of the transformer banks feeding the system; so that normally both the primaries and secondaries are on open circuit and we are not taking exciting current.

We found that sometimes when the station was automatically connected to the line, a heavy transient current would be produced due to energization of the transformer bank at a particular part of the cycle, and this heavy current would kick out the main switch about once in ten operations. This was overcome by adding a time-element relay to bridge the time interval during which transient currents might occur.

Each substation is visited daily to see that it is operating. Once every three months we make a complete inspection and clean contacts, adjust the apparatus, and so forth.

The system has been in service for about two and one-half years and so far, we have experienced very little trouble with substations.

C. M. Gilt: There is one thing we have which has been a considerable help to us in maintenance. We get from the manufacturer a wiring diagram which shows the physical connections; that is, if the connection to a certain relay is shown on the second point of a terminal block, we want it wired in that way so when we look at the wiring diagram we can go to the back of the board and pick out from the wiring diagram exactly where this relay

stud is and where that wire goes. We find that important in checking and maintaining our equipment.

As far as maintenance is concerned, we go over the automatic re-closing relays the same as we do our overload relays, that is, the ordinary relays about once in six months and the important part of these four times a year. There is an operator in the station so that if anything does go wrong, he gets the relay men right out; but our schedule seems to be adequate for the service.

C. A. Butcher: In ten years of contact with the development of automatic stations my experience has been that there is probably more trouble resulting from over-inspection than lack of inspection.

You can also neglect the equipment, as was pointed out. Monthly inspections, however, if of high quality, are far more satisfactory than daily inspections which are merely cursory. The factory attempts to make a proper sequence test of all the equipment.

The initial success of a new installation depends greatly upon the man who is making the installation. If he is careless about connecting up his interlocks and about properly adjusting them, he is going to have initial difficulties.

The Power Generation and Conversion Committee of the American Electric Railway Association has made some important studies of methods of ventilation which reduce very materially the amount of dirt that can filter into an automatic station. In the operation of rotating equipment, dust is a very great detriment to proper operation, and necessitates a higher order of maintenance.

Another thing which I believe should be given a great deal of study—especially in connection with the operation of railway converters—is the proper grounding of the d-c. apparatus. We have one side of our system grounded, the other side positive. There have been accidents causing the destruction of large and expensive equipment by the two polarities not being carefully isolated, and the structures not properly insulated from ground. The tendency in automatic stations is to put a great deal more apparatus in the same space than is ordinarily done in manually operated stations, with the result that we get a mass of equipment surrounding a bare bus back of a switchboard. Great care should be taken to see that switchboards on 600-volt railway boards are properly insulated.

Another matter is the grounding of the frame of a synchronous converter. It is often the practise to tie the frame of the machine directly to the negative bus. There is really no good excuse for this because, in the event of a flash-over, especially on certain converters, you cannot conceive of a higher current density than that allowed by such a very low-resistance path from positive to negative.

There is only one object in the grounding of a synchronous converter, and that is to keep the frame of the machine as near the earth potential as possible in order to protect the life of any man who has to work around that machine. Especially on railroads where the ballast provides rather a high order of insulation, the negative may rise in potential well above the frame of the generating machine. So with any installation, regardless of whether manual or automatic, we can well afford to study the installation methods that have appeared to be standard in the past and really analyse them in the light of the information we have gained through the operation of automatic stations.

Chester Lichtenberg: The experiences related by Messrs. Antoniono, Millan, Thomas and Gilt give very definite ideas which should be helpful to all of the users of these stations.

It has been found that visits at regular intervals, merely for observation or what might be called casual inspection, prove of value principally from a confidence point of view. The real satisfying condition is met by the complete inspection made at intervals varying from one week to one month in those stations having rotating apparatus and at longer intervals in those stations having apparatus operated less frequently.

The entire trend of the discussion has indicated that automatic stations are proving reliable and that by intelligent inspection and maintenance they can be depended upon to meet service requirements.

ELECTRICITY FOR OIL-WELL DRILLING

(MURPHY)

KANSAS CITY, MO., MARCH 18, 1927

W. G. Taylor: Both cable-tool and rotary drilling impose extremely heavy duty on the power equipment, as is indicated to some extent by the graphic charts submitted in Mr. Murphy's paper. It would be even more interesting if he had shown some records of the work required to handle and set the casing which lines the well. In fact, it is this work which really determines the size of motor necessary for cable-tool drilling. The work is fully as heavy as handling drill pipe in rotary drilling.

The exacting requirements of oil-well drilling by either method have resulted in the development of the special equipments and schemes of control which Mr. Murphy has described. In the case of cable-tool drilling, the relative success of the twin-motor and single-motor schemes has been determined by the practical rather than by the economic aspects, and some of these may well be mentioned here.

Experience has shown that the twin-motor equipment requires more than ordinary attention from the driller to avoid serious overloading of one motor, and that the average driller in the fields cannot be depended upon to handle this type of equipment without burning out a motor now and then. Belt maintenance has proved excessive, and it has been found difficult to keep the motors and countershaft in alignment. On the other hand, the single-motor equipment has been relatively free from troubles. These things explain why oil companies, especially those which have tried out both kinds of equipments on a large scale under similar field conditions and have thus obtained a fair comparison, have a decided preference for the single-motor cable-tool equipment.

It is of interest that a 75-h. p. single-motor cable-tool rig very successfully drilled a well in Colorado to a depth of 7300 ft., with every indication that the motor could continue the drilling work indefinitely to greater depths without the least distress.

Automatic feed of the bit in rotary drilling as exemplified by the Hild differential drive is a recent and very interesting development. Two devices of this kind are on the market, both operating on the fundamental principle of the differential gear. One of these is the Hild drive described by Mr. Murphy, and the other is the Halliburton drive. Both accomplish similar results, but the latter is driven by a single motor, or it may be driven by an engine of almost any type. The motor or engine drives the ring gear of the differential, as an engine drives the differential on an automobile. The two shafts, corresponding to the rear-wheel axles of the automobile, drive the drilling bit and the draw-works hoisting drum through suitable chain or gear reductions. Thus the feed of the bit is balanced against the torque of the load and varies inversely as the load, and the bit is automatically retrieved when the load exceeds a certain amount. A number of the Halliburton drives are in successful operation, with both motor and steam-engine drive, and the future will very probably see many more of both types installed, but it seems likely that their application will be limited to deep drilling as long as their present high prices prevail.

B. T. McCormick: Fig. 4 in Mr. Murphy's paper, shows that for a well of about 2000 ft. in depth 12,000 kw-hr. is required, which means about an average of 6 kw-hr. per ft.

Some of our recent experience in Pennsylvania field wells of about 2000-ft. depth drilled with gear units and also the old fashioned jack-shaft drive by Star Delta drilling motors indicates that we get an average of about 3 kw-hr. per ft. I do not know whether that difference is due to the difference in formation or not. I should imagine that difference might account for the very much lower kilowatt-hour draw in the Pennsylvania field.

I would like to ask just why the depth of the well influences the power requirements in the way it seems to. There seems to be a marked reduction in horse-power required as the well becomes deeper. That point has not been made entirely clear.

L. J. Murphy: In answer to the latter question, it might be stated that this reduction is due to several different causes—first, the decrease in diameter of the hole as the depth increases, second, a decrease in the size of drill stem used and, third, the slower motion.

Mr. McCormick mentioned that in the Pennsylvania fields they have records which show that drilling could be accomplished to 2000 ft. with a power consumption as low as 3 kw-hr. per ft. In this connection I might state that I have seen installations in the Bradford territory where drilling was accomplished to a similar depth with a 30-h. p. motor with a power consumption of 2.4 kw-hr. per ft. However, this equipment is such that high hoisting speeds are not possible, and, I believe, the same holds true of the equipment which Mr. McCormick mentions. In other words, the band-wheel speeds are not in excess of 50 rev. per min., and, hence, little power is used in the secondary resistance. This accounts for the low power consumption, but, in obtaining low power costs, the motor, during drilling, is operating at more nearly synchronous speed with the result that it has a rather stiff speed-torque characteristic not conducive to satisfactory drilling motion except with a manilla drilling line. The Bradford field is one of the few territories using this type of cable.

WOULD SIMPLIFY HEADLAMP FOCUSING

The vertical focusing adjustment for headlamps using two-filament lamps is not only unnecessary but so greatly complicates the correct focusing and aiming of the headlight beam that few persons can make the proper adjustment, asserted A. W. Devine of the Massachusetts Registry of Motor Vehicles, at the summer meeting of the Society of Automotive Engineers at French Lick, Ind., May 1927. He advocated dispensing with the requirement for double focusing in state motor vehicle regulations and declared that improvement in headlighting will be retarded if state laws or regulations require the vertical focusing adjustment in addition to the horizontal adjustment.

The horizontal adjustment alone suffices to give an acceptable light distribution with electric lights in which the placement of the filament falls within the range of inaccuracy now found in the lamps on the market, as it is possible to design headlamps so that they will be insensitive to these inaccuracies, and headlamps of this type have been approved for use in various states.

The ideal headlamp would require no adjustment by the car owner. As a means to this end, C. C. Bohner of the Tung-Sol Lamp Works, proposed the simple and inexpensive expedient of inserting in the socket of the reflector a fixed ring like the jig ring used by electric lamp manufacturers in the placing of the filament in the glass bulb and attaching the base. Such a ring, he said, will hold the lamp in the socket in precisely the same position as when the filament was put in and will locate the filament at the correct focal point.—S. A. E. *Journal*.

ILLUMINATION ITEMS

By Committee on Production and Application of Light

PHOTOELECTRIC RATING INCANDESCENT LAMPS

The Electrician (London, January 21, 1927) describes the machine for facilitating the rating of lamps photoelectrically which was shown recently by the Research Laboratories of the G. E. Co. Ltd., at the annual exhibition of the Physical and Optical Society.

The lamps to be rated are carried over a pair of photoelectric cells by a rotating device. The cells are made sensitive to different spectral regions by using sodium in one and rubidium in the other. They are adjusted so that for a given color quality of light, (corresponding for lamps of a given type to a certain operating temperature of filament), the currents through them are equal.

If the filament operating temperature departs from the value for which the cells are adjusted, the color quality of the light is changed and the electrical circuit is unbalanced by an amount indicated by an electrometer from which the proper rating can be read.

LIGHTING AND CONTRAST¹

Contrast in lighting deserves special consideration because effective lighting is possible only with a proper distribution of light. Unless high levels of illumination are used with consideration of contrast, best practical results are not necessarily insured. In the experimental work described, three effects of contrast are considered; these will be dealt with briefly here.

Contrast of Object with Background. The illumination required to distinguish test objects of various sizes having two degrees of contrast, with the background when exposed for various short intervals of time, was determined. The exposure of the test object was preceded and followed by confusion patterns in order to duplicate, in a fundamental way, the conditions met in ordinary vision.

The original paper gives detailed data on the results of the investigation covering exposure times of 0.05, 0.1, and 0.2 sec., object sizes from 1.5 to 4.5 mm., and contrast ratios of 100 to 4 and 100 to 73. The 3 mm. object required about five or six times as much illumination to be seen in 0.05 sec. as in 0.2 sec. If the contrast of the object with the background is changed, the time required to see it is also changed; thus, a 3-mm. test object of high contrast, (100 to 4), could be seen under a certain illumination in 0.05 sec., but if of low contrast, (100 to 73), it required 0.2 sec. to distinguish it. These data give valuable quantitative information on the "speed of vision" as it is likely to apply in actual practise.

Bright and Dark Areas in the Visual Field. Eyes

1. Abstract of paper by Cobb and Moss, *I. E. S. Transactions*, Feb. 1927.

viewing parts of work alternately in light and dark areas are handicapped in clear and quick seeing by the constant necessity for re-adaptation to the different brightnesses. An experiment was made in which the eyes were required to shift frequently between comparatively light and dark areas as in industrial work where details may be partially obscured by shadows. Several ranges of contrast were tried and compared with work done under uniform conditions of brightness. The results are rather complicated to describe in a few words, but where the eye had to adapt itself constantly to different brightnesses, the amount of work done was less than could be done under the lower but uniform level. The relative effects of the adaptation factor and the brightness factor at different levels of brightness is pointed out. An abundance of light improperly placed, even though not glaring, can be a handicap to vision.

Contrast of Immediate Visual Field with Surrounding Fields. The experiments indicate that when the immediate field is small (one or two degrees from the line of vision) very dark surroundings interfere with vision, but where the immediate field is of greater extent (three degrees or more) and the eye is working at one fixed point, the factor of contrast with darker surroundings becomes negligible.

In practical work there are sufficient evil effects of dark surroundings to prohibit the use of wide extremes of contrast.

The San Pedro Lighthouse outside Los Angeles, Cal., steadily signals its location by radio to ships in nearby waters without a hand touching the radio apparatus. Power for this lighthouse is furnished by three farm-lighting electrical generators in the base of the tower.

Night illumination of buildings for advertising or decorative value is an art still in its infancy, but will soon begin to develop astonishingly, according to Raymond M. Hood, architect and illumination expert. He points out that by means of the manipulation of light, buildings can be made to have the appearance of movement—even a fluttering movement—and various other stage effects can be produced.

A committee of engineers has made a recent survey of electrical wiring in this country to determine how well equipped homes are to make use of electricity. It has reported that more than half the houses that are already wired are using antiquated fixtures, many of them need rewiring and practically every one of them has too few electric outlets to permit the occupants to get the full benefit of the electricity they buy.

JOURNAL OF THE American Institute of Electrical Engineers

PUBLISHED MONTHLY BY THE A. I. E. E.
33 West 39th Street, New York
Under the Direction of the Publication Committee

C. C. CHESNEY, *President*
GEORGE A. HAMILTON, *National Treasurer* F. L. HUTCHINSON, *National Secretary*

PUBLICATION COMMITTEE

L. F. MOREHOUSE, *Chairman*
F. L. HUTCHINSON, *E. B. MEYER*
DONALD McNICOL, *I. E. MOULTROP*

GEORGE R. METCALFE, *Editor*

Subscription: \$10.00 per year to United States, Mexico, Cuba, Porto Rico, Hawaii and the Phillipines; \$10.50 to Canada and \$11.00 to all other countries. Single copies \$1.00. Volumes begin with the January issue.

Changes of advertising copy should reach this office by the 15th day of the month for the issue of the following month.

The Institute is not responsible for the statements and opinions given in the papers and discussions published herein. These are the views of individuals to whom they are credited and are not binding on the membership as a whole.

The Detroit Summer Convention

As we go to press, the Summer Convention of the A. I. E. E. is being held at Detroit, Michigan, June 20-24, and from the early reports, an unusually large attendance is predicted.

For the technical sessions, a large number of papers on practical operating subjects has been chosen, in addition to some of the latest scientific and theoretical contributions. These papers include such subjects as power stations, transmission-line operation, relays, control circuits, cable joints, communication, television, dielectrics, corona, rectifiers, electrical units and electric traction. Practically all fields of electrical engineering will be covered in the reports of the Technical Committees, which are scheduled for presentation.

Other features of special interest are the lecture by Professor K. T. Compton, of Princeton University on *The Nature of the Electric Arc*, and the symposium led by Dr. Herbert E. Ives, together with an operating demonstration of television.

A complete report of the Convention will appear in the August issue of the JOURNAL.

Pacific Coast Convention, Del Monte, Calif., Sept. 13-16

A very fine program is being arranged for the Pacific Coast Convention which will be held in Del Monte, Calif., September 13-16. The technical sessions will deal particularly with subjects of current interest in the West. Among the subjects are 220-kv. transmission, circuit breakers, oscillographs, sphere-gap voltmeters, communication and lightning protection for oil

tanks. The titles of the papers are given in the accompanying list of technical papers.

A student session will be held at which a number of papers by Branch members will be presented.

Inspection trips, a banquet and addresses are among the non-technical features of the meeting. A more complete announcement will be published in the August issue of the JOURNAL.

PROPOSED TECHNICAL PAPERS FOR PACIFIC COAST CONVENTION

Electric Oscillations in the Double-Circuit Three-Phase Transmission Line, Y. Satch, Stanford University.

The Relation Between Frequency and Spark-Over Voltage in a Sphere-Gap Voltmeter, L. E. Reukema, University of California.

Researches in the Ryan High-Voltage Laboratory, H. J. Ryan, Stanford University.

Advance Planning and Practises in Long-Distance Communication, J. N. Chamberlin, Pacific Tel. & Tel. Co.

Machine Tandem Trunks for Metropolitan Areas, E. Jacobsen, American Tel. & Tel. Co., and F. O. Wheelock, Southern California Telephone Co.

Carrier-Current Communication over Power Lines, L. F. Fuller, General Electric Co.

220-Kv. System Stability, R. J. C. Wood and L. F. Hunt, Southern California Edison Co. and S. B. Griscom, Westinghouse Elec. & Mfg. Co.

220-Kv. System Design, J. P. Jollyman, Pacific Gas and Elec. Co.
Intermediate Synchronous Condensers for Long Transmission Lines, R. D. Evans and C. F. Wagner, Westinghouse Elec. & Mfg. Co.

Circuit Breakers, Roy Wilkins, Pacific Gas and Elec. Co.

Oscillographic Recording Apparatus for Transmission-Line Studies, J. W. Legg, Westinghouse Elec. & Mfg. Co.

Experiments on Lightning Protection, R. W. Sorensen, California Institute of Technology, and M. E. Dice, General Petroleum Co.

Lightning Protection for Oil Tanks, E. R. Shaeffer, Johns Manville, Inc.

American Chemical Society Conference

Twenty-two conferences on *Chemistry in World Affairs* will be held at the new Institute of Chemistry of the American Chemical Society, opening its sessions July 4th at the Pennsylvania State College. These conferences will be similar to those held last year at the Institute of Politics, Williamstown, Mass., and will be followed by discussion presented by men prominent in education and the chemical industry. Mr. Harrison E. Howe, member of the National Research Council, treasurer of the American Engineering Council and editor of the Chemical Societies official journal will preside at the conference of July 5. The program will extend through July 29, and is inclusive of many subjects of engineering interest and high research values.

Work of New York Electrical Society

That the work of the New York Electrical Society in popularizing electrical science in New York City is to be continued and extended for another year was decided at the Annual Meeting of the Society, held Saturday, June 4, 1927, in the auditorium of the New York Telephone Building at 140 West Street, New York City. Reviewing the work of the Society during the past year, President Sergius P. Grace, said that total attendance at the meetings had aggregated approximately 9000 persons, probably the largest attendance of any scientific organization in the United States. President Grace said, that inquiries received and answered continually by the Society's officers, indicate that the Society is a recognized source of information upon electrical science.

The New York Electrical Society is the oldest electrical society

in the United States, perhaps in the world; having been organized February 23, 1881. The purpose of the Society is to humanize the presentation of all phases of electrical development, appealing to beginners and to the general public as well as to trained engineers. Officers elected for 1927-1928 are: President, E. E. Free, consulting engineer; Vice Presidents, R. B. Grove, United Electric Light & Power Company; W. T. Teague, Western Electric Company; Harvey C. Rentschler, Westinghouse Lamp Company; Treasurer, E. B. Meginniss, New York Telephone Company; E. E. Dorting of the Interborough Rapid Transit Company and G. H. Reid, of the General Electric Company remain as Vice Presidents; H. E. Farrer, 29 West 39th Street, re-elected Secretary.

Report on Standards for Measurement of Test Voltage in Dielectric Tests

A report on *Standards for Measurement of Test Voltage in Dielectric Tests* which has been for some time in course of preparation by a subcommittee of the A. I. E. E. Standards Committee, is now available. This report is No. 4 in the series of A. I. E. E. Standards and was prepared by a representative Working Committee under the chairmanship of F. W. Peek. The report is now issued in the belief that it has reached a stage where it should be circulated widely in order to obtain all possible criticisms and suggestions before final adoption.

The Standards as set forth in this section give the conditions peculiar to each of the various kinds of apparatus, the specific values for the test voltage, the frequency and the period of time required for the application for each particular kind of apparatus. Copies of the pamphlet may be obtained without charge by writing to H. E. Farrer, Secretary A. I. E. E. Standards Committee, 33 West 39th Street, New York, N. Y.

Standards for State Adoption

The 20th Annual Conference on Weights and Measures convened at Washington on May 27th. Resolutions adopted recommended that those weighing and measuring devices conforming to specifications and tolerances accepted by the Conference and endorsed by the Bureau of Standards be adopted by the state and approved for commercial use by every state in the Union. During the conference it was brought out that most of the nations of Europe exercise strict federal control over weights and measures apart from the control of local jurisdictions. An official of the Bureau of Standards announced that in response to continuing demand for information regarding all phases of the subject the Bureau is about to issue a handbook on "Weights and Measures Administration."

Officers re-elected were as follows: President, Dr. Geo. K. Burgess; Vice-Presidents J. Harry Foley and H. L. Flurry; Secretary, F. S. Holbrook; and an executive committee composed of men prominent in the field.

New Edition of "Recommended Practise for Electrical Installations on Shipboard"

The 1927 edition of *Recommended Practise for Electrical Installations on Shipboard* (Marine Rules) is now available, being issued as Section 45 of the A. I. E. E. Standards and of the same size and general form as followed with the other Standards. It is a paper covered pamphlet of 84 pages and is available at a cost price of \$1.50 subject to the usual 50 per cent discount for members of the A. I. E. E. Apply to A. I. E. E., 33 West 39th St., New York, N. Y.

The Institute's Committee on Applications to Marine Work under auspices of which *Recommended Practise for Electrical Installations on Shipboard* was compiled feels that the 1927 edition conforms to the latest developments of the art. In

general the forms of the 1920 edition has been followed although considerably revised and amplified. To the principal division *Direct-current Installations and Alternating-current Installations* of the former edition, has been added a new section on *Propulsion*, which it is hoped will form good ground work for future expansion in that important field.

Revised Edition of A. I. E. E. Standards No. 9 on Induction Motors

Pamphlet No. 9, A. I. E. E. STANDARDS for Induction Motors and Induction Machines in General has just been issued in revised form. The revisions included in this new edition concern the parts of the Standard dealing with rating, particularly rating of general purpose motors, and are the results of the work of the Sectional Committee on Rating of Electrical Machinery. This Committee under the chairmanship of Dr. D. C. Jackson has been at work for some time on the question of rating and the decision arrived at, which the unanimous vote of the committee shows is satisfactory to all, will now be applied also to Standards 5 and 7, "Direct-Current Rotating Machines, Generators and Motors" and "Alternators, Synchronous Motors and Synchronous Machines in General" respectively. Copies of the revised Pamphlet No. 9, June 1927, can be obtained by writing A. I. E. E. Headquarters, 33 West 39th St., New York, N. Y. Cost 40 cents to non-members of A. I. E. E. Fifty per cent discount allowed members.

Degrees Conferred Upon Six Scientists

Five scientists and executives of the General Electric Co. received honorary degrees from colleges at commencements in June. Owen D. Young, chairman of the board, received the degree of doctor of commercial science from New York University; Gerard Swope, president, doctor of laws at Colgate; Dr. W. R. Whitney, director of the research laboratory, doctor of science at University of Michigan; Dr. W. D. Coolidge, assistant director of the research laboratory, doctor of science at Union College and Lehigh University; and Dr. Irving Langmuir, assistant director of the research laboratory, doctor of science at Kenyon College.

Samuel E. Doane, chief engineer of the National Lamp Works of the General Electric Company at Cleveland, has been awarded an honorary degree in electrical engineering by Case School of Applied Science. Mr. Doane, associated with the early activities of Thomas A. Edison, has been an outstanding figure in the electrical industry since 1886, when he entered the laboratory of Professor Elihu Thomson. Since 1901 he has been chief engineer at the National Lamp Works.

Guggenheim School Opens

The new building for the Daniel Guggenheim School of Aeronautics at New York University, University Heights, New York, was formally opened on the 4th of June, when Mr. Guggenheim formally presented it to Chancellor Brown. Harry Guggenheim, son of the donor, pressed an electric button setting the great wind tunnel in operation. The new building is 120 by 50 ft. with a first story projection for the wind tunnel. Its equipment is complete for instruction, test and research work, with wind-tunnel of double return type, propeller-testing equipment, an apparatus for testing airscrews, a structural laboratory, power plant laboratory, a full-flight and instrument laboratory, airship laboratory for gas diffusion and a model ship for the construction of wind-tunnel models. Doctor Elmer A. Sperry, Fellow of the Institute, was one of three representatives from the Founder Societies, Professor Alexander Klemin and Mr. Calvin W. Rice, Secretary of the American Society of Mechanical Engineers also being present.

Air Activities of the Federal Government

The Assistant Secretary of Commerce for Aeronautics, William P. MacCracken, Jr., in a statement, June 1, announced that the Department of Commerce is preparing to take over the Trans-continental airway, now largely used by air mail pilots. It is planned to furnish weather reports and signals to both air mail and other commercial operators along the route.

Congress at its last session appropriated approximately \$82,500,000 for aircraft, exclusive of approximately \$25,000,000 more authorized, to be contracted for, according to a compilation of the House Committee on Appropriations made public June 1.

The definite appropriations for aircraft activities amounted to \$50,169,094. Other available appropriations are to be found in the proportion of expenditures for aeronautics authorized under general provisions for pay of the army and navy, subsistence, transportation, clothing, salaries of certain administrative officials, and other items applying to the Government generally but affecting the personnel of the air services as well as other branches of the Government.

The 29 Douglas air mail planes, recently acquired by the Post Office Department, will be sold. All planes are fitted with air mail equipment, including night flying appliances, and are to be delivered to the successful bidders at the close of Government operation of the air mail service, "when, as is, where, and if is."

Work Started on Federal Buildings

The \$50,000,000 building program for Federal construction in the District of Columbia will start late in July when the Department of Agriculture Building will be begun.

The Building Commission has approved the proposed structures, the first of these being a five-story marble building connecting the two wings of the Main Agricultural building now standing. Other buildings for early consideration are the structures intended for the Departments of Justice, Commerce and Labor and the Internal Revenue and Archives.

In regard to these latter buildings it is still undecided whether or not they will be modeled after the Louve in France.

Loan Funds Proposed for Aviation

Measures which will be introduced in the forthcoming Congress by Representative McLeod of Detroit will propose the creation of a \$100,000,000 loan fund to encourage the organization of airplane lines for carrying mail, passengers and freight.

Another recommendation includes the creation of standing committees of both the Senate and House to consider all matters relating to aviation.

It is proposed that the loans referred to above should be made under the rules prescribed by the Secretary of Commerce and in no case should they constitute more than two-thirds of the value of the aircraft built or to be built or the value of hangars or other necessary facilities of a concern. The Government would preserve a lien upon the equipment until the loans were repaid. It is pointed out in connection with the proposal for the standing aviation committees of both Houses that legislation pertaining to this subject under present rules could be referred to at least five different committees in the House and at least four committees in the Senate which are primarily interested in some other governmental function.

Patent Office Improvements

To further the carrying out of recommendations made by the Committee on Patent Office Procedure, the Commissioner and his staff have instituted periodic informational meetings of substantially the entire examining corps and other technical personnel of the Patent Office.

Meetings of the Patent Office personnel are held both during and after office hours, and substantially the entire Examining Corps with other members of the technical staff of the Patent Office at Washington assemble to discuss efforts to help improve the Patent system. These meetings are devoted to lectures, papers on scientific subjects, rules and procedures, cases of Patent Law decided by the U. S. Court and a series of moving pictures have been arranged to show the technique and detail of industrial scientific processes and products.

Washington Award Presented to Orville Wright

At the Annual Meeting of the Western Society of Engineers held June 1, the Washington Award for the year 1927 was presented to Orville Wright, "for fundamental scientific research and resultant successful airplane flight."

This award was made, in recognition of devoted, unselfish and preeminent service in advancing human progress, by the Western Society of Engineers on the recommendation of a Commission of Award representing the American Society of Civil Engineers, the American Institute of Mining and Metallurgical Engineers, the American Society of Mechanical Engineers, the American Institute of Electrical Engineers, and the Western Society of Engineers.

Electrical Safety Conference Dissolves

At its regular quarterly meeting held in New York City on June 15th, the Electrical Safety Conference, reviewed its activities and decided to dissolve. This decision was based upon the fact that the mission of the Conference seemed accomplished, and under present conditions, with the availability of other standards-making factors, its work was deemed no longer necessary.

500th Anniversary of University of Louvain

The University of Louvain invited Engineering Foundation to participate in the celebration of the 500th anniversary of the founding of the University. The Foundation has responded on behalf of its Founder Societies of Civil, Mining, Mechanical and Electrical Engineers, and has designated as its delegate Dr. Edward Dean Adams, John Fritz Medalist, Honorary Member and former Vice-Chairman of the Foundation Board. Dr. Adams has generously accepted this mission and attended the ceremonies in Louvain on June 28 and 29.

As the delegate of this large body of 56,000 American engineers, Dr. Adams carried to the University formal congratulations from each Founder Society, the Library Board and Engineering Foundation, handsomely bound together in a book. To the ancient Library of the University of Louvain, destroyed at the beginning of the World War and recently restored, he conveyed in handsome cases a set of year books of the Founder Societies and a set of the publications of the Foundation. The University has an engineering department from which more than one graduate found his way to the United States. Among them was the late E. Gybbon Spilsbury, a president of the American Institute of Mining and Metallurgical Engineers, chairman of Engineering Societies Library Board, vice-president of United Engineering Society, and member of Engineering Foundation, who gave his services generously to the engineering societies.

Professor Albert Van Hecke, the present head of the school of Civil Engineering, will be remembered by many engineers in the United States because he came to this country in 1914, he and his wife and a young child, having been driven from their house by the first rush of the German invasion. While among us he made many acquaintances and visited numerous engineering works before returning to war service in his own country.

Summer School for Engineering Teachers TO HAVE STRONG STAFF AND LARGE ATTENDANCE

As announced in the May JOURNAL, the Society for the Promotion of Engineering Education has undertaken an interesting experiment in the training of college teachers of engineering through the establishment of summer schools to be conducted by it at Cornell University and the University of Wisconsin during July, 1927.

The purpose of the schools will be the discussion and study of methods of teaching the basic subjects of the engineering curriculum. For the first year the subject of mechanics has been selected because of its fundamental importance and its pivotal position between the work in mathematics and physics and the study of engineering subjects proper. Mechanics was chosen also because all engineering teachers have a working knowledge of it and consequently will be able to appreciate discussions of methods of teaching in general when the discussions apply to this particular subject.

The teaching staffs of the two schools include many of the most able and prominent teachers of engineering in the country.

Dean Dexter S. Kimball, of the College of Engineering, Cornell University, will serve as Director of the Cornell session.

The Wisconsin session will be conducted under the directorship of Professor E. R. Maurer, Chairman of the Department of Mechanics of the University of Wisconsin.

Applications to attend the schools have been received in large numbers. It was necessary to close the registration of the Cornell session before the end of May because the maximum number which can be accommodated had been reached, and registration for the Wisconsin session had nearly reached the maximum number at that time.

Morning sessions will include formal lectures on mechanics and related subjects and on methods of teaching, demonstration—lectures, laboratory demonstrations, and model teaching. Afternoon sessions will be devoted largely to seminars in small groups and to assigned projects on the preparation of class exercises and lectures, the devising of problems, the setting of examinations, and the planning of experiments. Evening lectures will be delivered by prominent speakers on a wide range of subjects of general interest to engineering educators. The program will include a number of recreational features.

The summer schools are being conducted by the Society for the Promotion of Engineering Education, under the immediate direction of Dr. W. E. Wickenden, Director of Investigation, and Professor H. P. Hammond, Associate Director of Investigation, and are financed by a special appropriation for the purpose made by the Carnegie Corporation of New York.

PERSONAL MENTION

GEORGE H. KOHL, who has been hydraulic engineer for the Spanish River Pulp and Paper Mills, Ltd., Sault Ste. Marie, Ont., Canada, has now started his own consulting offices there.

JOHN D. BOWLES, chief engineer of the Federal Light and Traction Company, has been appointed one of its vice-presidents by its board of directors.

H. E. MCWETHY, formerly statistical engineer, St. Paul, Minn., has become valuation engineer, for the Twin City Rapid Transit Company, Minneapolis, Minn.

MR. ERNEST V. PANNELL, Technical Adviser to the British Aluminum Co., Ltd., London and New York, has left for London where he will spend two to three months on business matters.

G. M. SIMMONSON has established offices of his own in San Francisco, California, and will carry on his consulting engineering work there.

B. A. TRAVIS, until recently in charge of the motor department of the Westinghouse Elec. & Mfg. Co., has joined the City Electric & Fixture Company, Seattle, Washington.

S. H. BLAKE received appointment as chairman of the standardization committee of the General Electric Company, Schenectady, to succeed Mr. A. H. Moore upon his retirement August 1.

WILLIAM G. ELLIS has been appointed Philadelphia district sales manager for the Ohio Electric & Controller Company, Philadelphia, Pa. Mr. Ellis was previously with Charles E. Bonine, as assistant engineer.

A. H. MOORE, after 39 years of faithful and effective service with the General Electric Company and its associated foreign manufacturing companies, will, on August 1, 1927, retire because of ill health.

J. MAX LEE, formerly of the Westinghouse Elec. & Mfg. Co., is now secretary and treasurer of The James H. Knapp Co., Los Angeles, Calif. Mr. Lee will also be in full charge of the design, construction and sales of electric furnaces for the company.

PAUL NATHAN YOUNG, recent graduate of the University of Michigan and Associate of the Institute since 1926, on July 1 took up new duties in the commercial department of the West Penn Appliance Company, Pittsburgh. Mr. Young was graduated from the Officers Reserve Corp June 15, 1927.

M. M. MCINTIRE and R. W. SHOEMAKER have been engaged by the Imperial Irrigation District, Imperial, Calif., for work on the hydroelectric system utilizing the falls in the irrigation canal system, Mr. McIntire as electrical engineer and Mr. Shoemaker as consulting engineer.

E. S. JOHNSON has been transferred from the railway engineering department of the General Electric Company, Schenectady, N. Y., to have charge of all engineering questions in connection with railroad electrification in the Atlantic District. His new headquarters will be with the Company at Philadelphia, Pa.

E. M. HEWLETT is now consulting engineer of the switchboard department, General Electric Company. He is succeeded in his capacity of engineer by Mr. E. B. Merriam, whose appointment was announced as of June 1. The number of assistant engineers has also been increased to three by the appointment of Mr. Chester Lichtenberg, with headquarters at Philadelphia.

TRUMAN P. GAYLORD, acting vice-president of the Westinghouse Elec. & Mfg. Co., has been elected president of the Pittsburgh Chamber of Commerce by its board. Beside being its new president, Mr. Gaylord is a director of the Pittsburgh Chamber of Commerce, also a director and member of the executive committee of the Pennsylvania State Chamber of Commerce, and a member of the United State Chamber of Commerce.

C. F. HANSON, on December 31, 1926, resigned from the Habirshaw Cable & Wire Company, with which he has been associated for the past nine years in its department for the development of electric power cables, and is now oil specialty sales engineer for R. T. Vanderbilt Co., New York, N. Y. This new work is in the interest of the development and sales of electric insulating oils with particular attention to cables. Mr. Hanson spent five years with the National Bureau of Standards in the study of precision resistance measurements as well as capacity measurements.

WALTER S. MOODY, who, since its inception, has been in general charge of transformer engineering with the General Electric Company at Pittsfield, was recently appointed consulting engineer for all transformer departments of the company as well as those at the Pittsfield Works. Mr. Moody found it necessary to relinquish his administrative duties in order to devote more time to the broader problems of transformer work. Although his new work will represent special attention to the exchange of experience between the various transformer departments at Pittsfield, Erie, Fort Wayne, Oakland and Lynn, Mr. Moody will continue to make his headquarters at Pittsfield.

Obituary

Charles Frederick Rand, former president of the American Institute of Mining and Metallurgical Engineers, chairman of the Engineering Foundation, member of the National Research Council and many other representative bodies, died at his home in Merrywood, Hutton Park, West Orange, N. J., June 21, 1927. Born at Canaan, Me., October 21, 1856, Mr. Rand in 1876 at the age of 20 entered the service of a railroad corporation in Milwaukee. He remained with them for ten years, chiefly in the capacity of a financial officer. For many years prior to his death he was identified with the construction of new railways and the opening and operation of iron mines in Cuba. In 1921 he was elected an honorary member of the Iron and Steel Institute of Great Britain, an honor held by only five other men, among them the Prince of Wales. Mr. Rand was then chairman of the Board of Award for the John Fritz Medal established for achievement in applied science, and Sir Robert Hadfield was the one upon whom it was bestowed that year. In 1913, King Alfonso XIII of Spain decorated Mr. Rand with the Grand Cross of Knight Commander of the Order of Isabella Catolica and in 1922 the French Government again decorated him with the Croix de Chevalier de la Legion d'Honneur for distinguished services during the World War. Mr. Rand did much to encourage the founding of the Engineering Societies Building as the home of the leading national engineering bodies as well as an engineering center for all parts of the world. With the gift of Mr. Ambrose Swasey, and the inception of the Engineering Foundation, Mr. Rand was chosen chairman of the Engineering Foundation Board. Mr. Rand was vice-president of the Welfare Federation of the Oranges, member of the American Society for Testing Materials, the Engineers Club, the Railroad Club of New York, Downtown Club, Union League, Indian House, Metropolitan Club and the Essex Country Club. He was also former chairman of the American Red Cross Board of Directors of the Oranges, his civic life being as actively filled with accomplishment as was his professional.

Walter Stumpf, Associate of the Institute since 1923, was killed in an automobile accident May 14, 1927, at Towson, Md. Mr. Stumpf was a native of Baltimore, a grammar school graduate, he studied mechanical drafting at the Y. M. C. A. night school, supplemented this with a course in mechanical and structural drafting with the International Correspondence School and completed his academic training by a night school course in electricity at Johns Hopkins University. At the time of his death was chief engineer for The Black & Decker Mfg. Co., with which he had been associated ever since March 1912, when he started as an apprentice draftsman. His final work there, in charge of experimental testing department, designing and building all motors used in its products as well as testing and proving other electrical equipment, was noteworthy.

Gordon E. McLean, 1925 Associate, and switchboard engineer for the Commonwealth Power Corporation, Jackson, Michigan, died May 22, 1927. Mr. McLean was a native of Canada and was a graduate in electrical engineering from the Faculty of Applied Science and Engineering, University of Toronto. He was also a graduate student of the Westinghouse Elec. & Mfg. Company's course, East Pittsburgh, having completed that course June 1922. In 1924 he was made switchboard diagram engineer for the Westinghouse Company, East Pittsburgh, later to join the Commonwealth Power Company in similar capacity. By those who had opportunity to observe his work, Mr. McLean was counted a man whose professional ability held an active and noteworthy future.

Carlo Ferrari, who joined the Institute 1915 and was at the time of his death, technical manager of Societa Meridionale Electricita, Naples, Italy, died there March 31, 1927. Mr. Ferrari was born in Naples July 28, 1870, and while most of his professional career was expended in the European field, he was semi-occasionally in this country and contributed some valuable

inventions in electrical protective devices to technical developments here as well as abroad. His principal interests were in the transmission and distribution and his activities in this field have been frequently reported in the technical press, both foreign and domestic.

James Kynoch, chief engineer of the Canadian General Electric Co., Ltd., and Fellow of the Institute since 1918, died suddenly May 30, 1927, at Lake Simcoe, Ontario, Canada. Mr. Kynoch was a native of Scotland, born at Blairgowrie, Perthshire, November 18, 1865. His preliminary education was obtained at Grosvenor College, London, England, and City of London Schools, London, England. Sept. 1883 to July 1886, he attended the City Guilds of London Institute, London, England (now known as the Imperial College of Technology) under professors, Silvanus P. Thompson, W. E. Ayrton, John Perry and W. Armstrong. In 1886 Mr. Kynoch after spending a few months in the workshops of Messrs. Woodhouse and Rawson, London, England, took a position as Assistant Electrical Engineer to Mr. Killingworth Heges, Civil Engineer, London, England. In 1891 Mr. Kynoch came to Canada and immediately entered the employ of the Edison General Electric Co. where he was engaged in Lighting and Railway Construction and estimating for power, lighting, and railway plants. In 1892, when the Edison General Electric Co. was merged into the Canadian General Electric Co. he was assigned to cost estimating and superintending the erection of power plants. After five years on this work, Mr. Kynoch was promoted to Assistant-Chief Engineer and later to Chief Engineer. During this time, he was largely responsible for the engineering and layout of a number of notable installations, such as re-organization of the original Railway Lighting and Power Plants of the St. John Railway Co., the Winnipeg Electric Railway Co., the original plant of the Montreal Cottons, Limited, Valley field, P. Q., the erection of the power plant, overhead lines, submarine cables, apparatus for the sluice gates, lock gates, highway bridges of the Soulanges Canal near Montreal. In addition, he had general supervision of the installation of the Winnipeg Electric Railway Co.'s Hydro Electric Plant at Lac-du-Bonnet, Manitoba, Toronto Power Co.'s Generating and Sub-station at Niagara Falls, and the Ontario Power Co.'s Plant at Niagara Falls. In the last five years Mr. Kynoch's work has been more along executive and consulting lines. One of his most notable achievements was the supervision of the erection of the five generators of the General Electric Co., Ltd., at the Queenston Station of the Hydro Electric Power Commission of Ontario. On Jan. 14, 1887, he was elected Associate of the Institute of Electrical Engineers, London, England. He was also President of the Canadian National Committee of the International Electrotechnical Commission.

Addresses Wanted

A list of members whose mail has been returned by the postal authorities is given below, together with the addresses as they now appear on the Institute records. Any member knowing the present address of any of these members is requested to communicate with the Secretary at 33 West 39th St., New York, N. Y.

All members are urged to notify the Institute Headquarters promptly of any changes in mailing or business address, thus relieving the member of needless annoyance and also assuring the prompt delivery of Institute mail, the accuracy of our mailing records, and the elimination of unnecessary expense for postage and clerical work.

D. K. Alpern, Room 10-217, Mass. Inst. of Tech., Cambridge, Mass.

Constantin De Veyher, So. Calif. Tel. Co., Los Angeles, Calif.

Alexander S. Fraser, Box 477, Kamloops, B. C.

Akos Ludasy, 420 W. 7th St., Cincinnati, Ohio.

Frank A. Nerges, Submarine Base, New London, Conn.

George Stanley Phelan, General Delivery, Washington, D. C.

Harry W. Pierce, 436 Main St., Sarasota, Fla.

Past Section Meetings

SECTION MEETINGS

Akron

Inspection trip to the Avon Plant of the Cleveland Electric Illuminating Company, followed by a banquet. May 14. Attendance 75.

Boston

Annual Meeting. The following officers were elected: Chairman, E. W. Davis; Vice-Chairman, Prof. H. B. Dwight; Secretary-Treasurer, W. H. Colburn. May 19. Attendance 237.

Cincinnati

Power-System Stability—A Mechanical Analogy, by F. C. Hanker, Westinghouse Elec. & Mfg. Co. April 14. Attendance 96.

Electric Arc Welding as Applied to Manufacturing, by J. F. Lincoln, Lincoln Electric Co. May 17. Attendance 75.

Annual Dinner Meeting. The following officers were elected: Chairman, R. C. Fryer; Secretary, L. O. Dorfman. June 9. Attendance 36.

Cleveland

Our Debts to Scientific Research, by C. C. Chesney, National President, A. I. E. E. The following officers were elected: Chairman, A. M. Lloyd; Secretary-Treasurer, E. W. Henderson. May 12. Attendance 60.

Columbus

Joint meeting with Ohio State University Branch. (See Student Activities Section). April 22. Attendance 73.

Following the Cascades through Oregon, by J. F. Stone. Annual Dinner Meeting. The following officers were elected: Chairman, F. C. Nesbitt; Secretary, W. E. Metzger. May 27. Attendance 81.

Connecticut

Annual Outing. June 11. Attendance 44.

Detroit-Ann Arbor

Mechanical Ideas in Electricity, by Prof. W. S. Franklin, Mass. Inst. of Tech. May 17. Attendance 300.

Fort Wayne

Annual Banquet. Talk by C. C. Chesney, National President, A. I. E. E. The following officers were elected: Chairman, P. O. Noble; Vice-Chairman, C. F. Beyer; Secretary-Treasurer, F. W. Merrill; Assistant Secretary-Treasurer, T. McK. Evans. May 16. Attendance 94.

Indianapolis-Lafayette

Transmission-Line Stability, by A. P. Fugill, Westinghouse Elec. & Mfg. Co. May 27. Attendance 45.

Ithaca

Oscillographs, by Prof. Frederick Bedell, Cornell University. May 13. Attendance 70.

Kansas City

Professional Consciousness in Engineering, by F. Ellis Johnson, University of Kansas. The following officers were elected: Chairman, S. M. DeCamp; Secretary-Treasurer, B. J. George. May 23. Attendance 22.

Lehigh Valley

The Conowingo Project, by Raymond Bailey, Philadelphia Electric Co. Annual Meeting. The following officers were elected: Chairman, Mark R. Woodward; Secretary, G. W. Brooks. May 26. Attendance 71.

Louisville

The Development of the Fire-Alarm Telegraph, by W. G. Dey, Louisville Police and Fire Alarm Signalling Department. May 11. Attendance 23.

Lynn

The Electric Arc and Its Function in New Welding Processes, by Peter Alexander, Thomson Research Laboratory, G. E. Co. The following officers were elected: Chairman, W. F. Dawson; Vice-Chairman, G. Skoglund; Secretary-Treasurer, V. R. Holmgren. May 18. Attendance 225.

Madison

Transmission Features in Design and Operation of Toll Cables, by H. R. Huntley, Wisconsin Telephone Co. The following officers were elected: Chairman, J. T. Rood; Secretary-Treasurer, H. J. Hunt. June 7. Attendance 19.

Milwaukee

Trans-Atlantic Radio Telephony, by H. S. Osborne, Transmission Engr., American Tel. & Tel. Co. May 18. Attendance 200.

Minnesota

Business Meeting. May 4.
Dinner-Dance. May 16. Attendance 103.

Nebraska

Inspection trip for Junior and Senior Electrical Engineering Students at University of Nebraska, followed by a dinner. May 10. Attendance 100.

Portland

A-C. Transient Starting Current of Incandescent Lamps, by F. D. Crowther and R. L. Earnhart;

Voltage Resonance and the Influence of Insulation Resistance upon the Characteristics of Artificial Power and Telephone Lines, by O. C. Doty, V. E. Rinehart and W. C. Wing, and
The New Cuprous-Oxide Rectifier, by N. M. McKeel. Meeting preceded by a dinner. May 7. Attendance 85.

St. Louis

Reyrolle Armor-Clad Switch Gear, by H. O. Nye, Allis-Chalmers Co. May 18. Attendance 34.

Saskatchewan

Insulator Problems, by W. P. Dobson, Ontario Hydro-Electric System. May 20. Attendance 21.

Seattle

Short-Circuit Problems on High-Voltage Networks, by R. Rader, Puget Sound Power & Light Co. The following officers were elected: Chairman, C. R. Wallis; Secretary, R. Rader. May 17. Attendance 73.

Sharon

Engineering Features of Electrical Maintenance in Steel Mills, by A. C. Cummins, Carnegie Steel Co., and J. L. Parker, Sharon Steel Hoop Co. A motion picture, entitled "The Story of Steel," was shown. May 12. Attendance 83.

Southern Virginia

The Design of Hydraulic Turbines, by R. E. B. Sharp, I. P. Morris Co.;

Egypt and the International Navigation Conference at Cairo, by John C. Hoyt, Vice-President, A. S. C. E.;

Electrification of the Virginia Railway, by R. J. O'Brien, Westinghouse Elec. & Mfg. Co.;

The Electric Features of the Appalachian Region, by Graham Claytor, American Gas and Elec. Co.;

Railway Electrification, by F. E. Wynne, Westinghouse Elec. & Mfg. Co. and

Control of Steam Pollution, by G. W. Fuller, Consulting Engineer. Joint meeting with A. S. C. E. and A. S. M. E. May 20. Attendance 182.

Springfield

Mechanical Power and the Trend of Civilization, by C. E. Skinner, Westinghouse Elec. & Mfg. Co. May 20. Attendance 162.

Syracuse

Business Meeting. May 31.

Toledo

Lightning and Its Effects on Electric Circuits, by H. M. Towne, General Electric Co. Illustrated. May 20. Attendance 40.

Toronto

The Four Johns (A Character Study), by Thos. McGillicuddy. The following officers were elected: Chairman, C. E. Sisson; Secretary, F. F. Ambuhl. May 6. Attendance 47.

Urbana

Research and Progress in Insulating Materials, by H. C. P. Weber, Westinghouse Elec. & Mfg. Co. May 11. Attendance 75.

Vancouver

Insulation, by W. P. Dobson, Hydro-Electric Power Comm. of Ont. May 25. Attendance 52.

A. I. E. E. Student Activities

JOINT BRANCH MEETING IN MILWAUKEE

A joint meeting of the Marquette University, Armour Institute of Technology, Lewis Institute, and School of Engineering of Milwaukee Branches, sponsored by the Milwaukee Section, was held at Marquette University in Milwaukee on May 20 and 21, 1927. A number of members of the Chicago and Milwaukee Sections were present, and the total registration was 108.

The various events of the meeting are given in the following program:

MAY 20

- 4:00 p. m. Registration and Assignments.
 7:30 p. m. Fellowship Smoker.
 Address of Welcome, Prof. J. F. H. Douglas, Counselor, Marquette University Branch.
 Keynote Address, "Cooperation Among Engineers," Mr. F. J. Mayer, District Plant Supt., Wisconsin Telephone Co.
 Engineering Experiences, Dean F. C. French.
 Remarks, Prof. J. D. Ball, Vice President, School of Engineering of Milwaukee.

MAY 21

- 9:15 a. m. Technical Session.
 Address, Poise and Balance in Engineering, Mr. G. G. Post, Electrical Engineer, Milwaukee Electric Ry. & Light Co.
 Student Papers and Discussions.
 11:00 a. m. Business Session.
 Committee Reports.
 General Business.
 1:30 p. m. Inspection Trip to Lakeside Generating Plant of Milwaukee Electric Railway and Light Co.
 6:30 p. m. Banquet with Milwaukee Section.
 Toastmaster, Mr. H. R. Huntley, Transmission Engineer, Wisconsin Telephone Co.
 A. I. E. E. Membership Benefits, Mr. S. H. Mortensen, Electrical Engineer, Allis-Chalmers Mfg. Co.
 Address, Mr. B. G. Jamieson, Vice-President, Great Lakes District, A. I. E. E.

General plans for the meeting were made by a Joint Meeting Arrangements Committee composed of the following students:

Clifford Earle, General Chairman
 Joseph Zurfluh
 George Howden
 John Adriansen
 James Kelly.

Six special committees made arrangements for various features of the meeting.

A joint committee composed of members of the Marquette, School of Engineering, and Armour Branches was organized for the purpose of making plans for a Student Convention to be held this fall.

ANNUAL SPRING ENGINEERS' DAY AT UNIVERSITY OF COLORADO

On May 25, 1927, the Denver Section and the University of Colorado Branch participated in the sixth Annual Engineers' Day, held at the University of Colorado, Boulder, Colorado, which was sponsored by the Colorado Engineering Council. The program was as follows:

- 12:30 p. m. Tau Beta Pi luncheon for faculty.
 1:30-

- 4:00 p. m. Registration of visiting engineers and inspection of buildings.
 2:30 p. m. Senior-faculty baseball game.
 4:00 p. m. Presentation of Awards.
 Address of the day by Mr. L. C. Fritch, Vice-President, Rock Island Lines, on the subject: "Transportation Engineering."
 Election of officers of Council.
 Election of officers, Denver Section A. I. E. E.
 6:00 p. m. Banquet in honor of Mr. Fritch.
 8:00 p. m. Inspection of buildings.

The University of Colorado Branch provided demonstrations of the new automatic substation, oscillograph, high voltage and insulator testing, telephone laboratory, standardizing laboratory, constant voltage regulators developed by students, and all equipment in electrical laboratories. It also arranged a large illumination display on the outside of the building.

Engineers from the entire state were guests of the University, and the total attendance was 1190.

CONFERENCE ON STUDENT ACTIVITIES AT PITTSFIELD, MASS.

A conference on Student Activities was held on Friday evening, May 27, during the Regional Meeting of District No. 1, May 25-28, at Pittsfield, Mass. Of the ten Branches in the District, six were represented by their Counselors and Chairmen and each of three others was represented by either the Counselor or the Chairman.

Upon the recommendation of a special nominating committee, the Committee on Student Activities decided to organize an Executive Committee consisting of the Vice-President, District Secretary, Chairman of the Committee on Student Activities, and two other Counselors. Professor W. H. Timbie, Counselor, Massachusetts Institute of Technology, was elected Chairman, and Professors C. W. Henderson, Counselor, Syracuse University, and F. M. Sebast, Counselor, Rensselaer Polytechnic Institute, were elected members of the Executive Committee. The nominating committee's recommendation that an auxiliary committee of students be formed to cooperate with the Executive Committee was adopted, and at a meeting of student delegates held later the following committee was organized.

Chairman, W. M. Hall, Incoming Chairman, M. I. T. Branch.
 R. F. Scott, Incoming Chairman, University of Maine Branch.
 W. J. Brown, Jr., Incoming Chairman, Yale University Branch.

The Committee on Student Activities chose Professor W. H. Timbie as its delegate to the Summer Convention.

A resumé of the Conference on Student Activities, at Bethlehem, Pa., on April 23, 1927, was given by Assistant National Secretary Henline. Professor Harold B. Smith emphasized certain parts of the discussion at that Conference, notably those dealing with opportunities in Branch meetings for training in important elements of leadership. He spoke of the desirability of encouraging students to attend conventions by excusing them from university duties when possible. He said that, although moving pictures and visiting speakers have their places on Branch programs, the programs should usually be filled by Students, and that Branch affairs should be conducted by Students as far as possible.

A motion was made, seconded, and passed that the group recommend to the Board of Directors that consideration be given to the development of a definite plan for the publication of Student papers.

There was a strong desire that some means of publishing Student papers not of Institute grade be adopted. The opinion was expressed by several that good short papers are preferable

to abridgments and that when abridgments are published they should be prepared by the authors.

The disposition of the record of the discussion of the Student papers presented on the afternoon of May 27 was discussed, and several Students expressed a strong desire to secure copies of it if possible.

Professor Scott emphasized the importance of getting Students who are members of the Branches to do things on their own account, and said some of the methods used in other extra-curricular activities should be helpful in this connection.

STUDENT CONVENTION OF NORTHEASTERN DISTRICT

A Student Convention was held in conjunction with the Regional Meeting of District No. 1 at Pittsfield, Mass., May 25-28, 1927. The following papers were presented at the student technical session on Friday afternoon, May 27:

STUDENT PAPERS, A. I. E. E. GRADE

The Electrical and Magnetic Properties of Electrolytic Cobalt and Its Alloys with Iron, by W. C. Ellis, Rensselaer Polytechnic Institute.

Proximity Effect in a Seven-strand Cable, by J. E. L. Tweeddale, Massachusetts Institute of Technology.

Calculation of Stray Load Losses, by G. H. Roekwood, Massachusetts Institute of Technology.

STUDENT PAPERS, STUDENT GRADE

The Reversing Motor as a Source of Magnetizing Energy, by G. F. Kern, Syracuse University.

An Optical Method of Determining Internal Stresses in Homogeneous Materials, by C. F. Ffolliott, Rensselaer Polytechnic Institute.

A Chart for Combining Impedances of Parallel Circuits, by E. E. Mott, Massachusetts Institute of Technology.

Measurement of Flux in Watthour Meter, by W. W. Parker, Yale University.

The Measurement of Intense Magnetic Fields by Means of the Zeeman Effect on the Zinc Triplet, by A. C. Michels, Rensselaer Polytechnic Institute.

A Method of Measuring the Alternating Component of Current When it is Superimposed on Direct Current, by F. Massa, Massachusetts Institute of Technology.

Professor W. H. Timbie, Chairman of the Committee on Student Activities of District No. 1, presided.

The presentation of nearly all of the nine papers was excellent and there was a considerable amount of discussion. The students were strongly commended for the clearness and snap-piness of their discussion throughout the program.

At the close of the session, Professor Charles F. Scott of Yale University was requested to give his impressions of it. He said he had heard all the presentations and discussions from the back of the room, and that one can seldom do that during regular technical sessions. He discussed briefly but in a most interesting manner the early development of the electrical industry and the corresponding development of the Institute which resulted in 1902, during his term as President, in the formation of Sections and Branches. The present rapid growth of the electrical industry and the consequent responsibility on the students were emphasized.

COLUMBUS SECTION AND OHIO STATE UNIVERSITY BRANCH JOINT MEETING

A joint buffet lunch-smoker meeting was held on April 22, 1927, by the Columbus Section and the Ohio State University Branch at the Chittenden Hotel in Columbus.

The following program was presented:

Glimpses of Turkish Life, by Hrant Eknayan, Ohio State University Branch.

Reminiscences of Emile Berliner, by Paul E. Crouch, Ohio State University Branch.

The Virginian Railway Electrification and Some Highlights in the Life of B. G. Lamme, by Lee P. Doyle, Ohio State University Branch.

Some Recent Developments in the Manufacture of Mazda Lamps, by A. W. Janowitz, Columbus Section.

Some Suggestions Based on Practical Experiences, by Perry Okey, Columbus Section.

Some Experiences from the Practical Side of Electrical Engineering, by F. R. Price, Columbus Section.

A buffet lunch and smoker followed the program, and some entertainment was furnished by the Branch members.

LARGE POWER PLANT GENERATOR TESTED BY STUDENTS

Seniors in electrical engineering at the University of Southern California made a complete test of Generator No. 1 at Power Plant No. 1 of the Bureau of Power and Light, City of Los Angeles, on May 14 and 15. The generator is rated at 9375 kv-a., 6600 volts, 50 cycles, and 200 r. p. m., and is driven by Pelton wheels. The purpose of the tests was to determine and separate all losses, and the retardation method was used for both open-circuit and short-circuit tests which were carried out under the supervision of Mr. B. W. Creim, Bureau of Power and Light, and Professor Philip S. Biegler of the University of Southern California.

ENGINEERING OPEN HOUSE AT UNIVERSITY OF NORTH CAROLINA

The University of North Carolina Branches of the A. I. E. E. and A. S. C. E. held an Open House on May 4, 1927, for the purpose of acquainting students, faculty, and any others interested with the work of the School of Engineering.

The 21 exhibits were planned to be typical of the work required of students in the School, and covered a wide range of subjects, including physics, electrical engineering, water purification, mechanical engineering, materials testing, sanitary engineering, etc.

Refreshments were served and a guessing contest was supplied for the ladies.

The attendance was about 1200.

AWARD OF NATIONAL BEST BRANCH PAPER PRIZE

The Committee on Award of Institute Prizes has awarded the National Best Branch Paper Prize for 1926 to Mr. R. A. Schaefer, a member of the Marquette University Branch, for a paper entitled "A Study of Transverse Armature Reaction in Synchronous Machines by Means of a Second Machine With an Adjustable Stator," which he presented before that Branch on December 30, 1926.

This prize consists of \$100.00 and a certificate of award. The paper will be published in an early issue of the JOURNAL.

BRANCH MEETINGS

Alabama Polytechnic Institute

Social Meeting. May 5. Attendance 33.

University of Arizona

Radio Compass, by Mr. Carnes. April 2.

Mental Hygiene, by Mr. Attkinson, and

Power-Plants Field Trip, by Prof. J. C. Clark. April 23.

Business Meeting. April 30.

Testing of Magnetic Materials, by Mr. Autillon, and

Various Types of Circuit Breakers in Railway Service. May 14.

Henry Ford Trade School, by Mr. Riggins;

Resuscitation from Electric Shock, by Mr. Mitchell and

The Engineering Curriculum, by Mr. Sharpe. The following officers were elected: Chairman, G. T. Mitchell; Vice-Chairman, Albert Ellicoek. May 21.

Armour Institute of Technology

Smoker. April 27. Attendance 70.

Mercury-Arc Rectifiers, by Mr. Gutzmiller, American Brown Boveri Co. May 19. Attendance 40.

Business Meeting. The following officers were elected: President, L. J. Anderson; Secretary, Harold T. Dahlgren; Treasurer, W. J. Zenner. May 26. Attendance 23.

Bucknell University

Business Meeting. April 20. Attendance 38.

Artificial Lightning, by Prof. Lowry and Prof. Irland. April 27. Attendance 40.

Lightning, by Mr. Towne of General Electric Co. May 4. Attendance 57.

Business Meeting. The following officers were elected: President, G. B. Timm; Vice-President, John Bridegrum; Secretary-Treasurer, A. C. Urffer. May 18. Attendance 33.

Case School of Applied Science

Mercury-Arc Rectifiers, by R. M. Lawall, student, and

Thomas Alva Edison, by W. G. Plagens, student. May 7. Attendance 51.

Automatic Substations, by T. J. Wilson;

The Modern Electric Battleship, by P. K. Mentzer, and

The St. Lawrence River Power Project, by H. R. Waters. May 14. Attendance 28.

Banquet. May 16. Attendance 39.

Colorado Agricultural College

Business Meeting. The following officers were elected: Counselor, H. G. Jordan; President, Harold Groat; Vice-President, Cecil Wolcott; Secretary-Treasurer, Howard Steinmetz. May 9. Attendance 9.

University of Colorado

Transportation Engineering, by Louis Charlton Fritch, Vice-President, Rock Island System. A banquet followed the meeting. May 25. Attendance 600.

Social Meeting. The following officers were elected: Chairman, Joe A. Setter; Vice-Chairman, E. R. White; Secretary, R. D. Palmer; Treasurer, Alfred Decino. June 1. Attendance 56.

University of Denver

Business Meeting. The following officers were elected: Chairman, G. K. Baker; Vice-Chairman, Vernon Cato; Secretary-Treasurer, L. L. Booth. May 13. Attendance 11.

Duke University

Business Meeting. The following officers were elected: Chairman, O. T. Colclough; Vice-Chairman, L. L. Hardin; Secretary-Treasurer, F. A. Bevaqua. May 16. Attendance 14.

University of Idaho

Survey of Moscow Bakeries, by T. L. Styner, student. The following officers were elected: President, R. G. Elliott; Vice-President, C. N. Teed; Secretary-Treasurer, F. B. Peterson. May 12. Attendance 20.

Lehigh University

Operation of Klydonograph, by R. Cetina, student, and

Travels through Europe, by Prof. Wm. S. Esty. May 13. Attendance 61.

Louisiana State University

Salesmanship, by Mr. Geisler, Baton Rouge Electric Co. The following officers were elected: Chairman, R. C. Alley; Vice-Chairman, L. A. Bailey; Secretary-Treasurer, W. S. Marks. May 24. Attendance 18.

University of Maine

Railroad Electrification, by W. N. Bearse. Illustrated with motion pictures. May 12. Attendance 60.

Business Meeting. The following officers were elected: President, R. F. Scott; Vice-President, L. E. Lymburner; Treasurer, W. E. Creamer; Secretary, E. W. Jones. May 13. Attendance 19.

Michigan State College

Business Meeting. May 17. Attendance 24.

Induction Frequency Changer. May 24. Attendance 16.

University of Michigan

Mechanical Ideas in Electricity, by Prof. W. S. Franklin, Mass. Inst. of Technology. May 17. Attendance 325.

The Electric Harmonic Analyser, by I. J. Sandorf. May 19. Attendance 35.

Business Meeting. The following officers were elected: Chairman, L. J. Van Tuyl; Vice-Chairman, W. J. Poeh; Secretary, W. E. Reichle; Treasurer, G. H. Anderson. May 26. Attendance 17.

School of Engineering of Milwaukee

The Development of the Public-Utility Idea, by A. F. Tegen, Wisconsin Motor Bus Lines. June 7. Attendance 30.

University of Minnesota

Business Meeting. The following officers were elected: Chairman, G. C. Brown; Secretary, G. C. Hawkins; Treasurer, A. P. Burris. May 26. Attendance 59.

Mississippi Agri. and Mech. College

Business Meeting. The following officers were elected: President, H. M. Stainton; Vice-President, B. W. Robins. May 18. Attendance 25.

Montana State College

Our Mechanical Slaves, by Edwin Winkler, and

New Radio Fraternity, by Harold Rivenes. May 6. Attendance 151.

Usefulness of Vacua, by John Percy, and

Electric Water Heating in Rural Districts, by Roy Newkirk. May 20. Attendance 181.

University of Nebraska

A motion picture, entitled "Behind the Pyramids," was shown. The following officers were elected: Chairman, W. A. Van Wie; Vice-Chairman, R. D. Reed; Secretary-Treasurer, Keith Davis. May 25. Attendance 40.

College of the City of New York

Business Meeting. The following officers were elected: Faculty Chairman, Prof. Harry Baum; Student Chairman, Joseph Leipziger; Vice-Chairman, David Ginsberg; Secretary, A. H. Rapport; Treasurer, Julius Roth. June 6. Attendance 12.

Newark College of Engineering

Business Meeting. The following officers were elected: President, E. S. Bush; Vice-President, C. P. Hurd. June 1. Attendance 23.

University of North Carolina

Electrical Transients, by Prof. Daggett. May 12. Attendance 22.

Business Meeting. The following officers were elected: President, D. M. Holshouser; Vice-President, T. Griffin; Secretary, W. C. Burnett; Treasurer, J. D. McConnell. May 26. Attendance 27.

Northeastern University

Electrical Measurements, by E. S. Lee, General Electric Co. April 26. Attendance 50.

Insulation, by Dr. Hollenagle, General Electric Co. May 31. Attendance 36.

Ohio Northern University

Business Meeting. May 21. Attendance 27.

Oregon State College

Effect of Insulation Resistance on the Characteristics of an Artificial Line, by O. C. Doty, V. E. Rinehart and W. C. Wing;

A New Type of Rectifier, by N. M. Mekeel, and

A-C. Transients in Incandescent Lamps, by F. D. Crowther and R. L. Earnhart. May 7. Attendance 100.

Meter Testing, by John Hertz, and

Electric Refrigeration, by Kenneth Martin. The following officers were elected: President, John Hertz; Vice-President, Kenneth Martin; Secretary-Treasurer, Richard Setterstrom. May 25. Attendance 35.

Pennsylvania State College

Power Factor, by John Fink and G. C. Huggler. The following officers were elected: Chairman, Carl Dannorth; Secretary, W. J. Gorman; Treasurer, L. Hane. May 12. Attendance 47.

Stability of Transmission Lines, by A. Dovjikov, Westinghouse Elec. & Mfg. Co. May 18. Attendance 110.

Rensselaer Polytechnic Institute

Business Meeting. The following officers were elected: Chairman, W. F. Hess; Vice-Chairman, R. T. Knapp; Secretary, B. S. Morehouse; Counselor, Dr. Frederick M. Sebast. May 10. Attendance 32.

University of Santa Clara

Business Meeting. The following officers were elected: Chairman, R. P. O'Brien; Vice-Chairman, N. K. Delaney; Secretary-Treasurer, C. E. Newton. May 4. Attendance 28.

University of South Dakota

Talk by Mr. Bickley, Northwestern Bell Telephone Co. May 18. Attendance 17.

Stanford University

Transformers and Their Manufacture, by W. C. Smith, General Electric Co. Illustrated with motion pictures. May 25. Attendance 23.

Business Meeting. June 1. Attendance 22.

Inspection trip to Oakland Plant of the General Electric Co. June 4. Attendance 31.

Syracuse University

History and Construction of the Edison Storage Battery. April 28. Attendance 23.

Electrolysis of Water Mains, etc., by V. A. Hilarov. May 5. Attendance 23.

Mercury-Arc Rectifier, Mr. L. Soderholm, New York State Railways, Inc. May 19. Attendance 23.

The Water Power Development at Niagara Falls, N. Y., by L. Bradbury, Niagara Falls Power Co. May 24. Attendance 34.

University of Utah

New Developments in X-Rays, by F. J. Nicholes;

The Vitaphone, by R. N. Anderson;

Superpower, by W. S. Rigby, and

Power Factor of the Fynn-Weichsel Motor, by V. S. Thomander and O. C. Haycock. April 28. Attendance 50.

Business Meeting. The following officers were elected: Chairman, H. E. Larson; Vice-Chairman, C. E. White; Secretary, Junion Petterson. May 19. Attendance 20.

Virginia Military Institute

Business Meeting. The following officers were elected: Chairman, W. F. R. Griffith; Secretary, F. Barkus. June 2. Attendance 24.

Washington and Lee University

Business Meeting. May 12. Attendance 9.

Washington State College

Business Meeting. The following officers were elected: President, Harry Wall; Vice-President, Everett Martin; Secretary, Erwin Peters; Treasurer, Carlos Yerian. May 4. Attendance 21.

Features of the Senior Electrical's Inspection Trip, by Prof. R. D. Sloan. May 18. Attendance 25.

Washington University

A motion picture, entitled "Behind the Pyramids," was shown. The following officers were elected: President, R. L. Bolshe; Vice-President, Melvin Black; Secretary, J. G. Muzance, Jr. May 10. Attendance 25.

University of Washington

Graphical Solution of Steinmetz Equation for Hysteresis Loss, by H. J. Scott, student, and

Largest Automatic Hydro-Electric Station Constructed for the Pulp and Paper Industry, by W. L. Thraillkill and Roy Crosby, students. June 7. Attendance 13.

West Virginia University

Annual Banquet. May 11. Attendance 42.

University of Wisconsin

Norberg Diesel Engines, by H. M. Zoerb. The following officers were elected: President, John A. Sargent; Secretary-Treasurer, L. V. Saari. April 28. Attendance 75.

Engineering Societies Library

The library is a cooperative activity of the American Institute of Electrical Engineers, the American Society of Civil Engineers, the American Institute of Mining and Metallurgical Engineers and the American Society of Mechanical Engineers. It is administered for these Founder Societies by the United Engineering Society, as a public reference library of engineering and the allied sciences. It contains 150,000 volumes and pamphlets and receives currently most of the important periodicals in its field. It is housed in the Engineering Societies Building, 29 West Thirty-ninth St., New York.

In order to place the resources of the Library at the disposal of those unable to visit it in person, the Library is prepared to furnish lists of references to engineering subjects, copies or translations of articles, and similar assistance. Charges sufficient to cover the cost of this work are made.

The Library maintains a collection of modern technical books which may be rented by members residing in North America. A rental of five cents a day, plus transportation, is charged.

The Director of the Library will gladly give information concerning charges for the various kinds of service to those interested. In asking for information, letters should be made as definite as possible, so that the investigator may understand clearly what is desired.

The library is open from 9 a. m. to 10 p. m. on all week days except holidays throughout the year except during July and August when the hours are 9 a. m. to 5 p. m.

BOOK NOTICES MAY 1-31, 1927

Unless otherwise specified, books in this list have been presented by the publishers. The Society does not assume responsibility for any statement made; these are taken from the preface or the text of the book.

All books listed may be consulted in the Engineering Societies Library.

AIRCRAFT YEAR BOOK, 1927.

N. Y., Aeronautical Chamber of Commerce of America, 1927. 396 pp., illus., diags., maps, 9 x 6 in., cloth. \$5.25.

As in previous issues, this year book supplies a review of developments in civil and military aviation during 1926, together with much statistical material and miscellaneous information of value to those at work in this field. The reports cover all phases of aviation, commercial, technical and historical.

ASTRONOMY; a text book.

By John Charles Duncan. N. Y., Harper & Bros. 1926. 384 pp., illus., 9 x 6 in., cloth. \$4.00.

Although Professor Duncan's book is intended primarily as a college text for beginners, it will be found highly satisfactory

by general readers who wish a general view of the science of the stars. The book is an excellently balanced, up to date account of astronomy, which avoids difficult mathematical discussion and which is written in a clear, interesting style. The text is amply illustrated by line drawings and many fine photographs.

BELASTUNG DES BAUGRUNDES. Collected from "Sparwirtschaft."

Wien, Osterreichischer Normenausschuss für Industrie und Gewerbe, 1927. 78 pp., illus., diags., 8 x 6 in., paper. Price not quoted.

This contribution to the study of the bearing capacity of soils contains the discussions of the tentative standards of the Austrian Standards Commission which have appeared in "Sparwirtschaft." It also contains the revised tentative standard for tests of bearing capacity which the Commission adopted in December, 1926.

THE BRIDGE TO FRANCE.

By Edward N. Hurley. Phila., J. B. Lippincott Co., 1927. 338 pp., illus., ports., 9 x 6 in., cloth. \$5.00.

Mr. Hurley became Chairman of the United States Shipping Board and, ex-officio, President of the Emergency Fleet Cor-

poration soon after the United States entered the war and continued in office until the middle of 1919. Faced with the tremendous task of acquiring and operating sufficient cargo-ships to maintain an army in France, the Shipping Board successfully surmounted the enormous difficulties before it.

Of these difficulties and of the methods taken to overcome them he gives a most interesting account. Here are the stories of the fabricated steel ship, of Hog Island, of the labor troubles, of the convoy service and of the multitude of other problems that arose. In addition the book gives much of interest upon the naval, military, political and economic strategy of the Allies.

Although the book contains much detail, Mr. Hurley has skillfully avoided a dry recital of statistics and technical details and has produced an eminently readable, interesting book. Interesting descriptions are given of many prominent personages with whom he came in contact, and there is much comment upon the political events here and abroad. The book is a decided addition to the histories of the war.

DARSTELLENDGEOMETRIE FÜR MASCHINENINGENIEURE.

By Marcel Grossman. Berlin, Julius Springer, 1927. 236 pp., diags., 10 x 7 in., paper. 15.-r.m.

A college textbook which treats descriptive geometry from the point of view of the designer of machines rather than from that of the mathematician.

ELECTRICAL CONDENSERS.

By Philip R. Coursey. N. Y., Isaac Pitman & Sons, 1927. 637 pp., illus., charts; 9 x 6 in., cloth. \$10.00.

The general purpose of this book, apparently the only one in the English language devoted exclusively to the subject, is to dispel any feeling that the condenser is too frail an instrument for practical use by describing modern developments in its manufacture and many actual and possible industrial applications.

The book opens with a description of the fundamental properties of condensers, followed by a historical account of the early discoveries and inventions. The essential electrical properties of dielectrics which fit them for use in condensers are then set forth and followed by formulas for calculating the electrostatic capacity of condenser transmission lines, aerial and underground cables. The uses of condensers in radio communication are then discussed. The design and testing of condensers is then taken up and followed by chapters describing many types utilizing various dielectrics. The final chapters are devoted to the chief uses of condensers. A valuable feature is a bibliography of over two thousand articles.

DIE ELEKTRISCHEN EINRICHTUNGEN FÜR DEN EIGENBEDARF GROSSER KRAFTWERKE.

By Friedrich Titze. Berlin, Julius Springer, 1927. 160 pp., illus., diags., 9 x 6 in., boards. 12.-r. m.

A treatise upon the use of electricity in the operation of large electric and hydraulic power plants, with special reference to methods that cheapen the cost of power. The book discusses methods for producing the necessary electricity, switching apparatus, transformers, generators, motors, electrical machinery in the boiler house and condensing plant, uses of electricity in hydraulic plants, and electric heating in power plants.

FESTGABE CARL VON BACH.

Compiled by R. Bauman and others. Berlin, V. D. I. Verlag, 1927. (Forschungsarbeiten auf dem Gebiete des Ingenieurwesens, heft 295). 95 pp., illus., diags., port., tables, 12 x 9 in., paper. 14.-r. m.

In commemoration of the eightieth birthday of Dr. von Bach a number of his former pupils and associates have published this work, containing ten papers describing investigations in the field with which his name has been so long identified.

The papers include an account of investigations into the elasticity of Krupp special steels at temperatures from 20 deg. to 500 deg. cent.; an investigation of the effect of caustic soda and various salts upon boiler plates; tests of the effect of temperature upon the brittleness of steel and other metals; a summary of the most important results of the investigations of changes in volume of cement, concrete, etc., made at Stuttgart in the last twenty years; an article upon the design of foundations for large poles for electric lines; an investigation of the resistance of metals to cracking; the results of tensile tests under sudden loads; investigations of turbines, and a discussion of the crystallization of cast iron.

FLUSSIGE BRENNSTOFFE.

By Hermann Jentsch. Berlin, V. D. I. Verlag, 1926. 231 pp., illus., tables, 6 x 4 in., cloth. 4,50 r. m.

A pocket encyclopedia for practical men. The book gives a clear, readable account of the properties of the usual liquid fuels, of the methods of testing them and of the chemical and physical phenomena of combustion. Particular attention is directed to their use in internal-combustion engines.

HARVARD BUSINESS REPORTS, Vols. 2 and 3.

Compiled by the Graduate School of Business Administration, Harvard University. Chicago & N. Y., A. W. Shaw Co. 1926-27. 2 Vols., 9 x 6 in., cloth. \$7.50 each.

These volumes continue the series of cases illustrating business problems begun in 1925. These cases show how actual firms dealt with important matters of policy and form a valuable collection of data upon good business practice, from which business executives may draw hints for the solution of their own difficulties. Commentaries are given with each case.

Volume two treats of a variety of topics. The cases in volume three discuss marketing problems.

HYGIENE INDUSTRIELLE GENERALE.

By Leclercq Pulligny et Boulin. Paris, J.—B. Bailliere et fils, 1927. (Traité d'Hygiène). 452 pp., illus., 10 x 7 in., paper. Price not quoted.

This volume, which is part of an exhaustive treatise upon hygiene, discusses industrial hygiene in considerable detail, and gives a good review of the subject. The various occupational dangers to which workmen are exposed and the most effective methods for combatting these dangers are described. Sections are devoted to preventive and remedial measures, to medical inspection and to legislation.

INSULATING OIL; a List of References (1900-1925) in the New York Public Library.

Compiled by Arthur W. Fyfe, Jr. N. Y., New York Public Library, 1927. 71 pp., 10 x 7 in., paper. \$.50.

This bibliography will be very useful to all those interested in the design and manufacture of electrical appliances (transformers, switches, etc.) in which oil is used for insulating, cooling or for extinguishing arcs. It contains references to all the books and periodical articles on the subject, published between 1900 and 1925, which are in the extensive collection of the New York Public Library.

Nearly seven hundred publications are included. The list is chronological and good author and subject indexes are given. Every entry is competently annotated. The price is evidently well below the cost of the work.

JAHRBUCH DER ELEKTROTECHNIK, 1925.

Edited by Karl Strecker, Mün. u. Ber. R. Oldenbourg, 1927. 285 pp., 9 x 6 in., cloth. 16.-r. m.

The fourteenth volume of this year book reviews the periodical articles on electrical engineering which appeared during the year 1925. The text is arranged in the fashion common to such reference books, that of a classified connected account summarizing each article very briefly and giving a reference to the original publication. This makes it possible for the reader to review very quickly the progress of the year in any line. The various sections are the work of different specialists. Over two hundred magazines have been examined. Author and subject indexes are included.

MECHANISCHE SCHWINGUNGEN UND IHRE MESSUNG.

By J. Geiger. Berlin, Julius Springer, 1927. 305 pp., illus., diags., 9 x 6 in., cloth. 24.-r. m.

This treatise on vibration is addressed to the needs of the engineer rather than the physicist. The aim of the author is to avoid abstruse mathematics and to emphasize the methods of measurement and practical investigation.

After a general discussion of the theory of vibration, the more important measuring instruments are described and their uses explained. The methods of investigation and the interpretation of the results are discussed. A chapter is devoted to remedies for destructive vibrations in machinery and structures. The final chapter describes some useful applications of vibration.

NEW CONCEPTIONS IN COLLOIDAL CHEMISTRY.

By Herbert Freundlich. N. Y., E. P. Dutton & Co., [1927]. 147 pp., diags., tables 7 x 5 in., cloth. \$2.00.

The recent development of our conceptions of absorption, the electric potential of surfaces, the state of aggregation, and the shape of colloidal particles are set forth in this small book, which contains the subject-matter of the lectures delivered by its author in this country during the summer of 1925.

OLD CHEMISTRIES.

By Edgar F. Smith. N. Y., McGraw-Hill Book Co., 1927. 89 pp., ports., fac-sims., 10 x 7 in., cloth. \$2.50.

Dr. Smith adds another to his growing list of books upon early chemistry in America and its practitioners. This time he calls attention to the books from which the founders of American chemistry obtained their training. In a series of pleasant essays he describes a number of the popular textbooks of the latter half of the eighteenth and the early nineteenth century and tells something about their authors. The book contains many portraits.

PRACTICAL TELEPHONE HANDBOOK.

By Joseph Poole. 7th edition. N. Y., Isaac Pitman & Sons, 1927. 870 pp., illus., diags., 7 x 5 in., cloth. \$5.50.

The book gives a good account of the practise of the British Post Office in telephone engineering, with as much detail as can be compressed into a book of moderate size. Intended primarily for employees of the service mentioned, it naturally emphasizes the methods and apparatus used in Great Britain and will appeal to American readers chiefly as a convenient description of practise abroad.

The author has revised this edition carefully and has expanded and rewritten the text wherever necessary. In this he has been assisted by several specialists.

REPAIR SHOP DIAGRAMS AND CONNECTING TABLES FOR INDUCTION MOTORS.

By Daniel H. Braymer and A. C. Roe. N. Y., McGraw-Hill Book Co., 1927. 232 pp., 9 x 6 in., cloth. \$2.50.

These diagrams and tables are not intended for designers but for winders and repairmen who are called upon to lay out and connect new windings or to reconnect existing windings for voltage and other operating changes. To these workers the book furnishes practical step by step instructions covering different types of winding for induction motors, two-phase and three-phase, with from two to twenty-four poles. The diagrams are practical shop drawings, drawn upon a uniform basis and have been proven usable by the average winder, through several years of use.

ROMANCE OF CHEMISTRY.

By William Foster. N. Y., Century Co., 1927. 468 pp., illus., 9 x 6 in., cloth. \$3.00.

Professor Foster has attempted the difficult task of presenting the rudiments of chemistry to laymen in ordinary everyday language. In this he has succeeded admirably. The book presents the subject with more system than most books intended for the general reader, but by a clear, direct style and by emphasizing topics of general interest and importance, and by a due inclusion of human interest, the author has been able to make the book very readable and to give a good picture of the part played in modern life by the chemist.

SCHALTANLAGEN IN ELEKTRISCHEN BETRIEBEN, bd. 2.

By F. Niethammer. 2d. edition. Ber. u. Lpz., Walter de Gruyter & Co., 1927. 97 pp., illus., 6 x 4 in., cloth. 1,50 r. m.

Describes briefly the switchgear used for handling large currents, especially that used in European power plants and factories. Truck type switches, automatic control, substations, and open-air stations are discussed. There is a chapter on protective devices.

SHORT HISTORY OF PHYSICS.

By H. Buckley. Lond., Methuen & Co., 1927. 263 pp., 8 x 5 in., cloth. 7s 6d.

The object of the author "has been to present the theories of modern physics as illustrative of scientific thought and as essentially developments from the successes and failures of earlier investigators." He traces the development of physical science

from its earliest origins to the present day and has succeeded in covering the field within a comparatively small volume by careful compression. A useful feature is the presentation of the views of many masters of the science by quotations from their own writings.

TECHNICAL METHODS OF ANALYSIS AS EMPLOYED IN THE LABORATORIES OF ARTHUR D. LITTLE, INC., Cambridge, Mass.

Edited by Roger Castle Griffin. 2d edition. N. Y., McGraw-Hill Book Co., 1927. (International chemical series). 936 pp., illus., tables, 8 x 6 in., cloth. \$7.50.

A collection of analytical chemical methods that have been adopted as standard procedure by a large commercial laboratory. The methods cover a wide field and include most of the determinations frequently called for. The directions are clear and sufficiently detailed for any chemist with ordinary experience.

This edition has been carefully revised, the analytical tables have been recalculated and various additions have been made, including a new chapter on water, sewage and soils.

TELEGRAPHY, TELEPHONY AND WIRELESS.

By J. Poole. N. Y., Isaac Pitman & Sons, [1927]. (Common commodities & Industries series). 120 pp., illus., 7 x 5 in., cloth. \$1.00.

A good short general introduction to the industries dealing with the electrical transmission of intelligence, intended for readers with no special knowledge of electricity.

TREATISE ON LIGHT.

By R. A. Houstoun. 5th edition. N. Y., Longmans, Green & Co., 1927. 489 pp., illus., diags., col. plates, 9 x 6 in., cloth. \$4.20.

Dr. Houstoun has written a modern account, covering the whole subject, which is distinguished by its excellent balance, systematic treatment and clarity of style. The book is intended for students with some knowledge of physics and is an excellent beginning to more advanced study of light. This edition is but little changed from the fourth.

DIE TROCKENTECHNIK.

By M. Hirsch. Berlin, Julius Springer, 1927. 366 pp., illus., diags., plates in pocket, 9 x 6 in., cloth. 31,80 r. m.

This new addition to the literature upon drying is of especial value for its thorough discussion of the scientific principles involved and for the numerical data that it provides the designer of drying processes.

The book is divided into two sections. In the first the author discusses the general physical principles of artificial drying, the heat balance of evaporation and of drying, the efficiency of drying, the graphic presentation of the condition of damp gases and materials, interchange between damp gases and materials, data for the design of processes, the design of air-drying processes, the design of drying processes by heat transfer through heated surfaces, and the calculation of the energy consumed. The second section discusses practise. The various methods are discussed, the machinery is described, and the use of the methods for drying many materials is explained.

UNDERGROUND SYSTEMS FOR ELECTRIC LIGHT AND POWER.

By T. C. Ruhling. N. Y., McGraw-Hill Book Co., 1927. 346 pp., illus., diags., tables, 9 x 6 in., cloth. \$4.00.

A detailed description of practical methods for constructing underground conduits and installing underground transmission and distribution systems. The book is intended for young engineers and for foremen of construction and is based upon the experience of the author. Many practical "wrinkles" are shown and valuable cost data are given.

WIRELESS PICTURES AND TELEVISION.

By T. Thorne Baker. N. Y., D. Van Nostrand Co., 1927. 188 pp., illus., diags., 8 x 5 in., cloth. \$2.50.

Gives a concise account of efforts toward the transmission of pictures to a distance. Describes the work of various investigators, the apparatus used and the results attained. Most of the book is devoted to transmission over wire circuits, but there is a chapter on wireless transmission. Television is treated very briefly.

Engineering Societies Employment Service

Under joint management of the national societies of Civil, Mining, Mechanical and Electrical Engineers cooperating with the Western Society of Engineers. The service is available only to their membership, and is maintained as a cooperative bureau by contributions from the societies and their individual members who are directly benefited.

Offices:—33 West 39th St., New York, N. Y.,—W. V. Brown, Manager.
53 West Jackson Bl'v'de., Room 1736, Chicago, Ill., A. K. Krauser, Manager.
57 Post St., San Francisco, Calif., N. D. Cook, Manager.

MEN AVAILABLE.—Brief announcements will be published without charge but will not be repeated except upon requests received after an interval of one month. Names and records will remain in the active files of the bureau for a period of three months and are renewable upon request. Notices for this Department should be addressed to **EMPLOYMENT SERVICE, 33 West 39th Street, New York City**, and should be received prior to the 15th day of the month.

OPPORTUNITIES.—A Bulletin of engineering positions available is published weekly and is available to members of the Societies concerned at a subscription rate of \$3 per quarter, or \$10 per annum, payable in advance. Positions not filled promptly as a result of publication in the Bulletin may be announced herein, as formerly.

VOLUNTARY CONTRIBUTIONS.—Members obtaining positions through the medium of this service are invited to cooperate with the Societies in the financing of the work by nominal contributions made within thirty days after placement, on the basis of \$10 for all positions paying a salary of \$2000 or less per annum; \$10 plus one per cent of all amounts in excess of \$2000 per annum; temporary positions (of one month or less) three per cent of total salary received. The income contributed by the members, together with the finances appropriated by the four societies named above, will it is hoped, be sufficient not only to maintain, but to increase and extend the service.

REPLIES TO ANNOUNCEMENTS.—Replies to announcements published herein or in the Bulletin, should be addressed to the key number indicated in each case, with a two cent stamp attached for reforwarding, and forwarded to the Employment Service as above. Replies received by the bureau after the positions to which they refer have been filled will not be forwarded.

POSITIONS OPEN

ELECTRICAL ENGINEER, thoroughly experienced in motor and motor-control design, preferably gained in elevator industry. Must be thoroughly familiar with slow-speed, a-c. motors and controllers, and also with variable voltage control. Records must show own successful designs on this type of equipment. Apply by letter. Location: Ohio. X-2255-C.

MEN AVAILABLE

ELECTRICAL ENGINEERING GRADUATE, seven years out of college, with experience in testing (G. E.), switchboards, substation design and distribution design, desires position. B-8622.

INSTRUCTOR (part time), 30, married, electrical engineer, graduate of Electrical Engineering course at Cooper Union, ten years' experience in research laboratories of large electrical concern, desires position as instructor of mathematics or sciences in the evening. Location preferred, New York City. C-1780.

DISTRIBUTION ENGINEER, 27, with four years' experience in design and construction of distribution systems and transmission lines, two years General Electric test and transformer design. American, married, speaks Spanish. Now employed. Location immaterial. B-9780.

ENGINEER, 27, single, well M. I. T. trained in E. E., also in mechanical and civil engineering. Three years' experience previous to graduation, and two years' experience with manufacturing concern and public utility upon graduation. Business experience. Capable to produce good results. Wishes position with manufacturing or contracting concern. Available on short notice. Location immaterial. C-696.

ELECTRICAL ENGINEER, honor graduate of high standing university, married, two years General Electric test, several years designing a-c. and d-c. motors and generators, some experience substation design, desires position as designer or maintenance engineer. Location, Central or Eastern States, or with American concern in Canada. Available on short notice. C-3080.

RURAL SERVICE ENGINEER, experienced in distribution engineering and management, as well as in rural extension work. Has been unusually successful in building up good will and revenue on rural lines. Capable of developing rural service policy and directing operations. Age 36, married. For past four years with large public utility company in responsible positions. C-3079.

GRADUATE ELECTRICAL ENGINEER, 31, married, twenty-six months commissioned officer U. S. Army, eighteen months student course Westinghouse, one year in power sales department, and four years with large carbon brush manufacturing company in charge of testing and service. Experienced in application and care of brushes on electrical machines. Location preferred, South America. C-3085.

RADIO ENGINEER, age 28, single, desires permanent position with some reputable company. Ten years' experience all branches radio engineering, design and repair work. Foreign service preferred. Will appreciate correspondence. Available August. C-3089.

ELECTRICAL ENGINEER, 25, three years industrial, five years local distribution, some business. Can take charge of small power plant and its distribution systems, or fill responsible position with large power or industrial company. Location immaterial. C-3101.

SUPERINTENDENT, with long experience in the construction and operation of steam and hydroelectric properties, now available. Will accept either construction or operation. B-412.

CHIEF ELECTRICIAN, OR ASSISTANT CHIEF, for industrial plants, public utilities or consulting engineers, technical graduate, 39. Also graduate two year G. E. Company test course. Over ten years' practical electrical experience. Expert a-c. and d-c. trouble and maintenance man, mostly G. E. equipment, some Jeffrey, and some Westinghouse. Location, East or Southeast. Available August or September. B-242.

LICENSED PROFESSIONAL ENGINEER, M. I. T. education, with fourteen years' engineering and construction experience in the design of power station, substations, power and lighting of industrial buildings, appraisal of electric properties, desires a new connection with an engineering organization doing big things, preferably in New York City. B-5393.

COMPETENT, EXPERIENCED ENGINEER, available for position as executive, manager, chief or assistant. Several years with public utilities, hydroelectric and steam; design, superintendence of construction with supervision and control of staff; electrical, mechanical, structural steel, electrochemical, refrigeration, research, statistical and technical investigations; several years manufacturing, estimating, sales promotion. Accustomed position responsibility. B-9279.

ELECTRICAL ENGINEER, 38, married, eighteen years' broad experience testing, design construction and supervision with well known corporations, one year teaching. Desires permanent position with responsible company on construction or operation. Available on short notice. Location, United States, South preferred. B-1473.

ELECTRICAL SALES ENGINEER, 38, with executive ability and real personality, Yale graduate, married, desires an engineering sales position. Has had twelve years' experience in public utility work, power sales and engineering, also three years' experience in operation of power plants, electrical and mechanical construction, and maintenance work in industrial plants. Now employed. C-3093.

GRADUATE ELECTRICAL ENGINEER, 31, married, five years' varied experience in telephone plant, desires position along engineering lines. Philadelphia District preferred. C-3129.

ELECTRICAL ENGINEER, 29, assistant chief engineer of large concern, desires responsible position with engineering or manufacturing concern in New York City or vicinity. Available on three weeks' notice. B-7270.

ASSISTANT TO EXECUTIVE, 28, single, experienced and trained in engineering, financial, selling and general business work. College graduate, engineer. Desires a new connection in which his ability and energy may be fully utilized as assistant to executive or to fill a gap in an active organization. C-2973.

GRADUATE ELECTRICAL ENGINEER, eleven years' experience in industrial plants, designing, installations, maintenance of substations and electrical equipment, power generation, efficient distribution, inspection, reports, estimates and power factor improvements. Now in charge of meter and testing departments including heat control devices. Well experienced in design, installation and maintenance of electric heating, annealing and melting. B-1576.

ELECTRICAL ENGINEER, Cornell graduate '24, desires employment along investigative lines. Two and three-quarter years' experience in engineering department of a large manufacturing firm. Especially interested in transportation work. Married. At present employed. Available on one month's notice. C-3162.

ELECTRICAL ENGINEER, 34, married, three years testing department, three years construction and commercial departments, three years drafting, calculations of transmission line.

Very good knowledge of French. Graduate of a well known European college. C-082.

ELECTRICAL-MECHANICAL ENGINEER, technical graduate, licensed professional engineer in two states, fifteen years' experience in responsible positions with leading manufacturing and consulting engineering firms in varied industries; G. E. test, engineering, erection and complaint. Expert on complete power and industrial plants, transmission, etc. preliminary surveys, design, construction and operation. B-5675.

ASSISTANT IN VALUATION OR ESTIMATE WORK, 25, married, two years in construction work, one year in public utility valuation, and one year in electric railway motor and control manufacture on the Westinghouse graduate student course. Prefers railway work. C-3082.

ELECTRICAL ENGINEER, 35, married, technical graduate, G. E. test, five years' engineering experience with large manufacturing

company, including underground high voltage cable, general switchboard, automatic substation and railway equipment experience. A position reasonable permanent desired. Location, East. C-2565.

ELECTRICAL ENGINEER, testing or electrical engineering assistant, 26, single, nine months inspecting and testing fractional horse power motors, one year electrical design motor and generators from 3 h. p. up, one year electric meter building and repair, one year and nine months tool designer. Location preferred, New York City or its suburbs. C-2700.

MERCHANDISING OR SALES PROMOTION EXECUTIVE, 41, married, nine years central station commercial and merchandising experience, including department management, four years manager large industrial purchasing department, four years general manager gas and electric jobbing and retail appliance stores. Engineering university graduate. B-6619.

SALES ENGINEER, 34, married, electrical engineer, seven years sales specialist, excellent knowledge of use and costs of pole line construction material, also four years' electrical experience in connection with industrial plants and central stations. Wide acquaintance with central station field. Knowledge of purchasing. Location, New York or Eastern territory. B-1106.

ELECTRICAL ENGINEER, 38, single, fifteen years' experience, engineering investigations, construction, operation, maintenance, etc., general electrical field, outstanding industrial and consulting firms, industrial improvements, power plants, etc. Technical training. Not averse responsibility with actual work. Location immaterial. B-7034.

MANUFACTURERS REPRESENTATIVE, with office in Philadelphia, will represent manufacturers of engineering machinery and supplies, part or full time, salary or commission, or both. Technical graduate, large experience, excellent background. B-4658.

MEMBERSHIP — Applications, Elections, Transfers, Etc.

ASSOCIATES ELECTED JUNE 23, 1927

- ABBOTT, LAWRENCE W., Electrical Service, Victor X-Ray Co., 2012 W. Jackson Blvd., Chicago, Ill.
- ABRAMS, HAROLD MARTIN, Substation Operator & Survey Man, Cleveland Electric Illuminating Co., 75 Public Square, Cleveland; res., Cleveland Heights, Ohio.
- AOCARION, ANDRE, Testing Dept., General Electric Co., Schenectady, N. Y.
- ALTFATHER, CONRAD T., Engineer, Supply Engineering Dept., Westinghouse Elec. & Mfg. Co., East Pittsburgh, Pa.
- ANDERSEN, FRANK N., Division Construction Superintendent, Consumers Power Co., Saginaw, Mich.
- ANDERSON, HAROLD R., Transmission Line Construction Dept., Great Western Power Co., Oakland & San Francisco; res., Maryville, Calif.
- ANDERSON, WILLIAM KIRBY, Draftsman, Commonwealth Edison Co., 72 W. Adams St., Chicago, Ill.
- ANDREWS, CLARENCE A., Salesman, Westinghouse Elec. & Mfg. Co., Crocker 1st. National Bank Bldg., San Francisco, Calif.
- ANDREWS, JAMES MARION, Test Dept., Westinghouse Elec. & Mfg. Co., Sharon, Pa.
- ANDREWS, JOHN, JR., District Sales Manager, Westinghouse Elec. & Mfg. Co., 1535 Sixth St., Detroit, Mich.
- ASHTON, RANDOLPH, Service Engineer, American Brown Boveri Electric Corporation, Camden, N. J.; res., Swarthmore, Pa.
- ASTRIDGE, V. C., Superintendent, Guma Water Works, Mashobra, Simla, India.
- ATHANASON, NICHOLAS ARTHUR, Electrical Engineering Dept., Commonwealth Power Corporation, Jackson, Mich.
- AUTENRIETH, HARRY, Substation Operator, Commonwealth Edison Co., 7675 S. Chicago Ave., Chicago, Ill.
- BAKER, HARRY W., Manager, Electric Machinery Repair Dept., Denton Engineering & Construction Co., 512 Southwest Blvd., Kansas City, Mo.
- BARABAS, JOHN JOSEPH, Electrician Apprentice, Pennsylvania Railroad, Trenton, N. J.
- BARNEY, HENRY PARD, JR., Plant Wire Chief, Chesapeake & Potomac Telephone Co. of Va., 319 Commerce St., S. W., Roanoke, Va.
- BATES, FRANK M., Consulting Electrical Engineer, Terminal Annex Bldg., Philadelphia, Pa.
- BEAL, JOHN A., Maintenance Foreman, Union Gas & Electric Co., 667 West Front St., Cincinnati, Ohio.
- BECHERER, MAX O., Draftsman, Motor Drafting Dept., Westinghouse Elec. & Mfg. Co., East Pittsburgh, Pa.
- BECK, FRED JOHN, Research Engineer, Bell Telephone Laboratories, Inc., 463 West St., New York; res., Brooklyn, N. Y.
- BECKWITH, JOSEPH B., Electrician, Louisville Gas & Electric Co., 311 W. Chestnut St., Louisville, Ky.
- BEHL, JOHN H., Electrical Engineer, S. & F. Dept., Reading Co., 2821 Richmond St., Philadelphia, Pa.
- BELL, LESLIE C., Chief Engineer, Illinois Power & Light Corporation, Venice; res., East St. Louis, Ill.
- BELLINGHAM, LOWELL C., Research Engineer, Irvington Varnish & Insulator Co., 10 Argyle Terrace, Irvington; res., Atlantic Highlands, N. J.
- BENNETT, ALBERT F., Checking Draftsman, Commonwealth Edison Co., 72 W. Adams St., Chicago, Ill.
- BENNETT, ROY G., Sales Engineer, General Electric Co., 84 State St., Boston, Mass.
- BEST, IRVIN W., Assistant Chief Electrician, El Paso Electric Co., Marvin Bldg., El Paso, Texas.
- *BLAKE, CLARENCE DODGE, Assistant Distribution Operator, Edison Electric Illuminating Co. of Boston, 1165 Massachusetts Ave., Boston; res., Dorchester Center, Mass.
- *BLEVINS, EDWARD, Student Engineer, Ponce Electric Co., Ponce, Porto Rico.
- BONARDEL, LESTER F., Foreman Electrician, Essex Power Station, Public Service Electric & Gas Co., Newark; res., Irvington, N. J.
- BOSS, EBEN H., Superintendent of Distribution, Kansas Electric Power Co., 700 Mass. St., Lawrence, Kans.
- BOYLE, GARRETT JOSEPH, Electrician, Glen Alden Coal Co., Nanticoke Power Plant, Scranton; res., Plains, Pa.
- BRADY, RALPH WALDO, Engineer, Commonwealth Edison Co., 2233 Throop St., Chicago, Ill.
- *BROWN, CHARLES ROBERT, Student Engineer, General Electric Co., 1 River Road, Schenectady, N. Y.
- BURKE, EDMUND F., Sales Engineer, Electrical Engineering & Mfg. Co., 604 Mercantile Library Bldg., Cincinnati, Ohio.
- BURWELL, JOHN ARMISTEAD, Engineering Dept., Bell Telephone Laboratories, Inc., 463 West St., New York, N. Y.
- CADWALLADER, WILLIAM C., Construction Dept., Standard Underground Cable Co., 17th & Pike Sts., Pittsburgh; res., Crafton, Pa.
- CALDWELL, FREDERIC CLIFFORD, Transformer Engineer, Ferranti Electric, Ltd., 26 Noble St., Toronto, Ont., Can.
- CALLIERA, ARMANDO, Testing Dept., General Electric Co., Schenectady, N. Y.
- CAMERON, HUGH J., Insulation Engineer, General Electric Co., 1325 Broadway, Fort Wayne, Ind.
- CAMPBELL, JOSEPH E., Plant Engineer, Bell Telephone Co. of Pa., 416 Seventh Ave., Pittsburgh, Pa.
- CARPENTER, LYMAN EDWARD, Chief Operator, 108th St. High-Tension Transmission Terminal, Commonwealth Edison Co., 76 W. Adams St., Chicago, Ill.
- CARROLL, ALF LINDSAY, Engineering Assistant, Brooklyn Edison Co., Pearl & Wiloughby Sts., Brooklyn, N. Y.
- CARSON, THEODORE H., Equipment Chief, Western Union Telegraph Co., South Second & Mulberry Sts., Harrisburg, Pa.
- CASPER, THOMAS J., Electrical Construction Foreman, California Portland Cement Co., Colton, Calif.
- CASSIDY, ARTHUR R., Electrical Draftsman, Union Oil Co. U. O. Bldg., 7th & Hope Sts., Lds Angeles, Calif.
- CHAMBERLIN, CHARLES W., Chief Electrician, Public Service Electric & Gas Co., Essex Power Station, Newark; res., Kearny, N. J.
- CHRISTIANSEN, HANS PETER, Assistant Engineer, Elevator Supplies Co., 1515 Willow Ave., Hoboken, N. J.
- CHURCH, RICHARD ARTHUR, Service Statistician, Puget Sound Power & Light Co., 7th & Olive Sts., Seattle, Wash.
- CLOYD, LANUS WHEAT, Transmission Tester, Southwestern Bell Telephone Co., Bell Telephone Bldg., St. Louis, Mo.
- CODE, WALTER WILMER, 1438 Madison St., Oakland, Calif.
- CONLEY, WALTER J., Sales Engineer, Brown Instrument Co., Wayne & Windrim Sts., Philadelphia, Pa.; res., Cranford, N. J.
- COUY, CONSTANTINE J., Distribution Supervisor, Duquesne Light Co., 8th Floor, Duquesne Bldg., Pittsburgh, Pa.

- CREIGHTON, HAROLD CRANDELL, Tester, New York Edison Co., 92 Vandam St., New York, N. Y.
- CURTIS, PIERSON VIVIAN, Van Rensselaer Hotel, East 11th St., New York, N. Y.
- DARRIN, LAURENCE TOWNSHEND, Consulting Electrical Engineer, 211 Otis Bldg., Philadelphia, Pa.
- DAVIES, EDWARD H., Chief Operator, Commonwealth Edison Co., 11630 Front St., Chicago; res., Homewood, Ill.
- DAVIS, DAN B., Superintendent, Electric Distribution, Counties Gas & Electric Co., Ardmore, Pa.
- *DAVIS, HOWARD LANGWORTHY, JR., Technical Assistant, Philadelphia Electric Co., 2301 Market St., Philadelphia; res., Glen Olden, Pa.
- DAVIS, RALPH HARMOUNT, Sales Representative, Westinghouse Elec. & Mfg. Co., East Pittsburgh, Pa.
- DEPPE, RAYMOND MICHAEL, Testing Engineer, Commonwealth Edison Co., 72 W. Adams St., Chicago, Ill.
- DEVIN, WAVERLY C., Electrical Engineer, Chester Valley Electric Co., Coatesville, Pa.
- DEWITT, PAUL H., Construction Engineer, Illinois Power & Light Corp., 500 Compton Bldg., St. Louis, Mo.
- DODDS, HARRY EDGAR, Engineer, Commonwealth Edison Co., 72 W. Adams St., Chicago, Ill.
- *DODDS, ROBERT BENJAMIN, JR., Graduate Student, Yale University, 10 Hillhouse Ave., New Haven, Conn.
- DOUGLAS, JOHN, Designer, Turbo-Alternators & Waterwheel Alternators, General Electric Co., Witton, Birmingham, Eng.
- DOW, CHARLES OLIVER, Electrical Draftsman, Electrical Controller & Mfg. Co., Cleveland, Ohio.
- DOWELL, JAMES CRAWFORD, Testing Dept., General Electric Co., Schenectady, N. Y.
- DUER, CARL, Chief Equipment Inspector, Western Union Telegraph Co., 605 Merchants National Bank Bldg., Omaha, Nebr.
- DUIGNAN, HARRY E., Superintendent, Underground Construction, Metropolitan Edison Co., 16 S. 5th St., Reading, Pa.
- DUMKE, WILLIAM CARL, Draftsman, Commonwealth Edison Co., 72 W. Adams St., Chicago, Ill.
- EIPPER, WILLIAM A., Plant Manager, Eastern Area, Bell Telephone Co. of Pa., 1631 Arch St., Philadelphia, Pa.
- ELG, ERICH G., Electrical Engineer, Copperweld Steel Co., 129 S. Jefferson St., Chicago, Ill.
- ELGIN, EZRA K., Substation Operator, Commonwealth Edison Co., 64 W. Randolph St., Chicago, Ill.
- ELLISON, MURL J., Engineer, Canadian & General Finance Co., 357 Bay St., Toronto 2, Ont., Can.
- ELLMORE, W. AUSTIN, Instructor in Physics, Northwestern University, Evanston, Ill.; Designing Engineer, Scanlon Electric Mfg. Co., 1113-1119 N. Franklin St., Chicago, Ill.
- ENCKE, LUDWIG, Assistant Engineer, Electrical Engineering Dept., N. Y., N. H. & H. R. R. Co., New Haven, Conn.
- EVANS, HAROLD W., Chief Clerk, Brooklyn Edison Co., 14 Rockwell Place, Brooklyn, N. Y.
- *EVANS, JAMES CARMICHAEL, Teacher, Washington High School, 6th Ave. & 12th St., Miami, Fla.
- EVANS, WALTER MONROE, Load Dispatcher, Chicago, Milwaukee & St. Paul Railway Co., Coast Division, 102 S. 25th St., Tacoma, Wash.
- FAIRBANKS, STEWART JAY, Electrical Engineer, Waterloo, Cedar Falls & Northern Railway Co., Waterloo, Iowa.
- FAY, CLARENCE EUGENE, Construction Engineer, Bell Telephone Co. of Pa., 416 Seventh Ave., Pittsburgh, Pa.
- FEIN, MORRIS ELLISON, Assistant Engineer, New York Edison Co., 130 E. 15th St., New York; res., Brooklyn, N. Y.
- FELLER, EUGENE W., Controlboard Operator, Penn. Water & Power Co., Holtwood, Pa.
- FIFE, JAMES LYALL, Substation Operator, Commonwealth Edison Co., 72 W. Adams St., Chicago, Ill.
- *FISCHER, GEORGE HOWARD, Line Extension Estimator, Commonwealth Edison Co., 72 W. Adams St., Chicago, Ill.
- FITZSIMMONS, LAURENCE G., Division Superintendent of Plant, Pacific Tel. & Tel. Co., Room 518, 140 New Montgomery St., San Francisco, Calif.
- FOWLER, FREDERICK REMINGTON, Foreman Electrician, Big Creek Construction, Southern California Edison Co., Big Creek, Calif.
- *FOWLER, WILLIAM JOHN, Power Plant Dept., City of Jacksonville, Engg. Bldg., Jacksonville, Fla.
- FRICK, DUDLEY H., Manager, Western Electric Co., Detroit Distributing House, 1047 E. Kirby Ave., Detroit, Mich.
- FUNG, JOHN HAMILTON, Student, Electrical Engineering Dept., Pratt Institute, Brooklyn, N. Y.
- GABREE, JOSEPH VICTOR, Investigating Engineer, Western Electric Co., Inc., Hawthorne Sta., Chicago, Ill.
- GALPHIN, CLINTON BROWN, Engineer, with J. E. Strrine & Co., Greenville, S. C.
- GARRETT, PORTER A., Testing Engineer, Commonwealth Edison Co., 72 W. Adams St., Chicago, Ill.
- GARRISON, FREDERIC GARRETT, District Commercial Supt., Compania Telefonica Nacional de Espana, Iñlbaio, Spain.
- GEARHART, SHELDON R., Assistant Electrical Engineer, Pennsylvania Power & Light Co., 135 N. Washington St., Wilkes-Barre; res., Kingston, Pa.
- GEARY, ELMER A., Electrical Draftsman, Wm. Cramp & Sons S. & E. B. Co., Richmond & Norris Sts., Philadelphia, Pa.
- GELL, CHARLES FREDERIC, Substation Operator, Commonwealth Edison Co., 7675 S. Chicago Ave., Chicago, Ill.
- GERDANO, FRANK G., Assistant Switchboard Operator, Commonwealth Edison Co., 1812 W. 22nd St., Chicago, Ill.
- GRISSINGER, GEORGE GORDON, Electrical Engineer, Westinghouse Elec. & Mfg. Co., East Pittsburgh; res., Wilkinsburg, Pa.
- GROSS, CHARLES MILTON, Assistant Engineer, Inside Plant Division, Commonwealth Edison Co., 72 W. Adams St., Chicago, Ill.
- GUSTAFSON, HARRY G. H., Draftsman, Commonwealth Edison Co., Edison Bldg., 72 W. Adams St., Chicago, Ill.
- HALLIGAN, BURDETTE JOSEPH, Assistant Engineer in charge of Substation Maintenance, New York Telephone Co., 140 West St., New York, N. Y.
- HALVORSEN, CARL LUDVIG STABELL, Assistant to Test Engineer, Otis Elevator Co., Yonkers, N. Y.
- HANNA, J. N., Electrical Repair Work., Robt. Skeen Electric Works, 9th & Everett Sts., Portland, Ore.
- HARRINGTON, FRED C., Engineer, Commonwealth Edison Co., 72 W. Adams St., Chicago, Ill.
- HARRIS, S. GRANT, JR., Salesman, Page & Hill Co., 814 Plymouth Bldg., Minneapolis, Minn.
- HASKELL, EBEN BROWN, Student Engineer, Testing Dept., General Electric Co., Schenectady, N. Y.
- HATHAWAY, CLARENCE B., Electrical Engineer, Westinghouse Elec. & Mfg. Co., East Pittsburgh; res., Wilkinsburg, Pa.
- HENNY, IRWIN B., Superintendent of Substations, Edison Electric Co., Lancaster, Pa.
- HILDEBRANDT, THEODORE FREDERICK, Equipment Engineer, New York Telephone Co., 81 Willoughby St., Brooklyn; res., Richmond Hill, N. Y.
- HILL, GEORGE H., Electrician, Westinghouse Elec. & Mfg. Co., East Springfield; res., Willimansett, Mass.
- HOLLOWAY, CHESTER FRANKLIN, Substation Operator, Commonwealth Edison Co., 72 W. Adams St., Chicago, Ill.
- HOLLYDAY, HENRY ROBINS, Structural Detailer, Philadelphia Electric Co., 23rd & Market Sts., Philadelphia, Pa.
- HOPKINS, IRWIN B., Electrical Designer, Philadelphia Electric Co., 10th & Chesnut Sts., Philadelphia, Pa.
- HORIBE, SHIGETSUGU, Student Engineer, International General Electric Co., Schenectady, N. Y.
- HUDDLESTON, JOSEPH LLOYD, Load Dispatcher, Ohio Power Co., Newcomerstown, Ohio.
- HUDSON, HERBERT HAROLD, Salesman, Electric Storage Battery Co., 25 W. 43rd St., New York; res., Brooklyn, N. Y.
- HUDSON, HORACE LYLE, Resident Engineer, Phosphate Rock Mines, American Agricultural Chemical Co., Pierce, Polk Co., Fla.
- HUGHSON, CHARLES OLIVER, Wire Chief, Southern Bell Tel. & Tel. Co., Dunnellon, Fla.
- HUMMEL, LORIS R., Junior Engineer, Operating Dept., Duquesne Light Co., Philadelphia Bldg., 436 Sixth Ave., Pittsburgh, Pa.
- HUMPHREY, HARTLEY CRANSTON, Transmission Engineer, Vitaphone Corporation, 250 W. 57th St., New York, N. Y.; res., Nutley, N. J.
- HYDE, MERRITT ANDERSON, JR., General Engineer, Westinghouse Elec. & Mfg. Co., East Pittsburgh; res., Wilkinsburg, Pa.
- JABOOLIAN, EDWARD, Inspector, Gibbs & Hill, Inc., Field Office, Brooklyn, res., New York, N. Y.
- JACKSON, WAYNE CHESTER, 336 15th Ave., San Francisco, Calif.
- JAEGLE, WILLIAM HENRY, In charge of Electric Underground Dept., Louisville Gas & Electric Co., 731 W. Ormsby St., Louisville, Ky.
- JANSSON, ERIC OSKAR, Tester, Holtzer-Cabot Electric Co., 125 Amory St., Roxbury; res., Jamaica Plain, Mass.
- *JOHN, STUART WEARNE, Engineer, Scofield Engineering Co., Commercial Trust Bldg., Philadelphia; res., St. Davids, Pa.
- JOHNSON, CARL L., Electrical Engineer, Transformer Engineering Dept., General Electric Co., Pittsfield, Mass.
- JOHNSON, JOSEPH LOCKMAN, Substation Operator, Capital Traction Co., Substation No. 1, Rear 2107 14th St., N. W., Washington, D. C.
- JONES, BENJAMIN D., JR., Assistant Watch Electrician, Commonwealth Edison Co., 3501 S. Crawford Ave., Chicago, Ill.
- KATO, MORIO, Kogakushi Director and Chief Engineer, Hanshin Electric Railway Co., Amagasaki near Osaka, Japan.
- *KAUFMANN, FRANKLIN W., General Engineer, Westinghouse Elec. & Mfg. Co., East Pittsburgh, Pa.
- KEHOE, JOHN JOSEPH, JR., Wire and Cable Engineer, General Electric Co., Schenectady, N. Y.
- KEILLEN, SAUL M., Electrical Engineer, International Business Machines Co., Endicott; res., Binghamton, N. Y.
- KELLIHER, THOMAS HARRY, Assistant Test Engineer, Okonite-Callender Cable Co., 350 21st Ave., Paterson, N. J.
- KELLOGG, WILLIAM MCKINLEY, Instructor of Electrical Engineering, University of Arizona, Tucson, Ariz.

- KENNEDY, ARON BALD ROBERT, Electrical Tester, Westinghouse Elec. & Mfg. Co., East Pittsburgh; res., Wilkensburg, Pa.
- KENNEY, JOSEPH LYTLE, Chief Tester, Switchboard Test, Westinghouse Elec. & Mfg. Co., East Pittsburgh, Pa.
- KENT, VERNIE, Superintendent of Distribution, City Light Dept., Room 402, City Hall, Tacoma, Wash.
- KEYS, PAUL REID, Substation Operator, Commonwealth Edison Co., 7102 S. University Ave., Chicago, Ill.
- KILKENNY, JOHN EARL, Chief Electrician, Inman Poulsen Lumber Co., Ft. E. Caruthers St., Portland, Ore.
- KING, HARRIE JOHN, Electrical & Wireless Engineer; Partner, King & Strut, 17 Henslowe Road, East Dulwich, London, S. E. 22, Eng.
- KINNEY, EDWARD EVERETT, Instructor, Electrical Engineering Dept., Michigan State College, East Lansing, Mich.
- KINNEY, LOWELL K., Cable Engineer, Commonwealth Edison Co., 72 W. Adams St., Chicago, Ill.
- KOLODZIEJ, PAUL J., Distribution Engineer, Public Service Electric Corp., 71 Murray St., Elizabeth, N. J.
- KRADEL, FRED L., Assistant Engineer, West Penn Power Co., 14 Wood St., Pittsburgh; res., Millvale, Pa.
- KRAMER, LESLIE WILSON, Teacher, Electrical Subjects, Board of Education, B St. & Allegheny Ave., Philadelphia, Pa.
- KRAUS, RUDOLF, Squad Leader and Checker, Motor Drawing, Westinghouse Elec. & Mfg. Co., East Pittsburgh, Pa.
- KUBIK, EUGENE CLARENCE, Electrical Distribution Dept., Union Electric Co., 315 N. 12th Blvd., St. Louis, Mo.
- KUCKES, HERMAN F., Electrical Engineer, New York Central Railroad, 466 Lexington Ave., New York, N. Y.
- KUMMER, MARTIN THEODORE, First Class Electrician, Public Service Electric & Gas Co., Essex Power Station, Point-No-Point, Newark, N. J.
- LAMB, MARION DILLON, Draftsman, Commonwealth Edison Co., 72 W. Adams St., Chicago, Ill.
- LAMBERGER, EDWARD H., Engineer, General Engineering Dept., Westinghouse Elec. & Mfg. Co., East Pittsburgh, Pa.
- LARSON, CHARLES JOSEPH, Substation Operator, Commonwealth Edison Co., 72 W. Adams St., Chicago, Ill.
- LATHROP, FRANK, Engineering Dept., Southeastern Underwriters Association, Trust Co. of Georgia Bldg., Atlanta, Ga.
- LAZAN, (MISS) DEANY C., Assistant Branch Manager, Simplex Wire & Cable Co., 2019 Union Trust Bldg., Cleveland, Ohio.
- LEACH, EDMOND F., Supt., Ponce Electric Co., Ponce, Porto Rico.
- LEE, ROBERT E., Sales Agent, General Electric Co., Tacoma, Wash.
- LESLIE, JOHN O., Chief Load Dispatcher, Metropolitan Edison Co., 141 S. Seventh St., Reading Pa.
- LEVAN, WALTER A., Superintendent of Distribution, Interurban Lines, New York State Railways, 1372 E. Main St., Rochester, N. Y.
- LEVY, ADOLPH, Substation Operator, Commonwealth Edison Co., 72 W. Adams St., Chicago, Ill.
- LIFE, HAROLD G., Engineering Assistant, Western Union Telegraph Co., 195 Broadway, New York; res., Brooklyn, N. Y.
- LIMPERY, WILLIAM JOHN, 55 Hanson Place, Brooklyn, N. Y.
- LONG, CHARLES ERNEST, Hydro-Electric Power Plant Operator, Puget Sound Power & Light Co., Wenatchee; res., Leavenworth, Wash.
- LORENZ, A. M., Assistant Superintendent, Public Lighting Commission, 138 E. Atwater St., Detroit, Mich.
- LYNCH, EDWARD D., Salesman, Westinghouse Elec. & Mfg. Co., 152 Temple St., New Haven, Conn.
- LYNES, FREDERICK O., Manager, Arizona Edison Co., Yuma, Ariz.
- MACKAY, REGINALD WILLIAM JOHN, Engineer, General Engg. Dept., Westinghouse Elec. & Mfg. Co., East Pittsburgh; res., Wilkensburg, Pa.
- MAG, ANTHONY, Radio Fieldman, Duquesne Light Co., 800 Duquesne Bldg., Pittsburgh; res., Wilkensburg, Pa.
- MARESH, EDWARD J., Checking Draftsman, Commonwealth Edison Co., 72 W. Adams St., Chicago, Ill.
- MARSH, HARRY H., Jr., Superintendent, Maintenance Substation Dept., Duquesne Light Co., 435 Sixth Ave., Pittsburgh, Pa.
- MATZNER, THEOPHILE CARL, Junior Engineer, Commonwealth Edison Co., 2745 Lincoln Ave., Chicago, Ill.
- MAYO, CECIL ROY, Field Engineer, Commonwealth Edison Co., 72 W. Adams St., Chicago, Ill.
- MAZANEC, WILLIAM, Junior Distribution Engineer, Union Electric Light & Power Co., 315 N. 12th St., St. Louis, Mo.
- McELROY, CLAUD E., Draftsman, Commonwealth Edison Co., 72 W. Adams St., Chicago, Ill.
- McGINNIS, ARTHUR, Teacher of Electrical Subjects, Board of Education, City of Los Angeles; San Pedro High School, 1221 Gaffey St., San Pedro, Calif.
- McGUIRE, WILLIAM HENRY, Electrical Superintendent, Retsof Mining Co., Retsof, N. Y.
- McILWAIN, HERBERT A., Division Plant Superintendent, Delaware & Atlantic Tel. & Tel. Co., 1631 Arch St., Philadelphia, Pa.
- McKINLEY, VICTOR LAWRENCE, Shop Foreman, Electric Meters, Louisville Gas & Electric Co., 731 W. Ormsby St., Louisville, Ky.
- McLOUGHLIN, JAMES, Detailer, Underground Dept., Philadelphia Electric Co., 2301 Market St., Philadelphia, Pa.
- McNITT, DONALD P., Lighting Division, Department of Public Utilities, City of St. Louis, Room 416, City Hall, St. Louis, Mo.
- *MELTON, BENJAMIN STARR, Student Engineer, Gulf States Utilities Co., Port Arthur, Texas.
- MENZIES, JAMES AITKEN BROWN, Assistant Erection Engineer, American Brown Boveri Corporation, Camden, N. J.
- MERRILL, STANLEY O., Switchboard Operator, Commonwealth Edison Co., 3501 S. Crawford Ave., Chicago, Ill.
- MERRYMAN, JAMES ARTHUR, Electrical Tester, Westinghouse Elec. & Mfg. Co., East Pittsburgh; res., Turtle Creek, Pa.
- METHFESSEL, HERMAN, Reporter, *Evening World*, 63 Park Row, New York; res., Great Kills, N. Y.
- *MILNE, FREDERICK JAMES, Engineering Apprentice, Hydro-Electric Power Commission, 190 University Ave., Toronto 2, Ont., Can.
- MINOR, HERBERT HIBBIRD, Distribution Engineer, San Joaquin Light & Power Corporation, Room 702 Power Bldg., Fresno, Calif.
- MISTERSKY, FRANK R., General Superintendent, Detroit Municipal Plant, 137 E. Atwater St., Detroit, Mich.
- MOFFITT, GEORGE EDWARD, Assistant Manager, Cable Installation Dept., The Okonite-Callender Cable Co., Inc., 350 21st Ave., Paterson, N. J.
- MOONEYHAM, WILLIAM ANDERSON, Supt. of Construction, R. H. Milton Electric Co., Greensboro, N. C.
- MOORE, RAYMOND J., Engineering Assistant, Bell Telephone Co. of Penna., 1835 Arch St., Philadelphia, Pa.
- MOORE, VIRGIL G., Chief Electrician, Commission of Public Docks, Foot of Stark St., Portland, Ore.
- MORGAN, JAMES A., Superintendent, Electrical Dept., Carnegie Steel Co., Edgar Thomson Works, Braddock, Pa.
- MURPHY, EDWARD, Power Salesman, Puget Sound Power & Light Co., 7th & Olive Sts., Seattle, Wash.
- *MURRAY, CLARENCE MOFFITT, Jr., Student, University of Washington, Seattle, Wash.
- MUSTOE, ANTHONY QUINTUS, Junior Protection Engineer, Duquesne Light Co., 3rd Floor, Philadelphia Bldg., Pittsburgh, Pa.
- NASON, FRANK L., Sales Manager, Westinghouse Elec. & Mfg. Co., 10 High St., Boston, Mass.
- NEWCOMB, CLIVE DAVID, Inspector of Automatic Stations, British Columbia Electric Railway Co., Ltd., Vancouver, B. C., Can.
- NOLL, WILLIAM HENRY, Chief Operator, Commonwealth Edison Co., 10845 S. Michigan Ave., Chicago, Ill.
- O'DONNELL, JOHN JOSEPH, Partner, Heit & O'Donnell, 40 1st St., Portland, Ore.
- O'KELLY, FRANCIS C., Sales Engineer, General Electric Co., 650 17th St., Denver, Colo.
- OLMEDO, JOSE HERNANDEZ, Chief, In charge of Technical Dept., National Telegraph, Mexico City, Mex.
- OLSON, LEONARD WILLIAM, Street Lighting Engineer, Duquesne Light Co., Pittsburgh, Pa.
- OKAZAKI, NAOTARO, Electrical Engineer, Furukawa Electric Co.; Yokohama Electric Wire Works, Yokohama, Japan.
- PARSONS, JOHN SELBY, Designing Engineer, Supply Engineering Dept., Westinghouse Elec. & Mfg. Co., East Pittsburgh; res., Wilkensburg, Pa.
- PARSONS, WALTER SAMUEL, Salesman, Apex Rotorex Corporation, 24 W. 33rd St., New York, N. Y.; for mail, Naugatuck, Conn.
- PECK, VINCENT SYLVESTER, Operator, Commonwealth Edison Co., 515 S. Ashland Blvd., Chicago, Ill.
- PEDDICORD, WALTER EDWARD, Control Engineer, Westinghouse Elec. & Mfg. Co., East Pittsburgh, Pa.
- PERRONE, SALVATORE JOHN, Steam and Electric Engineer, U. S. Government, Ellis Island, New York; res., Brooklyn, N. Y.
- PETERSEN, MELVIN L., Junior Engineer, Commonwealth Edison Co., 72 W. Adams St., Chicago, Ill.
- PETERSON, P. IRVIN, Secretary of Complaint Committee, Cutler-Hammer Mfg. Co., Milwaukee, Wis.
- PETTEE, (MISS) FRANCES H., Florida Manager, Simple Wire & Cable Co., 1010 Barnett National Bank Bldg., Jacksonville, Fla.
- PICKENS, BRACE MITCHEL, General Engineering Dept., Westinghouse Elec. & Mfg. Co., East Pittsburgh, Pa.
- PILLAI, KANNUSAMY THIAGARAJA, Scholar in Hydro-Electric Engineering, Madras Government, India; for mail, 109 Acomb St., Whitworth Park, Manchester, Eng.
- PILLAY, J. M. NATARAJA, Electrical Engineer in Charge, Kastoorchand Mills, Dadar, Bombay, India.
- PRAY, RUTLEDGE P., President and Manager, Goodwin-Pray, Inc., 102 Murray St., Newark; res., Elizabeth, N. J.
- REBMANN, WALTER, Production Manager, Franklin Porcelain Co., Norristown, Pa.
- REED, RAYMON, Resident Engineer, Florida Power & Light Co., Fort Myers, Fla.

- *REGINA, FRANK CHURCHILL, Valuation Dept., Southern Pacific Railroad Co., 1729 13th St., Oakland, Calif.
- REID, CRAWFORD, Electrical Apprentice, Puget Sound Power & Light Co., 1324 Western Ave., Seattle, Wash.
- REISIG, CARL FREDERICK, Operator, Niagara Falls Power Co., Canal Basin, Niagara Falls; res., La Salle, N. Y.
- RENICK, RODERICK DHU, Engineering Dept., Illinois Power & Light Corporation, 500 Compton Bldg., St. Louis, Mo.
- RICE, IVAN S., Chief Substation Operator, Commonwealth Edison Co., 72 W. Adams St., Chicago, Ill.
- RICHTER, CHARLES WILLIAM, Laboratory Assistant, Atlantic Refining Co., 3144 Passyunk Ave., Philadelphia; res., Darby, Delaware Co., Pa.
- *RITNER, FORD CONKLIN, Assistant Engineer, Relay Dept., West Penn Power Co., 14 Wood St., Pittsburgh; res., Swissvale, Pa.
- RITTER, EDWARD ADOLF, 107-28 112th St., Richmond Hill, N. Y.
- ROBBINS, W. L., Assistant Engineer, Puget Sound Power & Light Co., Electric Bldg., Seattle, Wash.
- ROBERTSON, ANDREW WELLS, President, Philadelphia Company & Affiliated Corporation, 435 Sixth Ave., Pittsburgh, Pa.
- *ROBINSON, HENRY GERALD, Traffic Dept., Pacific Tel. & Tel. Co., Telephone Bldg., Seattle, Wash.
- ROKICKI, ALEXANDER JOHN, Assistant Superintendent, Ponce Electric Co., Ponce, Porto Rico.
- RUBENSTEIN, MAX, Sales Engineer, Standard Underground Cable Co., 1213 North American Bldg., Philadelphia, Pa.
- RUNGE, ADOLPH, Local Field Engineer, Public Service Electric & Gas Co., 323 Palisade Ave., Jersey City; res., West New York, N. J.
- SANDS, WILLIAM F., Engineering Dept., Atwater Kent Mfg. Co., 4700 Wissahickon Ave., Philadelphia; res., Norristown, Pa.
- SCHABER, RALPH FREDERICK, Student, Detroit Institute of Technology, 7414 Harper Ave., Detroit, Mich.
- SCHARFF, MAURICE ROOS, Chief Engineer, Pittsburgh Branch, Byllesby Engineering & Management Corporation, 435 Sixth Ave., Pittsburgh, Pa.
- SCHAUER, FRANK F., General Service Manager, Duquesne Light Co., 435 Sixth Ave., Pittsburgh, Pa.
- SCHMERTZ, PERCY, Electrical Engineer, Honolulu Iron Works Co., 165 Broadway, New York; res., Whitestone, N. Y.
- SCHMIDT, WILLIAM HENRY, Student Engineer, General Electric Co., Schenectady, N. Y.
- *SCHOMACKER, WILLIAM WICHMAN, Engineering Draftsman, Commonwealth Edison Co., 72 W. Adams St., Chicago, Ill.
- SCHOMAKER, GEORGE EDWARD, Sales Engineer & Director, Automatic Telephones, Ltd., Sydney, N. S. W., Aust.
- *SCHUCHERT, JOS. S., Power Sales Engineer, Duquesne Light Co., 453 Sixth Ave., Pittsburgh, Pa.
- SCOTT, WALTER FRANKLIN, Assistant Engineer, New York Telephone Co., 1060 Broad St., Newark, N. J.
- SEELEY, HAROLD THOMAS, Switchboard Engineering Dept., General Electric Co., 6901 Elmwood Ave., Philadelphia, Pa.
- SEYMOUR, CURZON, First Class Repairman, Penn. Power & Light Co., Ashley; res., Wilkes-Barre, Pa.
- SHERWOOD, HARRY BUTLER, Traffic Signal Engineer, City of Seattle, County City Bldg., Seattle, Wash.
- SHIRKEY, CHARLES O., Operator, Commonwealth Edison Co., 25th & Quarry Sts., Chicago, Ill.
- SHIROSAKI, KYUHEI, Electrical Engineer, Toho Electric Power Co., Marunouchi Kaijo Bldg., Tokio, Japan.
- SIMMONS, W. KELLY, District Manager, Missouri Power & Light Co., Clinton, Mo.
- *SMITH, MARSHALL E., Electrical Engineer, Commonwealth Power Corporation, Jackson, Mich.
- SMITH, RODNEY JAMES, Electrical Inspector, Dept. of City Transit, 1211 Chestnut St., Philadelphia, Pa.
- *SMITH, WARD BINNINGER, District Manager, S. Herbert Lanyon; Representative, Lapp Insulator Co., 210 Transportation Bldg., Los Angeles, Calif.
- SMITH, WILFRED WALTHER, Interference & Protection Engineer, New York Telephone Co., 1060 Broad St., Newark, N. J.
- SMITH, WILLIAM ALOYS, Substation Operator, Commonwealth Edison Co., 72 W. Adams St., Chicago, Ill.
- SPARKS, LOSEY D., Switchboard Operator, Commonwealth Edison Co., 72 W. Adams St., Chicago, Ill.
- STAHL, WILLIAM A., Assistant Engineer, Missouri Pacific Railroad, 1095 Railway Exchange, St. Louis, Mo.
- STAPLEY, MERRILL LAWRENCE, Substation Operating Engineer, Commonwealth Edison Co., 72 W. Adams St., Chicago, Ill.
- STEMPFLE, FREDERICK, Draftsman, Motor Drafting Dept., Westinghouse Elec. & Mfg. Co., East Pittsburgh; res., Wilkesburg, Pa.
- *STEWART, DONALD M., General Engineer, Westinghouse Elec. & Mfg. Co., East Pittsburgh, Pa.
- STIGERS, GEORGE H. W., Substation Operator, Commonwealth Edison Co., 72 W. Adams St., Chicago, Ill.
- STILWELL, WILSON H., Acting Signal Engineer, Louisville & Nashville Railroad Co., 805 Louisville & Nashville Bldg., Louisville, Ky.
- STOLTE, HENRY J., Telephone Equipment Engineer, New York Telephone Co., 360 Bridge St., Brooklyn; res., Ozone Park, N. Y.
- STRAUSS, ALFRED, High Power Laboratory, Westinghouse Elec. & Mfg. Co., East Pittsburgh; res., Wilkesburg, Pa.
- SUNDIUS, HERBERT WILLIAM, Engineer's Assistant, Southern New England Telephone Co., New Haven, Conn.
- SWEENEY, EUGENE JOSEPH, 372 Cleveland Ave. N., St. Paul, Minn.
- TAYLOR, JEROME J., Graduate Student, Johns Hopkins University, Baltimore, Md.; res., Schenectady, N. Y.
- THIES, FREDERICK ADOLPH, Engineering Assistant, Brooklyn Edison Co., 360 Pearl St., Brooklyn, N. Y.
- THOMAS, GEORGE MILLARD, Valuation Engineer & Appraiser, Coats & Burchard Co., 844 Rush St., Chicago, Ill.
- THOMPSON, WILMER SNOVER, Junior Engineer, New York & Queens Electric Light & Power Co., Flushing, N. Y.; res., Bayonne, N. J.
- THOMSON, PETER LAING, Draftsman, Commonwealth Edison Co., 72 W. Adams St., Chicago; res., River Forest, Ill.
- *THOMSON, WILLIAM HAROLD, Electrical Draughtsman, Detroit Edison Co., 2000 Second Ave., Detroit, Mich.
- TINKER, WALTER, Assistant Control Engineer, Electricity Dept., Shanghai Municipal Council, Shanghai, China.
- TOBUREN, JOHN O., Instructor, Air Core Technical School, 214 E. Champaign Ave., Rantoul, Ill.
- TOIVONEN, EGON OSKAR, Tester, Wireless Specialty Apparatus Co., Boston; res., Quincy, Mass.
- *TREVINO, JOSE LEONARDO, Inspector, Electrical & Telegraph Dept., National Railways of Mexico, Mexico, D. F., Mex.
- TRUDGIAN, WILLIAM, Salesman, Westinghouse Elec. & Mfg. Co., 1052 Gas & Elec. Bldg., Denver, Colo.
- TUPPER, FREDERICK MACDONALD, District Manager, Moloney Electric Co., Penn Athletic Club, Philadelphia, Pa.
- TURNER, FREDERICK REUBEN, c/o J. Barnes, 30 Fifth Ave., New York, N. Y.
- TWEDDELL, ALAN ELLIDGE, Engineering Assistant, Brooklyn Edison Co. Inc., 360 Pearl St., Brooklyn, N. Y.
- TWYMAN, CLYVE FULLER, Foreman, Electric Meter Dept., Louisville Gas & Electric Co., 731 W. Ormsby St., Louisville, Ky.
- TZICHEVSKY, JOSEPH A., Manager, Dept. of Electric Station Construction, U. S. S. R. Government, Glavselctro, Delovoi Dvor, Moscow, U. S. S. R., Russia.
- URNER, MARTIN JONAS, Assistant District Engineer, Potomac Edison Co., Frederick, Md.
- VALENTINE, CARROLL EDWARD, Engineer, Switchboard Engineering Dept., Westinghouse Elec. & Mfg. Co., East Pittsburgh, Pa.
- VAN WYK, H., Service Clerk, Puget Sound Power & Light Co., 7th & Olive Sts., Seattle, Wash.
- *VOLGOVSKOY, BORIS V., Test Engineer, Union Gas & Electric Co., Front & Rose Sts., Cincinnati, Ohio.
- WAGNER, ELMER HENRY, Relief Chief Operator, Commonwealth Edison Co., 72 W. Adams St., Chicago, Ill.
- WALKER, GEORGE A., Substation Operator, Commonwealth Edison Co., 72 W. Adams St., Chicago, Ill.
- *WALTHER, AUSTIN, Mapper, Pacific Gas & Electric Co., 923 Eleventh St., Modesto, Calif.
- *WARDLOW, HOWARD, Assistant Designer, Philadelphia Electric Co., 902 Chestnut St., Philadelphia, Pa.
- WEBER, ANTHONY JOSEPH, Maintenance Superintendent, Electrical & Mechanical, Electric Steel Foundry Co., 24th & York Sts., Portland, Ore.
- WELFORD, OLE CHRISTIAN, Draftsman, Westinghouse Elec. & Mfg. Co., East Pittsburgh, Pa.
- WERNER, A. F., Sales Engineer, Packard Electric Co., 50 Church St., New York, N. Y.; res., Newark, N. J.
- WESTEN, WILLIAM H., Testing Engineer, Commonwealth Edison Co., 28 N. Wacker Drive, Chicago; res., Oak Park, Ill.
- WHITWORTH, WILLIAM EDWARD, Member of Technical Staff, Bell Telephone Laboratories, Inc., 463 West St., New York, N. Y.; res., Bloomfield, N. J.
- WILD, EARLE, Operator, Commonwealth Edison Co., 3400 N. California Ave., Chicago, Ill.
- WILDE, OSCAR A., Chief Electrical Draftsman, Sun Shipbuilding & Dry Dock Co., Chester, Pa.
- WILSON, DEAN, Electrical Draftsman, Pacific Gas & Electric Co., 245 Market St., San Francisco, Calif.
- WILSON, HUGH ANDREW, Assistant Operator in Charge, Canadian Niagara Power Co., Ltd., Niagara Falls, Ont., Can.
- WING, LESHAR STILES, Engineer, California Farm Bureau Federation, 802 Balboa Bldg., San Francisco, Calif.
- WINTER, PAUL H., Construction Foreman, Scranton Electric Co., Scranton, Pa.
- WITT, EDWARD TEMPEST, Cadet Engineer, Phoenix Utility Co., Miami, Fla.
- WOHLAUF, RICHARD H., 606 W. 137th St., New York, N. Y.
- WOOD, HARVEY A., Testing Engineer, Commonwealth Edison Co., 28 Wacker Drive, Chicago, Ill.
- WOOLLEY, S. L., Junior Engineer, Byllesby Engineering & Management Corp., 435 Sixth Ave., Pittsburgh, Pa.

WRIGHT, ALEXANDER MACKAY, Electrical Engineer, Westinghouse Elec. & Mfg. Co., East Pittsburgh, Pa.

YOULE, B. JOSEPH, P. O. Box 237, Brooklyn, N. Y.

ZEPPE, EUDOLPH, Junior Engineer, Conduit Division, Commonwealth Edison Co., 72 W. Adams St., Chicago; res., Oak Park, Ill.

ZONDERVAN, BAUKE, Electrical Engineer, Western Electric Co., Hawthorne Station, Chicago; res., La Grange, Ill.

Total 310.

*Formerly enrolled Students.

ASSOCIATES REELECTED JUNE 23, 1927

BORDEN, DOUGLAS CLARE, Draftsman, Engineering Dept., Electric Bond & Share Co., 65 Broadway, New York, N. Y.

FLAHERTY, BENJAMIN GUY, Electrical Engineer, Puget Sound Bridge & Dredging Co., 811 Central Bldg., Seattle, Wash.

FORD, WALTER S., Teacher, Drexel Institute, 32nd & Chestnut Sts., Philadelphia, Pa.

HARMONY, CHARLES ALLEN, Suburban Division Superintendent, Puget Sound Power & Light Co., Bothell, Wash.

HELT, OSCAR BROWN, Partner, Helt & O'Donnell, 40 First St., Portland, Ore.

SAWYER, LEE ARTHUR, 726 Pennington St., Elizabeth, N. J.

STEVENS, EARL EVERETT, Testing Engineer, Commonwealth Edison Co., 72 W. Adams St., Chicago; res., Elmhurst, Ill.

MEMBER REELECTED, JUNE 23, 1927

WADE, HENRY NAZER, President, Wade Engineering Co., 1855 Industrial St., Los Angeles, Calif.

ASSOCIATE REINSTATED JUNE 23, 1927

SMITH, TRACY, Electrical Engineer, with Hugh L. Thompson, Waterbury, Conn.

MEMBERS ELECTED JUNE 23, 1927

BASSETT, ALFRED J., Asst. Engr., Brooklyn Edison Co., Brooklyn, N. Y.

BOWSER, CLEVE, Narrows Auto-Sales Co., Narrows, Va.

BURKE, THOMAS F., Engineer of Car Equipment, Interborough Rapid Transit Co., New York, N. Y.

BYLES, FRANK A., Electrical Engineering, General Electric Co., Schenectady, N. Y.

CLARKE, JOHN A. JR., Railway Equipment Engineer, Westinghouse Elec. & Mfg. Co., East Pittsburgh, Pa.

GUILLOU, A. V., Assistant Chief Engineer, California Railroad Commission, San Francisco, Calif.

HANCOCK, EDMUND W., Bell Telephone Laboratories, Inc., New York, N. Y.

HART, HENRY C., Vice President and Chief Engineer, Cuban Telephone Co., Havana, Cuba.

JONES, HERNDON C., Senior Engineer, Byllesby Engg. & Management Corp., Birmingham, Ala.

LEEMING, HARRY H., Asst. Elec. Engr., Hydro-Electric Commission, Toronto, Ont., Canada.

MARINO, RAPHAEL, Member of Technical Staff, Bell Telephone Laboratories, New York, N. Y.

MARTIN, GEORGE, Consulting Engineer, Snook-Hillhouse & Co., Columbus, Ohio.

PHILIPPS, FRANK R., Vice President and General Manager, Duquesne Light Co., Pittsburgh, Pa.

RICHARDSON, CHARLES LEPEL, Radio Engineer, Canadian General Electric Co., Ltd., 224 Wallace Ave., Toronto, Ont., Can.

ROLLINS, NORMAN A., Engineer, Industrial Substations, Commonwealth Edison Co., Chicago, Ill.

SAMSON, DUNCAN A., In charge, Power & Construction Div., Dodge Brothers, Inc., Detroit, Mich.

SMITH, DWIGHT L., Electrical Engineer, Chicago Rapid Transit Co., Chicago, Ill.

SQUIRES, H. O., Operating Engineer, Illinois Power & Light Corp., St. Louis, Mo.

TIMMS, MALCOLM C., Super-Tension Cable Engineer, Siemens Bros. & Co., Ltd., London, S. E. England.

WEST, DONALD C., General Engineer, Westinghouse E. & M. Co., East Pittsburgh, Pa.

WILCOX, HOWARD M., Section Engineer, Circuit Breaker Engg. Dept., Westinghouse E. & M. Co., East Pittsburgh, Pa.

WINCHESTER, LAURENCE S., Statistical Engineer, Duquesne Light Co., Pittsburgh, Pa.

FELLOW ELECTED JUNE 23, 1927

VERNIER, CHARLES, Chief Engineer, Macintosh Cable Co., Ltd., Rice Lane, Walton, Liverpool, Eng.

TRANSFERRED TO GRADE OF FELLOW JUNE 23, 1927

BARRON, JACOB T., General Manager, Elec. Dept., Public Service Electric & Gas Co., Newark, N. J.

HALL, HARRY Y., Supt., Hell Gate Station, United Electric Light & Power Co., New York, N. Y.

McCARTHY, J. B., Elec. Supt., International Nickel Co. of Canada, Copper Cliff, Ont., Can.

PEASLEE, W. D. A., General Manager, Daven Radio Corporation, Newark, N. J.

TRANSFERRED TO GRADE OF MEMBER JUNE 23, 1927

BAKER, DOUGLAS B., Vice-President and General Manager, Standard Electrica. S. A., Madrid, Spain.

BALL, FRANCIS L., Vice President, Fitchburg Gas & Electric Co., Boston, Mass.

BALL, WILMOT C., Research Dept., Okonite Callender Cable Co., Inc., Paterson, N. J.

BEAVERS, FRANKLIN J., Distribution Engineer, Scranton Electric Co., Scranton, Pa.

CALLAND, O. C., Chief Inspector, Ohio Insulator Co., Barberton, Ohio.

CAMILLI, G., Electrical Engineer, General Electric Co., Pittsfield, Mass.

CURTIS, HARRY A., Chief Engineer and General Manager, Hydro-Electric Dept., Hobart, Tasmania.

DAVID, BRUCE W., Chief Engineer, Sterling Mfg. Co., Cleveland, Ohio.

DEANE, L. EARL, Engineer, American Presbyterian Mission, Metet par Yaounde, Cameroun, West Africa.

DEWARS, ALLEN G., Supt. of Research, Northern States Power Co., St. Paul, Minn.

DOHERTY, ROBERT E., Consulting Engineer, General Electric Co., Schenectady, N. Y.

DONNELL, PHILIP S., Dean of College of Engg. and Professor of Elec. Engg., University of New Mexico, Albuquerque, New Mexico.

DOUGLASS, FORREST S., Electrical Engineer, Utilities Power & Light Corp., Chicago, Ill.

EARLY, RUPERT N., Development Engineer, Electric Machinery Mfg. Co., Minneapolis, Minn.

EMORY, FRED D., Electrical Engineer, California Oregon Power Co., Medford, Oregon.

FRISBY, ROGER L., Electrical Engineer of Stations, Kansas City Power & Light Co., Kansas City, Mo.

GOLL, WALTER SCOTT, Works Manager, General Electric Co., Fort Wayne, Indiana.

GRANFIELD, THOMAS H., Engineer of Costs and Practises, Northwestern Bell Telephone Co., Omaha, Nebraska.

GREEN, ADONIRAM J., Electrical Engineer, General Electric Co., Newark, N. J.

HALLORAN, HARRY R., Consulting Engineer, National Electrical & Engineering Co., Wellington, N. Z.

HARRINGTON, J. L., Telephone Engineer, Chesapeake & Potomac Telephone Co., Washington, D. C.

HARTMAN, GEORGE, Supt., Hydro-Electric Plant, The International Nickel Co. of Canada, Turbine, Ont., Canada.

KENT, WALTER, Electrical Engineer, General Electric Co., Fort Wayne, Indiana.

LANG, RICHARD H., Chief Operator, Consolidated Gas, Electric Light & Power Co., Baltimore, Md.

LLOYD, WILL L., Asst. to Consulting Engineer, General Electric Co., Pittsfield, Mass.

LOCKETT, RALPH G., Electrical Engineer, Cutler-Hammer Mfg. Co., Milwaukee, Wis.

LUNSFORD, ROBERT L., Power Equipment Development Engineer, Bell Laboratories, New York, N. Y.

MARTI, OTHMAR K., Chief Engineer in charge of Design and Construction, American Brown Boveri Elec. Corp., Camden, N. J.

METZ, LOUIS C., Assistant Engineer, Bell Telephone Co. of Pa., Philadelphia, Pa.

MICKEY, BRUCE C., D. C. Engg. Dept., General Electric Co., Schenectady, N. Y.

MILLIKEN, HUMPHREYS, Chief Engineer, Montreal Light, Heat & Power Consolidated, Montreal, Canada.

MOULTON, JAMES S., Asst. to Executive Engineer, San Joaquin Light & Power Corp.; Special Engineer, Great Western Power Co., Fresno, Calif.

NORTH, CHARLES, Electrical Supt., City of Kamloops, Kamloops, B. C., Canada.

PUCHSTEIN, ALBERT F., Assistant Professor, Elec. Engg. Dept., Ohio State University, Columbus, Ohio.

PYE, HARVEY N., Assistant Chief Engineer, Southeastern Underwriters Association, Atlanta, Ga.

REED, EMERSON G., Asst. to Transformer Dept. Engg. Manager, Westinghouse Elec. & Mfg. Co., Sharon, Pa.

SCHUHLER, ALBERT A., Sales Engineer and Manager, St. Louis District, Holtzer-Cabot Electric Co., Chicago, Ill.

SEBAST, FREDERICK M., Associate Professor of Elec. Engg., Rensselaer Polytechnic Institute, Troy, N. Y.

SHAW, HENRY S., Secretary and Chairman of Directors, General Radio Co., Cambridge, Mass.

SMITH, IRWIN F., Distribution Engineer, Duquesne Light Co., Pittsburgh, Pa.

SMITH, WILLIAM F., Asst. Electrical Supt., Pacific Electric Railway Co., Los Angeles, Calif.

STOCKWELL, FRANK CLIFFORD, Professor of Electrical Engineering, Stevens Institute of Technology, Hoboken, N. J.

THALHEIMER, J. J., Engineer, General Electric Co., Cincinnati, Ohio.

THORNTON, GEORGE C., District Manager, West Virginia Engg. Co., Norton, Va.

TYSON, EDWIN H., Supt. of Meters, Penna. Power & Light Co., Hazleton, Pa.

UMANSKY, L. A., Electrical Engineer, General Electric Co., Schenectady, N. Y.

VILSTRUP, ASGER, Assistant Engineer, B. C. Electric Railway Co., Ltd., Vancouver, B. C., Canada.

WAGNER, EDWARD A., Managing Engineer, Distribution Transformer Dept., General Electric Co., Pittsfield, Mass.

WARRING, ROYAL C., Return Circuit Engineer, Eastern Mass. Street Railway Co., Boston, Mass.

WOOD, JOSEPH D., Division Engineer, Condit Electrical Mfg. Corp., Boston, Mass.

WOODWARD, EDWARD B., Power Representative, Public Service Elec. & Gas Co., Camden, N. J.

WRIGHT, CHARLES A., Electrical Engineer, Research Laboratory, National Carbon Co., Cleveland, Ohio.

WRIGHT, FRANK T., Chief Electrical Engineer, Bombay, Baroda & Central India Railway, Bombay, India.

YAPP, LEON C., Engineer in Charge Contract Service Dept., General Electric Co., Fort Wayne, Indiana.

RECOMMENDED FOR TRANSFER

To Grade of Member

The Board of Examiners, at its meeting held May 16, 1927, recommended the following member for transfer to the grade of Member:

WARNER, EARLE E., Industrial Engineering Department, General Electric Company, Schenectady, N. Y.

APPLICATIONS FOR ELECTION

Applications have been received by the Secretary from the following candidates for election to membership in the Institute. Unless otherwise indicated, the applicant has applied for admission as an Associate. If the applicant has applied for direct admission to a higher grade than Associate, the grade follows immediately after the name. Any member objecting to the election of any of these candidates should so inform the Secretary before July 31, 1927.

Adams, William E., Elliott Engineer Co., Inc., Binghamton, N. Y.
 Attmore, W. B., Victor Talking Machine Co., San Francisco, Calif.
 Bender, L. L., Morganite Brush Co., Long Island City, N. Y.
 Berg, G., Westinghouse Elec. International Co., New York, N. Y.
 Brinkler, J. S., General Electric Co., Lynn, Mass.
 Cannon, D. L., Carolina Power & Light Co., Raleigh, N. C.
 Carswell, H. L., A. B. See Electric Elevator Co., New York, N. Y.
 (Applicant for re-election.)
 Castell, W. G., 75 Lenden Blvd., Brooklyn, N. Y.
 Coen, J. F., Wadsworth Elec. Mfg. Co., Detroit, Mich.
 Collett, C. S., Avalon Telephone Co., Ltd., St. Johns, Newfoundland
 Corbett, E. L., Patent Lawyer, New York, N. Y.
 Cunningham, J. A., Iowa State College, Ames, Iowa
 Damm, G. J., Jebens Hdw. Co., Blue Island, Ill.
 Devine, P. A., Iowa State College, Ames, Iowa
 Ducote, C. H., Stone & Webster, Inc., Boston, Mass.
 Fillmore, J. M., Contractor, Norwich, Conn.
 Franca, A., Brooklyn Edison Co., Brooklyn, N. Y.
 Geis, H. W., New York Telephone Co., New York, N. Y.
 Goodwin, H. F., Jackson & Moreland, Boston, Mass.
 Gray, W. H., Columbia Steel Co., Elyria, Ohio
 Green, C. H., Raytheon Manufacturing Co., Cambridge, Mass.
 Gross, F. P., Central Public Service Co., Chicago, Ill.
 Grove, A. W., Gibbs & Hill, New York, N. Y.
 Healy, K. T., Speen Street, Natick, Mass.
 Hokanson, C. G., Jr., Bureau of Power & Light, Los Angeles, Calif.
 Holly, G. S., Newcombe-Hawley, Inc., St. Charles, Ill.
 Jeffrey, E. F., Western Union Telegraph Co., Cleveland, Ohio
 Jewett, R. F., Western Electric Co., Keany, N. J.
 Jones, C. N., Brown & Bailey Co., Philadelphia, Pa.
 Keene, R., Mississippi Power & Light Co., Jackson, Miss.
 Kelly, F. G., Jr., Westinghouse Elec. & Mfg. Co., East Pittsburgh, Pa.

MacGuffie, C. I., General Electric Co., Schenectady, N. Y.
 Marks, M. M., Crane Co., Bridgeport, Conn.
 McLean, G. E., Power House, Stave Falls, B. C., Can.
 McLean, T., Cornell University, Ithaca, N. Y.
 Mealy, E. G., Ohio Boxboard Co., Rittman, Ohio
 Mills, B., Lapp Insulator Co., Chicago, Ill.
 Montapert, A. A., Safety Elevator Corp., Los Angeles, Calif.
 Nye, H. E., Warner Bros. Pictures Corp., Hollywood, Calif.
 Panzer, H. L., Williamsburgh Power Plant Corp., Brooklyn, N. Y.
 Paton, R. E., Leeds & Northrup Co., Philadelphia, Pa.
 Rickard, E. M., Wedjet Tie Co., New York, N. Y.
 Rudge, W. J., Jr., General Electric Co., Pittsfield, Mass.
 Salton, L. V., (Member), with T. Eaton Co., Ltd., Winnipeg, Man., Can.
 Schad, A. E., Westinghouse Elec. & Mfg. Co., Baltimore, Md.
 Siegfried, A. H., (Member), Abastecedora de Luz, Fuerza y Agua, Mazatlan, Sinaloa, Mex.
 Smith, B. D., Sterling Varnish Co., Irvington, N. J.
 Snell, E. J., Public Service Electric & Gas Co., Metuchen, N. J.
 Soltura, J. A., Asst. Chief Electrical Engineer, Central Moron, Pina, Cuba
 Stradling, H. M., Electrical Contractor, Indianapolis, Ind.
 Taylor, P. L., Westinghouse Elec. & Mfg. Co., East Pittsburgh, Pa.
 Tracy, E. S., Jr., (Member), Electrical Engineering Co., Date City, Fla.
 Ungerer, F. A., 2038 72nd St., Brooklyn, N. Y.
 Walker, A. S., New England Power Co., Worcester, Mass.
 Wilson, I. C., Asst. Electrician, Lane Hospital, San Francisco, Calif.
 Young, R. A., Petroleum Engineering Corp., Bradford, Pa.
 Total 56

Foreign

Buckland, L. G., with Herbert delCott Pty., Ltd., Melbourne, N. S. W., Aust.
 Gopaliyengar, B. K., (Member), Sira, Mysore, India
 Inamulla, S. M., Water Works & Pumping Station, Gaya, India
 Lugo, F. A., Dimas Pineda & Co., Maracaibo, Venezuela
 Mohri, K., Okazaki Dento K. K., Okazaki, Aichiken, Japan
 Murata, Y., Nippon Gaisi Kabushiki Kaisha, Atsuta-higashimachi, Nagoya City, Japan
 Noble, H. J. G., Shanghai Municipal Council, Shanghai, China
 Ostline, J. E., (Member), Automatic Telephone Mfg. Co., Liverpool, Eng.
 Scott, A. T., (Member), Balfour, Beatty & Co., Ltd., London, E. C. 4, Eng.
 Tutton, P. A., Riegos 7 Fuerza del Ebro, S. A., Barcelona, Spain
 Yoganandam, G., Indian Institute of Science, Bangalore, India
 Total 11.

STUDENTS ENROLLED

Althaus, Leland R., Ohio Northern University
 Amoo, Lloyd R., So. Dak. State College of A. & M. Arts
 Atkin, Robert, Brooklyn Polytechnic Institute

Ayres, Tom J., Stanford University
 Bakker, Pier, So. Dakota State College of A. & M. Arts
 Barnett, J. M., Pennsylvania State College
 Brown, Laurence T., University of Illinois
 Cardillo, Joseph V., Virginia Polytechnic Institute
 Churchill, Randolph P., Rensselaer Polytechnic Institute
 Cole, Bernard T., Rensselaer Polytechnic Institute
 Coleman, E. Emmons, University of Idaho
 Craddock, Reginald V., Rensselaer Polytechnic Institute
 Cutts, Richard, Jr., Mass. Institute of Technology
 Deaney, George T., Newark Technical School
 Dewey, E. Bruce, So. Dakota State College of A. & M. Arts
 Dinovo, Mario F., Rensselaer Polytechnic Institute
 Dominguez, Jose D., Mass. Inst. of Technology
 Dunn, Albion E., Virginia Polytechnic Institute
 Farmer, Robert M., University of North Carolina
 Farwell, Lyndon, Stanford University
 Foster, Eugene A., University of Illinois
 Fowler, Ralph R., University of Nebraska
 Frey, Richard C., Stanford University
 Garber, Wilbur A., Pennsylvania State College
 Gill, George T., Rensselaer Polytechnic Institute
 Goldbach, Frank, Newark Technical School
 Gorfinkle, Meyer G., Mass. Inst. of Technology
 Hall, Thomas S., State College of Washington
 Harvie, Ralph A., University of British Columbia
 Hendrick, Elvin G., Rhode Island State College
 Henning, H. W., Engg. School of Milwaukee
 Hoover, William G., Stanford University
 Hultquist, John A., University of Colorado
 Hupp, Raymond L., University of Illinois
 Keith, Ted, University of Washington
 Kuhn, J. Leonard, Newark Technical School
 Lee, Chite, State College of Washington
 Lindstrom, Henry L., Purdue University
 Lootens, Charles L., Engg. School of Milwaukee
 Lynde, Elliott D., Syracuse University
 Manning, Melvin L., So. Dakota State College of A. & M. Arts
 Martin, Merlin L., University of Wisconsin
 McGraw, Clyde, University of Nebraska
 Mitchell, Gary T., University of Arizona
 Montgomery, Wardwell B., Univ. of Wisconsin
 Moser, Robert P., Oregon Institute of Technology
 Place, Porter, Purdue University
 Reichle, Winfried E., University of Michigan
 Richardson, Bruce M., Stanford University
 Saari, Leonard V., University of Wisconsin
 Sanborn, Charles A., Mass. Inst. of Technology
 Sansone, Amerigo R., Lewis Institute
 Schultz, Gustav J., So. Dak. State College of A. & M. Arts
 Smith, Russell E., University of Michigan
 Sullivan, William L., Mass. Inst. of Technology
 Summers, Claude M., University of Colorado
 Svenson, J. Harold, University of Illinois
 Tarpley, Raymond E., University of Illinois
 Toth, Emerick, Newark Technical School
 Van Tuyl, Laurance J., University of Michigan
 Wallis, R. Clinton, Jr., Rice Institute
 Weinfeldt, Sidney, Newark Technical School
 Wideman, Norman E., University of Toronto
 Wilkie, Harry, Montana State College
 Willer, Fred W., Purdue University
 Willis, Peyton T., Stanford University
 Wolpert, Frederick S., Newark Technical School
 Wright, Ralph C., Michigan State College of Agr. & Applied Science
 Young, John W., Virginia Polytechnic Institute
 Ziegberman, Julius L., University of Colorado
 Total 70.

OFFICERS OF A. I. E. E. 1926-1927

- President**
C. C. CHESNEY
- Junior Past Presidents**
M. I. PUPIN
FARLEY OSGOOD
- Vice-Presidents**
H. M. HOBART
B. G. JAMIESON
GEORGE L. KNIGHT
H. H. SCHOOLFIELD
A. E. BETTIS
- Managers**
WILLIAM M. MCCONAHEY
W. K. VANDERPOEL
H. P. CHARLESWORTH
JOHN B. WHITEHEAD
J. M. BRYANT
E. B. MERRIAM
- National Treasurer**
GEORGE A. HAMILTON
- National Secretary**
F. L. HUTCHINSON
- Honorary Secretary**
RALPH W. POPE

LOCAL HONORARY SECRETARIES

- T. J. Fleming, Calle B. Mitre 519, Buenos Aires, Argentina, S. A.
H. W. Flashman, Aus. Westinghouse Elec. Co. Ltd., Cathcart House,
11 Castlereagh St., Sydney, N. S. W., Australia.
Carroll M. Maureau, Caixa Postal No. 571, Rio de Janeiro, Brazil, S. A.
Charles le Maistre, 28 Victoria St., London, S. W. 1, England.
A. S. Garfield, 45 Bd. Beausejour, Paris 16 E, France.
P. W. Willis, Tata Power Companies, Bombay House, Bombay, India.
Guido Semenza, 39 Via Monte Napoleone, Milan, Italy.
P. H. Powell, Canterbury College, Christchurch, New Zealand.
Axel P. Enstrom, 24a Greftevegatan, Stockholm, Sweden.
W. Elsdon-Dew, P. O. Box 4563, Johannesburg, Transvaal, Africa.

A. I. E. E. COMMITTEES

(A list of the personnel of Institute committees may be found in the June issue of the JOURNAL.)

GENERAL STANDING COMMITTEES AND CHAIRMEN

- EXECUTIVE, C. C. Chesney
FINANCE, H. A. Kidder
MEETINGS AND PAPERS, E. B. Meyer
PUBLICATION, L. F. Morehouse
COORDINATION OF INSTITUTE ACTIVITIES, Farley Osgood
BOARD OF EXAMINERS, Erich Hausmann
SECTIONS, Harold B. Smith
STUDENT BRANCHES, C. E. Magnusson
MEMBERSHIP, L. S. O'Roark
HEADQUARTERS, G. L. Knight
LAW, W. I. Slichter
PUBLIC POLICY, Gano Dunn
STANDARDS, J. Franklin Meyer
EDISON MEDAL, Gano Dunn
CODE OF PRINCIPLES OF PROFESSIONAL CONDUCT, John W. Lieb
COLUMBIA UNIVERSITY SCHOLARSHIP, W. I. Slichter
AWARD OF INSTITUTE PRIZES, E. B. Meyer
SAFETY CODES, J. P. JACKSON

SPECIAL COMMITTEES

ADVISORY COMMITTEE TO THE MUSEUMS OF THE PEACEFUL ARTS, J. P. Jackson
LICENSING OF ENGINEERS, Francis Blossom
TECHNICAL ACTIVITIES, A. G. Pierce

TECHNICAL COMMITTEES AND CHAIRMEN

- COMMUNICATION, H. P. Charlesworth
EDUCATION, P. M. Lincoln
ELECTRICAL MACHINERY, H. M. Hobart
ELECTROCHEMISTRY AND ELECTROMETALLURGY, George W. Vinal
ELECTROPHYSICS, V. Karapetoff
INSTRUMENTS AND MEASUREMENTS, A. E. Knowlton
APPLICATIONS TO IRON AND STEEL PRODUCTION, A. G. Pierce
PRODUCTION AND APPLICATION OF LIGHT, Preston S. Millar
APPLICATIONS TO MARINE WORK, G. A. Pierce
APPLICATIONS TO MINING WORK, W. H. Lesser
GENERAL POWER APPLICATIONS, A. M. MacCutcheon
POWER GENERATION, W. S. Gorsuch
POWER TRANSMISSION AND DISTRIBUTION, Philip Torchio
PROTECTIVE DEVICES, F. L. Hunt
RESEARCH, John B. Whitehead
TRANSPORTATION, J. V. B. Duer
ELECTRIC WELDING, J. C. Lincoln

A. I. E. E. REPRESENTATION

(The Institute is represented on the following bodies; the names of the representatives may be found in the June issue of the JOURNAL.)

- AMERICAN ASSOCIATION FOR THE ADVANCEMENT OF SCIENCE, COUNCIL
AMERICAN BUREAU OF WELDING
AMERICAN COMMITTEE ON ELECTROLYSIS
AMERICAN ENGINEERING COUNCIL
AMERICAN ENGINEERING STANDARDS COMMITTEE
AMERICAN MARINE STANDARDS COMMITTEE
AMERICAN YEAR BOOK, ADVISORY BOARD
APPARATUS MAKERS AND USERS COMMITTEE
BOARD OF TRUSTEES, UNITED ENGINEERING SOCIETY
CHARLES A. COFFIN FELLOWSHIP AND RESEARCH FUND COMMITTEE
COMMITTEE ON ELIMINATION OF FATIGUE, SOCIETY OF INDUSTRIAL ENGINEERS
ENGINEERING FOUNDATION BOARD
JOHN FRITZ MEDAL BOARD OF AWARD
JOINT COMMITTEE ON WELDED RAIL JOINTS
JOINT CONFERENCE COMMITTEE OF FOUR FOUNDER SOCIETIES
LIBRARY BOARD, UNITED ENGINEERING SOCIETY
NATIONAL FIRE PROTECTION ASSOCIATION, ELECTRICAL COMMITTEE
NATIONAL FIRE WASTE COUNCIL
NATIONAL MUSEUM OF ENGINEERING AND INDUSTRY, BOARD OF TRUSTEES
NATIONAL RESEARCH COUNCIL, ENGINEERING DIVISION
NATIONAL SAFETY COUNCIL, ELECTRICAL COMMITTEE OF ENGINEERING SECTION
THE NEWCOMEN SOCIETY
RADIO ADVISORY COMMITTEE, BUREAU OF STANDARDS
SOCIETY FOR THE PROMOTION OF ENGINEERING EDUCATION, BOARD OF INVESTIGATION AND COORDINATION
U. S. NATIONAL COMMITTEE OF THE INTERNATIONAL ELECTROTECHNICAL COMMISSION
U. S. NATIONAL COMMITTEE OF THE INTERNATIONAL ILLUMINATION COMMISSION
WASHINGTON AWARD, COMMISSION OF

LIST OF SECTIONS

Name	Chairman	Secretary	Name	Chairman	Secretary
Akron	A. R. Holden	H. L. Steinbach, Electrical Engineering Dept., Goodyear Tire & Rubber Co., Akron, Ohio	Mexico	Carlos Macias	G. Solis Payan, Ave. Portales 89, General Anaya, Mexico D. F., Mexico.
Atlanta	C. E. Bennett	W. F. Oliver, Box 2211, Atlanta, Ga.	Milwaukee	H. L. Van Valkenberg	R. G. Lockett, Cutler-Hammer Mfg. Co., Milwaukee, Wis.
Baltimore	W. B. Kouwenhoven	R. T. Greer, Madison St. Building, Baltimore, Md.	Minnesota	S. B. Hood	M. E. Todd, University of Minnesota, Minneapolis, Minn.
Boston	Hartley Rowe	W. H. Colburn, 39 Boylston St., Boston, Mass.	Nebraska	C. W. Minard	N. W. Kingsley, 1303 Telephone Bldg., Omaha, Nebr.
Chicago	K. A. Auty	William Wurth, 1634 Peoples Gas Bldg., Michigan Ave. at Adams St., Chicago, Ill.	New York	E. B. Meyer	O. B. Blackwell, American Tel. & Tel. Co., 195 Broadway, New York, N. Y.
Cincinnati	W. P. Beattie	L. J. Gregory, Union Gas & Electric Co., Cincinnati, Ohio	Niagara Frontier	H. B. Alverson	A. W. Underhill, Jr., 606 Lafayette Bldg., Buffalo, N. Y.
Cleveland	H. L. Grant	W. E. McFarland, 720 Illuminating Bldg., Cleveland, Ohio	Oklahoma	E. R. Page	C. C. Stewart, Oklahoma Gas & Electric Co., Norman, Okla.
Columbus	A. W. Janowitz	E. A. Williams, 231 N. Fifth St., Columbus, Ohio	Panama	L. W. Parsons	I. F. McIlhenny, Box 413, Balboa Heights, C. Z.
Connecticut	A. E. Knowlton	R. G. Warner, Yale University, 10 Hillhouse Ave., New Haven, Conn.	Philadelphia	Louis J. Costa	R. H. Silbert, 2301 Market St., Philadelphia, Pa.
Denver	W. H. Edmunds	R. B. Bonney, Telephone Bldg., P. O. Box 960, Denver, Colo.	Pittsburgh	D. M. Simons	W. C. Goodwin, Westinghouse Elec. & Mfg. Co., East Pittsburgh, Pa.
Detroit-Ann Arbor	Harold Cole	F. H. Riddle, Champion Porcelain Co., Detroit, Mich.	Pittsfield	E. F. Gehrken	C. H. Kline, General Electric Co., Pittsfield, Mass.
Erie	F. A. Tennant	L. H. Curtis, General Electric Co., Erie, Pa.	Portland, Ore.	J. C. Henkle	J. E. Yates, Gasco Bldg., Portland, Ore.
Fort Wayne	D. W. Merchant	C. F. Beyer, General Electric Co., Fort Wayne, Ind.	Providence	Edwin E. Nelson	F. W. Smith, Blackstone Valley Gas & Electric Co., Pawtucket, R. I.
Indianapolis-Lafayette	J. B. Bailey	C. A. Fay, 4206 Cornelius Ave., Indianapolis, Ind.	Rochester	Earl C. Karker	Wade H. Reichard, General Ry. Signal Co., Rochester, N. Y.
Ithaca	R. F. Chamberlain	G. F. Bason, Electrical Engineering Dept., Cornell University, Ithaca, N. Y.	St. Louis	L. F. Woolston	L. P. Van Houten, 2670 Washington Boulevard, St. Louis, Mo.
Kansas City	R. I. Baldwin	S. M. De Camp, 510 Dwight Bldg., Kansas City, Mo.	San Francisco	D. I. Cone	A. G. Jones, 807 Rialto Bldg., San Francisco, Calif.
Lehigh Valley	W. E. Lloyd, Jr.	G. W. Brooks, Pennsylvania Power & Light Co., 8th & Hamilton Sts., Allentown, Pa.	Saskatchewan	S. R. Parker	W. P. Brattle, Dept. of Telephones, Telephone Bldg., Regina, Sask.
Los Angeles	R. E. Cunningham	L. C. Williams, H. W. Hellman Bldg., Los Angeles, Calif.	Schenectady	R. E. Doherty	R. F. Franklin, Room 301, Bldg. No. 41, General Electric Co., Schenectady, N. Y.
Louisville	D. C. Jackson, Jr.	W. C. White, Southern Bell Tel. & Tel. Co., Louisville, Ky.	Seattle	C. E. Mong	C. R. Wallis, 609 Colman Bldg., P. O. Box 1858, Seattle, Wash.
Lynn	D. F. Smalley	Chas. Skoglund, River Works, General Electric Co., W. Lynn, Mass.	Sharon	H. L. Cole	L. H. Hill, Westinghouse Elec. & Mfg. Co., Sharon, Pa.
Madison	E. J. Kallevang	H. J. Hunt, D. W. Mead & C. V. Seastone, State Journal Bldg., Madison, Wis.	Southern Virginia	W. S. Rodman	J. H. Berry, 1338 Rockbridge Ave., Norfolk, Va.
			Spokane	Richard McKay	James B. Fiskens, Washington Water Power Co., Lincoln & Trent, Spokane, Wash.

LIST OF SECTIONS—Continued.

Name	Chairman	Secretary	Name	Chairman	Secretary
Springfield, Mass.	L. F. Curtis	J. Frank Murray, United Electric Light Co., 251 Wilbraham Ave., Springfield, Mass.	Utah	B. C. J. Wheatlake	D. L. Brundige, Utah Power & Light Co., Box 1790, Salt Lake City, Utah
Syracuse	C. E. Dorr	F. E. Verdin, 615 City Bank Bldg., Syracuse, N. Y.	Vancouver	R. L. Hall	C. W. Colvin, B. C. Electric Railway Co., 425 Carrall St., Vancouver, B. C.
Toledo	O. F. Rabbe	Max Neuber, 1257 Fernwood Ave., Toledo, Ohio	Washington, D. C.	C. A. Robinson	L. E. Reed, Potomac Elec. Power Co., 14th & C Sts., Washington, D. C.
Toronto	M. B. Hastings	F. F. Ambuhl, Toronto Hydro-Electric System, 226 Yonge St., Toronto, Ontario	Worcester	C. F. Hood	F. C. Crosby, Morgan Construction Co., 15 Belmont St., Worcester, Mass.
Urbana	J. T. Tykociner	L. B. Archer, 301 Electrical Engineering Lab., University of Illinois, Urbana, Ill.	Total 52		

LIST OF BRANCHES

Name and Location	Chairman	Secretary	Counselor (Member of Faculty)
Akron, Municipal University of, Akron, Ohio	Lee J. Shaffer	S. K. Worthen	J. T. Walthers
Alabama Polytechnic Institute, Auburn, Ala.	T. S. Lynch	P. E. Sandlin	W. W. Hill
Alabama, University of, University, Ala.	Sewell St. John	J. M. Cardwell, Jr.	J. C. Clark
Arizona, University of, Tucson, Ariz.	J. W. Cruse	Audley Sharpe	W. B. Stelzner
Arkansas, University of, Fayetteville, Ark.	Carroll Walsh	W. H. Mann, Jr.	D. P. Moreton
Armour Institute of Technology, 3300 Federal St., Chicago, Ill.	M. T. Goetz	C. W. Schramm	Robin Beach
Brooklyn Polytechnic Institute, 99 Livingston St., Brooklyn, N. Y.	William Berger	Joseph Heller	W. K. Rhodes
Bucknell University, Lewisburg, Pa.	A. Fogelsanger	J. D. Johnson	R. W. Sorensen
California Institute of Technology, Pasadena, Calif.	Thomas L. Gottier	Allan E. Capon	T. C. McFarland
California, University of, Berkeley, Calif.	F. H. McCune	A. G. Montin	B. C. Dennison
Carnegie Institute of Technology, Pittsburgh, Pa.	J. R. Power	R. O. Perrine	H. B. Dates
Case School of Applied Science, Cleveland, O.	G. J. Currie	C. S. Daily, Jr.	T. J. MacKavanaugh
Catholic University of America, Washington, D. C.	W. S. Sparks	W. C. Osterbrock	W. C. Osterbrock
Cincinnati, University of, Cincinnati, O.	C. W. Taylor	W. E. Turnbull	A. R. Powers
Clarkson College of Technology, Potsdam, N. Y.	H. J. Myrback	J. U. Wilson	S. R. Rhodes
Clemson Agricultural College, Clemson College, S. C.	L. R. Miller	Harold Groat	H. G. Jordan
Colorado State Agricultural College, Ft. Collins, Colo.	Harold Newsome	J. A. Setter	W. C. DuVall
Colorado, University of, Boulder, Colo.	A. D. Thomas	E. T. Reynolds	Norman L. Towle
Cooper Union, New York, N. Y.	H. T. Wilhelm	Alex A. Ohlson	R. E. Nyswander
Denver, University of, Denver, Colo.	Harold Henson	R. S. Eininger, Jr.	E. O. Lange
Drexel Institute, Philadelphia, Pa.	H. D. Baker	W. C. Earnhardt	W. J. Seelley
Duke University, Durham, N. C.	Oren Long	R. D. Ross	J. M. Weil
Florida, University of, Gainesville, Fla.	W. Stanwix-Hay	F. L. Kaestle	E. S. Hannaford
Georgia School of Technology, Atlanta, Ga.	W. M. McGraw	S. Blore	J. H. Johnson
Idaho, University of, Moscow, Idaho	J. W. Gartin	J. B. Cecil	F. A. Fish
Iowa State College, Ames, Iowa	A. G. Baumgartner	E. J. Hartman	A. H. Ford
Iowa, State University of, Iowa City, Iowa	Theo. VanLaw	John Yost	R. G. Kloeffler
Kansas State College, Manhattan, Kans.	A. M. Young	Miss Lottie Young	G. C. Shaad
Kansas, University of, Lawrence, Kans.	Elmer Bayles	C. D. McClanahan	Morland King
Kentucky, University of, Lexington, Ky.	R. W. Spicer	Daniel Paul	J. L. Beaver
Lafayette College, Easton, Pa.	Herbert Heinrich	J. Lloyd Dancy	F. A. Rogers
Lehigh University, Bethlehem, Pa.	A. W. Staller	O. D. Westerberg	M. B. Voorhies
Lewis Institute, Chicago, Ill.	James S. Howe	E. P. Athens	W. E. Barrows, Jr.
Louisiana State University, Baton Rouge, La.	K. J. Ozment	R. F. Scott	J. F. H. Douglas
Maine, University of, Orono, Me.	P. E. Watson	E. T. Baldwin	W. H. Timbie
Marquette University, 1200 Sycamore St., Milwaukee, Wis.	R. M. Franey	E. A. Michelman	L. S. Foltz
Massachusetts Institute of Technology, Cambridge, Mass.	Constantine Bary	J. C. Phelps	B. F. Bailey
Michigan State College, East Lansing	W. H. Bartels	H. R. Stevenson	John D. Ball
Michigan, University of, Ann Arbor, Mich.	M. H. Nelson	W. H. Freisleben	H. Kuhlmann
Milwaukee, Engineering School of, 415 Marshall St., Milwaukee, Wis.	Joseph Havlick	J. H. DuBois	L. L. Patterson
Minnesota, University of, Minneapolis, Minn.	C. H. Burmeister	B. W. Robins	I. H. Lovett
Mississippi Agricultural & Mechanical College, A. & M. College, Miss.	H. M. Alford	E. J. Gregory	M. P. Weinbach
Missouri School of Mines and Metallurgy, Rolla, Mo.	H. H. Brittingham	J. L. Egbert	J. A. Thaler
Missouri, University of, Columbia, Mo.	V. L. Tiller	J. A. Thaler	F. W. Norris
Montana State College, Bozeman, Mont.	W. E. Pakala	R. D. Reed	S. G. Palmer
Nebraska, University of, Lincoln, Neb.	H. H. Brown	Clark Amens	J. C. Peet
Nevada, University of, Reno, Nev.	Kenneth Knopf	C. H. Clarendon, Jr.	L. W. Hitchcock
Newark College of Engineering, 367 High St., Newark, N. J.	H. G. Patton	F. W. Hussey	Harry Baum
New Hampshire, University of, Durham, N. H.	T. C. Tappan	A. H. Rapport	J. Loring Arnold
New York, College of the City of, New York, N. Y.	Harold Wolf	Henry Och	G. C. Cox
New York University, University Heights, New York, N. Y.	H. U. Hefty	W. E. Mathews	P. H. Daggett
North Carolina State College, Raleigh, N. C.	J. W. Fagan	W. N. Michal	D. R. Jenkins
North Carolina, University of, Chapel Hill	H. E. Thompson, Jr.	Nels Anderson	W. L. Smith
North Dakota, University of, Grand Forks, N. D.	Alfred Botten	John L. Clark	J. A. Caparo
Northeastern University, 316 Huntington Ave., Boston, Mass.	W. P. Raffone	C. H. Schamel	I. S. Campbell
Notre Dame, University of, Notre Dame, Ind.	W. C. Davis	P. W. Wadsworth	F. C. Caldwell
Ohio Northern University, Ada, Ohio	M. W. Heft	L. G. Stewart	A. A. Atkinson
Ohio State University, Columbus, O.	A. B. Crawford	Glen R. Smith	Edwin Kurtz
Ohio University, Athens, Ohio	Clarence Kelch	J. Robertson	F. G. Tappan
Oklahoma A. & M. College, Stillwater, Okla.	B. Fonts	H. C. Mitschrich	F. O. McMillan
Oklahoma, University of, Norman, Okla.	G. B. Brady	E. F. Reddy	L. A. Doggett
Oregon Agricultural College, Corvallis, Ore.	F. D. Crowther	C. C. Huggler	C. D. Fawcett
Pennsylvania State College, State College, Pa.	F. F. Wilkins	W. H. Hamilton	H. E. Dyche
Pennsylvania, University of, Philadelphia	F. H. Riordan, Jr.	D. P. Mitchell	Malcolm MacLaren
Pittsburgh, University of, Pittsburgh, Pa.	M. G. Jarrett	J. M. Myers	A. N. Topping
Princeton University, Princeton, N. J.	John Reine	H. A. Hartley	F. M. Sebat
Purdue University, Lafayette, Ind.	H. L. Lindstrom	W. C. Michels	Wm. Anderson
Rensselaer Polytechnic Institute, Troy, N. Y.	F. M. Sebast	C. F. Easterbrooks	C. C. Knipmeyer
Rhode Island State College, Kingston, R. I.	G. A. Eddy	W. F. A. Hammerling	F. F. Thompson
Rose Polytechnic Institute, Terre Haute, Ind.	D. L. Fenner	W. H. Bohlke	D. W. Griswold
Rutgers University, New Brunswick, N. J.	E. C. Siddons	W. P. Fisher	J. O. Kammerman
Santa Clara, University of, Santa Clara, Calif.	Lloyd Whitwam	Harold Eade	B. B. Brackett
South Dakota State School of Mines, Rapid City, S. D.	D. A. White	L. E. Crowell	P. S. Biegler
South Dakota, University of, Vermillion, S. D.	Stanley Boegler	Osborne Hatch	T. H. Morgan
Southern California, University of, Los Angeles, Calif.	Gilbert Dunstan	I. G. Sharp	Frank C. Stockwell
Stanford University, Stanford University, Calif.	A. V. Pering	G. E. Witham	Lewis Fussell
Stevens Institute of Technology, Hoboken, N. J.	D. B. Weststrom	W. F. Denkhaus	C. W. Henderson
Swarthmore College, Swarthmore, Pa.	T. C. Lightfoot	T. P. Hall	Charles A. Perkins
Syracuse University, Syracuse, N. Y.	G. F. Kern	B. M. Gallaher	C. C. Yates
Tennessee, University of, Knoxville, Tenn.	F. N. Green	J. L. Pratt	J. A. Correll
Texas A. & M. College of, College Station, Texas	C. A. Altenbern	G. E. Schade	J. F. Merrill
Texas, University of, Austin, Tex.	A. L. Mayfield	M. L. Hoag	S. W. Anderson
Utah, University of, Salt Lake City, Utah	J. I. Farrell	M. L. Waring	Claudius Lee
Virginia Military Institute, Lexington, Va.	R. P. Williamson	M. B. Cogbill	W. S. Rodman
Virginia Polytechnic Institute, Blacksburg, Va.	R. M. Hutcheson	H. M. Roth	R. D. Sloan
Virginia, University of, University, Va.	R. C. Small	C. E. Peterson	H. G. Hake
Washington, State College of, Pullman, Wash.	Earl Munson	J. G. Mazanec, Jr.	George S. Smith
Washington University, St. Louis, Mo.	R. L. Belshe	Roy H. Crosby	R. W. Dickey
Washington, University of, Seattle, Wash.	C. M. Murray, Jr.	Bernard Yoopp	A. H. Forman
Washington and Lee University, Lexington, Va.	R. E. Kepler	P. E. Davis	C. M. Jansky
West Virginia University, Morgantown, W. Va.	I. L. Smith	Leonard Saari	H. A. Maxfield
Wisconsin, University of, Madison, Wis.	John Sargent	C. H. Kauke	G. H. Sechrist
Worcester Polytechnic Institute, Worcester, Mass.	D. A. Calder	Edward Joslin	Charles F. Scott
Wyoming, University of, Laramie, Wyo.	John Hicks	J. W. Hinkley	
Yale University, New Haven, Conn.	W. W. Parker		
Total 95			

DIGEST OF CURRENT INDUSTRIAL NEWS

NEW CATALOGUES AND OTHER PUBLICATIONS

Mailed to interested readers by issuing companies

Motors.—Bulletins 149 and 150, 4 pp. each, on the Wagner "66" and "76" small, single-phase, repulsion-induction type motors. Wagner Electric Corporation, St. Louis, Mo.

Theatre Dimmers.—Bulletin 68, 32 pp. Describes Ward Leonard vitrohm dimmers of the interlocking resistance type for the complete control of theatre lighting. Ward Leonard Electric Company, Mount Vernon, N. Y.

Meter Switches.—Bulletin, 8 pp. Describes Wadsworth accessible fuse meter switches. The Wadsworth Electric Manufacturing Co., Inc., Covington, Ky.

Traffic Signals.—Bulletin, 8 pp. Describes traffic signs and signals of various types. The A. G. A. Company, Elizabeth, N. J.

Distribution Transformers.—Bulletin L20321, 8 pp. Describes Westinghouse distribution transformers, types SB and SKB for industrial applications. Westinghouse Electric & Manufacturing Company, East Pittsburgh, Pa.

Motors.—Bulletin 144, 16 pp., describes Fynn-Weichsel motors. Treats of power factor problems and the use of the Fynn-Weichsel motor for correcting poor power factor. Wagner Electric Corporation, St. Louis, Mo.

Rates and Load Building.—This is the title of a 32-page bulletin describing the development of the rate systems of central stations and load building. Sangamo meters for current measurement are also described. Sangamo Electric Company, Springfield, Ill.

Ball Bearing Data.—A series of new data sheets containing information for engineers concerned with motor design or operation. It is stated that some of this data has not heretofore been published. Standard Steel & Bearings, Inc., Plainville, Conn.

Galvanometers.—Catalog 20, 40 pp. Describes the complete line of L & N galvanometers. Among the instruments listed for the first time are three designed to give extremely high current, voltage, and energy sensitivity. The Leeds & Northrup Company, 4901 Stenton Avenue, Philadelphia, Pa.

Installation of Motors.—Motor Dealer's Power Manual No. PM-7162, 20 pp. Deals with the mechanical installation of electric motors and control. While this bulletin is primarily intended for the information of G-E dealers, the information contained therein should also be of interest and value to any user of motors. General Electric Company, West Lynn, Mass.

Supervisory Control Equipment.—Bulletin 1780, 8 pp. Describes the new Westinghouse panel mounted supervisory control equipment, giving the outstanding installation features of this apparatus. The publication discusses synchronous visual type control, the audible-type control, the medium-frequency-type of control and the direct-wire type. Westinghouse Electric & Mfg. Company, East Pittsburgh, Penn.

NOTES OF THE INDUSTRY

Prices Reduced on G-E Transformers and Arresters.

The General Electric Company has announced a 5 per cent reduction in prices of distribution transformers and small power transformers. This reduction is the sixth since 1920. On certain types of large transformers, reductions which average five per cent for this class of product have also been made.

Lightning arresters for transmission voltages up to 73,000 volts have been reduced approximately four per cent, and for 110,000 volts and higher, ten per cent. Arresters for distribution circuits have been reduced from three to seven per cent.

Copperweld Steel Company to Move.—The Copperweld Steel Company, Rankin, Pa., announces the purchase of a 20-acre mill site, improved with ten acres of substantial brick buildings, at Glassport, Pa., just a few miles from the company's

present location, at Rankin, Pa. The new plant will enable the company to consolidate all departments under one roof with a continuance of the control of every stage of manufacture, from raw material to finished product. Production will be maintained at the present Rankin and Braddock mills during the installation of the most modern mill equipment in the newly acquired buildings. It is planned to have the new mill completed and in full production January 1, 1928.

Lower Prices for Westinghouse Lightning Arresters.—The Westinghouse Electric & Manufacturing Company has announced price reductions on auto-valve lightning arresters, which include a ten per cent reduction on the high-voltage station type arresters; a reduction of five per cent on low-voltage station arresters of 73 kv. and less, and a cut of from three to seven per cent on type LV distribution a-c. arresters.

Conference on Simplification of One-Piece Porcelain Insulators.

A simplified practise recommendation, covering varieties of one-piece porcelain insulators, was adopted by a general conference of the manufacturers and users of this commodity, held under the joint auspices of the National Committee on Metals Utilization and the Division of Simplified Practise on Friday, June 3, 1927. This program which will be identified as Simplified Practise Recommendation No. 73, provides for a total reduction from 272 varieties to 210, corresponding to an elimination of 22.4 per cent. The deletion of these items will take place in two stages. Twenty-three items will be deleted on the effective date of the recommendation, October 1, 1927. The remaining thirty-nine will, in the course of time, gradually be dropped from production for it is anticipated that the trade will progressively discourage their use.

While the conference frankly believed that further eliminations could be made without embarrassing the industry, it stated that this first application of the principles of Simplified Practise to porcelain insulators was sufficient in scope to bring the industry closer to the ultimate standards which will serve all interests best at a minimum of expenditure. It was also the opinion of the conference that the successful operation of Simplified Practise Recommendation No. 73 would not only pave the way for further reductions later on, but would also stimulate other branches of the electrical industry to similarly clear out the superfluous varieties of many of its commodities. This is the fourth project to be passed through the regular procedure of the Department of Commerce by the electrical industry.

Pursuant to the recommendation of the conference, the National Committee on Metals Utilization will organize a Standing Committee of the porcelain insulator industry, to revise or otherwise review this recommendation once a year, for the purpose of keeping it thoroughly useful and abreast of existing conditions and advancement of the art of insulation.

The names of those in attendance at the conference were as follows: George O. Anderson, representing General Porcelain Company, Parkersburg, W. Va.; Fred L. Bishop, Hartford Faience Co., Hartford, Conn.; R. H. Dalglish, American Electric Railway Association, New York; L. W. Freeman, Truscon Steel Company, Youngstown, O.; George I. Gilchrest, Westinghouse Electric & Mfg. Company, Derry, Pa.; H. R. Holmes, The R. H. Thomas & Sons Co., East Liverpool, O.; W. A. Hyde, National Association of Purchasing Agents, New York; C. W. Kettron, Illinois Electric Porcelain Co., Macomb, Ill.; R. S. Kirkwood, War Dept., Washington, D. C.; Alexander Maxwell, National Electric Light Association, New York; Jay R. Palmer, Ohio Brass Company, Mansfield, O.; Joseph V. Patterson, Findlay Electric Porcelain Company, Findlay, O.; Capt. W. K. Synder, U. S. Marine Corps, Edwin W. Ely, representing National Committee on Metals Utilization; A. B. Galt, Division of Simplified Practise; Arthur Halsted, Bureau of Standards.



KERITE

In 1752 Franklin invented the Lightning Conductor and identified lightning and electricity. A century later, Day invented

KERITE

Over half a century of experience has identified it as the most reliable and permanent insulation for Electrical Conductors



KERITE INSULATED WIRE & CABLE COMPANY
NEW YORK CHICAGO

"ONE THING WELL DONE"

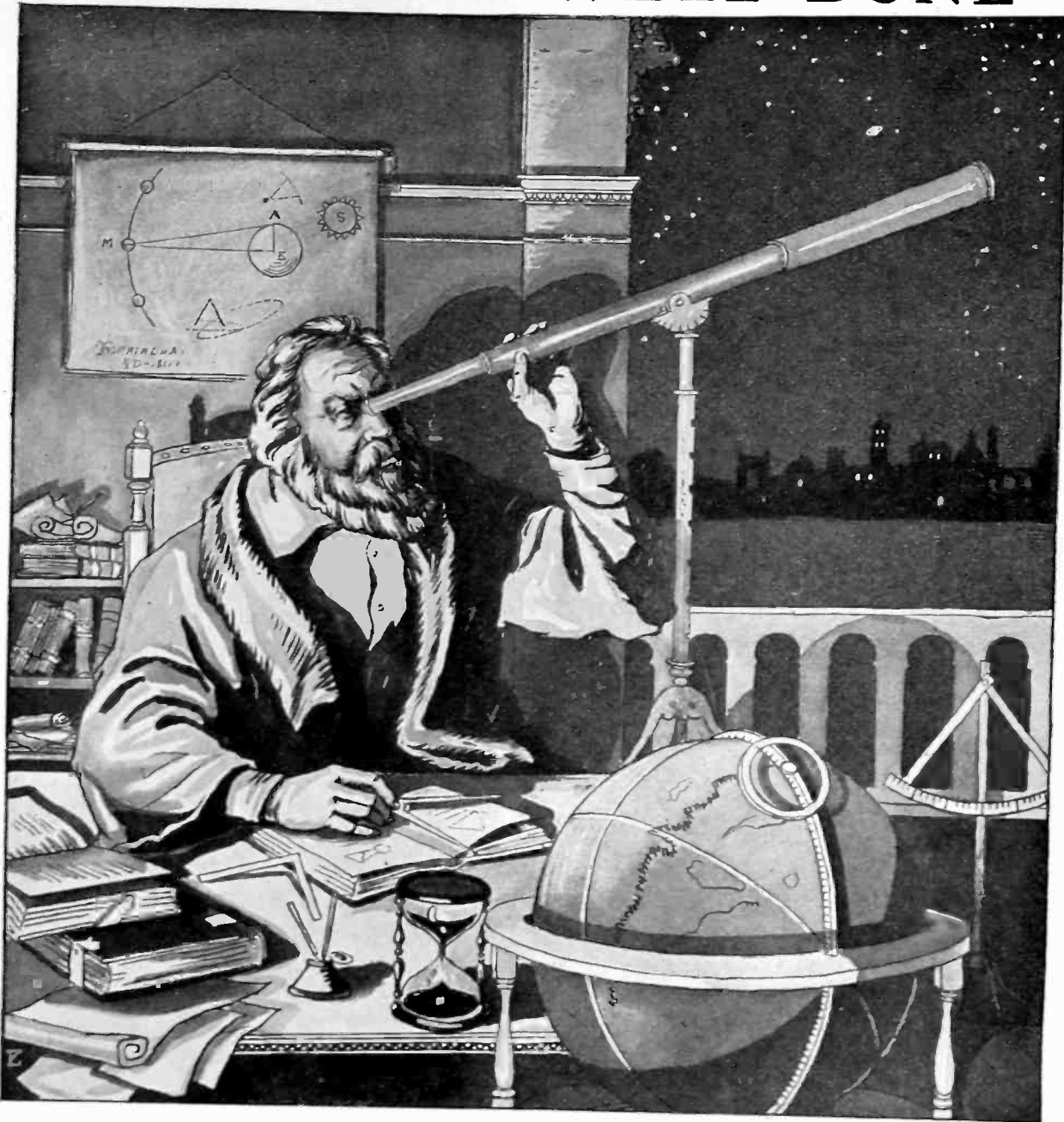

Galileo—greatest astronomer and mathematician of all time—set before himself a rigid standard of devotion to one purpose: a lifetime of study of the solar system and its infinite mysteries. His remarkable discoveries and calculations are the foundation of all modern astronomy.

Establishing the principles of a modern science—ELECTRICAL PROTECTION—has been

Cutter's sole enterprise since 1888. There can be no gainsaying the fact that I-T-E Circuit Breakers have introduced—throughout the past 40 years—a measure of safety, security and electrical economy that has become a recognized standard throughout the realm of industry and commerce.

"The Circuit Breaker Art of the World is what we have made it."

CUTTER

A 6000 Ampere, 250 volt, 2-pole overload, solenoid operated I-T-E Air Circuit Breaker installed in the Chicago steel district. Equipped with Auto-Ite, or mechanical non-closable-on-overload feature to protect equipment and employees and to guard against production delays.

THE CUTTER COMPANY, EST. 1888

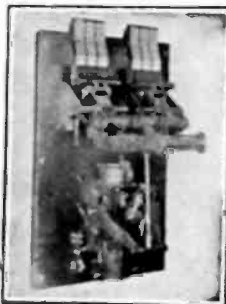

The "Handbook of the I-T-E Circuit Breaker"—with its 263 pages of text, tables, charts and illustrations on electrical protection—is worth having. Your copy will be mailed free on request.

505 N. 19th STREET—PHILADELPHIA

Please mention the JOURNAL of the A. I. E. E. when writing to advertisers.

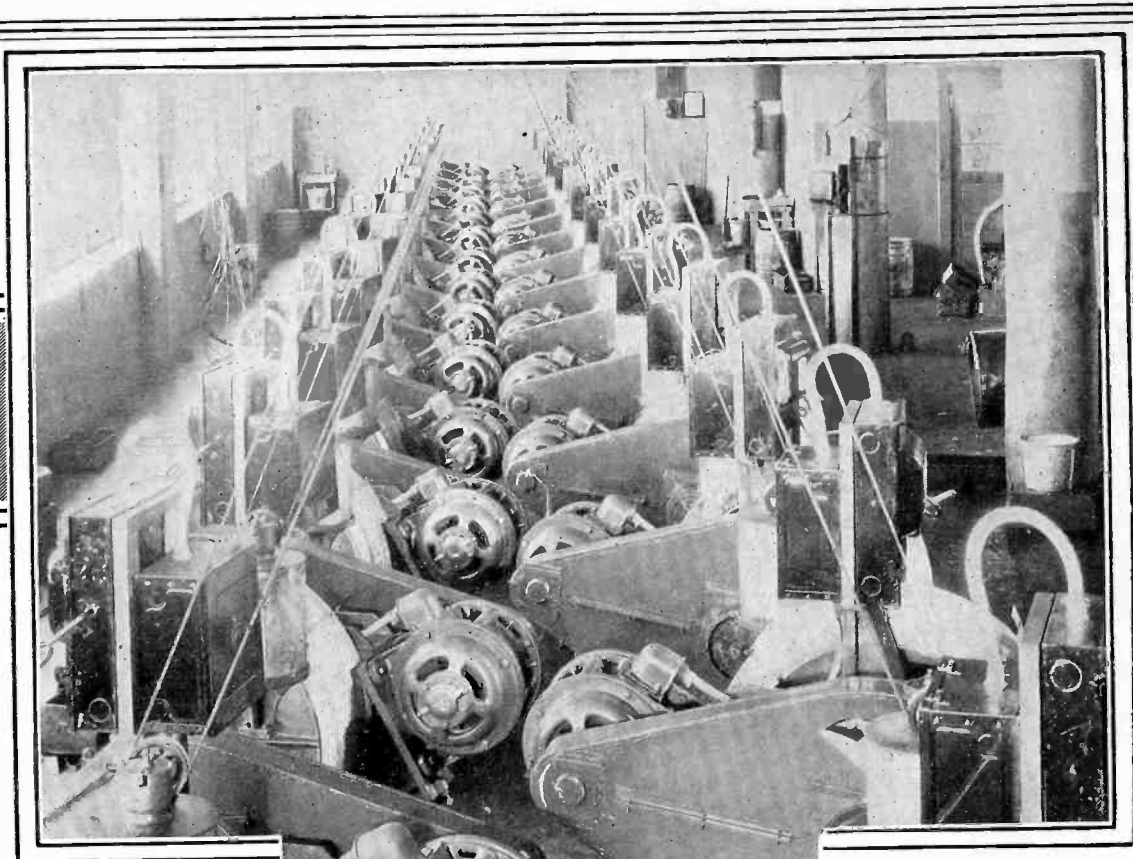

New Departure Ball Bearing equipped electric motors were specified on this job because: First, annual lubrication is sufficient; Second, motor feet

can be mounted at the unusual angle shown; Third, the driven machines can be mounted closely together on the floor, as easy access to the motor is not necessary.

New Departure Advantages and Economies Are Money Savers in Electric Motors

Write for copy of "Cutting Your Costs," non-technical treatise on the application of ball bearings to electric motors; also, "Booklet K," technical treatise on the same subject. Either or both sent on request.

Electric motors equipped with New Departure Ball Bearings operate without friction and without wear continuously and uninterruptedly requiring lubrication only once in 9 to 12 months.

Because of these superior advantages production is increased at a substantial reduction of maintenance cost, proving that New Departure Ball Bearings are more economical than any other type of anti-friction bearing.

The New Departure Manufacturing Company
 Detroit BRISTOL, CONNECTICUT Chicago



New Departure Quality Ball Bearings

583



DOSSERT

Solderless Connectors

are furnished in every required size and type for conductors from No. 14 B & S gauge, to large cables of 3,000,000 cir. mils. They are the adopted standard in

Central Station Practice



DOSSERT

Solderless Connectors

Tests which have been made from time to time by users of Dossert connectors show that the connectors run as at low temperature as enabled by the wires connected to them.

Send for Catalog Twenty

Dossert & Company

H. B. LOGAN, President
242 West 41st Street, New York



Please mention the JOURNAL of the A. I. E. E. when writing to advertisers.



Always associated with the best

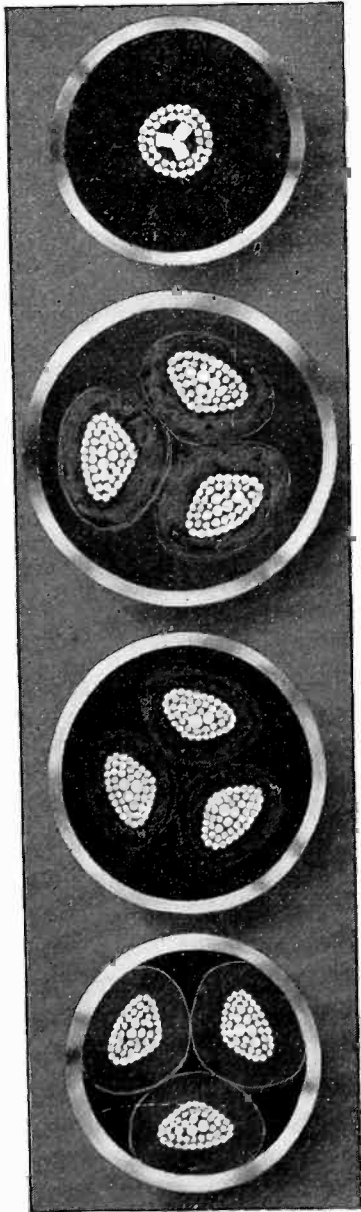

75,000 V.
52/64

33,000 V.
 $\frac{23 \times 9}{64}$

27,000 V.
 $\frac{18 \times 12}{64}$

Type CS.
27,000
22/64

13,000 V.
 $\frac{9 \times 5}{64}$

5,000 V.
 $\frac{6 \times 5}{64}$

2,300 V.
 $\frac{4 \times 3}{64}$

600 V.
8/64

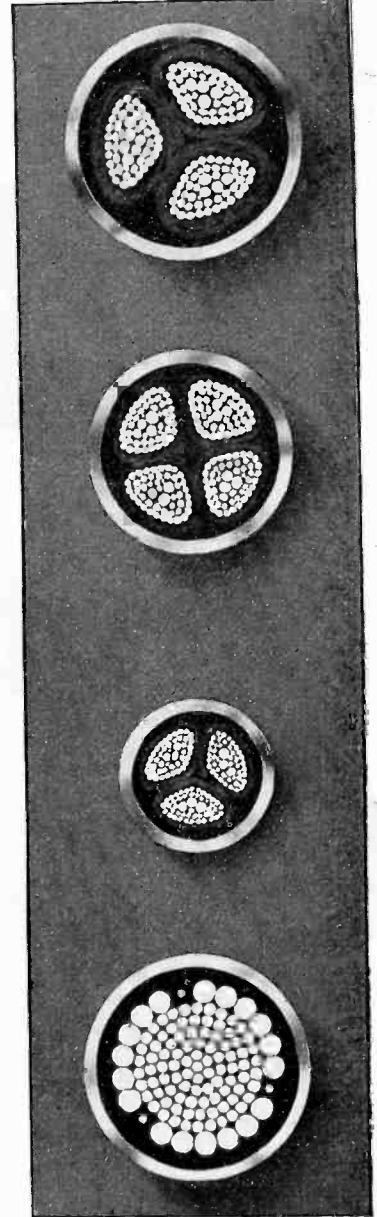

HABIRSHAW CABLE AND WIRE CORPORATION

10 East 43rd Street, New York City

Plants: Yonkers, N. Y.—Bridgeport, Conn.—Nepperhan, N. Y.

HABIRSHAW

PROVED BY THE TEST OF TIME

Paper Insulated Cable—Varnished Cambric Insulated Cable—Armored Cable—Rubber Insulated Cable

Please mention the JOURNAL of the A. I. E. E. when writing to advertisers.

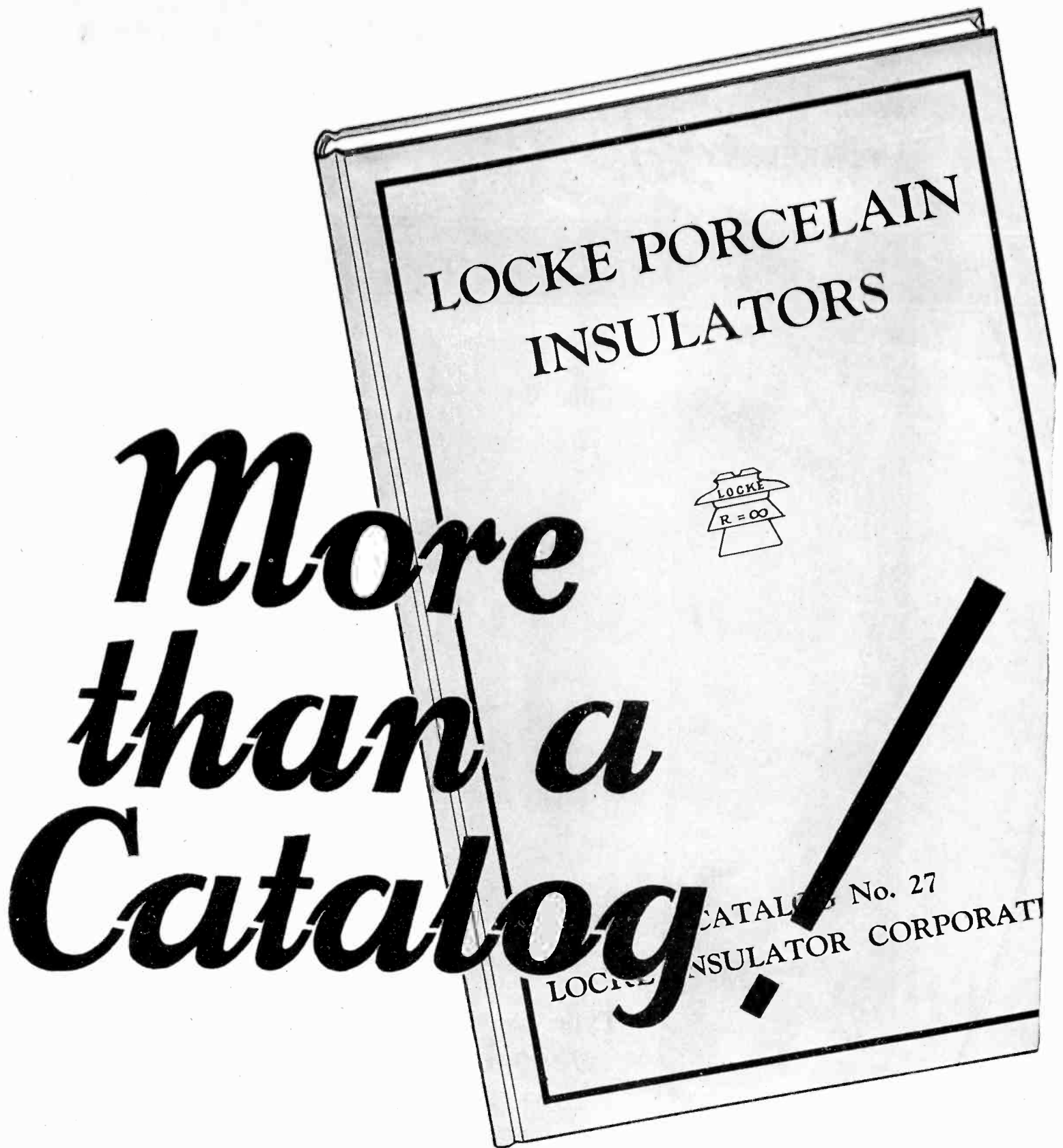

This book is more than a mere catalog. It is an invaluable textbook to any executive who is in any way concerned with high voltage transmission. If you have not yet received your copy, your name and address on a post-card will bring it to your desk.

LOCKE INSULATOR CORPORATION
BALTIMORE MARYLAND

Please mention the JOURNAL of the A. I. E. E. when writing to advertisers.

American Transformer

The Pioneer Transformer Manufacturer for Cottrell Precipitation Installations

With the rapidly increasing use of pulverized fuel for boiler firing, particularly in the large boiler plants of public utility power houses, the emission from the stacks of the powdered fuel ash is presenting a very serious problem to the operating companies on account of the nuisance resulting from passing this finely divided material into the atmosphere and its inevitable deposit on surrounding property.

The Cottrell Electrical Precipitation Process is a guaranteed method of solving this difficult problem.

From the very beginning, the American Transformer Company has specialized in Cottrell Precipitation Processes and is known throughout the United States as the pioneer transformer manufacturer for this work.

The largest mining and chemical companies have been users of American Transformers for many years. Cottrell Precipitation Process Installations using American Transformers with dates of installation are as follows:

A Few Typical Installations Still in Use After More Than 10 Years' Service

Raritan Copper Works, Perth Amboy, 1914
 Duquesne Reduction Co., Pittsburgh, Pa., 1914
 Standard Oil Co. of N. J., Bayonne, N. J., 1915
 Mineral Point Zinc Co., Mineral Point, Wis., 1915
 Union Carbide Co., Niagara Falls, N. Y., 1916.

Typical Installations Made Recently During 1923

American Smelting & Refining Co.
 Standard Oil Company of N. J.
 Union Gas & Electric Co., Cincinnati
 Union Smelting & Refining Co.

During 1924

Pennsylvania Salt Mfg. Co.
 Hoyt Metal Co.
 Baltimore Copper Smelting & Refining Co.

During 1925

St. Louis County Gas Co. Tampa Gas Co.
 Citizens Gas & Electric Co., Indianapolis North Shore Gas Co

During 1926-1927

Climax Molybdenum Co. Bird & Sons, Inc.
 Ashland By-Products Coke Co. Semet-Solvay Co.
 Wisconsin Gas & Electric Co. Lazote, Inc. and many others
 U. S. Industrial Chemical Co.

Continuous production has been maintained since the early development of this process.

If you are interested in this process for dust recovery or smoke abatement, write us for full information.

American Transformer Co.
 176 Emmett St., Newark, N. J.

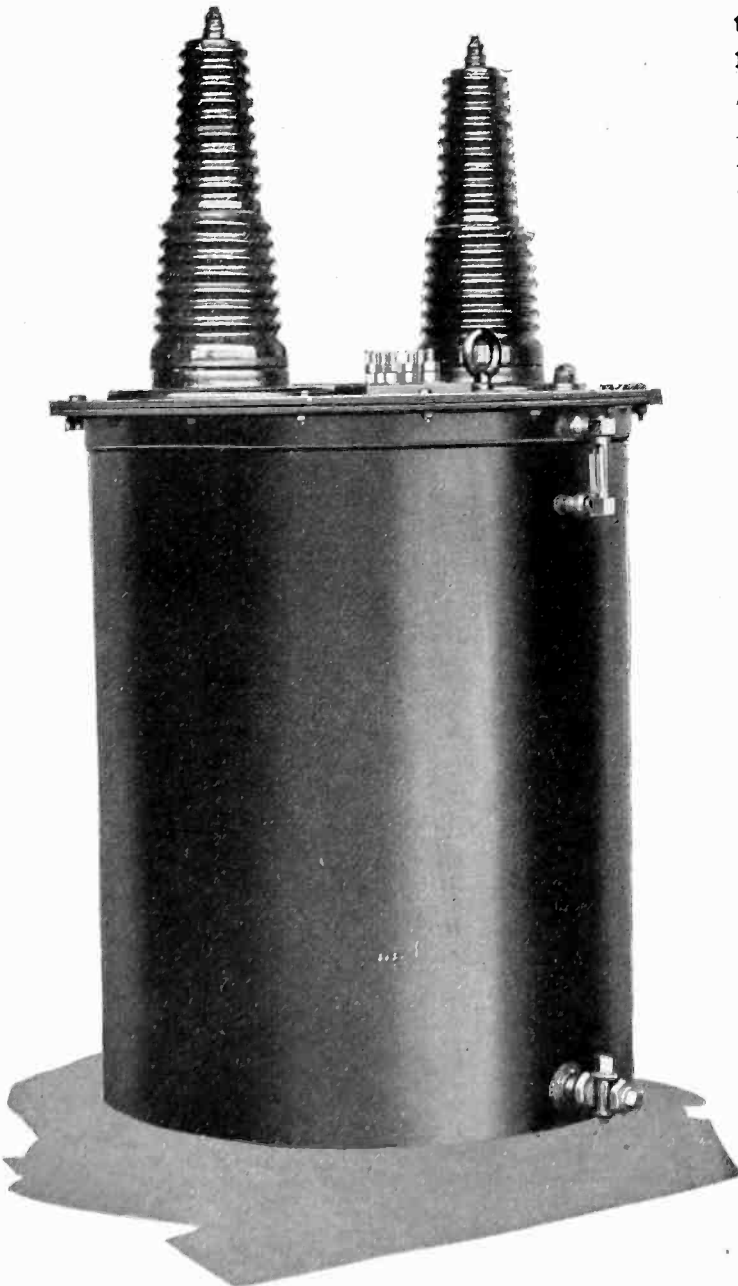

Typical American Transformer for Cottrell Precipitation Process

A special transformer for every industrial requirement

Please mention the JOURNAL of the A. I. E. E. when writing to advertisers.

Weigh the value of

A Partial List of G-E Oil Circuit Breakers

TYPE	Voltages	Current-Carrying Capacities	Interrupting Capacities (Amps. at rated volts)
INDUSTRIAL TYPES			
FP-115	110 to 550	50	400 to 500
FP-110	110 to 550	50	400 to 500
FK-20	2500	60 to 300	1300 to 1650
MANHOLE AND POLE TYPES			
FP-104	7500	200	240
FP-7	4500 to 15000	100 to 200	240 to 400
FKO-37	15000 to 37000	400 to 600	1000 to 1500
SWITCHBOARD TYPES			
FK-13	3300	200	1750
FK-5	600 to 7500	200 to 800	1400 to 15000
FK-35 and 35Y	600 to 7500	400 to 800	1700 to 20000
FK-12	15000	300 to 800	1000
FK-12B	4500	1500	4000
FK-132A and B	7500 to 15000	400 to 1200	1500 to 5300
FK-32C	7500 to 15000	600 to 1200	3600 to 8300
STATION TYPES			
FK-34A	4500	2000	6500
FK-25	600 to 2500	3000 to 5000	7200 to 30000
FK-53B	15000 to 25000	400 to 2000	2200 to 4600
FK-54	7500	600 to 1600	10500
FH-103, 203	7500 to 35000	500 to 2000	4700 to 32000
FH-206, 209	7500 to 35000	500 to 4000	6700 to 69000
FHD-17	15000	600 to 5000	32000
FHD-21	15000	600 to 4000	50000
FK-230A	15000 to 25000	600 to 3000	10700 to 30000
FHK-230B	15000 to 37000	600 to 3000	18500 to 60000
FK(O)-136A	25000 to 110000	400 and 800	1200 to 2300
FK(O)-236A	15000 to 73000	400 and 800	2000 to 7000
FHK(O)-236B	15000 to 88000	600 to 1200	3300 to 14000
FK(O)-39A	110000 to 154000	800	2600 to 3300
FHK(O)-39B	15000 to 220000	600 to 2000	2600 to 30000
FHK(O)-39C	15000 to 220000	600 to 2000	3900 to 38000

There's a G-E Breaker for every application



Oil Circuit Breakers

—part of the complete line of General Electric equipment to control and protect power generating and distributing apparatus.

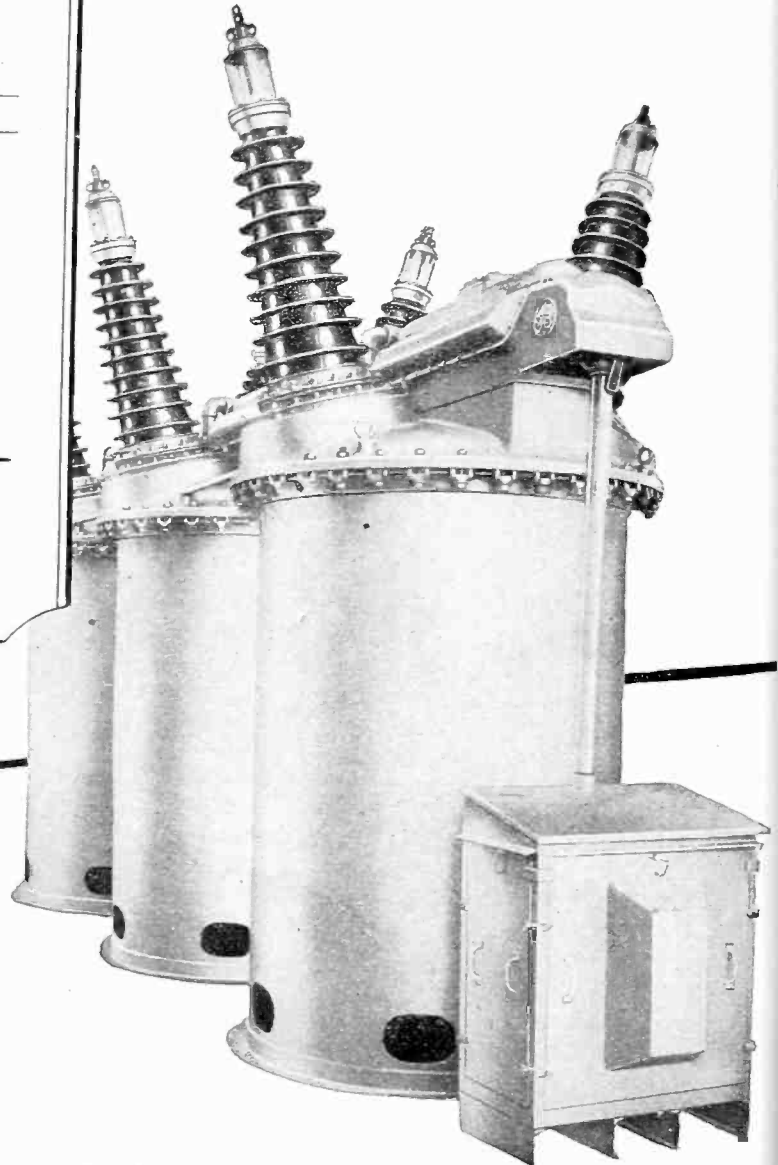

Type FHKO-39, 132,000-volt Oil Circuit Breaker

GENERAL

GENERAL ELECTRIC COMPANY, SCHENECTADY, N. Y.

Please mention the JOURNAL of the A. I. E. E. when writing to advertisers.

Engineering Analysis

Improvement of oil circuit breakers depends upon more than experience in design and manufacture and the observation of operation and test. Engineering analysis is essential if the information obtained is to be used to advantage.

G-E engineers use the data accumulated during thirty-two years to acquire exact knowledge of oil circuit breaker construction and requirements.

The value of this knowledge in designing new types and sizes of G-E Breakers is notably demonstrated by the success of the first 220,000-volt breakers ever built; its value to all G-E Breakers is demonstrated by the unequalled operating record of the complete line.

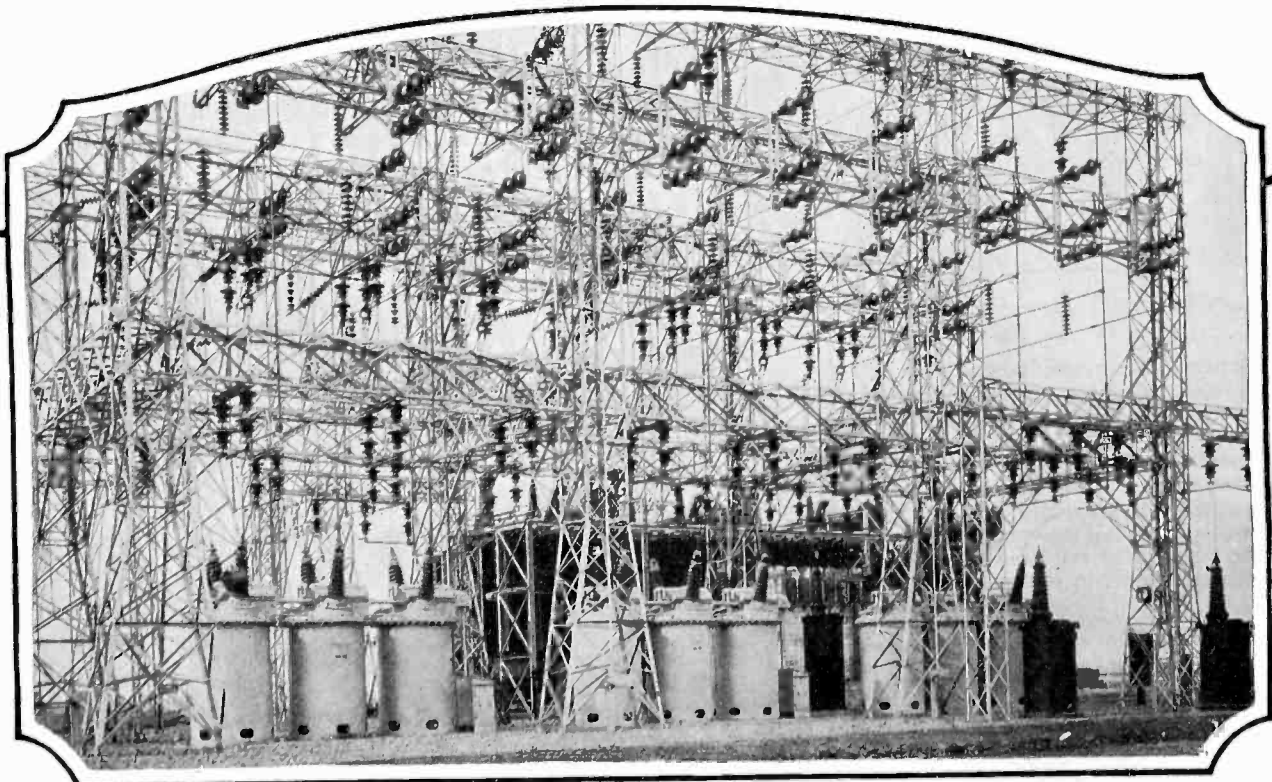

Type FHKO-39, 110,000-volt Oil Circuit Breakers in the Wilson Substation of the North American System, Merced, California

470-4

ELECTRIC

SALES OFFICES IN PRINCIPAL CITIES

Please mention the JOURNAL of the A. I. E. E. when writing to advertisers.

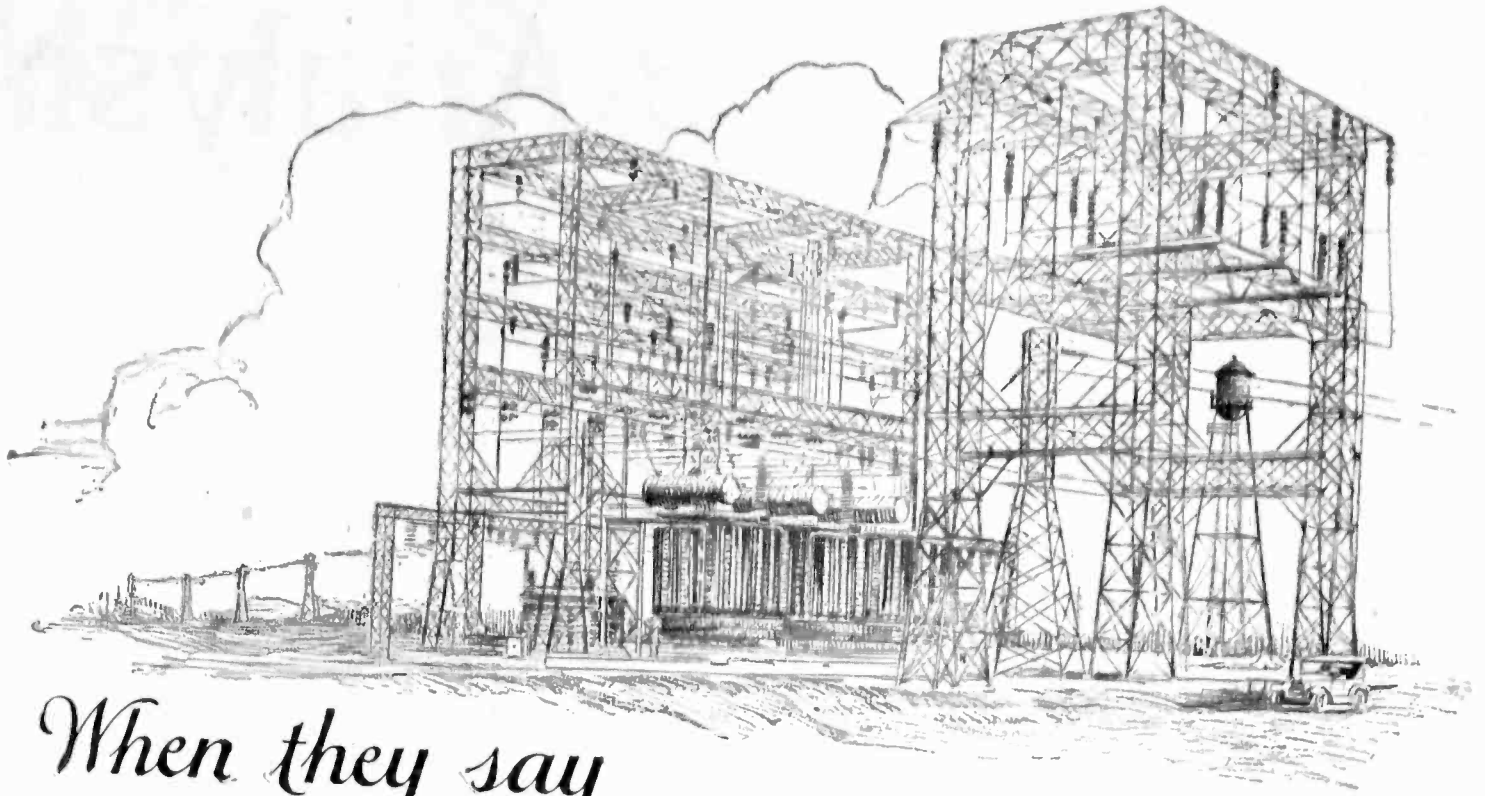

When they say
Tie the systems together

That means *more* power and *longer* distances. How these greater demands are being met with G-E transformers and protective and switching equipment is exemplified by the Wilson Substation shown in the illustration. Here, with a 90,000-kv-a. bank of G-E transformers, two great networks have been united to establish the final link of a transmission line extending the entire length of California.

General Electric enjoys the distinction of having pioneered many of the developments in power transformers throughout the range of established ratings, always endeavoring to keep in advance of requirements. Its original work in the development of other transformer and accessory products is hardly less conspicuous.

As a source of equipment for all transmission and distribution work, General Electric offers a very comprehensive service.

General Electric's position as a builder of equipment for transmission and distribution is unique. Not only can G-E Transformer Products be supplied for every normal requirement, but a service is available to study any special problem, and, if necessary, develop the equipment required to deliver reliable power in suitable form.

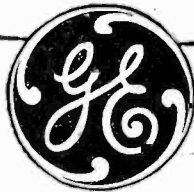

Transformer Products
— the Standards of Quality

GENERAL ELECTRIC 410-4

GENERAL ELECTRIC COMPANY, SCHENECTADY, N. Y. SALES OFFICES IN PRINCIPAL CITIES

Please mention the JOURNAL of the A. I. E. E. when writing to advertisers.



STAUNCH

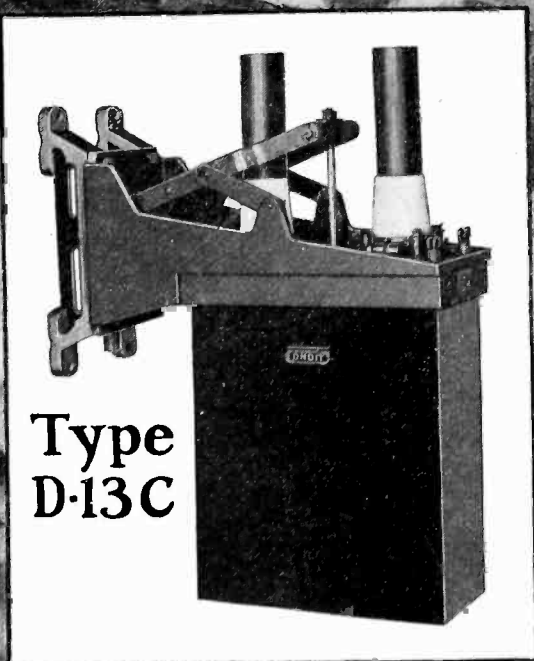

**Type
D-13 C**

—and firm on its solid foundation, the lighthouse calmly endures the onslaughts of storm driven seas. It is the same principle of solid foundation applied to the Condit type D-13 C Oil Circuit Breaker in its staunch and rigid steel frame that enables it to withstand the stresses and strains encountered in the interruption of high power circuits.

CONDIT ELECTRICAL MFG. CORPORATION
Manufacturers of Electrical Protective Devices
Boston, Mass.

Northern Electric Company
LIMITED

Sole Distributors for the Dominion of Canada

SPECIFICATIONS: 1, 2, 3, and 4 pole, manually and electrically operated, 1200 amperes or less, 15000 volts, 600 amperes or less, 25000 volts. Interrupting capacity 2700 amperes at 15000 volts.

CONDIT

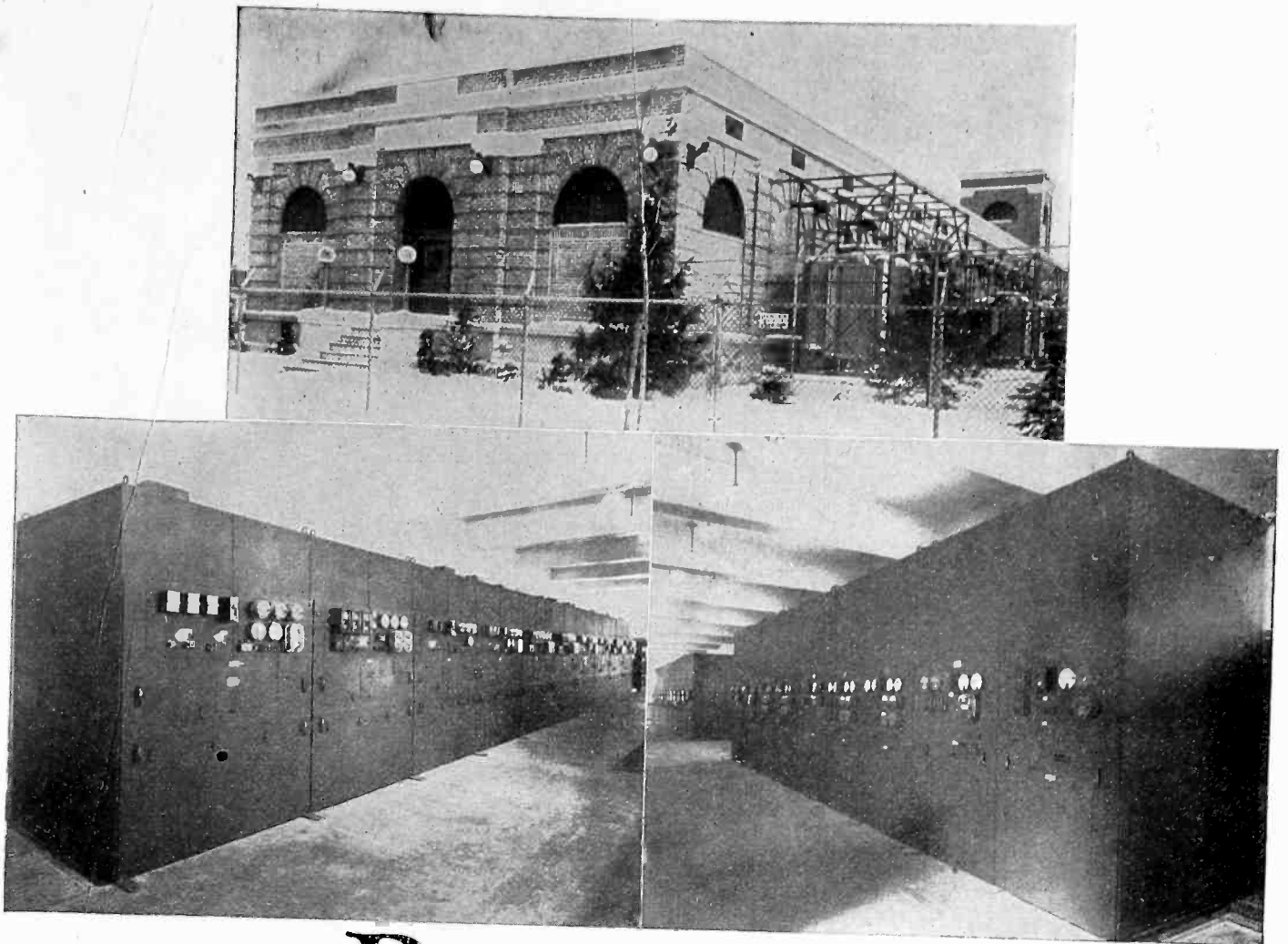

RELIABILITY



TO the inherent advantages of truck-type equipment, Westinghouse adds the following:

Extremely strong construction.

Equipment which is thoroughly interlocked assuring correct operation at all times.



Automatic shutters covering all live parts when the truck is removed.

Two-position secondary contacts which permit complete testing of equipment with primary contacts open.

Trucks and housings which are factory assembled and tested, and shipped as complete units. This means that installation time and expense are cut to the minimum.



Westinghouse Electric & Manufacturing Company
East Pittsburgh Pennsylvania

Sales Offices in All Principal Cities of
the United States and Foreign Countries

Westinghouse

Please mention the JOURNAL of the A. I. E. E. when writing to advertisers.

X93605

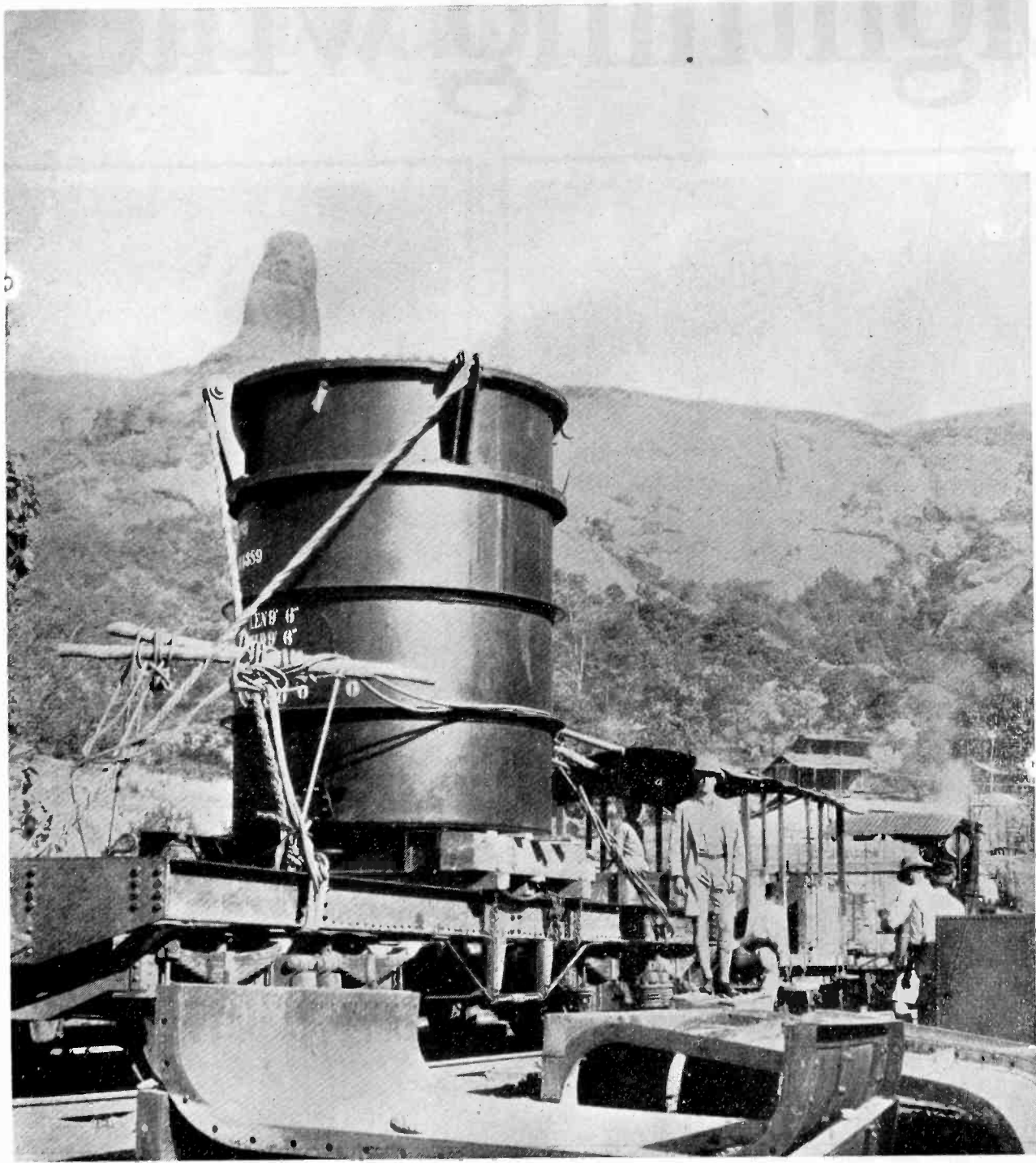

FERRANTI TRANSFORMERS

FERRANTI, INC.
130 W. 42ND STREET
NEW YORK

FERRANTI, LTD.
HOLLINWOOD
ENGLAND

FERRANTI ELECTRIC
LIMITED
TORONTO, CANADA

Please mention the JOURNAL of the A. I. E. E. when writing to advertisers.

Lightning writes its

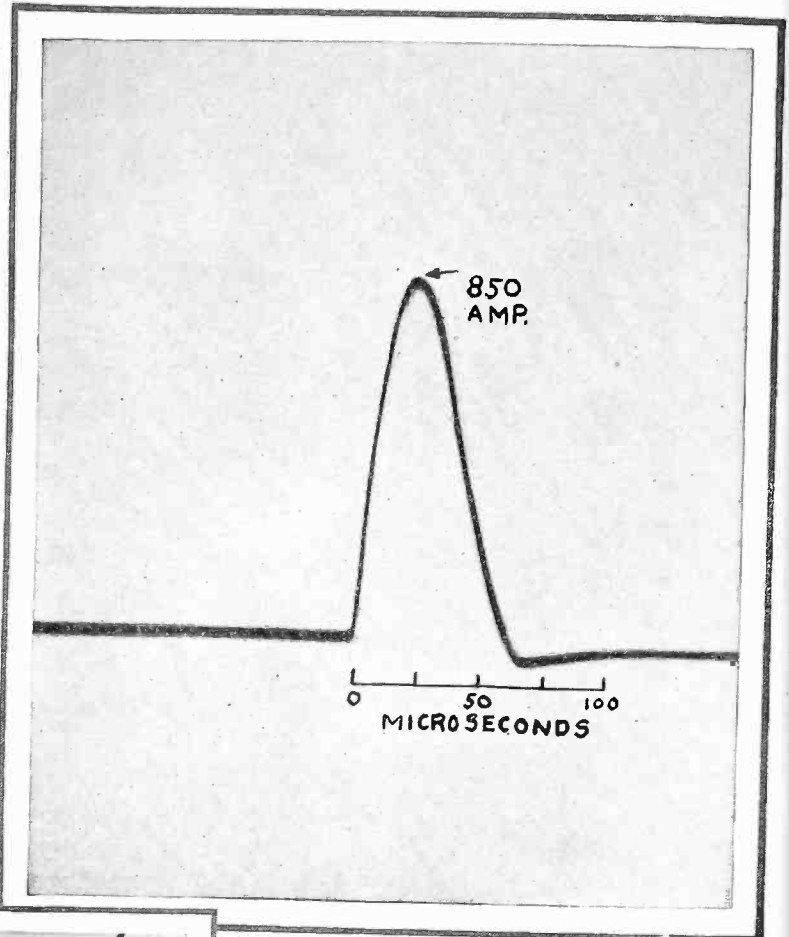
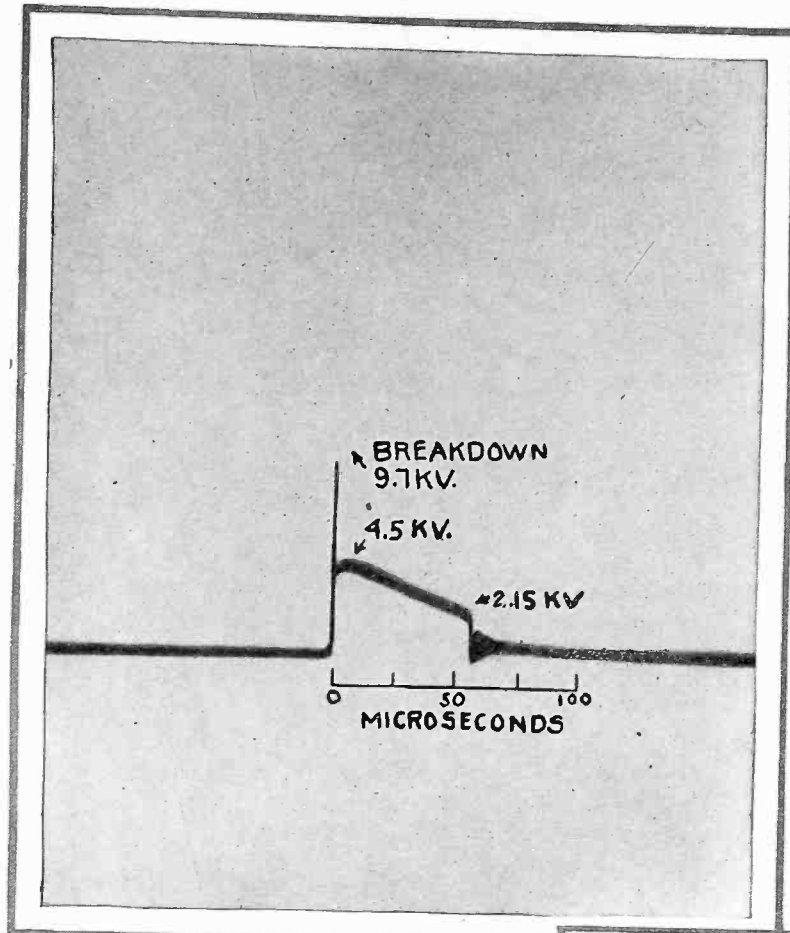

Volt-time characteristic of G-E pellet-type oxide film lightning arrester, recorded by the Dufour oscillograph

Ampere-time characteristic of G-E pellet-type oxide film lightning arrester showing the extremely short duration of the current flow



For more information regarding the operation of the Cathode-Ray Oscillograph and data obtained by its use, see the *GENERAL ELECTRIC REVIEW* for October, 1926, or send for reprint No. GEA-549.

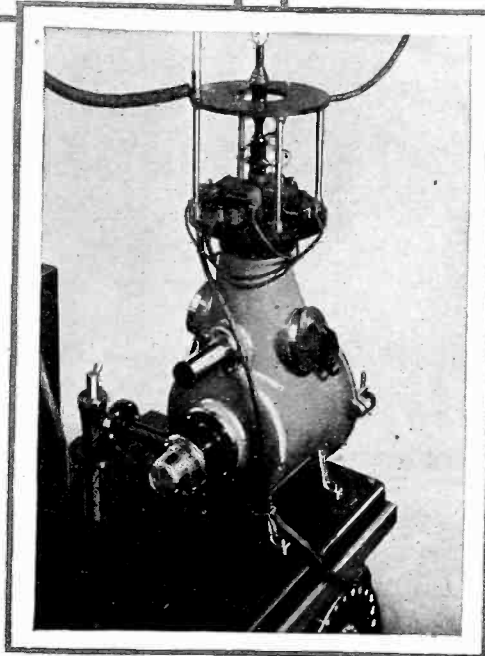

The Dufour Cathode-Ray Oscillograph, adapted by General Electric engineers to the photography of steep wave-front electrical transients

GENERAL

GENERAL ELECTRIC COMPANY, SCHENECTADY, N. Y.

Please mention the JOURNAL of the A. I. E. E. when writing to advertisers.

signature

—and verifies G-E arrester design

For the first time the protective characteristics of a lightning arrester have been recorded, showing clearly the volt-time, ampere-time, and volt-ampere curves.

Knowledge of what actually takes place inside an arrester while it is discharging lightning is one of the things that engineers have been seeking for many years. Part of that knowledge was gained when General Electric built the "Lightning Generator". Now the information has been made complete by means of the Dufour Oscillograph, which photographs with absolute fidelity the performance of the lightning arrester under conditions which may be caused by lightning.

By these exact scientific methods General Electric proves the protective qualities of its lightning arresters.

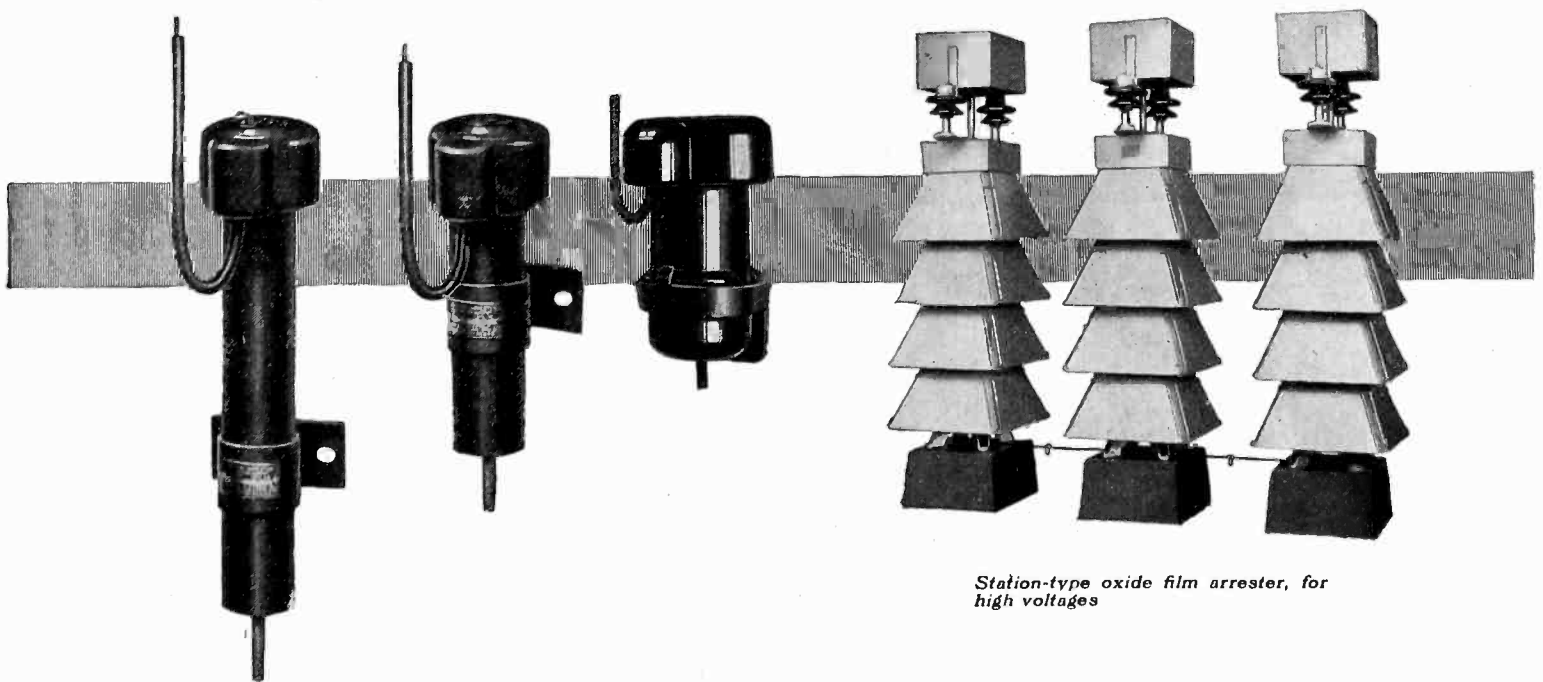

Pellet-type oxide film arresters of three different ratings. Built for voltages from 1000 to 50,000 volts

Station-type oxide film arrester, for high voltages

440-4

ELECTRIC

SALES OFFICES IN PRINCIPAL CITIES

Please mention the JOURNAL of the A. I. E. E. when writing to advertisers.

PRACTICE MAKES PERFECT

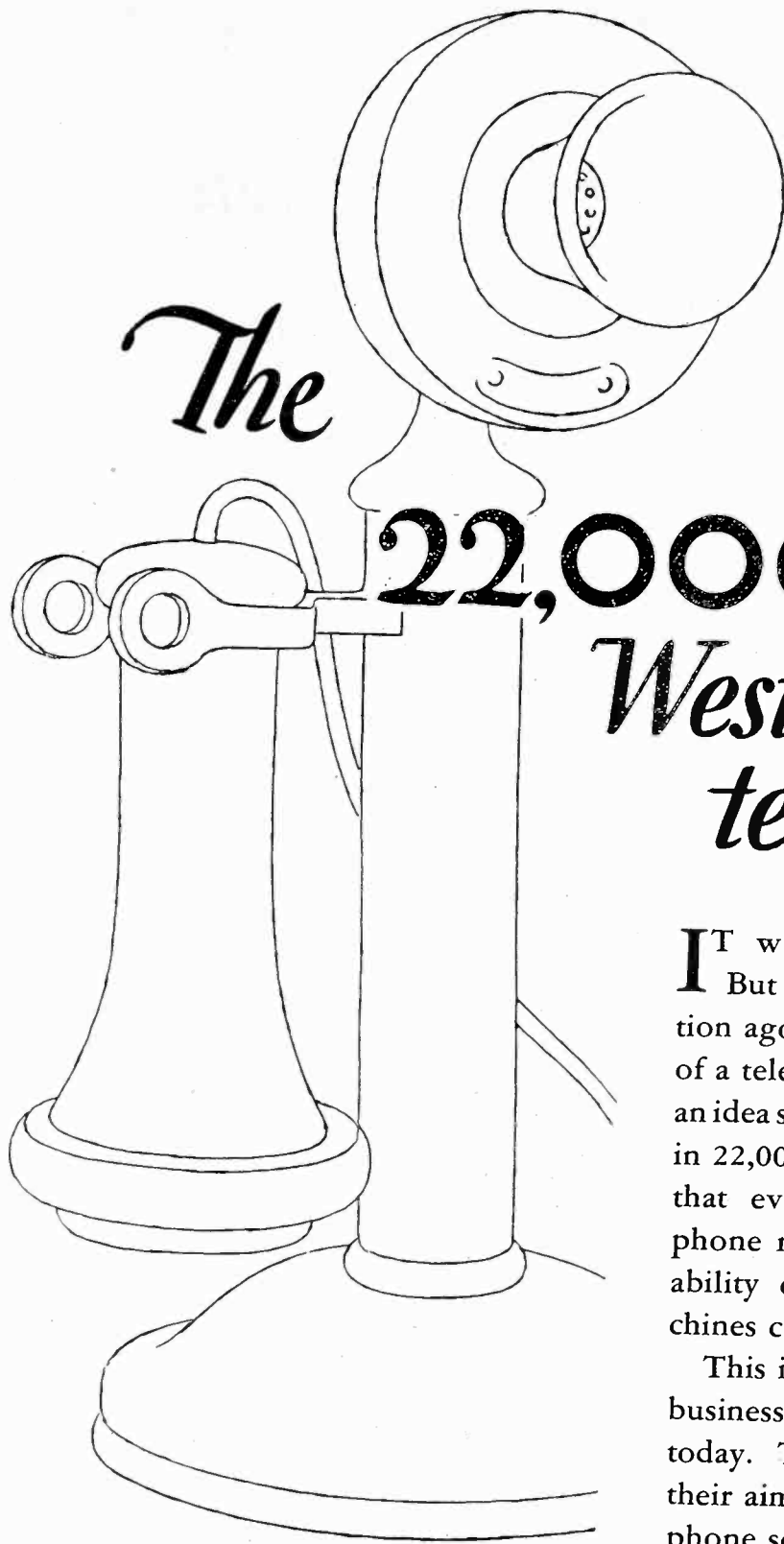

The

22,000,000th

*Western Electric
telephone*

IT was finished only recently. But it began well over a generation ago. It began, not in the shape of a telephone, but in the shape of an idea strong enough to be repeated in 22,000,000 telephones—the idea that every Western Electric telephone must be as good as human ability coupled with efficient machines could make it.

This ideal of the founders of the business still inspires the workers of today. That it will continue to be their aim is one assurance that telephone service in America will continue to maintain its supremacy.



*Back
of your
telephone*

Western Electric

SINCE 1882 MANUFACTURERS FOR THE BELL SYSTEM

Please mention the JOURNAL of the A. I. E. E. when writing to advertisers.



MATTHEWS FUSWITCHES

and DISCONNECTING SWITCHES

They enable you to give better service

Matthews Disconnecting Switches have made it possible for operating companies to isolate trouble, or transfer load from one feeder or substation to another, thereby rendering better service to the using public.

Matthews Disconnecting Switches are made of the best of materials and will withstand large overloads. Their long life and dependability make them an asset to any distribution system.

For more detailed information, write for Bulletin No. 502, or should you prefer, our representative will be glad to call.

Your nearest Electrical Distributer will be glad to serve you on Matthews Products

W. N. MATTHEWS CORPORATION
3706 Forest Park Blvd., St. Louis, U. S. A.

82

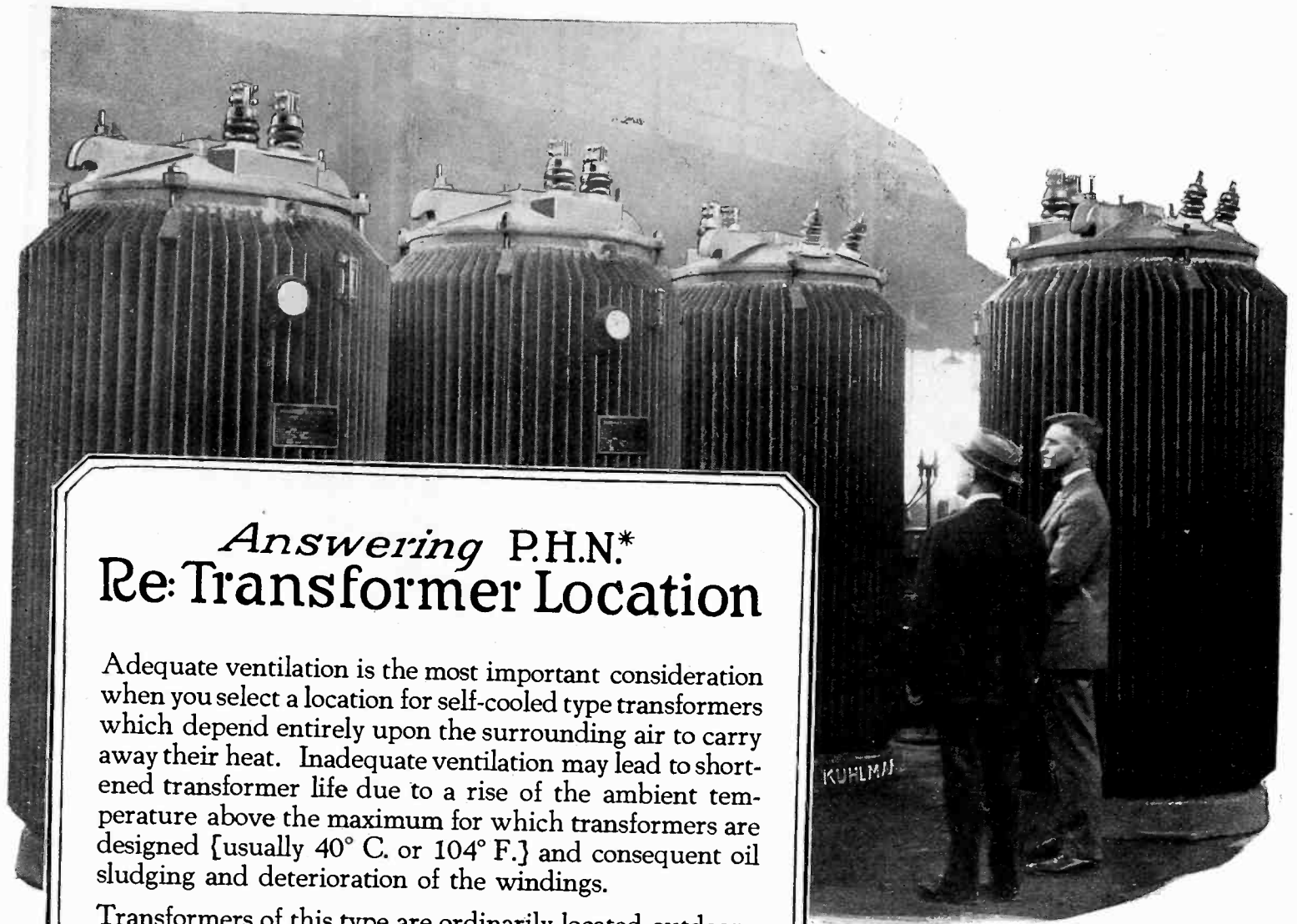

Answering P.H.N.* Re: Transformer Location

Adequate ventilation is the most important consideration when you select a location for self-cooled type transformers which depend entirely upon the surrounding air to carry away their heat. Inadequate ventilation may lead to shortened transformer life due to a rise of the ambient temperature above the maximum for which transformers are designed [usually 40° C. or 104° F.] and consequent oil sludging and deterioration of the windings.

Transformers of this type are ordinarily located outdoors, but even then care must be taken that they are not placed in a constricted space between buildings or fences which might prevent free air circulation.

When indoor installation is required, it is essential not only that the room is well ventilated, but also that the transformers are separated [at least 24" to 36" depending on transformer size] from one another and from adjacent walls, ceilings, partitions, etc., to permit free circulation about the tanks.

Accessibility of the location for easy installation and inspection is another factor. Protection of the transformers against tampering is also frequently an element in determining their location.

This is one of a series of answers to important questions frequently asked us regarding transformer design, construction and operation.

*"Where shall I locate these transformers?"
?

KUHLMAN TRANSFORMERS

KUHLMAN ELECTRIC CO., Bay City, Michigan

Akron.....High and Barges Sts.	Dallas.....Unit 2, Santa Fe Bldg.	Minneapolis.....1004 Marquette Ave.	Salt Lake City.....134 West 2d South St.
Atlanta.....411 Glenn Bldg.	Denver.....1843 Wazee St.	New York.....Graybar Bldg.	San Francisco.....Call Bldg.
Boston.....69-71 High St.	Detroit.....3-260 Gen. Motors Bldg.	Oklahoma City.....1013 Braniff Bldg.	Seattle.....314 Seneca St.
Buffalo.....280 Carolina St.	Greensboro, N. C.....333 S. Davie St.	Omaha.....923 W. O. W. Bldg.	Toledo.....424 Spitzer Bldg.
Chicago.....844 Rush St.	Indianapolis.....202 Indiana Ter. Whse.	Philadelphia.....1700 Walnut St.	Washington.....1328 New York Ave.
Cincinnati.....1308 Union Trust Bldg.	Los Angeles.....316 American Bank Bldg.	Pittsburgh.....839 Oliver Bldg.	N. W.
Cleveland.....627 Union Trust Bldg.	Milwaukee.....1031 Clybourn St.	Saint Paul.....1479 Blair St.	York, Pa.....335 W. Market St.

Please mention the JOURNAL of the A. I. E. E. when writing to advertisers.

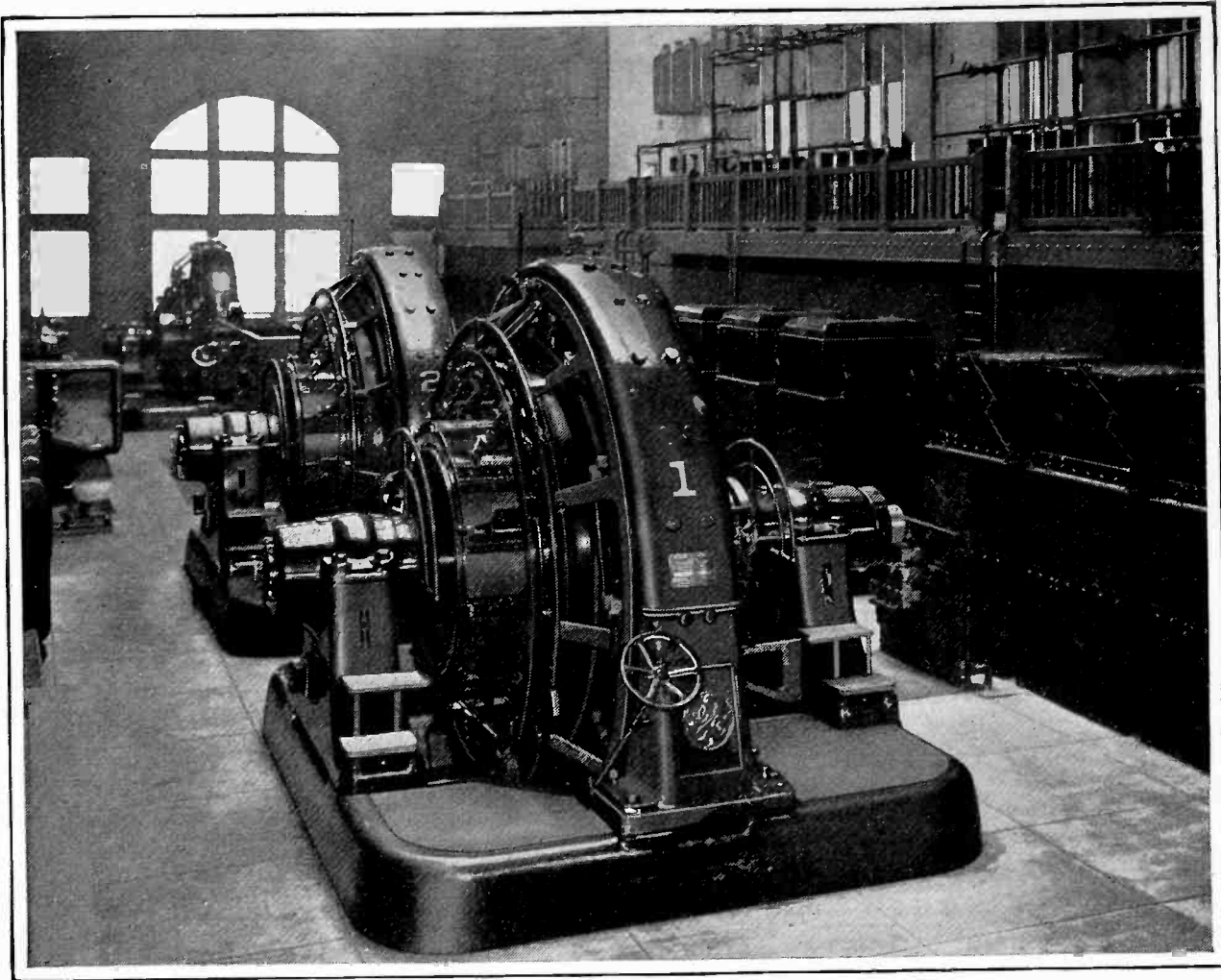

Irvington Substation, New York Central R. R.

The public rides on NCC Brushes

THOSE who go in and out of New York City on the Hudson River division of the New York Central travel in trains supplied with power from substations such as this one at Irvington, where National Pyramid Brushes are used. Here are three rotary converters of General Electric manufacture, which supply the track feeder system from which power is drawn not only by the electric short haul trains, but also by the electric locomotives that pull such trains as the 20th Century into Grand Central Terminal.

National Pyramid Brushes

NATIONAL CARBON COMPANY, INC.

Carbon Sales Division

Cleveland, Ohio

San Francisco, Cal.

Unit of Union Carbide and Carbon Corporation

Emergency Service Plants

CHICAGO ILL.
351 West Monroc St.
Phone: State 6092

PITTSBURGH, PA.
7th Floor, Arrott Power Bldg. No. 3,
Barkei Place. Phone: Atlantic 3570

NEW YORK, N. Y.
357 West 36th St.
Phone: Lackawanna 8153

BIRMINGHAM, ALA.
1824 Ninth Ave. N.
Phone: 3-6091

Please mention the JOURNAL of the A. I. E. E. when writing to advertisers.



SPANISH EDITION

A. I. E. E. STANDARDS



THIS SERIES of pamphlets, published by the Bureau of Foreign and Domestic Commerce, consists of Spanish Translations of certain of the standards promulgated by the American Institute of Electrical Engineers. These specifications are commercially acceptable and represent good practice in the United States.

The object of their translation and publication is to develop a broader knowledge and use of the standards and to facilitate trade in electrical products between the United States and Spanish-speaking countries.

AVAILABLE PAMPHLETS

- | | |
|--|--|
| 1. General principles upon which temperature limits are based in the rating of electrical machinery and apparatus. | 13. Transformers, induction regulators, and reactors. |
| 5. Direct-current, rotating machines, generators, and motors. | 14. Instrument transformers. |
| 7. Alternators, synchronous motors, and synchronous machines in general. | 15. Industrial control apparatus. |
| 8. Synchronous converters. | 16. Railway control and mine locomotive control apparatus. |
| 9. Induction motors and induction machines in general. | 19. Oil circuit breakers. |
| 10. Direct and alternating current fractional horse-power motors. | 22. Disconnecting and horn gap switches. |
| 11. Railway motors. | 30. Wires and cables. |
| | 37. Illumination. |
| | 41. Insulators. |

For convenience in filing or binding, the form and size of the English edition have been followed.

The price of each bulletin available is 10 cents,
except No. 1 and No. 14, which are 5 cents.



For sale by the
Superintendent of Documents, Government Printing Office, Washington, D. C.,
or any district office of the Bureau of Foreign and Domestic Commerce

A. I. E. E. STANDARDS
No. 1. 4000000000

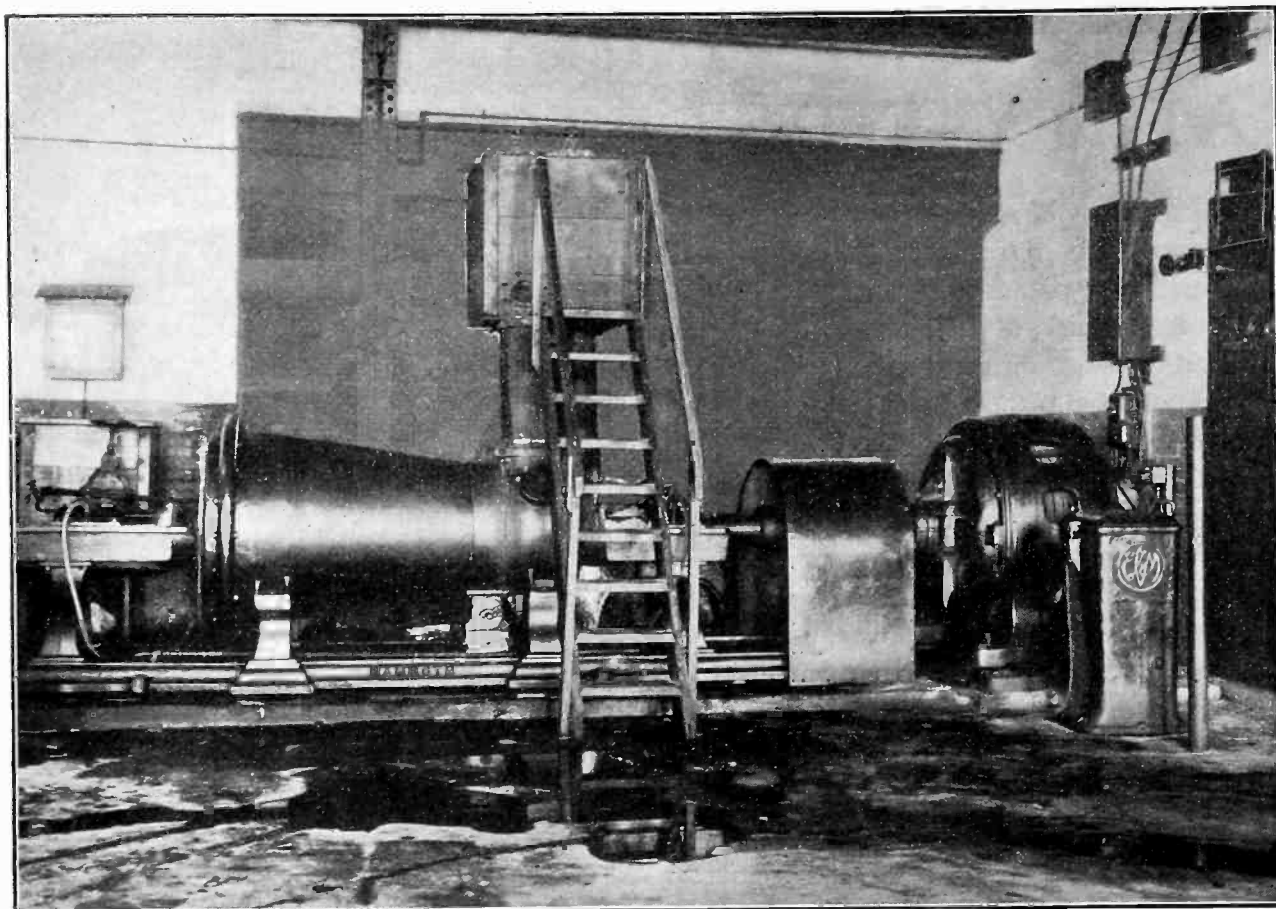

Starting Jordan Engines

A hard job for ordinary starting equipment but one easily handled by EC&M Automatic Compensators, which start the motors correctly and connect them to full voltage at the proper speed.

Protection against overloads is provided with EC&M Overload Protective Panels during the starting period as well as when the motors are operating at full speed. The Compensator contacts, opening under oil, are capable of handling excessive currents without injury.

EC&M Automatic Compensators have all of their working parts totally immersed in oil and each is sealed in a cast iron case. The operation of these automatic motor starters is unaffected by the large quantities of water and steam so often present in a paper mill.

Write for Bulletin 1042-F



THE ELECTRIC CONTROLLER & MFG. CO.

NEW YORK-50 CHURCH ST. CLEVELAND, OHIO PHILADELPHIA-WITHERSPOON BLDG.
 CHICAGO-CONWAY BLDG. MONTREAL-DRUMMOND BLDG. PITTSBURGH-OLIVER BLDG.
 DETROIT-DIME BANK BLDG. LOS ANGELES-AMERICAN BANK BLDG. SAN FRANCISCO-CALL BUILDING
 BIRMINGHAM-BROWN-MARX BLDG. SALT LAKE CITY-228 W. SO. TEMPLE SEATTLE-570 COLMAN BLDG.
 CINCINNATI-12TH NATIONAL BANK BLDG. TORONTO-REFORD BLDG. TULSA-217 E. ARCHER ST.



Please mention the JOURNAL of the A. I. E. E. when writing to advertisers.

SAFETY FIRST

THE safety of meters, relays and instruments as well as the operators who work with low potential circuits from instrument transformers, is dependent upon the insulation in the transformer which separates the high potential primary from the low potential secondary.

SANGAMO transformers are safe because in addition to being thoroughly insulated, [as a part of the process of construction] every SANGAMO transformer, when the windings are completed, is placed in a closed vessel [see illustration], all air exhausted leaving voids that are later filled with insulating compound applied with heat and pressure. The original high quality of the insulation is thus made permanent, giving the best assurance that modern methods can provide against contact with high potentials.

There is an extensive line of SANGAMO instrument transformers, each type designed for a definite set of service requirements. Name the conditions, we have the transformer.

Sangamo Electric Company

Springfield, Illinois

New York Boston Chicago Los Angeles San Francisco Birmingham

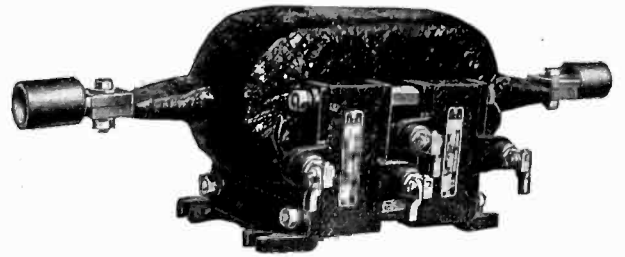

Type F-25 Sangamo Current Transformer with double secondary. This is only one of a great number of types. Ask for bulletin.

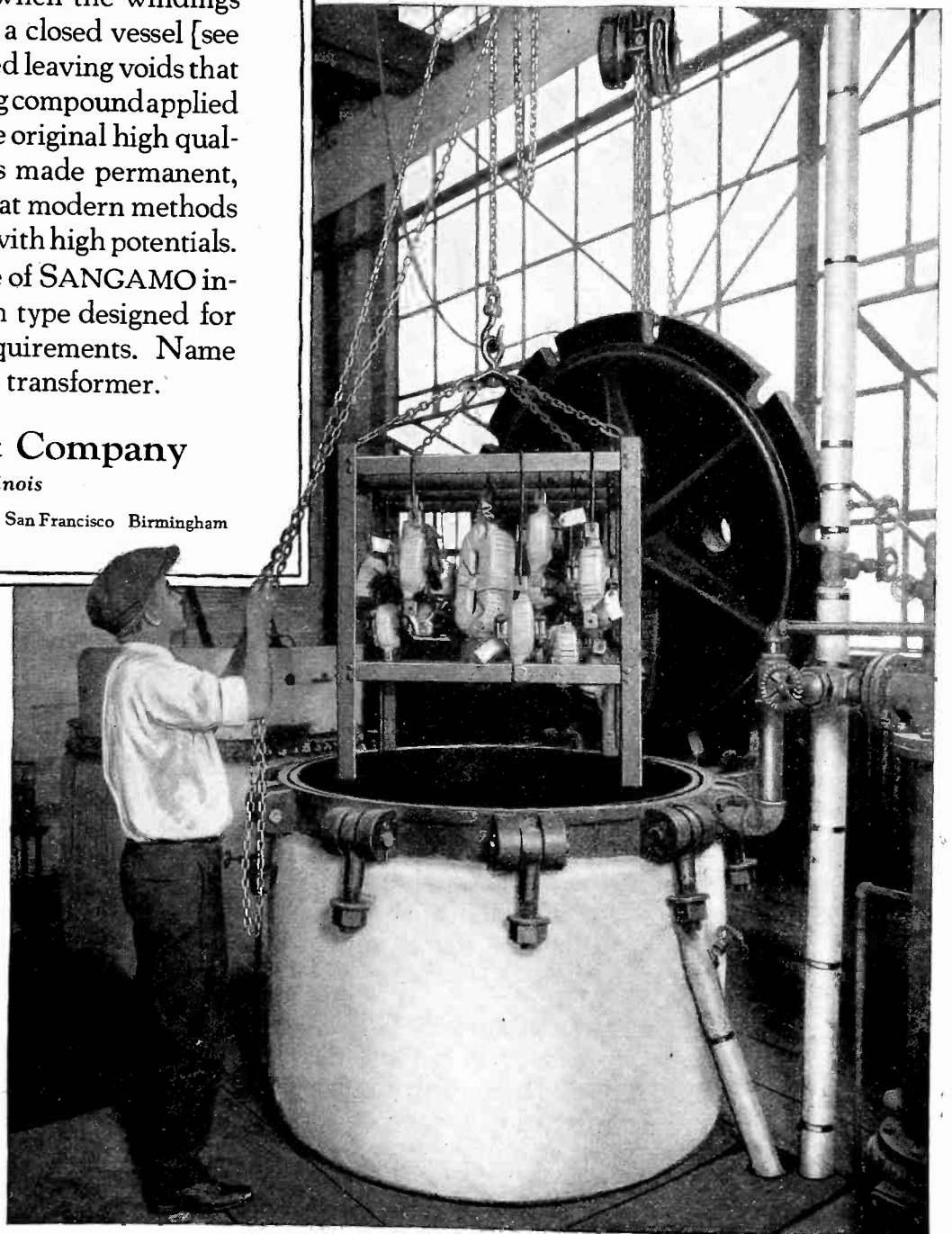

7-31-4

INSTRUMENT TRANSFORMERS

Please mention the JOURNAL of the A. I. E. E. when writing to advertisers.

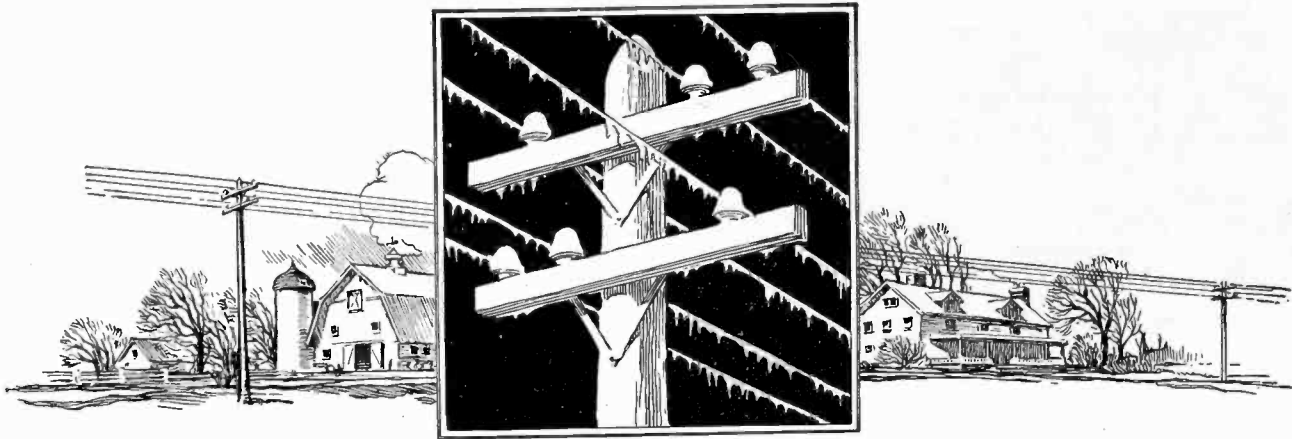

In rural electrification ANACONDA HITENSO "BB" WIRE reduces the risk of line failure

HITENSO "BB" is a high strength, high conductivity wire suitable for long spans. Size for size it has 77% of the conductivity of hard drawn copper, and 30% greater strength. Compared with hard drawn copper of equivalent conductance, it has 60% greater strength. Hitenso "BB" has the same density, modulus of elasticity and temperature coefficient of expansion as copper.

Because of its combination of high conductivity and great strength, Hitenso "BB" Wire of small diameter may be used for long spans. The

reduced surface exposed to wind and sleet lessens the danger of line failures and interrupted service.

Hitenso "BB" is as easy to handle as copper, and both original construction and extensions can be made with a minimum labor cost. It is highly resistant to abrasion and the effects of arcing.

An Engineering Department is maintained to assist electrical engineers in the design of cables for special conditions. You are invited to make use of this service.

ANACONDA COPPER MINING CO.—THE AMERICAN BRASS COMPANY
Rod, Wire and Cable Products

General Offices: 25 Broadway, New York Chicago Office: 111 W. Washington St.

ANACONDA COPPER
BRASS ANACONDA BRONZE
from mine to consumer

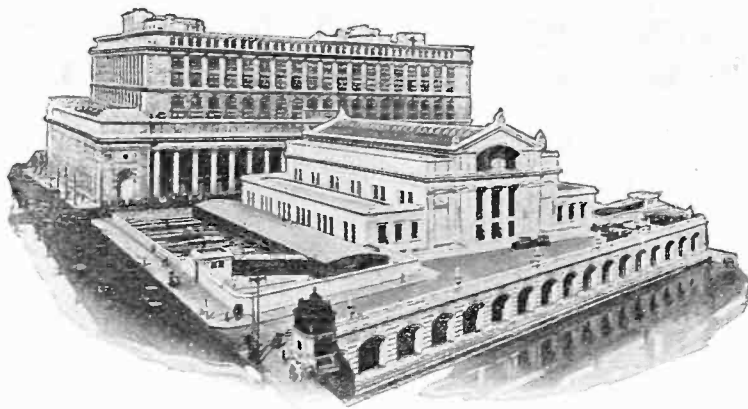

Graham-Anderson-Probst & White, Chicago - Architects
 John Griffiths & Son Co., Chicago - General Contractors
 Hatfield Electric Co., Chicago - Electrical Contractors

The New UNION STATION, Chicago
 wired with

American Steel & Wire
 Company's

Americore Rubber-covered Wire

THE new Chicago Union Station—one of the finest railroad stations in the world, and Chicago terminal for four great railroads is equipped with every known practical convenience for the traveling public. It is electrically wired throughout, from foundation floor to roof top with American Steel & Wire Company Americore Wire.

In selecting the hundreds of thousands of feet of rubber covered electrical wire needed for safely wiring this great new Chicago railroad station, the most rigid specifications were adopted. The fact that American Steel & Wire Company wire answered the specifications in every detail, expresses most forcibly the uniform and dependable quality of the product.

Let us send you an indexed catalogue and handbook of Electrical Wires and Cables. Estimates furnished promptly from any of our offices in all of the principal cities.

SALES OFFICES

CHICAGO	206 So. La Salle Street	NEW YORK	30 Church Street
CLEVELAND	Rockefeller Building	BOSTON	185 Franklin Street
DETROIT	Foot of First Street	PITTSBURGH	Frick Building
CINCINNATI	Union Trust Building	PHILADELPHIA	Widener Building
MINNEAPOLIS-ST. PAUL	Merchants Nat'l Bank Bldg., St. Paul	ATLANTA	101 Marietta Street
ST. LOUIS	506 Olive Street	WORCESTER	94 Grove Street
KANSAS CITY	417 Grand Avenue	BALTIMORE	32 So. Charles St.
OKLAHOMA CITY	First Nat'l Bank Bldg.	BUFFALO	670 Ellcott Street
BIRMINGHAM	Brown-Marx Bldg.	WILKES-BARRE	Miners Bank Bldg.
MEMPHIS	Union and Planters Bank Bldg.	SAN FRANCISCO	Rialto Bldg.
DALLAS	Praetorian Building	LOS ANGELES	2087 E. Slauson Ave.
DENVER	First National Bank Bldg.	PORTLAND	6th and Alder Sts.
SALT LAKE CITY	Walker Bank Bldg.	SEATTLE	4th Ave. So. & Conn. St.

*United States Steel Products Company

FIBREX TREE WIRE

Where trees must not be trimmed



A typical Fibrex installation in New England

Where hazards are greatest - places where trees must not be trimmed and where wires are rubbed and chafed by swaying limbs - splice in a piece of Fibrex Tree Wire.

Central Stations find that Fibrex creates good will by eliminating the short circuits and swinging grounds that interfere with the maintenance of steady voltage.

Short pieces of Fibrex spliced into the line will afford ample protection where overhead lines must run through trees.

Fibrex consists of a rubber insulated copper conductor protected by successive layers of tape, tarred jute, non-metallic Fibrex armor and a wear-resisting weatherproof braid.

An immediate check-up along the line and the early installation of Fibrex at danger points will save the repair gang many annoying and expensive emergency calls.

SIMPLEX WIRE & CABLE CO

MANUFACTURERS

201 DEVONSHIRE ST. BOSTON

CHICAGO SAN FRANCISCO NEW YORK
 CLEVELAND JACKSONVILLE

Please mention the JOURNAL of the A. I. E. E. when writing to advertisers.

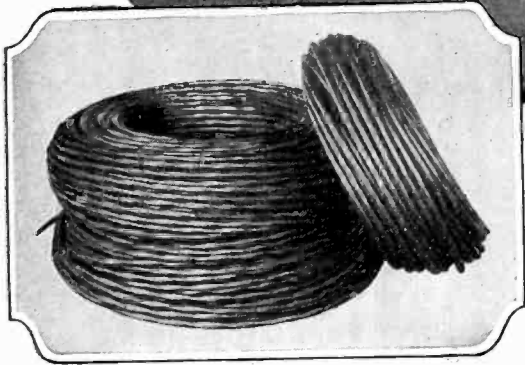
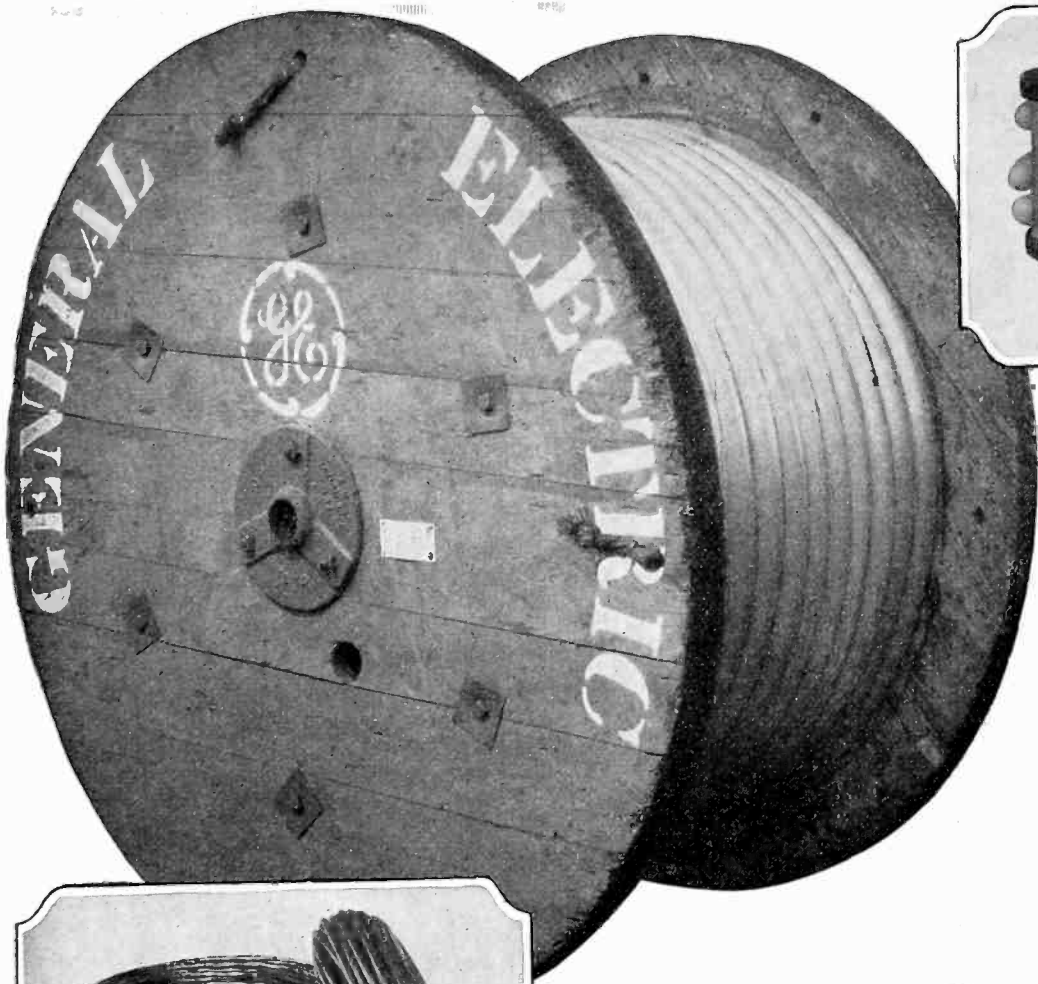

Cable

any voltage

any capacity

any duty

But one Quality

— *unexcelled*



The quality of General Electric cable is consistent with the high standard of all products identified by this monogram.

810-1

GENERAL ELECTRIC

GENERAL ELECTRIC COMPANY, SCHENECTADY, N. Y., SALES OFFICES IN PRINCIPAL CITIES

Please mention the JOURNAL of the A. I. E. E. when writing to advertisers.

STEEL TOWERS

and component parts

FOR ELECTRIC TRANSMISSION

AMERICAN BRIDGE COMPANY

71 Broadway, New York City

TOWER DEPARTMENT
Frick Building, Pittsburgh, Pa.

Offices in Principal Cities

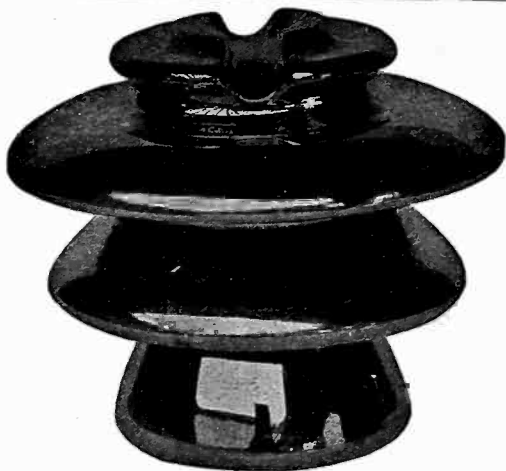

**Lapp Insulators
do not fail!**

LAPP INSULATOR CO., Inc.
LE ROY, N. Y.

Sales Representatives

BIRMINGHAM, ALA., Industrial Supply Co., 239 Brown-Marx Bldg.
BOSTON, Van Rosen Co., Stätler Building
CHARLOTTE, N. C., J. W. Fraser & Co., Commercial Bank Bldg.
CHICAGO, Transelectric Co., Inc., 140 So. Dearborn St.
COLUMBUS, O., Engineering Merchandising Syndicate, 600 Joyce Realty Bldg.
DALLAS, TEX., J. K. Webb, 1521 Commerce St.
DENVER, The O. H. Davidson Equip. Co., 130 W. 14th Ave.
INDIANAPOLIS, W. D. Hamer Co., 518 Trac. Terminal Bldg.
KANSAS CITY, MO., Power Machinery Co., 301 Dwight Bldg.
LOS ANGELES, S. Herbert Lanyon, 210 Transportation Bldg.
MINNEAPOLIS, J. E. Sumpter Co., 515 Security Bldg.
NEW YORK CITY, Shield Electric Co., 149 Broadway.
PHILADELPHIA, Harris & Butler, Real Estate Trust Bldg.
PITTSBURGH, Henry N. Muller Co., 2204 First National Bank Bldg.
SAN ANTONIO, TEX., L. G. Bassett, 723 Navarro St.
SAN FRANCISCO, S. Herbert Lanyon, 509 New Call Bldg.
SYDNEY, AUSTRALIA, Chas. M. Terry.
WELLINGTON, NEW ZEALAND, A. C. Thomas.

Specify
**Thomas
Quality
Insulators**
for
Permanently
Dependable
SERVICE

THE R. THOMAS & SONS CO.
East Liverpool, Ohio
New York Boston Chicago London

MANUFACTURERS OF INSULATORS
For 2,200 to 220,000 Volts
HIGH VOLTAGE PORCELAIN

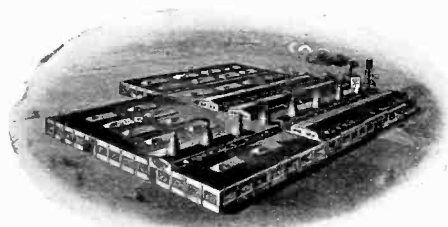

*Catalog
on request*

CANADIAN PORCELAIN COMPANY

Limited

HAMILTON — ONTARIO — CANADA
Cable Address "PORCELAIN," Hamilton, Ontario

Please mention the JOURNAL of the A. I. E. E. when writing to advertisers.

No. 662
Operating voltages
up to 8,000 volts



No. 661
Operating voltages
up to 6,600 volts



No. 401
Operating voltages
up to 40,000 volts

These Super-Glasses give permanent insulation

STURDY super-glasses—not the fragile article you use for ornamentation or in windows. Thoroughly homogeneous, highly practical—cannot absorb moisture, cannot deteriorate. **PYREX** Power Insulators give *permanent* insulation. Dept. R-J, Corning Glass Works, Corning, N. Y.

PYREX

T. M. Reg. U. S. Pat. Off.

POWER INSULATORS

Esco

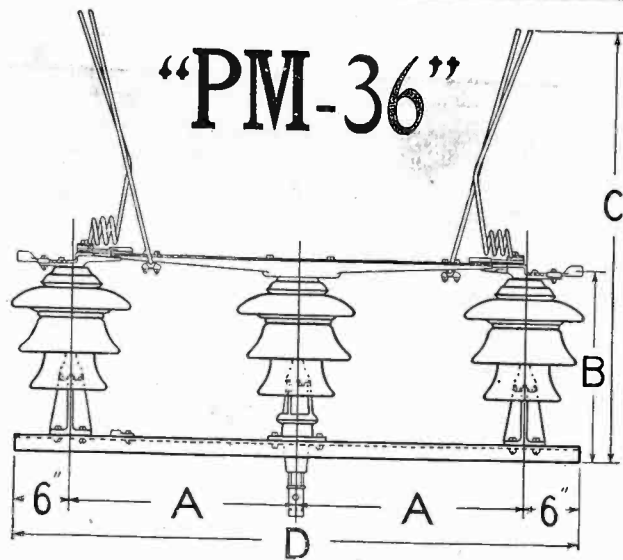

Construction of 50 k. v. and 73 k. v. Switches

THE STANDARD OF YEARS

Hard service, storms, intense competition have beat about it—but today it remains the real standard.

(Write for our monthly publication)

Delta-Star Electric Co

2400 Block, Fulton St. Chicago, Illinois

K-P-F POLE-TOP SWITCHES

Reduce Your Installation and Maintenance Costs

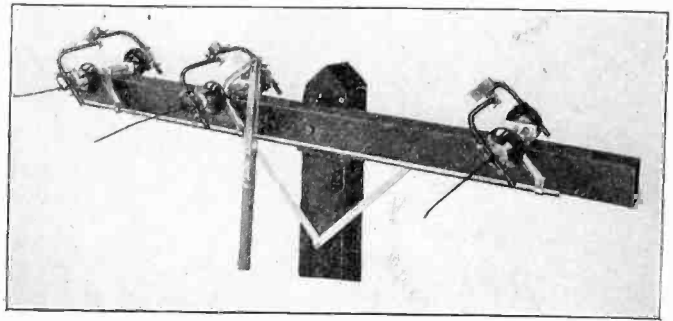

K-P-F type L-115—4500-V. Bolts to the cross-arm. Line wires can be dead-ended directly to it.

FOR SECTIONALIZING AND DISTRIBUTING SERVICE

Manufactured For Any Voltage

K-P-F SWITCHES have established their reputation for dependability, efficiency and economy through a period of many years of actual service under varying conditions.

Extra deadends not required. Switch bolts to a single cross-arm. Shipped completely assembled—ready to install.

Bulletin #106 covers this equipment in detail

K-P-F ELECTRIC CO.

855-859 Howard St.

San Francisco, Cal.

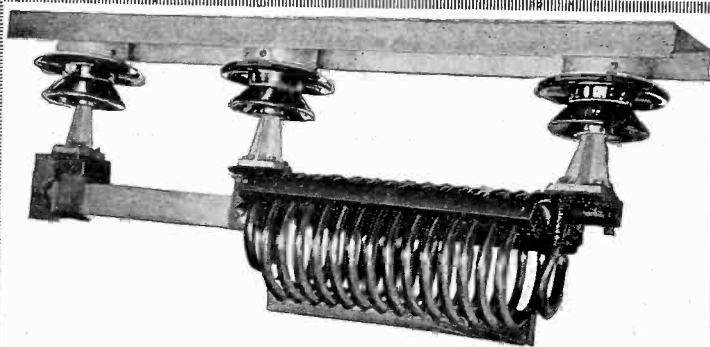

The New

THONER & MARTENS

underslung outdoor disconnecting switch

THE standard T & M underslung outdoor disconnecting switch, 800 amp., is now equipped with choke coil.

Working pressure is 22,000 volts, dry flush is over 88,000 volts and wet flush over 55,000 volts.

Other T & M features are the Bolt type lock and new sleet cover.

Write for further details

THONER & MARTENS

463 Commercial St., Boston, Mass., U. S. A.

KEARNEY

MANUFACTURERS OF

Preheated Certified Malleable Iron Screw Type Anchors
Outdoor Type Fuse Switches, Disconnecting Switches,
Choke Coils, and Combinations, 7500 and 15000 volts
Aluminum, Copper, and Galvanized Iron Guy Wire Clips
Extension Sleeve Twisters with Interchangeable Dies
Solderless Service Connectors
Expulsion Porcelain Plug Cutouts
Tap Off Clamps

Write for Catalog

JAMES R. KEARNEY CORPORATION
4220 Clayton Avenue ST. LOUIS, MO.

Prominent manufacturer is desirous of obtaining new electrical devices for manufacturing and marketing. Compensation for accepted items will be paid on a royalty basis or outright purchase arrangement if desired. Submit full particulars in strictest confidence to Box 126, JOURNAL of A. I. E. E., 33 West 39th St., New York.

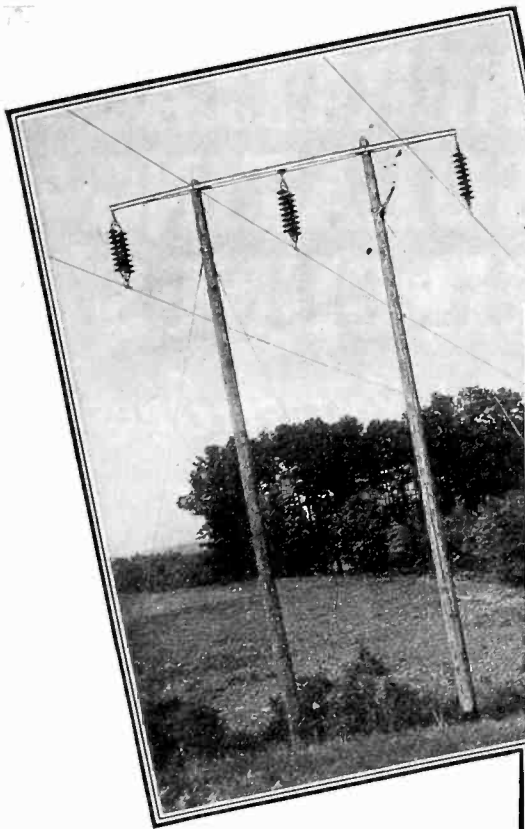

120,000-volt wood pole H-frame O-B Insulated line, Cleveland to Chattanooga. Yoked crossing for railroads.

Anchor tower—Tennessee River crossing. Valdeau-Ridgedale 44-kva. tie-line.

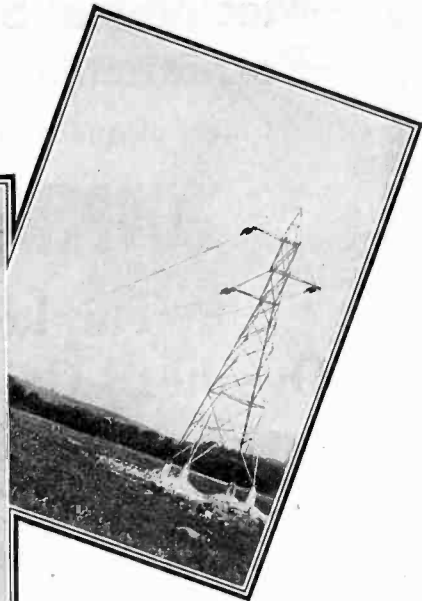
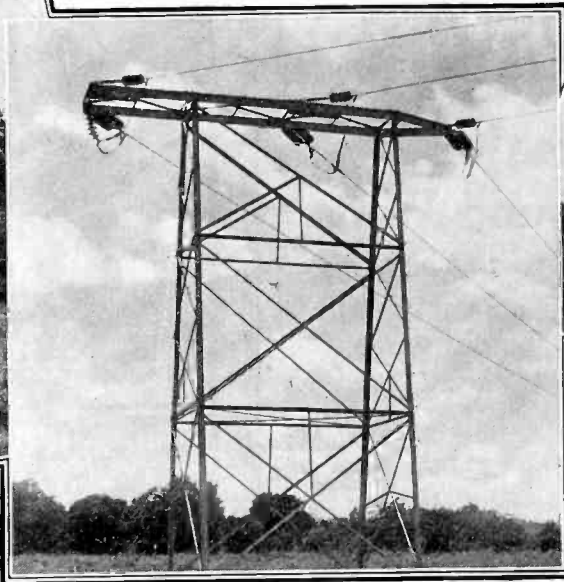

Anchor tower—Tennessee River crossing. Hales Bar-Richard City 44-kva. tie-line.

Enabling Tennessee to Capitalize its Natural Resources

TENNESSEE has numerous resources—57 of the 63 minerals found in the United States being found in some quantity in this state. Bauxite for aluminum, limestone and shale for cement, and ball clays for high grade insulators, porcelain, china and pottery are perhaps the most prominent of these minerals.

The Tennessee Electric Power Company with over 700 miles of lines operating at 22,000 volts or higher, serves Middle and East Tennessee—a territory with a population of over 1,000,000 persons, and includes more than 100 cities and towns. Nearly 300,000 h. p. in electric power is available from the Company's system.

This territory has experienced a rapid growth in the last decade—which is reflected in increased

consumption of electricity for lighting and power purposes. In fact, it may truly be said that it is the great abundance of cheap power made available by the Tennessee Electric Power Company which has released the state's mineral resources from bondage and capitalized their worth.

In addition to providing new hydroelectric and steam electric plants from time to time as the requirements of this territory increase, The Tennessee Electric Power Company has safeguarded the power supply to its customers by line interconnections with other power companies of the Southern States. On these transmission lines, this progressive organization has used thousands of O-B suspension and pin type insulators and hardware with satisfaction and economy.

Ohio Brass Company, Mansfield, Ohio
Dominion Insulator & Mfg. Co., Limited
Niagara Falls, Canada
408H

Ohio Brass Co.



- PORCELAIN INSULATORS
- LINE MATERIALS
- RAIL BONDS
- CAR EQUIPMENT
- MINING MATERIALS
- VALVES

SALES OFFICES: NEW YORK CHICAGO

PHILADELPHIA PITTSBURGH CLEVELAND
SAN FRANCISCO LOS ANGELES

Please mention the JOURNAL of the A. I. E. E. when writing to advertisers.

- Strength
- Mechanical Stability
- Permanence

a trinity of qualities which makes

“COPPERWELD”

The Ideal Overhead Ground Wire

Strength, mechanical stability and permanency are the essential requirements for the overhead ground wire.

These qualities can be found combined only in Copperweld which has the strength and mechanical stability of steel, with the rust-resisting properties of copper.

Copperweld Steel Company

MAIN OFFICE & MILLS—BRADDOCK P.O., RANKIN, PA.
30 CHURCH ST., NEW YORK 129 S. JEFFERSON ST., CHICAGO.
403 RIALTO BLDG., SAN FRANCISCO.

In Canada: Northern Electric Co., Ltd.

MINERALLAC INSULATING COMPOUNDS

For High-Voltage Lines

*-in Cable Joints
and Potheads*

Always Reliable

*High dielectric strength
Approved physical properties*

Minerallac Electric Company
1045 Washington Boulevard
Chicago, Ill.

PATENT PEND'G

**BURNDY
CONNECTORS**
WILL WITHSTAND
STORM AND SHOCK
AND CARRY FULL
CURRENT
INSTALLED
BY SIMPLY CLAMP-
ING BOLTS

**BURNDY
IMPROVED
T-CONNECTOR
FOR TUBING AND CABLES**

**BURNDY
ENGINEERING CO. INC**
10 EAST 43RD STREET NEW YORK

CATALOG ON REQUEST

Roebbling

Electrical Wires and
Cables. High in Con-
ductivity and Reliability.

John A. Roebbling's Sons Co.
Trenton, New Jersey



WIRE PRODUCTS For Varied Applications

We manufacture many types of wires, cords and cables for specific uses. Among them are:

Rubber Covered Wire—Solid Conductor, Stranded Conductor, Flexible Conductor, Extra Flexible Conductor. Lamp Cords, Reinforced Cords, Heater Cord, Brewery Cord, Canvasite Cord, Packinghouse Cord, Deck Cable, Stage Cable, Border Light Cable, Flexible Armored Cable, Elevator Lighting Cable, Elevator Operating Cable, Elevator Annunciator Cable. Switchboard Cables, Telephone Wire, Flameproof Wires and Cables, Railway Signal Wires, High Voltage Wires and Cables. Automobile Ignition Cables, Automobile Lighting Cables, Automobile Starting Cables, Automobile Charging Cables. Moving Picture Machine Cable.

Boston Insulated Wire & Cable Co.

Main Office and Factory:
Dorchester District Boston, Mass.
Canadian Branch, Office and Factory, Hamilton, Ont.

BOREHOLE OR SHAFT CABLES

VULCANIZED rubber compound is a superior water-proof insulation. Hazard Borehole and Shaft Cables are insulated with Hazard Standard Insulation, an unexcelled compound of vulcanized rubber. It is free from any liquid or plastic substance that will flow. It does not slip. It stays in place.

HAZARD Borehole and Shaft Cables are so constructed that they may be fastened at the top only, thereby supporting the entire weight of the cable.

THE galvanized armor wires protect the insulation from falling rock, coal, ore, or other mechanical injury.



HAZARD MANUFACTURING CO.

WILKES-BARRE

New York Pittsburgh Chicago Denver Birmingham Philadelphia

HAZARD PRODUCTS REDUCE MINING COSTS

A long step forward

in the development of cable protecting devices is represented by the new STANDARD Hollow Stem Type Terminal. This fact will be recognized by cable users upon inspection of the sectional view of this terminal as designed for use at working pressures ranging upwards from 12,000 volts.

STANDARD Hollow Stem Type D.O.A. Terminals

(Patent No. 1,605,470, November 2, 1926)

embody a new type of construction which insures complete flushing, elimination of all air pockets and a complete final filling with compound thus insuring complete protection to cable insulation and minimum expense for upkeep. At the same time they simplify installation, and possess all the other advantages, such as convenience and flexibility in operation, which characterize other types of STANDARD terminals.

Another important feature of this new design is that there are no rubber gaskets to deteriorate or wear out. The assembly joints consist of tapered, accurately machined surfaces clamped tightly together by lock nuts and protected by hooded cap nuts. A perfectly waterproof seal for the cable end with complete insurance against line surges is thus secured.

If you are interested in getting the greatest protection for your cable ends and the most value from your cable terminals, write our nearest office for further information.

Standard Underground Cable Co.

General Offices: Pittsburgh, Pa.

BOSTON	PHILADELPHIA	ATLANTA	CHICAGO	ST. LOUIS	SEATTLE
NEW YORK	WASHINGTON	PITTSBURGH	DETROIT	KANSAS CITY	LOS ANGELES
		SAN FRANCISCO			

Manufacturers of a complete line of Electric Wires and Cables and Cable Accessories.

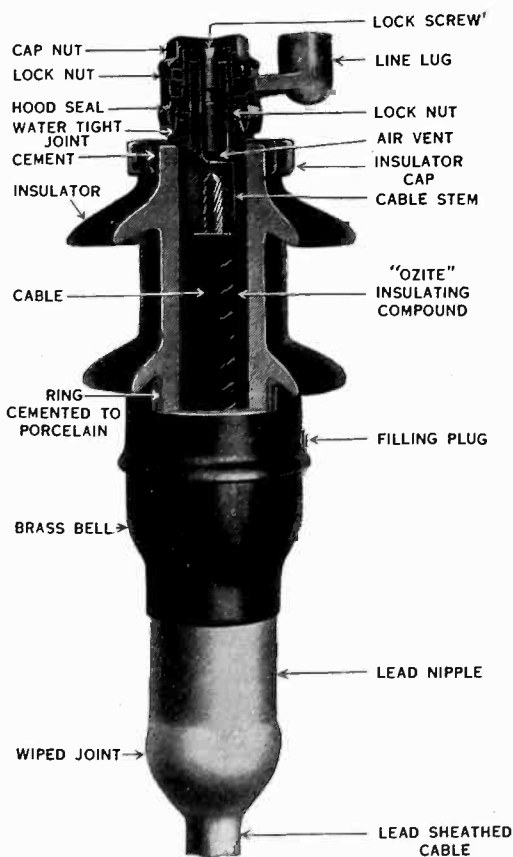

Moloney Transformers

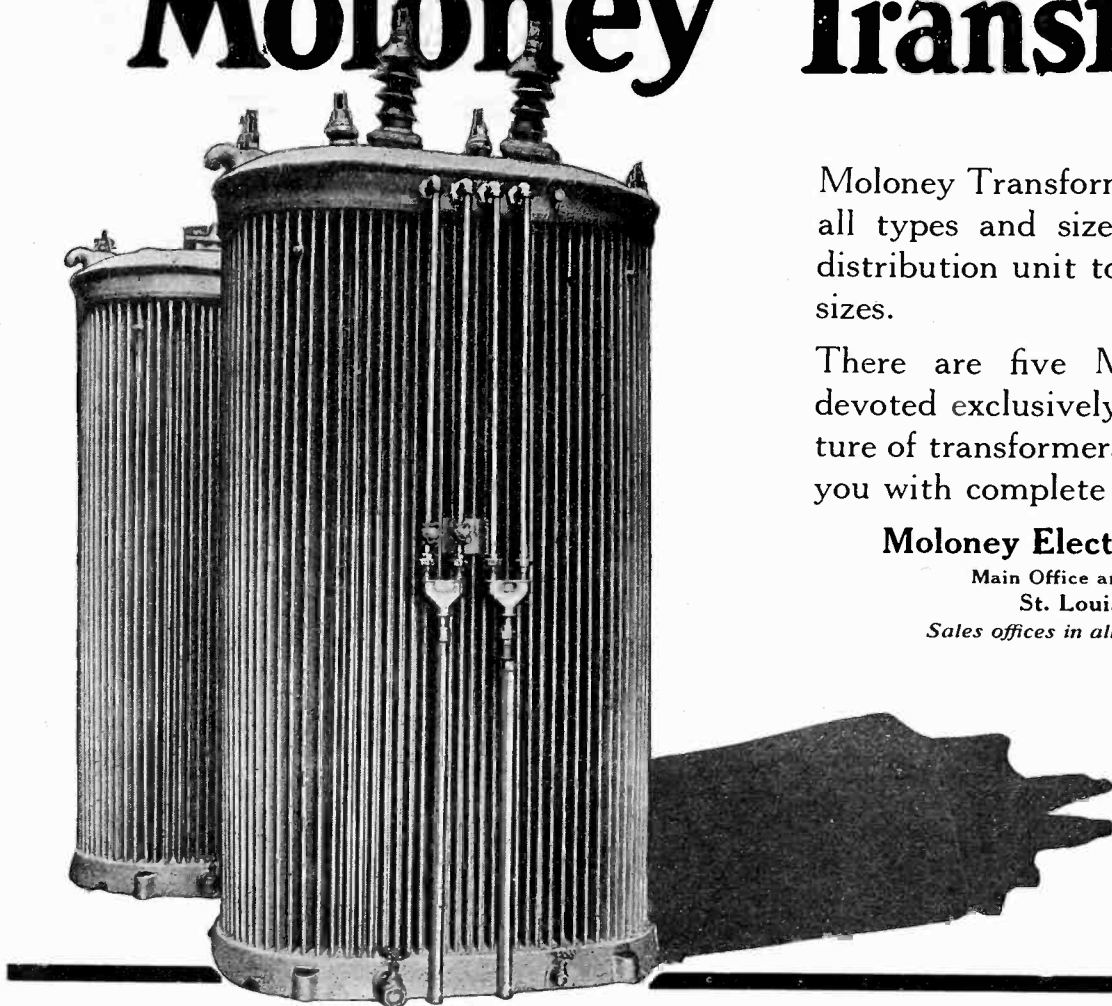

Moloney Transformers can be had in all types and sizes from the small distribution unit to the larger power sizes.

There are five Moloney factories devoted exclusively to the manufacture of transformers. Let us furnish you with complete details.

Moloney Electric Company

Main Office and Factories
St. Louis, Mo.
Sales offices in all principal cities

G & W Equipment builds "good will"

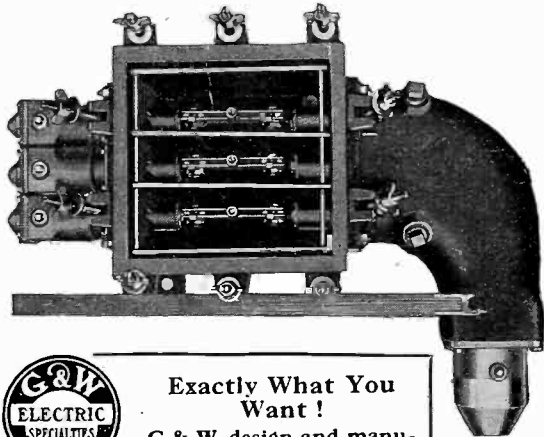

Continuity, reliability of service, and the customers confidence and good will go hand in hand.

Making service restoration quick, effective, and permanent wins the good will of the community, particularly when customers have favorable experience in service emergencies.

G & W distribution specialties have been developed from the application of engineering skill to those devices which any well built distribution system should have.

Reasonable expenditure for G & W specialties will effect return in insuring a more continuous revenue and customer good will.



Exactly What You Want!

G & W design and manufacture practically every device for the end of a cable. See Catalog No. 26.

- | | |
|------------------|--------------------|
| Potheads | Underground Boxes |
| Series Cutouts | Conduit Bells |
| Primary Cutouts | Ground Pipe Caps |
| Oil Fuse Cutouts | Ground Pipe Points |
| Vault Unit | Oil Disconnect |

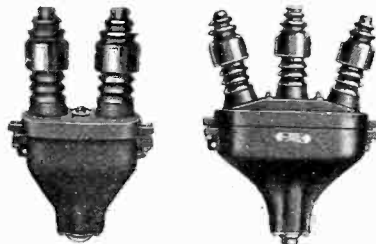

G & W ELECTRIC SPECIALTY CO.

7760 DANTE AVE.
CHICAGO, ILL.

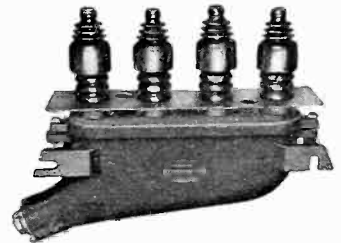

More than Protection POTHEADS AND BOXES for the Cable Ends

Please mention the JOURNAL of the A. I. E. E. when writing to advertisers.

WESTON RECTANGULARS[®] for METAL PANELS

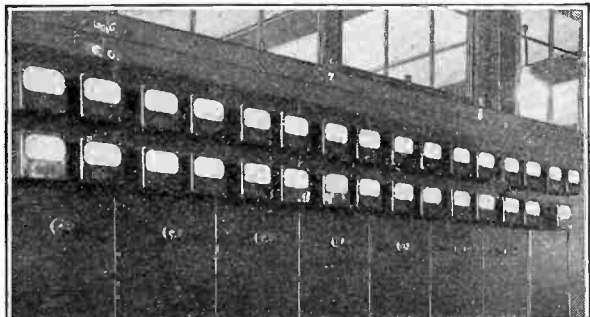

A Typical Insulation Showing Weston Rectangulars Mounted on Metal Panels

WESTON Rectangulars have been widely standardized upon by Engineers and Designers of large A. C. switchboards. Because they are the modern instrument for the modern switchboard they can be mounted directly on metal panels without any change or provision for special insulation.

The increasing use of metal panels does not present instrument problems when you think in terms of Weston Rectangulars.

Investigate these Weston Rectangular instruments for your next switchboard job, and you will be convinced that they embody every desirable feature in modern switchboard requirements.

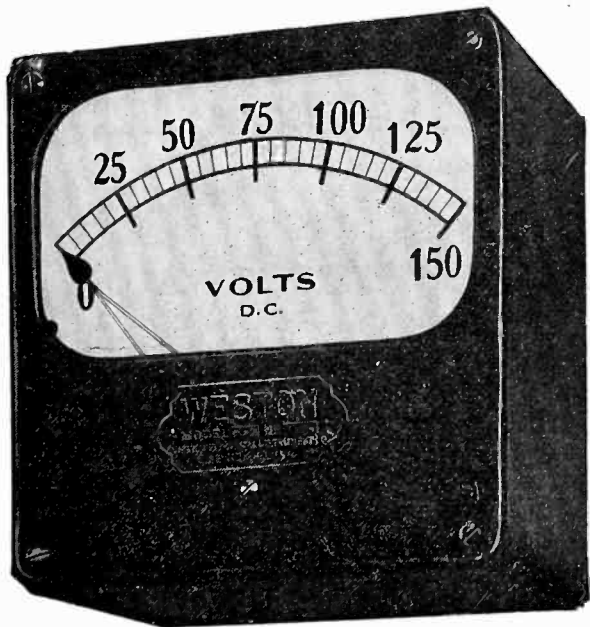

WESTON ELECTRICAL INSTRUMENT CORPORATION

48 Weston Avenue, Newark, N. J.



Now you can charge batteries without an attendant

Periodical charging of storage batteries at a high rate requires the service of an attendant. Today this is unnecessary.

A Balkite Charger on continuous or trickle charge keeps your batteries at full power always without attention. The charger and battery are installed as a complete unit to supply unfailing Direct Current from an Alternating Current source. In most cases the batteries can be charged in service.

If you use batteries anywhere Balkite Trickle Charging will greatly simplify and improve the service they give you. Our engineers will be glad to work with you on your charging and rectifier problems.

Descriptive bulletins on request.

FANSTEEL PRODUCTS COMPANY, Inc.
North Chicago, Illinois

FANSTEEL Balkite Trickle Chargers

FANSTEEL PRODUCTS COMPANY, Inc., North Chicago, Illinois
Gentlemen: Please send me a copy of "Balkite Trickle Charging."

Name _____

Company _____

Address _____

Position _____

A. I. E. E. - 7-27

*The Guidance of Chart Records
wherever
electrical
power is used*

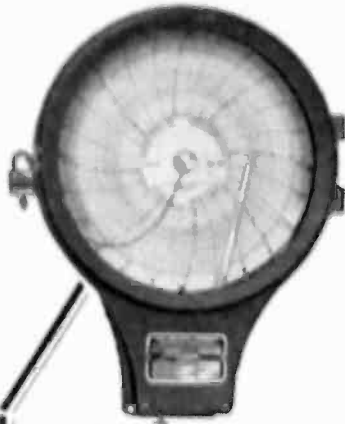

Bristol's Recording Voltmeter

It is much easier to maintain uniform load conditions under the guidance of Bristol's Recording Voltmeters; for they not only indicate each change in voltage, but make a

continuous, minute-to-minute record of these changes.

Bristol's Recording Voltmeters are ruggedly constructed, and designed to give years of satisfactory service without trouble. They can be furnished in round or strip chart models, for permanent mounting or portable use.

Write for Voltmeter Catalog, No. 1502

The Bristol Company Waterbury, Connecticut

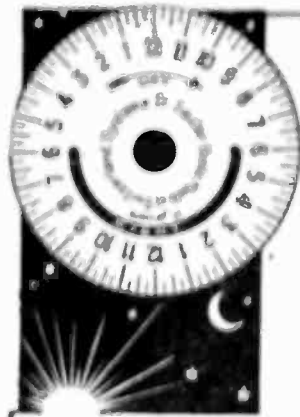

SAUTER
Electric
TIME SWITCHES

These "astronomic" time switches are carried in stock for circuits of
250 Volts: 10, 25, 40, 60, 100, 200, 300 Amps.
4600 Volts: 25 and 50 Amps.
8000 Volts: 25 and 50 Amps.

Ask for new catalog S-1.

R. W. CRAMER & COMPANY, INC.
136 Liberty St. New York City

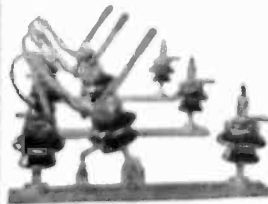

Standard Type K Disconnecting Switch—The most widely used product of this company—A standard specification with many large power companies on the Pacific and Atlantic coasts—Inexpensive to install and requiring no maintenance of any sort. Bulletin K.

Pacific Electric Manufacturing Co.

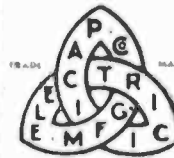

San Francisco—St. Louis

38 Church St. New York
Metropolitan Bldg. Chicago
Bynes Bldg. Denver
135 High St. Boston
Hoge Bldg. Seattle
H. W. Hellman Bldg. Los Angeles
419 Chemical Bldg. St. Louis

Pioneer Bldg. St. Paul
Interurban Bldg. Dallas
617 Doughty Bldg.
Kansas City, Mo.
American Trust & Savings
Bldg. Birmingham

DUNCAN
Watt-hour Meters



Model M2.

Accurate
and
Dependable

Write for bulletins

DUNCAN ELECTRIC MFG. CO.
Lafayette, Ind.

SUNDH ELECTRIC COMPANY

The Elements

of our Business

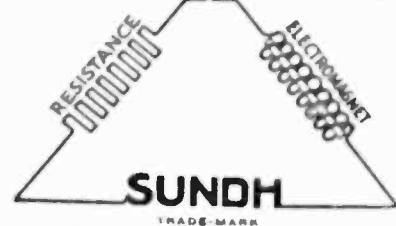

Automatic Starters
Circuit Breakers
Float Switches
Hand Starters
Magnet Switches

Pressure Regulators
Remote Switches
Speed Regulators
Transfer Switches
Valve Control

WRITE FOR CATALOG

Sundh Electric Company, 4 Ave. C, Newark, N. J.
Branch Offices or Sales Representatives in Principal Cities

Pittsburgh Transformer Company

Largest Manufacturers of Transformers exclusively
in the United States

Pittsburgh, Pennsylvania



CAPACITY METER

Type 383-A for the measurement of inter-electrode capacities of vacuum tubes, and other capacities of small magnitude up to 30 MMF.

Type 383-B for accurate measurements of capacities up to 600 MMF. Ideal for matching multiple unit condensers.

Price (either type).....\$80.00

Bulletin on request.

GENERAL RADIO COMPANY

Thirty State Street
CAMBRIDGE, MASSACHUSETTS

“What condensers do they specify?”

Experts in the radio field know from experience that Faradon Capacitors can be counted on to give long and satisfactory service.

Manufacturers particularly, recognize the value of specifying Faradon Capacitors. They know that a reputation for quality equipment warrants the inclusion of only the highest grade condensers.

There is a Faradon designed for each particular purpose. And constructed from high-quality materials with the experience of twenty years specialization on fine condensers.



WIRELESS SPECIALTY APPARATUS CO.
Jamaica Plain, Boston, Mass., U. S. A.
Established 1907

Faradon

673

FOR Eliminators,
Power and Audio Amplification —
JEFFERSON TRANSFORMERS!

We are equipped to design or make transformers to your specifications. Jefferson engineers will gladly cooperate with you. Write

Jefferson

ELECTRIC MFG. CO.

546 South Green St. - - - - - Chicago

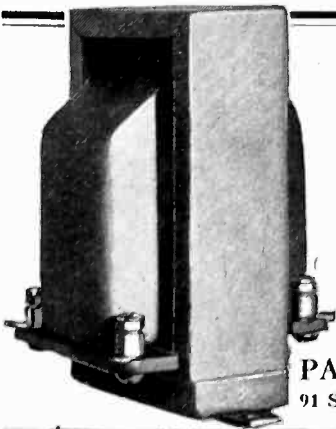

RUGGEDLY built high grade audio transformers designed to meet the requirements of flat curve distortionless amplification over the entire musical scale, and to carry high plate potentials used in modern power amplifying circuits.

Write for curve charts and technical data.

PACENT ELECTRIC CO., INC.
91 SEVENTH AVENUE, NEW YORK CITY

PACENT Transformers

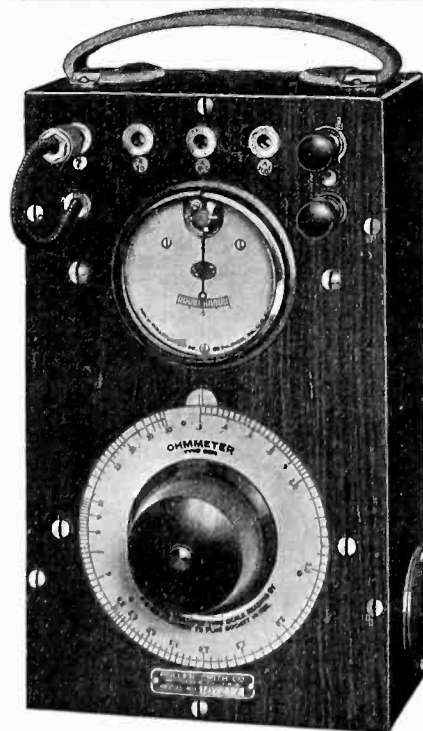

NEW
ROLLER SMITH
COM
OHMMETER

Portable direct reading, small, compact, light, rugged, accurate, entirely self-contained. Measures resistance values from .5 ohm to

50,000 ohms. List price \$70.00, subject to discount. Send for new Supplement No. 1 to Bulletin No. AE-300.

“Over thirty years’ experience is back of ROLLER-SMITH”

ROLLER-SMITH COMPANY
Electrical Measuring and Protective Apparatus

MAIN OFFICE
12 Park Place, NEW YORK

WORKS
Bethlehem, Penna.

Offices in Principal Cities in U. S. A. and Canada.
Representatives in Australia, Cuba and Japan.

A. I. E. E. PUBLICATIONS

JOURNAL. Published monthly.

An engineering periodical containing in full or in abstract engineering and theoretical papers and discussions as presented before meetings of the Institute and its Sections and Branches; descriptions of new developments characterized by notable advances, and items relating to the activities of the Institute and other organizations.

Subscription price \$10.00 per year. Agents, publishers and dealers are allowed 20 per cent discount; a special discount of 50 per cent is allowed on single subscriptions received directly from college or public libraries. Postage to Canada on annual subscription \$0.50 additional, and to foreign countries, \$1.00. (Postage should not be included when computing discounts).

JOURNAL BINDERS. A loose-leaf binder, especially designed for the JOURNAL of the A. I. E. E. is now available. The new binder is attractively finished in a long-wearing, processed material, resembling brown leather. From one to six copies of the JOURNAL can be inserted. The name of the publication is embossed in gold on the front cover and backbone. The binders are sold in sets of two at \$2.25; or \$1.25 for one.

TRANSACTIONS. Published annually.

Contains such of the technical papers and reports published by the Institute in the JOURNAL and elsewhere as are selected and authorized by the Publication Committee; also the discussions on the technical papers. The TRANSACTIONS form a permanent record of the progress of electrical engineering. Subscription price (to Institute members only) \$2.00 per year.

Current volume may be purchased by non-members at \$10.00 per year in either paper or cloth binding. (Prices for half morocco bound copies furnished on request.)

Available volumes of the TRANSACTIONS published prior to 1921 may be obtained at reduced prices. The volumes in stock and prices will be supplied upon request.

Discounts allowed on the current volume are as follows: 20 per cent to publishers and subscription agents 50 per cent to college and public libraries upon direct subscription to Institute headquarters.

INDEX TO TRANSACTIONS. Published every ten years. Vol. III of the TRANSACTIONS Index (Jan. 1, 1911 to Jan. 1, 1922) is a practical bibliography (168 pp.) of all A. I. E. E. papers and discussions printed during the period 1911-1922. Price to members and non-members \$2.00, with dealers' discount of 20 per cent.

SEPARATE PAPERS AND DISCUSSIONS.

Most of the recent papers and discussions contained in the TRANSACTIONS can be furnished separately at the following prices: Single copies of any paper, usually with discussion, \$0.50. Five or more copies of any paper, each \$0.40.

A discount of 20 per cent to publishers and subscription agents; 50 per cent is allowed from the above prices to Institute members and college and public libraries.

A. I. E. E. STANDARDS.

The work of revision of the A. I. E. E. Standards which has been in progress for several years has now reached a stage where a large number of sections of the Standards have been approved by the Board of Directors and are available in pamphlet form, as follows:

1—General Principles Upon Which Temperature Limits are Based in the Rating of Electrical Machinery, (.20); 5—Direct-Current Generators and Motors and Direct-Current Commutator Machines in General, (.40); 7—Alternators, Synchronous Motors and Synchronous Machines in General, (.40); 8—Synchronous Converters, (.40); 9—Induction Motors and Induction Machines in General, (.40); 10—Direct-Current and Alternating-Current Fractional Horse Power Motors, (.30); 11—Railway Motors, (.30); 13—Transformers, Induction Regulators and Reactors, (.40); 14—Instrument Transformers, (.30); 15—Industrial Control Apparatus, (.40); 16—Railway Control and Mine Locomotive Control Apparatus, (.40); 19—Oil Circuit Breakers, (.30); 22—Disconnecting and Horn Gap Switches, (.30); 30—Wires and Cables, (.40); 33—Electrical Measuring Instruments, (.30); 34—Telegraphy and Telephony, (.30); 36—Storage Batteries, (.20); 37—Illumination, (.30); 38—Electric Arc Welding Apparatus, (.40); 39—Electric Resistance Welding Apparatus, (.30); 41—Insulators, (.30); 42—Symbols for Electrical Equipment of Buildings, (.20).

A discount of 50% is allowed to Institute members. Numbers of the Standards Sections should be given when ordering.

STANDARDS BINDERS. The various sections of the Standards can be kept in bound form with the practical binder which has been designed for this purpose. Capacity of the binder is from 10 to 30 sections or pamphlets. Finished in brown fabrikoid with imprint on stiff back. Price \$1.75.

YEAR BOOK OF THE A. I. E. E.

A directory, published annually in March, of the membership of the A. I. E. E. Gives in alphabetical order, the names, occupations and addresses of all members. The membership is also listed in geographical order. The Year Book contains general information regarding the scope and activities of the Institute, including the Constitution and By-Laws, lists of Sections and Branches, the various committees, governing body, etc. Single copies will be supplied to members without charge upon application.

American Institute of Electrical Engineers
33 West Thirty-ninth Street, New York, N. Y.

“They Keep a-Running”

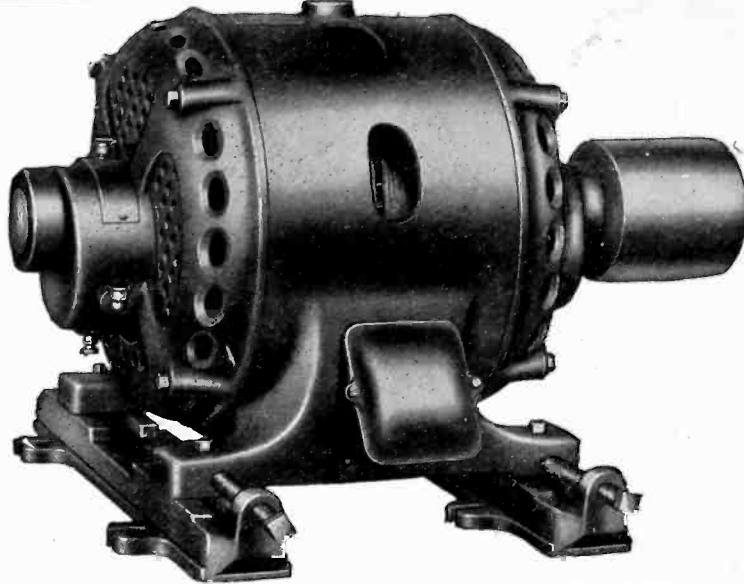

*10 Horse Power Century Type AS Automatic-start
Induction 3- and 2-phase Motor*

Overcoming Dead Loads at Starting

The high starting torque of Century Type AS Automatic-start Induction 3- and 2-phase Motors is one of the characteristics which makes them especially suitable for such applications as pumps, compressors, pulverizing mills and mixers—where heavy inertia must be overcome and the starting current must be held down to the minimum.

- 1** Starting torque is high—at least 225% of full-load torque.
- 2** Starting current is low—it does not exceed 245% of full-load current and cannot be varied by even an inexperienced workman.
- 3** No special fuses are required, as the starting current is low.
- 4** As no elaborate starting equipment is necessary, these motors are particularly suited to automatic and remote control installations.

Century Type AS Automatic-start Induction 3- and 2-phase Motors are built in all standard sizes from $\frac{1}{2}$ to 60 horse power. Temperature rise is not more than 40° Centigrade in the hottest spot.

CENTURY ELECTRIC COMPANY
1806 Pine Street ST. LOUIS, MO.

32 Stock Points in the United States and More Than 50 Outside Thereof

$\frac{1}{2}$ to 60 H. P.

Century
MOTORS

$\frac{1}{2}$ to 60 H. P.

Please mention the JOURNAL of the A. I. E. E. when writing to advertisers.

Pop "investigates" a little

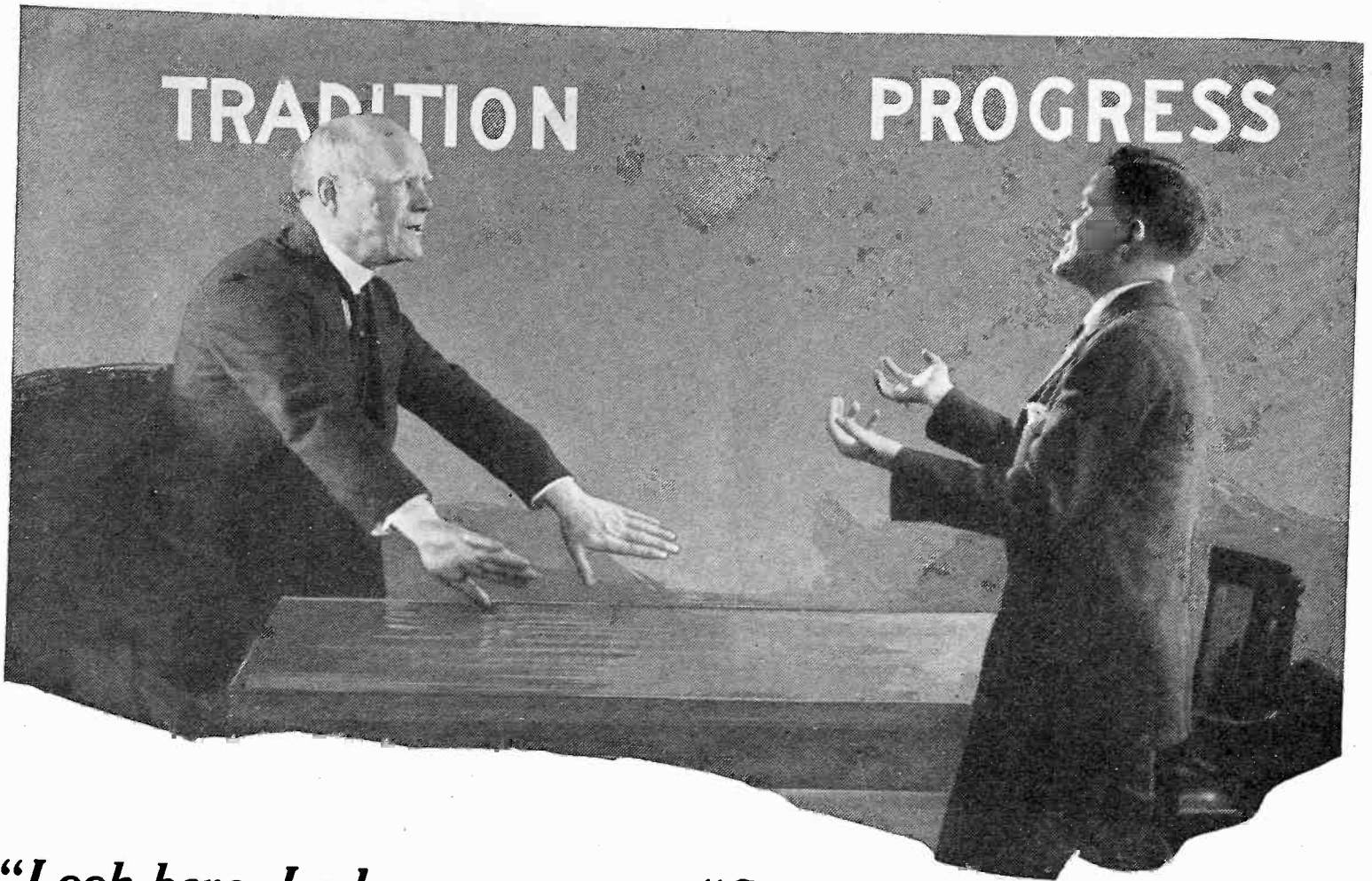

"Look here, Lad—

I've listened to you so long haranguing on that "Linc-Weld" motor as a cure for the bearing troubles that we've been having that I got to investigating a little.

I've asked representatives from different motor companies about this big shaft and bearings on "Linc-Weld" and without exception they've replied in the vernacular 'It's the bunk'."

"Sure, Pop—

climb a little higher than the crowd and you're a target for the knockers.

The makers of this "Linc-Weld" motor had the temerity to kick manufacturing standards in the face—hide-bound, deep-rutted standards.

They focused all engineering on motors exclusively.

If any other manufacturer agrees that "Linc-Weld" is right—he's admitting that the method he's wedded to is all wrong.

And you know, Pop, that nothing makes a bride so upset as to admit that she might have done better.

Boy, how she'll defend her stuffed shirt!"

The Lincoln Electric Co., Dept. No. 21-7, Cleveland, Ohio

MA-17

L *"Linc-Weld"*
INCOLN MOTOR

Please mention the JOURNAL of the A. I. E. E. when writing to advertisers.



CHOSEN

by **WRIGHT** for the
 severest duty in the "Whirlwind" Engine—
 the main crank shaft bearings

WESTERN UNION

RECEIVED AT 1 BANK STREET, STAMFORD, CONN.

8483 44 NL. PATERSON NJ 22

NORMA HOFFMAN BEARINGS CORP.

STAMFORD CONN

THE CRANKSHAFT OF THE WRIGHT WHIRLWIND ENGINE WHICH PULLED CAPTAIN LINDBERGH THROUGH THE AIR ON HIS ASTOUNDING NON STOP FLIGHT WAS MOUNTED ON TWO HOFFMAN ROLLER BEARINGS STOP WITHOUT RELIABLE MAIN BEARINGS IN HIS ENGINE CAPTAIN LINDBERGH'S GLORIOUS FLIGHT MUST HAVE ENDED IN DISASTER. WRIGHT AERONAUTICAL CORPORATION.

1927 MAY 22 PM 8 00

POSTAL TELEGRAPH - COMMERCIAL CABLES

TELEGRAMS TO ALL AMERICA

CABLEGRAMS TO ALL THE WORLD

DELIVERY NO.

STANDARD TIME INDICATED ON THIS MESSAGE

11 10 AM 56 BLUE

87 BROOKLYN NY MAY 24 1927

NORMA HOFFMANN BEARINGS CORPN

STAMFORD, CONN.

PIONEER INSTRUMENT CO CONGRATULATES YOU UPON THE PRODUCTION OF A TYPE OF BEARINGS SUITED TO THE NEEDS OF SUCH IMPORTANT FLYING EQUIPMENT AS THE EARTH INDUCTOR COMPASS USED BY CAPTAIN LINDBERGH ON HIS TRIUMPHANT EPOCHAL FLIGHT FROM NEWYORK TO PARIS THREE OF YOUR TYPE C NINE EIGHT WERE USED IN THIS INSTRUMENT

PIONEER INSTRUMENT CO

MAY 24 1927

N-38

and by
PIONEER
 for the Sensitive Earth
 Inductor Compass

PROVEN

in Service

On the San Diego-New York-Paris Flight by Capt. Charles Lindbergh

ONCE again the endurance and dependability of Norma-Hoffmann Precision Bearings have been demonstrated, in the achievement of Capt. Lindbergh—as in the 51-hour non-stop and later transatlantic flights of Chamberlin in the Bellanca plane.

NORMA-HOFFMANN BEARINGS CORP'N
 Stamford, Conn., U. S. A.

882

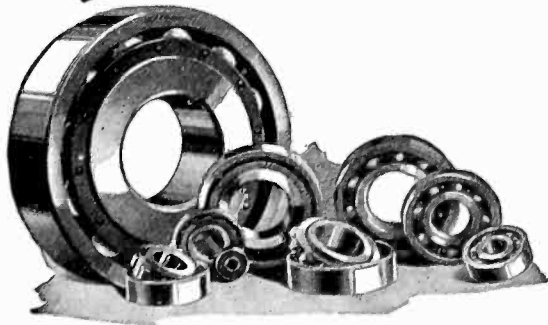

Bearings that justified the judgment of those who chose them for this critical duty, are worthy of the confidence of every executive, engineer and designer seeking the utmost in bearing service.

Catalogs 904, 905 and 917—yours on request.

NORMA - HOFFMANN

BALL & ROLLER BEARINGS

Please mention the JOURNAL of the A. I. E. E. when writing to advertisers.

Wearless, Dripless Mill Motors

In textile mills even more than in most industries, electric motor practices are a highly developed science. Naturally a strong preference exists for Timken-equipped motors. Their anti-friction properties reduce starting load and save all possible power, lubricant, and attention. They are drip-proof *in any position*. Mounted on ceiling, wall, or floor, no alterations are required for any form of drive, because on Timken Bearings all loads from all directions are carried equally well.

Only Timken-made electric steel, Timken tapered construction, and Timken *POSITIVELY ALIGNED ROLLS* produce this higher all-around load capacity. It makes possible a 15% average reduction in shaft length, saves aisle space, and assures complete protection against thrust, shock, radial load, friction—and burn-outs.

This gives textiles and other industries the strongest insurance ever known against wear, breakdowns, and stoppage.

THE TIMKEN ROLLER BEARING CO., CANTON, OHIO

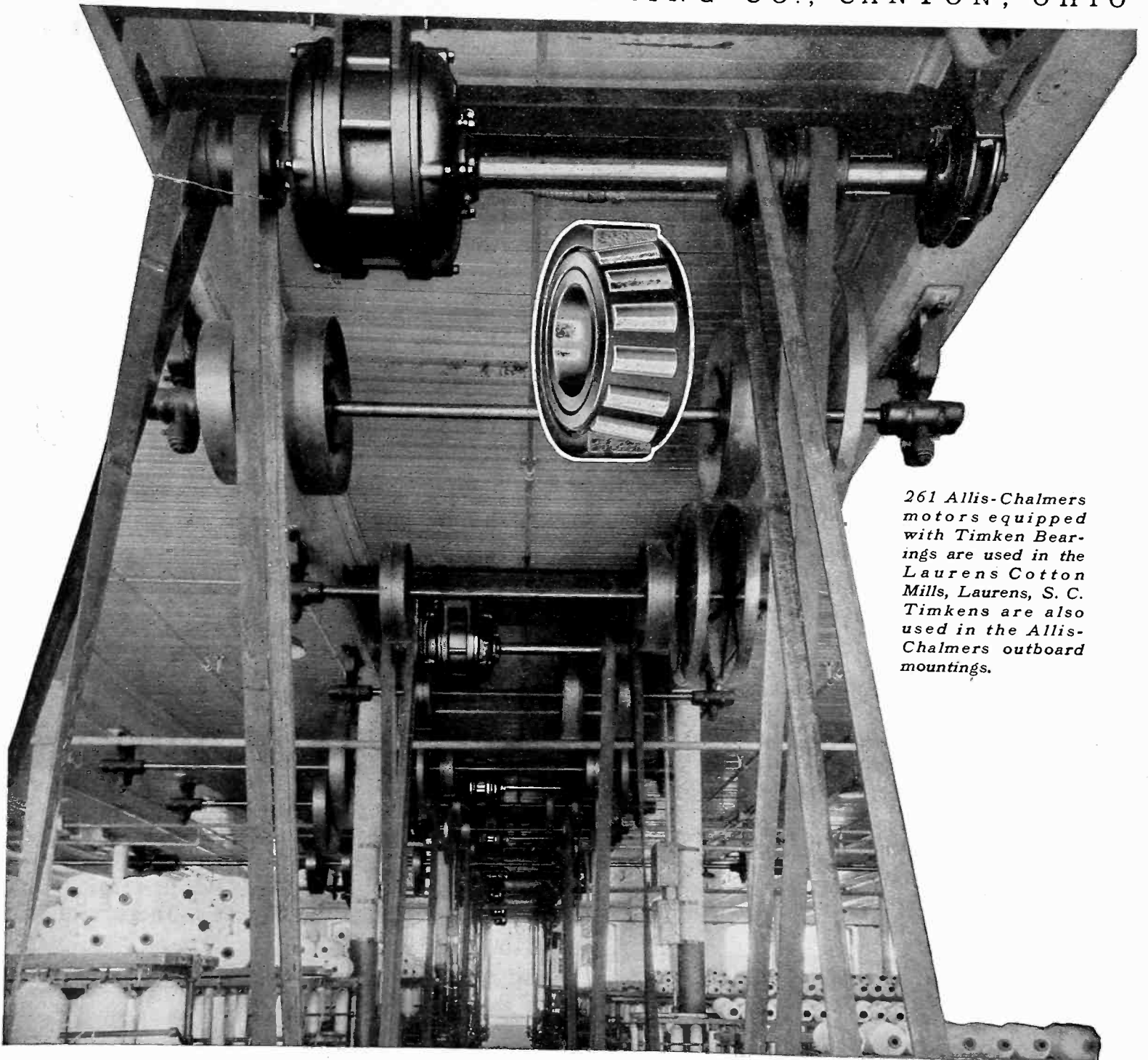

261 Allis-Chalmers motors equipped with Timken Bearings are used in the Laurens Cotton Mills, Laurens, S. C. Timkens are also used in the Allis-Chalmers outboard mountings.

TIMKEN *Tapered Roller* BEARINGS

Please mention the JOURNAL of the A. I. E. E. when writing to advertisers.

Compression Resistance Starters Are Superior to Compensators

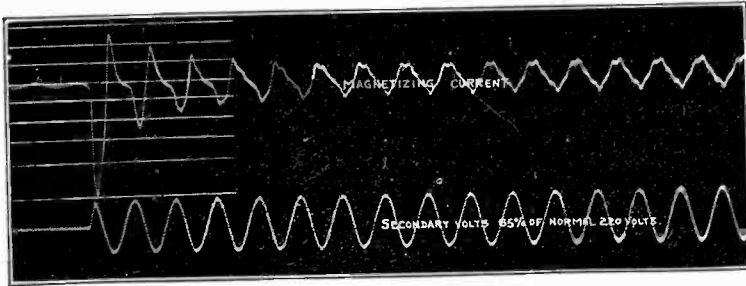

The oscillogram at the left shows the magnetizing current inrush which occurs with an unloaded compensator. When this is added to the normal starting current, a serious disturbance is created. It can be avoided by using the Allen-Bradley Compression Resistance Starter, which has no transformer in its construction.

The oscillogram at the right shows the violent current inrush required to bring the motor back into step, after it is switched from starting to running taps of a compensator. The second inrush, shown in the oscillogram, is frequently worse than the inrush that occurs when the compensator is first switched to starting position.

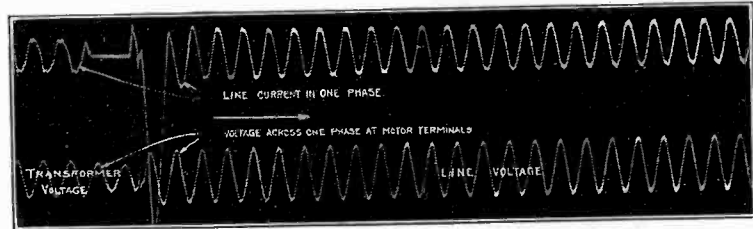

Don't Blame the Motor for Voltage Flicker It May Be Due to the Compensator

DID you ever stop to consider why the compensator is the cause of such serious line voltage disturbance?

Power engineers know that a large starting current, if built up slowly, is not as harmful to voltage regulation as a small starting current that reaches its maximum value with a violent inrush. To reduce the current inrush from the main line, when starting squirrel-cage motors with a compensator, a 60%, 70%, or 80% tap is used. Theoretically, the starting current drawn from the main line should be reduced to 80% of the motor current when the 80% tap is used, but actually this is not the case, due to serious inrushes caused by the compensator itself.

The first bad inrush takes place when the com-

pensator is thrown to the "start" position. In addition to the normal starting current, a heavy, momentary current, shown in the upper oscillogram, is required to magnetize the core of the compensator.

The second inrush (usually worse than the first) occurs when the compensator switches the motor from starting to running taps, and the motor is connected to the line. A heavy inrush of current is required to bring the motor into step with the line frequency. This severe second inrush, shown in the lower oscillogram, affects the line voltage. The starting compensator, not the motor, is the real cause of these severe current inrushes that produce voltage flicker.

Allen-Bradley Compression Resistance Starters build up the starting current smoothly and then switch the motor to line voltage without opening the motor circuit. For satisfactory starting of squirrel-cage motors, always use Allen-Bradley hand-operated or automatic resistance starters. Mail the coupon for complete technical bulletins.

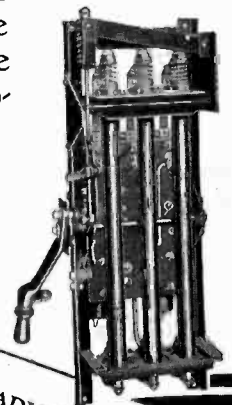
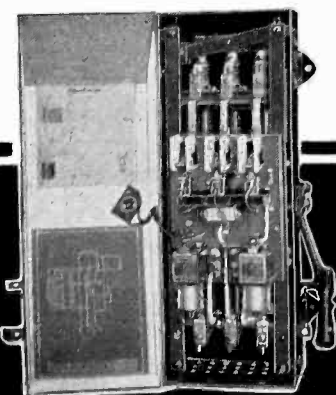

Allen-Bradley
Graphite Compression
RESISTANCE STARTERS
for Squirrel-Cage Motors

ALLEN-BRADLEY CO.,
494 Clinton St., Milwaukee, Wis.
Please send me engineering bulletin with oscillograph test of squirrel-cage motor starters.

Name.....
Company.....
Address.....

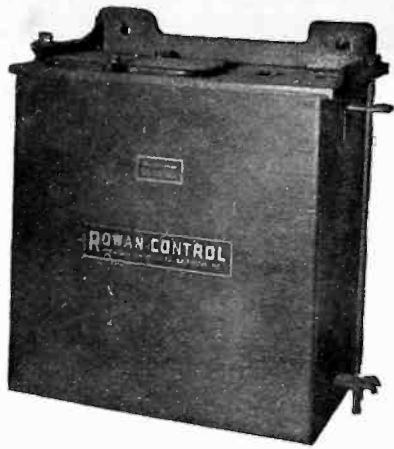

Here's a new starter!

Completely oil-immersed

Dust tight—Gas tight—Weatherproof

Write for complete details of this new across-the-line starter.

ROWAN CONTROL
THE ROWAN CONTROLLER CO., BALTIMORE, MD.

Science Abstracts

ALL electrical engineers actively engaged in the practice of their profession should subscribe to "Science Abstracts."

Published monthly by the Institution of Electrical Engineers, London, in association with the Physical Society of London, and with the cooperation of the American Institute of Electrical Engineers, the American Physical Society and the American Electrochemical Society, they constitute an invaluable reference library.

Through "Science Abstracts" engineers are enabled to keep in touch with engineering progress throughout the world, as one hundred and sixty publications, in various languages, are regularly searched and abstracted. "Science Abstracts" are published in two sections, as follows:

"A"—PHYSICS—deals with electricity, magnetism, light, heat, sound, astronomy, chemical physics.

"B"—ELECTRICAL ENGINEERING—deals with electrical plant, power transmission, traction, lighting, telegraphy, telephony, wireless telegraphy, prime movers, engineering materials, electrochemistry.

Through special arrangement, members of the A. I. E. E. may subscribe to "Science Abstracts" at the reduced rate of \$5.00 for each section, and \$10 for both. Rates to non-members are \$7.50 for each section and \$12.50 for both.

Subscriptions should start with the January issue. The first volume was issued in 1898. Back numbers are available, and further information regarding these can be obtained upon application to Institute headquarters.

American Institute of Electrical Engineers
33 West 39th Street, New York

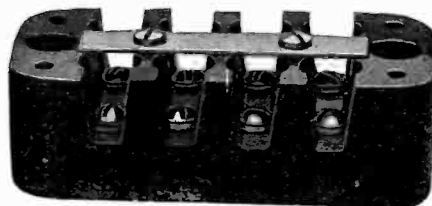

CONTROLEAD TERMINAL BLOCKS
WITH INTERCHANGEABLE SWITCH PARTS

Sample and Bulletin furnished on request

BURKE ELECTRIC CO., ERIE, PA.

Please mention the JOURNAL of the A. I. E. E. when writing to advertisers.

**THE
PIONEER MANUFACTURER
OF
Interpole & Ball Bearing
Motors**

1/2 to 1000 H. P. D. C. and A. C.

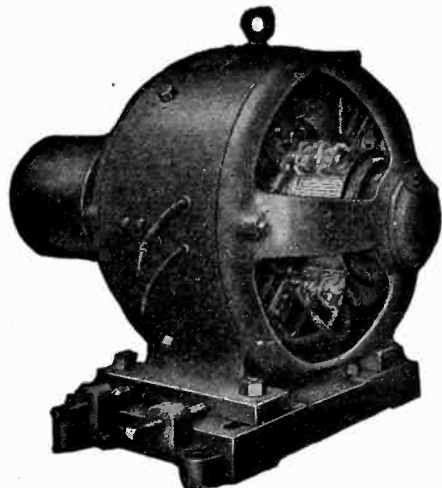

Type "S" Ball Bearing Motor with base and pulley

ELECTRO DYNAMIC COMPANY
Established 1880
BAYONNE, N. J.
Sales Offices in Principal Cities

Trade "ESCO" Mark
ELECTRIC SPECIALTY CO.
Engineers and Manufacturers

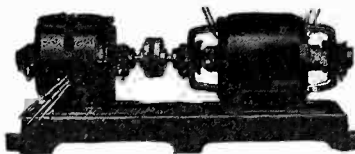

DESIGN —
DEVELOP —
PRODUCE —

Small Motors, Generators, Dynamotors,
Motor Generators, Rotary Converters, Etc.
FOR SPECIAL PURPOSES—Send Us Your Problems
222 South Street, STAMFORD, CONN., U.S.A.

MODELS

for
MANUFACTURING STANDARDS
SALES DEMONSTRATION AND DISPLAY
USE IN LITIGATION

Experimental Development under Client Supervision
**MANUFACTURERS' & INVENTORS'
ELECTRIC CO.**
(Smith Building)
228 West Broadway, N. Y. City
Incorporated 1897

Sturtevant Electric Motors

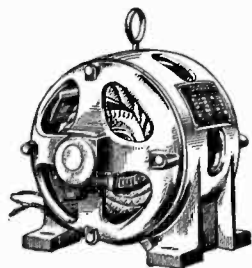

—A. C. and D. C.; single and polyphase—built in sizes from small fractional to 250 horse-power—designed to operate under a constant full load where uninterrupted service is demanded.

B. F. STURTEVANT COMPANY
HYDE PARK, BOSTON, MASS.

Star Ball Bearing Motors

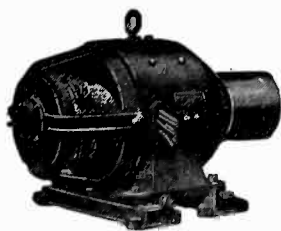

For
Hard
Usage
—
A. C.
and
D. C.

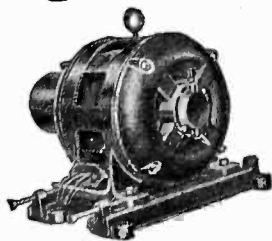

Complete line of standard motors and generators, all sizes up to 75 h. p. and 50 kw. respectively.
Our Engineering Department at your service for all special applications
STAR ELECTRIC MOTOR CO.
NEWARK, NEW JERSEY

Announcing

"Imperial" No. 7 Stone



for

Glazing Commutators

Glazes Commutators in two or three Minutes instead of two or three weeks. Hardens Surface of Bars, Improving Commutation. Increases the life of both Commutator and Brushes.

MARTINDALE ELECTRIC CO.,
1260 W. 4th St., Cleveland, O.

Please send me more information about your New Commutator Glazing Stone.

Name and Title

Company

Street

City

State

20-7-27

In Industry as in War...
**THERE IS STRENGTH
 IN NUMBERS**

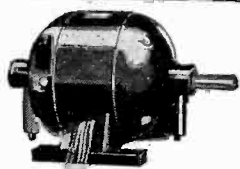
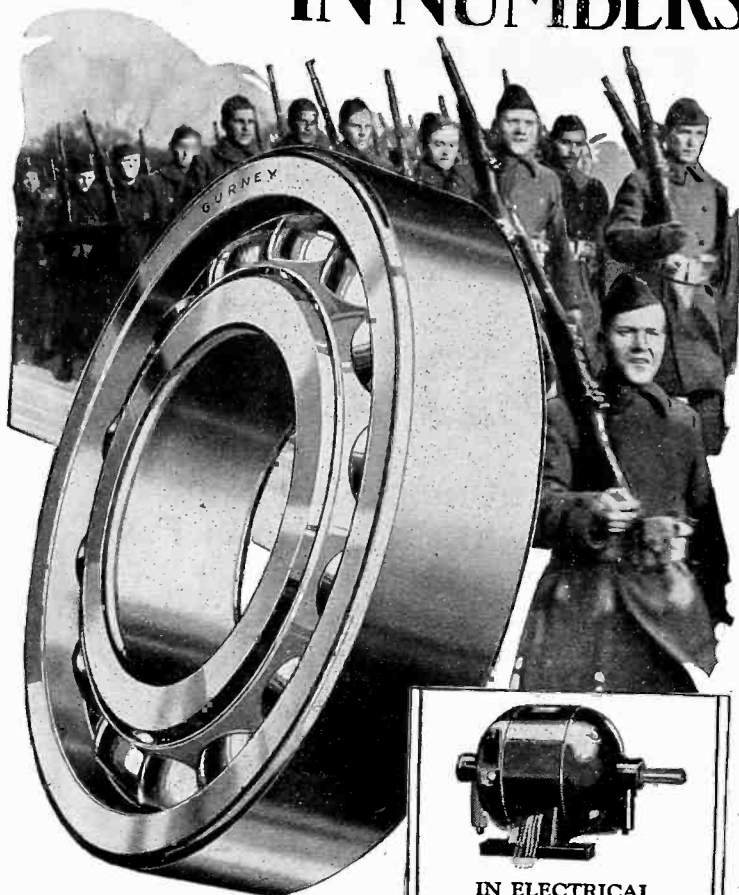

**IN ELECTRICAL
 MACHINERY**

For continuous performance at high speed under severe belt and gear loads. Gurney ball bearings have identified themselves by their reliable service and minimum maintenance.

Employing more balls strengthens Gurney maximum type bearings to resist the stresses and shocks of severe loads.

As in military strategy the brunt of service borne by each man is reduced by employing larger numbers, so in Gurney bearings the load on each ball is lessened by using more of them. Thus more balls combined with the toughening effect of Molybdenum steel contribute to the greater capacity and longer life which Gurney has long typified.

Reason enough for specifying them in your equipment. Our Engineering Department will gladly help you.

Marlin-Rockwell Corp.

Gurney Ball Bearing Division

Jamestown, N. Y.

GURNEY
BALL BEARINGS

BETTER STEEL - BIGGER BALLS - MORE OF THEM

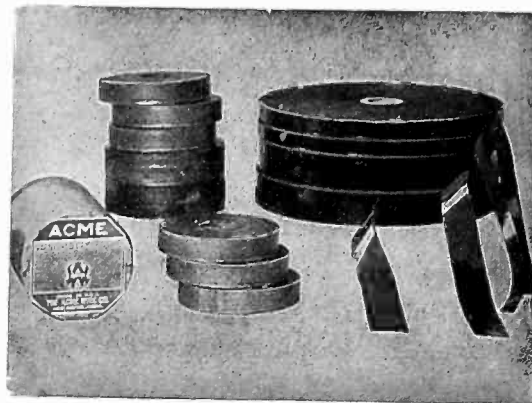

ACME
Bias Cambric Tapes
 for
Better Repair Work

Lessen the frequency of repairs by doing a better job in the first place. Use Acme Tapes. They have a dielectric margin that materially increases their life.

The cambrics are made from selected cotton cloth, woven from long-staple yarn and finished so as to insure great tensile and tearing strength and uniform thickness.

Only pure vegetable oil varnish is used, made in the Acme plant under scientific heat control and applied in special towers under heat again scientifically and accurately controlled. The result is a smooth, tough, flexible film.

Made in black and yellow, straight and bias cut, seamless and sewed. Thicknesses, .005" to .015"—widths, 1/4" to 36"—72 linear yds. to the roll. Standard finishes; dry, greasy and tacky.

If not at your jobber's, write for catalog and we will see that you are supplied.

ACME WIRE PRODUCTS

THE ACME WIRE CO.

Main Office and Plant, New Haven, Conn.

Branches at

New York, 52 Vanderbilt Ave. Chicago, 427 West Erie Street
 Cleveland, Guardian Bldg.

INSULATION

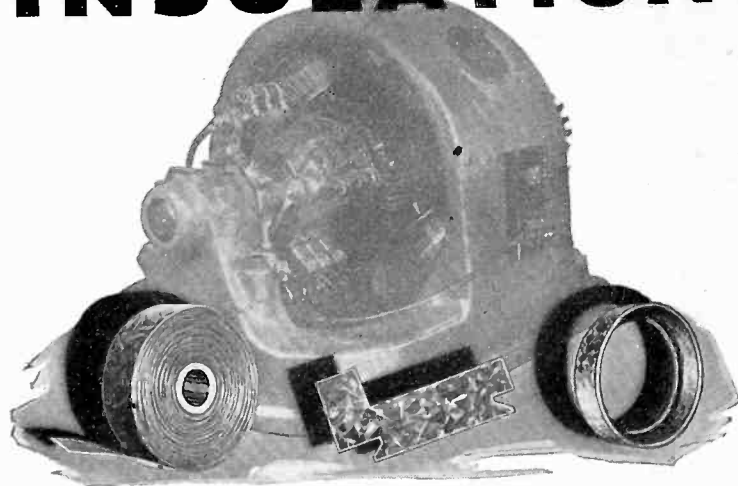

CONSTANT-UNIFORM QUALITY

MICABOND is manufactured almost entirely by machine—thereby eliminating the uncertainties of hand labor—constant, uniform quality is thus obtained—and today MICABOND is more than ever the Standard Mica Insulation.

A series of puncture and flash-over tests, recently conducted by competent engineers conclusively proves the outstanding quality of MICABOND

PUNCTURE TEST .025" PLATE

MICABOND No. 101 Molding Plate 27,416 Volts	MICABOND No. 104 Amber Segment Plate 22,171 Volts	MICABOND No. 102 India Segment Plate 23,212 Volts
Volts per mil of thickness computed from average breakdown voltage.		
1,097 Volts	1,109 Volts	1,161 Volts

No surface leakage during puncture tests was noted.

FLASH-OVER TEST (DRY)

MICABOND No. 101 Molding Plate 18,690 Volts	MICABOND No. 104 Amber Segment Plate 19,120 Volts	MICABOND No. 102 India Segment Plate 18,610 Volts
---	---	---

FLASH-OVER TEST (After Standing in Humid Air 24 Hours)

MICABOND No. 101 Molding Plate 18,970 Volts	MICABOND No. 104 Amber Segment Plate 18,440 Volts	MICABOND No. 102 India Segment Plate 18,460 Volts
---	---	---

SECOND READING (Electrodes in Same Position as in First Reading)

MICABOND No. 101 Molding Plate 18,770 Volts	MICABOND No. 104 Amber Segment Plate 18,560 Volts	MICABOND No. 102 India Segment Plate 18,290 Volts
---	---	---

MICABOND is manufactured in molding and commutator segment sheets, flexible plate, segments, rings, tubes, tape—and in punched or molded parts complete, ready for assembly. Send blue prints or specifications for prices.

CHICAGO MICA COMPANY

Offices in 18 Cities

Valparaiso, Indiana

MICABOND

THE STANDARD MICA INSULATION

I-N BOARD West Virginia Fibre Board

For Electrical Insulation

Tested and approved by the Underwriters' Laboratories.

High tensile and dielectric strength. Used successfully by many of the large electrical manufacturers.

A decided factor for economy.

Pulp Products Department
**West Virginia
Pulp & Paper Company**

200 Fifth Avenue, New York, N. Y.
505 Dime Bank Bldg. Detroit, Mich. 732 Sherman Street Chicago, Ill.
503 Market Street, San Francisco, Cal.

TRUMBULL



for years have stood the most exacting tests of scores of the largest motor, dynamo, generator, and radio builders in the United States.
Our Engineering Department is at your service. Write us concerning your requirements.

THE TRUMBULL STEEL COMPANY
WARREN Mills, Laboratories and General Offices OHIO

"IRVINGTON" PRODUCTS

Black and Yellow

Varnished Cambric Varnished Paper
Varnished Silk
Flexible Varnished Tubing
Insulating Varnishes and Compounds
"Cellulak" Tubes and Sheets

IRVINGTON VARNISH & INSULATOR CO.
Irvington, New Jersey.

Sales Representatives
Mitchell-Rand Mfg. Co., New York
E. M. Wolcott, Rochester
I. W. Levine, Montreal
A. L. Gillies, Toronto
Consumer's Rubber Co., Cleveland
Martin Woodard, Seattle
Prenter Brothers, Inc., Chicago
White Supply Co., St. Louis
Clapp & La Moree, Los Angeles

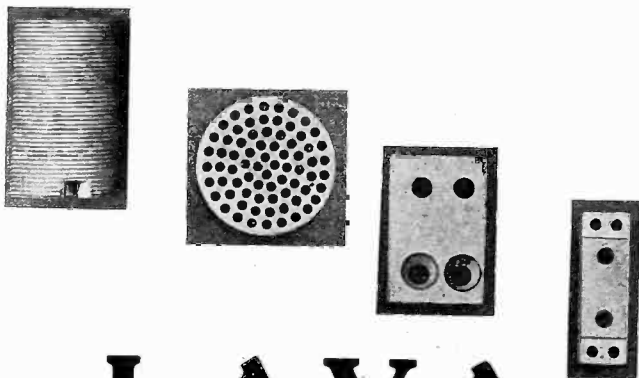

LAVA INSULATORS

Strong in dielectric properties, heat resistant, and maintaining accurate dimensions, Lava has been accepted as the ideal insulating medium by manufacturers who require dependable insulators.

AMERICAN LAVA CORPORATION
27-67 Williamson Street
Chattanooga Tennessee
Manufacturers of Heat Resistant Insulators

Y-26 High-Heat Mica Plate

For High Temperature Insulation

Possesses all the advantages of natural mica for insulating heating appliances. Is more economical, particularly when used in the larger units.

Supplied in sheets up to 30" x 42", in thicknesses of ten mils or over. Can be cut or punched to any form.

Send for samples and prices.



NEW ENGLAND MICA CO.
Waltham 54, Mass.

New York Office — 220 Broadway

ALL FORMS OF MICA FOR ELECTRICAL PURPOSES

**NATIONAL
VULCANIZED
FIBRE**

*Paper base
Canvas base*

**PEERLESS
INSULATION**

**SHEETS
RODS
TUBES
SHAPES**

PHENOLITE
Laminated BAKELITE

**SHEETS
RODS
TUBES
SHAPES**

*Graded to
your requirements*

NATIONAL VULCANIZED FIBRE CO.
WILMINGTON DEL., U. S. A.
Offices in principal cities

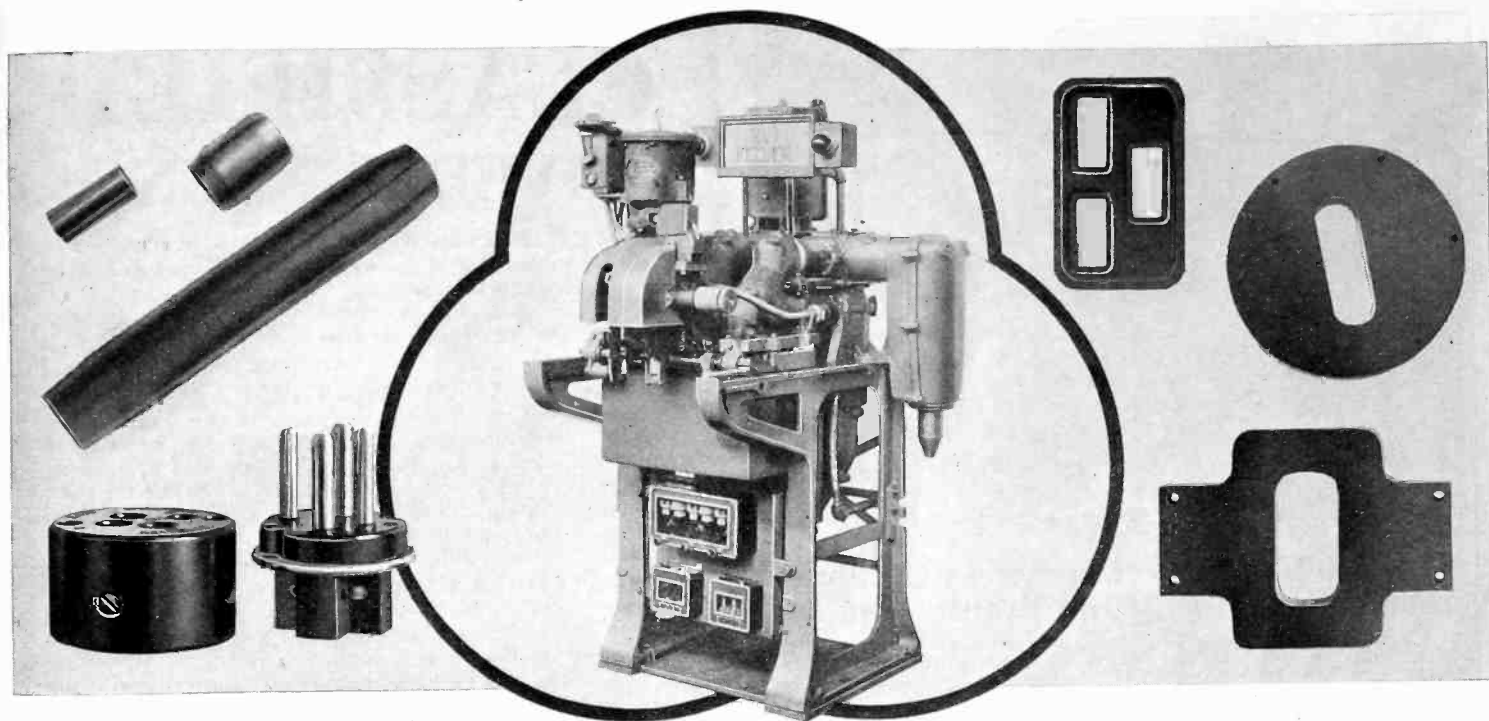

Allis-Chalmers Reyrolle Circuit Breaker Unit and some of the Bakelite parts used in it.

Three forms of Bakelite Insulation are found in this 15,000 volt Circuit Breaker Unit

IN the Allis-Chalmers Reyrolle 300 Amp. 15,000 volt Circuit Breaker Unit, Bakelite Molded is used for the bus bar spacer and the secondary plug and socket; Bakelite Laminated for the terminal board and secondary terminal board; and Bakelized Paper for the spout, socket and cable insulators. Similar Bakelite insulation is also used on the 33,000 volt unit.

The fact that Bakelite Insulation, in all forms, possesses high dielectric

strength, is non-hygroscopic, resists heat and oil and does not deteriorate with age, makes it superior for many applications on high-tension equipment.

Bakelite engineers and research laboratories always welcome opportunities to cooperate with manufacturers in solving difficult insulating problems. Write for a copy of Booklet No. 3 in which you will find much interesting data on Bakelite Materials and their uses.

BAKELITE CORPORATION

247 Park Ave., New York, N. Y., Chicago Office: 635 West 22nd St.

BAKELITE CORPORATION OF CANADA, LTD., 163 Dufferin St., Toronto, Ontario, Can.

BAKELITE

REGISTERED

U. S. PAT. OFF.



THE MATERIAL OF A THOUSAND USES

"The registered Trade Mark and Symbol shown above may be used only on products made from materials manufactured by Bakelite Corporation. Under the capital "B" is the numerical sign for infinity, or unlimited quantity. It symbolizes the infinite number of present and future uses of Bakelite Corporation's products."

Please mention the JOURNAL of the A. I. E. E. when writing to advertisers.



MARING PROCESS

MARING Process Guarantees Uniform Insulation, Firmly and Evenly Applied

Firm, even serving of the fabric, either over enameled or bare copper wire, by machines designed and built in our own shops guarantees maximum insulation value in all MARING Magnet Wire. A smooth, uniform thickness of insulation insures dependability and high dielectric strength. Careful and continuous analysis determines to a nicety the proper amount of cotton or silk, and the angle of application for each individual size of wire and the standard set by our laboratories is automatically maintained throughout the entire manufacturing process.

Write for new Catalog No. 27. Prices and complete information cheerfully given without obligation to you.

MARING WIRE COMPANY
Muskegon, Mich.
Branch Offices in Principal Cities

MARING

VENUS PENCILS

The Largest Selling Quality Pencil in the World
17 Black Degrees—3 Copying

THE first pencil ever sold under a guarantee of uniform grading; the superbly smooth and remarkably long lasting VENUS Pencils offer the technical user the strongest protection in the pencil field.

17 Black Degrees—3 Copying

- For bold, heavy lines . . . 6B-5B-4B-3B
- For writing, sketching . . . 2B-B-HB-F-H
- For clean, fine lines . . . 2H-3H-4H-5H-6H
- For delicate, thin lines . . . 7H-8H-9H

Plain Ends, per doz. . . \$1.00
Rubber Ends, per doz. . . 1.20

American Pencil Co.
204 Fifth Avenue
New York



At all stationers and drafting supply dealers

UNIQUE THIN LEAD COLORED PENCILS

Make fine lines for figuring, checking, sketching, blueprints, etc.

- | | | |
|-------|--------|-----------|
| Blue | Purple | Pink |
| Red | Brown | Lt. Blue |
| Green | Orange | Lt. Green |
| White | Yellow | Maroon |

\$1.00 per doz.

CLASSIFIED ADVERTISEMENTS

RATES. Fifty cents per line; minimum charge based on use of five lines; maximum space cannot exceed twenty lines.

Copy should be received by the 15th of the month, for insertion in the following issue.

TECHNICAL TRANSLATIONS by engineering graduate of American and European universities, handling highly specialized translations for largest manufacturers of electrical and mechanical equipment in the United States. Extreme accuracy and reliability are offered to manufacturers through this technical service. Adolph Luque, 150 Nassau Street, New York.

WANTED: Man with experience in exhausting of vacuum tubes, to take charge of approximately 15 trolley exhaust positions, also experience in maintenance and operation of pumps. Apply by letter giving full details as to age, experience, salary desired and when available. Address Box 128, JOURNAL of A. I. E. E., 33 West 39th Street, New York.

FOR SALE: A. I. E. E. TRANSACTIONS. A member wishes to dispose of his complete set of the yearly bound volumes of the A. I. E. E. Selling price \$250.00, including shipping charges. Address the A. I. E. E., 33 West 39th Street, New York.

WANTED: Copies of the October and December (1926) issues of the JOURNAL of the A. I. E. E. Wrappers returning these copies should bear the sender's name and address. Twenty-five cents will be paid for each copy received. Address American Institute of Electrical Engineers, 33 West 39th Street, New York.

BINDERS for the JOURNAL of the A. I. E. E. A loose cover binder, especially designed for the JOURNAL, is now available. The new binder is exceptionally pleasing in appearance, durable and handy. One to six copies of the JOURNAL can be inserted. Covers of long-wearing processed material, closely resembling rich brown leather. Remittance of \$2.25 for a set of two, (or \$1.25 for one) should accompany order. A. I. E. E., 33 West 39th Street, New York.

POPULAR RESEARCH NARRATIVES are proving useful 'round the world in many offices, schools and laboratories. They are interesting home reading, too. Two little books, just pocket size. In each book 50 short stories of research, invention, discovery—footprints of progress. Introductions by Dr. E. E. Slosson and Prof. M. I. Pupin. Only \$1.50 for the two volumes, postpaid. Engineering Foundation, 29 West 39th Street, New York, N. Y.

Engineering Societies Library

A reference library for engineers—contains 150,000 volumes—receives over 1,300 technical journals and periodicals on all branches of engineering.

Searches are made upon engineering subjects, translations from foreign publications, photostats made, etc.

Books may be borrowed by members of the A. I. E. E. For information address, The Engineering Societies Library, 33 West 39th St., New York.

At Your Service



The Coils the thing

*---that makes
your product do its work*

The performance of any electrical unit is no better than its coils

From the simplest bell ringing transformer to the most accurate indicating and recording meter, the real heart of the instrument is the coil.

Theoretically, a coil is a simple thing, but to provide the utmost in efficiency, in dependability, and in ability to withstand overloads and abuse, coils must be scientifically designed and constructed with watch-like precision.

For accuracy in the most sensitive meter, for reliability in relays and transformers, manufacturers come to Dudlo for coils.

The Dudlo engineering and experimental laboratories are open for your use to assist in improving present coils or to help you develop new coils for new products.

DUDLO

DUDLO MANUFACTURING CORPORATION, FORT WAYNE, INDIANA

56 EARL STREET
NEWARK, N. J.

160 NORTH LA SALLE STREET
CHICAGO, ILL.

4153 BINGHAM AVE.
ST. LOUIS, MO.

274 BRANNAN ST.
SAN FRANCISCO, CALIFORNIA

Please mention the JOURNAL of the A. I. E. E. when writing to advertisers.

PROFESSIONAL ENGINEERING DIRECTORY

For Consultants in the Fields of Engineering, and Related Arts and Sciences

AMBURSEN DAMS
Hydroelectric Developments
Water Supply and Irrigation Dams
DAMS ON DIFFICULT FOUNDATIONS
AMBURSEN CONSTRUCTION CO.
Incorporated
Grand Central Terminal, New York
Kansas City, Mo. Atlanta, Ga.

DAY & ZIMMERMANN, Inc.
Engineers
Power Plants, Sub-Stations,
Transmission Lines, Industrial Plants
Examinations and Reports, Valuations,
Management of Public Utilities
1600 WALNUT ST., PHILADELPHIA
New York Chicago

HOOSIER ENGINEERING CO.
Erectors of
Transmission Lines and Substations
325 South New Jersey Street
INDIANAPOLIS INDIANA

W. S. BARSTOW & COMPANY
Incorporated
Financial and Operating
Managers of
Public Utilities
50 Pine Street New York

DAVID V. FENNESSY
Consulting Power Engineer
MILLS BUILDING EL PASO, TEXAS

Dugald C. Jackson
Edward L. Moreland
JACKSON & MORELAND
CONSULTING ENGINEERS
31 St. James Ave. Boston, Mass.

BATTEY & KIPP
Incorporated
ENGINEERS
Complete Industrial Plants
Power Plants & Electrical Installations
Engineering Reports, Analyses & Appraisals
231 South LaSalle Street CHICAGO

FORD, BACON & DAVIS
Incorporated
ENGINEERS
115 Broadway, New York
Philadelphia Chicago San Francisco

E. S. LINCOLN
Consulting Electrical Engineer
Designs Investigations Reports
Electrical Research Laboratory
Graybar Building
420 Lexington Avenue NEW YORK

BLACK & VEATCH
Consulting Engineers
Water, Steam and Electric Power Investiga-
tions, Design, Supervision of Construction,
Valuation and Tests.
Mutual Building KANSAS CITY, MO.

FRANK F. FOWLE & CO.
Electrical and Mechanical
Engineers
MONADNOCK BUILDING CHICAGO

MCCLELLAN & JUNKERSFELD
Incorporated
Engineering and Construction
Power Developments—Industrial Plants
Electrifications—Examinations
Reports—Valuations
NEW YORK
68 Trinity Place
Chicago St. Louis

BYLLESBY
ENGINEERING AND MANAGEMENT
CORPORATION
231 S. La Salle Street
CHICAGO
New York San Francisco

FREY ENGINEERING COMPANY
Industrial Electric Power
Generation—Application—Purchase
Combustion Engineering
Electric Furnace Installations
CHICAGO PHILADELPHIA
310 South Michigan Ave. 1500 Chestnut St.

John Minton I. G. Maloff
JOHN MINTON, PH. D.
Consulting Engineer
For Developing, Designing & Manufacturing
of Radio Receivers, Amplifiers, Transformers,
Rectifiers, Sound Recording & Reproducing
Apparatus.
Radio & Electro-Acoustical Laboratory.
8 Church Street White Plains, N.Y.

WALTER G. CLARK
Consulting Engineer
Electrical, Mining and Industrial
Reports
Supervision of Organization and Arrange-
ments for Financing
LOS ANGELES NEW YORK
1211 Insurance Exch. Bldg. 40 Wall St.

A. BARNETT GREEN
Writing — Editing — Compiling
Engineering Matter
1328 BROADWAY NEW YORK

N. J. NEALL
Consulting Engineer
for
Electrical and Industrial Properties
12 PEARL STREET BOSTON, MASS.

EDWARD E. CLEMENT
Fellow A. I. E. E.
Attorney and Expert
in Patent Causes
Soliciting, Consultation, Reports,
Opinions
McLachlen Bldg. Washington, D. C.
700 10th St., N. W.

AUGUSTUS M. HENRY
COUNSELOR AT LAW
(Patents and Patent Causes)
WOOLWORTH BLDG. NEW YORK

NEILER, RICH & CO.
Electrical and Mechanical
Engineers
Consulting, Designing and
Supervising
431 So. Dearborn St. — — Chicago

HAROLD A. DANNE
LIGHT AND POWER
41 PARK ROW NEW YORK

Card space limited
to 1"x2" for each
advertiser.

OPHULS & HILL, Inc.
Formerly Ophuls, Hill & McCreery, Inc.
CONSULTING ENGINEERS
112-114 WEST 42nd ST., NEW YORK CITY
Ice Making and Refrigeration
Investigations and Reports

PROFESSIONAL ENGINEERING DIRECTORY

For Consultants in the Fields of Engineering and Related Arts and Sciences

FARLEY OSGOOD
 Consultant
 Design, Construction, Operation
 Inter-Connection
 of
PUBLIC UTILITIES
 National Bank of Commerce Building
 31 Nassau Street, New York, N. Y.
 Tel.: Rector 7878 Cable Address: Fargood

SCOFIELD ENGINEERING CO.
 Consulting Engineers
 Power Stations Gas Works
 Hydraulic Developments Electric Railways
 Examinations & Reports Valuations
 Philadelphia

STONE & WEBSTER
 Incorporated
 DESIGN AND CONSTRUCTION
 EXAMINATIONS REPORTS
 APPRAISALS
 INDUSTRIAL AND PUBLIC SERVICE
 PROPERTIES
 New York Boston Chicago

I. S. PRENNER
 Mem. A. I. E. E.
 Lawyer—Engineer
 Patent Practice
 Liberty Trust Bldg.
 Broad and Arch Sts. PHILADELPHIA

J. E. SIRRINE & COMPANY
 Engineers
 Textile Mills; Hydro-Electric Develop-
 ments; Tobacco Products Plants; Cotton,
 Tobacco and General Warehousing; Indus-
 trial Housing; Steam Power Plants; Steam
 Utilization.
 General Offices: Greenville, South Carolina
 Branches
 Chattanooga, Tenn. Birmingham, Ala.

PERCY H. THOMAS
 Consulting Engineer
ELECTRIC POWER
 Generation—Transmission
 Applications
 120 BROADWAY NEW YORK

**PUBLIC SERVICE
 PRODUCTION COMPANY**
 Engineers and Constructors
 Design and Construct: Power Plants,
 Transmission Lines, Industrial Plants,
 Highways, Railroad Shops and Terminals,
 Gas Plants, Commercial Buildings
 Make: Examinations, Reports and Valuations
 80 PARK PLACE NEWARK, N. J.

JOHN A. STEVENS
 CONSULTING POWER ENGINEER
 16 Shattuck Street
 LOWELL MASSACHUSETTS

THE U. G. I. CONTRACTING CO.
 Engineers & Constructors
 Power Developments, Industrial Plants, Gas
 Plants, Transmission Systems, Appraisals
 Broad & Arch Sts., PHILA., PA.
 421 Peoples Gas 928 Union Trust
 Bldg., Chicago, Ill. Bldg., Pittsburgh, Pa.

**SANDERSON & PORTER
 ENGINEERS**
 PUBLIC UTILITIES & INDUSTRIALS
 Design Construction Management
 Examinations Reports Valuations
 Chicago New York San Francisco

**STEVENS & WOOD
 INCORPORATED**
 Engineers and Constructors
 120 BROADWAY, NEW YORK
 Youngstown, O.

**THE J. G. WHITE
 ENGINEERING CORPORATION**
 Engineers—Constructors
 Oil Refineries and Pipe Lines,
 Steam and Water Power Plants,
 Transmission Systems, Hotels, Apartments,
 Offices and Industrial Buildings, Railroads
 43 EXCHANGE PLACE NEW YORK

SARGENT & LUNDY
 Incorporated
 Mechanical and Electrical
 Engineers
 1412 Edison Bldg., 72 West Adams Street
 CHICAGO ILLINOIS

William M. Stockbridge Victor D. Borst
STOCKBRIDGE & BORST
 Patent Lawyers
 41 PARK ROW NEW YORK CITY

J. G. WRAY & CO.
 Engineers
 J. G. Wray, Fellow A.I.E.E. Cyrus G. Hill
 Utilities and Industrial Properties
 Appraisals Construction Rate Surveys
 Plans Organization Estimates
 Financial Investigations Management
 576 First National Bank Bldg., Chicago

YOUR CARD in 24,000 copies of each issue of this publication
 —12 times a year, will keep your name and specialized
 service constantly before the electrical industry.
 Qualified advertisers in the Engineering Directory are invited
 to send for rates.

**ELECTRICAL
 TESTING
 LABORATORIES**
 80th Street and East End Ave.
 NEW YORK

Inspections — Tests — Research
 Tests may be used by the purchaser for the following purposes:
 (1) To determine the quality of competing samples. This enables the purchase
 of the best quality for the money.
 (2) To make sure that shipments comply with specifications. This makes possible
 the assurance to the customer that shipments match buying samples.
 (3) To furnish an impartial decision in case of disputes between purchaser and
 manufacturer.
 Testing places the whole buying problem on a sound basis.

Please mention the JOURNAL of the A. I. E. E. when writing to advertisers.

Classified Advertiser's Index for Buyers

Manufacturers and agents for machinery and supplies used in the electrical and allied industries.

Note: For reference to the Advertisements see the Alphabetical List of Advertisers on page 58.

- AIR COMPRESSORS**
Allis-Chalmers Mfg. Co., Milwaukee
General Electric Co., Schenectady
Western Electric Co., All Principal Cities
- AIR WASHERS**
Sturtevant Company, B. F., Boston
- AMMETER COMPENSATING COILS**
Minerallac Electric Co., Chicago
- AMMETER, VOLTMETERS**
(See INSTRUMENTS, ELECTRICAL)
- ANCHORS, GUY**
Hubbard & Co., Pittsburgh
Kearney Corp., Jas. R., St. Louis
Matthews Corp., W. N., St. Louis
- ARMS FOR STREET LIGHTING**
Hubbard & Co., Pittsburgh
- BATTERY CHARGING APPARATUS**
Allen-Bradley Co., Milwaukee
Electric Specialty Co., Stamford, Conn.
Fansteel Products Co., Inc., North Chicago
General Electric Co., Schenectady
Ward Leonard Electric Co., Mt. Vernon, N. Y.
Western Electric Co., All Principal Cities
Westinghouse Elec. & Mfg. Co., E. Pittsburgh
- BEARINGS, BALL**
Gurney Ball Bearing Division of Marlin-Rockwell Corp., Jamestown, N. Y.
New Departure Mfg. Co., The, Bristol, Conn.
Norma-Hoffmann Bearings Corp., Stamford, Conn.
Standard Steel & Bearings, Inc., Plainville, Conn.
- BEARINGS, ROLLER**
Timken Roller Bearing Co., The, Canton, O.
- BLOWERS**
Sturtevant Co., B. F., Boston
- BOXES, FUSE**
General Electric Co., Schenectady
Kearney Corp., Jas. R., St. Louis
Metropolitan Device Corp., Brooklyn, N. Y.
Western Electric Co., All Principal Cities
Westinghouse Elec. & Mfg. Co., Pittsburgh
- BOXES, JUNCTION**
G & W Elec. Specialty Co., Chicago
Metropolitan Device Corp., Brooklyn, N. Y.
Standard Underground Cable Co., Pittsburgh
- BRACKETS AND PINS, METAL**
Hubbard & Co., Pittsburgh
- BRUSHES, COMMUTATOR**
Carbon
Morganite Brush Co., Inc., L. I. City, N. Y.
National Carbon Co., Inc., Cleveland
Westinghouse Elec. & Mfg. Co., E. Pittsburgh
Copper Graphite
Morganite Brush Co., Inc., L. I. City, N. Y.
National Carbon Co., Inc., Cleveland
Westinghouse Elec. & Mfg. Co., E. Pittsburgh
- BUS BAR FITTINGS**
Burndy Engineering Co., Inc., New York
Delta-Star Electric Co., Chicago
General Electric Co., Schenectady
Westinghouse Elec. & Mfg. Co., E. Pittsburgh
- CABLE ACCESSORIES**
Delta-Star Electric Co., Chicago
Dossert & Co., New York
G & W Electric Specialty Co., Chicago
General Electric Co., Schenectady
Minerallac Electric Co., Chicago
Standard Underground Cable Co., Pittsburgh
Western Electric Co., All Principal Cities
- CABLE RACKS**
Hubbard & Co., Pittsburgh
Metropolitan Device Corp., Brooklyn, N. Y.
- CABLES**
See WIRES AND CABLES
- CABLEWAYS**
American Steel & Wire Co., Chicago
Roebeling's Sons Co., John A., Trenton, N. J.
- CAMBRIC, VARNISHED**
Belden Mfg. Co., Chicago
General Electric Co., Bridgeport, Conn.
Irvington Varnish & Ins. Co., Irvington, N. J.
Westinghouse Elec. & Mfg. Co., E. Pittsburgh
- CARRIER CURRENT TELEPHONE EQUIPMENT**
Western Electric Co., All Principal Cities
Wireless Specialty Apparatus Co., Boston
- CIRCUIT BREAKERS**
Air-Enclosed
Allen-Bradley Co., Milwaukee
Cutter Co., The, Philadelphia
Roller-Smith Co., New York
Sunth Electric Co., Newark, N. J.
Ward Leonard Electric Co., Mt. Vernon, N. Y.
Western Electric Co., All Principal Cities
Oil
Condit Electrical Mfg. Corp., Boston
General Electric Co., Schenectady
Pacific Elec. Mfg. Co., San Francisco
Westinghouse Elec. & Mfg. Co., E. Pittsburgh
- CLAMPS, GUY & CABLE**
Burndy Engineering Co., Inc., New York
Hubbard & Co., Pittsburgh
Kearney Corp., Jas. R., St. Louis
Matthews Corp., W. N., St. Louis
- CLAMPS, HOT LINE**
Hubbard & Co., Pittsburgh
Kearney Corp., Jas. R., St. Louis
- CLIPS, CABLE**
Hubbard & Co., Pittsburgh
Kearney Corp., Jas. R., St. Louis
- CLOCKS**
Cramer & Co., Inc., R. W., New York
- COILS, CHOKE**
Burke Electric Co., Erie, Pa.
General Electric Co., Schenectady
Kearney Corp., Jas. R., St. Louis
Westinghouse Elec. & Mfg. Co., E. Pittsburgh
- COILS, MAGNET**
Acme Wire Co., New Haven, Conn.
Belden Mfg. Co., Chicago
Dudlo Mfg. Corp., Ft. Wayne, Ind.
General Electric Co., Schenectady
Westinghouse Elec. & Mfg. Co., E. Pittsburgh
- COMMUTATOR SLOTTERS**
Martindale Electric Co., The, Cleveland
- COMMUTATOR STONES**
Martindale Electric Co., The, Cleveland
- CONDENSATION PRODUCTS**
Bakelite Corporation, New York
- CONDENSERS, COUPLING**
For Carrier Current Telephone
Wireless Specialty Apparatus Co., Boston
- CONDENSERS, RADIO**
General Radio Co., Cambridge, Mass.
Pacent Radio Corp., New York
Wireless Specialty Apparatus Co., Boston
- CONDENSERS, STEAM**
Allis-Chalmers Mfg. Co., Milwaukee
General Electric Co., Schenectady
Westinghouse Elec. & Mfg. Co., E. Pittsburgh
- CONDUIT, UNDERGROUND FIBRE**
Western Electric Co., All Principal Cities
- CONNECTORS, SOLDERLESS**
Dossert & Co., New York
Kearney Corp., Jas. R., St. Louis
Western Electric Co., All Principal Cities
Westinghouse Elec. & Mfg. Co., E. Pittsburgh
- CONNECTORS AND TERMINALS**
Belden Mfg. Co., Chicago
Burke Electric Co., Erie, Pa.
Burndy Engineering Co., Inc., New York
Dossert & Co., New York
G & W Electric Specialty Co., Chicago
Western Electric Co., All Principal Cities
Westinghouse Elec. & Mfg. Co., E. Pittsburgh
- CONTACTS, TUNGSTEN**
Fansteel Products Co., Inc., North Chicago
General Electric Co., Schenectady
- CONTROL SYSTEMS**
Ward Leonard Electric Co., Mt. Vernon, N. Y.
- CONTROLLERS**
Allen-Bradley Co., Milwaukee
Electric Controller & Mfg. Co., Cleveland
General Electric Co., Schenectady
Kewan Controller Co., Baltimore
Sunth Electric Co., Newark, N. J.
Western Electric Co., All Principal Cities
Westinghouse Elec. & Mfg. Co., E. Pittsburgh
- CONVERTERS—SYNCHRONOUS**
Allis-Chalmers Mfg. Co., Milwaukee
Electric Specialty Co., Stamford, Conn.
Westinghouse Elec. & Mfg. Co., E. Pittsburgh
- COPPER CLAD WIRE**
Belden Mfg. Co., Chicago
Copperweld Steel Co., Rankin, Pa.
Standard Underground Cable Co., Pittsburgh
Western Electric Co., All Principal Cities
- CROSS ARMS, STEEL**
Hubbard & Co., Pittsburgh
- CUT-OUTS**
Condit Electrical Mfg. Corp., S. Boston
General Electric Co., Schenectady
G & W Electric Specialty Co., Chicago
Kearney Corp., Jas. R., St. Louis
Metropolitan Device Corp., Brooklyn, N. Y.
Western Electric Co., All Principal Cities
Westinghouse Elec. & Mfg. Co., E. Pittsburgh
- DRAWING INSTRUMENTS**
Cramer & Co., Inc., R. W., New York
- DYNAMOS**
(See GENERATORS AND MOTORS)
- DYNAMOTORS**
Burke Electric Co., Erie, Pa.
Electric Specialty Co., Stamford, Conn.
- ELECTRIFICATION SUPPLIES, STEAM ROAD**
General Electric Co., Schenectady
Ohio Brass Co., Mansfield, Ohio
Westinghouse Elec. & Mfg. Co., E. Pittsburgh
- ENGINEERS, CONSULTING AND CONTRACTING**
(See PROFESSIONAL ENGINEERING DIRECTORY)
- ENGINES**
Gas & Gasoline
Allis-Chalmers Mfg. Co., Milwaukee
Sturtevant Company, B. F., Boston
Oil
Allis-Chalmers Mfg. Co., Milwaukee
Sturtevant Company, B. F., Boston
Steam
Allis-Chalmers Mfg. Co., Milwaukee
Sturtevant Company, B. F., Boston
- FANS, MOTOR**
Century Electric Co., St. Louis
General Electric Co., Schenectady
Star Electric Motor Co., Newark, N. J.
Sturtevant Company, B. F., Boston
Western Electric Co., All Principal Cities
Westinghouse Elec. & Mfg. Co., E. Pittsburgh
- FARM LIGHTING GENERATORS**
Western Electric Co., All Principal Cities
Westinghouse Elec. & Mfg. Co., E. Pittsburgh
- FIBRE**
Belden Mfg. Co., Chicago
National Vulcanized Fibre Co., Wilmington, Del.
- FLOW METERS**
General Electric Co., Schenectady
- FURNACES, ELECTRIC**
General Electric Co., Schenectady
Westinghouse Elec. & Mfg. Co., E. Pittsburgh



Is your name on our mailing list for bulletins and catalog?

Morganite Brushes

Morganite Brush Co., Inc.
3302-3320 Anable Ave.,
Long Island City,
N. Y.

Please mention the JOURNAL of the A. I. E. E. when writing to advertisers.



SRB WINS *with* LINDBERGH!

*A*N SRB Single Row Ball Bearing stood the acid test in the Wright Whirlwind Engine of Lindbergh's plane on his flight to Paris, continuously withstanding the strains due to propeller thrust hour after hour through rain and sleet and fog.

There was nothing hand-picked about this bearing. It was a regular No. 213 stock bearing out of our regular production, made to withstand all severe conditions and to perform reliably and dependably in motor cars, busses, trucks, electric motors, and industrial machinery for all purposes.

*Mo-lyb-den-um
means
More-Life-In-'Em*

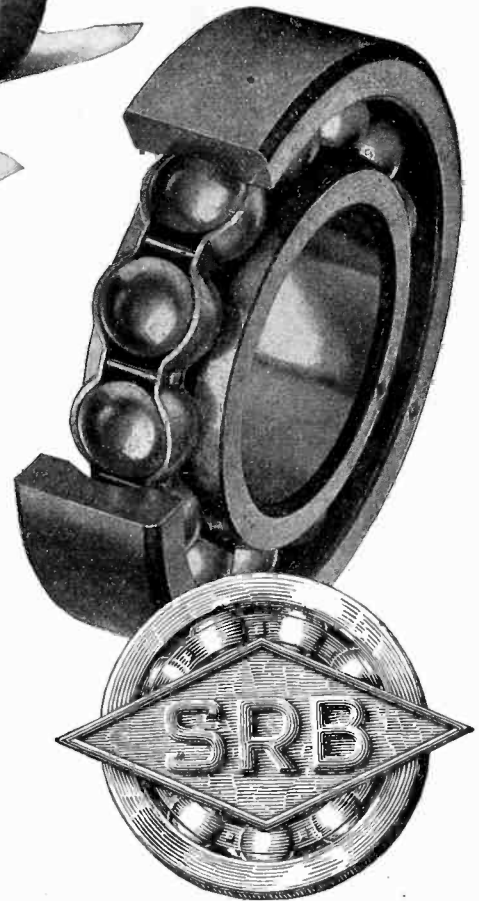

The tremendous thrust imposed by the 5150 pounds of weight in Lindbergh's plane on the take-off, and the 33½ hours of continuous propeller action was more than met by a No. 213 SRB Single Row Bearing with its maximum number of balls hot forged from Molybdenum Steel... What greater test of endurance could have been given any bearing?

STANDARD STEEL AND BEARINGS INCORPORATED

Plainville

USE SRB BALL BEARINGS—*First!*
—they'll last

Connecticut

Please mention the JOURNAL of the A. I. E. E. when writing to advertisers.

Classified Advertiser's Index for Buyers—Continued

- FUSES**
Enclosed Refillable
 General Electric Co., Schenectady
 Western Electric Co., All Principal Cities
 Westinghouse Elec. & Mfg. Co., E. Pittsburgh
- Enclosed Non-Refillable*
 General Electric Co., Schenectady
 Western Electric Co., All Principal Cities
- Open Link*
 General Electric Co., Schenectady
 Metropolitan Device Corp., Brooklyn, N. Y.
 Western Electric Co., All Principal Cities
- High Tension*
 Delta-Star Electric Co., Chicago
 Metropolitan Device Corp., Brooklyn, N. Y.
 Western Electric Co., All Principal Cities
- FUSE PULLERS**
 Kearney Corp., Jas. R., St. Louis
- GEARS, FIBRE**
 General Electric Co., Schenectady
- GENERATORS AND MOTORS**
 Allis-Chalmers Mfg. Co., Milwaukee
 Burke Electric Co., Erie, Pa.
 Century Electric Co., St. Louis
 Chandeysson Electric Co., St. Louis
 Electric Specialty Co., Stamford, Conn.
 Electro-Dynamic Co., Bayonne, N. J.
 General Electric Co., Schenectady
 Lincoln Electric Co., The, Cleveland
 Star Electric Motor Co., Newark, N. J.
 Sturtevant Company, B. F., Boston
 Western Electric Co., All Principal Cities
 Westinghouse Elec. & Mfg. Co., E. Pittsburgh
- GENERATING STATION EQUIPMENT**
 Allis-Chalmers Mfg. Co., Milwaukee
 Burke Electric Co., Erie, Pa.
 General Electric Co., Schenectady
 Western Electric Co., All Principal Cities
 Westinghouse Elec. & Mfg. Co., E. Pittsburgh
- GROUND CONNECTIONS**
 Hubbard & Co., Pittsburgh
- GROUND RODS**
 Copperweld Steel Co., Rankin, Pa.
 Hubbard & Co., Pittsburgh
 Western Electric Co., All Principal Cities
- HEADLIGHTS**
 Ohio Brass Co., Mansfield, O.
- HEATERS, INDUSTRIAL**
 General Electric Co., Schenectady
 Western Electric Co., All Principal Cities
 Westinghouse Elec. & Mfg. Co., E. Pittsburgh
- HIGH VOLTAGE GLASS**
 Corning Glass Works, "PYREX," Corning, N. Y.
- INDICATORS, SPEED**
 Bristol Co., The, Waterbury, Conn.
 Roller-Smith Co., New York
- INDICATORS, REMOTE, WATER LEVEL**
 Bristol Co., The, Waterbury, Conn.
 Cramer & Co., Inc., R. W., New York
- INSTRUMENTS, ELECTRICAL**
Graphic
 Bristol Co., The, Waterbury, Conn.
 Ferranti Ltd., Hollinwood, England
 Ferranti, Inc., New York
 Ferranti Electric Ltd., Toronto, Ont.
 General Electric Co., Schenectady
 Westinghouse Elec. & Mfg. Co., E. Pittsburgh
- Indicating*
 Bristol Co., The, Waterbury, Conn.
 Ferranti Ltd., Hollinwood, England
 Ferranti, Inc., New York
 Ferranti Electric Ltd., Toronto, Ont.
 General Electric Co., Schenectady
 Jewell Elec. Instrument Co., Chicago
 Roller-Smith Co., New York
 Westinghouse Elec. & Mfg. Co., E. Pittsburgh
 Weston Elec. Inst. Corp., Newark, N. J.
- Integrating*
 Duncan Elec. Mfg. Co., Lafayette, Ind.
 Ferranti Ltd., Hollinwood, England
 Ferranti, Inc., New York
 Ferranti Electric Ltd., Toronto, Ont.
 General Electric Co., Schenectady
 Roller-Smith Co., New York
 Sangamo Elec. Co., Springfield, Ill.
 Western Electric Co., All Principal Cities
 Westinghouse Elec. & Mfg. Co., E. Pittsburgh
- Radio*
 General Radio Co., Cambridge, Mass.
 Jewell Elec. Instrument Co., Chicago
- Repairing and Testing*
 Electrical Testing Laboratories, New York
 Jewell Elec. Instrument Co., Chicago
- Scientific, Laboratory, Testing*
 General Electric Co., Schenectady
 Jewell Elec. Instrument Co., Chicago
 Metropolitan Device Corp., Brooklyn, N. Y.
 Roller-Smith Co., New York
 Western Electric Co., All Principal Cities
 Westinghouse Elec. & Mfg. Co., E. Pittsburgh
 Weston Elec. Inst. Corp., Newark, N. J.
- Telegraph*
 Western Electric Co., All Principal Cities
- INSULATING MATERIALS**
Board
 General Electric Co., Bridgeport, Conn.
 West Va. Pulp & Paper Co., New York
- Cloth*
 Acme Wire Co., New Haven, Conn.
 General Electric Co., Bridgeport, Conn.
 Irvington Varnish & Ins. Co., Irvington, N. J.
 Minerallac Electric Co., Chicago
 Westinghouse Elec. & Mfg. Co., E. Pittsburgh
- Composition*
 American Lava Corp., Chattanooga
 Bakelite Corporation, New York
 Belden Mfg. Co., Chicago
 General Electric Co., Bridgeport, Conn.
 Westinghouse Elec. & Mfg. Co., E. Pittsburgh
- Compounds*
 General Electric Co., Bridgeport, Conn.
 Minerallac Electric Co., Chicago
 Standard Underground Cable Co., Pittsburgh
 Western Electric Co., All Principal Cities
 Westinghouse Elec. & Mfg. Co., E. Pittsburgh
- Fibre*
 General Electric Co., Bridgeport, Conn.
 National Vulcanized Fibre Co., Wilmington, Del.
 West Va. Pulp & Paper Co., New York
- Lava*
 American Lava Corp., Chattanooga, Tenn.
 Chicago Mica Co., Valparaiso, Ind.
- Mica*
 Chicago Mica Co., Valparaiso, Ind.
 New England Mica Co., Waltham, Mass.
 Westinghouse Elec. & Mfg. Co., E. Pittsburgh
- Paper*
 Acme Wire Co., New Haven, Conn.
 General Electric Co., Bridgeport, Conn.
 Irvington Varnish & Ins. Co., Irvington, N. J.
 Westinghouse Elec. & Mfg. Co., E. Pittsburgh
- Silk*
 Acme Wire Co., New Haven, Conn.
 General Electric Co., Bridgeport, Conn.
 Irvington Varnish & Ins. Co., Irvington, N. J.
- Tape*
 Belden Mfg. Co., Chicago
 General Electric Co., Bridgeport, Conn.
 Minerallac Electric Co., Chicago
 Okonite Co., The, Passaic, N. J.
 Western Electric Co., All Principal Cities
 Westinghouse Elec. & Mfg. Co., E. Pittsburgh
- Varnishes*
 Acme Wire Co., New Haven, Conn.
 General Electric Co., Bridgeport, Conn.
 Irvington Varnish & Ins. Co., Irvington, N. J.
 Minerallac Electric Co., Chicago
 Westinghouse Elec. & Mfg. Co., E. Pittsburgh
- INSULATORS, HIGH TENSION**
Composition
 General Electric Co., Schenectady
- Glass*
 Hemingray Glass Co., Muncie, Ind.
- Porcelain*
 Canadian Porcelain Co., Ltd., Hamilton, Ont.
 General Electric Co., Schenectady
 Hubbard & Co., Pittsburgh
 Lapp Insulator Co., Inc., LeRoy, N. Y.
 Locke Insulator Corp., Baltimore
 Ohio Brass Co., Mansfield, O.
 Thomas & Sons Co., R., East Liverpool, O.
 Western Electric Co., All Principal Cities
 Westinghouse Elec. & Mfg. Co., E. Pittsburgh
- Post Type*
 Delta-Star Electric Co., Chicago
- INSULATORS, TELEPHONE & TELEGRAPH**
 Hemingray Glass Co., Muncie, Ind.
 Western Electric Co., All Principal Cities
- INSULATOR PINS**
 Hubbard & Co., Pittsburgh
 Ohio Brass Co., Mansfield, O.
 Thomas & Sons Co., R., East Liverpool, O.
- LAMP GUARDS**
 Matthews Corp., W. N., St. Louis
 Western Electric Co., All Principal Cities
- LAVA**
 American Lava Corp., Chattanooga
- LIGHTNING ARRESTERS**
 Delta-Star Electric Co., Chicago
 General Electric Co., Schenectady
 Hubbard & Co., Pittsburgh
 Western Electric Co., All Principal Cities
 Westinghouse Elec. & Mfg. Co., E. Pittsburgh
- LOCOMOTIVES, ELECTRIC**
 General Electric Co., Schenectady
 Westinghouse Elec. & Mfg. Co., E. Pittsburgh
- LUBRICANTS**
 Texas Co., The, New York
- MAGNETIC SEPARATORS**
 Electric Controller & Mfg. Co., Cleveland
- METERS, ELECTRICAL**
 (See INSTRUMENTS ELECTRICAL)
- METER SEALS**
 Metropolitan Device Corp., Brooklyn, N. Y.
- MICA PRODUCTS**
 Chicago Mica Co., Valparaiso, Ind.
 New England Mica Co., Waltham, Mass.
 Westinghouse Elec. & Mfg. Co., E. Pittsburgh
- MICA UNDERCUTTERS**
 Martindale Electric Co., The, Cleveland
- MOLDED INSULATION**
 Bakelite Corporation, New York
 Belden Mfg. Co., Chicago
 Burke Electric Co., Erie, Pa.
 Westinghouse Elec. & Mfg. Co., E. Pittsburgh
- MOLYBDENUM**
 Fansteel Products Co., Inc., North Chicago
- MOTORS**
 (See GENERATORS AND MOTORS)
- OHMMETERS**
 Jewell Elec. Instrument Co., Chicago
 Martindale Electric Co., Cleveland
 Roller-Smith Co., New York
 Weston Elec. Instr. Corp., Newark, N. J.
- OIL SEPARATORS & PURIFIERS**
 Sharples Specialty Co., The, Philadelphia
 Westinghouse Elec. & Mfg. Co., E. Pittsburgh
- PANEL BOARDS**
 (See SWITCHBOARDS)
- PATENT ATTORNEYS**
 (See PROFESSIONAL ENGINEERING DIRECTORY)
- PLUGS**
 Delta-Star Electric Co., Chicago
 General Electric Co., Schenectady
 Western Electric Co., All Principal Cities
 Westinghouse Elec. & Mfg. Co., E. Pittsburgh
- POLE LINE HARDWARE**
 Hubbard & Co., Pittsburgh
 Ohio Brass Co., Mansfield, O.
- POLES, STEEL**
 American Bridge Co., Pittsburgh
 Western Electric Co., All Principal Cities
- POLES—TIES, WOOD**
 Western Electric Co., All Principal Cities
- POTHEADS**
 G & W Electric Specialty Co., Chicago
 Standard Underground Cable Co., Pittsburgh
 Western Electric Co., All Principal Cities
- PROTECTIVE DEVICES**
 Metropolitan Device Corp., Brooklyn, N. Y.
 Western Electric Co., All Principal Cities
- PULLERS, SLACK**
 Matthews Corp., W. N., St. Louis
- PUMPS**
 Allis-Chalmers Mfg. Co., Milwaukee
- PUMPS, SPIRAL**
 Morris Corporation, I. P., Philadelphia
- RADIO LABORATORY APPARATUS**
 General Radio Co., Cambridge, Mass.
 Westinghouse Elec. & Mfg. Co., E. Pittsburgh
- RAILWAY SUPPLIES, ELECTRIC**
 General Electric Co., Schenectady
 Ohio Brass Co., Mansfield, O.
 Western Electric Co., All Principal Cities
 Westinghouse Elec. & Mfg. Co., E. Pittsburgh
- REACTORS**
 General Electric Co., Schenectady
 Metropolitan Device Corp., Brooklyn, N. Y.
- RECTIFIERS**
 Fansteel Products Co., Inc., North Chicago
 General Electric Co., Schenectady
 Western Electric Co., All Principal Cities
 Westinghouse Elec. & Mfg. Co., E. Pittsburgh
- REELS, PAYOUT AND TAKEUP**
 Matthews Corp., W. N., St. Louis
- REGULATORS, VOLTAGE**
 Burke Electric Co., Erie, Pa.
 General Electric Co., Schenectady
 Western Electric Co., All Principal Cities
 Westinghouse Elec. & Mfg. Co., E. Pittsburgh
- RELAYS**
 Cramer & Co., Inc., R. W., New York
 Electric Controller & Mfg. Co., Cleveland
 General Electric Co., Schenectady
 Westinghouse Elec. & Mfg. Co., E. Pittsburgh
- RESISTOR UNITS**
 Allen-Bradley Co., Milwaukee
 General Electric Co., Schenectady
- RHEOSTATS**
 Allen-Bradley Co., Milwaukee
 General Electric Co., Schenectady
 Sundh Electric Co., Newark, N. J.
 Ward Leonard Electric Co., Mt. Vernon, N. Y.
 Western Electric Co., All Principal Cities
 Westinghouse Elec. & Mfg. Co., E. Pittsburgh
- ROPE, WIRE**
 American Steel & Wire Co., Chicago
 Roebling's Sons Co., John A., Trenton, N. J.
- SEARCHLIGHTS**
 General Electric Co., Schenectady
 Westinghouse Elec. & Mfg. Co., E. Pittsburgh
- SHEETS, ELECTRICAL**
 Trumbull Steel Co., The, Warren, O.
- SLEEVE TWISTERS**
 Kearney Corp., Jas. R., St. Louis

Please mention the JOURNAL of the A. I. E. E. when writing to advertisers.

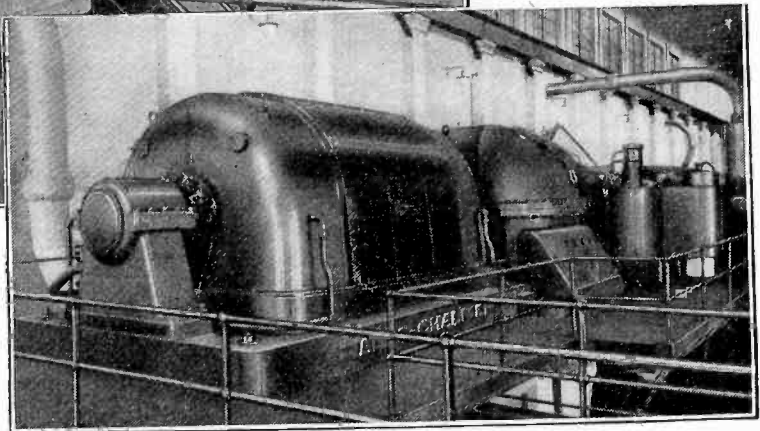
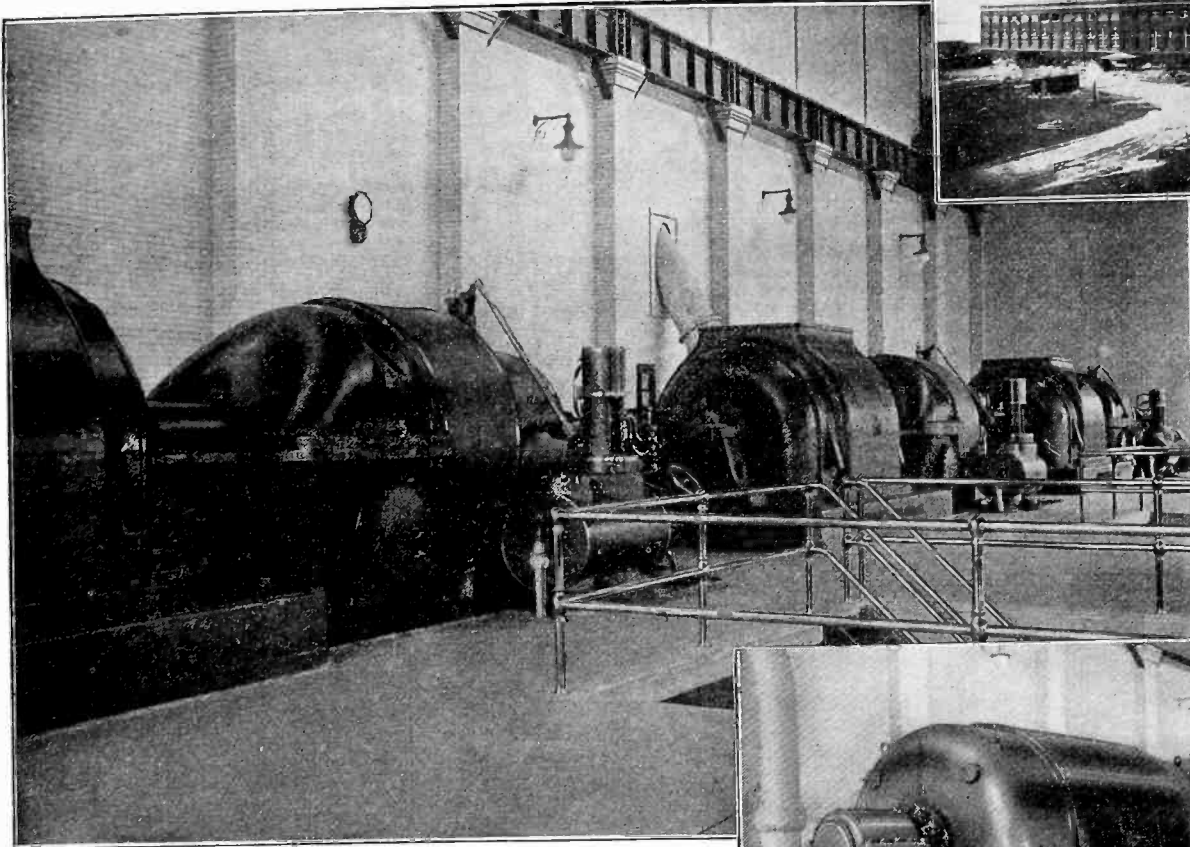
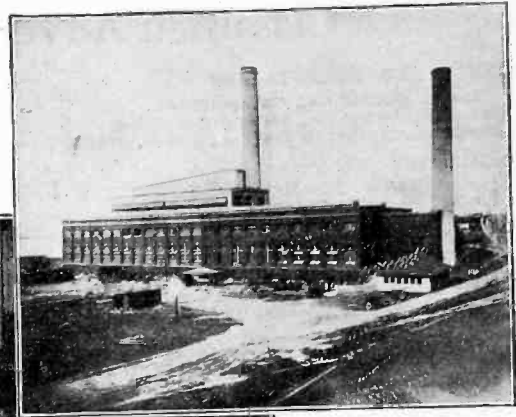

Steam Turbine Units

50,000 kw. in Allis-Chalmers Steam Turbine and Alternator Units are now installed in the station illustrated above.

In 1914 three 5,000 kw. units were installed, in 1919 a 10,000 kw. unit was added, while in 1922 another 10,000 kw. unit was placed in service.

In 1925 the 15,000 kw. unit shown above was installed making a total of six units in the station, ALL of ALLIS-CHALMERS manufacture.

SUCCESSIVE PURCHASES INDICATE CONFIDENCE
BORN OF SATISFACTORY SERVICE.

ALLIS-CHALMERS

MILWAUKEE, WIS. U. S. A.

Please mention the JOURNAL of the A. I. E. E. when writing to advertisers.

Classified Advertiser's Index for Buyers—Continued

SOCKETS AND RECEPTACLES

General Electric Co., Schenectady
Western Electric Co., All Principal Cities
Westinghouse Elec. & Mfg. Co., E. Pittsburgh

SOLENOIDS

Acme Wire Co., New Haven, Conn.
Belden Mfg. Co., Chicago
Dudlo Mfg. Co., Ft. Wayne, Ind.
Electric Controller & Mfg. Co., Cleveland
General Electric Co., Schenectady
Sundh Electric Co., Newark, N. J.
Ward Leonard Electric Co., Mt. Vernon, N. Y.
Westinghouse Elec. & Mfg. Co., E. Pittsburgh

SPRINGS

American Steel & Wire Co., Chicago

STARTERS, MOTOR

Allen-Bradley Co., Milwaukee
Condit Electrical Mfg. Corp., Boston
Electric Controller & Mfg. Co., Cleveland
General Electric Co., Schenectady
Rowan Controller Co., Baltimore, Md.
Sundh Electric Co., Newark, N. J.
Ward Leonard Electric Co., Mt. Vernon, N. Y.
Westinghouse Elec. & Mfg. Co., E. Pittsburgh

STEEL, SHEET & STRIPS

Trumbull Steel Co., The, Warren, O.

STOKERS, MECHANICAL

Sturtevant Company, B. F., Boston
Westinghouse Elec. & Mfg. Co., E. Pittsburgh

SUB-STATIONS

General Electric Co., Schenectady
Westinghouse Elec. & Mfg. Co., E. Pittsburgh

SWITCHBOARDS

Allis-Chalmers Mfg. Co., Milwaukee
Condit Electrical Mfg. Corp., Boston
General Electric Co., Schenectady
Metropolitan Device Corp., Brooklyn, N. Y.
Western Electric Co., All Principal Cities
Westinghouse Elec. & Mfg. Co., E. Pittsburgh

SWITCHES

Automatic Time
Cramer & Co., Inc., R. W., New York
General Electric Co., Schenectady
Minerallac Electric Co., Chicago
Sundh Electric Co., Newark, N. J.
Westinghouse Elec. & Mfg. Co., E. Pittsburgh

Disconnecting

Burke Electric Co., Erie, Pa.
Condit Electrical Mfg. Corp., Boston
Delta-Star Electric Co., Chicago
General Electric Co., Schenectady
Kearney Corp., Jas. R., St. Louis
K-P-F Electric Co., San Francisco
Matthews Corp., W. N., St. Louis
Pacific Elec. Mfg. Co., San Francisco
Thoner & Martens, Boston

Fuse

General Electric Co., Schenectady
Kearney Corp., Jas. R., St. Louis
Matthews Corp., W. N., St. Louis
Metropolitan Device Corp., Brooklyn, N. Y.
Thoner & Martens, Boston

Knife

Condit Electrical Mfg. Corp., Boston
Cramer & Co., Inc., R. W., New York
Electric Controller & Mfg. Co., Cleveland
General Electric Co., Schenectady
Matthews Corp., W. N., St. Louis
Western Electric Co., All Principal Cities
Westinghouse Elec. & Mfg. Co., E. Pittsburgh

Magnetic

Allen-Bradley Co., Milwaukee
Ward Leonard Electric Co., Mt. Vernon, N. Y.

Oil

Condit Electrical Mfg. Corp., Boston
General Electric Co., Schenectady
Pacific Elec. Mfg. Co., San Francisco
Western Electric Co., All Principal Cities
Westinghouse Elec. & Mfg. Co., E. Pittsburgh

Remote Control

Condit Electrical Mfg. Corp., Boston
Cramer & Co., Inc., R. W., New York
General Electric Co., Schenectady
Rowan Controller Co., Baltimore
Sundh Electric Co., Newark, N. J.
Western Electric Co., All Principal Cities
Westinghouse Elec. & Mfg. Co., E. Pittsburgh

TANTALUM

Fansteel Products Co., Inc., North Chicago

TELEGRAPH APPARATUS

Western Electric Co., All Principal Cities

TELEPHONE CONNECTORS

Kearney Corp., Jas. R., St. Louis

TELEPHONE EQUIPMENT

Western Electric Co., All Principal Cities

TESTING LABORATORIES

Electrical Testing Labs., New York

TOWERS, TRANSMISSION

American Bridge Co., Pittsburgh
Western Electric Co., All Principal Cities

TRANSFORMERS

Allis-Chalmers Mfg. Co., Milwaukee
American Transformer Co., Newark, N. J.
Duncan Elec. Mfg. Co., Lafayette, Ind.
Ferranti, Ltd., Hollinwood, England
Ferranti, Inc., New York
Ferranti Electric Ltd., Toronto, Ont.
General Electric Co., Schenectady
Jefferson Elec. Mfg. Co., Chicago
Kuhlman Electric Co., Bay City, Mich.
Moloney Electric Co., St. Louis
Pittsburgh Transformer Co., Pittsburgh
Western Electric Co., All Principal Cities
Westinghouse Elec. & Mfg. Co., E. Pittsburgh

Factory

American Transformer Co., Newark, N. J.
Kuhlman Electric Co., Bay City, Mich.
Moloney Electric Co., St. Louis
Pittsburgh Transformer Co., Pittsburgh
Western Electric Co., All Principal Cities

Furnace

Allis-Chalmers Mfg. Co., Milwaukee
American Transformer Co., Newark, N. J.
Moloney Electric Co., St. Louis
Pittsburgh Transformer Co., Pittsburgh

Melting

American Transformer Co., Newark, N. J.
Ferranti, Ltd., Hollinwood, England
Ferranti, Inc., New York
Ferranti Electric Ltd., Toronto, Ont.
Pittsburgh Transformer Co., Pittsburgh

Mill Type

Pittsburgh Transformer Co., Pittsburgh

Radio

American Transformer Co., Newark, N. J.
Ferranti, Ltd., Hollinwood, England
Ferranti, Inc., New York
Ferranti Electric Ltd., Toronto, Ont.
Jefferson Elec. Mfg. Co., Chicago
Pacent Radio Corp., New York

Street Lighting

Kuhlman Electric Co., Bay City, Mich.
Western Electric Co., All Principal Cities

TROLLEY LINE MATERIALS

General Electric Co., Schenectady
Hubbard & Co., Pittsburgh
Ohio Brass Co., Mansfield, O.
Western Electric Co., All Principal Cities
Westinghouse Elec. & Mfg. Co., E. Pittsburgh

TURBINES, HYDRAULIC

Allis-Chalmers Mfg. Co., Milwaukee
Morris Corporation, I. P., Philadelphia

TURBINES, STEAM

Allis-Chalmers Mfg. Co., Milwaukee
General Electric Co., Schenectady
Sturtevant Company, B. F., Boston
Western Electric Co., All Principal Cities
Westinghouse Elec. & Mfg. Co., E. Pittsburgh

TURBO-GENERATORS

Allis-Chalmers Mfg. Co., Milwaukee
Westinghouse Elec. & Mfg. Co., E. Pittsburgh

VALVE CONTROL, ELECTRIC

Bristol Company, The, Waterbury, Conn.

VALVES, JOHNSON HYDRAULIC

Morris Corporation, I. P., Philadelphia

VARNISHES, INSULATING

General Electric Co., Bridgeport, Conn.
Irvington Varnish & Ins. Co., Irvington, N. J.
Minerallac Electric Co., Chicago
Westinghouse Elec. & Mfg. Co., E. Pittsburgh

WELDING MACHINES, ELECTRIC

General Electric Co., Schenectady
Lincoln Electric Co., The, Cleveland
Ohio Brass Co., Mansfield, O.
Westinghouse Elec. & Mfg. Co., E. Pittsburgh

WELDING WIRES & RODS

American Steel & Wire Co., Chicago
Lincoln Electric Co., Cleveland
Ohio Brass Co., Mansfield, O.

WIRES AND CABLES

Armored Cable

American Steel & Wire Co., Chicago
Belden Mfg. Co., Chicago
Boston Ins. Wire & Cable Co., Boston
General Electric Co., Schenectady
Habirshaw Cable & Wire Corp., New York
Hazard Manufacturing Co., Wilkes-Barre, Pa.
Kerite Ins. Wire & Cable Co., New York
Okonite Company, The, Passaic, N. J.
Roebbling's Sons Co., John A., Trenton, N. J.
Simplex Wire & Cable Co., Boston
Standard Underground Cable Co., Pittsburgh
Western Electric Co., All Principal Cities

Asbestos Covered

American Steel & Wire Co., Chicago
Belden Mfg. Co., Chicago
General Electric Co., Schenectady

WIRES AND CABLES—Continued.

Automotive

American Steel & Wire Co., Chicago
Belden Mfg. Co., Chicago
Boston Ins. Wire & Cable Co., Boston
General Electric Co., Schenectady
Habirshaw Cable & Wire Corp., New York
Kerite Ins. Wire & Cable Co., New York
Roebbling's Sons Co., John A., Trenton, N. J.
Simplex Wire & Cable Co., Boston
Standard Underground Cable Co., Pittsburgh
Western Electric Co., All Principal Cities

Bare Copper

American Ins. Wire & Cable Co., Chicago
American Steel & Wire Co., Chicago
Anaconda Copper Mining Co., Chicago
Belden Mfg. Co., Chicago
Copperweld Steel Co., Rankin, Pa.
Hazard Manufacturing Co., Wilkes-Barre, Pa.
Roebbling's Sons Co., John A., Trenton, N. J.
Standard Underground Cable Co., Pittsburgh
Western Electric Co., All Principal Cities

Copper Clad

American Steel & Wire Co., Chicago
Copperweld Steel Co., Rankin, Pa.
Standard Underground Cable Co., Pittsburgh
Western Electric Co., All Principal Cities

Flexible Cord

American Steel & Wire Co., Chicago
Belden Mfg. Co., Chicago
Boston Ins. Wire & Cable Co., Boston
General Electric Co., Schenectady
Hazard Manufacturing Co., Wilkes-Barre, Pa.
Okonite Company, The, Passaic, N. J.
Roebbling's Sons Co., John A., Trenton, N. J.
Simplex Wire & Cable Co., Boston
Standard Underground Cable Co., Pittsburgh
Western Electric Co., All Principal Cities

Heavy Duty Cord

American Steel & Wire Co., Chicago
Belden Mfg. Co., Chicago
Hazard Manufacturing Co., Wilkes-Barre, Pa.
Okonite Company, The, Passaic, N. J.
Simplex Wire & Cable Co., Boston

Fuse

American Steel & Wire Co., Chicago
General Electric Co., Schenectady
Roebbling's Sons Co., John A., Trenton, N. J.
Western Electric Co., All Principal Cities

Lead Covered (Paper and Varnished cambric insulated)

American Steel & Wire Co., Chicago
Anaconda Copper Mining Co., Chicago
General Electric Co., Schenectady
Habirshaw Cable & Wire Corp., New York
Hazard Manufacturing Co., Wilkes-Barre, Pa.
Kerite Ins. Wire & Cable Co., New York
Okonite Company, The, Passaic, N. J.
Okonite-Callender Cable Co., The, Inc., Passaic, N. J.
Roebbling's Sons Co., John A., Trenton, N. J.
Simplex Wire & Cable Co., Boston
Standard Underground Cable Co., Pittsburgh
Western Electric Co., All Principal Cities

Magnet

American Steel & Wire Co., Chicago
Belden Mfg. Co., Chicago
Dudlo Mfg. Corp., Fort Wayne, Ind.
General Electric Co., Schenectady
Maring Wire Co., Muskegon, Mich.
Roebbling's Sons Co., John A., Trenton, N. J.
Standard Underground Cable Co., Pittsburgh
Western Electric Co., All Principal Cities

Rubber Insulated

American Steel & Wire Co., Chicago
Belden Mfg. Co., Chicago
Boston Ins. Wire & Cable Co., Boston
General Electric Co., Schenectady
Habirshaw Cable & Wire Corp., New York
Hazard Manufacturing Co., Wilkes-Barre, Pa.
Kerite Ins. Wire & Cable Co., New York
Okonite Company, The, Passaic, N. J.
Roebbling's Sons Co., John A., Trenton, N. J.
Simplex Wire & Cable Co., Boston
Standard Underground Cable Co., Pittsburgh
Western Electric Co., All Principal Cities

Tree Wire

Hazard Manufacturing Co., Wilkes-Barre, Pa.
Okonite Company, The, Passaic, N. J.
Simplex Wire & Cable Co., Boston

Trolley

American Steel & Wire Co., Chicago
Anaconda Copper Mining Co., Chicago
Copperweld Steel Co., Rankin, Pa.
Roebbling's Sons Co., John A., Trenton, N. J.
Standard Underground Cable Co., Pittsburgh
Western Electric Co., All Principal Cities

Weather proof

American Steel & Wire Co., Chicago
Anaconda Copper Mining Co., Chicago
Copperweld Steel Co., Rankin, Pa.
General Electric Co., Schenectady
Kerite Ins. Wire & Cable Co., New York
Okonite Company, The, Passaic, N. J.
Roebbling's Sons Co., John A., Trenton, N. J.
Simplex Wire & Cable Co., Boston
Standard Underground Cable Co., Pittsburgh
Western Electric Co., All Principal Cities

30 TIMES AS MUCH ELECTRICAL ENERGY
 IS REQUIRED TO DEPOSIT
CHROMIUM
 AS IS NECESSARY TO DEPOSIT
NICKEL

OVER THE SAME SURFACE

TO THE SAME THICKNESS

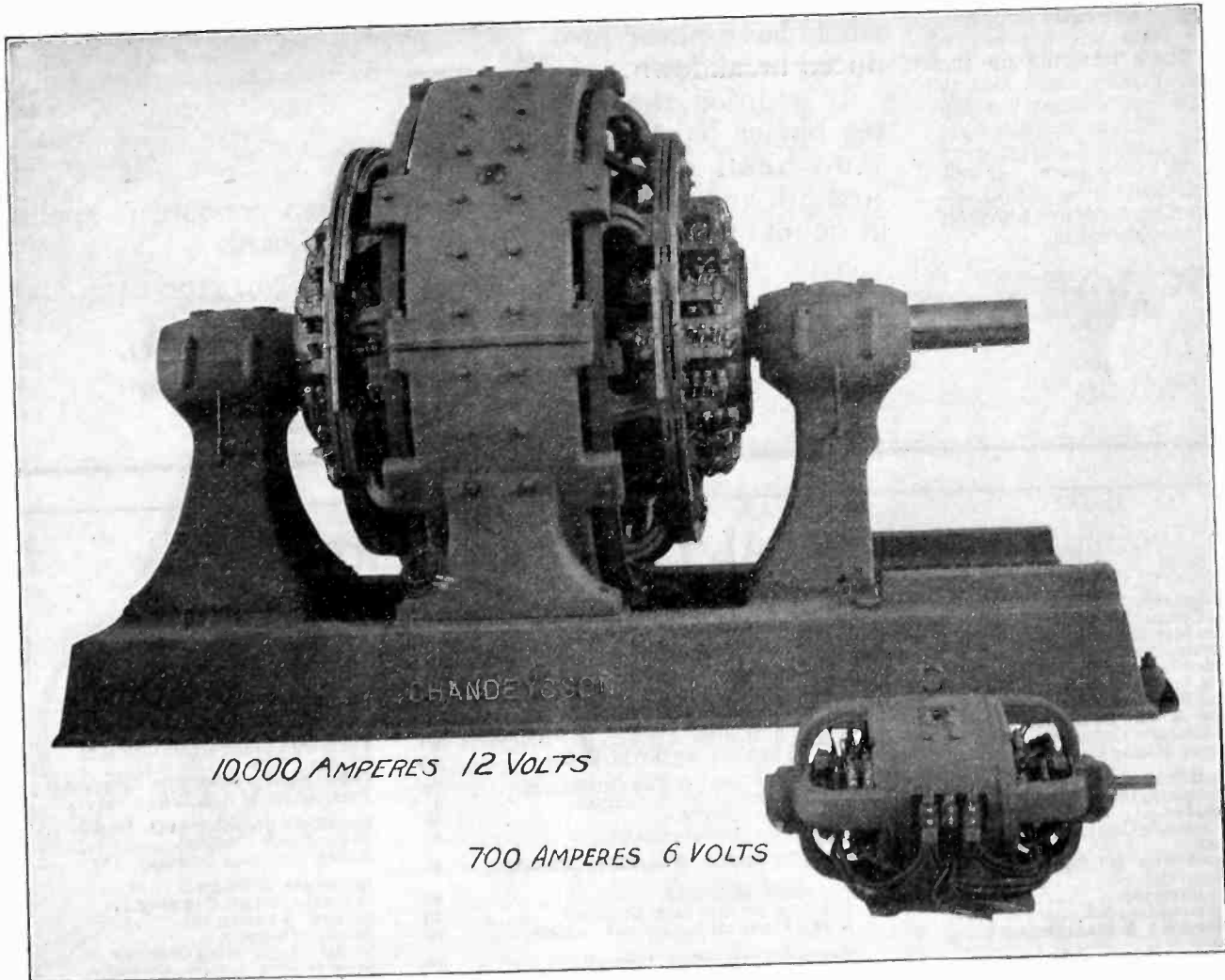

INCOMPARABLE **EFFICIENCY** ABSOLUTE **RELIABILITY**

12 VOLTS FROM EACH COMMUTATOR

COMPLETE **STANDARDIZED** LINE

25 AMPERES 12 VOLTS 300 WATTS

TO

25,000 AMPERES 12 VOLTS 300,000 WATTS

CHANDEYSSON ELECTRIC CO., St. Louis, U. S. A.

Please mention the JOURNAL of the A. I. E. E. when writing to advertisers.



Pattern No. 30

Pattern No. 30—The above illustration shows the plain case front of dull black devoid of distracting lettering. The extra large and wide scale opening makes the black lettering on the white back-ground clearly visible and distant reading easy. This is one example of the careful design carried out on every part. Jewell instruments incorporate advanced features not found in other instruments.



Insulation And Mechanical Strength Combine

Insulation and mechanical strength combine in the mounting studs on Jewell instruments. At the point where the stud passes through the instrument case all possibility of grounding has been overcome by the moulded design which provides insulation many times in excess of possible requirements. Insulation tests of 4,000 volts to ground conducted on the stud and instrument assembly as a whole have never produced breakdown.

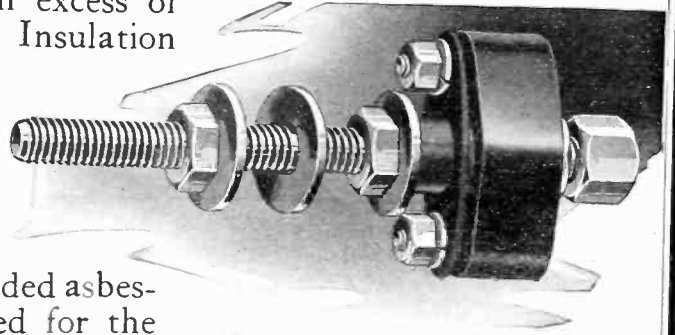

In addition, the moulded asbestos binder bakelite used for the stud head provides utmost strength and makes fracture remote when pressure is applied in tightening the instrument to a switchboard.

Write for descriptive Circular No. 1100

Jewell Electrical Instrument Co.
1650 Walnut St. - - - Chicago

"27 Years Making Good Instruments"

ALPHABETICAL LIST OF ADVERTISERS

	PAGE		PAGE		PAGE
Acme Wire Company, The	44	Ferranti, Incorporated	13	Ohio Brass Company, The	29
Allen-Bradley Company	41	Ford, Bacon & Davis, Inc.	50	Okonite Company, The	3rd Cover
Allis-Chalmers Manufacturing Co.	55	Fowle & Company, Frank F.	50	Okonite-Callender Cable Co., Inc.	3rd Cover
Ambursen Construction Company, Inc.	50	Freyn Engineering Company	50	Ophuis & Hill, Inc.	50
American Bridge Company	26	G & W Electric Specialty Company	32	Osgood, Farley	51
American Lava Corporation	46	General Electric Company	8, 9, 10, 14, 15, 25	Pacent Electric Company, Inc.	35
American Lead Pencil Company	48	General Radio Company	35	Pacific Electric Mfg. Company	34
American Steel & Wire Company	24	Green, A. Barnett	50	Pittsburgh Transformer Company	34
American Transformer Company	7	Gurney Ball Bearing Div. M. R. Co.	44	Prenner, I. S.	51
Anaconda Copper Mining Company	23	Habirshaw Cable & Wire Corporation	5	Public Service Production Company	51
Bakelite Corporation	47	Hazard Manufacturing Company	31	Publications of A. I. E. E.	36
Barstow & Company, Inc., W. S.	50	Hendry, Augustus M.	50	Roebing's Sons Company, John A.	30
Bathey & Kipp, Inc.	50	Hoosier Engineering Company	50	Roller-Smith Company	35
Belden Manufacturing Company	Back Cover	Irvington Varnish & Insulator Company	46	Rowan Controller Company, The	42
Black & Veatch	50	Jackson & Moreland	50	Sanderson & Porter	51
Boston Insulated Wire & Cable Co.	30	Jefferson Electric Mfg. Company	35	Sangamo Electric Company	22
Bristol Company, The	34	Jewell Electrical Instrument Company	58	Sargeant & Lundy, Inc.	51
Burke Electric Company	42	Kearney Corporation, James R.	28	Science Abstracts	42
Burdny Engineering Co., Inc.	30	Kerite Insulated Wire & Cable Co., Inc.	1	Scofield Engineering Company	51
Byllesby Engineering & Management Corp.	50	K-P-F Electric Company	28	Simplex Wire & Cable Company	24
Canadian Porcelain Company, Ltd.	26	Kuhlman Electric Company	18	Sirrine & Co., J. E.	51
Century Electric Company	37	Lapp Insulator Company, Inc.	26	Standard Steel & Bearings, Inc.	53
Chandeysson Electric Company	57	Lincoln, E. S.	50	Standard Underground Cable Company	31
Chicago Mica Company	45	Lincoln Electric Company, The	38	Standards, A. I. E. E. (Spanish)	20
Clark, Walter G.	50	Locke Insulator Corporation	6	Star Electric Motor Company	43
Classified Advertisements	48	Manufacturers' & Inventors' Elec. Co.	43	Stevens, John A.	51
Clement, Edward E.	50	Maring Wire Company	48	Stevens & Wood, Inc.	51
Condit Electrical Manufacturing Corp.	11	Marlin-Rockwell Corporation	44	Stockbridge & Borst	51
Copperweld Steel Company	30	Martindale Electric Co., The	43	Stone & Webster, Inc.	51
Corning Glass Works	27	Matthews Corporation, W. N.	17	Sturtevant, B. F., Company	43
Cramer & Co., Inc., R. W.	34	McClellan & Junkersfeld, Inc.	50	Sundh Electric Company	34
Cutter Company, The	2	Metropolitan Device Corporation	60	Texas Company, The	59
Danne, Harold A.	50	Minerallac Electric Company	30	Thomas, Percy H.	51
Day & Zimmermann, Inc.	50	Minton, John	50	Thomas & Sons Company, The R.	26
Delta-Star Electric Company	28	Moloney Electric Company	32	Thoner & Martens	28
Dessert & Company	4	Morganite Brush Company, Inc., The	52	Timken Roller Bearing Company	40
Dudlo Manufacturing Corporation	49	National Carbon Company, Inc.	19	Trumoull Steel Company, The	46
Duncan Electric Manufacturing Co.	34	National Vulcanized Fibre Company	46	U. G. I. Contracting Company, The	51
Electric Controller & Mfg. Co., The	21	Neall, N. J.	50	West Va. Pulp & Paper Company	46
Electric Specialty Company	43	Neiler, Rich & Company	50	Western Electric Company	16
Electrical Testing Laboratories	51	New Departure Manufacturing Co., The	3	Westinghouse Elec. & Mfg. Co.	12
Electro Dynamic Company	43	New England Mica Company	46	Weston Electrical Instrument Corp.	33
Engineering Directory	50, 51	Norma-Hoffmann Bearings Corporation	39	White Engineering Corp., The J. G.	51
Engineering Societies' Library	48			Wireless Specialty Apparatus Company	35
Fansteel Products Company, Inc., The	33			Wray & Company, J. G.	51
Fennessy, David V.	50				

(For classified list of Advertisers see pages 52, 54 and 56.)

Please mention the JOURNAL of the A. I. E. E. when writing to advertisers.

To Turbine Operators

We have remaining for distribution a few copies of the issue of our magazine —

Lubrication

which contains a comprehensive treatment of the subject of Steam Turbine Lubrication.

Included is a list of steam turbines (by name of maker) with complete Texaco recommendations for correct lubrication.



We cannot guarantee to fill all requests for the steam turbine issue of "Lubrication" magazine but will send them out "first come, first served" as long as the supply lasts.

THE TEXAS COMPANY
Texaco Petroleum Products

----- *Clip this Coupon* -----

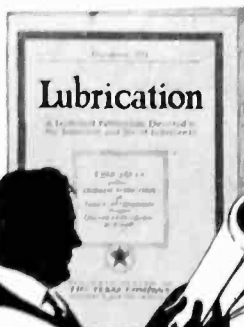

The Texas Company
Dept. W7—, 17 Battery Place
New York City

Please send me the issue of "Lubrication" magazine containing the article on Steam Turbine Lubrication and the chart of recommendations for correct lubrication of the Steam Turbines.

Name.....

Street Number.....

City..... State.....

Business.....

IS THIS A SUFFICIENT MARGIN OF SAFETY?

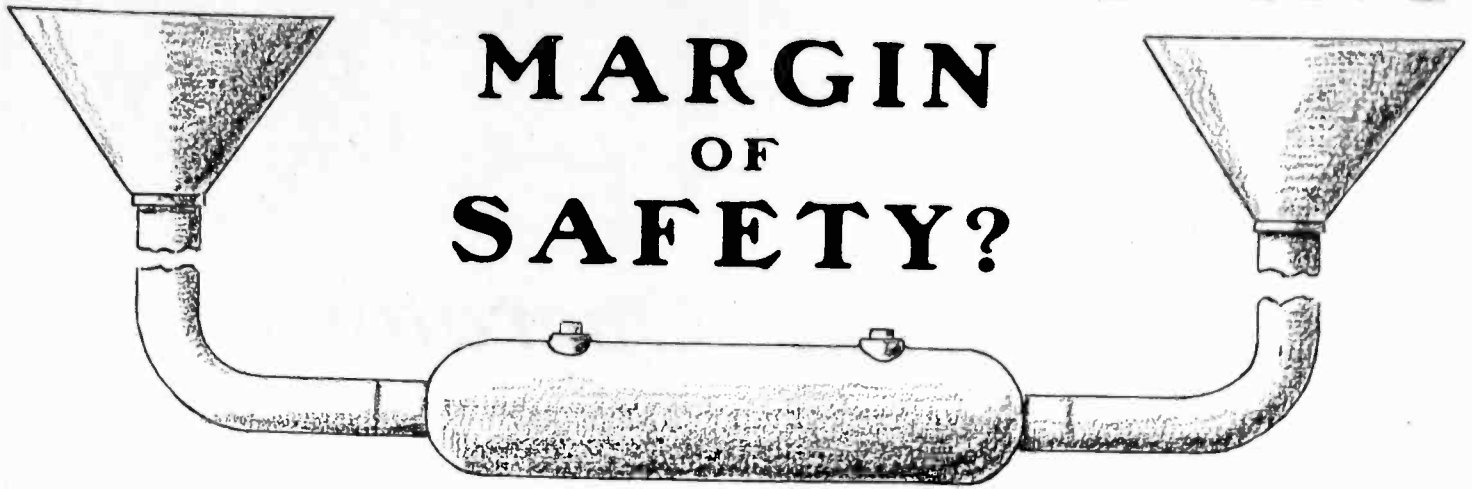

Before Deciding Upon The Metropolitan Joint with Electrostatic Shield and Metrolatum

A company made their own tests and found that the joint submitted for use on their 13,200 volt lines, withstood

160,000 VOLTS FOR EIGHT HOURS

That which distinguishes the Metropolitan High Tension Cable Joint, is the copper gauze stocking. This stocking acts as an electrostatic shield and distributes equally the electrical stresses around the conductors.

Cable engineers are in agreement that the use of mineral oil compound for filling the high tension cable joint, similar to that used for impregnating cables, is beneficial, adds life to the cable and guards against failure.

Metrolatum which is used for filling the Metropolitan High Tension Cable Joint is a high grade mineral oil compound. It has high dielectric strength (we guarantee 25,000 volts per 1/10 inch gap at 120° F) and low dielectric loss. It insures perfect uniformity of saturation between joint, sleeve and cable ends.

For further particulars and description of each step in making this joint send for 16 page booklet. Complete material for making joint supplied in two cartons.

Metropolitan Device Corporation

1250 Atlantic Ave., Brooklyn, N. Y.

METROPOLITAN DEVICE CORPORATION	
1250 Atlantic Avenue, Brooklyn, N. Y.	
Gentlemen: Please send me 16-page booklet describing High-Tension Cable Joints.	
Name	Company
Address	Title

Please mention the JOURNAL of the A. I. E. E. when writing to advertisers.

Georgia Railway and Power Co.

Morgan Falls Station

Okonite Products

OKONITE
INSULATED
WIRES AND
CABLES
VARNISHED
CAMBRIC
CABLES
OKONITE
INSULATING
TAPE
MANSON &
DUNDEE
FRICTION
TAPES
OKONITE
CEMENT
OKOCORD
OKOLOOM

Okonite- Callender Products

IMPREGNATED
PAPER
CABLES
SUPER-
TENSION
CABLES
SPLICING
MATERIALS

Okonite Wires and Cables
Used Exclusively



THE OKONITE COMPANY
THE OKONITE-CALLENDER CABLE COMPANY, INC.

Factories: PASSAIC, N. J.

PATERSON, N. J.

Sales Offices: New York · Chicago · Pittsburgh · St. Louis · Atlanta
Birmingham · San Francisco · Los Angeles · Seattle

Pettingell-Andrews Co., Boston, Mass.

Novelty Electric Co., Phila., Pa. · F. D. Lawrence Electric Co., Cincinnati, O.

Canadian Representatives: Engineering Materials Limited, Montreal

Cuban Representatives: Victor G. Mendoza Co., Havana



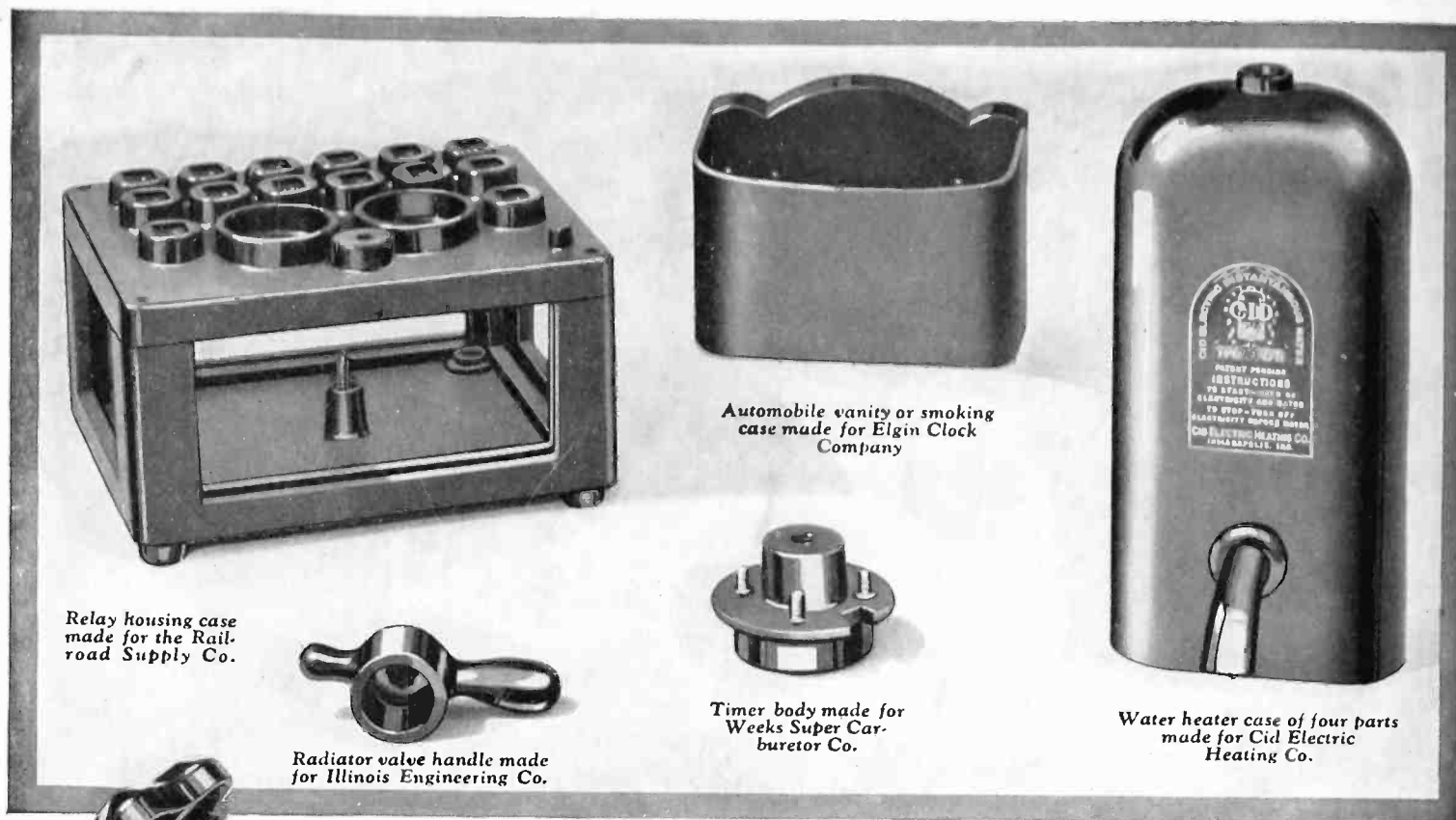

Relay housing case made for the Railroad Supply Co.

Automobile vanity or smoking case made for Elgin Clock Company

Radiator valve handle made for Illinois Engineering Co.

Timer body made for Weeks Super Carburetor Co.

Water heater case of four parts made for Cid Electric Heating Co.

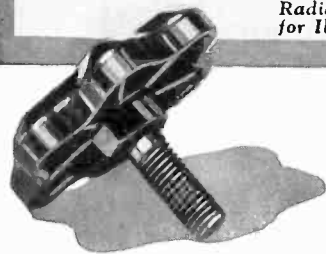

Wringer tension knob made for Haag Brothers.



Two-piece threaded assembly

A Complete Bakelite Service of Extensive Application

Beldenmold Bakelite Parts Look Better, Wear Better, Last Longer

AS insulators, supports, cases, handles, knobs, and in many other capacities, Beldenmold Bakelite parts are replacing metal, wood, rubber, and other materials. The beautiful finish of Beldenmold, its rigidity of form, imperviousness to atmospheric conditions, and the accuracy with which it can be molded, as well as its low cost, are all causes for its extensive use.

To investigate the possibilities of improving your product through the use of Beldenmold parts just furnish a sample of the parts you now use, no matter of what material, and let us tell you what Beldenmold can do.

The use of Beldenmold parts not only gives you a better selling product—it saves money and time, too.

BELDEN PRODUCTS

- Beldenamel and Textile Magnet Wire*
- Coil Windings*
- Beldenmold (Molded Bakelite Products)*
- Automotive Wires and Cables*
- Airplane Assemblies*
- Radio Wires, Cords and Cables*
- Rubber Covered Wires*
- Armored Cables*
- Flexible Armature Wires*
- Motor Lead Wires*
- Braided and Stranded Copper Cables*
- Cotton Sleeving*

Belden Manufacturing Company
2316B South Western Avenue Chicago, Illinois

Specify Belden