

# JOURNAL OF THE A. I. E. E.

NOVEMBER 1926



PUBLISHED MONTHLY BY THE  
AMERICAN INSTITUTE OF ELECTRICAL ENGINEERS  
33 WEST 39TH ST.  
NEW YORK CITY

# American Institute of Electrical Engineers

## COMING MEETINGS

New York Regional Meeting, New York, N. Y., Nov. 11-12

Winter Convention, New York, N. Y., Feb. 7-10

---

## MEETINGS OF OTHER SOCIETIES

American Welding Society, Buffalo, N. Y., Nov. 16-19

American Physical Society, Chicago, Ill., Nov. 26-27

The American Society of Mechanical Engineers, New York, N. Y., Dec. 6-9

First National Exposition of Power and Mechanical Engineering, Grand Central  
Palace, New York, N. Y., Dec. 6-11

# JOURNAL

OF THE

## American Institute of Electrical Engineers

PUBLISHED MONTHLY BY THE AMERICAN INSTITUTE OF ELECTRICAL ENGINEERS  
33 West 39th Street, New York

Subscription. \$10.00 per year to United States, Mexico, Cuba, Porto Rico, Hawaii and the Phillipines, \$10.50 to Canada and \$11.00 to all other Countries. Single copies \$1.00.

Entered as matter of the second class at the Post Office, New York, N. Y., May 10, 1905, under the Act of Congress, March 3, 1879. Acceptance for mailing at special rate of postage provided for in Section 1103, Act of October 3, 1917, authorized on August 3, 1918.

Vol. XLV

NOVEMBER, 1926

Number 11

### TABLE OF CONTENTS

#### Papers, Discussions, Reports, Etc.

Notes and Announcements .....	1059	A New Cathode-Ray Tube .....	1143
Transmission Features of Transcontinental Telephony, by H. H. Nance and O. B. Jacobs .....	1061	Unbalanced Conductor Tensions, by E. S. Healy and A. J. Wright .....	1144
Surface Heat Transfer in Electric Machines with Forced Air Flow (Abridged), by G. E. Luke .....	1070	Variable-Voltage Equipment for Electric Power Shovels, by R. W. McNeill .....	1151
Some Graphical Solutions of A-C. Circuits Founded Upon Non-Euclidian Geometry, by F. W. Lee .....	1078	Discussion at Midwinter Convention Experimental Determination of Losses in Alternators (Roth) .....	1155
Standards for Measuring the Power Factor of Dielectrics at High Voltage and Low Frequency, by Harvey L. Curtis .....	1084	Discussion at Madison Meeting The Quality Rating of High-Tension Cable with Impregnated Paper Insulation (Roper and Halperin) .....	1157
Establishment of Radio Standards of Frequency by the Use of a Harmonic Amplifier .....	1086	Papers on Rural Electrification (Neff and Post) .....	1166
Mercury Arc Rectifiers, by D. C. Prince .....	1087	Cooperation Between the Colleges and the Industries in Research (Wickenden, Potter, Bailey, Bennett) .....	1171
Multiplex Windings for D-C. Machines, by Carl C. Nelson .....	1094	Discussion at Annual Convention Remotely-Controlled Substations (Blackwood) .....	1174
Electric Welds for Building Construction .....	1097	General Theory of the Auto-Transformer (Upson) ..	1175
New Copper Beds Discovered in Canada .....	1097	Production and Application of Light (Millar) .....	1176
Report of Committee on Protective Devices .....	1098	The High-Speed Circuit Breaker in Railway Feeder Networks (McNairy) .....	1176
Electric Cars for Steam Railroads .....	1114	Mercury Arc Rectifiers (Prince) .....	1176
Seminars for Practising Engineers .....	1114	Multiplex Windings for D-C. Machines (Nelson) ..	1178
Report of Committee on Production and Application, of Light .....	1115	Report of Standards Committee (Osborne) .....	1181
Fire Protection of Water-Wheel Type Generators, by J. Allen Johnson and E. J. Burnham .....	1121	Vibration Recorder (Mershon) .....	1181
Report of Committee on Power Generation .....	1130	England Has All-Electric Village .....	1182
Why Good Headlighting is Difficult .....	1135		
The Space Charge that Surrounds a Conductor in Corona at 60 Cycles, by Joseph S. Carroll and Harris J. Ryan .....	1136		

#### Institute and Related Activities

New York Regional Meeting .....	1183	History of Engineering .....	1187
Award of John Fritz Medal for 1927 .....	1184	Personal Mention .....	1187
A. I. E. E. Directors' Meeting .....	1185	Behind the Pyramids .....	1188
Future Section Meetings .....	1185	Obituary .....	1188
New York Section Meeting .....	1185	Addresses Wanted .....	1188
2,000,000-Volt Laboratory at Stanford University ..	1186	Engineering Societies Library .....	1189
Charles M. Schwab, President-Elect A. S. M. E. ....	1186	Past Sections and Branch Meetings .....	1191
Use of Safety Codes .....	1186	Engineering Societies Employment Service Positions Open .....	1192
University of Pennsylvania Placement Bureau .....	1186	Men Available .....	1192
Tests of Welded Rail Joints .....	1186	Membership-Applications, Elections and Transfers ..	1193
Engineering Foundation Detroit Honors Engineering Foundation .....	1186	Officers of A. I. E. E. ....	1197
New Offer for Muscle Shoals .....	1187	List of Sections and Branches .....	1197
American Engineering Council Administrative Board Meets at Cornell .....	1187	Digest and Current Industrial News .....	1198
Participation in Highway Safety Conference .....	1187		
Proposal for New Patent Office Building .....	1187		

A REQUEST FOR CHANGE OF ADDRESS must be received at Institute headquarters at least ten days before the date of issue with which it is to take effect. Duplicate copies cannot be sent without charge to replace those issues undelivered through failure to send such advance notice. With your new address be sure to mention the old one, indicating also any change in business connections.

Copyright 1926. By A. I. E. E.

Printed in U. S. A.

Permission is given to reprint any article after its date of publication, provided proper credit is given.

# **Current Electrical Articles Published by Other Societies**

**Journal of Franklin Institute, September 1926**

Inductance of Overhead Transmission Lines with Unequal Spacing of Wires,  
by A. Still

**National Electric Light Ass'n. Bulletin, September 1926**

A Proposed Set of Voltage Standards for A-C. Electrical Systems and Equip-  
ment, by the Electrical Apparatus Committee

Electric Power in Agriculture, by L. R. Nash

Rural Electrification and the Canadian Hydro, by E. A. Stewart

Safety Precautions in a 150,000-H. P. Hydroelectric Station, by R. D. Shaub

# Journal of the A. I. E. E.

*Devoted to the advancement of the theory and practise of electrical engineering and the allied arts and sciences*

Vol. XLV

NOVEMBER, 1926

Number 11

## Student Activities in the A. I. E. E.

The prospects for better and more effective work by the Student Branches have been greatly increased during the past year by the appointment of faculty members as official Counselors, authorized by the Board of Directors a year ago. The Counselors, now eighty-seven in number, are ex-officio members of the Student Branches Committee and as a consequence the work during the year has centered chiefly on providing machinery for coordinating the efforts of the enlarged membership.

In general the plan in process of development may be outlined as follows:

1. A committee of Student Activities consisting of the Counselors, District Vice-president and Secretary to be organized in each District, with one of the Counselors as Chairman; the principal function of these committees will be to coordinate student activities in their respective districts.

2. That each District Student Activities Committee select each year one of its Counselor members as official delegate to an annual meeting of the Student Branches Committee during the Summer Convention of the Institute.

As part of the above outlined plan for the purpose of fostering and developing branch activity, the Sections delegates conference in joint meeting with the Committee on Student Branches at White Sulphur Springs, Va., during the Spring Convention of the Institute on May 21, after full discussion, took favorable action on the following recommendations to be submitted to the Board of Directors:

- (a) The payment from the Treasury of the Institute for travel expenses (at the usual rate of 10 cents per mile one way) for branch counselors and incoming chairmen of branches for one annual district meeting.

- (b) Similar payment of travel expenses of one district branch representative, selected by the Student Activities Committee of each district, to an annual national meeting held in conjunction with the Sections Delegates' Conference at the annual Summer Convention.

It is understood that the above is applicable only to those districts where permanent Student Activities Committees of Counselors, district Vice-president and Secretary have been effected.

In accord with the above general plan very successful meetings have been held during the year at several

regional conventions. Student Activities Committees have been organized as follows:

District No. 1, Boston, May 7, A. H. Timbie, Chairman. District No. 2, Cleveland, March 9, H. B. Dates, Chairman. District No. 5, Madison, May 7, C. M. Jansky, Chairman. District No. 8, Salt Lake City, Sept. 6, H. H. Henline, Chairman. District No. 9, Salt Lake City, Sept. 6, J. A. Thaler, Chairman.

Three very successful conventions of electrical engineering students were also held last spring at Boston, New York and Swarthmore College, Pa.

While the organization of Student Activities Committees and the meetings held during the several district conventions have received most attention, the general problem of increasing the effectiveness of the Student Branches has been approached from many directions. Among the suggestions discussed at the White Sulphur Springs Convention the following may be of special interest:

1. Recognition of Student Branch activities by the faculty as an essential factor in the work of electrical engineering students.

2. More frequent visits from A. I. E. E. officials.

3. Better cooperation between Branches and nearby Sections. Joint meetings, exchange of programs, etc.

4. Presentation of papers by students at regional meetings of the Institute.

5. Printing of more student papers either as a special section in the A. I. E. E. JOURNAL or otherwise.

The several suggestions listed above, especially numbers four and five, should be fully discussed by all Student Activities Committees in order that definite action may be taken at the meeting of the Student Branches Committee during the next Summer Convention of the Institute.

Another part in the year's work has been to assist in the drafting of the revised set of By-laws for Branches recently submitted to and approved by the Board of Directors.

During the past year the Student Branches Committee has submitted to the Board of Directors favorable recommendation on applications for the establishment of Student Branches at the following institutions:

1. Stevens Institute of Technology, 2. Worcester Polytechnic Institute, 3. University of Wyoming, 4. Washington and Lee University, 5. Ohio University, 6. Princeton University, 7. University of New Hampshire, 8. Louisiana State University, 9. Akron Municipal University, 10. College of Engineering of the Newark Technical School, 11. University of Santa Clara.

The status of general student Engineering Societies seeking affiliation with the Institute has been carefully considered and on May 21 definitely determined by the Board of Directors with the adoption of the following By-law:

"SEC. 59A. An established student engineering society in a university or technical school of recognized standing may, upon application of its officers and a member of the Institute connected with the school, and the approval of the Board of Directors, become associated with the Institute. Members of such associated student engineering society may have the same privileges as enrolled Students of the Institute and will be governed by the same requirements."

In adopting this By-law, it was definitely understood by the Board that in recognizing general student engineering societies in this way, no financial support from the Institute treasury is contemplated, but that students who are members of such societies and who desire to subscribe to the JOURNAL at \$3.00 per year, which is the same amount as paid by Enrolled Students of the Institute, may have this privilege; and also, the names of such affiliated organizations will be printed together with the list of Student Branches. In other words, the principal purpose of the By-law is to indicate clearly that the Institute is ready to cooperate with general student engineering societies in those institutions in which it is not deemed desirable, for one reason or another, to organize a separate Student Branch of the Institute.

C. E. MAGNUSSON,  
Chairman, Student Branches Committee.

### Some Leaders of the A. I. E. E.

Arthur William Berresford, thirty-third president of the Institute (1920-1921), was born in Brooklyn, New York, in the year 1872. After the completion of his grade school education, he entered the Brooklyn Polytechnic Institute to prepare for his professional career and was graduated with the class of 1892. He then entered as Senior at Cornell University, graduating in 1893 with the degree of M. E. in Electricity.

From 1893 to 1896 Mr. Berresford engaged in the varied line of occupation inevitable to the beginner of any profession, his preliminary experience ranging in scope from work in the car barns of the Brooklyn City Railway Company—overhauling motors, and ground-hand on trolley-line construction work, drafting, wiring and installation—to the fields of sales and invention. In 1896 he was placed in charge of the testing and design work of the Ward-Leonard Electric Company and from that time until 1923 he was closely identified with electric motor control.

In 1898, in company with two associates, he bought over the Iron Clad Rheostat Company which, under the new name of the Iron Clad Resistance Company, they restored to a sound basis in two years time and sold it to The Cutler-Hammer Mfg. Co., which is today one of the representative heads in the field of motor control. Entering this company's engineering department in 1900, Mr. Berresford, within a period of 23 years, be-

came successively superintendent, general manager and vice-president. His contributions to the profession have been largely from a managerial point of view, in encouraging and instructing many of the men who have achieved great things for the advancement of the electrical science. During the period of his service with The Cutler-Hammer Mfg. Co., many intricate devices were evolved, lending material betterment to modern steel mill equipment and production, hoisting and conveying machinery, electrically operated printing presses, modern electric elevator service and innumerable special control problems requiring a high order of engineering ability.

During the war period, Mr. Berresford was chairman of the General War Service Committee of the Electrical Manufacturing Industry and is now past-president of the Electrical Manufacturers Club and Associated Manufacturers of Electrical Supplies. He is also a member of the National Industrial Conference Board, The American Society of Mechanical Engineers, the Society of Naval Architects and Marine Engineers, the National Electric Light Association, Society for the Promotion of Engineering Education, Sigma Psi, Milwaukee and University Clubs of Chicago and Milwaukee, the Town Club, Country Club and Mohawk Clubs of Schenectady, the Engineers Club, New York Athletic Club and Chemists Club of New York. Mr. Berresford became an Associate of the Institute in 1894, was transferred to the grade of Member in 1906 and to the grade of Fellow in 1914. He was a Manager of the Institute from 1909-12, a Vice President from 1912-14 and President from 1920-21. He also served upon numerous important committees of the Institute, including the Executive, Sections, Public Policy, Meetings and Papers and Edison Medal Committees. He has represented the Institute upon the John Fritz Medal Board of Award and the American Engineering Council, and at the present time is a Vice-President of the latter organization.

He is now engaged in the field of electrical refrigeration as executive vice-president of the Nizer Corporation, of Detroit, one of the three units recently merged to form the Electric Refrigeration Corporation.

A system of budgeting the A. I. E. E. papers for the coming year was inaugurated by the Meetings and Papers Committee last year which has proved most satisfactory in limiting the amount of material accepted for JOURNAL publication to the number of pages available, without exceeding the appropriation allowed for this purpose. In previous years, in order to keep within the appropriation, it became necessary to abridge very drastically quite a number of papers; this year, by virtue of the budget system, we are able to publish all accepted papers either in full or with eight page abridgements as prescribed by the Publication Committee. A similar budget has been prepared for next year.

# Transmission Features of Transcontinental Telephony

BY H. H. NANCE<sup>1</sup>

Member, A. I. E. E.

and

O. B. JACOBS<sup>1</sup>

Associate, A. I. E. E.

*Synopsis.*—In this paper, the various steps in the establishment of the existing network of transcontinental type circuits and the transmission design considerations are reviewed. The discussion covers the communication channels obtained from transcontinental type facilities and the bands of frequencies employed, and includes

carrier-current systems, telephone repeaters and signaling systems. Mention is made of special uses of transcontinental telephone circuits, such as the transmission of program material for broadcasting and the transmission of pictures. Finally, the maintenance methods required to keep the system at full efficiency are outlined.

IN view of the fact that this convention is being held in Salt Lake City and that the original transcontinental telephone line connects this point with Pacific Coast points and the eastern part of the country including points on the Atlantic Coast, it was suggested to the authors that it would be of interest to present a discussion of the transmission features of transcontinental telephony at this time.

Since considerable information on this subject has been covered by previous papers presented before the Institute, this discussion will be confined to a resumé of the transcontinental type facilities provided for coast-to-coast telephone service and some of the general transmission considerations which are important factors in determining the design of these facilities.

The opening of the first transcontinental line in 1915, between New York and San Francisco, marked a new era in long distance telephony, as this was the first achievement of successful telephone transmission over distances materially in excess of 2000 mi. and demonstrated clearly the practicability of meeting the transmission requirements for a nation-wide telephone service. Previous to that time, New York to Denver represented about the maximum distance for telephone connections and the transmission obtained would not be considered any too good as judged by the standards of today. The circuits for the New York-Denver service had been constructed of copper wire, 165 mils in diameter (435 lb. per mile), and were loaded with 250-milhenry coils spaced about eight miles apart. Repeaters, or amplifiers, however, were not used since methods for applying them to loaded lines, as well as for their use at more than one point in a connection, had not been developed to a practical extent at that time.

By the time the new line west of Denver was constructed, telephone repeaters of new design and improvements in their application to telephone circuits had been developed so that the difficulty of operating in tandem and also over loaded lines had been overcome. Included in these improvements, which were applied to the new line and also to the existing line from New

York to Denver, were new loading coils of a more stable design, very accurately spaced, in order to provide uniform impedance characteristics and balancing networks of simple design for use at repeater points to match or simulate the impedance of the line. The repeaters were located about 500 mi. apart so that on a New York-San Francisco connection, six repeaters were normally in the circuit. The transmission loss in a connection of this kind was about half that in a former New York-Denver connection and about the same as that in a former New York-Chicago connection.

Many new developments have been applied to the transcontinental circuits since the first of these were placed in service and also to other similar circuits throughout the country, which have resulted in a better quality of transmission, including increased over-all volume efficiency<sup>2</sup>. Briefly, the outstanding features of the improved circuits are that they are non-loaded and that the repeaters and the associated equipment have improved transmission characteristics. With the non-loaded circuits, increased speed of propagation and smoother lines are obtained and consequently they can be operated to give better volume without increased echo effect. At the same time, transmission is further improved due to the better attenuation-frequency characteristics. Variations in line attenuation with weather conditions also are considerably reduced.

The transmission improvements in the repeaters and associated equipment consist chiefly of better transmission-frequency and impedance-frequency characteristics, which, together with improved balancing networks, contribute toward better quality of transmission not only from the standpoint of naturalness but also from that of volume efficiency. Due to the higher attenuation of non-loaded lines as compared with loaded lines, a larger number of repeaters is required on a long non-loaded circuit than on a loaded circuit of similar length and therefore the importance of the improvements in the repeaters is correspondingly greater.

Three telephone circuits were provided by the first transcontinental facilities, which consisted of four wires

1. Both of the American Telephone and Telegraph Co., New York City.

Presented at the Pacific Coast Convention of the A. I. E. E., Salt Lake City, Utah, Sept. 6-9, 1926.

2. Telephone Transmission Over Long Distances, by H. S. Osborne, TRANS. A. I. E. E., Vol. XLII, 1923, p. 984.

arranged for phantom operation. The circuit layout was planned to provide direct circuits between strategic points along the line to facilitate connections to other trunk routes as well as the handling of the message traffic between large cities on this route. The longest direct circuit set up was a Chicago-San Francisco circuit. There were also direct circuits from New York to Chicago, Chicago to Denver, Denver to San Francisco, Denver to Salt Lake City, Salt Lake City to San Francisco, etc.

For several years these facilities were sufficient to handle the long telephone message traffic connecting the country east of the Rocky Mountains with that to the west, but by 1923 the increase in traffic requirements made it advisable to provide additional facilities. After careful consideration of all factors, it was decided to provide these partly over the direct route between Chicago and Denver and thence over a new route to the south through El Paso and west through Tucson and Phoenix, Ariz. to Los Angeles. A second route from Chicago via Kansas City to Denver was already in existence, so by providing a new route west of Denver, two separate routes were made available from eastern points to the Pacific Coast. This was particularly desirable from the standpoint of service protection, and furthermore, there was an appreciable volume of traffic to Los Angeles and surrounding territory for which it was desirable to provide direct circuits. Toll circuits were already available between San Francisco and Los Angeles so that in times of trouble on either the central or the southern route, the other could be used for connections to both the northern and southern sections of the Pacific Coast.

Following the construction of the line from Denver to Los Angeles, the next steps were to provide trunk routes between New Orleans and Dallas and Dallas and El Paso which connect to other similar routes at New Orleans and Dallas, and to the Denver-Los Angeles route at El Paso. The line across Texas was completed in 1925 and at the present time transcontinental telephone connections may be established over an all southern route.

As a result of further increase in transcontinental traffic requirements, particularly to points in Washington and Oregon now reached over the central route by switching at San Francisco to circuits north along the coast, there is being constructed a direct northern route from Chicago through Minneapolis, Fargo, Bismarck, Billings, Helena, and Spokane, to Seattle. When completed, this will provide a third separate and distinct transcontinental route and will further insure the continuity of telephone service between the east and far west.

There are many other important routes throughout the country carrying circuits of the transcontinental type, as indicated on Fig. 1. Some of the longest direct circuits radiating from Chicago reach to San Francisco, Los Angeles, Denver, Dallas, Atlanta, Washington, New

York and Boston, while circuits of similar class radiating from New York terminate in Minneapolis, Milwaukee, St. Louis, Kansas City, New Orleans, Atlanta, West Palm Beach and Havana. Other circuits of corresponding type<sup>3</sup> connect San Francisco with Portland, Salt Lake City, Denver and Los Angeles, while Los Angeles has direct circuits to El Paso and Dallas.

Telephone circuits having repeaters at several intermediate points may be compared to a series of power transmission lines, each one of which receives power from the originating point or a repeater and delivers power to another repeater or to the terminal. In contrast to power transmission lines, however, the sections of a repeatered telephone circuit and the associated equipment are designed with the object of causing power of a complicated nature to be reproduced in form at a distant point, and the fact that none of the original power reaches the far terminal is of no concern since in any event it would be useful only as a means of transmitting intelligible sounds while it would have no appreciable value purely from the power standpoint.

While the application of telephone repeaters to long telephone circuits improves their over-all transmission efficiency, the efficiency from a power transmission standpoint is zero, since none of the original energy passes through a repeater point. It is fortunate that the energy losses do not involve large amounts of power and therefore do not represent an appreciable economic loss from the power standpoint.

In the early days of the telephone, the only method of improving the volume efficiency of a telephone line was to increase the amount of copper; that is, to use wires of larger diameter. The use of metals of higher conductivity than copper was clearly prohibitive because of the cost. But additional increments in copper result in less and less improvement in efficiency so that wire larger than 165 mils in diameter was not used to any important extent.

With the invention and development of the loading coil and its application to open wire lines, it became possible to operate at a higher voltage with a consequent reduction in line losses. With this method, however, leakage losses in wet weather are greatly increased, resulting in considerable variation in efficiency.

The development of efficient amplifying devices and of circuit arrangements for applying them to two-way circuits provided the means for increasing the transmission volume efficiencies of long telephone circuits to a much greater extent than the older methods. Without telephone repeaters but with other parts of a long telephone circuit unchanged, the delivery at the receiving end of the amount of power ordinarily obtained would require startlingly large amounts of power at other points in the circuit. For example, in the case of a San Francisco-New York connection, the amount

3. *Applications of Long Distance Telephony on the Pacific Coast*, by H. W. Hitchcock, *TRANS. A. I. E. E.*, Vol. XLII, 1923, p. 1071.



of power ordinarily applied at San Francisco would be required near Harrisburg, Pa. All of the power introduced ordinarily at all points in the line would be required at a point near Pittsburg. Power sufficient to light two 20-c. p. incandescent lamps would be necessary near Chicago, while the power of a five-kw. radio station would be required near Omaha. The requirements continue to rise rapidly until, near Rawlins, Wyo., a 50,000-kw. generator would have to deliver its entire rated capacity to the circuit, while at San Francisco, something in the order of the estimated

In the design of telephone circuits, it is necessary to consider the three transmission essentials for easy and natural conversation. These are volume, accurate reproduction, and freedom from disturbance. The factors which tend to impair these qualities are attenuation, distortion and noise. In addition, cross-talk must be so low as to preclude appreciable overhearing of speech over other circuits.

Fortunately it is not necessary, nor even desirable, that all of the energy reaching a telephone transmitter be delivered by the receiver at the other end of the



FIG. 1—ROUTES OF TRANSCONTINENTAL-TYPE TELEPHONE CIRCUITS IN THE UNITED STATES

total world production of mechanical and electrical power would be needed.

Let us suppose, however, that a 50,000-kw. generator delivered its entire output to the circuit at San Francisco, and overlook, for the moment, what would happen to the line if any such amount of energy were applied. The power received at New York would be of the order of one five-hundredth of a microwatt, which would have to flow for about 25,000 years in order to equal the energy required to light a 25-watt lamp for one minute.

From this it is evident that the economic solution of the problem of very long distance telephony does not lie in the application of large amounts of power at the circuit terminals, but rather in the use of amplifiers located at suitable intervals along the line.

circuit, and the characteristics of the hearing mechanism of the human ear are such that very slight amounts of distortion and noise do not materially affect the intelligibility of received speech energy when the latter is of reasonable magnitude. In designing long telephone circuits the engineer thus has a small range within which to work as regards each of the essential factors for satisfactory transmission.

The attenuation losses in line conductors may be offset largely by the use of repeaters applied at suitable points to give transmission gains. The extent to which such losses can be counteracted in non-loaded open wire circuits arranged for two-way operation is illustrated by the present transcontinental circuits between New York and San Francisco in which the total attenuation

is about 165 transmission units<sup>4</sup> and the total repeater gain about 153 transmission units.

Distortion results when too narrow a band of frequencies is transmitted, or when the volume of transmission of part of the frequencies within the range transmitted is materially different from that of another part of the frequency range. Another form of distortion occurs when currents which are reflected from irregularities in a circuit are again reflected by other irregularities and reach the listener as echo currents

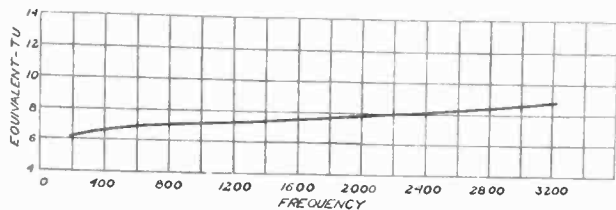

FIG. 2—TRANSMISSION—FREQUENCY CHARACTERISTIC OF 216-MI. REPEATER SECTION OF NON-LOADED 165-MIL PHYSICAL CIRCUIT

appreciably later than the direct transmission, due to the longer path traveled.

Distortion caused by a sloping attenuation-frequency characteristic of a line can be neutralized to a large extent by designing the telephone repeaters and associated equipment to have transmission-frequency characteristics complementary to those of the line. As an illustration of this, Fig. 2 shows the attenuation-frequency characteristic of a typical repeater section of non-loaded 165-mil open wire, 216 mi. in length, while Fig. 3 shows the gain-frequency characteristic of

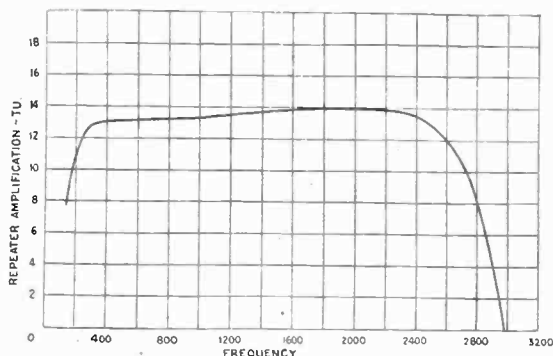

FIG. 3—AMPLIFICATION—FREQUENCY CHARACTERISTIC OF IMPROVED TYPE TWO-WAY TELEPHONE REPEATER

an improved type of telephone repeater which has been adjusted for use with the same section of wire. It will be noted that the attenuation in the line increases with the frequency and that the repeater gain, which corresponds to negative attenuation, also increases at approximately the same rate, so that the result of the combination of the line and the repeater is a trans-

mission-frequency characteristic that is substantially flat. The over-all transmission-frequency characteristic of a long circuit composed of several repeater sections is shown in Fig. 4, which indicates that practically uniform transmission is obtained over the range of frequencies important in speech.

In long repeatered telephone circuits, the time of transmission from one end to the other becomes an important factor in determining the transmission volume efficiency since the seriousness of echo current effects not only is a function of their magnitude compared to the original transmission but also is a function of the amount of delay involved. For this reason the speed of transmission over long telephone circuits must be high as compared with that over shorter circuits, and the line must be reasonably free from irregularities that would give rise to echo currents. Also, throughout the range of frequencies transmitted, the line impedance must be closely matched by the balancing network on each side of each repeater. Loaded circuits are inferior to non-loaded circuits with respect to speed of

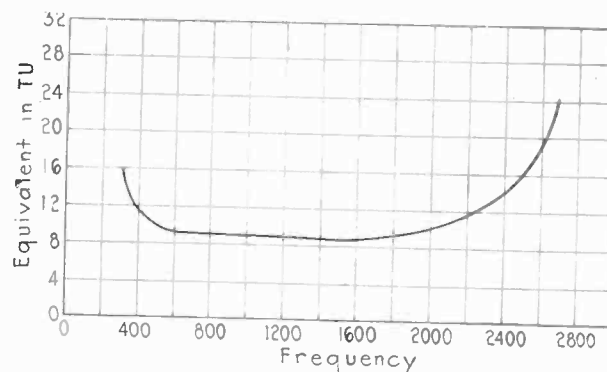

FIG. 4—OVER-ALL TRANSMISSION—FREQUENCY CHARACTERISTIC OF A 1400-MI. NON-LOADED 165-MIL CIRCUIT

transmission and smoothness of impedance-frequency characteristics. From this, it follows that the volume of transmission obtainable with loaded facilities is less than that obtainable with non-loaded facilities of the same length, when tandem repeater operation is involved.

Noise and cross-talk are reduced by transposing the wires at frequent intervals throughout the length of the line so that each wire of a circuit will be as nearly as practicable equally exposed to the disturbing influences which exist, at the same time carefully preserving the balance between the impedances to ground of the wires and associated equipment of each circuit<sup>5</sup>. The intensity of the extraneous influences of course should be controlled and kept within reasonable bounds. In designing the transposition layout, it is necessary to take into consideration the effect of each circuit on the line upon each of the other circuits, including the phantom circuits, as well as the effect of neighboring

4. *The Transmission Unit and Telephone Transmission Reference Systems*, by W. H. Martin, *TRANS. A. I. E. E.*, Vol. XLIII, 1924, p. 797.

5. *Telephone Circuit Unbalances, Determination of Magnitude and Location*, Ferris and McCurdy, *TRANS. A. I. E. E.*, Vol. XLIII, 1924, p. 1331.

power lines. A single series of transpositions which results in substantially equal exposures of each circuit to every other circuit on the line is called a transposition section. In general, one or more sections of this kind are required for each part of the line that is exposed to different outside influences. The phantom transpositions involve interchanging the positions of the two pairs from which the phantom circuit is derived.

Fig. 5 shows the power at different points in a New York-San Francisco connection, when an arbitrarily assumed power of 1000 microwatts is applied to the line at San Francisco. It will be seen that the power is attenuated at the inputs of many of the repeaters to a value which is of about the same order as that which reaches the New York end. Therefore, any noise induced in the circuit at such points may be as strong when it reaches a terminal of the circuit as it is at the points where it originates. In some places, the transmission level is even lower than at New York, as at Beaver Dam; so that noise introduced at such points

there are twenty two-way communication channels operating on these two pairs of conductors, six telephone circuits and fourteen telegraph circuits. A telephone circuit is obtained from each of the two pairs of wires, and a third from the combination of these "side circuits," to form a phantom circuit. The other three telephone circuits are obtained from a carrier-current telephone system superimposed on one of the pairs of wires.

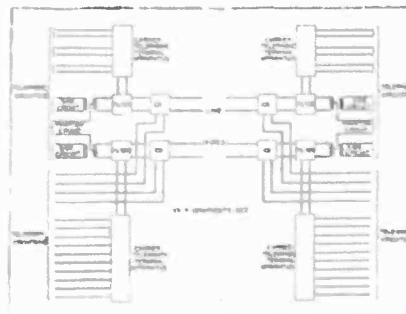

FIG. 6—COMMUNICATION CHANNELS ON FOUR WIRES OF GROUP OF TRANSCONTINENTAL FACILITIES BETWEEN DENVER AND SACRAMENTO

Ten of the telegraph circuits are obtained from a carrier-current telegraph system superimposed on the other pair of wires, and the other four telegraph circuits are direct current channels derived by ordinary compositing arrangements.

In some cases, a similar group of four wires may have a second carrier telephone system superimposed in place of the carrier telegraph system, while in other cases, a second carrier telegraph system is used in place of the carrier telephone system, according to the requirements for these types of facilities.

Fig. 7 shows the bands of frequencies used at present for communication purposes on typical long open wire

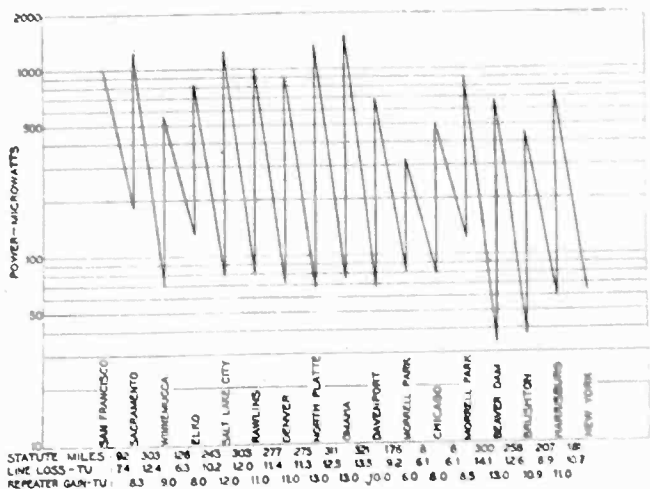

FIG. 5—POWER LEVELS OF SAN FRANCISCO-NEW YORK CONNECTION AT 1000 CYCLES, WHEN POWER OF 1000 MICROWATTS IS APPLIED AT SAN FRANCISCO

may reach New York at greater than its original strength. Thus it is evident that from the noise standpoint, the relative transmission levels at a disturbed point and at the terminals are of particular importance rather than the distances from the disturbed point to the terminals.

Besides providing voice-frequency telephone channels, the open wires composing the network of "backbone" telephone circuits are being used to a large extent for superimposed carrier-current systems<sup>6</sup> as well as for providing ordinary grounded telegraph facilities. An example of this is covered by Fig. 6, which shows, schematically, the various communication channels obtained from four wires of a group of transcontinental facilities between Denver and Sacramento. Altogether,

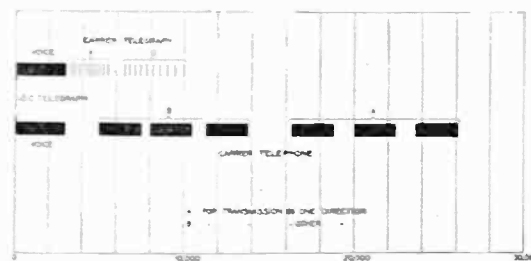

FIG. 7—FREQUENCY ALLOCATIONS ON TYPICAL TRANSCONTINENTAL FACILITIES

circuits. The lowest, from zero to about 80 cycles, is employed for the d-c. telegraph. Each telegraph circuit employs a single wire with ground return, so that two are obtained from each pair of wires.

The voice frequencies occupy the next higher band of frequencies, extending to about 3000 cycles. Some circuits of this type are made efficient at frequencies as low as 135 cycles to permit the employment of a current of this frequency for signaling purposes.

6. *Carrier-Current Telephony and Telegraphy*, by E. H. Colpitts and O. B. Blackwell, *TRANS. A. I. E. E.*, Vol. XL, 1921, p. 205.

Above the voice range, each pair of wires may be arranged for superimposed carrier-current operation, either telegraph or telephone. The former utilizes frequencies as high as 10,000 cycles; the latter, as high as 28,000 cycles.

The general use of large wire and long repeater spacings is advantageous in the case of very long circuits, since this results in a smaller number of repeaters, and, in the case of voice frequency circuits, the lesser number of echo current paths permits somewhat better over-all volume efficiencies to be obtained. Carrier systems involve, at the terminals, large investments in apparatus for converting the voice frequencies or telegraph signals, as the case may be, to carrier frequencies, and vice versa. Thus, in general, the longer the distance to be spanned, the lower is the cost of the carrier circuits per mile. The longer or "back-bone" circuits are usually of 165-mil diameter copper, with repeaters spaced from about 200 to 300 mi. apart, and, consequently, carrier systems have been applied to these much more extensively than to wires of smaller gage. In a few of these circuits, however, 128-mil or even 104-mil wire is used through some sections where repeater spacings and other conditions are favorable.

In carrier-current telephone systems, the frequency employed for carrier purposes is modulated by the voice currents, and one of the resulting bands of frequencies is filtered out from the others and transmitted over the line. At the terminals of the systems, the various bands are separated from each other and from the voice-frequency channels by properly designed filters. In the latest systems, six bands of carrier frequencies are utilized, the lower three for transmission in one direction and the other three for transmission in the opposite direction, these being combined at the terminals to form three two-way circuits. The use of separate channels for the two directions of transmission of each circuit permits the use of one-way amplifiers the gains of which are not limited by balance conditions. At repeater points, the lower bands are kept separate from the upper ones by filters, and each one-way repeater amplifies three carrier channels simultaneously.

In the carrier telegraph system, the fundamental carrier frequencies are under the control of telegraph relays and are applied to the line as spurts of high frequency currents. For a ten-channel system twenty different frequencies are employed, the lower ten for transmission in one direction and the upper ten for transmission in the opposite direction. As in the case of the carrier telephone systems previously mentioned, the group of frequencies transmitted in one direction is kept separate from the opposite bound group at repeater points by means of filters and an entire one-way group of frequencies is amplified by a similar method.

It is necessary, of course, to convert the received carrier telephone or telegraph currents to voice frequencies or d-c. telegraph signals, as the case may be.

In the case of the carrier telegraph system the signals are relayed in the form of ordinary direct-current telegraph impulses so that such circuits may be connected to telegraph circuits of other types as desired.

The application of carrier systems employing frequencies as high as 28,000 cycles has brought with it specially difficult problems from the standpoint of cross-talk. With these high frequencies, the transposition spacing requirements become quite stringent and the number of points at which transpositions are necessary is greatly increased. In addition, in toll entrance and intermediate cables, it is necessary usually to arrange the conductors in such a way that those used for carrier systems will not be adjacent to each other.

Frequent reference has been made to telephone repeaters<sup>7</sup> and repeater gains. The amplifying element of a telephone repeater, the vacuum tube, is essentially a one-way device, and for two-way operation it is necessary that the output of the element be prevented

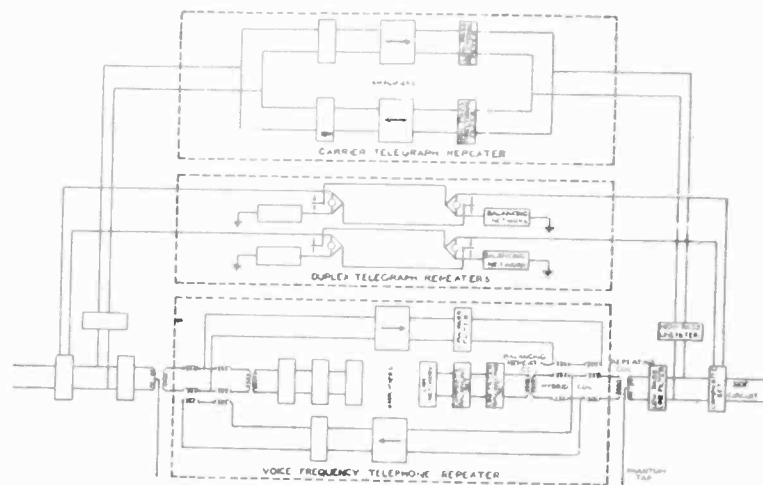

FIG. 8—SIMPLIFIED EQUIPMENT LAYOUT AT INTERMEDIATE REPEATER STATION ON TRANSCONTINENTAL-TYPE CIRCUITS

from getting back to the input side and thus setting up continuous oscillations known as singing or howling. This is accomplished by the use of two amplifying elements, each with its input connected at a neutral point in the output circuit of the other. The neutral point is obtained in a manner very similar to that employed in duplex telegraphy by dividing the output of each vacuum tube between the line and an artificial line having similar characteristics so that the electrical center of the output circuit remains at a constant potential unaffected by the changing currents in the output circuit itself.

Fig. 8 shows the equipment at an intermediate repeater point on one pair of wires of the type used for transcontinental service. The voice-frequency telephone repeater is shown connected to the line in the two directions. Each line, with its associated terminal equipment, is balanced by an artificial line with associated balancing equipment. The hybrid coil located

7. *Telephone Repeaters*, by B. Gherardi and F. B. Jewett, TRANS. A. I. E. E., Vol. XXXVIII, Part II, 1919, p. 1287.

in the electrical center between the line and artificial line is the means by which the transmission in the two directions is separated. Currents amplified by the upper one-way element pass through the so called third winding of the hybrid coil and set up voltages in the line windings. These voltages are of exactly the same magnitude on both sides of the electrical center of the coil and cause equal currents to flow in the line and artificial lines if their impedances balance each other perfectly. In practice, it is impracticable to obtain an exact balance due to the presence of unavoidable irregularities in the line and its associated equipment, the effect of which is to reflect energy which reaches the other amplifier. For successful operation, however, the average of the two transmission losses represented by the ratio between the reflected energy and the applied energy on each side of the repeater, must be substantially greater than the average of the transmission gains of the two amplifying elements.

The line repeating coil is shown in the figure with the mid-point of the line side indicated as the phantom circuit tap. The composite set is essentially a filter which allows the voice currents to pass between the line and the telephone repeater, while direct currents and the low frequency alternating currents involved in d-c. telegraph operation pass between the line and the telegraph repeaters. It will be noted that the telegraph repeaters, also, are arranged for two-way operation involving the employment of balancing networks.

The currents of carrier frequencies are prevented by a filter from reaching the low-frequency equipment but are transmitted easily through a high-frequency path in the filter to the carrier repeater. In the latter, for separating the two directions of transmission, advantage is taken of the fact that the currents in the two directions are of different frequencies so that directional filters can be used to separate them. The repeaters amplify the three one-way channels of a carrier telephone system or the ten one-way channels of a carrier telegraph system simultaneously. In order to avoid interaction or modulation between the various channels, it is essential that the relation between the output current and the input voltage of the vacuum tubes be a straight line function over the energy range employed in the carrier system.

Signal currents, also, must be relayed or amplified on long telephone circuits, just as voice and carrier frequencies are. On some short toll circuits, a signaling current of about 20-cycle frequency is used, the same as that for ringing the bells of subscribers' telephones. On circuits arranged for d-c. telegraph operation, it is impracticable to employ such a low frequency; it is necessary to use a frequency that will be transmitted satisfactorily by the circuit. In actual operation, the signaling channels at the ends of the circuits are arranged usually for 20-cycle operation by means

of relays which automatically apply higher frequency signaling currents and receive the incoming signals.

The signaling frequency commonly used on toll circuits of medium length is 135 cycles. With this system, the signals are relayed at least at every other voice-frequency repeater point since the attenuation loss at 135 cycles is greater than that over the main voice-frequency range. In very long circuits, this results in the necessity for operating a train of relays at successive points, which delays the transmission of the signals. To overcome signaling difficulties on such circuits, a system of ringing, employing 1000-cycle currents which are transmitted from end to end of the circuit with the same efficiency as speech currents of that frequency, has been developed and applied. The signaling currents are supplied from a suitable source and are controlled by 20-cycle relays at the terminals. At the receiving end, circuits tuned to the signaling frequency are employed to amplify and convert the signals to currents which operate relays. Interference from speech currents is avoided by interrupting the signaling current at the sending end about twenty times per second, while at the receiving end, the signals pass through a circuit tuned to 20 cycles.

At some points in a long telephone circuit, it is necessary to employ cable, as when passing through a large city. Because of this greater capacity between wires, cable circuits cause much greater attenuation per unit of length than open wire circuits, especially at carrier frequencies. In order to improve the efficiency of the cable circuits they are loaded by means of inductances placed at intervals along the circuit. The inductances and spacing are so chosen as to cause the characteristic impedances of the cable circuits to approximate closely those of the open wire circuits over the range of frequencies transmitted.

Circuits of transcontinental type are used often for special services such as for the transmission of program material to broadcasting stations<sup>8</sup> or to points where such material is desired in connection with a public address system. As this is essentially a one-way service and the programs usually include music, for which the best results are obtained by using a wider range of frequencies than ordinarily is employed for commercial telephone communication, the two-way repeaters in the line are replaced by one-way repeaters and associated equipment for amplifying the currents and equalizing the transmission throughout the wider range of frequencies. Programs are transmitted daily in this manner to a number of broadcasting stations in the eastern half of the country.

Typical of the larger networks that have been set up is that for the inauguration of President Coolidge. Fig. 9 shows the layout arranged for that purpose, which effectively covered the entire country.

<sup>8</sup> *High Quality Transmission and Reproduction of Speech and Music*, by W. H. Martin and H. Fletcher, *TRANS. A. I. E. E.*, Vol. XLIII, 1924, p. 384.

On occasions, a speaker in one city addresses a meeting in a distant city, the loud speakers at the receiving end being connected to the transmitting telephone by wire. In some cases, such speeches also are broadcast from one or more radio broadcasting stations.

Another use made of transcontinental type facilities is the transmission of pictures or facsimiles of printed or written matter, fingerprints and similar material. The frequencies employed for this purpose are within the voice range and the currents are transmitted in the same way as voice currents. Special apparatus is required, of course, at the transmitting and receiving ends.

The continuity of the many important services routed over the facilities used in making up these long circuits is dependent upon continuous and efficient maintenance methods and performance. Coordination of the work

including a complete description of the types of equipment and transmission data, are prepared and furnished to the terminal offices and intermediate repeater stations. These records are made on cards of convenient size as illustrated by Table I, which is reproduced from one of three cards containing the data for a Chicago-San Francisco circuit.

To insure satisfactory over-all transmission and proper functioning of the circuit, various tests and inspections are made at frequent intervals<sup>9</sup>. Some of the more important maintenance tests are as follows: insulation resistance, loop resistance and resistance balance of the line conductors; measurement of the gain-frequency characteristic as well as the gain at 1000 cycles, and tube tests on all repeaters to detect changes in amplification due to possible changes in the characteristics of the vacuum tubes or repeater equipment; balance tests at

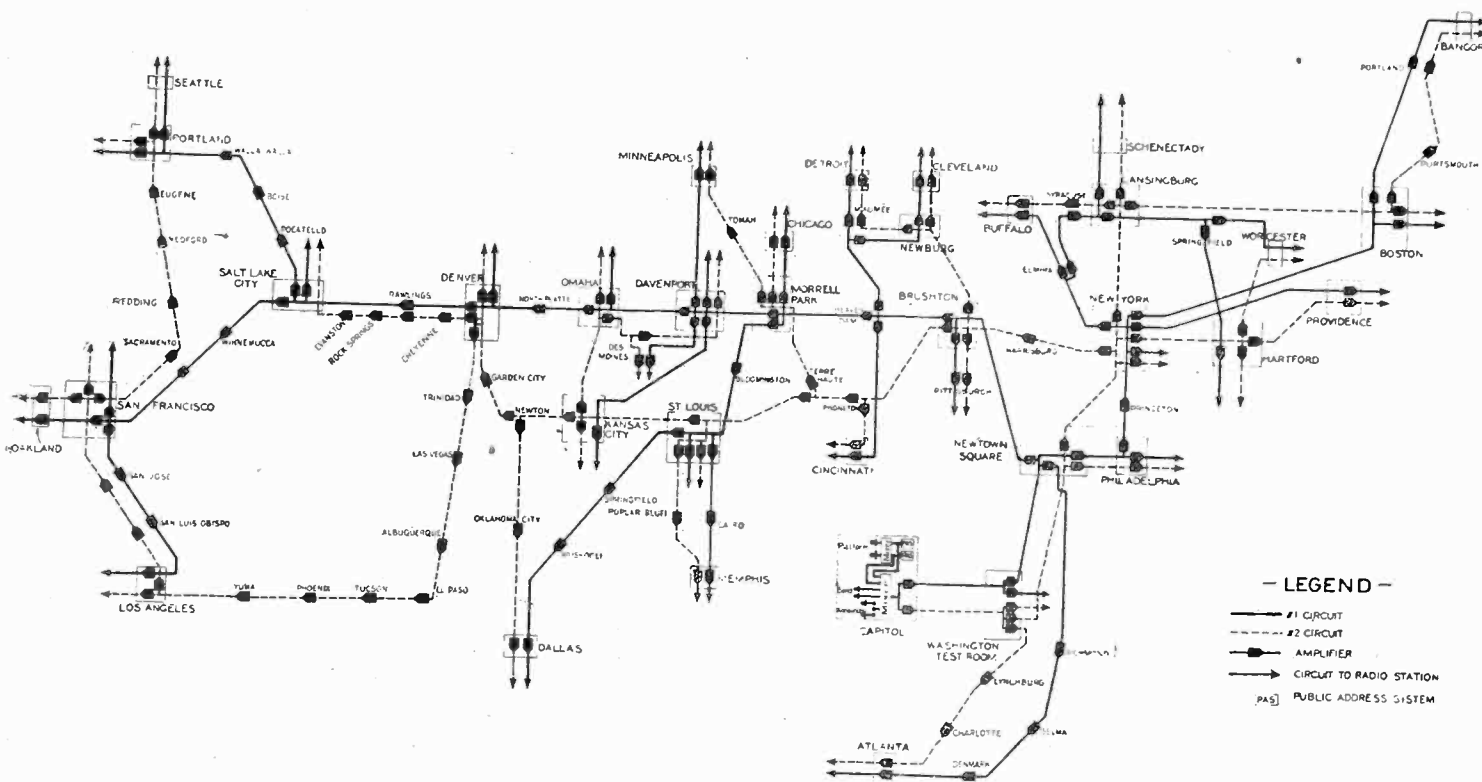

FIG. 9—NETWORK OF CIRCUITS FOR TRANSMITTING PROGRAM MATERIAL TO BROADCASTING STATIONS—LAYOUT MADE AVAILABLE FOR THE INAUGURATION OF PRESIDENT COOLIDGE

of the different offices is most essential in order to obtain best results especially on the longer direct circuits and on those built up by connecting together several circuits, as there are many variable factors. To assist in obtaining this coordination, one of the terminal offices of each circuit is designated as the controlling office for that circuit and is responsible for the direction and supervision of tests and adjustments required on the circuit as a whole. In addition to the duties in connection with the maintenance of the complete circuit, each office along the circuit is responsible for the proper physical maintenance of the plant in its territory. To assist in this maintenance work, accurate records of the circuit make-up from end to end,

each repeater station to check the degree of balance between the line circuit and its balancing network; noise and cross-talk measurements; 1000-cycle transmission measurements and transmission-frequency measurements on the over-all circuit to insure that the circuit equivalent is maintained within proper limits; and finally, over all talking and signaling tests.

In making many of the measurements, it is necessary to remove the circuit from service. This would result in considerable lost circuit time if each of the stations made the measurements and tests independently. In order to minimize this lost circuit time, it has been found

<sup>9</sup> *Practises in Telephone Transmission Work*, by W. H. Harden, *TRANS. A. I. E. E.*, Vol. XLIII, 1924, p. 1320.

TABLE I.  
TOLL-CIRCUIT LAYOUT RECORD

Circuit No. 2		Chicago (E)		San Francisco (W)		Equiv. in TU		E to W	W to E	Circuit order 5785 Item 42				
Control		Meas.		Noise		Req.		11	11	Date in service 6-1-26				
Office Chicago		At Chicago		Class.		Rat'g.		11	11	Card issue No. 1 Date 5-22-26				
From 1	To 2	Cable or line 3	Pair or pin numbers 4	Size of wire 5	Load- ing 6	Length 7	Equiv. 8	Toll line equipment				Ringer 13	Misc. 14	Loss (Columns (9 to 14) 15
								On side 9	For SX 10	For other use 11	CX 12			
C Chicago								75 A				3 A		0.8
D	Mori Park	Chg-MP CA 5	151	19	H-44	7.6	3.6	75 A						0.7
E Mori Park	MH 28	West TE CA	1	13	N	2.2	1.1	75 A			TS		KX	1.1
F P 128	P 328	Chg-Omaha	9-10	165	N	3.8	0.1							
G P 328	P 7415	" "	9-10	165	N	166.3	5.5							
H P 7415	P 7445	" "	9-10	165	N	0.7	0.0							
J P 7445	Davenpt	Aer Cable	9	13	N	0.1	0.0							
K Davenpt	P 7445	" "	5	13	N	0.1	0.0							
L P 7445	P 7557	Chg-Omaha	35-36	165	N	2.1	0.1							
M P 7557	P 7741	" "	25-26	165	N	4.5	0.1							
N P 12976	P 9047	Stl-Davpt	5-6	165	N	83.4	2.8							
P P 9047	Burlington	Aer Cable	5	10	N	0.5	0.2	75 A					KX	1.1
Q Burlington	P 9047	" "	15	13	N	1.0	0.5	75 A					KX	1.1
R P 9047	P 7930	Stl-Davpt	15-16	165	N	29.5	1.0							
S						Total							Total	

Telephone Repeater Data																Mileage	O. W.	CA. & O. W.
Office 16	Type 17	Imp. 18	Toward W						Toward E						Misc. 31	This company Other company	2002.3	2021.2
			Gain or CC step		Net 21	Singing point		Ring- ing 24	Ring- ing 25	Gain or CC step		Net 28	Singing point					
			Req. 19	Meas. 20		Req. 22	Meas. 23			Req. 26	Meas. 27		Req. 29	Meas. 30				
T Chicago	C	N	3		13 P	24												
U Mori Pk	2 A C	N	7.1		17 E	24			7.1		13 P	14						
V Burlington	21 P	N	12		17 F	24			12		17 F	24						
W Kans Cy.	21 P	N	12		17 F	24			12		17 F	24						
Z Newtn.	21 P	N	12		17 E	24			12		17 F	24						
																Net Equivalent		
																Four-wire section		
																Two-wire section		
																Carrier section		
																Total		2665.5

desirable in the case of long telephone circuits to set aside a definite time for making the periodic tests and to coordinate the work of making the tests under the direction of the controlling office. This testing routine has been perfected to such an extent that the circuit need not be kept out of service for more than a few minutes even in the case of the longest circuits.

The measurements of line resistance, insulation resistance, and resistance balance are made by means of Wheatstone Bridge arrangements in the testboards located at each repeater station and sometimes at intermediate points in a long repeater section. The amplification, or gain, given by each repeater is measured by means of a visual reading instrument of the vacuum tube type located at each repeater station. Balance between the line and network circuits in each direction at the various repeater stations is roughly checked by means of the repeater itself. This is done by disconnecting the line and network from one side of the repeater and connecting the two amplifying elements of the repeater in tandem, then increasing the amplification until the repeater circuit begins to oscillate. The sum of the calibrated gains of the two sides of the repeater is a rough measure of the degree of balance existing between the line and network circuits connected to the repeater. Measurements of the over-all equivalent of a circuit are made from the terminal offices by

means of transmission measuring sets<sup>10</sup> provided with variable frequency oscillators.

The long telephone circuits in the United States form a network by means of which many important points are connected directly to each other, while practically all large centers may be connected by a very few switches which rarely involve more than three such links. Economic use is made of the wires by the large number of telephone and telegraph channels superimposed on the voice-frequency circuits. The plant composing this network extends over the entire country and close coordination is essential to insure the best results both from the technical and the economic standpoints.

Main arteries of communication have been established in this way which bring the widely separated parts of the country into close touch with one another and the network is being augmented and extended to meet the growth in the traffic as it occurs. These arteries are being developed so that continuous service can be given by means of the protection afforded by alternate routes, and they are well maintained to give efficient service under all the varying conditions encountered.

10. *Methods for Maintaining the Transmission Efficiency of Telephone Circuits*, by F. H. Best, TRANS. A. I. E. E., Vol. XLIII, 1924, p. 423.

# Abridgment of Surface Heat Transfer in Electric Machines with Forced Air Flow

BY G. E. LUKE\*

Associate, A. I. E. E.

**Synopsis.**—Since the insulation of windings in electric machines has comparatively low temperature limits, the problem of cooling these machines with the most economical use of material becomes one of major importance. The design of such machines from a temperature standpoint is usually based on tests of a previously made similar machine or else is of the "cut-and-try" type where such tests are not available.

The predetermination of the operating temperature depends

a great deal upon the rate at which the heat losses can be liberated from the ventilating surface to some cooling fluid such as air, which is considered in this paper. Some data are available regarding this rate of heat dissipation with forced air convection currents; a comparison of the various results published, however, shows them to be inconsistent. The purpose of this paper is to submit additional information that should be of value to the industry and that will also explain some of the inconsistencies in the past tests.

## INTRODUCTION

THE main factor that limits the capacity of electric machines is the temperature of the windings. This temperature limit is comparatively low, ranging from approximately 100 deg. cent. to 150 deg. cent., depending upon the class of insulation and the type of machine. Air is used as a cooling medium in the great majority of rotating machines. The heat resulting from the iron and copper losses of the machine is conducted to the ventilating surfaces where it is transferred to the moving air. To conduct this heat through the solid material and to transfer it from a surface to a fluid requires a temperature gradient. Such a flow is shown on Fig. 1 with a radial duct. From the standpoint of heat transfer from a surface, air is one of the poorest of fluids. From 20 to 75 per cent of the temperature rise in rotating machines is due to the gradient necessary to transfer the heat from the surface to the ventilating air. This factor is therefore of considerable importance in the design of an economical machine.

Considerable data in the past have been published concerning heat liberated from surfaces with natural convection currents, but it has been just recently that data applicable to electrical machines with forced air flow have been available. To obtain information regarding the rate at which heat is dissipated with high velocity air flow is difficult since it will depend upon the particular conditions of air flow as well as the mean velocity. Experimental results published by various workers do not agree, therefore, in many cases. The purpose of this paper is to discuss some of the available tests and to submit new tests covering conditions of air flow such as are found in electric machines. The new data presented also will correlate some of the work which offhand seemed to be inconsistent.

\*Research Department, Westinghouse Electric and Manufacturing Co.

Presented at the Annual Convention of the A. I. E. E., White Sulphur Springs, W. Va., June 21-25, 1926. Complete copies available upon request.

## COMPARISON OF PUBLISHED DATA

Throughout this paper the coefficient of surface heat transfer will be symbolized ( $K_v$ ) or  $W/sq. in./deg. cent.$ , which means watts transferred per square inch of ventilating surface per deg. cent. difference between the surface and mean air temperature flowing in the duct. Thus, in Fig. 1, ( $K_v$ ) for the particular air flow would depend not upon the minimum air temperature nor upon the mean temperature as given by the curve but upon the integrated mean temperature taking into account the total mass flow. This is the only practical way of defining ( $K_v$ ) since in any ventilating duct the

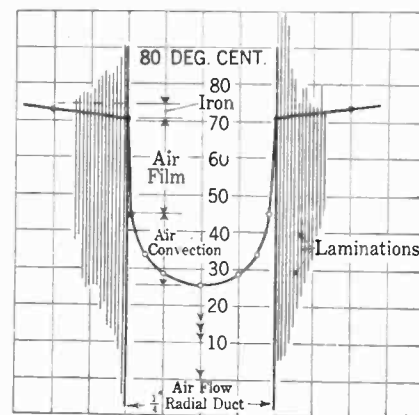

FIG. 1—TEMPERATURE GRADIENT DUE TO HEAT FLOW TO AIR STREAM IN RADIAL DUCT

air temperatures and velocities vary greatly at any particular point.

This coefficient of surface heat transfer is often called "rate of surface heat flow", "dissipation constant" and erroneously, "the emissivity constant". It may also be expressed in other units; the relation of some of these is approximately as follows:

- 1 B. t. u. per sq. ft. per deg. fahr. per hr. = 0.00366 watts per sq. in. per deg. cent.
- 1 Calorie per sq. cm. per deg. cent. per sec. = 27.0 watts per sq. in. per deg. cent.
- 1 Kilo-calorie per sq. m. per deg. cent. per hr. = 0.00075 watts per sq. in. per deg. cent.



1 watt per sq. cm. per deg. cent. = 6.45 watts per sq. in. per deg. cent.

A few of the experimental results published by Nusselt,<sup>1</sup> Dicksee,<sup>2</sup> Rice,<sup>3</sup> and the writer,<sup>4</sup> giving the rate of surface heat transfer for various air velocities, are plotted on Fig. 2. In all of these tests the air velocity referred to is the mean velocity in ft. per min. obtained by dividing the weight of air, in pounds, passing through the duct by the cross-sectional area of the duct in square feet, and by the weight of air in pounds per cubic

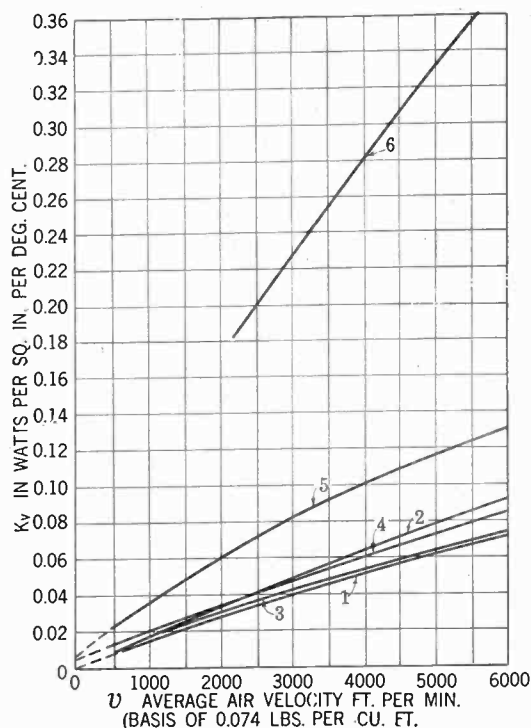

FIG. 2—SURFACE HEAT TRANSFER CONSTANT AGAINST AVERAGE AIR VELOCITY FOR VARIOUS DUCTS OF ATMOSPHERIC PRESSURE

Curve	Author	Type
1	Luke <sup>1</sup>	Smooth circular 1 1/4 in. Dia. 36 in. long.
2	Luke <sup>1</sup>	Rough circular 1 1/4 in. Dia. 36 in. long.
3	Nusselt <sup>1</sup>	Smooth circular 0.866 in. dia.
4	Luke <sup>1</sup>	Smooth concentric 25 in. by 26 in. dia. 36 in. long.
5	Dicksee <sup>2</sup>	Smooth concentric 3 in. by 5 3/8 in. dia. 7 in. long.
6	Rice <sup>3</sup>	Rough concentric 1.1 in. by 2 in. dia., 5.86 in. long.

feet (0.074). This factor (0.074) is the weight of dry air in pounds per cubic foot at 25 deg. cent. and atmospheric pressure of 29.92 inches of mercury. Thus the weight of air flowing will be proportional to the velocity factor.

Curves 1, 2, and 4, given by the writer,<sup>4</sup> were with air flowing through ducts such as are found in electric machines and are called axial ducts. Curve 1 applies to a smooth brass tube 1 1/4 in. in diameter and 36 in. long, with air flowing through it. Curve 2 is for a duct similar to Curve 1 except that the surfaces are rough, since the tube was made by stacking washers of 0.017 in. varnished iron with a 1 1/4 in. inside diameter. Since the punching and stacking varied a few thousandths of an inch, the inside bore was comparatively rough. This increased the coefficient of

1, 2, 3, and 4. See Bibliography.

friction (f) at least 50 per cent and the heat transfer (K<sub>v</sub>) from 20 to 30 per cent. Curve 1 provides a reasonably close check on the data given by Nusselt (Curve 3) which were obtained by using a smooth 0.866-in. diameter tube. Jordan<sup>5</sup> also gives the results of surface heat transfer constants (K<sub>v</sub>) with air flow through smooth tubes which are slightly below Curve 1.

Curves 4, 5, and 6 were obtained with the air flowing axially between two concentric cylinders. In the tests made by the writer the cylinders were 25 and 26 inches in diameter and 36 inches long. Due to the radiation loss the values are slightly greater than those indicated by Curve 1. This radiation loss is present in Curves 4, 5, and 6, since the heated surface was the outer surface of the inner cylinder. This radiation loss is approximately 0.003 to 0.005 W/sq. in./deg. cent. and will be independent of the air velocity. Curve 5 by Dicksee<sup>2</sup> was obtained with a much smaller heater cylinder upon which were soldered various numbers of radial copper fins with surfaces parallel to the air flow. The values of the heat liberated are about twice those given for Curve 1. Curve 6 by Rice<sup>3</sup> was plotted in terms of mean velocity instead of maximum velocity by using the mean velocity ratio of 0.85. The values of heat transfer are comparatively large, being about five times as great as those of Curve 1 and about 2 1/2 times as great as those of Curve 5.

From past experience in the cooling of electric machines with free convection currents, values of heat transfer from the ventilating surfaces have been obtained that are considerably greater than those given by

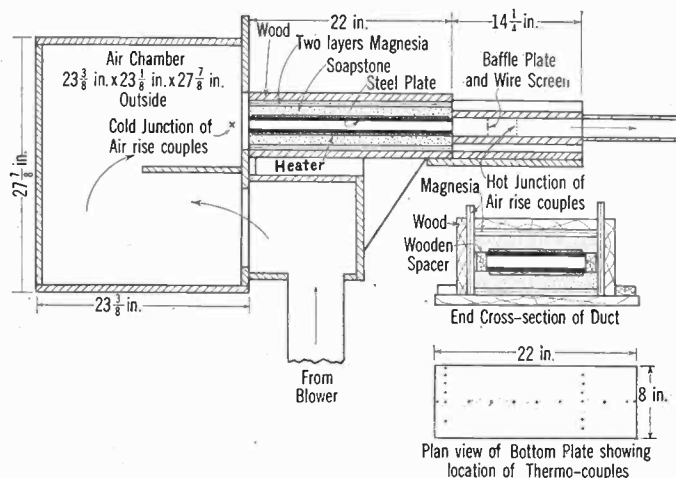

FIG. 3—APPARATUS FOR DETERMINING THE HEAT LOSS FROM FLAT PARALLEL PLATES

Curves 1 to 4. The writer has never obtained such high values, however, as those given by Curve 6 and hence additional tests were planned and executed for the purpose of giving more information concerning the variation of this cooling constant (K<sub>v</sub>) as influenced by varied air flow conditions.

EXPERIMENTAL

1. Air Flow Between Two Parallel Flat Plates. Electric machines are cooled more by radial ventilating

ducts in the iron core than by any other method. These ducts range in width from  $\frac{1}{4}$  in. to 1 in.,  $\frac{3}{8}$  in. being the more common figure. The air flow through them is very turbulent, due not only to the ventilating spacers or fingers and the coils but also to the changing cross-section for air flow. On large bore machines the change in air velocity due to the radial flow may not be great. The first test made was to imitate such conditions where a minimum rate of heat transfer is to be expected.

A sketch of the apparatus is shown on Fig. 3. The air was supplied by a centrifugal fan driven by an adjustable speed, d-c. shunt motor. This fan discharged into an expansion chamber. The air then passed through the ventilating duct formed by two hot plates 8 in. wide by 22 in. long, separated a definite distance by proper spacers. The hot discharge air then passed through an outlet duct where its average temperature was measured.

In all tests on heat transfer with forced air flow the accuracy of the data depends upon the true mean air velocity or volume. This volume may be obtained by using the pilot tube, anemometer, orifice meter, and other similar methods, but in many tests of this nature the writer has obtained the best and most accurate results by using the specific heat method. The volume was obtained after thermal equilibrium had been reached from the watts input to the air and the resulting air temperature rise. The watts absorbed by the air equals the total watts input minus the stray loss as given by the calibration curve corresponding to that particular heater temperature. The temperature rise of the air was obtained by five thermocouples with the hot and cold junction distributed in the outlet and inlet air respectively. The accuracy of this method depended upon obtaining the true temperature rise, which necessitated a thorough mixing of the hot air. This is accomplished best as shown by allowing the air to expand on discharge with a baffle placed in the direct path of the high velocity air, forcing the air to change its path. This scheme functioned successfully as shown by temperature traverses of the air with a single couple. The equation used was

$$V = \frac{1.765 W_a}{\theta_a}$$

where

$V$  = cubic feet of air per minute (25 deg. cent. temperature)

$W_a$  = watts absorbed by the air

$\theta_a$  = resulting air temperature rise deg. cent.

The average air velocity ( $v$ ) through the duct, then, is

$$v = \frac{V}{A}$$

where

$v$  = average air velocity in feet per minute, and

$A$  = cross-sectional area of duct in sq. ft.

The rate of heat loss ( $K_v$ ) from the surface for any given velocity was determined from the equation

$$K_v = \frac{W_a}{S \left( \theta_a - \frac{\theta_a}{2} \right)}$$

where

$K_v$  = surface heat transfer constant in  $W/\text{sq. in./deg. cent.}$ ,

$W_a$  = watts dissipated to ventilating air,

$S$  = ventilating surface of duct in sq. in.,

$\theta_a$  = average surface temperature rise of duct above intake air deg. cent., and

$\theta_a$  = temperature rise of the outlet air deg. cent.

A stray heat loss curve for each spacing was obtained

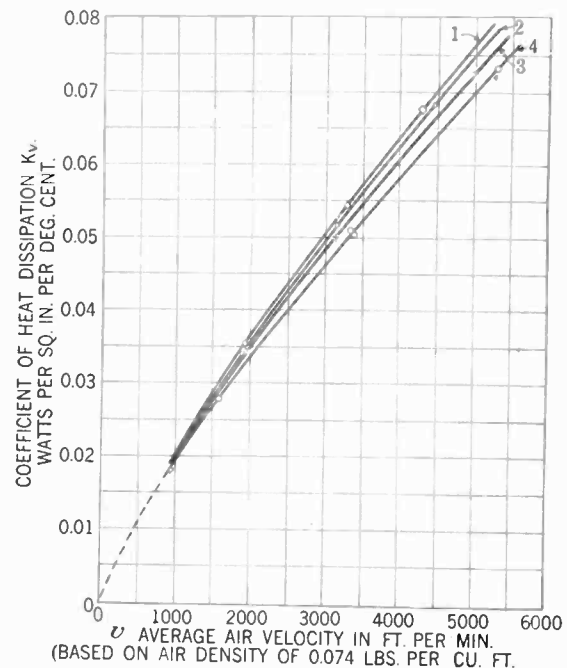

FIG. 5—CURVES FOR FLAT PARALLEL PLATE DUCT

Size duct 8 by 22 in.

Curve No. 1; (for  $\frac{1}{4}$ -in. spacing)

Curve No. 2; (for  $\frac{1}{2}$ -in. spacing).

Curve No. 3; (for  $\frac{3}{8}$ -in. spacing).

Curve No. 4; (for 1-in. spacing.)

which gave the watts stray loss for any average plate temperature. This was made by completely closing the ends of the duct so as to minimize loss by convection. The heater input, then, when steady conditions had been reached, was the stray loss flowing through the heat insulation. With forced convection the duct was given a definite spacing and air at a constant velocity was forced through. The current through the heaters was adjusted until an average plate temperature of about 80 deg. cent. was reached. When the temperatures became stable all thermocouples and heat inputs were measured. Direct current was used as the heater supply. The voltage dropped across the heater, across a fixed resistance in series with the heater, and the potentials given by the couples were all measured with a Leeds & Northrup type K potentiometer. In this manner tests at various velocities were made for

1/4-in., 1/2-in., 3/4-in., and 1-in. spacings, and ( $K_v$ ) was calculated as previously shown.

The results of these tests are shown on Fig. 5. These curves show a slight decrease in ( $K_v$ ) with increasing duct spacing. The values of the constant are not materially different from those of Curve 2 in Fig. 2.

In air blast transformers similar ducts between pancake coils are used, the coils being separated by the so called "wavy" fiber spacers. Such spacers will increase the turbulence of the air flow and should increase ( $K_v$ ). Results obtained with a 3/8 in.-width duct by the use of these spacers are shown on Fig. 6. The air velocity was calculated from the minimum cross-sectional area between spacers (0.375 in. by 1.25 in.), and the surface was taken as the product of the minimum clear dis-

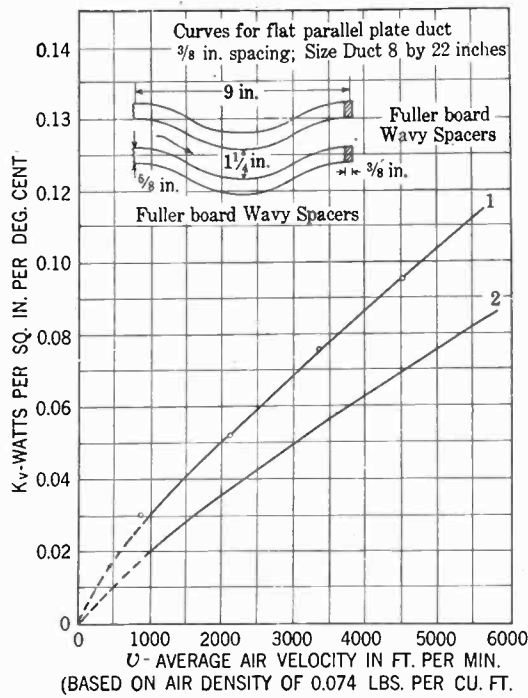

FIG. 6—CURVES FOR FLAT PARALLEL PLATE DUCT 3/8-IN. SPACING:

- Size duct 8 by 22 in.
- Curve No. 1
- 3/8-in. duct with 3/8-in. wavy spacers
- Curve No. 2
- 3/8-in. duct without wavy spacers

tance between spacers times the straight line length of the duct (1.25 in. by 22 in.). This heat loss coefficient is 40 or 50 per cent greater than that found in the duct without wavy spacers. The coefficient of friction ( $f$ ) was about 100 per cent greater than that for the duct without spacers. Curve 1, Fig. 6, shows that the turbulence of air flow was practically the same as that in Curve 5 of Fig. 2.

2. *Air Flow in Radial Duct.* The above described tests were on ducts of constant cross-section. In radial ducts, however, the cross-section is changing from point to point along the air path due to the resulting change in the diameter of the duct. In practise, also, such ducts will contain irregular spacers (ventilating fingers) and will be traversed by the conductors. All

of these factors will tend to produce very turbulent air flow which should result in a high rate of heat loss.

A sketch showing the cross-section of the apparatus is given on Fig. 7. The duct proper was formed by separating two parallel hot plate disks. These plates were 24 in. in outside diameter and 10 in. in inside diameter.

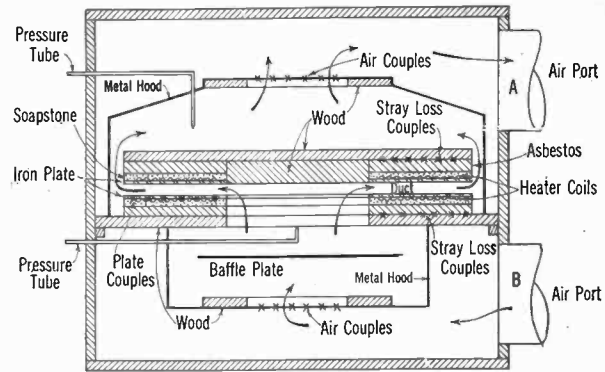

FIG. 7—ARROWS INDICATE THE DIRECTION OF AIR FLOW FOR DIVERGING AIR

They were made of resistance wire wound uniformly on one side of a 1/8-in. plate; mica was used as insulation with shellac as the binding cement. The heater and plate were likewise cemented to a 1-in. soapstone slab which acted as a heat insulator and also gave rigidity to the heater plate. Two such plates, properly spaced, were enclosed in a wooden box which acted as an air chamber. Ports were provided for attachment to the fan and discharge duct.

The heat loss constant ( $K_v$ ) was calculated as before,

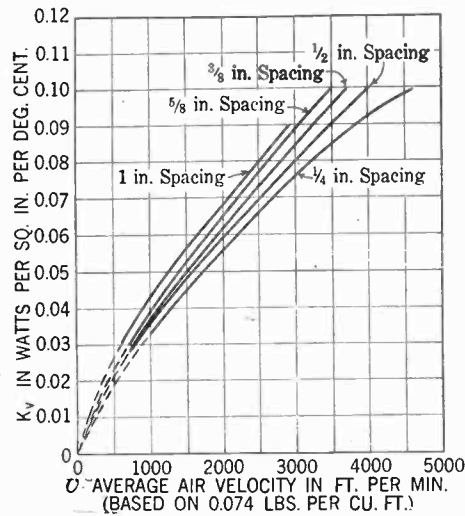

FIG. 8—UNIT POWER ( $K$ ) DISSIPATED VS. VELOCITY

No fingers or blocks Diverging air  
Radial ducts

based upon the average temperature difference ( $\theta_s - \frac{\theta_a}{2}$ ). The air velocity used in the curves is

the average velocity based upon the cross section in the middle of the duct and hence corresponds to the section where the duct diameter is  $(24 + 10)/2$  or 17 in.

When ventilating fingers were used the surface of the fingers was also included.

The results of tests with diverging flow through the unobstructed radial duct are shown on Fig. 8. The heat loss constant at a definite velocity is greater for the 1-in. ducts than for the 1/4-in. duct which is the reverse of the case given on Fig. 5. The values are also much higher due to greater turbulency of air flow. These

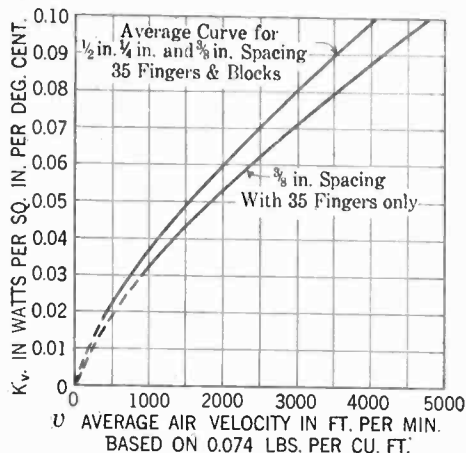

FIG. 9—UNIT POWER (*K*) DISSIPATED VS. VELOCITY

35 fingers—35 blocks diverging air Radial duct

values are of the same approximate value as that represented by Curve 5, Fig. 2. The curve of the 3/8 in. or 1/2 in. duct, Fig. 8, seems to be out of place. The values given, however, were rechecked several times.

When ventilating fingers and conductors are placed in the duct the curves are as shown on Fig. 9. Since the surfaces of the spacers are also included, the results

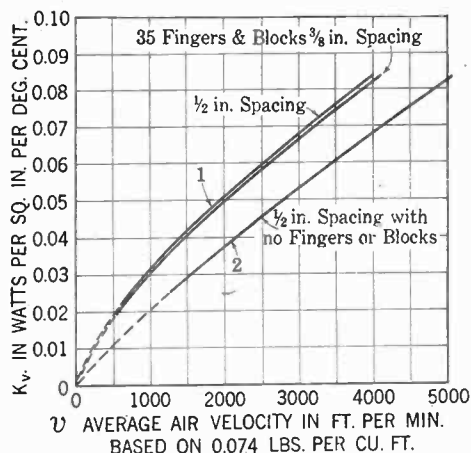

FIG. 10—UNIT POWER (*K*) DISSIPATED VS. VELOCITY

35 fingers—35 blocks converging air Radial duct

show that they are almost as effective as the duct surface.

Many machines are now ventilated with air flow radially inward (converging flow) through a portion of the ducts. The results of such a flow are shown on Fig. 10. It should be noted that the values obtained are lower than those obtained with diverging flow; Curve 2, particularly, is materially lower than the

similar curve on Fig. 8. This fact is to be expected since it is known that diverging air flow will be more irregular or turbulent than converging flow with the same axial change in cross-section. Thus the turbulence obtained with Curve 2, Fig. 10, is about the same as that found in Fig. 5 with a constant cross section since the rate of heat loss is about the same.

3. Air Flow between Two Concentric Cylinders. Mr. C. B. Dicksee,<sup>2</sup> working in this laboratory, investigated the heat loss from an air cooled gasoline engine cylinder with numerous fins attached. Curve 5, Fig. 2, gives the average results of these tests on a cylinder with 5 to 40 axial metal fins attached. These fins extended to the outer cylinder. The heat loss constant (*K<sub>v</sub>*) was independent of the number of fins used. At the time these tests were made the value of (*K<sub>v</sub>*) was considered high and no reason could be suggested why the heat loss should be any greater than, let us say, Curve 2.

The writer at that time had tests made with the smooth cylinder without fins as shown on Fig. 11.

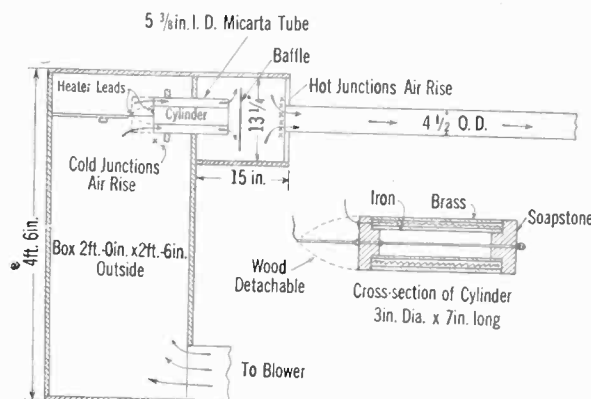

FIG. 11—DIAGRAM OF EXPERIMENTAL APPARATUS FOR DETERMINING HEAT LOSS FROM A CYLINDER WITH AXIAL AIR FLOW

This test equipment was the same as used in the above test. The cylinder was supported as shown, with a square orifice air intake. The average temperature of the inner cylinder was obtained with thermocouples as before; (*K<sub>v</sub>*) was calculated as it had been done previously and the air velocity was calculated from the cross-sectional area of the duct.

Curve 2, Fig. 12, gives the results of these tests. The values of (*K<sub>v</sub>*) are a little greater than those obtained on the finned cylinder, Curve 1. In comparing this Curve 2, Fig. 12, with Curve 4, Fig. 2, a great difference is observed, although the types of air flow system are about the same; the main difference is the length of duct (7 in. and 36 in.).

It has long been known that when air enters a duct of constant cross section from a larger chamber, a convergence or "vena contracta" of the air stream will take place, and later the effective air stream will expand and gradually assume a stable velocity condition. This convergence near the entrance of the duct and the resulting change in velocity beyond the "vena contracta" will result in turbulence and an increase in heat

loss coefficient ( $K_v$ ). This is evidently the explanation for the high value of ( $K_v$ ) shown on Curves 1 and 2, Fig. 12. Since the major part of this effect extends over only a few inches, this explains why its influence is small on Curve 4, Fig. 2, with a 36 in. length of duct.

About this time Rice<sup>3</sup> published his Curve 6, Fig. 2. This curve, as previously mentioned, gives values of ( $K_v$ ) about 2½ times as great as those of Curve 1 or 2, Fig. 12, and as Rice states, about five times those of Nusselt.<sup>1</sup> The explanations suggested were that the conditions of air flow and heater surface were different.

In order to investigate this inconsistency, the writer

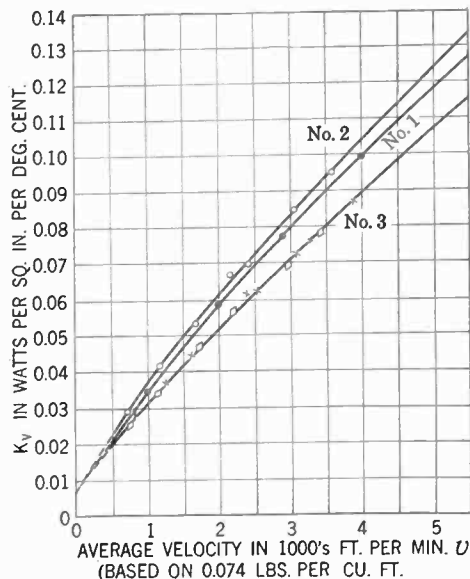

FIG. 12—HEAT LOSS FROM A CYLINDER WITH AXIAL AIR FLOW

made tests on the smooth cylinder with a converging entrance simulating conditions as described by Rice. This was done by attaching extensions to the cylinders as shown in the dotted lines, Fig. 11. The results of this are given by Curve 3, Fig. 12, and show a decrease in heat transfer instead of an increase. This decrease was expected since a converging entrance will result in less air turbulence than a square entrance.

To check the effect of roughness on the rate of heat transfer, the above 3-in. cylinder was closely wound with 0.0155-in. diameter enamel copper wire (0.0394 cm.). This was insulated from the brass tube and the outer exposed enamel was removed with sand paper. The resistance of this outer wire surface was obtained with a wheatstone bridge from which the temperature was calculated. The results of these tests were practically the same as the results of tests made with the smooth cylinder and line up with Curve 3, Fig. 12, within the error of test.

These test conditions, while not exactly the same as those given by Rice,<sup>3</sup> are nevertheless very similar. The dissimilarities due to size and other conditions should not be expected to give a value of ( $K_v$ ) of more than 20 to 30 per cent difference. The results as given for 4000-ft. per min. air velocity are, however, 0.09 for Curve 3, Fig. 12, and 0.28 Rice's value, Fig. 2.

Such a discrepancy is enormous and the writer's opinion is that Curve 6, Fig. 2, is incorrect since it is out of line with all other tests.

RATE OF HEAT LOSS AS INFLUENCED BY DUCT LENGTH

It was previously suggested that the rate of heat loss due to air flowing through a duct will not be constant for all parts of the duct, even with a constant cross section. It has been observed in machine design that machines with short duct lengths, both radial and axial, can dissipate more heat in proportion to the surface than can large machines with the same type and section of duct but with longer air flow path. A part of this difference was believed to be due to the conditions of air flow. The turbulence caused by the vena contracta at the duct entrance should cause an increase in heat loss comparable to that loss where the stream flow was more uniform. This effect has been masked in many of the past researches due to the difficulty in obtaining the rate of heat transfer over any part of the duct. Thus the work described by Nusselt,<sup>1</sup> Pohl,<sup>6</sup> Rice,<sup>3</sup> Dicksee,<sup>2</sup> and Jordan<sup>5</sup> was all based on an average heat transfer constant taken over the total length of the duct. The writer<sup>4</sup> notices this increased heat loss near the duct entrance but was unable to determine its value accurately because of a variable stray end loss. The Curves 1 and 2, Fig. 2, were; therefore, based upon the average heat loss in the middle ⅓ section of the duct.

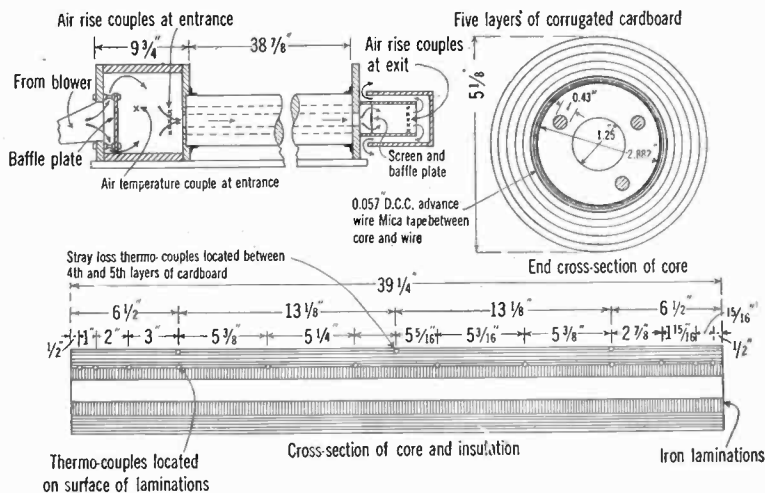

FIG. 14—APPARATUS FOR DETERMINING RATE OF HEAT DISSIPATION FROM AXIAL DUCTS

Curve 4 was based on the average loss over the total duct.

This variation in rate of heat loss with length of duct has been analytically considered by Latzko.<sup>7</sup> He developed a theory of heat transfer as determined by form and dimension with reference to the turbulency of flow. His work was based upon the hydrodynamical principles of fluid flow. No experimental work, however, was available, and none was submitted to substantiate the analysis.

The following work was planned in order to determine this variation in the rate of surface heat transfer with

duct length and also to check Curve 2, Fig. 2, previously submitted.

4. *Air Flow in a Circular Axial Duct.* This air duct used was practically a duplicate of that from which Curve 2, Fig. 2, was obtained. It is called an axial duct since it was made to imitate such ducts found in the punchings of electric machines. The duct was 1 1/4 in. in diameter and 39 1/4 in. long. The inside surface was rough since the duct was formed by stacking stampings in the form of washers made from 0.017 in.

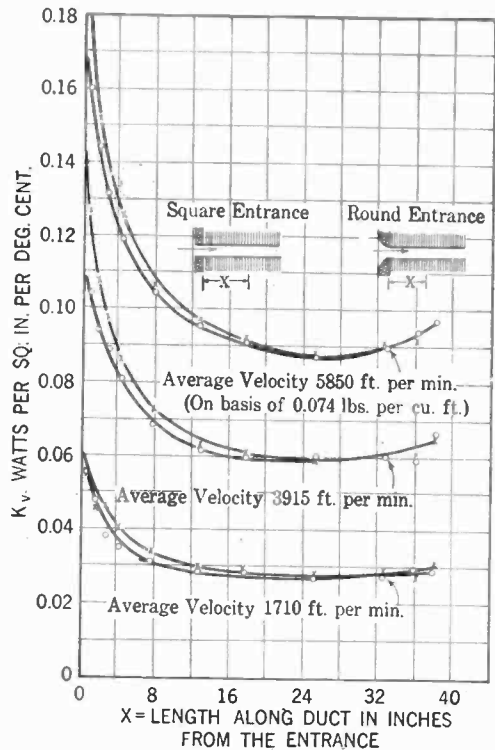

FIG. 17—RATE OF HEAT LOSS FROM SURFACE OF A LAMINATED AXIAL DUCT

1 1/4 in. diameter 39 1/4 in. long  
 o These dots are for duct with round entrance  
 X These dots are for duct with square entrance

sheet steel (1 per cent silicon). These stampings were bolted together by three long bolts running the length of the duct. A sketch of the construction and details is given in Fig. 14.

Tests were made with a sharp or square entrance and with a round entrance as shown on Fig. 17. These values of heat loss ( $K_v$ ) are the actual values obtained at any particular point along the duct. They verify the previously given theory that the rate of heat loss against duct length will be a variable and should be much higher near the entrance of the duct. For a constant volume, the loss ( $K_v$ ) is about twice as high for the first inch of the duct as that found near the middle of the duct. It should be noted, also, that there is a slight increase in ( $K_v$ ) near the outlet of the duct. This shows an increased turbulence and is verified by static air pressure explorations in that region.

The influence of the entrance is shown by an increase in ( $K_v$ ) with a square entrance over that given with a smooth entrance. Near the middle of the duct the two curves are practically the same.

*General Discussion and Conclusions.* (a). Expressing the rate of surface heat transfer ( $K_v$ ) in terms of the average air velocity ( $v$ ), the following constants for the equation

$$K_v = A \left( \frac{v}{1000} \right)^n$$

are found:

Type of Duct	A	n
Axial smooth surface const. cross section	0.0157*	0.85
Axial Rough surface const. cross section	0.0178*	0.93
Axial Annular smooth surface const. cross section	0.0367	0.75
Rectangular smooth (3/8 in.) const. cross section	0.0203	0.82
Rectangular smooth (3/8 in.) (wavy) const. cross section	0.0298	0.77
Radial 3/8 in. diverging flow no fingers variable sect.	0.0365	0.77
Radial 3/8 in. diverging flow with fingers variable sect.	0.0367	0.72
Radial 3/8 in. converging flow with fingers variable sect.	0.0310	0.70
Radial 3/8 in. converging flow no fingers variable sect.	0.0204	0.88

\*This factor will increase as the duct length decreases.

These results show a wide deviation in values of ( $A$ ) ranging from 0.0157 to 0.0367 and of ( $n$ ) from 0.70 to 0.93. In general the indications are that when ( $n$ ) is low the coefficient ( $A$ ) will be large. The value of ( $A$ ) of 0.0178 for the axial duct was based on uniform air flow

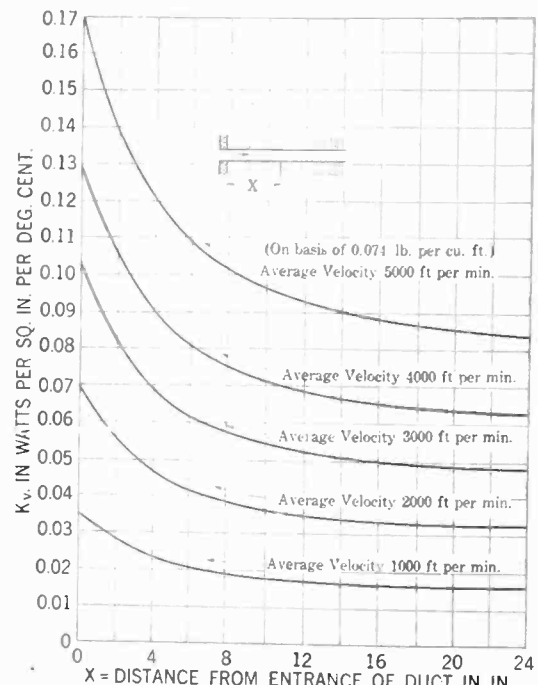

FIG. 18—RATE OF HEAT LOSS FROM SURFACE OF A LAMINATED AXIAL DUCT AT VARIOUS VELOCITIES

These curves are for duct with square entrance as shown 1 1/4 in. diameter 39 1/4 in. long

which would exist in very long ducts. As shown in Test 4, Fig. 18, this constant may increase to about double this value for very short ducts. Test 3, Fig. 12, showed that for such short ducts where very turbulent air flow is obtained, the influence of friction upon ( $K_v$ ) may be negligible. Test 2, Fig. 8, showed that radial ducts with diverging flow and changing cross section also gave irregular flow and hence high values for ( $K_v$ ). With converging flow, however, the values of ( $K_v$ ), Fig. 10, were much lower, even approaching

the minimum values found in Curve 1, Fig. 2. The rate of heat transfer ( $K_v$ ) for Test 1, Fig. 5, with a rectangular duct of constant cross section is also low and indicates a rather uniform air flow.

A general summary of the variation in ( $K_v$ ) is given on Fig. 23. It shows that the minimum value is given by the smooth  $1\frac{1}{4}$ -in. duct, Fig. 2, with regular flow. The maximum value of ( $K_v$ ) is found in the radial duct, Fig. 8, with a diverging air flow. This curve is closely approached by axial ducts, with a 1- to 2-in. duct length.

(b) Test 4, Fig. 18, giving the variation in ( $K_v$ ) at any point along the duct explains why many researches along this line have been inconsistent. The majority of these tests have been expressed in terms of a ( $K_v$ ) averaged over the total duct length and since this length varied greatly ( $K_v$ ) would also vary as shown by Fig. 18. This variable factor of duct length is in principle a check of Latzko's analysis. His equations,

( $K_v$ ) will tend to increase with the coefficient of surface friction. When the air flow is irregular, due to conditions such as entrance or irregular cross-section, ( $K_v$ ) will be large and may be practically unaffected by surface conditions. With the use of baffles the turbulency of the air can be greatly increased with an increase in rate of heat transfer ( $K_v$ ). The increase in static air pressure drop, however, will be at a greater rate.

(e) A general analysis of surface heat flow constant for a wide range of fluids and gases has been made by Davis,<sup>12</sup> Rice,<sup>3, 8</sup> Nusselt,<sup>1</sup> Latzko,<sup>7</sup> McAdams, Frost,<sup>13</sup> and many others. The equations, based upon the physical properties of fluids and upon frictional and hydrodynamical relations, were solved mainly by dimensional analysis. As a general solution, such work is valuable. For specific information regarding the heat transfer covering a definite fluid with definite conditions of flow, temperature, and the like, however, the above general solutions may be seriously in error. The workers listed above have shown that this rate of heat transfer is a function of the physical properties of the fluid such as density, specific heat, viscosity, velocity, thermal conductivity and also a function of the shape and principal dimension of the surface. The tests submitted by the writer have shown that this rate of heat transfer is also a function of the flow lines of the fluid and in this respect becomes a problem of more than a single dimension and at least involves a ratio of principal dimensions. To derive a general solution taking into account the hydrodynamical conditions in addition to the above physical properties seems visionary, at least as regards a practical solution. Thus, for specific information, which is desired by designing engineers of electric machines, experimental results such as submitted on Fig. 23 must be used.

It is also hoped that these specific tests may aid in forming a basis for a better general solution of this surface heat transfer problem covering, let us say, the more restricted field of gas flow which is of great importance in electrical industry.

The writer wishes to express his appreciation of the valuable assistance given in the performance of these tests by Messrs. L. W. Schad, R. R. Sirrs, J. H. Cone, C. G. Veinott, and E. Steinert.

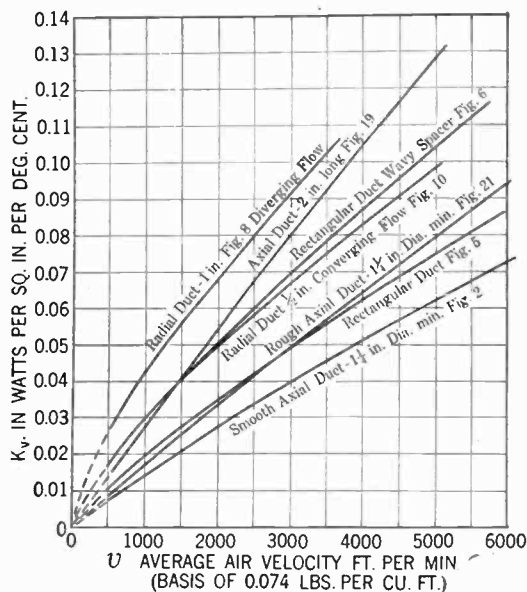

FIG. 23—SUMMARY OF SURFACE HEAT TRANSFER CONSTANT AGAINST AVERAGE AIR VELOCITY FOR VARIOUS DUCTS

Average air temperature intake 25 deg. cent.  
 Average surface temperature 75 deg. cent.  
 Atmospheric pressure

however, do not agree in detail with the curves on Fig. 8. According to his calculations, based purely on hydrodynamical relations, the curves on Fig. 18 should reach their minimum value in a length from the entrance much less than shown.

(c) Over the range of temperatures used, 25 to 150 deg. cent., the rate of heat transfer ( $K_v$ ) at a constant mass air flow decreases slightly with increasing temperature; its approximate relation is: ( $K_v$ ) varies as

$$\sqrt{\frac{1}{T_{avg}}}$$

where ( $T_{avg}$ ) is the average temperature Kelvin of the wall and air. This is in the direction indicated by Rice,<sup>3</sup> Royds, and Campbell,<sup>11</sup> but is opposite to that given by Nusselt,<sup>1</sup> Pohl,<sup>6</sup> and Jordan.<sup>5</sup>

(d) When air flows through ducts of constant cross-section and has reached a stable flow the heat transfer

**Bibliography**

References are numbered as they appear in the paper.

1. Heat Transmission in Conduits, by Wilhelm Nusselt. *Zeit. des Vereines deutscher Ing.* Oct. 23, 1909.
2. How to Determine the Cooling Capacity of Fins on Crank-case or Engine, by C. B. Dicksee. *Automotive Industries.* July 24, 1924.
3. Free and Forced Convection of Heat in Gases and Liquids, by Chester W. Rice. *A. I. E. E.*, 1923.
4. The Cooling of Electric Machines, by George E. Luke. *A. I. E. E.*, 1923.
5. On the Rate of Heat Transmission Between Fluids and Metal Surfaces, by H. P. Jordan. *I. M. E.*, 1909.
6. Fundamentals of Heating Calculation of Electric Machines, by R. Pohl. *Archiv. fur Elek.* June 30, 1923.

7. The Transfer of Heat to a Turbulent Flow of Liquid or Gas, by H. Lutzko. *Zeit. für Angewandte Math. und Mech.*, August, 1921.

8. Forced Convection of Heat in Gases and Liquids—II, by Chester W. Rice. *Ind. & Eng. Chemistry*. May 1924.

9. On the Extent and Action of the Heating Surface for Steam Boilers, by Osborne Reynolds. *Literary and Philosophical Society of Manchester*, 1874.

10. Passage of Heat Between Metal Surfaces and Liquids in

Contract with Them, by T. E. Stanton. *Roy. Soc.*, 1897.

11. Heat Transmission by Radiation, Conduction and Convection, by R. Royds.—Book published by Constable & Co., London.

12. Free and Forced Convection Papers by A. H. Davis. *Phil. Mag.*, 1920, 1921, 1922.

13. Heat Transfer by Conduction and Convection, by W. H. McAdams and T. H. Frost. *Ind. and Eng. Chemistry*, 1922.

## Some Graphical Solutions of A-C. Circuits Founded Upon Non-Euclidian Geometry

BY F. W. LEE<sup>1</sup>

Associate, A. I. E. E.

- Synopsis.*—1. A graphical method for the solution of alternating-current circuits is developed and discussed.  
2. The application of these transformations is shown graphically by numerous examples.  
3. Certain characteristics of circuits are identified which greatly simplify the graphical solutions of circuits.

### INTRODUCTION

THE purpose of this paper is to show how, with the aid of simple functional transformations, it is possible to obtain a mental picture of the limitations, as well as the influence, of each factor in an a-c. circuit upon the resultant voltages and currents. Steinmetz first explained how the influence of the individual factors of a circuit may be computed with the aid of his complex operator. Arnold also indicates how they may be used for constructing loci diagrams. The usual representation of an electric circuit is by the impedance or the admittance diagram; these operate upon the current or voltage in question and also determine the relative phase relations and magnitudes of the voltages and currents in the circuit. The method of analysis now presented has the limitation of the admittance or impedance diagrams for its objective.

Fundamentally, this idea embraces the operation carried out upon a function instead of a particular value. The function has all particular values as special cases. Also, if the functional transformations are simple, the individual operations may be traced after each functional change has been made. In this particular discussion the functions are circles and each particular solution may be followed with great rapidity. The effect of each functional change may be seen and any alteration of each particular factor visualized under various circuit conditions.

The nature of these solutions all have circles for their functions, but the parts of the circle which are physically operative may be greatly attenuated by circuit limitations. Nevertheless, the circle, has a very well defined physical, and also a mathematical, relation to

the circuit in question. Although the following transformations transform into similar figures, the circle, as will be seen, is a natural consequence in alternating circuit modifications. This operation upon a circle may take various forms; these are best understood when the equation of a circle is considered.

### OPERATIONAL CHANGES

The function for simplicity is taken as an impedance and is represented by  $Z$ . It may also, however, take the value of a voltage, a current, or an admittance, as conditions require. In Fig. 1, a circle of radius  $|r|$  is shown.

The equation of this circle is  $Z = |r| \epsilon^{j\theta}$ . Every

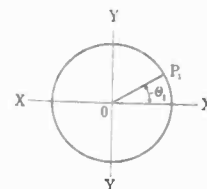

FIG. 1

point on this circle is uniquely defined; for example,  $Z_1 = |r| \epsilon^{j\theta_1}$ . The center of the circle coincides with the  $XX$  and  $YY$  axis. Certain operational changes may be made upon this function  $Z$  which will give rise to another function  $W$ ; for example, a constant complex value  $a = |a| \epsilon^{j\theta_a}$  may be added to every point upon the circle shown in Fig. 2.

$$W = Z + a$$

or

$$W = a + |r| \epsilon^{j\theta}. \quad (1)$$

From Fig. 2, it is seen that the diameter of  $W$  is the same but the center has been shifted for  $O$  to  $O'$ .

1. The Johns Hopkins University, Baltimore, Maryland.

Presented at the Annual Convention of the A. I. E. E., at White Sulphur Springs, W. Va., June 21-25, 1926.



Here it may also be seen that  $W$  is a more general expression for a circle.

Again consider the circle  $Z = |r| \epsilon^{j\theta}$  but let it be multiplied by  $\epsilon^{j\theta_1}$ . The new function  $W$  now is

$$W = Z \epsilon^{j\theta_1} = |r| \epsilon^{j\theta} \times \epsilon^{j\theta_1} = |r| \epsilon^{j(\theta+\theta_1)}. \quad (2)$$

This is shown in Fig. 3, the circle has the same

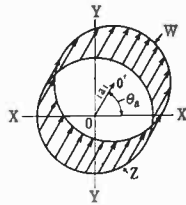

FIG. 2

radius as in Fig. 1, but the points have all been displaced by  $\theta_1$  deg.; or the circle has been rotated in a positive sense.

Had  $Z$  been multiplied by  $|b| \epsilon^{j\theta_b}$ , as demonstrated by Fig. 4, then

$$W = |r| \times |b| \epsilon^{j(\theta_b+\theta)}. \quad (3)$$

The original circle  $Z$ , having a radius  $|r|$ , will change

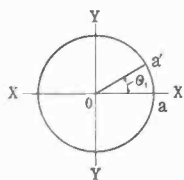

FIG. 3

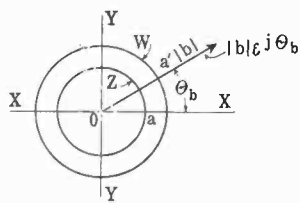

FIG. 4

into circle  $W$ , having a radius  $|r| \times |b|$ , or the product of the radii. The circle  $W$  would also be rotated with reference to  $Z$  by an angle of  $\theta_b$  degrees. Point  $a$  will go into  $a'$ , etc.

If a more general equation for a circle had been

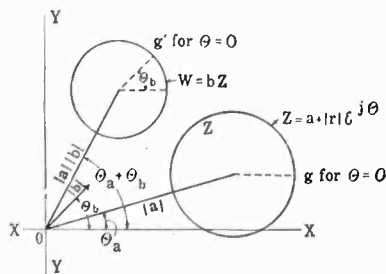

FIG. 5

considered, as  $Z = a + |r| \epsilon^{j\theta}$ , where  $a$  is a complex number, as shown in Fig. 5, and had  $Z$  been multiplied by  $b = |b| \epsilon^{j\theta_b}$ , the circle  $Z$  would have gone into

$$\begin{aligned} W &= Z |b| \epsilon^{j\theta_b} = [ |a| \epsilon^{j\theta_a} + |r| \epsilon^{j\theta} ] [ |b| \epsilon^{j\theta_b} ] \\ &= |a| |b| \epsilon^{j(\theta_a+\theta_b)} + |r| |b| \epsilon^{j(\theta+\theta_b)} \\ &= c + |r'| \epsilon^{j(\theta+\theta_b)}. \end{aligned} \quad (4)$$

Notice that the circle  $Z$  has been moved through an

angle  $\theta_b$ , and has also been revolved about its center by  $\theta_b$ . Its new radius  $r' = |r| \times |b|$  and its new distance from the origin  $c = |a| \times |b|$ .

To define a circle, three factors are necessary after a transformation, viz., (a) the radius or diameter, (b) the distance and direction from the origin, and (c) the value of  $\theta_b$  or its zero reference point.

Another equally important transformation is the

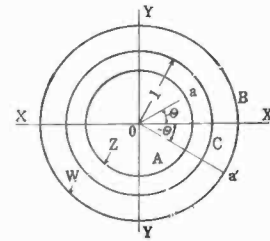

FIG. 6

reciprocal of a circle presented by Fig. 6.  $Z = |r| \epsilon^{j\theta}$  is a circle about the origin.

Then

$$= \frac{1}{Z} = \frac{1}{|r| \epsilon^{j\theta}} = \left| \frac{1}{r} \right| \epsilon^{-j\theta}. \quad (5)$$

From this equation a new circle arises, having a radius  $\left| \frac{1}{r} \right|$  with angles taken in the negative sense.

Circle  $Z$  will go into circle  $W$  and vice versa; point  $a$  would correspond to  $a'$ , a circle inside of the unit circle will fall outside, and a circle outside will fall inside, upon inversion. The unit circle will invert into itself but the points on it will not coincide. Should, however, the center of the circle not coincide with the

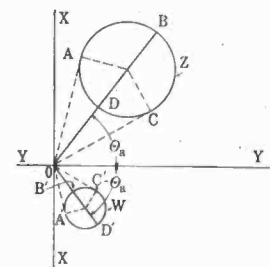

FIG. 7

origin, Fig. 7, then the inversion will also transform the circle into another circle.

Here

$$\begin{aligned} Z &= |a| \epsilon^{j\theta_a} + |r| \epsilon^{j\theta} \\ W &= \frac{1}{Z} = \frac{1}{|a| \epsilon^{j\theta_a} + |r| \epsilon^{j\theta}} = |a'| \epsilon^{-j\theta_a} + |r'| \epsilon^{j\theta'} \end{aligned} \quad (6)$$

$\theta$  and  $\theta'$  bear no linear functional relationship. This transformation may be proved from similar triangles upon elemental portions of the two circles. The angles, however, do not transform uniformly as a

Before the reactance is added the current in the circuit

is proportional to  $\frac{1}{Z_1 + Z_L}$  and afterwards to  $\frac{1}{Z_2 + Z_L}$

where, for example,  $Z_L$  is taken as a 50 per cent power factor locus.

It is evident that there is a short-circuit current for  $Z_L = 0$ , but from the diagram it is seen that this may not be the maximum current possible in the circuit. For a definite range of power factors touching the circles between  $a k c$  and  $b m c$  maximum currents greater than the short circuit current are possible. The inversion of the circles  $A$  and  $B$  indicates the locus of these maximum currents which are the straight lines  $a' c'$  and  $b' c'$ . These two lines intersect at  $c'$ , corresponding to the intersection at  $c$  of the two circles which is the resonant point in both instances. For this point the

$$I = \left[ \frac{1}{\frac{1}{Y_L + Y_2} + Z} + Y_1 \right] E/O \tag{10}$$

The successive operations which are necessary are indicated in this equation. The variable  $Y_L$  is the load admittance; the other factors are constants which are indicated as per Fig. 17, (I). The graphical operations are accomplished in the order in which equation (1) is derived and are indicated as follows:

$Y_L$  and  $Y_L + Y_2$  [Fig. 17, (II) ]

$$\frac{1}{Y_L + Y_2} \text{ and } \frac{1}{Y_L + Y_2} + Z \text{ [Fig. 17, (III) ]}$$

$$\frac{1}{\frac{1}{Y_L + Y_2} + Z} \text{ and } \frac{1}{\frac{1}{Y_L + Y_2} + Z} + Y_1$$

[Fig. 17, (IV) ]

$$I = E/O \left[ \frac{1}{\frac{1}{Y_L + Y_2} + Z} + Y_1 \right] \text{ [Fig. 17, (V) ]}$$

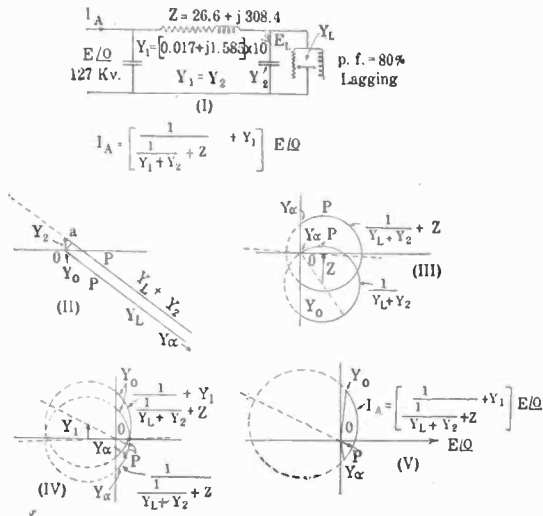

FIG. 17

ratio of the short-circuit currents corresponding to

line impedance  $Z_1$  and  $Z_2$  is  $\frac{o c'}{o c'} = 1$ ; for  $Z_L = 0$  the

ratio is  $\frac{o b'}{o a'} = 0.5$ ; at 50 per cent power factor leading

it is  $\frac{o m'}{o k'} = 0.633$ . Here again the dotted portions of

the loci represent the mathematical possibilities and the full lines the physical limitations. The points  $c$  and  $c'$  are the same for any reactances which may have been added to  $Z_1$ ; hence they may be called invariant points in the comparison.

Another example is the location of the generator current locus for a high-tension transmission line, in this case the 500-mile line published in the JOURNAL of the A. I. E. E. for September, 1924. Fig. 17 (I) shows the line reduced by the simple reduction formulas of Dr. Kennelly. It is loaded at a constant power factor of 80 per cent lagging current at the load. The equation of the current at the generator is

It will be seen from Fig. 17, (V) that the current is a minimum at  $P$ . In order to determine the exact value of load  $Y_L$  for this minimum current, this value of  $P$  may be traced through each transformation and is indicated by  $P$  on every locus.

From purely physical considerations of this circuit it is evident that the voltage at open circuit is the same, irrespective of the value of admittance  $Y_L$  as gradually decreased to zero. Also, the voltage at a short circuit is zero irrespective of how  $Y_L$  was increased to infinity. Hence there are two invariant points in this system common to any kind of loading, that for open circuit  $Y_L = Y_0$ , and that for short circuit  $Y_L = Y_\infty$ . All of the current loci will intersect at these two invariant points.

### DISCRIMINANT LOCI

Certain loci may have something common with other loci which allow the rapid evaluation of a large number of loci by the use of this locus. A locus which can be used in this manner may be called a discriminant locus. For example, suppose it were desired to compute all the generator current loci for all power factors of loading Fig. (18) and of circuit Fig. 17 (I).

Here are shown various power factors of loading  $Y_a = 50$  per cent leading,  $Y_b = 86$  per cent leading,  $Y_c = 86$  per cent lagging, and  $Y_d = 50$  per cent lagging as illustrated. It would be, with the above simple method of current evaluation, rather tedious to carry through each evaluation as per Fig. 17. From Fig. 18 (II) it is seen that  $Y_L + Y_2$  produces, for every power factor, a circle locus 123056; this circle has one point in common for every power factor in addition to the invariant points  $Y_0$  and  $Y_\infty$ ; it is a discriminant locus. Now by treating this circle as a special type of

load and carrying it through as per Fig. (17) a locus of  $I$  is found, Fig. 18, III. All power factors,  $Y_a$ ,  $Y_b$ ,  $Y_c$ , and  $Y_d$ , have the points 5, 6, 2 and 3 respectively, on this circle. Since the current loci must also pass through  $Y_0$  and  $Y_\infty$  in addition to a point on this locus, it is possible to draw a new circle through these three points, for example, point 2, Fig. 18 (IV), to deter-

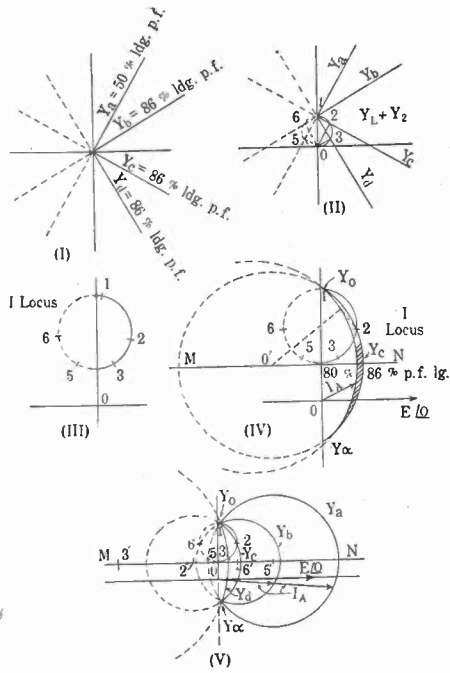

FIG. 18

mine the current locus at 86 per cent power factor. The small shaded area shows the change from 80 per cent power factor of Fig. 17 to 86 per cent power factor, or the range of generator current due to change of power factor at the load. The phase angle of the current  $I$  at the generator and the voltage  $E/O$  can be obtained directly from the diagram. Because all current loci have their centers in line  $MN$ , this line is also a discriminant locus. It can be seen from Fig. 18, (V), that a change of load power factor from 50

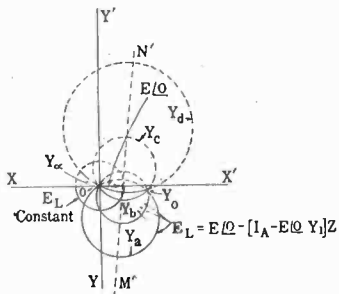

FIG. 19

per cent to 80 per cent, leading, corresponding to loci  $Y_a$  and  $Y_b$ , produces a much greater change of current at the generator than a similar change from 50 per cent to 86 per cent lagging, or circles  $Y_c$  and  $Y_d$ .

In order to determine the voltage  $E_L$  at the load, the relation

$$E_L = E/O - [I_A - E/O Y_1] Z \quad (10)$$

is used, and the transformations are followed as indicated in the equation, (see Fig. 19). All of the generator current loci of Fig. 18 (V) were operated upon as indicated in equation (10). The discriminant line  $MN$  of Fig. 18 (V) transforms into the line  $M'N'$  and allows a very rapid determination of the voltage at the load  $E_L$ . This diagram shows what values of  $Y_L$  must be chosen if the system is to have a constant voltage at the load end in conjunction with a constant voltage at the receiving end of a transmission line.

The well-known asynchronous machine can be graphically visualized with these transformations. The standard circuit of the induction machine is shown in Fig. 20 (I).

Remembering that the slip

$$s = \frac{\omega_1 - \omega_2}{\omega_1} \quad (11)$$

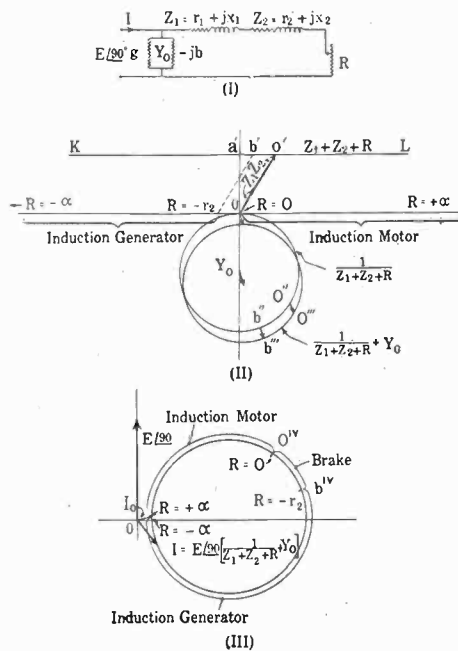

FIG. 20

in which  $\omega_1$  is the synchronous speed and  $\omega_2$  the speed of the rotor, in the equivalent circuit

$$s = \frac{r_2}{R + r_2} \quad (12)$$

OR

$$R = \left( \frac{r_2}{s} \right) - r_2 \quad (13)$$

where  $r_2$  is the rotor circuit resistance and  $R$  is the resistance equivalent to the mechanical load on the rotor.

The range of speed for the induction motor is

$$0 < \omega_2 < \omega_1$$

for which  $R$  varies from 0 to  $\infty$  resistance.

The range of speed for the induction generator is

$$+\infty > +\omega_2 > \omega_1$$

for which  $R$  varies from  $-r_2$  to  $-\infty$ .

The range of the frequency converter or brake is

$$-\infty < \omega_2 < 0$$

for which  $R$  varies from  $-r_2$  to  $0$ .

Here the critical locus is  $R$ , which has all values from  $+\infty$  to  $-\infty$  with singular points at  $O$  and  $-r_2$  as shown in Fig. 20 (II). The effect of adding the primary and secondary impedance is shown in the line  $KL$ . Upon inversion the circle through the origin is realized and the points  $R = +\infty$  and  $R = -\infty$  are the same point at  $O$ .

The current delivered to or from this circuit is shown in Fig. 20, (III)

$$I = \left[ \frac{1}{Z_1 + Z_2 + R} + Y_0 \right] E/90.$$

The voltage is chosen at 90 deg. to make the diagram

similar to the conventional representation of the Heyland diagram.

Further application of these methods to transformers, generators, filter circuits, vacuum tubes, etc., is obvious, once the view point is ascertained.

#### CONCLUSIONS

This analysis indicates how, with the aid of a few elementary transformation theorems, the operation of electric circuits, machinery, and vibrations of all kinds may be visualized and their limitations and possibilities discerned without the aid of extensive mathematical formulas.

It indicates a method for the computation of charts showing changes upon individual units comprising the system. It will show, for example, how a system may be operated with greatest efficiency or flexibility and what units added to this system will give best results.

The writer wishes to acknowledge the many kind suggestions of Dr. Whitehead and the careful comparisons of the proof by M. W. Pullen.

## Standards for Measuring the Power Factor of Dielectrics at High Voltage and Low Frequency<sup>1</sup>

BY HARVEY L. CURTIS<sup>2</sup>

Fellow, A. I. E. E.

**Synopsis.**—This paper points out the need which exists in the electrical industry, particularly in connection with the testing of high-voltage cables for convenient standards for use in the measurement of dielectric loss. At present most laboratories make use of air condensers. In the paper these are classified and certain

sources of error which must be guarded against are mentioned. Condensers with solid dielectrics would be much more convenient, more portable, and cheaper, but so far none have been produced which have satisfactory constancy for use as standards at high voltage.

IN any kind of measurement the need of standards is not apparent until the importance of this kind of measurement becomes evident. For example, standards of resistance were not needed so long as men were interested only in electrostatics. It was only when current electricity became of importance that resistance standards were developed. Likewise, the recent realization by industry of the importance of measuring the power factor of dielectrics has raised the question as to whether or not suitable standards can be prepared and maintained.

At the present time practically all laboratories which make measurements of the power factor at high voltages use an air or gas condenser as a standard. It is assumed that there is a negligible loss in such a condenser. Descriptions of a number of these condensers have

appeared in print.<sup>3</sup> Also a number of concerns, in response to a circular letter, have furnished the author with descriptions of the condensers which they are using.<sup>4</sup> Space does not permit a detailed description of all of these condensers. However, it is possible to classify them under certain general headings and thus indicate the important features of the condensers which are now being used.

In all of these condensers, great care has been exercised to so design the condensers that no corona will

3. Shanklin, *G. E. Review*, Vol. 19, 1916, p. 844. Whitehead & Isshiki, *TRANS. A. I. E. E.*, Vol. 30, 1920, p. 1076. Atkinson, *Electric Jour.*, Vol. 22, 1925, p. 62. Rayner, *Jour. Sc. Instruments*, Vol. 3, 1925, p. 33. Dawes & Hoover, *JOUR. A. I. E. E.*, April, 1926, p. 337.

4. The following firms have furnished unpublished descriptions:

- American Steel & Wire Company.
- Electrical Testing Laboratories.
- Habirshaw Cable & Wire Corporation.
- Safety Cable Company.
- Simplex Wire & Cable Company.
- Westinghouse Electric & Manufacturing Company.

1. Approved by the Director of the Bureau of Standards of the U. S. Department of Commerce.

2. Senior Physicist, Bureau of Standards.

Presented at the Regional Meeting of District No. 1, of the A. I. E. E., Niagara Falls, N. Y., May 26-28, 1926.

occur at the highest voltages at which they are to be used. This requires that the spacing between the plates shall be adequate and that the edges of the plates shall be finished by a curved surface having at all points a large radius of curvature. If a large room is available, these conditions are not difficult to meet.

The condensers may be classified either in regard to the kind of dielectric or in regards to the shape of the electrodes. When classified in regard to the kind of dielectric, the condensers naturally fall into two classes, (1) condensers using air at normal pressure as a dielectric and (2) condensers using a compressed gas as a dielectric. As the dielectric strength of a gas increases approximately in the same ratio as the pressure of the gas, the plates of a compressed gas condenser can be placed relatively close together, decreasing greatly the size required for a given capacitance. With a pressure of only 10 atmospheres, the plate separation for any given voltage need be no greater than with an oil condenser for that voltage. Moreover, there are no data to show that there is any dielectric loss in a compressed gas. The advantages and disadvantages of a compressed gas condenser in comparison with one using air at atmospheric pressure is shown in the following statement furnished by Mr. R. W. Atkinson:

Advantages	Disadvantages
Compactness	Lack of adjustability
Portability	Necessity of maintaining pressure
Cheapness	Inaccessibility of electrodes
Constancy	Difficulty of designing a gas-tight, high-tension bushing
Complete shielding	

Air condensers for high voltage may also be put in two classes as regards the shape of electrodes, *i. e.*, those using flat plates and those using coaxial cylinders. Those using flat plates may again be divided into those having a single high-voltage plate and those having several high-voltage plates. When there is a single high-voltage plate, most laboratories use two low-voltage plates, one on either side of the high-voltage plate. This doubles the capacitance with an increase in the cost of only 50 per cent. Many laboratories use a guard plate to shield each of the low-voltage plates of the condenser.

In the condensers made of coaxial cylinders, two types are used; those having the high voltage on the inner cylinder and those having the high voltage on the outer cylinder. In either case guard rings are generally used at the ends of the low-voltage cylinder. If the low-voltage cylinder is outside, it is customary to surround the low-voltage plate by a metallic screen which is connected to the guard rings at the end, thus completely shielding the low-voltage plate. If the low-voltage plate is on the inside cylinder, the guards at the end of the cylinder form a complete shield for this plate.

Certain difficulties arise in the use of air condensers as standards for power-factor measurements. There is

often some uncertainty concerning the loss in the leads which go to the air condenser as well as those which go to the specimen. In case a substitution method is used, care must be exercised to see that the loss in the leads is the same when the specimen is being measured as when the air condenser is substituted.

If the condenser does not have any guard plates, then it is important that all the lines of electrostatic force passing from one plate to the other shall go through air. Such condensers should be kept well away from the walls of the room, and the solid insulating material used to support the low-voltage plate must be so arranged that the loss in it is negligible.

In condensers using a guard, there is frequently a large capacitance between the guard and the shielded plate. If the guard plate is at every instant kept at the same potential as the shielded plate, then this large capacitance has no deleterious effect. However, in

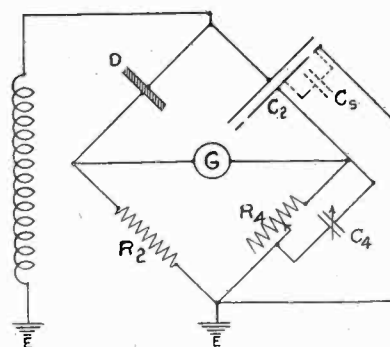

FIG. 1

very few of the published methods is any provision made for keeping the voltage of the guard plate the same as that of the shielded plate.

The effect of a slight difference of potential between the guard plate and low-voltage plate can easily be illustrated by reference to the Schering bridge.<sup>5</sup> This bridge, arranged for use with a guarded condenser, is shown in Fig. 1. The capacitance  $C_g$  between the shielded plate and the guard plate is in parallel with the measuring capacitance  $C_4$ . The power factor of the specimen  $D$  is given by the equation

$$\text{Power Factor} = 2 \pi f R_4 (C_4 + C_g)$$

Hence, if the value of  $C_g$  is omitted in computing the power factor, an error is introduced, the magnitude of which will depend on the relative values of  $C_4$  and  $C_g$ . For a given sample, the error will increase as  $R_4$  is increased. A rough estimate of the value of the capacitance  $C_g$  that may be expected in types of condensers now in use indicates that if  $R_4$  is as much as 1000 ohms, the error would be of the order of 0.01 per cent in the power factor, whereas if  $R_4$  is 10000 ohms the error would be of the order of 0.1 per cent.

All other methods of measuring power factor with a

5. See description by Everett S. Lee, *Jour. A. I. E. E.*, Feb. 1925, p. 160.

guarded condenser are subject to errors of the same magnitude as those indicated for the Schering bridge. The current that flows through the capacitance from the shielded electrode to earth decreases the current through the measuring instrument. Unless special provision is made to insure that the guard electrode is at the same potential as the shielded electrode, the errors that may result in the power factor of the specimen under test may be quite as large with a guarded condenser as with an unguarded condenser.

The problem of making power-factor measurements would be considerably simplified if suitable condensers with solid dielectric were available. These condensers could be certified for power factor in a standardizing laboratory. In order to be suitable, such condensers must be small enough to be portable and should have a low power factor which is stable with time and which is nearly independent of voltage, frequency, and temperature. No condenser which fulfills these requirements at high voltages has been produced. A mica condenser serves admirably at low voltage, but as yet it has not been adapted to high voltage.

Paper condensers for use on voltages up to 3000 volts are now a commercial article. Some unpublished experiments performed at the Bureau of Standards indicate that their power factor may change with time. Hence such condensers cannot at present be considered suitable for standards.

Glass condensers have been used in some cases. While very stable, the loss with most kinds of glass is high and there is a large change with temperature. Such condensers are not suitable as standards. There are unpublished data indicating that glass having a much lower loss than ordinary glasses will soon be available. This offers interesting possibilities for use in standard condensers.

Clear-fused quartz, often called silica glass, has been suggested as a suitable dielectric for high-voltage condensers. It answers the requirements of stability and of low dielectric loss. However, the effect on the power factor of changes in voltage, frequency, and temperature has not yet been determined. Until a condenser of this type has been given a complete test, there will be no certainty that fused-quartz condensers will make satisfactory standards for power-factor measurements.

The situation today in regard to power-factor standards at high voltage in many ways resembles the voltage situation forty years ago. Then if one wished to measure a voltage he must himself set up a Daniell cell which he could use as a standard. Now, practically every voltage measurement depends directly or indirectly on values maintained at a standardizing laboratory. The change from the first condition to the second has taken place gradually as new methods of maintaining standards have been developed, and as standardizing laboratories have been able to convince

industry that the standards which they furnish are reliable.

Now it is practically necessary for every laboratory that wishes to measure power factor at high voltage either to build an air condenser which is supposed to have zero power factor or to resort to difficult absolute measurements. However, if there is sufficient demand, standards will be developed and standardizing laboratories will put themselves in a position to certify to the value of the power factor under working conditions.

### ESTABLISHMENT OF RADIO STANDARDS OF FREQUENCY BY THE USE OF A HARMONIC AMPLIFIER

Scientific Paper No. 530 of the Bureau of Standards, by C. B. Jolliffe and Grace Hazen, bears the above title, and describes a method for measuring the ratio of a radio to an audio-frequency by the use of a harmonic amplifier. The harmonic amplifier makes it possible to use harmonics of a very high order from a known low-frequency source, such as a standard tuning fork. The method consists essentially of the production of harmonics of the fundamental frequency of an alternating current by means of the nonlinear characteristics of electron tubes, the selection of any desired harmonic by means of tuned circuits, and its amplification to sufficient power to operate a standard frequency meter (wave meter). Any harmonic of the source may be selected, and thus from a known audio-frequency source a frequency meter may be standardized throughout its entire range.

The harmonic amplifier consists of two units, one having a range from 8 to 450 kc, the other from 400 to 4000 kc. The first unit supplies a harmonic which is used as the fundamental for the second unit. The harmonic amplifier is given a preliminary calibration, so that the harmonic multiples can be readily determined.

A fixed frequency generator, such as a piezo oscillator, may be standardized with the aid of an auxiliary device to determine the frequency of the beat note occurring between a harmonic of the amplifier and the fixed frequency. The device used for this purpose is a sonometer. It consists of a steel piano wire mounted horizontally across two movable knife-edges with a known tension applied. The beat-note frequency is applied to the wire through a telephone receiver. The wire vibrates when its frequency is equal to the applied frequency. The frequency of vibration may be computed from the length, tension, and mass per unit length of the wire. Two audio-frequencies may be compared very accurately by the use of the harmonic amplifier and sonometer.

Copies of the complete paper may be obtained from the Superintendent of Documents, Government Printing office, Washington, D. C.

# Mercury Arc Rectifiers

BY D. C. PRINCE<sup>1</sup>

Fellow. A. I. E. E.

*Synopsis.*—Mercury rectifiers have been known for about twenty-four years, but until the last few years their principles of operation have not been understood with any certainty, and all are not yet conclusively proved. In the first part of this paper, the probable mechanism of the electron source or cathode spot is out-

lined, the source of the various losses is indicated, and the probable mechanism of arc back, that is, failure to rectify, is described.

The second part of the paper is devoted to the principles of simple rectifier circuits, while the third shows a variety of rectifiers of different kinds and sizes.

THE mercury arc rectifier has been known for about twenty-four years, but, in spite of the length of time which has elapsed, there are a great many things about it which are not understood with any degree of certainty. A good deal has, however, been found out, especially in the last few years, and since interest in rectifiers is growing, it may be worth while to go over some of the principal features so as to get a general idea of the rectifier and its problems.

Fig. 1 represents a standard, 50-ampere, 100-volt mercury arc rectifier. This form is shown for purposes of explanation on account of its simplicity. It consists of an evacuated glass bulb containing, in this case, two main anodes composed of graphite located in the anode arms projecting at either side of the bulb; two

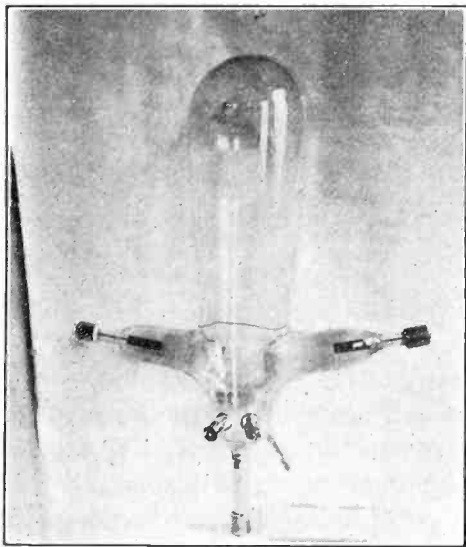

FIG. 1—50-AMPERE LOW-VOLTAGE RECTIFIER

auxiliary anodes also made of graphite lower down and on the front of the bulb; a starting anode made of mercury at the lower right; and a mercury cathode pool at the bottom.

The principle of operation in its barest essentials is similar to that of the vacuum tubes used in radio reception, with which most people are now familiar. In a vacuum tube a filament is heated until the electrons in it have so much energy that they are able to break through the metallic boundary into the surrounding

space. If the anode (plate) is positive, these electrons are attracted toward it and current flows. If the anode is negative with respect to the filament, the electrons will be drawn back upon the filament and no current can flow. Rectifier or check-valve action is thus established, since current can be carried in one direction only. In the high-vacuum rectifier the electrons filling the space between anode and filament produce a charge known as the "space charge" which tends to drive the electrons back. This causes a loss which becomes very high if it is attempted to draw considerable current.

In the mercury rectifier in place of the filament we have a small, bright, dancing spot called the "cathode spot" which is the source of the electrons. Electrons are drawn from this spot to the anodes when they are positive just as in the high vacuum tube, but when the anodes are negative they do not constitute a source of electrons, so that no current can flow and rectification is obtained. There is some difference of opinion as to what occurs in this spot. The electrons proceeding from it strike neutral molecules of mercury vapor and ionize them; that is, one electron is removed from the molecule and the remainder of the molecule then has a positive charge. These positively charged molecules, called positive ions, are attracted toward the cathode, and, since they are quite heavy, their striking represents considerable energy and the spot where they strike is heated. There is thus some action analogous to the heating of a filament. In addition to this heating, the positive ions, being heavy, move slowly, and a large accumulation of them near the mercury surface produces a high potential gradient which tends to draw electrons from the mercury surface at a temperature lower than that at which they would be able to leave it if there were no such strongly attractive force. The electrons drawn out ionize new molecules which heat the surface of the mercury and draw electrons from it, so that the process once started is self-continuing provided the potential necessary to make the current flow is present. To start the spot in the first place, an arc is drawn by tilting the tube so that the mercury in the cathode makes contact with the mercury in the starting anode. The potential is impressed on the starting anode through a small resistance. When the tube is returned to the vertical position, this circuit is broken and the resulting arc initiates the cathode spot.

Measurements have been made of the current density in the cathode spot, and it is believed to be of the order

1. Research Laboratory, General Electric Co., Schenectady, N. Y.

Presented at the Annual Convention of the A. I. E. E., White Sulphur Springs, W. Va., June 21-25, 1926.

of 26,000 amperes per sq. in. The heat due to bombardment of the positive ions evaporates a great deal of mercury. From this and other causes a pressure is built up at the cathode spot of the order of two atmospheres, although the vessel as a whole has been evacuated as perfectly as possible. The large glass bulb operates as a condenser to condense this jet of evaporated mercury. The high-pressure vapor is thus projected into a condenser where the pressure is of the order of 50 microns, that is, 5/100 of a millimeter.

The temperature of the cathode spot has not been definitely established. Some authorities give it as 2000 deg. cent., which would be the temperature required to produce the electron stream by heat alone. The actual temperature is probably much lower, although the amount has not been established. The potential drop required to maintain the cathode spot is approximately 10 volts. Approximately half of this 10 volts is consumed in latent heat of ionization of the mercury (work function 4.4 v.) and in the energy of the individual electrons as they escape from the pool. The remaining five volts appear as heat at the surface of the mercury pool, about half being used in evaporating mercury while the other half is conducted away through the liquid mercury in the pool. When the electrons combine with molecules, either on the walls of the vessel or at the anodes, the five volts represented by their energy are returned also as heat. Such electrons as combine with positive ions to form neutral molecules in the space give up some of their energy in the form of the greenish light so characteristic of the mercury arc rectifier.

About four or five amperes are required to maintain a stable cathode spot. For higher values of current the area of this spot increases, and above 40 amperes more than one spot may exist simultaneously. The spot, or spots, always move very rapidly from place to place due to the strong blast of mercury vapor and impinging positive ions. In order to make a rectifier operate down to zero load current, the auxiliary anodes are provided which draw a current of approximately five amperes so that the cathode spot is maintained in readiness even though the load is disconnected. These auxiliary anodes were not provided in some of the earlier rectifiers, but their provision facilitates many things and may be considered standard in future rectifiers both large and small.

The 10-volt cathode drop does not make up the entire loss. In the high-vacuum tube a drop is produced due to the presence of the electrons in the space. In the mercury arc this drop is eliminated by the presence of the positive ions. Whenever a drop tends to exist at any point, the electrons are accelerated until they are able to ionize neutral molecules. The resulting positive ions are of the opposite sign to the electrons so that the net space charge is reduced to approximately zero but does not disappear completely for some drop is

necessary to replace ions lost by recombination and collection by the walls.

Fig. 2 shows the form of arc drop curve for a small rectifier. The two lower curves apply to a tube of the same general form as that shown. That is, it has short, straight arms. The lowest curve gives the arc drop characteristic of the bulb cooled only by natural air circulation. To determine whether the anode area is important, the current has been collected by one anode, or by two, and it is observed that the total drop is almost exactly the same in both cases. The characteristic drop reduces to a minimum at 10 amperes and then rises. Below 10 amperes, therefore, it has the nature of a negative resistance. In order to operate a mercury rectifier, it is, therefore, necessary to include an impedance sufficient to make the average impedance positive; otherwise the tendency would be for the current to rise indefinitely or fall until the arc was extinguished. The rise in the drop beyond 10 amperes is due to excessive vapor pressure produced by heat. The next higher curve which has its minimum at about

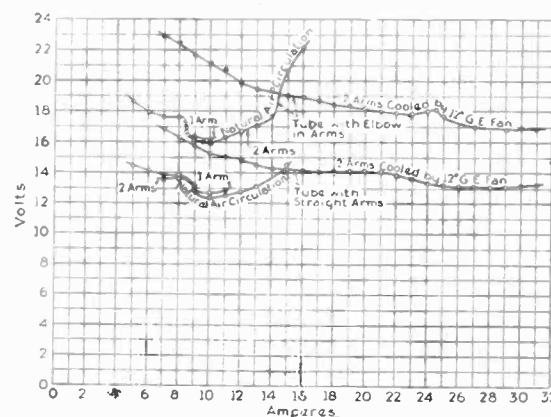

FIG. 2—ARC DROP CURVES OF 10-AMPERE TUBES TAKEN WITH DIRECT CURRENT

28 amperes was obtained from the same tube merely by cooling the condensing bulb with a 12-in. desk fan. A still greater increase can be maintained by more positive cooling methods such as oil or water. Beyond the minimum points, although the arc drop rises with increase in current, the response to instantaneous variations in current is still that of a negative resistance, so that even though rectifiers are operated beyond the point of minimum drop, two anodes still cannot be paralleled without some impedance to force a division of current.

The two higher curves on this figure are corresponding curves for a tube of the same size but having an elbow in the anode arm. Such a tube will be shown in a later figure. It appears that increasing the length of the path adds a nearly constant voltage drop. Since the drop in the rectifier is a function of current only, the capacity and efficiency are greater the higher the voltage used.

There is naturally a limit to the voltage that can be applied, and Fig. 3 shows the nature of this limit.



This figure shows what is known as the "arc back characteristic" of a 20-ampere glass rectifier with natural air circulation. It appears that for any current, there is a maximum voltage which the tube will rectify. Above this voltage one of the anodes becomes a cathode, so that the unidirectional conductivity of the device is lost.

Like the point of minimum arc drop, the current

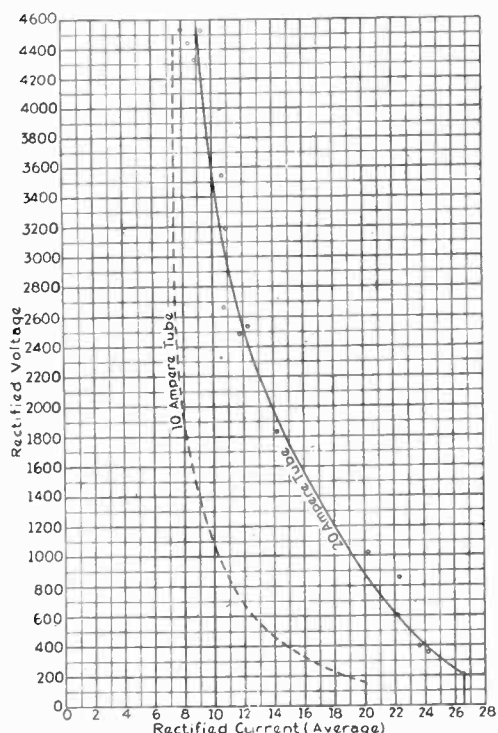

FIG. 3—ARC BACK CURVE FOR 20-AMPERE TUBES WITH BENT ARMS

at which such a failure or arc back occurs can be increased by cooling. The probable mechanism is substantially as follows. When the anode is negative, some of the positive ions will be attracted toward it and will strike it with considerable velocity. Under normal conditions very few of these collisions will produce electrons from the anode. Some few will be drawn out, however, and these will proceed toward

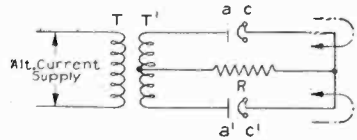

FIG. 4—IDEAL SINGLE-PHASE, FULL-WAVE RECTIFIER CIRCUIT

the cathode, ionizing further molecules as they go. The additional positive ions produced in the neighborhood of the anode will return toward it, and they also will produce a certain small number of electrons. The higher the negative voltage on the anode, the more of these electrons will be produced. The higher the vapor pressure, the more collisions each electron will make and the more positive ions they will produce. Thus a point is reached where, by increasing vapor

pressure with temperature or by increasing voltage, so many electrons will be drawn from the anode that it will become a cathode and rectification ceases.

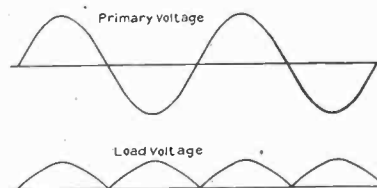

FIG. 5—WAVE SHAPES OBTAINED WITH CIRCUIT OF FIG. 4

This covers in a general way the principal phenomena of the rectifier. Under normal conditions it gives an almost perfect unidirectional action with a relatively small drop, so that in circuit determinations we may neglect all but the unidirectional effects.

Fig. 4 shows the most elementary rectifier circuit. Power is supplied from any alternating current source to transformer primary  $T$ . The secondary  $T'$  is connected at its terminals to anodes  $a$  and  $a'$ . In this case high-vacuum rectifiers are indicated. The cathodes  $c$  and  $c'$  are connected together and to the midpoint of transformer secondary  $T'$  through the load  $R$ .

Fig. 5 shows the primary voltage and voltage and current across load resistance  $R$ . During the half-cycle that anode  $a$  is positive, electrons flow from  $c$  to  $a$ ; that is, current in the usual sense flows from  $a$  to  $c$  and returns through  $R$  in the direction shown by the arrow.

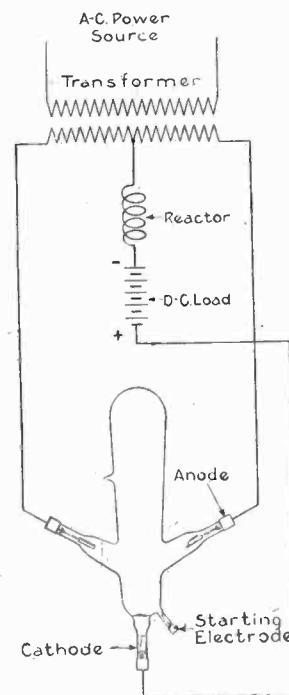

FIG. 6—MERCURY ARC RECTIFIER CIRCUIT WITH SMOOTHING INDUCTANCE IN OUTPUT CIRCUIT

During the other half-cycle,  $a'$  is positive and current flows from  $a'$  to  $c'$  and returns through  $R$  in the direction shown by the arrow, that is, during both of these half-cycles, current has flowed in the same direction

through  $R$  and rectification has been obtained. Since there is no other form of impedance present, the current through  $R$  and the voltage drop across  $R$  are both sinusoidal in form, but, due to the rectifier action, both half-waves are in the same direction. There would be no object in supplying rectified current to a resistance,

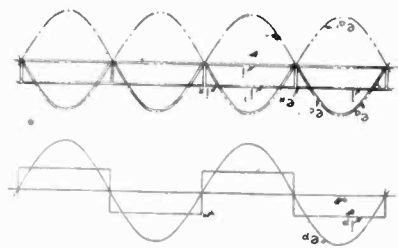

FIG. 7—PRIMARY AND SECONDARY VOLTAGES AND CURRENTS OF THE RECTIFIER SHOWN IN FIG. 6

so these figures are primarily interesting to show the rectifier action in its simplest terms.

To remove the current pulsations, an inductance may be connected in series with the load. Fig. 6 shows a circuit similar to that of Fig. 4, but including such an inductance and also including a battery as load in place of the resistance. A mercury rectifier is shown instead of the high-vacuum, hot-cathode rectifier. The inductance prevents the current from falling to zero, so that the cathode spot is maintained. A mercury rectifier could not be used in the circuit shown in Fig. 4 because it allows the cathode current to fall to zero.

If this smoothing reactor has a large value of induct-

storage battery and the reactor. Since the reactor maintains the current constant, there can be no variation in voltage across the battery. The entire voltage variation appears, therefore, across the reactor. The steady rectified current is shown at  $i_r$ . This current flows from whichever anode is positive for the moment.  $i$  and  $i'$  are, therefore, the respective anode currents. Neglecting transformer exciting currents, the transformer primary current must be of the same shape as the secondary.  $i_p$  is, therefore, the form of primary current obtained.

For storage battery charging, it is not necessary to employ a steady direct current. If the mercury rectifier is equipped with auxiliary holding anodes supplied from a separate source, a battery charging equipment can be arranged as shown in Fig. 8. With this arrangement a small current of approximately five amperes is maintained by an auxiliary transformer winding. The battery to be charged is then connected between the midpoint of the main compensator winding and the rectifier cathode. Current will flow to charge the battery only while the anode voltages are higher

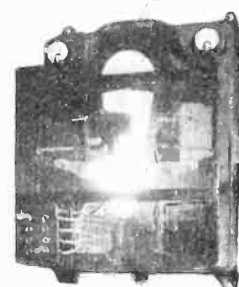

FIG. 9—MERCURY ARC RECTIFIER SET FOR CHARGING BATTERIES OF INDUSTRIAL TRUCKS

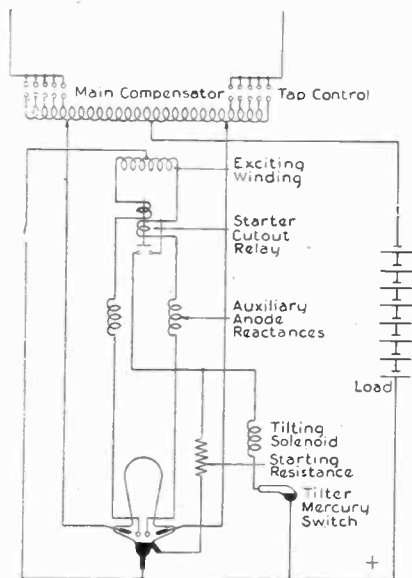

FIG. 8—WIRING DIAGRAM OF BATTERY-CHARGING RECTIFIER

ance so that the rectified current is held constant, the various waves have the form shown in Fig. 7. The sinusoidal primary voltage is impressed through the transformer on the two anodes  $a$  and  $a'$ . The cathode will assume a potential just enough less than the most positive anode to cause current to flow. The cathode potential is shown as trace  $e_c$ . This cathode potential is impressed upon the load circuit consisting of the

than the battery counter-electromotive force. Between times, the cathode spot is maintained by the auxiliary winding through auxiliary anode reactors which serve both to maintain the current at a steady value and to limit that value. This diagram also shows the arrangements for automatic starting. A relay which is normally closed is connected with its holding coils in the two auxiliary anode leads. When voltage is thrown on the rectifier, current flows through the contacts of this relay to a tilting solenoid and mercury switch which set up a rocking motion in the tube. A circuit is also made to the starting anode through a resistance. As soon as the cathode spot has been formed, the relay opens the circuit to the starting mechanism, and the rectifier is then ready for business. It is kept in an active condition by the auxiliary anodes whether the load is connected or not, a very desirable state where an unknown battery which may be badly sulphated or even open circuited is to be charged.

Fig. 9 is a photograph of one of these rectifiers.

Fig. 10 is a diagram of a three-phase rectifier. The transformer windings  $T_1$ ,  $T_2$ , and  $T_3$  are connected in delta and supplied from a three-phase, alternating-

current source. The transformer secondary windings  $t_1$ ,  $t_2$ , and  $t_3$  are connected so as to form a Y. The outer ends of the Y are connected to anodes  $a_1$ ,  $a_2$ , and  $a_3$ . The cathodes are connected through an inductance  $L$ , and the load  $R$  to the Y point of the transformer. Hot cathode rectifiers are indicated although no change would be involved in inserting a mercury rectifier.

Fig. 11 shows the wave forms obtained by this

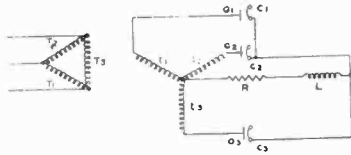

FIG. 10—CIRCUIT DIAGRAM OF THREE-PHASE RECTIFIER

arrangement. The three-phase or anode voltages are shown as  $e_1$ ,  $e_2$ , and  $e_3$ . The cathode follows these in succession, always assuming a potential sufficiently below the more positive anode to cause the current to flow. The total current is maintained constant by the inductance  $L$  so that the drop across the load is the average cathode potential and is shown at  $E$ . Since the total current is constant as shown at  $I$  and current flows always to the more positive anode, the three anode currents are as shown in  $i_1''$ ,  $i_2''$ , and  $i_3''$ , each one having full value of the rectified current for  $1/3$  of a cycle. Since the transformer will not transform direct current, the transformer primary will carry only the alternating

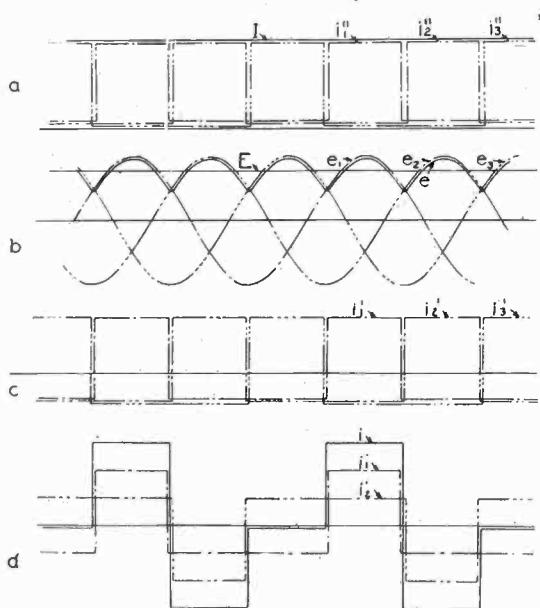

FIG. 11—PRIMARY AND SECONDARY VOLTAGES AND CURRENTS OF THE RECTIFIER SHOWN IN FIG. 10

component of these waves. These components are indicated as  $i_1'$ ,  $i_2'$ , and  $i_3'$ . Combining these currents in pairs at the corners of the delta gives the three line currents  $i_1$ ,  $i_2$ , and  $i_3$ . It is observed that both line and delta currents are not symmetrical. This indicates that with this connection there are even harmonics of current present. Even harmonics have an opposite phase rotation from the normal and so are still more objection-

able than odd harmonics. Two three-phase rectifiers may be connected as shown in Fig. 12, however, to form a six-phase rectifier. With this arrangement, instead of providing two inductances  $L$ , a single compensator or

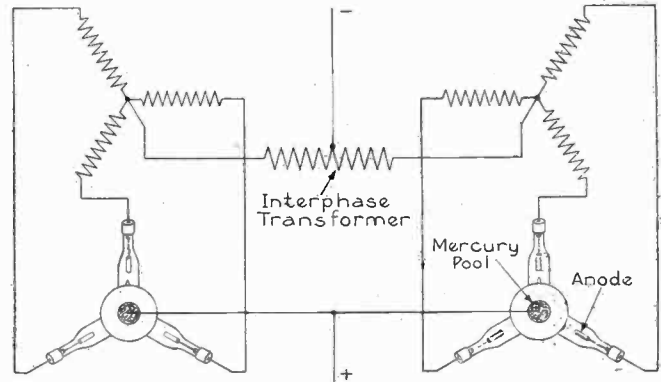

FIG. 12—DOUBLE THREE-PHASE RECTIFIER

“interphase transformer” can be used provided the two three-phase rectifiers are connected 180 deg. out of phase as shown. The resulting six-phase rectifier is the one which is usually used for power installations.

The foregoing wave diagrams are made on the assumption that there is no inductance in the alternating circuits. On this same assumption a mercury rectifier has a perfectly definite voltage ratio. If we have a rectifier of  $p$  phases, the cathode will follow the anode

of one phase for the fraction of a cycle  $\frac{2\pi}{p}$ . Since

the pulsations are absorbed by the inductance  $L$ , the direct voltage available is the average of a sine wave for this interval. By referring to Fig. 13, the average voltage may be obtained by integrating a cosine wave

from  $-\frac{\pi}{p}$  to  $+\frac{\pi}{p}$ . This gives a value for the

$$\text{direct-current voltage } G = \sqrt{2} E \frac{p}{\pi} \sin \frac{\pi}{p}.$$

This general expression gives the light load voltage for a rectifier of any number of phases. The rectifier in

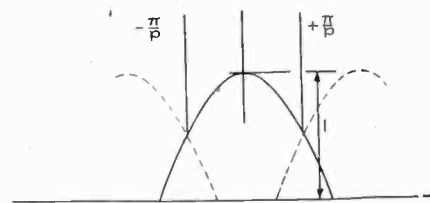

FIG. 13

Fig. 12 was made up of two three-phase units and therefore has an output voltage corresponding to three phases.

The perfectly square current waves shown in the current diagrams could only exist in an inductance less

circuit, since otherwise it would require infinite voltage to produce an instantaneous change of current. Actually, therefore, the current does not change instantaneously. Instead, when the point of the cycle is reached at which two anodes have the same potential, the current begins to shift from one to the other. Since this shift is brought about by a sinusoidal voltage difference between the two anodes, the changing component of

in effect short circuited for this interval, and there is no output voltage. This relation is shown in Fig. 15.  $i_a$  and  $i_{a'}$  represent the anode currents.  $a$  and  $a'$

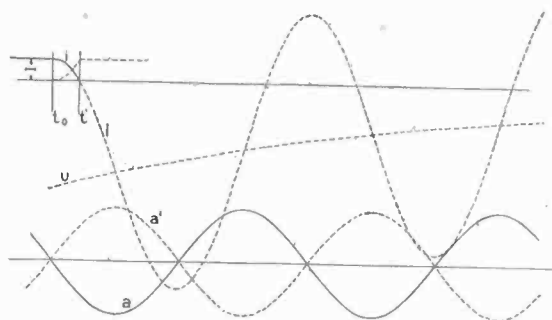

FIG. 14—GRAPHICAL REPRESENTATION OF CONDITION ARISING FROM THE SUPPOSITION THAT THE TRANSFORMER SHOWN IN FIG. 6 HAS LEAKAGE REACTANCE

current will be sinusoidal, and, if the primary impedance is nearly all inductive, as it usually is, the current will start to change just as though an alternating voltage were suddenly impressed on a circuit carrying a direct current. The condition is shown in Fig. 14. A steady current is maintained at a value  $I$  by the inductance  $L$  up to the time  $t_0$ , at which time there is no difference of potential between the anodes  $a$  and  $a'$ . At this point the current will begin to change as though it were going to follow the dotted curve  $i$ . This curve is exactly the curve that would be obtained in impressing a voltage on a circuit of inductance and small resistance; that is, it has an axis  $u$  which has the decrement factor  $e^{-\frac{r t}{L}}$ . The alternating component has a constant

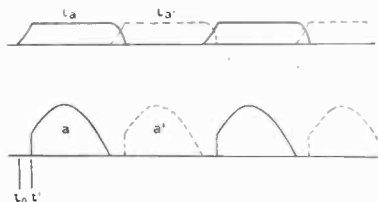

FIG. 15—OUTPUT CURRENT AND VOLTAGE WAVES, SHOWING EFFECT OF 26-DEG. PERIOD OF SHORT CIRCUIT DURING WHICH CURRENTS ARE TRANSFERRED AND NO VOLTAGE IS PRODUCED BY THE RECTIFIER

amplitude. Of course, this current cannot continue to flow, as by the time  $t'$ , the current to the anode  $a$  has been reduced to zero, and it is prevented from reversing by the unidirectional conductivity of the rectifier tube. We are therefore interested in only a part of this transient curve which takes place between times  $t_0$  and  $t'$ .

During the interval  $t_0$  and  $t'$  during which current flows from two anodes, those two anodes must be at the same potential. The transformer secondary is thus

represent the corresponding anode voltages. The cathode now follows these lines, and it, therefore, has an



FIG. 16—10-AMPERE, 300-VOLT GLASS RECTIFIER

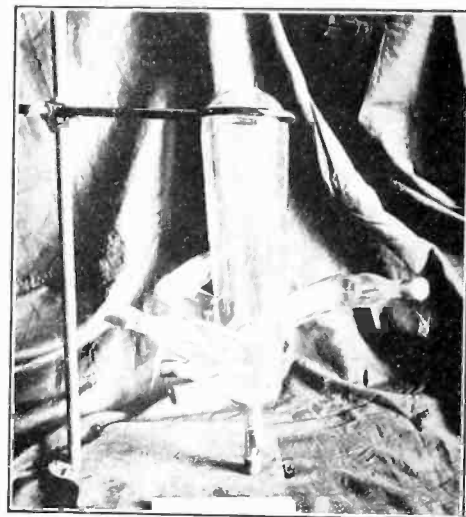

FIG. 17—THREE-PHASE, 20-AMPERE GLASS RECTIFIER



FIG. 18—50/100-AMPERE, THREE-PHASE RECTIFIER

average value somewhat less than in the case where no inductance is present.

This is the mechanism which acts for rectifier voltage regulation. Elaborate equations have been worked out to give the amount of this regulation, but they will not be dealt with at this time.

Leaving now the rectifier circuits, we shall review

Fig. 17 shows a three-phase, 20-ampere glass rectifier.

Fig. 18 shows a 50/100-ampere, three-phase rectifier. This rectifier is approximately 30 in. high and is the largest glass rectifier made by the company before 1925. The two ratings given are one for natural air

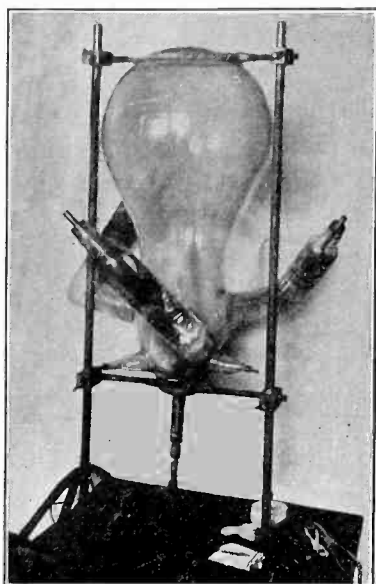

FIG. 19—250-AMPERE GLASS RECTIFIER

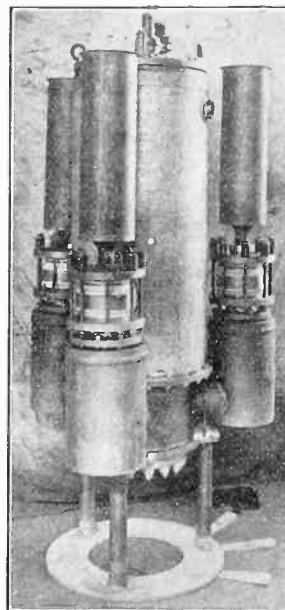

FIG. 22—EARLY IRON RECTIFIER

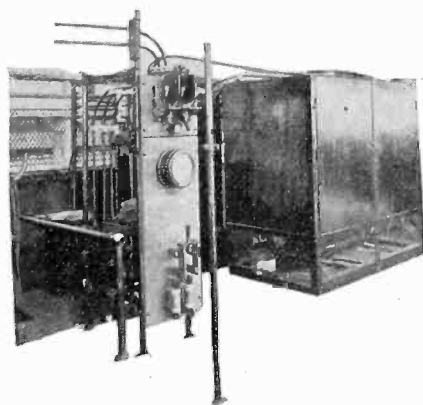

FIG. 20—100-KW. RECTIFIER USING TWO 250-AMPERE TUBES

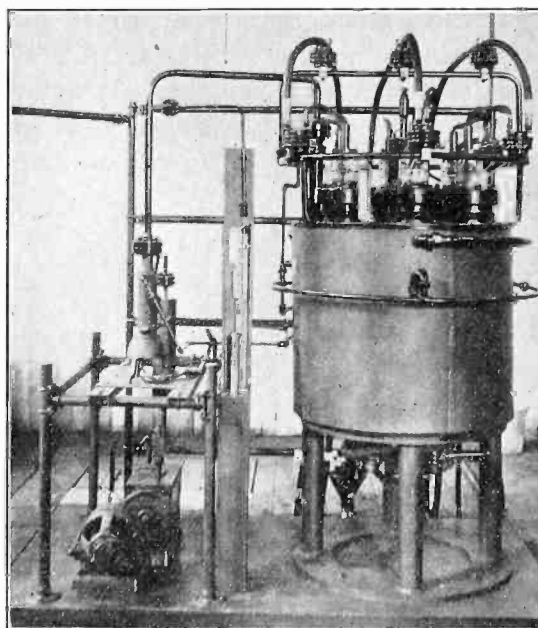

FIG. 23—MODERN IRON RECTIFIER

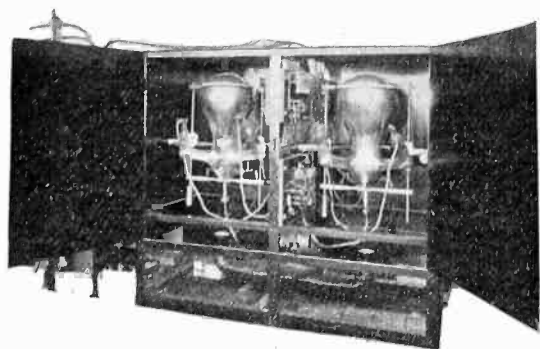

FIG. 21—INTERIOR OF A 100-KW. RECTIFIER

some of the forms of rectifiers which have been made.

Fig. 16 shows the smallest mercury rectifier now made by the General Electric Company. This rectifier has a rating of 10 amperes and 300 volts. It has an overall height of approximately 8 in.

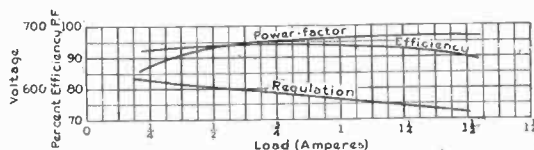

FIG. 24—CHARACTERISTIC CURVES OF AN IRON RECTIFIER

cooling and the other for fan cooling. The current ratings apply to approximately 220 volts and must be reduced somewhat if higher voltages are used. It is quite feasible to use voltages as high as 3000 for these tubes.

Fig. 19 shows the new 250-ampere glass rectifier

developed during the last year. The normal rating is 250 amperes, 250 volts fan cooling. One of this type was operated in oil at 200 amperes, 3000 volts and withstood repeated short circuits opened by a high-speed breaker.

Fig. 20 shows a 100-kw. rectifier now supplying a shop circuit in the Schenectady works. This rectifier employs two of the 250-ampere glass tubes. The interior of it is shown in Fig. 21. From the earliest days, attempts were made to make rectifiers of iron in

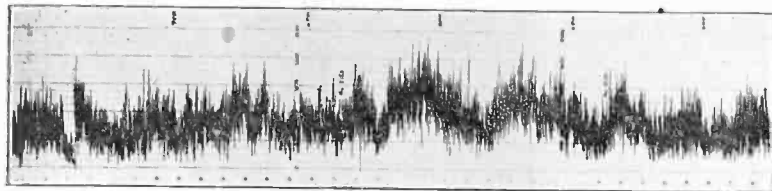

FIG. 25—TYPICAL STREET RAILWAY LOAD

large sizes. Fig. 22 shows one of these early rectifiers which was modeled quite closely in form after the glass rectifier. As iron is not subject to the same limitations as to form, later rectifiers have been made similar to Fig. 23, which is a photograph of the rectifier shown at the Atlantic City convention during the fall of 1925.

Fig. 24 shows the characteristic performance of such a rectifier operating a street railway load. The high efficiency under light loads is particularly significant as the load factor of street railways is notoriously poor.

Fig. 25 shows the kind of load factor met in this service.

One objection to the iron type of rectifier as usually constructed is that some leakage always occurs with bolted joints, although the amount may be very small. For this reason, it is necessary to have a vacuum pump attached to the rectifier, although it need not be operated at all times. Attempts have been made to

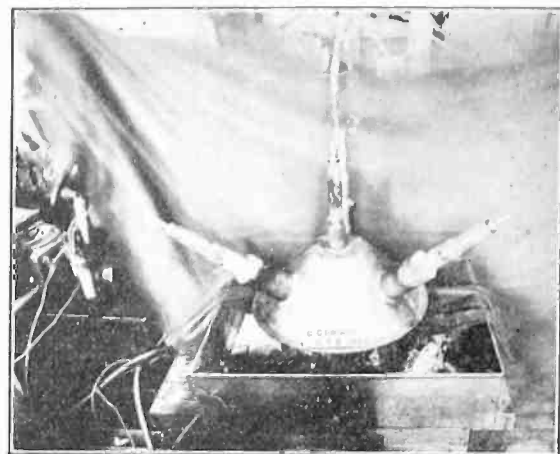

FIG. 26—SMALL IRON RECTIFIER WITH ALL JOINTS WELDED

avoid the need for a vacuum pump by the use of seals fused directly to the metal parts. The rectifier shown in Fig. 23 has no clamped joints between metal and insulation, and, by the use of well fitted metal to metal joints, the danger of leakage is greatly reduced. It is possible to go still further and make rectifiers in which the sealing is complete. Fig. 26 is a small one of this kind which showed no indications of impaired vacuum three months after being evacuated and sealed.

## Multiplex Windings for D-C. Machines

BY CARL C. NELSON<sup>1</sup>

Enrolled Student

*Synopsis.*—With the increase in capacity of d-c. machines, the question of their successful operation has become more and more important. It is thought that multiplex windings offer creditable advantages if they are designed so that cross connections can be suitably applied and the circuits thereby kept balanced, a feature which was not given thorough consideration when multiplex windings were first tried.

This paper describes machines in which the proper design may be secured when standard construction is used. Both the lap and wave types of windings are considered. The principles are applied to duplex windings in this paper, but if so desired they may be applied also to triplex and other multiplex windings.

A brief description of "frog leg windings," a recently developed type of multiplex winding, is also given.

THE use of multiplex windings in large d-c. machines offers marked improvements provided the windings can have armature cross connections properly applied to them, so that the armature circuits can be kept balanced; that is, the currents in the circuits may be kept equal. This result has been successfully accomplished with multiplex windings on practical machines with the ordinary type of cross connections in

a few cases (see references 6 and 7), and it seems probable that the same good results can be obtained in other cases.

Multiplex windings have, in general, more parallel paths and, consequently, less current per coil than the corresponding simplex windings which are usually used. Accordingly the current to be commutated is much smaller and therefore the amount of sparking is reduced. The fact that an increase in the number of parallel paths in an armature winding improves commutation, (other things being equal,) is exemplified by the

1. Massachusetts Institute of Technology.

Presented at the Annual Convention of the A. I. E. E., White Sulphur Springs, W. Va., June 21-25, 1926.

well-known case of an armature which is of such rating that either a wave or lap winding could be used. The latter is distinguished by more paths in parallel, more and narrower commutator bars and better commutation, as is well known from practical experience. If, then, multiplex windings, having even more paths in parallel than the ordinary lap windings, can be safely used and kept properly balanced, another step in the improvement of commutation may be expected. The advantages to be obtained justify further study and trial of multiplex windings.

The windings used in practise at the present time are usually simplex wave, simplex lap, and, occasionally, an eight-pole, duplex wave winding. This is a very limited assortment.

A number of machines tried in the past with multiplex windings were not designed properly and armature cross connections could not be applied suitably. The desirable condition would be the interconnection of equipotential points in one individual part of a multiplex winding to equipotential points in another individual part of the multiplex winding, and so on. In this way all the individual parts would be joined together. In addition, the winding should be so arranged that the resulting potential distribution on the commutator would be uniform and the volts per bar would be of a low value. Arnold has advocated the use of cross connections and has shown triplex wave windings<sup>2</sup> with the cross connections joining equipotential points of the three individual parts of the winding, which is the desirable condition. In describing Fig. 12 (reference 7), it is stated that triplex lap windings have been made with efficient cross connections on one end of the armature and have operated successfully. Arnold, however, has not shown duplex lap and triplex lap windings with simple cross connections joining the individual parts of the winding together. In his early work he has shown duplex lap windings<sup>3</sup> so arranged that equipotential points in the same part of the duplex windings were joined, thereby giving a potential distribution on the commutator such that bars in pairs were at the same potential. This has the same effect as using half the number of bars and therefore is not desirable. In his later work, Arnold has shown duplex lap windings with equalizing rings<sup>4</sup> both on the front and back of the windings and with connections from the front to back joining these rings, thus interconnecting the individual parts of the duplex winding. This method introduces the complication of cross connections at both front and rear ends of the armature, and of connectors along the shaft. It would be more desirable to use the arrangement proposed in this paper,

in which all the cross connections are at the rear end of the armature.

It is very desirable that multiplex windings be used where they are successful, since by means of them d-c. machines can be designed to have as many and as narrow commutator bars as possible. This results in a commutator bar in large machines from  $\frac{3}{16}$  to  $\frac{3}{8}$  in. in width, which is considerably narrower than many in use. The benefit of the smallest current per circuit as well as a corresponding improvement in commutation will thus be obtained.

A preliminary investigation as to the number of slots and bars and their relations in certain machines using multiplex windings has been made by the author in the Electrical Engineering Department of the Massachusetts Institute of Technology. It is his wish to duly acknowledge a number of valuable suggestions made by Professor H. B. Dwight of this department.

The windings used in the figures for purposes of illustration have been shown as applied to cores with extremely few slots and should therefore not be considered as actually, usable windings. This has been done so as to present clearly the principles which are to be applied to practical windings. The naming of the types of windings herein is similar to that used in the *Standard Handbook for Electrical Engineers*.

Multiplex windings were proposed in the early writings on d-c. machines, but little or nothing was said about cross connections. Where there are four or more parallel paths through the armature, these are usually necessary. The cross connections must be made between points having mathematically the same voltage, the flux being the same in all poles. This is provided for in the windings suggested in this paper.

The type of winding proposed is an ordinary multiplex winding so arranged that a system of cross connections, all at one end of the armature, can be conveniently applied to equipotential points, thereby joining to one another the individual parts of the winding<sup>5</sup> and producing a uniform distribution of potential on the commutator. These connections are shown on the diagrams of this article.

The shape of the coils of a duplex lap winding is the same as that of the coils for a simplex lap winding and no departure is made from the usual construction. All the coils for any one machine are of the same size and shape. The ends of the coils in a duplex lap winding are connected to bars 1, 3, 5, . . . . and so on to all the odd numbered bars. Another part of the winding placed in the slots connects to bars 2, 4, 6, . . . . and so on to all the even numbered bars. There are two cases to be considered. In Case I, when the total number of commutator bars is even, the two parts of the winding are separate and independent except as they

5. See p. 244, *The Dynamo*, C. C. Hawkins, Volume I, Sixth Edition, 1922, Sir Isaac Pitman & Sons, Ltd., London.

2. See p. 87, *Die Gleichstrommaschine Arnold—la Cour*, Third Edition, 1919, Julius Springer, Berlin.

3. See p. 177, *Die Gleichstrommaschine, Arnold*, Second Edition, 1906, Julius Springer, Berlin.

4. See p. 82, Same reference as 1, and Fig. 14, p. 604, *Standard Handbook for Electrical Engineers*, Edition of 1922.

are joined by equipotential or cross connections. A two-part winding of this type is known as doubly re-entrant and will be referred to herein as such. It is represented by the four-pole diagram, Fig. 1, and by the symbol  $\circ \circ$ .

In Case II when the number of commutator bars is odd and the coil ends are connected to every other bar, the first part of the winding goes around the armature and leads into the second part of the winding, which, after going around the armature, connects to the first

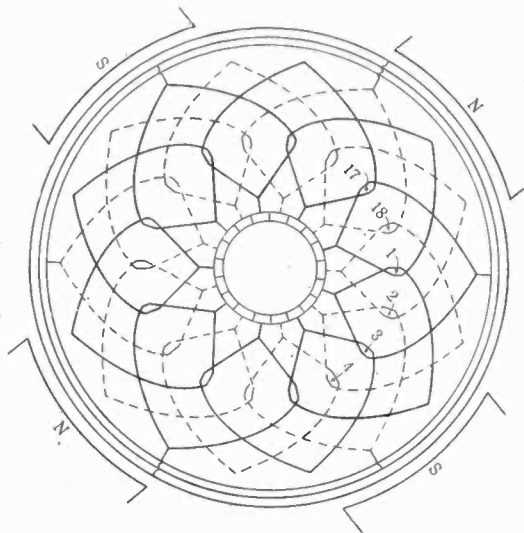

FIG. 1 (CASE I)—DUPLEX LAP WINDING, DOUBLE RE-ENTRANT  
Four poles, 18 slots, 18 bars, 8 paths. Cross connections as shown

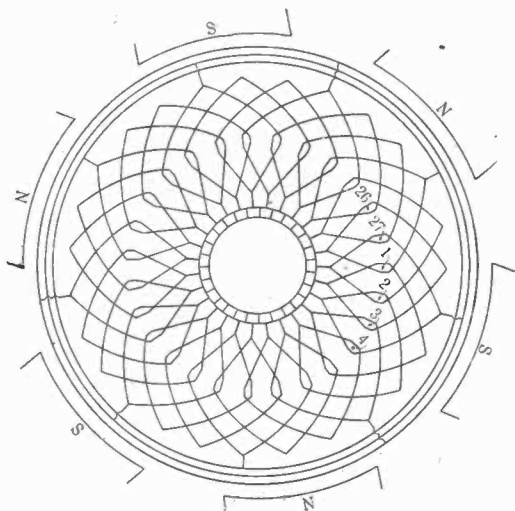

FIG. 2 (CASE II)—DUPLEX LAP WINDING, SINGLY RE-ENTRANT  
Six poles, 27 slots, 27 bars, 12 paths. Cross connections as shown

part, resulting in a continuous winding. This winding is referred to as singly re-entrant and is represented by the six-pole diagram, Fig. 2, and by the symbol  $\odot$ .

The diagrams show the cross connections joining the two parts of the duplex lap winding, which is a desirable feature. The commutator potential is shown to progress fairly uniformly around the commutator, which is also desirable. To arrange the cross connec-

tions properly and to secure these results certain numbers of slots and bars must be used. The method of cross connecting, as shown, can be used with duplex lap windings on the following machines when the choice of slots and bars is made as indicated in Table A.

TABLE A  
DUPLEX LAP WINDINGS

Number of Poles	Slots per Pair of Poles	Total No. Slots	Bars per Slot	Total No. Bars	Re-entrancy	
a. 4	Odd no.	Even no.	Odd no.	Even no.	Double	$\circ \circ$
b. 6	Odd no.	Odd no.	Odd no.	Odd no.	Single	$\odot$
c. 8	Odd no.	Even no.	Odd no.	Even no.	Double	$\circ \circ$
d. 10	Odd no.	Odd no.	Odd no.	Odd no.	Single	$\odot$
e. 12	Odd no.	Even no.	Odd no.	Even no.	Double	$\circ \circ$

There may be a cyclical change in the number of slots per path but this is quite possibly not harmful, for it occurs with two-circuit windings which operate successfully. The great improvement in commutating

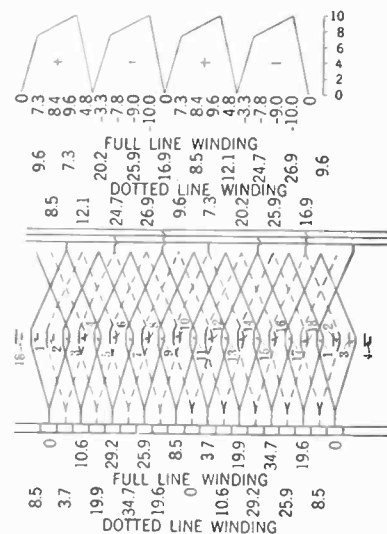

FIG. 3 (CASE I)—VOLTAGE DISTRIBUTION DIAGRAM FOR DUPLEX LAP WINDING, DOUBLY REENTRANT

Four poles, 18 slots, 18 bars, 8 paths, (same winding as Fig. 1)

characteristics obtained by having only half as much current per path to be reversed at one time would seem to be the important consideration in connection with this type of winding.

In determining the voltage distribution (see Fig. 3) the developed winding is laid out and a field form as might naturally be expected is plotted above the winding. As the voltage in a conductor is proportional to the flux it cuts, an excellent idea of the voltage distribution may be secured by summing up the voltages induced throughout the winding. In doing this, it is assumed that any conductor in a slot generates a voltage proportional to the flux directly above the center line of that slot.

Another type of winding is the duplex wave winding having four parallel paths through the armature. This type would give an intermediate step between the simplex wave and the simplex lap winding and although



the benefits to be derived from the use of this type are not expected to be as great as those obtained with the duplex lap winding, certain cases may justify the use of this type. An eight-pole, duplex wave winding is used rather extensively at the present time and has proven satisfactory. Such a winding with cross connections joining equipotential points of the individual parts of the duplex winding is advocated and shown by Arnold.<sup>6</sup>

Cross connections joining the two parts of a duplex wave winding are possible in certain cases. These connections should join points having mathematically the same voltage when all poles have an equal amount of flux. They can be used on the following machines when the choice of slots and bars is made as indicated in Table B.

TABLE B  
DUPLIX WAVE WINDINGS

Number of Poles	Total No. Slots	Bars per Slot	Total No. Bars	Re-entrancy
f. 8	Even no.	Odd no.	Even no.	Single or double according to whether commutator pitch is odd or even.
g. 12	Even no.	Odd no.	Even no.	
h. 16	Even no.	Odd no.	Even no.	

Of course these windings must be such that the commutator pitch,  $Y$ , is a whole number where

$$Y = \frac{\text{number of bars} \pm 2}{\text{pairs of poles}}$$

The cross connections in the windings of the above table will span half the number of poles, or in other words, they are diametral. When the number of pairs of poles is odd, such as in the six- or ten-pole machine, cross connections to equipotential points diametrically opposite are not possible. This can be explained as follows: Suppose that the choice of slots is made so that a point of one part of a duplex winding has a certain position relative to a pole with one polarity; then a corresponding point in the other part of the duplex winding has a position under the influence of a pole of opposite polarity, a condition which does not lend to cross connections. It may be possible that six- and ten-pole, single re-entrant windings of the duplex wave type would be successful even though they do not have cross connections.

Triplex windings could be designed on the same basis as the duplex windings herein described, but only duplex windings have been treated in this paper, since they involve the least departure from simplex windings, and so should be the first to be tried out.

Since the preparation of this article was commenced, a very interesting paper<sup>7</sup> on *Frog Leg Windings* by W. H. Powell and G. M. Albrecht has appeared. This illustrates the general principles of using a multiplex wave winding in the same slots with a lap winding either simplex or multiplex to a less degree than the

wave winding, so that both windings produce the same voltage at the brushes and are connected to the same set of commutator bars. The wave winding connects the circuits of the lap winding and the lap-wound coils connect the circuits of the wave winding thereby producing a thoroughly cross-connected winding. The name *frog leg* is used because of the peculiar shape of the coils which consist of a lap-wound coil and a wave-wound coil taped together. The advantages obtained by the authors are first, better cross connections, and second, the use of multiplex windings.

In Part III of the above described paper, a triplex winding with external cross connections as previously mentioned, and not of the frog leg type, is mentioned as having been made and operated successfully. If triplex windings, not of the frog leg type as referred to above, have been successful, then a duplex winding should also operate well when the choice of slots has been made properly and the cross connections applied efficiently as outlined herein.

It is possible that duplex lap windings with ordinary cross connections as shown will give some of the advantages of the frog leg winding without the complication of having two complete windings in the slots.

## ELECTRIC WELDS FOR BUILDING CONSTRUCTION

A pressure machine capable of applying a load of 10,000,000 lb. was used at the Bureau of Standards in Washington to determine whether steel girders welded by electricity can stand stresses necessary in skyscraper construction. The welds made good. In order to make the test some steel plates were fabricated by electric welding into a plate girder 15 ft. long having a web plate  $\frac{1}{2}$  in. thick and 24 in. deep. The flanges were 12 in. wide, one was  $1\frac{3}{4}$  in. thick and the other  $1\frac{7}{8}$  in. thick. A  $9\frac{1}{2}$ -in. cover plate was used on the top and bottom flanges. Pressure was applied in the middle of a  $13\frac{1}{2}$ -ft. span. The web buckled and the girder had deflected several inches before the electric welds connecting the web to the top flange failed at the ends. The welds withstood a load of well over 410 tons which was considered to be the full strength of the web.

## NEW COPPER BEDS DISCOVERED IN CANADA

According to report received from the American Consul at St. John, Canada, comparatively high grade copper ore has been located from recent prospecting near Elgin, Albert County, New Brunswick, the preliminary examination covering an area of approximately two square miles. According to official assays the ore value runs as high as \$15 per ton.

Shafts have been sunk over the prospected area and copper ore discovered in every instance, in most cases from within 16 inches of the surface and as far down as diggings were made.

6. See p. 86, *Die Gleichstrommaschine Arnold—la Cour*, Third Edition, 1919, Julius Springer, Berlin.

7. P. 345, *Iron and Steel Engineer*, September 1925.

# Present Practises in Protection

## Annual Report of Committee on Protective Devices\*

E. C. STONE, Chairman

To the Board of Directors:

### FOREWORD

Because of the many developments during the past few years within the scope of the Committee on Protective Devices, it was held desirable to present, this year, a survey of the present state of the art in the field of protective devices for power systems, and the following annual report has been prepared with this purpose in view. The Committee has also, during the past year, given careful attention to the possibilities of further standardization in the field of protective devices, and has certain definite recommendations to make.

As heretofore, the work has been carried on by subcommittees, each under the direction of its own chairman. The subjects covered and the chairmen in charge are as follows:

*Automatic Substations.* W. H. Millan, Union Elec. Lt. & Pwr. Co., St. Louis, Missouri.

*Current Limiting Reactors.* E. A. Hester, Duquesne Light Company, Pittsburgh, Pa.

*Lightning Arresters.* H. Halperin, Commonwealth Edison Co., Chicago, Illinois.

*Oil Circuit Breakers.* J. M. Oliver, Alabama Power Company, Birmingham, Alabama.

*Protective Relays.* J. A. Johnson, Niagara Falls Power Co., Niagara Falls, New York.

The Subcommittee on Grounding of Systems, which reported last year, was not continued this year, as it was felt that it had completed its work, for the time at least.

Following are some of the more important subjects dealt with in the report:

Full automatic stations of the following types are in successful operation:

Hydroelectric generating stations

Railway substations for city and heavy traction, as well as interurban service

Edison d-c. substations

Mining and steel mill substations

Alternating-current substations (reclosing breakers)

Synchronous condenser stations.

Mercury arc rectifiers for arc lighting and power

\*Committee on Protective Devices:

E. C. Stone, Chairman

F. L. Hunt, Vice-Chairman

W. S. Edsall,

George S. Humphrey,

W. H. Millan,

H. Halperin,

J. Allen Johnson,

J. M. Oliver,

F. C. Hanker,

M. G. Lloyd,

N. L. Pollard,

S. E. M. Henderson,

H. C. Louis,

E. J. Rutan,

R. A. Hentz,

A. A. Meyer,

E. R. Stauffacher,

E. A. Hester,

H. R. Summerhayes.

Presented at the Annual Convention of the A. I. E. E., at White Sulphur Springs, W. Va., June 21-25, 1926.

service are now being provided with automatic switching equipment.

Thorough periodic inspection and maintenance are essential to the successful operation of automatic stations.

There is a marked trend toward the use of reactors with insulated conductors, in order to obtain protection from external interference.

Lightning protection on low-voltage circuits (230-115) in general appears to be unnecessary. For distribution circuits up to 6.6 kv., having numerous transformers connected, satisfactory protection is being obtained from available types of arresters in many cases.

On circuits rated at 73 kv. and below, the general tendency is to install arresters, usually of the high discharge rate type. The installation of arresters on circuits from 73 kv. to 154 kv. is debatable, but there is a growing tendency to provide some means to reduce over-voltages due to lightning. On circuits at 154 kv. and higher, the tendency is to omit lightning arresters.

The Dufour oscillograph and klydonograph for measuring transient phenomena are expected greatly to increase our knowledge of lightning arrester performance and requirements for lightning protection.

Relative interrupting capacity ratings for oil circuit breakers under various operating duties have been agreed upon by the N. E. L. A. and Electric Power Club, and are presented herein.

Progress in the problem of short circuit interruption is recorded in further short circuit tests on operating systems, additional testing facilities in manufacturer's plants, and improvement in details of design. The problem still remains one of outstanding importance, however, and seems far from satisfactory solution.

In relay practise, definite trends are reported as follows:

a. Integration of entire system into one unit, so interconnected and relayed that its integrity shall not be broken by a fault.

b. Fault isolation by use of balanced relay systems or systems responsive to location or specific nature of the fault.

c. Use of "back-up" protection, in the form of a second system of relays to function in case of failure of the first system.

d. Use of devices for detection of approaching faults before they actually occur.

The committee has given active attention to the obtaining of papers for Institute meetings. Reference is made herein to a number of important subjects which should be covered by papers next year.

## AUTOMATIC STATIONS

*Survey.* A brief survey of the present status of the automatic station art seems desirable at this time. For convenience, this survey will be considered under several pertinent topical headings.

Automatic hydroelectric generating stations have been the subject of extensive development during the past three years. Stations containing two 9000-kv-a. units are now in successful operation, while many ranging from 100- to 5000-kv-a. are regularly being installed and operated. Automatic synchronizing has been perfected and is now used where large units are connected to small systems. Governor design has been improved to meet the rigid requirements of automatic station operation. In fact, practically all small hydroelectric developments and many moderate sized ones are now designed for automatic operation and uniformly successful results are reported.

Railway substations now being purchased are invariably automatic with rare exceptions due to local conditions. They are not only considered standard for interurban service but also standard for heavy city service and electrified portions of steam railroads. All kinds of service find them economical and reliable and their use is now being rapidly extended not only by the installation of new stations but also by the conversion of existing stations from manual to automatic operation.

Automatic substations for Edison, three-wire networks have now been in successful operation on small and moderate size systems for over four years. Their first application to two of the largest systems has just been completed. Their success for this class of service seems assured although more operating experience is desirable before extensive installations are made on important projects.

Mining substations now being purchased are all either completely or partially automatic as individual local conditions warrant. The various designs offered have been subjected to operating service for over five years. As a result the automatic substation is today considered standard by the electrical profession for the motor generators and synchronous converters used in the coal and metal mining industries for electricity supply.

Steel mills have been the latest industry to adopt automatic stations. One small installation of partially automatic-controlled synchronous motor-generators has been in successful operation over five years. Another extensive installation of completely automatically-controlled synchronous motor-generators has been in service almost two years. About eight additional extensive installations are now in progress so that it would seem as though steel mill electrical engineers have started toward adopting automatic stations as standard for their service.

Automatic feeders for alternating-current supply constitute by far the largest field for completely auto-

matic operation. In practical application, the art is still in an initial state of development. The equipments so far offered have simulated manual practise with the only improvement of more prompt operation. Successful a-c. motor-operated mechanisms are now being applied to the largest oil circuit breakers thus eliminating solenoids and batteries for reclosing service. Automatic reclosing relay and oil circuit breaker combinations are now in operation which permit clearing transient feeder faults without appreciable service interruption. These so far, however, have been applied only to moderate sized, relatively low pressure service, although in one particular case 44,000-volt feeders are being automatically reclosed on a relatively large capacity power system.

Synchronous condensers for power factor correction were first made automatic about ten years ago. Only a few installations have been made but each has been uniformly successful and the use of this type of automatic switching equipment is spreading with a relative degree of rapidity.

Mercury arc rectifiers for arc lighting and power service are now being provided with automatic switching equipment. The smaller sizes with glass tube rectifiers have been in service a sufficient length of time to demonstrate their success. Those for larger units using metal tanks are just being placed in service so that next year's report may contain further data concerning their performance.

Railway signal and automatic train control substations are the latest addition to the rapidly growing list of automatic applications. Some of these have been in successful operation for over three years. Many are now being installed to furnish power for the operation of track signals and train control circuits.

*Symbols.* Symbols for automatic station wiring diagrams have been attracting increased attention during the past year. Data which will give the existing practise are being collected by the subcommittee. It is then planned to correlate the various symbols, adjust differences where they exist, and finally prepare a simple, agreeable set which may be submitted to the Standards Committee for approval and promulgation.

*Nomenclature.* Nomenclature for various types of a-c. reclosing feeders was suggested in the 1925 report. These suggestions have been before the electrical engineering public for about a year and no unfavorable comments have been heard or received by the committee. Instead, it has been found that many of the designers and purchasers of automatic d-c. feeders have adopted the proposed nomenclature. It has, therefore, been presented to the Standards Committee for approval and inclusion in the A. I. E. E. Standards.

*Protection.* Recommended protection for railway and Edison automatic stations with synchronous converters and synchronous motor generators, as well as for automatic switching equipment in a-c. feeder service, was given in the 1925 report. These recommen-

dations have been adopted as standard by the principal manufacturers and users of these classes of automatic stations. This year there have been developed recommendations for the protection of mining and steel mill automatic stations using synchronous converters and motor generators as well as synchronous condensers in voltage regulating substations and hydroelectric generating stations using synchronous generators.

Steel mill substations are quite generally provided with synchronous motor generators. Some are partial automatic as when an attendant is constantly on duty in the vicinity. Others are completely automatic as when the stations are non-attended and locked. The partial automatic stations are similar in design to the completely automatic ones except that certain protective and re-starting features are omitted. The items to be omitted vary from installation to installation so that it is difficult at this time to make any complete recommendation for the partial automatic. For this year's report, therefore, consideration will be given only to the completely automatic synchronous motor-generators in steel mill service. It is recommended that these be provided with protective features as follows:

- A-c. undervoltage
- Severe a-c. overload
- Single-phase starting
- Excess temperature due to sustained moderate overload
- Imperfect start
- Loss of field of a-c. machine
- Loss of field of d-c. machine
- Reversed phase rotation
- D-c. reverse power
- Excess bearing temperature
- Machine overspeeding

Mine substations are usually equipped with synchronous motor-generators although some stations have synchronous converters and a few have induction motor generators, with mercury rectifiers beginning to be used. The recommended protection for synchronous motor-generators in mine substations is the same as that for synchronous motor-generators in steel mill service. Few induction motor-generators are now being applied and only two or three mercury rectifiers have been installed in mine service so that recommendations for these are omitted for the time being. For synchronous converters in mine service it is recommended that protection be given as follows:

- A-c. undervoltage
- Severe a-c. overload
- Single-phase starting
- Excess temperature due to sustained moderate overload
- Imperfect start
- Loss of field
- D-c. overload
- Incorrect polarity
- D-c. reverse power

#### Excess bearing temperature

#### Overspeeding

The protection for automatic hydroelectric stations with synchronous generators and for synchronous condenser stations is quite similar. For synchronous generators in automatic stations, the recommended protection is as follows:

- A-c. undervoltage
- Severe a-c. overload
- Excess temperature due to sustained moderate overload
- Single-phase operation
- Imperfect start
- Loss of a-c. machine field
- Exciter overvoltage
- Excess bearing temperature
- Machine overspeeding

Synchronous condensers usually have, in addition, a-c. undervoltage and single-phase starting protection. They are usually provided with automatic voltage regulators so that the exciter overvoltage protection included for synchronous generators is in that case omitted.

*Storage Batteries.* The majority of automatic stations are not provided with storage batteries. If they are automatic hydroelectric stations, a small turbine or waterwheel directly connected to a generator seems to be the preferred source of control power. If they are substations, then the source of power suitably transformed is used to supply the operating current.

Some designs of automatic stations, particularly those used for certain classes of Edison service and for all classes of remote supervision, require relatively small operating batteries. Practically all types of standard batteries have been used with an equal measure of success although some are better adapted than others for this service. In general, the batteries are trickle charged through rectifiers or motor generators. In a few unusual designs, a motor-generator is provided to carry the operating load with a battery floated on it for stand-by purposes.

*Oil Circuit Breakers.* Oil circuit breakers are used in automatic stations between incoming lines and the station equipment and between the station equipment and outgoing lines and feeders. The two applications require quite different treatment in the selection of the oil circuit breaker equipment if a maximum of reliability is obtained.

When used between the incoming line and the station equipment, the oil circuit breaker is closed each time the machine in the station is started and opened each time it is stopped. Usually such an oil circuit breaker is operated most frequently to make or break currents less than its normal continuous current carrying capacity. However, it may be required to operate from two to one hundred times each day depending upon the service conditions.

Oil circuit breakers used between the station equip-

ment and outgoing feeders are normally closed. They are opened usually only in case of trouble or to permit of circuit maintenance. These oil circuit breakers will consequently operate infrequently. Usually, however, when they do operate, they will be called upon to interrupt currents approximating their circuit interrupting capacity.

In the first case, a so called "one-shot" breaker suffices if its mechanical parts permit the required frequent operation. In the second case, the circuit interrupting capacity on successive interruptions is the more important function with the mechanical life of secondary consideration.

To meet the frequent operating requirements of the breaker located between the incoming line and the station equipment, there have been developed new designs of universal motor operating mechanisms. Some of these have been in service in excess of five years. They eliminate the difficulties experienced with the older type of operating mechanisms and give a very much improved automatic station equipment.

For improving the requirement of successive circuit interruption to clear feeder faults, various schemes have been approved and are being tried. Double tanks, slow release of gases, ventilating ducts, and explosion chambers are all in use with no marked preference conceded at this time.

*Reclosing Cycle.* The reclosing cycle used for oil circuit breakers which protect feeder service in automatic stations varies from application to application. In one extreme case, each time a feeder breaker opens, it is held open until closed from a central operating point; *i. e.*, it is closed under the supervision of an operator so that in case the trouble persists the operator can immediately report the difficulty to a central load dispatcher. At the other extreme is the application where an oil circuit breaker may reclose on a fault five or six times in rapid succession.

So far as is known by the committee, there are only two installations where the operation of the breakers is supervised after each automatic opening and only one installation where the breakers reclose five or six times in rapid succession on a circuit fault. By far the majority of automatic reclosing feeders in alternating-current service are reclosed two, three, or four times on a fault before being locked out.

The reclosing cycle having three reclosures before lock out is almost universally standard. The time intervals, between reclosures, however, vary between relatively wide limits. One group of operators, which is rapidly growing, prefers to have the breakers reclose immediately after the first or initial circuit interruption. They want this time made as short as practicably consistent with positive relay and oil circuit breaker operation. The majority of operating companies, however, appear to be satisfied with a time interval ranging from five to twenty seconds between the time the breaker opens initially and the time of the first reclosure. Practically all

classes of operators are content with automatic reclosing the second time from fifteen to thirty or forty seconds after the second circuit breaker opening. Those who use third and fourth reclosures appear to be satisfied with a time interval between the second and third and the third and fourth reclosures of about one minute each. There are some unusual conditions, however, where the time intervals between the first and second reclosure and the second and third reclosure are even longer, being as much as three minutes and five minutes respectively, but these are again unusual.

As a result, it is seen that there is a wide range of operating adjustments in the automatic reclosing of alternating current feeder circuits indicating that the art has not yet become stabilized.

*Relays.* Relays of many varieties form the primary basis on which successful operation of automatic stations depends. The devices have been the subject of much study, development and observation in automatic station practise. Relays are used not only for performing protective functions, but are also used for controlling operating sequence and as preventatives against avoidable damage to service and apparatus.

The early designs of automatic stations included relays which had been developed for use in manual stations. Gradually, however, most of these have been replaced by relays or their equivalents specially designed to meet the arduous service and strict regulation required for automatic station operation. However, not all of the relays or other similar devices employed in automatic stations today can be considered perfect. Service records indicate though, that as a result of relay development, automatic stations are today equally, if not more, reliable than the equivalent manual stations.

*Inspection.* Periodical inspection of automatic stations is essential to their successful operation. The frequency and extent of such inspection depends upon service requirements. Experience indicates that automatic stations provided with rotating machines and supplying important service should be inspected daily. Such inspection rarely requires over an hour in the station after the inspector has become proficient. For less important service, automatic stations with rotating machines may be inspected weekly while transformer stations with reclosing feeders only are inspected at even greater intervals. This class of inspection serves to detect any tendency for the devices in the station to change their adjustment or operating characteristics and prevents unnecessary service interruptions.

Inspection as thus outlined must not be confused with periodical maintenance. Quite different personnels are required for the two sets of functions although where the automatic stations are small the same staff may perform both duties.

Most of the systems having several or more automatic stations make it a rule for each inspector to file a

written report after each inspection of an automatic station. This report summarizes the work done in the station together with the observations which have been made. The reports differ from organization to organization depending upon local conditions. In general, however, these reports contain the time and date of the inspection, together with a list of devices inspected and comments on any device which requires attention. In some cases, the reports list the readings of the counting devices in the station and indicate the number of operations of the principal functions. Of course, reports are properly signed and dated and otherwise identified.

*Maintenance.* Periodical maintenance is equally as important as periodical inspection. The frequency of maintenance will depend upon the number of operations the automatic station is called upon to make. If only six or eight operations a day constitutes the cycle, thorough examination of the equipment with such cleaning of contacts and replacing of worn parts as is necessary ought to be made bi-monthly. If several hundred operations per day is the schedule, then weekly examination with such maintenance as is needed is generally recommended.

Maintenance reports are usually prepared on the moderate size and large systems which use automatic stations. Their form follows, in general, the inspection reports mentioned above, except that they may elaborate on the details of devices which require more than usual maintenance as well as list the renewal parts which are installed.

A clear distinction should be made between inspection and maintenance. One reviews, casually, the condition of each device or piece of apparatus in the automatic station. The other should be a minute inspection accompanied by such cleaning and adjusting and replacing of worn parts as the service may require. Every effort should be made not to confuse these two, and in many systems the distinction has been drawn so clearly that inspection is charged to the operating account while maintenance is charged to the usual maintenance account.

*Records.* Records of automatic station performance are quite necessary for their efficient adjustment and operation. These records may be divided into two classes as follows:

1. Records of device and functional performance.
2. Records of station performance.

Device and functional performance records are usually made chronological and recorded in a log book kept in the station. Here are listed the date and time of the visits of inspectors, maintainers, and others, with their observations and the adjustments and changes they may make from time to time in the station equipment. Brief summaries of the station log may be prepared and forwarded to a central supervisor from time to time and from these may be prepared condensed operating reports.

Station performance records are usually obtained automatically by curve drawing or recording instruments and meters. Sometimes the instruments and meters form a permanent part of the automatic station equipment. Ofttimes portable curve drawing instruments or meters are used at regular intervals to check service requirements and station operation. This portion of the automatic station art is just being developed and not many definite data are available as a result of service experience.

*Fire Extinguishment.* Automatic fire extinguishment in automatic stations has been considered by the committee for the past two years. Practically nothing has been done in automatic stations along this line. The art of automatic or even partial automatic fire extinguishment in manual stations is even now just in the experimental stage. The committee is watching all installations quite carefully and expects to report further progress next year.

*Remote Supervision.* Remote supervision of automatic stations is becoming more and more important. A number of systems are in the open market and some of the operating companies have manufactured their own systems. A general review of the situation was presented by Mr. Chester Lichtenberg under the auspices of the Protective Devices Committee at the Midwinter Convention in New York, February 1926, and reference is made to his paper for an up-to-date survey of the situation.

*Telemetering.* Telemetering is just now being developed particularly for automatic station service. There are about one-half dozen installations in partial or complete service, but this, too, is a new development in the art which will probably serve as the subject of further comments next year.

*Ventilation.* Ventilation of automatic stations forms a very important part of the design of these stations. In general, automatic stations are smaller than the equivalent manual stations. Therefore, a less volume of air is available for carrying off the heat generated in the station. This means that there must be larger openings provided for the air to enter and leave the station if the apparatus is to be maintained at a reasonable temperature. Very thorough studies of this subject are now being made by several members of the Institute and at least one member has promised to prepare a paper on this important topic for presentation to the Institute in the near future.

*Other Topics.* Other topics not yet studied by the automatic station subcommittee are as follows:

Nomenclature for types of automatic reclosing a-c. feeders.

Terminology for operations in automatic stations.

Protection against failure of cooling mediums.

Automatic warning of approach of apparatus failure.

Dielectric failure of oil where used as an insulating or cooling medium.

Loss of oil in transformers.

## CURRENT LIMITING REACTORS

A review of the status of current limiting reactors in the light and power industry during the past year reveals nothing revolutionary either in application or in manufacture and design. Preceding reports have indicated a general stabilization of both application and design practises and these tendencies have become even stronger. The practise of sectionalizing generating stations with reactors is on the increase and their use at other points on the system to localize faults and reduce short-circuit currents is becoming quite general.

The practise of insulating the coil conductors is increasing in popularity, and tests have been made which show the efficacy of this method of preventing trouble from external sources.

There is some activity in the development of oil immersed, steel enclosed reactors, and it is expected that the next year will show considerable progress. There has been one installation of this type of reactor operating successfully at 66,000 volts for some time.

The mechanical and electrical reliability of reactors seems to be quite definitely established in the minds of operating engineers. Cases of failure due to inherent weakness continue to occur but with such infrequency that they may be attributed to accidents of manufacture. It is felt that with reasonable care in installation and inspection for freedom from foreign objects the reactor may be counted among the most reliable of electrical equipment. Of the serious failures which have occurred recently the greater number may be attributed to the presence of something foreign to the reactor.

Out of a total of almost 5000 reactors installed during the past five years only thirty-seven failures have been reported and only a few of these could not be attributed to something other than defective design or manufacture. These results were reported by 43 operating companies. Of these 43, 11 reported that no reactors had been installed during the last five years.

In presenting last year's report the subcommittee made several recommendations of subjects requiring investigation.

The matter of thermal capacity and conductor cross-section continues to furnish material for discussion. Most operating companies appear to be specifying a thermal capacity of about five seconds and require a cross-section having the same carrying capacity as the cables to which the reactor is connected. This is a somewhat more liberal allowance than was usual some years ago where two seconds were allowed and a smaller cross-section used. It hardly seems logical to make the reactor the weakest link in the system and the longer time is the result of the more general use of the so called "back-up" protection.

The two-second idea seems to have grown out of the fact that this was the maximum allowable time for relay settings. Should the circuit breaker fail, then

the reactor was as good a place as any for the short circuit to burn clear. Now, there is usually at least one back-up circuit breaker and in the case of extreme contingency the time may run well above two seconds.

Attention has been given to the matter of providing reactors with taps and it is the general opinion of the subcommittee that this is undesirable except in cases of extreme necessity. It is recognized that occasions will arise when there is no alternative, as for instance, in the balancing of feeders, but it is suggested that each case be made the subject of special treatment. The manufacturers are willing to supply such reactors on special order but are unwilling to attempt to make them a standard product on account of manufacturing difficulties. Finally there is the objection to having many dissimilar reactors on the system with resulting chances of confusion.

Under the subject of shielded reactors two general classifications may be made, first, those having each individual conductor insulated, and second, those which are oil immersed and totally enclosed.

The insulated conductor reactor has proven quite popular and effective and it is predicted that they will largely replace the bare type on new installations, especially in generating stations. The number of failures due to the presence of foreign material is very likely to show a marked reduction.

There is not a great amount of data available on oil-immersed, totally enclosed reactors although there are some in operation. In order that the status of this type of apparatus may be put before the industry it is hoped to present a paper during the coming year, covering operating experience and possibilities.

It has been suggested that your subcommittee consider the use of current-limiting reactors with static condensers to aid in smoothing out surges, to limit the fuse current, and to increase the capacity of the condenser. Your subcommittee feels that, since a reactor considered in this light becomes a part of a specific device, it should be studied by the committee under whose jurisdiction static condensers are placed. The function of this subcommittee is to study the reactor as an individual piece of apparatus and its effect on the system as a whole.

There has been much discussion in the past few years as to whether the use of reactors actually increases the duty on oil circuit breakers. In the light of recent developments and tendencies in practise it would appear that the duty is actually decreased rather than otherwise. The fact that the installation of reactors in a great number of cases makes it possible for the oil circuit breaker to interrupt the short circuit current is clear indication that the gain in smaller current over-balances the disadvantage of a possible higher recovery voltage.

There are still two schools on the question of the efficacy of resistance-shunted reactors. The one side contends that the resistance is quite effective in ab-

sorbing the surge voltage while the other maintains that it has no appreciable effect. There are some of both types in service and a few tests have been made, but thus far the results have not been very conclusive. It is hoped that with the assistance of the Dufour oscillograph and the klydonograph, described in another section of this report, some definite settlement of the question may be obtained. A paper covering operating experiences with the two types is also recommended.

Some trouble has been experienced because of circulating currents in two-winding reactors due to unbalance in windings. Consideration of this brought out the fact that it is purely a manufacturing problem and therefore the concern of the particular manufacturer and the user experiencing the difficulty.

The effect of reactors on nearby magnetic materials has been mentioned as a subject for investigation. Your subcommittee is of the opinion that this is a fairly definite thing and that it has been well taken care of by the manufacturers in the printed specifications covering each type of reactor. Special cases must be subject to special attention by the manufacturer.

The arrangement of single-phase reactors on three-phase circuits and the position of the reactor with relation to the oil circuit breaker is sometimes brought up for discussion. This, however, is so often subject to local conditions that no set rules can be laid down with reference to physical arrangement. Obviously, the reactor must be between the source of power and the circuit breaker whose duty is to be limited but this again is subject to a great many variable factors and no standard can be applied.

The problem of standardization in reactors is a rather difficult one as is obvious from the foregoing considerations. Something may possibly be done on thermal capacity and conductor cross-section and your subcommittee is now considering this with the manufacturers.

The wide variety of reactance values and current ratings now in use is rather astonishing and it is suggested that the succeeding subcommittee look into the possibility of reducing these to some standard basis. It would seem feasible to standardize certain sizes with respect to current, voltage, and reactance values, as has been done with other types of equipment.

In reviewing papers which have been presented during the past few years a few points were found to be rather incompletely covered. This suggests the desirability of a few additional papers and the following are recommended:

1. Status and Operating Experience on Oil Immersed Reactors.
2. Effect of Shunting Resistance in Reducing Surge Voltages.
3. Further Operating Experience with Insulated Conductor Reactors.

## LIGHTNING ARRESTERS

*General.* In general, during the past year there have been no radical changes in the fundamental principles of lightning arrester design, and the efforts of manufacturers and operating companies have been directed mainly to increase in reliability of the arrester and economy in its use. One modification is the development by a manufacturer of a liquid type of arrester with an electrolyte, which is claimed to have a freezing temperature of about minus 48 deg. cent.; this development has been also accompanied by some changes in the construction of the arrester. Other recent developments have been more in the nature of increased ruggedness, additional refinements, and increased attention to special features imposed by operating conditions. The general tendency is to install arresters outdoors wherever possible.

For high-voltage networks, it has been found that the transient overvoltages which appear on the high-tension side of a transformer may also be induced on the low-tension side (and lines connected thereto) by means of electrostatic induction. This effect varies with the physical dimensions of the transformers, and there have been cases for transformers of large dimensions, that the induced voltage on the low tension side has been high as compared with normal overvoltages on that side; therefore, it appears that some consideration must be given to reducing such voltages.

*Development and Practise.* The A. I. E. E. Standards state that "a lightning arrester is a device for protecting circuits and apparatus against lightning or other abnormal potential rises of short duration." In operation the device must shunt or divert the transient current in a sufficient amount so that the resulting rise in the voltage will not be above what the apparatus will withstand. Since maximum shunting occurs when the impedance of the circuit is zero, it is evident that the most effective protection during the transient over-voltage will be secured when the impedance of the arrester and its connections to the ground is minimum.

The earliest efforts in overvoltage protection consisted in providing air-gaps connected between line and ground and so arranged that when the transient voltage appeared, the gap would break down and practically connect the circuit directly to earth. Usually the arc through the arrester would not break until the generator voltage and resulting system voltage became quite low. Neglecting the effect of the voltage fluctuation, this might have been satisfactory on some of the small systems, especially some years ago when generators of high impedance were used; but with the larger systems which have generators with lower impedance, the arc would be maintained and furthermore there was the possibility of accompanying high voltages due to what was in effect an arcing ground. The operating difficulties were so great that later some impedance, usually resistance, was introduced in the connection to ground



in order to facilitate the breaking of the arc; but this reduced the efficiency of the arrester as a protective device.

The operation of systems with inadequate protection was found to be impractical on account of many interruptions of the service, and, as the art developed and the customer grew to place more and more dependence upon continuity of electric power supply, greater and greater efforts were exerted by the operating companies to eliminate interruptions and large voltage fluctuations. The persistence of this demand led to the development of arresters with characteristics which provided a comparatively free path for flow of surge current at voltages above the operating voltage, but which did not permit current in detrimental amounts to flow, except during overvoltage. This important characteristic has been described as an "electric valve action" and arresters of these characteristics are known as "valve type" arresters.

The earliest of these was the electrolytic arrester, which, after some modification made through service experience, had very good protection characteristics. It had certain mechanical disadvantages, such as the use of oil and the use of an electrolyte which froze, and made the arrester practically inoperative at very low temperatures. There was some expense to operating these arresters on account of the periodic maintenance and daily charging during the warm weather, and, if the arrester was remotely located, then the expense became considerable.

There is now almost a universal agreement that for a high degree of protection a lightning arrester should have a high discharge rate, a short dielectric spark lag, and the ability to interrupt the dynamic current. This is borne out by theoretical considerations which have been presented on several occasions and tests and operating data reported by manufacturing and operating companies.

According to Peek,<sup>1</sup> "an induced stroke of lightning may produce a voltage on an overhead line equal to about 100 kv. per foot of elevation of the wires above ground. In the average case, this factor has been found to be 30 kv. per foot." On the low voltage lines, the line insulation is a smaller portion of the probable usual voltage induced by lightning than it is for the high voltage lines, for instance, on a 220-kv. line without a ground wire, the ratio of the usual highest lightning voltage to the insulator spark over voltage is about 1.1 while the corresponding ratio for a similarly designed 70-kv. line would be over two and for still lower voltages, this ratio would become larger. Direct strokes of still greater severity may be expected occasionally.

The present practise is approximately as follows:

1. *Low-Voltage Circuits.* Due to the fact that on such systems lightning arresters are spaced rather closely, a high individual discharge rate is not as es-

sential for low-voltage circuits as for high-voltage lines. A variety of arresters are being used with comparative success, and among other factors the simplicity of design is of considerable importance.

Experience on one system has shown that where the wires of low-voltage secondaries are placed directly under the wires of higher-voltage primaries, say rated at four kv. and the length of the secondaries are not more than about 600 feet, it has been found unnecessary to place arresters on secondaries when the primary wires are well protected from lightning by means of arresters connected to them. In the experience on another system it has been found that secondaries under 1000 feet in length, whether under protected primaries or not, do not require arresters. Theoretically, there is some question as to the degree of protection offered to secondaries by protected overstrung primaries, but there is no doubt that the general practise of grounding one secondary wire affords effective protection to the secondary circuit. Where the length of the secondaries is longer and there are no wires above them to protect them, it has appeared necessary to put arresters on the secondaries in order to obtain protection from lightning.

2. *High-Voltage Circuits (0.6 to 154 Kv.).* On high-voltage circuits, the lightning arresters are usually spaced a great distance apart so that the individual arrester, to be of any value, should have a large discharge rate which limits to a few types the number of arresters suitable for this purpose. The general tendency is to install arresters on circuits rated at 73 kv. and less. The installation of arresters on circuits from 73 kv. to 154 kv. seems to be debatable, but there is a growing tendency among engineers to provide some means to diminish the over-voltages due to lightning. This is done by either the rearrangement of the phase wires into a horizontal configuration in order to diminish the value of the induced voltage from lightning, or by the use of the ground wires to further reduce the induced voltage, or both, and also by the use of lightning arresters in order to protect the apparatus and circuits.

3. *Extra High-Voltage Lines.* There is a tendency to omit lightning arresters from lines operating at 154 kv. and higher, the main argument being that the line insulation is able to withstand the induced over-voltages and the direct strokes of lightning cannot be handled effectively by existing arresters.

As no arrester will insure an absolute protection against a direct stroke of lightning, a certain amount of damage to existing equipment is to be expected, its amount being dependent upon the degree of protection provided by a given installation of arresters. The installation of arresters by operating companies has been shown by Roper, Atherton, and others to be warranted only on a basis of the improvement and reliability of service to the customer, as the cost of installing and operating an arrester is many times the revenue that would be lost by the operating companies during the time of interruptions.

1. Address by F. W. Peek, Jr., at meeting of N. E. L. A., Overhead Systems Committee, February 11, 1926, Kansas City, Missouri.

The degree of protection to be selected for each case depends primarily on the economic considerations, and the problem can be treated in a manner similar to that described in an article by A. L. Atherton.<sup>2</sup> As an example, the Commonwealth Edison Company has found for business and residential sections with a high density of load, that on its 4000-volt distribution system, there is slight advantage in having more than 135 arresters per square mile. The less expensive line types of arresters are used on the lower voltages, except on important installations where the larger station type is installed. Above 50 kv., only the station type arresters are used.

#### NEW DEVICES

The outstanding recent event in the field of lightning arresters has been the application in this country of two excellent tools for investigations, that is, the Dufour cathode ray oscillograph and the klydonograph.

The Dufour oscillograph, which is essentially a laboratory instrument, was constructed in Europe several years ago, but it was not used in this country until recently. It will make records of voltage or current transients of a very much shorter duration than is possible by the ordinary vibrating type of oscillograph. (For further details see Appendix 1.) In the work of the subcommittee in the past few years, the measurement of the voltage-time curve (see JOURNAL of A. I. E. E., June 1924, p. 575) was recommended as a basis of comparing various lightning arresters. Until recent time, there have been no facilities available to determine this curve experimentally, but now this can be done with the Dufour oscillograph. This apparatus also affords a means of determining the relative time lag of insulations which is also important in the study of lightning protection.

The klydonograph makes it possible to obtain records of transient voltages as they appear on the systems. It makes a record which gives a direct indication of the polarity and the approximate magnitude of the over-voltage and an approximate indication of the wave front of the surge. (Further details are given in Appendix II.)

Both of these devices will give more definite information as to the nature of the surges due to lightning and other sources, and also determine the effect of lightning arresters on reducing the surges.

#### FURTHER WORK

Some further work to be done is as follows:

1. Standardization of technique for using lightning generators for testing lightning arresters.
2. Determination of voltage-time characteristics of lightning arresters, including rate of discharge and the dielectric spark lag.
3. Statistical data of operating experience on high voltage lines, especially those ranging above about

2. *Lightning Arrester Application from the Economics Standpoint*, A. L. Atherton, TRANS. A. I. E. E., 1924, page 581.

73-kv., should be gathered and correlated for systems which have one or more of the following conditions that affect the amount of the over voltages due to lightning and the methods of coping with these voltages:

- a. Wires of a given line in a horizontal arrangement.
- b. Wires in other configurations.
- c. Lines with and without arresters.
- d. Line protected by ground wires (See Peek's<sup>3</sup> article.)
- e. Lines constructed so that corona acts as lightning arrester.<sup>4</sup>

#### DUFOUR CATHODE-RAY OSCILLOGRAPH

For the first time in the history of the art of lightning arrester protection it is possible to secure oscillograms showing the voltage, current, and time relations of an electrical transient which may occupy a time of 1/100,000,000 of a second or less. This achievement has been made possible through the application of the Dufour cathode-ray oscillograph<sup>5</sup> to the measurement of transient phenomena encountered in the art of lightning protection.

This oscillograph makes use of a beam of electrons moving at high velocities which produce a photographic impression by impinging directly on the photographic film located inside of the vacuum chamber. Since such a beam of electrons can be deflected by both electrical and magnetic fields, it is possible to take volt-ampere curves of any device operating on a transient by super-imposing on the electron stream two fields at right angles, one proportional to the current and the other proportional to the voltage. Such curves may be taken in a millionth of a second and give information on the operating characteristics of apparatus subjected to transients which has not been obtainable in the past.

If the volt-time or current-time curves are desired, it is necessary to supply time axis usually perpendicular to the direction of deflection of the transient. For very slow speeds this may be conveniently done by the use of a moving film. For high speeds the moving film is impracticable because of the tremendous peripheral velocities involved; therefore, means are provided to move the electron stream at a uniform rate across the stationary photographic film. This is done by the use of a magnetic field whose change of intensity is suitably controlled. The upper limit of velocity, which is about  $\frac{3}{4}$  miles per second, is reached because of the increasing difficulty in timing the unknown transient so as to get the record on the films while the spot moving at the  $\frac{3}{4}$  miles per second rate is tra-

3. *Lightning and Other Transients on Transmission Lines*, F. W. Peek, Jr., JOURNAL A. I. E. E., August 1924, page 697.

4. *The Corona as Lightning Arrester*, J. B. Whitehead, JOURNAL A. I. E. E., October 1924, page 914.

5. *Studies of Time Lag of Needle Gaps*, K. B. McEachron and E. J. Wade, JOURNAL A. I. E. E., January 1926, page 46.

versing a film four in. by five in. in size. The timing accuracy obtained in usual operation is 50 microseconds.

For phenomena which takes place in 50 microseconds or less, the time scale must be greatly magnified, which is accomplished by the substitution of a high-frequency

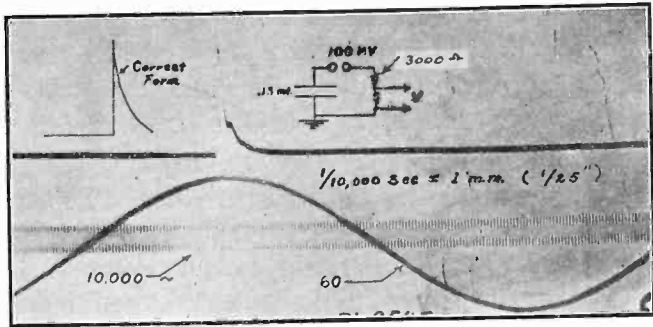

FIG. 1

field at right angles to the direction of deflection of the unknown transient. Thus the time taken to cross the film is determined by the frequency of the source and films have been taken using a frequency of 1,000,000 cycles, the time to cross the film being 1/2,000,000 of a second.

Frequently it is desirable to draw out the high frequency wave so as to render the results more intelligible, thus giving a zero line which may be many feet in length on the four in. by five in. film. This is accomplished by applying a uniform time motion perpendicular to the motion of the high frequency timing wave. The transient being studied also pro-

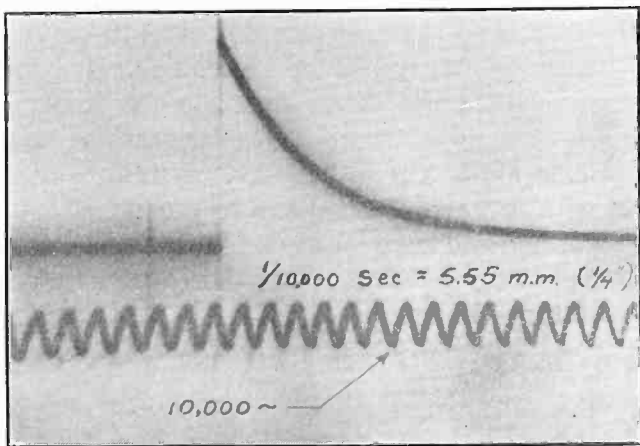

FIG. 2

duces its motion in the same direction as that of the uniform time motion but is usually very fast in comparison.

To show the use of this oscillograph of measuring transient phenomena, a series of films have been prepared of which four of the most typical films are shown here. A surge generator, similar to that used by Peek<sup>6</sup>, was used to send current impulse of known characteristics through non-inductive resistance across

6. *The Effect of Transient Voltages on Dielectrics*, F. W. Peek, Jr., TRANS. A. I. E. E., Vol. XXXIV, 1925, page 1857.

a part of which were connected the leads of the oscillograph. With such an arrangement, the voltage impulse across the oscillograph leads will be exactly similar in shape to the current surge in the main circuit. The first two films were taken on the same wave front. The first film (Fig. 1) shows the limit of speed of the ordinary Duddell or Blondel oscillograph. The second film (Fig. 2) shows the cathode-ray oscillogram of the same transient and the same 10,000 cycle wave, the time being such that 1/10,000 of a second equals 5.5 mm. It should be noticed that no distortion ap-

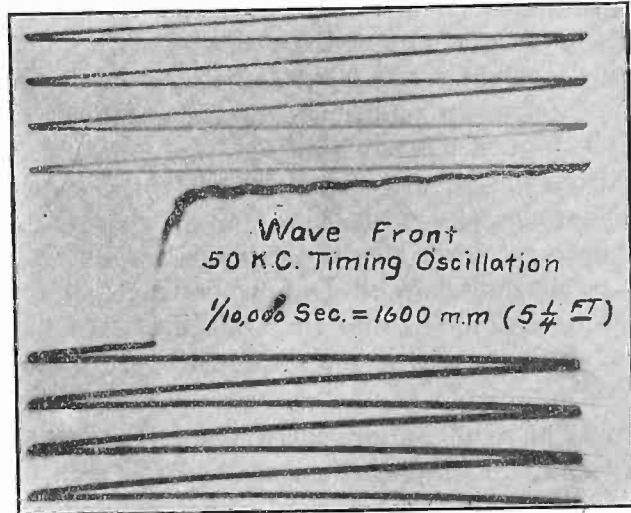

FIG. 3

pears in the transient voltage wave such as found in the first film due to inertia effect of the ordinary oscillograph.



FIG. 4

The second group of films shows the use of the high-frequency timing wave and the uniform sweeping motion combined; they were taken on the same transient. The first of the group (Fig. 3) used the 50,000 cycle timing wave, which represents a multiplying

factor of 1600 compared with that of Fig. 2. When taking the oscillograms shown in Fig. 4, the timing frequency was increased to 300,000 cycles and now it is possible to get an accurate picture of the wave front itself. The transients shown on Figs. 3 and 4 can be replotted on rectangular co-ordinates to eliminate the distortion effect of the timing oscillation on the shape of the wave front; however, such error is usually so small that it is not necessary. It will be noticed that there are high-frequency oscillations on the wave front of the main impulse which are due to reflections in the connecting leads between the oscillograph and the impulse circuit. However, in order to measure these high-frequency oscillations on the wave front, a timing frequency of 1,000,000 cycles would be necessary and for such conditions, the time required to traverse the film once is but  $1/2,000,000$  of a second. The oscillations on the wave front are of the order of 100,000,000 cycles and with such timing frequency, it is possible to get some idea of the wave shape of some of these oscillations. With Dufour oscillograph a magnification of 30,000 times that obtained with the ordinary oscillograph is possible without disturbing inertia effects.

As may be readily appreciated, from a study of these films, this oscillograph is destined to be of tremendous value in the study of transient phenomena since it is now possible to depict accurately the operating characteristics of any device under the action of an impulse. Studies which are being made will lead to a determination of the characteristics of all kinds of protection equipment, will give information concerning the breakdown of insulation with very short times of application, and will determine the nature of the overvoltages which appear on transmission and distribution systems.

#### KLYDONOGRAPH

The klydonograph<sup>7</sup> developed by J. F. Peters is a surge recorder which utilizes the principle of the Lichtenburg figures. When a voltage impulse is impressed on a terminal in contact with the emulsion of a photographic plate between it and a grounded metallic plate, upon development of the photographic plate there will be a figure which by its size indicates the magnitude of the voltage impressed and by its appearance indicates the nature of the voltage, that is, polarity and the approximate steepness of wave front. This instrument lends itself readily to application where a continuous graphic record of transient voltages is desired.

*Uses.* 1. The use to which the klydonograph is best adapted is the recording of surges on transmission lines. Since the range of voltages which may be applied directly to the klydonograph is from 2 kv. to 20 kv. in order to apply it to high voltage lines, a potentiometer, or multiplier, is necessary. This may be

7. *Klydonograph and Its Application to Surge Investigations*, J. H. Cox and J. W. Legg, JOURNAL A. I. E. E., October 1925, page 1094.

conveniently accomplished by taking the klydonograph potential from the middle plate of two suitably adjusted air condensers connected between the high tension conductor and ground.

2. A klydonograph connected as above to give the nature of the surge, and another connected to measure the voltage across a non-inductive resistance inserted in the ground lead of a lightning arrester will give the discharge current of the arrester and the nature of the surge which caused it.

3. The klydonograph may be used to measure indirectly the abruptness of a disturbance. To do this on a transmission line the instrument is connected to measure the voltage induced in an antenna loop. In the laboratory, the klydonograph is connected to measure the potentials across a non-inductive resistance and a concentrated inductance. From these the frequency of the disturbance may be calculated.

4. By the speed of propagation of the figures on the plate it is possible to measure time intervals of the order  $10^{-8}$  of second. Thus it can be used to estimate the time lags of spark gaps, insulators, etc.

5. Finally, the klydonograph lends convenience to all measurements where heretofore spark gaps have been used. This is for the reason that the klydonograph will indicate the correct voltage with one trial, while a spark gap indicates only minimum values.

*Results.* 1. Extended field tests have added to information on the magnitudes of surges due to lightning switching, arcing ground, etc. On three 120- and 140-kv. systems, three direct strokes of more than 1,000 kv. crest value were recorded in one season. Induced lightning up to 650 kv. was recorded on a 140-kv. system and exceeding 400 kv. on a 66-kv. line. In general they were single impulses, and the few oscillatory records were highly damped. The latter were probably line oscillations. On a 120-kv. system switching surges with a maximum voltage to ground of 390 kv. were recorded, and were rarely oscillatory.

Fig. 5 shows a section of film taken during an actual test on a transmission line.

#### OIL CIRCUIT BREAKERS, SWITCHES, AND FUSES

*Papers.* In 1918, at the Midwinter Convention of the A. I. E. E., Messrs. Hewlett, Mahoney, and Burnham presented a paper on *The Rating and Selection of Oil Circuit Breakers*. Since then much additional experience has been gained in the design and operation of oil circuit breakers. Factory and field tests have been conducted, methods of determining short-circuit current have received further attention, and new decrement curves have been prepared. Preparation of another paper bringing this information up-to-date is very desirable. The three larger manufacturers of oil circuit breakers have under consideration the preparation of such a paper and it is hoped that this paper will be available within the next year.

*Standardization.* Revised sections of the A. I. E. E.

Standards dealing with Oil Circuit Breakers (number 19) and Disconnecting and Horn Gap Switches (number 22) were adopted in June 1925 and are now available. The revised Standards cover these subjects more completely than ever.

As a result of its work during the present committee year, the Protective Devices Committee recommends the following additions to the above mentioned section of the Standards for Oil Circuit Breakers:

a. Rule No. 19-102. Add to present rule—"By rated voltage is meant the voltage from line to line as distinguished from line to neutral."

b. Rule No. 19-104. Add to present rule—"By normal voltage is meant line to line voltage as distinguished from to neutral."

c. In referring to interrupting capacity ratings, the term "arc amperes" is often used, and should be defined as—"The r. m. s. value of the current taken during

22-155—second line—incorrect reference to "oil circuit breaker."

Future revisions of the A. I. E. E. Standards should take into account the factors which determine the interrupting duty which may be imposed upon oil circuit breakers. No reference to these factors, or so called "Prescribed Conditions," is made in the revised Standards; however, the available fund of information upon this subject is limited and much further study will be necessary before definite recommendations can be agreed upon. Factory and field tests should materially assist in clearing up this matter. Particular attention is called to a paper by Mr. E. C. Stone on *The Oil Circuit Breaker Situation from an Operator's View Point*, presented at the Annual Convention of the A. I. E. E. at Saratoga Springs in June 1925 (see A. I. E. E. JOURNAL, July 1925, page 756). In this paper some of the factors affecting current to be interrupted and recovery voltage are set forth and discussed.

Standardization of interrupting ratings has progressed to the point where definite recommendations have been made for uniform standard interrupting capacity ratings. The recommended steps of rating, based on the standard operating duty (2-OCO), for power house indoor oil circuit breakers at 15,000 volts and below are given in the following tabulation:

Arc Amperes	Rated Volts	Arc Kv-a.
2,500	4,500	20,000
2,000	7,500	25,000
1,500	15,000	40,000
2,500	15,000	65,000
3,500	15,000	90,000
5,000	15,000	125,000
7,000	15,000	175,000
10,000	15,000	250,000
14,000	15,000	350,000
20,000	15,000	500,000
30,000	15,000	750,000
40,000	15,000	1,000,000
60,000	15,000	1,500,000
100,000	15,000	2,500,000

Definite progress is being made toward recommendations of standard steps of interrupting rating on oil circuit breakers rated from 15,000 to 220,000 volts. Standardization of this kind, it is believed, will materially reduce the present extensive lines of breakers and great variety of interrupting capacity and voltage ratings which manufacturers are forced to carry, ultimately leading to reduction in oil circuit breaker costs.

Progress is being made toward recommendations of definition of high-voltage fuse ratings. Steps have also been taken for preparation of a uniform test procedure for testing the interrupting rating of high-voltage fuses, similar to the procedure recently prepared for testing oil circuit breakers.

Research is under way for the determination of relative accuracy of current transformers and shunts to be used in connection with oscillographic records of short

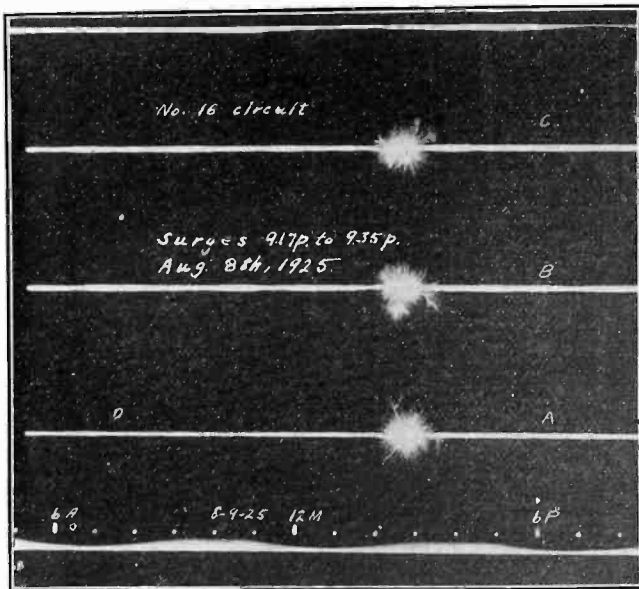

Fig. 5

the first half cycle of arc between contacts during the opening stroke."

Definitions of Normal (or Working) Voltage, Normal (or Working) Current, and Interrupting (or Recovery) Voltage should be adopted by the A. I. E. E. A tentative definition of Recovery Voltage, not approved by the Protective Devices Committee, is given here as a matter of interest:

Recovery Voltage is defined as the maximum peak value, measured from normal zero, of the voltage divided by  $\sqrt{2}$  which may occur on the live side of the breaker after the interruption of the arc and before normal voltage conditions are restored.

Attention is called to the following typographical errors in the revised Standards, Sections 19 and 22:

19-63—use "Isolating" instead of "Isolated."

22-55—use "Disconnecting" instead of "Disconnection."

22-59—second line—incorrect reference to "oil circuit breaker."

circuit tests; results and recommendations will probably be available within another year.

*Interrupting Capacity Ratings.* The following relative interrupting capacity ratings for oil circuit breakers have been approved by the N. E. L. A. and the Electric Power Club:

- |   |                              |
|---|------------------------------|
| a. One-unit operating duty . . . . .  | 100 per cent to 125 per cent |
| Rating varies between limits given with design of breaker.                          |                              |
| b. Two-unit operating duty, two-minute interval (Standard operating duty) . . . . . | 100 per cent                 |
| c. Four-unit operating duty, two-minute intervals . . . . .                         | 70 per cent                  |
| d. Four-unit operating duty, one-half minute intervals . . . . .                    | 60 per cent                  |
| e. Four-unit operating duty, no time intervals . . . . .                            | 25 per cent                  |
| f. 300-unit operating duty, 15-minute intervals . . . . .                           | 30 per cent                  |
| g. Four-unit operating duty, successive intervals of 0, 30, 75 seconds . . . . .    | 30 per cent                  |
| h. Four-unit operating duty, successive intervals of 15, 30, 75 seconds . . . . .   | 40 per cent                  |
| i. Three-unit operating duty, one-minute intervals . . . . .                        | 70 per cent                  |

1. With reference to operating duties (d), (e), (g) and (h), while there are no known limitations which prevent the general application of these operating cycles to all oil circuit breakers, still in view of lack of operating experience and possible hazard, it is recommended that these operating cycles be confined to breakers having interrupting rating on operating cycle (b) of not over 250,000 kv-a. and having voltage ratings of 37,000 and lower.

2. Zero means no time delay between full open position and start of closing.

3. The present factor which the operators are using for operating duty (e) is 30 per cent, but it is the opinion of the Power Club that 25 per cent is more suitable.

In the above tabulation a unit operating cycle is understood to consist of a closing of the circuit breaker followed immediately by its opening without purposely delayed action.

*Oil Circuit Breaker Tests.* High capacity testing facilities are now available at the plants of two large manufacturing companies. Plans are also under way for several operating companies to undertake a series of cooperative oil circuit breaker tests, interchanging results among the companies participating, all tests to be made according to recommendations of the uniform test procedure. It is believed that much valuable data as to oil circuit breaker performance, and conditions affecting interrupting duty, will be secured from such tests.

*General.* Improvements in the details of design have been made by the various manufacturers who are continuing the development of their oil circuit breakers on the basis of different design features as follows:

- High-speed contacts,
  - Explosion chambers,
  - Multiple contacts in series,
  - Resistance introduced into breaker circuit to reduce energy released by arc in the breaker,
  - Various methods of relieving gas pressure.
- Armored, or metal clad, switch gear which has been used extensively in Great Britain and Continental

Europe has been introduced in this country. The unit of metal clad switch gear is the three-phase circuit breaker with mountings and all auxiliaries. Each unit contains, within itself, the main oil breaker, bus bars, disconnecting devices, instrument transformers, cable potheads, and necessary minor features. All of the live conductors involved in this assembly are either immersed in oil or solidly imbedded in insulating compound and the whole is enclosed within grounded metal casings which form the exterior covering. Disconnection is provided by withdrawal, in a horizontal direction, of the carriage type oil circuit breaker.

The field of truck mounted breakers has been extended and high interrupting capacity outdoor breakers, up to circuit voltages of 154,000, are now being built with this type of mounting.

Working toward a better interchangeability of breakers of the smaller indoor type, single-pole elements are now being mounted on trucks and arranged for installation in a uniformly constructed steel housing; this will serve in place of the usual cell construction and will allow a more liberal interchange of elements and, because of the single- rather than triple-pole element, will permit a smaller stock of spare units to be carried. Each element may be controlled by a separate protective relay, allowing one pole to trip while the other two remain closed, continuing a single-phase supply over the circuit which the switch controls.

Another step toward universality is being made by one manufacturer who is arranging to build certain high-voltage breakers with provision for interchanging manual, solenoid, and motor operating mechanisms.

The application of motor mechanisms has been considerably widened to cover a greater number of breaker capacities and to meet a larger diversity in control circuits as to a-c. voltage, and frequency, and varying d-c. voltage.

Another manufacturer employs high-speed arcing contacts in high-voltage oil breakers. In the 110,000-, 132,000-, and 187,000-volt breakers the arcing contacts are of the high-speed bayonet type. A cam in the guide mechanism of the arcing contacts provides for a straight line motion of the arcing contact latch until the main contacts have parted a pre-determined distance, when the cam releases the arcing tips from the latch of the moving contacts. The release of the arcing tip is followed by a quick return to the normal position. The 25,000-, 37,000-, 50,000- and 73,000-volt breakers employ finger type high speed arcing contacts. The main contacts open at a moderate speed and when they reach a pre-determined separation, the arcing contacts are released at a high rate of speed. The contact parts are so arranged as to take advantage of the magnetic blow-out action of the current-carrying loop of the breaker. Another class of breakers, used for central station service, employs the double tank feature, the purpose being to prevent oil throwing and to provide additional assurance that a tank will not be burned

through. Breakers with interrupting ratings up to 1,500,000 kv-a., of the indoor type, are being provided with the resilient double tank and also each pole unit is designed in two sections so as to reduce the area which might be exposed to high gas pressures.

The multiple series break principle for 4, 6, 8, and 10 breaks is being employed on breakers from 15,000 to 220,000 volts.

Considerable interest has been manifested by a number of companies in the interrupting capacity of both high- and low-voltage fuses. Several companies have tested fuses in the 250- to 600-volt class.

In one series of tests on open-link fuses in sizes from 100 to 1000 amperes, with the fuses both initially hot and cold prior to test, it was found that in every case the fuse operation was selective between two fuses of adjacent current rating, the two fuses being in series for each individual test.

A series of tests conducted on renewable and one-time enclosed cartridge fuses indicated that the rupturing capacity of the fuse is largely a function of the length of the fuse element and the volume of the cartridge fuse case. The time for interrupting a circuit was found to be very selective between fuses of different sizes. The melting time of the fuse was a direct function of the thermal capacity of the element and inversely to the heating effect of the short-circuit current.

Tests have been made by a number of companies on high-voltage fuses for protection of transformer banks, sectionalizing lines, and similar service. Standards have been fairly well established on the liquid types of fuses. On the open link expulsion type fuses, a wide variety of results has been secured.

#### PROTECTIVE RELAYS

In view of the recent publication of the Relay Handbook, this year's report of the relay subcommittee consists principally of a resumé and analysis of the present status and trend of protective relay practise.

As the publication of the Relay Handbook has given to the industry a comprehensive picture of the relay art in detail, this report will refer in detail only to developments which have occurred since the Handbook went to press, and only generally to developments occurring prior to that date.

*Present State of Protective Relay Practise.* A "relay" in the electrical art is an automatic device whose function is to receive information and initiate action in response thereto. It is estimated that the total number of types of such devices used in the electric power and telephone industries alone is in excess of 60,000. However, this subcommittee, being a branch of the Committee on Protective Devices, deals primarily with relays for the protection of power circuits and apparatus. The function of the relay as a protective device is to receive information of some abnormal condition and initiate action to correct the abnormal

condition, or to disconnect the apparatus or circuit involved, from the source of energy.

Probably the oldest form of protection in use on electrical circuits is the fuse. From this developed the so called "overload" relays designed to act in response to excessive flow of current. At first these acted instantaneously, but as power systems, protected by "overload" relays, grew in magnitude and complication, it became necessary to differentiate between relays in different parts of the circuit by introducing the element of time. We therefore have today, as our fundamental system of protection against faults producing abnormal currents, a system depending on overcurrent relays with differing time adjustments, such time adjustment, in general, becoming longer the closer the generating station is approached. This has resulted, with the enormous and complicated power networks now existing, in the appearance of various limitations to the use of this system, due to the fact that the time differentials between relay settings cannot be reduced below a certain minimum on account of the inherent time required for relays and circuit breaking devices to function.

To meet this objection, a second general system of protection against abnormal current producing faults has developed, based upon the principle of balancing out of relay circuits all current except the fault current, thereby causing the protective relays to function in response to the fault current alone.

This general idea has crystallized in the system of protecting individual pieces of apparatus by balancing out of the relay circuits all current except that resulting from a fault within the particular piece of apparatus. There are two methods of applying this principle, first, by means of a series differential connection in which the two ends of a circuit are balanced against each other, and second, a parallel differential system which may be used where a circuit consists of parallel paths which may be balanced against each other.

In addition to systems of protection using current alone, we have a number of systems which depend upon the use of both current and voltage. Some of these systems, such as directional ground relaying systems, use both the fault current and the fault voltage; others, such as directional current and directional power systems, utilize the circuit voltage and total current, and certain other devices, such as the impedance relay, utilize the total current and fault voltage.

It should be observed that we have in the above, in general, two systems of current relaying, one depending upon total current and time for selective action, the other depending upon fault current and location for selective action.

In addition to protection against faults involving current, many other abnormal conditions are now protected against specifically by means of relays, such as abnormal voltage, temperature, speed, etc., single-phase operation of motors and generators, cessation of

flow of oil, water and air for lubrication or cooling purposes, and other conditions too numerous to mention. Development of many of these additional protective devices has been largely accelerated by the advent of the automatic station, in which, there being no operator to act in case of trouble, it is necessary to provide automatic devices.

*Trend of Protective Relay Practise.* The above outline of the types of protective relaying systems now in use, together with the chronological order of their development, indicates certain quite definite trends in the protective relay art. These may be briefly stated as follows:

First: With the development of large interconnected power systems supplied from numerous generating sources of varying efficiencies, there appears to be a growing trend towards the integration of all such sources into one comprehensive system so interconnected and relayed that its integrity shall not be broken by the occurrence of faults.

Second: Since the system of relaying which depends upon differential timing for selective fault isolation has not proved sufficiently flexible to promote the maintenance of the maximum integrity of such systems, there appears to be a strong trend towards obtaining such fault isolation through the use of balanced relay systems, or systems responsive to the location or specific nature of the fault.

Third: There also seems to be a rather strong trend towards the use of what may be called "back-up" protection, or a second line of defense, in the form of a second system of relays to function in case of failure of the first system, applied either to the same circuit breakers as the primary defense, or to others nearer the sources of energy.

Fourth: There also seems to be a strongly developing tendency toward the development and use of devices for the detection of abnormal conditions and approaching faults before such faults actually occur.

Summarizing the apparent trend of relaying practise in general, therefore, it would appear that the tendency is towards the maintenance of system integrity by the setting up of three lines of defense:

1. Relays which will detect and give warning of approaching faults or conditions which may cause faults,

2. Relays which respond to the abnormal conditions resulting from the occurrence of faults to isolate the particular piece of apparatus or circuit at fault,

3. A back-up system (consisting in its commonest form of overcurrent relays) adjusted with such time delay as to function only upon the failure of the first and second lines of defense.

The relay art has played an important part in the evolution of the modern superpower system and has itself evolved in sympathy therewith. This evolution is still going on and must continue to do so. We are

confident that it will go on until every requirement for continuous electric service has been met.

*Developments During the Past Year.* A number of new developments have occurred during the year, most of which are in the nature of detail improvements devised to keep abreast of the evolving art. The following specific developments are noted for the purpose of recording the advances in the art and as information as to new devices available.

1. Speed indicating relay for application to automatic stations. Makes separate contacts at definite per cent under-speed, at synchronous speed and at definite per cent over-speed.

2. Automatic network relay. For the control of alternating current network breakers. Connects transformers to network when capable of supplying load and disconnects them on reversal of energy flow. Will operate on magnetizing current of a transformer.

3. Ratio differential relay. For the differential protection of a-c. generators and transformers. Tripping current varies with load, allowing the relay to be set for close protection at normal loads. Does not require balancing auto-transformers for transformer protection.

4. Direct-current polarized relay. Has inverse definite minimum characteristics. A complete line is available including over-current, under-current, over-voltage, under-voltage, reverse power, polarized potential, and resistance measuring relays.

5. Duplex impedance relay. A combination of a directional impedance relay and a ground relay in one case.

6. Automatic reclosing relay. Has been modified to permit any desired duty cycle. Time intervals may be varied between five seconds and two minutes.

7. Over- and under-voltage relays. Have been modified by the addition of a voltage adjusting resistor controlled by a pointer and scale. Permits relay to be adjusted for any voltage within a definite range.

8. An over-voltage relay. The same as existing over current relay except that a voltage winding has been substituted for the current winding and certain other minor alterations.

9. A power directional over-current relay, offering power directional protection against ground faults, and against phase-to-phase faults where for any reason single-phase directional elements are preferred to a polyphase relay.

10. A network relay for protecting low-voltage a-c. networks against a faulty distributing transformer or feeder.

11. Power directional relays for sensitive protection against ground faults in grounded neutral circuits.

12. Differential frequency relay consisting of two induction frequency elements arranged in opposition on a single shaft. For application in connection with



two circuits that are interlinked by means of a rotating machine.

13. A phase unbalance relay for use in a polyphase circuit for protection against faults producing an unbalancing of currents in the several phases.

14. Synchronism indicating relay comprising an induction type differential element for preventing interconnection of two systems at one point unless they are already connected at some other point.

15. Motor-operated timing-relay for controlling the time elapsing between certain operations. Intended primarily for use with automatic reclosing of circuit breakers.

16. Auxiliary relay. A plunger type relay particularly adapted to automatic switching for introducing time in starting up and in shutting down machines. Can also be used in any a-c. or d-c. circuit where instantaneous pick-up and long time drop-out are required.

17. Electrically-reset instantaneous over-current and auxiliary relays. Equipped with a solenoid for resetting.

18. Flashing protective relay. Has a heavy winding for connection from d-c. machine frame to ground to protect against flashing or grounding of winding to frame. Instantaneous.

19. Plunger type trip free relay for use with electrically operated circuit breakers to prevent the breaker being held closed with over-current in the circuit.

20. Locking relay plunger type. Primarily for preventing a circuit breaker from opening on an excessively heavy over-current.

21. Locking relay. Primarily for preventing the opening of one circuit breaker due to surge conditions resulting from the opening of another circuit breaker.

*Recommendations.* Since the efforts of Institute Technical Committees are directed towards research, standardization, and publicity, it is believed that this subcommittee can be of most service this year by suggesting a few subjects on which research, standardization, or publicity appear desirable.

As to research, the following studies are recommended:

A. Study of pilot wire transmission line relay systems employed in Europe, to determine their proper field of usefulness. It is understood that many successful installations are in use and it is thought that American practise may benefit by the investigation thereof.

B. Study of characteristics of current transformers at very high overloads. The characteristics of current transformers at very high overloads are of importance in many relay applications, and the information at present available is somewhat meagre. It is recommended that the manufacturers be urged to investigate this matter and present the information to the industry in the form of papers, or otherwise.

It is recommended that standards be formulated and adopted for the following:

1. *Relay operation nomenclature.* The selection of terms to define the characteristics of relay operation are very chaotic at the present time, probably no two companies having the same conception of what is required, or using exactly the same terms. In order that material for publication regarding operating experience may have a common language of expression it is recommended that standard nomenclature for relay operation be adopted.

2. *Relay acceptance tests.* At the present time there are no Institute standards of overpotential tests, temperatures, etc., for relays. It is recommended that such standards be established.

3. *Relay designs and ratings.* At the present time there is no purposeful coordination of standard relay designs among the different manufacturers. This fact imposes considerable hardship upon the relay users, in view of the difficulty introduced thereby, of making relay applications involving relays of different manufacturers. It is therefore recommended that, in so far as appears feasible, standard ratings and operating characteristic curves be established for the more common types of relays.

4. *Current transformer characteristics.* A. Coordination between transformers of different types and voltages: Considerable difficulty arises in the application of balanced protection where transformers of more than one type or voltage rating are involved. It is recommended that in so far as possible the designs of transformers of different types and ratings be so coordinated that differing types can, without serious difficulty, be used for differential protection.

B. Coordination of characteristics as between different manufacturers: It is also recommended that in so far as may be practicable, current and potential transformer designs of different manufacturers of the same general type and voltage ratings, be so coordinated that like types will have like characteristics.

As to papers for publication, due perhaps to the above noted confusion as to nomenclature for relay operation, there has been little published information regarding the operation, successful or otherwise, of existing relay systems. It is therefore recommended that at a future general Institute meeting, an appropriate amount of time be allotted for the presentation of relay operating experience. It is suggested that this presentation might well be made under three general divisions:

Time differential systems, or systems in which selectivity is obtained principally by timing.

Current differential systems, or systems employing various current balancing plans for selective operation.

Voltage differential systems in which the abnormal voltage conditions resulting from a fault are utilized to assist selective operation, such as impedance relay applications.

In the advancement of the above suggested program the following sub-subcommittees have been appointed:

1. On Relay Operation Nomenclature and Experience.
2. On Relay Acceptance Test Specifications and Standards.
3. On Current and Potential Transformer Characteristics.

These subsubcommittees have not had time to complete their work this year, but it is hoped that they will be continued next year and continue their work to a useful conclusion.

### Appendix

#### REPORT OF SUBCOMMITTEE ON AUTOMATIC STATIONS

Since the presentation of the Automatic Stations Subcommittee Report this year, three points have

principal manufacturers and users and is now almost universal. This idea has practically standardized itself, but it is felt that these device function numbers should be transmitted to the Committee on Standards, who should be urged to accept and incorporate them in the Standards of the Institute.

*Device Symbols.* The subcommittee also submits a set of device symbols for use on automatic station wiring diagrams. These have just been accepted by the two principal manufacturers and will be used by them in the future. It is urged that these wiring diagram symbols be transmitted to the Committee on Standards for acceptance and incorporation in the Standards of the Institute.

WALTER H. MILLAN,  
Chairman.

MINIMUM PROTECTION  
FOR POWER APPARATUS IN AUTOMATIC STATIONS

Protection	Synchronous Converters			Syn. Motor Gen.		Gen.	Cond.
	Rwy. 600-volt	Edison 250-volt	Mining & indust.	Edison 250-volt	Mining & indust.	Synch. hydro.	Synch.
A-C. Under-voltage.....	x	x	x	x	x	x	x
A-C. Over-voltage.....						x	x
Incorrect Polarity.....	x	x	x				
Single-Phase Starting.....	x	x	x	x	x		x
Single-Phase Operation.....							
Loss of Field, A-C. Machine.....	x	x	x			x	x
Loss of Field, D-C. Machine.....						x	x
D-C. Reverse Power.....	x	x	x	x	x		
D-C. Overload.....	x	x	x	x	x		
Excess Temperature (Sustained Overload).....	x	x	x	x	x		
Imperfect Start (Lock-out).....	x	x	x	x	x	x	x
Machine Overspeeding (Lock-out).....	x	x	x	x	x	x	x
Severe A-C. Overload (Lock-out).....	x	x	x	x	x	x	x
Grounding Protection (Lock-out).....	x	x	x	x	x	x	x
Excess Bearing Temp. (Lock-out).....	x	x	x	x	x	x	x

developed on which is submitted supplementary information, including points as follows:

1. Minimum safe protection of power apparatus in automatic stations.
2. Device function numbers for use in automatic stations.
3. Device symbols for use on automatic station wiring diagrams.

*Minimum Safe Protection.* In its reports of 1925 and 1926, the subcommittee presented its recommendations for the protection of synchronous converters of railway, Edison, and industrial types; synchronous motor generators of Edison and industrial types; synchronous generators (in automatic hydroelectric applications) and synchronous condensers. These recommendations have been tabulated and are presented herewith. It is urged that they be transmitted to the Committee on Standards with the recommendation that they be accepted and incorporated in the Standards of the Institute.

*Device Function Numbers.* During the year 1924 the subcommittee submitted a set of device function numbers for use in automatic stations. Through the efforts of the subcommittee, this was accepted by the

### ELECTRIC CARS FOR STEAM RAILROADS

Electricity for local passenger service is going to the aid of steam railways that are not yet ready to completely electrify their systems. The Boston & Maine, after a summer's experience with seven passenger cars operated by electricity generated on board by a gas-line engine, is now installing seventeen more to make runs of 250 and 300 miles a day covering most of the main line of the railroad and many of the branch lines.

The new cars are 73 feet long and can seat 88 people in passenger, smoking and baggage compartments. The generators on each car are rated at 275 horse power. Car warmth in winter is provided by water electrically heated. Quick starting and high speed enable these cars to run on main lines to do local work between fast through trains. They reduce the cost of branch line service markedly.

### SEMINARS FOR PRACTISING ENGINEERS

In the October JOURNAL a paper by Edward Bennett bears the title "Excellent Seminars for Practicing Engineers." "Excellent" should be omitted. The word was inadvertently so affixed to the manuscript by a reviewer that it appeared to be part of the title.

# Status of Electric Lighting in 1926

## Report of Committee on Production and Application of Light\*

PRESTON S. MILLAR, Chairman

To the Board of Directors:

As required by provision of the By-laws, this report constitutes a brief resumé of the progress of the lighting art, including recent developments in electric lighting which appear to have significance as indicating an actual trend in the art.

### ILLUMINANTS

In electric illuminants there have been no new developments of a radical character during the past year. Among tungsten filament incandescent lamps there has been developed a new standard line in which the gas-filled type has been introduced in the 50- and 60-watt sizes heretofore generally of the vacuum type. These lamps, standardized thus far from the 15- to the 100-watt sizes of the 115-volt range, are characterized by

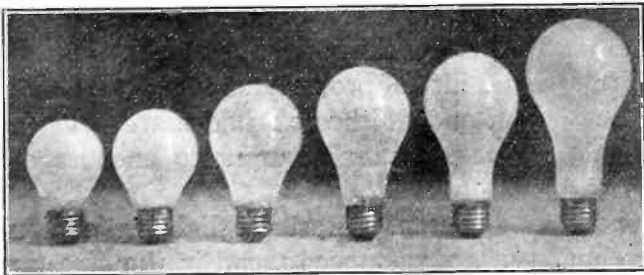

FIG. 1—NEW STANDARD LINE OF TUNGSTEN FILAMENT LAMPS

bulbs of a pleasing contour (Fig. 1), lightly frosted upon the inner surface, providing a measure of diffusion of light, while retaining the cleanly, smooth surface heretofore had only in the clear bulb and "natural glass" lamps. The adoption of this new standard line of lamps in place of a variety of types heretofore employed is a conspicuous example of the principle of simplification which the Department of Commerce has urged successfully and constructively upon industry in this country.

*Arc Lamps.* The employment of arc lamps in this country for general illumination is confined largely to the magnetite lamp which continues in successful operation in some localities, and which in its higher powered form has been utilized in several recent installations where high-intensity street lighting is desired.

For the projection of motion pictures in large houses,

the high-intensity arc is quite generally used. In medium-sized theatres carbon arcs, both alternating and d-c., operating at currents from 30 amperes to 80 amperes, are quite generally in use. A 10- to 30-ampere, horizontal carbon arc used with a reflector instead of a lens as a condenser has entered into use recently.

Practically all interior motion picture photography is now done with the aid of electric arcs for illumination. Four types of arc are used: the high-intensity arc (150 amperes), the white-flame arc, the ordinary carbon arc, and the mercury vapor arc. There is steady improvement in all forms of studio arc-lighting apparatus.

The high-intensity arc has been brought to its highest degree of perfection in military searchlight work and is now used universally by both the Army and Navy.

White-flame arcs are still quite generally used in photo-lithography and color reproduction work. Improved units are occasionally appearing in this field.

The use of white-flame arcs in portrait photography is increasing and several small, efficient arc mechanisms are now being used in this field.

*Small Gaseous Conductor Lamps.* A distinctly new development is the small gaseous conductor lamp<sup>1</sup> devised by Moore for indicator or marker purposes rather than for purposes of illumination. These lamps operate at 115 volts alternating-current or direct-current. They consume about one-half milliampere for the T-4 bulb size, and one milliampere for the G-10 bulb size, and have an efficiency of about one-third lumen per watt. The life is said to be 3000 to 5000 hours. One form of the lamp, fitted with a G-10 bulb, has an over-all length of two in. and a diameter of one to one-fourth in. This is provided with a wire resistance of about 35,000 ohms in the base, which is of the medium screw type. Another form has a T-4 bulb, an over-all length of about one to one-fourth in., and a diameter of one-half in. This is fitted with a candelabra screw base in which there is a composition paste resistance of about 70,000 ohms. The lamps are said to contain neon, helium, and argon in certain proportions. When excited by electric pressure at the electrodes, the gas becomes luminous at the cathode. On direct current, the gas around only one electrode glows; on alternating current the gas glows near both electrodes at a frequency depending upon the supply current.

The lighting and extinction of these lamps is practically instantaneous. They thus have properties which are peculiarly desirable for such instruments as strobo-

1. "Recent Developments of Moore Gaseous Conductor Lamps" by Moore and Porter, *Transactions, Illuminating Engineering Society*, Feb. 1926, p. 176.

\*Committee on Production and Application of Light:

Preston S. Millar, Chairman, Electrical Testing Laboratories,  
80th St. & East End Ave., New York

W. T. Blackwell,  
J. B. Bryant,  
W. T. Dempsey,  
H. W. Eales,  
F. M. Folkor,

F. F. Fowle,  
G. C. Hall,  
H. H. Higbie,  
A. S. McAllister,  
G. S. Merrill,

F. H. Murphy,  
Charles F. Scott,  
B. E. Shackelford,  
C. J. Stahl,  
G. H. Stickney.

Presented at the Annual Convention of the A. I. E. E.  
at White Sulphur Springs, June 21-25, 1926.

scopes, synchrosopes, etc. If 230 volts be applied, they merely glow a little more brightly than on 115 volts.

The two forms of this lamp are illustrated in Fig. 2. Application of the lamp to an electric flat iron is shown in Fig. 3. The small power consumption makes it practicable to use the lamp in a wide variety of service to indicate that the circuit is alive, or to indicate loca-

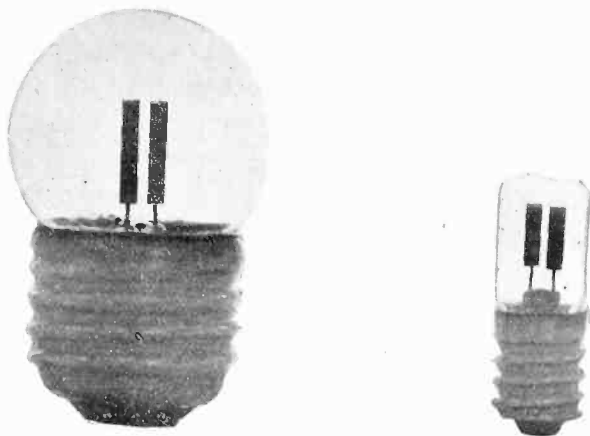

FIG. 2—GASEOUS CONDUCTOR LAMPS FOR 115-VOLT CIRCUITS

tions of switches, polarity of d-c. circuits, etc. For other applications see paper to which reference has been made.

*Double Filament Automobile Lamp.* The past year has witnessed the rather extensive introduction of the double filament automobile headlight lamps. In ordinary practise the lower filament provides the principal driving beam. When the upper filament is

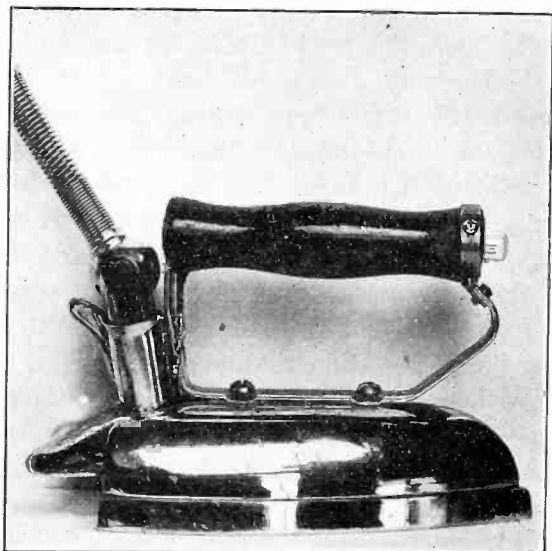

FIG. 3—GASEOUS CONDUCTOR LAMP TO INDICATE CLOSED CIRCUIT ON FLATIRON

switched into circuit the beam is depressed by two to three degrees. A further discussion of this development in relation to headlight practise appears under a later section of this report.

*Prefocusing Lamp Socket.* To meet the requirements for precise location of filaments of incandescent lamps used in motion picture machines, stereopticons, signals, etc., there has been developed a special type of base

and socket which insures correct operating position for the filament in such apparatus. Each lamp is based in an optical jig to secure exact filament location with respect to both axial alignment and light center length once the projection apparatus is properly fitted. This device eliminates the necessity of refocusing on renewing a lamp, and procures for users of projectors maximum screen illumination. While this equipment is not regularly listed by manufacturers it is understood that it can be procured when desired.

#### LIGHTING EQUIPMENT

*For Residence Lighting.* The trend in luminaries for home lighting in recent years has been largely in the direction of the candelabra type of equipment employing frosted or coated incandescent lamps which in large part have been without shades and wholly exposed to view. In illuminating engineering circles this trend has been regarded as contrary to the public interest in that it has brought within the field of ordinary vision sources of excessive brightness which have produced glare. With a view to correcting this condition much educational work is being done by central stations and other branches of the industry to impress the public with the desirability of properly shading light sources, and new types and finishes of shades are being made available by some manufacturers to encourage this practise.

*For Street Lighting.* In street lighting equipment there has been a pronounced trend in the direction of employment of directive equipment, usually of prismatic glass, surrounded by lightly diffusing outer glass envelopes. The purpose has been to secure a considerable measure of favorable redirection of light while keeping brightness and glare within bounds. A variety of equipment of this kind has been placed in service. In some cases effort is confined to redirection into the lower hemisphere of some of the light flux which otherwise would be directed upward. In other cases this has been combined with a latitudinal redirection along the street of some of the light flux which otherwise would fall upon building fronts.

#### ORGANIZED STUDY OF ILLUMINATION

*Illumination and Production.* Under the aegis of the National Research Council an effort is being made to ascertain some of the relations between changes in illumination and changes in industrial production. Investigations to date<sup>2</sup> have indicated that improved illumination has secured industrial advantage in the way of increased production, diminished shrinkage, and more favorable working conditions. The purpose of the present investigation is, if possible, to ascertain under independent auspices the facts in certain representative industries. Thus far, the committee having

2. Report of Committee to Promote Central Station Illuminating Engineering, Lighting Bureau, Commercial National Section, Presented at National Electric Light Association Convention, May, 1924. (Table III)

this enterprise in charge, and operating under the chairmanship of Professor D. C. Jackson, has engaged largely in developing methods with a view to the formulation of a procedure and the establishment of systems of control which when applied to an industry which is largely dependent upon vision, may be expected to determine the facts of relationship between illumination and industrial production.

*Street Lighting.* A committee of the Illuminating Engineering Society is endeavoring to develop a method of appraising the effectiveness of street lighting which will make it practicable to determine, at least approximately, the relative merits of two different street lighting systems. It is an interesting and notable fact that despite the extensive attention which has been devoted in recent years to the subject of street lighting, there is today nothing like consensus among the leaders of the art as to the best manner of locating and equipping street lamps and of distributing the light for purposes of street illumination. If the present attempt fails in its ultimate object, it may at least succeed in diminishing the divergence of views among street lighting engineers. There is included in the program a project for study of the elusive subject of glare in street lighting.

#### ORGANIZED MOVEMENTS FOR THE IMPROVEMENT OF LIGHTING PRACTISE

Electric lighting is receiving proportionately more attention at the hands of electric service companies throughout the country than has been the case in recent years. The potentialities of revenue from increased lighting load and a growing sense of responsibility for making available to the public the benefits of improved illumination have combined to command a greater degree of specialized attention to illumination.

*Training Course for Lighting Men.* At the 1924 Convention of the National Electric Light Association, a Committee to Promote Central Station Illuminating Engineering reported upon the importance of the opportunity in the lighting field afforded central stations, and described a training course for prospective central station illuminating engineers then in course of preparation. This course, under the joint auspices of the National Electric Light Association and the Illuminating Engineering Society, was arranged for the autumn of 1924 and was carried through with success. It made available to a training group the kind of instruction which in recent years had been given lighting students in training courses by the larger manufacturers of incandescent lamps, and supplemented this by the experience of central station companies who have pioneered in the organization and operation of lighting service departments and by a carefully chosen inspection trip.

*Selection of Lighting Equipment.* A further indication of central station concern for the improvement of electric lighting is furnished by action of the Lamp

Committee of the Association of Edison Illuminating Companies, which heretofore has functioned successfully in connection with incandescent lamps themselves, but has not concerned itself with lighting equipment. It is understood that this Committee has taken cognizance of unsatisfactory lighting conditions in residences, and has requested the Illuminating Engineering Society to formulate a statement of principles and perhaps some simple specifications which may be looked to for the guidance of central stations which desire to select satisfactory lighting equipment for sale to the public. It is further understood that the Illuminating Engineering Society is endeavoring to comply with this request and has a committee at work formulating such a statement of principles which may govern the selection of residence lighting equipment.

*Central Station Lighting Departments.* Whereas in the spring of 1924 only nine central station companies were known to have lighting service departments, today there are 42 central stations which have such departments and the number is fast growing. The principal limitation is the unavailability of trained men competent to organize and operate such activities.

This awakening of central stations to their opportunities and responsibilities in lighting is of large significance to the country. Most classes of illumination, and particularly residence, industrial, and street lighting, suffer needlessly from ineffective and inappropriate lighting which fails to take advantage of recent advances in the art. The light and power industry can contribute materially to the welfare of the country by lending its great influence to betterment of these conditions. It is a matter of gratification to this Committee that definite progress in this direction is indicated by the developments of the past year.

*I. E. S. and Central Station Lighting Men.* During 1925 the National Electric Light Association, in reorganizing its Commercial Section for greater effectiveness, dispensed with its Lighting Sales Bureau. In September, 1925, on the day preceding the opening of the Illuminating Engineering Society's annual convention, there was a gathering of central station lighting men out of which there was evolved a plan for greater activities in connection with central station lighting under the auspices of the Illuminating Engineering Society. In this connection it is understood that there is in course of preparation a Lighting Service Department Manual which will make available the experience of central stations which have assumed the lead in such work. This will include a brief survey of the lighting field and chapters on the organization of a lighting service department, its scope, needed equipment, and engineering and commercial features of its work.

*Lighting Demonstrations.* Interest in electric lighting has been enhanced and in all probability practise has been much improved as a result of demonstrations made in the elaborate Lighting Educational Centers

of the incandescent lamp manufacturers at Nela Park and Harrison. So successful have these been that less elaborate demonstrations have been set up and operated in a number of cities. Notable among these are demonstrations in Boston, Chattanooga, Cincinnati, Detroit, Kansas City, Knoxville, Louisville, Nashville, Philadelphia, Pittsburgh, and Providence. Others are understood to be in preparation.

#### MOTOR VEHICLE LIGHTING

Specifications for automobile headlamp and rear-lamp performance have been prepared by the Illuminating Engineering Society and revised as of 1922. These headlamp specifications cover laboratory tests for headlamps and headlighting devices and prescribe candle power limits for different parts of the beam. The headlamp specifications were endorsed in 1922 by the Society of Automotive Engineers, which organization, however, supplemented its endorsement by promulgating, within such limits, recommended practise calling for a higher maximum beam candle power and a higher candle power in the beam spread to the right and to the left than is stipulated in the specifications. The I. E. S. headlamp specifications were approved as a "Tentative American Standard" in 1922. They are in use by the Eastern Conference of Motor Vehicle Administrators in which are represented all the New England States, (except Massachusetts) New York, New Jersey, Pennsylvania, Maryland, Delaware, Virginia, District of Columbia, Ontario, and Quebec. The specifications are also in force, either wholly or in part, in Ohio, Wisconsin, Iowa, Utah, Nebraska, Texas, California, and Oregon. Also they are recommended in the "Uniform Act Regulating the Operation of Vehicles on the Highways" prepared under the direction of Secretary Hoover in the National Conference of Street and Highway Safety.

The rear lamp specifications developed by the Illuminating Engineering Society cover the general relation of the lamp and license plate holder and the quantity and uniformity of illumination upon the license plate. At the present time the rear lamp specifications used by the State of Massachusetts are substantially in accord with those prepared by the Illuminating Engineering Society.

During the past year the Automotive Lighting Association has prepared specifications covering stop and direction signals and the depressed beam from controllable headlights or auxiliary driving lights. Subsequently somewhat different specifications for depressed beam lighting have been formulated tentatively by the Illuminating Engineering Society's Committee on Motor Vehicle Lighting. The matter also is understood to be under consideration by the Eastern Conference of Motor Vehicle Administrators.

A further advance made in the practise of the Eastern Conference of Motor Vehicle Administrators is a requirement for excellence of headlamp construction

not formerly imposed. Another forward step was taken by the National Conference on Street and Highway Safety in formulating a Uniform Vehicle Code intended to promote uniformity of regulatory action in the several states.

The depressible beam, fast coming into use in motor car lighting, is a step in the direction of securing the advantages of the desirable headlighting characteristic required by the specifications now in general use with the element of advantage otherwise secured through dimming. It is a step further in the direction of doing away with the disadvantage inherent in each practise, measurably avoiding the glare to which the approaching driver is subjected under the first practise and the hazard of passing vehicles with lights dimmed involved in the second.

The depressed beam has become a practicable device through the development of a lamp having twin filaments, one placed 9/64 in. above the other and suitably coordinated with lens or reflector elements. By switching from one filament to the other, the beam is depressed by from two to three deg. in a simple, positive, and easily applied manner.

Although but few of these devices as thus far developed are understood to have been approved by the Eastern Conference, more than 20 car manufacturers have adopted such equipments for their new cars.

*Research.* As a result of discussion following the 1925 Conference on Street and Highway Safety, a joint Steering Committee on Headlight Research has been formed by the Society of Automotive Engineers and the Illuminating Engineering Society.

The first objective of the Committee is to stimulate and guide experimental research directed toward the determination of the most satisfactory methods of automobile headlighting and, in accordance with the results of research, to formulate a code of recommended practise with respect to headlight equipment, adjustment, and use.

A program has been projected by the Committee including collection of data on visibility of objects under various conditions, experimental studies of visibility under conditions of actual driving, collection of data on quality and condition of lamps as used and the possibilities of bettering them, and a demonstration of the lighting which various automobile manufacturers consider most satisfactory for all-around use.

*Relation to Street Lighting.* In this connection it may be interesting to observe that the Committee on Street Lighting of the Illuminating Engineering Society is of the opinion that urban streets ought to be sufficiently well lighted to make it practicable to do away entirely with powerful headlights on automobiles, as is the practise in New York City, and to a limited extent in some other cities. It is held that streets which support considerable traffic ought to be sufficiently lighted to make this practicable, and that where such condition exists, the safety and convenience of all

concerned will be promoted. The Committee is engaged in establishing street lighting minima above which it can feel confident in recommending the abolition of headlights.

#### RESIDENCE LIGHTING

One of the serious obstacles to the provision of better lighting in the home is the general lack of adequate outlets and the apparent difficulty and expense of making additions.

In the 1925 report of this Committee, reference was made to the Red Seal Campaign which undertakes to establish a minimum limit of adequacy of wiring according to the needs of each community. This plan has been adopted by nineteen different local electric leagues operating in six hundred and seventy-six communities and reaching nearly ten million people. One manufacturer is undertaking to establish a nationwide standard of quality and adequacy, and it is probable that others will follow along similar lines. It is therefore becoming the fashion to provide suitable wiring.

Although home-lighting equipment is still being selected with the main emphasis on the artistic features of metal working, with inadequate attention to the artistic and utilitarian values of the illumination itself, there yet seems to be a slow but general progress toward a better understanding of the merits of good lighting. The more common use of such terms as "shaded lights" indicates the trend.

#### SCHOOL LIGHTING

Preliminary tests have been made for the city of Newark, New Jersey, to secure an indication of the quantity and character of artificial light desirable for special public school classes of pupils having defective vision.

Observations of reading and writing suggested 15-ft. candles, or about 50 per cent more than ordinarily recommended. Comparison seemed to show semi-indirect and direct lighting, with large diameter diffusing glassware, to be equally acceptable, when supplementing daylight.

#### RAILWAY LIGHTING

The first edition of a Manual of Lighting Practise for Railroads has been practically completed by the Association of Railway Electrical Engineers.

The following topics have been covered: Fundamentals of Illumination and General Design, Design Data, Railway Shop and Roundhouse Lighting, Office and Drafting Room Lighting, Freight and Passenger Station Lighting, Warehouse and Pier Lighting, Yard Lighting, and Car Lighting.

#### BUS LIGHTING

The 12- to 16-volt systems are rapidly displacing the six- to eight-volt systems formerly used in bus lighting. A 21-c. p. incandescent lamp in an S-11 bulb designed for 300 hours of life has been standardized particularly for this purpose. It is interesting to note

that some of the modern double-deck motor coaches have as many as 42 lamps for interior lighting. Special types of enclosing units and opal glass reflectors have been developed for motor coach lighting. Enclosing units are being used in the majority of new buses.

#### ILLUMINATION OF RAILROAD CLASSIFICATION YARDS

The employment of flood lights for illumination of railroad classification yards is becoming general. The Committee on Illumination of the Association of Railway Electrical Engineers reported that in 1924, 35 railroads had 90 yards equipped with an aggregate of about 2100 flood lighting units. Since that time the practise has been extended, notable recent installations being in the Selkirk Yard of the New York Central Railroad and the Markham Yard of the Illinois Central Railroad.

The necessity for adequate and proper illumination is enhanced by the introduction of the so-called mechanical car-retarder system for controlling the speed of cars in the gravity type of classification yard since the operators of such equipment must have a good view of the entire yard from their control towers.

The above mentioned Committee has received a report from one railroad covering operating records of yards for several months before and after equipment with flood lighting, there previously having been no artificial illumination in the yard. This showed an increase of 15.5 per cent in number of cars handled at night with a decrease of 21 per cent in the average cost of damage suffered by cars and with entire elimination of personal injuries attributable to inadequate illumination during the months in which the records were studied.

#### LIGHTING FOR ADVERTISEMENT

Electric signs and illuminated displays are a constantly growing factor in the advertising field. There has been within the last year a noted increase in the diversity of form of such displays together with a more rational design of the illuminated pattern based upon new engineering information.

#### SIGNAL LIGHTING

*Traffic Signal Lighting.* With the large increase in the use of electric traffic signals, there has come fortunately an approach toward uniformity of practise in their use. Red quite generally now means "Stop" and green means "Go". Amber signifying "Caution" is employed in many cities for the assistance of the pedestrian.

A lens, a glass reflector, and an incandescent lamp are the usual equipment for each signal. Styles of signals are becoming more nearly uniform. Flexibility of control for isolated units and for large interlocked installations is a feature of the latest developments. A centrally controlled progressive system of signal operation has been developed and placed in operation in Chicago, which is greatly expediting the flow of traffic through the "Loop" district. Many of the signals

installed in the past have not been sufficiently bright to have the necessary attention value when seen against the sky near the sun. Experience indicates that this is a subject to which considerable attention must be given to insure the efficacy of the signal under all conditions.

The proper solution of the traffic problem in any given case requires real engineering analysis.

With the multiplication of traffic signal lights, there comes a possibility of confusion which merits further study. Red traffic signal lights are sometimes placed at elevations of not more than 10 ft. above the roadway; there are red tail lights; and sometimes red stop lights on street cars and port running lights on motor buses. In some districts there is also a red signal at fire alarm boxes. Police patrol stations and building exit markers further complicate the situation. This is a matter which clearly requires care and attention if we are to avoid complexity of signal lights which may result in confusion and increase the accident hazard.

The 1926 Conference of Street and Highway Safety, taking cognizance of the above described situation in regard to traffic signals, adopted by majority vote a recommendation that yellow be employed as a rear lamp signal for motor cars.

*Railway Signal Lighting.* Progress is reported in the development of electric signals both to replace the kerosene lamp for night use and to serve as a full color signal both day and night. The development has involved specialized design of lamp filament and bulb, of optical system, of a universal accurate focusing mechanism, and of means for directing the light as desired.

*Aviation Lighting.* After much experimentation, particularly on the part of the United States Air Mail Service, it appears that the following is likely to become general practise in aviation lighting: a 500,000,000-c. p., high-intensity arc searchlight, visible in clear weather for 150 mi., is located every 250 mi. along the route. Every 25 mi. between these beacons are located 60-ft. steel towers supporting a 24-in. rotating beacon, employing a 30-volt, 900-watt, tungsten filament lamp. This beacon has a beam c. p. of approximately 7,500,000, and in clear weather is visible for 75 mi. The beam is elevated at an angle of one to one-half deg. above the horizon, and rotates at a speed that provides a flash every 10 seconds. In very hilly or mountainous sections, routes are marked with smaller beacons consisting of four automobile headlamps equipped with 12- to 16-volt, 21-c. p. tungsten filament lamps. These beacons are rotated at a speed of 10 rev. per min.

The boundaries of the principal landing fields are marked by 60-c. p. series lamps spaced 150 ft. apart around the edge of the field. Emergency landing field boundaries are marked by two-c. p., three- to four-volt lamps, 28 of these being connected in series around the boundary of the field. They are operated from gasoline-electric equipments. Each fitting has a relay which introduces an equivalent resistance into the circuit

in case of a lamp failure. It is usual to place a number of flood-lighting equipments along two sides of the field to illuminate it for landing purposes. These have 120-deg. Fresnel lenses and are equipped with 900-watt, 30-volt, tungsten filament lamps. To some extent 10-kw. ribbon filament lamps are also used in very large Fresnel type lenses for flood lighting landing fields.

With the development of commercial flying it is probable that there will arise requirement for well defined routes and landing fields. The total lighting load at a typical air mail field is 38 kw.

#### A NEW APPLICATION OF LIGHT

The transmission by wire or wireless of actual scenes or so-called "television" is understood to have been accomplished experimentally. With the aid of the photoelectric cell and the Moore gaseous conductor lamp it has been found possible to use relatively simple apparatus for the transmission and reception of pictures within the interval imposed by the human eye as a requirement for sustained vision. It is expected that this new art will be brought to commercial development at a relatively early date.

#### ILLUMINATION NOMENCLATURE AND SYMBOLS

Nomenclature, abbreviations, and symbols in the illumination field are now fairly well fixed in this country. The report of the Committee on Nomenclature and Standards of the Illuminating Engineering Society, having been submitted some time ago to the procedure of the American Engineering Standards Committee, was adopted as an "American Standard."

#### ILLUMINATION ITEMS IN THE PROCEEDINGS

Under the auspices of this Committee there have appeared in the proceedings from time to time brief articles designed to keep the membership posted as to significant developments in the lighting field. Evidences of appreciation having been received, this practise is being continued and may be recorded as a supplementary activity of this technical committee.

#### CONCLUSION

The Committee on Production and Application of Light, having thus reviewed the field of lighting within its purview, is in a position to report to the Institute that electric lighting is undergoing a sound and wholesome development under the influence of forces largely commercial in character but greatly beneficial from a public point of view.

The Illuminating Engineering Society is intent upon developing the science and the art of illumination and is making measurable progress in its activities. Associations of manufacturing and operating interests are contributing notably through progressive engineering and business development which derives adequate sanction from the fundamentally favorable consideration that every improvement in equipment and practise in the lighting field is mutually advantageous to the commercial interests and to the public.



# Fire Protection of Water-Wheel Type Generators

BY J. ALLEN JOHNSON<sup>1</sup>

Associate, A. I. E. E.

and

E. J. BURNHAM<sup>2</sup>

Associate, A. I. E. E.

*Synopsis.*—In recent years, much attention has been given to fire protection of turbo generators, resulting in a trend towards closed ventilating systems and the use of inert gas to smother combustion. Water-wheel type generators are not so well adapted to this method of protection. In water-power plants, water is the most readily available means for fire extinguishment, but its indiscriminate use through perforated pipes or nozzles may cause damage equal to that of the fire.

The present paper describes a system of fire protection for water-

wheel type generators which is designed to limit both fire and water damage to the section of the generator immediately adjacent to the point of origin of the fire. This is accomplished, first, by air baffles which control the flow of ventilating air around the armature end projections, and second, by the use of fusible sprinkler heads which permit the application of the water solely to the region of the fire. The means for preventing and detecting fires in such generators are also outlined. Tests made during design to establish the effectiveness of the scheme and devices used are also described.

THE problem of protecting generators against fires of internal origin is closely associated with that of their ventilation. This is obvious from the fact that the cooling medium ordinarily employed, namely, air, contains the oxygen required to support combustion. This fact has been recognized in that one method employed for extinguishing fires in generators is to control the composition of the atmosphere within the ventilating system. In closed ventilating systems, such as are now becoming standard for steam turbo generators, this may be accomplished in various ways. For instance, the fire may be permitted to burn until enough of the oxygen contained in the closed ventilating system is used up so that the remaining gases will no longer support combustion, or an inert gas such as carbon dioxide may be admitted to the ventilating system in sufficient concentration to lower the free oxygen content to a point where combustion will stop. A third method which has been proposed is to maintain at all times in the closed ventilating system an inert gas, such as hydrogen, as a cooling medium instead of air. Methods of protection, however, which have been worked out for steam-turbine-driven generators are not in general applicable without modification to water-wheel type generators.

The purpose of this paper, therefore, is to point out certain factors involved in the problem of fire protection of water-wheel type generators, and to record the principles and devices employed in the fire protection of the 65,000-kv-a. Niagara generators.

Let us therefore first catalog some of the essential points in which water-wheel type generators differ from steam turbo generators from the standpoint of fire protection.

1. Water-wheel type generators are of relatively large diameter. This means that the armature windings occupy a considerable circumferential length. For instance, in the 65,000-kv-a. generators to which

reference was made, the circumferential length of the armature windings is approximately 75 ft., whereas in turbo generators the diameters are small and the windings concentrated into a much smaller space. The significance of this fact is that it ought not to be necessary to burn up a whole winding, say 75 ft. long, on account of a fire starting at one point.

2. Water-wheel type generators are usually of open construction and employ an open system of ventilation as contrasted with the closed systems now usually employed with turbo generators. It is, indeed, becoming more common to employ semi-enclosed systems of ventilation for water-wheel generators in which either the air inlet or air outlet is enclosed, but it is seldom that both inlet and outlet are enclosed, and no case is known to the writer where a completely closed system of ventilation with air coolers is employed with a water-wheel generator, although such a case may exist.

3. In turbo generators it is now usual to employ forced ventilation in which the air is moved by an external fan and directed in definite paths through the generator ventilating ducts. In water-wheel type generators, however, a natural system of ventilation is usually employed in which the air is moved by means of the natural blower effect of the generator rotor, sometimes assisted by fan blades attached to the rotor, and sometimes, also, by an external blower the only function of which, however, is to bring the air to, or remove it from, the generator. This method usually results in a considerable circumferential motion of the air around the armature windings, particularly about those portions of them which project beyond the iron core. These end projections are frequently insulated with inflammable materials, and on account of this and their extent and exposure to the whirling air currents, they constitute the principal element of fire hazard in the generator. In many cases of fires which have occurred in generators of this type, it has been the experience that a fire originating at one point of the circumference has been communicated very quickly throughout the entire circumference of the generator through the agency of these whirling currents of air. When this occurs, it usually results in the loss of the entire winding, if, indeed, damage does not also result to other parts of the

1. Electrical Engineer, Niagara Falls Power Co., Niagara Falls, N. Y.

2. Central Station Engg. Dept., General Electric Co., Schenectady, N. Y.

Presented at the Pacific Coast Convention of the A. I. E. E., Salt Lake City, Utah, Sept. 6-9, 1926.

structure. In large machines this involves a very considerable direct loss which, however, is usually exceeded by the cost of the loss of use of the machine while repairs are being made. The latter is of especial significance in hydroelectric plants where it is unusual to find spare capacity available.

Figs. 1 and 2 are cuts made from photographs of the results of fires in the armature end projections of two horizontal-shaft water-wheel type generators. Both of these started from faults in the armature coils, and within a few seconds after starting, the flames had been swept completely around the circumference of the machine. Eye-witnesses state that within one minute

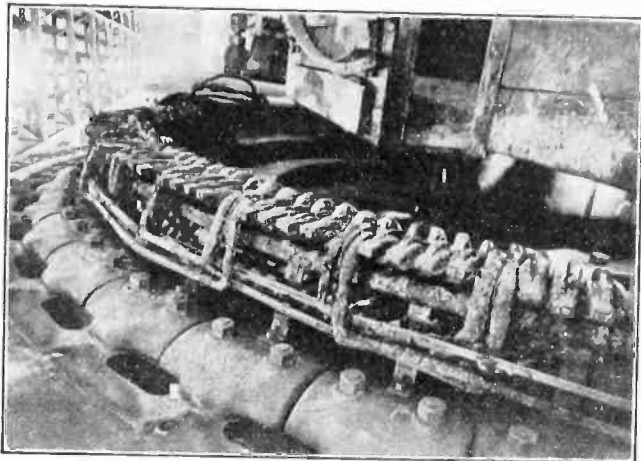

FIG. 1

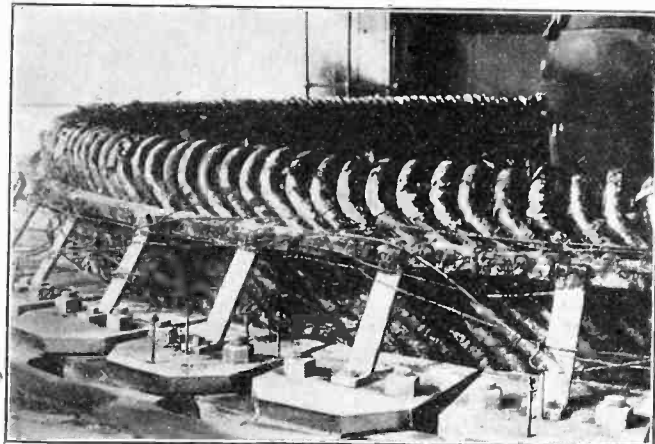

FIG. 2

FIGS. 1-2—EFFECT OF WHIRLING AIR CURRENTS ON FIRE IN END WINDINGS OF GENERATORS

after these fires started, the iron shields covering the end projections of the armature windings were at white heat. One of these fires occurred in a machine with completely closed ends and the other in one with partially closed ends, but the results were the same in both cases.

In view of these considerations, it would appear that, whereas in steam turbo generators the most promising element with which to work for fire protection is the *composition* of the ventilating atmosphere, in water-wheel type generators the *directing* of the ventilating atmosphere in its passage through the machine appears

to offer the most promising opportunity for the control of fire.

In any complete system of fire protection there are four necessary elements:

1. Prevention; that is, means should be provided to prevent, whenever possible, the starting of a fire.
2. Control; that is, assuming that a fire has started in spite of preventive methods, means should be provided to confine the fire to as small an area as possible.
3. Detection; means should be provided for promptly detecting the presence of a fire, and it is desirable that such means should also give an indication of its location.
4. Extinguishment; a fire having occurred, means for its prompt extinguishment should be provided.

#### PREVENTION

The only inflammable material built into a generator is the insulation. The use of non-combustible insulation, if that were possible, would therefore be the best fire preventive. Even Class "B" insulation as now employed, however, contains a considerable amount of inflammable material used as a binder, and the requirement for flexibility often dictates the use of fibrous or Class "A" materials on the armature end projections. Generator windings often also accumulate, between cleanings, considerable quantities of oily dirt of an inflammable nature, so that even the use of fire-proof insulation cannot always be depended upon to make a fire impossible.

Generator fires are usually caused by insulation breakdown. One obvious means of fire prevention, therefore, is to use a high factor of safety in the insulation of the windings.

Should a failure occur, however, the next obvious thing to do is to disconnect the generator from the system and remove its excitation as quickly as possible. This is best accomplished by means of differential relay protection in a manner now well understood and almost universally used. Such a differential relay system should be sensitive, and, from the fire prevention standpoint, should be arranged to de-energize the machine as promptly as possible. Reference is made to the recently published Relay Handbook for details of such applications.

#### CONTROL

In spite of all that may be done in the use of fire-resisting insulation, in preventing insulation failures and in de-energizing the machine in the event of a failure, a fire may nevertheless occur. In one case known by the authors, a stubborn blaze was initiated in a mica-insulated generator winding by an insulation breakdown on over-potential test with a 50-kw. testing transformer equipped with an instantaneous trip. Owing to the energy stored in the magnetic circuits of the generator, it is impossible to de-energize a machine instantaneously, and the writer therefore sees no reason

to believe that even the differential relay system will necessarily prevent the starting of a fire.

Assuming, therefore, that a fire may be started, the next problem is to prevent such a fire from spreading, or in other words to confine it to the smallest possible zone. Here appears the virtue of controlling the direc-

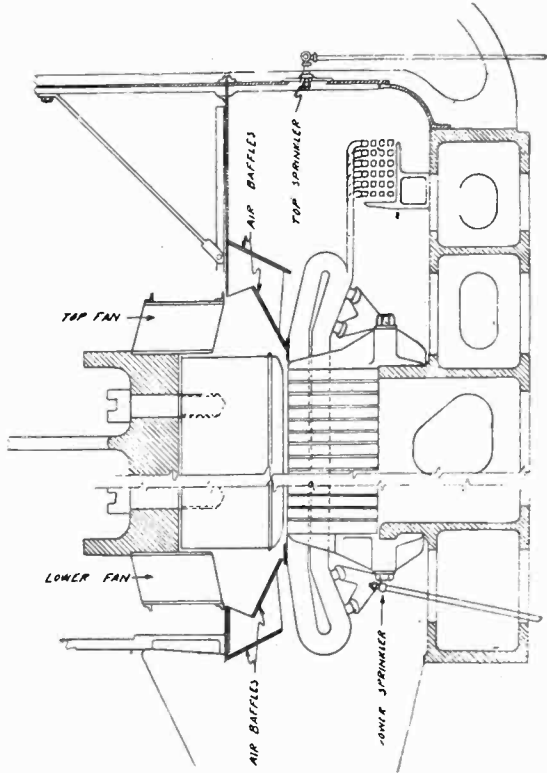

FIG. 3

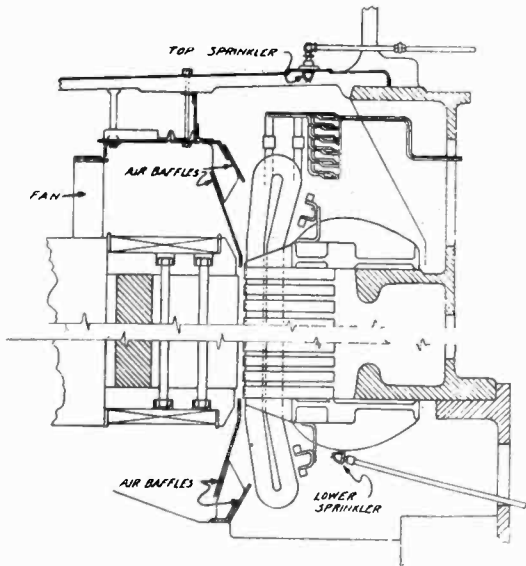

FIG. 4

FIGS. 3-4—CROSS-SECTIONS SHOWING APPLICATIONS OF FIRE BAFFLES TO TWO DESIGNS OF 65,000-KV-A., VERTICAL SHAFT GENERATORS

tion of flow of the ventilating air as it passes the generator windings. The minimum fire-spreading effect will result if the air currents are directed radially through the generator winding with complete suppression of the circumferential component of the movement. The requirements for cooling, of course, necessitate that

some air shall be allowed to pass through and around the armature windings. Through the core, ventilating ducts are provided for this purpose. It has been customary, however, to permit the air to flow about the projecting ends of the armature coils in any manner which might result from the chance arrangement of the parts without any specific provision for guiding it in any particular direction, radial or otherwise. The result has been the production of a large circumferential component of air velocity in the neighborhood of the armature end projections.

To rectify this condition, the idea was conceived of placing between the rotating field and the armature end projections a stationary structure of some sort for the purpose of guiding the air currents in a radial direction through and between the armature end projections. Such a structure might be of a number of different forms, such as, for instance, a perforated wall, or a series of vanes which might be of any required shape, or an arrangement of baffled passages. After considerable study of these three alternatives, an arrangement of passages between two inclined walls was adopted for the 65,000-kv-a. generators. Figs. 3 and 4 show the application of this scheme of air control to the two makes of 65,000-kv-a. generators installed by The Niagara Falls Power Company, and Fig. 5 is a reproduction of a photograph showing the baffles installed at the lower ends of the coils in one of the generators. In order to prevent the generation of eddy currents in these baffles due to their presence in a strong varying magnetic field, they are made of insulating material.

The effectiveness of these baffles in directing the air through the end windings is very marked, the hurricane of air usually found about the armature end projections in conventional machines of this type being entirely absent from the machines equipped with these baffles.

The effectiveness of the radially directed air currents in preventing the spread of a fire was demonstrated by means of tests on a full scale model of a small section of one of these generators. These tests will be hereinafter described, and seem to indicate that by this means a fire may be confined to a circumferential length of not over two ft.

#### DETECTION

A fire having been started, it is, of course, desirable to detect its presence immediately, and since we have now found means of confining a fire to a small section of the winding, means of locating it in the machine are also desirable. In the case of the 65,000-kv-a. machines, the heated ventilating air is collected in a steel housing which surrounds the armature frame and is thence blown out of the building by means of separate motor-driven blowers. This arrangement would lend itself very readily to a system of smoke detection involving the use of a photo-electric cell. Such a system has not, however, been installed. Various detectors based on

abnormal temperatures might also be employed; one device suggested consists of a fuse wire carried around the generator and arranged to give an indication upon being fused at any point. Another possible device would be a vapor tension thermometer with its bulb in the form of a long slender tube extending completely around the machine. This would indicate the maximum temperatures at any point throughout the length

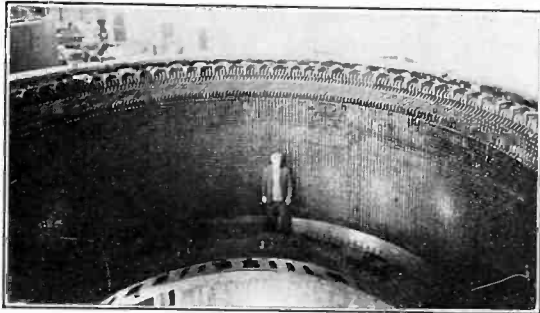

FIG. 5—FIRE BAFFLES INSTALLED AT LOWER END OF ARMATURE OF 65,000-KV-A. GENERATOR

of the tube. A third system of giving the indication of the presence of a fire is the use of sprinkler heads in which case the means of detection and of extinguishment are combined. With any system the provision of hand holes at frequent intervals about the circumference of the machine is desirable both for the purpose of locating the fire and for allowing access to it by means of hand extinguishers or a fire hose. The combination of sprinkler heads and hand holes was used in the 65,000-kv-a. generators (Fig. 6).

#### EXTINGUISHMENT

A number of mediums are now available for extinguishing fires in electrical apparatus, the principal ones

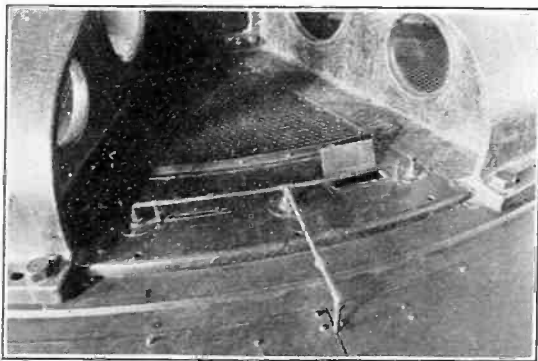

FIG. 6—HAND HOLES AND SPRINKLER HEADS AT TOP OF 65,000-KV-A. GENERATOR

being water, steam, carbon dioxide, carbon tetrachloride, "Fire Foam," and the well-known soda acid extinguisher. These may be applied in various ways; for instance, soda acid, "Fire Foam," and carbon tetrachloride are usually applied by hand or portable tank extinguishers. Water or steam may be applied through a hose; or water, steam, "Fire Foam," and carbon dioxide may be applied through permanent piping.

In the case of the 65,000-kv-a. generator at Niagara, the means provided for extinguishment consist, first, in a series of hand holes giving access to the windings for the use of hand or portable extinguishers or water hose. There is also installed at suitable points near the armature end projections, a series of sprinkler heads connected by piping through a manually-operated lever valve to a source of water under pressure. This sprinkler pipe is arranged to be maintained under air pressure with a contact-making gage adjusted to sound an alarm upon the reduction of this pressure through the blowing of a sprinkler head (Figs. 7, 8, 9, and 10).

It has been ascertained by means of tests upon the above mentioned model that a fire can be maintained for a considerable length of time under the system of air control installed in these machines without spreading appreciably beyond its point of initiation, so that upon

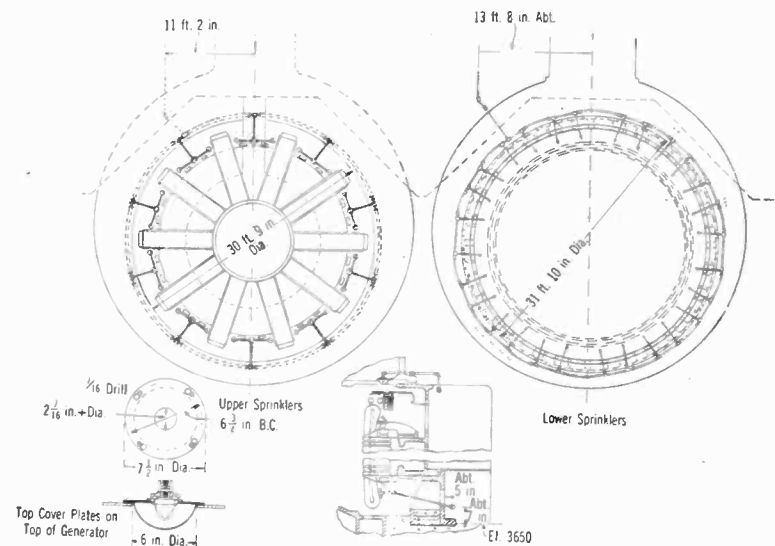

FIG. 7—DETAILS OF SPRINKLER HEAD AND PIPING INSTALLATION IN 65,000-KV-A. GENERATOR

occurrence of a fire, the operator has ample time to determine its location by inspection through the hand holes. Having located the fire, the operator is instructed to attempt its extinguishment first by means of hand or portable extinguishers using carbon tetrachloride or "Fire Foam." Should these prove insufficient, he can employ the soda acid extinguisher, or if his judgment indicates the necessity, he can turn on the water in the sprinkler system by means of the above mentioned lever valve. In this event the application of the water will be limited to one or two sprinklers which will have opened immediately adjacent to the fire, so that the water damage will be confined to as small a portion of the machine as possible.

If the use of carbon dioxide for fire extinguishment is perfected to a point where it is applicable to machines of this type, there would appear to be no reason why the general system of protection installed in these machines would not be readily adaptable to its use. It would appear that the baffles between the rotor and

armature coils might be of material assistance toward the effective use of carbon dioxide.

DETAILS OF INSTALLATION ON 65,000-KV-A. GENERATORS

These are shown in Figs. 7, 8, 9, and 10. The air baffles are constructed of bakelized canvas or asbestos supported by suitable castings with radial vanes forming passages for the cooling air.

The sprinklers are of modified standard design and are enclosed in baskets of sufficiently fine wire mesh to retain the loose parts resulting from a blow-off.

Separate piping systems are provided for the top and bottom ends of the armature windings with separate alarm signals so that a fire may be immediately located with respect to the two ends of the generator.

The manually-operated control valves shown in Figs. 9 and 10 are normally sealed in the closed position and are so arranged that any leakage of water into the

arrangement of sprinklers, to determine whether the temperatures produced by a fire would be sufficient to operate standard sprinkler heads, and whether the air control devices proposed would be effective in confining the fire to a small area.

The first series of tests was taken to determine the following points:

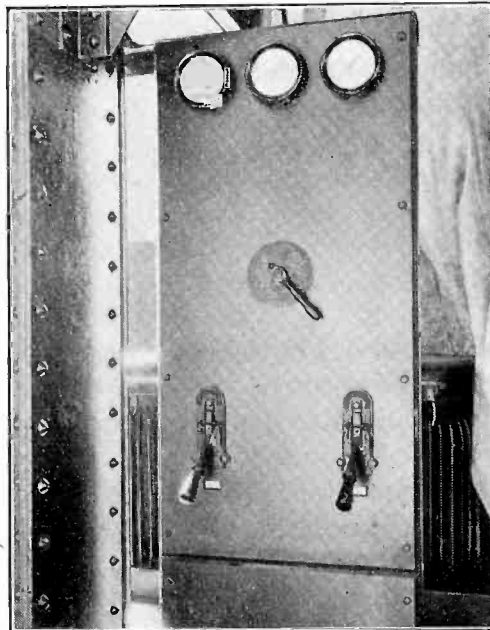

FIG. 9—ARRANGEMENT OF HANDLES OF THREE-WAY VALVES AND CONTACT-MAKING PRESSURE GAGES

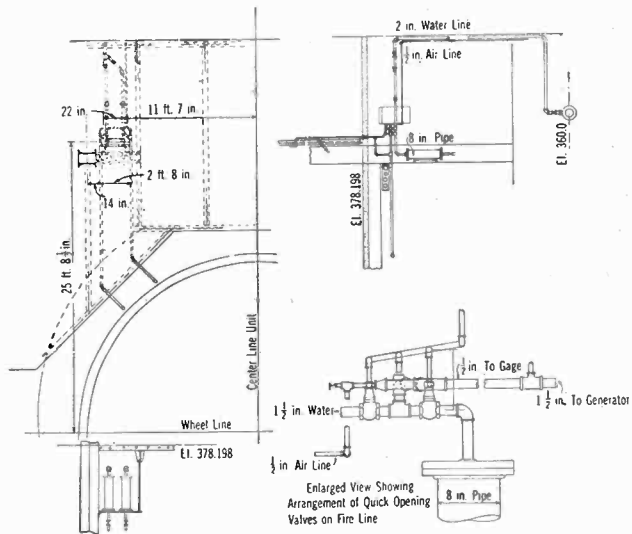

FIG. 8—LAYOUT OF AIR AND WATER PIPING, THREE-WAY VALVES, SUMPS AND CONTACT-MAKING GAGES

sprinkler piping which may take place is caught in a sump and may be periodically drained off. The opening of the valve for draining the sump will automatically test the alarm system by lowering the air pressure in the sprinkler system.

The air valves through which compressed air is supplied to the sprinkler pipes are of the needle type and may be kept slightly open so as to automatically maintain the air pressure so long as all sprinkler heads are intact. Upon the blowing of a head, the pressure will drop due to the throttling effect of the needle valve and the alarm will be given.

The contact-making pressure gage is of standard design arranged to close a contact upon a drop in pressure to a predetermined value. Any desired form of alarm can be used.

TESTS

Before adopting the above described system of protection for the 65,000-kv-a. generators, a series of tests was made to determine the best type and ar-

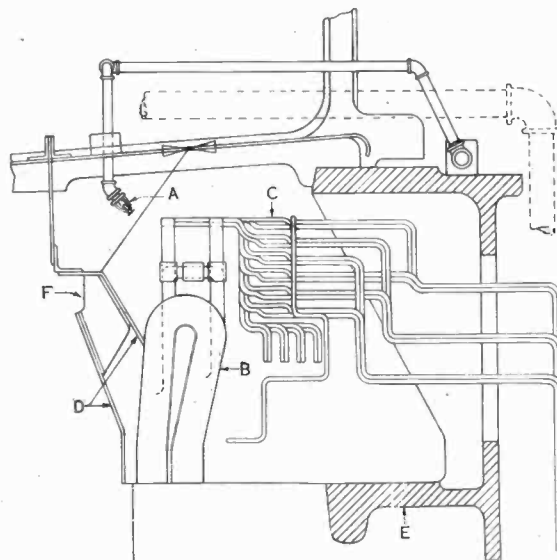

FIG. 10—SECTIONAL VIEW OF GENERATOR

Showing relative location of end windings, connections and sprinkler. A—sprinkler, B—stator coil, C—stator connections, D—fire bafflers, E—stator frame, F—air inlet

1. Location of sprinkler heads with respect to generator windings.
2. Design of sprinkler-head deflector.
3. Design of screen to catch links or parts which fly out from sprinkler heads when they operate.

It was impossible to make the proposed tests on one of the 65,000-kv-a. generators; therefore it was desirable

to make the conditions under which the tests were to be taken as near like actual conditions as possible.

Fig. 10 shows a section of the generator with location of sprinkler head as originally estimated to be approximately correct. Fig. 10 also shows the relative locations of the stator-coil end windings, stator connections, and fire baffles, and also shows the relatively small amount of space above the electrical parts in which to locate the sprinkler heads.

In order to see exactly how water would spray from the sprinkler heads under different conditions, a dummy

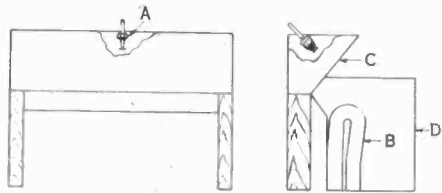

FIG. 11—DUMMY SECTION OF GENERATOR USED IN THE WATER-SPRAY TESTS

A—Sprinkler, B—stator coil, C—screen, D—beaver board

section of the generator was made up in the form of a wooden box as shown in Fig. 11. This box represented at full scale one of the generator sections in which a sprinkler head was to be located. The length of the box represented the length of one of these sections measured on the circumference of the generator at the air-gap. On account of the size of the 65,000-kv-a. generators, the air-gap did not vary far from a straight line in the length of a section being considered; therefore for our test purposes, the box was made without curvature.

The ends of the box represented the barriers to be placed between sprinkler heads. Side pieces made of beaver board were fastened to the ends of the box, and on each a stator-coil end projection was drawn in its relative position as shown in Fig. 11.

A screen was placed across the front of the box as some such protection would be needed in actual practice to keep the links of an operated head from dropping down into the generator windings. Medium-weight wire screening was used, having five wires per in. each way, it being found by trial that links from the sprinkler heads would not go through mesh of this description, while they would go through mesh having wires of the next greater standard spacing.

In this first set of tests no fire was used, as the principal object was to determine how well water would be sprayed into the generator windings and connections under different conditions. As fires in generators usually occur in the stator-coil connections or stator-coil end projections, it was necessary in the tests to find an arrangement in which water would reach these parts effectively.

Before taking the tests it was quite obvious that water could be sprayed in large quantities on the stator windings and connections directly in front of the

sprinkler, but it was not certain just what position of sprinkler head and type of deflector would give the best water distribution over the entire area to be considered. From Fig. 11 it can be seen that the area to be covered was much longer than it was wide, but it was just as important that the water reach the coils at the ends of a section, or in other words, that it reach coils midway between two sprinklers, as it was to reach the coils directly in front of the sprinkler.

In the sprinkler tests, over two dozen different special deflectors were used, and several locations of sprinkler and angle of spray were tried. The water pressure, also, was varied to determine the effect of such a change on the water distribution.

Under each test the water distribution was observed and rated in five ways as follows:

1. Distribution and distance water sprayed directly in front of sprinkler head.
2. Amount and distribution of water sprayed onto beaver boards at side.
3. Amount and distribution of water backward into box.
4. Amount of water to reach upper corners at each side of box.
5. Spray of water in general.

Regarding the location of sprinkler head and angle of spray, the best results were obtained with the sprinkler head tilted down 45 deg. from horizontal and located in the box so that the center of the sprinkler-head deflector was five in. from the back and three in. from the top of the box.

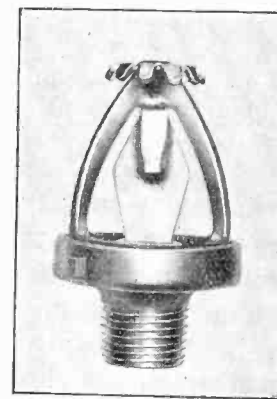

FIG. 12—STANDARD SPRINKLER HEAD USED IN FIRE PROTECTION OF BUILDINGS

If the sprinkler head was tilted more than 45 deg. from horizontal, an undue amount of water was sprayed into the box; and if the angle was made less than 45 deg., a larger portion of water than necessary was sprayed out directly in front.

Fig. 12 shows a common type of sprinkler head as generally used in fire protection of buildings. It will be noted that the deflector used at the top of this sprinkler has projections or ears around its outer edge which are bent downward. It was quite obvious that this type of deflector would not meet our needs, as the bent

ears have a tendency to spray a larger portion of the water backward.

After many tests were made in which a large number of different deflectors was used, it was found that a deflector as shown on sprinkler head in Fig. 13 gave the best results. This deflector, which is approximately 13/16 in. in diameter and is cupped upward slightly, happens to be a deflector which is used on many sprinkler heads in mills where the projecting ears of the

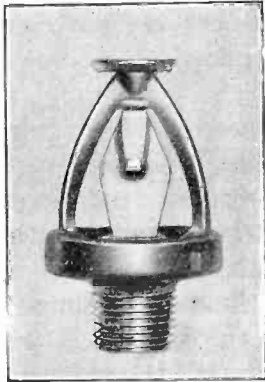

FIG. 13—SPRINKLER HEAD USED IN 65,000-KV-A. GENERATORS

standard sprinkler are objectionable. When used in mills, however, the deflector is cupped downward instead of upward.

In order to show how the design of a deflector affects the water distribution, a few of the deflector tests will be described.

1. Deflector in accordance with Fig. 13. The water was sprayed a distance of six ft. out in front of the box, and the beaver boards at the sides were well covered. Some water was sprayed backward into the box. With this deflector, the water was discharged in a fine spray which almost resembled a fog. The distribution of water over the desired area was very good.

2. Same as (1) except that deflector of larger diameter was used. Water was sprayed farther out in front than in case (1), but the spray was not as fine and the general distribution was not as good as in case (1).

3. Deflector in accordance with Fig. 12 except that all but two ears on opposite side were cut off. (It was thought that the two remaining ears might help throw more water out to the sides.) Water was sprayed farther out in front than in case (1). Water spouted up at ears, but distribution at sides was not as good as in case (1).

4. Same as (3) except that all ears were cut off. Results were about the same as those of (3).

5. Same as (1) except that deflector was inverted and therefore cupped down instead of up. Less water was sprayed out in front than in case (1). Practically no water reached the beaver boards at the sides. Large amount of water discharged back into the box.

The deflector tests such as described above were taken with a medium water pressure of 43 lb. per sq. in. With deflector used in case (1), the water pressure

was increased to 100 lb. per sq. in. With this pressure the spray became extremely dense, and the distribution of water remained good.

By decreasing the water pressure it was found that the quantity of water and the distribution of water was satisfactory down to a pressure of 30 lb. per sq. in. With a pressure of 25 lb. per sq. in. the results were only fair; therefore it was felt that in practise the water should be held up to at least 30 lb. per sq. in. This matter of water pressure can be easily taken care of in case of the 65,000-kv-a. generators, as the normal water pressure in the station is approximately 80 lb. per sq. in.

The principle of operation of the sprinkler heads used may be seen from the construction shown in Figs. 14 and 15. Fig. 14 shows the cross-section of a sprinkler head and position of links before the head has operated, and Fig. 15 shows the same head with position of links shortly after the head has operated.

It may be noted that the links of a sprinkler head are small levers so assembled that they can be held together in the normal position before operation by a very small amount of solder. By using solders of different melting points, the sprinkler heads can be made to operate over a wide range of temperatures.

Ratings of sprinkler heads have been standardized so that a head may be obtained having a rating of 155, 212, 286 or 360 deg. fahr. For each different rating the composition of the solder is such that the heads will operate at a temperature corresponding to the rating.

In order to make sure that sprinkler heads located in the 65,000-kv-a. generators as previously determined would operate satisfactorily in case of a generator fire, further tests were considered.

Actual fire tests seemed desirable, as it was not certain

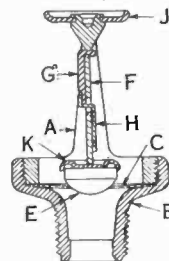

FIG. 14—CROSS-SECTION OF SPRINKLER HEAD

Showing position of links before operation

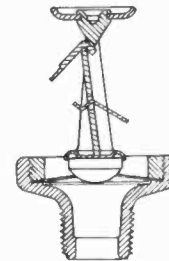

FIG. 15—CROSS-SECTION OF SPRINKLER HEAD

Showing position of links after operation

A—Yoke, B—body, C—diaphragm, E—glass valve, F—main strut piece, G—hook link, H—key link, J—deflector

that heat sufficient to operate the sprinkler heads would have a chance to reach them in case of a generator fire. The ventilation of these generators is such that a current of air passes in a horizontal direction through the stator connections and end windings and then out through openings in the stator frame. It seemed possible that in case of a fire in the end windings or con-

nections of one of the generators, sufficient heat to operate a sprinkler head might not pass up through this current of air.

Another point in question regarded the wire screen which was to be used to keep the links of an operated head from dropping down into the generator windings. It is known that a wire mesh offers some resistance to the passage of heat, and it was thought desirable to check this point in a test to find out if heat sufficient to operate a head in case of a generator fire would pass through the proposed screen.

In order that the second series of tests could be made

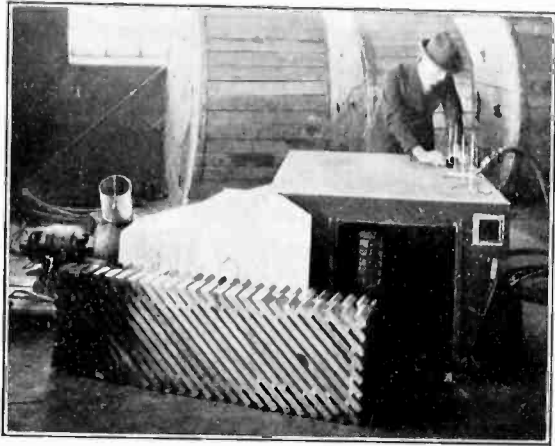

FIG. 16—DUMMY SECTION OF GENERATOR USED IN FIRE TESTS

conveniently, a dummy generator section was made of sheet metal. The construction of this compartment was such that, turned one way, it represented a section of the generator at the top of the machine, and inverted, it represented a bottom section of the generator. Dummy stator connections and stator-coil end projections were also constructed, these being made of wood. All parts were made to full scale.

Fig. 16 shows the dummy compartment in a position representing a top section of one of the generators. It may be noted that the door has been removed and the dummy coils taken out of the sheet metal compartment and placed in the foreground so that the construction may be seen. In the same figure, an end view of the dummy stator-coil connections may be seen in position in the compartment. The dummy connections and coils were made of boards one in. thick and spaced  $\frac{1}{2}$  in. apart. With this construction the wooden parts could be easily ignited for the fire tests.

A motor and exhaust fan were connected to the sheet metal compartment as shown in Fig. 16, in order that air might be circulated through the stator coils and connections in the normal way.

Provision was made for the mounting of a sprinkler head in the test compartment as previously determined. Four thermometers having 150-deg. cent. scales were suspended through small holes in the top of the compartment as shown. With the use of the thermometers, temperatures could be read at time intervals between the starting of the fire and the operation of the sprinkler

head. By means of a hose, air pressure was placed on the sprinkler heads so that the operation of a sprinkler head would be known immediately by the rush of air.

Fig. 17 shows a cross-section of the test compartment described above with door removed and the dummy connections and stator end projections in their normal position. The location of the wire screen and fire baffles is also given. The small glass window in the end of the dummy section was provided so that the intensity of the fire could be watched with the metal door in place and the compartment entirely closed except for the air inlet in the front and the air outlet in the rear.

Shutters were placed in the air inlet and a damper in the air outlet so that the flow of air through the compartment could be regulated if desired.

With the test equipment arranged as shown in Fig. 17, the first set of fire tests was made. Fire was started at different places in the dummy connections and coils by means of a small rag soaked in kerosene. After a sprinkler head operated, the wooden parts were taken from the compartment and the fire was put out by means of steam.

In Fig. 18 some representative temperature curves are given showing the results of a few of the tests made with the fire started in the dummy coils. In these curves, temperature in degrees centigrade is plotted against time in minutes. In the first four tests shown, the shutters in the air inlet and the damper in the air outlet were open and the fan was running. In the last test shown, the fan was shut down. The four different curves for each test represent the readings of the four different thermometers which were numbered one to four from right to left facing the front of the

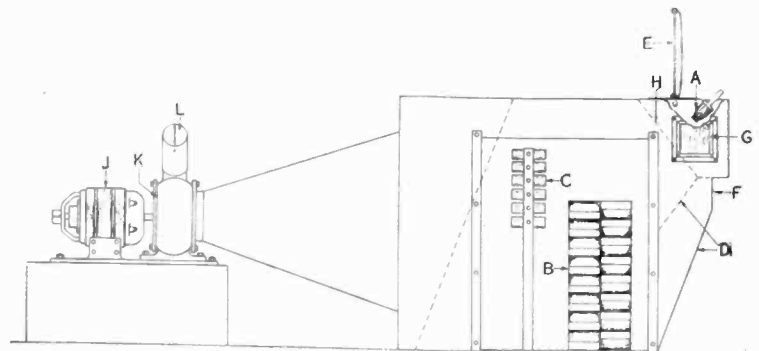

FIG. 17—CROSS-SECTION OF SHEET-IRON DUMMY COMPARTMENT USED IN FIRE TESTS

dummy compartment. Temperature readings were taken every quarter of a minute.

In tests 2, 5, and 7, 100-deg. cent. sprinkler heads were used and in tests 3 and 6, 68-deg. cent. heads were used. Facing the front of the compartment, the fire was started in the left end of the dummy coils in tests 2 and 3, and in the middle portion in tests 5, 6, and 7.

It should be noticed that in these tests the temperature curves become very steep close to the time of head operations. In fact, the temperature increased so



fast that the thermometers were raised out of the compartment in order to keep them from going off scale and breaking. This accounts for the fact that the curves do not in all cases extend to the vertical line which indicates the time of head operation.

As would be expected, the curves show that under similar conditions the 68-deg. heads operate sooner than the heads rated 100 deg., although the difference in time is small. By comparing test 2 with test 3, it may be seen that with the fan running and with the

the fire and in some cases the dummy coils were left more moist than in others. By comparing tests 5 and 6, it may be seen from the curves that soon after the fire was started it required  $\frac{1}{2}$  min. longer in test 5 than it did in test 6 to reach a certain temperature. By making correction for this difference, the 100-deg. cent. head of test 5 would have operated about  $\frac{1}{2}$  min. sooner, or in approximately  $2\frac{5}{8}$  min., had the fire developed to raise the temperature as in test 6 where a 68-deg. cent. head was used. In other words, the

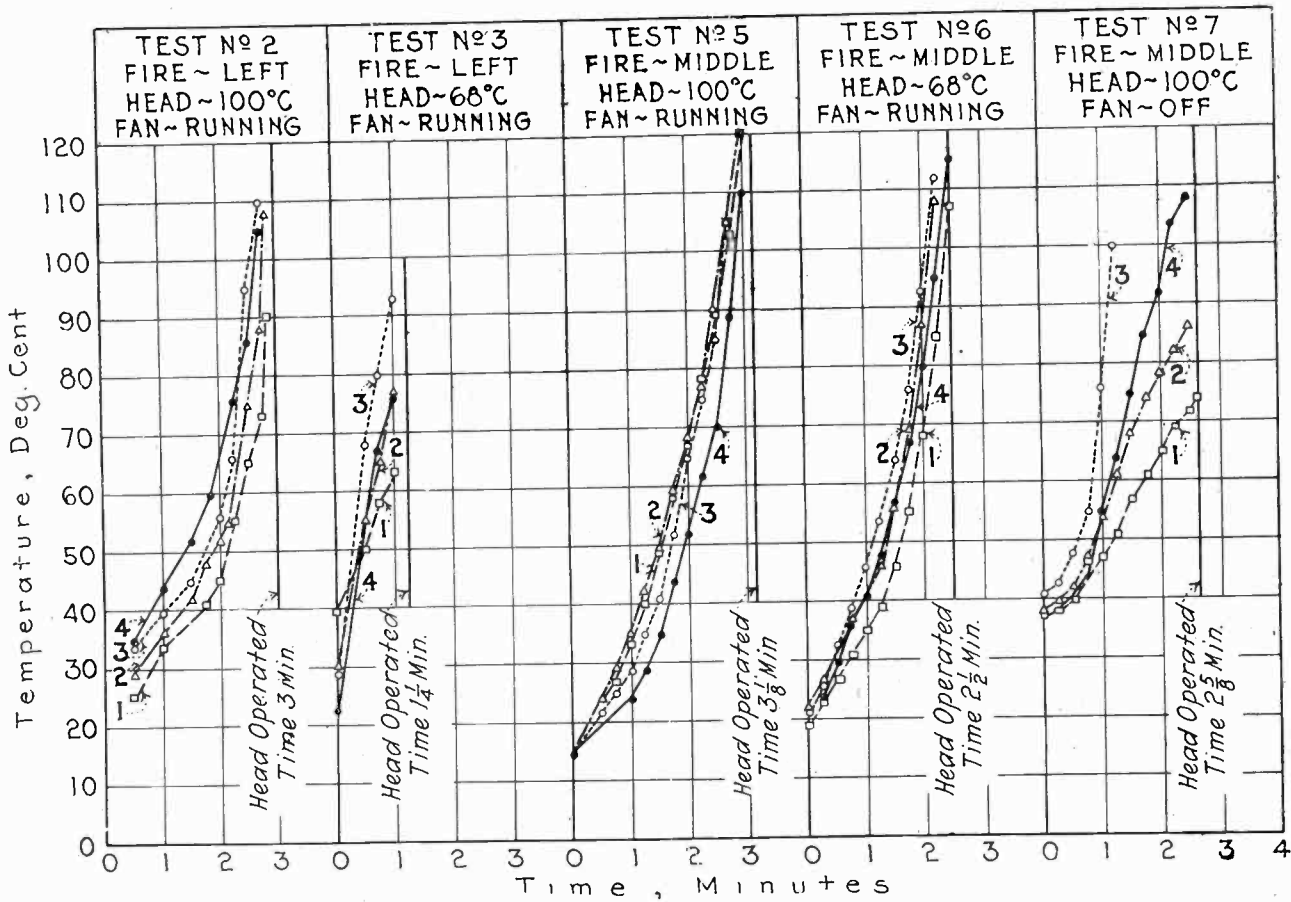

FIG. 18—REPRESENTATIVE TEMPERATURE CURVES

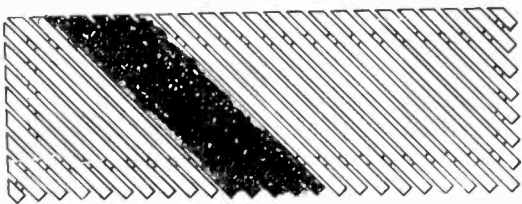

FIG. 19—DUMMY COILS SHOWING BURNED PORTION

fire started in the left end of the dummy coils, the 100-deg. head operated in three min. and the 68-deg. head in  $1\frac{1}{4}$  min.

Tests 5 and 6 show that under conditions similar to those described above except that the fire is started in middle of the dummy coils, the 68-deg. head operated in  $2\frac{1}{2}$  min. and the 100-deg. head in  $3\frac{1}{8}$  min.

It may be noted that in some of the tests the fire got started a little sooner than it did in other tests. This was due to the fact that steam was used to extinguish



FIG. 20—DUMMY CONNECTIONS SHOWING BURNED PORTION

difference between  $2\frac{5}{8}$  min. and  $2\frac{1}{2}$  min., or  $\frac{1}{8}$  min., gives approximately the difference in time between operation by a 100-deg. cent. head and a 68-deg. cent. head, under such conditions as existed in test 6.

In all cases it may be noted that the temperatures as measured with the thermometers exceeded the sprinkler head ratings before the heads operated. This does not mean that the heads were rated incorrectly but rather that with the temperature increasing rapidly, the time lag is greater in the sprinkler heads than in the thermometers.

Fig. 19 shows the way the dummy coils were burned and charred in Test No. 5, this being a typical case. In this test the fire was started in the middle of the dummy coils, and it should be noted that the fire followed up the diagonal wooden members, but due to the strong current of air that was being blown through the dummy coils, the fire did not spread to the right nor to the left appreciably. Fig. 20 shows the way the dummy connections were burned in the same test. Later a similar test was made in which the fire was allowed to burn for 15 min. in the dummy coils. The results were about the same in that the fire spread very little. This is a very important point since the fire damage can be reduced to a minimum if the fire in coils of generators can be prevented from spreading.

In test No. 7 the fan was not running; otherwise the test is the same as test No. 5. By comparing tests Nos. 7 and 5, it may be seen that the operating time is  $2\frac{5}{8}$  min. in one case and  $3\frac{1}{8}$  min. in the other, which shows that the current of air passing through the compartment has very little effect in the operation of the sprinkler heads.

Another set of tests was made with the fire located in the dummy connections. By moving the sprinkler heads back slightly from their first position, very good operation of the sprinkler heads was obtained. The operating time was approximately  $1\frac{3}{4}$  min. for the 68-deg. head and approximately  $2\frac{1}{2}$  min. for a 100-deg. cent. head.

With the dummy sheet metal compartment inverted, an additional set of tests was made to determine the effectiveness of the sprinkler heads in protecting the

stator-coil end projections at the bottom of one of the 65,000-kv-a. generators. For this case, the operating time was about  $2\frac{1}{4}$  min. for the 68-deg. cent. heads and approximately  $3\frac{1}{2}$  min. for the 100-deg. cent. heads.

#### CONCLUSION

The tests proved conclusively that the proposed scheme of fire protection as described would be very satisfactory for the 65,000-kv-a. generators for the following reasons:

1. Sprinkler heads arranged in the generator as shown and properly spaced would operate for a very small fire in the stator end windings or stator connections.

2. Sprinkler heads would operate in spite of the air currents, which, in case of the coil projections and connections at top of generator, would tend to carry the heat from a fire away from the sprinkler heads.

3. With current of air flowing radially through the end windings and connections, a fire started in these parts is confined to a small section even after the fire has burned for as long a time as 15 min.

4. If a fire started in the generator windings cannot be extinguished easily with hand fire extinguishers, the operator can then turn a valve which will allow water to be sprayed effectively in the region of the fire only, thereby doing minimum damage to the remainder of the machine.

The authors wish to acknowledge the valuable assistance given by Mr. Ira Knight of the General Fire Extinguisher Company, who furnished equipment and helped to carry out the water spray tests.

## Power Generation

### Annual Report of Committee on Power Generation\*

VERN E. ALDEN, Chairman

*To the Board of Directors:*

Last year's report of this Committee reviewed the many important developments in the art of power generation and dealt particularly with advances in steam station design and operation. As a committee we were just a little prone to believe that there could

not be the advance during 1925 that had taken place during 1924. Nevertheless, substantial progress has been made.

#### IMPORTANT TECHNICAL ACHIEVEMENTS OF THE LAST YEAR

1. The 3000-kw. turbine designed for operation with a steam pressure of 1200 lb. per sq. in., which was referred to in last year's report, was placed in operation in the Edgar Station of The Edison Electric Illuminating Company of Boston in December 1925. This turbine, receiving approximately 125,000 lb. of steam per hr. from a single high pressure boiler, exhausts its steam first through a reheating superheater built into the same setting with the high pressure boiler. The steam is then delivered to the main steam header of the station at a pressure of approximately 350 lb. per

\*Committee on Power Generation:

Vern E. Alden, Chairman, Consolidated Gas & Electric Company, Baltimore, Md.

H. A. Barre,	P. Junkersfeld,	J. C. Parker,
E. T. Brandon,	H. A. Kidder,	M. M. Samuels,
H. W. Eales,	J. T. Lawson,	F. A. Scheffler,
Louis Elliott,	W. H. Lawrence,	R. F. Schuchardt,
N. E. Funk,	James Lyman,	A. R. Smith,
C. F. Hirshfeld,	W. E. Mitchell,	Nicholas Stahl,
Francis Hodgkinson,	I. E. Moulthrop,	W. M. White.

This report published in pamphlet form includes an extensive bibliography.

*Presented at the Annual Convention of the A. I. E. E., White Sulphur Springs, W. Va., June 21-25, 1926.*

sq. in. The most annoying trouble encountered in connection with this unit has been vibration incident to double winding on rotor and possibly undue flexibility in the rotor shaft of the generator which runs at 3600 r. p. m.

The rotor was originally of the built-up type with squirrel-cage winding in addition to the usual externally excited field. This arrangement was adopted as a precaution in case there should be governor trouble arising from the use of extremely high pressure steam. As the governing and synchronizing have proved to be perfect, however, the generator has been equipped with a solid field and all vibration has been entirely eliminated.

The action of the unit is perfectly normal and indicates that equipment of this character is suitable for regular commercial service, where economically justifiable.

This unit has had over 1800 hours of commercial operation including one run of over three weeks' time without a shutdown.

The performance of the Edgar Station has been highly satisfactory. Operated with a favorable load factor and good coal, the 350-lb. pressure plant has a record of one lb. of coal per kw-hr. which means practically 14,000 B. t. u. per kw-hr.

With the single high-pressure boiler and the 3600-kw., 1200-lb. pressure turbine in service, the average coal consumption per kw-hr. for the whole station is reduced three per cent. This indicates that if all four boilers were of the high pressure type, the fuel consumption per kw-hr. would be reduced 10 per cent, to a value of 0.9 lb. of coal per kw-hr.

2. With the exception of moderately high outages of the generating units, the operation of the Philo Station of the Ohio Power Company, the Twin Branch Station of the Indiana and Michigan Electric Company, and the Crawford Ave. Station of the Commonwealth Edison Company, all at a pressure of 550 lb. per sq. in. and a steam temperature of 725 deg. fahr. with the reheating cycle, has been quite satisfactory. The troubles encountered have been of a nature not entirely chargeable to the use of the higher steam pressure and temperature and the use of the reheating cycle. The indications are that these stations may be counted upon for thoroughly satisfactory and reliable service.

3. The Columbia Power Company's new 90,000-kw. station designed for operation with steam at a pressure of 550 lb. per sq. in. and a temperature of 725 deg. fahr. and for operation on the reheating cycle was started in December of last year.

4. Two more turbines have been purchased for the Crawford Ave. Station in Chicago, and a turbine has been purchased for Waukegan Station of the Public Service Company of Northern Illinois, all for operation at a steam pressure of approximately 550 lb. per sq. in. Two new stations have been designed for operation with this same pressure. There is accordingly either in

operation at a pressure of 550 lb. per sq. in. or now projected a total of 925,000 kw. of power station capacity.

5. The Milwaukee Electric Railway and Light Company is installing in its Lakeside Station for operation at 1200 lb. pressure a boiler of modified Stirling type which will deliver steam to a 7000-kw. turbine, the steam temperature at the throttle being 720 deg. fahr. The steam will be exhausted through a reheating superheater into the main steam header of the station, maintained at a pressure of approximately 315 lb. per sq. in.

6. Of particular interest has been the increase in the size of turbo generator units as exemplified by the purchase during the last year of the following machines:

a. A 77,000-kw. and a 90,000-kw. unit purchased from the General Electric Company for the Crawford Ave. Station in Chicago.

b. An 80,000-kw. Westinghouse turbine for the Hudson Ave. Station in Brooklyn.

c. A 160,000-kw. turbine for the Hell Gate Station of the United Electric Light and Power Company of New York.

This trend towards the use of still larger units is further indicated by the projected use of turbo generator units of 200,000-kw. capacity in the New State Line Station near Chicago. It is to be remembered that the largest machine which we had to report upon twelve months ago was of 60,000-kw. capacity.

7. The first large furnace of the Fuller Well type designed for pulverized fuel firing with turbulent mixing of coal and air has been placed in operation under a 11,400-sq. ft. boiler in the River Station of the Buffalo General Electric Company. Three more boiler and furnace units of the same design are now being installed in the River Station.

8. The Combustion Engineering Corporation is advocating the use of an entirely new type of boiler which will completely surround a furnace built for pulverized fuel firing. It is proposed to transfer to an air preheater an extraordinarily large percentage of the work usually performed by the last passes of the boiler in scrubbing heat from the flue gases. This will result in the boiler itself being of relatively small area. Brickwork with its troublesome problem of maintenance is to be almost entirely eliminated.

It is reported in the technical press that the Combustion Engineering Corporation has contracted to install a total of 15 of these new boiler and furnace units in the stations of eight different companies. Each unit will be capable of evaporating approximately 100,000 lb. of steam per hour.

9. As indicative of the trend towards the use of very large boiler units we have the operation of one of the 26,470-sq. ft. Ladd boilers in the River Rouge Plant of the Ford Motor Company. The furnace for this boiler was rebuilt during the last year, water-cooled walls were installed, the pulverized coal feeders and

burners were revamped, and the boiler was equipped with air heaters and induced draft fans of ample proportions. Since being rebuilt this boiler unit has evaporated a total of 480,000 lb. of water per hr. which would correspond in a well designed steam generating station to a gross generation of 45,000 kw. in the turbine room.

10. The Milwaukee Electric Railway and Light Company has built a plant for the processing of coal, prior to its use in the boiler plant of the Lakeside Station. Coal in pulverized form while falling through two vertical retorts will mingle with rising currents of hot air and gas which will drive off a considerable amount of gas including the valuable by-products of the coal. The coke residue still in pulverized form, after being cooled in the hopper at the bottom of the lower retort, will be pumped to the pulverized fuel bunkers in the boiler house and burned in the furnaces. Equipment has been provided for removal of tar and benzol from the gas.

Experimental work extending over almost a year's time has indicated that no major difficulties will be encountered in operation. This installation in Milwaukee is well beyond the laboratory stage and provision is made for the expansion of this processing plant so as to take care of all the coal burned in the station.

This installation is of interest, as the successfulness of its operation will indicate the advantages which will accrue from the joint operation of our steam stations and low-temperature carbonization plants by means of which coal may be processed before being burned.

#### TRENDS IN STEAM GENERATING STATION DESIGN

Aside from the individual achievements referred to above there are certain definite trends in power station design and operation which should be noted:

1. The heating of the feed water to a temperature of from 350 to 400 deg. fahr. by means of steam bled from three or more stages of the turbine.
2. The removal of the heat in the flue gases after they leave the boiler by means of an air heater which returns this heat to the furnace.
3. The elimination of the economizer.
4. The wide-spread use of steaming surface for furnace walls and the elimination of a considerable part of the furnace brickwork.
5. The use of automatic control in the boiler house with consequent improvement in day-in and day-out operating efficiencies.
6. The use of separate ventilating fans in connection with very large generators of 62,500 kv-a. and higher capacities.
7. The use of relatively smaller surface condensers made possible by more careful design of the condensers themselves and by a better understanding of the relation of turbine performance to condenser performance.

#### DEVELOPMENTS IMMEDIATELY AHEAD

The present combination of boilers and water-cooled furnaces which are, as one engineer expressed it,

"fearful and wonderful jobs of plumbing," probably forecast certain changes in boiler and furnace design which will result in simplification and decreased investment, while at the same time maintaining what appears to be the most logical development of the boiler surrounding the furnace.

We are probably on the verge of being forced into the use of higher voltages in connection with the very large generators now contemplated.

#### AUXILIARY POWER SUPPLY

Two phases of the auxiliary power supply problem are worthy of study by the members of the Institute:

1. Is the use of 2300 volts for distribution to the station auxiliaries the best choice, involving as it does the use of expensive oil-immersed switching equipment occupying expensive space? The alternative is a voltage of the order of 440 and the substitution of carbon circuit breakers and contactors for oil switches. This alternative offers distinct advantages from the standpoint of reduced investment in equipment and in building, and in greater ease of inspection and maintenance.

2. What is the best solution for variable speed drive of the forced and induced draft fans in our new stations? The difficult nature of the problem is exemplified by an installation in one of the new stations now being built: Two 200-h. p. motors drive the forced draft fans of each boiler and two 550-h. p. motors drive the induced draft fans for each boiler. The speed of the fans must be varied by 50 steps through a range from seven to one and the total h. p. input to the four fans varies from 1500 to 15. In this case the motors for the fans in connection with one boiler cost approximately \$12,000 and the electrical control equipment for these motors cost approximately \$20,000 and occupied a considerable amount of rather expensive space. If electrical engineers can not work out a simpler and less costly solution for this admittedly difficult problem, power station designers may have to return to the use of steam turbine drive for these fans, much as they may wish to avoid this solution, with its attendant use of reduction gears.

#### USE OF STEAM AT HIGHER TEMPERATURES

The use of higher steam temperatures of the order of 800 deg. fahr. and perhaps as high as 900 deg. fahr. is being forecasted by scattered operating experience, most of it unpremeditated. Due in the main to errors in superheater design the steam temperatures have been higher than anticipated in connection with some of the new stations. Some of these stations have operated for appreciable periods of time with steam temperatures in excess of 775 deg. fahr. One turbine operated for a time with steam at a temperature of approximately 1000 deg. fahr. There have been no serious indications of distress as a result of operation at these high temperatures. It has recently been reported in the technical press that a 40,000-kw. turbine in the Gennevilliers Station in France operated for 135 hr. during the

months of October, November and December of last year with steam at temperatures ranging from 775 to 914 deg. fahr. An inspection made December 25th showed no indications of deterioration of the parts in contact with high-temperature steam. The turbine was returned to service and has continued to operate satisfactorily with steam at temperatures varying all the way from 700 deg. to 900 deg. fahr.

These experiences together with the experience gained in the operation of oil stills tend to show that we can avail ourselves of the attractive possibilities incident to the use of steam temperatures considerably in excess of the present accepted limit of 750 deg. fahr.

#### JOINT USE OF STEAM STATIONS AND WATER-POWER PLANTS

Worthy of attention are three examples of the broad general solution of power supply by the combined use of steam generating stations and water-power plants in:

1. The construction of the 350,000-h. p. hydro-electric plant at Conowingo for joint use with 520,000 kw. of capacity in steam stations of the Philadelphia Electric Company.

2. The construction of a new 70,000-kw. steam generating station by the Southern Power Company.

3. The completion of a 128,000-kw. addition to the Long Beach Steam Station of the Southern California Edison Company and the starting of work by this same company on a new station of at least 600,000-kw. ultimate capacity with an initial development of 94,000 kw. The Southern California Edison Company has approximately 350,000 kw. installed in water-power plants.

#### OPERATING RELIABILITY AND MARGIN OF SPARE CAPACITY

The results of studies made jointly by a number of the operating companies of this country having for their purpose the determination of the operating reliability of our large generating units, are of considerable interest.

An analysis of the operating records covering the calendar year of 1925 for 191 steam turbines aggregating 5,627,000-kw. capacity showed that on an average these machines were in service 65.1 per cent of total hours in the year and that they generated 44 per cent of the maximum possible number of kw-hr.

These machines were idle because not needed 21.25 per cent of the hours in the year. For 13.63 per cent of the hours in the year, however, they were out of service for overhauling, inspection, maintenance work and cleaning, these outages being allocated as shown below:

Turbine outage.....	— 7.29 per cent
Generator outage.....	— 1.85 per cent
Surface condenser outage...	— 3.51 per cent
Other causes.....	— 0.98 per cent
Total outages.....	— 13.63 per cent

Comparing the foregoing results with the results of similar analyses made during previous years covering operation for the period from 1914 to 1923 inclusive, three things stand out in striking fashion:

1. There is little if any evidence to indicate the decrease which we would like to see from year to year in turbine outages.

2. Prior to 1923 the generator outage averaged 2.8 per cent of the hours in the year. For 1923 and 1925 the generator outage has averaged 1.8 per cent. These statistics are concrete evidence as to what the generally adopted closed system of ventilation has accomplished.

3. The surface condenser outage has increased from 1.2 per cent to 3.51 per cent of the total hours in the year. This increase serves perhaps as an index of pollution of the water in our rivers and harbors.

A study of the fact referred to above, that the outages due to causes other than the turbine, the generator and the surface condenser, aggregated only 0.98 per cent of the total hours in the year and that this item is of only seven per cent of the relative importance of the outages due to other causes, is cause for reflection. It is not recorded that Oliver Wendell Holmes was an outstanding engineer but any one of us would have been proud to have been the designer of as perfectly proportioned a piece of equipment as his "One Horse Shay." On an average the investment in the turbine room with its equipment is only 40 per cent of the total investment in the station, yet 93 per cent of the outages of station capacity are chargeable to the turbine room. Perhaps we have been failing to strike the proper balance between installed capacities, with their corresponding investments in the turbine room and in the boiler house with its related coal handling equipment.

Turning to a consideration of water-wheel driven generators, an analysis made by the Hydraulic Power Committee of the National Electric Light Association shows that the total outage time on these units is appreciably less than on steam turbines. The analyses covered the operating records for 1924 on 56 water-wheels aggregating 950,000 h. p.

These machines were in operation 77 per cent of the hours in the year and generated 48.1 per cent of the maximum possible number of kw-hrs. They were idle because not needed for service 17.62 per cent of the total hours in the year and were out of service for 5.4 per cent of the total hours in the year for reasons indicated below:

1. General hydraulic causes.....	— 0.64 per cent
2. Water-wheels and auxiliaries.....	— 3.01 per cent
3. Generators and appurtenances.....	— 1.55 per cent
4. Electrical causes beyond the generator, related to switching equipment and outside transmission...	— 0.2 per cent

Total outages..... — 5.40 per cent

Outage time is related directly to the need for spare

capacity and the fixed charges on spare capacity constitute perhaps as much as 10 per cent of the total annual cost of power generation in steam generating stations. It behooves us to find ways of reducing this item of cost. A major responsibility in this connection lies with the equipment manufacturer. He must build equipment that will be capable of operation for all except a very few hours per year. Particularly must the manufacturer guard against any inherent weakness which will cause trouble involving unexpected shut-downs even though these outages be of short duration. Much can be accomplished by the engineer who designs the power station in foreseeing and eliminating certain features which may constitute the cause of an outage. The operating engineer can do much to control the necessary margin of spare capacity by the choice of the best operating methods, the careful training of personnel and by the careful scheduling of inspection, preventive maintenance and cleaning. With careful planning, a large percentage of outage time can be made to occur when the capacity is not needed for service.

#### PROBABLE USEFUL LIFE OF STEAM STATIONS NOW BEING BUILT

One of the most troublesome problems facing the executives of our large electric light and power companies today is "what to do with the old steam generating stations." Many of our large companies have sizeable blocks of capacity in steam generating stations in connection with which the coal consumption per kw-hr. generated is two pounds or higher. The costs of labor and maintenance are high. Viewed from the standpoint of operating costs (not including fixed charges), it seems nothing short of a crime to generate power in these stations, bearing in mind that the modern stations being operated by these same companies will generate power at a fuel consumption slightly in excess of one pound of coal and with much lower costs for operating labor and maintenance.

There is, of course, the possibility in some cases of rebuilding in part, at least, in order to improve the station performance. Notable examples of such programs of rebuilding are exemplified by the substitutions of unit coal pulverizers for the obsolete stoker equipment in the Brunots Island Station in Pittsburgh and in the Ashley Street Station in St. Louis. Some executives raise the objection, however, that such a procedure would, in connection with their stations, be sending good money after bad.

It is not our purpose to discuss this question of "What shall we do today with our old stations?", but rather to ask "What of the stations being built today in relation to our operating problems of 20 and 30 years from now?"

Assume, for example, that a company which had a system load of 400,000 kw. in December 1925 places in operation this year the initial 50,000-kw. unit of a new 300,000-kw. steam generating station. We will as-

sume that the average annual load growth is nine per cent, that the yearly load factor is 56 per cent, and that the shape of the load duration curve is typical of load conditions in almost any one of our large cities on the Atlantic seaboard. An additional 50,000-kw. turbine must be installed each year until 1931 when the station will be completed. Since the station will be half completed in 1929, we may take the beginning of its useful life from that date. If we follow conventional lines of thought, we will consider the useful life of this station to extend from 1929 to 1949. What shall we do with this station in 1949? Conceivably the new stations being built in 1949 may generate power for 9000 B. t. u. per kw-hr., whereas the very best our hypothetical station, started in 1926, can do, even on the basis of a good load factor, is 14,000 B. t. u. per kw-hr.

The system load has grown, however, from 400,000 kw. in 1925 to 3,185,000 kw. in 1949. As the result of the inevitable law which pushes the old station a little higher each year into the peak of the load duration curve, we find that our 300,000-kw. station will generate in 1949 only 300,000,000 kw-hr. corresponding to an annual use factor of 11.4 per cent. As the result of the low load factor, the B. t. u. per kw-hr. has been pushed up to 17,000. The annual coal consumption is 190,000 tons and the annual fuel cost is, let us say, \$1,300,000. By scrapping this station and substituting in its place a modern station of the 1949 vintage, we can reduce the annual fuel cost in connection with the 300,000,000 kw-hrs. of generation carried by this station from \$1,300,000 to \$800,000, with an annual fuel saving of \$500,000. Few of us would dare to predict that this 300,000 kw. of new capacity built in 1949 will cost less than \$18,000,000, or that the investment bankers of that day will be willing to finance new construction work at rates which would permit the increase in fixed charges incident to the construction of the new station to be less than \$2,200,000.

The major increase on load on most of our large systems comes about as a result of increase in load density. Consider therefore the strategic position which the station built in 1926 will probably occupy with respect to the load as of 1949 or 1959.

It would appear that the engineers and executives of 1949 are going to have a very difficult time justifying the scrapping of our 300,000-kw. station of 1926 vintage. Such a step will be even more difficult to justify in 1959, for by that time the annual fuel cost in connection with this station will have dropped from \$1,300,000 as of 1949 to approximately \$125,000 per year corresponding to an annual station use factor of one per cent. The function of this station will have changed from that of generating kilowatt-hours to one of supplying kilowatts of capacity. It is to be understood that the foregoing analysis is based not on this station being held merely in reserve but on its carrying its proportionate share of the system peak load.

This analysis rather places the burden of proof on us to show good reasons why we should not design our stations on the basic assumption that they will be used and useful not merely for a period of 20 years but for 100 years, 200 years, or until such a time as the use of electrical energy as related to the life of our large cities and our nation has become no longer necessary.

This statement is not to be construed as an argument for the doing away with renewal reserves. Sound business principles indicate the advisability of accumulating ample renewal reserves.

It is intended to make the engineer who lays down the design of a new generating station ask himself certain questions:

1. Is the equipment well adapted to the load conditions which will obtain in connection with this station after it has become 20 or 30 years old? These load conditions will involve starting and stopping all turbines in the station twice each day, and the picking up of large blocks of load at a rapid rate. The boilers must be banked frequently and they must be able to pick up load quickly.

2. Is the design of the station such that the costs of operating labor and maintenance will be reasonable?

In the example outlined above, after 1955, the costs of operating labor and maintenance will exceed the cost of coal and in 1959 will be at least five times the cost of the fuel.

During its first 100 years of life, our hypothetical station will probably burn \$90,000,000 worth of coal and require the expenditure of \$80,000,000 for operating labor and maintenance.

Consider the tremendous advantage in connection with this type of operation which a station of consistent design with duplicate units of interchangeable parts, would have.

3. Will it be necessary, solely from a standpoint of being able to install more kw. of station capacity on the available ground area, to do a costly job of rebuilding in the future? Perhaps the very policy now being pursued by some companies in building stations in which extra space is provided in the initial section of the station, so that later units installed may be increased in size, is laying the ground work for an expensive rebuilding job 20 or 30 years from now.

4. With changed conditions which will exist fifty or one hundred years from now, and with the city pressing in on our station from all sides, will we still be able to live peaceably with our next-door neighbors?

5. Is the station design such as to form the proper economic balance between fixed charges and operating costs on the basis of one hundred or even two hundred years' life?

These and a host of other questions press for answers

the moment you admit the possibility that the foregoing analysis may be correct. Perhaps those of us who are power station engineers and the executives making decisions bearing on power station design, had better try to find the answers to some of these questions. If we don't, we will probably be damned cordially by the men of the coming generation who will carry on our work.

## WHY GOOD HEADLIGHTING IS DIFFICULT

Lack of sufficient light is a much more common cause of accident than is glare, statistics show, asserts the October issue of the *Journal of the Society of Automotive Engineers*. It defines the ideal headlight as one that shows with sufficient clearness all that a driver needs to see when the road ahead is free from approaching vehicles, and that projects very little light to the spot occupied by the eyes of an approaching driver.

Obviously no system of lighting can accomplish both objects at the same time. As roads are neither level nor straight, the eyes of an approaching driver may occupy almost any position in the pattern of light thrown by the lamps, hence no adequate lighting is possible that will not at times cause glare. Any practical system, therefore, must be a compromise.

The light beams thrown by lamps mounted rigidly on the car can be adjusted to any desired angle with the horizontal, but when once adjusted all changes in direction, both horizontal and vertical, of the axis of the car must be followed by the axis of the light beams. The requisite compromise in angle of tilt lies between an axis high enough for illumination of the road and low enough to avoid the eyes of an approaching driver.

A compromise effected by devices for tilting or dimming the lamps involves changing the light pattern when meeting other cars. The driving light may give the best pattern for open road driving and the meeting light the best possible illumination compatible with the interests of both drivers.

On all roads where touring speeds are safe very little light is needed or desirable on the road surface within 50 to 100 feet, but when meeting other vehicles bright illumination is needed in this area and on the shoulder and righthand side of the road. This makes it imperative that practically no light should be projected above the horizontal at any time, and the driver, in self-protection, is forced to depress his own lights, thus automatically protecting the other driver from glare.

The safety feature might be enhanced by arranging the system so that switching from one adjustment to the other would be accomplished by pressure of the left foot of the operator, the depressed beam being the one in use except when the driver holds the button down.

# The Space Charge that Surrounds a Conductor in Corona at 60 Cycles

BY JOSEPH S. CARROLL<sup>1</sup>

and

HARRIS J. RYAN<sup>2</sup>

*Synopsis.*—An exploring potential wire was used to locate the radial position and to determine the potential of the space charge that surrounds a conductor in 60-cycle corona. The familiar concentric cylinder set-up was used. The potential of the exploring wire due to the applied voltage and its position in the electric field between the conductor and cylinder was maintained at zero so that the potential on the wire was due only to the presence of the space charge. The cyclic potentials of the exploring wire at various radial distances from the conductor in corona at the center of the

cylinder were observed with an electrometer of low capacitance connected through a phase-shifting synchronous contactor to the exploring wire and through its own capacitance to ground. The location of the space charge and the potential it sets up in the electric field in the space surrounding the conductor in corona were thus determined. The paper contains four sections: I—The Problem and Results, II—Description of the Apparatus Used and the Method of Application, III—Discussion, IV—Conclusions.

\* \* \* \* \*

## I. THE PROBLEM AND RESULTS

WHEN 60-cycle voltage is applied to a conductor high enough in value to produce corona, a corresponding space charge is formed and maintained about the conductor.<sup>3,4,5,6</sup> The existence and magnitude of the space charge have been studied heretofore<sup>4,5</sup>. The present studies were made with a potential exploring wire to determine the radial position of the space charge with respect to the conductor about which it was formed. The conductor was mounted at the center of a half-in. wire-mesh cylinder (see Fig. 1). Parallel thereto a potential exploring wire was mounted at various radial distances from the conductor, between it and the cylinder. Sixty-cycle corona-forming voltage was applied between the conductor and cylinder. In order that the potential to ground of the potential exploring wire would be due to the presence of the space charge only, the following arrangement was adopted: The high-voltage source-circuit was grounded at a point having the same potential as that of the position that was occupied by the potential wire in the electric field between the conductor in corona and the cylinder. By this strategy an electrometer of low capacitance could be used to measure the potentials of the wire caused only by the presence of space charges. It was thus necessary that the neutral of the high-voltage source-secondary could be changed through all intermediate values from zero voltage-to-neutral on the conductor and maximum voltage-to-neutral on the cylinder to maximum voltage on the conductor and zero voltage on the cylinder. This was accomplished by

means of a potentiometer. The isolated secondary of the high-voltage source-transformer was loaded with a water column resistance containing a grounded floating electrode. The electrode could be passed freely from either end to any desired point in the water column.

When a space charge is formed about a conductor in corona a few of the ions constituting the charge go astray and diffuse widely through the air. The voltage is alternating and so is the space charge. Following the application to the conductor of a corona-forming positive voltage crest, the charge is made up of positive

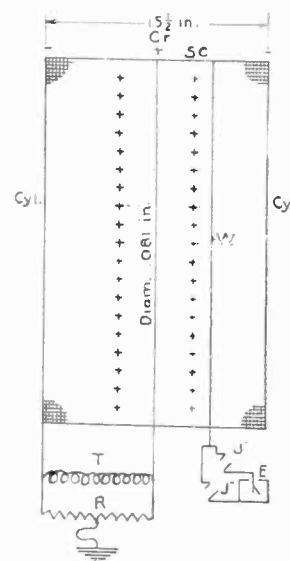

FIG. 1

1. Instructor and Graduate Student, Stanford University, California.

2. Professor of Electrical Engineering, Stanford University, California.

3. Franklin and McNutt, *Lessons in Electricity and Magnetism*, 1919 Ed., p. 148.

4. Ryan and Henline, *Hysteresis Character of Corona Formation*, *TRANS. A. I. E. E.*, Vol. XLIII, p. 1118, October 1924.

5. Hesselmeyer and Kostko, *On the Nature of Corona Loss*, *A. I. E. E. JOURNAL*, Oct. 1925, p. 1068.

6. Ryan and Carroll, *On the Nature of Corona Loss*, *Discussion*. *A. I. E. E. JOURNAL*, Feb. 1926, p. 175.

Presented at the Pacific Coast Convention of the A. I. E. E., Salt Lake City, Utah, Sept. 6-9, 1926.

ions. The next voltage crest will be negative; it will discharge the positive ions in the space charge and set up in their place a corresponding charge of negative ions. The net result of the diffusion of the alternating positive and negative charges is a small but very real rectifying effect, negative at the start of corona and positive when fully established<sup>7</sup>. This rectifying effect may be due to the differing mobilities<sup>8</sup> of positive and negative ions in the atmosphere.

7. J. B. Whitehead and T. Isshiki, *TRANS. A. I. E. E.*, Vol. XXXIX, Part II, p. 1091.

8. R. A. Millikan, *The Electron*, 2nd Ed. (1924), p. 36.



To obtain the cyclic relation of the voltage to the corresponding potential of the wire as affected by the presence of the space charge, a gold leaf electrometer having a small capacitance was connected to the wire by means of two synchronous contactors. The phase of one contactor could be shifted conveniently throughout a complete cycle. It connected the wire to the leaf deflector of the electrometer. The phase of the other contactor was fixed at an instant whereat the voltage

Corona began when the crest voltage applied between the clean conductor and cylinder reached 32,800. Visual corona was well developed over the wire with fair uniformity by the application of 34,400 crest volts. The corresponding "reading" on the space charge control electrometer was "23." By this control reading "23," the applied voltage was held to produce a constant space charge while the observations for six voltage-potential ( $E-V$ ) cyclograms were obtained corresponding to six different radial positions of the potential exploring wire. The following radial distances of the potential wire from the surface of the conductor were used, 0.5, 1.0, 2.0, 3.0, 4.5, and 6.0 in. The corresponding cyclograms obtained with the potential wire at these radial positions are reproduced in Figs. 2 and 3.

The character of the cyclograms changed decidedly as the radial distance of the potential wire was less or greater than about 2.8 in. A study of such changes reveals the fact that they are due to the inevitable shift in the space charge radially outward caused by repulsion during the quarter-cycle that followed the last voltage crest and again radially inward caused by attraction during the second quarter-cycle in which the voltage developed the next crest having an opposite sign to that of the potential of the space charge formed by the preceding crest. From inherent dimensional relations, such shift in the radial position of the space charge

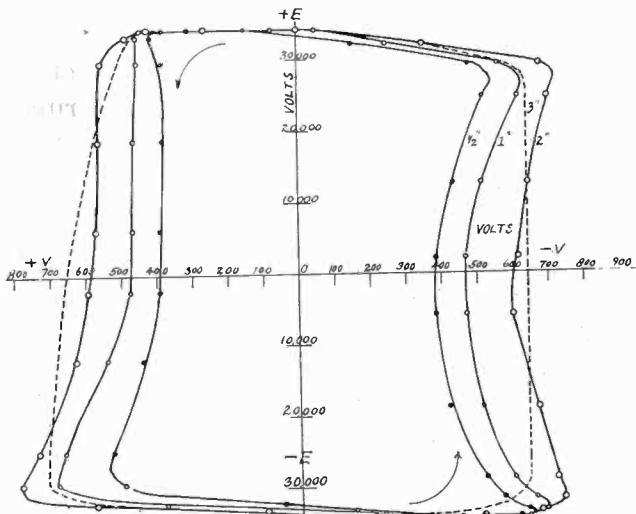

FIG. 2

applied between the conductor and cylinder was zero and the wire due to the space charge was not changing, or was changing very slowly. Thus the rectifying effect was eliminated. When the phase-changing contactor only was used and the leaf of the electrometer grounded, a positive charge on the electrometer was accumulated that varied with the change of the air currents through the open-mesh cylinder and about the conductor. This troublesome correction was avoided by the use of the two contactors just specified. The 60-cycle power supply for the high-voltage transformer was taken from a large power supply system. As the work progressed some inconsistencies in results were traced to variations in the supply voltage crest and the air density factors. In an intermediate stage of the work the voltage was, therefore, controlled by crest corrected for barometric-temperature variations in lieu of effective values. Other inconsistencies developed and were found to be due to the shifting neutral in the water column and stray capacitances attached to the column and its connections. The remaining inconsistencies were found to be due to the corona-aging effect on the conductor whereby the voltage required to produce a given magnitude of space charge had to be increased. The voltage was increased slowly, of course, but nevertheless rapidly enough to require a corresponding control of the voltage so that in whatever radial position the potential exploring wire was being used and however long the time required to run through an entire series, the space charge had the same value throughout.

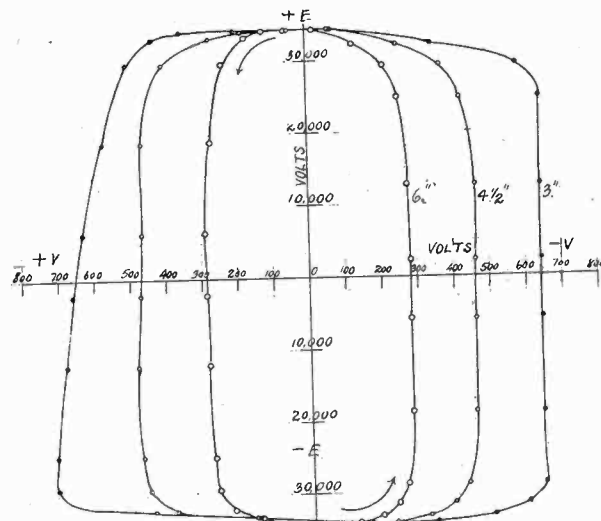

FIG. 3

affects the character of the cyclograms much more when the potential wire is inside the space charge and much less when outside. This change in the form-character of the voltage-potential cyclogram taken from the potential wire as the wire was shifted through the space charge was found to be as good a criterion for the location of the charge as the magnitude of the potential caused by the presence of the charge, which must be maximum when the potential exploring wire is located in its center.

If the space charge was placed in a fixed radial po-

sition as the voltage passes crest and falls below critical value, the voltage potentials due to the direct and reversed space charges would form approximately a rectangular cyclogram having straight parallel potential sides and slightly curvilinear voltage ends. Such was the case for the cyclograms taken from the potential wire when placed outside the space charge, while those taken from the wire mounted inside the space charge had decidedly concave sides due to the outward and inward movement of the space charge.

The understanding hereof is facilitated by the study of the curves in Fig. 4. Curve  $IV^1$  was located by using the radial positions of the potential wire as abscissas and the corresponding observed potentials  $V_o$ , due to the presence of the alternating space charge, as ordinates, occurring at the instant when the negative voltage crest has been completed. This curve locates a maxi-

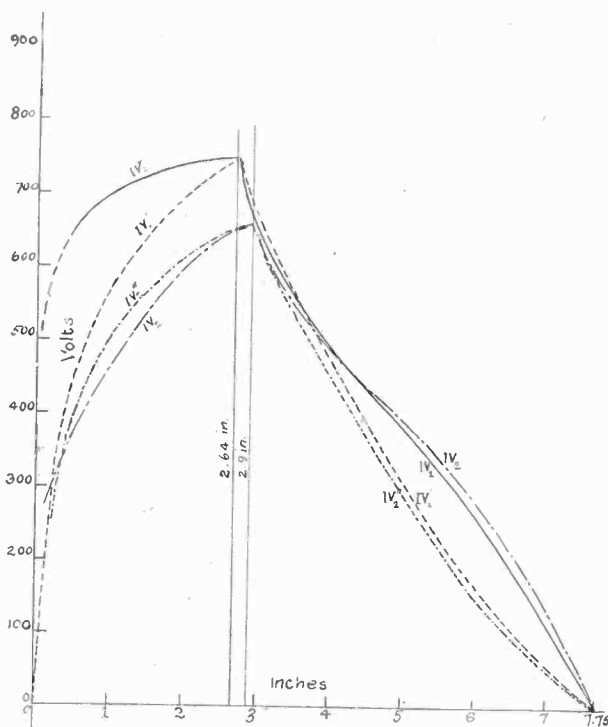

FIG. 4

mum for potentials for the wire placed at a radial distance from the conductor of 2.67 in. As a criterion for understanding the factors that determine the character of Curve  $IV^1$ , Curve  $IV^2$  was located by commonly adopted theory on the assumption that the entire space charge is uniformly distributed about the conductor at the radial distance of 2.67 in.

At positions within the space charge, the potentials were observed to be well above those obtained by calculation on the assumption that this region was free of ions. The differences may be taken as a measure of additional potentials due to the presence of negative charges in such space. The direct inference is that not all of the space charge is located at the radial distance of 2.67 in., and that a small portion thereof is distributed through the intervening space.

At corresponding positions without the space charge,

there is a close agreement between potentials by measurement and by calculation at first as the radial distance of the potential wire extends beyond 2.67 in. Beyond four in. the values of the observed potentials due to the presence of the space charge are higher than those by computation. The difference attains a maximum well out toward the surface of the mesh cylinder, let us say at a radial distance of about 6.5 in. This difference clearly indicates that while most of the charge occupies the cylindrical location at a radius of 2.67 in., some of it located in a broad zone at the 6.5-in. central radial position.

A quarter of a cycle, or  $1/240$  of a second later, the voltage was zero and curve  $IV_2$  was correspondingly located by the  $E - V_o$  values taken from the cyclograms at that phase. It will be noted that the maximum potential in the charge had dropped from 750 to 666 volts and that the central position of the charge had been repelled from the radial position of 2.67 to 2.90 in. Curve  $IV_2''$  was computed as the criterion to accompany Curve  $IV_2$  on the assumption that all of the space charge was located at the radial distance of 2.9 in. from the conductor. A comparison of the two curves, the one observed and the other calculated for the phase whereat the voltage is passing through zero from minus to plus, reveals the fact that the observed potentials through the region within the main space charge at the radial distance of 2.9 in. are now less everywhere than the corresponding values by computation. The inference is that only a small distributed vagrant charge remains in such space and that its sign is positive whereas the sign of such vagrant charge was negative as the voltage was falling from a negative crest.

Radially beyond the 2.9-in. position, corresponding observed and calculated values have scarcely been changed by the migration of the space charge. All of this is in complete agreement with the characteristic difference in the cyclograms taken from the potential wire when located within and without the space charge. The curves show that the cyclograms should have the concave sides when observed within the space charge and straight parallel sides when observed without such charge.

It was shown by Hesselmeyer and Kostko<sup>5</sup> that voltage-charge ( $E - Q$ ) cyclograms obtained for a line in corona change only slightly in character as the frequency is changed from 60 cycles upwards to 120 and downwards to 10.5 cycles. Substantially the same must be the case for voltage-space charge potentials. It follows, therefore, that in all ordinary study of these phenomena cyclograms, giving the direct relation of voltage and potential due to space charge with time omitted is particularly helpful. However, there are many who are not accustomed to the study of these phenomena without their relation to the times at which they take place. To assist them and for those considerations wherein the time factor is of definite importance, all of the values occurring in the cyclograms are re-

peated in waves reproduced in Fig. 8, using times for abscissas and voltages or potentials as ordinates. The radial distances of the potential exploring wire are marked on the waves to facilitate their comparison with corresponding cyclograms.

A further study of the voltage-potential cyclograms through the second quarter-cycle after the voltage has passed a negative crest similar to that which was made with the contents of Fig. 4 reveals the fact that at the close of the first half-cycle, just before active ionization is resumed and before the process of reversing the negative space charge has begun, the potentials at the several radial positions within the space charge have again increased and returned nearly to their original values obtained at the beginning of the cycle. There is, however, much less difference between the potentials by measurement and by calculation, showing that the vagrant charges of opposite signs are nearly equal and generally distributed through the region with the space charge. So much for the fact. One may also infer that many positive and negative ions which are vagrant within this region have disappeared by recombination.

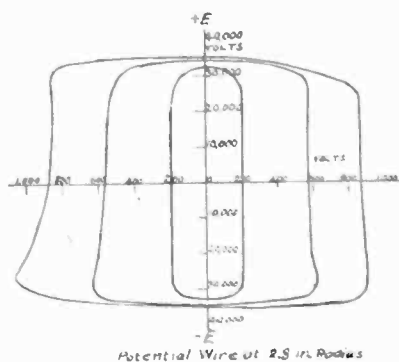

FIG. 5

To check this understanding as to the cause of the change in the form of the voltage-potential ( $E - V_0$ ) cyclograms taken from the exploring wire when located within and without the main body of the space charge, the potential wire was kept at the 2.8-in. radial distance from the conductor, while three cyclograms were obtained each at a different value of corona-forming voltage. The values were so chosen that one was low enough to place the space charge between the wire and the conductor, another that would place it in the same radial position as the wire, and the third voltage high enough to place the charge well beyond the wire. The first or inner cyclogram thus obtained (Fig. 5) had the flat parallel sides indicating as anticipated that the exploring wire was located radially beyond the space charge; the second or middle cyclogram in Fig. 5 showed but slight departure from that of the preceding rectangular cyclogram; the third or outer cyclogram, Fig. 5, showed a well developed distortion of the rectangular form;—each, therefore, showed characteristics that had been anticipated.

With the potential wire left in the 2.8-in. radial posi-

tion, the relation between the excess of crest over critical voltage,  $E - E_0$ , taken at the phase at which the value of the voltage  $E$  was zero and the potential of the space charge as given by the potential wire, was found to be linear between the limits used in this study, viz.,  $E_0 = 32,800$ , and  $E = 35,200$  volts crest. The relation is given by the equation:

$$(E - E_0) = 2.80 V_0 \tag{1}$$

Since  $V_0$  is the value of the voltage to which the condenser between the space charge and the cylinder was charged as determined by the exploring wire, it follows that the drop in voltage through the ionized air when it was conducting the space charge to such condenser was

$$(E - E_0) - V_0 = 1.80 V_0 \tag{2}$$

For example, when the value of  $E$  was 34,400,  $(E - E_0) = 1600$ , the space charge was located 2.8 in. from the conductor and its potential was observed to be  $V_0 = 572$  volts; the measured difference that applies for conducting the space charge through 2.8 in. of ionized air was, therefore,  $1600 - 572 = 1028$  volts, to check with  $1.80 \times 572 = 1030$  volts, as given in (2).

For those who are interested in the equipment used to obtain these results, and the manner in which it was employed, Part II follows. It contains a complete description of the apparatus, connections, and procedure in making the observations.

## II. DESCRIPTION OF THE APPARATUS USED AND THE METHOD OF OPERATION

In this description very little will be said of the "99 things" that were tried and did not work; however, it may be stated in passing that the only parts of the original set-up which were left were the wire-mesh cylinder, the copper conductor at its center, and the potential exploring wire.

Unfortunately, in the diagram of connections the relative importance of the various elements cannot be indicated by the amount of space they occupy on the paper. The cylinder of  $\frac{1}{2}$ -in. mesh was 15.5 in. in diameter and 15 ft. long. It was mounted vertically, the lower end being four ft. above the floor of the laboratory. The No. 12 B. & S. G. copper conductor stretched tightly at the center of the cylinder was supported by hard rubber rods across the ends of the cylinder. Vibrations in the conductor were suppressed by means of silk thread guys in four directions to the cylinder at two points along its length. Both potential wires shown in the diagram were No. 20 B. & S. G. copper. The end supports were hard rubber. To keep the wires free from vibrations,  $\frac{1}{4}$ -in. hard rubber rods were extended, through wood blocks on the cylinder, radially inward until they just touched the potential wire.

The source of high voltage was a 60-kv. transformer, the secondary of which had no permanent ground. A high-resistance water column potentiometer was con-

nected across this secondary in such a manner that the ground could be made any place between the two high-voltage terminals of the transformer. This potentiometer consisted of two sections of  $\frac{3}{4}$ -in. garden hose each about 12 ft. long. These were mounted vertically on a steel tower just outside the laboratory. The total resistance across the secondary of the transformer remains constant at about 250,000 ohms. With this arrangement the exploring wire can always be kept at ground potential due to its position, *i. e.*, the voltage across the right side of the potentiometer is made equal to the voltage between the exploring wire and cylinder; likewise the voltage across the left side

double-throw switches No. 5 closed either up or down, also switch No. 6 is open. The voltage on the 60-kv. transformer is slowly raised from zero by means of the tap transformer and induction regulator. Electrometer No. 1 will then indicate the voltage between the exploring wire and ground. The ground on the potentiometer must then be shifted until the electrometer shows zero voltage. Since the electrometer is not sufficiently sensitive at low voltages, a voltage is added to the circuit by closing switch No. 6 to phase A. This voltage is in phase with that applied between the No. 12 conductor and cylinder. The voltage used for this purpose is 300, which puts the electrometer leaf up into a sensitive position. If the potentiometer ground is not in the correct position, the exploring wire will have a voltage above ground that will increase the electrometer reading with switch No. 5 in one position and decrease it in the other position. The proper place for the ground on the potentiometer is that which gives the same electrometer reading for both positions of switch No. 5. With a little care, this ground can be set to within one volt in 25,000.

Since the position of this ground must be set below a voltage that will start corona on the conductor, some means must be established whereby it may be known when the position is correct at the operating voltage when the conductor is on corona. An arrangement must also be made to keep watch of this ground to see that it does not change on account of air bubbles in the water column, obstructions in the nozzles, shifting of the chain, or any other cause. To accomplish this, the potential plate condenser was built and connected in parallel with the conductor and cylinder. The condenser consisted of two cast iron disks 12 in. in diameter with amply rounded edges mounted parallel to each other about seven in. apart with a 12-in. aluminum disk as a potential plate  $\frac{1}{8}$  in. thick arranged to float between the two iron disks by means of a hard rubber rod and screw adjustment. This potential plate is connected to the leaf of electrometer No. 3, the case being connected to ground through the 300-volt transformer. When the position of the ground on the potentiometer is correct as shown by electrometer No. 1, the potential plate is raised or lowered until electrometer No. 3 shows no change on reversing switch No. 5. This means that the potential wire and the potential plate occupy the same electrical positions. Since there is no corona in the vicinity of this potential plate up to the highest voltage used, the correct position of the ground can be maintained by observing electrometer No. 3. This potential plate must obviously be reset each time the exploring wire is moved to another position.

There is another adjustment that must be made before the exploring wire is exactly at ground potential. If the charging current to ground from the apparatus and leads on one side of the high voltage transformer is not equal to the charging current to ground on the other side, the difference between these currents will flow

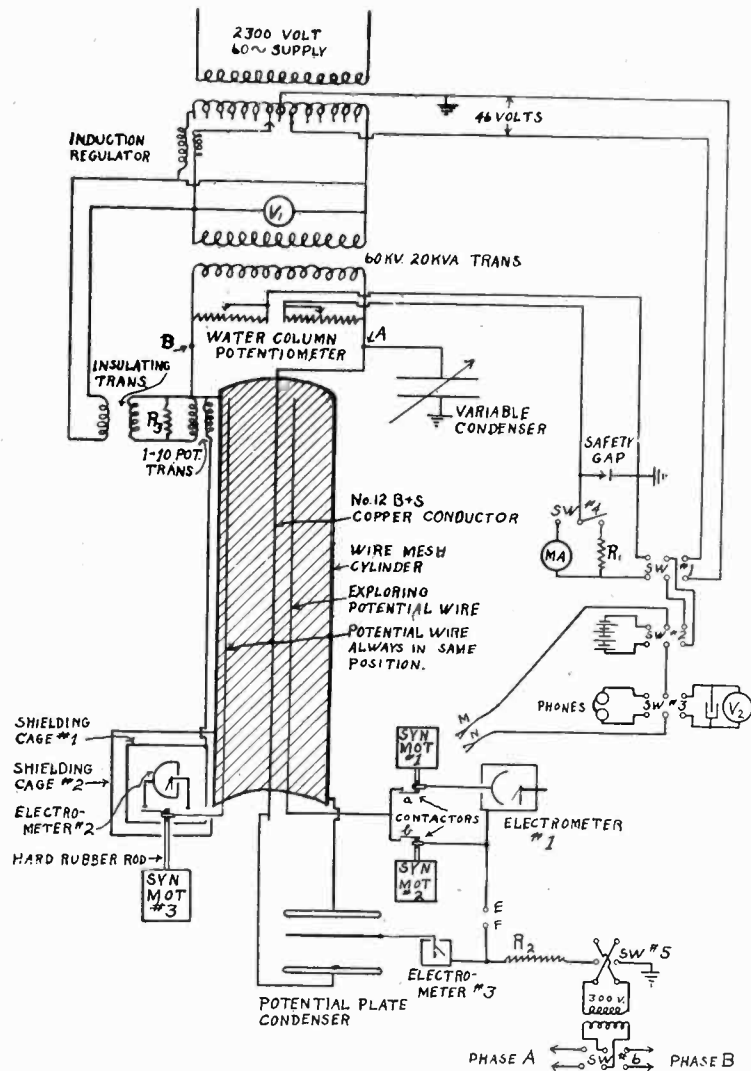

FIG. 6—CONNECTIONS FOR SPACE CHARGE STUDY

is made equal to the voltage between the exploring wire and the conductor at the center of the cylinder. Since the potentiometer is grounded at the center, the exploring wire must therefore be at ground potential due to its position when there is no corona present on the center wire.

The correct position of the ground on the potentiometer is found as follows, after the exploring wire has been moved to the desired position. No one of the three synchronous contactor motors is running, contact (a) is left closed, (b) is opened, terminals E and F are connected together and the quick-acting, double-pole

through one side of the potentiometer, thus shifting the phase of the voltage across this side with respect to the other, and making it impossible to find the correct position of the ground. To overcome this, a variable condenser must be connected on the side of the transformer furnishing the least charging current to ground. The test for the right amount of capacitance to be added is made by throwing switch No. 6 to phase *B*, which is in quadrature with respect to phase *A*. The variable condenser is then adjusted until the reading of electrometer No. 1 does not change on reversing switch No. 5. This adjustment must also be made each time the position of the exploring wire is changed, but when the balance is once made it will "stay put" and does not have to be watched. It is necessary when making this condenser balance to follow it up with the correct

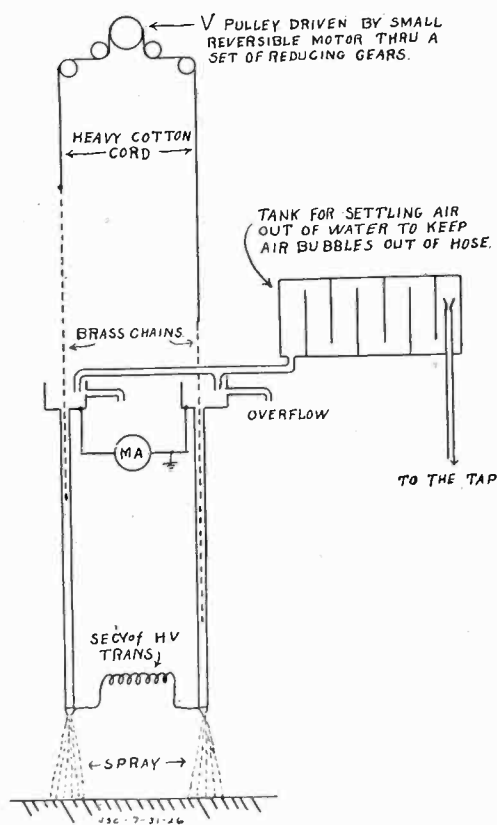

FIG. 7—HIGH-VOLTAGE POTENTIOMETER

position of the potentiometer ground by occasionally throwing switch No. 6 to phase *A*. The exploring wire must truly be at ground potential when there is no change in the reading of electrometer No. 1 for phase *A* and phase *B* when switch No. 5 is reversed.

With the exploring wire at ground potential due to its position it will show no voltage until corona appears on the conductor; then the voltage it indicates on electrometer No. 1 will be that set up by the charge sent out by corona. The effective value of this voltage can be measured by disconnecting *E* from *F* and grounding *E*. However, we are not only interested in the amount of this voltage but also in its wave form. The latter was determined by means of synchronous contactors and the gold leaf electrometer No. 1.

The three synchronous motors shown in the diagram were four-pole,  $\frac{1}{4}$ -h. p. induction motors, the rotors of which had been slotted for salient poles. The motors were mounted vertically to eliminate end play, ball bearings being used for the upper bearing. The contactors consisted of a hardened steel pin and thin laminated steel spring, contact being made on the center lamination only. Synchronous motor No. 1 was supplied with voltage from a phase shifter consisting of a wound-rotor two-phase induction motor. The phase angle was read on a scale fastened to the frame with a pointer on the rotor shaft. Motors No. 2 and No. 3 were driven from a voltage supply having a fixed phase angle.

First, motors No. 1 and No. 2 are started up. To be sure that motor No. 1 has the same polarity each time it is started up, the clips *M* and *N* are connected across contact (*a*); *E* and *F* are not connected; and the double-pole, double-throw switches No. 1, No. 2 and No. 3 are all thrown to the right. The polarity of the motor must be such that the d-c. voltmeter  $V_2$  reads positive when the phase shifter is on zero. To find the polarity of motor No. 2, the clips *M* and *N* are connected across the leads to electrometer No. 1, switch No. 1 is open, and switch No. 2 and switch No. 3 are closed to the left. By listening in the phones as the phase angle of motor No. 1 is shifted, a click will be heard at a certain position which means of course that contactors (*a*) and (*b*) are hitting at the same instant. The phase angle is then observed on the phase shifter scale.

Clips *M* and *N* are removed and voltage is applied between conductor and cylinder; when corona appears on the conductor, electrometer No. 1 will indicate a voltage due to space charge. The wave form of this voltage is determined by a step-by-step process. Contactor (*b*) was set so that it made contact when the applied voltage was zero; this was where the space charge was changing least rapidly. The phase angle of (*a*) was changed by means of the phase shifter and the angle read on the scale, the electrometer being read for each position. Readings were taken every 10 deg. where the voltage changed most rapidly and every 20 deg. on the flat parts. Suppose (*b*) is contacting at the point (*x*) on the curve taken at six in., and the phase shifter is set on zero; the difference in voltage of these two points on the wave, then, is 330 volts, which is read on the electrometer. The contactor (*a*) is set, say 10 deg. later, by means of the phase shifter and the voltage is found to be 420 and so on. When we get to, say, 240 deg., the voltage on the electrometer is practically zero, so that to get this half of the wave, motor No. 2 is slipped a pole, making the contactor (*b*) shift 180 deg. to (*y*), and then when the contactor (*a*) is on 240 deg. the voltage on the electrometer is 550.

In order to tie-in all the curves taken this way with the voltage wave, the exploring wire is disconnected from the contactors and the clips *M* and *N* are connected

across contactor (*a*). Switch No. 4 is thrown to the right, switch No. 1 left, switch No. 2 right, and switch No. 3 left. The phase shifter is then adjusted until there is no sound in the phones, which means that (*a*) is making contact when the voltage across  $R_1$  is zero. The angle is then read on the phase shifter scale.

The potential wire at the left of the conductor, Fig. 6, was used in controlling the voltage. The distance between the conductor and this wire was six in. Motor No. 3 drove a contactor in which the two contacts connected to electrometer No. 2 were 180 electrical deg. apart, both making contact very nearly the instant when the voltage between the conductor and cylinder is zero. This charged the electrometer with the voltage due to the space charge, the plus crest on one side of the electrometer and the minus crest on the other side. Since the voltage due to position amounted to considerably more than the space charge voltage, it would be necessary to keep the con-

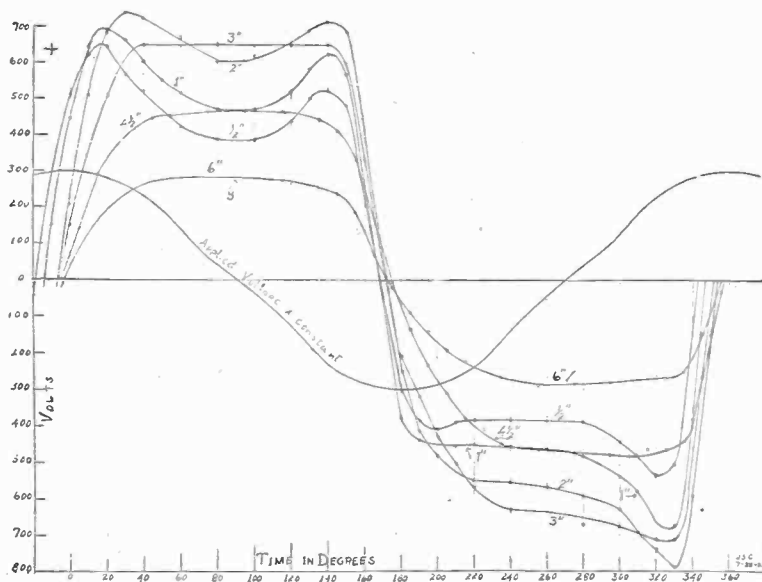

FIG. 8

tactors hitting exactly when the voltage due to position was zero. Practically, this could not be done with any degree of assurance. To overcome this difficulty, the voltage of this potential wire due to position was bucked out by surrounding the electrometer with a wire screen cage, No. 1, which was raised to the potential of the wire due to position by means of the transformers as shown in the diagram.  $R_3$  was connected across the secondary of the insulating transformer to compensate for the shift in phase angle in the 60-kv. transformer caused by the water column resistance load. To prevent any variation in shielding as the ground on the water column potentiometer was shifted, cage No. 1 was surrounded by a wire screen cage No. 2 which was connected to the wire-mesh cylinder. Electrometer No. 3 was read by means of a telescope and the voltage held so that it read "23" throughout all the runs which gave the data for the curves in Fig. 8.

### III. DISCUSSION

From the results of the preceding and present studies, it is now known that corona at all ordinary voltage wave forms, frequencies, and air densities is due essentially to the formation of mixed ions in the air near the conductor where the electric intensity exceeds a certain critical value (30 kv. per cm., or  $26.4 \times 10^{-10}$  coulombs per sq. cm. in air at unit density,  $\delta = 1$ , which occurs at a temperature of 25 deg. cent. and a barometer of 76 cms.). The mixed ions include only atoms that have lost or gained electrons and have thus become positive or negative ions of low mobilities, 1.36 and 1.83 cms. per sec. per volt per cm., and *free electrons*. The last function as negative ions having mobilities hundreds of times greater and which, when the electric intensity falls to about *one-thirtieth* of that which caused ionization, attach themselves to neutral atoms to form negative ions with their corresponding low mobilities. This electric intensity at which free electrons form negative ions occurred in the present studies at about 1000 volts per cm., or  $0.88 \times 10^{-10}$  coulombs per sq. cm., the air density being near unity. Much experimental work will have to be done to determine the limits through which the electric intensity varies at which the free electrons combine with neutral atoms to form slow moving negative ions.

During copious ionization near the conductor the ions that carry charges having signs unlike the charge on the conductor due to the applied voltage are drawn to contact with the conductor and thus discharged; the ions of the same sign are repelled to a radial distance at which the electric intensity has fallen to the value whereat free electrons can no longer exist, as such, and must form negative ions of low mobility instead. Further details of the action are not as yet clearly defined and much further study is necessary. However the fact is now known that the presence of free electrons in the midst of mixed ions, in aggregate effect, greatly increases the mobility of all the ions, and when that region of the field is reached in which the free electrons combine with neutral atoms to form negative ions, both positive and negative ions are actuated only by the low mobilities above specified. So low are such mobilities that the further effects they produce at 60 cycles are nearly the same as though they did not move appreciably during the remainder of the half-cycle.

Thus it comes about that electric stress in the region surrounding the conductor, between it and the nearly fixed space charge, can be increased but a small amount, if at all, by raising the applied voltage above the critical value of the voltage. The increase in voltage,  $E - E_c$ , is consumed in two ways: (1) by the ionic conduction that delivers the space charge at the radial distance above specified, and (2) by the space charge itself. While this understanding of the nature of corona is now clearly indicated by the results of many observers to date, much experimental work will have to be done to know the amount and position of the space charge under

most circumstances in order that corresponding formulas can be derived and used reliably for practical purposes.

Something should be said in conclusion in regard to the background of the subject of this paper. There may be many causes of contributing factors that bring about the occasional unexpected flashovers of high voltage insulators that function in air, but among them must always be remembered three factors as follows:

- I. Surface conductivity,
- II. Surface charger,<sup>9</sup>
- III. Space charge.

Surface conduction is a chaotic factor that nevertheless is much better known and understood than the other two. Nishi<sup>9</sup> found that when corona in air is present near an insulator, the surface of the insulator dielectric becomes heavily charged even when the voltage is alternating. There can be little doubt that the space and surface charges are related and that the nature of such relation qualitatively and quantitatively should be known. It is altogether likely that the zone of a comparatively heavy space charge standing well out around a transmission line conductor is a factor that will have to be reckoned with in various practical undertakings such, for example, as the coupling of carrier currents to power transmission lines. It may be that knowledge of the space charges due to the corona on insulator hardware, of surface charge, and of surface leakage will go far toward an understanding of the nature of things that requires the magnitude of tower clearances that practise is now slowly but surely discovering to be necessary.

The dimensional manner for many differing conditions in which the radial distance is related to the crest voltage in the production of space charge, and to the electric intensity of the field wherein the space charge is lodged, should be determined as soon as practicable. In the present study such radial distance was found to be at the average rate of 8.3 kv. (s. w. rms.) per in. and the corresponding electric intensity at the location of the space charge was found to be one kv. per cm. Our reconnaissance has revealed much evidence that the radial distance of the space charge from the conductor, cable, point or other high voltage electrode, is approximately equal to the distance through a needle gap that the corresponding voltage will discharge and, therefore, approximately at the distance-rate of one in. per 10 kv. (s. w. rms.). It must be remembered, however, that corona phenomena have always a strong tendency toward chaotic behavior and that few things can be taken for granted and that most of them must be determined by exact orderly procedure and measurement.

Until the values thus indicated have been reliably determined, it would be premature to write formulas for the power lost in corona due to the boundaries determined by the space charge and its capacitance. The temptation to do so is there, of course, because the

energy in such charge is drawn from the source, is never returned and is, therefore, a measure of the loss produced by corona when due allowance has been made for the ionic conduction by which the space charge was placed in position.

#### IV. CONCLUSIONS

1. A conductor in corona is surrounded by a free mobile space charge of the same sign as that on the conductor during the preceding voltage crest.
2. The sign of the space charge is reversed by the copious ionization that is produced during each succeeding voltage crest.
3. The mobility of the space charge is so low during interval between voltage crests that it behaves almost as though it were fixed in space about the conductor in corona.
4. The mobility of the mixed ions, positive, negative and free electrons, that reverse the space charge during the voltage crests is much higher than the mobility of the space charge during the interval between voltage crests.
5. For the most part, the space charge has an orderly relation in amount and space position to the voltage applied to the conductor and its dimensions and to the energy lost per cycle in corona at all ordinary frequencies used in the power industry.

#### A NEW CATHODE RAY TUBE

A vacuum tube which produces as many electrons per second as a ton of radium—and there is only a pound of that rare substance in the world—was announced by Dr. W. D. Coolidge of the research laboratory of the General Electric Company at a meeting of the Franklin Institute of Philadelphia, on the occasion of the award to him of the Howard N. Potts gold medal of the Institute for his outstanding work in the development of x-ray tubes.

Radium is constantly disintegrating, and in so doing is bombarding electrons—infinately small particles of matter or electricity—into space at very high velocities. The rate at which radium disintegrates is beyond human control; nothing that man can do seems to affect the rate at which the element breaks down. The cathode ray tube likewise bombards high speed electrons into space, but at a rate that can be controlled by man, and in quantities far greater than by all the radium in the world. The electrons given off by radium are of higher average velocity than those so far produced with the cathode ray tube, but otherwise the two are alike.

So much more concentrated are the rays from the tube that many startling experiments have been conducted with the new device. Crystals of the mineral calcite apparently become red hot coals when exposed for a moment to the rays, but they are glowing with cold light; ordinary salt is turned brown, and considerable time elapses before it again becomes the colorless substance it usually is; bacteria and small flies are almost instantly killed by exposure to the rays; ordinarily colorless acetylene gas is transformed into a yellow solid which cannot be dissolved.

9. T. Nishi, *Surface Charges on High Voltage Insulators*, A. I. E. E. JOURNAL, November, 1920.

# Unbalanced Conductor Tensions

## Tests to Show Their Effects in a Long Span Transmission Line

BY E. S. HEALY<sup>1</sup>

and

A. J. WRIGHT<sup>1</sup>

Associate, A. I. E. E.

Non-Member

*Synopsis.*—Some interesting studies of the unbalanced tensions produced by heavy ice loadings on long spans supported by suspension insulators were made in the course of designing the recently completed Wallenpaupack-Siegfried 220-kv. line of the Pennsylvania Power and Light Company. These studies included investigations of the effects produced on suspension insulator

construction by a broken conductor. Computations were verified in an approximate way by experiments on a one-mile section of the actual line. For the most part, results are given in diagrammatic form, in sufficient detail to allow both analysis and approximate application to similar problems.

### GENERAL PROBLEM OF UNBALANCED CONDUCTOR TENSIONS

**P**REDETERMINING the effect of carrying long spans on suspension insulators has long been a perplexing problem. Span lengths have been gradually increased without any undue operating difficulties until several lines are now in operation with spans averaging well over 1000 ft. Studies for extra high-voltage lines show economies for even longer spans, especially when some of the very high-strength conductors are considered. Such construction requires careful attention to prevent unbalanced conductor tensions,—of no particular importance on shorter spans,—from assuming serious proportions, where combined with long insulator strings and heavy ice loading. In fact, the ice loading appears to be the most important factor.

The unbalanced loads caused by a broken conductor

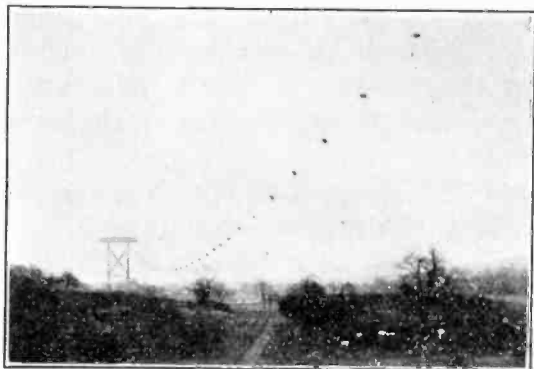

FIG. 1—SPAN LOADED WITH SAND BAGS BETWEEN TOWER No. 3 AND TOWER No. 4

are also of greater importance with the higher-strength conductors. The usual design for lines carrying comparatively small conductors, making each tower of sufficient strength to support one or more broken conductors, does not seriously affect the cost. The same assumption applied to very high-strength conductors so seriously affects the cost of the entire con-

struction as to make a careful study of the character and amount of the loads caused by a break decidedly important.

In working out the designs for the Wallenpaupack-Siegfried line of the Pennsylvania Power & Light Company, both of these problems assumed considerable importance. The 1100-ft. spans and insulators with an effective mechanical length of over nine ft., located in a very bad sleet country, combined to create rather unusual conditions. Some tests and computations made of these problems on that line are given here in the hope that they may be of assistance in similar studies and in the consideration of extra high-strength conductors.

### PROBLEMS ENCOUNTERED ON THE WALLENPAUPACK-SIEGFRIED LINE

As a basis for certain features of design of the Wallenpaupack-Siegfried line, a rather extensive set of calculations was made of the effect of unbalanced conductor tensions. The computed results are summarized in two charts, Fig. 5 showing the unequal tensions caused by a heavy ice load forming on a series of spans of unequal length and Fig. 6, the effect of ice dropping off of all but one or two of a series of spans. Extensive calculations were also made to determine the effect of the longitudinal swing of the insulator string and of the resulting slack thrown into the adjacent spans following a failure of the conductor.

The calculations were intended to obtain results for a few general conditions which could be used as a basis of selecting specific tower locations and as an aid in judging whether special precautions were necessary to meet any particular conditions encountered. For instance, when extra long spans were required over rough country, these calculations gave a logical means of determining how long a span could safely be carried on suspension insulators.

Realizing the importance of a practical verification of the computed results, a set of tests was made as soon as the construction work had reached a stage where it was possible to string a test conductor over a typical section of the actual line. The results of the experiments and a comparison with some of the computed results are shown in the diagrams, Figs. 2, 3, 4, 7, 8 and 9.

1. Transmission Line Engineer and Asst. Transmission Line Engineer of the Electric Bond and Share Company, New York City.

Presented at the Pacific Coast Convention of the A. I. E. E., Salt Lake City, Utah, Sept. 6-9, 1926.



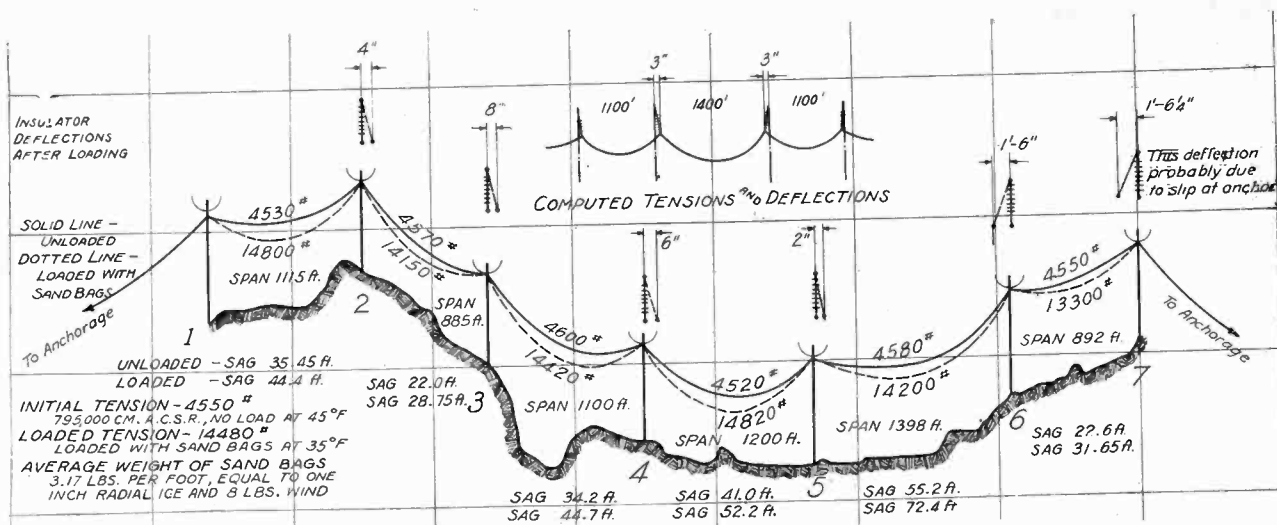

FIG. 2—EXPERIMENTAL RESULTS OF ARTIFICIALLY LOADING ALL SPANS OF THE SERIES  
795,000-cir. mil steel-reinforced aluminum conductor sagged to 4550 lb. and then artificially loaded with sand bags representing one-in. ice and eight-lb. wind

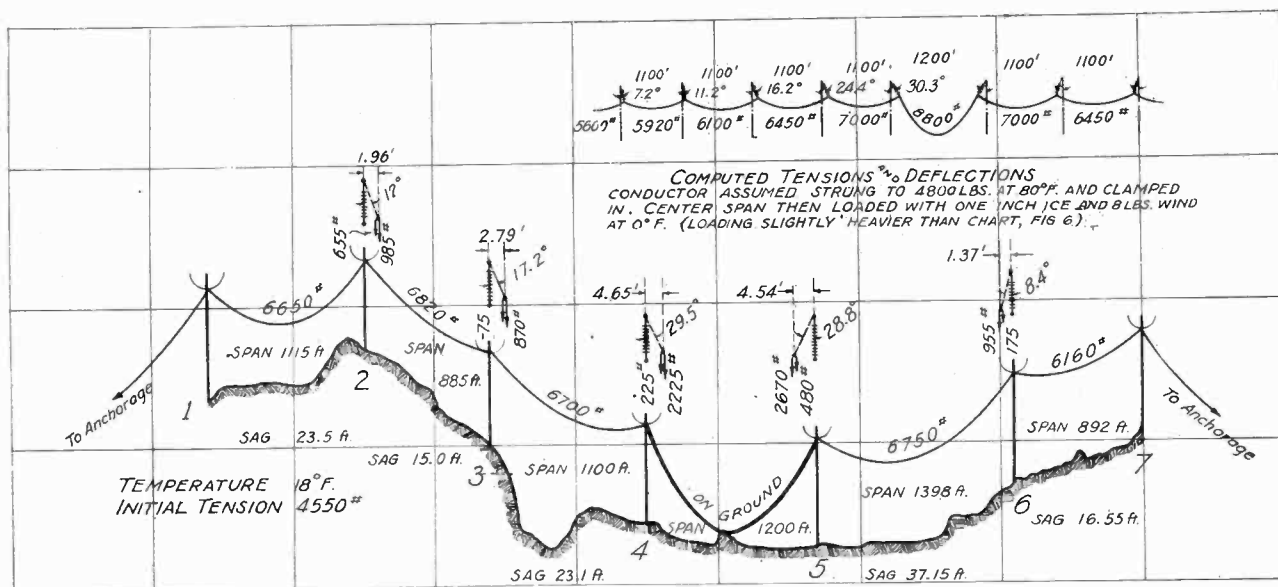

FIG. 3—EXPERIMENTAL RESULTS OF ARTIFICIALLY LOADING THE CENTER SPAN OF THE SERIES  
795,000-cir. mil steel-reinforced aluminum conductor sagged to 4550 lb. and the center span then loaded with sand bags representing one-in. ice and eight-lb. wind

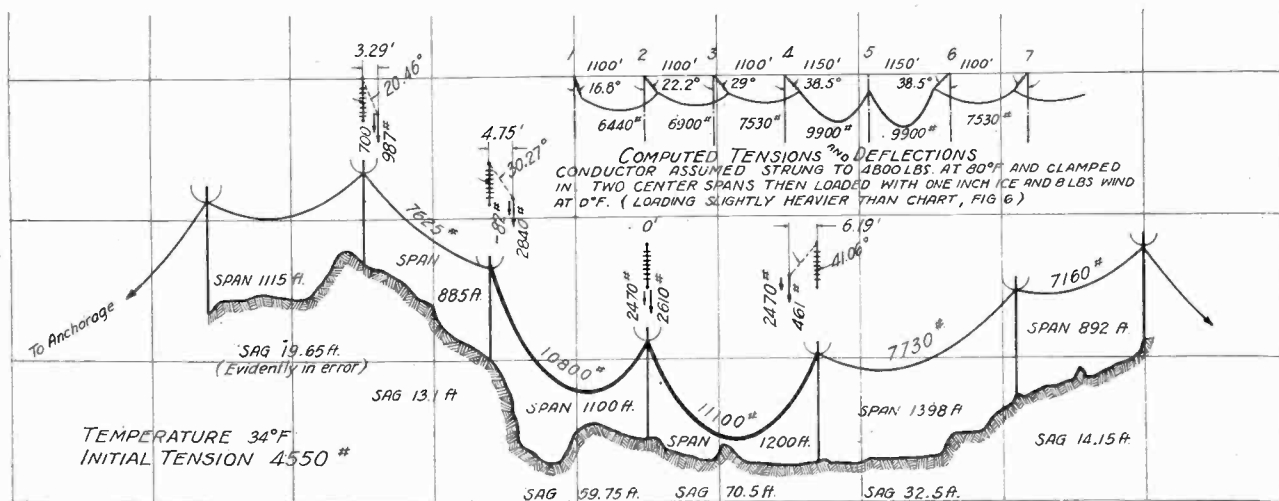

FIG. 4—EXPERIMENTAL RESULT OF ARTIFICIALLY LOADING TWO CENTER SPANS OF THE SERIES  
795,000-cir. mil. steel-reinforced aluminum conductor sagged to 4550 lb. and the two center spans loaded with sand bags representing one-in. ice and eight-lb. wind

The irregular profile and unequal spans of the experimental section as compared with the equal-length level spans assumed in the computations, together with the difficulties of making exact measurements in the field, make it impossible to consider the experimental results an exact confirmation of the computed results.

The results should be viewed rather as a comparison of the actual conditions found on one particular section of the line with one of a series of conditions assumed to

and dead-ended about 900 ft. back of Tower No. 1. The insulators were then clamped in, and loading tests made by suspending sand bags from the conductor at about 20-ft. intervals. A reproduction of a photograph of the line, with sand bags in place, is shown in Fig. 1.

The impact tests were made by "cutting" the conductor at a point about 700 ft. back of Tower No. 1, and allowing the conductor to swing free, supported only by the suspension insulators. The resulting insulator deflections at each tower and the sag in each span were measured both with and without artificial load.

The diagrams showing test results are generally self explanatory. Figs. 2, 3 and 4 indicate the conditions

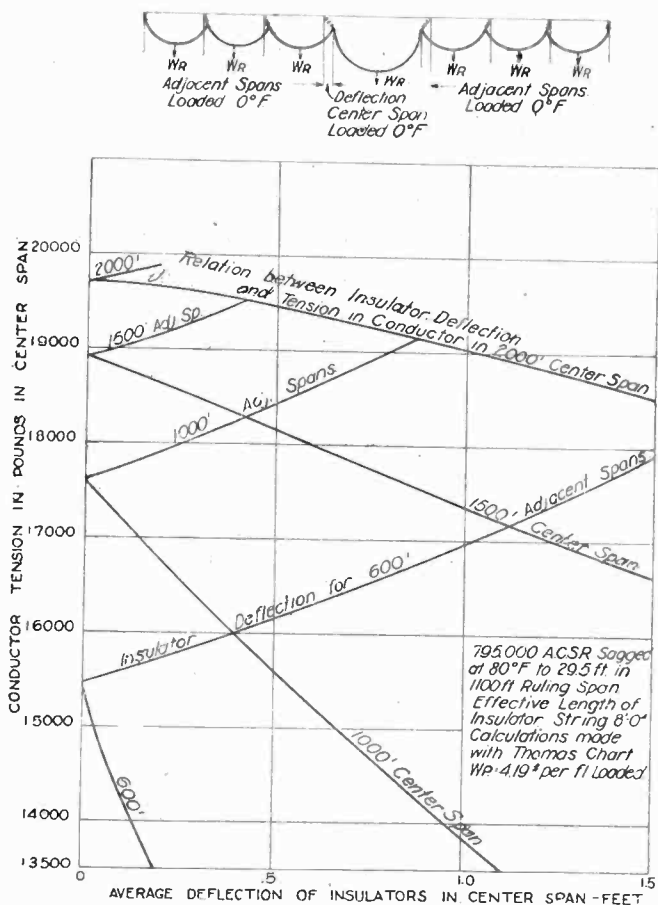

FIG. 5—COMPUTED EFFECT OF LOADING A SERIES OF SPANS

Chart showing maximum insulator deflection and conductor tension for all spans of a series loaded with one-in. ice and eight-lb. wind at 6 deg. fahr. 795,000-cir. mil steel-reinforced aluminum conductor

simplify computations and intended to approximate practically any condition encountered on the actual profile. On this basis, the result of the experiments and computations show deflections and tensions of reasonable consistency.

EXPERIMENTS WITH ARTIFICIAL LOADING

The tests consisted of two sets of experiments; one set to determine the effect of a one-inch radial ice load applied to a part or to the whole section with the conductors intact; and a second, to measure the impact on the tower and the tensions in the conductor caused by a broken conductor under various conditions.

A one-mi. length of 795,000-cir mil. steel-reinforced aluminum conductor was strung on snatch blocks over the section of line shown in the diagrams. The wire was dead-ended to ground pins about 600 ft. ahead of Tower No. 7, sagged to a tension of 4550 lb.,

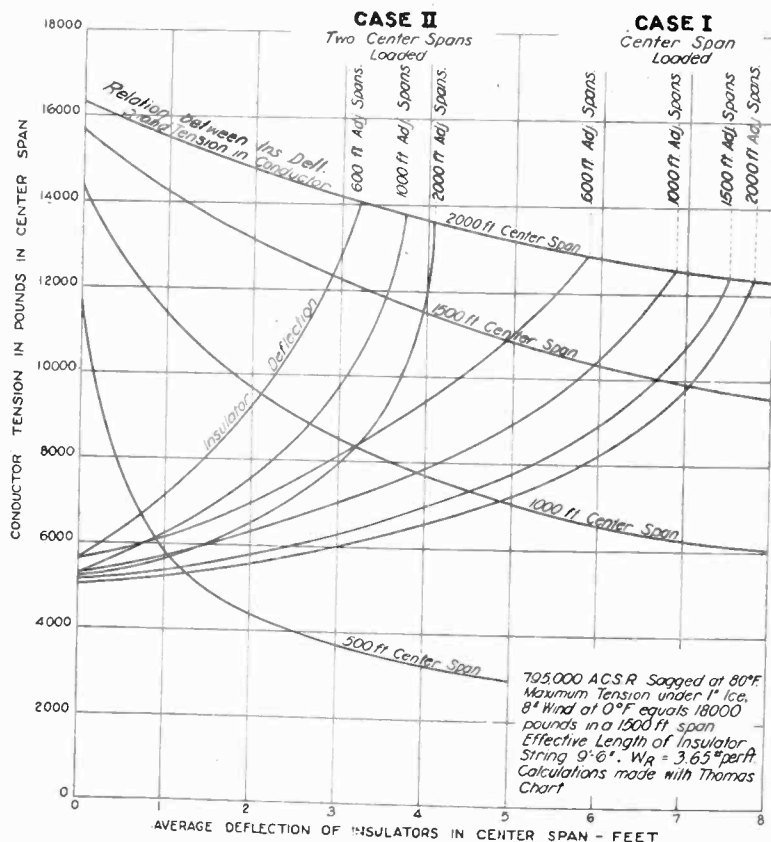
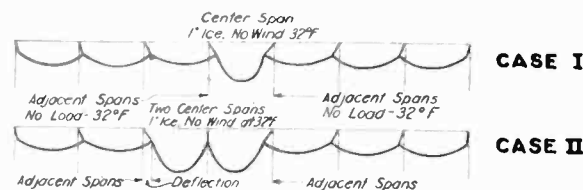

FIG. 6—COMPUTED EFFECT OF LOADING CENTER SPANS

Chart showing maximum insulator deflection and conductor tension with one and two spans of a series loaded with one-in. ice at 32 deg. fahr. No wind 795,000 cir-mil. steel-reinforced aluminum conductor

resulting from the artificial loading together with the results computed from a roughly similar series of spans on a level profile. The conductor tensions shown were computed from the measured sags. The vertical weights are obtained from the conductor lengths scaled from the profile with the sags drawn in to scale—the weight on an insulator being taken as the weight

of conductor from the insulator to the low point of the sag. All of these quantities show slight discrepancies due to small errors in the sag measurements, but more

accurate methods of measurement would not have increased materially the value of the results.

These experiments may be considered as an approxi-

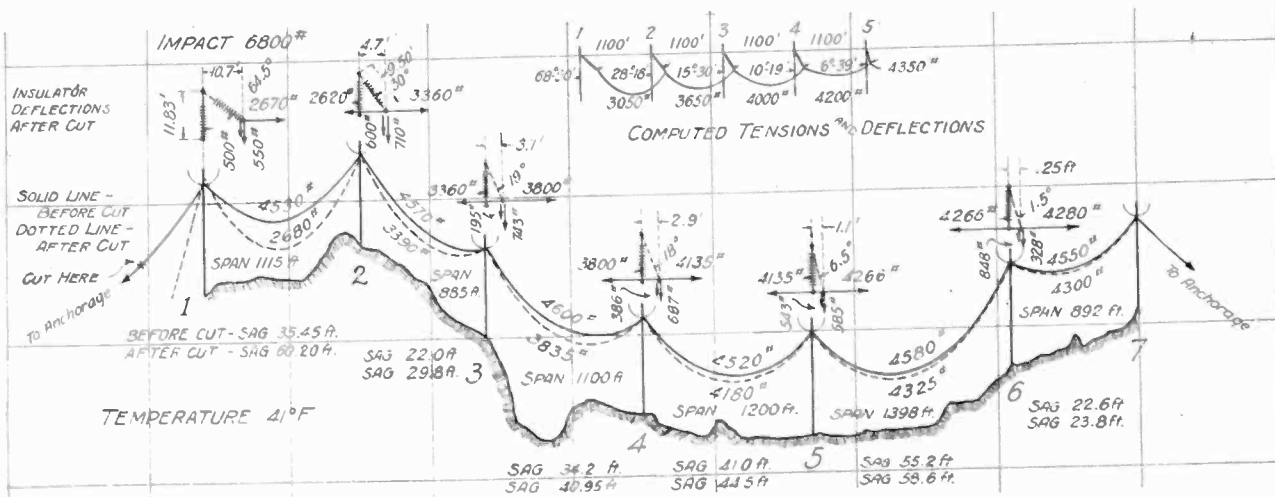

FIG. 7—EXPERIMENTAL RESULT OF BREAKING CONDUCTOR AT NORMAL TENSION

795,000-cir. mil steel-reinforced aluminum conductor "cut" when sagged to 4550-lb. tension. Clamps set to prevent slipping.

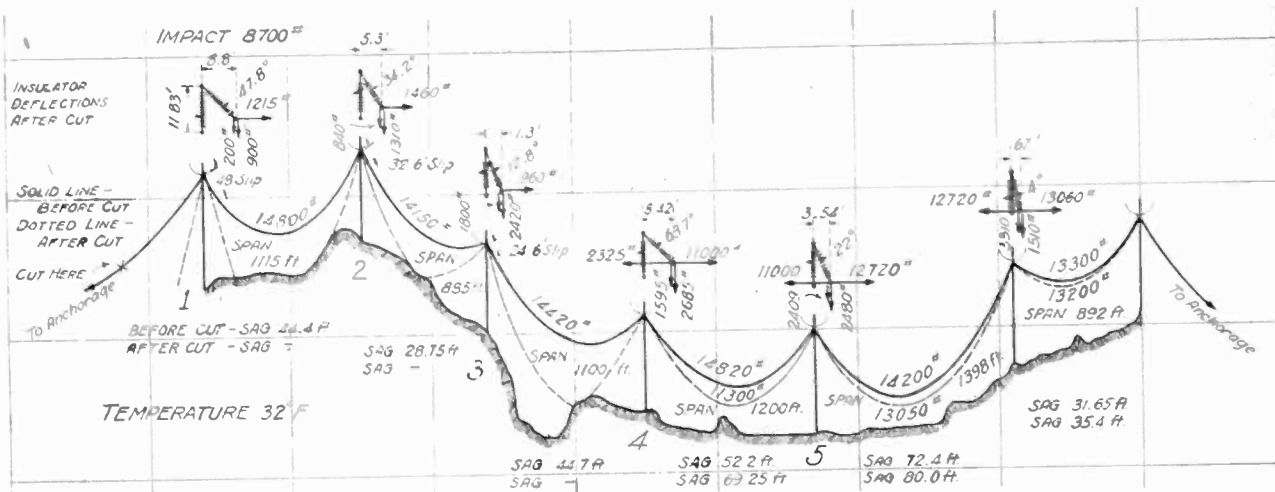

FIG. 8—EXPERIMENTAL RESULT OF BREAKING CONDUCTOR UPON ARTIFICIAL LOAD

795,000-cir. mil steel-reinforced aluminum conductor strung to 4550 lb. and then an artificial load of approximately 3.17 lb. per ft. added equivalent to one-in. and eight-lb. wind. Clamps set to slip at 5000 lb.

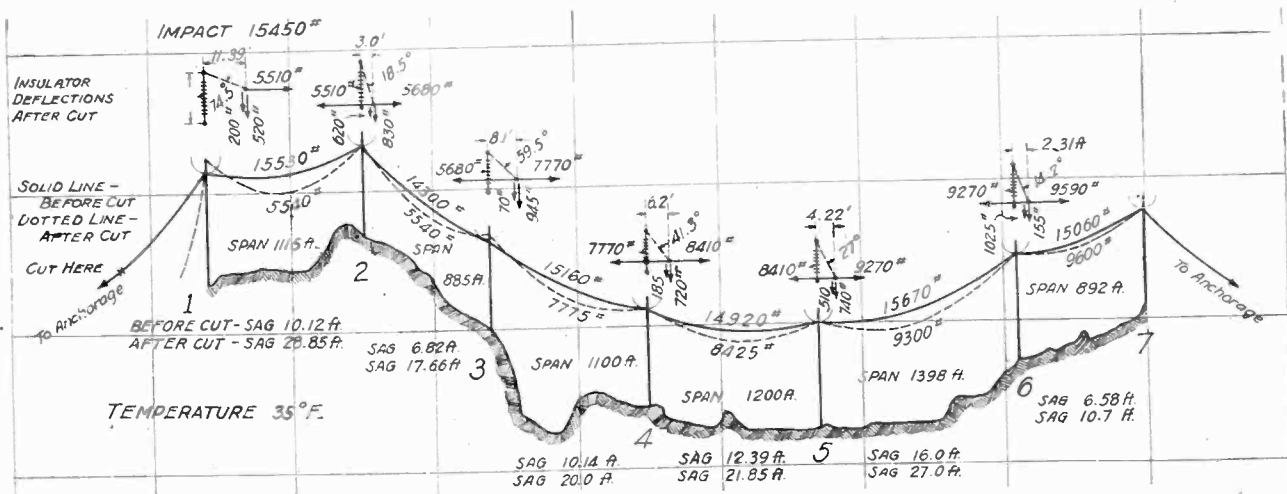

FIG. 9—EXPERIMENTAL RESULTS OF BREAKING CONDUCTOR AT 15,000-LB. TENSION

795,000-cir. mil steel-reinforced aluminum conductor "cut" when sagged to 15,000-lb. tension without artificial loading. Clamp on Tower No. 1 set with positive grip. Other clamps set to slip.

mate check of one of the many combinations of span lengths given by computation and shown in diagram in Figs. 5 and 6.

#### EXPLANATION OF CHARTS SHOWING COMPUTED RESULTS

Some explanation is required of the use of these charts and methods of making the calculations.

A series of spans was assumed with the insulator supports all on the same level and the conductor strung to the correct sagging tension at 80 deg. Fahr. The series of spans consisted of a long "center span" or, in one case, two "center spans" and several equal-



FIG. 10—TRIPPING DEVICE USED TO GIVE THE EFFECT OF "CUTTING" THE CONDUCTOR IN MAKING BROKEN-CONDUCTOR TESTS

A pull on the lower arm instantly releases the clamp, shown at right of the illustration, to which the conductor was attached

length shorter "adjacent spans" on each side of the center.

Fig. 5 shows the average deflection of the insulators on the center span and the tension in the conductor of the center span caused by dropping the temperature from 80 deg. to 32 deg. Fahr., and adding a one-inch ice load to the entire series. The solution of each combination of adjacent and center span lengths was made by a series of trials, interpolating between trial results for the correct solution. In making up the chart, a separate set of computations was carried through for each of several combinations of span lengths. These results were plotted and connected by a curve again by interpolating, obtaining results of intermediate conditions. As an example it may be assumed that in a section of the line over which spans averaged about 1000 ft., a span of 2000 ft. was encountered. For this case, the effect of a heavy ice load may be read from Fig. 5, thus: Following the curve for a 2000-ft. center span to its intersection with the curve for 1000-ft. adjacent spans, we find an insulator deflection of 0.7 ft. and a conductor tension of about 19,300 lb. in the center span. In the same manner, we may determine the effect of one center span of any length loaded with ice if the adjacent spans are unloaded from Case I, Fig. 6, or for two center spans loaded from Case II, Fig. 6. Sags may easily be computed from the tension.

Considering the computations involved in solving the various combinations of span lengths shown on Fig. 5, it is evident that the heavy ice loading causes considerably more stress in the long center span than in the shorter adjacent spans, and that this causes the insulators to swing over until the horizontal component of stress in the insulator string is equal to the difference in tension between the two adjacent spans. This effect is, of course, complicated by the swing of successive insulators on each side. However, it was found that about the fifth insulator from the center has a swing of only a few degrees, and that (approximately) the tension in the next span beyond is unchanged. Cases involving very large insulator deflections or more accurate results require this assumption to take effect at a greater distance from the center span.

One other assumption was required—that the deflections of the two insulators at the opposite ends of a span had the effect of increasing or decreasing, as the case might be, the length of the wire in the span by the sum or difference of the insulator deflections. With this assumption, supplementary "deflection-tension" curves were made, showing the change in tension in any span of the particular conductor and loading under consideration, for any increase or decrease in the length of the wire or as assumed difference in swing of the supporting insulators. These curves are easily made by use of the Thomas Chart, treating changes of wire



FIG. 11—TOWER NO. 1 AFTER "CUT" SHOWING DUMMY INSULATOR EMBRACING SPRING DYNAMOMETER AND IMPACT DYNAMOMETER

Conductor cut about 700 feet to the left

length due to insulator swing exactly as if due to temperature change.

As a trial, the deflection of the fifth insulator was assumed at some definite amount from one to 10 deg. and the conductor tension and insulator deflection computed for each successive span by use of the "deflection-tension" curve for the "adjacent spans." On reaching the "center span" it was found that the deflection and tension thus computed generally corresponded more or less closely to the relation between deflection and tension shown on the "deflection-tension"

curve for the "center span." Two or three trials were generally sufficient to interpolate for the correct results.

The chart shown on Fig. 6 was made in a similar manner.

Incidentally, there is shown in Fig. 2 an interesting comparison between the experimental and computed tension resulting from adding an ice load to the steel-reinforced aluminum conductor. The computed tension resulting from loading a 1100-ft. span, sagged to 4550 lb. with an ice load of 3.17 lb. per ft., is 13,800 lb. The average tension from the artificial loading in the experimental span series was 14,480 lb.

The computations in this case assumed that the steel and aluminum strands, initially of exactly the same length, worked together, each taking load proportional to its respective area and modulus of elasticity up to the elastic limit of the aluminum strands. For

reduced by the swing of the insulator. There was, however, a great deal of doubt as to what relation this reduced tension bore to the maximum load thrown on the tower. This maximum load would be applied suddenly and, depending on the momentum developed and the elasticity of the parts absorbing this momentum, the load on the tower might be anywhere from a few per cent to several times greater than the final tension in the span.

The broken-conductor test results are shown in diagram in Figs. 7, 8 and 9. These tests were made to determine the effect of a broken conductor under normal tension, Fig. 7, under maximum ice load, Fig. 8, and under a heavy tension without ice load, Fig. 9. In addition to the insulator deflections and conductor tensions, these diagrams indicate the impact load recorded on the tower next the break. As a check on

TABLE I  
SUMMARY OF IMPACT TESTS

Description of test	Temp. Deg. Fahr.	Wind velocity ft. per min.	Initial tension in conductor, lb.	Final tension in span adjacent to break, lb.	Cylinder length, in.	Impact from calibration curve, lb.	Reading of maximum hand of dynamometer, lb.	See diagram
Conductor sagged to 4550 lb. Clamps tightened with positive grip.....	41	410	4550	2680	0.3850	6800	6850	Fig. 7
Conductor sagged to 4550 lb. Clamps tightened with positive grip.....	45	..	4550	..	0.3935	6500	..	
Conductor sagged to 4550 lb. Clamps tightened with positive grip.....	45	..	4550	..	0.4028	6100	5800	
Conductor sagged to 4550 lb. Clamps tightened with positive grip.....	45	800	4550	..	0.3837	6900	8000	
Conductor sagged to 4560 lb. Clamps set to slip.....	32	..	4500	..	0.3975	6300	..	
Conductor sagged to 15,000 lb. Clamp set with positive grip.....	35	..	15,000	5540	0.423 0.426 0.427	15,450	21,500	Fig. 9
Conductor sagged to 4550 lb., then loaded with sand bags to give a total load of 4.19 lb. per ft. Clamps set to slip.....	32	..	14,500	..	0.4719 0.4716 0.4713	8470	10,000	Fig. 8

tensions greater than this, it was assumed that the steel alone carried the increasing loads.

In this connection, it should be noted that the experiments were made under roughly constant temperature conditions and that while this temperature actually averaged about 35 deg. fahr., the tensions in the conductor corresponded to about 80 deg. fahr. These tensions were used to approximate usual summer conditions. Actually, therefore, the artificial loading experiments correspond to about one-in. radial ice and eight-lb. wind at 80 deg. fahr.

TESTS ON THE EFFECT OF A BROKEN CONDUCTOR

Computed results indicated that the tension in the span adjacent to a break would be very materially

the impact readings, certain of these tests were repeated. A summary of the results is shown on Table I.

The tests of a break under normal tension were made with the suspension clamps all bolted down firmly to prevent any slipping and to obtain actual impact readings. In the test of the conductor with artificial load, the suspension clamps were used as they were assembled in the completed line; that is, to allow slipping under an unbalanced tension of about 5000 lb. The third impact test was made without any superimposed load but under a tension of about 15,000 lb. The conductor was positively gripped at the suspension insulator Tower No. 1 but the remaining clamps were set to slip as before.

The specific values of insulator deflections recorded

in the latter tests are therefore of little general value. While quite aside from the scope of this discussion, it might be mentioned that this type of clamp effectively held down the loads on the tower as intended. Furthermore, the results left a serious doubt as to whether a slipping clamp can be so applied to a multi-layer cable of this type as to avoid injury to the strands when slipping takes place.

The impact values given in these tests were measured by an ingenious adaptation of the U. S. Ordnance Department's "Crusher Gage" designed and made by J. B. Thomas, Chief Engineer of the Texas Power & Light Company, and shown in Fig. 12.

The conductor tests were all made with this impact dynamometer used in place of insulator disks on the insulator string of the first tower. The impact dynamometer was attached directly to the suspension clamp. Directly above this was placed an ordinary spring-type dynamometer and the remainder of the "insulator string" consisted of an iron bar of a length and weight to make the whole the same length and about the same weight as the usual string of insulator disks.

A little consideration will show that it is an exceedingly difficult matter to measure the force exerted on a

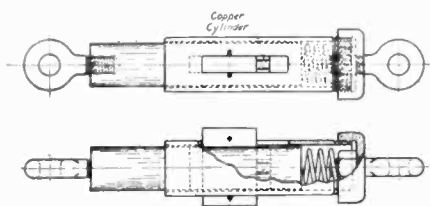

FIG. 12—IMPACT DYNAMOMETER USED IN MEASURING IMPACT ON TOWER RESULTING FROM A BROKEN CONDUCTOR

tower by the breaking of a conductor. The *crusher gage* method was devised for measuring the pressures developed in guns. As thus used, the device consists of a small steel cylinder with a light piston so arranged that the force of the explosion will compress a carefully calibrated cylinder of soft copper. The pressure is measured by the reduction in length of the copper cylinder. A description of the uses of the crusher gage is given in the U. S. Bureau of Standards, Technologic Paper, Paper No. 185. After consulting numerous authorities on the subject, it was concluded that even for the comparatively slowly applied loads resulting from these tests, the accuracy was well within practical requirements.

The spring dynamometer which was used in series with the impact dynamometer did not show consistent results. The impact was taken as the reading of the maximum hand. This hand is so arranged as to follow the indicating hand up to its maximum reading and remain at this point. The results indicated that the maximum hand was probably thrown beyond the proper reading as in only the first of the six tests made did the

maximum hand approximately check with the crusher gage. It was also found in calibrating the dynamometer, that after tests had been completed, the dynamometer readings were over 1000 lb. lower than before the test.

A small moving-picture camera provided with a telescopic lens was used in the test of the broken conductors, and set up about 300 ft. on one side from the first tower. A time analysis of these pictures should give some interesting information and should be a real aid in solving the mechanics of the problem. Thus far, however, time has not been available for this analysis.

#### CONCLUSIONS

The results of these experiments and computations were derived only for application to the Wallenpaupack-Siegfried line and in this served as the basis for important decisions.

The results indicated that even with the extraordinarily heavy ice loading adopted for the line, seriously unbalanced longitudinal loads would not result when span lengths were reasonably uniform in length. On the other hand, they indicated that the maximum tension increased quite rapidly for spans materially longer than the average. Consequently an effort was made to equalize span lengths as far as practicable, and spans greater than 1750 ft. were not carried on suspension insulators without a suitable reduction in the sagging tensions.

Curves of Fig. 6 were used as a means of checking the safety of the conductors against coming in contact with the ground under the condition of heavy ice load on one or more adjacent spans, all other spans being unloaded. Two adjacent spans, fully loaded, were assumed as the limiting condition for ground clearance.

Broken conductor tests demonstrated that insulator deflection from the vertical, of magnitude for practical concern, did not extend back more than five towers from the break. Furthermore, these tests demonstrated the ability of the slipping clamp to successfully protect the tower against impact and other stresses from the conductor.

Recent surveys indicate that the farm power bill is greater than that of any other industry, about \$3,000,000,000 per year. These surveys made by Stone & Webster, Inc., also indicate that of all the sources of power, animal power is most expensive, costing about 24 cents per horsepower-hour while electricity is probably the cheapest. The cost of the latter is rather variable because of local conditions but the average falls at about 5 cents per horsepower-hour.

Of the work to be done on a farm about 48 per cent is field work, 22 per cent hauling and 30 per cent stationary. It is to the last class of work that electricity is particularly applicable where savings up to 75 per cent in power costs are now made.

# Variable-Voltage Equipment for Electric Power Shovels

R. W. McNEILL<sup>1</sup>

Associate, A. I. E. E.

ALTHOUGH the power shovel was developed and brought to a high state of perfection by using steam as a motive power, a constantly increasing number of power shovels is being supplied for electrical operation. These electric power shovels are being used for all sorts of work although they are in particular favor for projects of a permanent nature or for those requiring a considerable period for completion. In some cases the electric power shovel has been adopted when starting these projects, or in other cases it has replaced the steam power shovel because of its superior operating economies. This process of replacement is very active at the present time in connection with open-pit copper and open-pit iron mines. Other extensive uses for electric power shovels are found in "strip" coal mines, quarries with output used in crushed form (such as for blast-furnace purposes), road materials, cement manufacturing steel plants for rehandling ore and slag, and contract work on dams, canals, tunnels, etc.

This widespread use of the electric power shovel has led to a considerable development in connection with this type of machine not only in connection with the electrical equipment but also with regard to general mechanical design. While earlier experiences with electric power shovels had indicated that very good results were obtainable by taking the steam power shovel design and replacing the steam engines and boilers with electrical equipment, later experience has shown that in order to obtain the full advantage of benefits of electrical operation, the shovel must be designed with this point especially in view. Mechanical improvements have taken the form of better gearing, (double helical gears having been substituted for coarse spur gears in many instances), and of better systems of lubrication for gears, bearings, etc.

The latest development in the line of electrical equipment for power shovel operation is characterized by two outstanding features. First is simplicity of control, and second, sturdiness of the entire electrical equipment. Simplicity of control is secured by use of the *variable-voltage* system of motor speed control and durability by designing all the electrical equipment with the same high standards as characterize the rugged reliable d-c. mill-type motors used for operation of the shovel.

In the development of this latest type of electrical

1. General Engineer, Westinghouse Electric and Mfg. Co., East Pittsburgh, Pa.

Presented at the Pacific Coast Convention of the A. I. E. E., Salt Lake City, Utah, Sept. 6-9, 1926.

equipment for operation of power shovels, every advantage gained by experience in perfecting the steam power shovel has been utilized and the equipment has been designed to duplicate the steam power shovel in performance and digging characteristics, for it is a well recognized fact that the power characteristics of the steam engine are practically ideal for power-shovel operation. The variable-voltage system of motor speed control as developed for electric power shovels employs an individual motor for drive of each principal motion, power being supplied to each motor from an

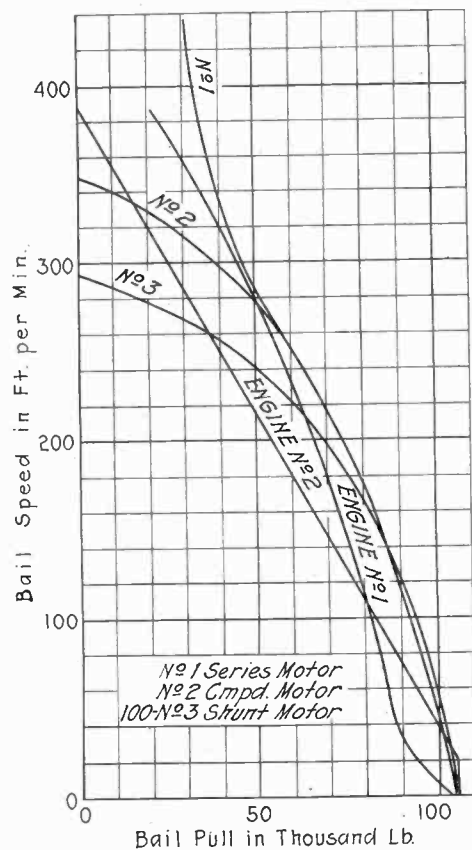

FIG. 1—COMPARISON OF STEAM-ENGINE AND VARIABLE-VOLTAGE-OPERATED MOTOR CHARACTERISTICS FOR POWER SHOVELS

individual generator of such design that the speed torque characteristics of the individual motors closely resemble those of the steam engines used on steam power shovels, as shown in Fig. 1.

Electrical equipment using the variable-voltage scheme of motor control is adapted to all sizes of shovels from the smallest to the largest, and its principle of operation is the same, regardless of the size of shovel. Where this system is used, a-c. power is usually supplied to the shovel from a central station system. This means that the complete electrical equipment for a shovel using the variable-voltage system will, of neces-

sity, consist of the following principal items in the order of their location with respect to the incoming power line.

1. Starting equipment for a-c. motor.
2. Motor-generator set.
  - a. A-c. driving motor.
  - b. D-c. generators for supplying power to individual shovel motors.
  - c. D-c. generator for furnishing excitation to above d-c. generators, shovel motors and a-c. motor, if same is of synchronous type. (This exciter may be separate-motor-driven, if physical limitations make it impossible to drive same from main set.)
3. Controllers and field resistors.
4. Shovel-driving motors.

Auxiliary equipment may consist of air compressors, magnet valves, solenoid brakes, etc.

Due to differences in size of equipment, type of driving motor, and voltage used, there will be considerable variation in the type of starting equipment furnished for the main motor-generator set. For the larger outfits using high-voltage synchronous driving motors, the usual practise will be to supply a combined synchronous motor and exciter panel of steel clad construction. If reduced-voltage starting is used, this panel or switch structure will include auto-transformer, double-throw oil switch, field rheostats, necessary current and potential transformers, and meter equipment. If full-voltage starting is used, the auto-transformer will be omitted, and if desirable, starting may be made automatic by using an electrically-operated circuit breaker. On the smaller sized motor-generator sets driven by induction motors, the equipment can be simplified and motor started at full-line voltage by use of an oil circuit breaker in case of high-voltage motors, and by means of an across-the-line type magnetic starter in case of low-voltage motors.

While the size of the motor-generator sets will vary with the different sizes and models of shovels, the general scheme will always be the same and the set will consist of an a-c. driving motor of either the synchronous or induction type, a d-c. generator for the hoist motion, a d-c. generator for the swing motion, a d-c. generator for the thrust motion, and a d-c. exciter. The exciter may or may not be part of the main motor-generator set, depending upon whether or not space limitations will permit the use of a five-unit motor-generator set. Where the exciter is separate-motor driven, it is usual to use a low-voltage driving motor, and, if power supply is at high voltage, to supply transformers for furnishing power to the exciter motor-generator set. Driving motors for the larger shovel motor-generator sets usually are wound so that by a simple change in connections they can be operated on either 2200 or 4000 volts. Smaller sets are wound for 2200, 550, or 440 volts. Lower voltages are not recommended on account of poor line regulation. Either synchronous or induction motors can be designed for full-voltage

starting if desirable. In general, this will be the standard method of starting the smaller induction-motor-driven sets.

The individual d-c. generators used for supplying variable voltage to the various motions are of the differentially-compound-wound type, designed with three separate field windings, *viz.*, a separately-excited shunt-field winding, a self-excited shunt-field winding, and a series winding so connected as respects the armature that its effect on total field strength will be subtractive or differential under-load current on the generator. This type of generator will deliver variable-voltage power to the shovel motors, the exact voltage value at any instant being dependent on two factors: first, the value of the separate shunt-field excitation, and second, the value of the load current flowing in the

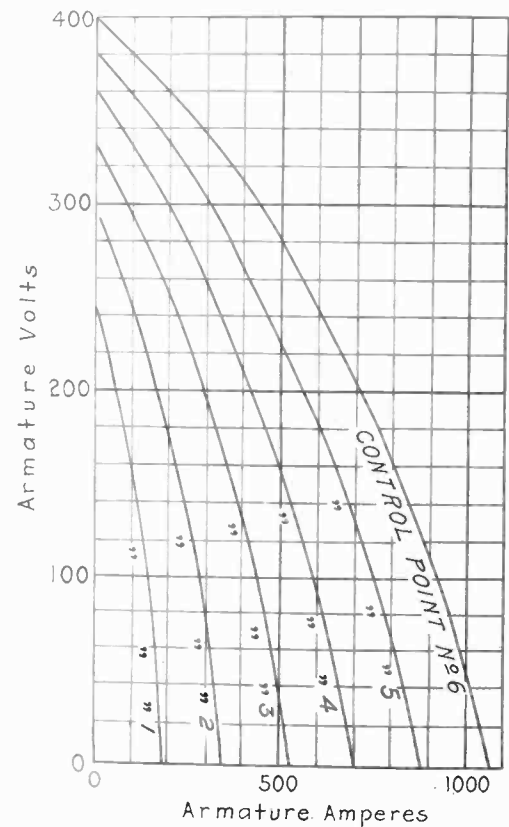

FIG. 2—VOLT-AMPERE CHARACTERISTICS OF DIFFERENTIAL COMPOUND GENERATOR AS USED SHOWING THE EFFECT OF EXCITATION CHANGES

armature and the differential series field winding. Fig. 2 shows voltage characteristics of a typical differential-compound-wound d-c. generator for power-shovel service under different conditions of separate-excited field strength and load currents. These characteristics are practically ideal for power-shovel operation, since by supplying power to the shovel motors from such generators, we are enabled to obtain motor speed torque characteristics closely resembling those of the steam engines used for power-shovel service. Actual practise in the design of these generators proportions the shunt-field windings so as to give the required light-load voltages and proportions the differential series winding so that the total field strength at heavy loads will be only



such value as to force the maximum required current through the main circuit consisting of motor and generator armatures, series and interpole field windings and connecting cables between the machines.

The motors used for driving the individual motions on variable-voltage equipped electric power shovels are of the well known d-c. mill type, used so extensively for auxiliary drives in steel mills and on heavy-duty cranes, hoist dumpers, etc. Open or ventilated type motors are usually used on hoist and swing motions, and totally enclosed motors on the thrust motion. Mill motors have massive cast steel frames split horizontally so that the top half can be readily swung back or lifted off. Widespreading feet, cast integral with the lower half of the frame, insure stability and freedom from vibration when the motor is bolted to a firm foundation. Electrically, the design is of the very highest order. Mica and asbestos insulation is used throughout; all main and commutating field poles are of laminated construction and coils are supported and banded in such a manner that there can be no loosening in service.

There is some variation in the type of field windings employed on d-c. motors used for shovel operation. The swing and thrust motions are always operated either by straight shunt-wound, separately-excited, d-c. motors or by compound-wound motors having separately excited shunt fields. The hoist may be operated either by series-wound motors or by separately-excited, shunt- or compound-wound motors. As compared to the compound-wound or series motor, the straight shunt-wound motor, when controlled by the variable-voltage method, possesses the advantage of no reversal of main circuit connections being necessary to secure reversing of direction of rotation of the motor. As compared to the series motor it has the advantage of positive regenerative braking being easily secured. As compared to the series and compound wound motors it has the disadvantage of not being designed to deliver the same maximum torque for the same current value and its speeds are inherently lower at light loads.

On the swing and thrust motions, the necessity of regenerative braking for quick stopping practically eliminates the series-wound motor, so that choice must be made between the straight, shunt-wound motor and the compound-wound motor. This also applies to the hoist-motion on high-lift shovels which use regenerative braking in lowering the dipper. The main objection to the use of compound-wound motors is that their use complicates the control, as it is necessary to furnish means of reversing the series fields for reversed service. On the smaller motors this is easily accomplished by additional contacts in the small drum controllers used for governing the operation of each motion. But on the larger motors, it is necessary either to add magnetic contactors for reversing these fields or to provide a series exciter, or its equivalent, so that compound motor characteristics can be obtained with shunt-field

windings in the motor. These schemes do not eliminate the reversing processes but do reduce the capacity required so that large magnetic contactors are unnecessary. The choice between straight-shunt and compound-wound motors for swing and crowd motions is not very clearly defined; in some cases the extra complications of the compound-wound motor will be justified, while in others the simplicity of control possible with the straight shunt motor will be the deciding factor in determining its use.

On the hoist motion the problem of proper type of motor is further complicated by differences in practise in operation, particularly on low-lift shovels. Some shovel manufacturers prefer to use the motors in lowering, using regenerative braking to obtain speed control, while other manufacturers prefer to lower the

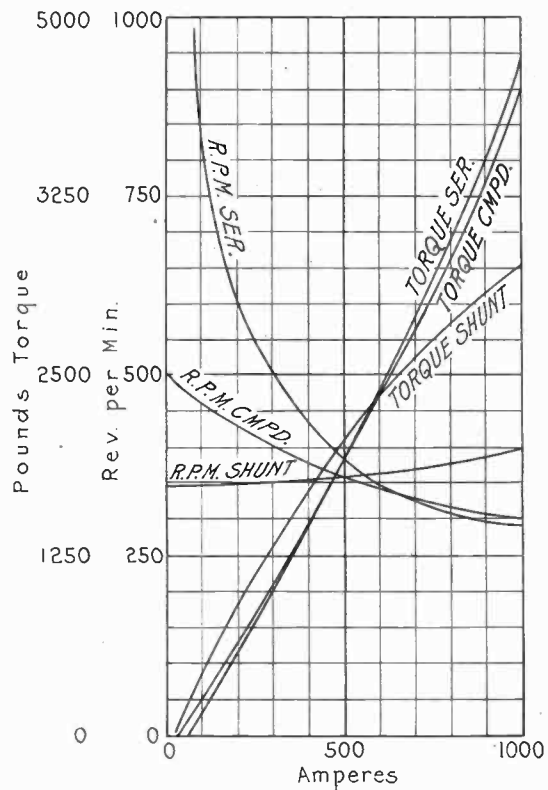

FIG. 3—SPEED-TORQUE CHARACTERISTICS OF 170-H. P., 230-VOLT, D-C. MILL-TYPE MOTORS FOR POWER SHOVEL SERVICE

dipper on a foot brake without operation of the hoist motor in the reverse direction. If the latter practise is followed there is little advantage in using the straight shunt or the compound-wound type of motor and advantage can be taken of the superior operating characteristics of the series-wound motor for the hoist motion. If, however, regenerative lowering is needed, a shunt or compound motor is used, control connections being so arranged on the compound wound motor that in lowering, it operates as a straight shunt-wound motor. Comparative speed torque characteristics of shunt, compound and series motors are shown on Fig. 3.

The control equipment necessary with electric power shovels operated by the variable-voltage system is of

the very simplest nature. Actual practise is to use small drum controllers and series resistors connected into the separately excited shunt fields of the individual generators in such a manner that operation of these controllers will direct the flow current and current strength in these fields. Additional contacts are regularly provided in this controller for weakening the self-excited shunt field of the generator in the off position for connection of field discharge resistors and for operation of brake and clutch circuits. Where straight shunt-wound motors are used, these controllers provide for the weakening of the motor shunt field in the off position and may provide for insertion of resistance into the motor field to secure high light-load speeds. When compound-wound motors are used, it is necessary to furnish not only the field weakening point in the off position for the separately excited shunt field, but also to furnish additional contacts either for reversing the series field direct through magnetic contactors or by reversing connections to a separate exciter used to secure compound-wound motor characteristics. Where series-wound motors are used on the hoist, it is not necessary to provide for frequent reversals, as the only time that reverse operation is required is when the hoist motor is used for propelling the shovel. This infrequent reversal is usually taken care of by a separate hand-operated reversing switch. Typical diagrams for shunt, compound-wound and series motors are shown on Figs. 1, 2 and 3.

Controllers used with the variable-voltage equipped shovels are all of the same general type and construction though they may differ somewhat as to drum development and method of operation. The currents to be handled by these controllers are small and the design is determined more by the demand for rugged mechanical construction and ease of operation than for current-carrying capacity. Full revolving shovels are built usually for one-man operation and for this reason there is some demand for a foot-operated controller to be used on one of the motions on these shovels. Standard controllers for variable-voltage equipped shovels are constructed with vertical operating handle. Thumb-operated auxiliary switches for operation of dipper-trip mechanisms, magnet valves, etc., are frequently added to the handle of standard controllers.

While the resistors used with the variable-voltage equipment are of small size and capacity, even on the largest shovels, they are quite an important feature of equipment and it is very essential that they be of ample capacity and rugged construction. Experience has demonstrated that these resistors should be wound on insulated metal supports and that special care should be taken to insure against connections loosening due to vibration. Practise in method of assembling resistor units varies with shovel design. On one type of shovel it

may work out to advantage to assemble resistors all in one unit and provide this assembling with a terminal board which will serve as a distribution center for all control wiring. In other cases, space limitations can best be met by making up the resistors in unit assembly, that is, one unit for hoist generator separate excited field, one unit for hoist generator sets excited field, etc.

Air compressors, when used with shovel equipment, are usually of the industrial type with a-c. driving motor. Air pressure is maintained at a constant value by means of an automatic governor which stops and starts the compressor as the air receiver pressure varies. Compressed air is used for operation of brakes on the swing and thrust motions and for brake and clutch on the hoist motion.

Magnet valves are used to give electrical control of the air brakes, clutches, etc. Two types of valves are used; these are known as "straight" and inverted valves. Both types of valves are of three-way construction and the difference between the two is in the method of operation. The *straight* valve is provided with three openings for pipe connections; one from the air supply, one to the brake or clutch cylinder, and an exhaust opening. With magnet of valve energized, the exhaust opening will be closed, the air inlet will be open, and full air pressure will be exerted against the brake or clutch cylinder. Interruption of magnet circuit closes inlet opening, opens exhaust port, and relieves pressure in brake or clutch cylinder. Operation of "inverted" valve is just the reverse of above, as magnet coil is energized to exhaust brakes or clutch cylinder and circuit broken to apply air pressure. The straight valve is always used on brakes which are of the spring- or gravity-applied, air-released type. The inverted valve is used in connection with air applied spring released clutches where it might be dangerous to use a straight valve as interruption of magnet circuit might be the cause of accident.

Solenoid brakes are used on electric-shovel equipments where compressor equipment is not supplied. On variable-voltage equipments these brakes are of the d-c. type with shunt-wound operating coils designed to operate from the exciter circuit.

While the above has covered only the application of the variable-voltage system to power shovels of the conventional type, the system is equally adaptable to dragline excavators, dipper dredges, and to hoist and swinging motions on all types of cranes, dredges, etc. It provides a simple automatic method of limiting motor torques where serious damage to the mechanical equipment might result if motor torques were not limited, and it also provides a simple automatic method for obtaining high motor torques with low kw-input to the motor. This last factor is a valuable one where power is purchased on a peak-load basis or where the primary source of power is of limited capacity.

## Discussion at Midwinter Convention

### EXPERIMENTAL DETERMINATION OF LOSSES IN ALTERNATORS<sup>1</sup>

(ROTH)

NEW YORK, N. Y., FEBRUARY 9, 1926

**W. F. Dawson:** In an article published in 1920<sup>2</sup> I called attention to the fact that in many cases load losses indicated during short-circuit test were greatly reduced when the machine was run at full voltage and rated power factor.

I have since run many other tests and while I am not prepared to lay down any definite rule, I am prepared to suggest that the present A. I. E. E. rule (paragraph 470, No. 7) which charges all of the load losses measured during short circuit against the losses of the machine, is probably unfair. Since the publication of my article in 1920, improved methods have been developed. At that time I intimated that electric heaters delivering a known quantity of energy into the discharge duct could be employed as a calibrating device. I had tried them in a rather amateurish way. Since then we have perfected our electrical air heaters and we have also perfected resistance thermometers for measuring the inlet air, the outlet air, and the temperature of the air after it has passed the electric heater. It is now a comparatively simple matter to measure the actual losses of a machine having an enclosed ventilating system, such as turbine alternators, under any condition of load.

We have satisfied ourselves that the question of convection, at least on high-speed machinery, introduces no appreciable error, even though we have not been able to establish an exact emissivity constant. This may possibly vary from 0.0125 watts per sq. in. per deg. cent. rise of the frame surface to 0.007 watts per sq. in. per deg. cent. rise; but when it is realized that even with the higher figure the convection loss amounts to less than two per cent of the total loss on an alternator as small as 3750 kv-a. and the total loss in turn is only 4.2 per cent of the rating (on 3000 kw.), the total loss due to convection will be only about 0.08 per cent of the rating.

It has been my pleasure, during the last year, to build and test a turbine alternator rated three-phase, 480 volts, 7518 amperes, 0.8 power factor. Check tests at full load, 0.8 power factor, were made on the customer's premises a few weeks ago. The factory test consisted of a zero-field (no excitation), open-circuit heat run at normal voltage and a short-circuit heat run at normal current, the calorific method being used to estimate the losses. The aggregate of these losses, assuming the same losses under operating condition as during short-circuit test, was 279 kw. On the customer's premises a check was made under contract conditions, except that the phases were slightly unbalanced; the average armature current was slightly over the rating and the armature voltage slightly less. The normal rating of 5000 kw. was maintained accurately, the field current held constant and the power factor, within one per cent of the 0.8 guaranteed.

What was the result? The generator was equipped with an air cooler. We installed flow meters to measure the quantity of cooling water, thermometer wells, and calibrated mercury thermometers reading to within 0.1 deg. fahr. We also installed numerous thermometers for measuring the temperature of the (inlet and outlet) air. Assuming that the factory measurement of quantity of ventilating air was still correct value, total losses by temperature gain of the ventilating air were 266 kw., while for the temperature gain of the cooling water, the value indicated was 270 kw., a check within 1.5 per cent. An average between the 270 kw. and the 266 kw. (between the air and the water method) gave 268 kw., which was 11 kw. less than the aggregate shown by the factory measurement.

**B. L. Barns:** What I have to offer has reference to the general subject of the determination of losses in alternators.

We have built in Canada some very large vertical shaft alternators which are installed in the Queenston Power House of the Hydro-Electric Power Commission. In making the acceptance tests it was not possible to determine the load losses by any of the methods described in the A. I. E. E. rules, and for the efficiency results an assumption was made regarding the value of these losses. Naturally in view of the size of these generators we were curious to know just what was the true value of these losses. In reviewing the work that had been done it was noticed that in 1913 Mr. H. M. Hobart had suggested what he called the calorimeter method. Later, in 1920, Mr. Dawson described the method which he, himself, has mentioned. Mr. Dawson's method involved heating the air that passes through the machine and under the conditions existing at the Queenston Power House it was quite difficult to take care of this feature. Furthermore it was very difficult to obtain an accurate measurement of the air passing through the generator.

Mr. Hobart's suggestion and Mr. Dawson's experiments offered a clue as to a method that might be used. An accurate determination had been made of the windage and friction and the open-circuit core loss on which we had consistent checks. It was reasoned that since the value of the core loss was known, it would be possible to determine by test the temperature rise of the air passing through the generator due to the core loss; then, having determined this constant, the losses under any other condition of load could be determined by measuring the temperature rise of the air. Thus, if it were found that the temperature rise of the air at full load was twice or three times the rise due to core loss alone it would be reasonable to conclude that the total loss was two or three times the core loss. Accordingly, a series of tests of this nature have been carried out on two of the generators. The tests consisted of measuring the temperature rise of the air under four conditions of load; windage and friction, open-circuit core loss, short-circuit core loss, and full rated load. It was necessary to separate the windage and friction from the open-circuit losses because the losses in the thrust and guide bearings were not taken up by the cooling air but were carried away by the cooling water and circulating oil. The difference in the temperature rise of the cooling air under conditions of open-circuit, normal-voltage core loss and windage and friction represents, therefore, the temperature rise for a known loss which is the core loss and the field copper loss. These results permit the establishment of a constant representing the kilowatts loss per degree rise of the cooling air. Having obtained the value of this constant, other runs at full load or on short circuit may be made and the temperature rise of the air measured and the value of the total losses determined.

This method of test of course involves the measurement by suitable test of the windage and friction and open-circuit core loss so that a known loss may be used for determining the temperature-rise constant. These losses may be determined by running the alternator as a synchronous motor and measuring the input, or by a retardation test. Tests by these two methods were made on one of the Queenston generators and remarkably consistent results were obtained. Our first trial of this method was made in June 1924, but, due to some unforeseen conditions, we were not well satisfied with the results and they were later repeated with quite satisfactory results which were described by the speaker in a paper which was read before the Toronto Section of the A. I. E. E., in February 1925. This method of test is briefly described by Mr. Roth in his paper<sup>3</sup> on the 60,000-kv-a. turbo alternators for Genevilliers.

1. A. I. E. E. JOURNAL, May 1926, p. 422.  
2. G. E. Review, Feb. 1920, Page 161.

3. Three-phase, 66,000-Kv-a., Turbo generators for Genevilliers, by E. Roth, A. I. E. E. JOURNAL, September 1925, page 927.

This method of test has certain limitations and obviously it cannot be used on all types of machines. No doubt it could be used with success in the case of most turbo alternators and enclosed alternators, synchronous motors, and condensers. The generator setting at the Queenston Power House is particularly well adapted to this method of test in that it is enclosed in a chamber having walls of hollow tile so that the radiation and convection are reduced to so small an amount that the error would be of a very small order. (A description of these generators and their setting is published in volume XLI, pp. 472-499, of the A. I. E. E. TRANSACTIONS). In carrying out a test of this kind it is essential that the true mean temperature of the air entering and leaving the machine should be obtained and several methods of doing this have been proposed. We have used a large number of thermometers with 0.1-deg. graduations together with an ordinary copper wire resistance grid, and the average readings of the thermometers have checked closely with the grid. I wish to call attention to one necessary precaution in making this test; each run should be continued long enough to obtain a constant temperature of the coils and iron of the machine and at the same time the temperature of the cooling air should be constant because a rising or falling temperature of the cooling air will introduce a considerable error even though a constant temperature rise of the air passing through the machine may be observed for considerable time. These precautions apply to the methods described by Mr. Dawson as well as to the method which I have described.

**P. A. Borden:** In most of the methods which have been used for the determination of losses by measurement of temperature rise in the cooling air, it would appear that there exists the necessity of either determining the quantity of air supplied to the machine, or of maintaining that quantity at a very steady rate of flow. In the testing of large units, exact measurement of the air flow is usually very difficult, while the maintenance of a uniform rate is seldom practicable.

While the following method is not offered as a panacea for all the troubles attending such a measurement, it would seem that the fact of its not being inherently dependent in its results upon volume or rate of air flow or upon temperature of the air supply would tend to remove many of the objections to the thermal system of loss determination.

Basically, the method, like a number of others, consists of introducing into the inlet and outlet air passages resistance grids having the same temperature coefficient, connected as two arms of a Wheatstone bridge. The bridge is first balanced in what we choose to call the "zero" position. After a steady condition of losses is established, the unbalance of the bridge due to the temperature gradient in the air column is corrected; but the restoring of the balance is not accomplished by manipulation of the circuit of the bridge, but by "artificially" raising the temperature of the cooler grid to meet that of the other. Measurement is then made of the power necessary to be introduced into the cool arm of the bridge to equalize the balance; and this value, expressed in watts, should bear a constant proportionality to the heat energy communicated to the air by the losses in the machine.

The elementary parts of the system are shown in the accompanying sketch, where  $R_1$  and  $R_2$  represent the resistance grids in the air inlet and outlet, respectively. These grids, as units, form two arms of a bridge circuit and are balanced on the galvanometer  $G$  by means of the slidewire  $S$ . The grid in the incoming air passage is itself made up in the form of a balanced Wheatstone bridge, so that the auxiliary heating current may be passed through it without disturbing the balance of the main bridge circuit. This current is derived from an auxiliary source (preferably alternating), and supplied to equipotential points of the grid  $R$ . It will be seen that with this arrangement neither the voltage drop due to the auxiliary current nor the resistance of the auxiliary circuit has any direct effect upon the balance of the main bridge. The other grid, while not necessarily a duplicate, is preferably of a similar construction and of

approximately equal resistance. Upon the establishment of a temperature difference between the two grids, with a consequent unbalancing of the bridge, current from the auxiliary source is fed into  $R_1$  and adjusted until the balance is restored. A reading on the wattmeter  $W$  of the amount of power thus supplied to the grid then gives a measure of the heat dissipated by the machine under test and communicated to the outgoing air. Calibration of the set-up is accomplished by making one or more determinations with a known value of losses dissipated by the machine, thus establishing the relationship between the measured value of the auxiliary watts and the quantity under investigation.

The controlling factor in the acceptability of this method of test would appear to lie in the constancy of ratio between the values of the auxiliary watts and the watts dissipated as losses in the machine; and there has not as yet (Feb. 1926) been an opportunity to study the soundness of the system on an actual power house installation<sup>4</sup>. Laboratory tests have been inde-

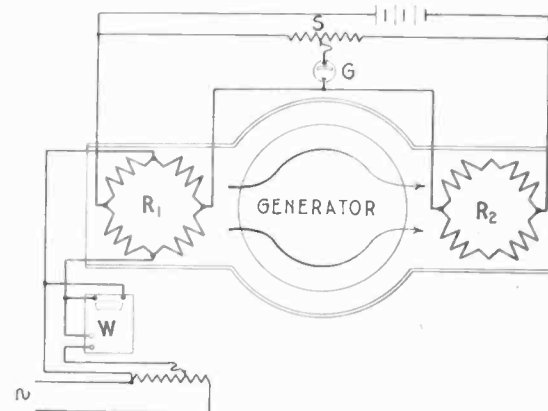

BALANCE METHOD FOR DETERMINING LOSSES IN TOTALLY ENCLOSED MACHINES

pendently made, however, by the writer and by Mr. Baker of the Ontario Power Company, using set-ups of dissimilar design and following different courses of procedure, but both with a view to establishing the constancy of the ratio under varying conditions, principally of air flow and watts loss.

While at the present time a compilation of the results of these tests is rather premature, it has been possible to arrive at conclusions which would appear to justify further investigation under actual service conditions; and it will be of great interest to learn of others following out a similar application of the principle described.

**W. J. Foster:** It is interesting to note that the author points out what many of us have been conscious of all along; that our method of determining the total losses of machines is approximate.

I should like to revert to the first attempt made to estimate load losses and speak of the two men whom I think had more to do with the exact formula than any others. I refer to Mr. Lamme and Dr. Steinmetz. They both regarded the determination of losses under short circuit as giving excessive values for load losses due to the very abnormal conditions the worst possible distortion of the flux existing. Consequently, they made an estimate of one-third of the short-circuit load losses as the load losses.

It soon became evident to all designers that that was not sufficient. On the occasion referred to by two or three of the speakers, when so many papers were prepared, determinations had been made by input and output method on a number of machines, and it was found that on the machines selected, the addition of the entire short-circuit losses to the other segregated losses gave efficiencies that agreed very closely with the over-all efficiency. That is how it happened to be agreed upon.

4. Since presentation of the above discussion this method has been tried out in a large hydroelectric station with very promising results.

Mr. Roth speaks of the method, I think, as applying to turbo generators. We are all aware that there is a difference in the type of generator. Turbo generators have almost invariably distributed field windings; that is, the field windings are in several slots, with practically uniform air-gap, and with the end windings secured by binding bands usually containing magnetic material. These bands are at almost the same radius, standing out in the line of the air-gap. Thus the determination of short-circuit losses undoubtedly involves larger losses at the heads of the rotor than exist under normal operating conditions.

In like manner the operation of that type of machine which has only a few poles on short-circuit results in losses at the heads of the stator that probably do not exist under ordinary operating conditions, especially at the 80 per cent power factor condition.

**C. J. Fehheimer:** Mr. Roth applies his method to a comparatively small, slow-speed machine, in which the "load losses" are almost negligible; that is,  $k r$  is only 9.4 per cent greater than  $r$ . Has he applied his method to machines in which the load losses are high, and if so, how close did it check with other tests?

It is questionable whether the method is applicable to the general case in which the power factor does not approach zero. Usually the cross-magnetization of the armature greatly distorts the flux, with the result that the magnetic inductions in the teeth, and to some extent in the core, are far from uniform. The iron losses may be considerably augmented thereby. It is believed that this statement is especially applicable to the machines described in a recent paper by Mr. Roth<sup>3</sup>. For those machines the armature ampere-turns are higher than are needed to excite the machine for no-load normal voltage.

Mr. Roth assumes the equation of the iron-loss curve to be a quadratic parabola (Fig. 2 in the paper). Inasmuch as when saturation is approached, that loss increases faster than the square of the voltage, so that a simple exponential form of equation can no longer be applied, he uses his method at 2000 volts instead of the normal 3000, in the machine he tested. How does Mr. Roth propose to extend his method so as to make it applicable at the normal voltage of the machine? If he assumes that the value of  $k$  is the same at normal voltage as at the reduced voltage, and if he allows for the incremental iron losses due to saturation by extending the tests as plotted in Fig. 2 to normal voltage plus the internal impedance drop added vectorially, it is questionable whether the method is correct. A large number of tests would have to be made to confirm the accuracy of the method.

In 1920 a method of separating the iron loss from the mechanical losses was suggested.<sup>5</sup> That did not require the assumption that the iron loss is proportional to the square of the voltage. The method has frequently been used at the Westinghouse Company, and Mr. Roth may find it useful. The machine is run idle as a synchronous motor with minimum excitation, just as as Mr. Roth does for Fig. 2. The calculations are, however, different.

A considerable part of the discussion has centered upon the thermal method of measuring losses. Many of us have attempted to measure losses that way, but it is rather difficult to obtain accurate results. The check that should be used is to run the machine without mechanically-connected load or driving machine, and measure the input with calibrated wattmeters. Then, if one is assured that the testing equipment is accurate, the load conditions may be fixed. It is expected that the results of tests along that line will be reported in an early paper by one of the Westinghouse engineers.

**E. H. Freiburghouse:** Mr. Roth points out, just as others have done, that there is considerable difficulty involved in measuring power input to a synchronous motor running light at low-power factor. It is more difficult to measure the power input to a stator of an alternator with the rotor removed. As stated

by Mr. Roth, the input to the alternator running as a synchronous motor can be measured quite accurately by determining the rate of flow and temperature rise of the air which cools it. In other words, it is quite possible to measure the entire losses of the alternator at low power factor. The method which he proposes, however, for determining the constants  $k$  and  $p$  depends upon the assumption that the electric losses of the alternator as a synchronous motor are the same when it is over-excited as when under-excited. I do not believe this assumption is justified since it is well known that the stray losses in the end structure of the stator are very much less when it is over-excited than when it is under-excited. These losses as defined by Mr. Roth are electrical, since they are known to be generated by the induction of the stator winding.

This is the principal criticism which I have to make of the method which he has proposed. It is rather ingenious and obtains results which seem to agree quite closely with the tests which he made upon the three different alternators. He found that in all cases the losses as determined by his method checked within 4.3 per cent with the losses as determined by the Rules of the A. I. E. E. and the French Rule.

Mr. Fehheimer called attention to the function of the voltage which appears in the equation on the sixth page. Of course that has been assumed as a square function; that is, as the square of the voltage. He assumed that and used that part of the no-load loss curve in which the relationship of loss to voltage was a square curve.

Mr. Fehheimer also called attention to the distorted form of Fig. 7 in relation to the loss. That is an insignificant influence because it really is the condition which the author states exists at the minimum input current, which is, of course, an extremely small current as compared with the rated current of that generator.

There is one other point; that is with reference to the cross magnetization. I think he takes account of that in the terminal voltage as a function of power factor. That is, one can determine the voltage which causes the loss by combining the fluxes for terminal voltage and that of the reactance voltage.

## Discussion at Madison

### THE QUALITY RATING OF HIGH-TENSION CABLE WITH IMPREGNATED PAPER INSULATION<sup>1</sup>

(ROPER AND HALPERIN)

MADISON, WISCONSIN, MAY 7, 1926

**W. S. Clark:** One very important feature in the paper of Messrs. Roper and Halperin is the correlation of tests and service, and nobody could do that except an operating man.

Now as to the rating of cable, I think it is most important to get into it a figure based on the so-called accelerated life test, as we have not yet found in Schenectady any test which would give us as correct a measure of the value of the cable as that. I should suggest that the tests on the cold and hot samples might have their ratings reduced to ten each, and the value of the added accelerated life test be put in at twenty, possibly reducing some of the observation tests because, of course, those are very undesirable on account of the personal element.

I should like to second Mr. Atkinson's suggestion that instead of testing to destruction by increasing the pressure 10 per cent every 30 sec. or every minute, the increase be at the rate of 15 per cent and at 5-min. intervals. I believe this would give more reliable data. The volts per mil, quoted in Mr. Farmer's paper, for instance, represent probably less than the one-minute strength of the cable.

Referring to Fig. 11 of Mr. Roper's paper, the slope of the curve in the type of cable on which it is based would be modified by temperature. It has been our experience with semi-solid

5. "A Method for Separating No-Load Losses in Electrical Machinery," by Carl J. Fehheimer. A. I. E. E. TRANSACTIONS, 1920, p. 291.

1. A. I. E. E. JOURNAL, June, 1926, p. 505.

compounds and on single conductors that the average life of a very large number of samples with insulation 0.28 in. thick, tested at 44 kv., or about 156 volts per mil, with a 2/0 conductor, would run around 40 hr. On the same samples, tested at 85 deg. the average life was in the nature of 1000 hr., the reason being that voids were not present in the second case in the same degree as in the first. You cannot prevent some voids in cable due to the process of manufacture unless you go back to the old Siemens' process and apply the lead cold, because the lead goes onto the cable at a temperature around 200 deg. cent. and it is evident that this must warm up the cable as a whole, so that when it cools to room temperature there is some shrinkage and some voids are created. It is for this reason, I believe, that in the past cables which were operated at average voltage stresses of less than 50 volts per mil have not given as much trouble as cables operated above 50 volts per mil average stress. This is due to the fact that at atmospheric pressure you get ionization effects around 50 volts per mil.

To illustrate how the curve in Fig. 11 may be varied with different types of impregnating compound, I have checked up and found that there the voltage ordinarily varies inversely as the seventh root of the time. We have this check on tests running up to 2800 hours and the results agree quite well with the formula.

On oil-filled cables of the Pirelli type, however, we have found that the exponent, instead of being seven, should be something in the neighborhood of nineteen, indicating a very much flatter curve.

There is one piece of information involving very long and expensive testing with reference to the effect of surges on cable on which I have data and I am giving a brief summary of results below:

Two samples of single-conductor 2/0 cable with insulation 0.28 in. thick; 10 ft. under the lead.

Sample No. 1 was continuously subjected to 13.2 kv. at 60 cycles at room temperature. Once a day a 50-kv., 10,000-cycle surge of approximately 300 microseconds was applied. Total number of surges applied up to the termination of the test, 357.

Sample No. 2 was subjected to an impulse voltage of approximately 300 microseconds duration from the lightning generator (the sphere-gap being set for 75 kv.) once a day. This sample was, of course, also under continuous stress of 13.2 kv. Total number of applications, 333.

Total length of time involved in the test on each sample—9933 hr.

The initial power factor at 28 kv., at room temperature, was 0.5 per cent. The final power factors were as follows:

At 5 kv.—0.6 per cent

At 15 kv.—0.5 per cent

At 28 kv.—0.6 per cent (an extremely small increase in the power factor.)

The above tests were on sample No. 1.

Sample No. 2 at the end of the test at 5 kv. showed 0.45 per cent; at 15 kv., 0.5 per cent, and at 28 kv., 0.6 per cent.

After the completion of the tests, samples were put under continuous stress at 48 kv. a-c. and they stood in excess of 36 hr.

**R. W. Atkinson:** Mr. Roper and his aids are to be commended for the large measure of accomplishment they have made toward the solution of the complex problem. They have shown that cable having the insulation of their 13-kv. system will not be free from operating difficulties unless it can meet certain test standards and that when it does meet these standards continued satisfactory operation seems assured, and, indeed, so far as their considerable experience goes, is assured by a large margin.

I endorse most of Mr. Roper's conclusions but wish to discuss two of them. The fourth one, stating that the ratio of puncture voltage obtained on cold bent samples to the puncture voltage obtained on the straight sample appears to be an excellent test of workmanship, contains a qualification which I wish to emphasize.

Mr. Roper uses the words "that this ratio appears to be an excellent test of workmanship." Undoubtedly, in many cases it is a test of workmanship. In general, American cables made at this time show approximately the same dielectric strength on the two tests, that is, this ratio is in the neighborhood of unity and without doubt the increase in the ratio from former times has resulted in no small measure from improvement in general excellence of workmanship. However, I do not believe that there is a fundamental relationship between the ratio and the quality of workmanship such that this condition will always remain true and I believe that the individual tests themselves and other tests and actual direct determinations of the quality of workmanship will be found to be much more important than any chance ratio which may seem to exist between these two tests. If proper weight is given to these other things, then the ratio between the two tests can be omitted from consideration.

I agree with Conclusion 9, that quality rating tables can be used with reasonable accuracy to determine relative merits of different lots of cable, but if this comparison is to be more than a very rough approximation, some additional types of measurements must be made in order to find better means than are now available to cover the subject of uniformity.

There cannot be any doubt of the value of the so called life tests, and the suggestion of these authors to change the eight-hour test in the Edison specification on reels to be used afterward to destruction tests on shorter lengths marks a distinct advance. For many years, we have been carrying on life tests in our laboratories, making these tests at relatively lower voltages and carrying them for many hundreds or thousands of hours. It is interesting to note that very much the same sort of data is obtained in the relatively shorter period, and of course tests for the shorter period have the very practical advantage that far more data can be obtained with a given space and equipment. I agree with these authors in placing this test as doubtlessly the most important single test. It is interesting therefore to note curves in Figs. 12 and 13, from which the authors conclude that this test gives substantially the same result as the rating table and that both are in general agreement with operating experience. The data given, however, do not justify this as a general conclusion.

Actually, the life test depends so largely upon the same things upon which the operating experience may be expected to depend that ordinarily there will be a very close relationship between them. It is easy however, to cite cases where this will not be true. The cable might be made with a compound of such characteristics that it would not well withstand a cold bending test or handling while cold; then be installed in extremely cold weather and give a very bad service record in spite perhaps of being able to pass an extremely severe life test.

If, when a group of cables is rated in the order of relative merit, (as determined by the best information available) any characteristic is found to fall in the same order as the rating of the cables, on first thought this may be assumed to indicate that this characteristic has fundamental importance in regard to the rating, or that it varies directly with some other very important property. I have already shown that even such an important test as the life test may vary in a way different from the service-ability of the cable. It is evident, then, that relatively minor properties may vary, in some cases, as the relative value of the cable, and in other cases, in an entirely contrary direction. To establish the importance of any particular test or item in the rating table, the individual item must be studied and its importance studied separately.

It follows, therefore, that we should be able to take a complete group of mechanical characteristics and get the same comparison as for a correlated and complete group of electrical characteristics. If these results do not coincide, there is no doubt that one or the other is not complete or is not properly evaluated. Each individual item that is given weight should be studied

analytically and the weight determined in that way. Evaluation of these different properties by mere comparison with operating experience, without the initial analytical comparison, is likely to be misleading.

These authors have followed the analytical method to some extent; for instance, in the case of the cold bending test. They have pointed out installation conditions and have shown the relatively excessive number of failures which once occurred in the manholes. They have ascribed the large reduction in such failures to the use of cable better able to withstand the bending test. I should ask, at this point, if the better results may not be partly a result of closer supervision of installation and greater assurance that cables are not subjected to conditions from which they can be protected or for which they were not designed. The general analytical treatment given the bending test justifies that it be considered of important weight.

I have already mentioned that there is no justification for the use in rating table of the ratio between breakdown of the bent and unbent samples. Substantially the same arithmetical result can be obtained by changing the weights and some changes in the limits. It may be asked, if there is no final arithmetical change in the rating due to making the change here proposed, what is the use of making it? In the first place, logic demands it; secondly, there is a very important practical reason. If the test on the bent sample is three times as important as the other, it warrants a great deal more relative attention. If it is three times as important, there should be three times as many tests made of this kind as of the other. Half of the present number of samples now intended for the straight test should be added to those tested after bending.

Uniformity of insulation resistance is given considerable weight in the rating table because it is assumed to be an index of the uniformity of the cable. It is, however, a measure of uniformity of only one property—insulation resistance. If insulation resistance measurements can be used to indicate uniformity in properties important in themselves, those advocating it as important for that purpose should suggest what properties it indicates and should use the insulation resistance measurements to aid in picking out non-uniformities in the important property.

There is, however, another aspect of the matter. Conditions in Chicago are known to be peculiar in one respect that has undoubtedly greatly influenced the whole handling of the cable problem. Street conditions have dictated a limitation of diameter to three inches and power requirements have been for very large capacities at high voltages. No doubt the standard necessarily set for 33-kv. cable had a bearing on a choice in Chicago of insulation thickness less than for usual American practise. Mr. Roper's experience has demonstrated that the problem of suitable specifications for cables with such insulation thickness is vastly more complex than where thicker insulation is used.

I want to express too my pleasure in hearing Mr. Roper mention two things which I have been preaching for quite a number of years. One is that low dielectric loss can be over-emphasized, and the other is that the cable manufacturers should not be limited to a particular kind of compound. Mr. Roper spoke of resin and its value. Some years ago the cable manufacturers had considerable difficulty in preventing operating people from insisting on putting into specifications the stipulation that a compound should be a mineral-base compound.

**D. M. Simons:** In general I agree with most of the conclusions of the authors, but I feel that real consideration should be given to the matter of whether or not some of the specific recommendations for tests are of general application or of general necessity. When the authors speak in general of a 13,000-volt cable, they have in mind a three-conductor, 500,000-cir. mil sector cable, insulated with 9/64-in. paper on the conductor, and 5/64-in. belt insulation. The mental picture of a 13,000-volt

cable in the mind of a manufacturer is very different. He will have in mind various sizes of conductor with conductor insulation thicknesses varying from 9/64 in. up to the more usual thicknesses of 12/64 to 16/64 in., and of various belt thicknesses. The manufacturer therefore has a tendency to wonder if the tests and data are of sufficient generality, large as they may be in extent, to justify general conclusions?

I should like to mention one other point. The authors are known to advocate very severe tests and also extremely thin insulation. I believe, however, that most companies go rather slowly in reducing thicknesses. It is of course possible to go to thinner insulation than the average used in the country for a given voltage, but, apparently, in order to do so, the severity and number of tests must be greatly increased so that at least part of the small saving in cable cost, due to thinner insulation, may be lost due to the increased cost of testing to find out if the cable is adequate. The authors state that *some* of the large operating companies have made reduction in the thicknesses of insulation. I do not find that this is by any means the general tendency; in fact out of a list of some fifty of the larger central stations I was able to note only three or four such cases in the entire country.

**Percy Dunsheath:** For twelve months I have known Mr. Roper has been working on this point of rating and I have not agreed with him. I have always felt that if you have a dozen different factors you can't add them together; any one of them, no matter how good the others are, may cause the cable to fail. For instance, if you have the papers on the cable very well registered, that counts for nothing if there is no compound in the cable. I have always criticized this method of Mr. Roper's on that score, but now I see this curve and I think I am converted. The curve does demonstrate pretty definitely that the testing of a cable by Mr. Roper's method comes very near the truth.

**R. J. Wiseman:** Mr. Roper's quality rating is most valuable to manufacturers. By using the weighted values, each of us can rate our own cables. Some of us may not agree entirely with the various weights of the separate factors, but as a whole the result should be a guide. As we get to know the various influencing factors which will cause a cable to fail in service, we can assign more weight to them. Is tearing in bending tests equal to half the weight of thoroughness in impregnation? I don't believe so. Today practically all manufacturers butt the tapes or use a slightly open wrap. There is not much difference between a tear and an open wrap. To be sure, too many openings at one point are undesirable. Registration of tapes is more serious than tears.

We still must consider that the dielectric strength of a cable is a big factor. I am glad to see Mr. Roper give most weight to items No. 9 and 10, dealing with voltage on the hot sample and cold bent sample. I believe that practically all manufacturers are getting nearly the same breakdown voltage for hot and cold samples. Therefore, it is possible to reduce the weight value of the ratio of the two and add a new factor, the long-time voltage test on a 75-ft. length. Some of its weight can be taken from item No. 11 and some from item No. 8. I think the weight of item No. 8 is too high. It is definitely known that power factor varies with voltage. Therefore, full weight should be for an actual change in power factor, say 0.5 per cent.

Uniformity of impregnation is the great need today. As the authors state in their paper, cable showing uniform tests, gives the best service. Insulation resistance is one of the best ways to determine uniformity but sometimes even this will not show up a defective reel of cable. If used in conjunction with the a-c. specific inductive capacity, however, it is a good guide to the uniformity of the cable. I am glad the authors recognize that it is the variation in insulation resistance and not the actual value that is important. It appears that there may be a relationship between insulation resistance and dielectric loss, but in each case it must be for each individual manufacturer.

There are some who do not believe the ionization test is of value. Here again, it is the individual manufacture as shown in Fig. 6 of the paper. Each one of us has his own curve, depending on the type of materials he uses and his own manufacturing methods. Let the user obtain the curve for each manufacturer and then compare results with this curve.

The new test for stability of compound needs to be perfected before we can use it as an accepted one. The idea is good but until we are able to prepare samples without entrapping air, we shall have to postpone using the test as a criterion for good compound.

The section of the paper dealing with the relationship between voltage and time of application is most valuable. Although others have referred to it and based their ideas upon short sample tests, the amount of data collected here give weight to the curves obtained. I think it would have been interesting if the authors plotted as ordinates, the logarithm of the maximum stress at the conductor instead of the ratio of breakdown voltage to rated voltage. Although some may question the accuracy of the formulas for calculating maximum stresses at the conductor for multiple-conductor cables, the work done by Atkinson and Simons has cleared up pretty well the discrepancies in the exact formulas. As it is now, a new set of curves must be drawn for each voltage. It is the maximum stress that the material can stand which is important. Low-voltage cables are being made today the maximum stress of which at breakdown is as high as for super-tension cables. Therefore, to expect a 33-kv. cable to withstand say seven times rated voltage for the same length of time as a 5-kv. or 13-kv. cable is asking too much.

There is a problem in connection with high-voltage testing which needs to be solved. We all know that we get different results if we apply a constant voltage until failure, noting the time. If we build up to this same voltage in steps, holding at each step, say one, five or ten minutes, and finally noting the time at the last voltage, the total time will be less, and it should be. On the way up to the last voltage the dielectric is being stressed; therefore, it is going through the fatigue pertaining to the breakdown phenomenon. The ultimate effect is the same failure. I believe the dielectric has been subject to just the same total amount of strain as in the first case. Although it did not stand up as long at the final voltage, it may be equally as good; in fact, it may be better. I have tried to evaluate the step test and the single voltage test but so far I have not been successful.

We must not misinterpret the formation of hot spots in a cable while subject to high voltages. If only one or two occur, it is an indication of possible weak spots but where there are many and uniformly distributed over the sample, I believe it is an indication of a uniformly manufactured cable, and although it may not stand as high a voltage ultimately as one with less hot spots, it may be a preferable cable. The whole length is failing at the same time and not here and there.

**H. G. Burd:** Many cable failures are charged too readily to defective cable. I should like to see considerable more study of operating conditions. A 25 per cent improvement of cable quality (as shown by recent tests) should be paralleled by a corresponding improvement in treatment of cable during and after installation. Quite radically different operating results in different cities on the same quality of cable present most convincing argument that many failures have a very close relation to operating problems and that even the best of cable as now made wouldn't overcome some operating handicaps.

**F. A. Farmer:** Some of us have been spending much time during the past two years trying to arrive at some method of taking all of the more or less intangible things which go to make up "quality" and combine them in such a way as to get a quantitative figure which we can call "quality." But even after we have done this, the proposed method must be tested finally by comparison with actual performance, and that is what Mr. Roper

has attempted to do. I think he is going to get a satisfactory answer before very long. That, to my mind, will be one of the most important contributions that has been made in many years to our discussion of this subject.

**E. S. Lee:** If you study the tables in the paper carefully you will find many interesting things. Take, for example, in Table I, the cable as represented by manufacturer *D*. This cable has the lowest rating for tearing in the bending tests and it has the lowest rating for dielectric power loss at 80 deg. cent. It has a relatively low rating on workmanship, insulation and fillers, and it has a relatively low rating on the ionization test. In spite of these deficiencies, the relatively high value of the puncture voltage on straight, and particularly on cold bent samples, earned this cable the highest total quality rating. Nor does this honor seem to be misplaced, for from Fig. 12 we see that samples from cable *D* outlived all others by several fold. Evidently tearing in bending tests, dielectric power loss, workmanship on insulation and fillers, and ionization test values, may have very little weight when the insulation has high dielectric strength.

Those interested will certainly eagerly await the results of this cable in actual operation. In other words, if we had had these figures from some cable that we were trying to rate, wouldn't the tendency have been for some to say, "Well, it has low tearing; it has relatively high dielectric power loss; it has a low rating in the ionization test. Even though it has high dielectric strength, will not these other factors possibly react to give a lower endurance of the cable?" Evidently in this case they have not, but perhaps in some other case they might.

Equally interesting is the fact that cables *A* and *B* rate practically equal in all respects, the total rating being 81.9 and 80.3; yet from Fig. 12 we learn that the life test of cable *B* was 45 hr. as opposed to a life of 115 hr. for the sample of cable *A*, or an increase in life of 156 per cent for the same quality rating. Perhaps this may be attributed to non-uniformity of insulation, though both cables are rated practically perfect as regards uniformity of insulation.

Now on the other hand, cable *C*, which rates inferior to cable *B* in practically every respect, having a total quality rating of only 46 as opposed to 80 for cable *B*, has a life of 35 hr. compared with life of only 45 hr. for cable *B*, or an increase in life for cable *B* of only 29 per cent for a quality rating 72 per cent greater.

I bring these to your attention because I should like to have explained to me how one can use a quality rating of this kind with these irregularities. I recognize that we have wide variations in all of this work, and to me, it seems that the wide variations are still present in this particular quality rating table.

I make an appeal, as has been done by several others, for the inclusion in this quality rating of two other tests, (1) the short-time breakdown test, with five-minute steps rather than one-minute steps, and (2) an electrical endurance test. Increasing the time length of steps in the short-time breakdown test will not increase the difficulties of the test but it will bring into account more prominently the effect of electrical endurance which I know both Mr. Farmer and Mr. Roper advocate. An electrical endurance test where some voltage such as Mr. Roper suggested as 3.6 times normal or some other value times normal for different ratings of cable, (because it will probably have to be different for different ratings of cable) are applied continuously, giving results as in Fig. 12, will serve to take into account all the factors in the quality rating which we can otherwise accomplish only imperfectly.

In Table II, cables *P* and *Q*, with total quality ratings much below those for cables *N* and *O*, have longer life, as shown by Fig. 13. A possible explanation is the fact that cables *P* and *Q* have low dielectric power losses, while cables *N* and *O* have high dielectric power losses. Apparently this factor obtains more prominence in 35-kv. cables than in 13-kv. cables, and is an added argument for including breakdown and electrical endurance tests in the quality ratings as suggested above.



I do not present these points to disparage the idea of quality ratings; I advocate them, and I hope that we may be able to perfect them so that they will be of greater use; but there are still uncertainties in these particular quality ratings, and I hope that they may either be explained so that we won't have to worry about them or that we can improve them so that they can be made of greater use to us.

**W. A. Del Mar:** I should like to mention something in relation to the point brought up by Mr. Wallace Clark; namely, that some of his associates, some years ago, showed that a determining critical stress in a cable is a stress of about 50 volts per mil or 18-kv. per centimeter, in which a very thin film of air ionizes at atmospheric pressure.

It is interesting to classify cables in accordance with the average stress at which they operate. I believe the average stress is of more significance than the maximum stress in this connection, and I therefore divided the cables into three groups.

The diameter of a cable must not exceed from 3 to 3½ in. but conductor sizes have been going up from the A. W. G. sizes to 500,000 cir. mils and larger and in the last few years working voltages have been rising rapidly. The net result has been a great decrease in the insulation thickness per volt; or in other words, a great increase in the electric stress. Confining our discussion to triplex cables, this increase may be seen from Table I:

TABLE I\*  
13-Kv. Cable

Insulation Thickness			Average Stress	
64ths on each cond.	Mils between cond.	Cm. between cond.	Volts per mil	Kv./Cm.
16				
14	437	1.111	29.7	11.7
12	375	0.953	34.6	13.6
11	244	0.874	37.8	14.9
10	312	0.794	41.6	16.4
9	281	0.714	46.3	18.2
(a)*				
8	250	0.635	52.0	20.4
7	219	0.556	59.4	23.4

27-Kv. Cable

Insulation Thickness			Average Stress	
64ths on each cond.	Mils between cond.	Cm. between cond.	Volts per mil	Kv./Cm.
23	719	1.825	37.5	14.8
22	688	1.746	39.2	15.5
20	625	1.588	43.2	17.0
19	594	1.508	45.5	17.9
18	563	1.429	48.0	18.9
(a)*				
16	500	1.270	54.0	21.2
15	469	1.191	57.7	22.6
14	438	1.111	61.6	24.3

35-Kv. Cable

Insulation Thickness			Average Stress	
64ths on each cond.	Mils between cond.	Cm. between cond.	Volts per mil	Kv./Cm.
30	938	2.38	37.3	14.7
23	719	1.83	48.7	19.1
22	687	1.75	50.9	20.0
21	656	1.67	63.4	21.0
20	625	1.59	56.0	22.0
19	594	1.51	59.0	23.2
(a)*				
18	563	1.43	62.1	24.5

\*The lines (a) represent 1926 insulation minima.

Considering cables on a basis of approximate equality of stress, we have the groups shown in Table II.

TABLE II

Rated Kv.	Group I		Group II		Group III	
	64ths each cond.	Mils between cond.	64ths each cond.	Mils between cond.	64ths each cond.	Mils between cond.
13	11	344	9	281	7	219
27	23	719	18	563	15	469
35	30	938	23	719	19	594

The cables in Group I have, as a rule, given practically no trouble in operation; those in Group II have given some trouble, but those in Group III have very generally been failures both in this country and abroad.

The reason is not far to seek if we remember the classic paper presented to the A. I. E. E. in 1919 by G. B. Shanklin and J. J. Matson<sup>2</sup>. These authors showed that at a stress of about 19 kv. per cm., (48 volts per mil), ionization of thin films of entrapped air occurs, and it has since been shown that such ionization is destructive due to its promotion of internal surface discharges and chemical deterioration of the compound. Hence it is not surprising to find Group I, without ionization, giving perfect service, while Group II, on the verge of ionization, is in the balance, and Group III, with decided ionization, is almost invariably in trouble<sup>3</sup>.

Mr. Roper's paper brings into prominence the significance of the time-breakdown voltage characteristic of a cable as a measure of its probable life in service. In this respect the paper deals practically exclusively with Group II and attacks the problem with rare insight and rationality. Mr. Roper shows that in order that a Group II cable may operate continuously, (i. e., at a stress of 48 volts per mil or 19.0 kv. per cm.), it must have a time-voltage characteristic at least equal to that represented by the stresses shown in Table III.

TABLE III

Minutes	Factor = times the rated voltage	Average Stress	
		Volts/Mil	Kv./Cm.
5	7	323	128
16	6	278	110
65	5	231	91
360	4	186	73
1000	3½	162	64

He has shown also that certain manufacturers have solved the problem of making Group II cables which are entirely satisfactory and he knows exactly how to obtain these cables and exclude those which are of poor or uncertain quality. This is a big forward step which marks an epoch in the cable industry. It should be noted that as thick insulation is weaker for unit thickness than thin insulation, the higher voltage cables having heavier insulation will be somewhat more severely tested than those for the lower voltages.

Mr. Roper now takes a step which, in the light of events, may or may not prove to be justifiable, for he does not furnish his justification. I refer to the extension of his conclusions to cover

2. *Ionization of Occluded Gases in High-Tension Insulation*, TRANS. A. I. E. E., 1919, p. 489.

3. The Shanklin and Matson paper deals with maximum stresses, but experience has since shown that the average stress is more significant in respect to ionization and breakdown. (See also the paper by P. L. Hoover, *The Mechanism of Breakdown of Dielectrics*, JOURNAL, A. I. E. E., September, 1926, p. 824.

all cables, including those in Group III. It should be noted that his time-voltage curves and tables are not expressed in terms of stresses but of factors of so many times the rated working voltage. When applied to cables in any one of my groups, this is equivalent to specifying stresses but if applied to another group, the factors do not correspond to the stresses, but to either lower ones in Group I or higher ones in Group III.

The question arises, which is the correct procedure, to use certain stresses or factors based on the working voltage? Let us see the voltages obtained by these two systems, as shown on Table IV, considering for brevity, only the 5- and 1000-min. tests.

TABLE IV  
Group I

Rated Kv.	64ths each cond.	Kilovolts		
		Min.	by Stress	by Factor
13	11	5	111	91
		1000	55.5	45.5
27	23	5	232	189
		1000	116	94.5
35	30	5	304	245
		1000	132	122.5

Group II

Rated Kv.	64ths each cond.	Kilovolts		
		Min.	by Stress	by Factor
13	9	5	91	91
		1000	45.5	45.5
27	18	5	182	189
		1000	95.5	94.5
35	23	5	232	245
		1000	116	122.5

Group III

Rated Kv.	64ths each cond.	Kilovolts		
		Min.	by Stress	by Factor
13	7	5	71	91
		1000	35.5	45.5
27	15	5	152	189
		1000	76	94.5
35	19	5	192	245
		1000	96	122.5

A study of Table IV, shows that if uniform quality of insulation is used in the three groups, so that the cables will stand the voltages calculated from the stresses in Table III, the test voltages for Group I will be far above those calculated by Mr. Roper's factors, whereas those for Group III will be equally below. Conversely, if the cables are to stand tests based on Mr. Roper's factors, the insulation of Group I may be of inferior quality to that of Group II, whereas the insulation of Group III must be of superior quality to that of Group II.

Group I cables, however, are used in order to obtain a greater safety factor, and it would be unfair for a manufacturer to give an inferior quality, as this would result in Group I cable users, who are paying for heavier insulation, being given no greater security than users of Group II. The obviously correct procedure for Group I cable users, is to rate their cables as of Group II in their specifications.

Experience tells us that 35-kv. Group III cables which pass the test voltages calculated on the stress basis, are not necessarily good cables. Cables impregnated with what would now be

considered highly unstable oils, will pass both the 5-min. and the 1000-min. tests. These cables would not have passed the tests based on the working voltage factors. Unfortunately the 5-min. test calculated by the factors cannot be tried for the 35-kv. cables, as no known type of terminal will consistently permit 245 kv. to be maintained for five minutes.

Whether the tests calculated from Mr. Roper's factors will insure the permanence of Group III cables, in my opinion, is yet a matter of conjecture. If this opinion is correct, prudence would suggest that Group II design be adhered to in our general practise until Mr. Roper can do for Group III what he has so ably done for Group II.

Present indications point both to the necessity of departure from the present design of triplex cables, if Group III stresses are to become practicable, and to the exercise of special care in operation to insure the maintenance of saturation and suitable internal pressure, so that the original quality which is insured by factory tests, will not be destroyed by chemical deterioration and temperature variations in operation.

Departure from the present standard design of triplex cables will be necessary for Group III cables, because the crude, twisted, paper fillers constitute nuclei of ionization and consequent surface discharges which must eventually lead to failure. It is somewhat early to prophesy the designs of the future, but necessity will doubtless lead to their early perfection.

**F. A. Brownell:** These authors' idea of a quality rating seems to be the best that has been advanced for the rating of cables.

The engineers of our company were very much impressed with this idea and arrangements have been made with our inspection department to gather the necessary data while inspecting cable so that this method can be followed.

At the bottom of the fourth page there is a clause which implies that all the cable rated at 13 kv. in Table I, is made up with manila paper. I should like to ask the authors if this is a fact, or if any of the cable in this list is made up with wood-pulp paper?

When we stop to realize that the cable tested at the factory and the cable after it has been in operation should have different characteristics, it does not seem so strange that we are unable to devise factory tests that will eliminate failures after the cable has been installed. We have set up a recording expansion meter on our cables at different times and have found that the cable is constantly in motion either expanding or contracting and, due to the different coefficients of expansion of lead, oil, paper and copper, these several parts are moving at different rates.

**S. J. Rosch:** Mr. Roper's company is probably the only one that has attempted to shed a little light upon what transpires after a cable has been installed; but after all, the results obtained are peculiar mainly to this particular system, because for any given voltage service, their thickness of insulation is lighter than others and therefore the factors of safety in operation are not comparable; and yet it is the work of the Commonwealth Edison Co. that has supplied the proper impetus necessary for further progress in the cable field.

The statement that a cable in the factory is not the same after it has been installed is very true, since the different methods of pulling cables into a duct are bound to change the physical structure of the cable more or less and consequently change some of the electrical characteristics as well.

I believe in placing greater reliance in the testing of cables than of samples, because the results obtained on a sample may not be indicative of a weak portion which may actually exist in the full length from which it is taken. This was very clearly borne out in Mr. Lee's paper in 1925 in which he pointed out that eight sections of cable made under identical conditions gave entirely different results. These are facts which cannot be denied, and in my opinion the only solution is a continuation of the 15-min. voltage test on all reels of cable for operation at voltages above 15 kv.

The quality rating table is a very desirable criterion of cable quality; nevertheless the points just brought out by Mr. Lee are very pertinent. For example, cable *D* had practically the poorest rating on all counts save one and yet the weight attached to this particular phase caused it to have the highest rating of all. It seems that the method of evaluation must be in error when poor workmanship on insulation and filler, excessive tearing on bending test samples, and high dielectric loss can be outweighed by high dielectric strength tests on samples of cable. If this method of evaluation is correct, then we ought to recognize this fact by changing our standards on those counts which are apparently unnecessary. This may change the entire method of manufacturing cables in this country.

But has cable *D* had an opportunity to demonstrate its superior operating characteristics in the duct system? Will the tears produced in the bending test repeat themselves with tears produced while pulling in the cables into the ducts, and will these tears impair the life of cable *D*? Not until these questions have been answered, shall we know whether the present method of quality rating of cables is the correct one.

**J. L. R. Hayden** (by letter): The curve in Fig. 1 herewith showing disruptive voltage vs. time of application for breakdown appears to be representative of all solid insulations, and various experiments indicate that some such relation may also hold for gases and liquids. As to the relative values of voltage, time and curve slope, these may vary over a wide range, depending upon type of insulation under consideration. The time element over which this characteristic has been generally determined is from a few seconds to an hour.

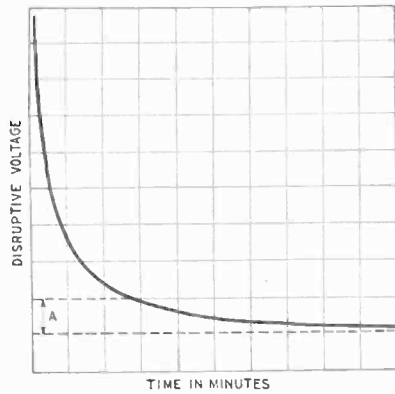

FIG. 1

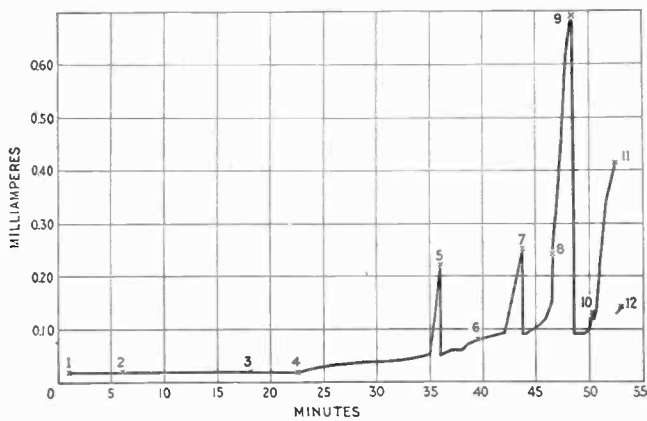

FIG. 2—CURRENT—TIME CURVES, CONTINUOUS VOLTAGE 10.9 Kv.—12 ELECTRODES—TOTAL CURRENT

The accompanying Fig. 2 showing current through the insulation plotted against time at constant voltage illustrates a characteristic which has been frequently obtained on solid insulations of rather low specific resistance. Obviously, such a characteristic is obtained only when the voltage applied is in the

range marked *A*, in Fig. 1. Such leakage currents are of the order of a few milliamperes at the highest, and it is observed that the current begins to increase rapidly (run away) at very low values of current. Because of these low current values and the

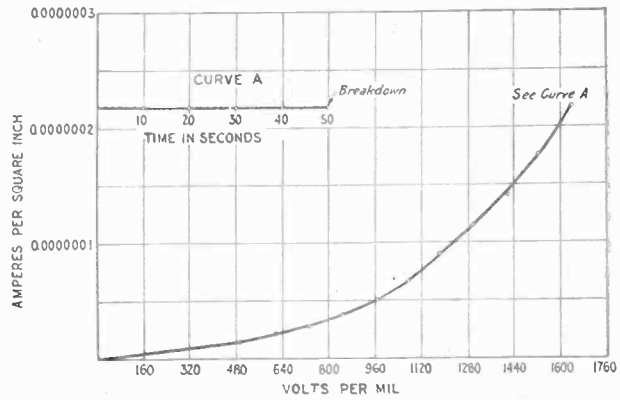

FIG. 3—VOLT-AMPERE DETERIORATION CHARACTERISTIC OF BLACK VARNISHED CAMBRIC (0.012 IN. THICK) AT 25 DEG. CENT.

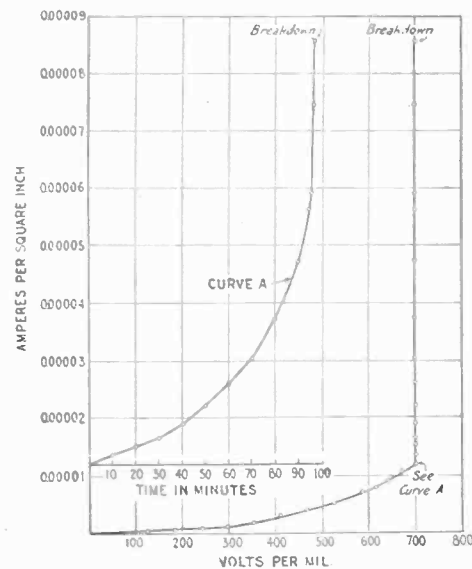

FIG. 4—VOLT-AMPERE DETERIORATION CHARACTERISTIC OF BLACK VARNISHED CAMBRIC (0.048 IN. THICK) AT 100 DEG. CENT.

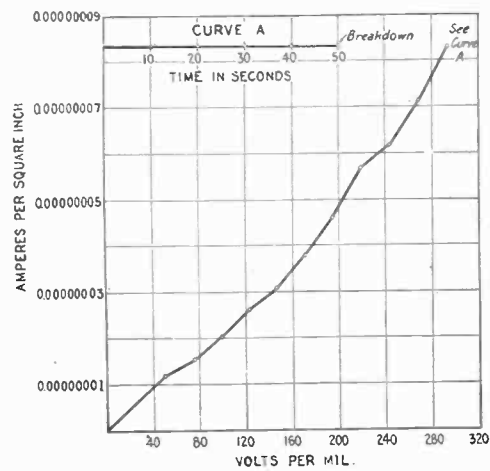

FIG. 5—VOLT-AMPERE DETERIORATION CHARACTERISTIC OF PETROLATUM IMPREGNATED PAPER CABLE INSULATION (0.115 IN. THICK) AT 100 DEG. CENT.

rapidity with which the current runs away previous to failure, it is often found difficult to obtain this characteristic, especially on insulations of high specific resistance. For example, the magnetic oscillograph, when applied to the determination of this

current before failure, will not usually indicate it, because the current is increasing at an enormous rate when it gets within the range of sensitivity of the oscillograph.

The question of whether or not all failures are preceded by a rise in current is, of course, an unanswered one. Examination of Fig. 2 will reveal that disruption of the insulation occurred under several electrodes without a detectable rise in current preceding the failure. This may mean that no gradual rise of current took place, or that the values of current were too low to be indicated. Also, comparing Figs. 3 and 4 herewith, taken on varnished cambric, it is noted that, in one instance, a decided increase in current was measured before failure, while in the other the breakdown seemed to be instantaneous. In similar tests on impregnated paper cable insulation no slow current rises previous to disruption of the insulation were noted at 25 deg. nor 100 deg. cent. The results obtained are shown on the curves in Figs. 5 and 6, of this discussion.

Attempts to substantiate the pyroelectric theory of failure by limiting this run-away current with a series resistance have usually been unsuccessful, because the current at the critical spot is a small proportion of the total leakage through the sample<sup>4</sup>. We succeeded in overcoming this difficulty in an electrode of small area, as the Nernst filament, and in another way with a large number of electrodes in parallel. Dr. Wagner's<sup>5</sup>

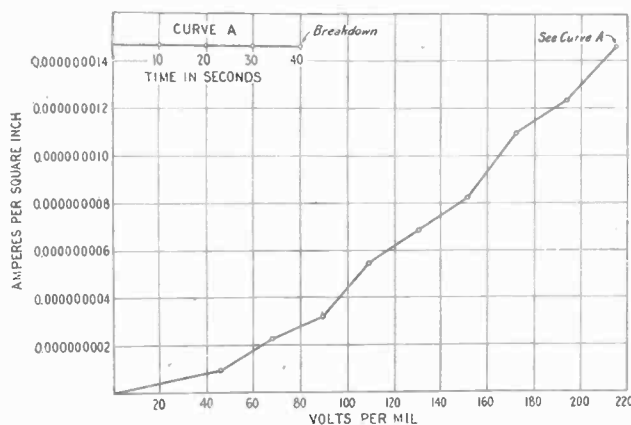

FIG. 6—VOLT-AMPERE DETERIORATION CHARACTERISTIC OF PETROLATUM IMPREGNATED PAPER CABLE INSULATION (0.130 IN. THICK) AT 25 DEG. CENT.

demonstrations of the same characteristic involved the use of the wooden block electrode.

While various experimenters have obtained results which seem to indicate that the mechanism of failure may be something other than a heat phenomenon, it is important that due recognition be given to the difficulties which had to be overcome by Messrs. Hayden, Steinmetz and Wagner in their efforts to demonstrate its nature. Nor is it to be presumed that all insulation failures have this physical nature.

Very few data are available on insulation failures caused by high voltage transients of very short time duration, or upon the chemical or physical changes which may accompany long time applications of low voltages.

It appears that the cathode-ray oscillograph, because of its great speed of operation, may be of considerable value in obtaining information on the run-away currents and the mechanism of failure with high voltages of short time duration.

**D. W. Roper:** I wish to compliment Mr. Lee upon the very careful study he has given the paper; otherwise, he would not have discovered the weak point in the quality rating table, the weak points being that we have not quite discovered how to make a quality rating and an accelerated life test that would be

4. Insulation Failure—A Pyroelectric Effect: Hayden and Steinmetz, *Electrical World*, October 21, 1922.

5. *Physical Nature of Electric Breakdown of Solid Insulations*: Dr. K. W. Wagner, A. I. E. E. TRANS., 1922, p. 288.

equally fair to cables of low and of high dielectric loss. There must be some change apparently both in the quality rating tables and in the accelerated life test, that is, the voltage at which the test is made in order to do that. We have not yet quite discovered how it should be done. That accounts for some of the variations to which Mr. Lee called attention.

Mr. Brownell inquired for some information regarding the cables which contained wood pulp paper and manila paper. The information was purposely omitted. The object of the paper is to get better cable by cooperation with the manufacturers and not to boost or discredit any manufacturer.

Several of the speakers have mentioned the plan of incorporating the results of accelerated life test in the quality rating tables. To me it doesn't seem desirable to do that but it seems preferable to use the accelerated life test as a parallel method of quality rating rather than to attempt incorporating the results of the accelerated life test in the quality rating table. Apparently we shall do better if we carry along the two methods of quality rating independently and see that we get results which are in accord rather than to put the one result in the other table.

Mr. Del Mar referred to the subject of high-voltage cables and stated that for the very high-voltage cables we must either use a different quality of insulation or a different design. I think he is quite correct in that point. In my opinion, for each quality of insulation there is a maximum operating voltage for which that quality should be used. If we wish to go to higher operating voltages, we cannot do so by merely increasing the thickness of the insulation, but we must improve the quality.

One of the speakers mentioned the point that in making the test on the full reels, we may cause incipient troubles in the cables which will later develop in service. Our tests indicate that with the full-reel test we are now requiring, high-voltage test of each reel at the factory, and with the proposed requirements which are given in the paper, the full-reel test as now being made will take about 2 per cent of the life of the cable if the cable is exactly on the line of the suggested requirements, while it will actually take only about 1 per cent of the life of the average quality that we are getting. We are getting above the suggested requirement. I think the manufacturing companies are willing to sacrifice 1 per cent of the life in order to assure themselves that the cable is of proper quality. Mr. Rosch, I believe, mentioned the fact, however, that we should test the cable itself rather than samples, and in the paper is mentioned a proposed test or a desired test should be made of each reel, if we could devise the test, so that we could from the test determine the minimum quality of the insulation of each section of cable as accepted by the purchaser at the factory.

Mr. Rosch commented upon cable *D* and mentioned its long life in spite of some deficiencies in workmanship as recorded in the early portion of Table I. It may not be proper to talk about the results of tests on the poorer grades of cable, but certainly no one can object to our giving a few details about the best cable.

This cable *D*, on the accelerated life test, showed a number of hot spots and we were somewhat curious to discover the causes of those hot spots. We opened up a number of them and what did we find? We found broken fillers, wandering fillers, missing fillers, and all of those other points that are given in the early part of Table I. My reaction is quite different from Mr. Rosch's on the point. To me it indicates that when this manufacturer *D* has been able to eliminate those defects in workmanship, which he undoubtedly will do, then what a remarkably high quality of cable he will secure!

**Herman Halperin:** The data presented by Mr. Clark regarding the slope of the voltage-time curves in Fig. 11 agree with our data in that the voltage varied inversely with about the seventh root of the time to failure for cables impregnated with a grease or a heavy oil and tested at room temperature. When an oil is used for the impregnating compound, the slope of the

curve is different, according to Mr. Clark, and it becomes necessary to change the Curve *S R*.

Regarding conclusion No. 9, Mr. Atkinson's point that the rating tables can be used only as "a very rough approximation" until better tests are available for covering the subject of uniformity. This does not agree with our experience, since the rating tables have been more consistent with our operating records than Mr. Atkinson's statement indicates as possible. An attempt has been made to cover the subject of uniformity in accordance with the best practise of today; and as has been indicated in conclusions Nos. 5 and 6, uniformity is very essential to obtaining the best cable.

Cable specifications allow cable to be installed with a minimum radius equal to six times the diameter of the cable, and it is the practise of this company to make this radius in installation eight to twelve times the diameter of the cable.

We agree with Mr. Atkinson that the accelerated life test alone cannot be used as an indication of the quality of cable, but it has been our experience that the rating table and life test together give a fairly accurate prediction of the quality.

In regard to the point by Messrs. Atkinson and Simons, that with thicker insulations the specifications need not be so stringent, it might be mentioned that considerable trouble has been experienced in this country with the so called thick insulations. The Commonwealth Edison Company, which has reduced the thicknesses of insulation considerably during the past seven years, has found that the quality of the newer cable with thinner insulation is such that for a given voltage cable, the breakdown voltages obtained on samples have increased from 60 per cent to 120 per cent. Another way of stating the improvement in quality is that on 5000-volt, four-conductor cable, with 5/64-in. insulation around each conductor and 3/64-in. belt insulation, the voltage tests are higher now than were considered sufficient a few years ago for 10-kv. cable.

If we were to continue using thick insulations in this country there would be little progress towards obtaining satisfactory extra high-tension cable, such as 35-kv., three-conductor, and 75-kv. and higher, single-conductor cable. The important thing for high-tension cable is to have high quality insulation. Then there will be considerably less liability of local spots of poor quality which contain germs of failures to take effect almost regardless of the thickness. With good insulation, it is an economic waste to have the extra great thicknesses that have been and still are used by some companies.

With reference to Mr. Simons point that manufacturers have to deal with a large number of sizes while our paper in arriving at certain test requirements presented data mainly for one size, our procedure is a common one in electrical practise. The knowledge of the variation of the requirements due to different sizes of conductor is entirely too indefinite now to arrive at any scale of test values which might be arranged according to the size of the conductor. From a practical standpoint the test on 500,000-cir. mil cable seems to be quite representative of the various sizes of commonly used conductors for transmission cables; that is, sizes from No. 0 to 750,000 cir. mils.

In regard to Mr. Dunsheath's statement that one type of defect in the cable may be so bad as to cause the cable to fail, it should be pointed out that the rating tables are for cable that has passed the specifications and has been shipped. Therefore, the cable would not be very likely to have a bad defect, such as a large number of registered tapes mentioned by him, as the specified tests at the factory would very probably cause such cable to be rejected. Furthermore, it has been our experience that when the cable of a certain manufacturer has more registered tapes than allowed by the specifications, this deficiency is found in several lengths and is revealed by poor results in several tests. In such a case, the poor quality of the cable would be indicated on the items concerning workmanship of the insulation, increase of power factor with voltage and puncture-voltage tests.

Dr. Wiseman's point that the tearing in the bending tests is given as much as one-half of the weight for thoroughness of impregnation, (for 13-kv. cable), appears to be in error. In Item 8, eight points are given for the increase in power-factor test (ionization), which test is generally considered the best electrical test known for thoroughness of impregnation. This weight of eight points and the weight of eight points for the visual test for thoroughness of impregnation make a total of 16 points, which is four times the points for tearing.

His point that the power factor always varies with voltage is not borne out for us by commercial tests made on several makes of high-tension cable.

Dr. Wiseman's statement that the stability test for compound cannot be used until samples can be prepared with no air present does not seem to be warranted by Mr. Farmer's test; but be that as it may, a stability test for compound in high-tension cable is necessary, and no doubt a test satisfactory to all parties concerned will be evolved shortly.

Dr. Wiseman and Mr. Del Mar have referred to dielectric stresses in judging cables. One of them prefers to use maximum dielectric stress in discussing the stress in the cable, while the other prefers average stress, thus indicating the indefiniteness of judging the stress in the cable. From the standpoint of operation, what one wishes to know is the factor of assurance for the cable for a given service. For example, how many times the normal operating voltage will a sample of the cable stand for eight hours? The operators see no reason why extra high-tension cable should be purchased with a considerably lower factor of assurance than is obtained for cable of the moderate voltages, such as 15 kv. As has been pointed out, the quality of the insulation for 35-kv. and 66-kv. cable and even higher voltages should be such that it will give a proper factor of assurance. Two of the discussors have stated that potheads are not available for testing 35-kv. cable at seven times its rated voltage for 5 min. If this is true, then the test can be made at a lower voltage for which potheads are available; for instance, at six times the rated voltage for 16 min., as was suggested in the paper.

The curve *SR* indicates the minimum test requirements for satisfactory cable, and if a purchaser adds extra insulation for 13-kv. cable, (such as indicated in Group I of Table II in Mr. Del Mar's discussion), then the test requirements should be increased above the line *SR* in order to get the extra factor of assurance that is desired.

Mr. Del Mar's statement that cables in Group III of Table II "have been very generally failures abroad" is not warranted by our information concerning 35-kv. cables which have 19/64-in. insulation or less on each conductor. There are many cases, in England, France, and elsewhere, of these cables having been in successful operation from a few years up to ten.

It is agreed, with Dr. Wiseman, that the evaluation of a step test to an equivalent test at one voltage is not easy, but it appears possible to approximate the step test. In order to do this for any make of cable, it is necessary to know the nature of its voltage-time curve. After this curve is determined then the step test can be drawn in on the curve sheet on log-log paper by the following method:

Corresponding to the first step, draw a horizontal line at the ordinate of the length representing the duration of this step. At the end of this line, draw another line parallel to the voltage-time curve and as high as the voltage of the next step. From the end of this diagonal line, draw a third line representing, in length, the duration of the second step. This process is continued until the last step is drawn and the result is the equivalent test given for the voltage of the last step. The abscissa for the resulting point at the end of the last line represents the equivalent time. If this test is to be evaluated for a test at another voltage, then it can be done by drawing a line through this last point parallel to the voltage-time curve, and reading the values from this new voltage-time curve for this particular test.

As to Dr. Wiseman's discussion of the general distribution of hot spots, in the high-voltage tests mentioned in the paper, the cable usually had a few pronounced local hot spots which were from about 5 to 74 deg. cent. above the temperature of the adjacent cable sheath.

Mr. Burd's statement that different operating results have been obtained with cable of the same quality when installed in different operating systems presupposes that the insulation thicknesses were the same for given voltage cables installed in these different cable systems. From general information this does not appear to be correct. No doubt, the treatment given the cable during installation and operation will have some effect on the number of failures of the cable. It has been the aim of the company with which we are associated to install and operate the cable in accordance with the best practise. This kind of practise appears to be followed by most companies, especially the relatively few large operating companies, which are the ones that use most of the underground cable. In our experience of the cable failures, it has been frequently found that if the insulation, for instance, had been thoroughly impregnated, the failure would not have occurred.

In regard to Fig. 12, Mr. Lee has pointed out that the points for cables A, B, and C did not come as close to the curve as they might. The durations of the accelerated life tests on these three makes of cable were in consistent relative order as compared with the ratings in the table. The ratings are based on the large number of various tests covering all of the 50,000 ft. or more of the cable for each manufacturer, while the accelerated life test results are based on tests on a few samples. It has been usually found in dielectric-strength tests that there will be fairly large variations in the results and obtaining a life of 115 hr. for cable A, which was rated at 81.9, and only obtaining a life of 45 hr. for cable B, which was rated at 80.3, would not usually be considered a great discrepancy for such long tests. The voltage-time curve for these tests indicates a difference in voltage rating of only about 12 per cent.

Regarding the effect of dielectric loss on the life of the cable, the 35-kv. cables with high power factors of the dielectric will have shorter lives than would cables with low power factors, but with the same qualities in other respects. On the 13-kv. cables the makes that had the highest dielectric loss were the ones that had the longest lives, indicating high qualities in other respects.

Several discussors have made unfavorable comments about taking the variation of insulation resistance as an indication of uniformity. To begin with, this item has been given a maximum weight of only six points. The experience has been that the makers who have the greatest variation of insulation resistance also have other troubles. Manufacturers B and C in Table I, and manufacturer Q in Table II, had the highest variations, respectively, in the two tables, and these manufacturers are the ones who had the most trouble at the factory and the lowest quality insulation in other respects.

Mr. Hayden's information regarding the mechanism of failure of insulation is interesting, and it is agreed that more such information based on testing is needed.

## PAPERS ON RURAL ELECTRIFICATION

(NEFF<sup>1</sup> AND POST<sup>2</sup>)

MADISON, WISCONSIN, MAY 6, 1926

**Eugene Holcomb:** I notice the difference in the rate schedules in these two papers. The rates shown by Mr. Post seem undoubtedly too low for average rural territory.

It has been our experience that copper-weld lines are more satisfactory than aluminum lines and I believe that with proper

sizes selected for the work to be performed, this will be found generally true.

The elastic limit as mentioned in the paper as 1860 lb. might also be checked. The sum of the strands in aluminum cable gives an elastic limit of 1593 lb., whereas this is stated in the table as 1860 lb.

The clearances given in the paper are mentioned as 18 ft. I believe 18 ft. in the code is for a 150-ft. span and for a 300-ft. span it is 19.3 ft. However, the clearances mentioned in the paper may be sufficient.

Mr. Neff has given a vivid illustration of the magnitude of rural electrification. Notwithstanding that only a very small dent in the total has thus far been made, the 33,000 mi. of lines mentioned in the inter-mountain section of the country would reach once entirely around the earth and one-third of the way on the second lap. Suppose we consider the possibilities of completely serving one township which is six miles square. A line on each one-mile road would total 72 mi. of line, counting the border lines as being half in the adjoining townships. A cost of \$1200 per mile gives a total investment of \$86,400 for lines. With an average of three customers per mile there would be 216 customers per township. Using the rates given in the paper and assuming the lowest monthly service charge at the stated average consumption, the monthly bill for each customer would be \$10.60 and the total annual revenue would be \$27,475 which, with good operating practise, would yield an adequate return on the investment and provide for replacements and other fixed charges.

Of the many forms of rate schedules proposed for rural service, the most practicable seem to be those which are based upon a demand or service charge plus a low energy charge. The simplest measure of demand seems to be the installed transformer capacity. This is tangible and easily understood and sufficiently accurate for the purpose. The energy charge should be made low to encourage the liberal use of equipment. The amount of the demand charge is determined by capacity or investment costs. Where the customer makes the investment in the lines and turns them over to the utility to maintain and operate, then the service charge should be reduced by the amount of interest on such investment. If the investment is \$400, the demand or service charge should be reduced \$2.66 per month from the amounts stated in Mr. Neff's paper and for a transformer capacity of not over 1½ kw., the amount of service charge becomes \$2.84. In respect to the costs to the customer, it matters little who makes the investment. The matter of permitting the consumption of a few kilowatt hours to be included with the minimum charge is a question of costs and if we are to have the large monthly consumptions desired, the difference would be very slight and by that time undoubtedly most of the rates now in effect will be materially modified.

To electrify all the 6,500,000 farms in America will require some \$6,500,000,000 of capital and years of time and probably some remote parts never will be served. As stated in the paper, however, progress is being made and as equipment is developed and experience gained from the experimental lines, the work will proceed more rapidly. Above all things in order to avoid costly mistakes, this work should be thoroughly mapped out and handled by men who are devoted to rural service.

Unquestionably our industry will be able presently to show how electricity can be utilized by the farmer so that it will be profitable to him and not only that, but will help do things for him and the people in the farm home that will make life there very much more attractive and satisfactory.

**C. B. Hayden:** There are a few points which I shall mention as important from the standpoint of the Railroad Commission in particular. The question of rural electrification is unquestionably important and the activity of the utility organization is cooperating with the farm bureaus and college experimental departments in developing a workable plan to bring

1. A. I. E. E. JOURNAL, August, 1926, p. 733.  
2. A. I. E. E. JOURNAL, May, 1926, p. 415.

about a complete consideration of the problems involved is highly commendable. The response of the utilities has been quite unanimous and I do not believe that it can be said that, in their enthusiasm to provide this service, their interests have been completely submerged. And this is as it should be because in some instances in the past the rural policy, at least in the early years following the construction, would not provide returns sufficient to carry the investment and operating expenses.

I believe that the general policy shown by these papers, in that it tends to provide rural service for the larger consumer at very low service rates, is decidedly good. In this connection, however, we must not lose sight of the impression to be created in the mind of the average urban consumer when he realizes that, under the average community rate, he cannot purchase energy as advantageously.

I realize fully that in order to make the service of value to the farmer, aside, perhaps, for the use of lighting and small power appliances, he must be able to purchase in quantity at low rates, and I think that in a few years the energy will be so used by the average farmer. For a number of years, however, and until the experimental lines and special installations have proved that the farmer can actually make money by the use of large quantities of energy on the farm, we must remember to provide for the smaller user on terms that will not be prohibitive to him. In this connection, I should like to say that where the farmer wants the energy it has not been difficult for him to see that it is necessary to pay the cost of securing it. This applies to the average well-to-do farmer and does not apply to the smaller farmer who is operating on 15 to 20 acres where he does not figure on making very much money, but on making a living and that is all. There the use of power in large quantities, except for special uses, is out of the question.

I should like to make this point; that the average farmer must be given full consideration during this development period, and also it must be borne in mind that the rates must not favor the farmer as compared to the urban consumer for the same quantity consumption.

**E. W. Lehmann:** I should like to outline briefly what I think is the purpose of this rural electrification program. From the standpoint of the farmer, I believe it is first to provide service so that he can improve his efficiency in production; second, to improve the economy or lower the cost of production; third, if possible to increase or improve the quality of produce; fourth, to make the job easier and more pleasant, and fifth, to improve home life. From the standpoint of the public service company, however, I believe that the problem is to extend service to the farmer and to build up a load which will pay for the service rendered. The real job will be to sell the idea of the value of electricity and in that way sell more kilowatt hours.

It is difficult, I think, to estimate the part that electricity will play in agricultural production in the future. A look into the past, however, seeing what machinery and equipment have done and analyzing our present problems will give a fair basis for an estimate.

There is no question but that machinery and equipment have played a larger part during the past 75 years in increasing the productive capacity of the individual farmer than any other factor. While about 90 per cent of our population were farming 75 years ago, only 26 per cent are doing the job at the present time.

In regard to the development of the dairy industry, which is so important in Wisconsin, in a statement before an agricultural policy committee in Illinois a few years ago, Dr. M. W. Hepburn, an authority on dairying, said, "In a general way we may say that four factors have been largely responsible for the development of dairy production. They are:

- "1. The introduction and utilization of the silo.
- "2. The centrifugal cream separator.
- "3. The discovery of the simple test for fat in milk,—the Babcock test, discovered at the University of Wisconsin.

"4. Better and more rapid transportation, together with the development of refrigeration."

All recognize these factors as being mechanical and their effectiveness is dependent on the application of power. Even the filling of the silo is a problem and there are other problems of the same kind.

In the whole field of crop production, equipment and machinery have played a large part; the production of wheat per person employed increased eighteen times from 1850 to the beginning of the twentieth century. With the advent of the gas tractor and the combine harvester-thresher, the efficiency per individual has been still further increased. A local farmer in Illinois who purchased a combine harvester-thresher rather recently told me that he harvested his grain at about one-third the former labor cost.

In discussing horticultural production, Dr. J. C. Blair, head of the Department of Horticulture in the University of Illinois, stated, "Without the protection afforded by spraying, insect and fungus attack will no doubt make apple-growing in Illinois an impossibility." This would apply also to other states. In certain sections of the country the application of electricity to the spray problem is being investigated with special attention to the stationary spray outfits. We should not overlook the fact that electrically driven equipment now plays an important part in the processing and manufacture of all sorts of fruits and garden produce. In addition to processing and canning, fruits are graded with electrically-driven graders and in that way made ready for market. In fact, in every phase of agriculture, mechanical equipment has played and still is playing an important part.

In considering the farmer's immediate problem we must recognize the fact that he is interested most in increasing his net income. There are three ways in which this may be done: First, by getting a better price for his produce; second, by lowering the cost of production; third, by producing more per worker. I believe the application of electricity will help in all of these methods.

In considering the application of electricity to the farm, remember that there is more than the mere matter of equipment and power involved in the farmer's problems. It is safe to say that four types of problems will be met in a rural electrification program; namely, (1) economic, (2) agricultural, (3) educational, (4) engineering.

I do not want to deprecate the part machinery has played in what I shall now say. From an economical standpoint, there are three equally important factors in agricultural production—land, labor and capital, or equipment. In addition to this, we, of course, have the item of managerial ability; in other words, the farmer himself. I believe he is as important a factor as any of the other three. Every manufacturer recognizes that there must be a proper balance between the three economic factors mentioned for economic and efficient production.

Where there is an abundance of good land, the tendency is toward the bonanza type of farming, rightfully called "agricultural exploitation." The recent rapid agricultural development in the Argentine has been due to this type of farming. The primary need there was machinery. That was formerly true in the Middle West. We cannot put too much emphasis now on the value of the soil; in fact, the life of our nation depends upon it. Much of our soil is already becoming depleted of its fertility. For efficient, economic production, our land must be well-drained, protected from erosion and must be used in accordance with the best farming practises to maintain a high state of fertility. The first step in economizing on land is a more intensive type of farming and that is a thing farmers will do when there isn't a chance for expansion.

In countries where really intensive agriculture is practised, labor is cheap and a low standard of living is the rule. We do not want this situation in America. Under our condition, we must

As to Dr. Wiseman's discussion of the general distribution of hot spots, in the high-voltage tests mentioned in the paper, the cable usually had a few pronounced local hot spots which were from about 5 to 74 deg. cent. above the temperature of the adjacent cable sheath.

Mr. Burd's statement that different operating results have been obtained with cable of the same quality when installed in different operating systems presupposes that the insulation thicknesses were the same for given voltage cables installed in these different cable systems. From general information this does not appear to be correct. No doubt, the treatment given the cable during installation and operation will have some effect on the number of failures of the cable. It has been the aim of the company with which we are associated to install and operate the cable in accordance with the best practise. This kind of practise appears to be followed by most companies, especially the relatively few large operating companies, which are the ones that use most of the underground cable. In our experience of the cable failures, it has been frequently found that if the insulation, for instance, had been thoroughly impregnated, the failure would not have occurred.

In regard to Fig. 12, Mr. Lee has pointed out that the points for cables A, B, and C did not come as close to the curve as they might. The durations of the accelerated life tests on these three makes of cable were in consistent relative order as compared with the ratings in the table. The ratings are based on the large number of various tests covering all of the 50,000 ft. or more of the cable for each manufacturer, while the accelerated life test results are based on tests on a few samples. It has been usually found in dielectric-strength tests that there will be fairly large variations in the results and obtaining a life of 115 hr. for cable A, which was rated at 81.9, and only obtaining a life of 45 hr. for cable B, which was rated at 80.3, would not usually be considered a great discrepancy for such long tests. The voltage-time curve for these tests indicates a difference in voltage rating of only about 12 per cent.

Regarding the effect of dielectric loss on the life of the cable, the 35-kv. cables with high power factors of the dielectric will have shorter lives than would cables with low power factors, but with the same qualities in other respects. On the 13-kv. cables the makes that had the highest dielectric loss were the ones that had the longest lives, indicating high qualities in other respects.

Several discussors have made unfavorable comments about taking the variation of insulation resistance as an indication of uniformity. To begin with, this item has been given a maximum weight of only six points. The experience has been that the makers who have the greatest variation of insulation resistance also have other troubles. Manufacturers B and C in Table I, and manufacturer Q in Table II, had the highest variations, respectively, in the two tables, and these manufacturers are the ones who had the most trouble at the factory and the lowest quality insulation in other respects.

Mr. Hayden's information regarding the mechanism of failure of insulation is interesting, and it is agreed that more such information based on testing is needed.

## PAPERS ON RURAL ELECTRIFICATION

(NEFF<sup>1</sup> AND POST<sup>2</sup>)

MADISON, WISCONSIN, MAY 6, 1926

**Eugene Holcomb:** I notice the difference in the rate schedules in these two papers. The rates shown by Mr. Post seem undoubtedly too low for average rural territory.

It has been our experience that copper-weld lines are more satisfactory than aluminum lines and I believe that with proper

sizes selected for the work to be performed, this will be found generally true.

The elastic limit as mentioned in the paper as 1800 lb. might also be checked. The sum of the strands in aluminum cable gives an elastic limit of 1593 lb., whereas this is stated in the table as 1800 lb.

The clearances given in the paper are mentioned as 18 ft. I believe 18 ft. in the code is for a 150-ft. span and for a 300-ft. span it is 19.3 ft. However, the clearances mentioned in the paper may be sufficient.

Mr. Neff has given a vivid illustration of the magnitude of rural electrification. Notwithstanding that only a very small dent in the total has thus far been made, the 33,000 mi. of lines mentioned in the inter-mountain section of the country would reach once entirely around the earth and one-third of the way on the second lap. Suppose we consider the possibilities of completely serving one township which is six miles square. A line on each one-mile road would total 72 mi. of line, counting the border lines as being half in the adjoining townships. A cost of \$1200 per mile gives a total investment of \$86,400 for lines. With an average of three customers per mile there would be 216 customers per township. Using the rates given in the paper and assuming the lowest monthly service charge at the stated average consumption, the monthly bill for each customer would be \$10.60 and the total annual revenue would be \$27,475 which, with good operating practise, would yield an adequate return on the investment and provide for replacements and other fixed charges.

Of the many forms of rate schedules proposed for rural service, the most practicable seem to be those which are based upon a demand or service charge plus a low energy charge. The simplest measure of demand seems to be the installed transformer capacity. This is tangible and easily understood and sufficiently accurate for the purpose. The energy charge should be made low to encourage the liberal use of equipment. The amount of the demand charge is determined by capacity or investment costs. Where the customer makes the investment in the lines and turns them over to the utility to maintain and operate, then the service charge should be reduced by the amount of interest on such investment. If the investment is \$400, the demand or service charge should be reduced \$2.66 per month from the amounts stated in Mr. Neff's paper and for a transformer capacity of not over 1½ kw., the amount of service charge becomes \$2.84. In respect to the costs to the customer, it matters little who makes the investment. The matter of permitting the consumption of a few kilowatt hours to be included with the minimum charge is a question of costs and if we are to have the large monthly consumptions desired, the difference would be very slight and by that time undoubtedly most of the rates now in effect will be materially modified.

To electrify all the 6,500,000 farms in America will require some \$6,500,000,000 of capital and years of time and probably some remote parts never will be served. As stated in the paper, however, progress is being made and as equipment is developed and experience gained from the experimental lines, the work will proceed more rapidly. Above all things in order to avoid costly mistakes, this work should be thoroughly mapped out and handled by men who are devoted to rural service.

Unquestionably our industry will be able presently to show how electricity can be utilized by the farmer so that it will be profitable to him and not only that, but will help do things for him and the people in the farm home that will make life there very much more attractive and satisfactory.

**C. B. Hayden:** There are a few points which I shall mention as important from the standpoint of the Railroad Commission in particular. The question of rural electrification is unquestionably important and the activity of the utility organization is cooperating with the farm bureaus and college experimental departments in developing a workable plan to bring

1. A. I. E. E. JOURNAL, August, 1926, p. 733.  
2. A. I. E. E. JOURNAL, May, 1926, p. 415.



about a complete consideration of the problems involved is highly commendable. The response of the utilities has been quite unanimous and I do not believe that it can be said that, in their enthusiasm to provide this service, their interests have been completely submerged. And this is as it should be because in some instances in the past the rural policy, at least in the early years following the construction, would not provide returns sufficient to carry the investment and operating expenses.

I believe that the general policy shown by these papers, in that it tends to provide rural service for the larger consumer at very low service rates, is decidedly good. In this connection, however, we must not lose sight of the impression to be created in the mind of the average urban consumer when he realizes that, under the average community rate, he cannot purchase energy as advantageously.

I realize fully that in order to make the service of value to the farmer, aside, perhaps, for the use of lighting and small power appliances, he must be able to purchase in quantity at low rates, and I think that in a few years the energy will be so used by the average farmer. For a number of years, however, and until the experimental lines and special installations have proved that the farmer can actually make money by the use of large quantities of energy on the farm, we must remember to provide for the smaller user on terms that will not be prohibitive to him. In this connection, I should like to say that where the farmer wants the energy it has not been difficult for him to see that it is necessary to pay the cost of securing it. This applies to the average well-to-do farmer and does not apply to the smaller farmer who is operating on 15 to 20 acres where he does not figure on making very much money, but on making a living and that is all. There the use of power in large quantities, except for special uses, is out of the question.

I should like to make this point; that the average farmer must be given full consideration during this development period, and also it must be borne in mind that the rates must not favor the farmer as compared to the urban consumer for the same quantity consumption.

**E. W. Lehmann:** I should like to outline briefly what I think is the purpose of this rural electrification program. From the standpoint of the farmer, I believe it is first to provide service so that he can improve his efficiency in production; second, to improve the economy or lower the cost of production; third, if possible to increase or improve the quality of produce; fourth, to make the job easier and more pleasant, and fifth, to improve home life. From the standpoint of the public service company, however, I believe that the problem is to extend service to the farmer and to build up a load which will pay for the service rendered. The real job will be to sell the idea of the value of electricity and in that way sell more kilowatt hours.

It is difficult, I think, to estimate the part that electricity will play in agricultural production in the future. A look into the past, however, seeing what machinery and equipment have done and analyzing our present problems will give a fair basis for an estimate.

There is no question but that machinery and equipment have played a larger part during the past 75 years in increasing the productive capacity of the individual farmer than any other factor. While about 90 per cent of our population were farming 75 years ago, only 26 per cent are doing the job at the present time.

In regard to the development of the dairy industry, which is so important in Wisconsin, in a statement before an agricultural policy committee in Illinois a few years ago, Dr. M. W. Hepburn, an authority on dairying, said, "In a general way we may say that four factors have been largely responsible for the development of dairy production. They are:

- "1. The introduction and utilization of the silo.
- "2. The centrifugal cream separator.
- "3. The discovery of the simple test for fat in milk,—the Babcock test, discovered at the University of Wisconsin.

"4. Better and more rapid transportation, together with the development of refrigeration."

All recognize these factors as being mechanical and their effectiveness is dependent on the application of power. Even the filling of the silo is a problem and there are other problems of the same kind.

In the whole field of crop production, equipment and machinery have played a large part; the production of wheat per person employed increased eighteen times from 1850 to the beginning of the twentieth century. With the advent of the gas tractor and the combine harvester-thresher, the efficiency per individual has been still further increased. A local farmer in Illinois who purchased a combine harvester-thresher rather recently told me that he harvested his grain at about one-third the former labor cost.

In discussing horticultural production, Dr. J. C. Blair, head of the Department of Horticulture in the University of Illinois, stated, "Without the protection afforded by spraying, insect and fungus attack will no doubt make apple-growing in Illinois an impossibility." This would apply also to other states. In certain sections of the country the application of electricity to the spray problem is being investigated with special attention to the stationary spray outfits. We should not overlook the fact that electrically driven equipment now plays an important part in the processing and manufacture of all sorts of fruits and garden produce. In addition to processing and canning, fruits are graded with electrically-driven graders and in that way made ready for market. In fact, in every phase of agriculture, mechanical equipment has played and still is playing an important part.

In considering the farmer's immediate problem we must recognize the fact that he is interested most in increasing his net income. There are three ways in which this may be done: First, by getting a better price for his produce; second, by lowering the cost of production; third, by producing more per worker. I believe the application of electricity will help in all of these methods.

In considering the application of electricity to the farm, remember that there is more than the mere matter of equipment and power involved in the farmer's problems. It is safe to say that four types of problems will be met in a rural electrification program; namely, (1) economic, (2) agricultural, (3) educational, (4) engineering.

I do not want to deprecate the part machinery has played in what I shall now say. From an economical standpoint, there are three equally important factors in agricultural production—land, labor and capital, or equipment. In addition to this, we, of course, have the item of managerial ability; in other words, the farmer himself. I believe he is as important a factor as any of the other three. Every manufacturer recognizes that there must be a proper balance between the three economic factors mentioned for economic and efficient production.

Where there is an abundance of good land, the tendency is toward the bonanza type of farming, rightfully called "agricultural exploitation." The recent rapid agricultural development in the Argentine has been due to this type of farming. The primary need there was machinery. That was formerly true in the Middle West. We cannot put too much emphasis now on the value of the soil; in fact, the life of our nation depends upon it. Much of our soil is already becoming depleted of its fertility. For efficient, economic production, our land must be well-drained, protected from erosion and must be used in accordance with the best farming practises to maintain a high state of fertility. The first step in economizing on land is a more intensive type of farming and that is a thing farmers will do when there isn't a chance for expansion.

In countries where really intensive agriculture is practised, labor is cheap and a low standard of living is the rule. We do not want this situation in America. Under our condition, we must

economize on labor as well as on land. With the apparently high wages paid in the industries competing with the farm, labor on the farm must not be wasted by the use of poor and inadequate equipment. Farm operations and organization must be more carefully studied so that the distribution of labor will tend toward more efficiency and greater economy in production.

Whether the farmer receives a living wage from his produce will depend on his ability as a manager as well as a worker. The average of forty cents an hour for the farmer as his wage is really a misnomer because he does not receive a wage until his expenses are paid and his products are sold. So the farmer is not receiving forty cents an hour as might be inferred from the remarks of the previous speaker.

We must also remember that the problems of the individual farmer will not be solved by greater production in the aggregate, but greater production per man and at lower cost. It is true that labor is one of the big items of farm production cost and we can well economize on this point. The farmer has many ways to economize on labor. His whole system of farming should be planned with this idea in mind. In agriculture, the rotation of crops, methods of handling, all affect the item of labor. One of the methods of harvesting submitted by our Farm Management Department is to use hogs. Another is to use sheep,—in other words, no equipment at all,—practically eliminating the entire item of labor and producing a finished product without the use of equipment as far as the harvesting of the crop is concerned.

It remains true however, in production that ordinarily when we economize on labor we must spend more for equipment. We recognize that the farmer's equipment must be adequate for the particular problems on the farm. I am emphasizing this because I believe the average engineer, or the man who goes out on rural electrification development work, must have a true appreciation and a true understanding of the farmer's problems, for unless he does have this true understanding he is likely to make mistakes concerning the application and the substituting of power in farming operations.

As I said before, the farmer's equipment must be adequate. But what was adequate twenty years ago might not be now. At the present time the cost of equipment on the farm is quite an item. If we study any problem in agriculture in the aggregate however, it will assume large proportions. For example the valuation of farm buildings in Illinois is around \$750,000,000. On the basis of depreciation, interest on investment and upkeep at 10 per cent, the farm buildings in Illinois are costing each year \$75,000,000. The cost of electrification from the standpoint of the farmer, getting his wiring done, lines connected and equipment installed might represent a little more than his building cost for a two-year period. Fifty dollars a year, if set aside on each farm, would electrify all of our farms in less than twenty years. This amount is about one-third of what it cost per year to own a low-priced car.

However, we cannot expect all our farms to be electrified. I think it is a wrong idea to believe that every section is going to be influenced the same way. The man who farms the poor land and has a small income cannot have the same type of equipment and the same buildings as the man who farms the most fertile lands.

There are situations where there is so much labor in a particular farm family that even if it costs only a few cents to operate a motor, it will be next to impossible to have it adopted.

From an agricultural standpoint, the individual farmer and the individual farm must be considered. There are a number of factors that would affect the amount and kind of equipment that can be economically used on a farm; but I will not discuss this phase of the subject. The present tendency is toward larger and fewer farms, better equipped. As you may know, there are fewer and larger farms now than ten years ago. On the larger farms the tendency is to displace labor with equipment, and this will continue as long as equipment costs less than

labor. When one farmer drops out and sells his land to his neighbor, that neighbor expands and uses different methods.

There are agricultural as well as economic problems involved. In attempting to electrify farms the principle should be recognized that while the type of farming may be changed successfully by a few individuals on applying electricity, this practice cannot be generally followed. In other words, because electricity plays a large part in poultry and dairy farming, we cannot expect every farmer who has his farm electrified to buy cows and chickens and build new barns and poultry houses. We must electrify grain farms and cotton farms as well as dairy farms.

Then there is the big problem of education. The fourth factor in production which I mentioned, managerial ability, will be greatly influenced by education. The trained farmer is interested in the largest possible net income, but with all factors of production considered. His labor income should not be produced at the expense of his land.

One particular point that I wish to mention is the question of seeing that the buildings are properly wired and that they have the proper number of outlets. If the wiring is left to the farmer and he hires a contractor, it is likely that a lot of needed outlets will be left out. My suggestion would be to have the rural service man make a definite plan and get this plan approved by the farmer when he is interested and knows just what he expects to install and then have the plan carried out by a reliable contractor. I believe every man from the utility company who comes in contact with the farmer should be a salesman, not necessarily a salesman of merchandise but one who can sell the idea of electric service. Regarding rates, I believe that we should have a rate that will encourage the use of electricity, and to do that you don't want to put into the rate schedule something that is going to penalize the farmer who is going to use this service. We should have a simple rate that is easily understood.

The question of financing the line has been discussed. The possibility of having the company finance the line and eliminate all refunds and special records, and the possibility of eliminating misunderstanding and suspicion on the part of the farmer as to whether he is getting back all that he should are matters that should be considered.

Mr. Post's schedule of rates may be adequate, but I really doubt it. I wonder if it is taking care of the situation. It seems to me that any rate schedule that makes it necessary to charge a man when he installs additional outlets, penalizes him and makes it harder to build up a load. I don't believe that the farmer wants to have, as would be indicated by this particular paper, one rate when service is started and a different rate later. I think the farmer should be sold on the basis of what it is going to cost him. Farmers are not looking for charity or any special privileges. To avoid misunderstandings and dissatisfaction, the rate should be simple and easily understood; this is quite important.

It does not necessarily hold true that rural electric service is going to cost the farmer either more or less than the urban customer; it might be more or it might be less. A farmer might be classed as a manufacturer, and there would be no question so far as the people in town criticizing are concerned because of the fact that he was getting a lower rate. The farmer expects to pay for what he gets whether used in his home or in his production work.

**F. W. Duffee:** I wish to speak of the matter of rate, because I believe that the matter of rate is one of the most important things to be taken up and settled first, as we believe that the rate can either kill or make the proposition.

There are just a few things we might mention as having been discovered about electric service and rates. The first is that the farmers all want electric service and they want it very much. They want light probably more than anything else, and very frequently that is about all they think of until they

nd out through education and experience the things they can do with electricity.

The next thing they want is a low monthly bill, \$1, \$2 or \$3 would suit them finely, but less than that would suit them still better. When you start talking about \$5 or \$6 as a minimum monthly bill it hurts and it hurts bad for a while until they are shown that they can actually get out of it \$5, \$6, \$7 or \$8 worth of value. That is a point we have to educate them up on, because probably the minimum monthly bill is going to be somewhere around \$5 or \$6.

Then, of course, we must show them the advantage of using equipment; and the rate should be such as to encourage the use of equipment, because there is no question, in any one's mind I believe, that a low rate per kw-hr. can only be secured by a large consumption and the rate should be such as to favor that to a very great extent. A great deal of effort should be directed toward educating the people to the fact that a large current consumption will bring a low rate. Some of the rates in effect now in Wisconsin are such that, with a consumption of around 200 kw-hr. per month, the rate per kw-hr. is actually less than in some of the fairly good-sized cities.

As to our line at Ripon which has been built and upon which we have been working, it might be interesting to say in connection with the point that Mr. Neff brought out regarding the amount of power which each worker uses, that on some of these farms we have from 10 to 12 h. p. of connected load around the farmstead at the present time. That includes all motors and all household equipment. I don't believe that we are beginning as yet to get the maximum results from that connected load by any manner of means. I believe we can do a great deal toward increasing the use of that equipment, thereby decreasing the amount of work which the man and woman have to do around the barn and around the farmstead, and as you reduce the time that he must spend around his barn, you can thereby increase the amount of time he can spend in his field. That is a way to make more money; it is an indirect way, but a very real way just the same.

Regarding the matter of rate, I have one very interesting example. Up near Ripon a farmer had built for himself a line. He was a rather well-to-do farmer. This line cost him about \$1500. He was the only one on it. It was built when the prices were high, but nevertheless it was quite long, I think a mile. He had installed and connected an electric range, refrigerator, motor-operated milking machine, a water pump and a large number of household appliances. His total consumption had been running less than 100 kw-hr. for all of that equipment. When asked why he didn't operate if after he had spent all of his money for this line and equipment, he said it would break him to operate it because the rate was constructed in such a way that it was prohibitive to use any large quantity of current. He has gone onto a different rate recently and I haven't heard what his consumption is at the present time.

As to the particular projects, some things which we consider of the greatest importance, I shall just mention:

1. Grain elevating and handling.
2. Grinding feed.
3. Grinding bones for chickens.
4. General utility motor.
5. Hoisting hay.
6. Individual cooking units.

Some of the above applications are fairly successful now, but it seems as if there was room for development in order to obtain the maximum benefits. That will be discussed later.

The following equipment is mechanically satisfactory if one can afford the initial expense of the equipment or the high cost of operation:

1. Electric ranges.
2. Electric refrigerators.
3. Electric ironers.
4. Water heaters for household use.

Electric ranges, surprising as it may seem, have been found rather economical in certain conditions where there is no natural fuel on the farm. We found, in one case, that they could operate an electric range for just about what they would pay for coal. It has been shown by monthly readings that they must learn to use a range and they must use certain types of utensils with it to get the best results. For example, one farmer bought his wife a pressure cooker. The current consumption dropped off about 20 or 25 per cent immediately afterward.

The handling of grain by elevators is a thing that can be done very readily by electric power and is something that is not done generally at the present time. At threshing time it usually takes anywhere from two to four extra hands to handle the grain. That can be cut down very readily to about one hand and a small motor and little equipment.

We have found that a small feed mill operated by a 3-h. p. to 5-h. p. motor can be equipped with an overhead self-feed hopper and a bin underneath for ground feed or an elevator to take it away. Two such mills are in operation and another could be operated with self-feed, except that it makes a good job for an 11-year old boy.

During the six-months' grinding season, these mills have averaged, monthly, from 12 to 35 kw-hr., grinding from 150 to 300 lb. daily. On the average these mills increase the monthly bill of each farmer 63 cents, grinding about 3.45 tons.

The local mills charge about \$2.00 to \$2.50 per ton. Even after adding interest, depreciation and repair on the motor and mill, the actual cash saving will almost pay the total monthly bill for electricity during the six months of use, to say nothing of the time saved in bagging up the grain and hauling it to town and back.

In connection with this it is important to note that two of the mills are not troubleproof. In one case, a mill clogged and a belt was burned in two. The third mill is priced so high as to put it out of the reach of the average farmer. We firmly believe, however, that developments will soon be made overcoming these objections. All of the mills will produce a satisfactory product when grinding small grains, and one of them will handle corn on the cob with a little special feeding mechanism.

Hoisting hay is a comparatively short job in the year, but a good job, providing we can operate a hoist satisfactorily with a motor. From a mechanical standpoint there is a tremendous overload at the beginning of the operation in breaking the bunch of hay away from the load, and you need either some kind of gear mechanism for quickly changing from a low speed to a higher speed or a large motor to handle the load at that time.

The ordinary household appliances are, of course, just as satisfactory on the farm as anywhere else, and some more so. The washing machine, for example, is worth more to the farmer's wife than to the city man's wife, I believe, for the reason that she has a great deal of hard work and many chores to do.

Incubation and brooding is a matter to which we have given considerable attention. Last year electric incubators did not work as well as the oil incubators, probably partly due to the fact that the operators were unfamiliar with the electric incubators. This year results show that they now compare favorably. In the meantime we have done some work in trying to perfect some of the electric controls because it has seemed that they were not sufficiently sensitive.

The problem of operating a milking machine is one to which electricity adapts itself most admirably. Electrical milkers are being used more all the time.

In this connection it is interesting to note that just recently the tariff has been raised on butter from eight to twelve cents, to permit farmers in this country to compete with the Danish farmer and the New Zealand farmer. The New Zealand farmer does not put butter on the market at a low price altogether because of the climatic conditions. It is true they have pasture practically all the year round, but at the same time they do use all the latest and best labor-saving equipment. I should like to

repeat a remark that was made to me recently by an engineer. He said he thought there wasn't a milking machine on the American market that was the equal of the average milking machine sold in New Zealand.

Another job that has proved very successful is water heating for the dairy. That has been a difficult problem. The electric water heater solved it very, very successfully and at a moderate cost, the average being 57 kw-hr. per month in one case. By turning on the switch when you start milking, the water will be hot by the time you get around to washing your utensils.

Water pumping is another job which can be very successfully handled by electricity. There are a few features about that which we have found are not taken care of in the ordinary system. The current will occasionally be disconnected and the stock absolutely must be watered. We must have some kind of standby power to be able to pump water while the current is off or else we must have storage. Most of the automatic systems are so arranged with the electric motor built into the system that it is impossible to operate them by hand or in any other way. This means you either have to have a big storage system, another well, or two pumps in one well so that you can operate one by hand or by some other means when the current is off. This is a rather important problem.

**E. A. Stewart:** The papers by Mr. Post and Mr. Neff are evidences of the fact that rural electrification is soon to be put on a sound scientific basis. The methods used in the past, whereby each public utility company blindly and arbitrarily developed some haphazard method of carrying out rural extensions, are now being superseded by orderly methods. The results secured by experimental work, such as we are doing at Red Wing, Minnesota, and in nearly a score of other states, will be of no avail to our farmers unless the electric utilities adopt some such plans as are proposed in these two papers. The steps taken by these two companies in adopting a uniform method of developing rural service in each of their territories is a wonderful step in the right direction. This movement should be enlarged so as to continue throughout the state and even across the state boundaries. I mean that these companies and other companies operating in this state should get together and agree upon certain fundamental factors so that the rural service will be put on a uniform basis throughout the state and eventually throughout all contiguous, comparable territory.

You will note that the methods of financing rural extensions and the fundamental methods of rate making as proposed by these two executives are radically different. One proposes that the company finance the major cost of the line, the other proposes the farmers finance the major part of the costs. Some companies propose to finance the entire cost of high line, transformers, and secondaries, while others propose to have the farmers finance the entire cost. Urban utility business is now financed largely on the same basis throughout all contiguous territory. It is essential that farm extensions be treated in a similar way.

On account of the difference in rate structures proposed by these two companies, at the fringes of their territories where the two services meet there will be a misunderstanding of these rates by the farmers and dissatisfaction produced. One proposes a rate based on a fixed or service charge, which we are inclined to call a delivery charge, and a low energy rate. The other proposes a rate using a minimum charge based upon energy consumption and type of installation. The former proposal is like the rate that was put into effect at Red Wing, Minn., in 1923, after a rate study extending over four years had been made. So far as I know, this was the first place in the U. S. A. to use this type of rate for farm service. This type of rate is being used now by companies in at least eight different states. Our Red Wing rate, based on three customers per mile of line with all 3-kv-a. transformer installations, is a delivery charge of \$6.90 per month per customer, and the first 30 kw-hr. at 5 cents per kw-hr., and

all excess at 3 cents per kw-hr. It may be necessary to modify this rate for consumptions beyond 500 kw-hr. per month, and for water-heating loads. There are about ten different types of rates in use throughout this middle-west territory. These rates must be unified and coordinated to allay distrust and to make some of them more equitable and applicable.

A movement has been started in Minnesota to unify methods of operating rural extensions. A committee is working on coordination of methods in making rural extensions, particularly as regards financing, rate structure, organization, line construction and utilization in rural service. We believe that it is essential for all states to agree on some comprehensive, workable plan that will unify methods of farm electric service.

The rate structure proposed by Mr. Post has some features which may be disadvantageous and complicate the explanations that must be given to the farmer. It makes no difference to a power company whether a man has ten rooms or three rooms, if his maximum demand at time of system demand is the same in both cases. Is not the installed transformer capacity necessary to carry the load a more probable indicator of demand? The active-room basis may apply to farm service as it has been, but not as it should be, and, may I predict, as it will be. Minimum-bill type of rates have influenced thousands of farmers to keep energy consumptions down to minimum-bill size by the psychological effect. High energy charges on the minimum amounts is bad propaganda and customers forget the cheap energy on the excess rate.

Methods of financing the farm lines are important. If the farmer is to make his electric service earn money and if he is to be a satisfied customer with such high basic costs as are necessary for farm service, he must utilize electricity for many uses. To use electricity in many operations requires adequate wiring and considerable equipment. Wiring and equipment will cost from \$500 to \$1500. The farmer needs his money and credit to carry out this program. It is obvious that the power company should carry the investment in the high line, and even services to the farm house, as is done in urban service.

In reference to disparity of average kilowatt-hour charges on farms and in adjacent towns and cities, I cannot see how they can be the same and be equitable. Are costs for taxes, foodstuffs, fuels, and transportation the same? Obviously they cannot be. The average kilowatt-hour rate on the Red Wing farms is now below six cents per kw-hr. Some farmers have as high as nine cents, and why should they be the same or the same as in urban service.

I want to commend the suggestion that the rural salesman sell service. Also I want to say "more power to you," when you suggest that farm service must be as reliable as city service. One hundred and eighty-five acetylene lighting plants were recently installed in a district having rural service. Many electric installations were removed. The farmers were right. The electric service was execrable. Electric incubators can be bought for a song in this territory. By its type of service this company has blasted the possibilities of electric service to hundreds of farmers.

I wish to commend Mr. Neff's suggestions on the formation of a department of rural service; also his suggestion as to the desirability of a proper type of rate. The manner of converting present customers over to the new rate structure must be carefully worked out. Some plan will be proposed for Minnesota very shortly. It may involve refunds to purchase equipment.

I am glad to hear the suggestion in regard to a rural service man. The farmer should have service. Many companies that are now selling farm equipment are already putting in service departments. Two large nation-wide organizations have started such service as suggested by Mr. Neff during the past year. The electric utility companies must adopt some such plan.

I wish to close this paper with a plea for unified action, not only within the state, but in adjoining states on rural service programs.

**K. A. Pauly:** I was particularly impressed with the convincing demonstration by Mr. Neff—that the farmer could never hope to be prosperous so long as his production is so largely dependent upon manual labor. This is a fact which all of us, who are connected with the electrical industry, fully appreciate, but I am afraid that too few workers realize the part which machinery plays in the prosperity of the wage earner.

Mr. Neff confirms the statement which I have frequently made myself and have heard others make, to the effect that it is not an unhealthy sign to see farmers' sons leaving the farm and going to the city. This merely indicates that improved methods in agriculture have made it possible for the ever increasing needs of the cities to be met without a corresponding increase in farm labor, a distinctly healthy, rather than unhealthy, symptom.

Without electric power, it would have been impossible to place at the disposal of the industrial worker the power which he now directs and which is the secret of his prosperity and I believe that the opportunities for the application of electric power in agriculture are just as great as they were in the industrial field. The tremendous advances in industries have been due largely to new methods made possible by electric power. So we must look for modifications in agricultural methods for our greatest gains, which methods will be, as was the case with the industries, built up around the convenience and flexibility of electric service. Just as the developments in the industries have been gradual and the outgrowth of experience with electric power, so, I believe, they will be in agriculture and the new ways of doing things will come step by step.

While I heartily advocate a thorough study of all the problems involved to avoid unnecessary and expensive errors, I am not optimistic to the degree of believing that we shall ever approach the ideal without putting into practise improved methods as they appear, and confidently expecting in the future to make still further improvements. Experience thus gained may be of material assistance in hastening the further development or may even point the way to entirely different lines of study which otherwise would not have been suggested. Advance in the industries has not been haphazard. On the contrary, much study and experimentation has been at the bottom of most of the essential advances.

**A. H. Ford:** In connection with the question of financing farm lines I wonder how many public utility men have considered that the farmer turns his capital very much slower than does the public utility? As the result of this, the public utility should finance the farm lines rather than leave it to the farmer; because it is too hard for the farmer to get the necessary capital.

Practically all the discussion concerning electric service on the farm has been based on the premises that the farm is a factory and everyone has been waiting for the time to come when the farm factory can use electric service to advantage. It will now be demonstrated that this is not necessary. The farm is a home as well as a factory. If the interest and taxes on the farm home and on a city home of the same grade are computed, each at the common rate, it will be found that the difference amounts to about \$100 per year. The fixed charges on a farm line will be less than this amount per customer. A farm with electric service can have the town advantages of water supply, electric light, refrigeration and electric cooking at a cost not greater than the same services would cost in town. It seems unnecessary therefore to wait until economical methods are developed for the use of electric service on the farm. Electric service can be sold to him at once for use in his home and at a price which he can afford to pay rather than move to town in order to get the use of the town utilities.

A couple of speakers have mentioned selling kilowatt-hours. I wish that we could forget that expression. We are not selling kilowatt-hours but electric power service. However, those who are engaged in the electric power business have thought in terms

of kilowatt-hours so long that they seem unable to get away from it. We are selling electric power service which involves a demand cost as well as an energy cost and if we talk about selling kilowatt-hours we are apt to forget the demand cost and the corresponding charge which should be made. We are also prone to talk kilowatt-hours to our customers who know nothing of the term. What the customer wants is service and he is not interested in kilowatt-hours. The sooner we stop talking kilowatt-hours and talk service, the better off we will be.

**G. G. Post:** Mr. Holcomb questions the elastic limit of the aluminum conductor mentioned in my paper. Since the meeting, the elastic limit of 1860 lb. given in the paper was checked with data furnished by the Aluminum Company of America and was found to be correct.

Mr. Holcomb made the statement that there was little difference as to who makes the investment in the line, whether it is the farmer or the utility. Of course in the long run the farmer pays for all that he gets. There is this to be borne in mind, however; where the farmer finances a portion of the line cost, he pays his money at the beginning; where the utility finances the extension work, the utility reminds the farmer every month forever thereafter that he has paid something toward the cost of the line. People who contribute toward the cost of extensions have the faculty, you know, of forgetting in time that they have paid, and it seems to me that in the long run the man who pays the smallest monthly bill is the one who is going to be permanently satisfied.

Two of the discussors stated that the rates to the small consumer under the two plans given are about the same. Consider the case of the farmer who uses perhaps 20 kw-hr. in a month. Under one rate he would pay \$2.00 and under the other he would pay \$6.60.

Mr. Lehman apparently is under a misapprehension concerning some of the provisions of the rate outlined in my paper. He spoke of the effect of changing the number of outlets from time to time. The number of outlets does not affect the rates. The amount that the farmer pays depends upon the active rooms which he has in all of his buildings and upon the h. p. of connected motor load in excess of 3 h. p.

There also seems to be a misapprehension concerning the meaning of the statement "a rate schedule designed to pay full returns on investment from the very start, by using burdensome minimum charges or high rates per kw-kr., will produce the opposite result." It is not the intention to change the rate in order to increase the return; the rate remains the same. What is meant is that a line which may not be productive of adequate return in the beginning will give an adequate return later when the use of the service on the line has grown sufficiently.

I think there was also some question as to the active-room basis taking care of motors. It is true it does not take care of the motors. Motors are taken care of in another way by adding fifty cents to the minimum charge for each h. p. connected above three.

## COOPERATION BETWEEN THE COLLEGES AND THE INDUSTRIES IN RESEARCH

(WICKENDEN, POTTER, BAILEY<sup>1</sup>, BENNETT)  
MADISON, WISCONSIN, MAY, 7, 1926

**E. B. Paine:** The Engineering Experiment Station of the University of Illinois was established December 8, 1903. The object of this experiment station was stated to be the encouragement of training in engineering and the study of problems of special importance to professional engineers and to engineering industries.

The control of the Engineering Experiment Station is vested in the executive staff, composed of the director, the heads of the nine departments in the College of Engineering, and the pro-

1. A. I. E. E. JOURNAL, August, 1926, p. 742.

fessor of Industrial Chemistry. The research work of the Station is conducted by a corps consisting of 32 full-time investigators, 14 research graduate assistants who devote one-half of their time to research and the other half to graduate study, and 50 members of the teaching staff of the college, who devote part of their time to research investigations. For the year 1925-26, approximately \$95,000 has been appropriated for this work from state funds and over \$60,000 has been contributed from outside sources for carrying on cooperative investigations.

The present list of research investigations includes 88 titles distributed among the engineering departments as follows:— Ceramic Engineering 10; Civil Engineering 11; Electrical Engineering 8; Mechanical Engineering 14; Mining Engineering 4; Theoretical and Applied Mechanics 13; Physics 8; Railway Engineering 6; Industrial Chemistry 14. Some of these investigations are carried on in part by funds from the state and in part by funds from industrial organizations. Work is now in progress on 25 cooperative investigations.

The Engineering Experiment Station, supported chiefly by public funds, cannot be employed in the exploitation of inventions or processes or in the conduct of scientific work, the results of which are to be held from the public. Cooperative research is undertaken only in those instances where the chief purpose is to establish fundamental principles and physical laws which have a wide practical application.

The standard agreement for a cooperative investigation at the University of Illinois provides that the University contribute the use of its facilities. It will also assume the general administration of the investigation and publish in bulletins or circulars of the Engineering Experiment Station the results of the investigation. The cooperating agency furnishes the funds which are necessary to pay the salaries of special investigators, to purchase materials and special apparatus needed for the work, and other necessary expenses of the investigation. The university retains the ownership of all data secured. The research program is outlined by an advisory committee representing the cooperative agency and the executive staff of the Engineering Experiment Station.

The Engineering Experiment Station will not undertake commercial tests except under unusual circumstances. In no case will it undertake such a test if the results are to be used for advertising purposes.

Whenever discoveries and inventions result from research investigations, whether conducted with funds from the state or with funds furnished by a cooperating agency, the member of the University staff who made the discovery may be required to obtain a patent at university expense and assign the patent to the University.

**John Mills:** Professor Bennett's well ordered paper is both diagnostic and specific of a functional disorder in our educational system. Financial considerations and a natural impatience to get to work will probably always act to limit the number of students who can pursue continuously more than the usual four years of an engineering course. Financial progress and increased scales of personal expenses will also act to prevent any large number of practising engineers from returning to resident graduate study. Since, in general, the student will neither remain nor return, the university must go to him; and Professor Bennett's suggested method seems worthy of wide trial and very definite support.

It presupposes on the part of the practising engineers an interest in further study which is found as a rule only in those engaged in investigative work as distinct from work in commercial relations with the public or in the industrial management of routine operations. It is immediately evident that it is not for those who brag that they have never had occasion in their engineering careers to consult the theoretical books or to use the calculus tables of their student days.

Of the three types of seminar which are proposed, the first two

deserve the emphasis in the judgment of the present writer who believes that a combination of the two would be most satisfactory. In such a combination the consideration of recent advances would accompany and serve to motivate reviews and extensions of theoretical considerations.

This is the type of post-graduate study in industry with which the writer is most familiar. Within Bell Telephone Laboratories there was evolved a scheme for such study which for some years has been organized by George B. Thomas, its Personnel Director. There the group of engineers and scientists is large enough to carry on such work as a self-contained group without assistance from educational institutions. Courses of graduate grade of difficulty, highly analytical in character, but illustrated by current problems and recent developments, are offered to the members of its technical staff. These are given by other members of the staff who are experts in the particular subjects. Each year there are several hundred registrations for these courses. Both instruction and attendance and study are on the time of the individual and are entirely optional. The preparation of the text material, however, is carried out as part of the regular company duties as are all the other matters with the exception of instruction and attendance. Incidentally there are neither tuition fees nor special payments to instructors, for the immediate rewards of instruction are non-financial although ultimately there may be financial return.

Some of the text material has attracted interest in academic circles and one of the texts, namely on telephonic transmission was published some time ago. Another on the subject of sound is at present on the press, and the text material of certain other courses, in mimeograph form, is being revised for publication. Such a cooperative scheme of advances in education, however, is probably unique and will always be limited to large groups, homogeneous in training and interests. To provide for similar groups representing members of different corporations some scheme like Professor Bennett's must ultimately be adopted. That advanced education of the character described is valuable both to the individual and to industry has been proved in the eight years' experience with the so-called "Out-of-Hour Courses" in Bell Telephone Laboratories. That it should be available more widely and could be accomplished under the proposed plans appears to the writer of these remarks to be so self-evident that Professor Bennett's program should meet with immediate acceptance and trial in several localities.

**S. H. Mortensen:** Speaking as a practising engineer, I feel that seminars conducted along the lines suggested in Professor Bennett's paper would be of great value to the experienced engineer as well as to the young graduates.

Practising engineers frequently encounter problems the successful solution of which could be quickly facilitated by means of a discussion with university professors and research workers as well as with engineers active in the same or allied fields.

Certain of these problems would be suitable for investigation in a research department of the universities and others for factory or field tests. Cooperation in this work between the universities and the industries would lead to improved measures and a broader interpretation of the results obtained.

In arranging a program for practising engineers it might be well to bear in mind that they are called away frequently on business trips. For this reason it would be desirable if each meeting would take care of one subject in such a manner that it would be more or less independent of the preceding and the following meetings, thereby making continuity of attendance less imperative.

There is little doubt in my mind that the proposed seminars will benefit universities and industries alike. The university research department and teaching staff will be in touch with the problems of the day and the practising engineers will gain added experience and broadened vision.

**J. S. Coldwell:** Professor Bennett's paper appeals to me

very much and I believe if any university would plan several such seminars and properly approach practising engineers and industrial concerns, they would be well attended.

Cooperation between the universities and industry would be mutually beneficial. The industrial organization would keep pace with the advance of science and would have available a very high type of research organization. On the other hand, the arrangement would broaden the university professors, keep them in touch with industrial conditions, make their teaching more effective and probably serve as a means for increased remuneration. Of the two I should say that the universities and the professors would profit the most and it is significant to note that the five papers presented were given either by a commissioner of education or by college deans. I get the impression of an effort to sell the research ability of the university to industry.

In the first place, this cooperation can be achieved only when both the university and industry have the same point of view. At present the universities' point of view is generally the advancement of science whereas industry's point of view is profit.

In order to serve industry properly and to be sought for service by industry, it will be necessary for the universities to get the profit point of view and sell their services to the industry as anything else is sold to industry. Any time the university can show industry anything which will lead to a profit in dollars and cents, it will be taken up immediately by industry.

At present it is doubtful that industry can refer immediate and concrete problems to the university for research on account of the need for familiarity with the many commercial, manufacturing, service, and other factors, also the need for quick action and furthermore on account of patent complications and competitive situations.

It is significant that in the ten years I have been with the Cutler Hammer Mfg. Company, I have seen only two university professors who visited our department. The universities and the professors should interest themselves in industry, call upon industry with much the same general point of view as a salesman, get acquainted with industrial problems and bring themselves to the attention of industry. If I were a university professor, I should visit various industrial plants, making myself acquainted with their problems and their personnel, at the same time letting them know of my familiarity with certain particular problems which they are working upon and that in a very short time the industry would be naturally turning to me as a source of information on their particular problems.

The university professors would be very welcome at our plant or other plants, and we would be glad to discuss many interesting problems with them, even pointing out the road for many important investigations of a general nature which we now have a commercial demand but which we either cannot afford to work upon or which do not tie in with our particular problems occupying most of our time.

Furthermore, if the universities want to serve industry, and at the same time maintain their organization and personnel, they will have to cut loose from traditional restrictions and make it possible for their professors to sell their services and their patents at such a price that their income would be sufficient to keep them with the university.

Some years ago when I was with a concern in the East, we had an instructor from the Cornell Metallurgical Laboratory working as a draftsman during the summer. While he was here, a rather difficult heat-treating problem came up and in the course of time it occurred to some one that he might be able to help us. The minute we put the problem up to him he gave us a general answer, and after very little checking he gave a specific answer. Immediately all the other heat-treating problems which arose were referred to him, and he continued to take care of their metallurgical problems after he went back to Cornell.

**F. E. Turneure:** The question of research in the engineering colleges has been of much interest to me for many years,—in fact, ever since I began teaching at Washington University, St. Louis, where the late Dean J. B. Johnson was operating a materials-testing laboratory. In the early days of college research the subject of probably the most general interest was that of strength of materials. It is a research subject comparatively easy to develop in a college laboratory, and many of the engineering constants and empirical formulas used in civil-engineering design have been determined in the college research laboratory. Later on, many other lines of research have been developed, as have been explained before this meeting, and concerning which most of you are well informed. Along with this development of college research work has come a much closer cooperation between engineers and teachers. I suppose this is because the practitioner is becoming more scientific and the college professor more practical. This is well illustrated in the organization of the research committees of our national engineering societies, made up as they generally are of a combination of engineers and professors. The college professor is relied upon generally to conduct the research, and the practitioner offers practical suggestions relative to his experience. It is interesting to note how harmoniously they now cooperate, and at their meetings it is often difficult to distinguish between the professor and the practitioner. It is a good illustration of the growing scientific basis of engineering practise; and in electrical engineering this condition has, of course, obtained for many years.

Considering the trend of things, it would seem certain that there will be a considerable further extension of cooperative research between engineers and colleges or between industries and colleges. I believe that such cooperation is one of the very best aids in the development of the right kind of engineering instruction. Perhaps the most valuable feature is the effect that it has upon the teachers themselves, and through them, upon the students.

**C. F. Harding:** President Frank of the University of Wisconsin has emphasized the importance and necessity of making practical the pure research which has been developed during the last ten years. It seems to me the principal object of this discussion is the converse of that proposition; namely, the development of research in the colleges and universities resulting from practical problems. Many of these have been listed in the different institutions of the country.

At Purdue University we have been particularly interested in high-voltage developments. The great educational value of our high-voltage laboratory and the research carried on therein has resulted very largely from what may be considered commercial tests undertaken primarily as tests of a practical engineering nature of particular interest to the public utilities of the State. Like the tests at Illinois, as outlined by Professor Paine no commercial tests are undertaken unless they have some development or research value, but, for example, if competitive high-voltage insulator tests are made, in practically every case a long series of researches has resulted which has been valuable, I believe, to the profession as a whole. The same thing is true of corona tests between wires, started in the first place as a purely commercial investigation and developed in a number of years into a fundamental research in connection with corona losses. A number of other similar cases might be listed as illustrations.

In addition to this, the value of senior and graduate theses and investigations carried on partly as a result of cooperation on the part of utilities and manufacturers has enhanced very greatly the educational work of the institution.

Commenting upon Professor Bennett's excellent suggestion, it seems to me that the conferences which have been held at different technical universities are bordering very closely upon the *B* and *C* types of seminars which he outlined. Most of you are familiar with the conferences for electric meter men that are held at the different educational institutions. Following that

precedent, conferences for superintendents of distribution, particularly in the State of Indiana, and quite recently the innovation of industrial electric heating conferences, one of which was just concluded last month, have in all cases developed a fine cooperation between the university, manufacturers and public utilities of the state and have resulted in continued research and development problems of value.

So it seems to me that the work outlined in these papers is perhaps on a par with the application of pure research to industry as outlined by President Frank.

**Edward Bennett:** In his discussion, Mr. Coldwell makes one statement which calls for comment; namely, the statement that "if the universities want to serve industry, and at the same time maintain their organization and personnel, they will have to cut loose from traditional restrictions and make it possible for their professors to sell their services and their patents at such a price that their income would be sufficient to keep them with the university."

In other words, university professors, whose primary loyalty should be to the ideals and objectives of the educational world, are to find it feasible to remain in educational work because of the compensation received from industry for services rendered directly to industry!

When the proposal is stated in these terms it should require but slight reflection to see that in the conduct of its own affairs, industry does not subscribe to such a doctrine of divided loyalty. The old statement still holds that "No man can serve

two masters: for either he will hate the one, and love the other; or else he will hold to the one and despise the other."

I cannot emphasize too strongly my view that a policy of meeting the situation or the competition pictured in Mr. Coldwell's statement simply by permitting and encouraging educators (engineering, medical, or otherwise) to supplement an inadequate salary by private practise is a short-sighted policy for which society is paying dear. The results obtained under such a program, as contrasted with those obtained under a program displaying educational statesmanship, are well presented in an article entitled, "The Extension of the Full-Time Plan of Teaching to Clinical Medicine" appearing in *Science* for Aug. 11, 1922.

As stated in my paper, it seems to many educators that the essential features of a policy under which a State university and an industrial enterprise can effectively cooperate in industrial research are set forth in the circular of the Engineering Experiment Station of the University of Illinois, entitled "The Functions of the Engineering Experiment Station of the University of Illinois." In his discussion, Professor Paine has outlined this policy.

There is, however, an element of truth in Mr. Coldwell's statement, and it seems to me to lie in his definite recognition of the fact that no engineering college can hope to enter upon the worth-while and greatly desired program of cooperative research with industry so long as it pays inadequate salaries. One of the essential first steps in the advancement of such a program is the adoption of an adequate scale of salaries.

## Discussion at Annual Convention

### REMOTELY CONTROLLED SUBSTATIONS<sup>1</sup>

(BLACKWOOD)

WHITE SULPHUR SPRINGS, W. VA., JUNE 23, 1926

**C. M. Gilt:** The load and service requirements in the metropolitan districts are such that there has been some hesitancy in the introduction of purely automatic stations. In these territories it is common practise to maintain crews on 24-hr. duty for the promptest possible restoration of service in case of feeder outages. It is therefore important that the repair crews learn of the outage of any particular feeder as quickly as possible after it has occurred.

The purely automatic station does not provide this information without special indicating equipment approaching remote-control in cost and complications. In some cases indicators have been installed to show that a feeder in a particular substation is out and in other cases, the indication has shown in addition, which feeder is open.

The remote-control equipment not only indicates which feeder has gone out for any cause, but makes it possible for the operator to reclose the breaker under directions from the repair crews as soon as they find the trouble or sectionalize the feeder. It also provides some indication of load characteristics and distribution as well as voltage conditions which frequently are of great value in maintaining proper service.

As indicated by this paper, equipment is available for accomplishing the results over comparatively few wires, and in spite of the fact that it appears light and delicate to the man accustomed to powerhouse equipment, it seems to have a remarkably satisfactory record of performance. It is to be hoped that the manufacturers will continue their efforts in developing simpler and more sturdy devices for this very important type of control.

**F. B. Johnson:** Mr. Blackwood spoke of bus regulation and if I understand him correctly, that refers to bus regulation on the

4000-volt side of the substation. I would like to ask him how large blocks of power are regulated through bus regulation?

**Chester Lichtenberg:** The remotely-controlled substations which have been described seem to be only an intermediate step in the development of the art. They seem to be merely an extension of the manual operation of substations and, therefore, are only a step towards the ultimate which probably is a completely automatic system.

In many parts of the country, central station companies have adopted the use of automatic substations for the class of service described by Mr. Blackwood. Some of the stations are remotely supervised where this has been deemed necessary.

A consideration of remotely-controlled substations brings with it a very important question. It is the hazard introduced if equipment designed for supervisory purposes is used for remote-control purposes.

Remote-control equipment in common use today has a distinctive feature. It is provided with at least one wire between the controlling point and the outlying station for each device to be controlled. Supervisory equipment, on the contrary, uses only a few wires for controlling a number of devices in an outlying station. It uses these wires in a predetermined fashion and as a result there may be quite an appreciable time lag between the operation called for by a supervisory equipment and the functioning of the devices at the remote end. Besides, this time interval may vary from one to two seconds up to eight or ten seconds. It is therefore difficult to operate a supervisory system as a remote-control system unless the limitations of the supervisory equipment are realized.

**G. O. Brown:** We have advanced beyond the remotely-controlled substations by the use of entirely automatic substations.

In about 1920 the Kansas City Power & Light Company put in two substations entirely automatic and during the next year added only the indicating part of the supervisory control

1. A. I. E. E. JOURNAL, June, 1926, p. 531.



so the load dispatcher would know what was going on in those stations.

Within the last two years we have added two automatic substations of the same type and this fall we shall convert the last two of our manually operated stations into automatic. This will make all substations within Kansas City entirely automatic.

Our experience with this method of operation, using the supervisory-control devices for indication only, has been highly satisfactory. There have been less interruptions, and the time required to restore service has been much less than in the manually controlled stations.

**E. K. Huntington:** Our experience has been somewhat similar to that mentioned by Mr. Brown, in having two fully automatic, a-c. substations built about three years ago. Later we installed a simple form of remote indication which advises the system operator of trouble in the stations. This indication divides the trouble into three classes: transformers and station equipment; feeder circuits; and street-lighting circuits, so that the proper gangs may be sent out. Inasmuch as we have to rely upon circuits available from the local telephone company, I fear that at times entire control of the station by this means would be rather unsatisfactory. Much better service could be obtained by the use of a direct line, preferably underground, between the substation and system operator's office.

I fully agree with what Mr. Lichtenberg has said in connection with the automatic station having a number of advantages over the station which is entirely remote-controlled with no automatic equipment whatsoever in the station.

**R. J. Wensley:** The two stations described by Mr. Blackwood presented many new problems in design of the supervisory control equipment. The requirements of the induction-regulator control and of the single-pole breakers on the three-phase, four-wire circuits presented the most difficult problems. In the solution of these and other new problems incident to the remote control of the stations described, it is believed that a reasonably satisfactory solution of a complex problem has been obtained.

The author gives as his conclusion that supervisory control equipment should be made more sturdy. He is misled by the belief popular among engineers used to dealing with heavy power equipment, that size constitutes sturdiness. There are many cases where increase in size or weight of parts actually makes the device less suitable for its duty.

In his discussion<sup>2</sup> of the Lichtenberg paper on the subject of supervisory systems, (presented at the Midwinter Convention, February 1926). F. R. McBerty, President of the North Electric Manufacturing Co. and a telephone engineer of many years standing, gives an excellent brief for the telephone relay as a reliable device. He shows that the design tests on this class of equipment run into many millions of continuously successful operations. In the equipment described by Mr. Blackwood, the telephone-type relays have been improved by the addition of twin contacts. These operate on the halves of a split spring, each half of which is free to move independently. The chance of failure due to simultaneous contact trouble is small. This twin-spring construction has been standard with one manufacturer for about three years.

The upward swing of the sales curve of supervisory control equipment is so pronounced that it is felt that the idea is now well established and that there is a large future for this class of equipment. So many possibilities in the flexible and economical control of power distribution systems are revealed when these problems are examined as potential applications of supervisory control that many large power systems are being studied to determine where this new art may be used to advantage. Another year will undoubtedly show a great increase in number of equipments in service as well as some improvement in general

design. This improvement will probably show mostly in simplification rather than in change in design of essential parts.

**W. C. Blackwood:** I shall close by answering the question as to the blocks of power which are bus-regulated. In the Hollis Station we have three 7500-kv-a. transformers and the total station load of 15,000 kv-a. will be bus regulated. The area served by the station is approximately a circle with a radius of from about 2 to 2 1/2 miles.

## GENERAL THEORY OF THE AUTO-TRANSFORMER<sup>1</sup>

(UPSON)

WHITE SULPHUR SPRINGS, W. VA., JUNE 25, 1926

**J. R. Craighead:** In calculations on instrument transformers, more exact work is necessary than on power transformers if the results obtained are to be worthy of the accuracy which can be developed in the transformer itself.

One of the main difficulties that we have found in obtaining exact results by calculation is the separation of the primary self-inductance from the secondary self-inductance. It is very easy to obtain a total self-inductance for a transformer but not easy to separate the two components.

We have used various methods and are now able to separate the two quantities with reasonable accuracy on standard transformers. In certain cases where auto-transformers are concerned, there is considerable difficulty in finding a method which will accurately separate the two components.

I should like to ask if Mr. Upson has any suggestions as to how this fundamental separation of the two inductances can be made for purposes of accurate calculation?

In attempting the separation of secondary reactance in current transformers we have calculated ratio and phase angle from exciting current and losses. Successive assumptions were made of secondary reactance until a value was found which brought the result of calculation into agreement with test results. This value of secondary reactance was then assumed to be characteristic of the structure of the type of transformer under consideration. We also built models in which the secondary was made of cored wire so that the inner wire could be used to obtain measurements from which the secondary resistance was excluded.

If we did that with the auto-transformer, would the resulting complex of primary and secondary voltage render the function an unsatisfactory one from which to calculate?

**W. L. Upson:** I don't think we should have any greater difficulty with the auto-transformer. In general, I think it would be more symmetrical than the other, or may be made so at any rate.

If you are going to fix up an auto-transformer, you can carry the wires themselves right along together so that they will be perfectly symmetrical with respect to one another and that will give you the minimum leakage reactance, which is what you want. In general, that is true; I don't know whether you want it for your current transformers, but I presume that you do. You get better action from an auto-transformer with the minimum reactance and there is no reason why you shouldn't get your leakage reactances by that method in the auto transformer if you can in the other.

I think we can get the leakage reactances and inductances combined with some fair degree of accuracy. But, to separate them into their two parts and get the correct values for both of them,—the only way I know of doing that, (and it is no good for accurate work) is by some sort of graphical or geometrical study of the system.

I have a feeling, though, that we can make some progress in that kind of determination and that that is about as far as I can go. I don't know how to get at it in any other way.

2. A. I. E. E. JOURNAL, July, 1926, p. 672.

1. A. I. E. E. JOURNAL, July, 1926, p. 661.

## PRODUCTION AND APPLICATION OF LIGHT

(MILLAR)

WHITE SULPHUR SPRINGS, W. VA., JUNE 22, 1926

**W. E. Beaty** (Cincinnati): The application of individual motor drive to varied machines, and particularly to the machines requiring 5 h. p. and below, has introduced the need for indicating lamps in connection particularly with automatic control of such machines. The gaseous lamp shown may meet that problem, and I should like to ask Mr. Millar what the voltage limitations are on a lamp of that character? I am wondering if the lamp can be used on all circuits up to, say, including 550 volts?

**W. N. Goodwin:** We are quite familiar with these gaseous lamps for advertising purposes in tubes several feet long employing a few thousand volts. I understand that in those, the the voltage is frequently a function of the distance between the electrodes, so that it should be quite easily possible to adopt them for any voltage from 115 volts up to several thousand.

**P. S. Millar:** The Committee Report records the achievement of operating these small lamps on a voltage as low as 115. It should be easy to make them operate on 220 or 550 volts.

## THE HIGH-SPEED CIRCUIT BREAKER IN RAILWAY FEEDER NETWORKS<sup>1</sup>

(McNairy)

WHITE SULPHUR SPRINGS, W. VA., JUNE 23, 1926

**J. J. Linebaugh:** Very few engineers other than those actively engaged in railway substation and distribution work appreciate the great advance made during the last few years in the protection of substation apparatus and railway networks, due to the development of the high-speed breaker.

It should be appreciated that the high-speed breaker operates and opens the circuit so quickly that practically all of the phenomena regarding amperes, volts, etc., are actually transients. This opens up possibility of obtaining selectivity and protection which has not been possible in the past.

Another important feature of the high-speed breaker described by Mr. McNairy is the characteristic that it only operates with current in one direction. This feature makes it possible to obtain maximum selectivity in railway networks under short circuits.

It is now possible to tie as many tracks together as desired utilizing all the copper in regular operation to the best advantage and isolate any section if it should become grounded or short-circuited without disturbing other tracks or sections. This is particularly applicable and advantageous on systems of two or more tracks.

The high-speed breaker has practically eliminated short circuits as we originally knew them on substation apparatus and distribution systems; that is, the breaker operates so quickly after short circuit occurs that the current is prevented from reaching dangerous values which would cause serious damage. This is due to the speed with which it attacks the circuit rather than the speed or time of rupturing the circuit which is about the same as with an ordinary breaker.

The advantages of high-speed breaker protection are becoming more evident as their use is extended. Figures now available indicate that they very materially decrease locomotive and substation maintenance.

**Chester Lichtenberg:** The circuit breakers described have been of the so called magnetic type. In addition, there is the latched-in type of high-speed breaker. Emphasis is laid upon the difference between these two types because in applying them different parameters must be recognized. Those of the latched-in type were the first high-speed circuit breakers developed. The magnetic type followed. Both have been very successful where

their inherent characteristics were recognized and applications correctly made.

A prime characteristic of the latched-in type is that it will always trip at a definite current depending upon the setting of its overload feature. It always trips at the same current whether the rate of rise of current is slow or rapid.

The magnetic type described in the paper has a quite different characteristic. It is provided with a so called bucking bar, which gives it a discriminating characteristic; that is, if set for tripping at a definite, steady current, it will trip at a lower current. The difference between the point of tripping and the point of setting will depend upon the rate of rise of the current.

This characteristic can be and sometimes has been incorporated in the latched-in type of high-speed breaker and wherever this discriminating feature is incorporated in the breaker, allowance must be made in its application.

This point is quite important in the application of high-speed breakers because if they are not correctly adjusted or set, they will open when they should not. The discriminating characteristic is a point of very great importance because it extends their application.

## MERCURY ARC RECTIFIERS

(PRINCE)

WHITE SULPHUR SPRINGS, W. VA., JUNE 25, 1926

**A. Odermatt:** While it is true that there are still some phenomena in connection with the mercury arc rectifier which we don't quite understand, it is also true that we know enough about the process taking place inside the rectifier to design perfectly reliable converters of both the glass-bulb and the iron-clad types.

Statistics covering about 800 rectifiers in service, with a total output of over 400,000 kw. supplied by the European Brown Boveri Company, show that the percentage of failures with rectifiers is smaller than with most of the other classes of electrical machinery such as synchronous converters, generators and motors. This refers to big rectifiers in iron casings but probably also holds good for the glass-bulb type. With the latter, of course, the risk of breakage should be taken into account, but on the other hand, it is easy to have available spare tubes for replacement.

I mention this in order to emphasize that the mercury arc rectifier, after having gone through a period of development of over twenty years, is today a thoroughly reliable apparatus, and its many advantages at higher d-c. voltages especially give the static mercury vapor converter a marked superiority over the rotating type.

The Brown Boveri Company is still using the condensing chamber, which has given excellent results in preventing the mercury from being extracted by the air pump. This rather long chamber of comparatively small diameter acts indeed as a kind of safety device in that direction, the piping through which the air and gases are exhausted being connected to the top of the condensing chamber.

It has been mentioned previously that the operating engineers in Chicago do not feel very enthusiastic about the results obtained with the rectifiers there. So far as the Brown Boveri rectifiers installed by the Commonwealth Edison Co. are concerned, I should like to make the following statement:

Two rectifier substations were installed there in the summer of 1925, both of which have given excellent results until the spring of 1926, when there was some trouble with one of them. The other one has given entire satisfaction all the time. The trouble which occurred was due to an external cause and had nothing to do with the proper working of the rectifier. It was water entering the working chamber, as a result of corrosion at the welding seam, that caused the breakdown; and not only rectifiers,

<sup>1</sup> A. I. E. E. JOURNAL, July, 1926, p. 619.

but most electrical apparatus would stop working satisfactorily under such conditions.

Although it is easy to prevent the repetition of a breakdown of that kind, it is most unfortunate that this should have happened in one of the few plants installed in this country, because it is likely to put the reliability of the rectifier in a wrong light. I can give assurance, however, that rectifiers installed in great numbers—I mentioned the number of 800 before—have given such excellent results that the percentage of failures is actually smaller than with other electrical equipment. The 800 rectifiers of which I am speaking are spread over the five continents of the world and the fact that over 50 of them are operating very satisfactorily, as far away as Australia and Japan, is the best evidence of the great reliability of this apparatus.

**C. P. Osborne:** About twenty-three years ago, the company with which I am associated was the first to try out the mercury arc rectifiers for street lighting. These sets were installed by the General Electric Company and some of them are still in operation.

The operating engineer today is greatly interested in mercury arc rectifiers not only for street lighting but for low-voltage distribution. Operating companies will no doubt install more d-c. distribution in the future than in the past, if it can be done with the mercury arc rectifier.

Our company is confronted at this time with a program which necessitates moving motor-generators which feed our d-c., three-wire Edison system from one location to another. At present the system is fed by motor-generator sets and it would be much more convenient if mercury arc rectifiers could be used and not have rotating apparatus in the new building.

I feel that the 1400-volt mercury arc rectifier will be a success and that the manufacturers' further developments and research will succeed in building lower voltage sets at a reasonable cost so they can be considered instead of converters and motor-generator sets for d-c. systems.

We visited in Chicago a substation where the mercury arc rectifier was furnishing energy for railway operation, and we did not find a great deal of enthusiasm among the men from the results they were getting from the mercury arc rectifier. The sets had just been started, however, and no doubt there will be changes which will be found necessary in order to get the desired results.

We operating men are responsible to the public for good service and in trying out new equipment we feel the manufacturers should be sure of its good operation before it is placed in service for the public. We are anxious to give the public good service in the cheapest way, but we must consider that the service comes first.

**J. A. Cook:** A small power application of mercury arc rectifier tubes is important to electric utility companies in street-lighting work. Glass tubes for this service have an average life of several thousand hours. Individual tubes may last double normal life or may fail after a few hours' operation. Such failure is attended by darkness on those city streets where lamps are located which depend upon this tube for their supply of current. It follows that failures of tubes should be anticipated so far as possible. C. M. Green, at West Lynn, advances the theory that failure can in some instances be anticipated. He uses a 1-to-1 ratio current transformer designed to operate at open circuit without excessive heating. The secondary of this transformer is connected through suitable resistance to the vibrator of an oscillograph. This gives a view of the ripples superimposed on the direct current. When certain tubes are about to fail there will be noted a pronounced peak which occurs on an otherwise flat portion of the wave. I should like to ask Mr. Prince if he can tell us of a test of this kind and whether tubes can be successfully treated to restore their full usefulness after the indication of approaching failure has been observed. I should also like to ask him if there is on the market an inex-

pensive oscillograph for visual use which would permit an operator to detect this condition in advance of failure.

I have tried the oscilloscope and find that it is not adequate for routine use by a station operator. The mirror is not driven synchronously, but is turned with the thumb. A wave without a peak can be made to show a peak. I have also tried an oscillograph of the spring-galvanometer type. Depending upon the tension of the spring, a large number of wave forms can be observed due to mechanical resonance of the vibrator system. I should repeat that a device which would indicate approaching failure of rectifier tubes on street-lighting work will be most valuable to public utility companies.

**W. A. Hillebrand:** I should like to ask if the use of the mercury arc rectifier is accompanied by any danger from radio interference, particularly in railway service? Is there any danger that arcing between trolley wire and collector will be more likely to set up troublesome oscillations when the circuit is supplied through a rectifier than when the source of supply is a rotating machine?

**D. C. Prince:** There are two general ways in which series street-lighting rectifiers fail. In one, the rectifiers actually break down at the peak of the voltage wave, due either to poor vacuum or to high temperature in the tank. If the failure be due to too high temperature it can, of course, be guarded against by keeping track of the temperature and reducing it by additional cooling water if it passes the safe value. The other type of failure is due to too perfect a vacuum. As the tube operates, the vacuum becomes more and more perfect until there is nothing to remove charges which accumulate on the glass arms. These charges prevent the current from shifting from one anode to another until a high voltage has been built up, and then the transfer occurs with a considerable shock which may break down some part of the tube or connected apparatus. This kind of breakdown in its incipient state appears as a distortion of the wave, such as is shown in Steinmetz' "Transient Electric Phenomenon Oscillations," first edition, Fig. 77. This condition can be detected by any sort of oscillograph. When this condition becomes apparent, the tube may be taken out of service and it is customary in some utility properties to impair the vacuum slightly by heating the tube in oil, water, or a small oven, after which the tube can usually be returned to service if the heating has not been overdone.

The question of radio interference has been raised a great many times. As far as we know, a rectifier in good order does not produce any radio interference. However, interference may be caused by the fading condition which produces oscillations, such as shown in Dr. Steinmetz's oscillogram, or by loose contacts. When complaints of radio interference have been made in the past, I believe they have always originated in one or the other of these ways.

Regarding the use of rectifiers on locomotives, I believe that the Westinghouse Company operated a motor car by means of a rectifier over the New Canaan branch of the New Haven railroad. There are naturally difficulties due to vibration, but I do not believe any of them is insurmountable.

As to the voltage limit of mercury arc rectifiers, I believe Mr. Odermatt will corroborate me in saying that his company has in operation a 4000-volt, d-c. railroad system supplied by mercury arc rectifiers. We have experimentally operated at 10,000 volts and there is no apparent theoretical limit, provided the proper temperatures can be maintained.

At present the floor space required by a 600-volt mercury arc rectifier is greater than that required by rotating equipment of the same voltage. At 1500 volts and higher, I believe that the advantage is in favor of the rectifier. It is probable that as rectifiers become more standardized it will be possible to reduce considerably the area which they require.

## MULTIPLEX WINDINGS FOR D-C. MACHINES

(NELSON)

WHITE SULPHUR SPRINGS, W. VA., JUNE 23, 1926

**H. B. Dwight:** Part of the work done by Mr. Nelson in preparing his paper was a detailed study of all editions of Professor Arnold's books as well as a study of the few other books which have referred to multiplex windings on cross-connected d-c. armatures.

While Arnold's recommendations were valuable, they were not, by any means, complete. They consisted mainly of isolated examples. A clear description of the types of windings recommended and the types which should be avoided was not given. Some of the earlier editions of Arnold's books contained arrangements of multiplex windings with armature cross connections which were unworkable or inadvisable, and which were not included in the later editions. Probably they were recognized by Professor Arnold as being inadvisable. Other types of windings, which Mr. Nelson's paper states appear favorable and should be tried out by the industry on practical machines, were not described in Arnold's books.

**J. L. Burnham:** The impression I get from reading this paper is that the entire emphasis is given to the necessity of equalizing at points 360 electrical degrees apart and devising windings that will give interconnecting points exactly 360 degrees apart in the different windings employed. The necessary condition for obtaining windings that can be so equalized involves the use of an odd number of armature slots per pair of poles, thereby giving armature circuits having unequal numbers of conductors in parallel between adjacent sets of brushes of opposite polarity. This point is mentioned in the first paragraph of the third page and passed over casually as possibly of no importance. I believe that this is a very vital objection to these arrangements of multiplex windings. The intimate connection through the brushes of these adjacent circuits having unequal voltages varying in a cyclical manner to produce a continuous exchange of current through the brushes, is harmful to commutation, causing excessive local currents in the brush contact surfaces. I have observed performance of such machines in which the brushes were severely burned in sharply defined zones, causing very rapid wear of brushes and roughening and pitting of the commutator bars.

The arrangements of windings described in this paper are not new. It seems strange that such arrangements of windings have not been used commercially if they have the merits claimed. It is probable that they have been tried and found inferior to the more usual types of simple windings.

The frog-leg winding, to which reference is made at the end of the paper, has been discussed considerably of late. With this arrangement, which requires four layers of windings in the armature slots, the objections mentioned above have been diminished, but it is my feeling that well equalized, simple windings, giving equal circuits between adjacent sets of brushes, are to be preferred. The conductors of such windings may be split to reduce eddy-current losses to any degree equivalent to that obtained in the frog-leg winding. When commutation limits are reached with the simple coil, it is possible to split the individual coils to reduce the reactance voltage, giving the equivalent for which investigators have been striving in devising the multiplex windings without the objectionable features that preclude good performance in the type of windings described in this paper and the objectionable structural features of the four-layer frog-leg winding.

**H. B. Dwight:** The fact that duplex wave windings are successfully used at the present time by designers of machines in the United States and Canada, is one of the strongest reasons for giving a thorough practical try-out to other multiplex windings, which are in some ways very similar to the approved duplex wave windings.

Duplex wave windings consist of two wave windings side by side but cross-connected and built according to the rules described in the paper by Mr. Nelson. Duplex wave windings, as well as simplex wave windings, have a cyclic variation in the number of conductors per path. This does not seem to increase the sparking at the brushes. On the contrary, duplex wave windings have been proved by test to have less sparking than the corresponding simplex windings of the same voltage and amperage rating but with fewer and wider commutator bars. The improvement in commutation that goes with more, and narrower, commutator bars, is due, probably, as stated by Mr. Nelson, to the substantial decrease in amperes per bar and the resulting decrease in the number of amperes that are reversed when a brush leaves a commutator bar. An example of this is commonly observed by designers; namely, when they change a two-circuit, wave-wound, four-pole armature so as to give the same voltage and amperage with a multiple winding. The latter requires twice as many commutator bars and the improvement in commutation is most marked.

One criterion of the commutation characteristics of a winding is the width of the commutator bar, other things being equal. If the narrow bars are obtained by using a duplex wave winding, which is as irregular as any winding described in Mr. Nelson's paper, it has been shown by test that the improvement in commutation is obtained. Nothing has been shown to prove that the improvement will not be obtained by using other multiplex windings, such as the duplex lap winding, in order to have narrow commutator bars. Consequently, such windings should be given a trial.

Some failures with multiplex windings 25 or 30 years ago were due clearly to the lack of cross-connections. The inequality in length of paths was probably not a contributing factor. It is not peculiar that these failures put all kinds of multiplex windings into disrepute, for the action of armature cross-connections was not well known at that time, when they were just beginning to be used with simplex lap windings.

The improvements due to the frog-leg winding are probably that it gives thorough cross-connection and reduces the amperes per commutator bar. It cannot be said that it does away with inequality in length of paths, for it is made up of usual simplex and multiplex windings. Reference 7 specifies that the number of bars divided by the number of pairs of poles should be an integer, but not necessarily an even number. Thus, in Part II of Reference 7 there are  $52\frac{1}{2}$  slots per pole in the 1000-kw. generator, and so the number of coil sides between two adjacent brushes continually varies between 52 and 53.

**A. A. Nims:** The cross-connections in multiple or multiplex armature windings should connect points which are at equal potential for all positions of the armature. To make sure of this a general method of examination is preferable to one based upon a definite position of the armature.

Such a general method is indicated by the fact that the several coil e. m. f.'s. are essentially alternating and therefore may be represented by vectors. Though these coil e. m. f.'s. are likely not to be sinusoidal, they are identical in wave-shape and amplitude, disregarding any minor effect of different positions of the various conductors in a slot. Therefore, some convention may readily be devised<sup>1</sup> whereby the coil e. m. f.'s. may be represented by vectors of equal length, but in proper phase.

To apply this scheme to some of the windings illustrated in the paper, it will be found more convenient to use coil-side voltage vectors rather than coil voltage, as thereby the potentials of the rear noses of the coils, to which cross-connections are attached, become apparent.

Fig. 1A shown herewith then represents vectorially the conductor voltages of the winding of Case I, Fig. 1 of the paper. For clearness, the several vectors are radiated from a nine-sided polygon instead of from a point, since there are nine slots per

1. *Electrical World*, September 28, 1912, p. 660.

pair of poles. The vectors labeled with the slot number followed by the letter *b* represent the voltages of the bottom coil-sides or conductors, assumed to be shown at the left side of each slot in the original paper, while *t* suffixed to the slot number designates the voltages of the top coil sides assumed to be shown at the right of the slots.

In Fig. 2B herewith these coil-side voltage vectors are combined in the order shown in Fig. 1 of the original paper; the outer

Cross-connections are often used between the equipotential points of a simplex lap winding. These points are under alternate poles as in the case of the duplex winding. But it is to be noted that in the winding proposed as typical, duplexing the winding has not increased the number of points having any given potential. There is only one point in each winding having

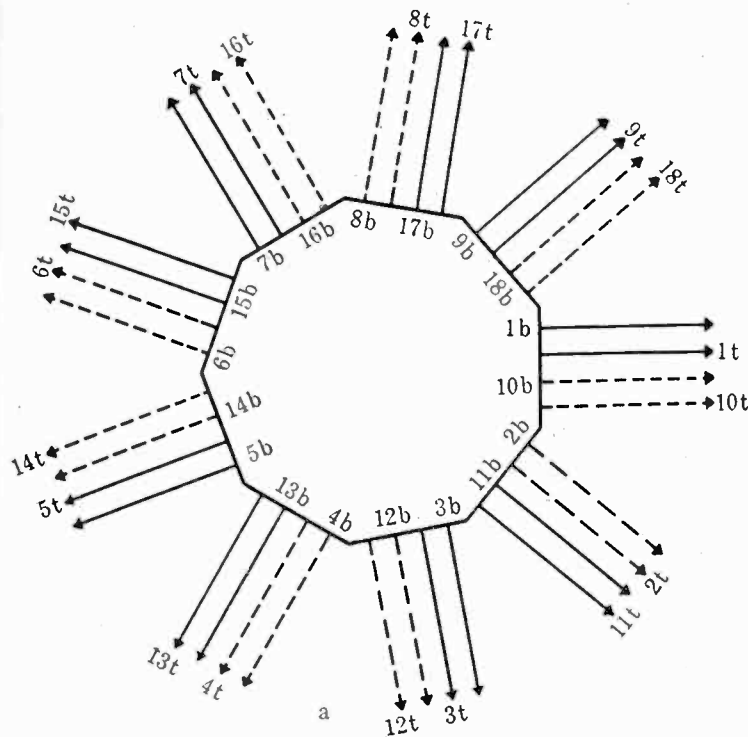

FIG. 1A—COIL-SIDE VOLTAGE VECTORS SEPARATE. DOTTED LINES REFER TO ONE WINDING; SOLID LINES TO OTHER

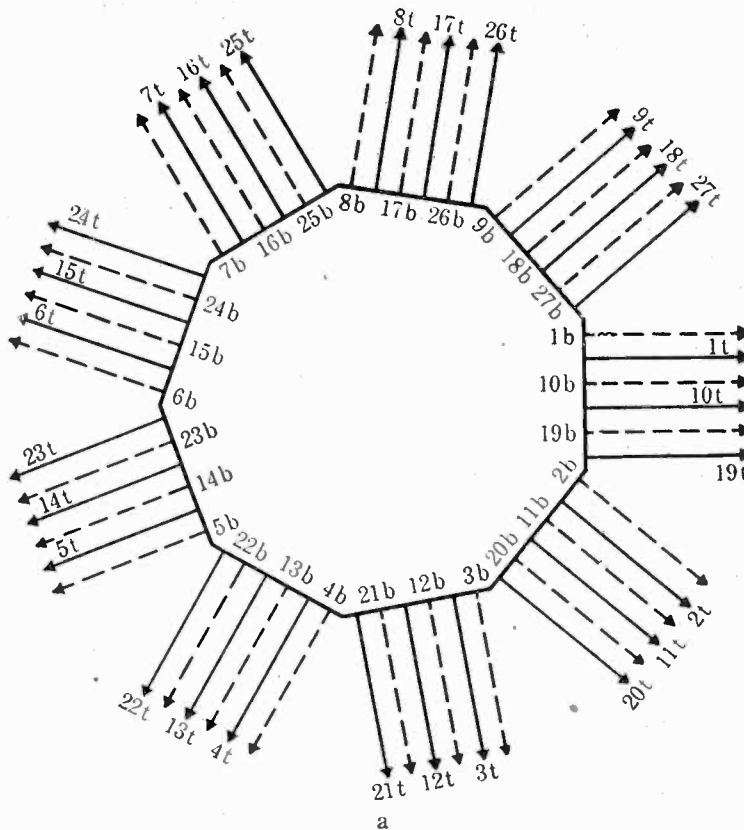

FIG. 2A—COIL-SIDE VOLTAGE VECTORS SEPARATE. DOTTED LINES REFER TO COIL-SIDES AT BOTTOM OF SLOTS

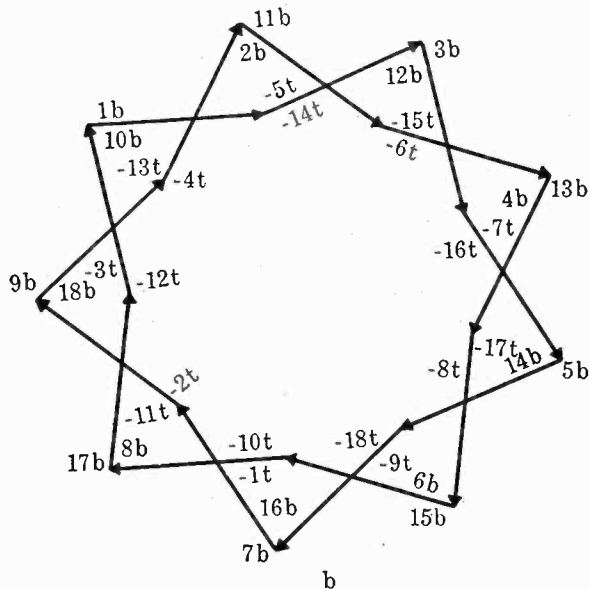

FIG. 1B—COIL-SIDE VOLTAGE VECTORS COMBINED IN THE ORDER SHOWN IN WINDING OF FIG. 1, ORIGINAL PAPER

The vector diagrams for both windings coincide; thus all lines appear solid.

points of the star correspond to commutator bars, and the inner points to the rear noses of the armature coils. It is then evident that for every commutator bar or rear nose in one of the windings there is a commutator bar or rear nose respectively at the same potential in the other winding. This is in agreement with the statement in the paper that equipotential connections may all be located at the rear end of the armature.

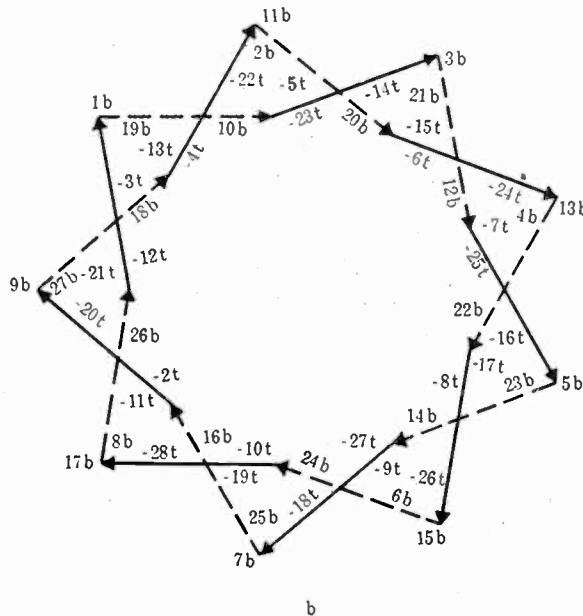

FIG. 2B—COIL-SIDE VOLTAGE VECTORS COMBINED IN THE ORDER SHOWN IN WINDING OF FIG. 2, ORIGINAL PAPER

any given potential, and the cross-connections still unite only two points.

Fig. 2, A and B, are corresponding diagrams for Case II of the original paper, showing that there are three commutator bars or rear noses having a given potential. The cross-connections now tie three points together, as in simplex lap winding for

six poles. Since there are only two windings, these three points must be in one winding, or two in one winding and one in the other. With single re-entrancy as in this case, the distinction between the two windings practically disappears, and since the equipotential points divide the winding into three equal parts, the symmetry appears to be complete.

In the earlier treatises on armature windings, practically the only consideration imposed on multiplex windings, either lap or wave, seemed to be the selection of a proper number of commutator bars, armature coils or coil sides to permit re-entrancy. Later study brought out the importance of symmetry between circuits, and in 1916 there was added to the usual winding formulas the condition that the ratio of poles to armature circuits must be integral<sup>2</sup>.

This condition limits windings to the usual simplex lap and wave windings, the duplex wave winding in four-pole machines, the triplex in six-pole machines, the duplex and quadruplex in eight-pole machines, the duplex, triplex and sextuplex in twelve-pole machines, and so on, always keeping to a degree of multiplicity which is an exact factor of the number of bipolar elements of the machine.

Multipolar machines may be regarded as an aggregation of bipolar elements. If each of these elements be regarded as a unit in arranging the series-parallel grouping, the numerical reason for the condition that the ratio of poles to armature circuits must be integral is apparent from Fig. 3, which shows the possible com-

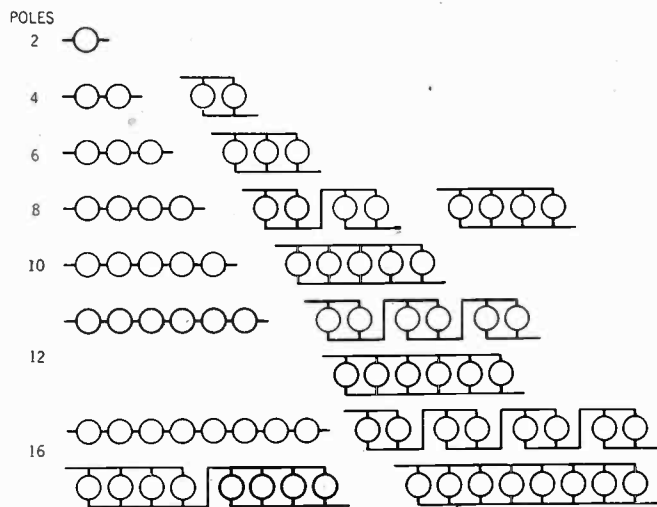

FIG. 3—MULTIPOLAR ARMATURE WINDINGS; COMBINATIONS OF BIPOLAR ELEMENTS

binations of different numbers of units up to 16 poles, except for 14 poles, which has the same combinations as 10 poles.

It is now suggested that some of these parallel combinations may be duplexed or even triplexed, thereby making the number of circuits greater than the number of poles. This, of course, violates the condition of an integral ratio of poles to paths. Such a procedure appears to give symmetrical windings that can be cross-connected conveniently, and records of satisfactory performance are cited. Evidently some modification of the condition just mentioned is indicated.

Experience with four-circuit, six-pole windings has been such as to warrant staying pretty close to the rule that the ratio of poles to paths must be integral when the paths are fewer than the poles. But if more paths than poles are desired, the indications are that the ratio of paths to poles should be integral.

**C. C. Nelson:** At the present time we are not in possession of any complete and conclusive evidence to show that multiplex windings will not work. The knowledge we have on such windings is of a fragmentary nature and consists mostly of what we have gained from the observation of a few isolated cases. In

regard to Mr. Burnham's discussion, I grant that there may be a cyclical change in the number of conductors per path but there has not been any direct work done in connection with this to show that it is a vital objection. We do have the cross-connected duplex wave winding, however, which now operates well but which was not satisfactory before cross-connections were applied, indicating that the cross-connections have made it a useful type of winding, commercially, whereas formerly it was objectionable. As pointed out by Professor Dwight, this winding is as irregular as any of those described, and yet it has given a satisfactory improvement in commutation when the cross-connections were suitably applied.

To my knowledge, the duplex wave winding with cross-connections is the only multiplex winding which has gained a great deal of commercial importance before the introduction of the recent frog-leg winding. For this reason the other types described in the paper should be tried, with a view to possibly increasing the number of types of windings which are to be considered useful. If designers are to be satisfied with only simple windings we cannot hope to progress very far in the armature-winding art.

Professor Nims' general method of pointing out the equipotential points may be preferable to one based upon a definite position of the armature. The conclusions reached by the two schemes are in agreement, indicating that the general method may be of some value.

On the first doubly re-entrant wave windings used without cross-connections there was considerable unbalancing between the two parts of the winding and hence cross-connections joining the two parts of the winding were put on to equalize and balance the circuits. Before cross-connections were used the results secured with the singly re-entrant winding may have caused it to gain some favor due to the fact that the singly re-entrant winding is continuous and not separated like the doubly re-entrant type and hence would probably not unbalance so much as the doubly re-entrant type.

Professor Nims states that the number of equipotential points with the duplex lap winding is not greater than the number of equipotential points secured with the simplex lap winding. This is true but the fact that unbalancing between the separate parts of a multiplex winding was experienced when these parts were not interconnected indicates that multiplex windings should be designed so that the cross-connections join the separate parts and cause as good equalization between the circuits as possible. It is probable that a greater number of cross-connections would be necessary on multiplex windings than on simplex windings.

Professor Nims further states that the ratio of poles to armature circuits must be integral and cites the case of the four-circuit, six-pole winding as being a violation of this rule. I infer from his statement that he believes experience has shown this to be an unfavorable type of winding. The four-circuit, six-pole winding of regular design cannot be cross-connected and hence there are no means whereby the circuits can be kept balanced. This is evident from the following explanation.

To produce points of equipotential it is necessary for one conductor to occupy a position under one pole while another conductor occupies a similar position under another pole of similar polarity, assuming, of course, that the flux in the poles is equal and similarly distributed. As the conductors are in slots, it is necessary that the slots occupy similar positions. If  $n_x$  denotes the number of slots per  $x$  poles, where  $x$  is necessarily an even number if similarly situated slots are to be obtained, then the total number of slots is given by

$$N = n_x \frac{p}{x}, \text{ where } p = \text{the total number of poles.}$$

In the above  $p/x$  must be a whole number so that the total number of slots can be a whole number, remembering of course that  $n_x$  must be a whole number. Also  $p/x$  must be greater than one

2. S. P. Smith. *London Electrician*. June, 1926.

if similarly situated slots are desired, or in other words  $x$  is not to be taken equal to or greater than the number of poles,  $p$ . Then for duplex wave windings the commutator pitch is given by

$$Y = \frac{n_x \frac{p}{x} B_s \pm 2}{\frac{p}{2}} = \frac{\text{number of bars} \pm 2}{\text{pairs of poles}}$$

$$= \frac{2 n_x B_s}{x} \pm \frac{4}{p}, \text{ where } B_s = \text{the bars per slot,}$$

and because  $p = 2P$  where  $P$  = the pairs of poles the above equation becomes

$$Y = 2 \left( \frac{n_x B_s}{x} \pm \frac{1}{P} \right).$$

The commutator pitch,  $Y$ , must be a whole number. The product,  $n_x B_s$ , must be a whole number because each individually must be a whole number. Therefore  $Y$  can be only a whole number when  $x = P$  and as  $x$  must be even,  $P$ , the pairs of poles, must be even. Furthermore the similarly situated slots are  $x$  poles apart and as  $x = P$ , where  $P$  = numerically half the number of poles, the similarly situated slots are necessarily diametrically opposite. The above explanation is general and holds for all duplex wave windings.

If the nature of the four-circuit, six-pole winding was such that cross-connections could be conveniently applied so as to balance the circuits it then probably would be a favorable type of multiplex winding.

#### REPORT OF STANDARDS COMMITTEE

(OSBORNE)

WHITE SULPHUR SPRINGS, W. VA., JUNE 22, 1926

**H. M. Hobart:** It seems to me that we are only just beginning a much larger activity in standardization. Now that the Standards are being brought out in a large number of different pamphlets, it seems to me that we are just at the beginning of an era when hundreds of people can be doing the standardizing work.

Those people should be doing the work who are specialists in particular subjects. It seems to me that the most natural way to bring this about is for each Technical Committee to take on automatically those Standards relating to the subjects coming under the purview of that technical committee. Each committee would probably have two or three Standards that would be its special property, and it would be its special responsibility to keep those up to date.

Some progress has been made in that direction. In the Electrical Machinery Committee we have a subcommittee on Standards, of which Mr. J. C. Parker is Chairman, and during the past year this committee has done a good deal of very vigorous work in connection with the further revision of standards.

There is one Standard entitled Synchronous Alternators which has been adopted for less than a year but since that time very many suggestions have come from very many people. Ambiguities have been pointed out; the attention of the committee has been called to incorrect statements; the need for revision in various limits has been urged. Take, for instance, in the company where I work, there used to be just a few people interested in standardization. Now that we have Standards in separate pamphlets, the designing and commercial departments are interested and they have made at least a dozen suggestions since the revision suggesting that that Standards Committee, when opportunity presents itself, should have certain changes made.

That ought to be going on all over the country in all of the manufacturing companies. They could either come straight to

the Standards Committee with those suggestions or send them to the particular Technical Committee that would deal with the subjects in which they are interested.

I want to suggest that now it isn't necessary for a few of us to be working hard on standards, but it is arranged so nicely and naturally that the subject falls into the hands of hundreds of members of the Institute in respective committees, if the committees see fit to turn their attention in that direction.

#### VIBRATION RECORDER<sup>1</sup>

(MERSHON)

WHITE SULPHUR SPRINGS, W. VA., JUNE 25, 1926

**W. F. Davidson:** Some time ago, I had occasion to consider the possibility of carrying on measurements of about the type described by Mr. Mershon and looked into the possibility of several methods, but we seemed to run into difficulties because the vibrations that we wanted to record were in the order of 200 cycles. Modulating a 500-cycle wave with 200 cycles does not give a very satisfactory wave to work on. On the other hand, using frequencies higher than 500 cycles is likely to lead to some circuit difficulties, especially if an oscillograph is to be used. I have wondered whether it might be possible to use frequencies in the order of several thousand cycles and then, through a valve arrangement similar to a radio detector circuit, unscramble the composite current so that the wave can pass through the oscillograph and reproduce truly the original modulating action. It seems to me that there is a possible development of considerable value in this direction.

**J. W. Legg:** Mr. Mershon's paper proves that the study of vibrations in turbines, and in machinery in general, must be very important or such recording apparatus would not have been developed by several large companies in approximately the same period of time.

Mr. Mershon has perfected one method of recording minute vibrations with the oscillograph. The apparatus described is nicely arranged and has many of the undesirable features of that method eliminated. However, this particular method, of transforming mechanical vibrations into changes in current through an oscillograph vibrator, had so many drawbacks that the writer abandoned this method years ago and chose to push through a design which required no high-frequency alternator for excitation and which gave a true wave record and not a modulated record.

The final design consisted of an inductor-alternator modification which generated a voltage and set up a current in the oscillograph vibrator which was always proportional to the actual vibrations being studied. The calibration was constant over the range of vibrations studied. This apparatus was much more sensitive than that described by Mr. Mershon, and operated over a much greater range. Furthermore it required no 500-cycle motor-generator set nor any other electrical excitation or amplification. A cobalt-steel permanent magnet was the only excitation, and the complete apparatus was no larger than a medium-sized fan motor.

This vibration converter fitted into a cavity in the end of the shaft of a steam turbine or other rotating apparatus. Torsional vibrations of even less than 0.01 deg. and longitudinal vibrations of even less than 0.00001 in., at frequencies even above 2000 cycles, have been recorded. On the same film, within a small fraction of a second, more than a dozen different frequencies have been recorded ranging from 60 cycles to 2200 cycles per second. Such records could never be made by modulating a 500-cycle wave, or even a 5000-cycle wave.

In order to achieve these results, the usual principle of the alternator was modified so that the rotor would tend to seek the position where a slight relative movement between rotor and stator would give the *maximum* voltage generated in the wind-

1. A. I. E. E. JOURNAL, September, 1926, p. 820.

ing, instead of minimum voltage. Also the flux distribution was uniform, each side of this stable position. Both rotor and stator of this special inductor alternator rotated at the same speed as the machine being studied, but one member (usually the outside member) was rigidly fixed to the shaft of the machine being studied, while the other member (usually the inside member, consisting of permanent magnet, pole tips and shaft) was free to rotate at a strictly uniform angular velocity even though the other member vibrated torsionally or longitudinally while it rotated at the same speed.

The special cobalt-steel magnet was magnetized, in place, with 300,000 ampere-turns, and the magnetizing coil (of copper) was allowed to remain on the magnet to have an additional fly-wheel effect.

One end of the permanent magnet had a multiplicity of north poles, each under two teeth of the stator. The stator teeth had a series winding in which was induced the torsional vibration currents. The other end of the permanent magnet had a ring-shaped south pole inside a toroidal winding on the outside member. This winding had radial punchings on each side so that longitudinal vibrations induced currents in this winding proportional to the amplitude of vibration of the machine being studied. The inductive drop in each winding was kept large compared with the ohmic-resistance drop, over the range of frequency to be studied, and hence a calibration *constant* could be used in place of a complicated calibration curve.

The extreme sensitivity, efficiency and compactness of this apparatus made it possible to install several of these vibration converters in different positions in the shafts of the turbines of an ocean liner. Tests were made under actual operating conditions of the vessel during a severe storm, without in any way interfering with its reliability in carrying the usual quota of first-class passengers and freight. The portable oscillograph was located in a first-class cabin at the end of a 250-ft., 12-conductor cable.

In spite of the simplicity of this device, it recorded more minute vibrations in the turbine blades themselves, by reaction through the turbine shaft to the vibration converter, than could be recorded by the apparatus described by Mr. Mershon even though the latter were attached to the blades themselves.

The outstanding advantages of the inductor-alternator vibration-converter scheme over that of the varying inductance, bridge and 500-cycle motor-generator set, may be summarized as follows:

1. Extremely compact (about the size of a fan motor).
2. Fits in a cavity in the end of the shaft of the machine being studied.
3. Requires no wires stretching up into the heart of the apparatus being studied.
4. Will operate on a standard steam turbine running in normal service and yet record the vibration of turbine blades which may be at a dull red temperature in highly super-heated steam.
5. Has actually recorded turbine vibrations of 0.00001 in. at frequencies up to 2200 cycles per second. This is not the limit of possibilities.
6. Has a calibration constant and not the complications of a calibration curve, over the operating range of frequencies.
7. When once determined, this calibration constant did not vary perceptibly even when the converters remained on turbines operating over 12,000 mi. of ocean.
8. Oscillograms are comparatively easy to read even though many different frequencies of vibration are present in a record made in 0.1 sec.
9. Both longitudinal and torsional components of vibration may be recorded simultaneously with but one converter and two oscillograph elements.

**A. V. Mershon:** In regard to the possibility of measuring mechanical vibrations around 200 cycles per sec., I might speak

of Fig. 7 as having a natural mechanical frequency of 120 cycles per sec. What is called approximately 500 cycles in my article is actually around 700 cycles for Fig. 7. We did not try in any case to hold the 500-cycle generator at 500 cycles and I feel sure that the same circuit can be used to measure a 200-cycle mechanical frequency with very good results, and in that case, in order to obtain proper shading, it would be necessary to boost up the frequency of the 500-cycle generator to around 1000 or 2000 cycles. This frequency I do not believe would be harmful to the working of the oscillograph. In this case, as the frequency is boosted up the losses which occur around the coil would decrease the sensitivity, but not seriously.

The main difference between the vibration converter described by Mr. Legg and the vibration recorder presented in the present paper lies in the results obtained on the oscillograms. The deflections obtained on the oscillograms using the vibration converter are a function of the frequency. The oscillogram deflections obtained by the vibration recorder are true representations of the magnitude of the mechanical vibrations regardless of frequency.

The vibration converter is designed and built to do one class of investigational work and is more analytical than quantitative. The vibration recorder is designed to investigate a different kind of mechanical motion and the results obtained are more quantitative. Each circuit has its own class of investigational work to perform and should be able to perform one class of work better than the other.

The vibration converter cannot be applied at the point where the vibration occurs on turbine blades because a piece of apparatus as heavy as a fan motor is too large. The vibration converter evidently will not work well without the magnetizing coil attached to add weight so that the rotor will have a fly-wheel effect. A heavy vibration converter the size of a fan motor could not be mounted on the turbine blades on account of the mechanical strength required to hold it in place, furthermore if such a scheme of mounting could be used it would damp out the vibration and destroy its natural period. There are many cases in which the weight of a fan motor would change the natural period of a vibrating mass and render the application of a vibration converter impracticable.

The vibration recorder requires a small test coil only 1 in. in diameter by  $\frac{3}{4}$  in. thick which is not attached to the vibrating part. This small coil can be mounted at the periphery of a rotating wheel adjacent to the blade that is vibrating and measure the vibrations without changing the natural period, and it will not damp the vibrating blade. A calibration curve is determined very easily, simply by varying the air-gap a fixed amount and observing the oscillographic deflections.

The vibration recorder has an additional advantage of being able to measure pressure variations. Pressure variations as slow as one per minute can be measured as easily as 200 per sec.

## ENGLAND HAS ALL-ELECTRIC VILLAGE

An all-electric village has grown up in Eltham, England. When the housing scheme of the Woolwich Borough Council was first proposed it was the intention to provide electricity for lighting only and gas for cooking. The plan was apparently dealt a heavy blow when it was found that gas would not be available in that locality. Subsequent investigation however, indicated that the advantages of complete electric service could be had without sacrificing economy so that today a thriving community of 600 houses uses electricity entirely for lighting, cooking, heating and the performance of household chores.



# JOURNAL OF THE American Institute of Electrical Engineers

PUBLISHED MONTHLY BY THE A. I. E. E.  
33 West 39th Street, New York  
Under the Direction of the Publication Committee

C. C. CHESNEY, *President*  
GEORGE A. HAMILTON, *National Treasurer*      F. L. HUTCHINSON, *National Secretary*

#### PUBLICATION COMMITTEE

L. F. MOREHOUSE, *Chairman*  
F. L. HUTCHINSON, *Member*      E. B. MEYER, *Member*  
DONALD McNICOL, *Member*      I. E. MOULTROP, *Member*

GEORGE R. METCALFE, *Editor*

Subscription. \$10.00 per year to United States, Mexico, Cuba, Porto Rico, Hawaii and the Phillipines; \$10.50 to Canada and \$11.00 to all other countries. Single copies \$1.00. Volumes begin with the January issue.

Changes of advertising copy should reach this office by the 15th of the month for the issue of the following month.

*The Institute is not responsible for the statements and opinions given in the papers and discussions published herein. These are the views of individuals to whom they are credited and are not binding on the membership as a whole.*

## New York Regional Meeting

NOVEMBER 11 AND 12, 1926

A program of very timely interest will be presented at the Regional Meeting to be held in New York City, November 11 and 12, under the direction of District No. 3 of the American Institute of Electrical Engineers. There will be three instructive technical sessions and other attractive features. The Engineering Societies Building, 33 West 39th Street, will be headquarters for the meeting.

#### TECHNICAL PAPERS

The technical papers will include the general subjects of a-c. distribution networks, illumination and communication.

*Demonstration of the Induction Lamp.* A striking demonstration of the electrodeless induction lamp will be made on Friday morning, November 12, in connection with the paper on this subject by T. E. Foulke.

#### LECTURE THURSDAY EVENING

On Thursday evening a lecture of great general interest will be given by a well-known and able speaker.

#### BUFFET LUNCHEONS

An excellent opportunity for pleasant informal association of those at the meeting is offered by the buffet luncheons which will be served at a reasonable charge after the morning session on each day. These luncheons will be served on the fifth floor of the Engineering Societies Building so that it will be convenient for all to attend.

#### INSPECTION TRIPS

A number of interesting trips of inspection are planned among which are those to the Lighting Institute of the Edison Lamp

Works, picture transmission and machine switching at a plant of the American Telephone and Telegraph Company, shops and signal system of the Interborough Rapid Transit Company, the Electrical Testing Laboratories, the New York-New Jersey Vehicular Tunnel and the Hudson Avenue Plant of the Brooklyn Edison Company. Further details of these trips may be obtained at the meeting.

#### REGISTER IN ADVANCE

All who will attend this meeting are urged to notify Institute Headquarters as soon as possible. Also please indicate whether or not you will take lunch with the other members in the Engineering Societies Building. All should visit the registration desk at the meeting as early as possible to receive badges, to register for trips, etc. This desk will open at 9:00 o'clock each morning and the sessions will begin promptly at 10:00 a. m.

The committee in charge of the New York Regional Meeting is as follows: G. L. Knight, Vice-President, District No. 3; H. A. Kidder, General Chairman; O. B. Blackwell, H. V. Bozell, W. A. Del Mar, H. E. Farrer, E. B. Meyer and G. H. Stickney.

#### PROGRAM

##### THURSDAY MORNING

- 9:00 a. m. Registration.  
10:00 a. m. Distribution Session (Auditorium).  
*Recent Progress in Distribution Practise*, J. F. Fairman and R. C. Rifenburg, Brooklyn Edison Company.  
*Design and Application of A-C. Network Units*, G. G. Grissinger, Westinghouse Electric & Mfg. Co.  
*Evolution of the Automatic Network Relay*, J. S. Parsons, Westinghouse Electric & Mfg. Co.  
*Operating Requirements of the Automatic Network Relay*, W. R. Bullard, Electric Bond and Share Company.  
*A-C. Network Relay Characteristics*, D. K. Blake, General Electric Company.

##### THURSDAY NOON

Buffet Luncheon (Fifth Floor)

##### THURSDAY AFTERNOON

2:00 p. m. Inspection Trips.

##### THURSDAY EVENING

8:15 p. m. Lecture (Auditorium).

##### FRIDAY MORNING

- 10:00 A. M. Illumination Session (Auditorium).  
(Joint session with N. Y. Section of Illuminating Engineering Society).  
*Remote Control of Multiple Street-Lighting Systems*, W. S. Dempsey, New York Edison Company.  
*Lighting of Railway Classification Yards*, G. T. Johnson, New York, New Haven and Hartford R. R.  
*Illumination from Atoms.*  
(a) *Theoretical Considerations*, Saul Dushman, General Electric Company.  
(b) *The Induction Lamp, A New Source of Visible and Ultra-Violet Radiation*, T. E. Foulke, Cooper-Hewitt Electric Company.  
(Interesting demonstrations of the induction lamp will be made.)

##### FRIDAY NOON

Buffet Luncheon (Fifth Floor.)

##### FRIDAY AFTERNOON

- 2:00 p. m. Communication Session (Auditorium).  
*Frequency Measurements with the Cathode-Ray Oscillograph*, F. J. Rasmussen, Bell Telephone Laboratories, Inc.  
*A Shielded Bridge for Inductive-Impedance Measurements*, W. J. Shackleton, Bell Telephone Laboratories, Inc.  
*Radio Broadcast Coverage of City Areas*, Lloyd Espenschied, American Telephone and Telegraph Company.

### Award of John Fritz Medal for 1927

The John Fritz Gold Medal for 1927 was awarded Oct. 13, 1926, to Elmer Ambrose Sperry of New York, for the development of the gyro-compass and the application of the gyroscope to the stabilization of ships and aeroplanes.

This annual award was made unanimously by the board of sixteen from the four founder American societies of Civil, Mining & Metallurgical, Mechanical and Electrical engineers, representative of an aggregate membership of 56,000. It is given for notable scientific or industrial achievement, without restriction as to sex or nationality and is a memorial to John Fritz of Bethlehem, Pa., the great leader in the American iron and steel industry.

This is the 23rd award; the first was to Mr. Fritz himself in 1902, in celebration of his eightieth birthday. A few of the subsequent medalists have been Lord Kelvin, George Westinghouse, Alexander Graham Bell, Charles T. Porter, Alfred Noble, James Douglas and Henry M. Howe.

The members of the Board of Award for 1927 were as follows: American Society of Civil Engineers: John R. Freeman, Charles F. Loweth, C. E. Grunsky, Robert Ridgway, American Institute of Mining and Metallurgical Engineers: Charles F. Rand, Arthur S. Dwight, William Kelly, J. V. W. Reynders. The American Society of Mechanical Engineers: Fred J. Miller, Henry B. Sargent, Fred R. Low, W. F. Durand, and the American Institute of Electrical Engineers: Frank B. Jewett, Gano Dunn, Farley Osgood, M. I. Pupin, all past presidents of the Institute.

The official presentation of the medal will take place on the evening of Tuesday, December 7, at 8:30 o'clock in the Engineering Auditorium, 29 West 39th Street, New York as a function of the annual meeting of the American Society of Mechanical Engineers. At this session President William L. Abbott, of the Society, will deliver the annual address and Mr. Charles M. Schwab, President-elect, will be inaugurated. The medal will be presented by Frank B. Jewett, Ph. D., Chairman of the board which made the award. Members of the four Founder Societies and ladies are invited to attend the presentation of the medal and the other ceremonies of the evening.

Elmer Ambrose Sperry, engineer and inventor, was born in Cortland, New York, October 12, 1860. In 1879, when not yet twenty, he had become the inventor of a successful device, perfecting one of the first electric arc lights in America, and secured its practical adoption. The following year he founded the Sperry Electric Company, of Chicago, for the manufacture of arc lamps, dynamos, motors and other electric appliances. In 1883, he erected on Lake Michigan the highest electrical beacon in the world, (about 350 ft.) equipped with 40,000 c-p. arc lights. In 1888 he won the distinction of having been the first to produce electrical mining machinery.

Shortly after his first successes in mining machinery, Mr. Sperry designed electrical street railway cars. He then founded the Sperry Electric Railway Company, of Cleveland, Ohio, to manufacture his cars, and continued with success to 1884, when the patents were purchased by the General Electric Company.

While the earliest pioneers of the American gasoline automobile were still conducting experiments, Mr. Sperry designed a successful electric carriage, which he manufactured for several years. He also drove the first American built automobile in Paris in 1896 and 1897, where afterward, a large number was sold.

The field of electrochemistry is also indebted to Mr. Sperry. An important commercial process for producing caustic soda and bleach is due to his activity. The National Battery Company was organized and operates under Sperry patents. Among other of his achievements may be mentioned an electrolytic process whereby white lead of superior quality is produced at low cost from waste of copper mines.

About thirty years ago Mr. Sperry turned his attention to the

gyroscopes and soon concluded that this "scientific curiosity" could be put to work. His investigations led him to the belief that it could be used as a true compass, and it was he who made the first successful gyro-compass.

For many years it was obvious that something should be developed for stabilizing ships. Fruitless attempts were made by naval architects and engineers throughout the world, but no practical means were brought forth until as a result of tedious and expensive work Mr. Sperry's gyroscopic ship's stabilizer was evolved. It has been recognized by the foremost naval architects as an innovation revolutionizing ships' hull design, and by insuring a steady gun platform it increased the efficiency of naval gunnery many times.

Mr. Sperry has done much also to increase the efficiency of arc lights. Some eight years ago he made the first public announcement of his high intensity arc searchlight. Notwithstanding the fact that the old type of carbon arc had been accepted as the ultimate. The art was at a standstill. The old type of searchlight, however, was of practically no value for military and naval use with the increased range of gunnery and the advent of the airplane, in one step Mr. Sperry produced a practical light with a brightness 500 per cent greater than the brightest previous artificial light, an advance which may be ranked with Sir Humphrey Davy's discovery in 1807 of the electric arc itself. By using a positive carbon with a mineralized core, or a vapor-producing material, an incandescent gas is generated to give brilliancy as high as 900 c. p. per sq. mm. with a temperature of nearly 6000 deg. cent. Development of this form of arc, together with the electrical and mechanical means for operating it and caring for tremendously high temperatures, produced a searchlight which is standard for the principal armies and navies and used successfully for aircraft and coast line beacons, giving a white finger of light that has been seen upwards of a hundred miles.

This light has revolutionized also the production of motion pictures, and the same light is utilized for projecting pictures on the screens in theatres.

About thirty years ago Mr. Sperry produced his first compound, internal combustion engine, since then adding substantial contributions to its development from time to time. His greatest achievement is his compound diesel engine, lately put into a practical power plant usage with the lowest grade fuel oil but giving high efficiency.

Soon after Wright and Curtiss built their first airplanes, Mr. Sperry became interested in aerodynamics and has brought forth several inventions for the aircraft industry. In 1914 he was awarded first prize by the Aero Club of France for his airplane stabilizer, or automatic pilot, which is also the basis for the aerial torpedo. With its aid, aerial torpedoes have been made to function reliably for distances of over 200 mi. The gyro-compass has also been adapted to aircraft. Mr. Sperry also brought out the drift indicator, (for which in 1918 he was awarded the Collier trophy), and the turn indicator which makes it possible to fly in fogs and other adverse weather. He is an active member of the Naval Consulting Board and chairman of two important committees thereof. The value of his contributions to American and foreign governments during the late war is inestimable.

Mr. Sperry is a charter member of the American Institute of Electrical Engineers and the American Electro-chemical Society, a member of the American Society of Mechanical Engineers, American Chemical Society, Society of Naval Architects and Marine Engineers, Society of Automotive Engineers, and many others. He has been the recipient of the following Awards: Honorable Mention, World Columbia Exposition, 1894, for Mining Machines; First Prize, Aero Club of France, 1914; Franklin Medal, Philadelphia, 1914; Grand Prize for Gyro-Compass and Gyroscopes, San Francisco Exposition, 1915; American Museum of Safety Medal. He was deco-

rated by Czar Nicholas III, of Russia, for navigational equipment, and in 1922 received the Order of the Rising Sun from the Emperor of Japan.

### A. I. E. E. Directors' Meeting

The regular meeting of the Board of Directors of the American Institute of Electrical Engineers was held at Institute headquarters, New York, on Friday, October 15, 1926.

There were present: President C. C. Chesney, Pittsfield, Mass.; Past President Farley Osgood, New York; Vice-Presidents W. P. Dobson, Toronto, H. M. Hobart, Schenectady, N. Y., G. L. Knight, Brooklyn, N. Y.; Managers H. P. Charlesworth, New York, E. B. Merriam, Schenectady, H. A. Kidder, New York, I. E. Moulthrop, Boston, H. C. Don Carlos, Toronto, F. J. Chesterman, Pittsburgh; National Secretary F. L. Hutchinson, New York. Present by invitation: Dr. William McClellan, Dr. Clayton H. Sharp.

The minutes of the Directors' meeting of August 10, 1926, were approved as previously circulated.

Action of the Executive Committee, under date of September 24, 1926, in approving applications for Student enrolment, admission to membership, and transfer to higher grades of membership, was ratified.

Reports were presented of meetings of the Board of Examiners, held September 20 and October 11, 1926, and upon the recommendation of the Board of Examiners, the following actions were taken upon pending applications: 166 Students were ordered enrolled; 36 applicants were elected to the grade of Associate; 3 applicants were elected to the grade of Member; 43 applicants were transferred to the grade of Member.

Upon request, the Meetings and Papers Committee was given authority to accept for presentation at the New York Regional Meeting, November 11-12, papers from four non-members.

Upon application from the various Districts concerned, regional meetings were authorized as follows:

Kansas City, Mo., March 17-18, 1927

(South West District)

Bethlehem, Pa., April 14-15, 1927

(Middle Eastern District)

Pittsfield, Mass., May 25-27, 1927

(North Eastern District)

Approval by the Finance Committee for payment of monthly bills amounting to \$33,119.73 was ratified.

A budget for the appropriation year beginning October 1, 1926, was adopted as prepared by the Finance Committee.

Upon the recommendation of the National Secretary, an increase of approximately twenty per cent in the advertising rates of the Institute Journal was authorized.

A selection of five members of the Board to serve on the National Nominating Committee, as required by the by-laws, was made as follows: H. P. Charlesworth, G. L. Knight, E. B. Merriam, I. E. Moulthrop, E. C. Stone.

Upon application, the Board authorized the organization of a Section of the Institute at Louisville, Kentucky, and Student Branches at the Municipal University of Akron, Akron, Ohio; the College of Engineering of the Newark Technical School, Newark, N. J., and the University of Santa Clara, Santa Clara, Calif.

A revision of Sec. 83 of the By-laws was adopted, changing the date upon which the president of the Institute becomes a member of the John Fritz Medal Board of Award from the third Friday in January to the third Friday in October, to conform with the change in date of the annual meeting of the Board.

Upon the recommendation of the Marine Committee and the Standards Committee, the Marine Rules of the Institute were adopted as Section 45 of the Institute Standards, with the title "Recommended Practice for Electrical Installations on Shipboard."

Consideration was given to the appointment of a Local

Honorary Secretary in Australia to fill a vacancy. Mr. H. W. Flashman of Sydney was appointed.

The following representatives were appointed: Mr. Calvert Townley, on the Board of Trustees of the United Engineering Society, to succeed Mr. H. H. Barnes, Jr.; Mr. L. B. Stillwell, on Engineering Foundation Board (reappointment); Mr. H. M. Hobart, on American Engineering Standards Committee (reappointment); Dr. J. Franklin Meyer, Mr. John C. Parker, and Mr. L. T. Robinson, alternates on American Engineering Standards Committee.

The following were appointed as a special committee to make recommendations upon the design and conditions of Award of the Lamme Gold Medal, for the annual award of which the Institute received a bequest from Benjamin G. Lamme: Professor Charles F. Scott (Chairman), Messrs. H. H. Barnes, Jr., E. B. Meyer, L. W. W. Morrow, and N. W. Storer.

Other matters of importance were discussed, reference to which may be found in this and future issues of the JOURNAL.

### Future Section Meetings

#### Cleveland

Inspection Trip to Avon Power Plant of the Cleveland Electric Illuminating Company. Joint meeting with Association of Iron and Steel Electrical Engineers. November 18.

*The Transmission of Pictures over Telephone Lines*, by R. D. Parker, American Tel. & Tel. Co. December 16.

#### Columbus

*Standards*, by C. E. Skinner, Westinghouse Electric & Mfg. Co. December 3.

#### Pittsfield

Mr. C. C. Chesney, National President, A. I. E. E., will give an account of his trip to the Pacific Coast. November 2.

*Modern Reproduction of Sound*, by L. T. Robinson, General Electric Co. November 16.

*Why Intelligent People Do not Vote*, by W. J. Millard, Field Secretary of the National Municipal League. December 16.

#### St. Louis

*The Public Utility Engineer's Privileges and Responsibilities*, by B. H. Peck, Illinois Power & Light Corp. November 17.

*Radio-Photography*, by Dr. E. F. W. Alexanderson, General Electric Co. December 15.

#### Seattle

*The Geology of the Puget Sound Region*, by Dean Henry Landes, University of Washington. November 17.

*Liblo Development of the Skagit River Project*, by J. D. Ross, Supt. of the Lt. and Pr. Dept., City of Seattle. December 15.

### New York Section Meeting

The first meeting of the New York Section of the Institute for the year 1926-27 was held on Friday evening, October 8, 1926, at the Engineering Societies Building, New York. Before an audience of over 700 Dr. Irving Langmuir of the Research Laboratory, General Electric Company, delivered an exceedingly interesting talk on "The Flames of Atomic Hydrogen."

Dr. Langmuir's work, originating some fifteen years ago in a theoretical investigation of the heat loss of tungsten filaments of incandescent lamps in a hydrogen atmosphere, has now been applied in a different field—the development of a new method of welding. In brief, a stream of hydrogen is passed between two electrodes, the heat of the arc breaking up the hydrogen molecules into atoms. These combine again a short distance in front of the arc with the liberation of an enormous amount of heat. Much higher temperatures are obtained than with usual welding methods, and welding can be accomplished without oxidation and without fluxes. The speaker illustrated his talk with a very interesting collection of slides and a motion picture of the actual application of atomic hydrogen in welding. The

great interest manifested in the meeting was evidenced by the fact that when Chairman E. B. Meyer opened the meeting to questions and discussion, the questions occupied a period of over one hour.

### 2,000,000-Volt, High-Tension, Laboratory at Stanford University

The highest voltage yet obtained by man was demonstrated in the new laboratory of Stanford University, California, on Friday, September 17, before an assemblage of eminent men of science including Cummings C. Chesney, president of the Institute of Electrical Engineers, and the press, a ribbon of living flame, more than 20 ft. long, leaped between two points high into the air above six giant transformers, marking the highest voltage yet attained at commercial frequency.—2,100,000 volts.

With this new equipment experiments will be carried on under the direction of Professor Harris J. Ryan, of the electrical engineering department of the University and past president of the A. I. E. E., who with his assistants, will endeavor to determine the necessary facts for engineers toward design of equipment to handle the high voltages which will be needed in the near future when electrical power in the far west (utilizing 60 per cent of the whole nation's water power) will have to be carried over long distances from its sources in the waters of the mountains to cities and valleys hundreds of miles away. The laboratory will also be used by scientists and engineers of the electrical industry, with whom Professor Ryan has cooperated for a number of years in working out practical problems.

The laboratory has been erected by Stanford University and the nation with the aid of a number of the large electrical concerns of the Pacific Coast, as a monument in recognition of Professor Ryan's contributions to electrical science and industry and to insure his continuing his research work which has outgrown the capacity of the high-voltage laboratory building erected by the University in 1913.

The new laboratory is an immense structure, the main building being 173 ft. long, 60 ft. wide, and 65 ft. high, with an interior height of 50 ft. in the clear to the roof trusses, with no supporting columns.

When expedient the building can be made light-proof, not a ray penetrating to its vast interior. For other uses, practically one whole side can be rolled away, utilizing three doors that are the largest ever constructed, each 47 ft. high and 40 ft. wide. A single man can move them easily, opening a space 120 ft. long.

The studies and tests which Professor Ryan and his assistants will carry on in the new laboratory are vitally essential to the growth and continued development of the Far West.

### Chas. M. Schwab, President Elect of the American Society of Mechanical Engineers

The American Society of Mechanical Engineers announces Charles M. Schwab as its president elect of the Society for the coming year. Mr. Schwab is already well known to the 18,000 members of this national engineering organization, having been elected an Honorary Member in 1918 in recognition of his great part in the upbuilding of the steel industry and his ability as an industrialist, a financier and an organizer of men.

Mr. Schwab will formally assume his new office as A. S. M. E. President at the Annual Meeting of the Society in New York early in December, at which time he will succeed William L. Abbott of Chicago.

### Use of Safety Codes

A series of statements have been issued recently by the Bureau of Labor Statistics in the Department of Labor giving a record of industrial accidents and accident prevention. They also summarize in outline form, the use of national safety codes

by the various States. Although numerous codes have been issued in various publications, it was shown that they have not been widely adopted. From several States, however, reports were received indicating that similar codes were being enforced or that the standardized codes were being studied from the standpoint of enacting suitable legislation.

The Bureau's statement gives complete references to the safety codes as approved by the American Engineering Standards Committee and the results of a questionnaire which was sent to all States.

### University of Pennsylvania Placement Bureau

Following action by its Board of Directors and with the appointment of Professor Clarence Edward Clewell as its first director, the University of Pennsylvania has established a Placement Service, according to announcement made by Doctor Josiah H. Penniman, President and Provost.

The creation of this service marks the first important step taken by the trustees toward fulfillment of the plans for graduate educational service designed to supply cultural and technical information to the University's graduates and to render them such further service as may be possible. It is the expressed opinion of Doctor Penniman that the bureau will be able to perform an important economic service to alumni, the industries, and, incidentally, the various communities throughout the country.

### Tests of Welded Rail Joints

The American Electric Railway Association and the American Bureau of Welding (The Bureau is the welding research department of the American Welding Society and the Division of Engineering, National Research Council), united in an authoritative investigation of various types of welded rail joints in commercial use, through a representative Committee which was organized late in 1921. This Committee now has a membership of about sixty individuals including Way Engineers of several of the larger street railway companies, representatives of manufacturers of welded joints and welding equipment, welding experts, scientists and testing experts.

Dr. G. K. Burgess head of the Division of Metallurgy, Bureau of Standards at the time this investigation was organized and now Director of the Bureau of Standards, was elected Chairman. Mr. E. M. T. Ryder, Way Engineer of the Third Avenue Railway System was selected Vice-Chairman and Mr. W. Spraragen, 29 W. 39th St., New York City, Secretary of the Division of Engineering and the American Bureau of Welding, was appointed Executive Secretary. Inasmuch as it was impossible to have this large committee meet more than once or twice a year, the administration of the affairs of the committee were left in the hands of a small representative Executive Committee.

Three progress reports have been made, Report No. 2 containing 72 pages and Report No. 3, 136 pages of proved data.

The committee is now studying and testing the effect of varying the form and dimensions of the side bars and of variations in the method of welding. This work will result, it is believed, in a material increase in the life of the joints under service conditions.

## ENGINEERING FOUNDATION

### DETROIT HONORS ENGINEERING FOUNDATION

For the purpose of promoting the cause of Engineering Foundation and its service as a joint engineering research organization, the Associated Technical Societies of Detroit gave a dinner at Hotel Statler, in that city, on October 4, with Mr. Ambrose

Swasey, Founder of Engineering Foundation, as guest of honor. Captain Harrington Place, Chairman of the Associated Technical Societies, presided. Mr. Rose, Technical Adviser to Mayor John W. Smith of Detroit, spoke on behalf of the Mayor, who was unable to be present and Vice-Chairman, Elmer A. Sperry, of Engineering Foundation, widely known as an inventor and, for his work on gyroscopic compasses and stabilizers for ships and aircraft, medallist of the John Fritz Award for 1927, was the principal speaker. He told of the history and general benefits of applied science research and described some notable research achievements. Alfred D. Flinn, Director of the Foundation, told of its purposes and policies, also describing a number of projects which the Foundation was aiding and the work which it had accomplished in the years gone by. Mr. Swasey closed the speaking of the evening with an expression of appreciation for the value of the service being done by science and engineering for the benefit of mankind, and a plea for the spiritual values of life along with the material advancement.

### A New Offer Announced for Muscle Shoals

A group of New York engineers and financiers are prepared to make a new offer for Muscle Shoals, involving stock from \$20,000,000 to \$80,000,000 depending upon whether or not the third dam is constructed. The plan for development and the offer will be presented to Congress when it convenes in December. The proposal, which will come from the Farmers Federated Fertilizer Company, is understood to involve a 50 year lease of the property with guarantee for using the power generated in making nitrate for fertilizer.

## AMERICAN ENGINEERING COUNCIL

### ADMINISTRATIVE BOARD MEETS AT CORNELL

Upon invitation from President Dexter S. Kimball, the Administrative Board of American Engineering Council has decided to hold its next meeting at Cornell University, Ithaca, N. Y., November 11 and 12. The regular meeting of the Executive Committee will precede the meeting of the Board.

The program of work for this meeting has not been completed, but will be issued about the middle of October.

### PROPOSAL FOR NEW PATENT OFFICE BUILDING

It now seems certain that the Department of Commerce will get a new building. It is the wish of Secretary Hoover that all offices of this department shall be located in the same building and although the Public Buildings Commission and the National Commission of Fine Arts are still giving consideration to the nature of the proposed new building and its location, it is understood that it will probably be located on Pennsylvania Avenue at 14th Street.

American Engineering Council, the National Association of Manufacturers, and the American Patent Attorneys Association are using their influence for a new Patent Office Building out of the \$50,000,000 appropriation now available for the District of Columbia, and to have it either in or near the new Commerce Department Building.

Those interested in the Patent Office can help in this effort by writing to the Buildings Commission or the National Commission of Fine Arts, both of which are located in the District of Columbia, urging that the Patent Office be put in a new building in or near the proposed new Department of Commerce Building. Meetings will be held early in November in an effort to reach final decision on this question so that early action is required.

Work in the improvement of Patent Office equipment has been started with the installation of four miles of steel shelves for the filing of copies of patents. This is the beginning of the replacement of approximately 20 miles of wooden shelves on which copies have formerly been filed.

### PARTICIPATION IN STREET AND HIGHWAY SAFETY CONFERENCE

Committees of the National Conference on Street and Highway Safety, of which the Council is a member, met with Secretary Hoover on October 15th for the purpose of reviewing their work to date.

It now appears that American Engineering Council will be supplied with finances for extending the work of the Street and Highway Traffic Facilities Committee so that a complete survey may be made to develop the best form of lighting system, traffic control, and other engineering phases of the problem. The Committee on Elimination and Protection of Grade Crossings reported that a large number of crossings had been eliminated at great expense.

Mr. Hoover emphasized to the conference the importance of this work and urged that all branches of it be pushed forward to the fullest extent. He pointed out that while some excellent results had been obtained there were still many places in which there was no apparent improvement.

Those attending the Conference as representatives of American Engineering Council were: Dean A. N. Johnson, W. B. Powell, H. E. Riggs, and L. W. Wallace.

### History of Engineering

The Engineering Societies library is the most complete library on engineering subjects in the world. Among other features it has an interesting collection of books on the history of engineering which it is anxious to better, for it finds considerable demand for such books and few subjects are more alluring to the technical man. The library has, however, but a small fund with which to purchase books, and this fund must necessarily be used in the purchase of such new books appear as from time to time on engineering subjects. Quite a number of engineers have interested themselves during the course of their professional career in collecting books upon the history of engineering. These books are usually of little interest to the family of the engineer and although they may have cost the owner a relatively large sum of money, they can seldom be disposed of with much advantage to the estate. This condition has suggested to the Library Board a possible method of building up the historical side of engineering within the library. It is requested that those engineers who have collections of books on the history of engineering or related subjects communicate with Mr. Sydney N. Ball, Chairman of the Library Board, or Dr. Harrison W. Craver, Director, Engineering Societies Library, and indicate their willingness to bequeath to the library their books upon the history of any branch of engineering. The library proposes to keep a card catalogue of such bequests. If the owners of books on the history of engineering feel disposed to cooperate with the Library Board in this way the library's historical collection can be strengthened gradually but greatly.

### PERSONAL MENTION

LEONARD S. HORNER has been appointed president of the Niles-Bement-Pond Company, having resigned the vice-presidency of the Acme Wire Company of New Haven to accept this new position, with headquarters in New York.

THOMAS J. MAITLAND has resigned his position as instructor in Electrical Engineering at the University of New Hampshire and has accepted a position with the Long Lines Dept. of the American Telegraph and Telephone Company, New York City.

IRVING W. PHILLIPS, formerly with Perry & Whipple, Providence, R. I., has formed new connections with Gray's Electrical Engineering and Construction Company,—also of that city—engaged in the construction of power and light installations and specializing in power plant and large industrial work.

JAMES E. THOMPSON, until recently in the office of the Metropolitan Division Traffic Superintendent, New York, is now on leave of absence and is acting as Instructor in Mathematics at Pratt Institute. Mr. Thompson is pursuing his graduate studies in Physics and Electricity at Columbia College as well.

ELMER L. GOLDSMITH, who, for some time has been associated with Lockwood & Lockwood, Patent and Trade-Mark Attorneys, Indianapolis, Ind., has just been elected a member of the firm, with the Company name of Lockwood, Lockwood, Goldsmith & Galt.

NOEL F. HARRISON, formerly of Winnipeg, Canada, has opened an office of his own in Bri Cualann, County Wicklow, Ireland, where he will carry on general engineering practise in design, supervision, investigation and reports. Mr. Harrison was for some years assistant to the late R. J. Parke, consulting engineer of Toronto, prior to going to Western Canada where he served with the Canadian Northern Railway Company, the Manitoba Power Commission and the Manitoba Power Company.

DR. HERBERT GROVE DORSEY, research engineer in the Submarine Signal Corp., Boston, Mass., has been appointed Senior Electrical Engineer in the U. S. Coast and Geodetic Survey. In the Hydrographic and Topographic Division of the Coastal Survey, he will continue his research work in acoustic methods of depth measurement and radio acoustic methods of position finding, to facilitate and lend accuracy to the making of charts. This work was begun on the *S. S. Lydonia* at Wilmington, N. C.,—later transferred to the Pacific Coast.

GUSTAV F. WITTIG, formerly Assistant Professor of Electrical Engineering at Yale, has resigned that position to become Statistical Editor of the *Electrical World*, New York, N. Y. For the past two years he has been a regular contributor to the Digest of Electrical Literature of the "World." Before going to Yale he had been head of the Department of Physics and Electrical Engineering at the University of Alabama for eight years, having joined the faculty shortly after the organization of the College of Engineering to include the newer engineering departments. He also taught for a time at the University of Maine. Mr. Wittig is a graduate of Rutgers and also holds the degree of E. E. from Columbia. He joined the Institute in 1905.

### "Behind the Pyramids"

The National Carbon Company, Inc., Cleveland, Ohio, has prepared a moving picture entitled "Behind the Pyramids" which shows in a very interesting manner the manufacture, application, operation and care of carbon brushes and other carbon products used in the electrical industry. This picture will be shown before technical society meetings, operating department groups, engineering college classes, etc. There are three reels, requiring approximately forty-five minutes for showing. Arrangements for this film may be made with the Carbon Sales Division, National Carbon Company, Inc., at Cleveland, Ohio.

### Obituary

**George Schley Davis**, president of the Wireless Specialty Apparatus Company, Boston, Mass., and Associate of the Institute since 1913, died suddenly at Brookline, Mass., October 10, 1926. Mr. Davis was born at North Platte, Nebraska, October 1, 1884. At the completion of his high school education, he undertook his technical education through the United States Naval Training Schools and home study courses. He had seven years in the Navy School and as chief electrician in charge of the wireless telegraph station, Navy Yard, Brooklyn, N. Y. For three and a half years he was with the United Fruit Company as chief operator and assistant superintendent; then superintendent, and at the time of his death he was one of its vice-presidents.

He was a director of the Radio Corporation of America and a Fellow of the Institute of Radio Engineers, having been closely identified with the development of radio engineering for many years. He was an intimate friend of Marconi, Edison, General Harbord as well as of other notable scientists and his loss will be felt keenly in this field of service to mankind.

**Adolphe Alfred Dion**, one of the most prominent electrical engineers of Canada, and a Fellow of the Institute, died October 8, 1926, in the Water Street General Hospital, Ottawa, Canada, following a critical operation. Born and educated in the city of Quebec, Mr. Dion's activity in the electrical field included telegraphy, railway operations and electric light and power work. When he removed to Ottawa, he entered the employ of the Old Dominion Telegraph Company. After occupying various positions there, he was given charge of the electrical work of the Intercolonial Railway, running from Montreal to Halifax: in fact for 35 years he has been identified with electrical enterprises in Ottawa, in addition to engaging in his own consulting work.

In spite of his many activities and responsibilities in public utilities, Mr. Dion found time to participate in association work, and was for four terms president of the Canadian Electrical Association, first in 1900 and 1901 and again in 1912 and 1913. He joined the Institute in 1890 and was transferred to the grade of Fellow in July 1913. He was also a member of the British Institution of Electrical Engineers and of the Canadian Society of Civil Engineers. At the time of his death, he was general manager of the Ottawa Electric Company, the Ottawa Light, Heat and Power Company and the Ottawa Gas Company.

### Addresses Wanted

A list of members whose mail has been returned by the postal authorities is given below, together with the addresses as they now appear on the Institute records. Any member knowing the present address of any of these members is requested to communicate with the Secretary at 33 West 39th Street, New York.

All members are urged to notify the Institute Headquarters promptly of any change in mailing or business address, thus relieving the member of needless annoyance and also assuring the prompt delivery of Institute mail, the accuracy of our mailing records, and the elimination of unnecessary expense for postage and clerical work.

- 1.—M. C. Benedict, 940 Ash St., Johnstown, Pa.
- 2.—R. L. Bertolacci, 2937 So. Normandie Ave., Los Angeles, Calif.
- 3.—Eric G. Blomquist, 1954 Winona St., Chicago, Ill.
- 4.—Lincoln Bouillon, 731 21st Avenue N, Seattle, Wash.
- 5.—William A. R. Brown, c/o Radio Corp. of Am., 33 W. 42nd St. New York.
- 6.—Andres R. Conde, 505 So. 5th Ave., Maywood, Ill.
- 7.—John C. Donahue, 1601 No. 8th St., Tacoma, Wash.
- 8.—I. H. El-Kordi, Royal Consulate of Egypt, 103 Park Ave., New York, N. Y.
- 9.—John C. Fretz, N. Y. & Queens Elec. Lt. & Pr. Co. Bridge Plaza North, Long Island City, New York.
- 10.—Wm. F. Gilman, Belgrade Lakes, Me.
- 11.—Newman D. Gray, 41 Sanford Street, St. Augustine, Fla.
- 12.—Edward C. Hanson, Box 59, Pinelawn, New York.
- 13.—A. Hirth, 519 Lincoln Pl., Apt. 20; Brooklyn, N. Y.
- 14.—M. Kalapesi, Faculty of Tech. Union, Sackville St., Manchester, Eng.
- 15.—Eric Kjellgren, 145 13th Street, Milwaukee, Wis.
- 16.—Victor J. Kubanyi, 708 St. Nicholas Ave., New York, N. Y.
- 17.—Otto U. Lawrence, Avenue A., Bound Brook, New Jersey.
- 18.—Akos Ludasy, P. O. Box 1841, Chicago, Ill.
- 19.—L. Lustig, Krizik Elec. Mfg. Co., Karlin-Prague, Czechoslovakia.
- 20.—Ronald W. S. Marsano, 714 Curtis Avenue, Merchantville, New York.

- 21.—Eugene Messinger, Otis Elevator Co. Engg. Dept., 26th St. & 11th Ave., 4th Floor, New York, N. Y.  
 22.—Wilbur Miller, Y. M. C. A., Dallas, Texas.  
 23.—Stafford Montgomery, Riverside, Ill.  
 24.—Jack Nile, 378 Boyden Avenue, Hilton, New Jersey.  
 25.—Edward W. Parry, 23 Passaic Avenue, Passaic, New Jersey.  
 26.—G. K. Pierce, 2619 So. 59th Court, Cicero, Ill.  
 27.—Irving T. Roberts, 2355 Prairie Avenue, Evanston, Ill.  
 28.—Orville B. Weeks, 305 Martense St., Brooklyn, New York.  
 29.—E. J. Schouw, 775 27th St., Milwaukee, Wis.  
 30.—Wm. E. Seaman, 1253 Leland Avenue, New York, N. Y.  
 31.—N. V. Stonestreet, Central Y. M. C. A., Baltimore, Md.

## Engineering Societies Library

*The library is a cooperative activity of the American Institute of Electrical Engineers, the American Society of Civil Engineers, the American Institute of Mining and Metallurgical Engineers and the American Society of Mechanical Engineers. It is administered for these Founder Societies by the United Engineering Society, as a public reference library of engineering and the allied sciences. It contains 150,000 volumes and pamphlets and receives currently most of the important periodicals in its field. It is housed in the Engineering Societies Building, 29 West Thirty-ninth St., New York.*

*In order to place the resources of the Library at the disposal of those unable to visit it in person, the Library is prepared to furnish lists of references to engineering subjects, copies or translations of articles, and similar assistance. Charges sufficient to cover the cost of this work are made.*

*The Library maintains a collection of modern technical books which may be rented by members residing in North America. A rental of five cents a day, plus transportation, is charged.*

*The Director of the Library will gladly give information concerning charges for the various kinds of service to those interested. In asking for information, letters should be made as definite as possible, so that the investigator may understand clearly what is desired.*

*The library is open from 9 a. m. to 10 p. m. on all week days except holidays throughout the year except during July and August when the hours are 9 a. m. to 5 p. m.*

### BOOK NOTICES (SEPTEMBER 1-30, 1926)

Unless otherwise specified, books in this list have been presented by the publishers. The Society does not assume responsibility for any statement made; these are taken from the preface or the text of the book.

All books listed may be consulted in the Engineering Societies Library.

#### AIRCRAFT YEAR BOOK, 1926.

N. Y., Aeronautical Chamber of Commerce of America, 1926. 331 pp., illus., diagrs., 9 x 6 in., cloth. \$5.25.

The 1926 Yearbook presents the customary review of the developments of the year in commercial aviation in America and abroad. It gives a concise account of the principal events in this country—commercial, governmental and technical. Chapters are devoted to special uses of aircraft in agriculture, exploration, etc. Legislative needs are discussed. A chronology and revision of the year are given as well as a summary of technical development. Appendixes contain data on commercial and technical associations, government services and appropriations, etc.

#### AMERICAN MACHINISTS' HANDBOOK.

By Fred H. Colvin and Frank A. Stanley. Fourth edition. N. Y., McGraw-Hill Book Co., 1926. 972 pp., illus., tables, 7 x 4 in., fabrikoid. \$4.00.

The new edition of this popular handbook is but little larger than its predecessor, which it closely resembles in appearance. The authors state, however, that it has been thoroughly revised and that much of the earlier material has been replaced by new standards and shop practices, so that the book is again representative of the best current practise.

#### DIELEKTRISCHES MATERIAL.

By A. Bultemann. Berlin, Julius Springer, 1926. 160 pp., diagrs., 10 x 7 in., paper. 10, 50 r. m.

The manufacture of insulating materials is constantly being undertaken, says Dr. Bultemann, by persons who are insufficiently conversant with the existing information on these important substances. As a result there are placed on the market all kinds of insulating materials, many of which are practically worthless and lead at times to heavy losses.

To disseminate correct information on the subject is the purpose of the present book. It sets forth, in easily understood fashion, the properties of all classes of dielectrics—gases, liquids, plastics and solids. The chemical and physical properties of each are explained and the effect of these on their dielectric properties is discussed. The methods of manufacture are set forth concisely. Methods of testing are given, with German and foreign standard specifications. The book affords a useful concise survey of the subject, with special emphasis on manufacture.

#### ELEKTROCHEMIE . . . v. 3; ENERGIE.

By Heinrich Danneel. Ber. & Lpz., Walter de Gruyter & Co., 1926. 149 pp., 6 x 4 in., cloth. 1, 50 r. m.

The third volume of Dr. Danneel's treatise on electrochemistry is devoted to the question of energy. In it he discusses the theoretical thermodynamical principles, the total energy, energy and equilibrium, electrode potentials, galvanic cells and the use of E. M. F. measurements in chemistry.

#### EMPLOYEE REPRESENTATION.

By Ernest Richmond Burton. Balt., Williams & Wilkins, 1926. (Human Relations series). 283 pp., tables, 8 x 6 in., cloth. \$3.00.

The author presents a careful investigation of employee representation which has occupied his time during the past seven years. His purpose has been to ascertain the history of the movement, the reasons that have prompted employers to adopt the plan, the extent to which it has achieved the objects sought, and the difficulties that have beset the movement. The book also endeavors to define the place and function of employee representation in the policy of personnel relations and to indicate the desirable direction of its development.

#### ENGLISH APPLIED IN TECHNICAL WRITING.

By Clyde W. Park. N. Y., F. S. Crofts & Co., 1926. 313 pp., 8 x 6 in., cloth. \$2.25.

This book, by the Professor of English in the College of Engineering and Commerce, University of Cincinnati, is intended for use as a textbook in technical schools. The aim of the author is to assist the student to acquire a clear personal style and the ability to express his ideas correctly in practical writing. Throughout the book, instruction in English is linked with the written work done by the students in their technical courses. The book is not only a good text but will also be useful as a reference book for counsel.

#### ENLARGED HEAT DROP TABLES: H. P. GAUGE PRESSURES, L. P. ABSOLUTE PRESSURES.

By Herbert Moss, from the formulae and enlarged steam tables of H. L. Callendar. Lond., Edward Arnold & Co., 1925. 88 pp., 9 x 6 in., cloth. \$3.75. (Gift of Longmans, Green & Co., N. Y.)

In 1917 Mr. Moss published a set of tables, based on Professor Callendar's formulas and tables, showing the adiabatic heat drop of steam with initial pressures up to 400 lbs. per sq. in. and vacua from 27.0 to 29.1 in. The present book supplements the original set. It gives new tables of the adiabatic heat drop of 1 lb. of steam, in British thermal units, for initially dry saturated or supersaturated steam of pressures from 400 to 2000 lbs. per sq. in. gauge and vacua from 27.0 to 29.5 in. of mercury. It also extends the original tables to vacua from 29.2 to 29.5 inches.

#### ENLARGED MOLLIER OR H- $\phi$ DIAGRAM FOR SATURATED AND SUPERHEATED STEAM.

Plotted by H. L. Callendar from his enlarged steam tables. Lond., Edward Arnold & Co., 1926. 30 x 40 in. paper. \$1.35. (Gift of Longmans, Green & Co., N. Y.)

An excellent diagram, clearly printed on heavy paper and sufficiently large to be read easily.

#### GENERAL CHEMISTRY.

By Hamilton P. Cady. 2nd edition. N. Y., McGraw-Hill Book Co., 1926. (International chemical series). 540 pp., illus., 8 x 6 in., cloth. \$3.25.

A textbook intended to meet the usual requirements of a general college course in chemistry. It is based on the author's "Inorganic Chemistry," being to some extent an abridgment and simplification of that work. The new edition has been carefully revised and considerable new matter has been added.

#### INTRODUCTION TO THE THEORY OF INFINITE SERIES.

By T. J. I'a. Bromwich. 2nd ed., revised. Lond. & N. Y., Macmillan Co., 1926. 535 pp., 9 x 6 in., cloth. \$10.50.

Beginners with an adequate knowledge of the differential and integral calculus will find this book a very satisfactory introduction to the study of infinite series. The author includes much material that is not easily accessible elsewhere to English readers and has also provided a great number of examples.

The new edition consists largely of a reproduction of the first edition, with additional theorems and examples.

#### MECHANICS FOR ENGINEERING STUDENTS.

By G. W. Bird. N. Y. & Lond., Isaac Pitman & Sons, 1926. (Technical School Series). 142 pp., diags., 9 x 6 in., cloth. \$1.50.

A concise textbook covering the subjects required as preparation for the British National Certificate examination. The course is designed for one year and is marked by the large number of worked examples.

#### PETROLEUM REGISTER.

1926. N. Y., Holland S. Reavis, 1926. 587 pp., 12 x 9 in., cloth. \$10.00.

A reference book for those in the oil industry. Contains a buyers' guide to manufacturers and dealers in all kinds of equipment, and directories of refiners, marketers, jobbers, producers, pipe lines and producers of natural gasoline. Other features are an index of trade names, a traffic guide to refineries and a directory of drilling contractors, a list of oil associations and an alphabetical list of the chief executives of the companies in the oil business. Various tables of statistics are given and there are outline maps of the oil-producing countries, showing the location of the oil fields.

#### PHOTOGRAPHIC PHOTOMETRY.

By G. M. B. Dobson, I. O. Griffith and D. N. Harrison. Oxford, Clarendon Press, 1926. 121 pp., plates, diags., tables, 8 x 5 in., cloth. 7s 6d. (Gift of Oxford Univ. Press, Amer. Branch, N. Y.)

In view of the increasing applications of photographic methods for measuring the intensity of light, this book by authors who have spent much time and research during recent years on the best technique for photographic photometry, will be welcome. In it is reviewed the whole subject, theory and practise. The principal methods employed, the sources of errors, how these errors can be minimized, and generally how to find the best method of working, are the topics here discussed. The book should prove most useful to any one starting work in this subject.

#### PRINCIPLES UNDERLYING THE DESIGN OF ELECTRICAL MACHINERY.

By W. I. Slichter. N. Y., John Wiley & Sons, 1926. 312 pp., illus., diags., tables, 9 x 6 in., cloth. \$3.75.

Contents: General principles and fundamental relations.—Continuous-current generator.—Salient-pole alternating-current generator.—Turbine-driven alternating-current generator.—Transformer.—Induction motor.—Index.

Dr. Slichter's book is developed from a course of lectures given at Columbia University and from his experience as a designing engineer. It is to some extent an amplification of his articles on the subject written for Pender's "Handbook of Electrical Engineering."

The purpose throughout is to give a practical method of design, with explanations of the physical meaning of the arbitrary constants used by the professional designer. To assist in this, the author derives the formulas from fundamental principles,

explains each of them and gives the reasons for the various standards of practise. He gives a systematic method of procedure for the design of each type of machine treated, with a complete sample calculation in each case.

The book is intended as a text for a course on design. It will also be an aid to young engineers through its explanation of the reasons for certain conventional practises.

#### RAILROAD FREIGHT SERVICE.

By Grover G. Huobner and Emory R. Johnson. N. Y., D. Appleton & Co., 1926. 589 pp., diags., forms, maps, 9 x 6 in., cloth. \$5.00.

Written to assist railroad officials and those in charge of the traffic and transportation activities of industries. The book describes in detail the railroad freight services, freight traffic rules and practises, and the organization of the departments that perform the services. The authors have succeeded in compressing a comprehensive account of the railroad freight service, in all its phases, into a single volume.

#### DER RUHRVERBAND.

By Karl Imhoff. Berlin-Dahlem, Verlag Wasser, Druck von C. W. Haarfeld in Essee, 1926. 29 pp., map, 12 x 8 in., paper. 3,-r. m.

The Ruhr industrial region has a population of 1,266,000 wholly dependent for its water supply on the Ruhr river. The problem of keeping the river water sufficiently pure, a difficult one in so thickly populated a district, has been met by the erection of large purifying works. These works are administered by the Ruhrverband, at the expense of the waterworks that serve the district.

This pamphlet briefly sets forth the history and administration of the Ruhrverband and describes briefly the plants that have been erected.

#### STORY OF STEEL.

By J. Bernard Walker. N. Y., Harper & Bros., 1926. 208 pp., illus., 8 x 6 in., cloth. \$4.00.

A non-technical description of the manufacture of steel as carried on in this country, based on an extended inspection of the properties and methods of the United States Steel Corporation. Starting at the Minnesota mines, the author traces the processes through the blast-furnace and the steel furnace to the finished sheet, pipe and section. Chapters are also devoted to the social and economic policies of the Corporation.

#### THEORIE DER BRENNKRAFTMASCHINEN UND DEREN BRENNSTOFFE VOM STANDPUNKTE DER CHEMISCHEN GLEICHGEWICHTSLEHRE.

By Markus Brutzkus. Halle (Saale), Wilhelm Knapp, 1926. 62 pp., diags., tables, 10 x 7 in., paper. 3, 80 r. m.

While most branches of modern engineering owe their origin and development principally to theoretical knowledge, according to this author, the industrial development of the internal combustion engine is, even today, more advanced than its theory. Only once, in the case of Diesel, has theoretical contemplation led to any important improvement.

This condition arises, he thinks, because students of the theory and designers have turned their attention principally to pure thermodynamics, and left out of consideration theoretical chemistry, in which field lie the most important problems of the theory of these motors. The problem of best converting a given quantity of heat into mechanical energy has been constantly studied, but the equally important problem of achieving the combustion in a time not greater than four one-hundredths of a second has scarcely been considered. To answer the latter question, from the point of view of chemical theory, is the task undertaken in this book.

#### DER ZUGVERSUCH.

By G. Sachs and G. Fiek. Lpz., Akademische verlagsgesellschaft. 1926. 252 pp., illus., diags., 9 x 6 in., paper. 12-mk.

A discussion of tensile strength tests by two experienced German engineers, addressed to those who have the task of drawing useful conclusions from tests of materials, especially makers and users of structural materials, and engineers of tests. It contains, in addition to directions for the practical conduct of our most important test of materials, a thorough discussion of all the points of view which are of importance for the process of testing, on the one hand, and for the interpretation of the results on the other.

In the first part of the book the authors discuss thoroughly the signification of strength, ductility and other characteristics, the influence of nicks and other flaws, and the relation of tensile tests to other tests. A section is devoted to the influence of combined requirements.



The second part briefly reviews the structure of materials and also those influences on tensile tests, such as temperature, speed and cold working, which presuppose a knowledge of structure. The third section discusses the choice of equipment for testing for any given purpose.

An appendix, describing the shapes of test pieces used in different countries, and a bibliography are given.

#### DOMESTIC ENGINEERING CATALOG DIRECTORY.

1926. Chic., Domestic Engineering Co., 1926. 1972 pp., illus., 11 x 8 in., bound. \$5.00.

A convenient collection of condensed catalogs representing several hundred manufacturers of plumbing and heating supplies, classified by products for the convenience of buyers. The book also contains a directory of manufacturers with addresses; a list of all materials used by the plumbing and heating industry,

with the names of manufacturers and an exhaustive index; and a collection of useful standard tables and rules.

#### METHODS OF TEACHING INDUSTRIAL SUBJECTS.

By Arthur F. Payne. N. Y., McGraw-Hill Book Co., 1926. 293 pp., 9 x 6 in., cloth. \$3.00.

The teacher of industrial subjects, selected because of his mastership of some trade, usually finds himself to be a novice in the profession of teaching and handicapped by his ignorance of the philosophy, principles and technique of teaching.

To remedy this situation, he must master the techniques of his new profession, and the present book is a contribution toward that end. It brings together the fundamentals of the techniques of teaching, presents them as simply as possible and indicates their use in the teaching of industrial subjects. Good bibliographies are given.

## Past Section and Branch Meetings

### SECTION MEETINGS

#### Chicago

*Flames of Atomic Hydrogen*, by Dr. Irving Langmuir. September 27. Attendance 400.

#### Detroit-Ann Arbor

Social Meeting. A talk was given by Therman Miller. September 29. Attendance 109.

#### Fort Wayne

Social Meeting. September 30. Attendance 50.

#### Los Angeles

*Standardization in the Development of A-C. Systems*, by C. C. Chesney, National President, A. I. E. E.;

*Lightning*, by F. W. Peek, Jr., General Electric Co. Illustrated; and

*Lightning Protection*, by K. B. McEachron, General Electric Co. The meeting was preceded by a dinner. September 14. Attendance 244.

#### Mexico

Business Meeting. The following officers were elected: Chairman, Carlos Macias; Secretary-Treasurer, G. Solis Payan. September 2. Attendance 37.

#### Pittsburgh

*New Landmarks in Electrical Communication*, by P. B. Findley, Bell Telephone Laboratories. Illustrated. September 14. Attendance 220.

*Automatic Train Control*, by L. F. Howard, Union Switch and Signal Company. October 12. Attendance 425.

#### Portland

*Growth and Standardization*, by C. C. Chesney, National President, A. I. E. E.;

*Lightning Protection for Oil Tanks*, by F. W. Peek, Jr.; General Electric Co. Illustrated; and

*The Cathode-Ray Oscillograph*, by K. B. McEachron, General Electric Co. September 20. Attendance 80.

#### St. Louis

Dinner Meeting. Joint with Engineers' Club of St. Louis. A talk was given by Lawrence McDaniel. September 15. Attendance 124.

#### Seattle

*Research*, by C. C. Chesney, National President, A. I. E. E.; and

*Lightning Protection*, by K. B. McEachron, General Electric Co. Illustrated. A motion picture showing the manufacture of transformers was also shown. A dinner preceded the meeting. September 22. Attendance 115.

#### Southern Virginia

*Interconnection of Transmission Lines in Virginia and North Carolina*, by W. C. Bell, Virginia Electric & Power Co.;

*The Design of a High-Pressure Industrial Power Plant*, by R. S. Boynton; and

*The Opportunity of the Engineer in Industry*, by Arthur Scrivenor. September 29. Attendance 45.

#### Spokane

*The Development and Manufacture of Transformers*, by C. C. Chesney, National President, A. I. E. E.; and

*Lightning Protection*, by K. B. McEachron, General Electric Co. Illustrated. A dinner preceded the meeting. September 24. Attendance 65.

#### Springfield

*Some Recent Developments in Radio-Frequency Amplification*, by W. F. Cotter and B. V. K. French, American Bosch Magneto Co. September 27. Attendance 51.

#### Toronto

*A-C. and D-C. Current Rectification for Radio Uses*, by Professors H. W. Price and T. R. Rosebrugh, Toronto University. September 24. Attendance 175.

#### Vancouver

Luncheon, Inspection Trip in Vancouver Harbor, and Dinner. Members of A. I. E. E., Engineering Institute of Canada and others. August 28. Attendance 64.

Inspection trip to Britannia Mining and Smelting Co. September 11. Attendance 93.

*Standardization and Research*, by C. C. Chesney, National President, A. I. E. E. A film, entitled "Development and Manufacture of Large Transformers," was shown.

*Lightning Protection*, by K. B. McEachron, General Electric Co. September 27. Attendance 90.

#### Washington

A short talk was given by Hon. Proctor L. Dougherty, District Commissioner. September 16. Attendance 52.

*The Electrical Work of the Bureau of Standards*, by E. C. Crittenden, Bureau of Standards. Motion pictures entitled "The World of Paper" and "The Magic of Communication" were shown. October 12. Attendance 244.

### BRANCH MEETINGS

#### Alabama Polytechnic Institute

R. C. Crawford, student, gave a review of the paper by H. H. Henline, entitled *Engineering Education—Its History and Prospects*. September 22. Attendance 40.

*The Development and Uses of Bakelite*, by Professor C. R. Hixon. September 29. Attendance 70.

Talks on their experiences during the summer were given by J. L. Jones and J. B. Walters. October 6. Attendance 29.

#### University of Arkansas

A short talk was given by Professor W. B. Stelzner. September 28. Attendance 15.

#### University of California

*The Use of the Trielectrode Vacuum Tube in Telephone Circuits*, by H. G. Tasker, Pacific Telephone and Telegraph Co. A motion picture entitled "The Transmission of Voice by Electricity" was also shown. September 8. Attendance 50.

Banquet. September 14. Attendance 89.

Business Meeting. September 29. Attendance 23.

#### University of Colorado

*Student Membership in the A. I. E. E.*, by Dean H. S. Evans. September 29. Attendance 85.

#### University of Denver

Business Meeting. October 1. Attendance 15.

#### Drexel Institute

*The Greater View of the Engineering Profession*, by Professor Disque. October 8. Attendance 33.

#### University of Florida

Business Meeting. The following officers were elected: Chairman, W. Stanwix-Hay; Vice-Chairman, R. T. Lundy; Secretary, R. D. Ross. September 27. Attendance 10.

**University of Idaho**

*The Salt Lake City Convention of the A. I. E. E.*, by Professor J. H. Johnson. October 5. Attendance 18.

**Kansas State College**

*My Summer Employment*, by R. H. Mears, H. V. Rathbun and L. E. Woodman. October 4. Attendance 76.

**University of Kansas**

Social Meeting. October 7. Attendance 115.

**Marquette University**

Smoker. September 23. Attendance 55.

**University of New Hampshire**

Business Meeting. The following officers were elected: Chairman, T. C. Tappan; Secretary, F. W. Hussey. September 27. Attendance 38.

A motion picture entitled "White Coal" was shown. October 4. Attendance 40.

A motion picture entitled "The Single Ridge Method" was shown. October 11. Attendance 42.

**College of the City of New York**

Inspection Trip to the Schenectady Plant of the General Electric Co. September 20 and 21. Attendance 8.

Business Meeting. October 7. Attendance 20.

**North Carolina State College**

Business Meeting. October 5. Attendance 17.

**Ohio Northern University**

Smoker. September 23. Attendance 44.

*Radio*, by Messrs. Wadsworth and Neff. October 7. Attendance 34.

**Pennsylvania State College**

Business Meeting. September 29. Attendance 39.

A talk was given by Dr. E. C. Woodruff on his trip to Europe last summer. October 6. Attendance 200.

**Purdue University**

*Central American Experiences*, by Dr. Bray, and

*A. I. E. E. and the Purdue Branch*, by Professors C. F. Harding and A. N. Topping. October 5. Attendance 250.

**Rensselaer Polytechnic Institute**

Business Meeting. The following officers were elected: Chairman, F. M. Sebest; Secretary-Treasurer, W. C. Michels. October 6. Attendance 25.

**South Dakota State School of Mines**

*The Training of Young Men by the General Electric Company*, by Professor J. O. Kannerman. September 29. Attendance 15.

**University of South Dakota**

*Kinetic Theory of Gases*, by Maurice Nelles. The following officers were elected: Chairman, Maurice Nelles; Secretary, Stanley Boegler. September 29. Attendance 12.

**Stevens Institute of Technology**

*Independence in Engineering*, by L. A. Hazeltine, Research Engineer. September 29. Attendance 66.

**Texas Agricultural and Mechanical College**

Business Meeting. The following officers were elected: Chairman, C. A. Altenberg; Vice-Chairman, G. D. Heye; Secretary, J. L. Pratt. October 1. Attendance 160.

**West Virginia University**

Business Meeting. The following officers were elected: Chairman, I. L. Smith; Vice-Chairman, H. S. Muller; Secretary, P. E. Davis. September 27. Attendance 37.

*The Current-Carrying Capacity of Busses*, by G. H. Cornell; *The Dipping and Baking of Armature Coils*, by W. W. Reed; *The Use of Electric Power in Steel Mills*, by A. L. P. Schmiechel; *Life of George Westinghouse*, by L. T. Kight; *Industry*, by G. E. Phillips; *Method of Testing Insulated Rotary Parts*, by H. S. Muller; *Porcelain Insulators*, by H. S. McGowan; *Cone Loud Speakers*, by H. H. Hunter, and *Routine Test of Telephone Engineers*, by S. C. Hill. October 4. Attendance 37.

*Safety and the Engineer*, by W. F. Davis; *High-Power D-C. Line Tests*, by W. E. Vellines; *Florida East Coast Railway*, by D. Carle; *Re-Determination of the Velocity of Light*, by E. W. Conway; *New Ships for Old*, by P. E. Davis; *Using X-Ray to Solve Puzzles*, by E. R. Long; *Accelerometers*, by A. M. Kalo; *Testing Radio Sets*, by P. L. Johnston; and *How a Long-Distance Call is Made*, by J. P. Paine. October 11. Attendance 37.

**Yale University**

Social Meeting. September 14. Attendance 35.

## Engineering Societies Employment Service

Under joint management of the national societies of Civil, Mining, Mechanical and Electrical Engineers cooperating with the Western Society of Engineers. The service is available only to their membership, and is maintained as a cooperative bureau by contributions from the societies and their individual members who are directly benefited.

Offices:—33 West 39th St., New York, N. Y.,—W. V. Brown, Manager.

53 West Jackson Bl'v'de., Room 1736, Chicago, Ill., A. K. Krauser, Manager.

57 Post St., San Francisco, Calif., N. D. Cook, Manager.

**MEN AVAILABLE.**—Brief announcements will be published without charge but will not be repeated except upon requests received after an interval of one month. Names and records will remain in the active files of the bureau for a period of three months and are renewable upon request. Notices for this Department should be addressed to **EMPLOYMENT SERVICE, 33 West 39th Street, New York City**, and should be received prior to the 15th of the month.

**OPPORTUNITIES.**—A Bulletin of engineering positions available is published weekly and is available to members of the Societies concerned at a subscription rate of \$3 per quarter, or \$10 per annum, payable in advance. Positions not filled promptly as a result of publication in the Bulletin may be announced herein, as formerly.

**VOLUNTARY CONTRIBUTIONS.**—Members obtaining positions through the medium of this service are invited to cooperate with the Societies in the financing of the work by nominal contributions made within thirty days after placement, on the basis of \$10 for all positions paying a salary of \$2000 or less per annum; \$10 plus one per cent of all amounts in excess of \$2000 per annum; temporary positions (of one month or less) three per cent of total salary received. The income contributed by the members, together with the finances appropriated by the four societies named above, will it is hoped, be sufficient not only to maintain, but to increase and extend the service.

**REPLIES TO ANNOUNCEMENTS.**—Replies to announcements published herein or in the Bulletin, should be addressed to the key number indicated in each case, with a two cent stamp attached for reforwarding, and forwarded to the Employment Service as above. Replies received by the bureau after the positions to which they refer have been filled will not be forwarded.

**POSITIONS OPEN**

**ELECTRICAL DESIGN ENGINEER.** on large direct current machines having at least five years' design experience; experience in steel mill applications of direct current motors is desirable. Apply by letter giving full particulars concerning age, technical education, design experience, references, salary expected, and date when available. Apply by letter. Location, Pennsylvania. X-S19-C.

**SALES ENGINEER,** must be thoroughly conversant with air compressors. Apply by letter. Salary \$4000 a year, and commission. Location, East. X-955.

**MEN AVAILABLE**

**COMMERCIAL ENGINEER.** E. E. graduate, 26. Westinghouse graduate engineering course and test, application engineering experience. railway operating investigation. Desires position with public utility or holding and management

company which will lead to administrative work. Can furnish good reference. Available on reasonable notice. B-9001.

**TECHNICALLY TRAINED MAN,** 36, married, thirteen years' experience in construction, operating and estimating, substation and power house work. Desires position with construction or holding company or contractor. New York City or vicinity preferred. Available on two weeks' notice. B-1011.

**ELECTRICAL ENGINEER**, 33, married, graduate B. S. in E. E., eight years' electrical engineering experience; one year steel mill engineering on electrical applications and equipment, three years telephone engineering and design of protective apparatus for telephone and telegraph equipment, over four years control engineering design and controlling equipment for industrial and special control applications. Executive accustomed to assuming responsibility. Good record and references. At present employed. Available month's notice. Location, East. C-1864.

**JUNIOR ENGINEER**, 1923 graduate electrical engineer, two years' experience as illuminating engineer, three years electrical testing and inspection, desires position in construction or power installation work. Would consider sales engineering position if located in East. B-8148.

**A RECENT GRADUATE** in science and electrical engineering seeks afternoon employment (part time 1 P. M. on) at either instructing in physics, mathematics or engineering, or in electrical engineering, radio engineering, or patent law. At present studying for a J. D. degree (in law) in the morning. Good draftsman. College experience with thermionic vacuum tubes. Location, New York City only. C-1969.

**ELECTRICAL ENGINEER**, college graduate '26, age 28, single, speaks Russian, English and French, desires to work in company that deals with foreign countries. Location, any place. Available at any time. C-1981.

**EXECUTIVE** with an E. E. degree, 36, married, desires an opportunity. Experienced in operation and distribution problems involving a large system using A. C. and D. C. Am particularly interested in relays and their application to protection problems and automatic control of operations. B-7701.

**TECHNICAL GRADUATE**, 28, single, with four years' experience with the Westinghouse E. & M. Co. Two years in testing department, and two years in their Electrical Service Engineering Dept. Desires position with industrial firm as Electrical Engineer or Chief Electrician. B-8985.

**ELECTRICAL ENGINEER**, age 34, technical graduate, will be available January 1st. Experience on factory test, service and construction, and general office engineering with large manufacturer. Now employed as field engineer on large hydro electric development. A total of thirteen years of broad experience. First class references. Location desired, East or Middlewest. B-9936-97.

**EXECUTIVE**, M. E., E. E. degrees, age 37, married; five years apprenticeship mechanical engineering; fifteen years' industrial engineering. Scientific management and business organization. Six years public utility, Chief Engineer in charge of design, construction, operation and maintenance of Power Plant, substations, transmission and distributing lines, desires position as General Superintendent, Manager, Chief Engineer, Mechanical Electrical Superintendent or Consultant. Available immediately. B-7944.

**ELECTRICAL ENGINEER**, University (Leeds, Eng.), 38, married, nine years operation and maintenance, two years Westinghouse Company, Ltd., on erection, service, drafting and design, seven months general electrical design for plant extension. Can organize and control men and plant. Desires executive position, anywhere in Canada, preferably east or B. C., as superintendent or assistant superintendent of plant, power supply or industrial, or as underwriter. Minimum salary \$200.00 a month. Available after November 1st, 1926. C-1989.

**TRANSMISSION LINE ENGINEER**, university graduate, ten years' experience in design of transmission lines with special regard to mechanical features and safety. Experience includes formulation and application of safety codes, design of structures, standardization, sag and tension investigations, estimating, etc. At present assistant transmission line engineer in charge of design for a large public utility. Salary \$4200 per annum. C-2014.

**TECHNICAL GRADUATE** in E. E., 32, married, able in assuming responsibility and handling of men with results. Three years mechanical installations and repairs, five and half years general electrical construction, installations, maintenance and tests power plant and substations, one year operating and plant problems, wishes position. Speaks French and some Spanish. Location, United States or abroad. Available at once, present station about completed. References present employer. C-2021.

**SUPERINTENDENT OF POWER**, electrical engineer with twelve years' experience steam power plants and electrical generating stations. Construction, operation, maintenance. Speaks Spanish. Location, preferably foreign. C-1372.

**GENERAL SALES EXECUTIVE**, 40, married, electrical and mechanical engineer, considered a keen analyst of business conditions, an organizer and successful negotiator of large contracts involving power and equipment. Specialist on power rates and application of power to large industries. Salary \$7500. Now retiring from present position and will be available sixty days. B-4221.

**MERCHANDISING OR SALES PROMOTION EXECUTIVE**, nine years' central station commercial and merchandising experience, including department management, four years manager large industrial purchasing department, four years general manager gas and electric appliance jobbing and retail stores. Engineering university graduate. Services available November 1st. Location preferred, Eastern States. B-6619.

**SALES EXECUTIVE ENGINEER**, technical graduate, electrical design, construction, sales of power house equipment. Has large active clientele in New York City. Age 39. Location, New York. Salary \$6000. B-2123.

**COMMERCIAL ENGINEER**, technical graduate, nine years' experience in the public utility business on design, construction and

operation of hydroelectric machinery and substations. Desires position as commercial engineer with manufacturing or utility company with possibility for advancement. Available one month. C-2035.

**ELECTRICAL ENGINEER**, with twenty years' practical experience in industry and utility, desires position of responsibility in a growing organization with modern business policies. Research and developmental department on small electro-mechanical apparatus desired; meters and instruments a specialty. At present employed in charge of laboratory. C-1867.

**SUPERINTENDENT** of hydroelectric properties wishes new connection. Eighteen years' experience in operation, control and management, general public utility business, including maintenance, purchasing and financing. Recently discharged as "receiver" of international corporation. Age 35. Location immaterial. Salary \$3000. B-6686.

**PHYSICIST**, honor graduate with Ph. D. degree. Three years of university practical post-graduate research in electrical and radio problems. Two years' experience in industrial research for electrical firms. At present head of department of physics and dean of college of pre-engineering at a prominent university. Inventor and owner of three famous basic radio patents. Salary must exceed \$4500. Age 27. Available January 1, 1927, or June 1, 1927. C-2048.

**ENGINEER**, mechanical and construction, ten years' general experience in American methods, is returning to England on November 6th and is open to represent or execute commissions for a reliable American concern. Excellent connections in Europe. B-7433.

**ELECTRICAL ENGINEER**, 29, seven years' experience, layout and design of power house, substation, transmission line, with material requisition work. At present doing wiring plans, specifications, etc. on theatres, office buildings, hotels, desires similar position with architect or electrical contracting firm anywhere in United States or Canada. Available within four weeks. B-4217.

**ELECTRICAL AND VALUATION ENGINEER**, 33, married, with ten years' experience, formerly with New York State Public Service Commission, desires position with public utility establishing inventories and appraisals, classifying fixed capital accounting systems and property records. Location, New York City or New York State. B-9636.

**CABLE ENGINEER**, 36, married, cable engineer and inspector. Long experience on all kinds of wire and cable, especially high tension paper cable. Can write specifications, supervise manufacture, make tests at factory, supervise cable installation and final tests. Long experience with public utility and construction work. Location, prefers New York District or State. B-3625.

## MEMBERSHIP — Applications, Elections, Transfers, Etc.

### ASSOCIATES ELECTED OCTOBER 15, 1926

**ATKINS, GEORGE E.**, Inspection Engineer, Bell Telephone Laboratories, Inc., 463 West St., New York, N. Y.; for mail, Jersey City, N. J.

**ATKINSON, CHARLES SYDNEY**, Chief Operator, Shawinigan Water & Power Co., Power Bldgs., Craig St., Montreal; res., Shawinigan Falls, P. Q., Can.

**BANERJEE, ANIL CHANDRA**, Asst. Electrical Engineer, Rampur State, Rampur, U. P., India.

**BRANDT, ROBERT**, Central Station Engg. Dept., General Electric Co., Schenectady, N. Y.

**BRIGGS, MELVIN JOHN**, Electrical Subforeman, Stone & Webster, Tampa, Fla.

**CAMPBELL, IVOR S.**, Professor of Elec. Engg., Ohio Northern University, Ada, Ohio.

**CARTER, THOMAS E.**, Asst. Load Dispatcher, Florida Power & Light Co., 523 N. W. 11th St., Miami, Fla.

**COPELAND, WILLIAM T.**, Electrical Engineer, E. H. Faile & Co., 441 Lexington Ave., New York; res., Mt. Vernon, N. Y.

**CULLWICK, ERNEST GEOFFREY**, Draughtsman, Canadian General Electric Co., Peterboro, Ont., Can.

**DANIELS, CLIFFORD CLAYTON**, Power House Operator, Mystic Lake Plant, The Montana Power Co., Columbus, Mont.

**DOWDY, JOSEPH WILSON**, Electrician & Licensed Marine Engineer, 1086 Bush St., San Francisco, Calif.

**DURE, HENRY J.**, Transformer Engineer, Edison Electric Illuminating Co. of Boston, 1165 Mass. Ave., Roxbury; res., Medford, Mass.

**FINIGAN, WILLIAM**, Supt., Federal Trust & Clinton Buildings, 24 Commerce St., Newark, N. J.

**FITZGERALD, EDWARD BERNARD**, 28 Meridian St., Greenfield, Mass.

**FOLEY, JOHN RAYMOND**, Asst. Engineer, Appalachian Electric Power Co., Roanoke, Va.

- GAYLORD, CLAIR EUGENE, Outside Plant Engineer, New York Telephone Co., 63 E. Delavan Ave., Buffalo, N. Y.
- HUFFMAN, GEORGE A., Telephone Equipment Engineer, New England Tel. & Tel. Co., 50 Oliver St., Boston, Mass.
- KEMPF, RUPERT EDWARD, Foreman, Pacific Oil & Lead Works, 155 Townsend St., San Francisco; res., Berkeley, Calif.
- KUCHER, ANDREW ALBERT, Consulting Engineer, Westinghouse Elec. & Mfg. Co., 812 Glen Terrace, Chester, Pa.
- LUNDGREEN, SVEN O. G., Draftsman, General Electric Co., 6801 Elmwood Ave., West Philadelphia, Pa.
- MAIMAN, ABE, 1430 Van Ness Ave., Fresno, Calif.
- MAX, CHARLES, Draftsman, Elec. Dept., Central Railroad of New Jersey, Elizabethport; res., Dunellen, N. J.
- MAYOR, ROMAN, JR., Engineer, General Electric Co. of Cuba, Havana, Cuba.
- McLEAN, MARCUS M. M., Student Electrical Engineer, General Electric Co., West Lynn, Mass.
- REMALY, CURTIS E., Sales Engineer, The R. Thomas & Sons Co., East Liverpool; for mail, Sandusky, Ohio.
- REMINGTON, HENRY NOYES, Special Sales Engineer, International Creosoting & Construction Co., 6748 Crandon Ave., Chicago, Ill.
- RIENSTRA, ALBERT R., Engineer, Bell Telephone Laboratories, Inc., 463 West St., New York, N. Y.
- SCANAVINO, STEVEN ANGELO, Asst. Foreman Electrician, Pacific Gas & Electric Co., San Francisco; res., Stockton, Calif.
- SHORTALL, WILBERT JOSEPH, Testing Dept., General Electric Co., 1 River Road, Schenectady, N. Y.
- STOCKWELL, HARLAN LOOMIS, Substation Inspector, Tampa Electric Co., Tampa, Fla.
- STORM, S. B., Secretary, Marine Electric Co., 104 E. Market St., Louisville, Ky.
- \*WAGNER, HERMAN H., Student, Automatic Electric Co., Inc., 1001 W. Van Buren St., Chicago, Ill.
- WEINER, WILLIAM W., Electrical Engineers' Office, Pennsylvania Railroad System, Altoona, Pa.
- WILSON, HORACE R., Electrical Designer, Philadelphia Electric Co., 1000 Chestnut St., Philadelphia, Pa.
- ZUCKERMAN, HARRY, Wholesale Radio Equipment Co., 115 Leonard St., New York, N. Y.
- Total 35  
\*Formerly Enrolled Student.
- ASSOCIATE REELECTED OCTOBER 15, 1926**
- HALL, HENRY MONROE, Electrical Engineer-American Copper Products Corp., 233 Broadway, New York, N. Y.; res., Plainfield, N. J.
- MEMBERS ELECTED OCTOBER 15, 1926**
- BRADT, ANDY WOODRE, General Supt., Hamilton Hydro Electric System, 12 King St., E., Hamilton, Ont., Can.
- BROWN, WILLIAM WILBUR, Electrical Radio Engineer, General Electric Co., Schenectady, N. Y.
- DELLA RICCIA, ANGELO, Consulting Electrical Engineer, 253 Chaussee d'Alseberg, Brussels, Belgium.
- TRANSFERRED TO GRADE OF MEMBER OCTOBER 15, 1926**
- ANDREWS, HARDAGE L., Assistant Engineer, Railway Engineering Dept., General Electric Co., Schenectady, N. Y.
- ANDREWS, JOSEPH F., American Tel. & Tel. Co., New York, N. Y.
- AUTY, CLARENCE, Assistant Electrical Engineer, C. H. Tenney & Co., Boston, Mass.
- BALE, LAWRENCE D., Supt. of Power, Cleveland Railway Co., Cleveland, Ohio.
- BATES, LOUIS I., Engineer of Electric Distribution, Bronx Gas & Electric Co., New York, N. Y.
- BENTON, JOHN R., Professor of Physics and Electrical Engineering, University of Florida, Gainesville, Fla.
- BETTANNIER, EUGENE L., Electrical Engineer, Municipal Light & Power Department, Pasadena, Calif.
- BOWMAN, HAROLD L., Service Engineer, Westinghouse Electric & Mfg. Co., New York, N. Y.
- BROWN, HUGH A., Assistant Professor of Electrical Engineering, University of Illinois, Urbana, Ill.
- CAVE, JOSEPH, Electrical Superintendent, Canadian General Electric Co., Toronto, Ont.
- DREW, ERNEST C., Assistant Engineer, Bell Tel. Co. of Pennsylvania, Philadelphia, Pa.
- DUBOSE, McNEELY, Electrical Superintendent, Aluminum Co. of Canada, Ltd., Arvida, Que., Can.
- FISHEL, ANTHONY D., Sales and Electrical Engineer, A. D. Fishel Co., Cleveland, Ohio.
- FROM, OWEN C., Telephone Systems Engineer, Bell Telephone Laboratories, Inc., New York, N. Y.
- GILLILAN, P. M., Railway Engineer, General Electric Co., Schenectady, N. Y.
- HAMILTON, HAROLD C., Asst. Supt., Standardizing & Testing Dept., Edison Electric Illuminating Co. of Boston, Boston, Mass.
- HART, R. PHILIP, Manager, Cazenovia Electric and Cazenovia Tel. Corp., Cazenovia, N. Y.
- HENLINE, HENRY H., Associate Professor of Electrical Engineering, Stanford University, Stanford University, Calif.
- HIGHT, WILLIAM R., Assistant Compass Engineer, Sperry Gyroscope Co., Brooklyn, N. Y.
- JOHNSON, FRANCIS E., Professor of Electrical Engineering, University of Kansas, Lawrence, Kans.
- KONGSTED, L. P., Research Engineer, American Bosch Magneto Corp., Springfield, Mass.
- KURTZ, EDWIN, Professor and Head, Dept. of Electrical Engineering, Oklahoma A. & M. College, Stillwater, Okla.
- LA ROQUE, HAROLD B., Switchboard Engineering Dept., General Electric Co., Schenectady, N. Y.
- McFARLIN, JOHN R., Electrical Engineer, Electric Service Supplies Co., Philadelphia, Pa.
- McMILLAN, FRED O., Associate Professor of Electrical Engineering, Oregon State Agricultural College, Corvallis, Ore.
- MICHENER, HAROLD, Asst. to Executive Engineer, Southern California Edison Co., Los Angeles, Calif.
- MILLER, JOHN H., Chief Electrical Engineer, Jewell Electrical Instrument Co., Chicago, Ill.
- MONG, CLIFFORD E., Engineer, Pacific Tel. & Tel. Co., Seattle, Wash.
- MONROE, WENDELL P., Assistant Engineer, Illinois Central Railroad, Chicago, Ill.
- MORROW, ALLEN, Department Head, Power Department, Standard Oil Co. of California, Richmond, Calif.
- NETHERCUT, DONALD W., Distribution Supt., Ohio Public Service Co., Sandusky, Ohio.
- NYMAN, ALEXANDER, Director, Radio Patents Corp., New York, N. Y.
- O'NEAL, J. P., Westinghouse Electric & Mfg. Co., Sharon, Pa.
- PACKARD, ANSEL A., Division Manager, Connecticut Power Co., Middletown, Conn.
- PETERS, LEO J., Asst. Professor of Electrical Engineering, University of Wisconsin, Madison, Wis.
- POTTS, LOUIS M., Electrical Engineer, Bell Telephone Laboratories, Inc., New York, N. Y.
- READ, WALTER V., Telephone Engineer, American Tel. & Tel. Co., New York, N. Y.
- RODEY, BERNARD H., JR., Engineer Accountant, United Electric Light & Power Co., New York, N. Y.
- RYAN, FRANCIS M., Radio Engineer, Bell Tel. Laboratories, Inc., New York, N. Y.
- SCHENCK, CHESTER, Materials Engineer, Elec. Engr. Dept., Commonwealth Power Corp., Jackson, Mich.
- SHACKELFORD, BENJAMIN E., Chief Physicist, Westinghouse Lamp Co., Bloomfield N. J.
- THOMAS, RALPH L., Asst. to General Superintendent, Pennsylvania Water & Power Co., Baltimore, Md.
- WORRALL, ROBERT H., Radio Engineer, U. S. Naval Research Laboratory, Bellevue, D. C.

**RECOMMENDED FOR TRANSFER**

The Board of Examiners, at its meetings held September 20 and October 11, 1926, recommended the following members for transfer to the grade of membership indicated. Any objection to these transfers should be filed at once with the National Secretary.

**To Grade of Fellow**

- BEAVER, J. LYNFORD, Associate Professor of Electrical Engineering, Lehigh University, Bethlehem, Pa.
- LEE, LOUIS R., Engineer, Commonwealth Power Corporation, Jackson, Michigan.
- MOURADIAN, H., Toll Fundamental Plan Engineer, Bell Tel. Co. of Pennsylvania, Philadelphia, Pa.
- PANTER, THOMAS ALFRED, Electrical Engineer, Bureau of Power & Light, City of Los Angeles, Los Angeles, Calif.
- ROSSMAN, ALLEN M., Electrical Engineer, Sargent & Lundy, Chicago, Ill.
- SINDEBAND, M. L., Vice President, American Gas & Electric Company, New York, N. Y.

**To Grade of Member**

- ADAMS, LEE F., Commercial Engineer, General Electric Company, Schenectady, N. Y.
- ARMOR, JAMES C., Electrical Engineer, Pittsburgh Transformer Company, Pittsburgh, Pa.
- BACHRACH, ALFRED, Commercial Engineer, General Electric Company, Los Angeles, Calif.
- BENNETT, CLARENCE S., Construction Engineer, General Electric Company, Portland, Oregon.
- BERKLEY, H. WALTER, Electrical Engineer, Westinghouse Electric & Mfg. Company, East Pittsburgh, Pa.
- BILLHIMER, FRANK M., General Engineer, Westinghouse Electric & Mfg. Company, East Pittsburgh, Pa.
- BOISSONNAULT, F. L., Control Engineer, Westinghouse Electric & Mfg. Company, San Francisco, Calif.
- BROWN, STEWART K., Assistant Superintendent, Meter Department, Potomac Electric Power Company, Washington, D. C.
- CAROTHERS, ROBERT M., In Administrative Charge, Flow Meter Regular Engineering Department, General Electric Company, Schenectady, N. Y.
- CROSBY, GEORGE L., Vice President (Sales), Roller-Smith Company, New York, N. Y.
- CURRIER, PHILLIP M., Electrical Engineer, General Electric Company, Schenectady, N. Y.
- DART, HARRY F., Radio Engineer, Westinghouse Lamp Company, Bloomfield, N. J.
- DICKINSON, WILBUR K., Electrical Engineer, General Electric Company, West Lynn, Mass.
- DUNCAN, P. M., Electrical Engineer, Allis-Chalmers Mfg. Company, Milwaukee, Wis.
- DUNN, STEPHEN E., Sales Engineer, Clapp and LaMorse, San Francisco, Calif.
- EDWARDS, GEORGE DE FOREST, Telephone Engineer, Bell Telephone Laboratories, Inc., New York, N. Y.

- ELDER, L. R., Manager, Motor Department, General Electric Company, Portland, Oregon.
- FALLOON, E. J., Hydraulic Engineer, Glen Alden Coal Company, Scranton, Pa.
- FETHERLING, H. G., Sales Engineer, General Electric Company, Pittsburgh, Pa.
- FLANNERY, DANIEL THOMAS, Assistant Engineer, Hydro-Electric Power Commission of Ontario, Toronto, Ont., Canada.
- FRIIS, HAROLD T., Research Engineer, Bell Telephone Laboratories, Inc., Cliffwood, N. J.
- GARMAN, CHARLES P., Electrical Engineer, Dept. of Water and Power, Los Angeles, Calif.
- GASSAWAY, STEPHEN G., Assistant Manager, Commercial Dept., Oklahoma Gas & Electric Company, Oklahoma City, Okla.
- GEORGE, CLIFFORD H., Superintendent, Light and Power, Puget Sound Power & Light Company, Wenatchee, Washington.
- HAGAR, GEORGE H., Assistant to General Superintendent, Great Western Power Company, San Francisco, Calif.
- HAMILTON, WILLIAM STORRS H., Electrical Engineer, Railway Engineering Department, General Electric Company, Schenectady, N. Y.
- HANSEN, EDMUND H., Research Engineer, Radio Corporation of America, New York, N. Y.
- HOGG, CHARLES J., Engineer, New England Tel. & Tel. Company, Boston, Mass.
- KNOWLES, EVERETT H., Assistant Chief, Operation of Substations, Chile Exploration Company, Chuquicamata, Chile, S. A.
- KOBROCK, JOHN P., Division Plant Engineer, New England Tel. & Tel. Company, Boston, Mass.
- KRIEGSMANN, ARNOLD E., Assistant Engineer, Hodenpyl, Hardy & Company, Inc., New York, N. Y.
- LAMPE, J. HAROLD, Instructor in Electrical Engineering, Johns Hopkins University, Baltimore, Md.
- LAWRENCE, ROGER C., Electrical Engineer, American Steel & Wire Company, Cleveland, Ohio.
- LEWIS, HOWARD O., Assistant Engineer, Electrical Engineering Department, Boston Elevated Railway, Boston, Mass.
- LOVELL, CLEMENS M., Designing Engineer, Moloney Electric Company, St. Louis, Mo.
- LYON, WILLIAM R., Electrical Engineer, Products Protection Corporation, New Haven, Conn.
- MARTIN, HARRISON A., Assistant Electrical Engineer, Electric Bond & Share Company, New York, N. Y.
- MAXSTADT, FRANCIS W., Instructor of Electrical Engineering, California Institute of Technology, Pasadena, Calif.
- MCGRATH, MAURICE K., Managing Director, Le Materiel Telephonique, Paris, France.
- McLAGAN, ERNEST G., Sales Engineer, Allis-Chalmers Mfg. Company, St. Louis, Mo.
- MEREDITH, GAILEN E., Superintendent, Engineering Research Laboratory, Kansas City Power and Light Company, Kansas City, Mo.
- MILLER, WILLIAM J., Dean of Engineering, Texas Technological College, Lubbock, Texas.
- NEEDHAM, OLLIE, Electrical Engineer, Westinghouse Electric & Mfg. Company, East Pittsburgh, Pa.
- NELSON, ARTHUR L., Manager, Construction Dept., Jackson & Moreland, Boston, Mass.
- OSHIMA, HIROYOSHI, Director and Chief Engineer, Osaka Electric Lamp Co., Ltd., Osaka City, Japan.
- PANCOAST, D. F., Consulting Engineer, Cleveland, Ohio.
- ROBBINS, FRANCIS J., Supt. Distribution, Grays Harbor Railway and Light Company, Aberdeen, Washington.
- SAMUELS, IRVING, President, Automatic Devices Company, President, Samuels Stabilarc Company, Allentown, Pa.
- SHEPARD, WILLIAM M., Vice President and General Agent, The California Oregon Power Company, Medford, Oregon.
- SMITH, CHARLES GROVER, Physicist, Raytheon Mfg. Company, Cambridge, Mass.
- SMITH, WALTER C., Sales Engineer, Meters and Transformers, General Electric Company, San Francisco, Calif.
- STAUFFACHER, EDWIN R., Superintendent of Protection, Southern California Edison Company, Los Angeles, Calif.
- THOMPSON, RUSSELL G., Assistant Superintendent, North East Electric Company, Rochester, N. Y.
- TRAWICK, HENRY PHILLIPS, Proposal Engineer, Switchboard Sales, General Electric Company, Baltimore, Md.

#### APPLICATIONS FOR ELECTION

Applications have been received by the Secretary from the following candidates for election to membership in the Institute. Unless otherwise indicated, the applicant has applied for admission as an Associate. If the applicant has applied for direct admission to a higher grade than Associate, the grade follows immediately after the name. Any member objecting to the election of any of these candidates should so inform the Secretary before July 31, 1926.

- Abbott, A. C., Shawinigan Water & Power Co., Montreal, P. Q., Can.
- Abbott, T. A., Sheffield Scientific School, Yale Univ., New Haven, Conn.
- Alger, E. C., Bethlehem Shipbuilding Corp., Quincy, Mass.
- Andrews, J. L., Carolina Power & Light Co., Moncure, N. C.
- Bair, B., with C. E. Wise, Detroit, Mich.
- Barney, H. S., Chester County Light & Power Co., Kennett Square, Pa.  
(Applicant for re-election.)
- Beck, Partner, Beck Bros., Philadelphia, Pa.
- Bell, N. W., Gibbs & Hill, Inc., New York, N. Y.
- Bishop, N., Bell Telephone Laboratories, Inc., New York, N. Y.
- Bowman, C. F., Pittsburgh & Lake Erie Railroad, Pittsburgh, Pa.
- Brown, G. N., Okonite Co., Atlanta, Ga.
- Bruno, S. F., General Electric Co., New York, N. Y.
- Buresch, E. E., Contracting, 1016 Caton Ave., Brooklyn, N. Y.
- Bryant, L. A., The Dayton Power & Light Co., Dayton, Ohio
- Carlson, L., Western Electric Co., New York, N. Y.
- Chunko, P. P., Westinghouse Elec. & Mfg. Co., East Pittsburgh, Pa.
- Cleveland, V. M., General Electric Co., Pittsburgh, Mass.
- Close, G. A., Electrical Engineer & Contractor, Portland, Me.
- Cole, I. V., Lexington Electric Prod. Co., New York, N. Y.
- Colyer, A. R., New York Edison Co., New York, N. Y.
- Cone, W. B., Shevlin-Hixon Co., Bend, Ore.
- Connor, F. A., (Member), General Electric Co., Pittsburgh, Pa.
- Cooley, G. R., (Member), Electrical Engr., 90 Columbia St., Seattle, Wash.
- Doolittle, F. B., So. California Edison Co., Los Angeles, Calif.
- English, J. R., (Member), Erie Lighting Co., Penn Public System, Erie, Pa.
- Eschmann, W. G., Splitdorf Electrical Co., Newark, N. J.
- Evans, L. E., General Electric Co., Kansas City, Mo.
- Gates, S. H., Southern Bell Tel. & Tel. Co., Louisville, Ky.
- Georgies, A. M., Eisemann Magneto Corp., Brooklyn, N. Y.
- Gillmor, J., Toronto Hydro-Electric System, Toronto, Ont., Can.
- Glasgow, E. M., Russell & Stoll Co., New York, N. Y.
- Greene, R. E., Detroit Edison Co., Detroit, Mich.
- Greenwood, J., (Member), Electrical Engineer, New York, N. Y.
- Grillette, D. P., Public Ledger Co., Philadelphia, Pa.
- Haberer, J. P. A., General Electric Co., Lynn, Mass.
- Hammond, C. S., Georgia Railway & Power Co., Atlanta, Ga.
- Hammond, R. A., General Electric Co., Kansas City, Mo.
- Heim, H. J., Purdue University, Lafayette, Ind.
- Hendrickson, H. A., Westinghouse Elec. & Mfg. Co., Sharon, Pa.
- Hildebrand, T. F., American Gas & Electric Co., New York, N. Y.
- Hodgman, J. W., General Electric Co., Fort Wayne, Ind.
- Holbrook, P. H., (Member), Turners Falls Pr. & Elec. Co., Agawam, Mass.
- Holmes, M. C., General Electric Co., West Lynn, Mass.
- Hornberger, R. G., U. S. Bureau of Reclamation, Denver, Colo.
- Hull, R. M., Alabama Power Co., Birmingham, Ala.
- Jorgenson, L. M., Kansas State Agricultural College, Manhattan, Kans.
- Kaminsky, M. M., W. J. Holliday & Co., Indianapolis, Ind.
- Kasindorf, S., Commodore Radio Corp., New York, N. Y.
- Keonig, E. L., Engineer, 4130 Fifth St., Washington, D. C.
- Komives, L. I., The Detroit Edison Co., Detroit, Mich.
- Kormendy, L., Westinghouse Elec. & Mfg. Co., Sharon, Pa.
- Kovach, A. J., with Richard Bros., Detroit, Mich.
- Kroneberg, A. A., So. California Edison Co., Los Angeles, Calif.
- LeWald, H. P., K & B., Elec. Equipment Co., Inc., New York, N. Y.
- Malmstrom, A. L., Detroit Edison Co., Detroit, Mich.
- Manasari, B. B., Postal Telegraph Cable Co., New York, N. Y.
- Manuel, E. J., Detroit Edison Co., Detroit, Mich.
- McCrea, W. S., Jr., Washington Water Power Co., Spokane, Wash.
- McHenry, W. C., Pennsylvania Power & Light Co., Allentown, Pa.
- Miller, J. E., Kentucky Utilities Co., Four Mile, Ky.
- Moore, E. R., Detroit Edison Co., Detroit, Mich.
- Morrison, L. H., Cia Mexicana de Terrenos Y Petroleo, S. A., Grontera, Tabasco, Mex.
- Neimoeller, E., The Pacific Tel. & Tel. Co., Los Angeles, Calif.
- Nelson, W. L., The Ohio Public Service Co., Elyria, Ohio
- Olving, B. G., New York Edison Co., New York, N. Y.
- Peruzzi, E., Detroit Edison Co., Detroit, Mich.
- Poggemeyer, B. H., U. S. Gypsum Co., Genoa, Ohio
- Pringle, J. B., Northern Electric Co., Montreal, P. Q., Can.
- Rasmussen, F. J., Bell Telephone Laboratories, Inc., New York, N. Y.
- Rodgard, H., The New York Edison Co., New York, N. Y.
- Rowland, W. B., Union Carbide & Carbon Corporation, Havana, Cuba
- Russell, W., (Member), The New York Edison Co., New York, N. Y.
- Schenck, F. W., Pine Hill Coal Co., Minersville, Pa.
- Shears, C. C., Otis Elevator Co., Los Angeles, Calif.
- Siewert, D. R., General Electric Co., Kansas City, Mo.
- Sinclair, D., 218 Garfield Place, Brooklyn, N. Y.
- Skeels, W. R., Postal Telegraph Co., Chicago, Ill.
- Slepian, A., Wheeler Insulated Wire Co., Bridgeport, Conn.

- Taylor, H. B., (Member), The William Cramp & Sons Ship & Engine Building Co., Philadelphia, Pa.  
 Thomas, A. J., L. J. Healing & Co., Ltd., Tokyo, Japan.  
 Thornwell, E. A., (Member), Manufacturer's Agent, Atlanta, Ga.  
 Turpin, O. E., American Smelting & Refining Co., Omaha, Nebr.  
 Wartfield, C. N., University of Richmond, Richmond, Va.  
 Widell, B. A., Jr., (Member), General Electric Co., Erie, Pa.  
 Work, H. R., Crocker-Wheeler Electric Mfg. Co., Ampere, N. J.  
 Zielinski, F. J., General Electric Co., Worcester, Mass.
- Total 86

**Foreign**

- Cater, C., c/o Bank of London & South America, Santiago, Chile, S. A.  
 Hopkins, H. D., Melbourne City Council, Melbourne, Victoria, Aust.  
 Iyer, A. V. D., Kanadukathan Elec. Supply Co., Kanadukathan, Ramnad Dt., Madras Pres., India  
 Knighton, D. W. R., Ste. Madeleine Sugar Co., Ltd., Usine Ste. Madeleine, San Fernando, Trinidad, B. W. I.  
 Leino, A. P., "Svetlana" Incandescent Lamp Works, Lesnoj, Leningrad, Russia  
 Mani, R. S., Tata Hydro-Elec. Supply Co., Ltd., Lalwady, Bombay 12, India  
 Pillay, J. M. P., Kastoorchand Mills, Dadar, Bombay, India  
 Shimidzu, K., Sumitomo Elec. & Wire Cable Works, Okijimaminamino-cho, Konohanaku, Osaka, Japan  
 Telmo, P. M., (Member), Public Utility Commission, Manila, P. I.
- Total 9

**STUDENTS ENROLLED**

- Ackley, Norman D., Ohio Northern University  
 Anderson, Rudolph W., University of So. Dak.  
 Anewalt, Samuel B., Lafayette College  
 Annand, George I., University of California  
 Bailly, L. W., Kansas State Agricultural College  
 Baker, Lyle W., Pennsylvania State College  
 Ballantyne, Thomas J., Drexel Institute  
 Baumgartner, Alfred G., Iowa State College  
 Berry, Paul, Missouri School of Mines  
 Black, William F., Rice Institute  
 Blau, Elmer W., University of California  
 Blickle, Herbert G., Case School of Applied Science  
 Bradley, Richard D., Kansas State Agricultural College  
 Brandt, Eugene S., Case School of Applied Science  
 Bridges, James M., University of Maine  
 Broadbent, John H., Drexel Institute  
 Brown, Clyde L., Alabama Polytechnic Institute  
 Brown, Robert E., Alabama Poly. Institute  
 Butcher, John H., Rice Institute  
 Byther, Harry S., Jr., State College of Washington  
 Cameron, A. L., Alabama Poly. Institute  
 Chappell, George R., University of Maine  
 Chew, Louis, University of California  
 Chinn, Howard A., Mass. Inst. of Technology  
 Coffman, Melvin C., Kansas State Agricultural College  
 Coles, Francis A., University of California  
 Cook, Kenneth H., Kansas State Agricultural College  
 Craddock, Gerald V., Drexel Institute  
 Orena, Francis V., Drexel Institute  
 Crosby, Lynn B., Case School of Applied Science  
 Crowell, Lysle E., University of So. Dak.  
 Daniels, Harold H., University of California  
 Ditchman, Joseph P., Case School of Applied Science  
 Dobson, Ellsworth S., Lafayette College  
 Dodge, Ernest H., Mass. Inst. of Technology  
 Drane, Henry Tupper, Alabama Poly. Institute  
 Duncan, Curtis H., University of California  
 Earl, Edwin O., Kansas State Agricultural College  
 Earle, Clifford, Marquette University  
 Eddy, George A., Rhode Island State College  
 Ellard, Walter, Northeastern University  
 Evans, Kennis, Kansas State Agricultural College  
 Fenander, Walter A., University of California  
 Fifield, Sumner H., University of Maine  
 Flanders, Norton B., University of California  
 Folsom, Elwood E., Jr., University of Maine  
 Foulon, Fred., University of California  
 Fraser, S. M., Kansas State Agricultural College  
 Fulwiler, Harry, Jr., Alabama Polytechnic Institute  
 Gabert, Ronald E., Lafayette College  
 Gilbert, Walter E., Drexel Institute  
 Goeller, Charles P., Northeastern University  
 Gorman, Walter J., Pennsylvania State College  
 Gove, Kenneth G., Mass. Inst. of Tech.  
 Grant, D. William, Kansas State Agricultural College  
 Gray, Carl J., Pennsylvania State College  
 Gregory, Claude H., University of California  
 Griswold, Elmer Prescott, Northeastern University  
 Hale, Stuart G., University of California  
 Hancock, John L., Kansas State Agricultural College  
 Hansen, Joseph, Washington State College  
 Heal, John E., Drexel Institute  
 Hottle, Warren M., Drexel Institute  
 Hunter, James H., Rice Institute  
 Ishimura, Henry M., University of California  
 Ivanof, Vladimir, University of California  
 Jacobs, Frank C., University of California  
 Johnson, Harry A., University of California  
 Johnson, Thomas J., Rice Institute  
 Johnston, Richard H., Jr., Lafayette College  
 Jones, Samuel C., Drexel Institute  
 King, Arthur W., Pennsylvania State College  
 Kirkland, Robert D., University of California  
 Knerr, Lewis R., University of California  
 Kozel, Henry C., Oklahoma A. & M. College  
 Kranenburg, P. J., Iowa State College  
 Lagrone, George N., Alabama Polytechnic Institute  
 Larson, Oscar C., Rhode Island State College  
 Laufenberg, Clemens W., University of California  
 Lindsay, James R., University of California  
 Linscott, Jack H., Kansas State Agricultural College  
 Lubeke, Harry R., University of California  
 Laundry, Victor E., Kansas State Agr. College  
 Lymburner, Lawrence E., University of Maine  
 Lynch, Thomas S., Alabama Poly. Institute  
 Lynip, Benjamin F., Jr., University of California  
 Maxwell, John F., University of California  
 Melson, George H., Drexel Institute  
 Merrels, Joseph E., Lafayette College  
 Merrill, Oliver E., Northeastern University  
 Meyers, Clifford R., University of So. Dak.  
 Michaels, Henry J., South Dakota State College  
 Michelman, Edward A., Mass. Inst. of Technology  
 Mikulasek, George W., University of California  
 Montin, J. Ragnar, University of California  
 Moore, John P., University of Maine  
 Morgan, Archie Le Roy, Kansas State Agr. College  
 Morgan, Howard K., University of California  
 Mortimer, Harold E., Rice Institute  
 Nathanson, M., McGill University  
 Newbold, Wm. Herbert, Pennsylvania State College  
 Nixon, Henry O., University of California  
 Obrecht, R. Gardner, Kansas State Agr. College  
 Oishi, Ta., University of California  
 Olsen, Raymond C., University of California  
 O'Neil, William H., Jr., Northeastern University  
 Pastoret, J. Eugene, Drexel Institute  
 Perron, Raymond T., Rhode Island State College  
 Petersen, Wilbur C., Case School of Applied Science  
 Petrick, Frank L., Jr., Pennsylvania State College  
 Phillips, William H., Mass. Inst. of Technology  
 Pickett, Gerald, Oklahoma A. & M. College  
 Poling, Virgil D., Ohio Northern University  
 Potter, James L., Kansas State Agr. College  
 Power, James R., Carnegie Inst. of Technology  
 Putnam, William H. H., Alabama Polytechnic Institute  
 Ravenscroft, Henry A., University of California  
 Reiner, Fred P., Univ. of California  
 Rezos, George, University of California  
 Richards, Amyle P., Oklahoma A. & M. College  
 Richardson, Harvey O., State Col. of Washington  
 Ricker, Raymond A., Northeastern University  
 Rigby, William H., Drexel Institute  
 Ritchie, Edward C., University of California  
 Robinson, Edward P., Ohio Northern University  
 Rogers, Thomas A., University of California  
 Rose, Harry B., University of New Hampshire  
 Sacco, Benjamin J., Northeastern University  
 Sauter, John D., The Pennsylvania State College  
 Schmidhammer, Stephen F., Pennsylvania State College  
 Schrock, John E., Kansas State Agr. College  
 Seaman, Blair C., Pennsylvania State College  
 Seeburg, Albert L., University of California  
 Shattuck, Orris C., Jr., University of So. Dak.  
 Shenk, Eli C., Kansas State Agr. College  
 Sisk, Harland P., Mass. Inst. of Tech.  
 Sloan, Claude W., Kansas State Agr. College  
 Smith, Arthur A., University of Maine  
 Soorin, Andrew J., University of California  
 Sorg, Harold E., University of California  
 Southwick, Alva F., Michigan State College  
 Stephens, Paul E., Pennsylvania State College  
 Stevens, John P., University of New Hampshire  
 Stewart, James D., Alabama Polytechnic Institute  
 Stockwell, Donald P., University of So. Dak.  
 Stone, Leighton A., University of California  
 Tabor, Howard L., Alabama Poly. Institute  
 Thompson, Wesley A., Kansas State Agr. College  
 Thurber, Walter P., University of New Hampshire  
 Tilles, Abe, University of California  
 Touraine, Edgar J., University of California  
 Vaile, Robert B., Jr., California Inst. of Tech.  
 Vallin, Gordon, University of So. Dak.  
 Vogel, M. Augustus, Lafayette College  
 Vologodsky, Nicholas T., University of California  
 Wagener, Winfield G., University of California  
 Wahlander, Adrian A., University of California  
 Walker, Robert I., Pennsylvania State College  
 Wendel, William R., Pennsylvania State College  
 Wheeler, Henry J., University of North Carolina  
 White, Harold D., University of California  
 White, Harry J., University of California  
 Wilkins, Frank F., Pennsylvania State College  
 Winer, John, Pennsylvania State College  
 Woolman, Harold A., Drexel Institute  
 Zbradovsky, Boris V., California Inst. of Tech.  
 Zehner, Richard W., Pennsylvania State College
- Total 167

**OFFICERS OF A. I. E. E. 1926-1927**

**President**  
 C. C. CHESNEY

**Junior Past Presidents**  
 M. I. PUPIN  
 FARLEY OSGOOD

**Vice-Presidents**  
 P. M. DOWNING  
 HERBERT S. SANDS  
 W. E. MITCHELL  
 ARTHUR G. PIERCE  
 W. P. DOBSON

**Managers**  
 WILLIAM M. MCCONAHEY  
 W. K. VANDERPOEL  
 H. P. CHARLESWORTH  
 JOHN B. WHITEHEAD  
 J. M. BRYANT  
 E. B. MERRIAM

**National Treasurer**  
 GEORGE A. HAMILTON

**National Secretary**  
 F. L. HUTCHINSON

**Honorary Secretary**  
 RALPH W. POPE

**LOCAL HONORARY SECRETARIES**

T. J. Fleming, Calle B. Mitre 519, Buenos Aires, Argentina, S. A.  
 H. W. Flashman, Aus. Westinghouse Elec. Co. Ltd., Cathcart House,  
 11 Castlereagh St., Sydney, N. S. W., Australia.  
 Carroll M. Mauseau, Caixa Postal No. 571, Rio de Janeiro, Brazil, S. A.  
 Charles le Maistre, 28 Victoria St., London, S. W. 1, England.  
 A. S. Garfield, 45 Bd. Beausejour, Paris 16 E, France.  
 F. W. Willis, Tata Power Companies, Bombay House, Bombay, India.  
 Guido Semenza, 39 Via Monte Napoleone, Milan, Italy.  
 P. H. Powell, Canterbury College, Christchurch, New Zealand.  
 Axel F. Enstrom, 24a Grefturegatan, Stockholm, Sweden.  
 W. Elsdon-Dew, P. O. Box 4563, Johannesburg, Transvaal, Africa.

**A. I. E. E. COMMITTEES**

(A list of the personnel of Institute committees may be found in the September issue of the JOURNAL and will be published again in the January 1927 issue.)

**GENERAL STANDING COMMITTEES AND CHAIRMEN**

EXECUTIVE, C. C. Chesney  
 FINANCE, H. A. Kidder  
 MEETINGS AND PAPERS, E. B. Meyer  
 PUBLICATION, L. F. Morehouse  
 COORDINATION OF INSTITUTE ACTIVITIES, Farley Osgood  
 BOARD OF EXAMINERS, Erich Hausmann  
 SECTIONS, Harold B. Smith  
 STUDENT BRANCHES, C. E. Magnusson  
 MEMBERSHIP, L. S. O'Roark  
 HEADQUARTERS, G. L. Knight  
 LAW, W. I. Slichter  
 PUBLIC POLICY, Gano Dunn  
 STANDARDS, J. Franklin Meyer  
 EDISON MEDAL, Gano Dunn  
 CODE OF PRINCIPLES OF PROFESSIONAL CONDUCT, John W. Lieb  
 COLUMBIA UNIVERSITY SCHOLARSHIP, W. I. Slichter  
 AWARD OF INSTITUTE PRIZES, E. B. Meyer  
 SAFETY CODES, J. P. JACKSON

**SPECIAL COMMITTEES**

LICENSING OF ENGINEERS, Francis Blossom  
 TECHNICAL ACTIVITIES, A. G. Pierce

**TECHNICAL COMMITTEES AND CHAIRMEN**

COMMUNICATION, H. P. Charlesworth  
 EDUCATION, P. M. Lincoln  
 ELECTRICAL MACHINERY, H. M. Hobart  
 ELECTROCHEMISTRY AND ELECTROMETALLURGY, George W. Vinal  
 ELECTROPHYSICS, V. Karapetoff  
 INSTRUMENTS AND MEASUREMENTS, A. E. Knowlton  
 APPLICATIONS TO IRON AND STEEL PRODUCTION, A. G. Pierce  
 PRODUCTION AND APPLICATION OF LIGHT, Preston S. Millar  
 APPLICATIONS TO MARINE WORK, G. A. Pierce  
 APPLICATIONS TO MINING WORK, W. H. Lesser  
 GENERAL POWER APPLICATIONS, A. M. MacCutcheon  
 POWER GENERATION, H. W. Eales  
 POWER TRANSMISSION AND DISTRIBUTION, Philip Torchio  
 PROTECTIVE DEVICES, F. L. Hunt  
 RESEARCH, John B. Whitehead  
 TRANSPORTATION, J. V. B. Duer

**A. I. E. E. REPRESENTATION**

(The Institute is represented on the following bodies; the names of the representatives may be found in the September issue of the JOURNAL and will be published again in the January 1927 issue.)

AMERICAN ASSOCIATION FOR THE ADVANCEMENT OF SCIENCE, COUNCIL  
 AMERICAN BUREAU OF WELDING  
 AMERICAN COMMITTEE OF ELECTROLYSIS  
 AMERICAN ENGINEERING COUNCIL  
 AMERICAN ENGINEERING STANDARDS COMMITTEE  
 AMERICAN MARINE STANDARDS COMMITTEE  
 AMERICAN YEAR BOOK, ADVISORY BOARD  
 APPARATUS MAKERS AND USERS COMMITTEE  
 BOARD OF TRUSTEES, UNITED ENGINEERING SOCIETY  
 CHARLES A. COFFIN FELLOWSHIP AND RESEARCH FUND COMMITTEE  
 COMMITTEE ON ELIMINATION OF FATIGUE, SOCIETY OF INDUSTRIAL ENGINEERS  
 ENGINEERING FOUNDATION BOARD  
 JOHN FRITZ MEDAL BOARD OF AWARD  
 JOINT COMMITTEE ON COMPENSATION, CHARLES F. SCOTT  
 JOINT COMMITTEE ON WELDED RAIL JOINTS  
 JOINT CONFERENCE COMMITTEE OF FOUR FOUNDER SOCIETIES  
 LIBRARY BOARD, UNITED ENGINEERING SOCIETY  
 NATIONAL FIRE PROTECTION ASSOCIATION, ELECTRICAL COMMITTEE  
 NATIONAL FIRE WASTE COUNCIL  
 NATIONAL MUSEUM OF ENGINEERING AND INDUSTRY, BOARD OF TRUSTEES  
 NATIONAL RESEARCH COUNCIL, ENGINEERING DIVISION  
 NATIONAL SAFETY COUNCIL, ELECTRICAL COMMITTEE OF ENGINEERING SECTION  
 THE NEWCOMEN SOCIETY  
 RADIO ADVISORY COMMITTEE, BUREAU OF STANDARDS  
 SOCIETY FOR THE PROMOTION OF ENGINEERING EDUCATION, BOARD OF INVESTIGATION AND COORDINATION  
 U. S. NATIONAL COMMITTEE OF THE INTERNATIONAL ELECTROTECHNICAL COMMISSION  
 U. S. NATIONAL COMMITTEE OF THE INTERNATIONAL ILLUMINATION COMMISSION  
 WASHINGTON AWARD, COMMISSION OF

**LIST OF SECTIONS**

Name	Chairman	Secretary	Name	Chairman	Secretary
Akron	A. R. Holden	H. L. Steinbach, Electrical Engineering Dept., Goodyear Tire & Rubber Co., Akron, Ohio	Fort Wayne	D. W. Merchant	C. F. Beyer, General Electric Co., Fort Wayne, Ind.
Atlanta	C. E. Bennett	W. F. Oliver, Box 2211, Atlanta, Ga.	Indianapolis-Lafayette	J. B. Bailey	C. A. Fay, 4206 Cornelius Ave., Indianapolis, Ind.
Baltimore	W.B. Kouwenhoven	R. T. Greer, Madison St. Building, Baltimore, Md.	Ithaca	R. F. Chamberlain	G. F. Bason, Electrical Engineering Dept., Cornell University, Ithaca, N. Y.
Boston	Hartley Rowe	W. H. Colburn, 39 Boylston St., Boston, Mass.	Kansas City	R. L. Baldwin	S. M. De Camp, 510 Dwight Bldg., Kansas City, Mo.
Chicago	K. A. Auty	William Wurth, 1634 Peoples Gas Bldg., Michigan Ave. at Adams St., Chicago, Ill.	Lehigh Valley	W. E. Lloyd, Jr.	G. W. Brooks, Pennsylvania Power & Light Co., 8th & Hamilton Sts., Allentown, Pa.
Cincinnati	W. P. Beattie	L. J. Gregory, Union Gas & Electric Co., Cincinnati, Ohio	Los Angeles	R. E. Cunningham	L. C. Williams, H. W. Hellman Bldg., Los Angeles, Calif.
Cleveland	H. L. Grant	W. E. McFarland, 720 Illuminating Bldg., Cleveland, Ohio	Lynn	D. F. Smalley	Chas. Skoglund, River Works, General Electric Co., W. Lynn, Mass.
Columbus	A. W. Janowitz	E. A. Williams, 231 N. Fifth St., Columbus, Ohio	Madison	E. J. Kallevang	H. J. Hunt, D. W. Mead & C. V. Seastone, State Journal Bldg., Madison, Wis.
Connecticut	A. E. Knowlton	R. G. Warner, Yale University, 10 Hillhouse Ave., New Haven, Conn.	Mexico	Carlos Macias	G. Solis Payan, Ave. Portales 89, General Anaya, Mexico D. F., Mexico.
Denver	W. H. Edmunds	R. B. Bonney, Telephone Bldg., P. O. Box 960, Denver, Colo.	Milwaukee	H. L. Van Valkenberg	R. G. Lockett, Cutler-Hammer Mfg. Co., Milwaukee, Wis.
Detroit-Ann Arbor	Harold Cole	F. H. Riddie, Champion Porcelain Co., Detroit, Mich.	Minnesota	S. B. Hood	M. E. Todd, University of Minnesota, Minneapolis, Minn.
Erie	F. A. Tennant	L. H. Curtis, General Electric Co., Erie, Pa.	Nebraska	C. W. Minard	N. W. Kingsley, 1303 Telephone Bldg., Omaha, Nebr.

## LIST OF SECTIONS—Continued.

Name	Chairman	Secretary	Name	Chairman	Secretary
New York	E. B. Meyer	O. B. Blackwell, American Tel. & Tel. Co., 195 Broadway, New York, N. Y.	Sharon	H. L. Cole	L. E. Hill, Westinghouse Elec. & Mfg. Co., Sharon, Pa.
Niagara Frontier	H. B. Alverson	A. W. Underhill, Jr., 608 Lafayette Bldg., Buffalo, N. Y.	Southern Virginia	W. S. Rodman	J. M. Berry, 1358 Rockbridge Ave., Norfolk, Va.
Oklahoma	E. R. Page	C. C. Stewart, Oklahoma Gas & Electric Co., Norman, Okla.	Spokane	Richard McKay	James B. Pluken, Washington Water Power Co., Lincoln & Trent, Spokane, Wash.
Panama	L. W. Parsons	I. F. McIlhenny, Box 413, Balboa Heights, C. Z.	Springfield, Mass.	L. P. Curtis	J. Frank Murray, United Electric Light Co., 251 Wilbraham Ave., Springfield, Mass.
Philadelphia	Louis J. Costa	R. H. Silbert, 2301 Market St., Philadelphia, Pa.	Syracuse	C. E. Dorr	P. E. Verdin, 615 City Bank Bldg., Syracuse, N. Y.
Pittsburgh	D. M. Simons	W. C. Goodwin, Westinghouse Elec. & Mfg. Co., East Pittsburgh, Pa.	Toledo	O. P. Rabbe	Max Neuber, 1257 Fernwood Ave., Toledo, Ohio
Pittsfield	E. F. Gehrken	C. H. Kline, General Electric Co., Pittsfield, Mass.	Toronto	M. B. Hastings	P. P. Ambuhl, Toronto Hydro-Electric System, 226 Yonge St., Toronto, Ontario
Portland, Ore.	J. C. Henkle	J. E. Yates, Gasco Bldg., Portland, Ore.	Urbana	J. T. Tykociner	L. B. Archer, 301 Electrical Engineering Lab., University of Illinois, Urbana, Ill.
Providence	Edwin E. Nelson	F. W. Smith, Blackstone Valley Gas & Electric Co., Pawtucket, R. I.	Utah	B. C. J. Wheatlake	D. L. Brundige, Utah Power & Light Co., Box 1700, Salt Lake City, Utah
Rochester	Earl C. Karker	Wade H. Reichard, General Ry. Signal Co., Rochester, N. Y.	Vancouver	R. L. Hall	C. W. Colvin, C. Electric Railway Co., 425 Carrall St., Vancouver, B. C.
St. Louis	W. H. Millan	L. N. Van Hook, 3869 Park Ave., St. Louis, Mo.	Washington, D. C.	C. A. Robinson	D. S. Wegg, Dept. of Commerce, Room 817, Pennsylvania Ave., at 19th St., N. W., Washington, D. C.
San Francisco	D. I. Cone	A. G. Jones, 807 Rialto Bldg., San Francisco, Calif.	Worcester	C. F. Hood	F. B. Crosby, Morgan Construction Co., 15 Belmont St., Worcester, Mass.
Saskatchewan	S. R. Parker	W. P. Brattle, Dept. of Telephones, Telephone Bldg., Regina, Sask.	Total 51		
Schenectady	R. E. Doherty	R. F. Franklin, Room 301, Bldg. No. 41, General Electric Co., Schenectady, N. Y.			
Seattle	C. E. Mong	C. R. Wallis, 609 Colman Bldg., P. O. Box 1858, Seattle, Wash.			

## LIST OF BRANCHES

Name and Location	Chairman	Secretary	Counselor (Member of Faculty)
Alabama Polytechnic Institute, Auburn, Ala.	J. D. Stewart	I. L. Knox	W. W. Hill
Alabama, University of, University, Ala.	C. E. Rankin	Sewell St. John	
Arizona, University of, Tucson, Ariz.	J. W. Cruse		
Arkansas, University of, Fayetteville, Ark.	Carroll Walsh	W. H. Mann	W. B. Stelzner
Armour Institute of Technology, Chicago, Ill.	M. T. Goetz	C. W. Schramm	D. P. Moreton
Brooklyn Polytechnic Institute, Brooklyn, N. Y.	F. Wanpel	Joseph Heller	Robin Beach
Bucknell University, Lewisburg, Pa.	A. Fogelsanger	J. D. Johnson	W. K. Rhodes
California Institute of Technology, Pasadena, Calif.	Thomas L. Gottier	Alan E. Capon	R. W. Sorensen
California, University of, Berkeley, Calif.	C. F. Dalziel	R. S. Briggs	T. C. McFarland
Carnegie Institute of Technology, Pittsburgh, Pa.	J. R. Power	R. O. Perrine	B. C. Dennison
Case School of Applied Science, Cleveland, O.	C. A. Baldwin	E. E. Samson	H. B. Dates
Catholic University of America, Washington, D. C.	B. J. Kroeger	J. E. O'Brien	T. J. MacKavanaugh
Cincinnati, University of, Cincinnati, O.	F. Sanford	W. C. Osterbrock	W. C. Osterbrock
Clarkson College of Technology, Potsdam, N. Y.	W. R. MacGregor	L. G. Carney	A. R. Powers
Clemson Agricultural College, Clemson College, S. C.	L. R. Miller	J. U. Wilson	S. R. Rhodes
Colorado State Agricultural College, Ft. Collins, Colo.	C. O. Nelson	D. W. Asay	
Colorado, University of, Boulder, Colo.	A. D. Thomas	J. A. Setter	W. C. DuVall
Cooper Union, New York, N. Y.	F. H. Miller	H. T. Wilhelm	Norman L. Towle
Denver, University of, Denver, Colo.	Harold Henson	Allea Ohlson	R. E. Nyswander
Drexel Institute, Philadelphia, Pa.	H. D. Baker	R. S. Eininger, Jr.	E. O. Lange
Florida, University of, Gainesville, Fla.	W. Stanwix-Hay	R. D. Ross	J. M. Weil
Georgia School of Technology, Atlanta, Ga.	W. M. McGraw	F. L. Kaestle	E. S. Hannaford
Idaho, University of, Moscow, Idaho	J. W. Gartin	S. Blore	J. H. Johnson
Iowa State College, Ames, Iowa	A. G. Baumgartner	J. B. Cecil	F. A. Fish
Iowa, University of, Iowa City, Iowa	L. Dimond	A. C. Boeke	A. H. Ford
Kansas State College, Manhattan, Kans.	A. M. Young	John Yost	C. E. Reid
Kansas, University of, Lawrence, Kans.	W. L. Immer	H. R. Hilkey	G. C. Shaad
Kentucky, University of, Lexington, Ky.	J. A. Weingartner	C. E. Albert	
Lafayette College, Easton, Pa.	Herbert Heinrich	Daniel Paul	Morland King
Lehigh University, S. Bethlehem, Pa.	F. G. Kear	J. H. Shuhart	J. L. Beaver
Lewis Institute, Chicago, Ill.	O. D. Westerberg	R. G. Raymond	F. A. Rogers
Louisiana State University, Baton Rouge, La.	K. J. Ozment	E. P. Athens	M. B. Voorhies
Maine, University of, Orono, Me.	S. B. Coleman	H. S. McPhee	W. E. Barrows, Jr.
Marquette University, Milwaukee, Wis.	R. M. Franey	E. T. Baldwin	J. F. H. Douglas
Massachusetts Institute of Technology, Cambridge, Mass.	Constantine Bary	E. A. Michelman	W. H. Timbie
Michigan State College, East Lansing	Mr. Way	Mr. Phelps	L. S. Foltz
Michigan, University of, Ann Arbor, Mich.	M. H. Nelson	H. R. Stevenson	B. F. Bailey
Milwaukee, Engineering School of, Milwaukee, Wis.	S. A. Moore	B. J. Chromy	B. A. Bovee
Minnesota, University of, Minneapolis, Minn.	C. H. Burmeister	J. H. DuBois	H. Kuhlmann
Missouri, University of, Columbia, Mo.	M. P. Weinbach	L. Spraragen	M. P. Weinbach
Missouri School of Mines and Metallurgy, Rolla, Mo.	W. J. Maulder	R. P. Baumgartner	I. H. Lovett
Montana State College, Bozeman, Mont.	W. E. Pakala	J. A. Thaler	J. A. Thaler
Nebraska, University of, Lincoln, Neb.	R. Worrest	C. J. Madsen	F. W. Norris
Nevada, University of, Reno, Nev.	George Fairbrother	Cornelius Fort	S. G. Palmer
New Hampshire, University of, Durham, N. H.	T. C. Tappan	F. W. Hussey	
New York, College of the City of, New York, N. Y.	Harold Wolf	J. Leipziger	Harry Baum
New York University, New York, N. Y.	H. U. Hefty	Henry Och	J. Loring Arnold
North Carolina State College, Raleigh, N. C.	J. W. Fagan	W. E. Mathews	G. C. Cox
North Carolina, University of, Chapel Hill	H. L. Coe	C. M. Lear	P. H. Daggett
North Dakota, University of, University	V. L. Cox	O. B. Medalen	D. R. Jenkins



## LIST OF BRANCHES—Continued

Name and Location	Chairman	Secretary	Counselor (Member of Faculty)
Northeastern University, Boston, Mass.	W. P. Raffone	John L. Clark	W. L. Smith
Notre Dame, University of, Notre Dame, Ind.	W. C. Davis	C. H. Schamel	J. A. Caparo
Ohio Northern University, Ada, Ohio	M. Heft	P. W. Wadsworth	
Ohio State University, Columbus, O.	Lee P. Doyle	J. S. Hoddy	F. C. Caldwell
Ohio University, Athens, Ohio	N. R. Smith	J. E. Quick	A. A. Atkinson
Oklahoma A. & M. College, Stillwater, Okla.	W. J. Beckett	Lee Rogers	Edwin Kurtz
Oklahoma, University of, Norman, Okla.	G. B. Brady	J. C. Glaze	F. G. Tappan
Oregon Agricultural College, Corvallis, Ore.	F. D. Crowther	E. F. Reddy	F. O. McMillan
Pennsylvania State College, State College, Pa.	F. F. Wilkins	C. C. Huggler	L. A. Doggett
Pennsylvania, University of, Philadelphia	F. H. Riordan, Jr.	W. H. Hamilton	C. D. Fawcett
Pittsburgh, University of, Pittsburgh, Pa.	M. G. Jarrett	D. P. Mitchell	H. E. Dyche
Purdue University, Lafayette, Ind.	A. Howard	T. B. Holliday	A. N. Topping
Rensselaer Polytechnic Institute, Troy, N. Y.	F. M. Sebast	W. C. Michels	F. M. Sebast
Rhode Island State College, Kingston, R. I.	G. A. Eddy	C. Easterbrooks	Wm. Anderson
Rose Polytechnic Institute, Terre Haute, Ind.	J. H. Utt	E. Letsinger	C. C. Knipmeyer
Rutgers University, New Brunswick, N. J.	E. C. Siddons	W. H. Bohlke	F. F. Thompson
South Dakota State School of Mines, Rapid City, S. D.	C. Allen	Harold Eade	J. O. Kammerman
South Dakota, University of, Vermillion, S. D.	Maurice Nelles	Stanley Boegler	B. B. Brackett
Southern California, University of, Los Angeles, Calif.	Karl Raife	E. E. Smith	C. E. Guse
Staford University, Stanford University, Calif.	A. V. Pering	J. G. Sharp	H. H. Henline
Stevens Institute of Technology, Hoboken, N. J.	D. B. Wesstrom	Gene Witham	Frank C. Stockwell
Swarthmore College, Swarthmore, Pa.	J. S. Donal, Jr.	R. W. Lafore	Lewis Fussell
Syracuse University, Syracuse, N. Y.	G. F. Kern	T. P. Hall	C. W. Henderson
Tennessee, University of, Knoxville, Tenn.	K. N. Green	B. M. Gallaher	Charles A. Perkins
Texas A. & M. College, College Station, Texas	C. A. Altenbern	J. L. Pratt	F. C. Bolton
Texas, University of, Austin, Tex.	F. W. Langner	H. W. Zuch	J. A. Correll
Utah, University of, Salt Lake City, Utah	F. C. Bates	C. E. Hoffman	J. F. Merrill
Virginia Military Institute, Lexington, Va.	R. P. Williamson	M. L. Waring	S. W. Ariderson
Virginia Polytechnic Institute, Blacksburg, Va.	M. R. Staley	R. M. Hutcheson	Claudius Lee
Virginia, University of, University, Va.	R. C. Small	G. L. Lefevre	W. S. Rodman
Washington, State College of, Pullman, Wash.	S. H. White	H. R. Meahl	H. V. Carpenter
Washington University, St. Louis, Mo.	E. B. Kempster, Jr.	R. L. Belshe	H. G. Hake
Washington, University of, Seattle, Wash.	C. M. Murray, Jr.	Roy H. Crosby	George S. Smith
Washington and Lee University, Lexington, Va.	D. S. McCorkle	C. M. Wood	R. W. Dickey
West Virginia University, Morgantown, W. Va.	I. L. Smith	P. E. Davis	A. H. Forman
Wisconsin, University of, Madison, Wis.	Benj. Teare	N. B. Thayer	C. M. Jansky
Worcester Polytechnic Institute, Worcester, Mass.	D. A. Calder	C. H. Kauke	H. A. Maxfield
Wyoming, University of, Laramie, Wyo.	John Hicks	J. O. Yates	G. H. Sechrist
Yale University, New Haven, Conn.	W. W. Parker	J. W. Hinkley	Charles F. Scott

Total 89

# DIGEST OF CURRENT INDUSTRIAL NEWS

## NEW CATALOGUES AND OTHER PUBLICATIONS

*Mailed to interested readers by issuing companies*

**Circuit Breakers.**—Bulletin 1004, 40 pp. "The Selection and Application of Oil Circuit Breakers." Condit Electrical Manufacturing Corporation, Boston, Mass.

**Air Filters.**—Bulletin 2223, 12 pp. Describes American Blower air filters, cell construction type. American Blower Company, Detroit, Mich.

**Tree Wire.**—Bulletin, 24 pp. Describes Okonite tree wire, for use when electric light and power lines must be placed through trees. The Okonite Company, Passaic, N. J.

**Power Rectifiers.**—Bulletin 301, 20 pp. Describes mercury arc power rectifiers, manual or automatic control. American Brown Boveri Electric Corporation, 165 Broadway, New York.

**Motors.**—Bulletin 111, 4 pp. Describes Type H-O self starting, squirrel cage motors, equipped with only one rotor winding. Northwestern Manufacturing Company, Milwaukee, Wis.

**Ball Bearings.**—Bulletin, 32 pp. "Ball Bearings for Electric Motors." Describes the advantages of ball bearings for electrical machinery and economies effected by their use. Illustrations show applications of ball bearing equipped motors in the various industries. The Fafnir Bearing Company, New Britain, Conn.

**Control Apparatus.**—Bulletin 600, 8 pp., A-C. Resistance Starters; Bulletin 710, 4 pp., Across-The-Line Starting Switch; Bulletin 740, 4 pp., Automatic Resistance Starters. All bulletins with price lists. Allen-Bradley Company, 496 Clinton Street, Milwaukee, Wis.

**Ball Bearings.**—Bulletin, 20 pp., "Cutting Your Costs or What New Departure Ball Bearings Mean In Your Motor." Describes the advantages of New Departure ball bearings when applied to electric motors, and gives figures showing upkeep savings resulting through their use. The New Departure Manufacturing Company, Bristol, Conn.

**Mica.**—Bulletin, 24 pp., "Mica and Mica Products." Material from which this publication has been compiled was taken from a series of lectures on electrical insulating materials by Professor H. Schering, of Berlin, and describes the varieties and applications of mica for electrical insulation principally. William Brand & Company, 27 East 22nd Street, New York.

**Roller Bearings.**—The new Timken Engineering Journal, a loose-leaf book of 110 pp., contains technical information relative to the application of Timken bearings to automotive and industrial machinery. Typical problems, with the solutions, involving the calculation of various loads and the selection of suitable bearings are given. Tables showing bearing ratings, capacities and dimensions, as well as speed capacity-curves, are included. A full set of dimension sheets accurately drawn to scale, together with formulas and recommendations for the application of Timken bearings, developed through experience gained in applying more than 150,000,000 bearings, comprise another section. The Timken Roller Bearing Company, Canton, Ohio.

## NOTES OF THE INDUSTRY

**New Sales Manager for Wagner Electric Corporation.**—Edward H. Cheney has been appointed sales manager of the Wagner Electric Corporation at St. Louis, succeeding Thomas T. Richards, who resigned October 1st. Mr. Cheney has been with the Wagner Corporation since 1905, when he was appointed Chicago office manager. In 1909 he was promoted to Chicago district manager, in which position he served up until his recent appointment as sales manager.

**General Electric Sales.**—The statement of sales and net earnings of the General Electric Company for the nine months

ending September 30, announced by President Gerard Swope, shows the net sales totalled \$229,638,216 and the profit available for dividends on common stock and surplus was \$30,051,619. Orders received for the three months ending September 30, totalled \$81,587,917, as compared with \$73,561,483 for the same quarter in 1925, an increase of 11%.

**The Power Plant Supply Company, Widener Building, Philadelphia,** has been organized to furnish power plants in Philadelphia and vicinity with engineering equipment and supplies. The activities of the company will be devoted between two departments; the supply department will act as jobbers or agents for power plant supply material, and the engineering department will handle the consulting and special service work of its customers.

**Ohio Brass Will Have New Office Building.**—Much needed larger working quarters will be provided for the general offices of the Ohio Brass Company when the new administration building is completed, on which construction work started October 1st. The new office building will cost approximately \$500,000. It is to be a five-story steel and brick structure, fire-proof throughout.

**Pennsylvania Railroad Orders More Electrical Equipment.**—The Pennsylvania Railroad has recently placed an order with the Westinghouse Electric & Manufacturing Company for electrical equipment for ninety-three coaches. In addition, the contract calls for motors and control for four large electrical passenger locomotives. These coaches will be put into service on the Wilmington Division now being modified for electrical operation.

**American Brown Boveri Appointments.**—G. C. Barry has been appointed assistant to Earle T. Hines, general sales manager of the American Brown Boveri Corporation at 165 Broadway, manufacturers of heavy electrical equipment. Mr. Barry began his electrical career with the Western Electric Company in 1912, and later became associated with the Hart Manufacturing Company at Hartford. Major James R. Worth has been placed in charge of the Holding Company sales. Previously he had been in charge of power plant construction in the U. S. Army and was subsequently connected with other power companies.

**Large New York Building To Be Floodlighted.**—The Paramount Building on Times Square, New York, now nearing completion, will have the largest installation of floodlights which has ever been made, according to the General Electric Company. The building is thirty-five stories high, and from the thirteenth to the thirty-fifth floor it will be floodlighted. These upper stories are set back to conform to the new zoning law in New York. The lighting equipment consists of 473 G-E types L9-11-15 floodlights, with a total load of 230 kilowatts.

**Cleveland Honors Electrical Industry.**—The electrical industry of Cleveland, on October 26, was toasted by 2,000 of the city's leading business men attending a huge luncheon meeting in the mammoth convention hall to learn about Cleveland's position in the electrical world. A special census developed the fact that Cleveland has 135 manufacturers of electrical products which utilize \$75,000,000 of capital, outside of the many millions invested in the electrical public utilities. The output of these manufacturers in the last year had a value of \$130,000,000 exclusive of the value of public utility services. Among those presented to the meeting were R. C. Norberg, vice-president of the Willard Storage Battery Company; Charles F. Brush, inventor of the arc lamp; Joseph H. Alexander, the new president of the Cleveland Railway Company; and Edwin F. Carter, new president of the Ohio Bell Telephone Company. The two principal speakers were J. F. Lincoln, vice-president of the Lincoln Electric Company, and M. H. Aylesworth, president of the newly formed National Broadcasting Company, Inc.



The careful investor judges a security by the history of its performance.

# KERITE

in a half-century of continuous production, has spun out a record of performance that is unequalled in the history of insulated wires and cables.

Kerite is a seasoned security.

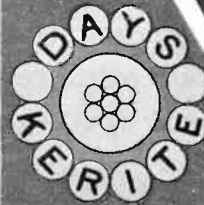
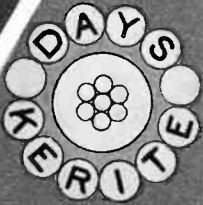

**THE KERITE INSULATED WIRE & CABLE COMPANY INC**  
 NEW YORK    SAN FRANCISCO    CHICAGO

# DIGEST OF CURRENT INDUSTRIAL NEWS

## NEW CATALOGUES AND OTHER PUBLICATIONS

*Mailed to interested readers by issuing companies*

**Circuit Breakers.**—Bulletin 1004, 40 pp. "The Selection and Application of Oil Circuit Breakers." Condit Electrical Manufacturing Corporation, Boston, Mass.

**Air Filters.**—Bulletin 2223, 12 pp. Describes American Blower air filters, cell construction type. American Blower Company, Detroit, Mich.

**Tree Wire.**—Bulletin, 24 pp. Describes Okonite tree wire, for use when electric light and power lines must be placed through trees. The Okonite Company, Passaic, N. J.

**Power Rectifiers.**—Bulletin 301, 20 pp. Describes mercury arc power rectifiers, manual or automatic control. American Brown Boveri Electric Corporation, 165 Broadway, New York.

**Motors.**—Bulletin 111, 4 pp. Describes Type H-O self starting, squirrel cage motors, equipped with only one rotor winding. Northwestern Manufacturing Company, Milwaukee, Wis.

**Ball Bearings.**—Bulletin, 32 pp. "Ball Bearings for Electric Motors." Describes the advantages of ball bearings for electrical machinery and economies effected by their use. Illustrations show applications of ball bearing equipped motors in the various industries. The Fafnir Bearing Company, New Britain, Conn.

**Control Apparatus.**—Bulletin 600, 8 pp., A-C. Resistance Starters; Bulletin 710, 4 pp., Across-The-Line Starting Switch; Bulletin 740, 4 pp., Automatic Resistance Starters. All bulletins with price lists. Allen-Bradley Company, 496 Clinton Street, Milwaukee, Wis.

**Ball Bearings.**—Bulletin, 20 pp., "Cutting Your Costs or What New Departure Ball Bearings Mean In Your Motor." Describes the advantages of New Departure ball bearings when applied to electric motors, and gives figures showing upkeep savings resulting through their use. The New Departure Manufacturing Company, Bristol, Conn.

**Mica.**—Bulletin, 24 pp., "Mica and Mica Products." Material from which this publication has been compiled was taken from a series of lectures on electrical insulating materials by Professor H. Schering, of Berlin, and describes the varieties and applications of mica for electrical insulation principally. William Brand & Company, 27 East 22nd Street, New York.

**Roller Bearings.**—The new Timken Engineering Journal, a loose-leaf book of 110 pp., contains technical information relative to the application of Timken bearings to automotive and industrial machinery. Typical problems, with the solutions, involving the calculation of various loads and the selection of suitable bearings are given. Tables showing bearing ratings, capacities and dimensions, as well as speed capacity-curves, are included. A full set of dimension sheets accurately drawn to scale, together with formulas and recommendations for the application of Timken bearings, developed through experience gained in applying more than 150,000,000 bearings, comprise another section. The Timken Roller Bearing Company, Canton, Ohio.

## NOTES OF THE INDUSTRY

**New Sales Manager for Wagner Electric Corporation.**—Edward H. Cheney has been appointed sales manager of the Wagner Electric Corporation at St. Louis, succeeding Thomas T. Richards, who resigned October 1st. Mr. Cheney has been with the Wagner Corporation since 1905, when he was appointed Chicago office manager. In 1909 he was promoted to Chicago district manager, in which position he served up until his recent appointment as sales manager.

**General Electric Sales.**—The statement of sales and net earnings of the General Electric Company for the nine months

ending September 30, announced by President Gerard Swope, shows the net sales totalled \$229,638,216 and the profit available for dividends on common stock and surplus was \$30,051,619. Orders received for the three months ending September 30, totalled \$81,587,917, as compared with \$73,561,483 for the same quarter in 1925, an increase of 11%.

**The Power Plant Supply Company, Widener Building, Philadelphia,** has been organized to furnish power plants in Philadelphia and vicinity with engineering equipment and supplies. The activities of the company will be devoted between two departments; the supply department will act as jobbers or agents for power plant supply material, and the engineering department will handle the consulting and special service work of its customers.

**Ohio Brass Will Have New Office Building.**—Much needed larger working quarters will be provided for the general offices of the Ohio Brass Company when the new administration building is completed, on which construction work started October 1st. The new office building will cost approximately \$500,000. It is to be a five-story steel and brick structure, fire-proof throughout.

**Pennsylvania Railroad Orders More Electrical Equipment.**—The Pennsylvania Railroad has recently placed an order with the Westinghouse Electric & Manufacturing Company for electrical equipment for ninety-three coaches. In addition, the contract calls for motors and control for four large electrical passenger locomotives. These coaches will be put into service on the Wilmington Division now being modified for electrical operation.

**American Brown Boveri Appointments.**—G. C. Barry has been appointed assistant to Earle T. Hines, general sales manager of the American Brown Boveri Corporation at 165 Broadway, manufacturers of heavy electrical equipment. Mr. Barry began his electrical career with the Western Electric Company in 1912, and later became associated with the Hart Manufacturing Company at Hartford. Major James R. Worth has been placed in charge of the Holding Company sales. Previously he had been in charge of power plant construction in the U. S. Army and was subsequently connected with other power companies.

**Large New York Building To Be Floodlighted.**—The Paramount Building on Times Square, New York, now nearing completion, will have the largest installation of floodlights which has ever been made, according to the General Electric Company. The building is thirty-five stories high, and from the thirteenth to the thirty-fifth floor it will be floodlighted. These upper stories are set back to conform to the new zoning law in New York. The lighting equipment consists of 473 G-E types L9-11-15 floodlights, with a total load of 230 kilowatts.

**Cleveland Honors Electrical Industry.**—The electrical industry of Cleveland, on October 26, was toasted by 2,000 of the city's leading business men attending a huge luncheon meeting in the mammoth convention hall to learn about Cleveland's position in the electrical world. A special census developed the fact that Cleveland has 135 manufacturers of electrical products which utilize \$75,000,000 of capital, outside of the many millions invested in the electrical public utilities. The output of these manufacturers in the last year had a value of \$130,000,000 exclusive of the value of public utility services. Among those presented to the meeting were R. C. Norberg, vice-president of the Willard Storage Battery Company; Charles F. Brush, inventor of the arc lamp; Joseph H. Alexander, the new president of the Cleveland Railway Company; and Edwin F. Carter, new president of the Ohio Bell Telephone Company. The two principal speakers were J. F. Lincoln, vice-president of the Lincoln Electric Company, and M. H. Aylesworth, president of the newly formed National Broadcasting Company, Inc.

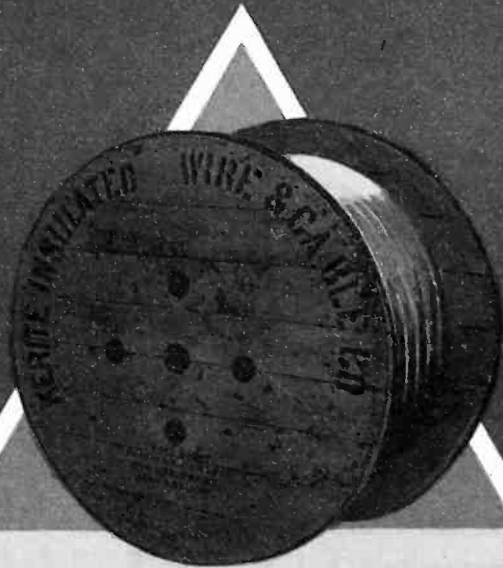

The careful investor judges a security by the history of its performance.

# KERITE

in a half-century of continuous production, has spun out a record of performance that is unequalled in the history of insulated wires and cables.

Kerite is a seasoned security.

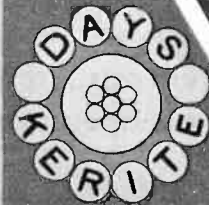
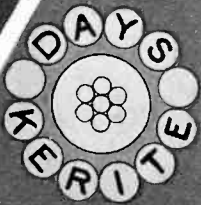

**THE KERITE INSULATED WIRE & CABLE COMPANY INC**  
 NEW YORK    SAN FRANCISCO    CHICAGO

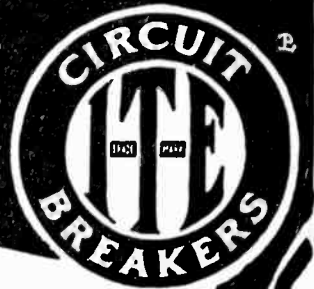

# PROTECTION!

Cutter has made Circuit Breaker history—has designed, refined and perfected I-T-E Protection. Today, farsighted executives and chief engineers demand I-T-E Breakers for the safety they afford. I-T-E Protection is adequate—it is sure—it is 100 per cent dependable. It entirely displaces fuses, safety switches or other disconnecting devices.

In short, I-T-E is the one and only *right* protection—and only a Cutter Circuit Breaker can give such far-reaching security against the “shorts” and overloads encountered in modern, everyday plant operation.

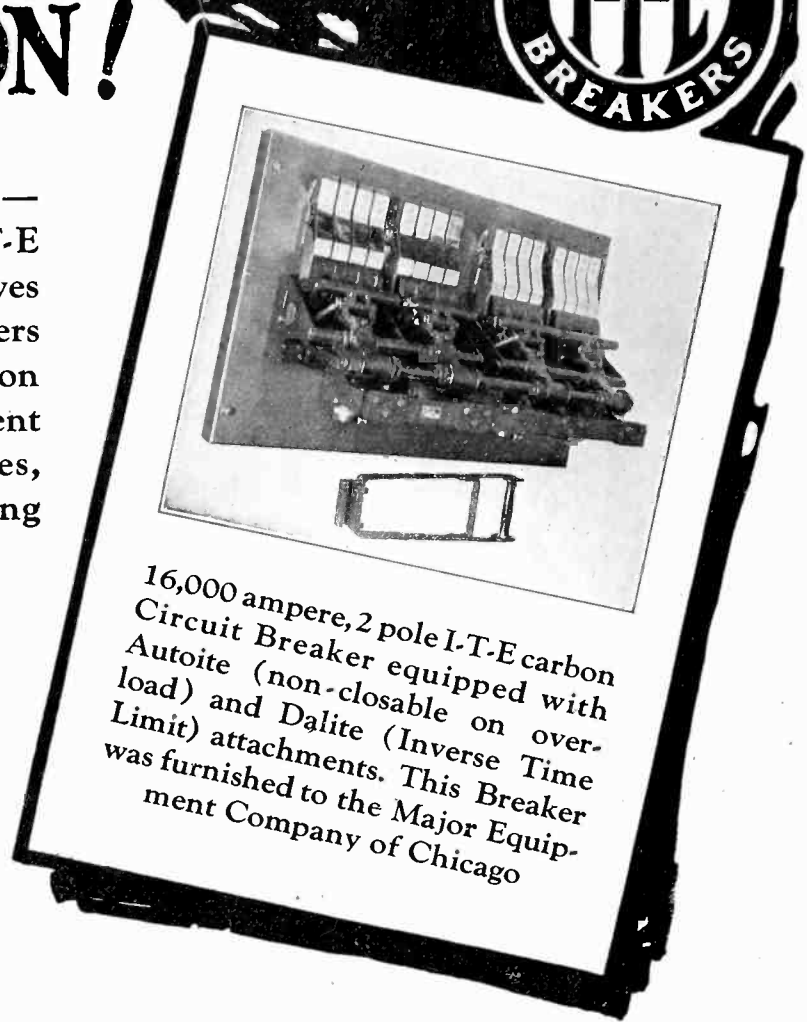

16,000 ampere, 2 pole I-T-E carbon Circuit Breaker equipped with Autoite (non-closable on overload) and Dalite (Inverse Time Limit) attachments. This Breaker was furnished to the Major Equipment Company of Chicago

THE CUTTER COMPANY

ESTABLISHED 1888—PHILADELPHIA  
1829 Hamilton Street

# CUTTER

U-RE-LITE    I-T-E    CIRCUIT BREAKERS



## Giving "General Purpose" a New and Broader Meaning

New Departure Ball Bearings in the general purpose electric motor permit mounting that motor with shaft horizontal, vertical, or tilted; —and with feet on the floor, wall or ceiling without *change in the position of end bells*.

New Departures permit the use of grease as a lubricant and this, with New Departure-designed seals and enclosures, banishes these and many other difficulties inherent in the sleeve bearing electric motor.

Best of all, by equipping with New Departure Ball Bearings you reduce the cost of rewinding burned-out motors 70%—cut lubricating and inspection costs about 82%—save 80% of the cost of new bearings and 88% of the expense of installing them.

*"Cutting your Costs" is the name of a new booklet just off the press outlining these worth-while economies. For engineers we have issued a Technical Bulletin giving the complete story of ball bearing electric motors. Both are available upon request.*

**The New Departure Manufacturing Company**  
**Bristol, Connecticut**  
 Detroit                      San Francisco                      Chicago



## New Departure Quality Ball Bearings

439

Please mention the JOURNAL of the A. I. E. E. when writing to advertisers.

# "Steam Cured"

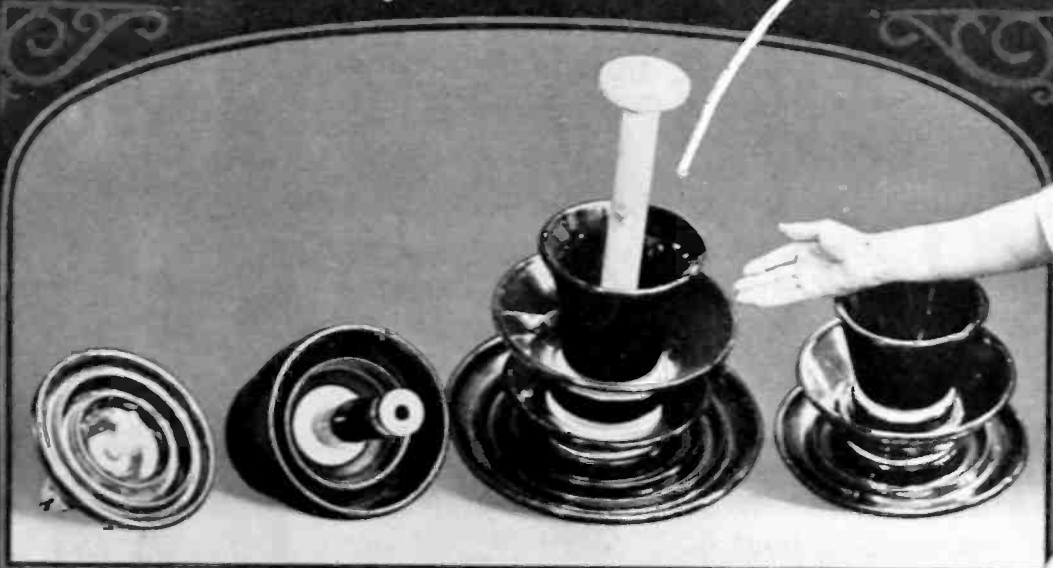

Not just cemented by steam, but steam-cured.

By this original Locke method your insulators have developed maximum strength and are pre-aged--proof against chemical reactions and thermal changes--before they leave the Locke factories.

It is the only method known which eliminates temperature-moisture-weight variables, and provides definite assembly and service constants.

Year after year Locke steam-cured, cemented insulators and bushings are providing dependable service and uniform performance under all conditions.

## LOCKE INSULATOR CORPORATION

Baltimore, Md.

Factories at Victor, N.Y. and Baltimore, Md.

Experience, continuous development and progress—these are the foundations of service. The evidence of Locke Service is found in the long list of original methods and developments contributed to the high voltage porcelain industry which Locke founded 32 years ago.

The unexcelled quality of Locke Porcelain Insulators is due in large part to the long experience and loyal service of the men who exercise control over the extremely delicate processes required in their making. This number of employees and their collective years of service is without parallel in the industry.

ESTABLISHED

**LOCKE**  
PORCELAIN

1894

Please mention the JOURNAL of the A. I. E. E. when writing to advertisers.



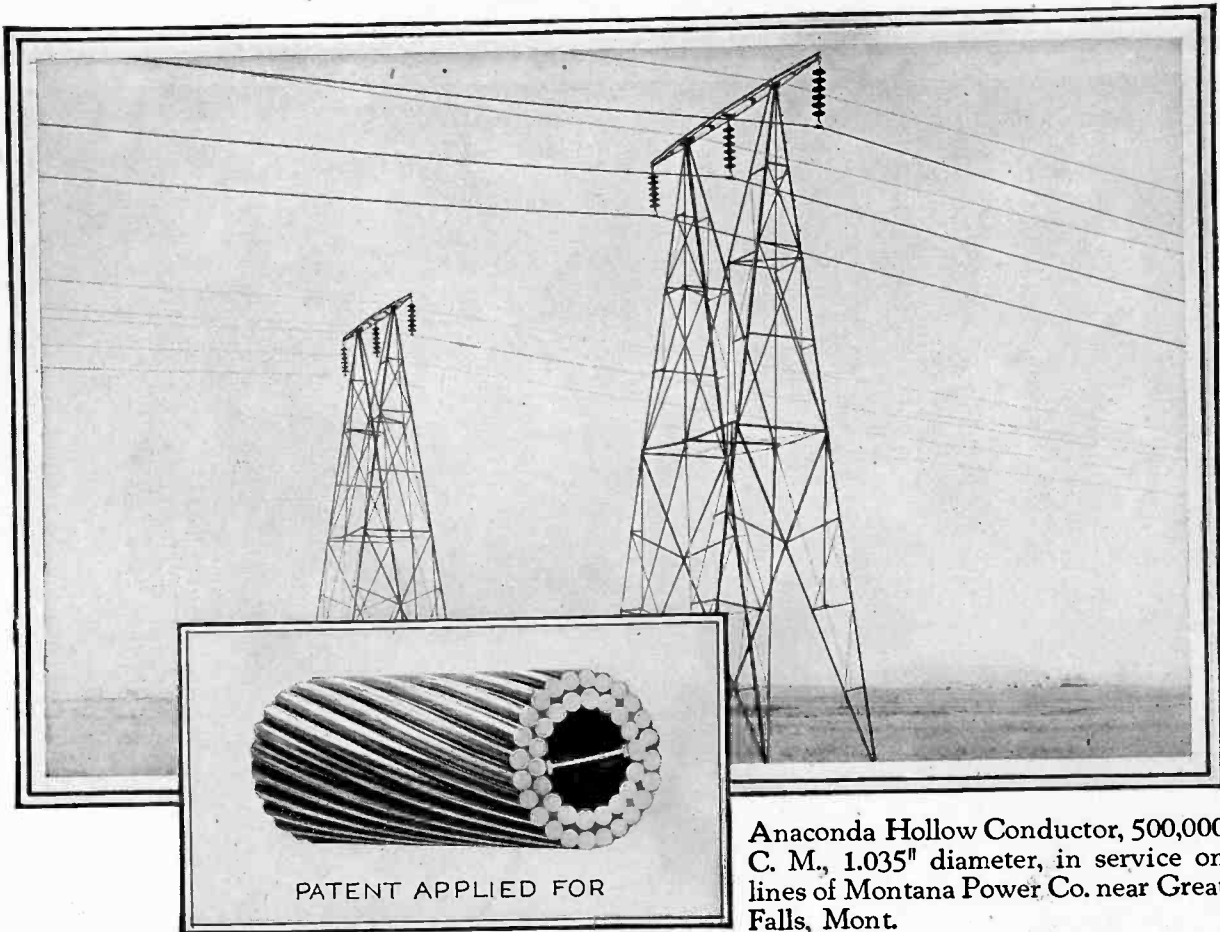

Anaconda Hollow Conductor, 500,000 C. M., 1.035" diameter, in service on lines of Montana Power Co. near Great Falls, Mont.

## ANACONDA HOLLOW CONDUCTORS *effect double economy*

**T**HE Anaconda Hollow Conductor effects double economy because it reduces corona and resistance losses, and at the same time reduces the cost of equipment. It saves in conductor costs because it obviates the necessity of using either an inert, non-conducting and perishable core such as hemp, or a heavy metal core of reduced conductivity, subject to corrosion, such as galvanized steel.

Innumerable tests in laboratory and field, as well as results obtained in actual installations, prove the all-copper Anaconda Hollow Conductor to be the most economical and durable conductor obtainable for power transmission, particularly for high voltages or large currents.

Detailed information on this efficient, economical all-copper Hollow Conductor is contained in Research Bulletin C-6. May we send a copy?

ANACONDA COPPER MINING CO.  
THE AMERICAN BRASS COMPANY  
*Rod, Wire and Cable Products*

General Offices: 25 Broadway, New York  
Chicago Office: 111 W. Washington St.

# ANACONDA COPPER

# BRASS BRONZE

from mine to consumer

Please mention the JOURNAL of the A. I. E. E. when writing to advertisers.

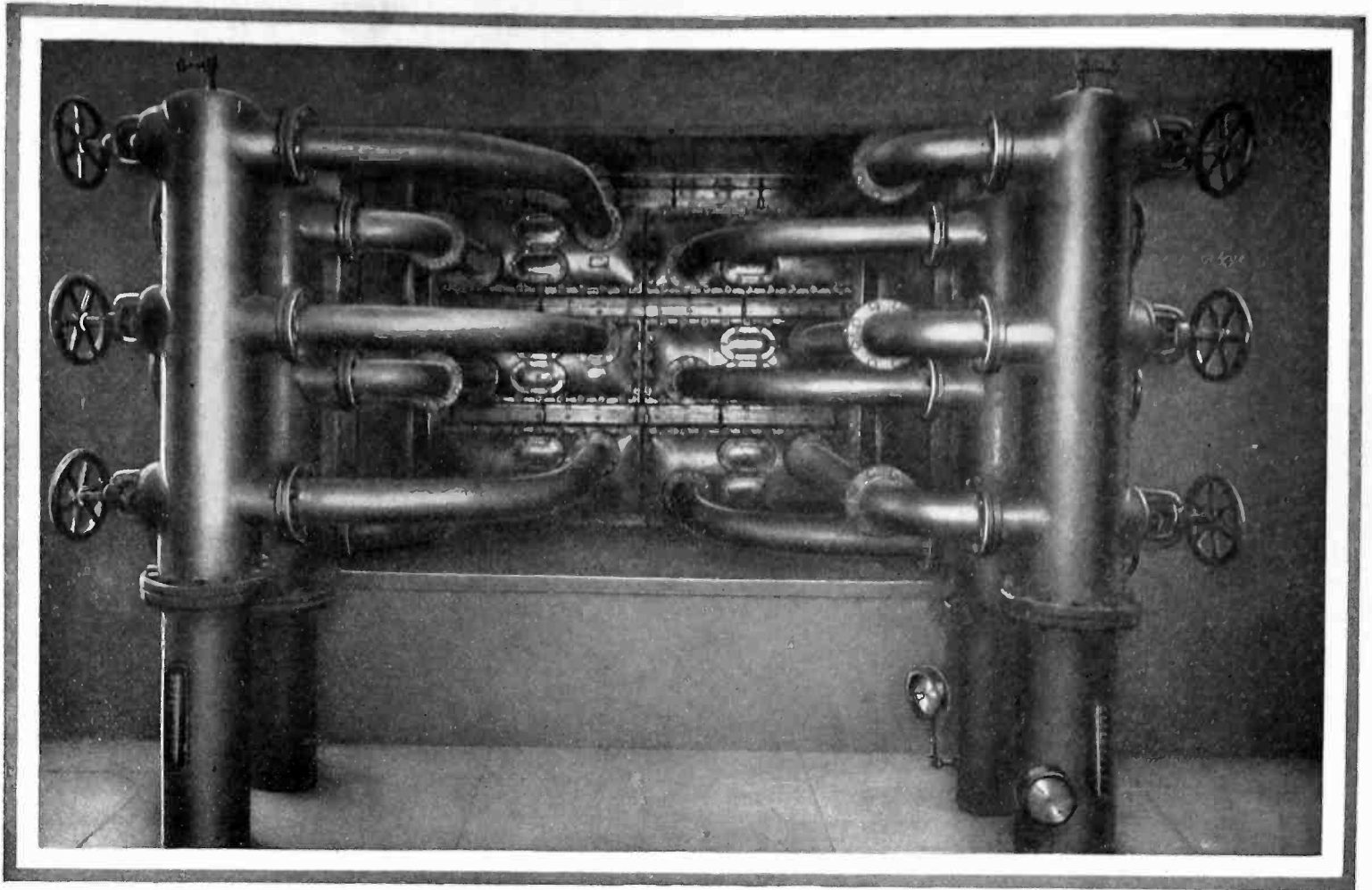

## Forecast for the Richmond Station generators: "Cool and Clean"

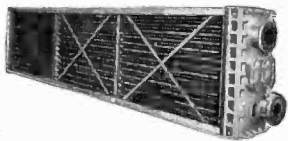

One section of the Richmond Station coolers

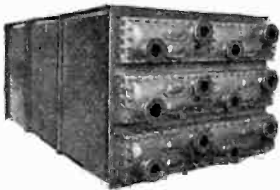

The six sections of one cooler, assembled in a self-contained frame.

Richmond Station, one of most modern stations in the world, chose G-E Surface Air Coolers. Consequently, its 50,000-kw. G-E Generators will not only be kept cool; they will always be perfectly clean. This fact emphasizes one of the many advantages of the closed system of generator ventilation, a system made possible by the surface-type cooler.

This installation of the Philadelphia Electric Company marks an advance in surface air-

cooler design, in that all of the sections are assembled in an enclosing frame which forms part of the air duct, making the entire cooling equipment self-contained.

Any five of the six sections installed under each generator furnish sufficient cooling capacity. This permits any one of the sections to be out of service for cleaning without interrupting the operation of the generating unit.

*Bulletin GEA-226 gives general information covering the G-E Surface Air Cooler.*



# GENERAL ELECTRIC

880-5

GENERAL ELECTRIC COMPANY, SCHENECTADY, N. Y., SALES OFFICES IN PRINCIPAL CITIES

Please mention the JOURNAL of the A. I. E. E. when writing to advertisers.

This portable De Laval Transformer Oil Purifier at the Dix Dam plant of Kentucky-Hydro Electric Company keeps both insulating and lubricating oil clean and dry.

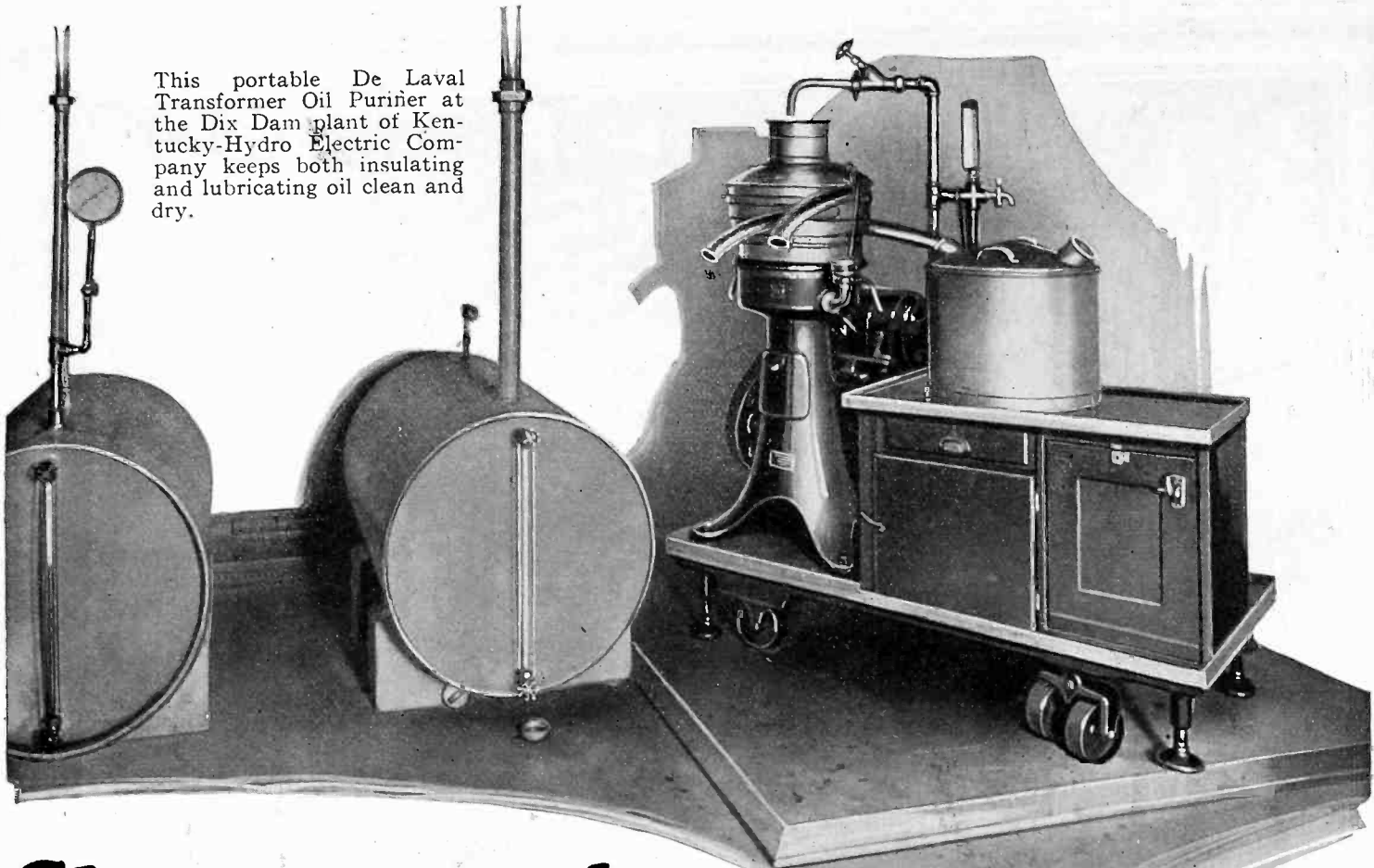

# Clean, dry oil for Dix Dam plant

Oil used at the Dix Dam plant of the Kentucky-Hydro Electric Company is maintained at high efficiency by means of the portable De Laval Transformer Oil Purifier shown above. A good part of the time the machine is operated as a stationary unit in the oil room, but it is a simple matter to move it alongside a transformer or oil circuit breaker which needs dehydrating, or for that matter, to take it to a substation miles out in the country.

The chief engineer at Dix Dam states that this machine has given very satisfactory service and he finds it far superior to older types of oil filtering apparatus.

Here is a big point to remember when considering oil purifying methods: The disc construction of

the De Laval bowl which so greatly increases the purifying efficiency of the machine also makes it possible to design the entire machine along sound engineering lines. The bowl operates at a low number of revolutions per minute and is shaped so that it spins naturally like a top. These are twin points of excellence which in a large measure account for the many years of trouble-free service that De Laval's will give. Moreover, this disc construction makes it possible to provide in the bowl a space for storing solid impurities removed from the oil where they cannot interfere with the effectiveness of purification.

Mail the coupon for information on what this has meant for others and what it can mean for you.

## The De Laval Separator Company

165 Broadway, New York

600 Jackson Blvd., Chicago

DE LAVAL PACIFIC COMPANY  
San Francisco

# De Laval Oil Purifiers

Please send Bulletin containing further information regarding the De Laval Oil Purifier as checked below:

- Purification of turbine lubricating oil.
- Purification of Diesel lubricating oil and fuel oil
- Dehydration of transformer oil. (Stationary Plant.)
- Dehydration of transformer oil. (Portable Outfit.)

Name.....

Company.....

Address.....

J.A.I.-637T

Please mention the JOURNAL of the A. I. E. E. when writing to advertisers.

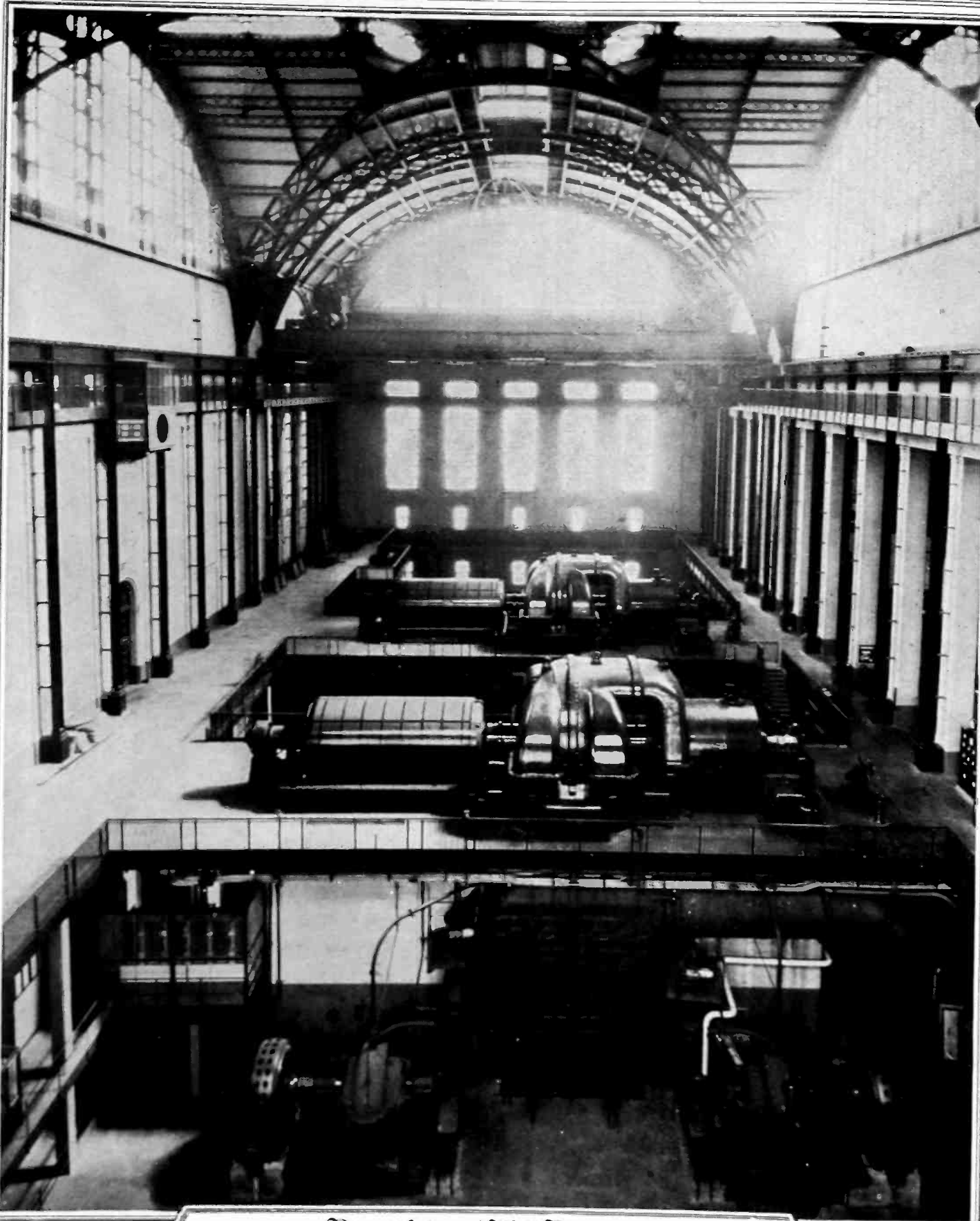

*Beautiful and Well Designed  
Richmond Station, The Philadelphia Electric Company System*

# GENERAL

GENERAL ELECTRIC COMPANY, SCHENECTADY, N. Y.

Please mention the JOURNAL of the A. I. E. E. when writing to advertisers.

# The Richmond Station

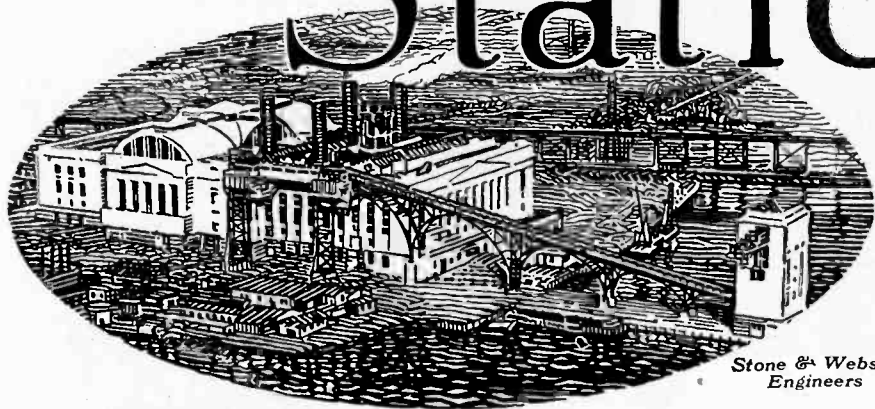

Stone & Webster  
Engineers

AMONG the modern steam power stations that have been placed in operation during the past few years, the Richmond Station of The Philadelphia Electric Company System is outstanding in many respects. The location, the building design (both from the standpoint of operation and appearance), the protective features, the arrangement and uniformity of equipment to obtain utmost reliability, the operating efficiency—all received careful consideration and were subjects of the most painstaking investigations. The result is a source of much satisfaction to the operating company and does great credit to the community.

The equipment in the first section of the Richmond Station includes the following furnished by General Electric:

2—60,000-kw. Turbine Generators  
2—Generator Air Cooler Equipments  
2—Generator Voltage Regulators  
62—FHK-130 15,000-volt Oil Circuit Breakers  
58—25,000-volt gang-operated Disconnecting Switches  
88—FKR-132B Oil Circuit Breakers  
600—Instrument Transformers



6—Current-Limiting Reactors for generators  
63—Current-Limiting Reactors for feeders  
6—Motor-Generator Sets  
1—30,000-volt Testing Transformer  
1—300,000-volt Kenotron Cable Testing Set  
130—Motors, totaling 6360 h. p. for station auxiliaries

# ELECTRIC

SALES OFFICES IN PRINCIPAL CITIES

174-2

Please mention the JOURNAL of the A. I. E. E. when writing to advertisers.

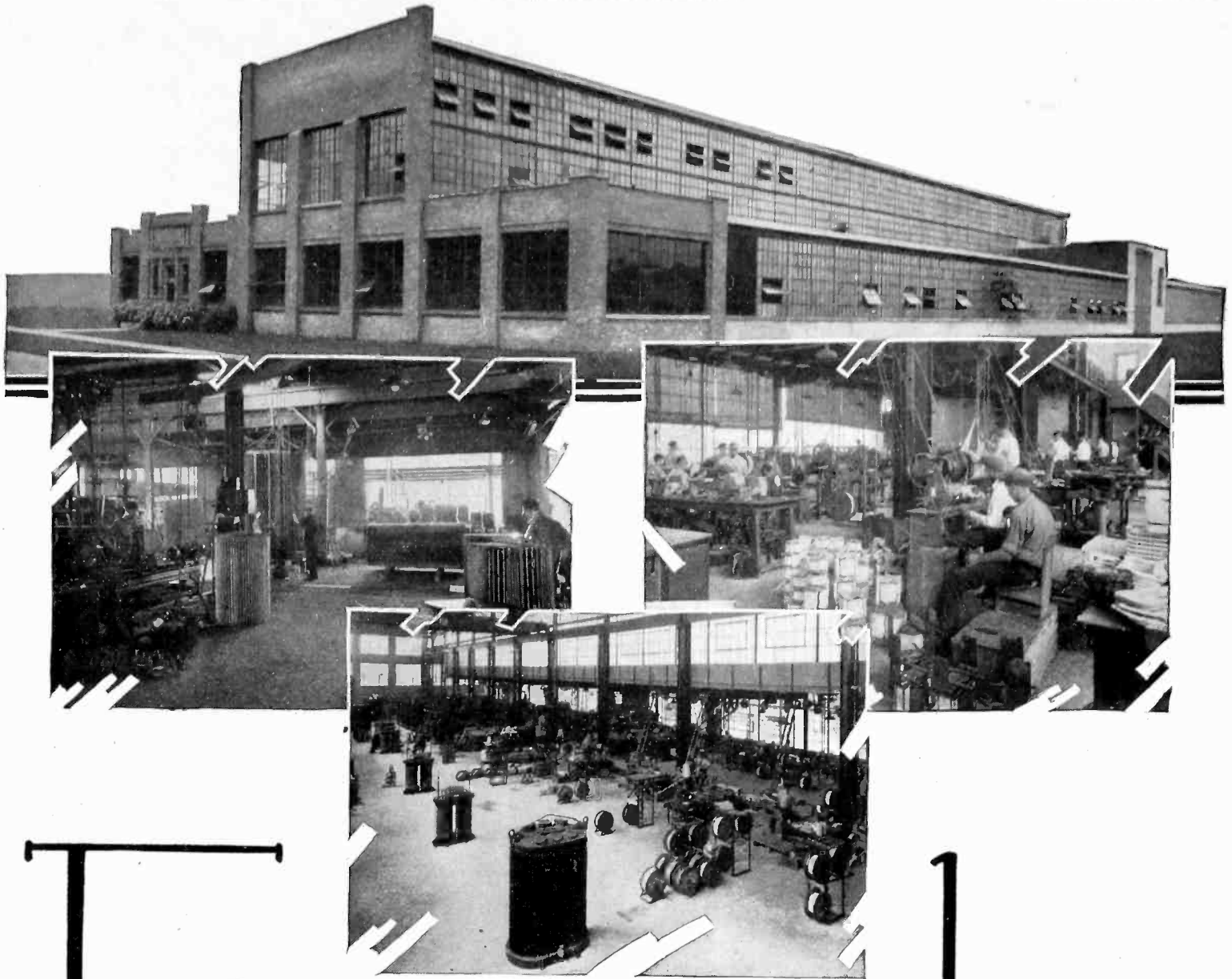

## o Serve You even better

The photographs here cannot tell the entire story, but you will get from them an indication of the additions that have recently been made to the Kuhlman Factory—additions that will enable us to serve you and other transformer users even better than we have in the past.

The increase and improvement is not only in factory space, but also in equipment and personnel. The greater space permits arrangement of

equipment for more efficient production. The new building provides better light and more pleasant working conditions. These improvements are reflected in the product and the benefits are thus realized by the purchasers of Kuhlman Transformers.

Another fact—these additions have been made possible and necessary by the ever-growing demand for Kuhlman Transformers.

*Write for the Transformer Handbook A. I. E. E. 210*

**KUHLMAN ELECTRIC CO.**  
BAY CITY, MICHIGAN

# KUHLMAN TRANSFORMERS

**POWER-DISTRIBUTION - STREET LIGHTING**

Please mention the JOURNAL of the A. I. E. E. when writing to advertisers.

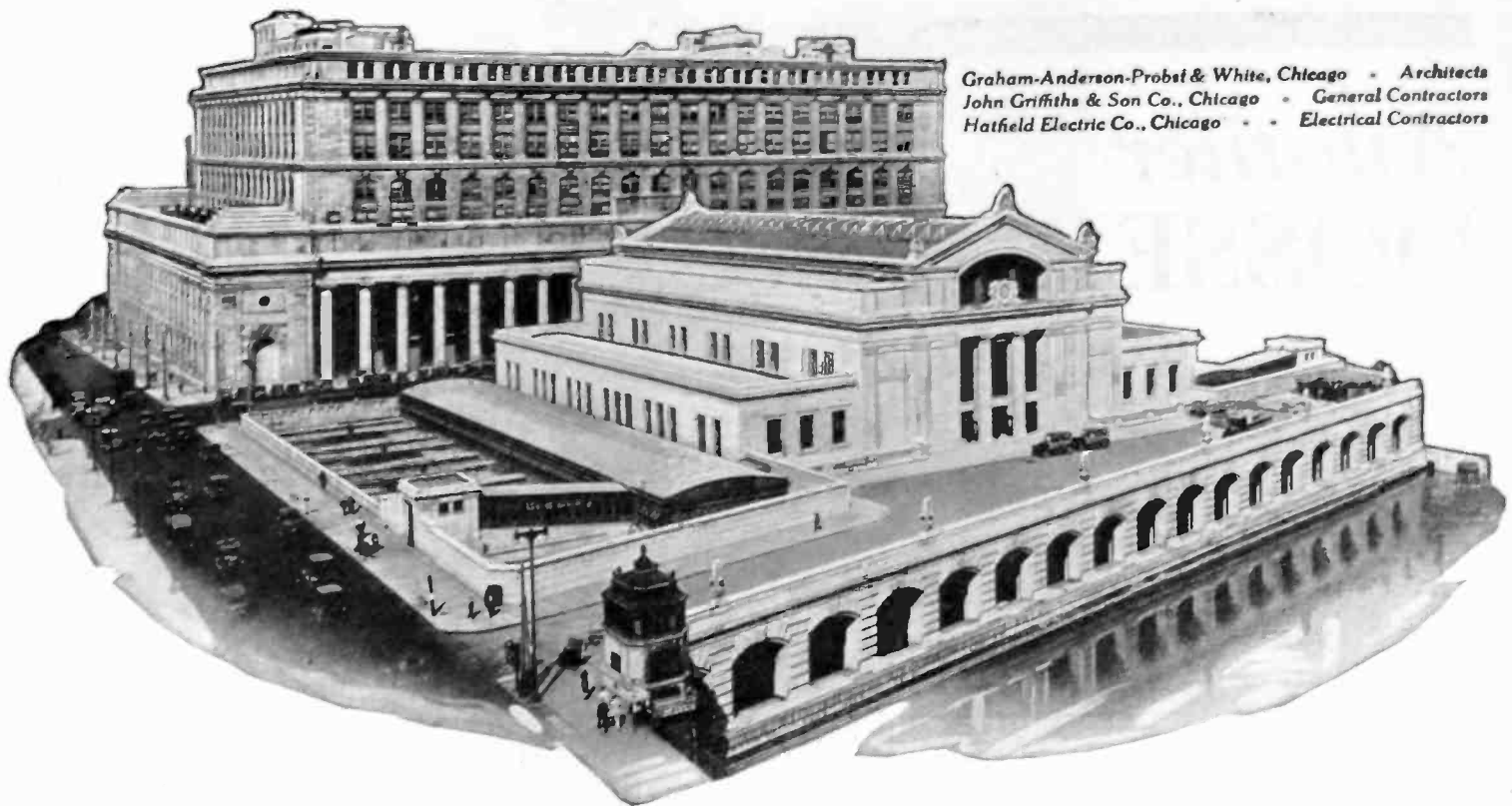

The New UNION STATION, Chicago, *Wired with*  
**American Steel & Wire**  
 Company's  
**Americore**  
**Rubber-covered Wire**

**T**HE new Chicago Union Station — one of the finest railroad stations in the world, and Chicago terminal for four great railroads is equipped with every known practical convenience for the traveling public. It is electrically wired throughout, from foundation floor to roof top with American Steel & Wire Company Americore Wire.

In selecting the hundreds of thousands of feet of rubber covered electrical wire needed

for safely wiring this great new Chicago railroad station, the most rigid specifications were adopted. The fact that American Steel & Wire Company wire answered the specifications in every detail, expresses most forcibly the uniform and dependable quality of the product.

Let us send you an indexed catalogue and handbook of Electrical Wires and Cables. Estimates furnished promptly from any of our offices in all of the principal cities.

**SALES OFFICES**

CHICAGO . . . 208 So. La Salle Street	ST. LOUIS . . . . . 506 Olive Street	NEW YORK . . . . . 30 Church Street	WORCESTER . . . . . 94 Grove Street	DALLAS . . . . . Praetorian Bldg.
CLEVELAND . . . . . Rockefeller Bldg.	KANSAS CITY . . . 417 Grand Avenue	BOSTON . . . . . 185 Franklin Street	BALTIMORE . . . . . 32 So. Charles Street	DENVER . . . First National Bank Bldg.
DETROIT . . . . . Foot of First Street	OKLAHOMA CITY . . . . . First National Bank Bldg.	PITTSBURGH . . . . . Frick Bldg.	BUFFALO . . . . . 670 Ellicott Street	
CINCINNATI . . . . . Union Trust Bldg.	BIRMINGHAM . . . . . Brown-Maxx Bldg.	PHILADELPHIA . . . . . Widener Bldg.		
MINNEAPOLIS—ST. PAUL . . . . . Merchants Nat'l Bk. Bldg., St. Paul	MEMPHIS . . . . . Union and Planters Bank Bldg.	ATLANTA . . . . . 101 Marietta Street	WILKESBARRE . . . . . Miners Bank Bldg.	SALT LAKE CITY . . . . . Walker Bk. Bldg.

UNITED STATES STEEL PRODUCTS COMPANY, San Francisco, Los Angeles, Portland, Seattle

# Another DOSSERT

SERVICE . . . on the lines of  
the Atlantic City  
R.R. ... Reading System  
at Camden, N. J.

*And here are a lot more services on which Dosserts will save your time and money*

Connecting cables, stranded or solid wires, rods and tubing.

Connecting two conductors of same size or different sizes.

Connecting wires to cables, cables to rods or tubing.

Connecting conductors at right angles.

Making three-way splices at right angles or other angles or with wires parallel.

Connecting branch circuit to main circuit.

Connecting one or two conductors to lug direct or at an angle.

Connecting wires to studs.

Connecting one or two cables to anchor.

To equalize load on two feeders.

Connecting to service boxes and cutouts.

Connecting grounds.

Connectors for all iron pipe sizes of tubing.

Special connectors for special services.

Dossert Cable Taps used to connect the horn gap disconnecting switch leads to the power lines.

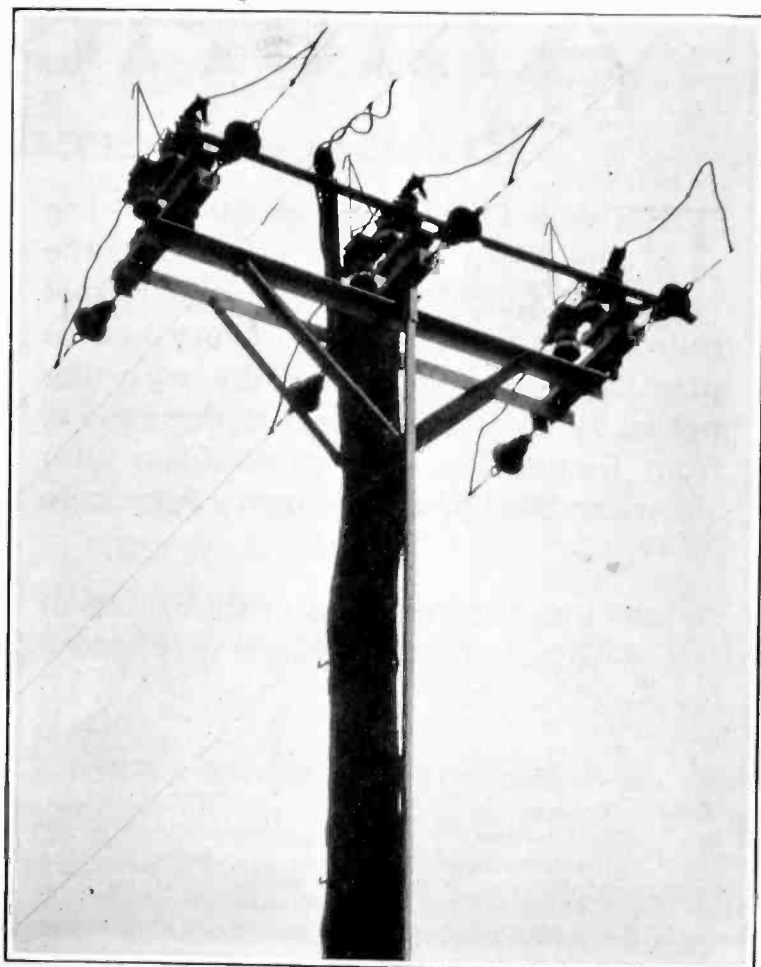

Write for the Dossert 20th Year Book which shows the line and the data.

## DOSSERT & COMPANY

H. B. Logan, Pres.

242 West 41st St.

New York, N. Y.



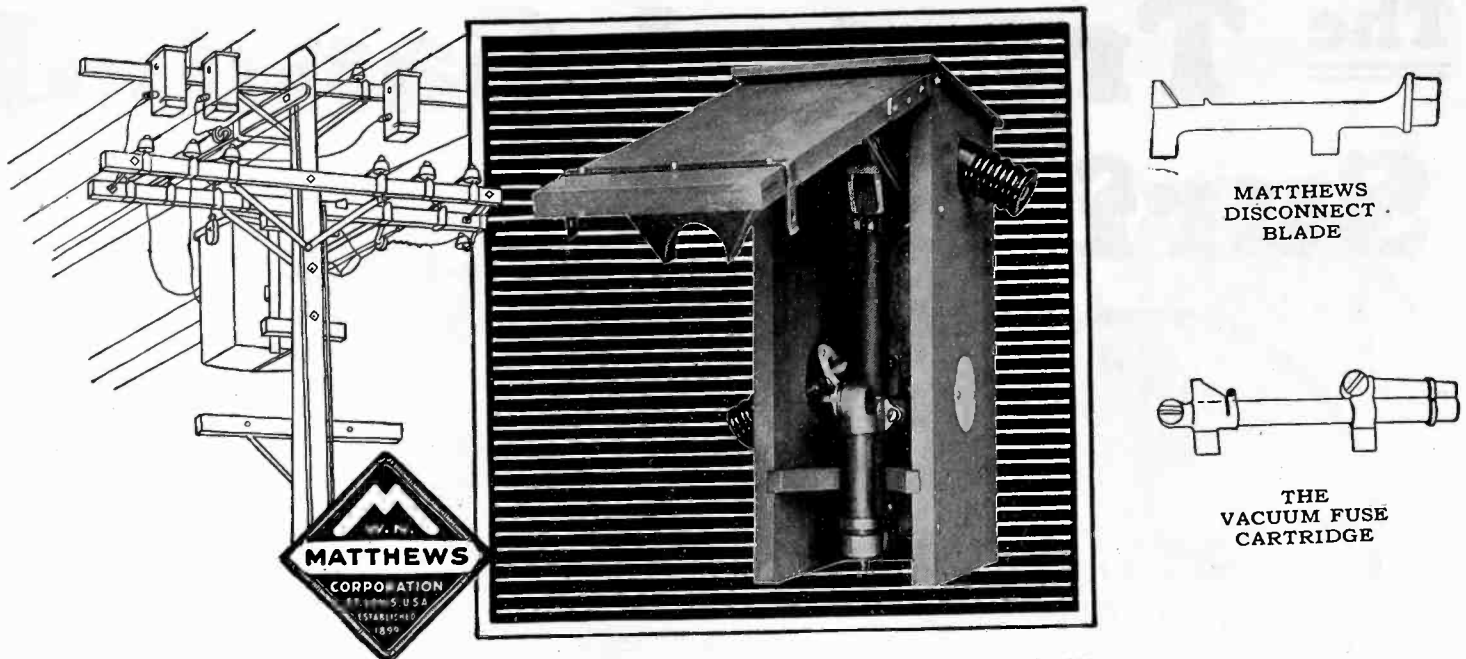

# On Dead Short Tests

by power companies everywhere Matthews Fuswitches regularly prove amazing certainty and economy of short control. In recent tests, as high as 53 consecutive shorts, without injury to the box, have demonstrated perfect rupturing.

So completely have Matthews Fuswitches overcome common faults in fuswitch design and operation that they mark an astonishing step forward in low cost maintenance. Consecutive shot tests, time and time again, reveal absolute certainty of rupture without slightest damage to box. Send for detailed information.

## Vacuum Fuse Cartridge

The Matthews vacuum principle, double tube cartridge insures positive rupture of the heaviest surges, with simultaneous discharge of gases so directed that the vacuum formed in the lower tube positively extinguishes the arc, so the arc cannot get to the lower contact midway between contacts.

## 10 Year Box Guarantee

"The Wood Eternal," thoroughly seasoned, linseed oil treated, branded Tidewater Cypress, is used. The three-ply roof is copper covered. Heavy brass screw fastenings throughout—no nails. The door carries no

part of the fuse unit to cause interruption of service during complete inspection of fuse and contacts. It opens upward, fastening automatically at 90 degrees, this feature is patented. Closes tight at bottom, preventing entrance of birds or of metallic gases after rupture. The entire box is coated with paint of high dielectric value which also has exceptional weather resistance and thorough insulation. Stands surface leakage test of thousands of volts per inch. Each box for encasing Types OK and HQ Matthews Fuswitches and Disconnecting Switches is guaranteed to withstand weathering for a period of ten years. Send for details of this guarantee on Matthews Fuswitch boxes.

## Other Advantages

Current leakage, danger to men and damage to property are avoided by excessive flashover resistance—spacings stand four times more than given ratings. Wet process porcelain of high tensile strength, representing the highest development in resis-

tance to either dry or wet flashover, is used for support mountings and entrance bushings. Entrance wires may be admitted from either right or left side. Contact lugs doubly secured to resist vibration. By simple substitution of Matthews Disconnect Blade for the patented vacuum fuse cartridge, the Matthews Fuswitch affords instant, low cost dual service. Gives perfect protected disconnect service without need for warehousing extra switches. In addition to fuswitches you need stock only the disconnect blades.

## Read Bulletin 501

Learn exactly why Matthews Fuswitches and Disconnect Switches represent the outstanding triumph in this division of maintenance supplies. See why they are bringing new conceptions of power company service to communities everywhere. How they bring rapid location and repair with minimum interruption of service, as well as lower costs and maximum safety to men and apparatus. Write today.

W. N. MATTHEWS CORPORATION  
3706 Forest Park Blvd. St. Louis, U. S. A.

# MATTHEWS FUSWITCHES

and DISCONNECTING SWITCHES

### Ask About These

Matthews Fuswitches  
Matthews Disconnecting Switches  
Matthews Scrulix Anchors

Matthews Adjustable Reel  
Matthews Guy Clamps  
Matthews Slack Puller  
Matthews Cable Clamps

Matthews Lamp Guards  
Matthews Telefault  
Matthews Teleheight  
*Distributors in all Principal Cities*

Please mention the JOURNAL of the A. I. E. E. when writing to advertisers.

# The Treated Sanded Surface



Magnified Treated Sanded Surface Joint  
as used in O-B insulator assemblies

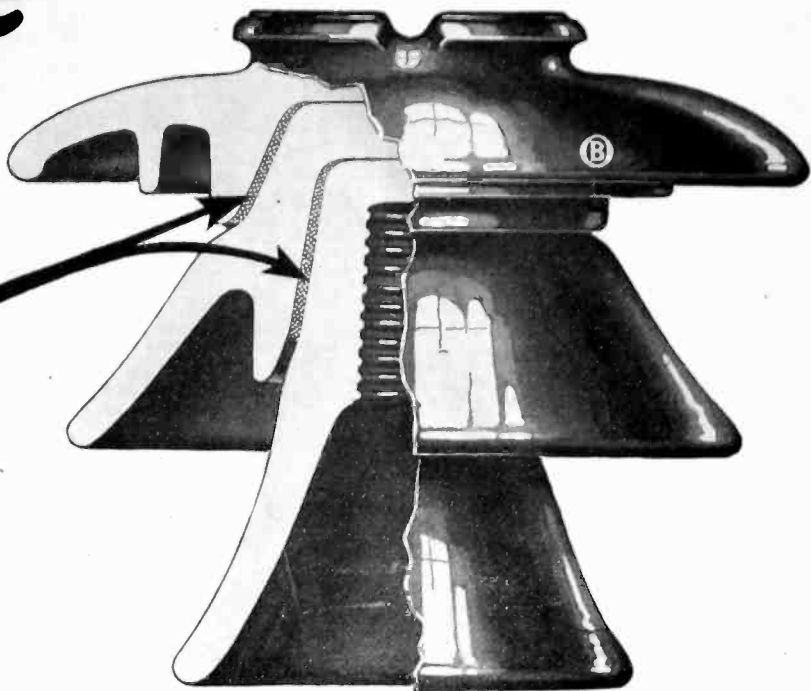

**T**HE TREATED SANDED SURFACE describes a feature of the method by which the joints in O-B suspension, multipart, switch and bus insulators have been made for the past 10 years. It seems to be the best method yet devised to obtain the necessary resiliency in the cemented joint without sacrifice of mechanical and electrical reliability. It provides the flexibility—the give and take needed for the internal stresses that would otherwise develop to crack the porcelain. It is a safe and sure method, because its application can be held under definite control.

This patented refinement has been a feature of over 20 million O-B insulators in use all over the world; in every possible climate from the tropics to the arctic circle; under loads ranging from the highest on long spans and river crossings down to the support of a few feet of copper bus.

Not a single instance of failure or short life from causes which this treatment was designed to meet has been reported from the field.

Now that the merit of the Treated Sanded Surface has been thoroughly established and its value as a means of overcoming insulator cracking proved, insist on this feature in your insulators.

Ohio Brass Company, Mansfield, Ohio  
Dominion Insulator & Mfg. Co., Limited  
Niagara Falls, Canada  
189 H

HISTORY TELLS WHICH LINE EXCELS

# Ohio Brass Co.

PORCELAIN  
INSULATORS  
LINE MATERIALS  
RAIL BONDS  
CAR EQUIPMENT  
MINING  
MATERIALS  
VALVES

Please mention the JOURNAL of the A. I. E. E. when writing to advertisers.



*In a restricted residential district*

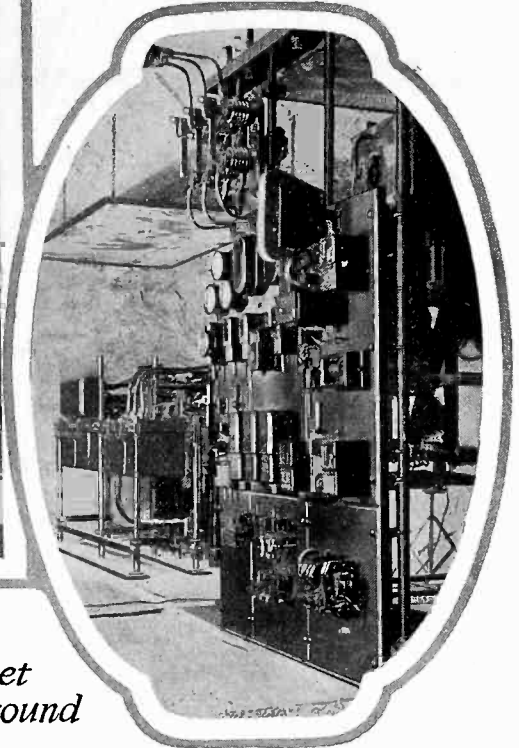

*1100 feet underground*

## Economic substation locations —are you taking advantage of them?

The most economic location for a substation depends upon load and system conditions, but the expense or difficulty of manual operation often makes this location impracticable. However, it is possible to take advantage of such a location by installing G-E Automatic Switching Equipment.

Substations thus controlled are operating successfully 1100 feet underground in a salt mine, where a small station would not justify the expense of an operator; in a restricted residential district, where elimination of noise requires a sound-proof, and hence nearly airtight, construction; in a sewage disposal plant, where hydrogen sulphide fumes are constantly present; and in many other unusual locations.



It has been proved many times that the extra expense of automatic control is soon repaid by reduced operating and maintenance costs and by improved service.

But G-E Automatic Switching Equipment does more than enable you to secure the most economic location—for it also operates promptly, at least cost, and with accuracy, safety, and reliability.

# GENERAL ELECTRIC

GENERAL ELECTRIC COMPANY, SCHENECTADY, N. Y., SALES OFFICES IN PRINCIPAL CITIES

461-2

Please mention the JOURNAL of the A. I. E. E. when writing to advertisers.

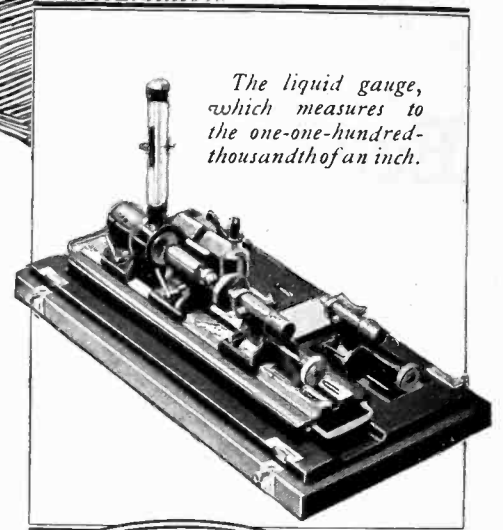
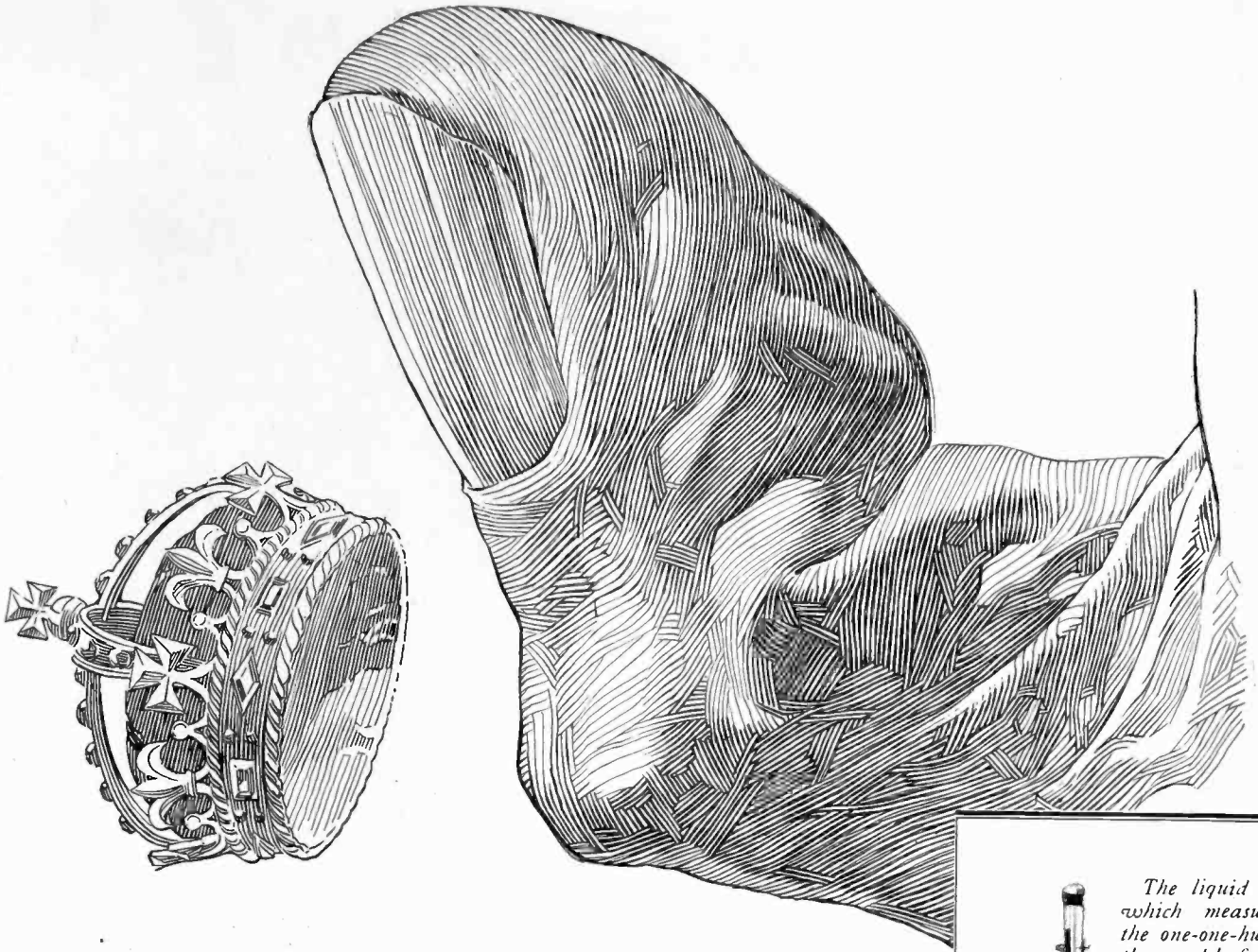

The liquid gauge, which measures to the one-one-hundred-thousandth of an inch.

## The "rule of thumb" is over...

**K**ING THUMB rules no more. The rule of thumb, with all its costly guesswork, has no place in Western Electric telephone making.

Here exact measuring standards are the rule, precise in many cases to the ten-thousandth part of an inch. And this habit of being exact controls every factory activity—in the systematic planning of the great task of telephone production, in manufacturing to known standards of quality, in constantly improving methods of work—not in haphazard experiment but by scientific attack by a group of skilled industrial engineers.

At the same time, as makers of the nation's telephones, Western Electric is meeting its responsibility by holding down the cost of telephone apparatus to a figure well below the increased cost of general commodities.

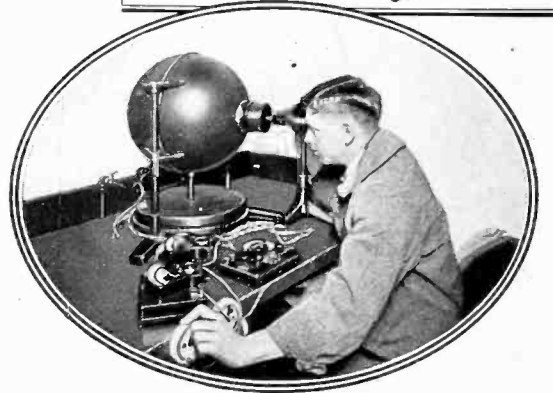

Looks like a bomb, but really a little "dark room" which permits the inspector to know exactly whether a tiny switchboard lamp comes up to the mark.



Back of  
your  
telephone

# Western Electric

SINCE 1882 MANUFACTURERS FOR THE BELL SYSTEM

Please mention the JOURNAL of the A. I. E. E. when writing to advertisers.

# SOMETHING NEW

*and Just What You Have Been Waiting For!*

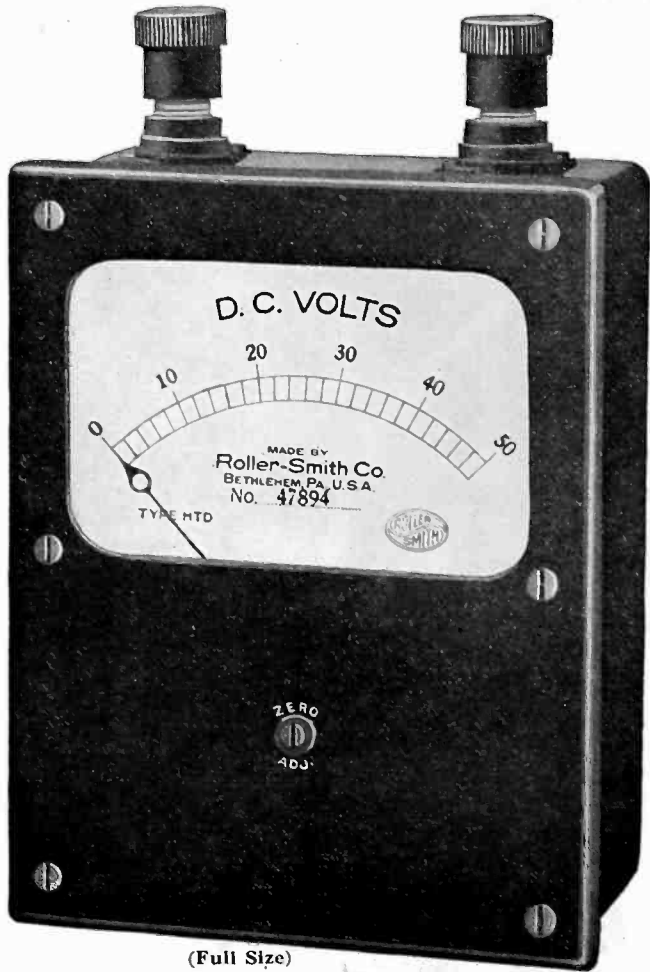

(Full Size)

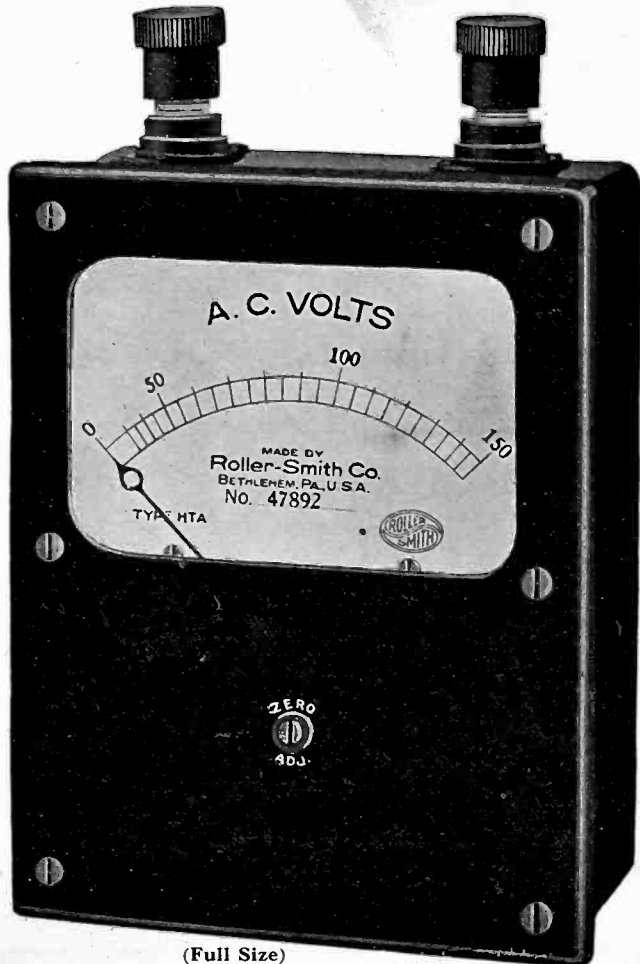

(Full Size)

## Real Pocket Portable

*Direct and Alternating Current*

### Ammeters, Voltmeters, Volt-Ammeters and Wattmeters

*ROLLER-SMITH Types HTD and HTA. Small enough for your pocket, your tool kit or your traveling bag.*

*Compact and light enough to satisfy the most critical.*

*Accurate and rugged enough to suit the most exacting requirements.*

*A wide enough variety of ranges to cover many tests that have heretofore required large portables.*

Send for *New Bulletins AE-110 and AE-150.*

Use the coupon.

*"Over thirty years' experience is back of ROLLER-SMITH"*

### **ROLLER-SMITH COMPANY**

Electrical Measuring and Protective Apparatus

MAIN OFFICE  
12 Park Place, NEW YORK



WORKS  
Bethlehem, Penna.

*Offices in principal cities in U. S. A. and Canada.  
Representatives in Australia, Cuba and Japan.*

ROLLER-SMITH COMPANY, 12 Park Place,  
New York City.

Gentlemen:

Please send me ROLLER-SMITH Bulletins Nos. AE-110 and AE-150.

Name .....

Company .....

Address..... State.....

Please mention the JOURNAL of the A. I. E. E. when writing to advertisers.

# Chandeysson

## Generators

25 to 25,000 Amperes

Direct Connected to



## Motors

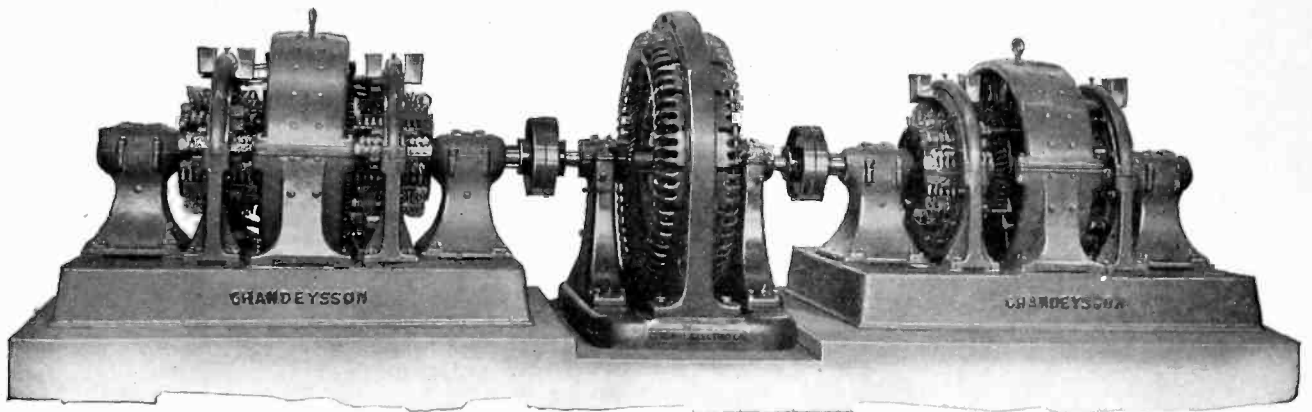

Double Commutator Generator,  
7500 amperes at 8 volts

G-E Synchronous Motor,  
200 h. p., .8 p. f., 3-phase,  
60 cycles, 2200 volts, 240 r. p. m.

Double Commutator Gen-  
erator, 7500 amperes  
at 8 volts

# 15000-AMPERE UNIT

OPERATING AT THE RIM GALVANIZING PLANT OF THE  
**FIRESTONE STEEL PRODUCTS CO.**

*Installed in 1926*

CHANDEYSSON ELECTRIC CO., ST. LOUIS, U. S. A.

# Consider the frame

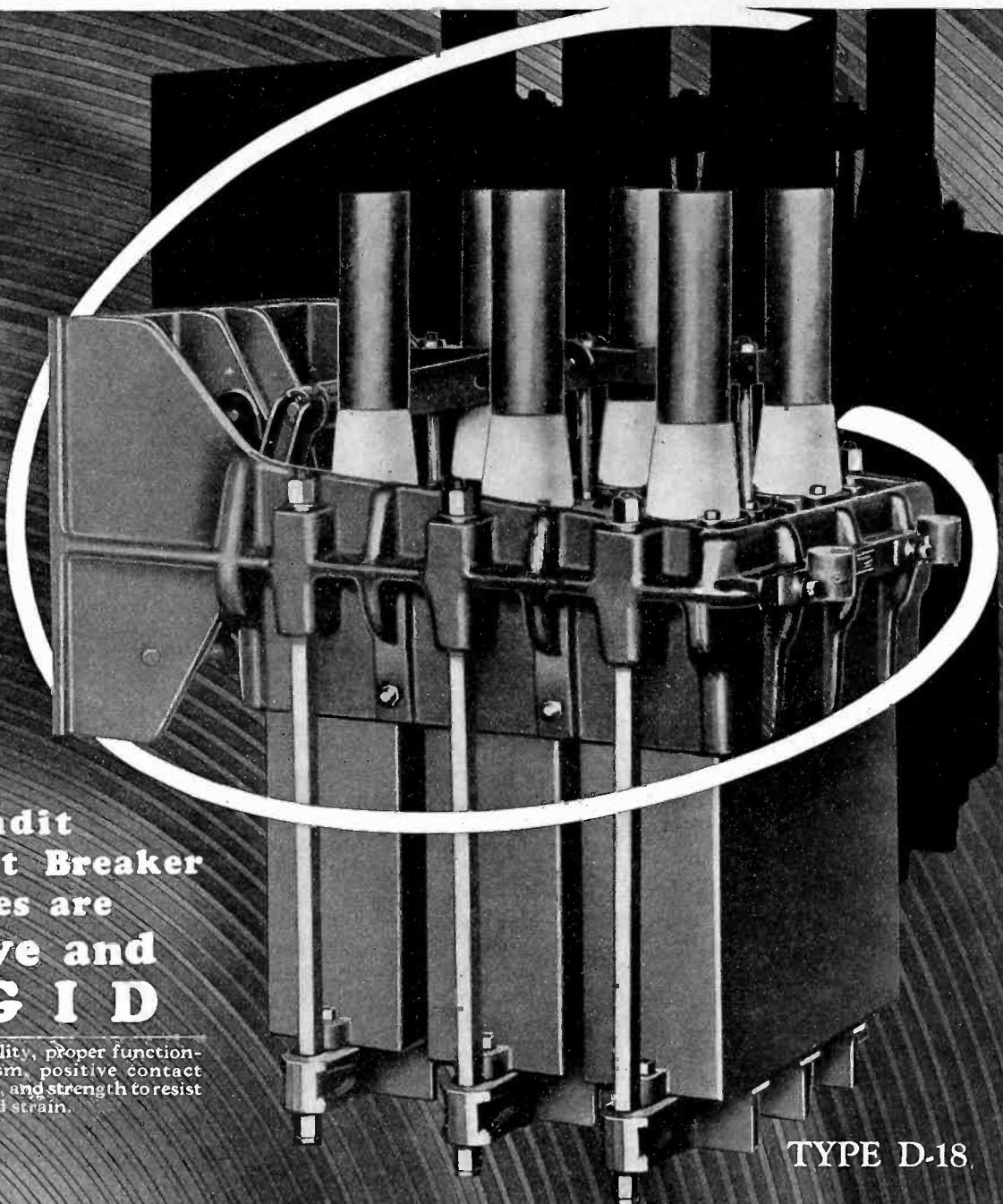

**Condit  
Oil Circuit Breaker  
Frames are  
Massive and  
R I G I D**

Rigidity assures stability, proper functioning of the mechanism, positive contact alignment on all poles, and strength to resist unbalanced stress and strain.

TYPE D-18

**CONDIT ELECTRICAL MFG. CORPORATION**

*Manufacturers of Electrical Protective Devices*

BOSTON, MASS.

*Northern Electric Company*

LIMITED

Sole Distributor for the Dominion of Canada

Get in touch with Condit

SPECIFICATIONS:—800 Amperes or less, 15,000 volts; 1200 Amperes, 7500 volts. Two, three and four pole. Manually or electrically operated. Interrupting capacity: 3600 Amperes at 15,000 volts.

72

**CONDIT**

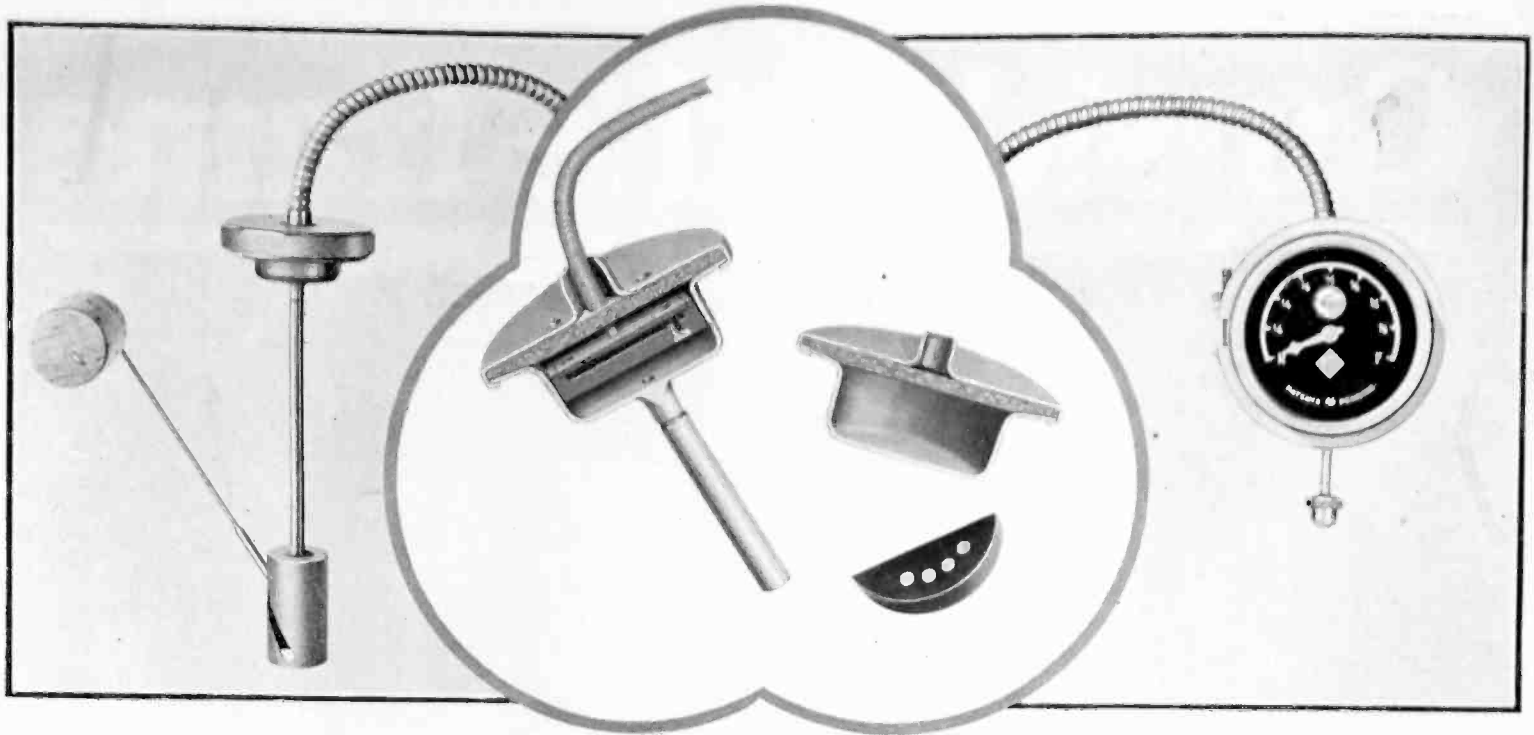

*Bakelite insulated Damsel Electro-Gauge, made by the Damsel Electro Gauge Co., Columbus, Ohio.*

## “Without Bakelite we would have been unable to make our gauge”

This statement by the Damsel Electro Gauge Company, Columbus, Ohio, summarizes the importance of Bakelite in the construction of a very useful automotive accessory—an electrically operated gasoline gauge.

A feature of this device is the automatic illumination of the indicator dial when the gasoline level falls to 2½ gallons. The vital part of the control mechanism is a disc of Bakelite molded 1¼ in. in diameter, in which is solidly embedded a series of accurately spaced metal contacts. When tested by the underwriters' laboratories at Chicago, this Bakelite part successfully withstood a 500 volt A C test—although the service for which

it is designed involves only low voltage. In a vibration test, 600 heavy vibrations per minute, applied during eight consecutive hours, did not damage the Bakelite part.

Through the use of Bakelite the ideas of many designers have been made practical and the performance of many devices has been improved. The experience of our engineers, and the facilities of our research laboratories, are offered without obligation, to manufacturers interested in determining the possibilities of Bakelite in connection with their particular products.

Write for Booklet No. 3, “Bakelite Molded,” and interesting description of Bakelite and its uses.



### BAKELITE CORPORATION

247 Park Ave., New York, N. Y.

Chicago Office: 636 West 22nd St.

BAKELITE CORPORATION OF CANADA, LTD., 163 Dufferin Street, Toronto - - Ontario, Can.

# BAKELITE

REGISTERED

U. S. PAT. OFF.

THE MATERIAL OF  A THOUSAND USES

“The registered Trade Mark and Symbol shown above may be used only on products made from materials manufactured by Bakelite Corporation. Under the capital “B” is the numerical sign for infinity, or unlimited quantity. It symbolizes the infinite number of present and future uses of Bakelite Corporation's products.”

Please mention the JOURNAL of the A. I. E. E. when writing to advertisers.



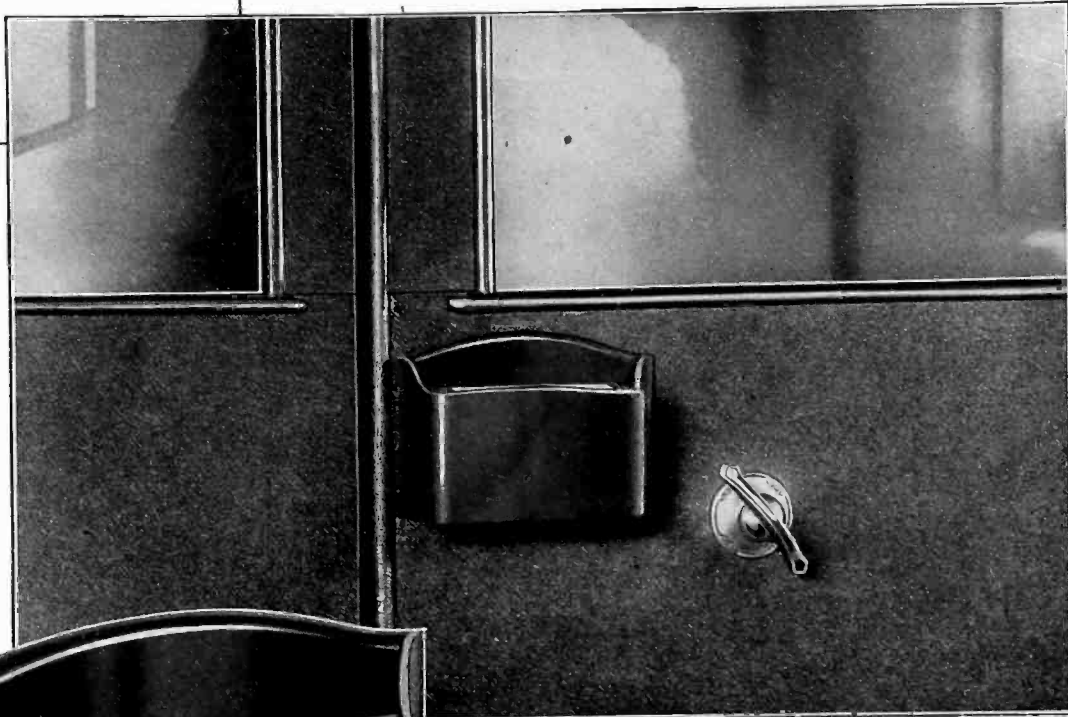

This picture shows a Beldenmold Bakelite vanity case used in a popular sedan.

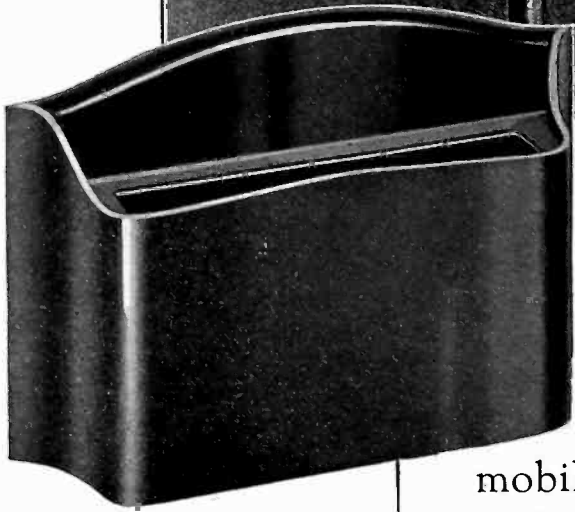

Although the bare Beldenmold Bakelite vanity case or match box illustrated takes a beautiful finish, in some cars the Beldenmold is covered to match the upholstery.

## Beldenmold Replaces Wood Looks Better—Costs Less

THINK of it! Vanity cases and match holders in automobiles, which formerly were made of wood, are now made of Beldenmold Bakelite. Why? Because it makes a neat, durable case that is far more substantial than wood—and *the cost is less*. When used for uncovered receptacles it takes a beautiful, high polished finish—for covered receptacles it provides a smooth, even surface to which glue readily adheres.

FOR many purposes in a wide variety of industries Beldenmold is replacing wood and metal with results that are surprisingly satisfactory. Perhaps there is a place in your business for Beldenmold parts. Our engineering department is at your service. Just furnish a sample of the part you need and let us tell you what Beldenmold can do for you. More than likely we can save money for you, too! Get our Beldenmold Booklet. *Use the coupon.*

*Specify*  
**Belden**

Belden Manufacturing Company,  
2316B So. Western Ave.,  
Chicago, Illinois

Of course we want to know all about the money saving possibilities of Beldenmold. Send us the Beldenmold Booklet.

Name .....

Address .....

# FERRANTI

# NOMAG

(Non-magnetic cast iron)  
 Ferranti-Dawson Patent No. 204598.

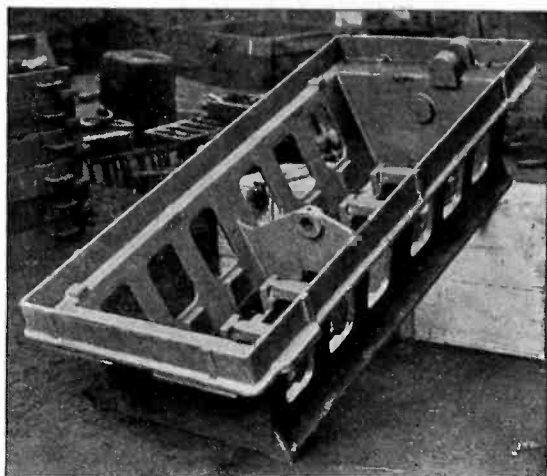

Base for a large Oil-Switch

**N**OMAG OPENS A NEW FIELD FOR THE DESIGNER OF ELECTRICAL MACHINERY AND APPARATUS.

IT COMBINES, IN A UNIQUE WAY, HIGH RESISTANCE AND LOW PERMEABILITY, AS SHOWN BY THE FIGURES IN THE ADJACENT TABLE.

	Magnetic Permeability Maximum.	Specific Resistance Micro-ohms per cm. cube.
Ordinary Cast Iron	330.00	95.0
NOMAG . . .	1.03	140.0
Brass . . . .	1.00	7.5

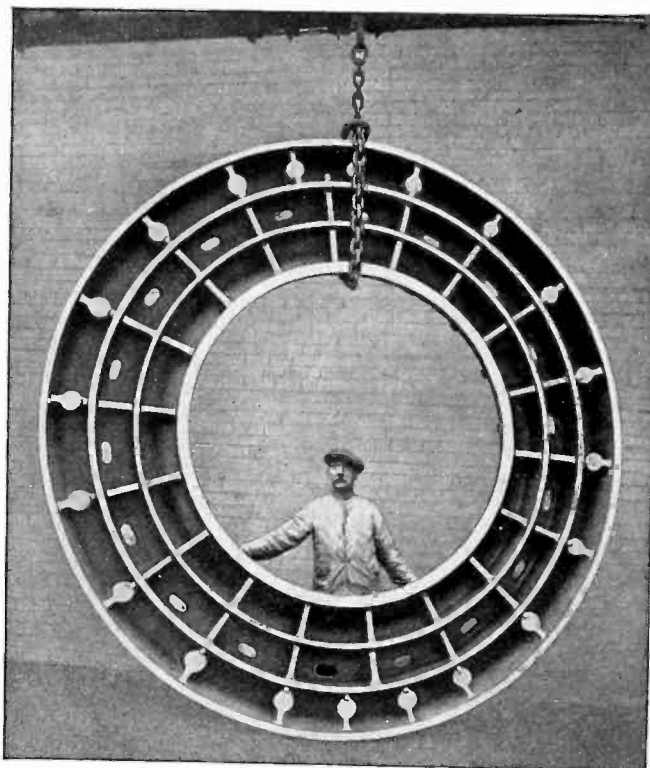

End-ring for a Turbo-Alternator. Weight 3½ tons.

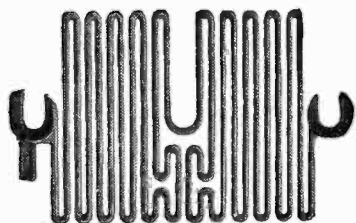

Resistance Grid

Ferranti, Ltd.,  
 Hollinwood,  
 England

The Ferranti Meter &  
 Transformer Manufacturing  
 Co., Ltd.  
 Toronto, Canada

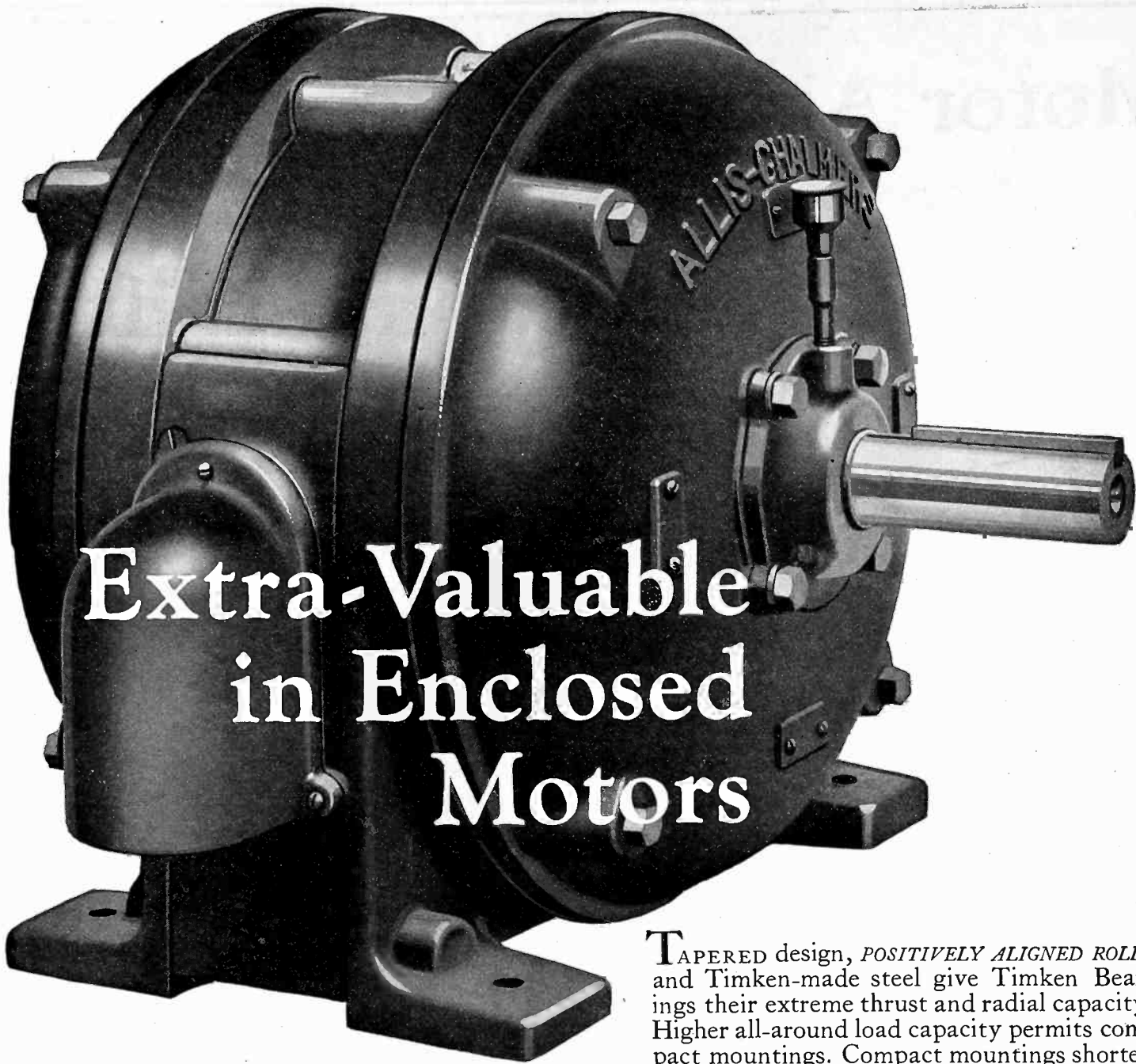

## Extra-Valuable in Enclosed Motors

**T**APERED design, *POSITIVELY ALIGNED ROLLS* and Timken-made steel give Timken Bearings their extreme thrust and radial capacity. Higher all-around load capacity permits compact mountings. Compact mountings shorten the shaft. Thus Timken Bearings largely offset the increased size which is necessary for enclosed motors.

As in any type of Timken-equipped motor, the Timken Bearings themselves can be so perfectly enclosed, and they run so free of friction that the lubricant lasts for months or more. Timken lubrication starts when the motor does, which gives still more wear-prevention.

Timkens actually mean that the bearings will last as long as any part of the motor, with almost no attention, while improving every phase of performance.

THE TIMKEN ROLLER BEARING CO., CANTON, OHIO

Technical information regarding bearing sizes and their mountings can be secured from the Timken Roller Bearing Service & Sales Company's Branches located in the following cities: Atlanta, Boston, Buffalo, Chicago, Cincinnati, Cleveland, Dallas, Denver, Detroit, Kansas City, Los Angeles, Memphis, Milwaukee, Minneapolis, Newark, New York, Omaha, Philadelphia, Pittsburgh, Richmond, St. Louis, San Francisco, Seattle, Toronto, Winnipeg

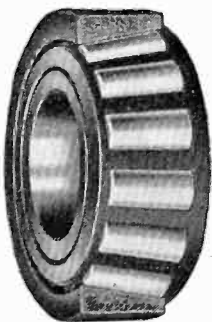

# TIMKEN *Tapered* Roller BEARINGS

Please mention the JOURNAL of the A. I. E. E. when writing to advertisers.

# Motor Ability

is Limited by

# Bearing Ability

A motor can stand what its bearings will stand—and no more. It will last as long as its bearings—and no longer.

With “**Norma**” Precision Ball Bearings in successful month-after-month operation at speeds up to 50,000 R.P.M.—

And with “**Hoffmann**” Precision Roller Bearings standing up month after month at speeds up to 20,000 R.P.M.—

Need you look further for an answer to the question “what are the bearings to use for dependable motor service?”

Because—obviously—a bearing that is safe at these super-speeds, has a still higher factor of safety at the usual motor speeds.

*Ask our engineers for more data—or write for catalogs 904, 905 and 915.*

**NORMA-HOFFMANN BEARINGS CORPORATION**

Stamford—Connecticut

PRECISION BALL, ROLLER AND THRUST BEARINGS

# NORMA-HOFFMANN

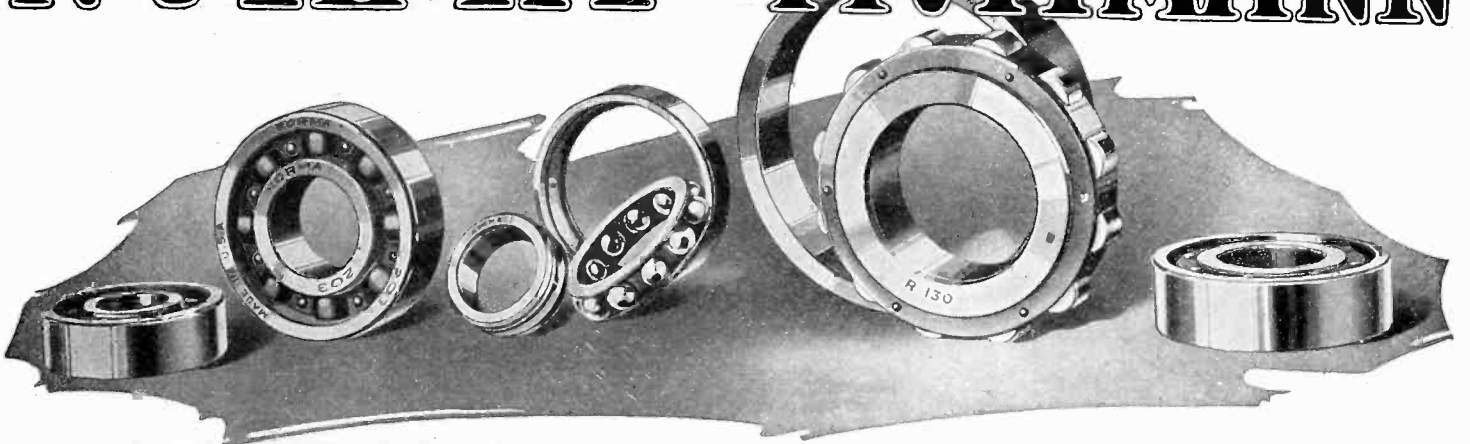

Please mention the JOURNAL of the A. I. E. E. when writing to advertisers.



## This Silver Strand (Reg.) now marks the shunts of all National Pyramid Brushes

ON ANY brush-equipped electrical machine, look at the brush shunts. Look for the Silver Strand. It is the visible identifying mark on all National Pyramid Brushes—your guarantee of satisfactory brush performance.

All shunts of National Pyramid Brushes now bear this Silver Strand as an identifying mark, visible to the most casual glance. The familiar letters NCC, the three pyramids and the grade number will still be found on the brush itself for your guidance in purchasing

and installing. When the brush is in service, the Silver Strand in the shunt is a visual sign to all that here is a National Pyramid Brush, supremely suited for the work for which it is designed.

Thousands of brushes are now in use bearing this shunt, which has the same conductivity as the former unmarked shunts. The Silver Strand is a mark that indicates, but does not affect, the perfection of performance you have learned to expect from National Pyramid Brushes. Look for the Silver Strand.

# National Pyramid Brushes

*Manufactured and guaranteed by*

NATIONAL CARBON COMPANY, INC.

Cleveland, Ohio

*Carbon Sales Division*

San Francisco, Cal.

Canadian National Carbon Co., Limited, Toronto, Ontario

*Emergency Service Plants*

CHICAGO, ILL.  
551 West Monroe St.  
Phone: State 6092

PITTSBURGH, PA.  
7th Floor, Arrott Power Bldg. No. 3, Barker Place  
Phone: Atlantic 3570

NEW YORK, N. Y.  
357 West 36th St.  
Phone: Lackawanna 8153

BIRMINGHAM, ALA.  
1824 Ninth Ave., N.  
Phone: Main 4016

Please mention the JOURNAL of the A. I. E. E. when writing to advertisers.

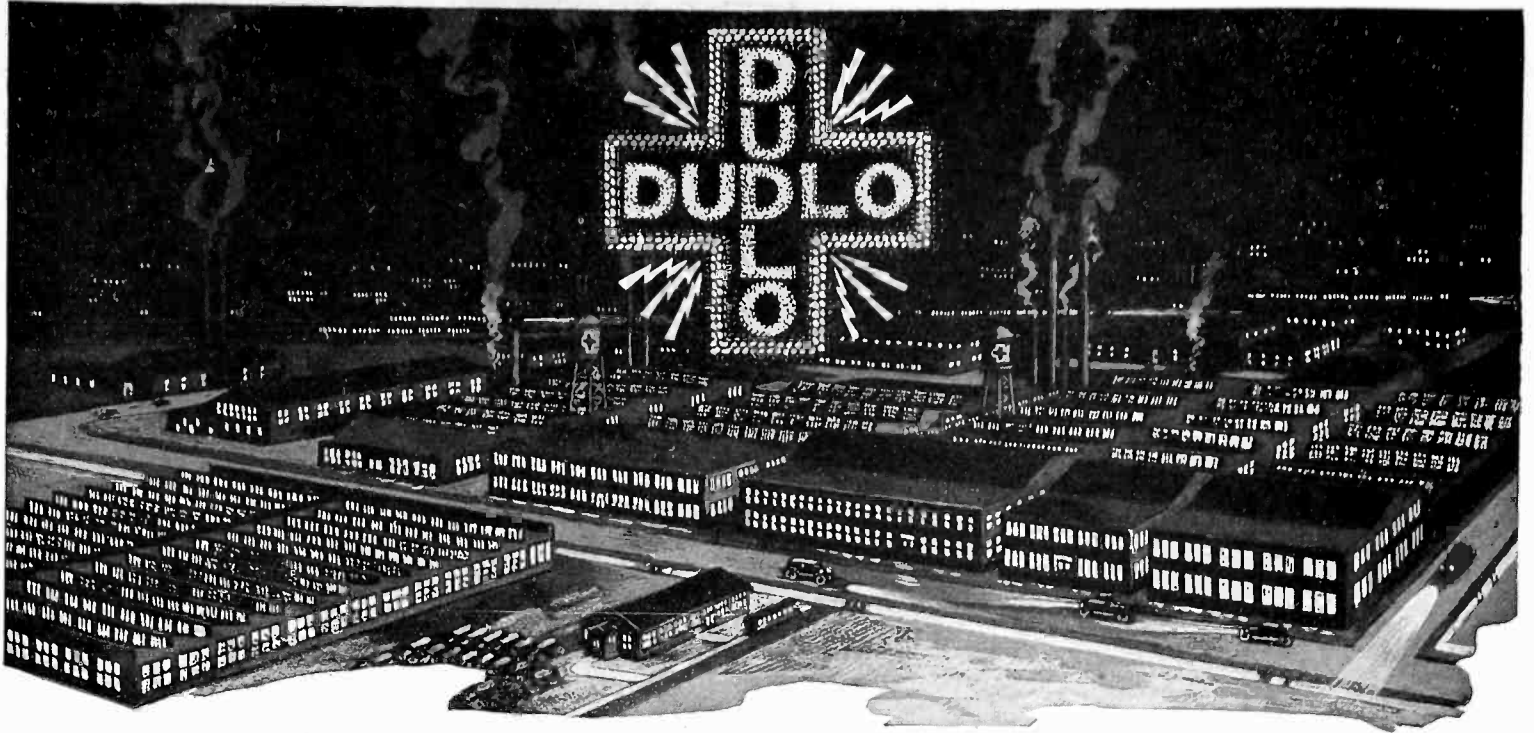

## The Logical Source of Supply For Magnet Wire and Coils

The plain facts are that Dudlo resources, products, and service make Dudlo the logical source of supply

**First: Volume.** Volume reflects the ability to supply quantity on short notice. It also reflects organization, facilities, financial strength and popularity of product.

**Second: Experience.** The combined experience of Dudlo magnet wire and coil experts affords resources that are not duplicated.

**Third: Engineering Facilities.** The Dudlo engineering staff and experimental laboratories offer buyers an expert free service. They function as if they were a part of the buyer's own organization.

**Fourth: Location.** Fort Wayne is centrally located on trunk line railroads. With private side tracks directly connecting, unsurpassed shipping facilities are made possible.

**Fifth: Branch Offices.** Branch offices and warehouses at Newark, Chicago, St. Louis, San Francisco and other points, are prepared to efficiently serve those nearer to them than to the Fort Wayne factory.

**Sixth: Service.** First, last, and always, the whole Dudlo organization is geared to and revolves around a service that leaves no loop hole for other than complete and uninterrupted satisfaction.

# DUDLO

**DUDLO MANUFACTURING CORPORATION, FORT WAYNE, INDIANA**

412 Chamber of Commerce Bldg.  
NEWARK, N. J.

160 North La Salle Street  
CHICAGO, ILL.

4153 Bingham Ave.  
ST. LOUIS MO.

274 Brannan St.  
SAN FRANCISCO, CALIFORNIA

Please mention the JOURNAL of the A. I. E. E. when writing to advertisers.

# WILLS SAINTE CLAIRE

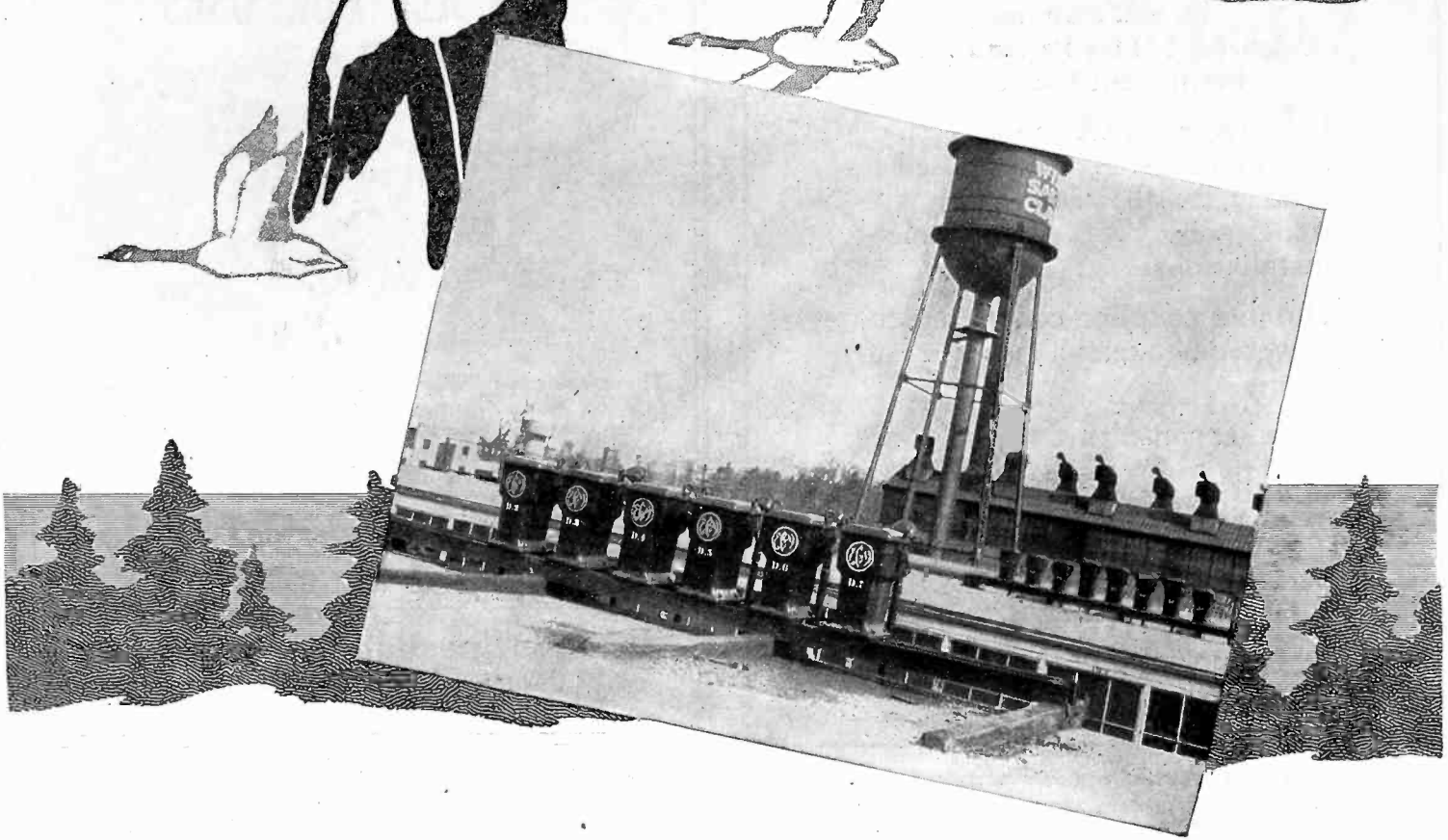

**O**UT on the open stretches and over the hills, into the trail of the sinking sun, follow the Gray Goose of the Wills Sainte Claire.

Men who possess that mysterious gift which creates and dares to venture, have built and are building the Wills Sainte Claire automobile.

Dozens of EC&M Automatic Compensators were placed on the roof of their machine shop building because space beneath that roof was needed for more machinery, placed where they must withstand the zero weather of Michigan's winters and the baking heat of its summer sun, where no ordinary electrical equipment would be expected to stand up, but where these men dared to place them.

For over five years these EC&M Oil-immersed Automatic Compensators for starting the electric motors in the plant below, from push buttons placed near the machines, have been working steadily under these most trying weather conditions and have justified the confidence of the men who placed them there.



## THE ELECTRIC CONTROLLER & MFG. CO.

BIRMINGHAM - BROWN-MARX BLDG.  
 CHICAGO - CONWAY BLDG.  
 CINCINNATI - NATIONAL BANK BLDG.  
 DETROIT - DIME BANK BLDG.  
 NEW YORK - 50 CHURCH ST.

**CLEVELAND, OHIO**

LOS ANGELES - THOMAS MACHINERY CO.  
 AMERICAN BANK BLDG.

PHILADELPHIA - WITHERSPOON BLDG.  
 PITTSBURGH - OLIVER BLDG.  
 SAN FRANCISCO - CALL BUILDING  
 SEATTLE - 570 COLMAN BLDG.  
 TORONTO - TRADERS BANK BLDG.



Please mention the JOURNAL of the A. I. E. E. when writing to advertisers.

## When You Buy Condensers

When you buy condensers—what do you demand?

**Accuracy! Low Power Factor! Permanent Capacity!**

Dubilier condensers meet these requirements. They are used in practically all transmitting stations and U. S. Government installations.

Dubilier coupling condensers for power line telephony are supreme.

Dubilier consulting engineers are always at your service—they can help you too.

4377 Bronx Blvd., New York, N. Y.

**Dubilier**  
CONDENSER AND RADIO CORPORATION

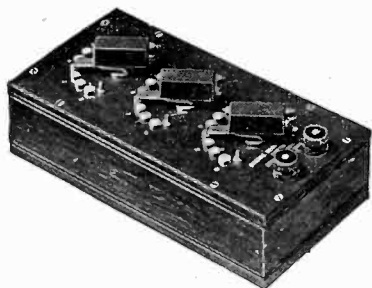

## 102 Decade Resistances

The 102 Decade Resistance boxes present a convenient arrangement of standard resistances.

The resistances used are non-inductive and of extremely low capacity, the Ayrton Perry method of winding being employed.

The accuracy of adjustment is 0.1% on units above 5 ohms resistance.

Convenient two, three and four dial decade arrangements include a range of one tenth the one hundred thousand ohms.

The Type 102 Boxes are particularly well suited for use in bridge set ups where an accurate and easily variable resistance is required.

*Bulletin 211E on request.*

Prices . . . . . \$24.00 to \$95.00

**GENERAL RADIO COMPANY**  
30 State Street Cambridge, Mass.

# Faradon

## ELECTROSTATIC CONDENSERS FOR ALL PURPOSES



There are over 200 standard "FARADON" condensers on which immediate deliveries can be made. Complete new catalogue will be sent on request. Those interested in Carrier Current Coupling Condensers should ask for copy of Bulletin 101.

*The engineering staff of the Wireless Specialty Apparatus Company will co-operate fully with those having special equipment under consideration. Estimating data, quotations or any other information furnished promptly on request.*

**Wireless Specialty Apparatus Co.,**  
Jamaica Plain, Boston, Mass.  
Established 1907

# DUNCAN

Watthour Meters

Accurate  
and  
Dependable

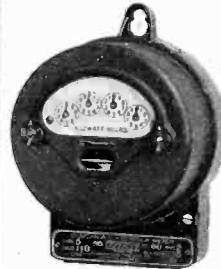

Model M2.

Write for bulletins

**DUNCAN ELECTRIC MFG. CO.**  
Lafayette, Ind.

### THE ELEMENTS OF OUR BUSINESS

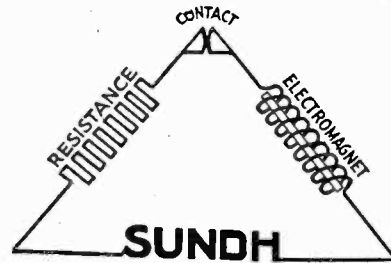

- TRADE-MARK
- |                    |                     |
|--------------------|---------------------|
| Automatic Starters | Pressure Regulators |
| Circuit Breakers   | Remote Switches     |
| Float Switches     | Speed Regulators    |
| Hand Starters      | Transfer Switches   |
| Magnet Switches    | Valve Control       |

### WRITE FOR CATALOG

Sundh Electric Company, Newark, N. J.  
Branch Offices or Sales Representatives in Principal Cities



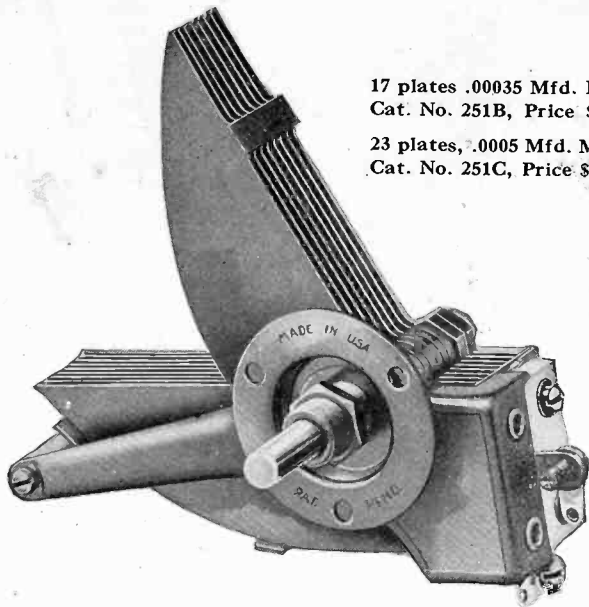

17 plates .00035 Mfd. Max.  
Cat. No. 251B, Price \$3.50  
23 plates, .0005 Mfd. Max.  
Cat. No. 251C, Price \$4.50

## From Start to Finish *True* Straight Line Frequency

EVERY single part of the Pacent *True* Straight Line Frequency Condenser was especially designed and constructed for real straight line frequency operation.

When you buy a Pacent Straight Line Frequency Condenser, you are purchasing a product that is the result of 18 months engineering research and experiment, and can be absolutely sure of perfect straight line frequency operation with wide, accurate spacing of stations.

*Full information on request.*

**PACENT ELECTRIC CO., INC.**  
91 SEVENTH AVENUE NEW YORK CITY

*Canadian Licensed Manufacturer:*  
White Radio Limited, Hamilton, Ont.  
*Manufacturing Licensees for Great Britain  
and Ireland:*

Igranic Electric Co., Ltd., London and  
Bedford, England

**Pacent**  
**RADIO ESSENTIALS**

# WESTON

## Rectangular Switchboard Instruments

A. C. Ammeters, Voltmeters and Wattmeters, Reactive Component Meters, Frequency Meters, Power Factor Meters, Triplex Ammeters and D. C. Voltmeters and Ammeters.

THEY fill every power switchboard need. Their great popularity is largely due first to their high Weston standard of performance and durability and to the numerous advantages of the rectangular type. (This rectangular case, developed by Weston engineers, makes possible savings in switchboard space, gives greater readability, standardization of mounting and exceptionally simple and pleasing appearance. (Our engineers will be glad to show you the space savings you may make in particular switchboard plans and to furnish you with complete information and specifications.

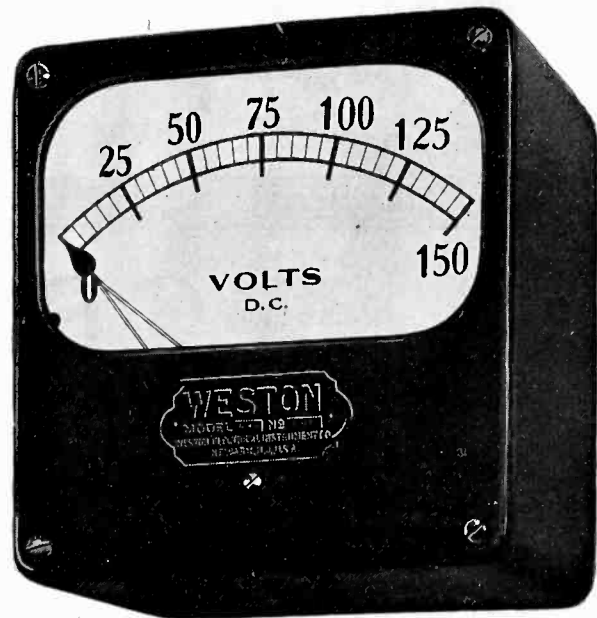

**WESTON ELECTRICAL INSTRUMENT  
CORPORATION**

48 Weston Avenue, Newark, N. J.



STANDARD THE WORLD OVER

**WESTON**

*Pioneers since 1888*



Please mention the JOURNAL of the A. I. E. E. when writing to advertisers.

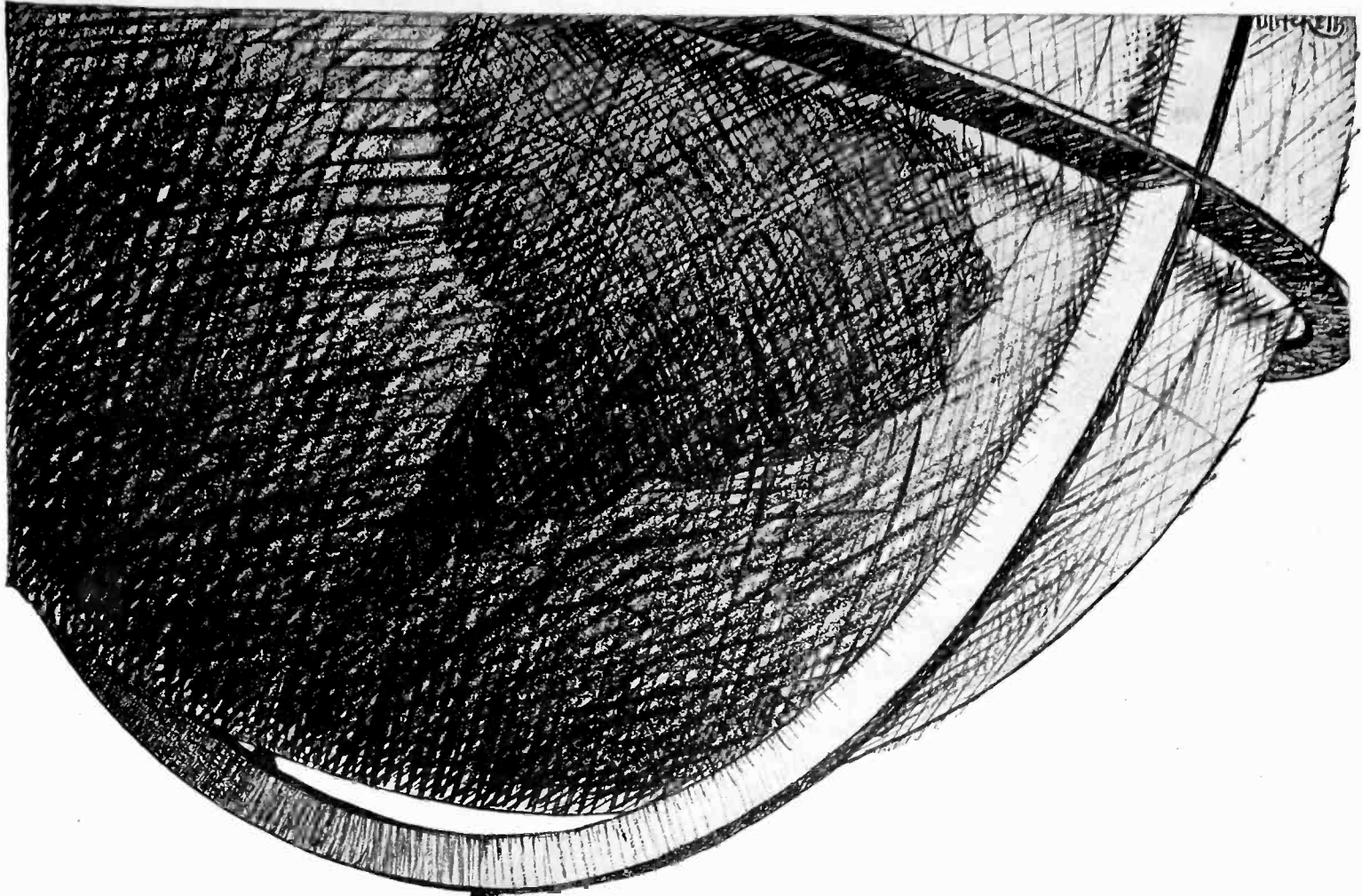

VISIT the Sangamo Electric Company's exhibit at the Sesqui-Centennial Exposition; Machinery Palace, Building 5.

## WORLD-WIDE

In 1897 the Sangamo organization began operations in one room. Today, Sangamo is a world-wide organization with four factories on three continents, and representatives in the principal cities of the globe. The Sangamo products are:

Alternating-current Watthour Meters; Service and switchboard types; Direct-current Watthour

Meters, Service and switchboard types; Ampere-hour Meters, Service and switchboard types; Portable Test Meters; Distant-dial Mechanisms; Circuit-breakers; Current Shunts; Instrument Transformers; Maximum-demand attachments.

Every sixteen seconds of every working day, a Sangamo Meter is installed.

### THE ASSOCIATED SANGAMO ELECTRIC COMPANIES

SANGAMO ELECTRIC COMPANY  
*Springfield, Illinois*

SANGAMO ELECTRIC COMPANY  
OF CANADA LIMITED  
*Toronto, Ontario*

BRITISH SANGAMO COMPANY LIMITED  
*Ponders End, Middlesex, England*

ASHIDA ENGINEERING COMPANY  
*Osaka, Japan*

6731-4

Please mention the JOURNAL of the A. I. E. E. when writing to advertisers.



Accurate and well designed tools are essential in the manufacture of measuring instruments. Where clearances are close Jewell tool makers must build punches, dies, jigs and special tools, with exceptionally small tolerances.

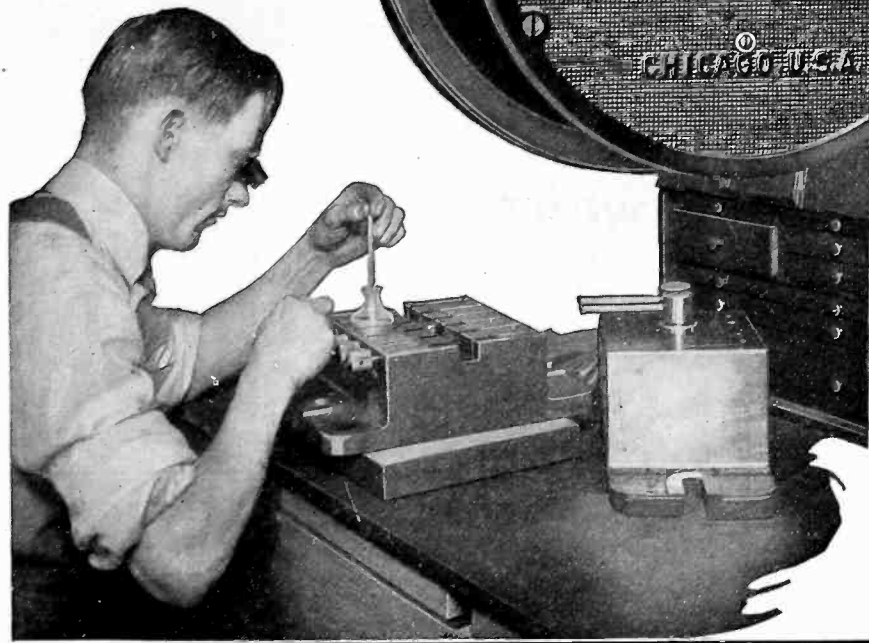

*Instrument mechanism that insures accuracy under all conditions*

Wattless current or "electrical froth", as it was recently called, is costing the country a large sum. When reducing idle current losses and raising the power factor of your load, you should install the proper measuring instruments.

The Jewell power factor meter on the crossed coil dynamometer principle with its proven features of stability and accuracy of indication assures accurate power factor measurement.

**JEWELL ELECTRICAL INSTRUMENT CO.**  
1650 Walnut Street  
CHICAGO, ILL.

**For Station Tie-Ins—**



Frequency Meter

**Bristol's  
Frequency  
Meters**

Load dispatchers like them and good reason why. It helps them to prevent bucking on station tie-ins.

With the tie-ins that are made between different plants and systems, it is very important that the frequency of the circuits be held within very close limits.

Load dispatchers who are responsible for tying in the circuits have advised us that they have found Bristol's Frequency Meters of great value and that they are very enthusiastic about them.

These instruments are available in models using round smoked charts and strip charts.

Write for detailed information.



**MIDWEST FILTERED AIR  
for the Power Plant**



**Clean Midwest Air Pays on  
Power Plant Diesel Engines Too!**

This type B-3 Midwest Filter serves the 200 H. P. Type Y Fairbanks-Morse engine of the Biggar Electric Co., Biggar, Saskatchewan.

The overall operating cost of less than 10c. a day is repaid many times by reduced repair and maintenance costs.

Ask Dept. E for complete performance reports on Midwest installations in your field.



# Low Voltage

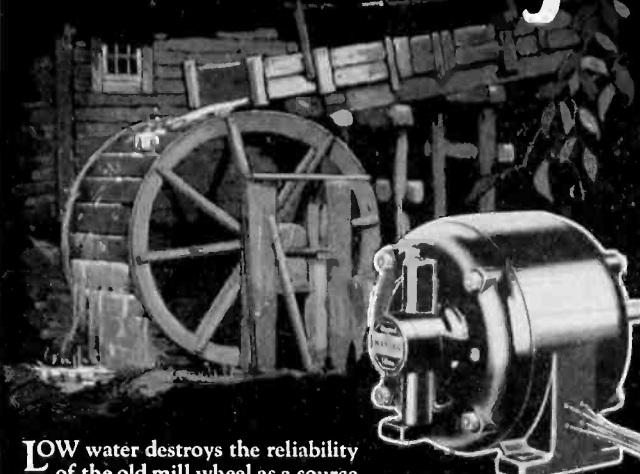

**L**OW water destroys the reliability of the old mill wheel as a source of power. Low voltage has the same effect on motors that do not have the proper characteristics to meet low voltage conditions. **MASTER GUARANTEED MOTORS** will start and operate rated load on as low as 70% normal voltage.

**The Master Electric Company**  
Linden & Master Aves. Dayton, Ohio

STOCKS CARRIED IN PRINCIPAL CITIES

## MASTER GUARANTEED MOTORS

$\frac{1}{8}$  TO  $7\frac{1}{2}$  H.P.  Less than 40°

## That Year in and Year out Service

# ROWAN

### Impedance Starter for Squirrel Cage Induction Motors

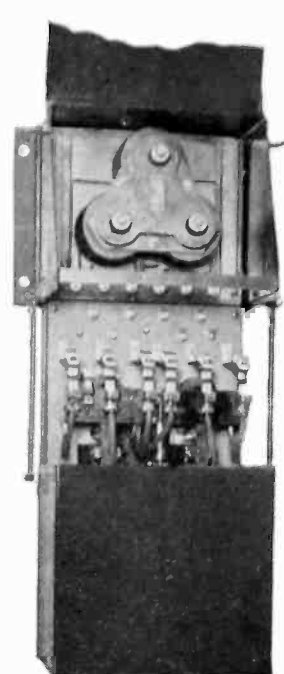

## ROWAN CONTROL

THE ROWAN CONTROLLER CO., BALTIMORE, MD.

## Star Ball Bearing Motors



For Hard Usage — A. C. and D. C.

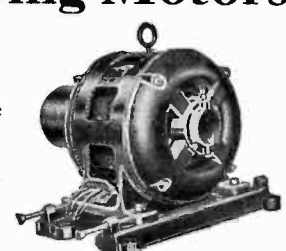

Complete line of standard motors and generators, all sizes up to 75 h. p. and 50 kw. respectively.  
*Our Engineering Department at your service for all special applications*

### STAR ELECTRIC MOTOR CO.

NEWARK, NEW JERSEY

## Sturtevant Electric Motors

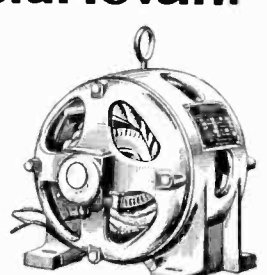

—A. C. and D. C.; single and polyphase—built in sizes from small fractional to 250 horse-power—designed to operate under a constant full load where uninterrupted service is demanded.

### B. F. STURTEVANT COMPANY

HYDE PARK, BOSTON, MASS.

### ELECTRICAL TESTING LABORATORIES

80th Street and East End Ave.  
NEW YORK

*Inspections — Tests — Research*

Tests may be used by the purchaser for the following purposes:

- (1) To determine the quality of competing samples. This enables the purchase of the best quality for the money.
- (2) To make sure that shipments comply with specifications. This makes possible the assurance to the customer that shipments match buying samples.
- (3) To furnish an impartial decision in case of disputes between purchaser and manufacturer.

Testing places the whole buying problem on a sound basis.



Is your name on our mailing list for bulletins and catalog?

# Morganite Brushes

Morganite Brush Co., Inc.  
519 W. 38th St.  
New York

Please mention the JOURNAL of the A. I. E. E. when writing to advertisers.

# CLASSIFIED ADVERTISEMENTS

**RATES.** Forty cents per line; minimum charge based on use of five lines; maximum space cannot exceed twenty lines.

Copy should be received by the 15th of the month, for insertion in the following issue.

**WANTED: RADIO TUBE PATENTS.** The largest exclusive manufacturer of radio tubes in the United States is ready to assist inventors and persons who have useful ideas or patents pertaining to radio tubes. These ideas can take in processes and construction of 110 volt and other type tubes. This manufacturer has a well equipped laboratory and the most up-to-date factory where all ideas can be brought to a successful conclusion, if at all practical from a manufacturing and merchandising standpoint. Satisfactory remuneration will be the reward for ideas accepted. Address Class-117, JOURNAL of the A. I. E. E., 33 West 39th St., New York.

**WANTED:** Copies of the following back numbers of the JOURNAL of the A. I. E. E.: (1925 issues) JUNE, OCTOBER, NOVEMBER, DECEMBER. Wrappers returning these copies should bear the sender's name and address. Twenty-five cents will be paid for each copy received. Address American Institute of Electrical Engineers, 33 West 39th Street, New York.

## A. I. E. E. STANDARDS

THE following approved STANDARDS are available in pamphlet form, at the prices indicated, with a discount of 50% to A. I. E. E. members:

General Principles Upon Which Temperature Limits are Based in the Rating of Electrical Machinery, (.20); Direct-Current Generators and Motors and Direct-Current Commutator Machines in General, (.40); Alternators, Synchronous Motors and Synchronous Machines in General, (.40); Synchronous Converters, (.40); Induction Motors and Induction Machines in General, (.40); Direct-Current and Alternating-Current Fractional Horse Power Motors, (.30); Railway Motors, (.30); Transformers, Induction Regulators and Reactors, (.40); Instrument Transformers, (.30); Industrial Control Apparatus, (.40); Railway Control and Mine Locomotive Control Apparatus, (.40); Oil Circuit Breakers, (.30); Disconnecting and Horn Gap Switches, (.30); Wires and Cables, (.40); Telegraphy and Telephony, (.30); Storage Batteries, (.20); Illumination, (.30); Electric Arc Welding Apparatus, (.40); Electric Resistance Welding Apparatus, (.30); Insulators, (.30); Symbols for Electrical Equipment of Buildings, (.20).

**AMERICAN INSTITUTE of  
ELECTRICAL ENGINEERS**  
33 West 39th Street New York

Trade "ESCO" Mark

## ELECTRIC SPECIALTY CO.

Engineers and Manufacturers

DESIGN — DEVELOP — PRODUCE

Small Motors, Generators, Dynamotors,  
Motor Generators, Rotary Converters, Etc.

FOR SPECIAL PURPOSES

Send Us Your Problems

222 South Street STAMFORD, CONN., U.S.A.

## TRUMBULL



for years have stood the most exacting tests of scores of the largest motor, dynamo, generator, and radio builders in the United States.

Our Engineering Department is at your service. Write us concerning your requirements.

**THE TRUMBULL STEEL COMPANY**  
WARREN Mills, Laboratories and General Offices OHIO

## THE PIONEER MANUFACTURER OF Interpole & Ball Bearing Motors

1/2 to 1000 H. P. D. C. and A. C.

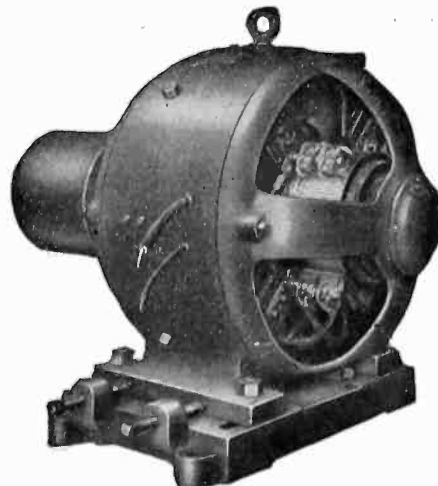

Type "S" Ball Bearing Motor with base and pulley

**ELECTRO DYNAMIC COMPANY**

Established 1880

BAYONNE, N. J.

Sales Offices in Principal Cities

**"They Keep a-Running"**

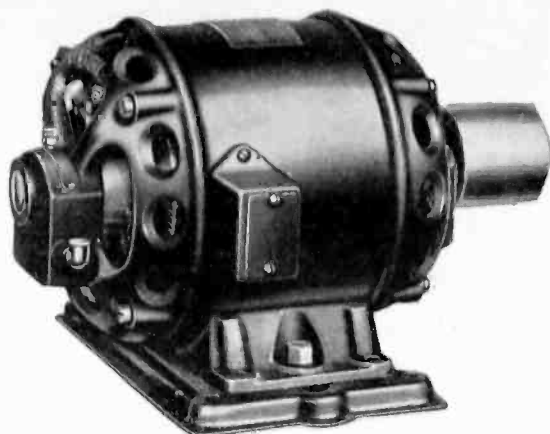

*1/4 Horse Power Century Repulsion-start Induction Single-phase Motor.*

## If the Load is Hard to Start Use Century Repulsion-start Induction Single-phase Motors

Century Repulsion-start Induction Single-phase Motors start against heavy static loads, as in refrigerating systems, air compressors, pumps, mixers and other machines of this character.

- 1 They develop the high starting torque necessary to start heavy static loads.
- 2 They start as repulsion motors, but, after attaining approximately full speed, the brush tension is removed automatically and the motor then runs as an induction motor. The same construction as used for 23 years.
- 3 Starting current is low—not in excess of 260% of full load current. Fuses used for full-load operation are usually of sufficient capacity to effect a start.
- 4 Any approved single-throw switch may be used for starting.
- 5 Suitable for all types of automatic or remote control service.
- 6 The Century Wool-yarn System of Lubrication—applied to all one horse power and smaller motors—assures at least one year's continuous 24-hour-per-day operation without re-oiling.

Temperature rise not more than 40° Centigrade.

Century Repulsion-start Induction Single-phase Motors are built in all standard sizes from 1/8 to 40 horse power.

Send for new Single-phase folders.

**Century Electric Co.**  
1806 Pine St. St. Louis, Mo.

*For More Than 23 Years at St. Louis*

1/8 to 40 H. P.

**Century  
MOTORS**

1/8 to 40 H. P.

## Hot Forged from Molybdenum Steel!

IN the first place, the balls which go into SRB Bearings won their reputation long ago...established it, in years spent speeding up and lightening the loads of machines in factory shops.

In the second place, these balls are now made from the newer, tougher, longer-lasting Molybdenum Steel...a steel which proved its resistance in shell-battered army tanks during the war. Durable as SRB Bearings were... this added still more years to their lives...at least 25% more in actual performance.

...and in the third place, this tougher steel is shaped into balls by the SRB

### Hot Forging

process under Bradley Hammers—a process known by all metallurgists to improve the grain structure of steel...to shape it with minimum strain...to toughen it...to strengthen it.

Now! Add point to point and you will specify, not alone ball bearings, but SRB Bearings with Balls Hot Forged from Molybdenum Steel.

*SRB Service Now Includes  
M-R-C Thrust Bearings*

See our Exhibit in the Fifth National Exposition of Power and Mechanical Engineering, Booth No. 336, Mezzanine Floor, Grand Central Palace, New York, December 6th to 11th, 1926.

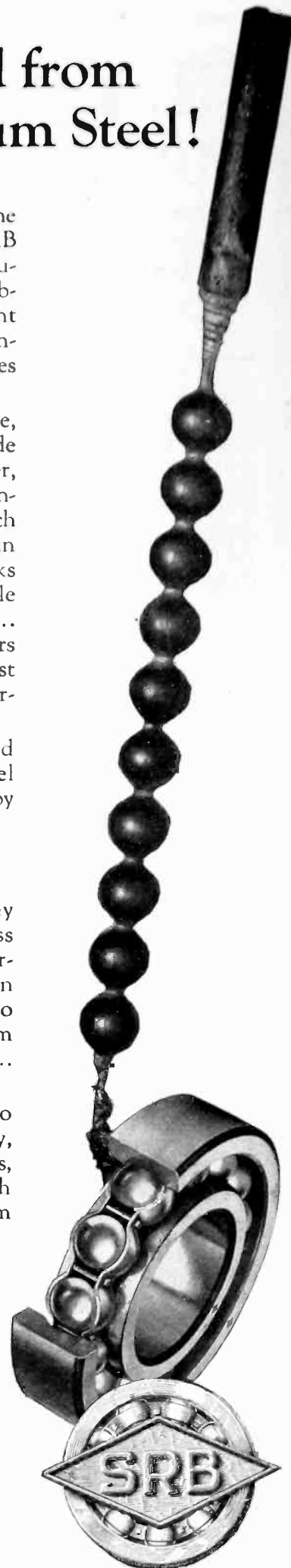

STANDARD STEEL AND BEARINGS INCORPORATED  
Plainville Connecticut

USE SRB BALL BEARINGS—*First!*  
—they'll last

Please mention the JOURNAL of the A. I. E. E. when writing to advertisers.

## Pop Gets Hot About a Hot Motor



**“Lad—**

I'm running to the ground every one of these shutdowns we've had on the machines. They're nearly all due to your lack of regular motor inspection. Here's a case where this fan was all loose and bent. Of course the motor heated up because you didn't catch the trouble. Then you blame it on the motor.”

**“Yes, Pop—**

did you expect when you bought those motors from your non-development gang that you'd have to spend the price of the motors each year for private detective service to watch over the crimes that the maker put into them? That could never—yes, NEVER—happen to a Linc-Weld motor because they make their fans by punchings from He-Steel welded (Stable-Arc of course) smack up against the rotor end plate.”

*See how they do it—Page 9 of the Motor Book. If you haven't a copy write to—*

**The Lincoln Electric Co., Cleveland, Ohio**

MA-1

**L** *“Linc  
Weld”*  
**INCOLN MOTOR**

Please mention the JOURNAL of the A. I. E. E. when writing to advertisers.



## ACME

### Varnished Insulations Electrically and Physically Tested\*

for

DIELECTRIC STRENGTH  
DIELECTRIC CONSTANT  
DIELECTRIC LOSS  
INSULATION RESISTANCE  
POWER FACTOR  
FLEXIBILITY  
RESISTANCE TO TEAR  
TENSILE STRENGTH  
EFFECT OF HEAT  
RESISTANCE TO OILS  
RESISTANCE TO IMPREG-  
NATING COMPOUNDS

[ \*A. S. T. M. Tests are followed in all Acme tests of raw materials and finished products. ]

Acme Varnished Insulations are furnished in tape form to meet specification. Furnished in widths of  $\frac{1}{4}$  inch and wider; and in rolls of continuous lengths without splices up to 225 lineal yards. Special finishes furnished on order. Write for Catalog 3-A, telling the story of Acme Varnished Insulations.

## ACME WIRE PRODUCTS

The Acme Wire Co., New Haven, Conn.

Branches at

New York, 52 Vanderbilt Ave. Chicago, 427 West Erie St.  
Boston, 80 Federal St. Cleveland, Guardian Bldg.

# West Virginia Fibre Board

## I-N BOARD

*For Electrical Insulation*

I-N Board has been tested and approved by the Underwriters' Laboratories for electrical insulation.

This board has a very high tensile and dielectric strength and is being used successfully by many electrical manufacturers who are finding it a decided factor for economy.

Pulp Products Department

**West Virginia Pulp & Paper Company**

200 Fifth Avenue, New York, N. Y.  
505 Dime Bank Bldg. Detroit, Mich. 732 Sherman Street Chicago, Ill.  
503 Market Street, San Francisco, Cal.

## Y-26 High-Heat Mica Plate

### For High Temperature Insulation

Possesses all the advantages of natural mica for insulating heating appliances. Is more economical, particularly when used in the larger units.

Supplied in sheets up to 30" x 42", in thicknesses of ten mils or over. Can be cut or punched to any form.

Send for samples and prices.



**NEW ENGLAND MICA CO.**

Waltham 54, Mass.

New York Office — 220 Broadway

ALL FORMS OF MICA FOR ELECTRICAL PURPOSES

## "IRVINGTON" PRODUCTS

Black and Yellow

Varnished Cambric Varnished Paper  
Varnished Silk

Flexible Varnished Tubing  
Insulating Varnishes and Compounds  
"Cellulak" Tubes and Sheets

**IRVINGTON VARNISH & INSULATOR CO.**  
Irvington, New Jersey.

*Sales Representatives in all principal cities*



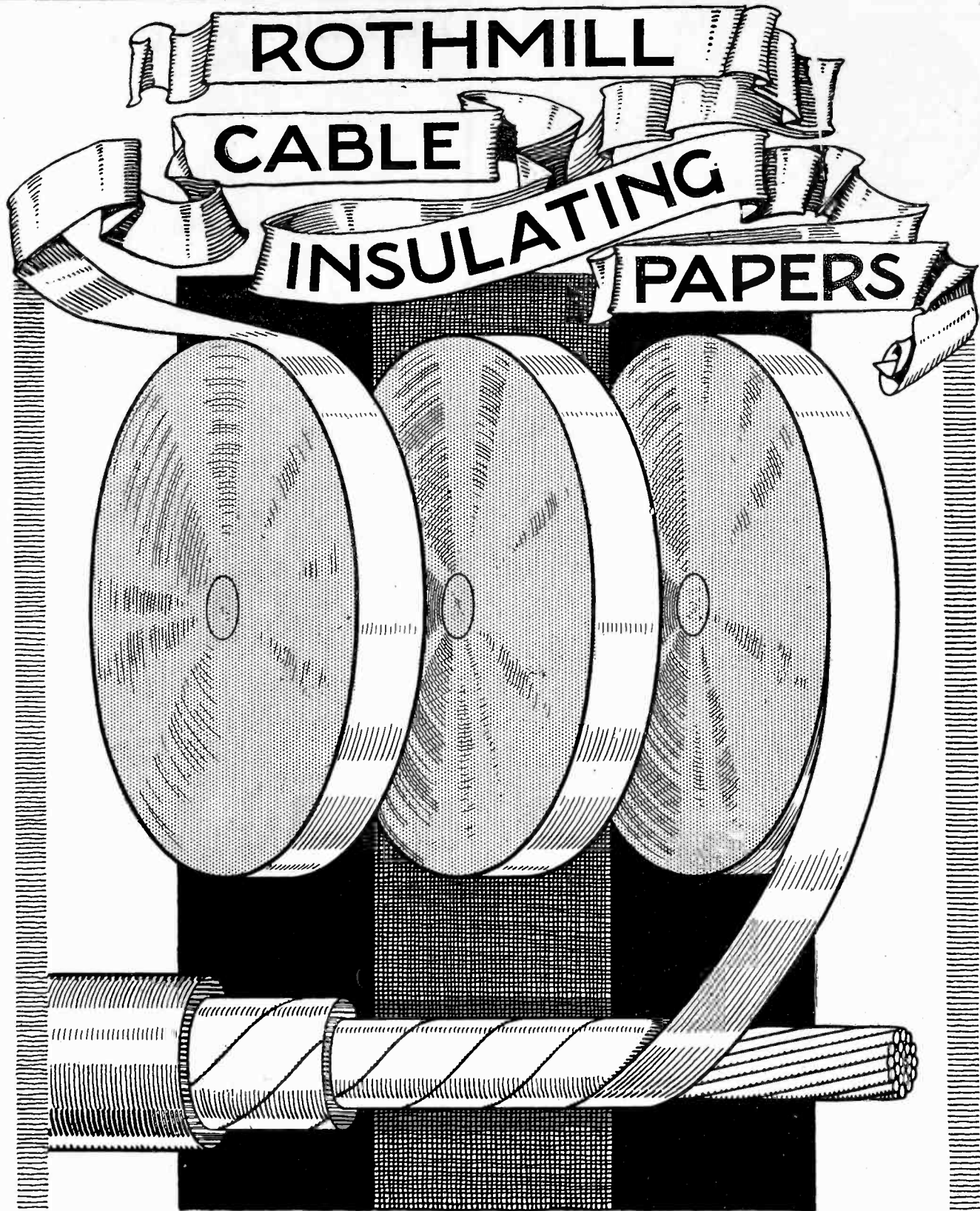

# TULLIS, RUSSELL & CO. LTD.

HEAD OFFICE AND MILLS  
MARKINCH, SCOTLAND  
CABLES—"TULLIS, MARKINCH"

PAPER MAKERS  
ESTABLISHED 1809  
SALES OFFICE  
1, TUDOR STREET,  
LONDON, E.C. 4. ENG  
CABLES AUCHMUTY, LONDON

MANCHESTER OFFICE  
376 CORN EXCHANGE BUILDING  
CORPORATION STREET  
MANCHESTER

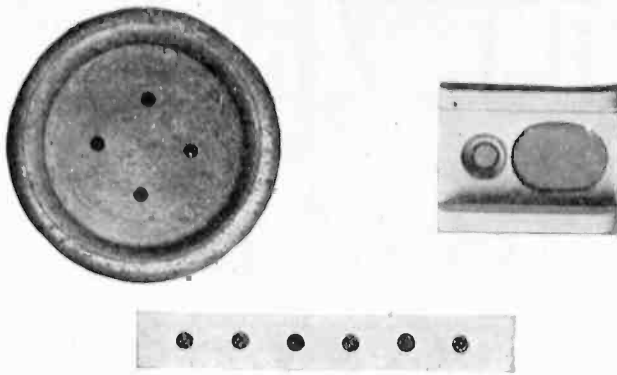

# LAVA INSULATORS

Lava Insulators are unexcelled in instruments requiring a fixed relation of their parts under all conditions.

Permanent in nature, lava is not subject to variations in structure and composition.

AMERICAN LAVA CORPORATION  
27-67 Williamson Street  
Chattanooga Tennessee



## BUY CHRISTMAS SEALS

and help us to keep  
you healthy



THE NATIONAL, STATE AND LOCAL TUBERCULOSIS  
ASSOCIATIONS OF THE UNITED STATES

Makes  
fine lines  
for

Figuring  
Checking  
Underscoring  
Blueprints,  
etc.

- No.
- Blue . . . 1206
- Red . . . 1207
- Green . 1208
- Yellow . 1209
- Purple . 1210
- Brown . 1212
- Black . . 1213
- Orange . 1214
- White . 1215
- Light Blue  
1216
- Pink . . 1217
- Light Green  
1218

Price  
**\$1.00**  
per doz.

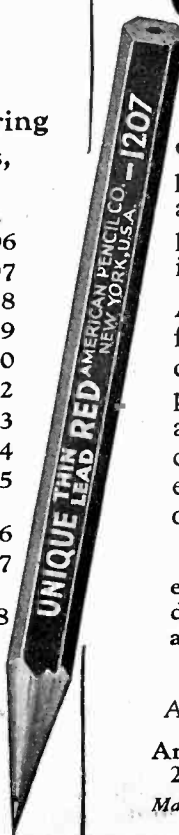

## UNIQUE THIN LEAD Colored Pencils

SOMETHING wanted for years! A colored pencil with the same diameter lead as in writing pencils; can be sharpened in a pencil sharpener.

An absolute necessity for making fine lines in color on charts and plans—something never achieved before. The 12 colors also enable each executive to have his own color symbol.

Adopted by  
executives • accountants  
draftsmen • photographers  
artists • teachers  
useful to everyone

At all dealers, or write us direct  
American Lead Pencil Co.  
204 Fifth Ave., New York  
Makers of the famous Venus Pencils

# Contemporary Physics

BY KARL K. DARROW,  
Member of the Technical Staff, Bell Telephone Laboratories.

A connected account of the chief phenomena upon which contemporary atomic theories are based, and an introduction to the theories themselves. Recently Published, \$6.00.

## Theory of Vibrating Systems and Sound

BY IRVING B. CRANDALL,  
Member of the Technical Staff, Bell Telephone Laboratories.  
Recently Published, \$5.00.

## Transmission Circuits for Telephonic Communication

BY K. S. JOHNSON,  
Member of the Technical Staff, Bell Telephone Laboratories.  
An epitome of facts on the theory and practical principles of transmission circuits and lines. Price \$5.00.

## X Rays and Electrons

BY ARTHUR COMPTON,  
Professor of Physics at the University of Chicago.  
A detailed treatment of the phenomena of X Rays and Electrons, covering the author's important original investigations on the subject, as well as the valuable contributions of other scientists. Published October, \$6.00.

### D. VAN NOSTRAND COMPANY

8 Warren Street

New York



# Balkite Trickle Charging for TELEPHONE BATTERIES

Power for small telephone switchboards and private branch exchange boards is supplied either by storage or primary batteries or over wires from a central office. If storage batteries are used, they are charged either over wires from the central office or by a charging device which operates from the local power supply.

Power furnished from the central office or by primary batteries is inherently expensive and can be used only where the load is light.

The best source of power is a storage battery, and the best way of charging such a battery is by the BALKITE TRICKLE CHARGING SYSTEM.

Balkite Trickle Charging is simple, reliable, economical, and operates from the local alternating current power supply. It insures a constant power supply and releases telephone wires for revenue producing telephone service.

A complete booklet describing the system and its operation is available on request. Write for it.

FANSTEEL PRODUCTS COMPANY, Inc., North Chicago, Ill.

# FANSTEEL Balkite Battery Chargers

FANSTEEL PRODUCTS COMPANY, Inc., North Chicago, Illinois  
Gentlemen: Please send me a copy of Balkite Trickle Charging.

Name \_\_\_\_\_

Company \_\_\_\_\_

Address \_\_\_\_\_

Position \_\_\_\_\_

**VENUS PENCILS**

“THE world's finest drawing pencil” is what engineers call VENUS; because VENUS has given to engineers a service incomparably more perfect and complete than that of any other pencil.

For sketch, plan or blueprint VENUS is the pencil of precision.

**17 black degrees, 3 copying**  
 For bold, heavy lines . . . 6B-5B-4B-3B  
 For Writing, sketching . . . 2B-B-HB-F-H  
 For clean, fine lines . . . 2H-3H-4H-5H-6H  
 For delicate, thin lines . . . 7H-8H-9H

Plain Ends, per doz. . . . . \$1.00  
 Rubber Ends, per doz. . . . . 1.20

*At Stationers and Stores throughout the World.*

**American Lead Pencil Co.**  
 204 Fifth Avenue, New York

*The largest selling Quality pencil in the world.*

Also makers of Unique Thin Lead Colored Pencils 12 colors \$1.00 per doz.

# SELENIUM

In The  
Tirex 60% Rubber Armor  
increases the  
Resistance to Abrasion  
50%



TIREX Cables have always been protected by a sheath of the most wear-resisting rubber compound known to the art, but now with their new Selenium Rubber jacket they have the toughest and most wear-resisting protective armor ever made. Wear tests prove this.

The process of vulcanizing rubber with Selenium was developed in our laboratories and is covered by U. S. patents Nos. 1,249,272 and 1,364,055. This advance in the art of rubber compounding increases the toughness or wear-resisting qualities of a rubber compound fifty per cent.

The use of Selenium in rubber compounds to increase their wearing qualities is as important a development as were rubber sheathed cables, first put on the market by us a few years ago.

Write for further information.

## SIMPLEX WIRE & CABLE CO

MANUFACTURERS

201 DEVONSHIRE ST., BOSTON  
CHICAGO SAN FRANCISCO NEW YORK  
CLEVELAND SAINT AUGUSTINE

## "AMERICAN BRAND"

Weatherproof Copper Wire and Cables

COST



You can buy weatherproof wire cheap, but is it worth what it costs?

"American Brand" gives you more mileage per dollars with a longer life on the line.

Get a sample and satisfy yourself.

American Insulated Wire & Cable Co.

954 West 21st Street, Chicago

# Roebbling

Electrical Wires and Cables. High in Conductivity and Reliability.

John A. Roebbling's Sons Co.  
Trenton, New Jersey



# ATLANTIC

INSULATED WIRES



Including all types of rubber covered, and rubber covered lead encased wires and cables, bare wire, magnet wire, and flexible cords.

ATLANTIC INSULATED WIRE & CABLE COMPANY  
Rome, N. Y.

## WIRE PRODUCTS For Varied Applications

We manufacture many types of wires, cords and cables for specific uses. Among them are:

Rubber Covered Wire—Solid Conductor, Stranded Conductor, Flexible Conductor, Extra Flexible Conductor. Lamp Cords, Reinforced Cords, Heater Cord, Brewery Cord, Canvasite Cord, Packinghouse Cord, Deck Cable, Stage Cable, Border Light Cable, Flexible Armored Cable, Elevator Lighting Cable, Elevator Operating Cable, Elevator Annunciator Cable. Switchboard Cables, Telephone Wire, Flameproof Wires and Cables, Railway Signal Wires, High Voltage Wires and Cables. Automobile Ignition Cables, Automobile Lighting Cables, Automobile Starting Cables, Automobile Charging Cables. Moving Picture Machine Cable.

Boston Insulated Wire & Cable Co.

Main Office and Factory:

Dorchester District Boston, Mass.

Canadian Branch, Office and Factory, Hamilton, Ont.

# HAZARD

## Spiralweave

# TREE WIRE



The secret  
of its durability  
lies in the spiral weave.

Highest grade rubber insulation, perfectly sealed from outside influences by the special rubberized tape. Protective outer coat *spiralwoven* of hard, long staple cotton, thoroughly weatherproofed.

For protection from wear there is nothing which will surpass Hazard Spiralweave.

Ask for our prices, stating size and voltage.  
Samples on request.

**Hazard Manufacturing Company**  
Wilkes-Barre, Pa.

New York Pittsburgh Chicago Denver Birmingham Philadelphia  
Maydwell & Hartzell, Agents, 158 11th St., San Francisco

## Something New in Electric Cables

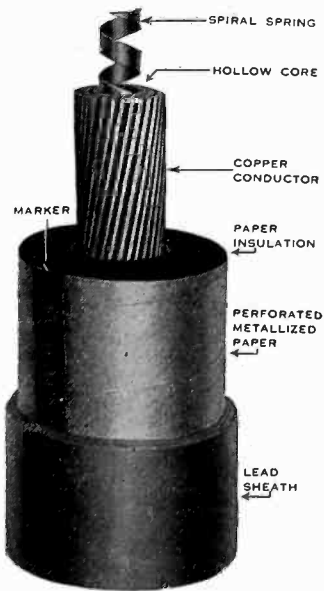

75KV TYPE H CABLE

The perforated, metallized paper over the insulation prevents ionization in gaps likely to exist between cable insulation and the lead sheath. Used if stresses are high.

### STANDARD Type H Cable

is winning recognition among large cable users on account of its dependability.

The Commonwealth Edison Co., Chicago, and the Duquesne Light Co., Pittsburgh, have installed 75,000-volt, single conductor, Type H cable on their systems.

*A line to our nearest office will bring complete information in regard to this economical type of cable.*

### Standard Underground Cable Co.

BOSTON  
NEW YORK

PHILADELPHIA  
WASHINGTON

ATLANTA  
PITTSBURGH

CHICAGO  
DETROIT  
SAN FRANCISCO

ST. LOUIS  
KANSAS CITY

SEATTLE  
LOS ANGELES

FOR CANADA: STANDARD UNDERGROUND CABLE CO., OF CANADA, LIMITED, HAMILTON, ONT.

\*Please mention the JOURNAL of the A. I. E. E. when writing to advertisers.

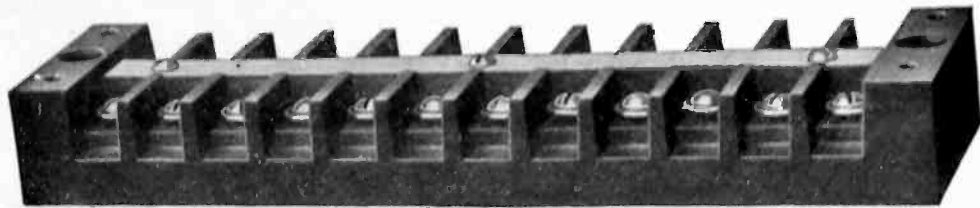

## “BURKELECT” Moulded Controlead Terminal Blocks

By the use of these Terminal Blocks simplifications in all methods of control wiring circuits are possible and offer many other advantages which are fully described in Bulletin H-2.

**BURKE ELECTRIC COMPANY**

HIGH TENSION EQUIPMENT DIVISION

ERIE, PA.

The strength and life of the guy and messenger wires are frequently the determining factors in the reliable and uninterrupted operation of an overhead system.

When a guy or messenger rusts its strength and life are decreased. Its protective value is lessened. It is no longer a safeguard, but a menace.

## “COPPERWELD”

**GUY AND MESSENGER WIRE**

**Does Not Rust**

Thus, the economic reasons justifying its use are—much longer life and protection from rusting, with a consequent reduction in renewals, labor and maintenance costs.

*You cannot afford to ignore the costly replacement and damage losses caused by rusting. Minimize them by using Copperweld.*

**Copperweld Steel Company**

MAIN OFFICE 6 MILLS-BRADDOCK P. O., RANKIN, PA.  
30 CHURCH ST., NEW YORK. 129 S. JEFFERSON ST., CHICAGO.  
403 RIALTO BLDG., SAN FRANCISCO.

In Canada: Northern Electric Co., Ltd.

## MINERALLAC INSULATING COMPOUNDS

For filling Cable Joints  
and Potheads  
on High-Voltage lines

*“A safe specification”*

High dielectric  
Strength

Approved  
physical  
properties

**MINERALLAC  
ELECTRIC COMPANY**

1045 Washington Blvd.  
CHICAGO ILL.

## Pittsburgh Transformer Company

Largest Manufacturers of Transformers exclusively  
in the United States

Pittsburgh, Pennsylvania

# G & W BOXES

MORE THAN PROTECTION FOR CABLE ENDS

## SECTIONALIZE THE LOW TENSION WITH TYPE "M" BOXES.

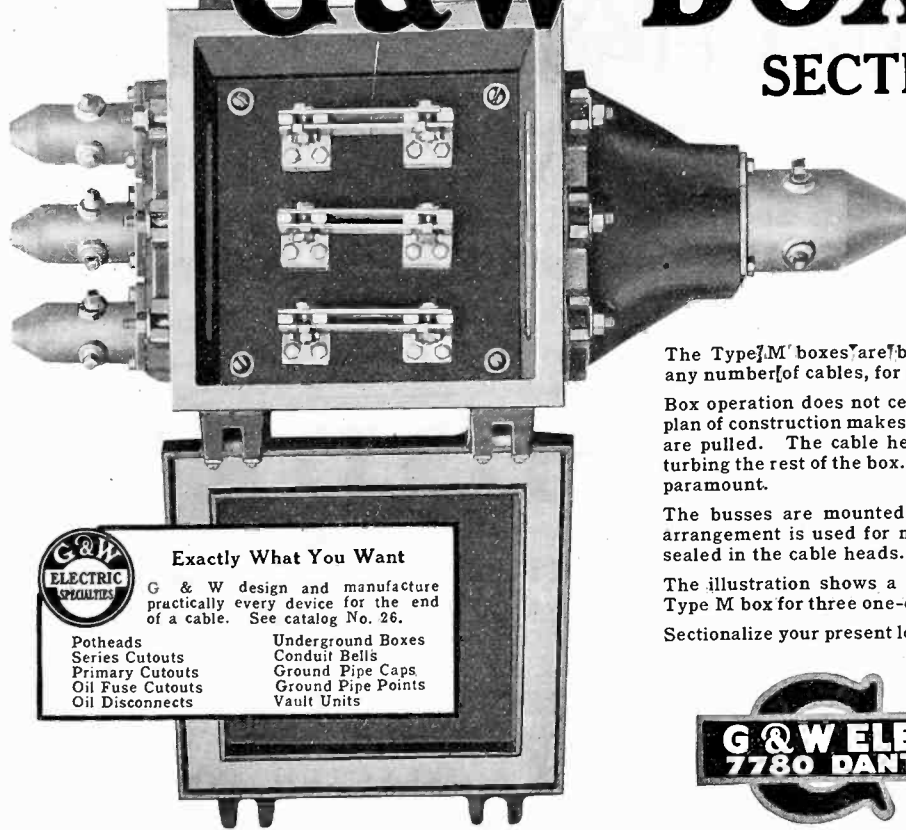

The Type M boxes are built for one, two, three and four conductors, for any number of cables, for any size of cable, for 250 and 600 volts.

Box operation does not cease when a cable is damaged. The G & W unit plan of construction makes each cable a unit right up to the bus. The links are pulled. The cable head and cable are removed as a unit without disturbing the rest of the box. This is most valuable where service continuity is paramount.

The busses are mounted under the panel for safety. The same internal arrangement is used for multiconductor cables or singles. The cables are sealed in the cable heads.

The illustration shows a 250 volt, 400 ampere, two-way, three-conductor, Type M box for three one-conductor and one three-conductor cable.

Sectionalize your present low tension cables with the Type M box.



### Exactly What You Want

G & W design and manufacture practically every device for the end of a cable. See catalog No. 26.

- |                  |                    |
|------------------|--------------------|
| Potheads         | Underground Boxes  |
| Series Cutouts   | Conduit Bells      |
| Primary Cutouts  | Ground Pipe Caps   |
| Oil Fuse Cutouts | Ground Pipe Points |
| Oil Disconnects  | Vault Units        |



# Moloney Transformers

*Every Installation Fully  
Demonstrates Moloney Quality*

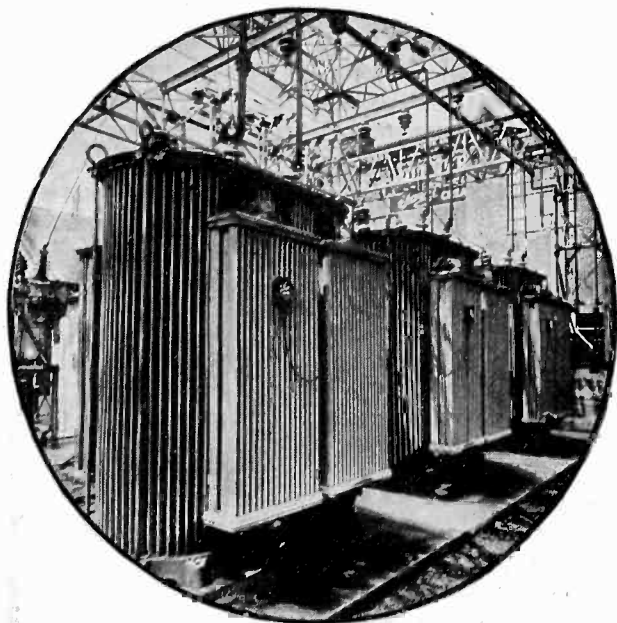

High quality performance has been identified with the name Moloney over a period of thirty years. During this time we have applied our complete efforts, time and experience to giving industry better transformers.

*Complete information furnished upon request*

**Moloney Electric Company**  
St. Louis, Mo.

# HOW MANY MANUFACTURERS

We have  
and it is  
At Your Service

# HAVE A 750 K.V. TESTING ROOM?

Delta-Star  Electric Co

2400 Block, Fulton St.

Chicago, Illinois

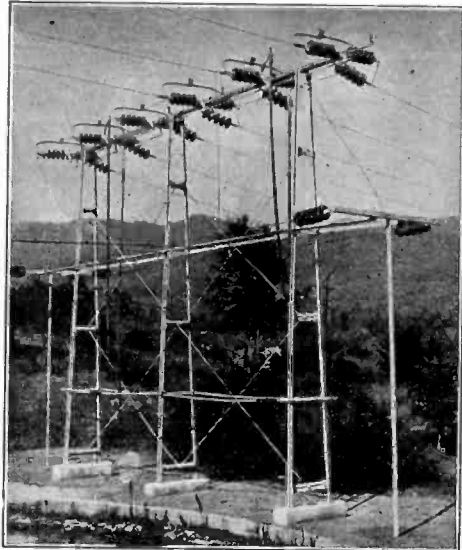

Simpler—  
Stronger—  
Better—

Installation K-P-F  
60 KV. Switches,  
San Joaquin Lt. &  
Pwr. Corp., Calif.

K-P-F POLE TOP SWITCHES consist of fewer parts, are more rugged and require less labor and material for installation than any other.

Each pole becomes a self-contained unit. Switches are shipped ready to bolt on to cross-arm in place of line insulator.

One crossarm supports it. Contacts are far removed from insulators and a unique device prevents sticking or freezing.

Send for bulletin K105 containing full details.

**K-P-F ELECTRIC CO.**

855-859 Howard St.

San Francisco

# MODELS

for

MANUFACTURING STANDARDS  
SALES DEMONSTRATION AND DISPLAY  
USE IN LITIGATION

Experimental Development under Client Supervision

MANUFACTURERS' & INVENTORS'  
ELECTRIC CO.

(Smith Building)

228 West Broadway, N. Y. City

Incorporated 1897

# Transmission Line Structures

Built of High Elastic Limit Steel

Refined — Rolled — Fabricated —

Galvanized in Our Own Plants

**PACIFIC COAST STEEL COMPANY**

MANUFACTURERS OF

**OPEN HEARTH STEEL**

STRUCTURAL SHAPES MERCHANT AND REINFORCING BARS

TRANSMISSION TOWERS AND STRUCTURES

Gen'l Office: Rialto Bldg., San Francisco Plants: San Francisco, Portland, Seattle

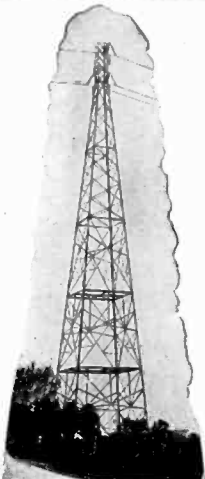

Please mention the JOURNAL of the A. I. E. E. when writing to advertisers.



# STEEL TOWERS

*and component parts*

**FOR ELECTRIC TRANSMISSION**

## AMERICAN BRIDGE COMPANY

71 Broadway, New York City

TOWER DEPARTMENT  
Frick Building, Pittsburgh, Pa.

*Offices in Principal Cities*

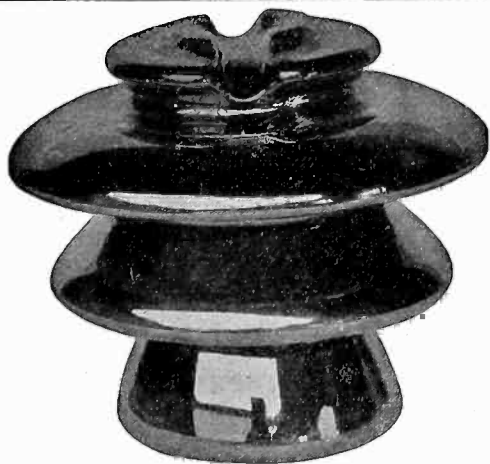

***Lapp Insulators  
do not fail!***

**LAPP INSULATOR CO., Inc.  
LEROY, N. Y.**

*Sales Representatives*

BIRMINGHAM, ALA., Industrial Supply Co., 21 Brown-Marx Bldg.  
BOSTON, Van Rosen Co., 141 Milk St.  
CHARLOTTE, N. C., J. W. Fraser & Co., Commercial Bank Bldg.  
CHICAGO, Transelectric Co., Inc., 360 No. Michigan Ave.  
COLUMBUS, O., Engineering Merchandising Syndicate, 600 Joyce Realty Bldg.  
DALLAS, TEX., J. K. Webb, 1621 Commerce St.  
DENVER, The O. H. Davidson Equip. Co., 1633 Tremont St.  
INDIANAPOLIS, W. D. Hamer Co., 518 Trac. Terminal Bldg.  
KANSAS CITY, MO., Power Machinery Co., 301 Dwight Bldg.  
LOS ANGELES, S. Herbert Lanyon, 210 Transportation Bldg.  
MINNEAPOLIS, J. E. Sumpster Co., 919 Security Bldg.  
NEW YORK CITY, Shield Electric Co., 149 Broadway.  
PHILADELPHIA, Hurris & Butler, Real Estate Trust Bldg.  
PITTSBURGH, Henry N. Muller Co., 2201 First National Bank Bldg.  
SAN ANTONIO, TEX., L. G. Bassett, 723 Navarro St.  
SAN FRANCISCO, S. Herbert Lanyon, 509 New Call Bldg.  
SYDNEY, AUSTRALIA, Chas. M. Terry.  
WELLINGTON, NEW ZEALAND, Jas. J. Niven & Co.

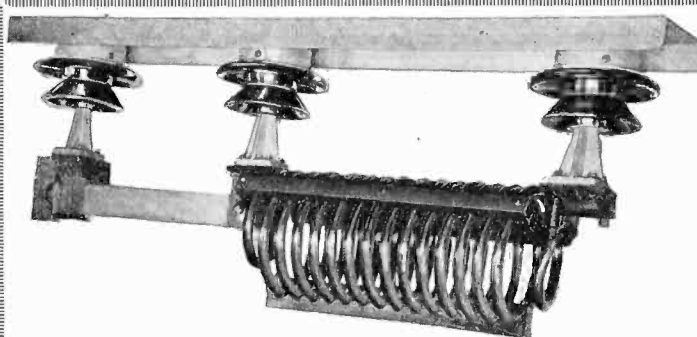

The New  
**THONER & MARTENS**

*underslung outdoor  
disconnecting switch*

THE standard T & M underslung outdoor disconnecting switch, 800 amp., is now equipped with choke coil.

Working pressure is 22,000 volts, dry flush is over 88,000 volts and wet flush over 55,000 volts.

Other T & M features are the Bolt type lock and new sleet cover.

*Write for further details*

**THONER & MARTENS**  
463 Commercial St., Boston, Mass., U. S. A.

# PROFESSIONAL ENGINEERING DIRECTORY

For Consultants in the Fields of Engineering, and Related Arts and Sciences

*Established 1857*  
**ALEXANDER & DOWELL**  
 Attorneys at Law  
 PATENT, TRADEMARK AND  
 COPYRIGHT CASES  
 902 F Street, N. W. Washington, D. C.

**WALTER G. CLARK**  
 Consulting Engineer  
 Electrical, Mining and Industrial  
 Reports  
 Supervision of Organization and Arrange-  
 ments for Financing  
 LOS ANGELES NEW YORK  
 1211 Insurance Exch. Bldg. 40 Wall St.

**FRANK F. FOWLE & CO.**  
 Electrical and Mechanical  
 Engineers  
 MONADNOCK BUILDING CHICAGO

**AMBURSEN DAMS**  
 Hydroelectric Developments  
 Water Supply and Irrigation Dams  
 DAMS ON DIFFICULT FOUNDATIONS  
 AMBURSEN CONSTRUCTION CO.  
 Incorporated  
 Grand Central Terminal, New York  
 Kansas City, Mo. Atlanta, Ga.

**EDWARD E. CLEMENT**  
 Fellow A. I. E. E.  
 Attorney and Expert  
 in Patent Causes  
 Soliciting, Consultation, Reports,  
 Opinions  
 McLachlen Bldg. Washington, D. C.  
 700 10th St., N. W.

**FREYN ENGINEERING COMPANY**  
 Industrial Electric Power  
 Generation—Application—Purchase  
 Combustion Engineering  
 Electric Furnace Installations  
 CHICAGO PHILADELPHIA  
 310 South Michigan Ave. 1500 Chestnut St.

**THE AMERICAN APPRAISAL CO.**  
 Valuations and Reports  
 of  
 Public utility, industrial  
 and all other properties  
 Rate Cases Condemnation Suits  
 Reorganizations Liquidations  
 NEW YORK MILWAUKEE  
 1896 And Principal Cities 1926

**C. E. CLEWELL**  
 Consulting Engineer  
 Municipal Street Lighting Systems  
 Factory and Office Lighting  
 Engineering Bldg. Philadelphia, Pa.  
 33rd and Locust Streets

**M. H. GERRY, JR.**  
 Consulting Engineer  
 Electrical Transmission of Power  
 Hydroelectric Developments  
 Steam and Diesel Plants  
 Industrial Applications  
 1107 Hobart Building San Francisco

**W. S. BARSTOW & COMPANY**  
 Incorporated  
 Financial and Operating  
 Managers of  
 Public Utilities  
 50 Pine Street New York

**HAROLD A. DANNE**  
 LIGHT AND POWER  
 41 PARK ROW NEW YORK

**A. BARNETT GREEN**  
 ENGINEERING PUBLICITY  
 1328 BROADWAY NEW YORK  
 EDITING — COMPILING — WRITING

**BATTEY & KIPP**  
 Incorporated  
 ENGINEERS  
 Complete Industrial Plants  
 Power Plants & Electrical Installations  
 Engineering Reports, Analyses & Appraisals  
 231 South LaSalle Street CHICAGO

**DAY & ZIMMERMANN, Inc.**  
 Engineers  
 Power Plants, Sub-Stations,  
 Transmission Lines, Industrial Plants  
 Examinations and Reports, Valuations,  
 Management of Public Utilities  
 1600 WALNUT ST., PHILADELPHIA  
 New York Chicago

**L. F. HARZA**  
 HYDRO-ELECTRIC ENGINEER  
 Monadnock Bldg. Chicago

**BLACK & VEATCH**  
 Consulting Engineers  
 Water, Steam and Electric Power Investiga-  
 tions, Design, Supervision of Construction,  
 Valuation and Tests.  
 Mutual Building KANSAS CITY, MO.

**DAVID V. FENNESSY**  
 Consulting Power Engineer  
 MILLS BUILDING EL PASO, TEXAS

**AUGUSTUS M. HENRY**  
 COUNSELOR AT LAW  
 (Patents and Patent Causes)  
 WOOLWORTH BLDG. NEW YORK

**BYLLESBY**  
 ENGINEERING AND MANAGEMENT  
 CORPORATION  
 231 S. La Salle Street  
 CHICAGO  
 New York San Francisco

**FORD, BACON & DAVIS**  
 Incorporated  
 ENGINEERS  
 115 Broadway, New York  
 Philadelphia Chicago San Francisco

**HOOSIER ENGINEERING CO.**  
 Erectors of  
 Transmission Lines and Substations  
 325 South New Jersey Street  
 INDIANAPOLIS INDIANA

**M**AKE your name and specialized service  
 well known to the electrical industry  
 through a card in the ENGINEERING DIRECTORY

Please mention the JOURNAL of the A. I. E. E. when writing to advertisers.

# PROFESSIONAL ENGINEERING DIRECTORY

For Consultants in the Fields of Engineering and Related Arts and Sciences

Dugald C. Jackson  
Edward L. Moreland  
**JACKSON & MORELAND**  
CONSULTING ENGINEERS  
31 St. James Ave. Boston, Mass.

**PUBLIC SERVICE  
PRODUCTION COMPANY**  
Engineers and Constructors  
Design and Construct: Power Plants,  
Transmission Lines, Industrial Plants,  
Highways, Railroad Shops and Terminals,  
Gas Plants, Commercial Buildings  
Make: Examinations, Reports and Valuations  
80 PARK PLACE NEWARK, N. J.

William M. Stockbridge Victor D. Borst  
**STOCKBRIDGE & BORST**  
Patent Lawyers  
41 PARK ROW NEW YORK CITY

**E. S. LINCOLN**  
Consulting Electrical Engineer  
Designs Investigations Reports  
Electrical Research Laboratory  
534 Congress St. PORTLAND, MAINE

**SANDERSON & PORTER  
ENGINEERS**  
PUBLIC UTILITIES & INDUSTRIALS  
Design Construction Management  
Examinations Reports Valuations  
Chicago New York San Francisco

**STONE & WEBSTER**  
Incorporated  
Examinations Reports Appraisals  
on  
Industrial and Public Service  
Properties  
NEW YORK BOSTON CHICAGO

**MCCLELLAN & JUNKERSFELD**  
Incorporated  
Engineering and Construction  
Power Developments—Industrial Plants  
Electrifications—Examinations  
Reports—Valuations  
NEW YORK  
68 Trinity Place  
Chicago St. Louis

**SARGENT & LUNDY**  
Incorporated  
Mechanical and Electrical  
Engineers  
1412 Edison Bldg., 72 West Adams Street  
CHICAGO ILLINOIS

**PERCY H. THOMAS**  
Consulting Engineer  
ELECTRIC POWER  
Generation - Transmission  
Applications  
120 BROADWAY NEW YORK

**W. E. MOORE & CO.**  
Engineers  
Plans and Specifications for  
Hydroelectric and Steam Power Plants  
Industrial Plants and Electric Furnaces  
Union Bank Building Pittsburgh, Pa.

**SCOFIELD ENGINEERING CO.**  
Consulting Engineers  
Power Stations Gas Works  
Hydraulic Developments Electric Railways  
Examinations & Reports Valuations  
Philadelphia

**THE U. G. I. CONTRACTING CO.**  
Engineers & Constructors  
Power Developments, Industrial Plants, Gas  
Plants, Transmission Systems, Appraisals  
Broad & Arch Sts., PHILA., PA.  
421 Peoples Gas Bldg., Chicago, Ill. 928 Union Trust  
Bldg., Pittsburgh, Pa.

**N. J. NEALL**  
Consulting Engineer  
for  
Electrical and Industrial Properties  
12 PEARL STREET BOSTON, MASS.

Card space limited  
to 1"x2" for each  
advertiser.

**VIELE, BLACKWELL & BUCK**  
Engineers  
Designs and Construction  
Hydroelectric and Steam Power Plants  
Transmission Systems Industrial Plants  
Reports Appraisals  
49 WALL STREET NEW YORK

**NEILER, RICH & CO.**  
Electrical and Mechanical  
Engineers  
Consulting, Designing and  
Supervising  
431 So. Dearborn St. - - - Chicago

**J. E. SIRRINE & COMPANY**  
Engineers  
Textile Mills; Hydro-Electric Develop-  
ments; Tobacco Products Plants; Cotton,  
Tobacco and General Warehousing; Indus-  
trial Housing; Steam Power Plants; Steam  
Utilization.  
Greenville Chattanooga  
South Carolina Tennessee

**THE J. G. WHITE  
ENGINEERING CORPORATION**  
Engineers—Constructors  
Oil Refineries and Pipe Lines,  
Steam and Water Power Plants,  
Transmission Systems, Hotels, Apartments,  
Offices and Industrial Buildings, Railroads  
43 EXCHANGE PLACE NEW YORK

**OPHULS & HILL, Inc.**  
Formerly Ophuls, Hill & McCreery, Inc.  
CONSULTING ENGINEERS  
112-114 WEST 42nd ST., NEW YORK CITY  
Ice Making and Refrigeration  
Investigations and Reports

**JOHN A. STEVENS**  
CONSULTING POWER ENGINEER  
16 Shattuck Street  
LOWELL MASSACHUSETTS

**J. G. WRAY & CO.**  
Engineers  
J. G. Wray, Fellow A.I.E.E. Cyrus G. Hill  
Utilities and Industrial Properties  
Appraisals Construction Rate Surveys  
Plans Organization Estimates  
Financial Investigations Management  
1217 First National Bank Bldg., Chicago

**FARLEY OSGOOD**  
Consultant  
Design, Construction, Operation  
Inter-Connection  
of  
PUBLIC UTILITIES  
National Bank of Commerce Building  
31 Nassau Street, New York, N. Y.  
Tel.: Rector 7878 Cable Address: Fargood

**STEVENS & WOOD  
INCORPORATED**  
Engineers and Constructors  
120 BROADWAY, NEW YORK  
Youngstown, O.

*To be printed in the following  
issue, copy for cards must be  
received by the 20th of the month.*

# Classified Advertiser's Index for Buyers

Manufacturers and agents for machinery and supplies used in the electrical and allied industries.

Note: For reference to the Advertisements see the Alphabetical List of Advertisers on page 54.

- AIR COMPRESSORS**  
Allis-Chalmers Mfg. Co., Milwaukee  
General Electric Co., Schenectady  
Western Electric Co., All Principal Cities
- AIR COMPRESSOR FILTERS**  
Midwest Air Filters, Inc., Bradford, Pa.
- AIR FILTERS, COOLING**  
Midwest Air Filters, Inc., Bradford, Pa.
- AIR WASHERS**  
Sturtevant Company, B. F., Boston
- ALARMS, TEMPERATURE, PRESSURE**  
Cory & Son, Inc., Chas., New York
- AMMETER COMPENSATING COILS**  
Minerallac Electric Co., Chicago
- AMMETER, VOLTMETERS**  
(See INSTRUMENTS, ELECTRICAL)
- ANCHORS, GUY**  
Matthews Corp., W. N., St. Louis
- ANNUNCIATORS, AUDIO-VISIBLE**  
Cory & Son, Inc., Chas., New York
- BATTERY CHARGING APPARATUS**  
Electric Specialty Co., Stamford, Conn.  
Fansteel Products Co., Inc., North Chicago  
General Electric Co., Schenectady  
Ward Leonard Electric Co., Mt. Vernon, N. Y.  
Western Electric Co., All Principal Cities  
Westinghouse Elec. & Mfg. Co., E. Pitts-  
burgh
- BEARINGS, BALL**  
New Departure Mfg. Co., The, Bristol, Conn.  
Norma-Hoffmann Bearings Corp., Stamford,  
Conn.  
Standard Steel & Bearings, Inc., Plainville,  
Conn.
- BEARINGS, ROLLER**  
Timken Roller Bearing Co., The, Canton, O.
- BOOKS, TECHNICAL**  
Van Nostrand Company, D., New York
- BOXES, FUSE**  
General Electric Co., Schenectady  
Metropolitan Device Corp., Brooklyn, N. Y.  
Western Electric Co., All Principal Cities  
Westinghouse Elec. & Mfg. Co., Pitts-  
burgh
- BOXES, JUNCTION**  
G & W Elec. Specialty Co., Chicago  
Metropolitan Device Corp., Brooklyn, N. Y.  
Standard Underground Cable Co., Pittsburgh
- BRUSHES, COMMUTATOR**  
*Carbon*  
Morganite Brush Co., Inc., New York  
National Carbon Co., Inc., Cleveland  
Westinghouse Elec. & Mfg. Co., E. Pitts-  
burgh  
*Copper Graphite*  
Morganite Brush Co., Inc., New York  
National Carbon Co., Inc., Cleveland  
Westinghouse Elec. & Mfg. Co., E. Pitts-  
burgh
- BUS BAR FITTINGS**  
Delta-Star Electric Co., Chicago  
General Electric Co., Schenectady  
Westinghouse Elec. & Mfg. Co., E. Pitts-  
burgh
- CABLE ACCESSORIES**  
Delta-Star Electric Co., Chicago  
Dossert & Co., New York  
G & W Electric Specialty Co., Chicago  
General Electric Co., Schenectady  
Minerallac Electric Co., Chicago  
Standard Underground Cable Co., Pittsburgh  
Western Electric Co., All Principal Cities
- CABLES**  
See WIRES AND CABLES
- CABLEWAYS**  
American Steel & Wire Co., Chicago  
Roebling's Sons Co., John A., Trenton, N. J.
- CAMBRIC, VARNISHED**  
Belden Mfg. Co., Chicago  
Irvington Varnish & Ins. Co., Irvington, N. J.
- CARRIER CURRENT TELEPHONE EQUIP-  
MENT**  
Dubilier Condenser & Radio Corp., N. Y.  
Western Electric Co., All Principal Cities  
Wireless Specialty Apparatus Co., Boston
- CIRCUIT BREAKERS**  
*Air-Enclosed*  
Cutter Co., The, Philadelphia  
Roller-Smith Co., New York  
Sundh Electric Co., Newark, N. J.  
Ward Leonard Electric Co., Mt. Vernon, N. Y.  
Western Electric Co., All Principal Cities  
*Oil*  
Condit Electrical Mfg. Corp., Boston  
General Electric Co., Schenectady  
Westinghouse Elec. & Mfg. Co., E. Pitts-  
burgh
- CLAMPS, GUY & CABLE**  
Matthews Corp., W. N., St. Louis
- COILS, CHOKE**  
Burke Electric Co., Erie, Pa.  
General Electric Co., Schenectady  
Westinghouse Elec. & Mfg. Co., E. Pitts-  
burgh
- COILS, MAGNET**  
Acme Wire Co., New Haven, Conn.  
Belden Mfg. Co., Chicago  
Dudlo Mfg. Corp., Ft. Wayne, Ind.  
General Electric Co., Schenectady  
Westinghouse Elec. & Mfg. Co., E. Pitts-  
burgh
- CONDENSATION PRODUCTS**  
Bakelite Corporation, New York
- CONDENSERS, COUPLING**  
*For Carrier Current Telephone*  
Dubilier Condenser & Radio Corp., New York  
Wireless Specialty Apparatus Co., Boston
- CONDENSERS, RADIO**  
Dubilier Condenser & Radio Corp., New York  
General Radio Co., Cambridge, Mass.  
Pacnet Electric Co., New York  
Wireless Specialty Apparatus Co., Boston
- CONDENSERS, STEAM**  
Allis-Chalmers Mfg. Co., Milwaukee  
General Electric Co., Schenectady  
Westinghouse Elec. & Mfg. Co., E. Pittsburgh
- CONDUIT, UNDERGROUND FIBRE**  
Western Electric Co., All Principal Cities
- CONNECTORS, SOLDERLESS**  
Dossert & Co., New York  
Western Electric Co., All Principal Cities  
Westinghouse Elec. & Mfg. Co., E. Pitts-  
burgh
- CONNECTORS AND TERMINALS**  
Belden Mfg. Co., Chicago  
Burke Electric Co., Erie, Pa.  
Dossert & Co., New York  
G & W Electric Specialty Co., Chicago  
Western Electric Co., All Principal Cities  
Westinghouse Elec. & Mfg. Co., E. Pitts-  
burgh
- CONTACTS, TUNGSTEN**  
Fansteel Products Co., Inc., North Chicago  
General Electric Co., Schenectady
- CONTROL SYSTEMS**  
Ward Leonard Electric Co., Mt. Vernon N. Y.
- CONTROLLERS**  
Electric Controller & Mfg. Co., Cleveland  
General Electric Co., Schenectady  
Rowan Controller Co., Baltimore  
Sundh Electric Co., Newark, N. J.  
Ward Leonard Electric Co., Mt. Vernon, N. Y.  
Western Electric Co., All Principal Cities  
Westinghouse Elec. & Mfg. Co., E. Pitts-  
burgh
- CONVERTERS—SYNCHRONOUS**  
Allis-Chalmers Mfg. Co., Milwaukee  
Electric Specialty Co., Stamford, Conn.  
Westinghouse Elec. & Mfg. Co., E. Pitts-  
burgh
- COPPER CLAD WIRE**  
Belden Mfg. Co., Chicago  
Copperweld Steel Co., Rankin, Pa.  
Standard Underground Cable Co., Pittsburgh  
Western Electric Co., All Principal Cities
- CUT-OUTS**  
Condit Electrical Mfg. Corp., S. Boston  
General Electric Co., Schenectady  
G & W Electric Specialty Co., Chicago  
Metropolitan Device Corp., Brooklyn, N. Y.  
Western Electric Co., All Principal Cities  
Westinghouse Elec. & Mfg. Co., E. Pitts-  
burgh
- DIMMERS, THEATRE**  
Ward Leonard Electric Co., Mt. Vernon, N. Y.
- DYNAMOS**  
(See GENERATORS AND MOTORS)
- DYNAMOTORS**  
Burke Electric Co., Erie, Pa.  
Electric Specialty Co., Stamford, Conn.
- ELECTRIFICATION SUPPLIES, STEAM  
ROAD**  
General Electric Co., Schenectady  
Ohio Brass Co., Mansfield, Ohio  
Westinghouse Elec. & Mfg. Co., E. Pitts-  
burgh
- ENGINEERS, CONSULTING AND CON-  
TRACTING**  
(See PROFESSIONAL ENGINEERING  
DIRECTORY)
- ENGINES** *Gas & Gasoline*  
Allis-Chalmers Mfg. Co., Milwaukee  
Sturtevant Company, B. F., Boston  
*Oil*  
Allis-Chalmers Mfg. Co., Milwaukee  
Sturtevant Company, B. F., Boston  
*Steam*  
Allis-Chalmers Mfg. Co., Milwaukee  
Sturtevant Company, B. F., Boston
- FANS, MOTOR**  
Century Electric Co., St. Louis  
General Electric Co., Schenectady  
Star Electric Motor Co., Newark, N. J.  
Sturtevant Company, B. F., Boston  
Western Electric Co., All Principal Cities  
Westinghouse Elec. & Mfg. Co., E. Pitts-  
burgh
- FARM LIGHTING GENERATORS**  
Western Electric Co., All Principal Cities  
Westinghouse Elec. & Mfg. Co., E. Pitts-  
burgh
- FIBRE**  
Belden Mfg. Co., Chicago
- FIRE PROTECTION APPARATUS**  
Kidde & Co., Inc., Walter, New York
- FLOW METERS**  
Cory & Son, Inc., Chas., New York  
General Electric Co., Schenectady
- FURNACES, ELECTRIC**  
General Electric Co., Schenectady  
Westinghouse Elec. & Mfg. Co., E. Pitts-  
burgh
- FUSES** *Enclosed Refillable*  
General Electric Co., Schenectady  
Western Electric Co., All Principal Cities  
Westinghouse Elec. & Mfg. Co., E. Pitts-  
burgh  
*Enclosed Non-Refillable*  
General Electric Co., Schenectady  
Western Electric Co., All Principal Cities  
*Open Link*  
General Electric Co., Schenectady  
Metropolitan Device Corp., Brooklyn, N. Y.  
Western Electric Co., All Principal Cities  
*High Tension*  
Delta-Star Electric Co., Chicago  
Metropolitan Device Corp., Brooklyn, N. Y.  
Western Electric Co., All Principal Cities
- GEARS, FIBRE**  
General Electric Co., Schenectady
- GENERATORS AND MOTORS**  
Allis-Chalmers Mfg. Co., Milwaukee  
Burke Electric Co., Erie, Pa.  
Century Electric Co., St. Louis  
Chandeysson Electric Co., St. Louis  
Electric Specialty Co., Stamford, Conn.  
Electro-Dynamic Co., Bayonne, N. J.  
General Electric Co., Schenectady  
Lincoln Electric Co., The, Cleveland  
Master Electric Co., The, Dayton, O.  
Star Electric Motor Co., Newark, N. J.  
Sturtevant Company, B. F., Boston  
Western Electric Co., All Principal Cities  
Westinghouse Elec. & Mfg. Co., E. Pitts-  
burgh
- GENERATING STATION EQUIPMENT**  
Allis-Chalmers Mfg. Co., Milwaukee  
Burke Electric Co., Erie, Pa.  
General Electric Co., Schenectady  
Western Electric Co., All Principal Cities  
Westinghouse Elec. & Mfg. Co., E. Pitts-  
burgh
- GROUND RODS**  
Copperweld Steel Co., Rankin, Pa.  
Western Electric Co., All Principal Cities
- HEADLIGHTS**  
Ohio Brass Co., Mansfield, O.
- HEATERS, INDUSTRIAL**  
General Electric Co., Schenectady  
Western Electric Co., All Principal Cities  
Westinghouse Elec. & Mfg. Co., E. Pitts-  
burgh
- INDICATORS, LOAD**  
Cory & Son, Inc., Chas., New York
- INDICATORS, SPEED**  
Bristol Co., The, Waterbury, Conn.  
Roller-Smith Co., New York
- INDICATORS WATER LEVEL**  
Bristol Co., The, Waterbury, Conn.  
Cory & Son, Inc., Chas., New York
- INSTRUMENTS, ELECTRICAL**  
*Graphic*  
Bristol Co., The, Waterbury, Conn.  
Ferranti, Ltd., London, Eng.  
Ferranti Meter & Transformer Mfg. Co.,  
Ltd., Toronto, Ont.  
General Electric Co., Schenectady  
Westinghouse Elec. & Mfg. Co., E. Pitts-  
burgh  
*Indicating*  
Bristol Co., The, Waterbury, Conn.  
Ferranti, Ltd., London, Eng.  
Ferranti Meter & Transformer Mfg. Co.,  
Ltd., Toronto, Ont.  
General Electric Co., Schenectady  
Jewell Elec. Instrument Co., Chicago  
Roller-Smith Co., New York  
Westinghouse Elec. & Mfg. Co., E. Pitts-  
burgh  
Weston Elec. Inst. Corp., Newark, N. J.  
*Integrating*  
Duncan Elec. Mfg. Co., Lafayette, Ind.  
Ferranti, Ltd., London, Eng.  
Ferranti Meter & Transformer Mfg. Co.,  
Ltd., Toronto, Ont.  
General Electric Co., Schenectady  
Roller-Smith Co., New York  
Sangamo Elec. Co., Springfield, Ill.  
Western Electric Co., All Principal Cities  
Westinghouse Elec. & Mfg. Co., E. Pitts-  
burgh  
*Radio*  
General Radio Co., Cambridge, Mass.  
Jewell Elec. Instrument Co., Chicago  
*Repairing and Testing*  
Electrical Testing Laboratories, New York  
Jewell Elec. Instrument Co., Chicago

Please mention the JOURNAL of the A. I. E. E. when writing to advertisers.

# Today's topic in radio is battery eliminators

Everyone interested in radio is talking eliminators. The new power tubes for receivers require higher plate voltages. This means that an eliminator must be used. Resistance is one of the essentials of every eliminator, and this resistance must carry power; in other words, it gets hot. Heat breaks down an improperly made resistor. The surest way to prevent this happening is by using

## Ward Leonard Vitrohm Resistors

Electrical men know from experience that there is only one permanently satisfactory resistance—a wire wound resistance, vitreous enamelled. In brief, Ward Leonard Vitrohm. It is practically indestructible; non-inductive; always accurate, because it started that way and time does not alter it.

For 34 years, Ward Leonard Vitrohm Resistors have been specified by technical men, because heat does not affect the enamel enclosure. The newest branch of the electrical industry—radio—finds Ward Leonard prepared to furnish Vitrohm resistors in forms that meet its needs.

Any desired resistance; handy kits containing assorted resistor units totalling 21,750 ohms; Edison base units; tab terminals and screw terminals; units for AC eliminators and units for DC eliminators; made in forms so compact that 10,000 ohms can be furnished in the size of a cigarette. High watts capacity.

Let us quote on your specifications.

### Vitrohm Resistor Unit showing steps in the process of manufacture

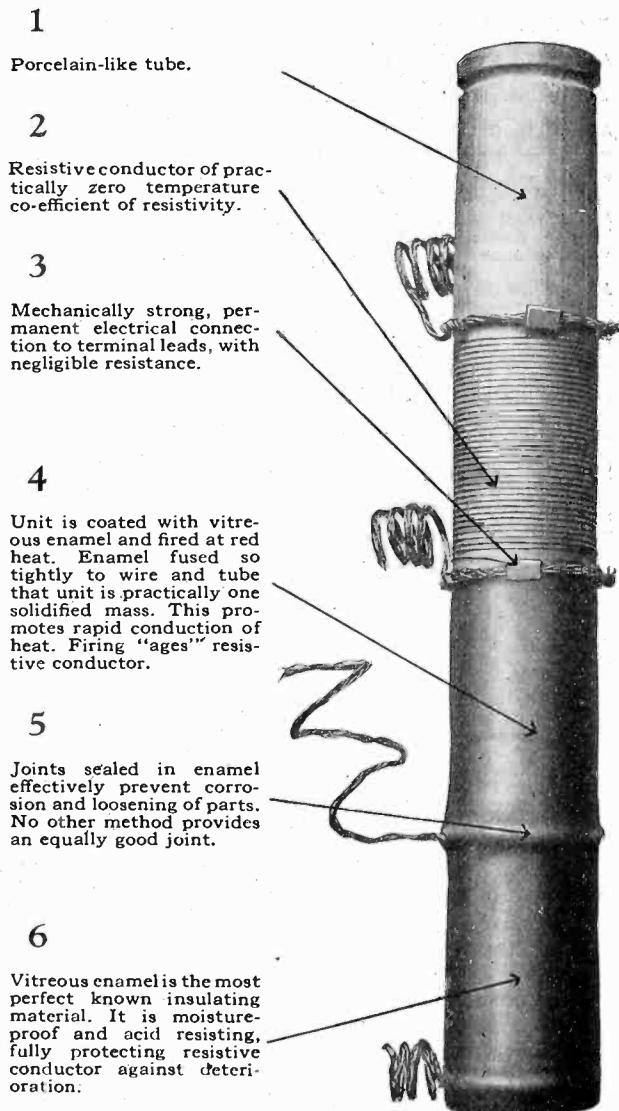

## Ward Leonard Electric Company

37-41 South Street

Mount Vernon, N. Y.

Atlanta—C. P. Atkinson  
Baltimore—J. E. Perkins  
Boston—W. W. Gaskill  
Chicago—Westburg Eng. Co.

Cleveland—W. P. Ambos Co.  
Detroit—C. E. Wise  
Los Angeles—Bell & Slimon  
New Orleans—Electron Eng. Co., Inc.  
Melbourne and Sydney, Australia—Warburton, Franki, Ltd.

Philadelphia—W. Miller Tompkins  
Pittsburgh—W. A. Bittner Co.  
San Francisco—Elec. Mat'l Co.  
Seattle—T. S. Wood

St. Louis—C. W. Pieksen  
Montreal—Bishop Sales Corp.  
Toronto—D. M. Fraser, Ltd.  
London, Eng.—W. Geipel & Co.

Please mention the JOURNAL of the A. I. E. E. when writing to advertisers.

## Classified Advertiser's Index for Buyers—Continued

- INSTRUMENTS, ELECTRICAL—Continued**  
*Scientific, Laboratory, Testing*  
General Electric Co., Schenectady  
Jewell Elec. Instrument Co., Chicago  
Metropolitan Device Corp., Brooklyn, N. Y.  
Roller-Smith Co., New York  
Western Electric Co., All Principal Cities  
Westinghouse Elec. & Mfg. Co., E. Pitts-  
burgh  
Weston Elec. Inst. Corp., Newark, N. J.  
*Telegraph*  
Western Electric Co., All Principal Cities
- INSULATING MATERIALS**  
*Board*  
West Va. Pulp & Paper Co., New York  
*Cloth*  
Acme Wire Co., New Haven, Conn.  
Irvington Varnish & Ins. Co., Irvington, N. J.  
Minerallac Electric Co., Chicago  
Westinghouse Elec. & Mfg. Co., E. Pitts-  
burgh  
*Composition*  
American Lava Corp., Chattanooga  
Bakelite Corporation, New York  
Belden Mfg. Co., Chicago  
Westinghouse Elec. & Mfg. Co., E. Pittsburgh  
*Compounds*  
Minerallac Electric Co., Chicago  
Standard Underground Cable Co., Pittsburgh  
Western Electric Co., All Principal Cities  
*Fibre*  
West Va. Pulp & Paper Co., New York  
*Lava*  
American Lava Corp., Chattanooga, Tenn.  
*Mica*  
New England Mica Co., Waltham, Mass.  
*Paper*  
Acme Wire Co., New Haven, Conn.  
Irvington Varnish & Ins. Co., Irvington, N. J.  
Tullis, Russell & Co., Ltd., London, Eng.  
*Silk*  
Acme Wire Co., New Haven, Conn.  
Irvington Varnish & Ins. Co., Irvington, N. J.  
*Tape*  
Belden Mfg. Co., Chicago  
Minerallac Electric Co., Chicago  
Okonite Co., The, Passaic, N. J.  
Western Electric Co., All Principal Cities  
Westinghouse Elec. & Mfg. Co., E. Pittsburgh  
*Varnishes*  
Acme Wire Co., New Haven, Conn.  
General Electric Co., Schenectady  
Irvington Varnish & Ins. Co., Irvington, N. J.  
Minerallac Electric Co., Chicago
- INSULATORS, HIGH TENSION**  
*Composition*  
General Electric Co., Schenectady  
*Glass*  
Hemingray Glass Co., Muncie, Ind.  
*Porcelain*  
General Electric Co., Schenectady  
Lapp Insulator Co., Inc., ReRoy, N. Y.  
Locke Insulator Corp., Baltimore  
Ohio Brass Co., Mansfield, O.  
Thomas & Sons Co., R., East Liverpool, O.  
Western Electric Co., All Principal Cities  
Westinghouse Elec. & Mfg. Co., E. Pitts-  
burgh  
*Post Type*  
Delta-Star Electric Co., Chicago
- INSULATORS, TELEPHONE & TELEGRAPH**  
Hemingray Glass Co., Muncie, Ind.  
Western Electric Co., All Principal Cities
- LAMP GUARDS**  
Mathews Corp., W. N., St. Louis  
Western Electric Co., All Principal Cities
- LAVA**  
American Lava Corp., Chattanooga
- LIGHTING FIXTURES**  
Cory & Son, Inc., Chas., New York
- LIGHTNING ARRESTERS**  
Delta-Star Electric Co., Chicago  
General Electric Co., Schenectady  
Western Electric Co., All Principal Cities  
Westinghouse Elec. & Mfg. Co., E. Pitts-  
burgh
- LOCOMOTIVES, ELECTRIC**  
General Electric Co., Schenectady  
Westinghouse Elec. & Mfg. Co., E. Pitts-  
burgh
- MAGNETIC SEPARATORS**  
Electric Controller & Mfg. Co., Cleveland
- METERS, ELECTRICAL**  
(SEE INSTRUMENTS, ELECTRICAL)
- MICA**  
New England Mica Co., Waltham, Mass.
- MOLDED INSULATION**  
Bakelite Corporation, New York  
Belden Mfg. Co., Chicago  
Burke Electric Co., Erie, Pa.  
Westinghouse Elec. & Mfg. Co., E. Pitts-  
burgh
- MOLYBDENUM**  
Fansteel Products Co., Inc., North Chicago
- MOTORS**  
(See GENERATORS AND MOTORS)
- OHMMETERS**  
Cory & Son, Inc., Chas., New York  
Jewell Elec. Instrument Co., Chicago  
Roller-Smith Co., New York  
Weston Elec. Instr. Corp., Newark, N. J.
- OIL SEPARATORS & PURIFIERS**  
DeLaval Separator Co., The, New York  
Sharples Specialty Co., The, Philadelphia  
Westinghouse Elec. & Mfg. Co., E. Pitts-  
burgh
- PANEL BOARDS**  
(See SWITCHBOARDS)
- PATENT ATTORNEYS**  
(See PROFESSIONAL ENGINEERING  
DIRECTORY)
- PLUGS**  
Delta-Star Electric Co., Chicago  
General Electric Co., Schenectady  
Western Electric Co., All Principal Cities  
Westinghouse Elec. & Mfg. Co., E. Pitts-  
burgh
- POLES, STEEL**  
American Bridge Co., Pittsburgh  
Pacific Coast Steel Co., San Francisco  
Western Electric Co., All Principal Cities
- POLES—TIES, WOOD**  
Western Electric Co., All Principal Cities
- POTHEADS**  
G & W Electric Specialty Co., Chicago  
Standard Underground Cable Co., Pittsburgh  
Western Electric Co., All Principal Cities
- PROTECTIVE DEVICES**  
Metropolitan Device Corp., Brooklyn, N. Y.  
Western Electric Co., All Principal Cities
- PULLERS, SLACK**  
Mathews Corp., W. N., St. Louis
- PUMPS**  
Allis-Chalmers Mfg. Co., Milwaukee
- PUMPS, SPIRAL**  
Cramp & Sons Ship & Engine Bldg. Co.,  
The Wm., Philadelphia
- RADIO LABORATORY APPARATUS**  
General Radio Co., Cambridge, Mass.  
Westinghouse Elec. & Mfg. Co., E. Pitts-  
burgh
- RAILWAY SUPPLIES, ELECTRIC**  
General Electric Co., Schenectady  
Ohio Brass Co., Mansfield, O.  
Western Electric Co., All Principal Cities  
Westinghouse Elec. & Mfg. Co., E. Pitts-  
burgh
- REACTORS**  
General Electric Co., Schenectady  
Metropolitan Device Corp., Brooklyn, N. Y.
- RECTIFIERS**  
Fansteel Products Co., Inc., North Chicago  
General Electric Co., Schenectady  
Western Electric Co., All Principal Cities  
Westinghouse Elec. & Mfg. Co., E. Pitts-  
burgh
- REELS, PAYOUT AND TAKEUP**  
Mathews Corp., W. N., St. Louis
- REGULATORS, VOLTAGE**  
Burke Electric Co., Erie, Pa.  
General Electric Co., Schenectady  
Western Electric Co., All Principal Cities  
Westinghouse Elec. & Mfg. Co., E. Pitts-  
burgh
- RELAYS**  
Cory & Son, Inc., Chas., New York  
Electric Controller & Mfg. Co., Cleveland  
Westinghouse Elec. & Mfg. Co., E. Pitts-  
burgh
- RESISTOR UNITS**  
General Electric Co., Schenectady  
Ward Leonard Electric Co., Mt. Vernon, N. Y.
- RHEOSTATS**  
General Electric Co., Schenectady  
Sunth Electric Co., Newark, N. J.  
Ward Leonard Electric Co., Mt. Vernon, N. Y.  
Western Electric Co., All Principal Cities  
Westinghouse Elec. & Mfg. Co., E. Pitts-  
burgh
- ROPE, WIRE**  
American Steel & Wire Co., Chicago  
Roebbling's Sons Co., John A., Trenton, N. J.
- SEARCHLIGHTS**  
General Electric Co., Schenectady  
Westinghouse Elec. & Mfg. Co., E. Pitts-  
burgh
- SHEETS, ELECTRICAL**  
Trumbull Steel Co., The, Warren, O.
- SOCKETS AND RECEPTACLES**  
General Electric Co., Schenectady  
Western Electric Co., All Principal Cities  
Westinghouse Elec. & Mfg. Co., E. Pitts-  
burgh
- SOLENOIDS**  
Acme Wire Co., New Haven, Conn.  
Belden Mfg. Co., Chicago  
Dudlo Mfg. Co., Ft. Wayne, Ind.  
Electric Controller & Mfg. Co., Cleveland  
General Electric Co., Schenectady  
Sunth Electric Co., Newark, N. J.  
Ward Leonard Electric Co., Mt. Vernon, N. Y.  
Westinghouse Elec. & Mfg. Co., E. Pitts-  
burgh
- SPRINGS**  
American Steel & Wire Co., Chicago
- STARTERS, MOTOR**  
Condit Electrical Mfg. Corp., Boston  
Electric Controller & Mfg. Co., Cleveland  
General Electric Co., Schenectady  
Rowan Controller Co., Baltimore, Md.  
Sunth Electric Co., Newark, N. J.  
Ward Leonard Electric Co., Mt. Vernon, N. Y.  
Westinghouse Elec. & Mfg. Co., E. Pitts-  
burgh
- STEEL, SHEET & STRIPS**  
Trumbull Steel Co., The, Warren, O.
- STOKERS, MECHANICAL**  
Sturtevant Company, B. F., Boston  
Westinghouse Elec. & Mfg. Co., E. Pitts-  
burgh
- SUB-STATIONS**  
General Electric Co., Schenectady  
Westinghouse Elec. & Mfg. Co., E. Pitts-  
burgh
- SWITCHBOARDS**  
Allis-Chalmers Mfg. Co., Milwaukee  
Condit Electrical Mfg. Corp., Boston  
General Electric Co., Schenectady  
Metropolitan Device Corp., Brooklyn, N. Y.  
Western Electric Co., All Principal Cities  
Westinghouse Elec. & Mfg. Co., E. Pitts-  
burgh
- SWITCHES Automatic Time**  
Ferranti, Ltd., London, Eng.  
Ferranti Meter & Transformer Mfg. Co.,  
Ltd., Toronto, Ont.  
General Electric Co., Schenectady  
Minerallac Electric Co., Chicago  
Sunth Electric Co., Newark, N. J.  
Westinghouse Elec. & Mfg. Co., E. Pitts-  
burgh  
*Disconnecting*  
Burke Electric Co., Erie, Pa.  
Condit Electrical Mfg. Corp., Boston  
Delta-Star Electric Co., Chicago  
General Electric Co., Schenectady  
K-P-F Electric Co., San Francisco  
Mathews Corp., W. N., St. Louis  
Thoner & Martens, Boston  
*Fuse*  
General Electric Co., Schenectady  
Mathews Corp., W. N., St. Louis  
Metropolitan Device Corp., Brooklyn, N. Y.  
Thoner & Martens, Boston  
*Knife*  
Condit Electrical Mfg. Corp., Boston  
Electric Controller & Mfg. Co., Cleveland  
General Electric Co., Schenectady  
Mathews Corp., W. N., St. Louis  
Western Electric Co., All Principal Cities  
Westinghouse Elec. & Mfg. Co., E. Pitts-  
burgh  
*Magnetic*  
Ward Leonard Electric Co., Mt. Vernon, N. Y.  
*Oil*  
Condit Electrical Mfg. Corp., Boston  
General Electric Co., Schenectady  
Western Electric Co., All Principal Cities  
Westinghouse Elec. & Mfg. Co., E. Pitts-  
burgh  
*Remote Control*  
Condit Electrical Mfg. Corp., Boston  
General Electric Co., Schenectady  
Rowan Controller Co., Baltimore  
Sunth Electric Co., Newark, N. J.  
Western Electric Co., All Principal Cities  
Westinghouse Elec. & Mfg. Co., E. Pittsburgh
- TANTALUM**  
Fansteel Products Co., Inc., North Chicago
- TELEGRAPH APPARATUS**  
Western Electric Co., All Principal Cities
- TELEPHONE EQUIPMENT**  
Cory & Son, Inc., Chas., New York  
Western Electric Co., All Principal Cities
- TESTING LABORATORIES**  
Electrical Testing Labs., New York
- TOWERS, TRANSMISSION**  
American Bridge Co., Pittsburgh  
Pacific Coast Steel Co., San Francisco  
Western Electric Co., All Principal Cities
- TRANSFORMERS**  
Allis-Chalmers Mfg. Co., Milwaukee  
American Transformer Co., Newark, N. J.  
Duncan Elec. Mfg. Co., Lafayette, Ind.  
Ferranti, Ltd., London, Eng.  
Ferranti Meter & Transformer Mfg. Co.,  
Ltd., Toronto, Ont.  
General Electric Co., Schenectady  
Kuhlman Electric Co., Bay City, Mich.  
Moloney Electric Co., St. Louis  
Pittsburgh Transformer Co., Pittsburgh  
Western Electric Co., All Principal Cities  
Westinghouse Elec. & Mfg. Co., E. Pittsburgh  
*Factory*  
American Transformer Co., Newark, N. J.  
Kuhlman Electric Co., Bay City, Mich.  
Moloney Electric Co., St. Louis  
Pittsburgh Transformer Co., Pittsburgh  
Western Electric Co., All Principal Cities  
*Furnace*  
Allis-Chalmers Mfg. Co., Milwaukee  
American Transformer Co., Newark, N. J.  
Moloney Electric Co., St. Louis  
Pittsburgh Transformer Co., Pittsburgh  
*Metering*  
American Transformer Co., Newark, N. J.  
Ferranti, Ltd., London, Eng.  
Ferranti Meter & Transformer Mfg. Co.,  
Ltd., Toronto, Ont.  
Pittsburgh Transformer Co., Pittsburgh  
*Mill Type*  
Pittsburgh Transformer Co., Pittsburgh  
*Radio*  
American Transformer Co., Newark, N. J.  
*Street Lighting*  
Kuhlman Electric Co., Bay City, Mich.  
Western Electric Co., All Principal Cities
- TROLLEY LINE MATERIALS**  
General Electric Co., Schenectady  
Ohio Brass Co., Mansfield, O.  
Western Electric Co., All Principal Cities  
Westinghouse Elec. & Mfg. Co., E. Pitts-  
burgh

Please mention the JOURNAL of the A. I. E. E. when writing to advertisers.

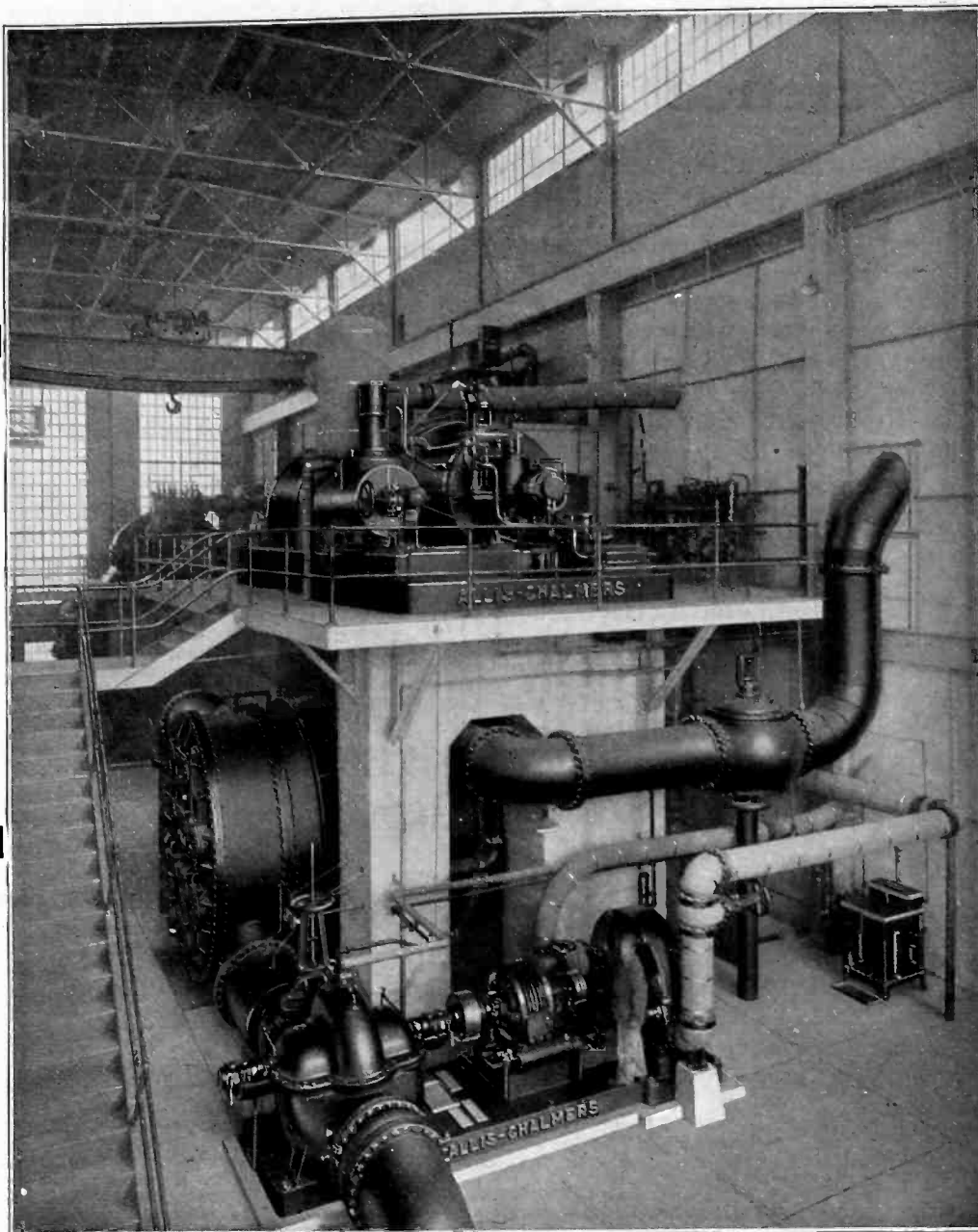

## Steam Turbo-Generators

12,500 k. w.  
Steam Turbine  
Generator Unit  
complete with  
Surface  
Condenser,  
Turbine-driven  
Circulating and  
Condensate  
Pumps, all of  
Allis-Chalmers  
manufacture.

The relatively low steam velocities employed in Allis-Chalmers Steam Turbines combined with low blade velocities and highest type of blade construction insures long blade life and sustained efficiency.

# Serving Public Utilities

Many public service companies testify to the advantages and appreciable savings under the Allis-Chalmers plan of "Undivided Responsibility," where the manufacturer assumes complete responsibility for the design, building and placing in operation of the principal equipment for the power plant.

Complete equipment "from prime mover to switchboard" is built by the Allis-Chalmers organization. This includes all types of prime movers—steam turbines, hydraulic turbines, steam, gas and oil engines, together with complete electrical equipment. Condensers of all types, pumps, air compressors and many other auxiliaries are also supplied. Allis-Chalmers equipment is used in plants of all sizes, and includes some of the largest power units ever built.

*Let Allis-Chalmers Engineers Serve You.*

**ALLIS-CHALMERS PRODUCTS**  
Electrical Machinery  
Steam Turbines  
Steam Engines  
Gas and Oil Engines  
Hydraulic Turbines  
Crushing and Cement Machinery  
Mining Machinery

**ALLIS-CHALMERS**  
**MANUFACTURING COMPANY**

**MILWAUKEE, WISCONSIN. U.S.A.**

**ALLIS-CHALMERS PRODUCTS**  
Flour and Saw Mill Machinery  
Power Transmission Machinery  
Pumping Engines-Centrifugal Pumps  
Steam and Electric Hoists  
Air Compressors - Air Brakes  
Agricultural Machinery  
Condensers

Please mention the JOURNAL of the A. I. E. E. when writing to advertisers.

# Science Abstracts

ALL electrical engineers actively engaged in the practice of their profession should subscribe to "Science Abstracts."

Published monthly by the Institution of Electrical Engineers, London, in association with the Physical Society of London, and with the cooperation of the American Institute of Electrical Engineers, the American Physical Society and the American Electrochemical Society, they constitute an invaluable reference library.

Through "Science Abstracts" engineers are enabled to keep in touch with engineering progress throughout the world, as one hundred and sixty publications, in various languages, are regularly searched and abstracted. "Science Abstracts" are published in two sections, as follows:

"A"—PHYSICS—deals with electricity, magnetism, light, heat, sound, astronomy, chemical physics.

"B"—ELECTRICAL ENGINEERING—deals with electrical plant, power transmission, traction, lighting, telegraphy, telephony, wireless telegraphy, prime movers, engineering materials, electrochemistry.

Through special arrangement, members of the A. I. E. E. may subscribe to "Science Abstracts" at the reduced rate of \$5.00 for each section, and \$10 for both. Rates to non-members are \$7.50 for each section and \$12.50 for both.

Subscriptions should start with the January issue. The first volume was issued in 1898. Back numbers are available, and further information regarding these can be obtained upon application to Institute headquarters.

**American Institute of Electrical Engineers**  
33 West 39th Street, New York



## Classified Advertiser's Index for Buyers—Continued

### TURBINES, HYDRAULIC

Allis-Chalmers Mfg. Co., Milwaukee  
Cramp & Sons Ship & Engine Bldg. Co.,  
The Wm., Philadelphia

### TURBINES, STEAM

Allis-Chalmers Mfg. Co., Milwaukee  
General Electric Co., Schenectady  
Sturtevant Company, B. F., Boston  
Western Electric Co., All Principal Cities  
Westinghouse Elec. & Mfg. Co., E. Pitts-  
burgh

### TURBINE SIGNAL SYSTEMS

Cory & Son, Inc., Chas., New York

### TURBO-GENERATORS

Allis-Chalmers Mfg. Co., Milwaukee  
Westinghouse Elec. & Mfg. Co., E. Pitts-  
burgh

### VALVE CONTROL, ELECTRIC

Bristol Company, The, Waterbury, Conn.  
Cory & Son, Inc., Chas., New York

### VALVES, JOHNSON HYDRAULIC

Cramp & Sons Ship & Engine Bldg. Co.,  
The Wm., Philadelphia

### VARNISHES, INSULATING

General Electric Co., Schenectady  
Irvington Varnish & Ins. Co., Irvington, N. J.  
Minerallac Electric Co., Chicago  
Westinghouse Elec. & Mfg. Co., E. Pitts-  
burgh

### WELDING EQUIPMENT, ELECTRICAL

General Electric Co., Schenectady  
Lincoln Electric Co., The, Cleveland  
Ohio Brass Co., Mansfield, O.  
Westinghouse Elec. & Mfg. Co., E. Pitts-  
burgh

### WIRES AND CABLES

*Armored Cable*  
American Steel & Wire Co., Chicago  
Atlantic Ins. Wire & Cable Co., Rome, N. Y.  
Belden Mfg. Co., Chicago  
Boston Ins. Wire & Cable Co., Boston  
General Electric Co., Schenectady  
Hazard Manufacturing Co., Wilkes-Barre, Pa.  
Kerite Ins. Wire & Cable Co., New York  
Okonite Company, The, Passaic, N. J.  
Roebling's Sons Co., John A., Trenton, N. J.  
Simplex Wire & Cable Co., Boston  
Standard Underground Cable Co., Pittsburgh  
Western Electric Co., All Principal Cities  
*Asbestos Covered*  
American Steel & Wire Co., Chicago  
Atlantic Ins. Wire & Cable Co., Rome, N. Y.  
Belden Mfg. Co., Chicago  
General Electric Co., Schenectady

### *Automotive*

American Steel & Wire Co., Chicago  
Atlantic Ins. Wire & Cable Co., Rome, N. Y.  
Belden Mfg. Co., Chicago  
Boston Ins. Wire & Cable Co., Boston  
General Electric Co., Schenectady  
Kerite Ins. Wire & Cable Co., New York  
Roebling's Sons Co., John A., Trenton, N. J.  
Simplex Wire & Cable Co., Boston  
Standard Underground Cable Co., Pittsburgh  
Western Electric Co., All Principal Cities

### *Bare Copper*

American Ins. Wire & Cable Co., Chicago  
American Steel & Wire Co., Chicago  
Anaconda Copper Mining Co., Chicago  
Atlantic Ins. Wire & Cable Co., Rome, N. Y.  
Belden Mfg. Co., Chicago  
Copperweld Steel Co., Rankin, Pa.  
Hazard Manufacturing Co., Wilkes-Barre, Pa.  
Roebling's Sons Co., John A., Trenton, N. J.  
Standard Underground Cable Co., Pittsburgh  
Western Electric Co., All Principal Cities

### *Copper Clad*

American Steel & Wire Co., Chicago  
Copperweld Steel Co., Rankin, Pa.  
Standard Underground Cable Co., Pittsburgh  
Western Electric Co., All Principal Cities

### *Flexible Cord*

American Steel & Wire Co., Chicago  
Atlantic Ins. Wire & Cable Co., Rome, N. Y.  
Belden Mfg. Co., Chicago  
Boston Ins. Wire & Cable Co., Boston  
General Electric Co., Schenectady  
Hazard Manufacturing Co., Wilkes-Barre, Pa.  
Okonite Company, The, Passaic, N. J.  
Roebling's Sons Co., John A., Trenton, N. J.  
Simplex Wire & Cable Co., Boston  
Standard Underground Cable Co., Pittsburgh  
Western Electric Co., All Principal Cities

### *Fuse*

American Steel & Wire Co., Chicago  
General Electric Co., Schenectady  
Roebling's Sons Co., John A., Trenton, N. J.  
Western Electric Co., All Principal Cities

*Lead Covered (Paper and Varnished cambric insulated)*

American Steel & Wire Co., Chicago  
Anaconda Copper Mining Co., Chicago  
Atlantic Ins. Wire & Cable Co., Rome, N. Y.  
General Electric Co., Schenectady  
Hazard Manufacturing Co., Wilkes-Barre, Pa.  
Kerite Ins. Wire & Cable Co., New York  
Okonite Company, The, Passaic, N. J.

Okonite-Callender Cable Co., The, Inc.,  
Passaic, N. J.  
Roebling's Sons Co., John A., Trenton, N. J.  
Simplex Wire & Cable Co., Boston  
Standard Underground Cable Co., Pittsburgh  
Western Electric Co., All Principal Cities

### *Magnet*

American Steel & Wire Co., Chicago  
Atlantic Ins. Wire & Cable Co., Rome, N. Y.  
Belden Mfg. Co., Chicago  
Dudlo Mfg. Corp., Fort Wayne, Ind.  
General Electric Co., Schenectady  
Roebling's Sons Co., John A., Trenton, N. J.  
Standard Underground Cable Co., Pittsburgh  
Western Electric Co., All Principal Cities

### *Rubber Insulated*

American Steel & Wire Co., Chicago  
Atlantic Ins. Wire & Cable Co., Rome, N. Y.  
Belden Mfg. Co., Chicago  
Boston Ins. Wire & Cable Co., Boston  
General Electric Co., Schenectady  
Hazard Manufacturing Co., Wilkes-Barre, Pa.  
Kerite Ins. Wire & Cable Co., New York  
Okonite Company, The, Passaic, N. J.  
Roebling's Sons Co., John A., Trenton, N. J.  
Simplex Wire & Cable Co., Boston  
Standard Underground Cable Co., Pittsburgh  
Western Electric Co., All Principal Cities

### *Tree Wire*

Hazard Manufacturing Co., Wilkes-Barre, Pa.  
Okonite Company, The, Passaic, N. J.  
Simplex Wire & Cable Co., Boston

### *Trolley*

American Steel & Wire Co., Chicago  
Anaconda Copper Mining Co., Chicago  
Atlantic Ins. Wire & Cable Co., Rome, N. Y.  
Copperweld Steel Co., Rankin, Pa.  
Roebling's Sons Co., John A., Trenton, N. J.  
Standard Underground Cable Co., Pittsburgh  
Western Electric Co., All Principal Cities

### *Weatherproof*

American Ins. Wire & Cable Co., Chicago  
American Steel & Wire Co., Chicago  
Anaconda Copper Mining Co., Chicago  
Atlantic Ins. Wire & Cable Co., Rome, N. Y.  
Copperweld Steel Co., Rankin, Pa.  
General Electric Co., Schenectady  
Kerite Ins. Wire & Cable Co., New York  
Okonite Company, The, Passaic, N. J.  
Roebling's Sons Co., John A., Trenton, N. J.  
Simplex Wire & Cable Co., Boston  
Standard Underground Cable Co., Pittsburgh  
Western Electric Co., All Principal Cities

Please mention the JOURNAL of the A. I. E. E. when writing to advertisers.



# If electricity were your children's clothes

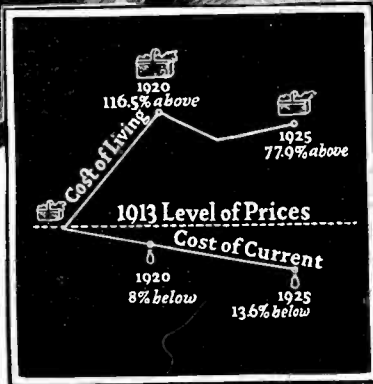

YOU realize how prices have gone up when you pay bills for clothing—for food, fuel, furniture.

Suppose business in other lines was like the electric service business—so that managers, by improving methods, were able to offset rising costs and even reduce prices to a point where your bills today were less than they were in 1913.

That would make a big difference in your household budget, wouldn't it?

Considering everything the family uses, it costs you \$1.77 for the same things a dollar bought back in 1913. That includes things to wear, things to eat, things to improve the home.

However, if all the necessities of life had followed the same price trend as has electricity, you'd pay only 87 cents today for what now costs you \$1.77.

Here's another example of the advantages you derive from the capable management of the electric service companies. It's another case where *public* service has been construed in its literal sense—as good service plus good value.

WESTINGHOUSE ELECTRIC & MANUFACTURING COMPANY / Offices in All Principal Cities / Representatives Everywhere

Localized Service — Men, Parts, Shops

# Westinghouse

© 1926, W. E. & M. Co.

Please mention the JOURNAL of the A. I. E. E. when writing to advertisers.



### Solving Cable Problems

A typical cable testing transformer recently installed. 220 volt primary and 50,000 and 100,000 volt secondary

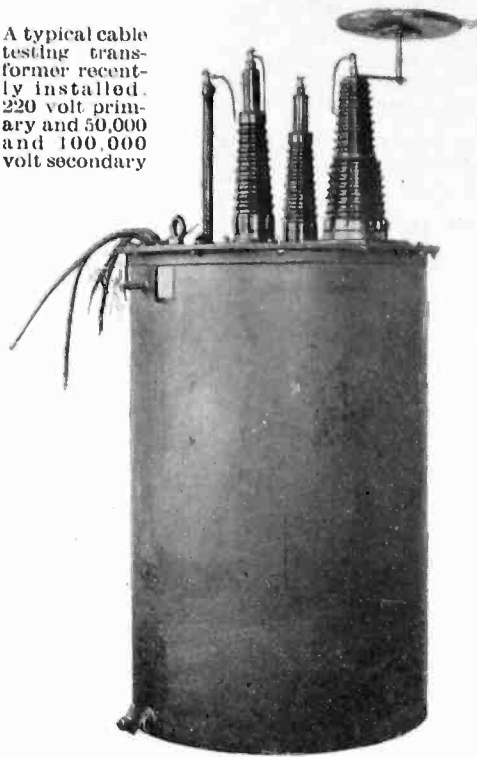

DISTRIBUTION engineers today are vitally interested in tests that can be made in a laboratory on cables up to 132 kw. and made in such a manner as to approximate as far as possible conditions met in actual practice. Developing standard loads that may be used as a basis of comparison—determining standard life tests, etc., are some of the problems that are being studied and that no doubt will be solved.

Many of the larger utilities are experimenting on higher voltage cables both in the laboratory and by making actual installations for test purposes. For the former, a number of power companies are depending upon American Transformers built especially for this service. They know by experience that they can get special equipment, designed correctly and built quickly, with which they can get accurate results.

Whatever your requirement consult with us. Full information, including prices, will be given on transformers to meet your specifications.

Bulletins 1025 and 1030 on testing transformers sent on request.

## AMERICAN TRANSFORMER COMPANY

176 Emmet Street, NEWARK, N. J.

*A Transformer for every special requirement*

## ALPHABETICAL LIST OF ADVERTISERS

Table listing advertisers and their page numbers, organized alphabetically in two columns. Includes entries like Acme Wire Company, Ferranti, Limited, Ophuls & Hill, Inc., etc.

(For classified list of Advertisers see pages 48, 50 and 52.)

Please mention the JOURNAL of the A. I. E. E. when writing to advertisers.

# When an interruption occurs on your a-c. distribution system, how soon is service restored?



The G-E Motor-Operated Timer is used to initiate the automatic reclosing of a-c. feeders after an interruption has occurred, and can control both motor- and solenoid-operated mechanisms.

**B**ECAUSE continuity of service demands that outages be of the shortest possible duration, power companies are relying more and more upon automatic equipment for reclosing.

In order to provide the automatic equipment that will restore service as soon as possible, it is necessary to know the conditions that must prevail on the lines before the breaker is reclosed. These conditions vary for different types of lines and cause procedures that vary from throwing in a breaker three times at definite intervals to synchronizing two systems.

Consideration of the requirements of only one line will result in relay installations that will operate to protect only that one line without regard to the rest of the system. Service is best maintained on the system in which all the relays are co-ordinated—a task that requires the supervision of a Protection Engineer.



Relays are an increasingly important factor in the generation, distribution, and utilization of electric power and the protection of electrical apparatus. Hence the Protection Engineer, who thoroughly knows relays and their applications, can be of service to every operating department.

There are many different types of relay installations that are satisfactorily maintaining service on distribution lines throughout the country. The experience obtained on these systems is available to Protection Engineers through G-E Relay Specialists, whose assistance will prove most valuable in planning any type of relay installation.

501-4

# GENERAL ELECTRIC

GENERAL ELECTRIC COMPANY, SCHENECTADY, N. Y., SALES OFFICES IN PRINCIPAL CITIES

Please mention the JOURNAL of the A. I. E. E. when writing to advertisers.

# Super Tension Cable Joints

The effectiveness of the METROPOLITAN METROLATUM FILLED CABLE JOINT has been proved through years of operation and test. We have found, however, through intimate touch with the industry and the study of their problems, an added feature which we have embodied in the joint.

Lead sleeve which is supplied with entire material for making splice.



We are now supplying what we have termed a "Dome Type Sleeve," which provides a greater reservoir for the storing of a reserve quantity of METROLATUM in the joint, thus making provision for the absorption of the METROLATUM in the voids caused by the expansion of the cable lead sheath.

In enlarging the sleeves usual space requirements have been carefully considered so that standard spacings between cables need not be altered to accommodate adjacent joints.

Entire material for making a joint; packed in two cartons—ready for splicer on the job. Clip coupon for booklet.

## Metropolitan Device Corporation

1250 Atlantic Avenue  
BROOKLYN, NEW YORK

METROPOLITAN DEVICE CORPORATION  
1250 Atlantic Avenue, Brooklyn, N. Y.

Gentlemen: Please send me 16-page booklet describing High-Tension Cable Joints.

Name..... Company.....

Address..... Title.....

Please mention the JOURNAL of the A. I. E. E. when writing to advertisers.

# Scientifically Made Impregnated Paper Cables

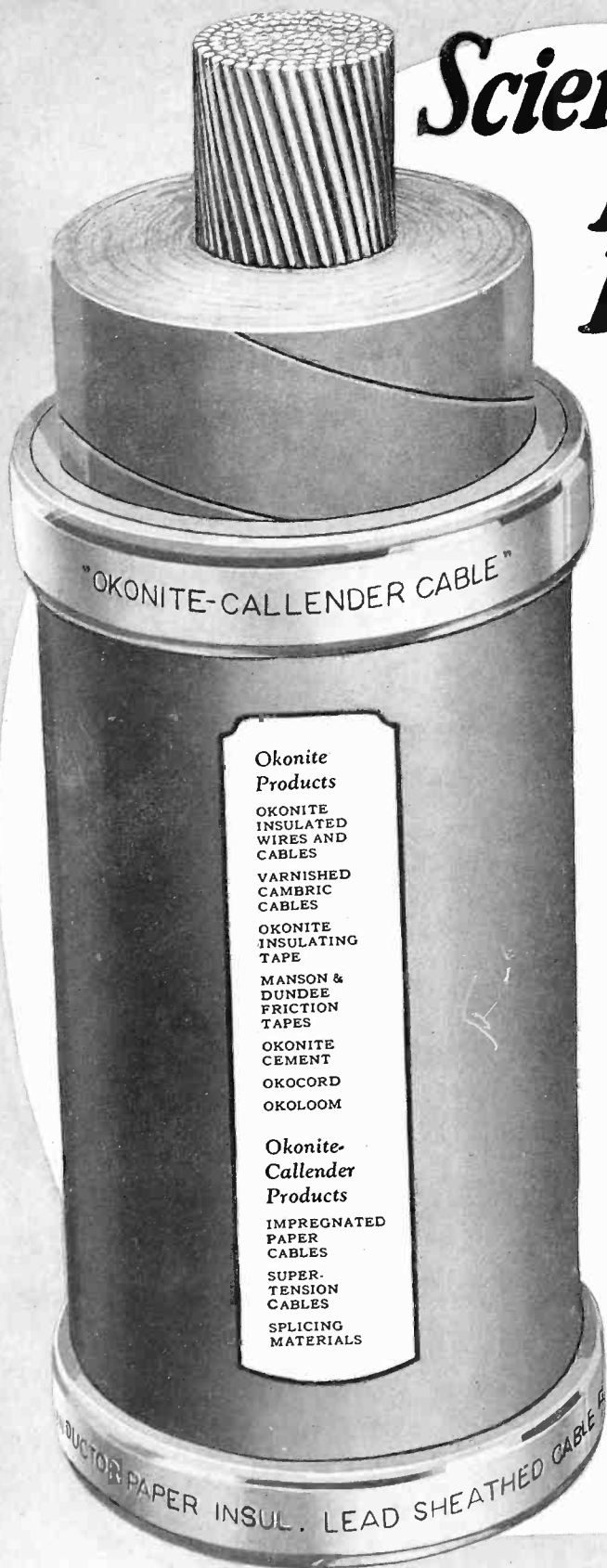

#### Okonite Products

OKONITE  
INSULATED  
WIRES AND  
CABLES  
VARNISHED  
CAMBRIC  
CABLES  
OKONITE  
INSULATING  
TAPE  
MANSON &  
DUNDEE  
FRICTION  
TAPES  
OKONITE  
CEMENT  
OKOCORD  
OKOLOOM

#### Okonite- Callender Products

IMPREGNATED  
PAPER  
CABLES  
SUPER-  
TENSION  
CABLES  
SPlicing  
MATERIALS

**O**KONITE-CALLENDER Impregnated Paper Cables are the result of many years of scientific research and experimenting together with years of practical test in the operating field.

All possible types and kinds of raw materials have been carefully studied both chemically and electrically. Even aging tests of the dielectric under electrical stress have been carried on continuously for more than twenty years.

The result is a Cable that can be depended upon to do the work for which it was designed.

Order Okonite-Callender Impregnated Paper Cables and let their performance tell their story. Our Electrical Research Laboratory and our Engineering Department are at your service to assist you in your cable problems.

## Send For Full Particulars

THE OKONITE COMPANY  
THE OKONITE-CALLENDER CABLE COMPANY, INC.

FACTORIES: PASSAIC, N. J.    PATERSON, N. J.  
SALES OFFICES: NEW YORK . CHICAGO . PITTSBURGH . ST. LOUIS . ATLANTA  
BIRMINGHAM                      SAN FRANCISCO                      LOS ANGELES                      SEATTLE

Pettingell-Andrews Co., Boston, Mass.    F. D. Lawrence Electric Co., Cincinnati, O.  
Novelty Electric Co., Philadelphia, Pa.

Canadian Representatives: Engineering Materials Limited, Montreal  
Cuban Representatives: Victor G. Mendoza Co., Havana



# again chosen

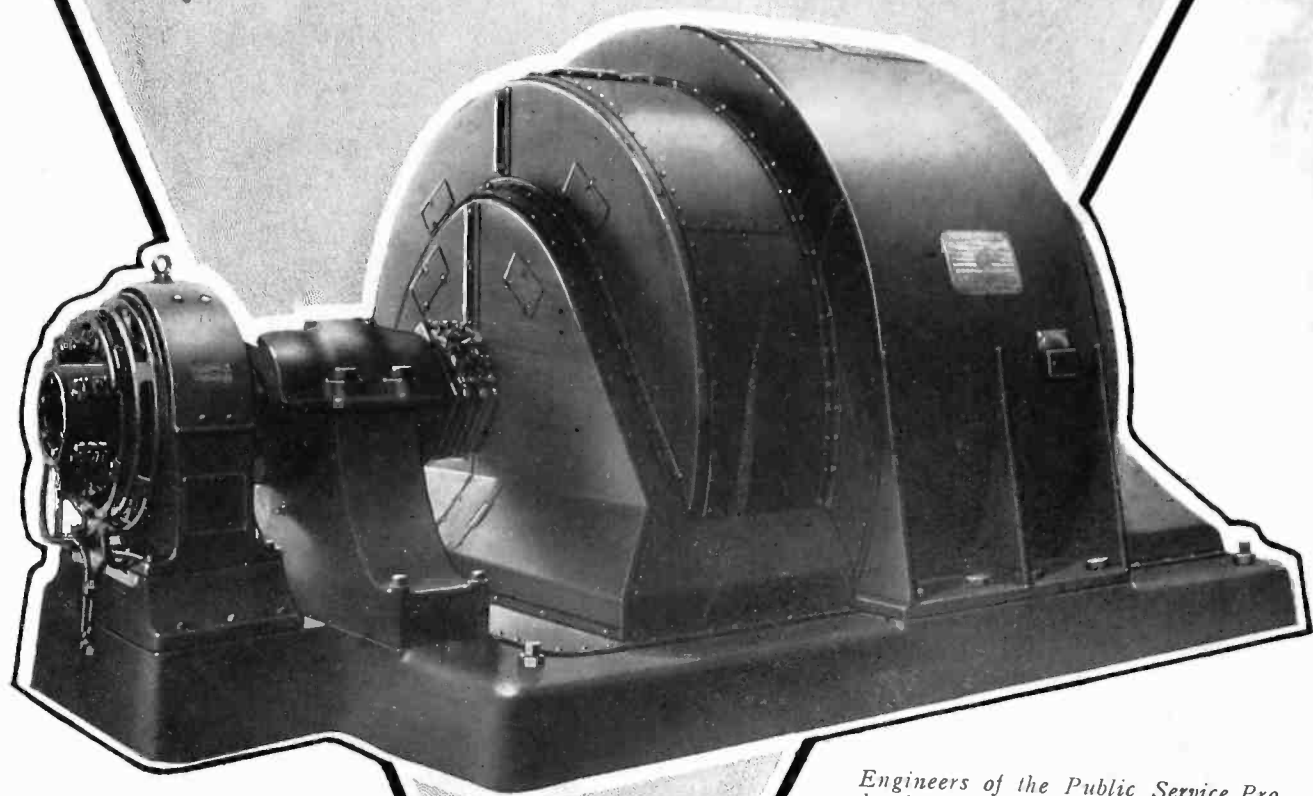

*Engineers of the Public Service Production Company are protecting the new 15,000 kv-a. Synchronous Condenser in the Trenton Switching Station of the Public Service Electric & Gas Co. with LUX released carbon dioxide.*



## FIRE EXTINGUISHING SYSTEM

San Francisco  
Montreal  
Seattle  
Paris

**Walter Kidde & Company, Inc.**  
140 Cedar Street  
New York

The Hague  
Hamburg  
London  
Milan  
Tokio