

# JOURNAL OF THE American Institute of Electrical Engineers



PUBLISHED BY THE INSTITUTE  
33 WEST 39<sup>TH</sup> ST • NEW YORK CITY

# American Institute of Electrical Engineers

## COMING MEETINGS

---

Annual Convention, Swampscott, Mass., June 26-29

Pacific Coast Convention, Del Monte, California, October 2-5

## MEETINGS OF OTHER SOCIETIES

American Electrochemical Society, New York, May 3-5

American Institute of Chemical Engineers, Wilmington, Del., June 20-23.

American Society of Mechanical Engineers, Montreal, May 28-31

American Society for Testing Materials, Annual Meeting, Atlantic City, N. J., June  
25-30

National Electric Light Association, New York, June 4-8

Pacific Coast Electrical Association, San Francisco, Cal., June 19-22

# JOURNAL

OF THE

## American Institute of Electrical Engineers

PUBLISHED MONTHLY BY THE AMERICAN INSTITUTE OF ELECTRICAL ENGINEERS  
33 West 39th Street, New York

Subscription. \$10.00 per year to United States, Mexico, Cuba, Porto Rico, Hawaii and the Philippines; \$10.50 to Canada and \$11.00 to all other Countries. Single copies \$1.00.

Entered as matter of the second class at the Post Office, New York, N. Y., May 10, 1905, under the Act of Congress, March 3, 1879. Acceptance for mailing at special rate of postage provided for in Section 1103, Act of October 3, 1917, authorized on August 3, 1918. Printed in U. S. A.

Vol. XLII

MAY, 1923

Number 5

### TABLE OF CONTENTS

#### Papers, Discussions, Reports, Etc.

Discussion of Application and Economics of Automatic Railways Substations, by L. D. Bale . . .	439	The Wave Antenna-III, by Harold H. Beverage, Chester W. Rice and Edward W. Kellogg . . .	510
Theory of Electric Wave Filters Built up of Coupled Circuit Elements, by Leo. J. Peters . .	445	The Pallophotophone, by C. A. Hoxie . . . . .	520
Measurement of Transients, by Frederick E. Terman . . . . .	462	Cable Geometry and the Calculation of Current-Carrying Capacity, by Donald M. Simons . . .	525
The Neutral Grounding Reactor, by W. W. Lewis .	467	An Electrically Driven Ship . . . . .	539
1922 Developments in Autovalve Lightning Arresters, by A. L. Atherton . . . . .	485	The Production of Porcelain for Electrical Insulation-II, by Frank H. Riddle . . . . .	540
Observations on Electric Railway Practise, by W. B. Potter . . . . .	490	Tests of Welded Rail Joints . . . . .	543
Electrolysis Investigation, Galveston, Texas . .	497	Illumination Items	
Wave-Length Measurements in the Arc Spectra of Gadolinium and Dysprosium . . . . .	497	Relative Performance of Tungsten Filament Lamps under Test upon Alternating and Direct-Current Circuits . . . . .	544
Some Problems in Electric Furnace Operation, by F. V. Andraea . . . . .	498	Effect of Light on the Drawing Power of the Show Window . . . . .	545
		Proper Use of Mill-Type Lamps . . . . .	545

#### Institute and Related Activities

A. I. E. E. Spring Convention . . . . .	546	Convention of the National Association of Manufacturers . . . . .	551
A. I. E. E. Summer Convention Plans . . . . .	546	The Technical Club of Oklahoma Organized . . . . .	551
Pacific Coast Convention . . . . .	548	Westinghouse War Memorial Scholarships . . . . .	551
A. I. E. E. Annual Meeting . . . . .	548	Addresses Wanted . . . . .	552
Amendments to Standards Rules . . . . .	548	Personal Mention . . . . .	552
American Association for the Advancement of Science . . . . .	549	Schuyler Skaats Wheeler . . . . .	553
Future Section Meetings . . . . .	549	Obituary . . . . .	553
Sir Alfred Yarrow Makes Gift to Royal Society .	549	Past Section Meetings . . . . .	554
American Engineering Council		Past Branch Meetings . . . . .	555
Chairman of Committee on Coal Storage Appointed . . . . .	550	Engineering Societies Library	
Federal Safety Legislation . . . . .	550	Book Notices . . . . .	557
American Engineering Standards Committee		Employment Service Bulletin	
Plans for Better Lighting in Schools . . . . .	550	Opportunities . . . . .	559
A. I. E. E. a Sponsor for Radio Standardization . . . . .	550	Men Available . . . . .	560
Engineering Foundation		Membership . . . . .	562
Fatigue of Metals . . . . .	551	Officers, A. I. E. E. . . . .	567
Meeting of American Electrochemical Society in New York . . . . .	551	Local Honorary Secretaries . . . . .	567
Revision of Illuminating Engineering Nomenclature and Photometric Standards . . . . .	551	A. I. E. E. Committees . . . . .	567
		A. I. E. E. Representation . . . . .	567
		Digest of Current Industrial News . . . . .	568

Copyright 1923. By A. I. E. E.

Permission is given to reprint any article after its date of publication, provided proper credit is given.

# **Current Electrical Articles Published by Other Societies**

## **Association of Iron and Steel Electrical Engineers, March, 1923.**

Protection Against Overvoltages in the Iron and Steel Industry, by H. M. Towne.

## **Journal of the American Welding Society, March, 1923.**

Graphite Welding Electrodes, by S. L. Walworth.

Extracts from a Report on Arc Welding (K. Jellberg's System) by M. Harmiishi.

Welding Thin Sections in Cast Iron, by C. J. Holslag.

## **American Electrochemical Society.**

Electrotitration with the Aid of the Air Electrode, by N. Howell Furman.

The Preparation of Fuzed Zirconium, by Hugh S. Cooper.

Chromizing, by F. C. Kelley.

# Discussion of Application and Economics of Automatic Railway Substations

BY L. D. BALE

Associate, A. I. E. E.  
Cleveland Railway Co., Cleveland, O.

**Review of the Subject.**—The automatic substation is defined, and its history is traced from the first station placed in service in 1914 to the present time. The number of automatically controlled railway stations up to the beginning of 1922 is given as 142 equipments totaling 86,000 kw. Outside the city of Cleveland, two-unit stations have been installed in but four instances, although a number of these stations are now under construction. With manually operated stations, especially in interurban work, the location of stations is determined by local conditions, availability of labor, etc. rather than by load conditions. But with the advent of the automatic substation it is possible to locate stations more nearly at the proper points to take care of the system loads giving improved voltage conditions with a minimum of feeder copper. Accessory advantages, in addition to the labor saving item, include a reduction in running light losses, a reduction in distribution losses, lower cost of substation and, in some cases, an actual retirement of existing feeder copper. An example is cited of a double track line 80 miles long with figures from a report which shows a net annual return on the investment, including 6 per cent interest, of 34.9 per cent. The labor saving is based on two twelve-hour shifts, and it is further calculated that with three eight-hour shifts the annual saving would be increased by an appreciable figure. The Des Moines City Railway was the first system to install a group of automatic substations for city service, while the Cleveland Railway Company is given credit

for installing the first two-unit automatic substation for metropolitan railway service. Reasons are advanced for using two-unit stations in Cleveland in contrast to the general practise of employing single-unit stations in interurban work. Emphasis is laid on the necessity for absolutely uninterrupted service in a large city system, even under such emergencies as either an interruption of the a-c. power supply, or short circuit due to breaking of the trolley wire. A further comparison between the operation of manual and automatically controlled substations is taken from one of the surveys made in Cleveland. The tabulation indicates a net annual saving of \$13,900 per year for the automatic over the existing stations.

As to the reliability of automatic control equipments, conclusion is reached that an operator is very unlikely to anticipate trouble, whereas with automatic control the protective equipment operates so successfully that various interruptions are a rare occurrence. There is also the possibility of an operator making an error in judgment, thereby causing trouble which might not otherwise occur. A further consideration which should not be overlooked is the possibility of loss of operators due to strikes or other causes. An outline of the equipment used in the Cleveland stations is given with special reference to outgoing feeders and the proposed method of eliminating current-limiting resistance. Description is also given of the remote control equipment now being manufactured, which will enable the several automatic stations to be supervised from a central point by a dispatcher.

PERHAPS for the benefit of some of those who have not had the opportunity to follow this development a definition of an automatic substation will not be out of order. Messrs. Allen and Taylor define the automatic substation as a substation in which the functions of starting and connecting machines to the line whenever there is a demand for power and finally shutting down, after the demand for power has been satisfied, are all performed in their proper sequence without the assistance of an operator, either in it or at adjacent stations.

Further, it might be added that to make this scheme possible, there must necessarily be arrangements made for taking care of the equipment in such a substation, and protecting service under all of the operating conditions which railway power equipment is subjected to.

The first successful installation of an automatic railway substation, as far as I am aware at least, is the installation of a 300 kw. 600 volts, 25 cycles, 3-phase, synchronous converter on the Elgin & Belvedere Electric Railway, an interurban road. The equipment in this substation was rearranged for automatic control and placed in service December, 1914.

The idea of automatic control for this station, as I understand, originated with an engineer in the employ of one of the large electrical manufacturing companies,

who upon presenting the idea to his company was informed that it was impractical. He, however, thinking otherwise, broached the subject to Mr. B. J. Arnold, who, I believe, was interested in the Elgin & Belvedere Railway Company. In any event, after securing a miscellaneous assortment of relays, contactors, and such other equipment that was applicable to this control system, and was at that time more or less standard in steel mill control work, the station referred to was put into successful operation.

Needless to say, after the practicability of the idea had been demonstrated, the manufacturing companies adopted it. It is, therefore, noteworthy that the history of the automatic substation does not extend over an appreciable length of time. But, in this period there has been a wide adaption of the scheme throughout this country.

A summary of automatically controlled synchronous converters and motor-generator sets in railway service up to this time a year ago, discloses the fact that there are some 80,750 kw. of converters and some 5200 kw. of motor-generator sets in railway service automatically controlled. The capacity is distributed over 129 installations and involves a total of 142 equipments. The majority of these being stations containing a unit of 300 to 500 kw., although there are some 1000-kw. converters involved. Of the 129 installations there are but four cases, except Cleveland, where two units were used in one station. There are, of course, numerous

*Presented before the Cleveland Section, A. I. E. E., April 18th, 1922, also at the Midwinter Convention of the A. I. E. E., New York, N. Y., February 14-17, 1923.*

recent installations not included in this list which have been placed in operation since the tabulation was made. Today, I understand, there are about half again as many orders for equipments of this type upon the books of the two manufacturing concerns building this equipment.

There is as far as this discussion is concerned, three general types of electric railways. The first of these groups is the interurban system, with which as far as we are concerned may be included small suburban systems. In this type of service there is found by far the greatest number of installations of the automatic substation. The idea originated on an interurban system, as was noted, and it is in this class of service that the greatest savings are possible when compared with the manually operated plant. Further, the more infrequent the service the greater will be the proportional saving beyond the item of labor saved. A brief discussion of some of the principal items is as follows:

With manually operated plants in interurban work, it is too often the case that the location of the plants instead of being decided by the load conditions, is of necessity influenced by having to place the station either in or near a center of inhabitants wherein the station operator and his family may live, for without at least some of the conveniences of modern civilization, the railway companies are presented with the inability to secure competent help or are compelled to pay exorbitant wages to hold a sufficient number of competent men to operate the stations.

The necessity of having two or in some cases three shifts of skilled attendants for each station also influences the number and size of such stations, that is, the number of stations provided are held at a minimum, which in turn is reflected in the amount of feed copper necessary to connect the station with the load. Therefore, it is readily seen that if the human element could be eliminated from the operation of a substation, that the station could be located with respect to load only. It is desirable to have as many stations feeding a line as are economically possible, for by this method the feed copper may be held to a minimum, the operating potential of the line may be maintained, and a greater guarantee of service is gained by reason of the numerous points of supply. The approach to this ideal has been made possible by the advent of the automatic substation development. There are other items of savings referred to previously made possible by the use of this type of station on interurban lines. Principal among these items, is the elimination of light load running losses. These losses on an average interurban line may amount to considerably over a period of twenty-four hours where the headway between cars is infrequent. With automatic equipment the station will shut down after the car has run beyond the territory served by the station and the station will again start as the next car comes into the territory. On single-track lines with cars spaced an hour apart, and possibly meeting somewhere in the vicinity of the station, there are instances

where the substation is required to run for only fifteen or twenty minutes out of an hour. This frequent starting and stopping of the equipment is not done if the station is manually operated, consequently with the automatic substation, the average load carried on the equipment may approach more nearly the point of highest operating efficiency. Distribution losses are reduced on account of the possibility of utilizing more stations and locating them where required without having to consider increased labor in operating costs. The cost of the substation building may be materially reduced, for it is unnecessary to provide the usual clearances around equipment, likewise, the apparatus may be arranged with regard to a minimum size of building, rather than to ease of operating as is necessary in arranging for manual control, also facilities for the comforts of the operator are eliminated.

The advent of the automatic substation for interurban work has resulted in several instances in a complete rearrangement of the power facilities of some of these lines, while on others, automatically equipped stations have been installed between existing manual stations, eliminating the necessity of installing additional feeder copper to care for increase in load, in several instances allowing copper to be removed, at the same time increasing the average trolley voltage and at no increased cost of operation. An instance where the power facilities of an installation could be completely rearranged at a considerable saving in operating cost is illustrated by the following summary of a report made on an eastern property. This property operates a double track line approximately eighty miles long.<sup>1</sup> The schedule is essentially one car each way every forty minutes. Local cars are operated at schedule speed of 23 mi. per hr., and limited trains at 30 mi. per hr. The power is supplied to the trolley at 600 volts d-c. from eight manually operated substations spaced approximately ten miles apart. There is a .0000 trolley wire over each track and in addition a 500,000 cm. feeder running the entire length of the line.

It was proposed to retain five of the present substation locations. Three of the present substations are to be moved to new locations and there will be four additional substations made up of equipment now used as spare apparatus in other stations. This will make a total of seven new buildings and eleven automatic control equipments to be supplied, together with high-tension switching for each station.

The balance sheet for this proposed installation of automatic control on this interurban is as follows:

<i>Investment Required</i>	
Seven new buildings.....	\$20,000
Auto. control, etc. high-tension switching..	125,975
Installing of switching equip. and reinstallation of rotaries and transformers....	16,300
<b>Total.....</b>	<b>\$162,275</b>

1. From report by Mr. C. A. Butcher, Westinghouse Electric & Mfg. Company.

Rearrangement of feeder system.....	\$6,030	
Removal of 66.58 miles of 500,000 cm. cable at \$50.....	3,330	
Extension of transmission system.....	4,350	
	<hr/>	
Gross Investment.....	\$175,985	
<i>Credits</i>		
85-1/10 miles of 500,000 cm. cable at 18c. per pound.....	\$123,000	
Salvage, other materials.....	6,000	
	<hr/>	
Total.....	\$129,000	
Net Investment.....	\$46,985	
<i>Annual Savings</i>		
Operators' wages eliminated.....	\$22,330	
Power saved.....	2,860	
Other misc. substation savings.....	200	
	<hr/>	
Total.....	\$25,390	
<i>Annual Charges</i>		
Inspectors' wages.....	\$4,725	
Fixed charges, not including interest on investment.....	4,230	
	<hr/>	
Total.....	\$8,955	
Net Annual Saving.....	\$16,435	
Return on investment including 6 per cent interest.....		34.9 per cent
Return on investment not including interest.....		28.9 per cent
Total investment would therefore be retired in approximately 3 1/2 years.		

The labor saving shown in the table is based on two twelve-hour shifts of one man per each station. At the time this report was made an eight-hour day was in demand. This would increase the item of labor by a third and under this condition the net annual saving would be increased to \$23,878. By this new arrangement of power and distributing system the trolley voltage at the car would be increased by twenty volts. This would result in an increase in running speed and therefore a possible decrease in platform expense, that is, train crews.

You may now realize that the automatic substation has adapted itself ideally to the interurban field where the savings made possible by its application are most apparent. Until about 1918 the automatic equipment was limited almost entirely to the interurban field. This was due, I believe, to the greater cost of the control equipment compared with manual equipment of the same capacity which was thought apparently could not be justified unless savings made possible by its application were without question large, also the scheme was looked upon by quite a few as more or less of a makeshift for use only on the small suburbs.

To Des Moines, Iowa, a city of 126,000 inhabitants belongs the credit of advancing the application of this type of station one step from the purely interurban service. The Des Moines City Railway operates 91.27 miles of single track and 150 cars of all types including interurban, had in operation in 1921, eight or nine automatic substations of 500 kw. capacity each, in city and interurban work. These installations, as I recall, represent simply the use of the interurban type of

station to move city cars, and no new departures were made by reason of the different service.

The next step in progression was made in Cleveland. The Cleveland Railway Company has in operation today, three automatic installations which represent the first case on record of the adaptation of the automatically controlled substations to metropolitan service. These installations also enjoy the distinction of being the first two unit automatic substations of large capacities having been constructed. Each of these stations contains two 1500-kw., 60-cycle, converters. I might add that to date they are the only installations of their kind in existence.

While the application of automatic substation to the interurban system is now on more or less of a standard basis, variations being slight, and principally in kw. capacity, the question of applications on metropolitan systems does not lend itself to standardization nearly so readily. This fact must be realized when the great variety of conditions, principally brought about by operating practises, are considered on various large city systems.

When the problem of layout or rearranging of power generation and distribution facilities of a large system is considered, it will be found that there are numerous items which enter into and effect immensely the ultimate results, that do not appear in planning for the interurban system, and further the weight of these various problems regarding the whole, change, dependent upon what particular city one may be working in.

The various problems are closely co-related. Unfortunately the time available will not allow a full discussion of all the various phases, but, briefly, the results obtained in a survey depend primarily upon the importance of the station or stations to the balance of the system, that is, whether the station is located on the outskirts of the city, in which event it may be considered of relatively less importance than one located perhaps in a congested area serving possibly several important lines of transportation. The area or zone to be supplied by a given station, that is the current density, which also fixes the kw. capacity of the station, is in general determined by land value, building cost and restriction, reserve capacity, a-c. and d-c. feeders, investment necessary in building equipment and feeders, together with annual charges and losses. The paramount necessity, however, is that the system must be conducive of a high degree of reliability of service.

Still another factor referred to previously as "operating practise" has a direct bearing upon the question. It is this phase that tends to make it almost impossible to standardize or make comparisons of proper power facilities for metropolitan systems. By "operating practise" I refer particularly to the quality or type of service rendered by the operating company to the car riding public. An illustration will perhaps make this more clear. The principal source of trouble to the power department of a railway company comes from

the falling of a trolley wire, bad order car equipments, and overloads due to traffic delays, etc. When a trolley wire breaks and grounds, it is of course disconnected from the source of power at the station by automatic breakers, that is, if manual stations are used. On a great number of roads it is the practise to hold these grounded feeders or sections open until the wire has been picked up either by the car crews or the line emergency crews. The power plant is then notified and power is restored. By this procedure the amount of trolley wire annealed or destroyed is held at a minimum as is also the matter of maintenance on station equipment. The great disadvantage of this method, however, lies in the fact that important lines are tied up for indefinite lengths of time, schedules are disarranged which on heavy lines may require the remainder of the day to rectify, and most important of all, thousands of patrons of the line are delayed, in some instances seriously.

The progressive management is really trying to produce the best possible service, free from interruption, realizing that to have cars standing in the street without power, does not, to say the least, improve public relationship.

For example, the management of the railway in Cleveland is most insistent in its demands that power be supplied under all conditions. When a short circuit occurs upon a feeder section, instead of leaving the section out or dead, until the trouble has been cleared, every attempt is made to maintain the power supply upon the faulty section, for, with power the cars continue to move. To make this possible, it can readily be appreciated that the layout of the generating and distributing system will be considerably more extensive, more complicated and expensive, than on a property where power service is discontinued when trouble arises on the line.

The question of the size (kw. capacity) and the number of units to be installed within the automatic substation in metropolitan service is one which also is receiving much discussion at present. There is no question but that to increase the number of points of supply to a system will result in a better average operating voltage at the car, and with a reduction in the amount of feeder copper necessary, also by reducing the potential gradient of the rails do much to eliminate electrolysis. It would, therefore, appear that the ideal layout of automatic substations should consist of a series of small single-unit installations located at relatively short distances from each other and in a very simple, small inexpensive building. With low land values and building cost, and the absence of building restrictions, which are encountered generally in small cities, sparingly settled areas or suburban districts of larger cities, there seems to be no doubt but that a number of single-unit installations answer the requirements admirably. On the other hand, where the cost of

land and buildings is high and there are numerous restrictions to be complied with as is the case in Cleveland the multiple unit station works to the greatest economy, taking every item into consideration. On the metropolitan system where continuity of service is the one ruling factor, it is necessary (as was previously noted) to protect or make possible this continuous service by installing reserve capacity in equipment and distribution system. To exemplify this, take but one of the phases necessary for insurance to continuity of service, the a-c. power supply.

In small cities where underground construction of high-tension lines is not necessary, the cost of connecting the a-c. power supply to the numerous small single-unit stations is not much of a factor. On the other hand, in large cities, where underground construction is necessary, the cost of supplying all of the small stations with a-c. lines becomes an expensive matter. In this connection, the installation of duplicate a-c. feeders to a station of importance containing more than one unit is warranted, insuring as it does freedom from station "shut downs" arising from a-c. line failures. In the case of less important stations having but a single unit, this feature of safety to service is sacrificed, for the duplication of supply cable being in the case hardly permissible. Where the multiple-unit station proves the most efficient and economical type to install, the factor of service insurance is further increased by reason of the scheme of automatic sequence which is a part of this type of station.

On the average interurban system the load taken as a whole upon the system tends toward a flat characteristic, that is, each of the stations upon the system is subjected to numerous peaks during the period of operation of the line. These peaks occurring when there is a train within the territory supplied by any particular station and as noted previously as the train moves out of the territory, the station shuts down. On the large city system, the load is of an entirely different nature. There is a continuous load on the station which varies more or less gradually from the peak condition, morning and evening, to the base running schedule period. In the former case, that of the interurban, the power equipment is being worked to the highest possible over-all efficiency. In city service, however, the frequent starting and stopping of equipment is impossible, for with all stations upon the system arranged to feed into what results, by reason of emergency tie feeders, a general network of feeders, and with very low ohmic resistance (0.03 approximately) between stations, each and every machine in service will attempt to assume its portion of the system load. This tends to keep equipment in service when there is really no necessity for same. This would result detrimentally to the all-day station conversion efficiencies. There is, of course, a limit that can be established above which an increased average trolley potential will not reduce platform or



other expenses materially. Beyond this limit it is obviously unnecessary to have converter equipment operating at the resulting low-load factor.

The two-unit station has an advantage in this connection, in that the two units will operate to capacity during the peaks, while the remainder of the day one unit will shut down, leaving the remaining unit in operation.

There were numerous reasons for the adoption of automatic equipment in Cleveland. Primarily, the company was presented with the necessity of supplying additional power to portions of the city lying within the district wherein, by reason of recent developments and natural traffic growth, the power supply was in some cases inadequate. It was found impractical to attempt to increase the operating potential in most of these territories by additional feeders from existing plants, for not only were feeders necessary, but additional conversion equipment would have to be installed at the various plants to absorb the increased load, together with losses. The alternative was, of course, additional power facilities, located within the territory in which the load originated. The results taken from one of the several surveys made to determine the most economical procedure with respect to a given territory, indicates the following:

<i>Power supplied from existing plants locations</i>	
Proportional part of building, together with new equipment necessary to be installed for the load . . . . .	\$ 89,398
Total feeder copper (existing plus additional copper) . . . . .	274,251
Total . . . . .	325,251
Annual charges . . . . .	53,636
<i>Power supplied for manually operated substations*</i>	
Building, land, equipment and feeders . . . . .	\$221,263
Annual charges . . . . .	44,240
Operation . . . . .	\$ 8,290.
Feeder losses . . . . .	11,644.
<i>Power supplied for automatically operated substations</i>	
Buildings, land, equipment and feeders . . . . .	\$242,129
Annual charges . . . . .	39,735
Inspection . . . . .	\$ 400.
Feeder losses . . . . .	11,644.
<i>Basis upon which annual charges are calculated</i>	
Buildings . . . . .	8¾ per cent (Insurance, taxes, depreciation, interest).
Land . . . . .	6 per cent (Taxes, interest).
Equipment . . . . .	10¼ per cent (Insurance, taxes, depreciation, interest).
Maintenance . . . . .	(Buildings, equipment).
Operation . . . . .	or Inspector.
Feeder copper . . . . .	9 per cent (Taxes, interest).
Feeder losses . . . . .	\$11,644.

\*Used for comparison purposes only.

This indicates a net annual saving of \$13,900 comparing the automatic substation with the scheme of supplying the territory from existing plants. In comparing the automatic with the manually operated plant of like capacity an annual saving of \$4500 is indicated in favor of the automatic substation, notwithstanding the fact that \$20,866 increase investment is made. Incidentally, a comparison of the cost of feeders in the first and second plants would emphasize

the relation which this item bears to the economical location of power facilities with regard to load, particularly when working with low voltages. It might be of interest to note that if the present power facilities of the company were all on an automatic basis today, calculation indicates that a saving in operating expense could be made amounting to approximately \$175,000 annually.<sup>3</sup>

With these possible savings in mind, it remained but to ascertain the reliability of automatic equipment. From operating records available it appeared that this equipment, where properly installed and maintained, was more reliable than the manually operated. From experience this is borne out.

This is easily seen when it is considered that the chances of an operator being able to anticipate trouble are remote. Abnormal conditions develop so quickly and are often so obscure that before he has the opportunity to realize what is occurring the damage is often done, or if not, his principal duty then will be to limit the extent of injury and to confine it to the particular piece of apparatus or circuit in which it originated. While he is so engaged service is, in all probability, at a standstill. With automatic control the equipment is protected as the trouble occurs, and is prevented from spreading. This is accomplished by the various protective devices peculiar to this type of control. Interruptions to service are, therefore, held at a minimum.

No matter how well trained the operators may be, there are certain errors of judgment that must necessarily enter into the operation. In large centers of population, where the tendency normally is for high labor turnover, there will always be a larger percentage of new operators on the system than in some of the less active cities. This element of inexperienced operators will result in operating mishaps, which are avoided by use of automatic control. In connection with the item of labor, there is the intangible but undoubtedly great value obtained in adopting automatic control in the assurance gained by the knowledge that labor difficulties cannot interfere with the success or continuity of service of a system so equipped.

As has been previously mentioned, the installation of the automatic substation in Cleveland, represents the first attempt to utilize this type of equipment in metropolitan service. These stations then represent pioneer work, there being no precedent. Utilizing the experience and knowledge of operating conditions in Cleveland, continuous studies were made of the adaptability of this type of control, as it was being planned, with the result that changes and additions were made in the layout prior to its manufacture, and in fact, while in the process of manufacture. These were necessary to bring the equipment to a point where it would meet with all of the operating conditions and where absolute dependence could be placed upon it under all

3. Comparison made with present system, including steam plant

conditions. The results have been exceedingly gratifying, for aside from the d-c. outgoing feeder control scheme, there have been comparatively few changes found necessary considering the immensity of the problem. Some of the changes necessitating the redesign, addition or rearrangement of relays, while the majority were accomplished by changing circuit connections.

Referring to the control of outgoing d-c. feeders, the solution to this phase has been the most troublesome of the whole development. There was installed and in fact still exists in these stations, a type of feeder control, known as the current limiting resistance method of control, which has met with success in interurban and small city work. At the time of installation it was the only scheme available. With this scheme, in the event of a short circuit or overload occurring on the feeder, the current flow and voltage to the feeder is reduced by inserting the resistance. If this abnormal condition persists, the section is finally cut off from the source of power entirely. This method of operation on the property where a premium is placed upon continuity of service is not acceptable. Recently a new method of feeder control has been devised. This scheme eliminates the current limiting resistance entirely. By the use of a current transformer on the d-c. feeder, an arrangement is secured whereby the feeder will be disconnected only in the event of a short circuit occurring on the feeder. This is a step towards the continuity of service we wish to obtain, however, it still does not fill all the requirements, for, in our desire for continuous service, it is necessary that wherever possible, power must be supplied to faulty feeders for the movement of cars and to clear the feeder of fault. To accomplish this and other phases of operation which are desired, it has been necessary to devise a method of remote control. By utilizing an auxiliary or transfer bus in each station with feeders arranged for automatic transfer on short circuits only, a most flexible system is obtained by the addition of this control. Provisions are had for load shifting in case of severe load congestion, failures of conversion equipment, a-c. feeders, etc. This is accomplished by transferring load to adjacent plants over tie feeders, these same feeders furnishing the means of "burning off" grounds on faulty sections, thus replacing the present current limiting resistance.

A brief outline of the remote control equipment which is at present being manufactured, will be of interest. A dispatcher's office will be established at a centralized point from which there will extend two pairs of telephone conductors to each automatic substation. At the dispatcher's office, arranged in a semi-circular desk, each substation will be represented by a small panel containing a series of telephone lamps behind the customary lenses. On the table of this desk is to be arranged a series of buttons, controlling relays by which

combinations may be set up sending impulses to any particular substation where, it will cause to operate certain relays which in turn perform required changes in the operating conditions of the stations. As these changes take place at the station, the dispatcher is advised by the signal lamps mounted on his desk. These lamps enabling him to ascertain at any time the positions of the controlling relays or contactors at any station. The functioning of these devices by reason of automatic operation will also set up signals at the dispatcher's board. To enable the dispatcher to know the load conditions of the stations, that he may act intelligently in cases of emergency, arrangement is had to duplicate in the dispatching center, continuous loading of each station upon a graphic chart. It might be well to state that this system of remote control does not supersede the automatic substation control in any sense. All the various benefits derived from full automatic control still remain. This system is so arranged that in the event of the remote control becoming inoperative from any reason whatsoever, it is automatically disconnected from the substation control leaving the station still under full automatic control.

The present plan of the railway company contemplates the use of automatically controlled stations for the entire property eventually. It is proposed where practical to break up the existing manually operated stations into units of one and two machines each. With this in mind, the remote control has been designed with facilities for increasing the number of station positions to thirty.

Regarding the future of automatic control: While I have limited myself to the railway applications only, the development has not been limited to this field. Engineers in other fields of electric generation and distribution have not failed to grasp the idea and apply it. There are several installations in 220-volt d-c. Edison service, likewise, there are several industrial applications. The idea has also been utilized in one or two instances in hydro-generating plants. In this particular field automatic control should, it seems to me, have as wide an application as in the railway field, for by the use of this control, thousands of small water power sights are made possible of development and may produce power economically whereas before, this was impossible.

Each and every application of automatic equipment, no matter in what field, will present a variation of control features by reason of new or different operating conditions met with upon each new application, but with the engineering talent and ingenuity displayed by the men heading the control divisions of the principal companies engaged in this particular field, together with the inclination of the engineer in charge of the property to cooperate and study conditions and requirements, the limitations of automatic control are not in sight.

# Theory of Electric Wave Filters Built up of Coupled Circuit Elements

BY LEO J. PETERS\*

Engineering Experiment Station, University of Wisconsin

**Review of the Subject.**—This paper is essentially a treatment of certain types of coupled circuit networks by methods similar to those used in the discussion of the properties of long lines with distributed constants. This method of treating those coupled circuit chains to which it can be applied far surpasses other methods of treatment in several important ways. First, the number of elements in the chain can be made as large as desired without complicating the problem in any way whatsoever. Second, the very method of treatment leads directly to the rational design of selective systems of a type which the older methods of treatment did not even show to exist. Third, this method of attacking the problem is much better adapted to a transient state treatment (following the methods of J. R. Carson and T. C. Fry) than the older methods of handling the coupled circuit problem.

In the second section of this paper there is developed the general theory of the properties of identical circuits coupled so as to form a chain. The equations giving the current and voltage of any circuit in the chain are identical in form with those giving the current and voltage at any point of a long line with distributed constants. The propagation constant however, instead of being an algebraic function of the circuit constants and the impressed frequency as in the case

for the line with distributed constants, is a transcendental function of the circuit constants and the frequency of the current being transmitted. The nature of this transcendental function is such that sharp changes occur in the characteristic curve which portrays the attenuation constant as a function of the frequency.

The third section shows how, by proper termination and design, these sharp changes in the attenuation frequency characteristic can be employed to build up filter networks.

The fourth section gives an application of the general theory by presenting a detailed treatment of simple series circuits magnetically coupled so as to form a chain. In this section a number of curves is presented. These curves give a visual picture of the general theory and bring out points useful in the designing of selective networks which must meet preassigned requirements.

The fifth section discusses the problem of building up filters using sections of many different types. General methods of attacking this problem are given and design formulas for three different types of filter sections which may be used together in building up a filter system, are derived. Curves are given which illustrate the methods of building up desirable characteristics. The design of selective systems is put upon a rational basis.

## I. INTRODUCTION AND PURPOSE

The increase in the use of radio communication and the introduction of carrier current telephony has led to a very great interest in the problem of separating currents having frequencies which lie in a given band from currents of all other frequencies. Systems of circuits used to perform this separation have been called electric wave filters, or simply wave filters. Some of the properties of coupled circuits which make them valuable as wave filters have been known and employed for some time. It is the purpose of this paper to point out some new properties of certain types of systems built up of coupled circuits, and to show how systems having preassigned characteristics may be

\*During the summer of 1921 the writer was employed as an assistant in filter design by the Western Electric Company. During this period he became very familiar with the series shunt type of filter element and with the methods used by the engineers of this company in handling filter design problems. This experience with the Western Electric Co. is reflected in this paper in such things as the loss method of treatment, the use of sections of different types to build up given characteristics, and the methods of obtaining the design formulas. The material for this paper was inspired by the previous work on coupled chains and on selective systems in general carried out by Professors Bennett, Crothers and the author at the University of Wisconsin. The general use of different equations in handling artificial line problems was acquired by the author from the published papers of Campbell and Carson. The conception of circuit and transfer impedance as a broad basis for filter theory and the type of filter section to which the treatment leads directly are thought to be original.

Presented at the Midwinter Convention of the A. I. E. E., New York, N. Y., February 14-17, 1923.

built up in a rational way by an application of the theory presented.

In this paper chains built up of coupled circuits will be treated in a manner similar to that employed in arriving at the properties of long lines with distributed constants. In the telephone art it is common practice to give the transmission properties of long lines, or of any piece of apparatus by stating the loss in miles of standard cable or more rationally in attenuation units, incurred by inserting the line or the piece of apparatus between two points of known impedances. This method is very well adapted to a discussion of the properties of wave filters, and will be employed in this paper.

Wave filters built up of series and shunt impedances have been discussed by G. A. Campbell<sup>1</sup> and K. W. Wagner.<sup>2</sup> The general theory presented in the following sections is somewhat broader than that presented by Campbell and Wagner, as it includes as a special case the filter built up of series and shunt elements as the shunt element may be considered as a coupling element.

In this paper illustrations of the general theory will be given by discussing particular types of filters which are not built up of series and shunt elements. Illustrations from this class of filters are used because it is the application of long line theory to such coupled circuit chains which forms the main contribution of

1. Campbell, U. S. Pat. Specs. No. 1,227,113; 1,227,114 of 1917.

2. Wagner, *Archiv fur Elektrotechnik*, vol 8, page 145, (1919).

this paper to the literature on wave filters. The series shunt type of structure has already been described by Campbell and Wagner, and has been used for some time in the plant of the Bell Telephone System.

## II. CURRENT PROPAGATION THROUGH A CHAIN BUILT UP OF IDENTICAL CIRCUITS COUPLED TOGETHER

(1) *General Equations and the Propagation Constant.* Consider the chain of circuits shown in Fig. 1. Each circuit is identical with every other circuit. The impedance of each circuit when removed from the chain and isolated is represented by  $Z_c$ . That is with the circuit taken out of the group and  $E$  volts impressed in it the current flowing would be  $E/Z_c$ .  $Z_c$  will be called the circuitual impedance. In general it will be of the form  $a + jb$ . The coupling is represented by the square box. The transfer or mutual impedance is represented by  $Z_m$ . That is the voltage in the  $(q + 1)$ th circuit due to the current in the  $q$ th circuit is  $I_q Z_m$ . In general  $Z_m$  may also be of the form  $a + jb$ . The source of power, represented by a generator works through an impedance  $Z_0$  into a terminating circuit of half the normal circuitual impedance. The chain ends at the other end in a half circuit closed by a load impedance  $Z_n$ .

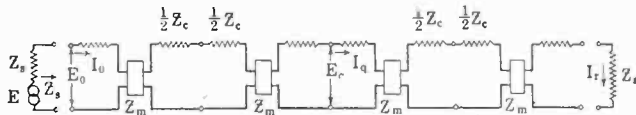

FIG. 1

Now applying Kirchoff's law to the  $q$ th circuit we obtain:

$$-Z_m I_{q-1} - Z_m I_{q+1} - Z_c I_q = 0 \quad (1)$$

The voltage across the mid-point of the  $q$ th circuit is:

$$E_q = -Z_m I_{q-1} - Z_c/2 I_q \quad (2)$$

Equation (1) is a difference equation relating the currents in three adjacent circuits. Its solution is:

$$I_q = A \epsilon^{q\tau} + B \epsilon^{-q\tau} \quad (3)$$

Substituting (3) in (1) there results:

$$\begin{aligned} Z_c/Z_m (A \epsilon^{q\tau} + B \epsilon^{-q\tau}) + A \epsilon^{-\tau} \epsilon^{q\tau} + B \epsilon^{\tau} \epsilon^{-q\tau} \\ + A \epsilon^{\tau} \epsilon^{q\tau} + B \epsilon^{-\tau} \epsilon^{-q\tau} = 0 \end{aligned} \quad (4)$$

Collecting terms:

$$\begin{aligned} Z_c/Z_m (A \epsilon^{q\tau} + B \epsilon^{-q\tau}) + A \epsilon^{q\tau} (\epsilon^{\tau} + \epsilon^{-\tau}) \\ + B \epsilon^{-q\tau} (\epsilon^{\tau} + \epsilon^{-\tau}) = 0 \end{aligned} \quad (5)$$

Factoring:

$$(A \epsilon^{q\tau} + B \epsilon^{-q\tau}) (Z_c/Z_m + \epsilon^{\tau} + \epsilon^{-\tau}) = 0 \quad (6)$$

If the first term were identically zero, no current would exist anywhere in the chain. The first term is therefore different from zero and we have:

$$Z_c/Z_m + (\epsilon^{\tau} + \epsilon^{-\tau}) = 0 \quad (7)$$

or

$$\cosh \tau = -\frac{Z_c}{2Z_m} \quad (8)$$

In the long line theory  $\tau$  has been called the propagation constant. This name will be retained here. Equation (8) is the fundamental equation relating the propagation constant to the circuit constants.

The constants  $A$  and  $B$  of equation (3) are arbitrary and may be determined in the terms of any two currents, any two voltages, or in terms of a current and a voltage at some mid-circuit position.

(3) *The Voltage Equation.* Upon substituting for  $I_{q-1}$  and  $I_{q+1}$  in equation (2) we obtain:

$$\begin{aligned} E_q = -Z_m (A \epsilon^{(q+1)\tau} + B \epsilon^{-(q+1)\tau}) - Z_c/2 (A \epsilon^{q\tau} \\ + B \epsilon^{-q\tau}) \end{aligned} \quad (9)$$

From equation (5) we obtain the relation,

$$\begin{aligned} Z_c/2 (A \epsilon^{q\tau} + B \epsilon^{-q\tau}) = -Z_m/2 (\epsilon^{\tau} + \epsilon^{-\tau}) (A \epsilon^{q\tau} \\ + B \epsilon^{-q\tau}) \end{aligned} \quad (10)$$

Substituting (10) in (9) there results

$$E_q = (-Z_m \sinh \tau) [A \epsilon^{q\tau} - B \epsilon^{-q\tau}] \quad (11)$$

From (8)

$$\begin{aligned} \cosh \tau = -\frac{Z_c}{2Z_m}; \quad \sinh \tau = \sqrt{\frac{Z_c^2}{4Z_m^2} - 1} \\ E_q = -\sqrt{Z_c^2/4 - Z_m^2} [A \epsilon^{q\tau} - B \epsilon^{-q\tau}] \end{aligned} \quad (12)$$

The term  $\sqrt{Z_c^2/4 - Z_m^2}$  plays the same role here as the characteristic impedance, plays in long line theory. Therefore, this quantity will be called the characteristic impedance. It will be represented by the symbol  $Z_s$ . That is:

$$Z_s = \sqrt{Z_c^2/4 - Z_m^2} \quad (13)$$

$$E_q = -Z_s [A \epsilon^{q\tau} - B \epsilon^{-q\tau}] \quad (14)$$

(4) *Determination of the Constants A and B.* In Terms of the Current and Voltage of the First Circuit. When  $q = 0$  let  $E_q = E_0$  and  $I_q = I_0$ .

Then from (14) we obtain:

$$E_0 = -Z_s (A - B) \quad (15)$$

$$I_0 = A + B \quad (16)$$

$$A = 1/2 (I_0 - E_0/Z_s) \quad (17)$$

$$B = 1/2 (I_0 + E_0/Z_s) \quad (18)$$

The current and voltage equation then become

$$I_q = 1/2 (I_0 - E_0/Z_s) \epsilon^{q\tau} + 1/2 (I_0 + E_0/Z_s) \epsilon^{-q\tau} \quad (19)$$

$$E_q = 1/2 (E_0 - Z_s I_0) \epsilon^{q\tau} + 1/2 (E_0 + Z_s I_0) \epsilon^{-q\tau} \quad (20)$$

Represent the real and imaginary parts of  $\tau$  by  $h$  and  $k$  respectively so that

$$\tau = h + jk \quad (21)$$

Equations (19) and (20) may now be written in two alternate forms, one involving the trigonometric functions and the other involving the hyperbolic functions.

The trigonometric forms are:

$$I_q = 1/2 (I_0 + E_0/Z_s) \epsilon^{-hq} (\cos kq - j \sin kq) + 1/2 (I_0 - E_0/Z_s) \epsilon^{hq} (\cos kq + j \sin kq) \quad (22)$$

$$E_q = 1/2 (E_0 + Z_s I_0) \epsilon^{-hq} (\cos kq - j \sin kq) + 1/2 (E_0 - Z_s I_0) \epsilon^{hq} (\cos kq + j \sin kq) \quad (23)$$

The hyperbolic forms are:

$$I_q = I_0 \cosh q\tau - E_0/Z_s \sinh q\tau \quad (24)$$

$$E_q = E_0 \cosh q\tau - Z_s I_0 \sinh q\tau \quad (25)$$

(5) *The Current and Voltage of Any Circuit in Terms of the Initial Voltage and the Terminating Impedance.* For some purposes it is useful to have the equations for current and voltage in terms of the sending end voltage and the terminating or load impedance. We next proceed to write these equations in terms of these constants.

The current in the end or  $n$ th section is:

$$I_n = I_0 \cosh n\tau - (E_0/Z_s) \sinh n\tau \quad (26)$$

The voltage in the  $n$ th section or across the terminating impedance is:

$$E_n = E_0 \cosh n\tau - Z_s I_0 \sinh n\tau \quad (27)$$

Also

$$Z_n I_n = E_n \quad (28)$$

From (26), (27) and (28) we obtain:

$$I_0 = E_0 \frac{\cosh n\tau + Z_n/Z_s \sinh n\tau}{Z_n \cosh n\tau + Z_s \sinh n\tau} \quad (29)$$

In (29) the reciprocal of the quantity multiplying  $E_0$  is the impedance of the string of circuits looking into the generator end of the line. We represent this impedance by  $Z_L$ . That is:

$$Z_L = \frac{Z_n \cosh n\tau + Z_s \sinh n\tau}{\cosh n\tau + (Z_n/Z_s) \sinh n\tau} \quad (30)$$

And 
$$I_0 = E/Z_L \quad (31)$$

Equations (22) and (23) may now be written:

$$I_q = 1/2 E_0 (1/Z_L + 1/Z_s) \epsilon^{-hq} (\cos kq - j \sin kq) + 1/2 E_0 (1/Z_L - 1/Z_s) \epsilon^{hq} (\cos kq + j \sin kq) \quad (32)$$

$$E_q = 1/2 E_0 (1 + Z_s/Z_L) \epsilon^{-hq} (\cos kq - j \sin kq) + 1/2 E_0 (1 - Z_s/Z_L) \epsilon^{hq} (\cos kq + j \sin kq) \quad (33)$$

Equations (24) and (25) may now be written

$$I_q = E_0 (1/Z_L \cosh q\tau - 1/Z_s \sinh q\tau) \quad (34)$$

$$E_q = E_0 (\cosh q\tau - (Z_s/Z_L) \sinh q\tau) \quad (35)$$

(6) *Comparison of the Equation with the Equation for the Smooth Line.* The equations which have been written down for current and voltage in the coupled circuit chain are identical in form with the equations for the current and voltage at any point of a long line with uniformly distributed constants. Thus equations (22), (23), (24) and (25) apply identically to the line

with uniformly distributed constants. However the expressions for  $Z_s$  and  $\tau$  are different for the smooth line than for the coupled circuit chain. The most striking and fundamental difference occurs in the propagation constants for the two cases. For the smooth line the propagation constant is an algebraic function of the line constants, while for the coupled circuit chain the propagation constant is a transcendental function of the circuit constants. It will be shown later that this difference portrays the difference in the characteristics of the two types of systems. In the equation for the coupled circuit chain,  $q$  is a positive integer. For the smooth line  $q$  need not be an integer.

(7) *Conditions under which the Reflected Wave Disappears.* In equations (22) and (23) the first terms decrease as the circuit under consideration recedes from the generator end of the chain. In the case of the smooth line this term has been called the main wave of current, and voltage respectively. The second term of each of these equations increases in magnitude as the circuit under consideration recedes from the generator end. In long line theory these terms have been called the reflected waves. This terminology is both useful and convenient and will be adopted in the discussion of the coupled circuit chain. In the case of the smooth line the reflected wave can be made to disappear in two ways, first by making the line very long, second by terminating in an impedance equal to the characteristic impedance of the line. We proceed to show that if these same conditions are fulfilled, the reflected waves disappear from the equation for current and voltage in any circuit of the coupled circuit chain.

In equation (30), which relate  $Z_L$  to the circuit constants, divide both numerator and denominator by  $\cosh n\tau$ . This gives

$$Z_L = \frac{Z_n + Z_s \tanh n\tau}{1 + (Z_n/Z_s) \tanh n\tau} \quad (36)$$

$$\lim_{n \rightarrow \infty} Z_L = Z_s \quad (36)$$

So that for a very great number of circuits in the chain  $E_0/Z_s = I_0$ ;  $I_0 Z_s = E_0$  and the terms representing the reflected wave disappears from the equations for current and voltage.

Now consider the chain to be terminated by an impedance equal to the characteristic impedance of the chain. That is, let  $Z_n = Z_s$ .

Then it can readily be seen from equation (30) or (36) that  $Z_L = Z_{sL}$  and the reflected wave is again absent.

Thus, when the chain is again made up of many circuits, or when it is terminated in an impedance equal to its characteristic impedance, the impedance looking into the chain is equal to the characteristic impedance and the terms representing the reflected wave are absent from the equations for current and

voltage. The current and voltage in the  $q$ th circuit are then given by the following simple equation.

$$I_q = I_0 \epsilon^{-q\tau} \quad (37)$$

$$E_q = E_0 \epsilon^{-q\tau} \quad (38)$$

$$I_q = I_0 \epsilon^{-hq} (\cos kq - j \sin kq) \quad (39)$$

$$E_q = E_0 \epsilon^{-hq} (\cos kq - j \sin kq) \quad (40)$$

(8) *The Attenuation Constant and the Wave Length Constant.* In the equation for current and voltage in the  $q$ th circuit of the chain of coupled circuits, the propagation constant  $\tau$  is in general a complex number. We have represented  $\tau$  by  $h + jk$ . Now consider the general equation for current or voltage. If we confine our attention to the main wave alone or to the reflected wave alone, then equations (22) and (23) show that  $h$  affects the amplitude of the wave without affecting its phase position. For this reason it is called the attenuation constant.  $k$ , on the other hand, affects only the phase position and in a number of circuits such that  $kq = 2\pi$  the phase of the current in either the main or reflected wave shifts through 360 deg., or when we pass over a number of circuits  $q_w$  given by

$$q_w = \frac{2\pi}{k} \quad (41)$$

We have gone the equivalent of one wave length on a smooth line. For this reason  $k$  is called the wave length constant.

The propagation constant  $\tau$  has already been evaluated in terms of the circuit constants. For many purposes it is convenient to evaluate  $h$  and  $k$  separately in terms of these constants.

From equation (8) we have

$$\cosh \tau = \cosh (h + jk) = -\frac{Z_c}{2Z_m} \quad (8)$$

$$\text{Let } Z_c/Z_m = u + jv = \gamma/\phi \quad (42)$$

Expanding (8)

$$\cosh (h) \cos (k) + j \sinh (h) \sin (k) = -\frac{u + jv}{2} \quad (43)$$

Since  $h$  and  $k$  are assumed real,  $\sinh h$ ,  $\cosh h$ ,  $\sin k$ , and  $\cos k$  are all real. Equating real and imaginary parts there results:

$$\left. \begin{aligned} \cosh (h) \cos (k) &= -u/2 \\ \sinh (h) \sin (k) &= -v/2 \end{aligned} \right\} \quad (44)$$

$$\left. \begin{aligned} \cosh^2 h \cos^2 k &= u^2/4 \\ \sinh^2 h \sin^2 k &= v^2/4 \end{aligned} \right\} \quad (45)$$

$$(\cosh^2 h - 1)(1 - \cos^2 k) = v^2/4 \quad (46)$$

$$\cos^2 k = 1 - \frac{v^2}{4(\cosh^2 h - 1)} \quad (47)$$

$$(\cosh^2 h) \left[ 1 - \frac{v^2}{4(\cosh^2 h - 1)} \right] = u^2/4 \quad (48)$$

$$\cosh^4 h - (\cosh^2 h) \left[ 1 + \frac{u^2 + v^2}{4} \right] = -u^2/4 \quad (49)$$

$$\cosh (h) = \left[ \frac{1}{2} \left\{ \left( \frac{u^2 + v^2}{4} + 1 \right) + \sqrt{\left( \frac{u^2 + v^2}{4} + 1 \right)^2 - u^2} \right\} \right]^{1/2} \quad (50)$$

$$\cosh (h) = \left[ \frac{1}{2} \left\{ (\gamma^2/4 + 1) + \sqrt{(\gamma^2/4 + 1)^2 - \gamma^2 \cos^2 \phi} \right\} \right]^{1/2} \quad (51)$$

In like manner we obtain the relations

$$\cos k = \frac{-u}{\sqrt{u^2}} \left[ \frac{1}{2} \left\{ \left( \frac{u^2 + v^2}{4} + 1 \right) - \sqrt{\left( \frac{u^2 + v^2}{4} + 1 \right) - u^2} \right\} \right]^{1/2} \quad (52)$$

$$\cos k = \frac{-u}{\sqrt{u^2}} \left[ \frac{1}{2} \left\{ \left( \frac{\gamma^2}{4} + 1 \right) - \sqrt{\left( \frac{\gamma^2}{4} + 1 \right)^2 - \gamma^2 \cos^2 \phi} \right\} \right]^{1/2} \quad (53)$$

Equations (52) and (53) do not determine the sign (or the quadrant) of  $k$ . If the sign of  $k$  is determined so as to satisfy the relation:

$$\sin k = \frac{-v}{2 \sinh (h)} \quad (53a)$$

then equations (50), (51), (52) and (53) always give real values to  $h$  and  $k$  which satisfy equations (41). The term  $-u/\sqrt{u^2}$  is introduced into equations (52) and (53) so as to make  $\cos k$  change sign with  $u$  as it must in order that equations (41) may be satisfied.

### III. SELECTIVE PROPERTIES OF THE COUPLED CIRCUIT CHAIN

(9) *General Attenuation Characteristics.* Fig. 2 represents a chain of coupled circuits terminated by an impedance equal to  $Z_s$  so as to eliminate the reflected wave. The current in the  $q$ th circuit then is given by equation,

$$I_q = I_0 \epsilon^{-q\tau} \quad (37)$$

or

$$I_q = I_0 \epsilon^{-qh} (\cos kq - j \sin kq) \quad (38)$$

Where

$$\cosh \tau = -\frac{Z_c}{2Z_m} = -1/2(u + jv) \quad (4)$$

Let us now define an ideal filter as one built up of coils and condensers in which no energy dissipation takes place. Let the circuit under consideration be an ideal filter. Then  $Z_c$  and  $Z_m$  are both pure imaginary quantities and  $Z_c/Z_m$  is a real number, that is,  $v$  is equal to zero. For the ideal case then:

$$\cosh \tau = -\frac{Z_c}{2Z_m} = -u/2$$

where  $u$  is a real number. For any particular structure  $Z_c/Z_m$  is a function of the frequency of the applied

voltage and therefore also is a function of the frequency of the current being transmitted.

If  $Z_c/Z_m < -2$  then  $\cosh \tau > 1$  and  $\tau$  is a positive real number; that is  $h$  has some positive value and  $k = 0$ . Thus currents having frequencies that make  $Z_c/Z_m < -2$  decrease in magnitude but retain the same phase position as the circuit under consideration recedes from the generator end of the chain.

If  $Z_c/Z_m > 2$  then  $\cosh \tau$  is a negative number less than  $-1$ . Under these conditions  $h \neq 0$   $K = \pi$ . Thus currents having frequencies that make  $Z_c/Z_m > 2$  decrease in magnitude as the circuit under consideration recedes from the generator end of the string. There is also a phase shift of 180 deg. in passing from one circuit to the next adjacent circuit. If  $-2 < Z_c/Z_m < 2$  then  $\cosh \tau$  is a real number which in absolute value is less than unity. Under these conditions  $h$  is zero and  $k$  is, in general, different from zero. Thus currents having frequencies that give values of  $Z_c/Z_m$  that lie between  $-2$  and  $+2$  are transmitted without diminution through the chain. The frequencies that give to  $Z_c/Z_m$  the value plus or minus 2 for the idealized filter will be called the cut-off frequencies. The frequencies that give to  $Z_c/Z_m$  values between  $-2$  and

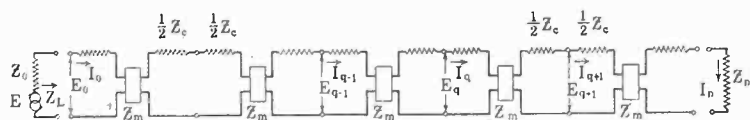

FIG. 2

$+2$  will be called the transmitted band of frequencies. Frequencies that cause  $Z_c/Z_m$  to take the values outside the range  $-2$  to  $+2$ , are said to be in region of attenuation or in the attenuated region.

It is to be noted that the attenuation characteristics described above are independent of any power loss in the filter network as the assumption was made that the coils and condensers used in building up the network were free from power losses. The characteristics come about solely through complex interaction of one circuit on the other. When particular types of structure are considered it will be shown that resistance causes attenuation in the transmitted region and lowers the attenuation in the attenuated region. We can, however, approach very near to the characteristic of the ideal filter by making the losses in coils and condensers as low as feasible.

(10) *General Wave Length Constant or Phase Shift Characteristics.* The general phase shift characteristics are most easily obtained from the general relation of equation (8).

$$\cosh \tau = \cosh (h + jk) = \frac{Z_c}{-2Z_m} = -\frac{u + jv}{2}$$

In the ideal filter we have shown that  $v$  is always zero, so for the ideal structure we may write  $\cosh (h + jk) = -u/2$ . When  $u < -2$ ,  $\tau$  is real and  $k = 0$ .

When  $u > -2$ , but less than  $+2$ ,  $\tau$  is a pure imaginary and as  $u$  varies from  $-2$  to  $+2$ ,  $k$  varies from  $0$  to  $\pi$ . That is within the transmitted band  $k$  varies from  $0$  at one cut-off frequency to  $\pi$  at the other cut-off frequency. As the frequency approaches one of the cut-off points from the attenuated region  $u$  is continually less than  $-2$  and  $k$  is continually zero, as the other cut-off frequency is approached from the attenuated region  $u$  is continually greater than  $+2$  and  $k$  continually equals  $\pi$ .

Sections (9) and (10) taken together give some very interesting properties of the ideal coupled circuit structures. In the attenuated regions, the phase shift or wave length constant remains at a constant value  $0$  or  $\pi$ , while the attenuation constant continually, takes on different values. For all frequencies within the transmitted band, the attenuation constant remains constant while the phase shift constant varies from zero to  $\pi$ .

(11) *General Impedance Characteristics.* Consider again the circuit of Fig. 2. Let the problem be that of transferring maximum power at frequencies within the transmitted band or within a portion of the transmitted band from the generator to a utilization device terminating the filter. Let the generator impedance be represented by  $Z_0$ . For the theory of section (9) to apply the utilization device must have the impedance  $Z_s$  or must be corrected to  $Z_s$  by means of a suitable transformer. It will be shown later that  $Z_s$  may be a pure resistance.

Let the terminating impedance  $Z_n$  be a pure resistance  $R_n$ . If  $R_n$  were directly across the generator terminals it would receive maximum power when  $Z_0 = R_n$ , or was corrected to  $R_n$  by means of a transformer. If the termination is such that  $R_n = Z_s$  then the theory of section (9) applies and the resistance  $R_n$  receives the same power as though it were across the generator terminals. Therefore, for maximum power delivery from the generator to the terminating device, the system should be so designed that  $Z_0 = R_n = Z_s$ .

If  $Z_n$  and  $Z_0$  are to be fixed resistances then in general we can satisfy the above relation for only one particular frequency within the transmitted band as  $Z_s$ , although it may be made a pure resistance within the transmitted band, varies with the frequency. The detailed manner in which it varies with the frequency will have to be taken up for each type of structure considered. In general, however, it may be stated that the impedance curve is fairly flat for quite a range of frequencies within the transmitted band, but falls to zero at the cut-off points. In the consideration of special types of structure it will be shown that this change in characteristic impedance has the effect of introducing a loss in the transmitted band. Over the greater share of the transmitted band this loss may be made small but at the cut-off points it may have an appreciable value.

(12) *Filters with Dissipation in Coils and Condensers.* In the discussion thus far contained in Part III it has been assumed that the coils and condensers used

in building the filter did not dissipate energy. This assumption insured that the ratio of the circuitual to the transfer impedance should be a real quantity. This in turn leads to the sharp breaks in the characteristics of the attenuation and phase shift constants described in sections (9) and (10). In any real filter both coils and condensers dissipate energy. For any real filter then the impedance ratio  $Z_c/Z_m$  is in general a complex number and the ideal filter theory does not rigorously apply. We can, however, approximate the ideal filter by using coils and condensers in which the ratio of resistance to reactance is small. We would expect the widest divergence between the characteristic of the ideal filter and the real filter at those points where the ideal filter characteristic takes a sudden break, namely at the cut-off points. This expectation will be verified when the actual characteristics of some particular types of structures are given.

#### IV. APPLICATION OF THE GENERAL THEORY TO A FILTER BUILT UP OF SIMPLE SERIES CIRCUITS MAGNETICALLY COUPLED TOGETHER

(13) *Conventions and General Method of Handling the Problem.* Before starting the discussion of particular types of filters, it will be of advantage to give a general survey of the method to be employed in treating the selective properties of these systems. The method has been employed by telephone engineers for some time in the discussion of transmission through all types of networks.

In section (11) it was shown that maximum power was delivered to the filter when the filter was so designed that its characteristic impedance was equal to the generator impedance which was taken to be a pure resistance, or was connected to the generator impedance by means of a suitable transformer. In the ideal filter within the transmitted band this power is transmitted undiminished to a utilization resistance if this resistance has a value equal to the characteristic impedance,  $Z_s$ , of the filter. Under these conditions we would say that the loss through the filter, or attenuation of the filter is zero because the power delivered to the utilization device is the same as though this device were connected directly across the generator terminals.

Now since our utilization devices can always be reduced to equivalent resistance it is obvious that instead of discussing power ratios, we may discuss current ratios. That is in order to obtain the loss occasioned by the filter it is sufficient to obtain the ratio of the current delivered to the utilization device when placed across the generator terminals to the current delivered to the device with the filter interposed between the generator and the utilization device. Let the current with the filter interposed be  $I_0$  and let the current delivered with the utilization resistance across the generator be  $I_0'$ . Then the ratio  $I_0''/I_0$  gives the effect of interposing the filter. Instead of using this ratio it is more convenient to use the natural logarithm

of the ratio. Then in the system to be used the loss will be one attenuation unit when the natural logarithm of the ratio of the current with the utilization device across the generator terminals to the current in the utilization device with the filter interposed between it and the generator is unity. The convenience and application of this unit will become apparent as the discussion proceeds. As an example of its usefulness however, consider the following.

A filter chain is terminated so that the reflected wave is absent. The impedances are such that the generator delivers maximum power to the filter. The current in any section of the filter then is:

$$I_q = I_0 \epsilon^{-q\tau}$$

$$|I_q| = |I_0| \epsilon^{-hq}$$

But  $I_0$  is also the current which would flow if the terminating impedance were across the generator terminals, and we have,

$$|I_q'/I_q| = \epsilon^{qh}$$

$$\log_e |I_q'/I_q| = qh$$

Or the attenuation per section is  $h$  attenuation units. For  $q$  sections it is  $hq$  attenuation units.

(14) *Chain of Simple Series Circuits Magnetically Coupled. Ideal Case. (a) Cut-off Points.* The general theory thus far presented is very general and

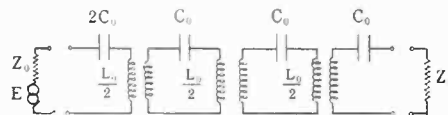

FIG. 3

applies to all chain systems built up of identical circuits associated in such a way that the impedances of the system can be broken up into circuitual impedances and transfer impedances. The illustrations which follow, however, give rise to filter systems which in general cannot be broken up into series and shunt elements.

As a first application of the theory consider the system shown by Fig. 3. This system obviously fulfills the conditions of the general theory. For the purpose of synthetically building up filter systems it is convenient to think of Fig. 3 as made of elements, as shown in Fig. 4. Each of these elements will be called a filter section. Fig. 4 represents a two section filter.

We will first assume that Fig. 4 represents an ideal filter; that is, a filter in which the coils and condensers do not dissipate energy. The circuitual impedance is,

$$Z_c = j \left( \omega L_0 - \frac{1}{\omega C_0} \right) \quad (54)$$

The mutual or transfer impedance is:

$$Z_m = j \omega M$$

$$\text{Let } M = \frac{K_0 L_0}{2}; \quad |K_0| < 1$$



$K_0$  may be positive or negative. Then,

$$Z_m = \frac{j \omega L_0 K_0}{2} \tag{55}$$

$$Z_c/Z_m = \frac{2 \left( \omega L_0 - \frac{1}{\omega C_0} \right)}{\omega L_0 K_0} \tag{56}$$

The angular velocities corresponding to the cut-off frequencies are such as to make,

$$Z_c/Z_m = \frac{2 \left( \omega L_0 - \frac{1}{\omega C_0} \right)}{\omega L_0 K_0} = \pm 2 \tag{31}$$

$$\omega L_0 - \frac{1}{\omega C_0} = \pm K_0 \omega L_0$$

The cut-off angular velocities are,

$$\omega_A = \sqrt{\frac{1}{L_0 C_0 (1 - K_0)}} = \omega_{r0} \sqrt{\frac{1}{1 - K_0}} \tag{57}$$

$$\omega_B = \left( \sqrt{\frac{1}{1 + K_0}} \right) \omega_{r0} \tag{58}$$

Where  $\omega_{r0}$  is defined by the equation

$$\omega_{r0} = \frac{1}{\sqrt{L_0 C_0}} \tag{59}$$

It is interesting to note that the cut-off angular velocities are given by the same equation that give the natural angular velocities of two simple series circuits magnetically coupled together.

(b) *Attenuation Characteristics of the Ideal Filter.* For the ideal filter it has been shown that the propagation constant is given by the relation,

$$\cosh \tau = - \frac{Z_c}{2 Z_m} = - u/2 - j 0 \tag{8}$$

For the structure under consideration this gives

$$\cosh (\tau = h + j k) = (1/K_0) [ (\omega_{r0}/\omega)^2 - 1 ] \tag{60}$$

At this point we are chiefly interested in the general shape of the attenuation curve; that is, in the general shape of the curve which has values of  $h$  for ordinates and angular velocity or frequency for abscissa. Within the transmitted band, that is for values of  $\omega$  lying between  $\omega_B$  and  $\omega_A$ , the cut-off angular velocities,  $h$  is zero.

When  $\omega = 0$ ,  $\cosh (h + j k) = \infty$  and  $h = \infty$ . When  $\omega = \infty$ ,  $\cosh (h + j k) = -1/K_0$ . For the

ideal filter equation (50) gives  $\cosh h = \pm \frac{u}{2}$ ;  $h$

$$= \cosh^{-1} (|u/2|)$$

$$\frac{d h}{d \omega} = \frac{d h}{d u} \frac{d u}{d \omega}$$

$$= \frac{\pm 2 \omega_{r0}^2}{\omega K_0 \sqrt{(1/K_0)^2 (\omega_{r0}^2 - \omega^2)^2 - \omega^4}}$$

$$\text{When } \omega = 0, \left| \frac{d h}{d \omega} \right| = \infty$$

$$\text{When } \omega = \infty \text{ then } \frac{d h}{d \omega} = 0$$

$$\text{When } \omega = \omega_A = \omega_{r0} \sqrt{\frac{1}{1 - K_0}}; \frac{d h}{d \omega} = \infty$$

$$\text{When } \omega = \omega_B = \omega_{r0} \sqrt{\frac{1}{1 + K_0}}; \left| \frac{d h}{d \omega} \right| = \infty$$

The general attenuation characteristic then has a verticle tangent at  $\omega = 0$  and becomes great without limit as  $\omega \rightarrow 0$ . As  $\omega$  is increased from zero the slope remains finite and different from zero until  $\omega = \omega_B$ ; here the curve has another verticle tangent and  $h$  takes the value zero and remains zero until  $\omega = \omega_A$ .

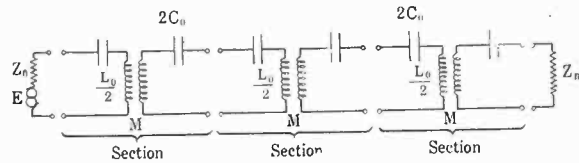

FIG. 4

At  $\omega = \omega_A$  the curve has another verticle tangent and as the frequency becomes great without limit the value of  $h$  approaches the value  $\cosh^{-1} (1/K_0)$ . The general attenuation characteristic is, therefore, as shown by the sketch of Fig. 5.

When  $\omega_A$  and  $\omega_B$  are both finite the attenuation constant of the ideal filter for angular velocities lying between  $\omega_A$  and  $\omega_B$  is zero and the structure is called a band pass filter.

If  $K_0 = 1$ ,  $\omega_A = \infty$  and the attenuation constant is zero for all angular velocities above  $\omega_B$  and the filter is called a high pass filter.

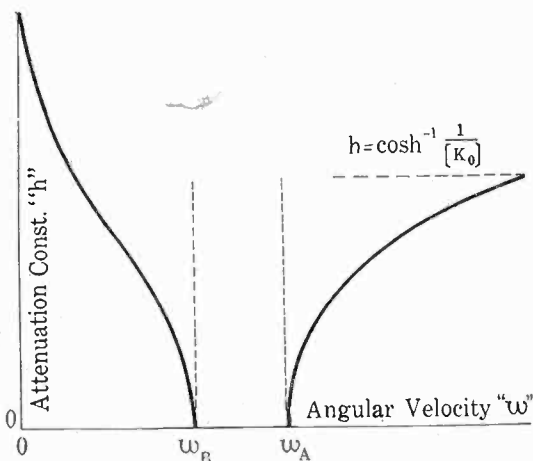

FIG. 5

(c) *Phase Shift Characteristics of the Ideal Filter.* The manner in which the phase shift or wave length constant varies with the frequency can most readily be obtained by using the equation:

$$\cosh h \cos k = - u/2 \tag{45a}$$

$$\sinh h \sin k = - v/2 = 0 \tag{45b}$$

Case I  $K_0$  positive

From equation (56) we obtain:

$$Z_c/Z_m = u = 2/K_0 [1 - (\omega_{r0}/\omega)^2]$$

For values of  $\omega$  less than the lower cut-off angular velocity  $u$  is negative and it has been shown that  $h$  is different from zero.  $\sinh h$  is thus different from zero and to satisfy (45b),  $\sin k$  must equal zero. The value of  $k$  must therefore be  $0$  or  $\pi$ . In equation (45a)  $\cosh h$  is positive,  $u$  is negative, and therefore  $\cos k$  must be positive. Therefore, for frequencies below the lower cut-off frequency,  $k$  must equal zero.

For values of  $\omega$  greater than the upper cut-off angular velocity,  $\sinh h$  is different from zero so that  $\sin k$  must equal zero and  $k$  must equal  $0$  or  $\pm \pi$ . Now  $u$  is positive so also is  $\cosh h$  so that  $\cos k$  must be negative.  $k = \pm \pi$ .

When  $\omega = \omega_{r0}$ ,  $u = 0$  so that  $\cos k = 0$ ,  $k = \pm \pi/2$ .  $\sinh h$  is also zero so equation (45b) becomes:

$$\sin k \frac{-v = 0}{2 \sinh h = 0} \quad (61)$$

If resistance were allowed in the circuits:

$$\begin{aligned} Z_c/Z_m = u + jv &= 1/K_0 \left[ \frac{a \pm jb}{js} \right] \\ &= 1/K_0 [\pm b/s - ja/s] \quad (61a) \end{aligned}$$

(61a) shows that when  $K_0$  is positive  $v$  is negative and that  $k$  must lie in the first or second quadrant. We then may assign values to  $k$  as follows. Below and including  $\omega_B$ ,  $k = 0$ . At  $\omega_{r0}$   $k = \pi/2$ . Including and above  $\omega_A$ ,  $k = \pi$ .

Inside the transmitted band of an ideal filter  $k$  is given by

$$k = \cos^{-1} 1/K_0 [(\omega_{r0}/\omega)^2 - 1] \quad (61b)$$

Taking the derivative with respect to  $\omega$ , we obtain:

$$\left| \frac{dk}{d\omega} \right| = \frac{2\omega_{r0}^2}{\omega \sqrt{K_0^2 \omega^4 - [\omega_{r0}^2 - \omega^2]^2}} \quad (61d)$$

$$\text{When } \omega = \omega_B \quad \text{then} \quad \left| \frac{dk}{d\omega} \right| = \infty$$

$$\text{When } \omega = \omega_A \quad \text{then} \quad \left| \frac{dk}{d\omega} \right| = \infty$$

The wave length constant-angular velocity curve thus has a verticle tangent at each cut-off point. The general shape of the curve for  $K_0$  positive is given by the full line curve of Fig. 6.

Case II.  $K_0$  negative.

The derivatives for this case are as given above for case I. For angular velocities below  $\omega_B$ ,  $\sinh h$  is different from zero so  $\sin k = 0$ ,  $k = 0$  or  $\pm \pi$ .  $u$  is positive. So also is  $\cosh h$  and therefore  $\cos k$  must be negative.  $k = \pm \pi$ .

For values of  $\omega$  greater than  $\omega_A$   $\sinh h$  is different from zero so  $\sin k$  must equal  $0$ .  $k = 0, \pm \pi$  or  $\pm 2\pi$ .  $u$  is negative, so  $\cos k$  must be positive.  $k = 0$  or  $\pm 2\pi$ .

When  $\omega = \omega_{r0}$ ,  $u$  is zero and  $\cos k$  is zero.  $k = \pm \pi/2$ .  $\sin k$  is again indeterminate. However from (61a) when  $K_0$  is negative,  $v$  is positive and we see that  $k$  must lie in the second or third quadrant. Then

$k$  must equal  $-\pi/2$ . We then may assign values to  $k$  as follows: For  $\omega$  equal to and less than  $\omega_B$ ,  $k = -\pi$ . For  $\omega = \omega_{r0}$ ,  $k = -\pi/2$ . For  $\omega$  equal to or greater than  $\omega_A$ ,  $k = 0$ .

The general shape of the wave length constant curve for  $K_0$  negative is as given by the dotted curve of Fig. 6.

(d) *Characteristic Impedance of the Ideal Filter and Design Formula.* The characteristic impedance is given by the relation:

$$Z_s = \sqrt{Z_c^2/4 - Z_m^2} = \sqrt{(Z_c/2 - Z_m)(Z_c/2 + Z_m)} \quad (13)$$

For the idealized structure under consideration:

$$Z_c/2 - Z_m = 1/2j \left[ \omega L_0 (1 - K_0) - \frac{1}{\omega C_0} \right]$$

$$Z_c/2 + Z_m = 1/2j \left[ \omega L_0 (1 + K_0) - \frac{1}{\omega C_0} \right]$$

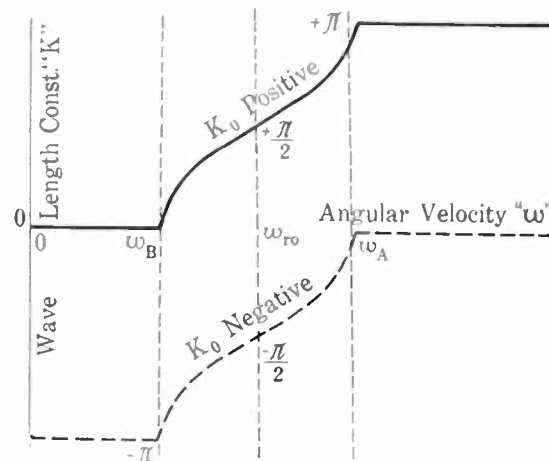

FIG. 6

$$\begin{aligned} Z_s^2 = -1/4 \frac{1}{\omega^2 C_0^2} [\omega^2 L_0 C_0 (1 - K_0) \\ - 1] [\omega^2 L_0 C_0 (1 + K_0) - 1] \quad (62) \end{aligned}$$

$$\begin{aligned} Z_s^2 = -1/4 \frac{1}{\omega^2 C_0^2} [(\omega/\omega_{r0})^2 \{ (\omega/\omega_{r0})^2 (1 \\ - K_0)^2 - 2 \} + 1] \quad (63) \end{aligned}$$

At this point it is well to pause and consider the manner in which the constants of the filter are to be fixed.  $\omega_{r0}$  is fixed by the location of the band to be transmitted.  $K_0$  is determined by the width of the band of frequencies to be transmitted. Within the transmitted band the filter should have an impedance which matches the generator and power receiving device. That is  $Z_s$  at some point within the transmitted band is fixed by the impedance of the devices between which the filter is to be placed. We choose to fix the impedance for the angular velocity  $\omega_{r0}$  and we wish to determine  $L_0$  and  $C_0$  in such a way that at  $\omega_{r0}$ ,  $Z_s$  shall equal  $Z_0$ . Upon applying this condition to equation (63), there results

$$Z_0^2 = -1/4 \frac{1}{\omega_{r0}^2 C_0^2} [-K_0^2] = 1/4 \frac{K_0^2}{\omega_{r0}^2 C_0^2} \quad (64)$$

$$Z_0 = \frac{K_0}{2 \omega C_0} \tag{65}$$

It is to be noted that  $Z_0$  is a pure resistance. Since in general, as stated before,  $Z_0$  is fixed by the conditions of the problem so (65) really determines  $C_0$  in such a way that the filter shall have the impedance  $Z_0$ . That is,  $C_0$  is given by the design formula:

$$C_0 = \frac{|K_0|}{2 \omega_{r0} Z_0} \tag{66}$$

The inductance is determined by the relation:

$$\begin{aligned} \omega_{r0}^2 &= \frac{1}{L_0 C_0} \\ L_0 &= \frac{2 Z_0}{|K_0| \omega_{r0}} \end{aligned} \tag{67}$$

Upon substituting (66) in (63) there results

$$Z_s = Z_0 \sqrt{(\omega/\omega_{r0})^2 - 1/K_0^2 (\omega/\omega_{r0} - \omega_{r0}/\omega)^2} \tag{68}$$

For some discussions it is desirable to have  $Z_s$  in terms of one of the cut-off frequencies instead of  $K_0$ . To obtain this relation we note that (57) solved for  $K_0$  gives,

$$K_0 = \frac{\omega_A^2 - \omega_{r0}^2}{\omega_A^2} = \frac{\omega_{r0}^2 - \omega_B^2}{\omega_B^2} \tag{69}$$

When (69) is substituted in (68) there results:

$$Z_s = \frac{Z_0 \omega_A^2}{\omega_A^2 - \omega_{r0}^2} \sqrt{\frac{\omega^2/\omega_A^2 (\omega_A/\omega_{r0} - \omega_{r0}/\omega_A)^2}{-(\omega/\omega_{r0} - \omega_{r0}/\omega)^2}} \tag{70}$$

$$= \frac{Z_0 \omega_B^2}{\omega_{r0}^2 - \omega_B^2} \sqrt{\frac{\omega^2/\omega_B^2 (\omega_{r0}/\omega_B - \omega_B/\omega_{r0})^2}{-(\omega/\omega_{r0} - \omega_{r0}/\omega)^2}} \tag{71}$$

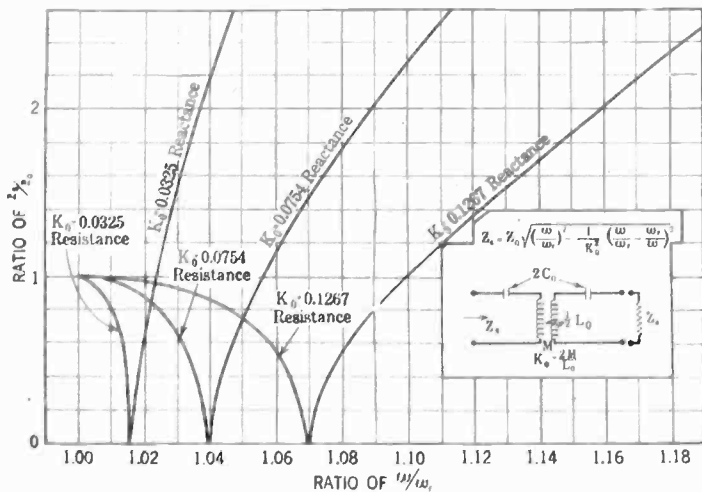

FIG. 7—CHARACTERISTIC IMPEDANCE FOR COUPLED CIRCUIT WAVE FILTER

Equation (70) and (71) show that in the ideal filter  $Z_s$  is real or is a pure resistance through the transmitted band. At the cut-off points  $Z_s$  falls to zero and outside the transmitted band it is a pure reactance. The curves of Fig. 7 give a more accurate picture of the manner in which the characteristic impedance varies with the frequency in the ideal filter. Only the part of the

curve for frequencies above the resonant frequency is plotted since in each case the other half is nearly a reflection in a line through the resonant frequency of the part plotted.

(e) *Actual Curves for the Attenuation and Phase Shift Constants.* We are now in a position to actually plot up some curves showing the manner in which the attenuation and phase shift constants of the simple magnetically coupled filter vary with the frequency of the current being transmitted. In order to make these curves more general, for abscissa we will use the

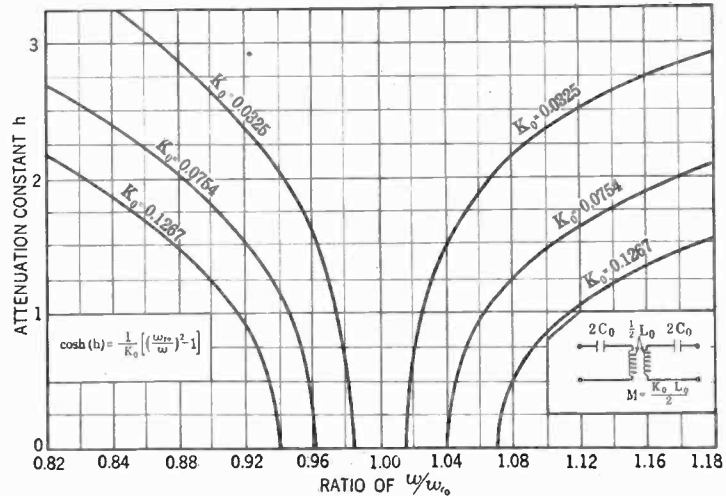

FIG. 8—ATTENUATION CONSTANT CURVES FOR IDEAL FILTER

ratio  $\omega/\omega_{r0}$  and the coupling coefficient or band width constant will be used as a parameter.

We have the relation:

$$Z_c/Z_m = \frac{2 \left( \omega L_0 - \frac{1}{\omega C_0} \right)}{\omega L_0 K_0} \tag{56}$$

This equation can be put in the form:

$$Z_c/Z_m = 2/K_0 [1 - (\omega_{r0}/\omega)^2] = u + jv \tag{72}$$

$$\cosh [\tau = h + jk] = 1/K_0 [(\omega_{r0}/\omega)^2 - 1] \tag{73}$$

Both  $h$  and  $k$  are readily obtained from (73) for the following reasons. For angular velocities below  $\omega_n$ ,  $k$  is zero so (73) gives  $h$  directly. Within the transmitted band  $h$  is zero so (73) gives  $k$  directly. For angular velocities above  $\omega_n$ ,  $k = \pi$  so  $h$  is again readily obtained. Within the transmitted band it is more convenient to use the relation:

$$\cos k = 1/K_0 [(\omega_{r0}/\omega)^2 - 1] \tag{74}$$

for obtaining values of  $k$ .

Actual curves for  $h$  and  $k$  are given by Figs. (8) and (9).

(f) *Line Impedance Characteristics.* The line impedance is given by the equation:

$$Z_L = \frac{Z_n \cosh \tau n + Z_s \sinh \tau n}{\cosh n \tau + Z_n/Z_s \sinh n \tau} \tag{30}$$

In order to make the curves independent of the terminating impedance  $Z_n$ , the ratio of  $Z_L/Z_s$  will be

used as ordinates. Dividing both sides of (30) by  $Z_n$  we obtain:

$$Z_L/Z_n = \frac{\cosh n \tau + Z_s/Z_n \sinh n \tau}{\cosh n \tau + Z_n/Z_s \sinh n \tau} \quad (75)$$

The computation for  $Z_L/Z_n$  is straight forward until it is attempted to find the value of this ratio at a cut-off point. At the cut-off points  $\sinh n \tau$  is zero, so also is  $Z_s$ . We have therefore in the denominator of (75) an indeterminate form  $0/0$  to evaluate. We proceed to obtain the equation which gives the value of  $Z_L/Z_n$  at the cut-off points.

At a cut-off point  $\tau = 0$  or  $j \pi$ . For either value of  $\tau$   $\sinh n \tau = 0$ . Now within the transmitted band of an ideal filter  $\tau = j k$ , and we have the relations:

$$\cosh n \tau = \cosh j n k = \cos n k$$

So that at a cut-off point (75) becomes:

$$(Z_L/Z_n)_{\omega_A \text{ or } \omega_B} = \frac{\cos n k}{\cos n k + Z_n \frac{\sinh n \tau}{Z_s}} \quad (76)$$

Now we have the relation:

$$\cosh \tau = \frac{-Z_c}{2Z_m}$$

So

$$\sinh \tau = \sqrt{\frac{Z_c^2}{4Z_m^2} - 1}$$

also

$$Z_s = \pm Z_m \sqrt{\frac{Z_c^2}{4Z_m^2} - 1} \quad (77)$$

$$Z_s = \pm Z_m \sinh \tau \quad (78)$$

The sign to be used with (78) must be such as to cause the real part of  $Z_s$  to be a real positive number. Now inside the transmitted band of an ideal filter  $\tau = j k$ , so we have:

$$\sinh \tau = \sinh j k = j \sin k$$

Also inside the transmitted band of an ideal filter  $Z_m$  is a pure imaginary or:

$$Z_m = \pm j |Z_m|$$

$$Z_s = \pm |Z_m| \sin k$$

Now from (53a) the sign of  $k$  is opposite to the sign of  $v$  so within the transmitted band of an ideal filter we have:

$$Z_s = \frac{-v}{\sqrt{v^2}} |Z_m| \sin k \quad (79)$$

Also  $\sinh n \tau = \sinh j n k = j \sin n k$

So that

$$\frac{\sinh n \tau}{Z_s} = \frac{j \sin n k}{\frac{-v}{\sqrt{v^2}} |Z_m| \sin k}$$

$$\text{Lim.}_{\kappa = 0 \text{ or } \pi} \frac{\sinh n \tau}{Z_s} = \frac{-v}{\sqrt{v^2}} \frac{j}{|Z_m|} \frac{n \cos n k}{\cos k} \quad (80)$$

$$k = 0 \text{ or } \pi$$

And equation (76) becomes

$$(Z_L/Z_n)_{\omega_A \text{ or } \omega_B} = \frac{1}{1 - j n (Z_n/|Z_m|) (v/\sqrt{v^2}) \cos k}; \quad (k = 0 \text{ or } \pi) \quad (81)$$

Now equation (81) contains the term  $v/\sqrt{v^2}$ . Now this term was introduced solely to fix a sign and thus avoid the necessity of carrying a double sign. However in an ideal filter  $v$  is zero. We must therefore use the sign which  $v$  would give if some small resistance were in the filter coils. This sign is readily determined from physical considerations or from equations like (99) which are derived hereafter.

Equation (81) is general and applies to all types of coupled circuit wave filters. For the type of structure now under consideration it may be put in a form more convenient for use as follows:

$$|Z_m| = 1/2 \omega L_0 |K_0|$$

$$L_0 = \frac{2 Z_0}{|K_0| \omega_{r0}}$$

$$|Z_m| = Z_0 \omega / \omega_{r0}$$

If the filter is terminated, as is usually the case, so that  $Z_0 = Z_n$  then:

$$|Z_m| = Z_n \omega / \omega_{r0} \quad (82)$$

In the structure under consideration if loss were allowed in the coils we would have:

$$Z_c/Z_m = u + j v = \frac{a \pm j b}{j K_0 S}$$

$$u + j v = 1/K_0 \left[ \frac{j a \pm b}{-s} \right] = 1/K_0 [\pm b/s - j a/s]$$

Or  $v$  has a sign opposite to  $K_0$ . This result could also be obtained from equation (99). We then may write:

$$v/\sqrt{v^2} = \frac{-K_0}{\sqrt{K_0^2}} \quad (83)$$

Upon substituting (82) and (83) in (81) there results:

$$(Z_L/Z_n)_{\omega_A \text{ or } \omega_B} = \frac{1}{1 + j n (\omega/\omega_{r0}) (K_0/\sqrt{K_0^2}) \cos k} \quad (84)$$

This is the equation giving the values of  $Z_L/Z_n$  at the cut-off points of the simple filter under discussion.

In applying equation (75) to obtain values of  $Z_L/Z_n$  within the transmitted band it is well to note that for certain frequencies the value of this ratio can be obtained with very little calculation if curves for the ratio  $Z_s/Z_n$  and of  $k$  have already been plotted. These frequencies are those which make  $\cosh n \tau$  equal to zero and those which make  $\sinh n \tau$  equal to zero. When  $\cosh n \tau = 0$  then:

$$Z_L/Z_n = (Z_s/Z_n)^2 \quad (85)$$

When  $\sinh n \tau = 0$  then:

$$Z_L/Z_n = 1 \quad (86)$$

$\cosh n \tau$  is zero for those frequencies which cause  $n \tau$  to equal  $j p \pi/2$  where  $p$  is an odd integer.  $\sinh$

$n\tau$  is zero for those frequencies which cause  $n\tau$  to equal  $j q \pi$  where  $q$  is a positive integer. These frequencies are readily found from curves like those of Fig. 9.

A line impedance curve for  $K_0 = 0.0754$  and  $n = 3$  is shown by Fig. 10, on y the part of the curve for

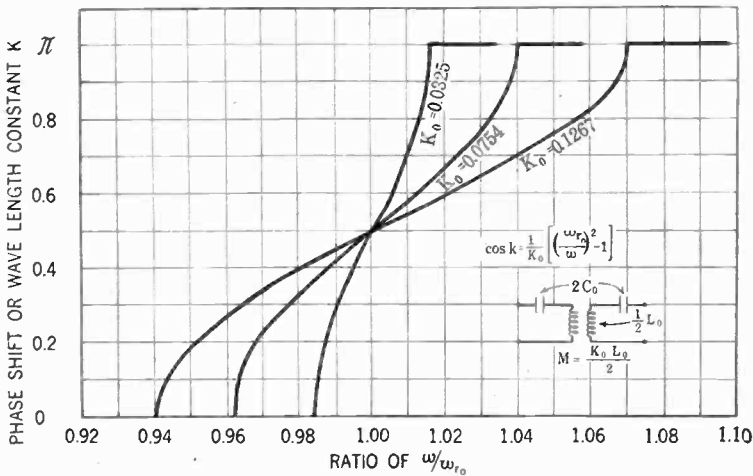

FIG. 9—PHASE SHIFT OR WAVE LENGTH CONSTANT FOR IDEAL FILTER

frequencies above the resonant frequency is shown as the other part has the same general shape. This curve is flatter for a greater portion of the transmitted band than the curve giving the characteristic impedance for  $K_0 = 0.0754$ . A flat impedance curve is desirable in those cases where the filter is used in circuits in which impedance irregularities are undesirable.

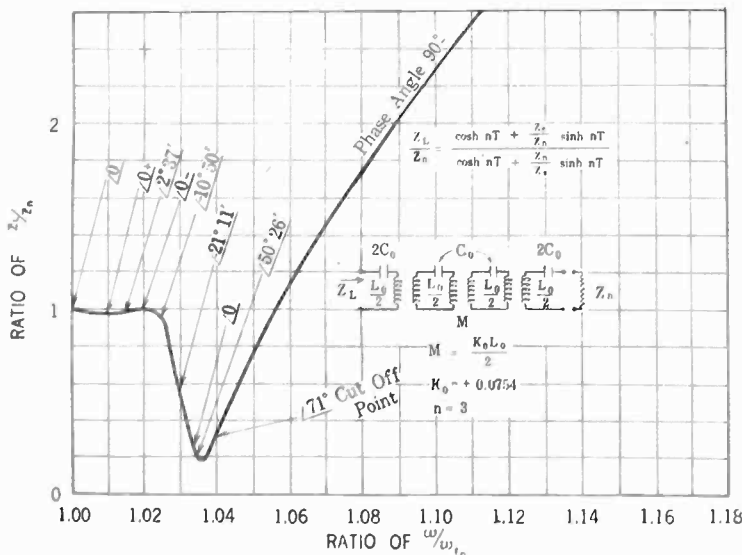

FIG. 10—IDEAL FILTER LINE IMPEDANCE

(g) *Total Loss Characteristics of the Ideal Filter.* From equation (34) we have for the current in the  $q$ th section of a coupled circuit wave filter the relation:

$$I_q = E_0 [1/Z_L \cosh q \tau - 1/Z_s \sinh q \tau] \quad (34)$$

This equation gives the current in terms of the voltage of the first section. We wish  $I_q$  in terms of the

impressed voltage. The relation between  $E_0$  and the impressed voltage is

$$E_0 = \frac{E Z_L}{Z_0 + Z_L} \quad (87)$$

$$I_q = \frac{E}{Z_0 + Z_L} [\cosh q \tau - Z_L/Z_s \sinh q \tau] \quad (88)$$

If the terminating impedance were across the generator terminals, the current delivered to it would be:

$$I_n' = \frac{E}{Z_0 + Z_n} \quad (89)$$

The ratio of the current delivered to the terminating impedance to the current which would be delivered to it if it were across the generator terminals is given by the equation:

$$I_n/I_n' = \frac{1 + Z_n/Z_0}{1 + Z_L/Z_0} [\cosh n \tau - Z_L/Z_s \sinh n \tau] \quad (90)$$

If, as is generally the case,  $Z_n = Z_0$  then (90) becomes:

$$I_n/I_n' = \frac{1}{1 + Z_L/Z_0} [\cosh n \tau - Z_L/Z_s \sinh n \tau] \quad (91)$$

In accordance with the plan announced at the beginning of this section the effect of interposing the filter between the generator and terminating impedance will be specified by giving the loss in attenuation units which results from the introduction of the filter. This loss has been defined by the relation:

$$A = \log_e I_n'/I_n \quad (92)$$

The calculation of the current ratio  $I_n/I_n'$  is straight forward until a cut-off point is reached. At a cut-off point  $\sinh n \tau$  is zero, so also is  $Z_s$ . This gives rise to the indeterminate form:

$$\frac{\sinh n \tau}{Z_s} = -0/0$$

This indeterminate form was encountered before and its value is given by equation (80). Upon substituting (80) in (91) and letting  $\omega = \omega_A$  or  $\omega_B$  we have:

$$(I_n/I_n')_{\omega = \omega_A \text{ or } \omega_B} = \frac{2 \cos n k}{1 + Z_L/Z_n} [1 + (v/\sqrt{v^2}) j n (Z_L/|Z_m|) \cos k] \quad (93)$$

$k = 0 \text{ or } \pi$

Equation (93) is a general equation applying to all types of ideal coupled circuit wave filters. For the simple filter under consideration (93) can be simplified by the use of equations (82) and (83). Then for the filter under consideration we may write:

$$(I_n/I_n')_{\omega = \omega_A \text{ or } \omega_B} = \frac{2 \cos n k}{1 + Z_L/Z_n} [1 - j n (Z_L/Z_n) (\omega_{r0}/\omega) (K_0/\sqrt{K_0^2}) \cos k] \quad (94)$$

$k = 0 \text{ or } \pi$

signed in accordance with the formulas given is obtained very closely by multiplying the ordinates of the attenuation constant curve by the number of sections in the filter. These two facts aid very much in the design of filters which must meet preassigned requirements.

V. FILTERS BUILT UP OF SECTIONS HAVING DIFFERENT ATTENUATION CHARACTERISTICS

(16) *General Considerations of the Problem of Building a Filter of Different Types of Sections.* If we have a chain built up by joining together an infinite number of identical coupled circuit filter sections then it has been shown that the transmission loss between any two sections is equal to the attenuation constant times the number of sections which separate the two under consideration. This follows because the reflected wave term drops out of the current equation and the current is given by a simple exponential expression. In filters with a finite number of sections we approach this condition by terminating the filter in such a way that over the greater portion of the transmitted band the structure acts as though it were in its infinite chain.

Let us now consider a chain built up of an infinite number of coupled circuit filter sections, but let us not require that all the sections be identical. Let us require, however, that all types of sections have the same characteristic impedance at all frequencies.

The chain may be divided up into groups of identical sections as shown by Fig. 14. To any of the groups as the *S*th group we may apply our general equations which give the current in any section of the group in terms of the current in the first section of the group. The terminating impedance is the impedance looking into the *S* + 1 group of sections. Since the chain is infinite or terminated by an impedance equal to *Z<sub>s</sub>*, this impedance is also equal to *Z<sub>s</sub>* and the reflected wave term is absent from the equations applying to the *S*th group. The transmission loss through the group is therefore *h<sub>s</sub> n*. Also the loss through group *S* - 1 is *n' h<sub>s-1</sub>* and so on. The total transmission loss between points *A* and *B* is *n' h<sub>s-1</sub> + h<sub>s</sub> n + n'' h<sub>s+1</sub>*. From this it follows that the total transmission loss between any two sections is equal to the



FIG. 14

sum of the attenuation constants for all the sections separating the two under consideration.

That which has been said concerning the infinite chain also applies to the structure terminated by an impedance equal to the common characteristic impedance of the elements.

It follows from the above discussion that the problem of building up a filter of different types of sections is solved when we can so design the sections that the different types have the same characteristic impedance. In the sections which follow we will base the design of

two types of filter sections upon the design of the section discussed in part IV in such a way that all three types have the same characteristic impedance and therefore can be used together in building up filters.

In sections which follow, attenuation characteristics alone will be employed in giving examples of built up filters. This is justifiable because it has been shown that the loss computed from the attenuation constant alone gives a good idea of the total loss characteristics of a structure.

(17) *The Filter Element Derived from Two Simple Series Circuits with Electrostatic and Electromagnetic*

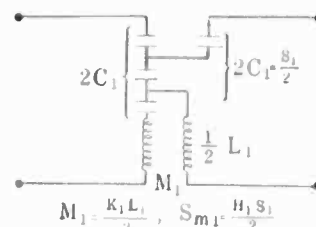

FIG. 15

*Coupling Between Them.* The filter element to be considered here is shown by Fig. 15. The mutual inductance between the circuits is given by:

$$M_1 = \frac{L_1 K_1}{2}$$

The mutual elastance is given by the relation

$$S_m = \frac{S_1 H_1}{2}$$

In accordance with the principles laid down in section (16) we proceed to determine design formulas for this type of section so that it will have the same characteristic impedance at all frequencies as the simple section discussed in part IV. In the discussion which is to follow, all constants referring to the simple type of section or basic section will bear the subscript *o* while those referring to the section of Fig. 15 will bear the subscript *1*.

The condition which we are to satisfy is stated by the equation:

$$Z_{o0} = \sqrt{Z_{c0}^2/4 - Z_{m0}^2} = Z_{o1} = \sqrt{Z_{c1}^2/4 - Z_{m1}^2} \tag{102}$$

Upon putting the values of *Z<sub>c</sub>* and *Z<sub>m</sub>* in (102) and squaring both sides there results:

$$\left. \begin{aligned} \omega^2 L_0^2 - \frac{2 L_0}{C_0} + \frac{1}{\omega^2 C_0^2} - \omega^2 K_0^2 L_0^2 \\ = \omega^2 L_1^2 - \frac{2 L_1}{C_1} + \frac{1}{\omega^2 C_1^2} \\ - \omega^2 L_1^2 K_1^2 + \frac{2 K_1 H_1 L_1}{C_1} \\ - \frac{H_1^2}{\omega^2 C_1^2} \end{aligned} \right\} \tag{103}$$

Since (103) is to hold for all angular velocities, we may equate coefficients of like powers of  $\omega$ .

From the constant terms there results:

$$L_0/C_0 = L_1/C_1 (1 - K_1 H_1) \tag{104}$$

From the terms in  $\omega^2$  there results:

$$L_1^2 = L_0^2 \frac{1 - K_0^2}{1 - K_1^2} \tag{105}$$

From the terms in  $1/\omega^2$  there results:

$$C_1^2 = C_0^2 (1 - H_1^2) \tag{106}$$

Upon substituting (105) and (106) in (104) there results:

$$\frac{(1 - K_1^2)(1 - H_1^2)}{1 - K_0^2} = (1 - K_1 H_1)^2 \tag{107}$$

Equations (105), (106) and (107) fix  $L_1$  and  $C_1$  and either  $H_1$  or  $K_1$  in terms of  $L_0$ ,  $C_0$  and  $K_0$ . The ratio of  $H_1/K_1$  is arbitrary. The manner of choosing this ratio will be taken up along with the discussion of the general shape of the attenuation constant characteristics.

The attenuation constant is a function of the impedance ratio  $Z_c/Z_m = u + jv$ , so we proceed to determine this ratio for the filter, section under discussion:

As before let  $d = \frac{R}{\omega L}$

Then

$$Z_c = (d + j) \omega L_1 - \frac{j}{\omega C_1}$$

$$Z_m = j/2 \left( \omega K_1 L_1 - \frac{H_1}{\omega C_1} \right)$$

$$Z_c/Z_m = u + jv = \frac{2 [ (\omega/\omega_{r1})^2 - 1 - j d (\omega/\omega_{r1})^2 ]}{(\omega/\omega_{r1})^2 K_1 - H_1} \tag{108}$$

Where

$$\omega_{r1} = \frac{1}{\sqrt{L_1 C_1}}$$

For the ideal filter in which  $d = 0$  this becomes

$$u = \frac{2 [ (\omega/\omega_{r0})^2 - 1 ]}{(\omega/\omega_{r1})^2 K_1 - H_1} \tag{109}$$

The attenuation constant for the ideal filter is determined by the relation:

$$\cosh(h) = |u/2|$$

There are four cases depending upon the relative values of  $K_1$  and  $H_1$

Case I  $H_1 = 0$

This is the case of the filter discussed in detail in part IV.

Case II  $K_1 = 0$

This is the case of the filter section with electrostatic coupling only. The general shape of its attenuation constant characteristic will now be determined for the ideal filter.

When  $\omega = 0$ ,  $u = -2/H_1$   $h = \cosh^{-1} \left( \frac{1}{H_1} \right)$

When  $\omega = \infty$ ,  $u = \infty$   
 $h = \cosh^{-1} \infty = \infty$

The attenuation constant characteristic for this section is then as shown by Fig. 16.

Case III

$H_1 > K_1$

At  $\omega = 0$ ;  $\cosh h = 1/H_1$

At  $\omega = \infty$ ;  $\cosh h = 1/K_1$

When  $\omega/\omega_{r1} = \sqrt{H_1/K_1}$   $\cosh h = \infty$  and the at-

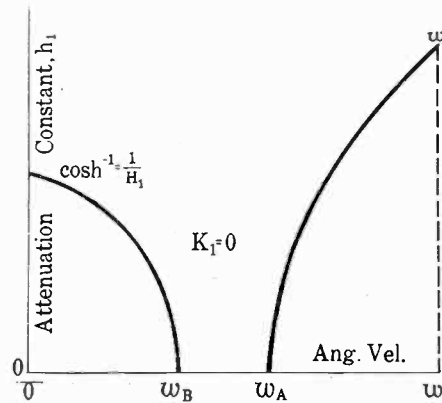

FIG. 16

tenuation constant is infinite. That is the ratio of  $H_1/K$  may be thought of as a design parameter which fixes the frequency at which infinite attenuation occurs.

The general shape of the attenuation characteristic for a section coming under Case III is shown by Fig. 17.

An actual attenuation constant curve for a dissipative filter coming under Case III is given by curve A of Fig. 20.

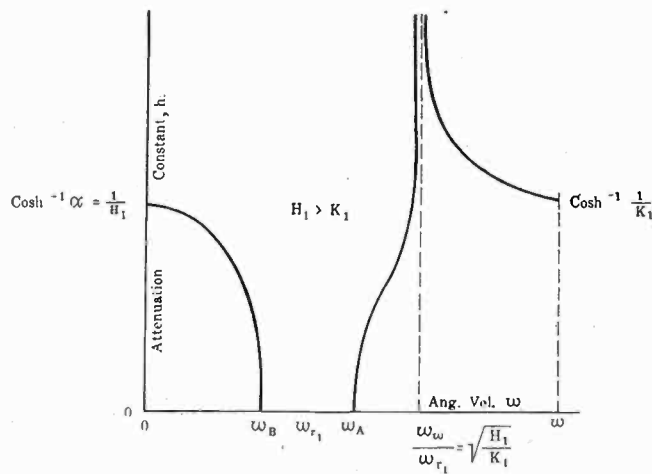

FIG. 17

Case IV.  $H_1 < K_1$

Here again at  $\omega = 0$   $\cosh h = 1/H_1$  at  $\omega = \infty$   $\cosh h = 1/K_1$  at  $\omega/\omega_{r1} = \sqrt{H_1/K_1}$ ;  $\cosh h = \infty$ .

The general shape of the attenuation constant for a filter section coming under case IV is shown by Fig. 18. The design of all four cases of the filter section shown by Fig. 15 has been based upon the design of Case I in such a way that at all frequencies the filters have the same characteristic impedance. Now at a

cut-off point the characteristic impedance for the ideal structure fall to zero and changes from a pure resistance to a pure reactance and this is the only place at which this occurs so the different sections having the same characteristic impedance will also have the same cut-off points. For the ideal filter section, shown by Fig. 15 and designed in accordance with the formulas given, the characteristic impedance and the cut-off points can be computed from the equations given in part IV.

The cut-off points can also be found by determining the value of  $\omega$  in equation (109) which will cause  $u$  to equal  $\pm 2$ . These cut-off angular velocities are found to be

$$\left. \begin{aligned} \omega_{A \text{ or } B} &= \omega_{r1} \sqrt{\frac{1 + H_1}{1 + K_1}} \\ \omega_{A \text{ or } B} &= \omega_{r1} \sqrt{\frac{1 - H_1}{1 - K_1}} \end{aligned} \right\} \quad (110)$$

where  $\omega_{r1} = \frac{1}{\sqrt{L_1 C_1}}$

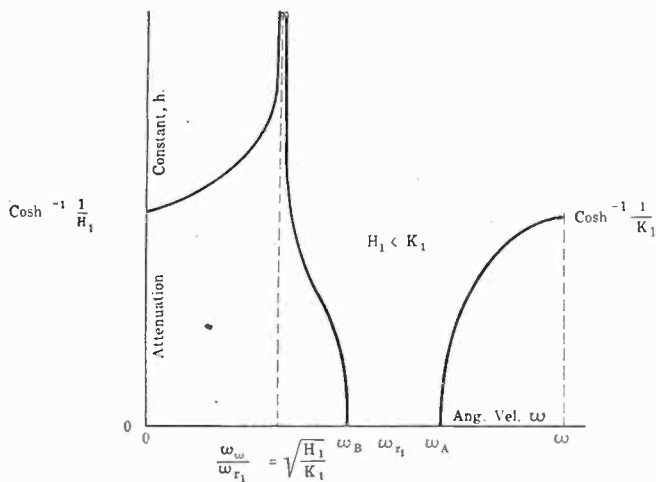

FIG. 18

It can be shown that the  $\omega_A$  and  $\omega_B$  determined from (110) are the same as those determined from (57) and (58) by substituting in (110) value for  $L_1 C_1$ ,  $H_1$  and  $K_1$  from equation (105), (106) and (107).

(18) *Examples Built-up Attenuation Characteristics and of the Use of the Design Formulas.* In order to give a picture of the manner in which attenuation characteristics may be built up, the curves of Figs. 19, 20 and 21 were plotted. Curve A of Fig. 19 is the attenuation constant characteristic for a section in which  $H_1 = 0$ ,  $K = K_0 = 0.0325$ ,  $d = 0.001$ . Curve B of Fig. 19 is the attenuation characteristic for a two section filter in which the first section is the one described above and section 2 has the following constants  $H_1 = K_0 = 0.0325$ ,  $K_1 = 0$ ,  $d = 0.001$ . This combination gives a symmetrical band pass filter; that is, the attenuation for  $\omega = A$  is the same as the attenuation for  $\omega = 1/A$ . This combination has infinite attenuation at  $\omega/\omega_{r0} = 0$  and  $\omega/\omega_{r0} = \infty$ . Curve A of Fig. 20 is the attenuation curve for a section in which

$K_0 = 0.0325$ ,  $K_1 = 0.2859$ ,  $H_1 = 0.3153$ ,  $d = 0.001$ . Curve B is an attenuation curve for a two section filter. One section has the constants given above. For the other section the values of  $H_1$  and  $K_1$  have been interchanged. This combination of sections gives a symmetrical band pass filter in which the points of

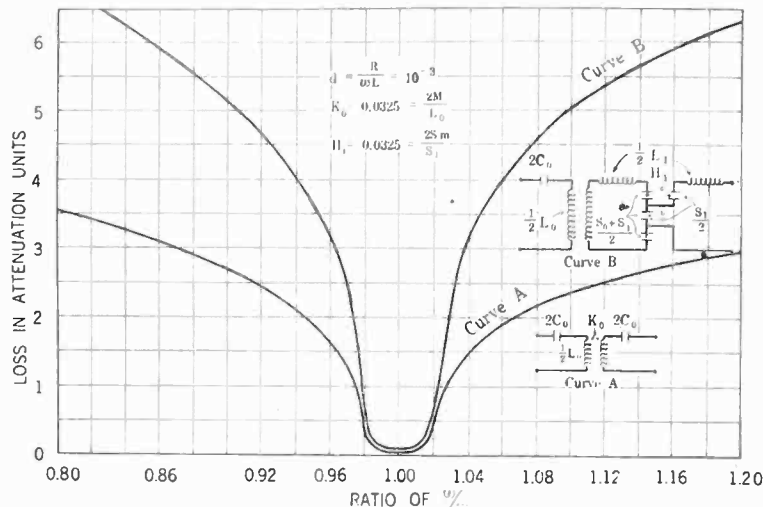

FIG. 19—ATTENUATION CURVES FOR BAND PASS WAVE FILTER

infinite attenuation have been brought in from  $\infty$  and 0 to

$$\omega/\omega_{r1} = \sqrt{\frac{0.3153}{0.2859}} \quad \text{and} \quad \omega/\omega_{r1} = \sqrt{\frac{0.2859}{0.3153}}$$

The curve of Fig. 21 is the attenuation characteristic of a three section filter obtained by adding a section for which  $K_0 = 0.0325$ ,  $K_1 = 0$ ,  $H_2 = 0.0325$ ,  $d = 0.001$  to the filter just described above.

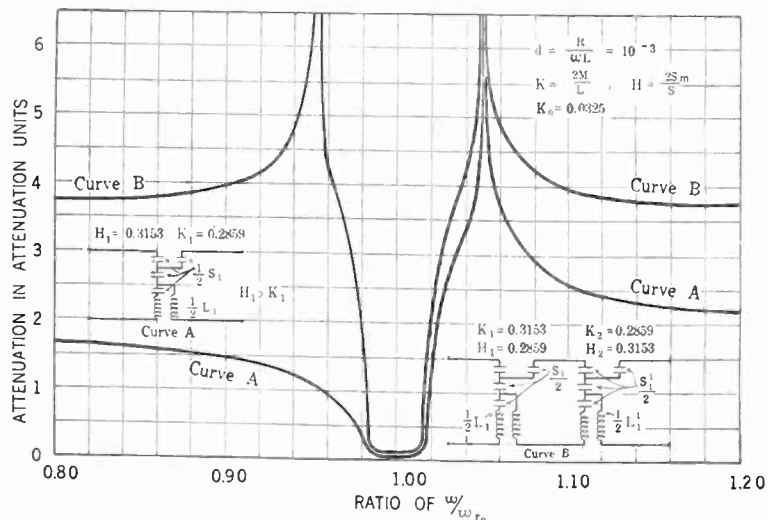

FIG. 20—ATTENUATION CURVES FOR COUPLED CIRCUIT WAVE FILTERS

As an illustration of the use of the design formulas let us consider the following problem:

It is desired to introduce between a generator whose impedance is 600 ohms, and a power receiving device of 600 ohms, resistance, a filter having the following characteristics:

The filter shall pass frequencies from 29,700 ~ to



30,300 ~ with as small a loss as possible. The variation in loss over this transmitted band not to exceed 0.2 of an attenuation unit. The loss at 31,000 ~ and above and at 29,000 ~ and below shall exceed 5 attenuation units. Required, the constants of the filter.

We will assume that the value of the ratio of resistance to reactance which it is possible to obtain in coils is 0.002. The resonant frequency,  $f_{r0}$  will be taken at

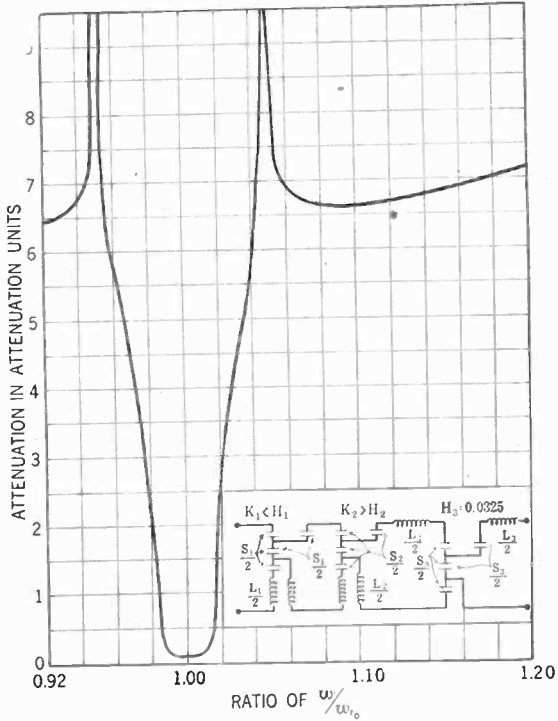

FIG. 21—ATTENUATION CURVE FOR COUPLED CIRCUIT WAVE FILTER

the center of the transmitted band, namely as 30,000 ~. The theoretical cut-off points must be taken so as to be outside the band which it is desired to transmit as there is appreciable loss at the theoretical cut-off points. We will choose  $f_{\Lambda}/f_{r0} = \omega_{\Lambda}/\omega_{r0}$  as 1.016. The value of  $K_1$  is obtained from equation (57).

$$K_0 = 1 - (\omega_{r0}/\omega_{\Lambda})^2 = 0.0325$$

We will first try a two section filter, one section having a point of infinite attenuation at  $\omega_{\infty}/\omega_{r1} = 1.05$  and the other having a point of infinite attenuation at  $\omega_{\infty}/\omega_{r1} = 1/1.05 = 0.952$ . The value of the  $K_i$  are then as follows:

For the first section,

$$\sqrt{H_1/K_1} = 1.05; \quad H_1/K_1 = 1.105$$

Substituting this in equation (107) we obtain

$$K_1 = 0.2859$$

$$H_1 = 0.3153$$

For the second section we obtain in like manner,

$$K_2 = 0.3153$$

$$H_2 = 0.2859$$

The losses in this two section filter based upon the attenuation constants alone is given by curve B of Fig. 20. This filter does not quite meet the require-

ments. To this filter we will add a third section for which  $\omega_{\infty}/\omega_{r1} = \infty$ . For this section then  $K_3 = 0$ . Equation (107) gives  $H_3$  as follows:

$$H_3 = K_0 = 0.0325$$

The loss through this three section filter based upon the attenuation constants alone is shown by the curve of Fig. 21. This filter meets the requirements. Its constants are found as follows:

$C_0$  is given by equation (66) as

$$C_0 = \frac{|K_0|}{2 \omega_{r0} Z_0}, \quad \text{where } Z_0 = 600$$

$$C_0 = 1.437 \times 10^{-10} \text{ farads}$$

$L_0$  is given by equation (67) as

$$L_0 = \frac{2 Z_0}{|K| \omega_{r0}} = 0.1958 \text{ henrys}$$

$L_1$  is given by equation (105) as

$$L_1 = L_0 \sqrt{\frac{1 - K^2}{1 - K_1^2}} = 0.204 \text{ henrys}$$

$C_1$  is given by equation (106) as

$$C_1 = C_0 \sqrt{1 - H_1^2} = 1.364 \times 10^{-10} \text{ farads}$$

$L_2$  is given by equation (105) as

$$L_2 = L_0 \sqrt{\frac{1 - K_0^2}{1 - K_1^2}} = 0.2062 \text{ henrys}$$

$C_2$  is given by equation (106) as

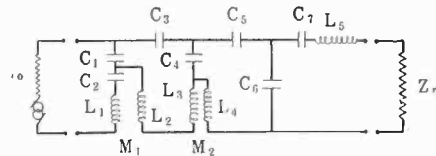

FIG. 22

- $Z_0 = Z_n = 600 \text{ ohms}$
- $C_1 = 8.652 \times 10^{-10} \text{ farads}$
- $C_2 = 3.974 \times 10^{-10} \text{ "}$
- $C_3 = 1.958 \times 10^{-10} \text{ "}$
- $C_4 = 3.974 \times 10^{-10} \text{ "}$
- $C_5 = 1.678 \times 10^{-10} \text{ "}$
- $C_6 = 8.843 \times 10^{-10} \text{ "}$
- $C_7 = 2.971 \times 10^{-10} \text{ "}$
- $K_0 = 0.0325, \quad K_1 = 0.2859, \quad K_2 = 0.3153$
- $H_1 = 0.3153, \quad H_2 = 0.2859, \quad H_3 = 0.325$
- $\omega_{\Lambda}/\omega_{r0} = 1.016, \quad \omega_{\infty 1}/\omega_{r0} = 1.05, \quad \omega_{\infty 2}/\omega_{r0} = 0.952$
- $\omega_{r0} = (30,000) 2\pi, \quad d = 0.001$
- Attenuation characteristics given by Fig. 21.

$$C_2 = C_0 \sqrt{1 - H_2^2} = 1.377 \times 10^{-10} \text{ farads}$$

$L_3$  is given by relation (105) as

$$L_3 = L_0 \sqrt{1 - K_0^2} = 0.1958 \text{ henrys}$$

$C_3$  is given by (106) as

$$C_3 = C_0 \sqrt{1 - H_3^2} = 1.437 \times 10^{-10} \text{ farads}$$

The filter goes together as shown by Fig. 21. After combining elements, the constants of the filter are shown by Fig. 22.

## COMPILATION OF SYMBOLS

$\gamma$	Defined by $Z_c/Z_m = \gamma/\phi$	$S_m$	Represents mutual elastance
$C$	Stands for capacitance	$\tau$	Represents the propagation constant
$d$	Stands for the ratio of resistance to reactance of coils = $R/\omega L$	$u$	Represents the real part of the ratio $Z_c/Z_m$
$E$	Stands for voltage	$v$	Represents the imaginary part of the ratio $Z_c/Z_m$
$\epsilon$	Represents the naperian base of logarithms	$\omega$	Represents angular velocity
$f$	Represents frequency	$\omega_a$ & $\omega_b$	Represent cut-off angular velocities
$h$	Represents the attenuation constant	$\omega_{r_0}$	Represents the resonant angular velocity
$H$	Represents the coefficient of electrostatic coupling	$\omega_\infty$	Represents the angular velocity at which the attenuation becomes infinite
$I$	Represents current	$Z_c$	Represents the circuitual impedance that is the impedance of each circuit when isolated from the chain
$j$	Represents the rotative operator $\sqrt{-1}$	$Z_L$	Represents the line or chain impedance looking into the generator end of the chain
$k$	Represents the wave length or phase shift constant	$Z_m$	Represents the mutual or transfer impedance
$K$	Represents the coefficient of electromagnetic coupling	$Z_n$	Represents the terminating or load impedance
$L$	Represents self inductance	$Z_0$	Represents the generator impedance
$M$	Represents mutual inductance	$Z_c$	Represents the characteristic impedance of the chain = $\sqrt{Z_c^2/4 - Z_m^2}$
$R$	Represents resistance		
$S$	Represents elastance		

## Measurement of Transients

BY FREDERICK E. TERMAN

Leland-Stanford University

**Review of the Subject.**—The transient crest meter was developed to investigate several pressing problems in high-voltage transients. It consists of a gold leaf electroscope in series with a rectifying device, an electron tube, which enables the electroscope to charge, but prohibits discharge. The charge that is captured in this manner is proportional to the maximum impressed potential, and where adequate insulation is possible, will remain substantially undiminished for many seconds or even minutes after the transient has passed by.

The instrument described is thus seen to be essentially a crest voltmeter. By the proper use of inductance, resistance, and capacitance it is possible to make the applied voltage dependent upon the maximum peak, maximum slope, or maximum area of current and voltage waves, thus giving information regarding the character as well as the size of the transient.

The method of calibration, and the precautions that must be taken in measuring transients with this instrument are pointed out in detail in the paper. In particular, care must be taken to

carefully insulate the gold leaf. The minute charge stored at several hundred volts makes it necessary to employ special vacuum bulbs with the filament and plate leads coming through opposite ends of the tube.

The crest meter has already served successfully in several investigations. The first application was the measurement of the potential of the sphere electrode of a high-voltage oscillator. The method followed consisted in measuring the charging current to the sphere by means of a shielded electroscope resting within this electrode. When combined with a second gold leaf acting as relay contact to give an alarm at a given voltage, the instrument is admirably suited for the study of transmission system disturbances, for the observer need be tied no closer to the test than remain within hearing distance of an electric bell. Such an application was made during four months of the past summer on a 110 kv. line belonging to the Pacific Gas & Electric Company, in an effort to discover the cause of apparently unprovoked flashovers which this particular line experienced from time to time. Other similar applications become evident as their need arises.

### PRINCIPLE

TRANSIENT phenomena occur continually in electrical practise, and are often of the most practical importance because of the disturbances they give rise to in electrical circuits. Due to the momentary nature of transients, direct experiment and measurement of such oscillations is unusually difficult, and the choice of methods available for any investigation is very limited.

While studying certain high-voltage phenomena, Prof. Harris J. Ryan of Stanford University found it necessary to develop a new type of transient crest

Presented at the Midwinter Convention of the A. I. E. E., New York, N. Y., February 14-17, 1923.

voltmeter. The instrument that was evolved to fill this want can be used to advantage in the investigation of many types of transient oscillations, to determine their nature and magnitude. The following paragraphs give an outline of this meter with the hope that others will find it of assistance in solving their problems.

Some years ago, Dr. Clayton Sharp<sup>1</sup> described a crest meter used to determine the form factor of low-frequency alternating-current waves. This indicator consisted of an electron tube in series with a condenser, and made use of the principle that the vacuum tube will allow a condenser to charge, but not discharge.

1. Sharp and Doyle, "Crest Voltmeters," A. I. E. E., 1916.

The condenser will hence charge to the crest voltage of the wave and hold this potential.

A consideration of the principles involved in such an instrument brings forth the remarkable possibilities of this type of indicator in reference to high-frequency transients. From elementary electrostatics, the voltage across a condenser is:

$$E = (1/C) \int i \cdot dt$$

It is apparent that the factors controlling the time required for the condenser voltage to attain a certain value are the rate of current flow and the amount of current required, that is to say, upon the size of condenser used, and the space current of the vacuum tube. In practise the charging rate cannot be greatly increased, since the saturation current of vacuum tubes is at best only a few hundredths of an ampere. Where the time element is very small, as in the case of radio frequencies, it is evident that this low rate of charge lasting only a small part of a second requires a very minute capacitance to build up to the voltage of the transient.

The requirement of a small capacitance led to the adoption of a gold leaf electroscope as the basic unit of the instrument. This arrangement was chosen since a gold leaf electroscope not only supplies a very small capacitance, but also reads the potential of the condenser by the deflecting gold leaf. The capacitance can be very small, in the neighborhood of two millionths of a microfarad being the value for the instruments constructed. This quantity is such that one one hundredth of an ampere flowing for a ten millionth of a second is sufficient to charge the electroscope to five hundred volts. It is obvious that with such minute amounts of energy stored at potentials of hundreds of volts, insulation of the very best must be provided.

Throughout the instrument particular care must be taken in this regard. The gold leaf and its electrode should preferably be isolated by a piece of cast sulphur. Sulphur is chosen, since it can be readily handled, and is an almost perfect non-conductor. In fact the resistance between the gold leaf and the case of one electroscope constructed was several trillion ohms, and a large part of this conductivity could undoubtedly be attributed to leakage arising from surface contamination rather than by conductivity through the sulphur.

A great amount of trouble is experienced in obtaining adequate insulation between elements of the vacuum tube. It is well known that glass gathers a surface film of moisture, a film varying in thickness with conditions, and practically impossible to remove. Due to this factor, a long leakage distance between elements of the bulb is necessary, the ordinary tube with all connections coming out of the same press being practically useless. It was found necessary after some experimentation to employ two element bulbs built especially for the crest meter by the Moorhead laboratories. These tubes have the leads coming from op-

posite ends, and hence give a one hundred per cent utilization of the possible leakage distance.

Even with such construction certain atmospheric conditions cause the leakage rate to be excessive. To reduce the thickness of the moisture film on the glass to a minimum it is desirable to keep the walls of the electron tube slightly warmer than the surrounding air. In practise this can be gained by covering the bulb with a celluloid hood that prevents convection currents carrying away the heat radiated by the filament. Under normal conditions the rate of leakage per minute will not exceed ten to fifteen per cent of the total charge. For most kinds of work it is possible to provide a relay that will disconnect the electroscope from the bulb after the transient has passed. Action by the relay makes it possible for the leakage to take

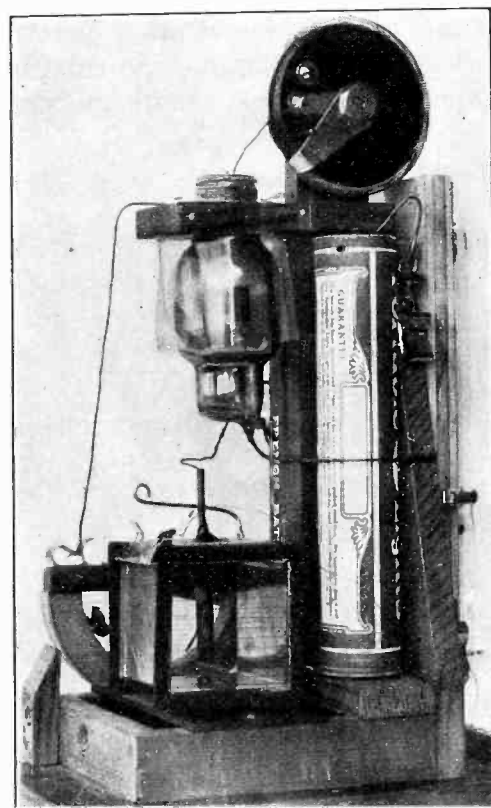

FIG. 1—THE TRANSIENT CREST VOLTMETER

place only over the superior sulphur insulation, and hence reduces the rate of loss of charge to something less than one per cent a minute.

The appearance of the electroscopes that have been built is shown in Fig. 1. The method of construction illustrated is both simple and very satisfactory. The case was formed on four sides by bending a long strip of sheet tin into a cube. The edges were flared out as shown, and small wires run across the open ends and soldered in place, forming a complete electrostatic cage with perfect visibility to the interior. To protect the gold leaf from air currents it is necessary to shield the open ends with thin glass plates held in place by heavy paper pasted over the edge. The sulphur insulation is in the form of a slab fitting on the top of the cube, and supporting the gold leaf on a rod extend-

ing through a hole in the metal case. Other details of construction, as well as the celluloid hood, are clearly shown in the photograph, so will not be described further.

The deflection of the gold leaf is read by lining up a thread with the deflected leaf, and determining the thread angle by means of a protractor that is mounted on the electroscope as shown in Fig. 9. An accuracy of about plus or minus a half of a degree can be readily obtained with a little practise. The personal equation enters strongly into the readings of the instrument, and it is preferable, though not necessary, that calibration curves and observations during tests be made by the same investigator.

#### APPLICATIONS OF THE CREST METER

The crest meter that has been described is essentially a crest voltmeter, but in this capacity its use can be extended to the investigation of other quantities. By utilization of the proper circuits, the crest meter will indicate the *maximum* peak, *maximum* steepness of

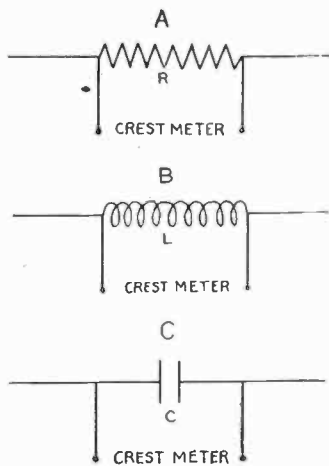

FIG. 2—CONNECTIONS FOR MEASURING PROPERTIES OF CURRENT WAVES

wave front, and *maximum* area of both voltage and current waves.

A series of such connections for the investigation of current waves is shown in Figure 2. The measurement of peak currents is almost self explanatory. It must be remembered that  $R$  should be absolutely non-inductive where radio frequencies are present. Replacing the resistance by an inductance as shown in Fig. 2B makes the voltage indicated by the crest meter equal to the maximum value of  $L di/dt$ , that is, proportional to the steepness of the wave front. Using a capacitance in place of the inductance gives information regarding the area of the wave, since the e. m. f. across a condenser is the time integral of the current flowing in the condenser. Extending the same principles to the study of voltages is a simple matter. Peak voltages can be read either directly or by the use of a potentiometer. Wave fronts and areas can be determined by the applications of the principles illustrated in Fig. 3B and 3C. In these circuits if the

impedance offered by  $R$  greatly exceeds that offered by  $L$  or  $C$ , the current through the shunt circuit containing  $R$  is an exact replica of the voltage wave in the main line.

In the study of transmission line transients, a potentiometer of the water filled hose type<sup>2</sup> serves

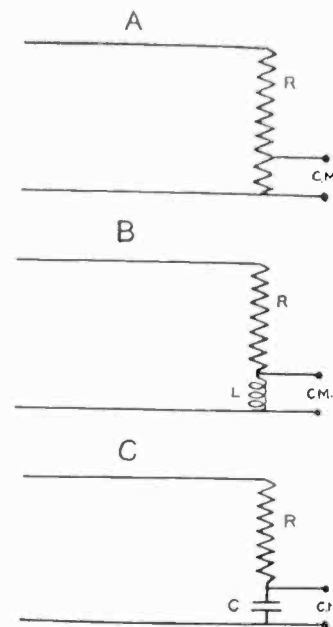

FIG. 3—CONNECTIONS FOR MEASURING PROPERTIES OF VOLTAGE WAVES

admirably. Fig. 4 shows such a potentiometer used in an investigation conducted on a 110,000-volt line. The power consumption in the hose is about two kilowatts for the complete loop of two hoses in parallel, so by circulation of the water through a wash tube as

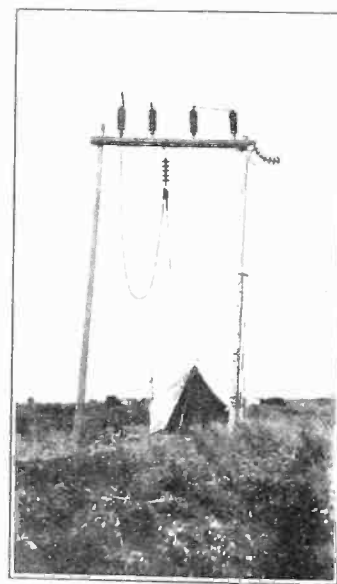

FIG. 4—HIGH-VOLTAGE POTENTIOMETER USED WITH CREST METER

reservoir, the necessary dissipation of energy can be obtained with a limited amount of water.

The equivalent circuit of the crestmeter is shown in Fig. 5. The electroscopes acts as a pure capacitance,

<sup>2</sup> H. J. Ryan, "The High Voltage Potential Meter," A. I. E. E., 1916.

the electron tube as a capacitance shunted by a variable resistance. In the proportions existing in the instrument the condenser furnished by the bulb is the smaller of the two by only a slight amount. This brings into consideration certain complications that can affect the accuracy of the results obtained.

An examination of Figure 5 will make this evident. At the crest of a transient the potential of the two elements of the electron tube is the same. As soon as the voltage begins to die away  $R$  becomes infinite, the potential of the filament is no longer equal to that of the

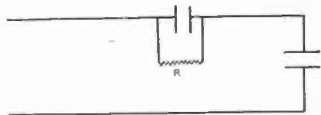

FIG. 5—EQUIVALENT CIRCUIT OF CREST METER

plate, and an electric field is set up between them. The energy represented by this field comes from the charge the electroscope possesses, and hence must affect the indication of the gold leaf. Where the final potential of the filament is not controlled, serious errors will be introduced in this fashion.

The remedy is simple, being merely to always keep the filament at a definite potential in respect to the

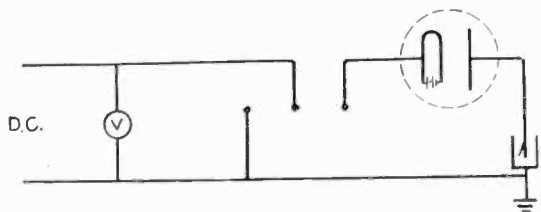

FIG. 6—CIRCUIT FOR CALIBRATION OF CREST METER

electroscope case when reading deflections. The easiest way of accomplishing this is to connect the two together. This operation makes the variable element otherwise present become constant at a value easily reproducible. Where connections such as shown in Fig. 2A are used, and there is no current flowing when the instrument is being read, it is obvious that this condition is attained without the special switch necessary under other circumstances.

CALIBRATION

Calibration of the instrument may be readily carried out using direct current, keeping in mind the considerations that have just been presented by using the circuit shown in Fig. 6. Throwing the switch one way impresses the known voltage on the instrument, throwing to the other side connects the case and filament. If the potential is supplied by a generator it is preferable to use a machine with a large number of commutator segments and with steady brushes to reduce the ripple to a minimum. One must remember at all times that the crest meter reads the peak voltage, while the direct-current voltmeter does not.

A calibration of the crest meter incorporating the electroscope shown in Fig. 1 is given in Fig. 7. It is seen that the useful range of this particular instrument is between two hundred fifty and one thousand volts. Above this the curve changes too rapidly to be of very much use. It had been thought that the intense field at the edges of the gold leaf might start ionization of the air at low potentials, but investigation

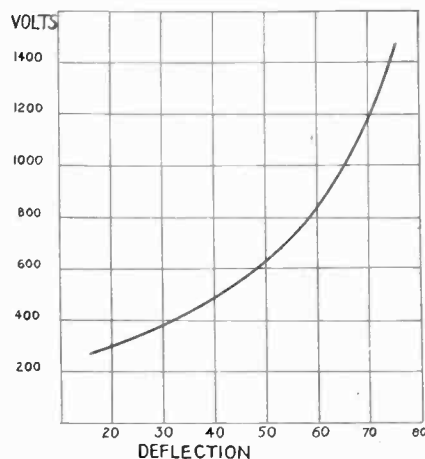

FIG. 7—TYPICAL CALIBRATION CURVE

of this point up to twenty-two hundred volts gave no evidence that such was the case. From a comparison of the various electroscopes built, the size of the gold leaf appeared to be the principle factor determining the sensibility, the general over-all dimensions in other respects having very little direct influence.

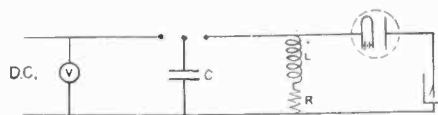

FIG. 8—A CIRCUIT WHICH SET UP UNEXPECTED TRANSIENTS THAT WERE OBSERVED BY THE CREST METER

The calibration of the electroscope changes from day to day. This variation extends in a similar fashion to the entire range of the gold leaf, and will raise and depress the calibration curve as much as seven or eight per cent at times. Where relative or approximate values are desired this factor does not introduce such serious trouble, but when absolute values are being determined, frequent recalibration is necessary.

OPERATION OF THE CREST METER

The very sensitiveness of the crest meter is often a source of trouble and error. The peak value of voltage is always read by the instrument, irrespective of whether or not this voltage is the one being investigated. In this connection an interesting discovery serves as a typical example. A circuit such as shown in Fig. 8. was being used to study damped oscillations. From the connections it would appear that the voltage read by the crest meter after charging the condenser and closing its switch would be equal to or less than the charging potential, but the result was actually three to four times this value. Analysis of the factors involved

gave the explanation of this unexpected result. The circuit comprising the electroscopes, electron tube, and leads, made a series circuit of inductance and capacitance to which was applied an instantaneous voltage upon switching in the condenser. It can be shown that under these conditions large voltages of extreme frequencies will exist over parts of the circuit, exactly as the crest meter indicated. This is merely cited to show how apparently unreliable results merely verify the integrity of the instrument as an indicator of crest voltages. It was found that such resonance phenomena did not occur when the instantaneous voltage was supplied by generators instead of con-

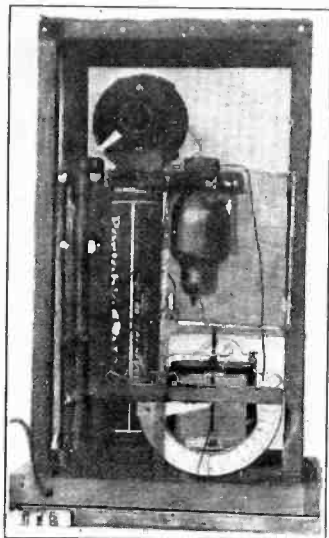

FIG. 9—SHIELDED CREST METER, WITH WINDOW TO INTERIOR OPEN

densers, apparently the inductance of the machine windings preventing the rapid mobilization of energy possible in the condenser discharges.

A number of possibilities of the crest meter idea will occur to the engineer. An electrostatic voltmeter can be used to replace the electroscopes, although a considerable increase in capacitance results which will render the instrument unfit for the most rapid transients. It must be remembered, also, that the crest meter as described can only work on one-half of the wave being investigated, due to the unilateral conductivity of the vacuum tube. Where it is suspected that positive and negative crests are different, two such instruments connected back to back must be used. Fig. 9 shows a useful form of the instrument for the investigation of currents flowing in parts of a high-voltage circuit. Being self-contained, and completely shielded by copper gauze, the crest meter may be raised to any potential above ground that is convenient.

In the investigation of infrequent surges it is advisable to incorporate a relay in the test outfit. By placing an additional gold leaf in the electroscopes arranged as shown in Fig. 10 in relation to an adjustable contact, a relay capable of handling sufficient current to throw a polarized relay results. The

polarized relay can operate any number of circuits, which may perhaps ring a bell, short-circuit the filament of the tube to the electroscopes case, and then disconnect the tube altogether from the electroscopes to reduce leakage, and so on.

By carefully providing protection from dust, dirt,

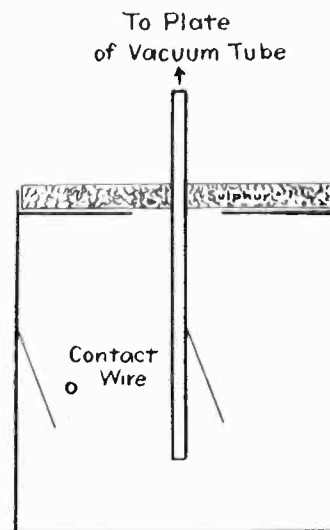

FIG. 10—SHOWING ADDITIONAL GOLD LEAF ACTING TO CLOSE A RELAY CIRCUIT

and dew, the electroscopes will serve very well for field use. Fig. 4 gives a picture of the arrangement for a ten-day, two-hundred-and-forty-hour test on a 110,000-volt power line. In such open conditions it is always necessary to keep the actual crest meter inclosed to protect it from dirt, spider webs, etc.

#### SUMMARY

The electron tube-condenser type of crest meter affords a means of investigating the character as well as the size of transients of extremely short duration. In order to accomplish this, certain precautions in construction and operation must be observed. Of particular importance is the capacity and insulation of the condenser, and the filament potential at the time of making a reading. The final instrument is suitable for the reading of *maximum* height, area, and steepness of current and voltage waves with considerable accuracy. Its readings are readings of maximum disturbances occurring, and if unsuspected oscillations of a greatly different frequency exist side by side with those being investigated, the crest meter can only be expected to give an indication of the largest disturbance. For this reason it requires an apprenticeship before reliable results can be expected. The application of the transient crest voltmeter is largely limited to laboratory and research work, but by proper protection from disturbing elements it is available for field service.

The writer wishes to give special acknowledgment to Prof. Harris J. Ryan in connection with the transient crest meter. He is the originator of the instrument, and took a constant and most helpful interest in the work that was performed with it.

# The Neutral Grounding Reactor

BY W. W. LEWIS

Member A. I. E. E.  
General Electric Co., Schenectady, N. Y.

**Review of the Subject.**—A neutral grounding reactor (Peter- sen Coil) has been in operation on the system of the Alabama Power Company since October 12, 1921. This is the first of these devices in this country, although there are perhaps several hundred of them in operation in Europe. The present paper discusses the tests made shortly after installation of this reactor. A companion paper by Messrs. J. M. Oliver and W. W. Eberhardt, discusses the operation of the reactor for a period of about a year.

It is believed that this device has a somewhat limited use in this country on account of the prevalence and popularity of the solidly grounded neutral. Nevertheless, there are certain installations favorable to the use of the reactor and it is partly the purpose of the

present paper to outline the field of this device as well as to show how its rating may be determined for a particular system.

## CONTENTS

Review of Subject.	(150 w.)
Introductory Remarks.	(225 w.)
Theory of Operation.	(1300 w.)
The Alabama Power Co. Installation.	(1000 w.)
Tests (Steady Conditions).	(750 w.)
Determination of Resonance Point.	(350 w.)
Arcing Tests.	(2250 w.)
Short Circuit from Line to Line.	(225 w.)
Solid Grounds on Line.	(350 w.)
Limitations in Use and Other Forms of Device.	(500 w.)
Conclusion.	(500 w.)
References.	(100 w.)

**I**SOLATED neutral systems are disadvantageous from the standpoint of abnormal voltages produced by arcing grounds and the difficulty of relaying against the short circuits frequently produced by such abnormal voltages. The grounded neutral has eliminated the overvoltages and allowed the relaying to become positive. Systems with neutrals grounded solidly or through a low resistance predominate in this country, and their operation has been very satisfactory.

However, there are some systems for which grounding is not desirable for one reason or another: For example, the apparatus will not stand short circuit, or there being but a single circuit, the frequent interruption of this circuit cannot be tolerated. For such systems, various schemes have been proposed with the object of eliminating the dangerous arcing grounds, thereby allowing the system to continue in operation. Among these are the arcing ground suppressors of Creighton and Nicholson, the neutral grounding reactor of Petersen and kindred devices.

The neutral grounding reactor has been used a great deal in Europe, but very little in this country, owing largely to extensive and satisfactory use of the grounded neutral system. However, there has been a reactor in operation on the Alabama Power Company system since October 12, 1921, and it is the purpose of the present paper to describe this installation and some tests made thereon. Messrs. J. M. Oliver and W. W. Eberhardt will discuss the operation of the reactor in service.

## THEORY OF OPERATION

Suppose that on a three-phase system, of which the Y of Fig. 1 represents the generator, or more commonly the high-tension side of the step-up transformer bank, there is an arc from phase 3 to ground. Then charging currents will flow through the capacitances  $C_1$  and  $C_2$  from phases 1 and 2 to ground, through the arc, back on

conductor 3 to the transformer and thence to conductors 1 and 2 as shown on the figure. Capacitance  $C_3$  is short-circuited by the arc. There are also charging currents passing from conductors 1 and 2 directly to conductor 3 and back to the transformer over conductor 3, but as these do not enter the arc circuit, they are immaterial in this discussion and will be ignored.

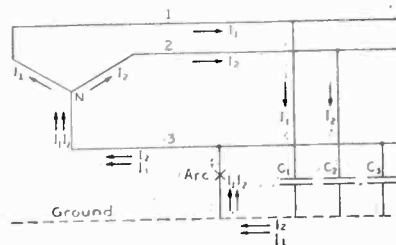

FIG. 1—THREE-PHASE SYSTEM WITH AN ARC FROM PHASE 3 TO GROUND. FIGURE SHOWS FLOW OF CURRENTS

In Fig. 2 are represented assumed positive directions for the various voltages, and it is also shown how voltages  $E_{13}$  and  $E_{23}$  are formed by horizontal and vertical components.

If we let  $E_{12} = E$  and let the direction of  $E_{12}$  be the line of reference, then  $E_{13}$  and  $E_{23}$  may be expressed vectorially as follows:

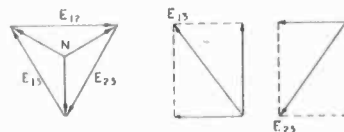

FIG. 2—ASSUMED POSITIVE DIRECTIONS OF VOLTAGES, AND FORMATION OF VOLTAGES  $E_{13}$  AND  $E_{23}$

$$E_{13} = -E/2 - jE/2\sqrt{3}$$

$$E_{23} = -E/2 + jE/2\sqrt{3}$$

Also the current  $I_1$  and  $I_2$  may be expressed:

$$I_1 = +jE_{13}\omega C_1$$

$$I_2 = -jE_{23}\omega C_2$$

Let

$$C_1 = C_2 = C_G$$

Presented at the Spring Convention of the A. I. E. E., Pittsburgh, Pa., April 24-26, 1923.

Then 
$$I_1 + I_2 = j \omega C_G (E_{13} - E_{23})$$

$$= j \omega C_G (-2j E/2 \sqrt{3})$$

$$= \omega C_G E \sqrt{3}$$
(1)

But  $E = \sqrt{3} e$   
 in which  $e =$  voltage to neutral,

Then 
$$I_1 + I_2 = 3 \omega C_G e$$
(2)

That is, by equation (1) the current through the arc is  $\sqrt{3}$  times the charging current from one of the two ungrounded conductors to ground when the third conductor is grounded, or by the equation (2) it is three times the normal charging current from one of the three conductors to ground, when none of the conductors is grounded.

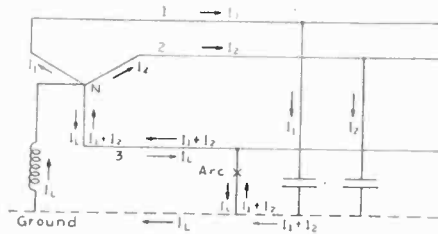

FIG. 3—THREE-PHASE SYSTEM WITH REACTOR BETWEEN NEUTRAL AND GROUND. FIGURE SHOWS FLOW OF CURRENTS WITH ARC FROM PHASE 3 TO GROUND

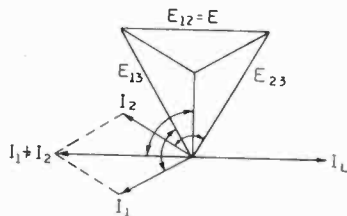

FIG. 4—VECTOR RELATION OF CURRENTS FLOWING IN CIRCUIT OF FIG. 3. ALL ANGLES MARKED BY ARROWS EQUAL 90 DEG.

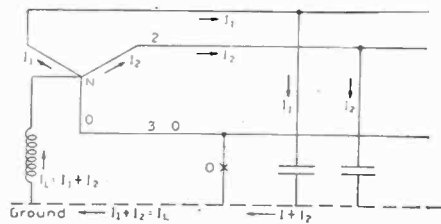

FIG. 5—FLOW OF CURRENT IN CIRCUIT OF FIG. 3 WHEN THERE IS PERFECT NEUTRALIZATION OF LAGGING AND LEADING CURRENTS

Now if a reactor is inserted between the neutral and ground as in Fig. 3, a current  $I_L$  will flow through the reactor and the arc as shown. Vectorially the charging currents of Fig. 1 and the reactor current of Fig. 3 may be represented as in Fig. 4.

If we so proportion the reactor that the current  $I_L$  is numerically equal to  $I_1 + I_2$ , as it is directly opposite in phase, the resultant current through the arc will be zero, and the final flow of current will be as shown in Fig. 5.

The inductance necessary to give this relationship is found as follows:

$$I_L = \frac{e}{\omega L}$$

Let  $I_L = I_1 + I_2$

Then 
$$\frac{e}{\omega L} = 3 \omega C_G e$$

From which 
$$L = \frac{1}{3 \omega^2 C_G}$$

In actual practise there is a watt component of current due to the losses in the reactor and lines, and this

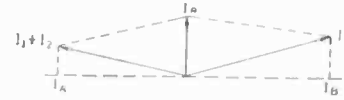

FIG. 6—TYPICAL RELATION OF CURRENTS IN A PRACTICAL CIRCUIT, WITH WATT AS WELL AS REACTIVE COMPONENTS

cannot be balanced out, but exists as a residual current through the arc. (See Fig. 6). In this figure  $I_1 + I_2$  is the line charging current and  $I_L$  the reactor current, both with a watt component, which add up to give the total watt or resultant current  $I_w$ . The reactive components  $I_A$  and  $I_B$  neutralize each other.

The next question that arises is how to determine  $C_G$ , the capacitance from line to ground. The writer has done this for three typical arrangements by means of Maxwell's coefficients. The arrangements chosen are shown in Fig. 7. In each case conductor 3 was grounded. The charging currents found, in terms of the normal three-phase charging current, are as follows:

Case A.

Normal charging current .....	= 1.00
Conductor 1 .....	$I_1 = 1.31$
Conductor 2 .....	$I_2 = 1.29$

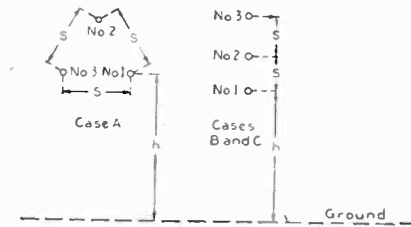

FIG. 7—ARRANGEMENT OF TYPICAL CIRCUITS FOR CALCULATING THE CAPACITANCE TO GROUND BY MEANS OF MAXWELL'S COEFFICIENTS

Case A

Spacing .....	$s = 9.8$ ft.
Height lowest conductor .....	$h = 46.5$ ft.
Diameter Conductor .....	$d = 0.4$ in.

Case B

Spacing .....	$s = 6$ ft.
Height lowest conductor .....	$h = 30$ ft.
Diameter conductor .....	$d = 0.365$ in.

Case C

Spacing .....	$s = 10$ ft.
Height lowest conductor .....	$h = 43.5$ ft.
Diameter conductor .....	$d = 0.47$ in.

Conductor 3 (beyond ground) .....	$I_3 = 0.51$
Ground .....	$I_G = 1.45$
Conductor 3 (generator side of ground) .....	$I_3 + I_G = 1.96$



Case B.

Conductor 1 .....	$I_1$	= 1.36
Conductor 2 .....	$I_2$	= 1.41
Conductor 3 (beyond ground) .....	$I_3$	= 0.52
Ground .....	$I_G$	= 1.51
Conductor 3 (generator side of ground) .....	$I_3 + I_G$	= 2.03

Case C.

Conductor 1 .....	$I_1$	= 1.32
Conductor 2 .....	$I_2$	= 1.35
Conductor 3 (beyond ground) .....	$I_3$	= 0.48
Ground .....	$I_G$	= 1.51
Conductor 3 (generator side of ground) .....	$I_3 + I_G$	= 1.99

Average

Conductor 1 .....	$I_1$	= 1.33
Conductor 2 .....	$I_2$	= 1.35
Conductor 3 (beyond ground) .....	$I_3$	= 0.50
Ground .....	$I_G$	= 1.49
Conductor 3 (generator side of ground) .....	$I_3 + I_G$	= 1.99

Grounding a conductor other than No. 3 may change the results slightly, and other configurations may give

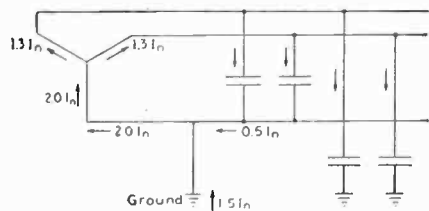

FIG. 8—CALCULATED FLOW OF CURRENT WITH ONE CONDUCTOR GROUNDED.

Current Values Expressed in Terms of Normal Three-Phase Charging Current.

somewhat different results. The presence of a ground wire will increase the capacitance of the conductors to ground and thereby probably increase the current to ground, and consequently increase  $I_G$ .

The results of the preceding tabulation, somewhat rounded off, are shown in Fig. 8. From these figures it will be seen that the capacitance from the ungrounded conductors to ground is about 75 per cent of the normal three-phase capacitance from one conductor to neutral.

Now it is simply necessary to calculate the normal three-phase charging current of the line, and multiply this by 1.5 in order to get the current to ground, in case of a ground on one conductor. Then the neutral grounding reactor should be designed for this current. That is, the ohmic reactance of the neutral reactor is found from the relation:

$$X = \frac{e}{1.5 I_n}$$

in which  $X$  = reactor ohms

$e$  = voltage line to neutral

$I_n$  = normal line charging current.

The writer has recently read Technical Report No. 52 of the Report of the Joint Committee on Inductive

Interference of the California Railroad Commission and from this has learned that Mr. L. P. Ferris of that committee worked out a similar relationship between the charging currents of a line with one conductor grounded. Mr. Ferris also refers in his report to some work done a number of years ago by Mr. Geo. S. Humphrey. The figures of both Mr. Ferris and Mr. Humphrey check fairly well with those of the writer as given in the preceding tabulations and in Fig. 8.

### The Alabama Power Co. Installation

The system chosen for a trial installation of the neutral grounding reactor is the 44-kv., 60-cycle system

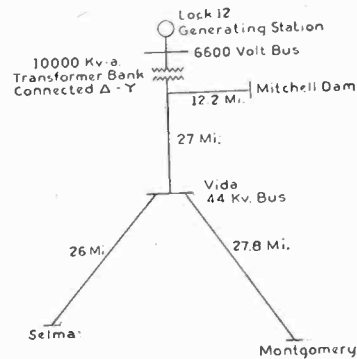

FIG. 9—ONE LINE DIAGRAM OF SYSTEM ON WHICH REACTOR TESTS WERE MADE.

System is 44 kv. 60 Cycles.

of the Alabama Power Company extending from Lock 12 generating station to Montgomery and Selma, Alabama. This is not the main 44-kv. network of this company, but only a small, though important, isolated section. This line is subjected to frequent and severe

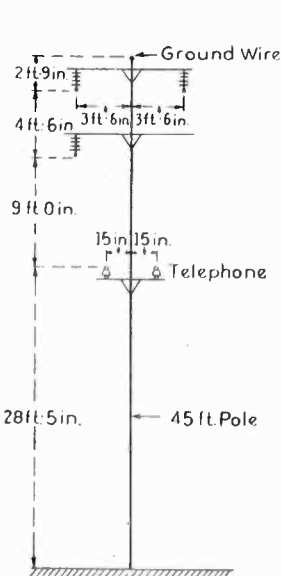

FIG. 10 (A)—ARRANGEMENT OF CONDUCTORS ON LOCK-12-VIDA SELMA SECTION.

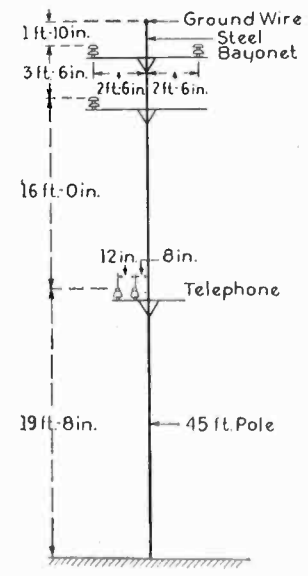

FIG. 10 (B)—ARRANGEMENT OF CONDUCTORS ON THE VIDA-MONTGOMERY SECTION.

lightning disturbances and has given considerable trouble from this cause in the past.

Fig. 9 shows a simplified one-line diagram of the line. Fig. 10A shows the arrangement of conductors on the Lock 12-Vida-Selma section, Fig. 10B the Vida-

Montgomery section and Fig. 10c the Lock 12-Mitchell Dam section.

Following are the data as to the transmission line conductors, lengths of line, etc.:

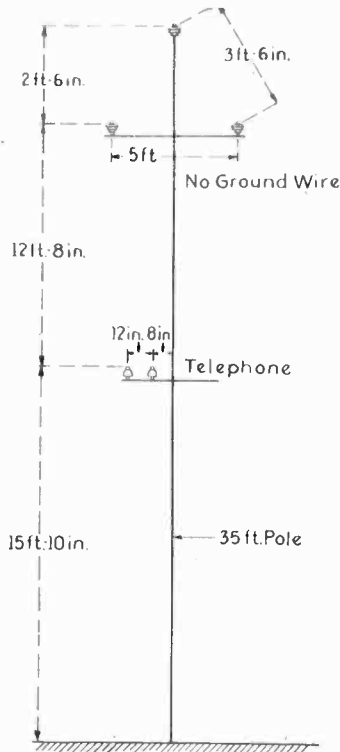

FIG. 10 (c)—ARRANGEMENT OF CONDUCTORS ON THE LOCK 12-MITCHELL DAM SECTION

Section	Conductor	Spacing Ft.
1. Lock-12-Vida	3/0 Alum. steel core	5-3.5-6.1
2. Vida-Selma	No. 4. Copper	5-3.5-6.1
3. Vida-Montgomery	3/0 Alum. steel core	7-4.5-8.3
4. Lock 12-Mitchell Dam	No. 4 Aluminum	3.5-3.5-5

Section	Length Mi.	Calculated capacitance to Neutral $\mu f.$
1. Lock 12-Vida	27	0.476
2. Vida-Selma	26	0.375
3. Vida-Montgomery	27.8	0.434
4. Lock 12-Mitchell Dam	12.2	0.184

The calculated capacitance is based on the geometrical mean spacing. The normal charging current, assuming balanced line conditions, at 60 cycles and 46,000 volts (the actual operating voltage) is for the total system 14.7 amperes, and for sections 1, 2 and 4 (that is, omitting the Vida-Montgomery line) 10.35 amperes.

In order to take care of various combinations of the present line, and some future proposed extensions, as well as to compensate for possible errors in calculating the current to ground with one conductor grounded, the reactor was designed with taps in approximately 5 per cent steps from 2015 ohms to 811 ohms. The change from one tap to another is made by means of two ratio adjusters with control handles at the top of the cover.

Following is a list of the taps as found by test with the corresponding amperes flowing through the reactor:

Tap	Reactance Ohms	Ampere at 46,000 volts.
1	2015	13.2
2	1915	13.9
3	1825	14.5
4	1735	15.3
5	1630	16.3
6	1567	16.9
7	1492	17.8
8	1410	18.8
9	1357	19.6
10	1276	20.8
11	1207	22.0
12	1140	23.3
13	1088	24.4
14	982	27.0
15	929	28.6
16	870	30.5
17	811	32.7

The reactor has no core. It is oil immersed and water cooled, and designed to operate continuously at 795 kv-a. with 55 deg. cent. rise. In order to prevent eddy losses in the steel tank, the cooling coils are connected as a short-circuited winding in accordance with the Kierstead Patent.<sup>1</sup> The total losses in the reactor at full voltage and maximum current are about 21 kw. Fig. 11 is an external view of the reactor and Fig. 12 an internal view of a similar reactor.

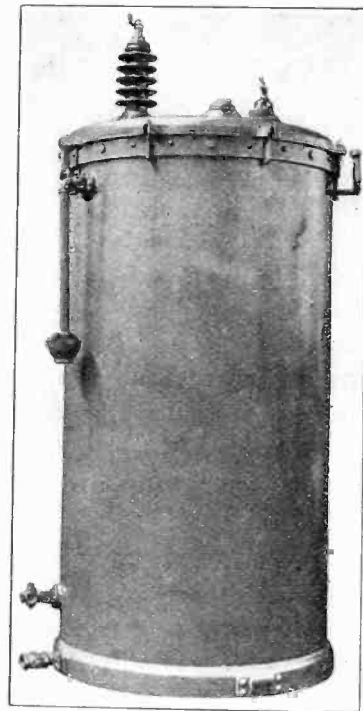

FIG. 11—EXTERNAL VIEW OF NEUTRAL GROUNDING REACTOR

Occasionally there may be a ground on a conductor which is in the nature of a dead ground, for example ground wire against a conductor, conductor down on ground, baling wire connecting conductor and ground wire or conductor and tower, shattered or punctured insulator, etc. In these cases, while the grounding reactor would neutralize the current at the fault, still

1. U. S. Patent 1,394,910.

there would be a large ground current flowing and the system would be in a state of voltage unbalance. It therefore would be desirable to be able to cut out the section of the system in trouble. This is accomplished as follows:

In series with the reactor at the ground end is placed

and the section in trouble is tripped out. This scheme was suggested by Mr. E. W. Pragst.<sup>2</sup>

Connected to the secondary of the current transformer is a recording ammeter, which gives an indication when current passes through the reactor, and across

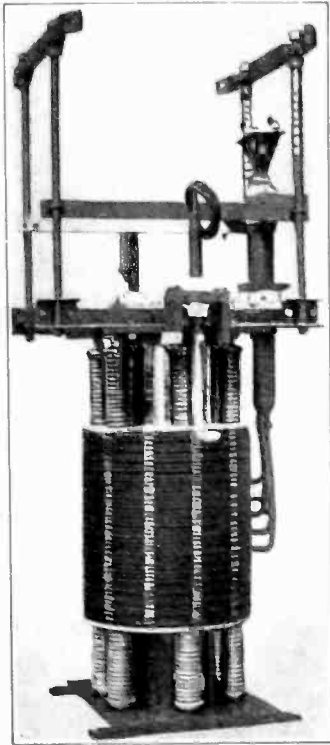

FIG. 12—INTERNAL VIEW OF NEUTRAL GROUNDING REACTOR

a current transformer of suitable ratio. To the secondary of the current transformer is connected a definite time limit relay, set so that with the minimum current through the reactor the relay will operate in a pre-determined time and energize the closing coil of an oil circuit breaker, which closes around and short-circuits

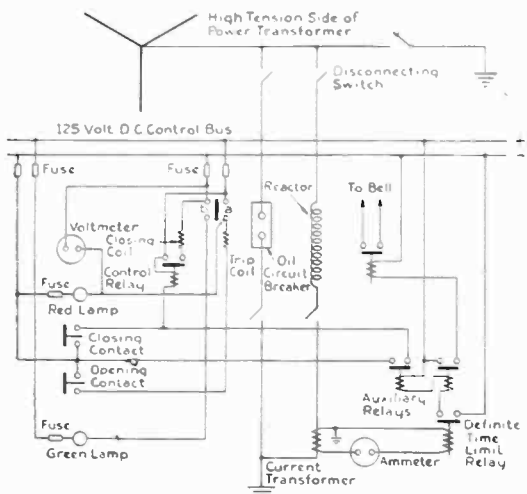

FIG. 13—DIAGRAM SHOWING CONNECTION OF REACTOR AND AUXILIARY DEVICES IN CIRCUIT

the reactor. The system now has a dead or solidly grounded neutral and short-circuit current flows from the power source to the point of line ground. The regular protective relays respond to the short circuit



FIG. 14—VIEW OF REACTOR INSTALLED

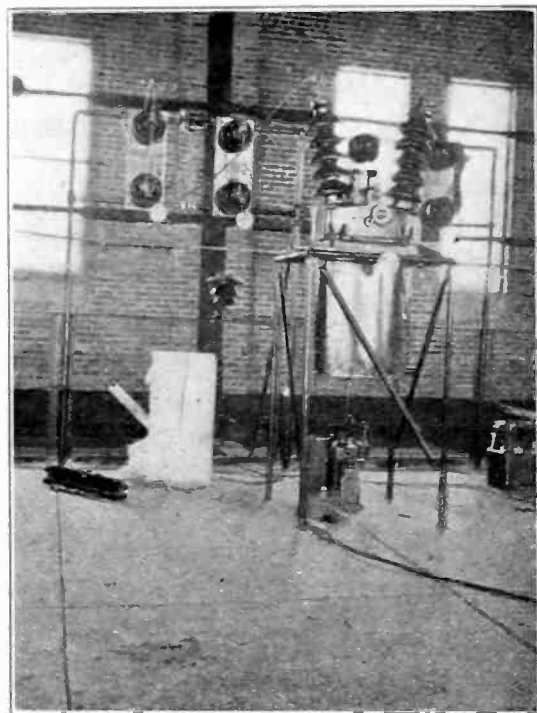

FIG. 15—VIEW OF OIL CIRCUIT BREAKER AND DISCONNECTING SWITCHES USED WITH REACTOR

the red lamp of the oil circuit breaker is a recording voltmeter. By these devices a record may be kept of the operation of the reactor and the short-circuiting breaker. A bell alarm also warns the operator that the circuit breaker has closed.

<sup>2</sup> U. S. Patent 1,378,557.

TABLE I.  
Summary of Test Results  
All Readings Changed to 46,000 Volts Equivalent

Test	Date	Voltage				Current					
		Line to Line	Line to Ground	Line to Neutral	Neutral to Ground	1	2	3	N	G	L
1	11/27	46,000			369	9.88	11.05	10.82			
	12/4	46,000	26,800	26,700	793	10.1	11.02	11.07			
	Av.	46,000	26,800	26,700	581	9.99	11.04	10.95			
2	11/27	46,000			26,800	21.1		14.35		17.7	
	12/4	46,000			26,950	21.4	14.55	14.2		17.77	3.85
	Av.	46,000			26,875	21.3	14.55	14.28		17.74	3.85
3	11/27	46,000			29,100	21.3		14.33			
	12/4	46,000			28,000	21.72	14.9	14.1		18.3	
	Av.	46,000			28,550	21.51	14.9	14.22		18.3	
4	11/27	46,000		26,600		9.6		10.7	0.52		
	12/4	46,000		26,600		10.35	11.1	10.8	0.59		
	Av.	46,000		26,600		9.98	11.1	10.75	0.56		
5	11/27	46,000		26,400	1,050	9.22		11.43	1.58		
	12/4	46,000		26,400	3,613	9.53	11.08	11.7	2.46		
	Av.	46,000		26,400	2,332	9.38	11.08	11.57	2.02		
6	11/27	46,000			27,600	6.29		14.98	15.3	3.04	
	12/4	46,000			26,400	6.28	13.9	14.2	14.86	2.6	3.81
	Av.	46,000			27,000	6.29	13.9	14.59	15.08	2.82	3.81
7	11/27	46,000			27,250	5.14		14.28	14.95		
	12/4	46,000			26,300	6.1	14.54	14.15	15.02	0 +	
	Av.	46,000			26,775	5.62	14.54	14.22	14.99	0 +	

Fig. 13 is a wiring diagram of the auxiliary connections and shows how the reactor is connected in circuit. Figs. 14 and 15 show views of the apparatus in service.

TESTS

Steady Conditions.

A series of tests was made under steady conditions (no arcs). The Vida-Montgomery section was disconnected and tests made on the remaining sections, *i. e.*, Lock 12-Vida, Vida-Selma and Lock 12-Mitchell Dam. The line was not loaded and the step-down transformers at the ends of and along the line were disconnected.

Fig. 16 shows a diagram of connections for these tests. The readings were taken by means of current and potential transformers connected directly to the high-tension lines. In Table I are summarized and averaged the results of the tests of November 27th and December 4th, 1921, the results in all cases being changed to equivalent figures at 46,000 volts. In tests 5, 6 and 7 the reactor was set at 1735 ohms.

In Table II are summarized the calculated currents for the various conditions. These calculations are based on a capacitance of 1.035 microfarads for the lines in circuit. This would give a normal three-phase charging current of 10.35 amperes, and with one conductor grounded the following amperes in accordance with the previous discussion and as shown in Fig. 8.

$$\begin{aligned}
 I_1 \text{ (grounded conductor)} & \dots 2 \times 10.35 = 20.7 \\
 I_2 \text{ (ungrounded conductor)} & \dots 1.3 \times 10.35 = 13.5 \\
 I_3 \text{ (ungrounded conductor)} & \dots 1.3 \times 10.35 = 13.5 \\
 I_L \text{ (beyond ground)} & \dots 0.5 \times 10.35 = 5.2 \\
 I_G \text{ (current to ground)} & \dots 1.5 \times 10.35 = 15.5
 \end{aligned}$$

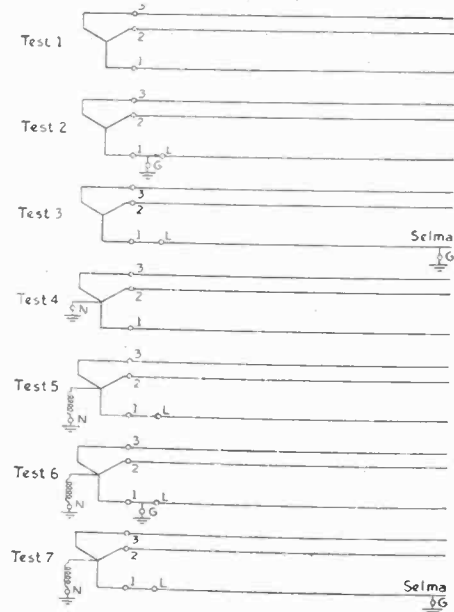

FIG. 16—DIAGRAM OF CONNECTIONS FOR TESTS 1 TO 7 INCLUSIVE MADE UNDER STEADY CONDITIONS

Based on a current to ground of 15.5 amperes, the reactor setting should be 1710 ohms. The nearest tap 1735 ohms was used in the tests. Comparing the cal-

TABLE II.  
Calculated Currents  
Lock 12—Vida, Vida—Selma, Lock 12—Mitchell Dam Lines

Test	Voltage		Current					
	Line to Line	Line to Neutral	1	2	3	N	G	L
1	46,000	26,540	10.35	10.35	10.35			
2	46,000	26,540	20.7	13.48	13.48		15.53	5.18
3	46,000	26,540	20.7	13.48	13.48		15.53	20.7
4	46,000	26,540	10.35	10.35	10.35			
5	46,000	26,540	10.35	10.35	10.35			
6	46,000	26,540	5.18	13.48	13.48	15.3	0.23	5.18
7	46,000	26,540	5.18	13.48	13.48	15.3	0.23	5.18

These values are what would be expected if the three conductors were symmetrically arranged with respect to each other and ground. This not being the case in practise, the actual values should differ somewhat from the above.

culated currents with those measured in tests 2 and 3 we find that the current to ground averages about 18 amperes against a calculated current of 15.5 amperes. Also the current in conductor 1 beyond the ground measures 3.85 amperes against a calculated current of 5.2 amperes. In other words, the current to ground is about 16 per cent greater and that to the grounded conductor about 26 per cent less than calculated.

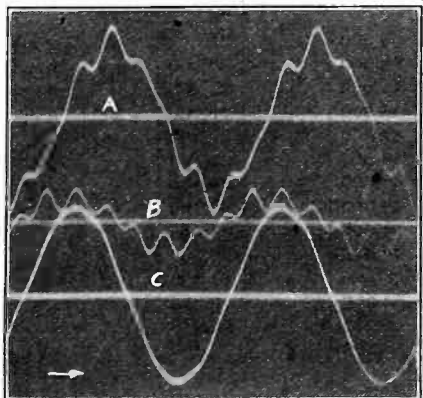

FIG. 17—C D 57279, TEST 4, LINE CHARGED, NO LOAD, NEUTRAL SOLIDLY GROUNDED

Curve A, Current in Conductor 2.  
Curve B, Current in grounded neutral.  
Curve C, Voltage between conductors 2 and 3.

This is very likely due to the ground wire, which increases the capacitance of the ungrounded conductors and thereby their charging current to ground. All the ground current, whether it goes directly to ground or first to the ground wire, must eventually return by way of the fault or grounded point on the conductor.

Using the figure of 18 amperes for ground current, then the proper setting of the reactor would be about 1470 ohms instead of 1710 ohms. It will be interesting to compare this figure with that found from the resonance point test reported in the next section.

In test 1 there was measured a voltage from neutral to ground of about 600 volts. This is evidently the residual voltage due to the unbalanced capacitance from the three conductors to ground. If the neutral is grounded a current should flow, due to this voltage. In test 4 (neutral directly grounded) there is a neutral current of about 0.6 amperes and in test 5 (neutral

grounded through reactor) there is a neutral current of about 2 amperes.

From the oscillogram Fig. 17 it is interesting to note

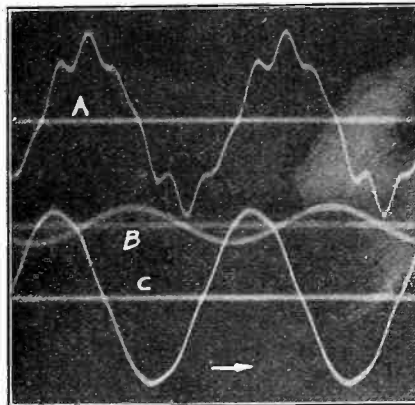

FIG. 18—C D 57281, TEST 5, LINE CHARGED, NO LOAD, REACTOR BETWEEN NEUTRAL AND GROUND

Curve A, Current in Conductor 2.  
Curve B, Current in Neutral Reactor.  
Curve C, Voltage between Conductors 2 and 3.

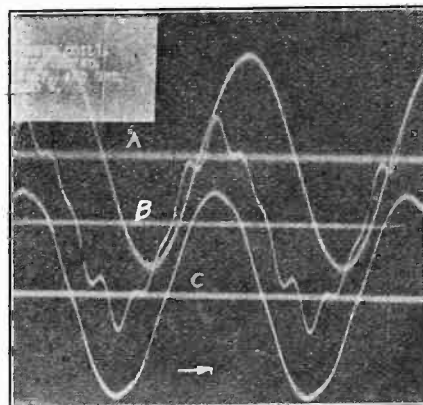

FIG. 19—C D 57282, TEST 5, LINE CHARGED, NO LOAD, REACTOR BETWEEN NEUTRAL AND GROUND

Curve A, Voltage between Neutral and ground.  
Curve B, Current in Conductor 1.  
Curve C, Voltage between Conductors 2 and 3.

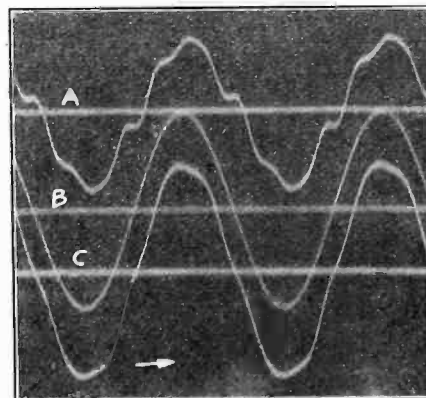

FIG. 20—C D 57293, TEST 7, LINE CHARGED, NO LOAD, REACTOR BETWEEN NEUTRAL AND GROUND. CONDUCTOR 1 SOLIDLY GROUNDED AT SELMA

Curve A, Current in Conductor 2.  
Curve B, Current in Neutral Reactor.  
Curve C, Voltage between Conductors 2 and 3.

that the neutral current of Test 4 consists of a fundamental and large fifth and seventh harmonics, *i. e.*, the same harmonics as contained in the line charging current. However, in the neutral current of Test 5 (Fig.

18) the harmonics have disappeared, leaving the fundamental only, although the line charging current is practically identical with that of Test 4. The voltage across the reactor (Curve A, Fig. 19,) also contains a fundamental only. The impedance of the reactor to harmonics other than the fundamental is apparently so high that they are wiped out. This conclusion is confirmed by numerous other oscillograms, for example, Fig. 20 curve B shows the current through the reactor for Test 7. This is again a pure sine wave of fundamental frequency.

DETERMINATION OF RESONANCE POINT

The resonance point was determined in two ways:

a. Under normal conditions with no conductors

TABLE III.  
Test 12. Determination of Resonance Point.  
System Unloaded. No Line Grounds.  
Vida—Montgomery Line Out.  
Jan. 20, 1922.

Reactor Ohms	Amp. N Direct	Amp. N at 46,000 V
1207	3.15	3.2
1276	4.2	4.27
1357	6.4	6.5
1410	7.65	7.78
1492	6.15	6.25
1567	4.3	4.37
1630	3.1	3.15
1735	2.27	2.31

Readings at about  $113 \times 400 = 45,200$  volts  
Raining during test.  
See Fig. 21.

TABLE IV.  
Test 12. Determination of Resonance Point.  
System Normal, Carrying Load  
Vida—Montgomery Line in Dry Weather Jan. 18, 1922.

Reactor Ohms	Volts 2-3		Volts N G		Current N Direct
	Read	Actual	Read	Actual	
811	114.7	45,880	43	2580	2.13
		46,000		2590	2.14
870	114.5	45,800	52	3120	2.92
		46,000		3140	2.94
929	114.6	45,840	70	4200	4.35
		46,000		4210	4.37
982	114.5	45,800	104	6240	6.05
		46,000		6250	6.08
1088	114.5	45,800	67	4020	3.46
		46,000		4040	3.48
1140	114.7	45,880	54	3240	2.31
		46,000		3250	2.32
1207	114.6	45,840	49	2940	1.68
		46,000		2950	1.69
1276	114.6	45,840	43	2580	1.35
		46,000		2590	1.36
1357	113.5	45,400	40	2400	1.07
		46,000		2440	1.09
1410	113.8	45,520	38	2280	0.91
		46,000		2300	0.92
1492	113.5	45,400	36	2160	0.79
		46,000		2190	0.80
1567	113.8	45,520	33	1980	0.69
		46,000		1995	0.70
1630	113.6	45,440	32	1920	0.60
		46,000		1950	0.61

Pot. Trans. Ratio for Volts 2-3 = 400  
" " " " " NG = 60  
See Fig. 22.

TABLE V.  
Test 12. Check on Resonance Point  
Wet Weather Conditions Jan. 19, 1922.

Reactor Ohms	Current N Direct	Current N at 46,000 V.
811	2.35	2.44
870	3.35	3.48
929	4.9	5.09
982	5.55	5.75
1088	2.95	3.06
1140	2.1	2.18
1207	1.6	1.66

Rain all along line for several hours previous to, and during this test.  
See Fig. 22.

TABLE VI.  
Test 13. Determination of Resonance Point  
System Carrying Load. One Conductor Grounded.  
Vida—Montgomery Line In. Jan. 18, 1922.

Reactor Setting	Volts 2-3		Volts N G		Cur. G		Cur. N	
	Av. Reading	Actual	Av. Reading	Actual	Av. Reading	Actual	Av. Reading	Actual
1630	111.5	44,600	107	26,800	4.9	9.8	2.53	15.2
		46,000		27,600		10.1		15.7
1567	111.2	44,500	106.1	26,600	4.63	9.26	2.63	15.8
		46,000		27,400		9.57		16.4
1492	111.5	44,600	106.3	26,600	4.23	8.46	2.77	16.6
		46,000		27,400		8.74		17.1
1410	111.5	44,600	105.9	26,400	3.82	7.64	2.9	17.4
		46,000		27,200		7.87		17.9
1357	111.0	44,400	104.9	26,200	3.34	6.68	3.05	18.3
		46,000		27,200		6.94		19.0
1276	111.0	44,400	104.9	26,200	2.84	5.68	3.23	19.4
		46,000		27,200		5.89		20.1
1207	111.0	44,400	104.5	26,150	2.37	4.74	3.4	20.4
		46,000		27,100		4.91		21.2
1140	111.0	44,400	104.25	26,100	1.9	3.8	3.59	21.6
		46,000		27,050		3.94		22.4
1088	111.0	44,400	104.5	26,150	1.45	2.90	3.8	22.8
		46,000		27,100		3.0		23.6
982	111.5	44,600	104.6	26,150	1.19	2.38	4.2	25.2
		46,000		26,900		2.45		26.0
929	111.5	44,600	104.65	26,150	1.53	3.06	4.46	27.4
		46,000		26,900		3.16		28.2
870	111.5	44,600	104	26,000	2.23	4.46	4.74	28.4
		46,000		26,800		4.6		29.2
811	111.5	44,600	103.8	25,950	3.1	6.2	5.02	30.1
		46,000		26,700		6.39		31.0

Pot. Trans. ratio Volts 2-3 = 400  
Volts N-G = 250  
Cur. Trans. ratio Cur. G = 2  
Cur. N = 6

See Fig. 23.

grounded. In this case the reactor ohms are varied and readings taken of the reactor current, which current in this case is merely a residual capacitance current due to unbalanced capacitance from the three conductors to ground. The resonance point is indicated by the maximum current.

b. When one conductor is grounded. The reactor ohms are again varied and readings taken of current flowing into the ground. This current is the resultant of the leading charging current and the lagging reactor current, combined with the loss current. At the point of resonance this current should be a minimum and consist only of the loss current.

In Table III are given the readings taken with the system unloaded and the Vida-Montgomery section of line disconnected. The results are plotted in Fig. 21 and show that the resonance setting in this case is about

1410 ohms, which should be compared with the 1470 ohms found from Tests 2 and 3 and 1710 ohms in the original calculation.

In Table IV are given the readings taken with the

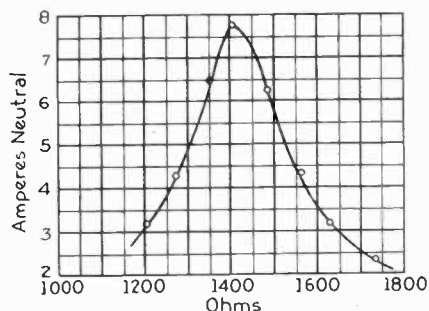

FIG. 21—RESONANCE CURVE, SYSTEM NOT LOADED, VIDA-MONTGOMERY SECTION OUT, NO GROUNDS ON LINE. WET WEATHER CONDITIONS.

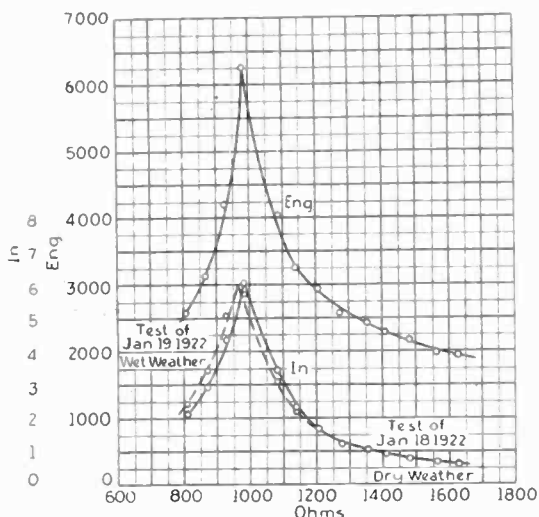

FIG. 22—RESONANCE CURVE, SYSTEM LOADED, ALL CIRCUITS IN. NO GROUNDS ON LINE. DRY AND WET WEATHER CONDITIONS

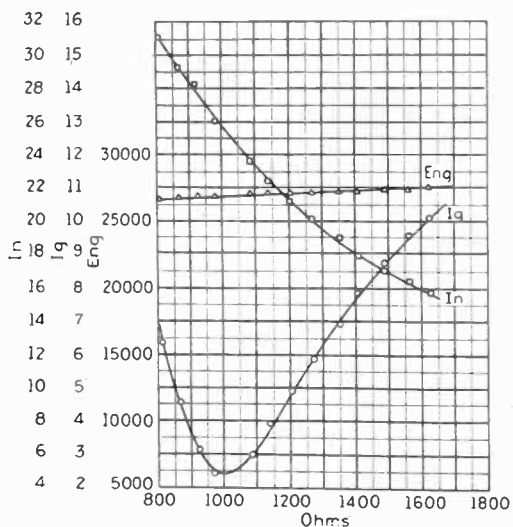

FIG. 23—RESONANCE CURVE, SYSTEM LOADED, ALL CIRCUITS IN. CONDUCTOR 1 GROUNDED AT LOCK 12. DRY WEATHER CONDITIONS

system carrying load and all lines in circuit including the Vida-Montgomery section. There are no grounds on the conductors and the weather is dry. In Table V are similar readings for wet weather conditions, the two

sets of readings having been taken respectively on January 18th and 19th, 1922. The results are plotted in Fig. 22. The resonance point is at about the 982 ohm setting and is apparently shifted to a slightly lower value for the wet condition.

In Table VI are shown the readings for the case in which conductor No. 1 was grounded at Lock 12. The results are plotted in Fig. 23. The resonance point is again at about 982 ohms. This figure should be compared with the 1204 ohms calculated from 1.5 times the normal charging current of the system.

ARCING TESTS

Several series of arcing tests were made, totalling about 50 arcovers. These were made over horn gaps, pin-type insulators and suspension insulators, with various settings of the reactor and with the line loaded and unloaded. Most of the arcs were made at Lock 12 but one each was made at Selma and Montgomery. A typical set of tests is shown by Figs. 24 to 32 inclusive. These show the result of arcs over a 50,000-volt pin-type insulator at Lock 12 with the system loaded and all lines in service. A one-ampere fuse was placed over the insulator and then an oil circuit breaker closed, thus grounding conductor No. 1 through the fuse. Upon the fuse blowing there would result an arc across the insulator. The reactor setting was varied from 811 to 1630 ohms, the normal setting being 982 ohms. Thus the current was off balance anywhere from 40 per cent leading to 21 per cent lagging, *i. e.*, at one extreme the resultant or residual current at the arc was leading and 40 per cent of the total ground current, and at the other extreme the resultant current was lagging and 21 per cent of the total ground current. The results are summarized in Table VII.

In this series of tests the arc was extinguished in from 5½ to 14 cycles. There was only one arc which resembled a power arc, that at the 811 ohms setting. Practically all the other arcs were extinguished with a sharp snap. In some later tests power arcs were produced on two other occasions, both at the 811 ohm setting.

Figs. 33 and 34 are typical photographs of arcs over pin-type insulators, with the reactor set at 1630 and 811 ohms respectively. Figs. 35 and 36 show views of arcs over three suspension insulator disks with the 1630 and 811 ohm settings.

Now we have found by test that a reactor setting of 982 ohms gives resonance with the total system in circuit. The capacity reactance of the system must also be 982 ohms. From this we can work back and find the

capacitance of the system by the relation  $X_c = \frac{1}{2\pi f C}$

At a frequency of 60 cycles this gives a capacitance of 2.7  $\mu f$ . from each of the two ungrounded conductors to ground. Using this value of capacitance and the various reactor ohms, we can now figure the natural

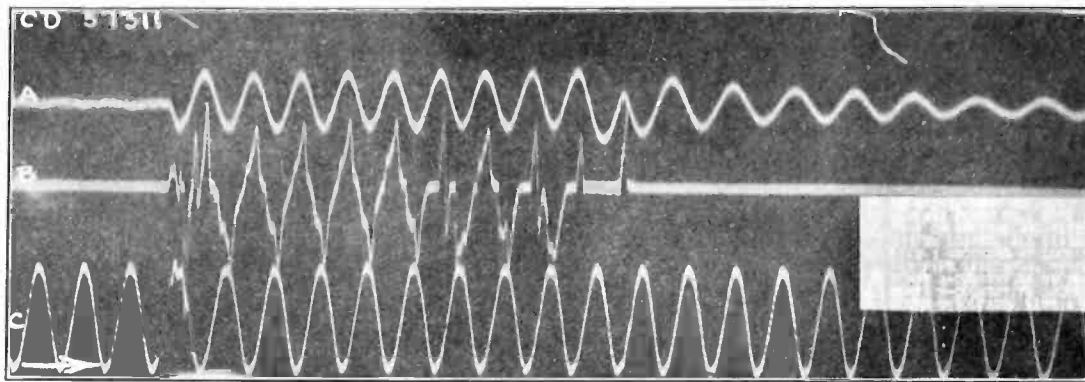

FIG. 24—C D 57311, SYSTEM LOADED, ALL LINES IN SERVICE. CONDUCTOR 1 GROUNDED AT LOCK 12 BY 1 AMPERE FUSE OVER PIN TYPE INSULATOR. NEUTRAL REACTOR SETTING 1630 OHMS.

Curve A, Current in Neutral Reactor.  
 Curve B, Current from Conductor No.1 to ground.  
 Curve C, Voltage between Conductors 2 and 3.

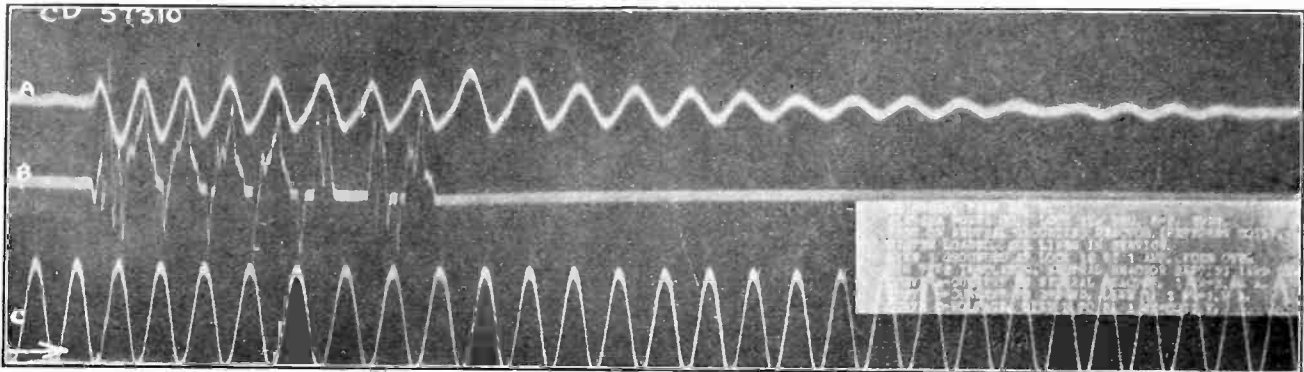

FIG. 25—C D 57310, SYSTEM LOADED, ALL LINES IN SERVICE. CONDUCTOR 1 GROUNDED AT LOCK 12 BY 1 AMPERE FUSE OVER PIN TYPE INSULATOR. NEUTRAL REACTOR SETTING 1492 OHMS.

Curve A, Current in Neutral Reactor.  
 Curve B, Current from Conductor 1 to ground.  
 Curve C, Voltage between Conductors 2 and 3.

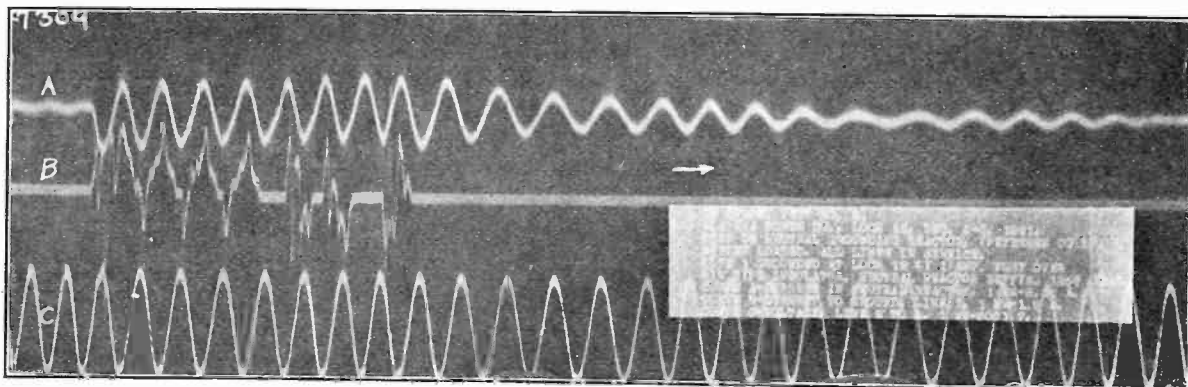

FIG. 26—C D 57309, SYSTEM LOADED, ALL LINES IN SERVICE. CONDUCTOR 1 GROUNDED AT LOCK 12 BY 1 AMPERE FUSE OVER PIN TYPE INSULATOR. NEUTRAL REACTOR SETTING 1357 OHMS.

Curve A, Current in Neutral Reactor.  
 Curve B, Current from Conductor 1 to ground.  
 Curve C, Voltage between Conductors 2 and 3.

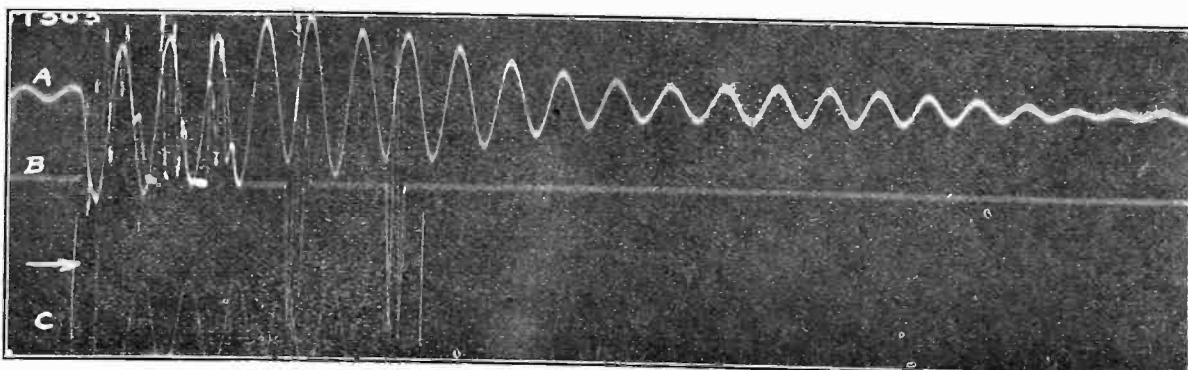

FIG. 27—C D 57303, SYSTEM LOADED, ALL LINES IN SERVICE. CONDUCTOR 1 GROUNDED AT LOCK 12 BY 1 AMPERE FUSE OVER PIN TYPE INSULATOR. NEUTRAL REACTOR SETTING 1207 OHMS.

Curve A, Current in Neutral Reactor.  
 Curve B, Current from Conductor 1 to ground.  
 Curve C, Voltage between Conductors 2 and 3.



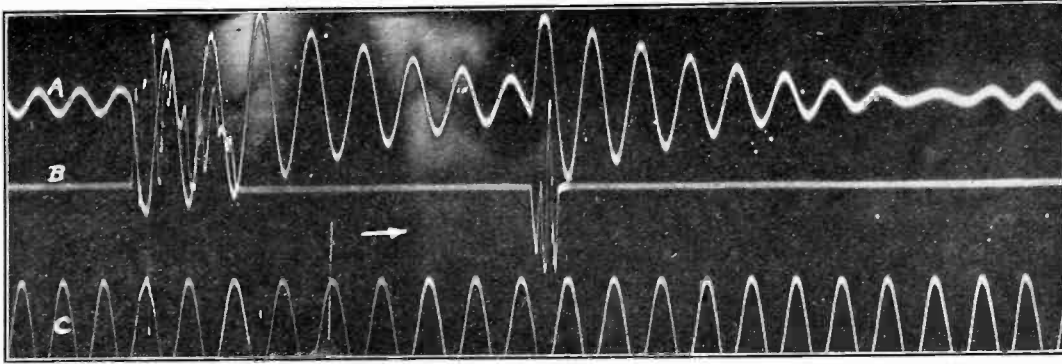

FIG. 28—C D 57304, SYSTEM LOADED, ALL LINES IN SERVICE. CONDUCTOR 1 GROUNDED AT LOCK 12 BY 1 AMPERE FUSE OVER PIN TYPE INSULATOR. NEUTRAL REACTOR SETTING 1088 OHMS

Curve A, Current in Neutral Reactor.  
 Curve B, Current from Conductor 1 to ground.  
 Curve C, Voltage between Conductors 2 and 3.

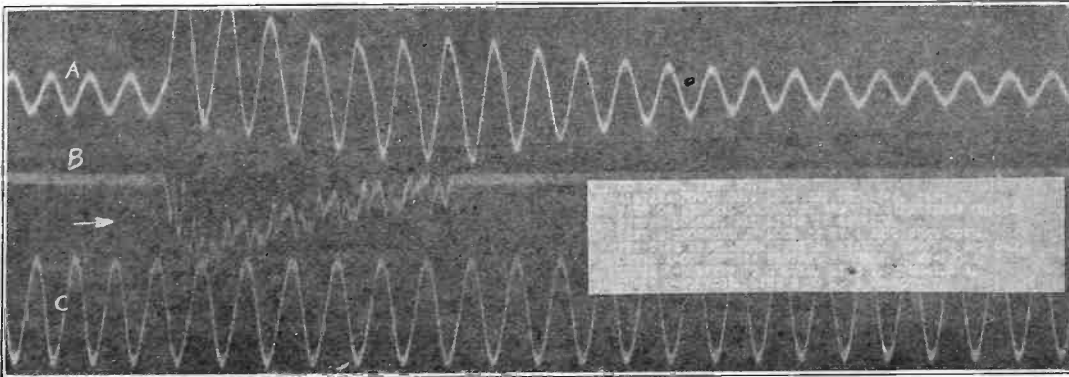

FIG. 29—C D 57305, SYSTEM LOADED, ALL LINES IN SERVICE. CONDUCTOR 1 GROUNDED AT LOCK 12 BY 1 AMPERE FUSE OVER PIN TYPE INSULATOR. NEUTRAL REACTOR SETTING 982 OHMS

Curve A, Current in Neutral Reactor.  
 Curve B, Current from Conductor 1 to ground.  
 Curve C, Voltage between Conductors 2 and 3.

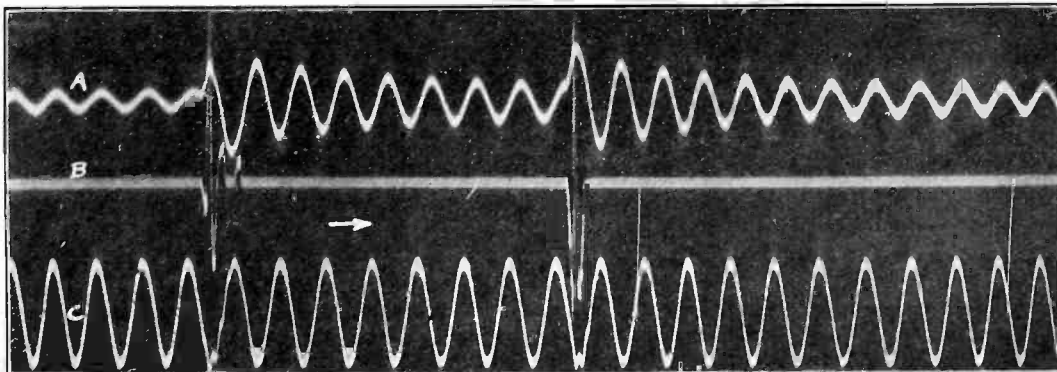

FIG. 30—C D 57306, SYSTEM LOADED, ALL LINES IN SERVICE. CONDUCTOR 1 GROUNDED AT LOCK 12 BY 1 AMPERE FUSE OVER PIN TYPE INSULATOR. NEUTRAL REACTOR SETTING 929 OHMS

Curve A, Current in Neutral Reactor.  
 Curve B, Current from Conductor 1 to ground.  
 Curve C, Voltage between Conductors 2 and 3.

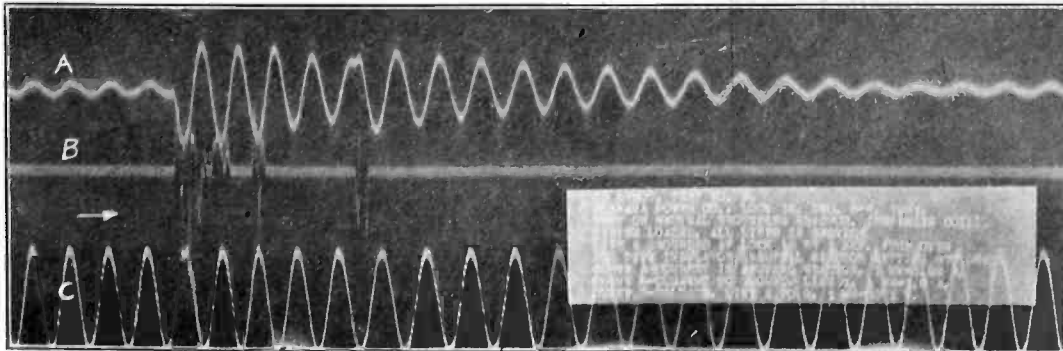

FIG. 31—C D 57307, SYSTEM LOADED, ALL LINES IN SERVICE. CONDUCTOR 1 GROUNDED AT LOCK 12 BY 1 AMPERE FUSE OVER PIN TYPE INSULATOR. NEUTRAL REACTOR SETTING 870 OHMS

Curve A, Current in Neutral Reactor.  
 Curve B, Current from Conductor 1 to ground.  
 Curve C, Voltage between Conductors 2 and 3.

TABLE VII.  
Arc-Over Tests with Neutral Reactor  
Pin Type Insulator

Fig.	C D	Ohms	Amperes	Per cent Unbalance	Arc Lasts
24	57,311	1630	16.3	40 load	10.5 cycles
25	57,310	1492	17.8	34 "	7.5 "
26	57,309	1357	19.6	27 "	8.5 "
27	57,303	1207	22.0	19 "	7.0 "
28	57,304	1088	24.4	10 "	9.5 "
29	57,305	982	27.0	Zero	6.5 "
30	57,306	929	28.6	6 lag	8.5 "
31	57,307	870	30.5	13 "	5.5 "
32	57,308	811	32.7	21 "	14.0 "

frequency of the circuit consisting of reactor and line capacitance for different settings of the reactor by the

equation  $f = \frac{1}{2\pi\sqrt{LC}}$ . In Table VIII are summarized

the results for the reactor settings corresponding to

and a residual current of 6 amperes circulates through the reactor and arc in series. The resonant circuit has a natural frequency of 66 cycles.

Now suppose that the arc breaks. Then the 6 amperes through the arc cease to flow. The 27 amperes in the reactor-condenser circuit tend to die away by an oscillation at the natural frequency of the circuit, 66 cycles. The potential of conductors 1 and 2 decreases from 1.732 times normal to normal potential (*e*) above ground. The potential of conductor 3 increases from zero to normal potential (*e*) above ground. The charges on conductors 1, 2 and 3 adjust themselves correspondingly. This adjustment takes place through a compound oscillation, consisting of a superposition of the normal frequency and the frequency of the resonant circuit.

Fig. 39 illustrates the adjustment of the voltage of conductor 3 to ground when the normal frequency is

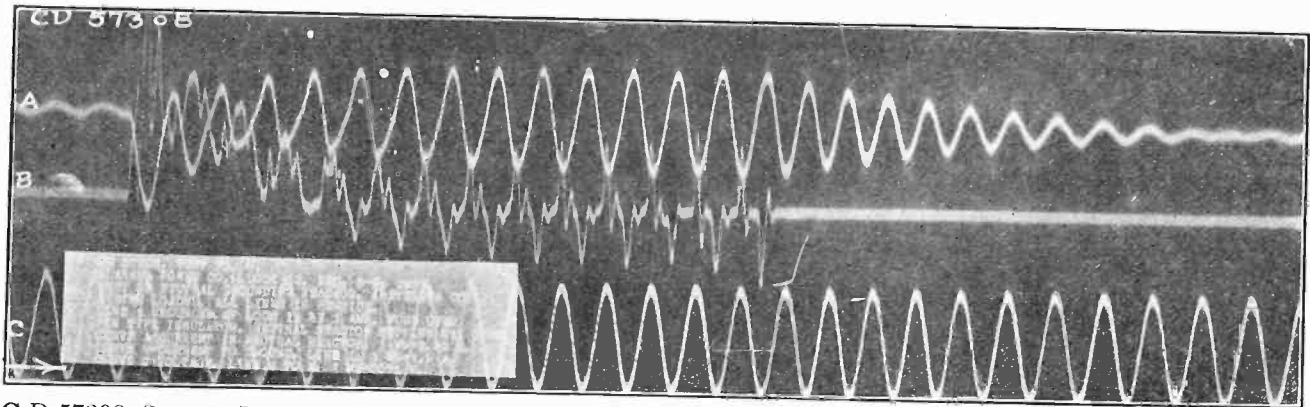

FIG. 32—C D 57308, SYSTEM LOADED, ALL LINES IN SERVICE. CONDUCTOR 1 GROUNDED AT LOCK 12 BY 1 AMPERE FUSE OVER PIN TYPE INSULATOR. NEUTRAL REACTOR SETTING 811 OHMS

Curve A, Current in Neutral Reactor.  
Curve B, Current from Conductor 1 to ground.  
Curve C, Voltage between Conductors 2 and 3.

Figs. 24 to 32 inclusive, both as calculated and as measured from the oscillograms.

Assume a reactor setting of 811 ohms. Then currents will flow somewhat as shown in Fig. 37 (neglecting

60 cycles and the frequency of the resonant circuit greater than, equal to, and less than 60 cycles.

From this figure it will be noticed that there is a

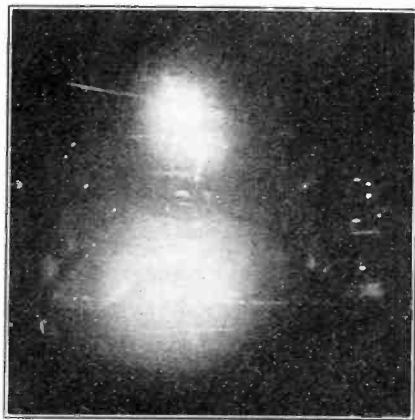

FIG. 33—PHOTOGRAPH OF ARC OVER PIN TYPE INSULATOR. REACTOR SETTING 1630 OHMS. TAKEN WITH C D 57311 (FIG. 24)

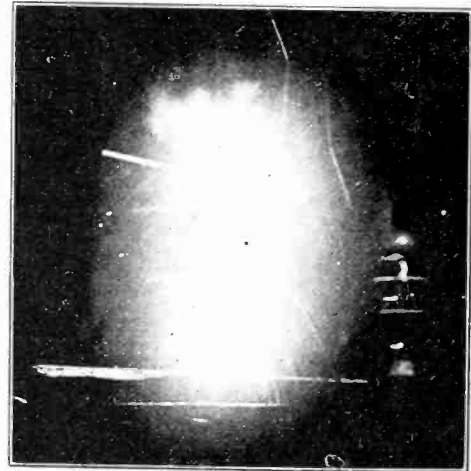

FIG. 34—PHOTOGRAPH OF ARC OVER PIN TYPE INSULATOR. REACTOR SETTING 811 OHMS. TAKEN WITH C D 57308 (FIG. 32)

loss current). Fig. 38 represents an equivalent circuit. A current of 27 amperes circulates in the resonant circuit consisting of reactor and line capacitance,

tendency for the voltage from conductor to ground to over-shoot in the adjustment to normal value after the arc is extinguished. Mr. L. F. Blume has shown this

in another way by plotting, in polar coordinates, the voltage from neutral to ground (voltage across reactor). Three of his plots are reproduced in Figs. 40, 41 and 42, these being respectively for the 49, 60 and 66-cycle resonance frequencies. The data for these tests are



FIG. 35—PHOTOGRAPH OF ARC OVER THREE SUSPENSION INSULATOR DISKS. REACTOR SETTING 1630 OHMS



FIG. 36—PHOTOGRAPH OF ARC OVER THREE SUSPENSION INSULATOR DISKS. REACTOR SETTING 811 OHMS

TABLE VIII.

Natural Frequency of Resonant Circuit

Fig.	C D	Ohms	L Henry	C Mf.	Natural Frequency Calculated	Natural Frequency Measured
24	57,311	1630	4.32	2.7	47 cycles	47 cycles
25	57,310	1492	3.95	2.7	49 "	49 "
26	57,309	1357	3.6	2.7	51 "	51 "
27	57,303	1207	3.2	2.7	54 "	54 "
28	57,304	1088	2.88	2.7	57 "	57 "
29	57,305	982	2.6	2.7	60 "	60.75 "
30	57,306	929	2.46	2.7	62 "	62.5 "
31	57,307	870	2.3	2.7	64 "	63 "
32	57,308	811	2.15	2.7	66 "	66 "

taken directly from the oscillograms, Figs. 25, 29 and 32 as follows:

Curve A of the oscillograms shows the current in the neutral reactor. This may equally well be taken for the voltage across the neutral reactor, this voltage having the same shape and being at all times the prod-

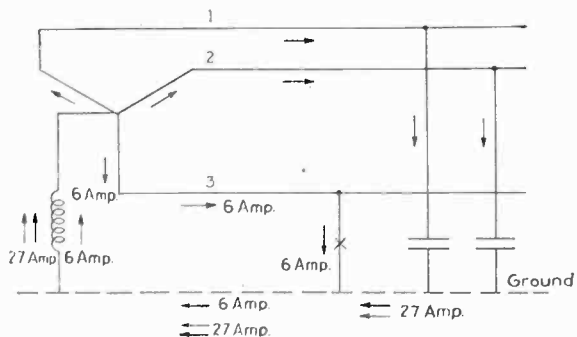

FIG. 37—THREE-PHASE CIRCUIT WITH NEUTRAL GROUNDING REACTOR OHMS OFF BALANCE. ASSUMED FLOW OF CURRENTS

uct of the current in the reactor times the ohms. The amplitude of the reactor voltage may therefore be measured on the oscillograms and the angle of lag or lead determined by comparison with the reference voltage, Curve C, remembering that the reactor voltage

is 90 deg. ahead of the current. After plotting these to scale it is then possible to determine at any instant the voltage from any point to ground, the ground being considered to occupy successive positions along the spiral. Thus in Fig. 40 at the instant the arc breaks, the voltage from conductor 2 to ground is the distance 2-G, conductor 3 to ground 3-G, and neutral to ground 0-G, conductor 1 being at ground potential. At the instant represented by the first positive peak after the arc breaks the voltages are respectively from conductor 3 to ground 3-G<sub>1</sub>, from conductor 2 to ground 2-G<sub>1</sub>, from conductor 1 to ground 1-G<sub>1</sub> and from neutral to ground 0-G<sub>1</sub>, etc. The voltage from neutral to ground

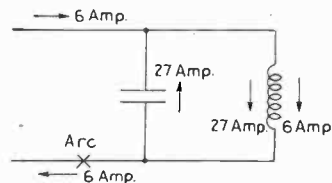

FIG. 38—EQUIVALENT DIAGRAM, SHOWING RESONANT CIRCUIT

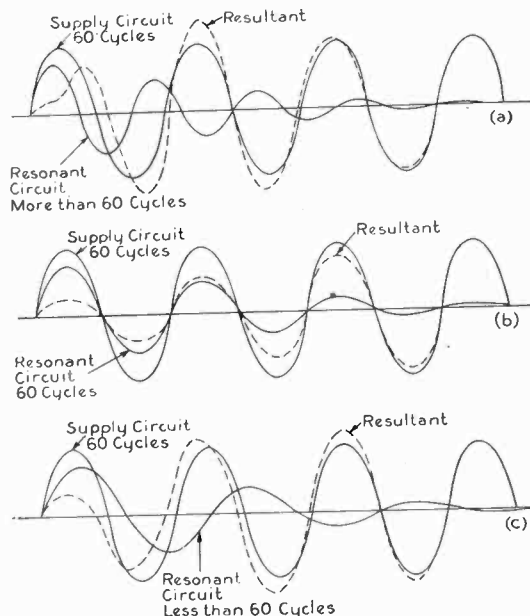

FIG. 39—ADJUSTMENT OF VOLTAGE FROM FAULTY CONDUCTOR TO GROUND AFTER ARC BREAKS

- a—Natural frequency of resonant circuit greater than that of supply circuit.
- b—Natural frequency of resonant circuit same as that of supply circuit.
- c—Natural frequency of resonant circuit less than that of supply circuit.

does not finally go to zero but remains at some value such as 0-G<sub>11</sub> on account of the residual ground current which flows through the reactor at all times.

It will be noted that on some of the oscillograms the curve of current in the neutral reactor after the arc breaks apparently decreases to a minimum value and then increases, in other words has an anti-nodal point. Fig. 43 illustrates this nicely. This is because the current in the reactor consists of the oscillation current at the natural frequency of the oscillation circuit, superimposed on the 60-cycle residual ground current. At times their maxima coincide and at other times oppose and the anti-nodes appear at the points of opposition.

We have thus seen that there is the theoretical possibility when the arc-breaks of a voltage building up from the faulty line to ground greater than the normal line to neutral voltage and from the sound lines to ground greater than the normal line to line voltage, in case there is a difference between the resonant and supply

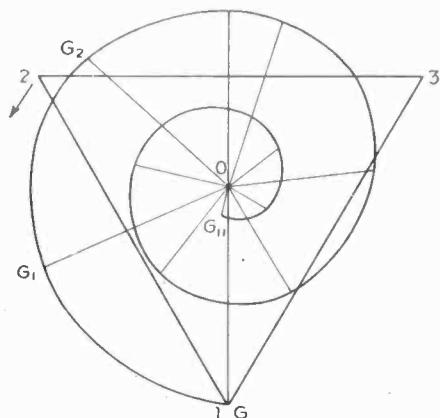

FIG. 40—POLAR DIAGRAM OF VOLTAGE OSCILLATION AFTER BREAKING OF ARC. FROM CD 57310 (FIG. 25). REACTOR SETTING 1492 OHMS. FREQUENCY DECREASES FROM 60 TO 49 AT INSTANT FUSE BLOWS

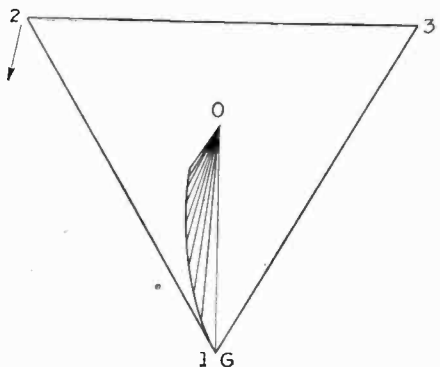

FIG. 41—POLAR DIAGRAM OF VOLTAGE OSCILLATION AFTER BREAKING OF ARC. FROM CD 57305 (FIG. 29). REACTOR SETTING 982 OHMS. FREQUENCY DECREASES FROM 60 TO 59.4 AT INSTANT FUSE BLOWS

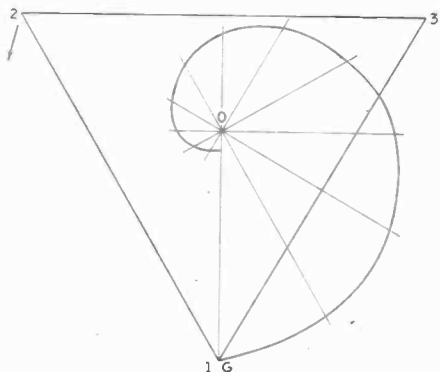

FIG. 42—POLAR DIAGRAM OF VOLTAGE OSCILLATION AFTER BREAKING OF ARC. FROM CD 57308 (FIG. 32). REACTOR SETTING 811 OHMS. FREQUENCY INCREASES FROM 60 TO 66 AT INSTANT FUSE BLOWS

frequencies, *i. e.*, providing the reactor setting is not in exact resonance. Let us see what the tests show in this respect.

Two tests were made at the 982 ohm setting (resonance setting), arcing over a  $\frac{3}{4}$ -inch horn gap from conductor 1 to ground. The oscillograms showed the

following: (a) the wave of voltage line 1 to ground went abruptly to zero at the making of the arc and at the breaking of the arc slowly increased to normal. (b) The voltage from line 3 to ground jumped from normal to about 40 per cent above normal (should theoretically go to 73 per cent above normal for a dead ground). (c) The voltage from neutral to ground goes to a value of about 26,800 root-mean-square volts (theoretically should be 26,500 volts) and remains at this value throughout the arc, except that at the first half cycle after the arc is made there is a peak 5 to 20 per cent greater than the steady peak value.

With the 1207 ohm setting (19 per cent unbalance leading) three tests were made, one with an arc over a  $\frac{3}{4}$ -inch gap and two over a  $3\frac{1}{2}$ -inch gap from conductor 1 to ground. The oscillograms showed (a) wave of voltage line 1 to ground, after the arc broke, went through a slow oscillation increasing above normal then decreasing to less than normal and finally increasing to normal. The maximum was about 35 per cent above normal. (b) The voltage from line 3 to ground increased from normal to a steady value of 50 per cent over normal and for a half cycle to about 70 to 75 per cent above normal. (Should go to 73 per cent above normal as a steady value for a dead ground). (c) The voltage from neutral to ground goes to a steady value of about 26,800 volts, but at the first half cycle after the arc is made there is a peak 15 to 25 per cent greater than the steady peak. Fig. 44, Fig. 45 and Fig. 46 are typical.

As far as the oscillograms are concerned for the limited number of settings tried, there is no overvoltage from any conductor to ground beyond the 73 per cent excess voltage expected from two conductors to ground when the third conductor is grounded. From neutral to ground there is a half-cycle peak about 25 per cent above the line to neutral voltage expected with one conductor grounded. Possibly a further unbalance in the reactor setting would increase these figures somewhat.

Some check tests were made on this point by means of a  $12\frac{1}{2}$ -cm. sphere gap, with one sphere connected to ground and the other sphere connected to the line conductor by means of four disk insulators, arranged two in series and two in multiple. Readings were taken for the four tests just described and also for three additional tests in which arcs were made from conductor 1 over  $3\frac{1}{2}$ -inch horn gaps and with reactor settings of 1630 ohms (40 per cent unbalance leading), 1207 ohms (19 per cent unbalance leading) and 811 ohms (21 per cent unbalance lagging). The insulator and gap were arranged in some of the tests between conductor 1 and ground and in others between conductor 2 and ground. The sphere gap was set above the expected arcing distance and then screwed down until it arced. The results are given in Table IX.

The figures of Table IX may be discussed as follows: With the sphere located between conductor 1 and

ground and the 1207 ohm setting, the sphere gaps arced over in one case at 9.5 kv. and in another case at 14.5 kv. With the sphere from conductor 2 to ground and the 1207 ohm setting, the sphere gap arced over at 25 kv. in one case and 30 kv. in another case. With the 1630 ohm setting the spheres arced over at 30 kv. and with the 811 ohm setting at 25 kv. Now in order to interpret these results, it would be necessary to know the division of voltage between the spheres and the insulators. This division of voltage depends upon the relative capacitances of the sphere gap and insulators, and on whether the spheres are grounded or not.

that high-voltage switching operations on grounded neutral and ungrounded neutral systems commonly give overvoltages 70 to 80 per cent above normal (theoretically twice normal), also that single-phase short circuits from line to neutral on grounded neutral systems will so distort the voltage triangle as to give an overvoltage between the two unshort-circuited conductors of approximately 80 per cent. Overvoltages less than these values should therefore not be considered excessive.

SHORT CIRCUIT FROM LINE TO LINE

Some tests were made to determine whether or not a

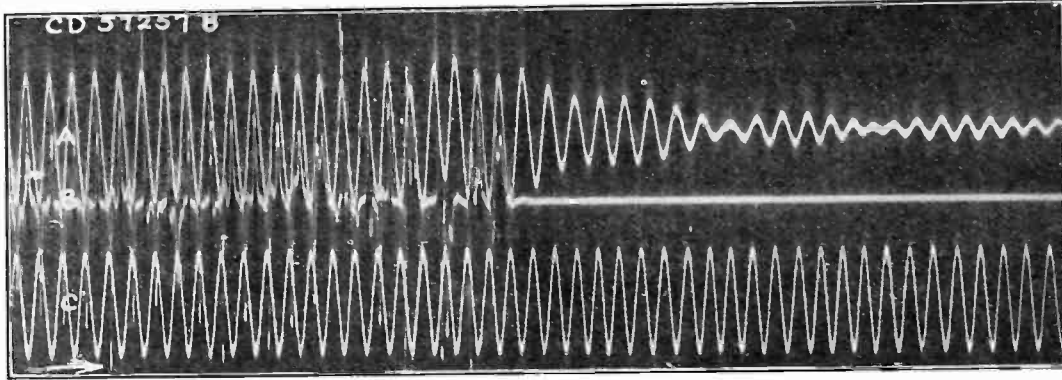

FIG. 43—C D 57257-B. SYSTEM NOT LOADED. VIDA-MONTGOMERY LINE OUT. CONDUCTOR 1 GROUNDED AT LOCK 12 BY 1 AMPERE FUSE OVER 3.5 INCH HORN GAP. NEUTRAL REACTOR SETTING 2015 OHMS

Curve A, Current in Neutral Reactor.  
 Curve B, Current from Conductor 1 to ground.  
 Curve C, Voltage between Conductors 2 and 3.

This is further complicated by the fact that the capacitance of the spheres varies with the setting, being greater with smaller settings. It is possible that the division of voltage is such as to give rather high momentary voltage from line to ground. However, if so, this is not sufficiently prolonged to show itself on the oscillograms, and therefore is probably relatively harmless.

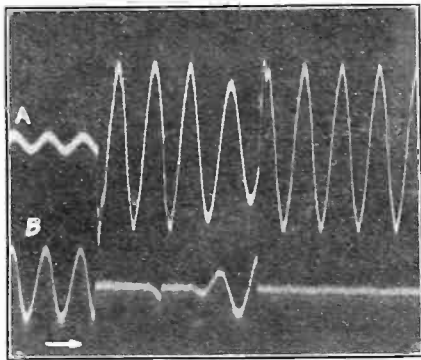

FIG. 44—C D 57367-A. SYSTEM LOADED. ALL LINES IN SERVICE. CONDUCTOR 1 GROUNDED AT LOCK 12 BY 1 AMPERE FUSE ACROSS 3.5 INCH HORN GAP. NEUTRAL REACTOR SETTING 1207 OHMS

Curve A, Voltage from Neutral to ground.  
 Curve B, Voltage from Conductor 1 to ground.

In considering the question of overvoltages, we must remember that all transformers (except those with graded insulation, which at present are not very common) are tested at 3.46 times normal (line to ground) voltage and that the line insulation has this much or greater factor of safety. Also it must be remembered

TABLE IX.

Test 15. Measurement of Voltage-Rise During Arcing Test

12 1/2 Cm. Spheres Placed on Ground Side of 4 Insulator Discs Arranged Two Series and Two Multiple.

Arc from Conductor 1 to Ground Over Horn Gap.

Jan. 19, 1922

Reactor Ohms	Horn Gap Setting Inches	Spheres Located	Sphere Gap		Sphere Gap Arc or Not Arc	Oscillo C D
			Cm.	Kv.		
982	3/4	1-G	1.65	35	No	57,360-1
			1.2 to	26 to	No	57,362-3
			1.0	21		
1207	3/4	1-G	1.2 to	26 to		57,364-5
			0.51	10	No	
			0.5	9.5	Yes	
1207	3/4	1-G	0.5 to	9.5 to		57,366-7
			0.72	14.5	Yes	
			0.73	15	No	
1207	3/4	2-G	2.45	50	No	57,368-9
			2.1	44	No	
			1.65	35	No	
			1.0	20	Yes	
			1.15	25	Yes	
			1.4	30	No	
1630	3/4	2-G	1.4	30	Yes	
			1.65	35	No	
			1.65	35	No	
1207	3/4	2-G	1.4	30	Yes	
			1.65	35	No	
811	3/4	2-G	1.4	30	No	
			1.15	25	Yes	

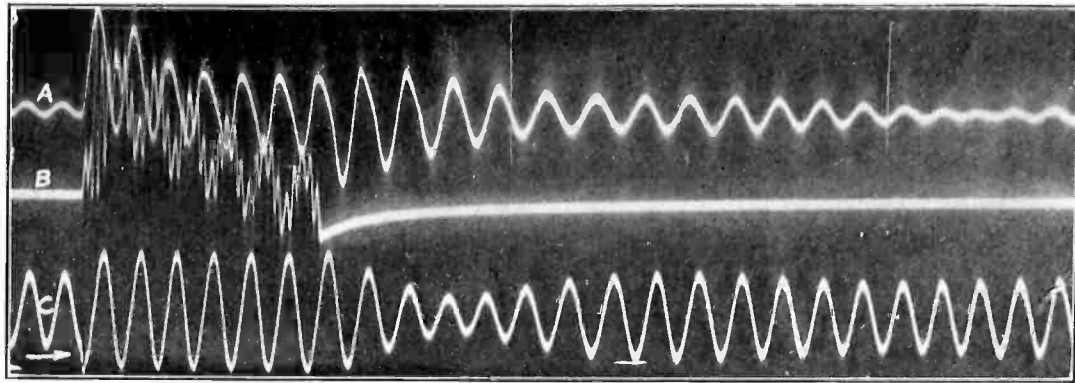

FIG. 45—C D 57368. SYSTEM LOADED. ALL LINES IN SERVICE. CONDUCTOR 1 GROUNDED AT LOCK 12 BY 1 AMPERE FUSE ACROSS 3.5 INCH HORN GAP. NEUTRAL REACTOR SETTING 1207 OHMS  
 Curve A, Current in Neutral Reactor.  
 Curve B, Current from Conductor 1 to ground.  
 Curve C, Voltage from Conductor 3 to ground.

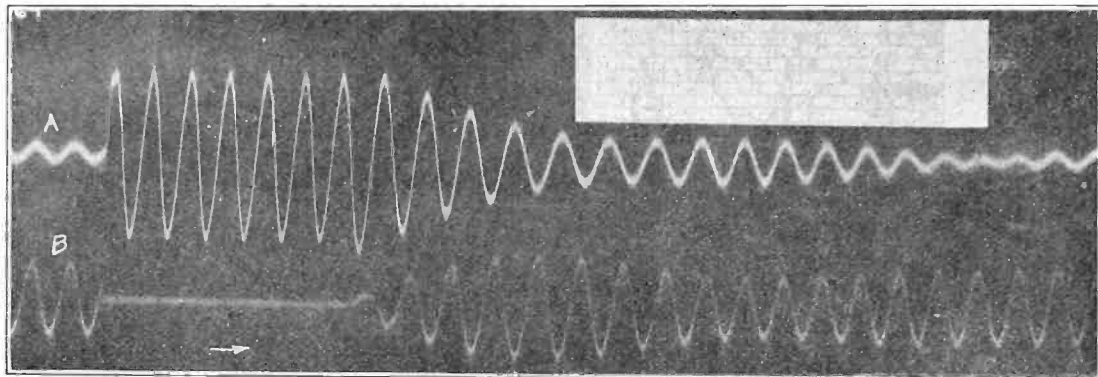

FIG. 46—C D 57369. SYSTEM LOADED. ALL LINES IN SERVICE. CONDUCTOR 1 GROUNDED AT LOCK 12 BY 1 AMPERE FUSE ACROSS 3.5 INCH HORN GAP. NEUTRAL REACTOR SETTING 1207 OHMS  
 Curve A, Voltage from Neutral to ground.  
 Curve B, Voltage from Conductor 1 to ground.

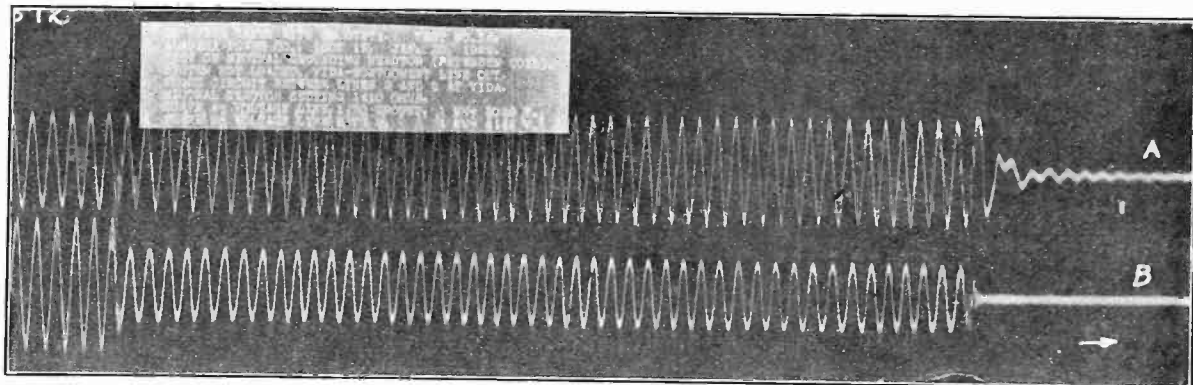

FIG. 47—C D 57372. SYSTEM NOT LOADED. VIDA-MONTGOMERY LINE OUT. NEUTRAL GROUNDED THROUGH REACTOR SET AT 1410 OHMS. SHORT CIRCUIT BETWEEN CONDUCTORS 2 AND 3 AT VIDA  
 Curve A, Voltage from Conductor 1 to ground.  
 Curve B, Voltage between Conductors 2 and 3.

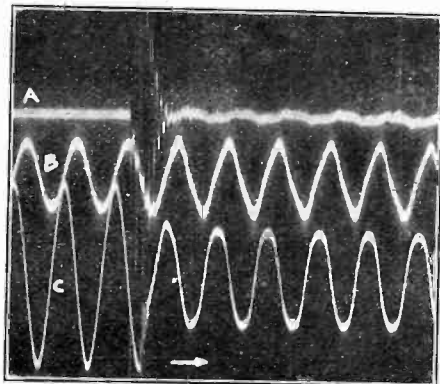

FIG. 48A

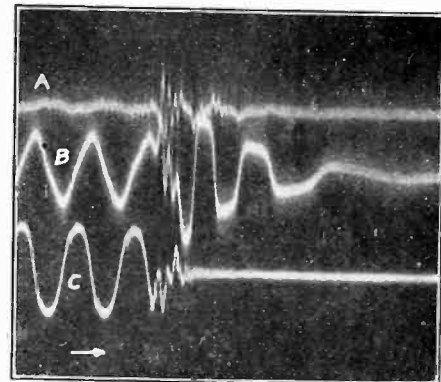

FIG. 48B

FIG. 48—C D 57375-A, C D 57375-C. SYSTEM NOT LOADED. VIDA-MONTGOMERY LINE OUT. NEUTRAL SOLIDLY GROUNDED. SHORT CIRCUIT BETWEEN CONDUCTORS 2 AND 3 AT VIDA.  
 Curve A, Current in grounded neutral.  
 Curve B, Voltage from Conductor 1 to ground.  
 Curve C, Voltage between Conductors 2 and 3.

single-phase line to line short circuit would cause a voltage rise from the unshort-circuited line to ground. The system was not loaded, and the Vida-Montgomery line was out. A single-phase short circuit was placed between conductors 2 and 3 at Vida and the switch closed at Lock 12. Voltage was measured from Line 1 to ground and between lines 2 and 3. Tests were made with the neutral grounded through the reactor, set at 1410 ohms, and also with the neutral solidly grounded. Fig. 47 illustrates the case with reactor, Fig. 48 the case with the neutral solidly grounded. It is interesting to note that in Fig. 47 there is a momentary rise at the make and break of the short circuit of 57 to 58 per cent in the voltage from line 1 to ground. In Fig. 48 there is a voltage rise of about 63 per cent at the break of the short circuit. In other words there is about the same voltage rise whether the neutral is grounded solidly or through a reactor, and this is probably solely due to the distortion of the voltage triangle by the short-circuit current acting on the generator voltage.

SOLID GROUNDS ON LINE

As previously explained when a solid ground occurs on a conductor, means are provided to cut off the sec-

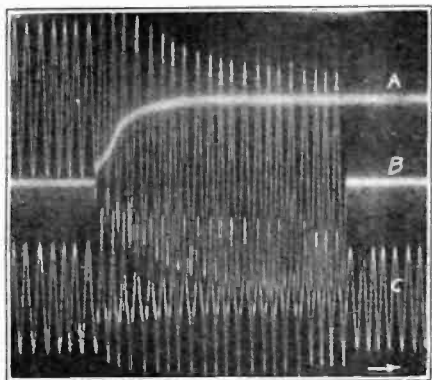

FIG. 49—C D 57262. SYSTEM NOT LOADED. VIDA-MONTGOMERY LINE OUT. NEUTRAL REACTOR SETTING 1735 OHMS. CONDUCTOR 1 SOLIDLY GROUNDED AT LOCK 12 AND REACTOR AUTOMATICALLY SHORT CIRCUITED, THUS PLACING SHORT CIRCUIT ON SYSTEM

Curve A. Current in Neutral Reactor.  
Curve B. Short circuit current.  
Curve C. Voltage between Conductors 2 and 3.

tion in trouble at a predetermined time. Fig. 49 and Fig. 50 illustrate the action of this device.

In Fig. 49 the top wave is the current through the reactor due to the solid line ground on conductor 1 at Lock 12. About the middle of the oscillogram the oil circuit breaker closes and short-circuits the reactor, the reactor current going slowly to zero. Short-circuit current then flows (middle wave) until the line is disconnected by the overload relays. The bottom wave is the voltage between conductors 2 and 3 and it is interesting to note that this increases in value to a marked extent, the highest peak being about 90 per cent greater than normal.

In Fig. 50 the middle wave is the reactor current, which is residual current only until the line ground is thrown on about  $\frac{3}{8}$  of the distance from the left end of C D 57302-A. At the end of the two seconds the oil circuit breaker short-circuits the reactor and the reactor current goes to zero (just beyond the center of C D 57302-B.) The short-circuit current then appears in the top wave and is cut off by the line oil circuit breaker near the end of the oscillogram. The bottom wave is the voltage from conductor 1 to conductor 3, which increases during the time of short circuit at the maximum peak about 70 per cent above normal voltage and about 30 per cent during the sustained period of the short circuit.

The relay connected to the secondary of the current transformer in series with the reactor, in this case was

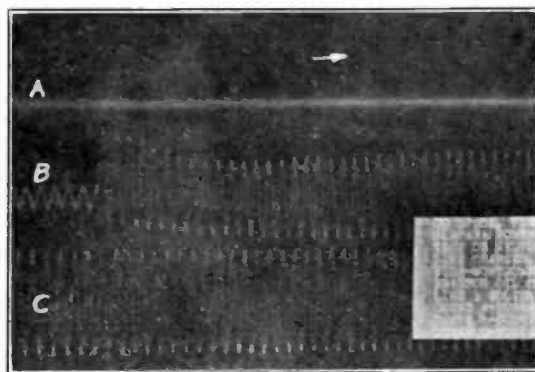

FIG. 50A

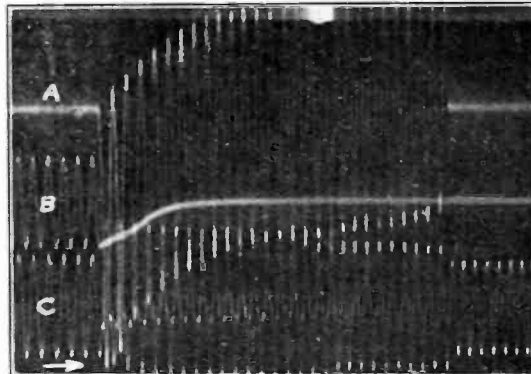

FIG. 50B

FIG. 50—C D 57302-A, C D 57302-B. SYSTEM NOT LOADED. VIDA-MONTGOMERY LINE OUT. NEUTRAL REACTOR SETTING 1735 OHMS. CONDUCTOR 1 SOLIDLY GROUNDED AT LOCK 12 AND REACTOR AUTOMATICALLY SHORT CIRCUITED, THUS PLACING SHORT CIRCUIT ON SYSTEM

Curve A. Short circuit current.  
Curve B. Current in Neutral Reactor.  
Curve C. Voltage between Conductors 2 and 3.

set to operate in two seconds and on about 12 amperes, and in Fig. 50 it will be noted that the reactor oil circuit breaker closed in just 120 cycles after the ground was placed on the circuit.

LIMITATIONS IN USE AND OTHER FORMS OF DEVICE

From the writer's study of this device he is of the opinion that its use will be limited for the present to

comparatively low-voltage lines of moderate length, *i. e.*, perhaps up to 66,000 volts, or in a few cases up to 100,000 volts if the length is short. The reason for this limitation is as follows: The current through the reactor is affected by the line reactance. In the case of a short line or low-voltage line this is comparatively small. For example, the Alabama line we have been considering has about 20 ohms reactance, which added to 982 ohms makes an insignificant change in the reactor current. On the other hand a typical 154,000-volt line may require 200 ohms in the reactor and reactance of the line itself may be 150 ohms. It is probable that the residual current in this case would maintain the arc.

In this country the device appears most applicable to those systems which are now operating isolated neutral, and which for some reason connected with the operation or apparatus, do not wish to go to the solidly grounded neutral.

If more than one point is grounded, a reactor must be provided for each point.

If there are no points suitable for grounding, an artificial neutral may be provided by means of a grounding transformer connected *Y*-delta, the *Y* being connected to the high-tension line and the reactor placed between its neutral and ground, or the reactor may be connected in one corner of the low-tension delta, or the neutral of the transformer may be grounded solidly and the necessary reactance placed inherently in the transformer between high-tension and low-tension windings.

It has been suggested that with each section of the line a reactor be provided, which may be switched on and off with the line section, thus providing a good balance at all times. Such a reactor may take any of the forms previously mentioned or it may consist merely of a reactor between each of the three conductors and ground, this reactor being designed to balance the capacitance to ground of that section of the line. If one conductor becomes grounded, then the reactor on that phase is short-circuited as well as the capacitance to ground, while on the other two phases the reactor and capacitance as well are raised to the same voltage above ground, and therefore still neutralize each other. By this method, the reactors being in circuit at all times, tend to counteract the normal line charging current, which is sometimes useful for line regulation.

#### CONCLUSION

Calculations show that the current to ground when one conductor of a three-phase system is grounded is approximately 1.5 times the normal three-phase charging current. Tests on one system show that if the system has a ground wire the ground current is increased about 20 per cent.

About 50 arcover tests were made with the neutral grounding reactor in service, and various settings of reactance both in and out of balance. The reactor satisfactorily performed its function as an arc ex-

tinguisher. From the tests it would appear that considerable tolerance is permissible in the setting of the reactor.

From the standpoint of voltage stresses, the system with reactor is more like an isolated neutral system than a grounded neutral system, except that the excessive voltage rises due to arcing grounds which occur on an isolated neutral system are eliminated. There is a possibility of overvoltage when the arc breaks due to a difference between the resonant and supply frequencies, providing the reactor setting is not in exact resonance.

The system with reactor has an advantage over the grounded neutral system in that arcs are eliminated without short circuit, which is desirable since short circuits cause mechanical stress to apparatus as well as frequent interruption of service.

In the case of a dead ground on the line, the reactor is short-circuited, the neutral grounded and the circuit cleared by line relays. The device designed to take care of this operation satisfactorily performed its function in test.

In the writer's opinion the device will be limited to comparatively low voltage and short systems for the present, owing to the expense of installing on high voltage and long systems and the difficulty of obtaining a current balance at the arc. Owing to the popularity of and satisfaction achieved with grounded neutral systems in this country, the use of the grounding reactor will probably be limited mainly to isolated neutral systems, whose operation is not satisfactory, but on which for some reason it is not wished to solidly ground the neutral.

On the system tested there was a small current flowing at all times to the solidly grounded neutral, due to unbalanced line capacitance. This current contained fifth and seventh harmonics. The neutral reactor caused this current to increase appreciably but the fifth and seventh harmonics were totally eliminated.

The writer wishes to acknowledge the hearty cooperation of Mr. J. M. Oliver, Operating Engineer of the Alabama Power Company, and his assistants, also that of Messrs. M. A. Rusher and C. L. Schermerhorn of the General Engineering Laboratory of the General Electric Company in making the tests.

#### Bibliography

1. Limitation of Earth Current and Suppression of Earth Fault Arcs by the Earthing Coil, by W. Petersen, *Elektrotechnische Zeitschrift* Jan. 2 and 9, 1919. The fundamental paper on the subject of the neutral grounding reactor.
2. Grounding Through Earth Coils as a Means of Protection Against Accidental Grounds and the Resultant Overvoltages, by R. Bauch, *Elektrotechnische Zeitschrift*, June 2 and 9, 1921. Discusses the use of grounding transformers in lieu of the Petersen Coil.
3. The Petersen Earth Coil, by R. N. Conwell and R. D. Evans, *JOURNAL, A. I. E. E.*, Feb. 1922. Discusses the results of some tests made on the system of the Public Service Company of New Jersey.



# 1922 Developments in Autovalve Lightning Arresters

BY A. L. ATHERTON

Member A. I. E. E.

Westinghouse Electric & Mfg. Co., E. Pittsburgh, Pa.

*The work done in the past year in developing commercial forms of lightning arresters based on the "autovalve" principle is reported. Fundamental data given by Dr. Slepian at the 1922 Midwinter Convention are briefly reviewed. The balance of the paper deals with new material and covers further research, development and test. Further research supports the original findings and gives specific information on basic relations. In the development work, required characteristics are first determined, and then structures are developed to give these characteristics. Commercial forms of the arresters are shown and the performance characteristics described, in fundamental units and in comparison with standard electrolytic arresters. Tests in the laboratory and observation under service conditions verify the calculated results and show the "autovalve" arresters designed for station service to parallel the electrolytic in performance. Test methods and results are described and service results reported.*

AT the midwinter convention in February 1922 reference was made in discussion by Dr. Slepian, to a new principle of lightning arrester construction with which work was being carried on. At that time there had been a considerable amount of laboratory experience and a small amount of service experience with devices on the new principle and the results had been so uniformly promising that an intensive program of development was inaugurated.

Owing to the nature of the conditions which a lightning arrester is called upon to meet, it was felt that in this case as in others, the ordinary laboratory proof of the experimental and design work should be supplemented by extensive trials of experimental installations under close observation and under actual service conditions.

Since that time the work of one year has been done. Results of increasing promise and of continued interest have been secured. This work is here described.

The new principle, which is being referred to by the name "autovalve," consists in the imparting to an arrester of the spark gap type, the valve or counter e. m. f. characteristics which are generally recognized to be, if not essential, at least very desirable in lightning arresters for all classes of service. For a spark gap to possess valve characteristics, it is necessary that the breakdown voltage and the voltage across the gap when current is flowing be at least approximately equal. Current flow across an air gap may be in the form of an arc or of a glow discharge. The voltage of an arc is low, of the order of 50 volts or less, while that of a glow is of the order of several hundred volts. For practical reasons the glow is preferable because of the higher voltage. Studies have shown that up to 5 mils length, the glow discharge voltage is practically constant over a wide range of current density which is a further desirable characteristic of the glow discharge.

If the electrodes of the gap are made of material of considerable resistivity, the discharge is distributed over the face of the electrode, the current is prevented from concentrating in any local area, local heating is

*Presented at the Midwinter Convention of the A. I. E. E., New York, N. Y., February 14-17, 1923.*

not possible and therefore an arc cannot form, and the discharge is maintained as a glow.

Assuming that a glow discharge is to be used, it is necessary that the breakdown voltage be in the vicinity of 350 volts, which is the voltage across the glow. Studies have shown that the breakdown voltage of very small gaps is as shown in Figure 1. This means that for the required 350 volts, the gap length should be such as to give the minimum breakdown voltage for air at atmospheric pressure, or approximately 0.0003 in. in length. This seems at first sight to be impractical. It has, however, been found that use may be made

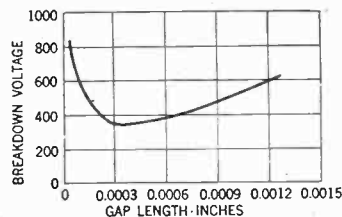

FIG. 1—BREAKDOWN VOLTAGE OF SMALL GAPS IN AIR

of the well known fact that when conductors are separated by insulating spacers, breakdown tends to take place over the edge of the spacer at voltages lower than would be required for the gap. Trials have demonstrated that when the electrodes are separated by mica spacers of the thickness to give correct gap lengths, 3 to 5 mils, from the standpoint of voltage across the discharge, the breakdown voltage remains at the minimum value of 350.

Thus, a structure composed of a column of flat electrodes separated by mica spacers approximately 5 mils in thickness will operate as a valve, the critical voltage being equal to approximately 350 per gap, and the characteristic for voltages above this value being dependent on the resistance of the electrodes between plane surfaces. The discharge current capacity may be controlled by proper selection of disk area and thickness to give the characteristics required for any particular service. The voltage at which the discharge starts is 350 per gap within close limits and the speed of operation has been found to be very high.

In the work of development of lightning arresters made on this principle, there were three major problems;

namely, (1) experimental work consisting of the determination of characteristic relations and of the development of a suitable material for the electrodes, (2) design, consisting of the determination of the proper proportions to give the necessary performance characteristics and of the development of structures, (3) testing which consists of the determination of durability and performance characteristics by comparison in the laboratory with established forms of lightning arresters and by observation under actual service conditions.

In the *fundamental experimental work*, the initial attack was research with small glow discharges to determine breakdown voltage, the relation between voltage and current density, the distribution of voltage across minute gaps, the variation of voltage distribution with current density and various similar points.

From the data secured in these studies, it is desired to select a set of conditions which will give equal values for the breakdown voltage and for the voltage across the discharge while current is flowing and under which conditions the voltage across the discharge will be approximately constant over a considerable range of current density.

For gaps up to 5 mils in length, the discharge consists almost entirely of the cathode dark space and cathode glow, both of which are practically constant in voltage over a large range of current density. When larger separations are used, a portion of the positive column is included, introducing a variation of voltage with current change. From this standpoint, the limit of gap length is about 0.005 in. which gives a voltage across the discharge which remains practically constant at 350 volts over any anticipated range of conditions.

Two means are available to secure the desired breakdown volts. If plane electrodes of ordinary manufacture are placed in contact, there will be actual contact at several points and over the rest of the surface there will be separations up to say 2 or 3 mils. For low voltages, the current will be that due to conductivity at the contacts. At voltages above 350 per gap however, the gaps break down at the points where the separation is correct for the minimum breakdown voltage and the discharge is then distributed over the face of the electrode by reason of the resistivity. The alternative and preferred means depends on the fact referred to above that, when conductors are separated by an insulating spacer, breakdown tends to take place over the edge of the spacer at voltages lower than required for the gap.

Trials demonstrated that when the electrodes are separated by mica spacers of the thickness required to give correct separation from the standpoint of voltage across the discharge (that is 0.003 in. to 0.005 in.) the breakdown voltage remains at the minimum value of 350.

The unit construction therefore becomes thin flat plates of resistance material separated by gaps of not more than 0.005 in. by mica spacers. For convenience

in manufacture, the disks are made circular in form and the spacers in the shape of circular washers.

With these points fixed, *development work* was begun using disks of resistance material with various resistivities to determine the limit of resistivity required and to verify the findings of the research work by performance with structures of the size required for lightning arresters.

A considerable problem was encountered in the development of a material for the disks which would have the right characteristics and be feasible in manufacture. Ultimately however, a composition material was devised which is sufficiently durable, being mechanically more or less similar to porcelain, and which is electrically right, having a conductivity controlled by the methods of manufacture. With this material it has been found possible to manufacture disks of the desired resistivity and which, in sizes required for the structures, are remarkably true in dimensions. The nature

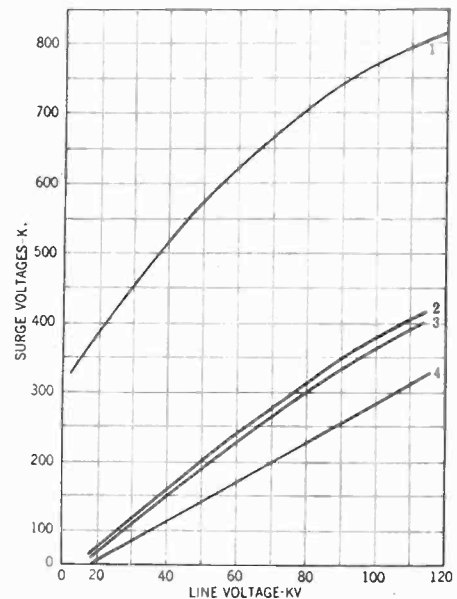

FIG. 2—VOLTAGE RELATIONS

- 1 = Induced Surge Voltage
- 2 = Resultant Voltage Electrolytic Arrester
- 3 = Resultant Voltage Autovalve Arrester
- 4 = Peak Value of Max. Line Volts

of the material is such as to establish confidence in the permanence of characteristics.

The resistivity of the disk material required to give proper distribution of discharge over the face of the disk in order to insure that the discharge is maintained as a glow, depends on the type of material used for the electrodes, upon the gap length, and upon differences in gap length over the area of any particular gap. Experimental trials in the laboratory, in which observation was made by oscillographic record as to whether or not power current follows the static discharge, demonstrate that the material used in the structure for service tests and in commercial production is such that under the conditions of manufacture and application, no power current flows. This means that the discharge is distributed sufficiently so that a counter voltage is definitely maintained. A considerable factor of safety

is provided in order to allow for variations in service conditions and manufacture.

On the basis of a critical or counter voltage of 350, instantaneous value, per gap and assuming that a reasonable factor of safety is desirable, the basis is established that the number of disks in series in a structure is such as to give one gap per 200 r. m. s. line volts maximum. This gives a factor of safety of approximately 25 per cent.

With the factors thus far determined, a valve type arrester is provided which begins to operate at 25 per cent over voltage and which stops the current flow when the voltage is decreased to this value, and it only remains to determine the resistance required in the contemplated arresters to give the necessary freedom of discharge and to select a disk area which will give this value. On this particular factor, there are years of service experience with the electrolytic arresters as a guide. If the same freedom of discharge can be secured with the proposed arrester as is given by the electrolytic, satisfactory results will be secured. As a check however, the study shown in the curves of Figs. 2 and 3 was made. In the figures, various characteristics of

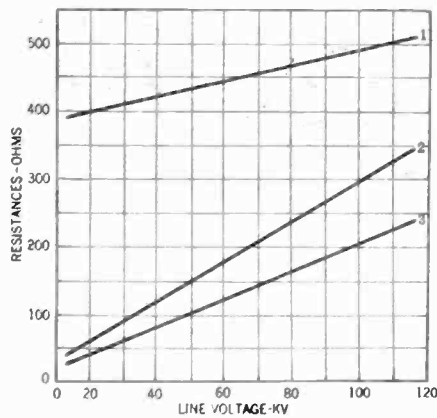

FIG. 3—SURGE IMPEDANCE AND ARRESTER RESISTANCES

- 1 = Surge Impedance
- 2 = Equivalent Resistance Electrolytic
- 3 = Equivalent Resistance Autovalve

ordinary transmission lines are plotted against line volts. The curve in Fig. 3 of surge impedance is intended to represent average practise. The curve Fig. 2 of surge voltage induced in the line is made directly proportional to an assumed height of line above ground, starting with the initial assumption of 500,000 volts for a line 20 feet above ground. The curve of permissible surge voltage represents the peak value of double line voltage. This is of course an assumption. From these data, a curve, Fig. 3, is given showing the results secured with electrolytic arresters of the present standard design. From all this information a disk area of 61 square cm. was chosen, giving resistance and performance characteristics as shown in Figs. 2 and 3, in the curves for station type autovalve arresters. The data from which the curves are plotted are tabulated in Table 1.

The arrester resistance values of Fig. 3 were determined by laboratory tests under surge conditions *i. e.* with steep wave front impulses applied by a condenser

discharge at voltages corresponding to the peak value of double line voltage as described more in detail later.

The permitted surge voltages are calculated from the assumed values of induced surge voltage, surge impedance and arrester resistance as follows: The excess of impressed voltage over the critical or counter voltage of the arrester is reduced by the arrester current in the ratio of arrester resistance to the sum of arrester resistance and surge impedance. The permitted surge voltage is then the sum of the critical voltage and this reduced surge voltage. Thus, for a 22-kv. station type autovalve arrester, the assumed impressed surge voltage is 400 kv., the critical voltage 42 kv., making the excess 358 kv. The arrester resistance is 45 ohms, the assumed surge impedance 400 ohms, and the ratio of reduction

$$\frac{45}{400 + 45} = 0.101. \text{ The permitted excess surge}$$

voltage is then  $0.101 \times 358 = 36$  kv. and the total surge voltage  $36 + 42 = 78$  kv.

It must be kept in mind, in considering the curves and data of Fig. 2 and 3, and Table 1 that they are based on assumptions in factors which are of vital importance, namely, in the values of surge voltage impressed on the lines. Assumptions are also made in the values of surge impedance, but in this case the values given are known to be fairly representative. The other values given and calculated are, with a fair degree of accuracy, correct. Thus, while the intention is not to state that the maximum voltage which may be applied to insulation, protected by an electrolytic arrester on a 22 kv. line, for example is 83-kv., it is a fact that under the assumed conditions the voltage will be as shown for the various arresters. It will be noted from these data that although the values of resistance of the autovalve arrester are well below that of the electrolytic arrester, the permitted surge voltage is only slightly lower than for the electrolytic. This is due to the fact that there is a factor of safety of 25 per cent between the peak value of line voltage and the critical voltage with the autovalve arrester while no such factor of safety exists with the electrolytic since the critical voltage is determined by the line voltage.

In addition to the factors which control performance required and performance delivered it is necessary in selecting or in designing lightning arresters to take account of economic factors. An arrester which gives perfect protection but which costs more to install and maintain than it is worth in saving in service and apparatus is not justified.

From this standpoint and since it is possible to make quite appreciable reductions in manufacturing cost by a reduction in disk area, it has been found desirable to develop a line of low-voltage arresters of reduced capacity for the protection of very small installations. In this line of arresters, a disk area of 15 sq. cm. is used giving the characteristics shown in curve Fig. 3 for the distribution type autovalve arrester.

In the average installation made with this size of arrester, the reduction in the "discharge current capacity" is off-set to some extent by the fact that transformers are installed on the same system fairly close together and the energy of any particular disturbance is taken care of by several arresters in parallel.

Figs. 4 to 6 show the forms in which arresters involving the autovalve principle have been made. Fig. 4

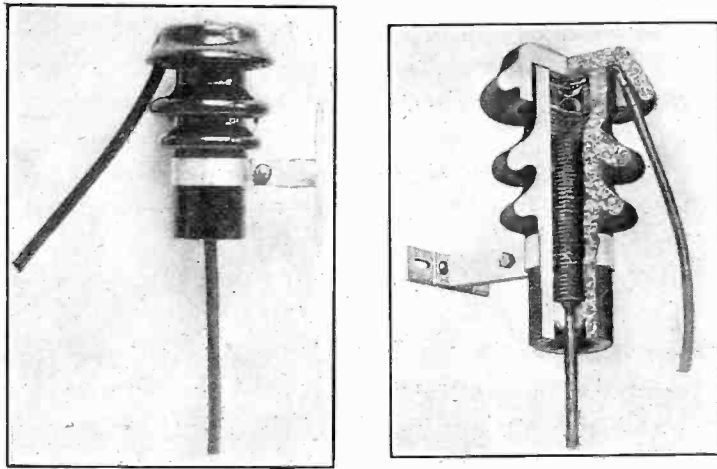

FIG. 4—7500-VOLT DISTRIBUTION TYPE AUTOVALVE ARRESTER shows the distribution type, primarily intended for protection of distribution transformers, and therefore made for cross arm mounting, in unit form, entirely self contained in a porcelain case and with leads for connection to the line and ground wire. The station or large capacity arresters are built up of units such as are shown in Fig. 5. The assembly of these units into structures is shown in Fig. 6.

A change which has been made from the previous standard practise is in the use of three complete columns for a three-phase structure instead of the former standard, four phase legs in the "multiplex" connection. An interconnection between phase stacks is provided at the phase voltage point in each stack. This connection is based on the thought that the requirements from

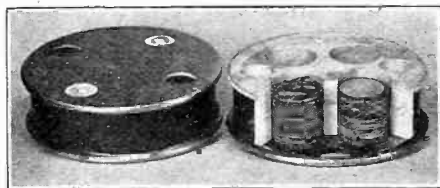

FIG. 5—STATION TYPE AUTOVALVE LIGHTNING ARRESTER UNIT the standpoint of discharge current capacity are fixed by the most severe conditions, which are those imposed by disturbance of external or atmospheric origin. Such disturbances are imposed on the three lines alike and in flowing to ground through the arrester when the multiplex connection is used, the charges from the individual lines flow first through the corresponding phase legs and then together through the ground leg. The result is that the impedance of the path to ground from any wire is equivalent to four times the impedance of a single-phase leg. Since each phase leg is proportional to 58 per cent of line voltage, the total

impedance is equivalent to that of a structure proportional to 2.32 times line voltage. With the connection used in the autovalve structures this impedance is reduced to that of an arrester for line voltage only. The performance is in this respect improved in the ratio of 2.32 to 1 while the material added is increased in the ratio of 3 to 2.32, in other words an addition of 29 per cent in the material used increases the performance by 132 per cent. In respect to the performance under the less severe conditions of surges of internal origin in which the voltage is applied between lines, this connection is the same as the former standard connection.

Tests for establishment of the various characteristics referred to and for proof of the performance and durability of the structures resulting have been made

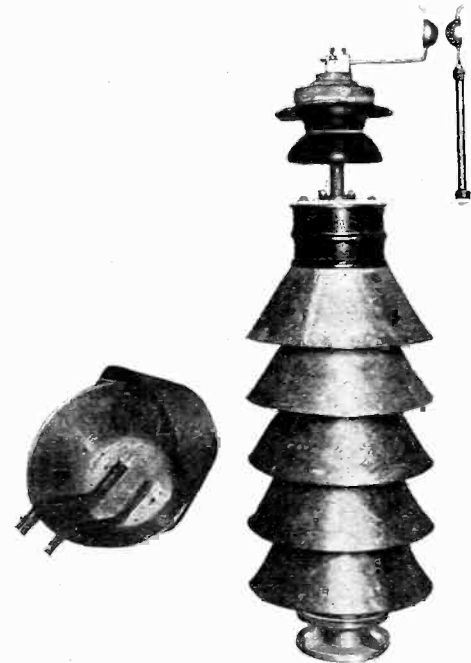

FIG. 6—PHASE ELEMENT OF 37-KV. STATION TYPE AUTOVALVE LIGHTNING ARRESTER

Rain sheds for gap and top units are removed to show structure.

both in the laboratory and by observation of results in service.

For the early laboratory work, use was made of a testing equipment consisting of a condenser of 0.2 microfarads capacity, capable of being charged to a maximum voltage of approximately 130,000, together with the necessary charging apparatus and discharge circuit. For later tests it has been found desirable to extend the range of voltage over which performance of the structures could be determined in the laboratory and accordingly a duplicate testing equipment was provided and arranged for connection either in multiple or in series with the original equipment. The available maximum voltage is thus approximately 250,000 with a capacity of 0.1 microfarad with an alternative of 120,000 volts and 0.4 microfarad.

Tests for durability consist in general of the connection to the arrester of a power voltage of the maximum value for which the arrester is intended and the simultaneous discharge through the arrester of a condenser

such as to give the assumed maximum of double the peak value of line voltage across the arrester. Where it is possible, that is with the arresters for the lower voltages, or smaller capacities additional tests are made at surge conditions just under the flashover limit. It was intended to determine something in regard to the arrester life by a count of the number of discharges of double line voltage peak value required to cause some sort of failure, but practically indefinite tests do not

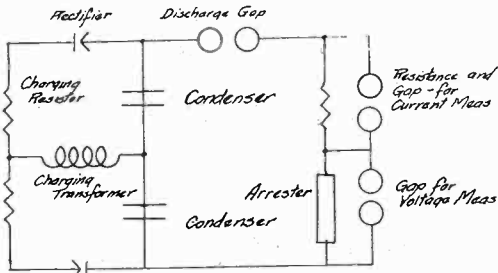

FIG. 7—CONNECTIONS FOR SURGE TESTS

cause any observable change in the arrester either from the standpoint of performance or appearance. As the surge conditions are increased in intensity, failure occurs by flashover at a voltage of the order of 15 to 20 times the voltage for which the arrester is designed. When surges just below the value necessary to cause flashover are repeatedly applied until failure occurs, the type of failure depends on the cycle of test. If the tests are close enough together to cause excessive heating, failures have been noted due to destruction of the valve characteristics and the consequent flow of power current. Parallel tests on commercial arresters of other types show the same general type of failure to occur under the same conditions, which are so much more severe than any we can expect, except in the case of a

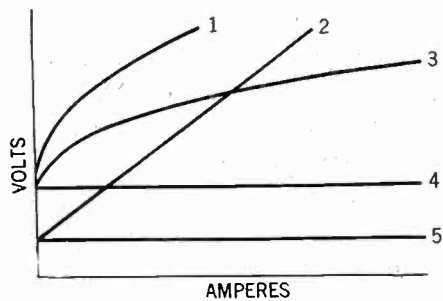

FIG 8—TYPICAL VOLT-AMPERE CURVES FOR AUTOVALVE AND ELECTROLYTIC LIGHTNING ARRESTERS

- 1 = Distribution Autovalve
- 2 = Electrolytic
- 3 = Station Autovalve
- 4 = Critical Voltage Autovalve
- 5 = Critical Voltage Electrolytic

direct stroke that the test is interesting only as an establishment of limits. If the discharges are timed far enough apart to eliminate excessive heating, the life of the structure seems to be indefinite.

As would be expected, the only failures that have been observed in service to date have been due to flashover and the flashover point of the commercial design has been increased considerably from the early samples with which this trouble was noted in the field.

The total failures of arresters installed in service to date are something under 1 per cent.

The testing method to determine performance characteristics is to discharge through the arrester condenser charges of various characteristics. The performance may be shown by means of volt-ampere curves determined by such tests in which the surge conditions are varied over a considerable range. The current through the arrester is measured by a spark gap measurement of voltage across a resistance of known and permanent value which is connected in series with the arrester. The voltage is determined by a direct spark gap measurement across the arrester.

The fact that consistent results of the type reported can be secured in this test demonstrates the remarkable speed with which the autovalve arresters operate. The measurements of voltage across the arrester were made with a 125-millimeter sphere gap connected directly across the arrester. No resistance was used in series with the gap. In spite of the extreme speed of

TABLE I  
CALCULATION OF ARRESTER PERFORMANCE

Line kv.	Ht. ft.	Surge kv.	Ins. str. kv. inst.	Z ohms	Electrolytic			Exc. kv.	Total kv.	
					Equip. res. ohms	Crit. volts kv.	Surge excess kv.			
22	20	400	62	400	65	31	369	0.14	52	83
66	32 1/2	650	186	450	195	93	557	0.302	168	261
110	40	800	312	500	325	155	645	0.393	253	409

Line kv.	Station Autovalve					Total kv.
	Res. ohms	Crit. volts kv.	Surge excess kv.	R / R + Z	Excess kv.	
22	45	42	358	0.101	36	78
66	135	126	524	0.231	121	247
110	225	210	590	0.31	183	393

such a gap, the discharge started in the arrester, and discharge currents of several thousand amperes flowed through the arrester before the sphere gap broke down. When this type of test is made with an arrester which has a high dielectric spark lag, as compared to that of the sphere gap used for measurement of voltage, the indicated voltages will be determined in general by the factors which control initial breakdown of the arrester rather than by the impedance drop in the arrester. This does not mean that in such a case the measurements are untrue, but merely that they give no dependable indication as to the discharge impedance of the arrester.

The circuit used in these tests is shown in Fig. 7 and typical volt-ampere curves for both the distribution and station type arresters are shown in Fig. 8. For comparison a volt-ampere curve of a standard electrolytic arrester is also shown in Fig. 8. The data of Table I and the curves based thereon shown in Figs. 8 and 3 are calculated from resistance values determined from the volt-ampere curves of voltage corresponding to the assumed maximum permissible surge voltage.

The tests under service conditions give in general less specific information than laboratory tests, but they are valuable from the fact that they act as a sort of a court of last appeal. A total of 527 units has been installed on lines ranging up to 25,000 volts, both in the factory and on lines of various operating companies for periods up to 17 months. There failures have been observed with low voltage distribution units installed at the beginning of last year and the conditions were such as to point almost conclusively to flashover as the cause of failure. Several other failures were noted among the earliest arresters installed and these failures are known to have been caused by errors in design which were discovered after the arresters were installed. The major portion of these service installations were

made with 2500-volt distribution arresters of an early design, very close to the present type but using a disk area of 8.5 sq. cm. These tests, while they do not furnish specific values for the characteristics such as are available from laboratory tests, give final proof of the fundamentals, and thus add sufficient support to the laboratory tests to assure the results shown in Figs. 2 and 3.

It is fitting that mention should be made that the work reported here has been contributed by a considerable group of people in various degrees, but each in important measure. These include Dr. Slepian, the originator of the device and Messrs. G. M. Little, I. R. Smith, L. R. Golladay, S. M. Pineles, and E. J. Haverstick as well as the writer.

## Observations on Electric Railway Practise

BY WILLIAM B. POTTER

Member, A. I. E. E.

Chief Engineer, Railway Dept., General Electric Co.

**T**HE development of rail transportation since the day of stage-coaches and horsedrawn tram cars, has been a process of evolution in which some reminders of the past are still noticeable.

Before the days of steam, the track gage used for the tram cars of the British coal mines was presumably the origin of the odd dimension of 4 ft. 8½ in., which has become so generally accepted as the standard track gage of the railroads of today. In Great Britain freight cars are still called "wagons," and many of the older passenger vehicles there and on the continent are a sort of multiple-unit stage coach in arrangement and interior fittings. These passenger coaches are much as if several coach bodies were mounted on a flat car, and to carry out the illusion, the exteriors of the separate compartments are sometimes so paneled as to resemble the outlines of a coach. The doors, windows and the interior are as nearly like the old stage as one could imagine, not omitting the looped strap arm rest for those sitting at the ends of the seats.

The modern European passenger cars, although retaining the compartment plan, are usually provided with a corridor throughout and vestibuled passage between the cars. These cars are well equipped, comfortable and afford a privacy which we do not enjoy without extra price.

Our first electric cars were converted horse-cars, and in keeping with their previous motive power, there was at first a disposition to use much smaller motors than were suitable. About one and one-half horse power was probably a fair average for the old horse-car; and where two horses had served, an equipment of two

10-horse power motors seemed out of proportion despite the improvement in schedule.

While the speed was limited in the horse-car days, there was progress in other respects, of which one instance is worthy of note. Perhaps some of you may remember the red glass panel in the monitor of the Stephenson horse-cars that once ran in New York. This panel was inscribed with the legend,—“This car is equipped with super-springs, contributing to quiet and ease.” You may also remember riding in these cars, and the comfort derived from reading this sign—it at least had the merit of auto suggestion!

The single truck of the old horse-car was not suitable for the higher speeds and longer car bodies soon called for in the electric service. The bogie or double-truck motor car so generally used today was a natural adaptation from steam railway practise, and the simplicity of this design was early appreciated as advantageous for electric locomotives. One of the first electric locomotives used in the regular service of this country, was an electrically equipped bogie truck railway express car. The motor car practise of mounting geared motors directly on the axle has been quite generally applied and proved very satisfactory for electric locomotives. In continental Europe the development of the electric locomotive seems largely to have been carried out with the idea of substituting the electric motor for the steam locomotive cylinder and retaining the feature of connecting rod drives.

While there is a similarity in the character of traffic and the conditions under which it is carried on in the European countries, there is a great difference in these respects between Europe and this country. The influence of precedent, experience and individual

*Presented at the Midwinter Convention of the A. I. E. E., New York, N. Y., February 14-17, 1923.*

opinion under these quite different conditions, has naturally led to a different viewpoint and to some differences in practise between this country and Europe. There is much to commend and little to criticise in the railway practise and equipment, as it exists in the different countries. Each country has endeavored to provide transportation of a character most suitable for its particular requirements. Occasional visits to any country do not give the opportunity of becoming well informed on this subject comprehensively, but even casual observations, as in this instance, may serve as an excuse for comment and comparison.

The weight of European freight trains and the maximum draw-bar pull allowed are about one-quarter of what they are in this country. The weight of their passenger trains is about one-half. The permissible weight on driving wheels is about two-thirds and the weight per axle of their cars is about one-half of our usual practise. The low draw-bar pull and the car weight permit a relatively light mechanical design of rolling stock, and the requirements as to strength are further made easier by the method of car coupling.

The screw coupler, *i. e.*, two clevises connected by a rod with a right and left-hand thread, is used almost universally.

Each drawbar has a hook that is provided with a screw coupler, and in the process of coupling the clevis of one of the couplers is thrown over the hook of the other draw-bar, and the cars in effect are jack-screwed together by hand. There are two mushroom-shaped buffers with faces about one foot in diameter; the right one having a rounded face, and the left hand a flat face,

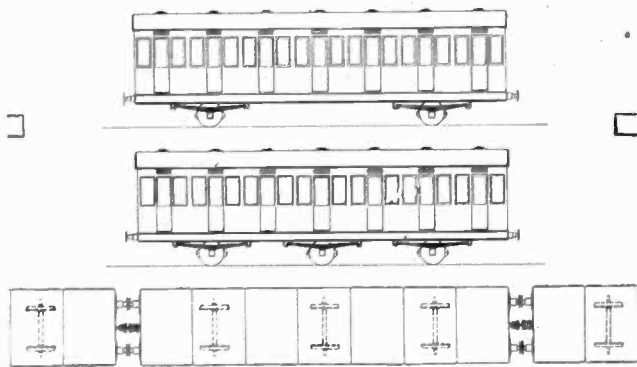

Side elevations of the large two and three-axle cars on European railways. Weight from 20 to 23 tons, seating from 35 to 72 passengers, depending on the class. Over all wheel base 28 to 30 ft. Plan shows arrangement of screw coupler and car buffers.

these are located near the outer end corners of the car. The initial tension on these buffers is about 2000 lb., and when fully compressed the pressure is approximately 20,000 lb. As might be expected, there is ordinarily no shock when coupling with this kind of a coupler as a slight compression of the buffer is all that is required. With our automatic couplers the shock of coupling is occasionally in the nature of a crash.

Admitting the advantages of the automatic type of coupler, the use of the screw coupler does permit a much lighter end framing on locomotives and cars. An inquiry as to European experience with automatic

couplers brought forth the comment that the couplers were all right, but that the process of coupling wrecked the rolling stock. Allowing for various requirements, the weight of European electric locomotives is from two-thirds to three-quarters the weight of electric locomotives in this country having the same horse power.

The speed of European trains on the average is rather higher than in this country. Many of the European cars have two or three axles, which does not seem to be a wheel arrangement that would provide for smooth running. In many instances these cars have no truck framing, but depend upon the car springs to hold the axles in alinement. These springs are usually about

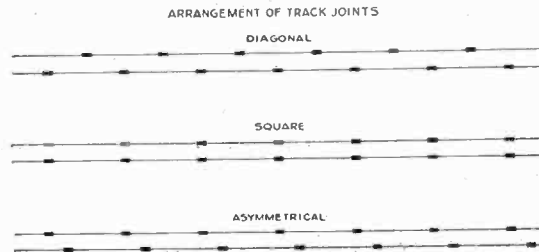

Different plans for locating track joints to illustrate effect on transverse oscillations of a car.

six feet long and semi-elliptical in shape, although so little curved as to be nearly flat. The springs bear directly on the journal boxes, and are so resilient that the vertical shock from track joints is very well cushioned. The shorter wheel base two-axle car and many of the three-axle cars have a tendency towards transverse oscillation, which may be decidedly uncomfortable unless the cars are properly coupled together. The combination of the screw coupler and buffers has more influence in steadying the car and preventing oscillations than might be supposed. When the coupling is set up sufficiently to compress the buffers, the friction between them is sufficient to prevent any relative movement, so that each car is steadied by the one to which it is coupled.

On a fast train made up of similar cars having bogie trucks, there was a noticeable difference in the riding qualities of those cars on which the couplers had been screwed up and certain others so loosely coupled that the buffers did not touch. It is the usual practise to screw up the coupler sufficiently to compress the buffers, but there are exceptions. A remembered instance was a trip on a two-axle car of about 14-ft. wheel base which was loosely coupled to the rear end of the passenger train. At a speed of about 55 miles, the transverse oscillation, or "side slogger" as it has been called, was so bad as to cause some apprehension to the uninitiated. At the first stop the coupling was screwed up, which was all that was necessary to effectually check the "slogging." The frequency of these transverse oscillations appeared to be the natural period of the car body as established by the scheme and proportions of its flexible supporting structure. The track did not seem to induce any supplemental oscillation.

The method of locating track joints perhaps has

more influence on the running quality of the rolling stock than is commonly appreciated. The European practise is to lay the track with square joints, *i. e.*, with the joint of each rail directly opposite. The customary practise in this country is to lay the track with joints spaced diagonally and located midway between the opposite rail. The trial run of an electric locomotive over a track with square joints, which were in poor condition, afforded an exceptional opportunity to observe the reaction of a track with this arrangement of joints. This locomotive had bogie trucks and at about sixty miles an hour there was a very decided vertical vibration, but no tendency whatever towards enforced side oscillation. With diagonally laid joints, in as poor condition, it is questionable whether any locomotive or car could have been run at that speed without something giving way; particularly if the transverse oscillation, which is diagonal in direction relative to the track, had happened to synchronize with a diagonal location of the low joints. Only one railway in Europe was noted where the rails were laid with diagonal joints. The manager remarked that his electric motor cars were subject to so much oscillation that it was his intention to relay this track with square joints.

A comparison of the influence of square and diagonal joints on the running qualities of a motor car was recently observed in this country, over a line having both kinds of joints. On the portion of track having square joints, there was observed a slight steady oscillation of uniform character at the rate of about 150 per minute; on the portion of track with diagonal joints, the same car did not oscillate with equal steadiness and at times had a noticeable swing toward one side or the other. As the car was running at about 60 miles per hour, the natural period of oscillation did not correspond

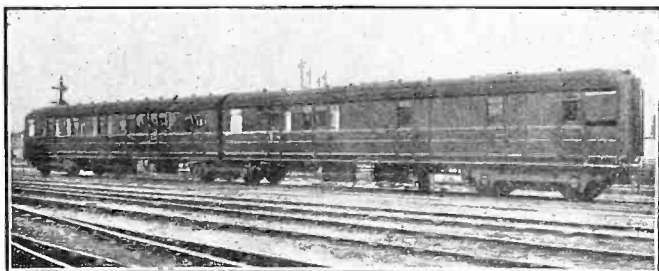

Great Northern Railway, England. Two articulated cars showing the intermediate truck midway between the cars. Groups of five cars, similarly articulated, are in regular main line service.

with the location of the diagonal joints. Had the vibration synchronized with the joints, an enforced and increased oscillation might reasonably have been expected. This particular track was in good condition throughout.

There is no doubt that track laid with square joints, is more difficult to keep up as the impact on the ballast is more severe when both wheels strike the joints simultaneously. With the less weight per axle customary in European practise, it is much easier to maintain their track, than it would be with our heavier weights per axle.

The writer suggests that it might be possible to secure the advantage of diagonal joints in respect to track maintenance and the steadier running quality of square joints by laying the track with joints asymmetrically spaced, that is, instead of overlapping a half rail length, to overlap one quarter and one third, preferably a length of lap that would not be an even fraction of the rail length.

There was observed on the Great Northern Railway, England, an articulated arrangement of cars into groups, which is a departure from the conventional car with two bogie trucks. This articulation is accomplished by locating a truck midway between each of the several

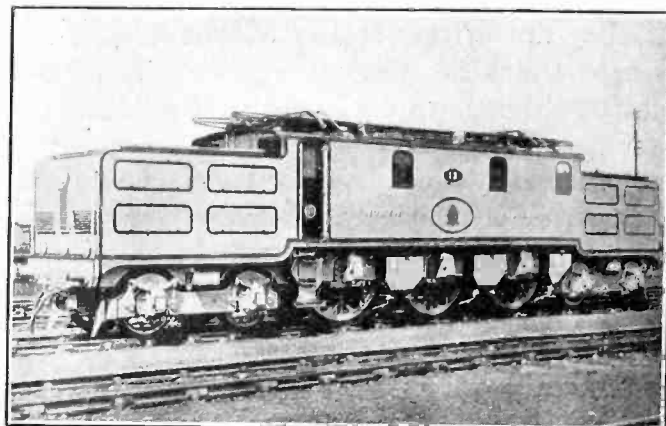

North Eastern Railway, England. Locomotive with geared quill drive. Designed by North Eastern Railway for high-speed service of 75 miles or more per hour. Built by Metropolitan Vickers Co. and North Eastern Railway.

cars in the unit group, so that the number of trucks is only one in excess of the number of cars constituting the group. In the suburban service the trains were composed of two groups each of four cars, thus requiring ten trucks for the eight cars. On the main line the train was made up of a number of individual cars and a five car articulated group. The reduction in weight, as compared with two bogie trucks for each car, was said to be about 10 per cent; it was also stated that the train friction was reduced. A noticeable feature on the main line train at high speed was the smooth running of the group; the riding was exceptionally good and noticeably better than individual cars in the same train.

In the brief reference to electric locomotives, the motor car and steam locomotives were mentioned as prototypes, which have influenced the trend of electric locomotive development. To elaborate, there are at least seven general designs of driving mechanism or methods of motor mounting under which electric locomotives may be classified. These different classes may be briefly described as—axle geared, quill geared, outside geared, axle gearless, quill gearless, direct-connected side rod and geared side rod.

Each of these designs, with the exception of the outside gear, is employed in this country. In England the axle geared drive has been most generally used, but there has been completed recently a high-speed locomotive for the North Eastern Railway equipped with the



quill geared drive. The side rod drive does not seem to have met with favor, the following reference to side rod drive is quoted from a paper by Sir Vincent Raven

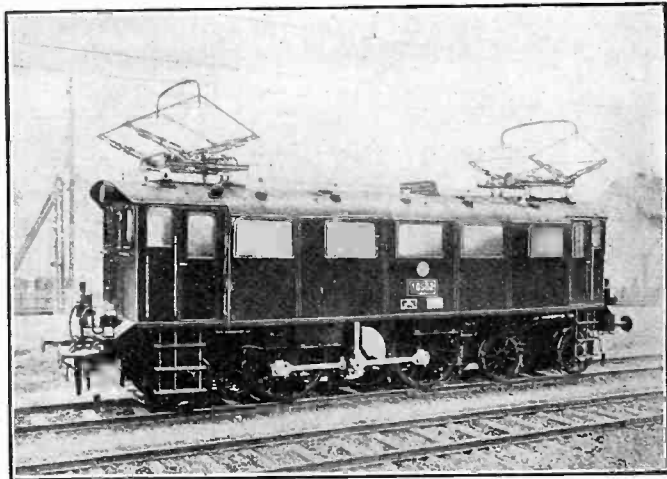

Prussian State Railways. Locomotive with direct-connected side rod drive with one motor through a vertical rod to the Jack cranks. Built by A. E. G., Berlin.

(North East Coast Institution of Engineers and Ship-builders, Dec. 16, 1921).

"On the Continent, notably in France, Switzerland, Italy, Germany, Austria and Sweden, the connecting rod drive in one form or other is almost universal. Up to the present, electrification in these countries has been carried out mainly on the single-phase or three-phase system and Continental engineers consider that the additional complications caused by the introduction of cranks and coupling rods are more than compensated for by the advantage of having a free hand with the motor design.

"A large number of designs have been worked out. Some have proved quite satisfactory, others have given rise to a good deal of trouble. In most cases the trouble has been eliminated by strengthening up special parts such as crank pins, Scotch yokes, etc., and by introducing a certain amount of flexibility into the connections between the motors and the crankshafts."

The mechanism of the motor driven side rod drive needs to be maintained in close adjustment, and may

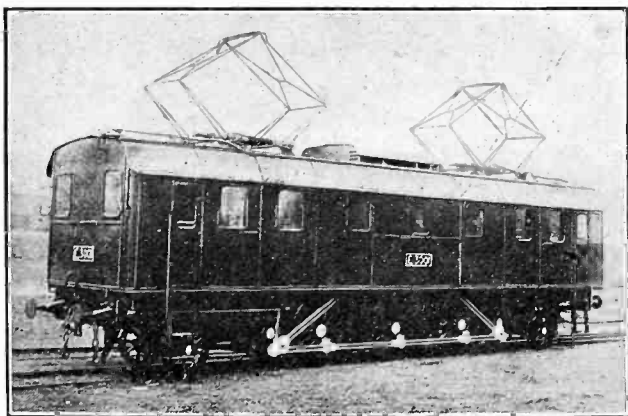

Midi Railway, France. Locomotive with direct-connected side rod drive with two motors connected to jack cranks, exterior to the driving wheels. Built by C. F. T. H., Paris, and the Swiss Locomotive and Machine Works, Winterthur.

reasonably be expected to require more attention and have a higher cost of maintenance than some of the other methods of transmitting power to the drivers.

The transmission of power from a motor driven crank,

whether direct-connected or geared, introduces strains in the connecting mechanism somewhat different from those which occur in a steam locomotive. With the best adjustment and with operating clearance only in the bearings, the motor-driven connecting rods on either side transmit alternately the power through 90 degrees, except for such spring of the parts as may cause the rods to work together for a brief interval. As this transfer of the power from one rod to the other takes place at about 45 degrees from the dead center, the pins, connecting rods and included frame will be subjected to the full strain of driving when the crank is at an angle of about 45 degrees. If the two sides are not in an even adjustment this angle may be even less.

Aside from centrifugal forces and the shock due to lost motion in the driving mechanism, the stress in the rods, pins and frame of a steam locomotive is limited and may be predetermined from the size of the cylinder and steam pressure. With a motor driven crank the

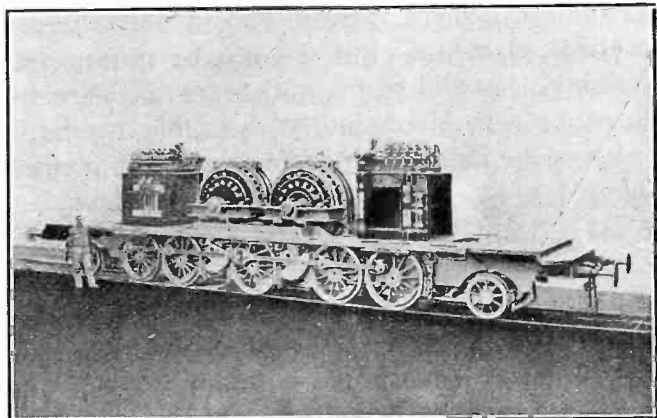

Loetschberg Railway, Switzerland. Locomotive with geared side rod drive. View with cab removed showing location of apparatus and driving gear. Built by Brown, Boveri & Co., Baden, the Oerlikon Co., and the Swiss Locomotive and Machine Works, Winterthur.

stress is dependent on the crank angle and is affected by the adjustment of the mechanism.

As an extreme illustration, one side of a steam locomotive may be stripped and with the other side on dead center, the throttle may be opened wide without damage to the locomotive. Under the same conditions with a motor-driven crank, the resultant toggle action would set up enormous stress and undoubtedly wreck some part of the mechanism involved.

There is, further, an irregularity in the angular rotation of the crank, with respect to the driving wheel, which creates a superimposed stress on the driving mechanism, and which may be the cause of very disagreeable vibration, should the natural period of the rotating mass involved, happen to synchronize with the nodal points of angular variation. The effect of this irregularity in relative uniformity of rotation of the crank and wheel is more in evidence in some forms of side rod drive than others. The most severe case observed was on a direct-connected locomotive with a V arrangement of connecting rods which ran with but

little vibration, except at the critical speed, when a knock developed which sounded as if the crank shaft was broken, or being struck by a steam hammer. As this irregularity is due to the play in the bearings and

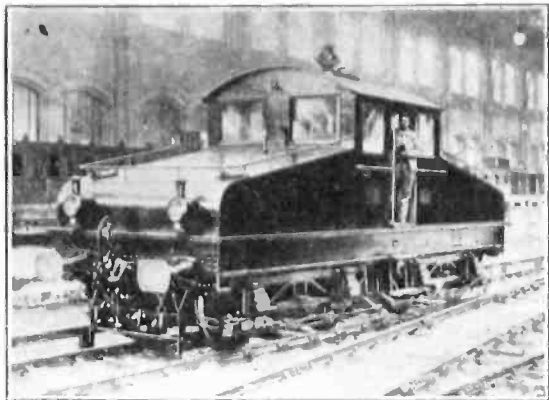

Paris-Orleans Railway. Locomotive with axle geared drive. A number of locomotives of this type has been used in their Paris terminal service for the past 20 years. Originally built by the General Electric Co., and the American Locomotive Co., Schenectady, N. Y.

the spring in the parts, it cannot be entirely eliminated in practical operation, but it may be minimized by maintaining the alinement and close adjustment of the bearings. It is obviously desirable to diminish shock by cushioning as much of the rotating mass as possible.

Mr. H. Parodi, Chief Electrical Engineer of the Paris-Orleans Railway, in the *Revue Generale des Chemins De Fer* of March, 1922, has written of the vibratory characteristics of the side rod drive and described the method he employed to improve the operation, by the introduction of springs, permitting

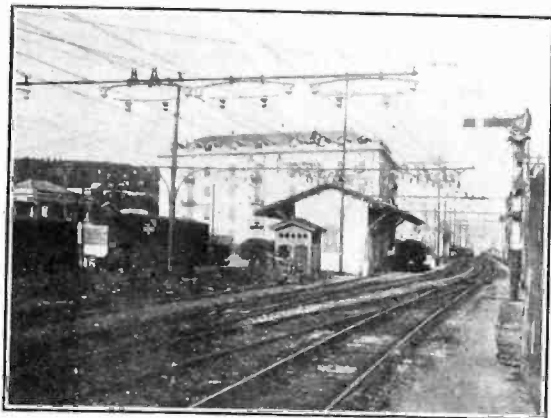

Italian State Railways. View of overhead lines of three-phase system, showing long bracket arm construction and bow shaped supports to facilitate the alinement of the conductors.

angular movement between the mass of the motor armature and the crank shaft.

An attempt will be made to show graphically on the screen something of characteristics of side rod drive. To better illustrate the action, the mechanism is assumed to be inelastic, the pin bearings of the rods are shown with exaggerated clearance, and the ordinates of the characteristic curves are greatly out of proportion. In reality, the value of these ordinates is

dependent upon the working clearance in the bearings together with the inertia of the rotating masses and whatever may be their actual value, the character of the action calls for its consideration in the design of motor-driven side rod mechanism. Furthermore, the arc of action and the sharp angles of the characteristic curves

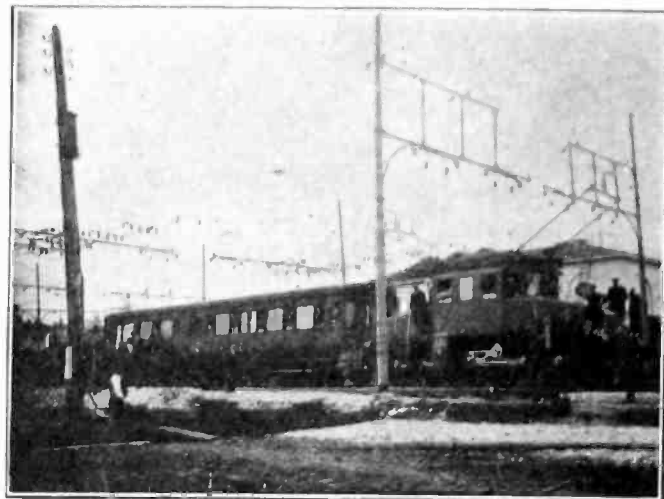

Italian State Railways. Locomotive with direct connected side rod drive with two motors connected to a Scotch yoke. Originally built by the Italian Westinghouse Vado Ligure Works. A large number of locomotives with similar drive has since been built by other Italian manufacturers.

as shown, would be modified by the spring in the connecting parts.

There appears to be an increasing interest on the Continent in other methods of drive, requiring less attention and maintenance. The Paris-Orleans Railway has been operating axle-g geared locomotives in their Paris Terminal for more than twenty years, and have recently ordered 200 of this type for local passenger and freight service on their main line extension. Over 100 locomotives of similar type are being built for the Midi and State railways. Locomotives with the same type

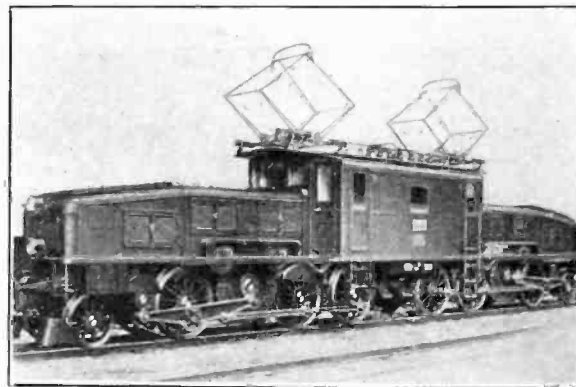

Swiss Federal Railways. Locomotive with geared side rod drive; each of the jack cranks is driven by two motors, the connecting yoke which is attached to the driver, being carried by an idle crank at its outer end. Built by the Oerlikon Co. and the Swiss Locomotive and Machine Works, Winterthur.

of drive are also being built for the Spanish Northern Railway.

The electric locomotives on the Italian Railways are mostly of the direct-connected, side rod type. The workmanship and finish of these locomotives is excep-

tionally fine, so good in fact from our point of view, that we might consider it an extravagance. They are well maintained, are giving good service and many additional locomotives have been built from the same design.

The electrification of the railways in Switzerland has been very well carried out and they may well take pride

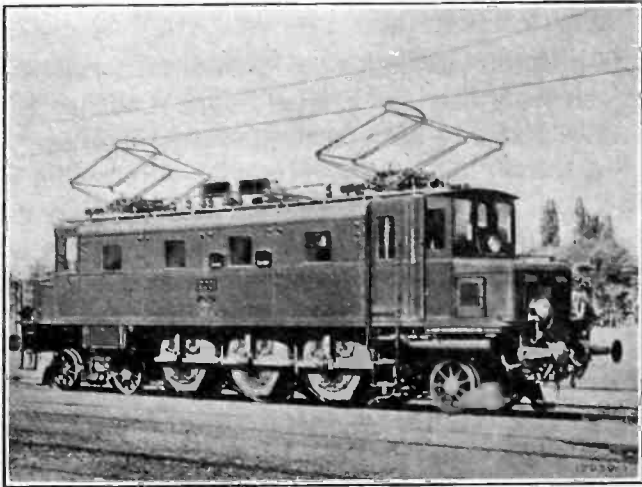

Swiss Federal Railways. Locomotive with outside geared drive. Each of the three motors is mounted directly over and geared to their respective drivers. Built by Brown, Boveri & Co., Baden, and the Swiss Locomotive and Machine Works, Winterthur.

in their construction and equipment. The Swiss railways have a variety of locomotives which are principally of the geared side rod type. The finish and workmanship of these locomotives is excellent, and they are very fine examples of geared side rod construction.

An interesting departure from side rod drive is a Swiss locomotive having the novel design of an outside geared drive, which is being given a thorough service trial with a number of locomotives. These locomotives have

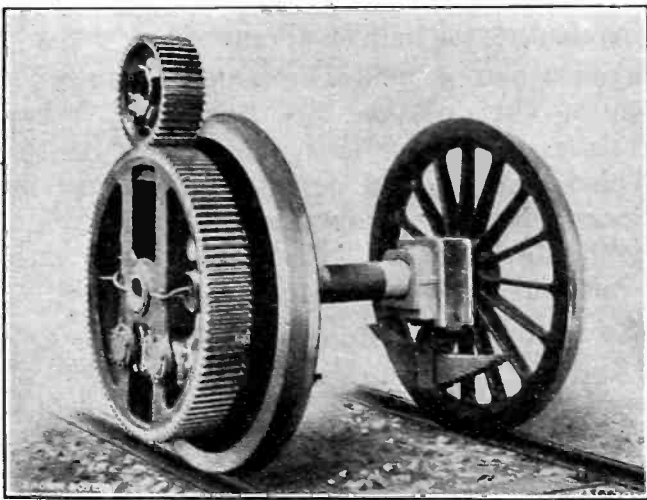

Swiss Federal Railways. Locomotive with outside geared drive. View showing location of gear and pinion with respect to the driving wheels.

an inside frame the same as a steam locomotive, the motor being carried on the frame directly over the driving wheel. The armature pinion is located beyond the outer face of the driver. The gear case is attached to the locomotive frame, and is a strong structure provided with a pin in the center on which the gear re-

volves. The gear is carried about 3 in., from the outer face of the driver, and within the gear is a system of balanced links, which engage with the two pins projecting from the driving wheel. These links are so designed as to provide for independent movement of the gear and driver in any direction while still maintaining their relative uniformity of rotation. This locomotive runs very smoothly without any characteristic vibration, and the more general use of this type of drive on the Swiss Railways may reasonably be expected. These railways have also in trial service a number of locomotives with geared quill drive.

European motive power equipment is generally of more elaborate finish and gives the impression of being better maintained than is customary with us. An instance is recalled of the two steam locomotives which were double heading on the London and Northwestern. One of these locomotives was built in 1897 and the other in 1867. They were polished and varnished with equal care and had every appearance of being of the same vintage, until one observed the date label, and that the older locomotive had only one pair of drivers while the other had two. As an illustration of the greater attention given to details, it is customary on many of the European railways to equip both steam and electric locomotives with a speed indicating and recording instrument. The record obtained is very complete, showing the speed at all times during the run, distance covered, time of the run and the location and duration of the stops.

The braking equipment of European trains is quite different from our almost universal practise. Their passenger trains are equipped with power brakes of either the vacuum or pressure type and usually with two brake shoes per wheel. As there are several different braking systems in use, it is necessary in some instances to equip through cars, which run over different railways, with more than one system. In the trans-European service to Constantinople, it is said that each car has to be equipped with four different braking systems to conform with the regulations en route.

Power brakes are seldom used on the freight trains and some of the freight cars have no brakes whatever. In many of the freight yards there will be found wooden wedges, which are for the purpose of chocking the wheels to hold the cars in place. The hand brake attachment to the braking system, is usually through a screw and nut, instead of the chain and brake staff we commonly use. In some instances the brakes are applied only by a lever extending along side. To handle freight trains on grades, where the brakes are necessary to control the speed, it is customary to provide a brakeman for every four cars. In ordinary freight movements the braking is done entirely with the locomotive.

The sliding contact for current collection from overhead lines is almost universal on the Continent, for both tram cars and locomotives. Two triangular tubes

of brass or copper are used for the contact on many of the Italian three-phase locomotives, and triangular blocks of carbon are used on some of the direct-current lines; but generally for tram cars and single-phase locomotives the collector is an aluminum bow of U-shaped section with a groove for lubricant.

In locomotive service it is the practise to use two of these bow collectors on each locomotive, and because of the soft material the pressure against the conductor is limited to about 8 lb. With this light pressure, some arcing might reasonably be expected and is observable when collecting from a single wire. In some places two conducting wires with interspaced hangers are used, which is better for current collection than a single wire, as it provides greater flexibility, and doubles the collection contacts. Where the double wire construction had been used, there was no observable arcing at the collector. While the aluminum bow serves its purpose well for collecting the 100 amperes or more for which it is used, it would not be suitable for collecting current of any great magnitude.

Collectors of this type would by no means serve for the Chicago, Milwaukee & St. Paul locomotives, on which the current ranges from 800 to 1200 amperes. The collector used with these locomotives has two separate, flat, copper contact surfaces, while the overhead system has double wire conductors with interspaced hangers. This provides four independent contacts in parallel each of which are  $4\frac{1}{2}$  in. long, so that theoretically the aggregate contact is a line 18 in. long. The pressure of the collector against the conductor is about 30 lb. The relatively large amount of current taken by these locomotives is collected with no observable arcing, as the continuity of contact is well ensured and the contact surface is of adequate capacity.

Any appreciable arcing at the contact between the collector and conductor is unquestionably more destructive to both than the wear that occurs from mechanical friction. Continuity of contact must be maintained, if destructive arcing is to be avoided and the design of the collecting system should be such as will best ensure this continuity.

After investigating the various systems of railway electrification, a number of the European countries have established regulations in favor of a particular system for the electrification of their steam lines.

France, Belgium and Holland have decided in favor of 1500 volts direct current. The overhead system of conductors will, presumably, be used in these countries with but few exceptions. There was some discussion in France as to whether 1500 volts should be the generated or the average voltage of the system. It was finally ruled that 1500 volts referred to the generated voltage, but that a maximum tolerance of 5 per cent, would be allowed. There are no electrified railways of importance in Belgium and no projects whatever under immediate consideration. In Holland an initial electrification is being undertaken between Leyden and the Hague, this

being a portion of the main line that will ultimately be electrified between Amsterdam and Rotterdam.

England has also decided in favor of 1500 volts direct current, except in special cases, of which the London, Brighton and South Coast Railway is an example. This railway is partially electrified with single phase and it is proposed to complete the electrification with this system.

It is presumable that a 1500-volt third rail will be quite generally used in England, The Lancashire and Yorkshire Railway have been operating over about 20 miles of third rail at 1200 volts with success, for some seven years. The North Eastern Railway have been operating 600 volts third rail for something over 15 years, and have a more recent electrification, with an overhead system at 1500 volts. The London and Southwestern Railway have a 1500-volt third rail under consideration. The South Eastern Railway, which runs near the Greenwich Observatory, are proposing to use two third-rails with 3000 volts potential between them, but with the generating and motive power equipment connected in three-wire relation to the track, so that the voltage between each rail and ground will be only 1500 volts. The purpose of this double rail arrangement is to eliminate currents in the earth, which might effect the observatory instruments.

The principal railways in England, some twelve in number radiating from London, have recently been consolidated into four groups, corresponding to the Northern, Eastern, Southern and Western portions of the country. The purpose of these consolidations is to better coordinate the service of the railways in each group, and to direct the transportation of the country more effectively and economically through four general boards of Directors, instead of through the large number representing the individual railways.

There has been no official decision in Spain as to the system of electrification for their steam railways. There is in operation a short line equipped with the three-phase system. An important electrification on the Spanish Northern Railway, over a mountain division in the north of Spain, will soon be in operation with 3000 volts direct current.

Switzerland has standardized the single-phase system at  $16\frac{2}{3}$  cycles for their principal electrifications, and this system is being generally extended, although 1500 volts direct current is being used on some of the smaller railways. For other than single-phase railways, the standardized frequency is 50 cycles.

The Italian electrifications are almost exclusively three phase, although there are several lines equipped with 600 volts and there is a recent installation of 4000 volts direct current. Consideration is being given to a thorough trial of 3000 volts direct current in the central portion of Italy, south of the present zone of three-phase operation.

Germany is continuing the use of single phase for

steam railway electrification, although it was stated that 1500 volts direct current would presumably be employed for heavy multiple unit and interurban service.

The subject of electric railway systems is under discussion in Sweden. The more important existing electrifications are equipped with the single-phase system at 16 2/3 cycles. As the standard frequency for general purposes is 50 cycles, there appears to have arisen some question as to the expediency of generating and transmitting a particular frequency for the railways only. The more general utilization of natural resources and the better load factor resulting from diversity of use, would seem to indicate an economic advantage in favor of generation at the standard frequency with substation conversion into whatever form of electrical power the railways may require.

The economy in fuel obtained by modern steam power stations and the many available sources of hydraulic power, have contributed to stimulate greatly the electrification of the steam railways in Europe. Government endorsement of the projects has also been helpful in financing these enterprises.

The following list, compiled from available records, will give an idea of the extent of railway electrification throughout the world. It includes the steam railways which have been electrified or are in process of electrification, but not the steam railways on which multiple unit trains are being used exclusively, or electric railways which were not formerly operated by steam.

STEAM RAILWAY ELECTRIFICATION

	Route Miles	No. of Elec. Locos.
United States...	1607	375
Switzerland...	661	156
Italy.....	650	309
France.....	602	338
Germany.....	550	49
Austria.....	340	42
Sweden.....	237	44
Cuba.....	180	18
Africa.....	174	77
Chile.....	154	42
England.....	129	12
Canada.....	49	9
Spain.....	48	17
Japan.....	39	42
Norway.....	39	37
Mexico.....	30	10
Brazil.....	26	16
China.....	25	13
Java.....	25	5
Total.....	5565	1611

This is less than one per cent of the railway route mileage of the world. Conceding the efficacy of the steam locomotive for much of the world's service, there still remains a very large mileage which could be advantageously electrified. In the execution of this great undertaking we have many engineering and economic problems, the solution of which demands the cordial cooperation of all who are engaged in the furtherance of railway transportation.

### ELECTROLYSIS INVESTIGATION, GALVESTON, TEXAS

The Bureau of Standards has recently undertaken an extensive electrolysis investigation in the City of Galveston, Texas. This investigation is cooperative in character, all of the utilities in Galveston which were concerned in the electrolysis problem having arranged to participate in it and cooperate actively with the Bureau in making the tests. The primary object of the work is to secure additional data concerning the application of the earth current meter to electrolysis testing. It is expected that the results will demonstrate further the utility and necessity of employing this method and instrument where reliable information as to electrolysis conditions and a quantitative measure of the degree of hazard are required. The investigation is, therefore, mainly one of fundamental research, although it is expected that considerable detailed information regarding the local electrolysis conditions will be obtained, and a study of the effectiveness of existing mitigative measures will be made.

### WAVE-LENGTH MEASUREMENTS IN THE ARC SPECTRA OF GADOLINIUM AND DYSPROSIUM

Compounds of the rare earth elements which are used extensively in the manufacture of gas light mantles and cored carbons for electric arcs, and less extensively in the textile and glass industries for their coloring properties, are about the most difficult salts for the chemist to prepare in a pure state. The chemistry laboratory of the University of Illinois has succeeded in preparing some of the members of the rare earth family in a high degree of purity and has submitted to the Bureau of Standards samples of these materials for spectroscopic analysis. The work on the original assignment of materials is now completed and Scientific Paper No. 466 has just been issued describing the results that have been obtained for the two elements, gadolinium and dysprosium. Two preceding papers have dealt with yttrium, lanthanum, and cerium, and with neodymium and samarium. The spectroscopic analysis confirms the degree of purity attained by the chemists in separating the gadolinium and dysprosium salts from the original materials and in addition yields an accurate description of the green, yellow, red, and infra red spectral regions of these elements which have only been covered incompletely heretofore.

The data collected from the observations are compiled in two tables, one of which contains about 950 wave lengths in the arc spectrum of gadolinium, and the other, about 800 wave lengths in the arc spectrum of dysprosium. These data are of value chiefly to chemists who are interested in problems of analysis, to astronomers who are concerned with the chemical composition of the stars, and to physicists in connection with atomic structure.

of brass or copper are used for the contact on many of the Italian three-phase locomotives, and triangular blocks of carbon are used on some of the direct-current lines; but generally for tram cars and single-phase locomotives the collector is an aluminum bow of U-shaped section with a groove for lubricant.

In locomotive service it is the practise to use two of these bow collectors on each locomotive, and because of the soft material the pressure against the conductor is limited to about 8 lb. With this light pressure, some arcing might reasonably be expected and is observable when collecting from a single wire. In some places two conducting wires with interspaced hangers are used, which is better for current collection than a single wire, as it provides greater flexibility, and doubles the collection contacts. Where the double wire construction had been used, there was no observable arcing at the collector. While the aluminum bow serves its purpose well for collecting the 100 amperes or more for which it is used, it would not be suitable for collecting current of any great magnitude.

Collectors of this type would by no means serve for the Chicago, Milwaukee & St. Paul locomotives, on which the current ranges from 800 to 1200 amperes. The collector used with these locomotives has two separate, flat, copper contact surfaces, while the overhead system has double wire conductors with interspaced hangers. This provides four independent contacts in parallel each of which are  $4\frac{1}{2}$  in. long, so that theoretically the aggregate contact is a line 18 in. long. The pressure of the collector against the conductor is about 30 lb. The relatively large amount of current taken by these locomotives is collected with no observable arcing, as the continuity of contact is well ensured and the contact surface is of adequate capacity.

Any appreciable arcing at the contact between the collector and conductor is unquestionably more destructive to both than the wear that occurs from mechanical friction. Continuity of contact must be maintained, if destructive arcing is to be avoided and the design of the collecting system should be such as will best ensure this continuity.

After investigating the various systems of railway electrification, a number of the European countries have established regulations in favor of a particular system for the electrification of their steam lines.

France, Belgium and Holland have decided in favor of 1500 volts direct current. The overhead system of conductors will, presumably, be used in these countries with but few exceptions. There was some discussion in France as to whether 1500 volts should be the generated or the average voltage of the system. It was finally ruled that 1500 volts referred to the generated voltage, but that a maximum tolerance of 5 per cent, would be allowed. There are no electrified railways of importance in Belgium and no projects whatever under immediate consideration. In Holland an initial electrification is being undertaken between Leyden and the Hague, this

being a portion of the main line that will ultimately be electrified between Amsterdam and Rotterdam.

England has also decided in favor of 1500 volts direct current, except in special cases, of which the London, Brighton and South Coast Railway is an example. This railway is partially electrified with single phase and it is proposed to complete the electrification with this system.

It is presumable that a 1500-volt third rail will be quite generally used in England, The Lancashire and Yorkshire Railway have been operating over about 20 miles of third rail at 1200 volts with success, for some seven years. The North Eastern Railway have been operating 600 volts third rail for something over 15 years, and have a more recent electrification, with an overhead system at 1500 volts. The London and Southwestern Railway have a 1500-volt third rail under consideration. The South Eastern Railway, which runs near the Greenwich Observatory, are proposing to use two third-rails with 3000 volts potential between them, but with the generating and motive power equipment connected in three-wire relation to the track, so that the voltage between each rail and ground will be only 1500 volts. The purpose of this double rail arrangement is to eliminate currents in the earth, which might effect the observatory instruments.

The principal railways in England, some twelve in number radiating from London, have recently been consolidated into four groups, corresponding to the Northern, Eastern, Southern and Western portions of the country. The purpose of these consolidations is to better coordinate the service of the railways in each group, and to direct the transportation of the country more effectively and economically through four general boards of Directors, instead of through the large number representing the individual railways.

There has been no official decision in Spain as to the system of electrification for their steam railways. There is in operation a short line equipped with the three-phase system. An important electrification on the Spanish Northern Railway, over a mountain division in the north of Spain, will soon be in operation with 3000 volts direct current.

Switzerland has standardized the single-phase system at  $16\frac{2}{3}$  cycles for their principal electrifications, and this system is being generally extended, although 1500 volts direct current is being used on some of the smaller railways. For other than single-phase railways, the standardized frequency is 50 cycles.

The Italian electrifications are almost exclusively three phase, although there are several lines equipped with 600 volts and there is a recent installation of 4000 volts direct current. Consideration is being given to a thorough trial of 3000 volts direct current in the central portion of Italy, south of the present zone of three-phase operation.

Germany is continuing the use of single phase for

steam railway electrification, although it was stated that 1500 volts direct current would presumably be employed for heavy multiple unit and interurban service.

The subject of electric railway systems is under discussion in Sweden. The more important existing electrifications are equipped with the single-phase system at 16 2/3 cycles. As the standard frequency for general purposes is 50 cycles, there appears to have arisen some question as to the expediency of generating and transmitting a particular frequency for the railways only. The more general utilization of natural resources and the better load factor resulting from diversity of use, would seem to indicate an economic advantage in favor of generation at the standard frequency with substation conversion into whatever form of electrical power the railways may require.

The economy in fuel obtained by modern steam power stations and the many available sources of hydraulic power, have contributed to stimulate greatly the electrification of the steam railways in Europe. Government endorsement of the projects has also been helpful in financing these enterprises.

The following list, compiled from available records, will give an idea of the extent of railway electrification throughout the world. It includes the steam railways which have been electrified or are in process of electrification, but not the steam railways on which multiple unit trains are being used exclusively, or electric railways which were not formerly operated by steam.

STEAM RAILWAY ELECTRIFICATION

	Route Miles	No. of Elec. Locos.
United States...	1607	375
Switzerland...	661	156
Italy.....	650	309
France.....	602	338
Germany.....	550	49
Austria.....	340	42
Sweden.....	237	44
Cuba.....	180	18
Africa.....	174	77
Chile.....	154	42
England.....	129	12
Canada.....	49	9
Spain.....	48	17
Japan.....	39	42
Norway.....	39	37
Mexico.....	30	10
Brazil.....	26	16
China.....	25	13
Java.....	25	5
Total.....	5565	1611

This is less than one per cent of the railway route mileage of the world. Conceding the efficacy of the steam locomotive for much of the world's service, there still remains a very large mileage which could be advantageously electrified. In the execution of this great undertaking we have many engineering and economic problems, the solution of which demands the cordial cooperation of all who are engaged in the furtherance of railway transportation.

### ELECTROLYSIS INVESTIGATION, GALVESTON, TEXAS

The Bureau of Standards has recently undertaken an extensive electrolysis investigation in the City of Galveston, Texas. This investigation is cooperative in character, all of the utilities in Galveston which were concerned in the electrolysis problem having arranged to participate in it and cooperate actively with the Bureau in making the tests. The primary object of the work is to secure additional data concerning the application of the earth current meter to electrolysis testing. It is expected that the results will demonstrate further the utility and necessity of employing this method and instrument where reliable information as to electrolysis conditions and a quantitative measure of the degree of hazard are required. The investigation is, therefore, mainly one of fundamental research, although it is expected that considerable detailed information regarding the local electrolysis conditions will be obtained, and a study of the effectiveness of existing mitigative measures will be made.

### WAVE-LENGTH MEASUREMENTS IN THE ARC SPECTRA OF GADOLINIUM AND DYSPROSIUM

Compounds of the rare earth elements which are used extensively in the manufacture of gas light mantles and cored carbons for electric arcs, and less extensively in the textile and glass industries for their coloring properties, are about the most difficult salts for the chemist to prepare in a pure state. The chemistry laboratory of the University of Illinois has succeeded in preparing some of the members of the rare earth family in a high degree of purity and has submitted to the Bureau of Standards samples of these materials for spectroscopic analysis. The work on the original assignment of materials is now completed and Scientific Paper No. 466 has just been issued describing the results that have been obtained for the two elements, gadolinium and dysprosium. Two preceding papers have dealt with yttrium, lanthanum, and cerium, and with neodymium and samarium. The spectroscopic analysis confirms the degree of purity attained by the chemists in separating the gadolinium and dysprosium salts from the original materials and in addition yields an accurate description of the green, yellow, red, and infra red spectral regions of these elements which have only been covered incompletely heretofore.

The data collected from the observations are compiled in two tables, one of which contains about 950 wave lengths in the arc spectrum of gadolinium, and the other, about 800 wave lengths in the arc spectrum of dysprosium. These data are of value chiefly to chemists who are interested in problems of analysis, to astronomers who are concerned with the chemical composition of the stars, and to physicists in connection with atomic structure.

# Some Problems in Electric Furnace Operation

BY F. V. ANDREAE

Associate, A. I. E. E.  
Electrical Engineer, Anniston, Ala.

*Review of the Subject.*—Based upon the theory that the reactance of a three-phase electric furnace does not depend upon the load but is a constant depending on the arrangement of the conductors, the general equations of the three-phase furnace are developed and discussed.

It is shown that, due to the fact that the main conductors carrying the current from the interlaced bus bars to the furnace are more or less in one plane, a transformer action is introduced between phase 1 and phase 3, taking power away from 1 and transporting it to 3. The phase rotation being 1, 2, 3. This power may be considerable.

When voltages between phases and currents are balanced the power delivered by the three electrodes is quite unbalanced, a fact that is very apparent in large furnaces, electrode 1 seeming dead while electrode 3 takes most of the power.

Nevertheless, when only voltage, current and total power are concerned, very simple expressions can be used which are entirely satisfactory in practise.

A few methods are suggested to reduce the unbalancing of the load.

Finally the two-phase connection of the load is studied to show that the unbalancing of the currents which is inherent in this connection does not check with observations on the furnace under operation.

The load must be considered as connected in star, the bottom of the furnace being the neutral. The electric energy is transformed into heat energy in three separate zones situated under the three electrodes.

The load resistance is probably furnished by an arc in an atmosphere of vapors under pressure.

\* \* \* \* \*

WHEN operating electric furnaces of the ordinary ferro-alloy type it is often necessary to know in advance what a furnace will do under changed conditions, and it has been tried in the following to develop and discuss the general equations of the electric furnace. Most of the large furnaces are of the three-phase type and only such have been considered here.

A large number of tests made on different furnaces manufacturing various products showed that the reactance per phase, measured on the low-tension side, was practically constant over the whole range of loads. This reactance depends upon the disposition of the bus bars and other conductors carrying the current into the furnace.

The load circuit, that is, this part of the circuit where the electric energy is transformed into heat does not show any reactance and acts like a pure resistance.

In some of the tests mentioned above, the current was increased from 6000 to 24,000 amperes per phase, at constant voltage without the reactance changing its value.

Through a large number of observations the writer is led to believe that the transformation of electric energy into heat energy, in the furnace of the type considered, occurs in an arc passing through an atmosphere of vapors under pressure. The properties of the arc will naturally vary with different materials. Other conditions remaining the same the current will increase when the arc is shortened under constant voltage, and for constant current, the voltage across the arc will increase with increasing length.

It has been suggested that the heat energy was generated by the current passing through the slag and the molten metal.

To this view it may be objected that, if the electrode tips were touching the molten bath, the path through

the bath to the bottom of the furnace would offer much less resistance to the current, due to its short length and large section, than the path across the bath to the nearest electrode, which is long and of narrow section and the current would flow directly to the bottom. The resistance of the short length of molten metal and slag is much too small to account for the power which is dissipated according to the  $i^2 R$  rule. It can further be shown that the electrodes are far above the bath.

If, on the other hand, the pasty charge above the bath were the resistor, the current would pass mostly to the nearest electrode without going to the bath. The conditions are here reversed; the larger resistance would be toward the bath.

In a three-phase furnace such a distribution of load would correspond to an open delta connection. When a load is connected across two phases only of a three-phase system, the center conductor carries a current which is about  $1\frac{3}{4}$  times the current in the outer conductors.

Such an unbalancing does not appear in our furnaces and in following the movements of the electrodes and their effect upon voltage, current and load one is led to the conclusion that the load is star-connected with the bottom of the furnace acting as the neutral point. As for the cold charge, it can be considered as a perfect insulator.

The heat energy, therefor, is generated in three small zones situated between the ends of the three electrodes and the bath; most of that energy is used up by the chemical reactions and to bring the products to their final temperature. The balance flows through the charge and the walls of the furnace, from points of higher to points of lower temperature.

If the electrodes are too far apart it might happen that the zone half way between two electrodes is too cold to keep the charge in fusion and we get a wall in the furnace.

Presented at the Spring Convention of the A. I. E. E., Pittsburgh, Pa., April 24-26, 1923.



To raise the temperature at this point we have to increase the input of energy. For constant current this is done by increasing the voltage, so that indirectly the distance between electrodes is a function of the voltage.

Based on the above conclusion, that the reactance per phase was a constant, independent of the load, the general equations of the three-phase furnace were developed.

To avoid any undue complications and obtain equations which could be easily discussed, the following assumptions were made:

The furnace is fed by three parallel and similar conductors situated in one plane and symmetrically disposed in relation to the middle one. Constant voltage across phases is impressed to these conductors by the transformers and their resistance is neglected, unless otherwise specified. As can be seen the impedance of the transformer is neglected also, unless otherwise specified.

GENERAL EQUATIONS

The voltage drop due to the inductance in three parallel conductors is:

$$\left. \begin{aligned} I_1 X_a &= -I_2 X_{1.2} - I_3 X_{1.3} \\ I_2 X_b &= -I_1 X_{2.1} - I_3 X_{2.3} \\ I_3 X_c &= -I_1 X_{3.1} - I_2 X_{3.2} \end{aligned} \right\} \text{ where } \quad (1)$$

$$\begin{aligned} X_{1.2} &= X_{2.1} \\ X_{2.3} &= X_{3.2} \\ X_{3.1} &= X_{1.3} \end{aligned}$$

and where  $I_1, I_2, I_3$  designate the currents in phase 1, 2 and 3 respectively in amperes

$X_{1.2}$  is the effective reactance of phase 1 due to current  $I_2$  in ohms

$X_{2.3}$  is the effective reactance of phase 2 due to current  $I_3$

$X_{3.1}$  is the effective reactance of phase 3 due to current  $I_1$

for reasons of symmetry  $X_{12} = X_{23} = X$ ,  $X_{13}$  can be written  $\alpha X$  where  $\alpha > 1$ . A dot above a quantity indicates that it must be taken as a vector.  $\dot{I}_1, \dot{I}_2, \dot{I}_3$  being star currents must add up to 0.

$$\dot{I}_1 + \dot{I}_2 + \dot{I}_3 = 0 \quad (2)$$

Using the complex notation and taking  $I_2$  as the origin we have

$$\left. \begin{aligned} \dot{I}_1 &= I(-\gamma - j\beta) \\ \dot{I}_2 &= I \\ \dot{I}_3 &= I(-\epsilon + j\beta) \end{aligned} \right\} \quad (3)$$

where  $\gamma + \epsilon = 1$ .

If we call  $R_a, R_b, R_c$  the resistance of the load in phase 1, 2 and 3 respectively.  $I_1 R_a, I_2 R_b, I_3 R_c$  are the voltage drops due to load.

The total voltage drop in the three phases, from the point where the voltage is impressed to the neutral is:

$$\left. \begin{aligned} \dot{I}_1 Z_1 &= \dot{I}_1 (R_a - jX_a) = \dot{I}_1 R_a + j\dot{I}_2 X + j\dot{I}_3 \alpha X \\ \dot{I}_2 Z_2 &= \dot{I}_2 (R_b - jX_b) = \dot{I}_2 R_b + j\dot{I}_3 X + j\dot{I}_1 X \\ \dot{I}_3 Z_3 &= \dot{I}_3 (R_c - jX_c) = \dot{I}_3 R_c + j\dot{I}_1 \alpha X + j\dot{I}_2 X \end{aligned} \right\} \quad (4)$$

Combining (3) and (4):

$$\left. \begin{aligned} \dot{I}_1 Z_1 &= I \{ -(\gamma R_a + \beta \alpha X) - j [ (\alpha \epsilon - 1) X + \beta R_a ] \} = \dot{e}_1 \\ \dot{I}_2 Z_2 &= I [ R_b - jX ] = \dot{e}_2 \\ \dot{I}_3 Z_3 &= I \{ -(\epsilon R_c - \beta \alpha X) - j [ (\gamma \alpha - 1) X - \beta R_c ] \} = \dot{e}_3 \end{aligned} \right\} \quad (5)$$

The impedances of the three phases are:

$$\left. \begin{aligned} Z_1 &= R_a + \frac{(\alpha - 1) \beta X}{\beta^2 + \gamma^2} \\ &\quad - jX \left( \alpha - \frac{(\alpha - 1) \gamma}{\beta^2 + \gamma^2} \right) = R_1 - jX_1 \\ Z_2 &= R_b - jX = R_2 - jX_2 \\ Z_3 &= R_c - \frac{(\alpha - 1) \beta X}{\beta^2 + \epsilon^2} \\ &\quad - jX \left( \alpha - \frac{(\alpha - 1) \epsilon}{\beta^2 + \epsilon^2} \right) = R_3 - jX_3 \end{aligned} \right\} \quad (6)$$

We see that in phase 1 a resistance  $\frac{\alpha - 1}{\beta^2 + \gamma^2} \beta X$  is added to the load resistance  $R_a$ , in phase 3 a resistance  $\frac{\alpha - 1}{\beta^2 + \epsilon^2} \beta X$  is subtracted from  $R_c$ . Multiplying these two resistances by  $I_1^2$  and  $I_3^2$  respectively we have

$$P_{t_1} = I_1^2 \cdot \frac{\alpha - 1}{\beta^2 + \gamma^2} \beta X$$

$$P_{t_3} = I_3^2 \cdot \frac{\alpha - 1}{\beta^2 + \epsilon^2} \beta X$$

but  $I_1^2 = I^2 (\beta^2 + \gamma^2)$  and  $I_3^2 = I^2 (\beta^2 + \epsilon^2)$  so that

$$P_{t_1} = P_{t_3} = P_t = I^2 (\alpha - 1) \beta X \text{ Watts} \quad (7)$$

$P_t$  represents an amount of power which is subtracted from phase 1 and transmitted to phase 3 by a transformer action.

If  $E_1, E_2, E_3$  are the voltages impressed across phase 2 and 3, phase 3 and 1 and phase 1 and 2 respectively, we have in combination with (5)

$$\left. \begin{aligned} \dot{E}_3 &= \dot{e}_1 - \dot{e}_2 = I [ -(\gamma R_a + R_b + \beta \alpha X) - j [ (\epsilon \alpha - 2) X + \beta R_a ] ] \\ \dot{E}_1 &= \dot{e}_2 - \dot{e}_3 = I [ (R_b + \epsilon R_c - \beta \alpha X) - j [ (2 - \alpha \gamma) X + \beta R_c ] ] \\ \dot{E}_2 &= \dot{e}_3 - \dot{e}_1 = I [ -(\epsilon R_c - \gamma R_a - \epsilon \beta \alpha X) - j [ (\alpha \gamma - \alpha \epsilon) X - \beta R_a - \beta R_c ] ] \end{aligned} \right\} \quad (8)$$

$$\dot{E}_1 + \dot{E}_2 + \dot{E}_3 = 0$$

The total power consumed by phases 1, 2 and 3 respectively are:

$$\left. \begin{aligned} W_1 &= I_1^2 R_1 = I^2 [ (\beta^2 + \gamma^2) R_a + (\alpha - 1) \beta X ] \\ W_2 &= I_2^2 R_2 = I^2 R_b \\ W_3 &= I_3^2 R_3 = I^2 [ (\beta^2 + \epsilon^2) R_c - (\alpha - 1) \beta X ] \end{aligned} \right\} \quad (9)$$

The power delivered to the furnace by electrodes 1, 2 and 3 respectively are:

$$\left. \begin{aligned} W_a &= I_1^2 R_a = I^2 [(\beta^2 + \gamma^2) R_a] \\ W_b &= I_2^2 R_b = I^2 R_b \\ W_c &= I_3^2 R_c = I^2 [(\beta^2 + \epsilon^2) R_c] \end{aligned} \right\} \quad (10)$$

Equations (8) which include voltage, current, resistance and reactance are the desired general equations of the three phase furnace.

DISCUSSION

Taking first the general case where the three impressed voltages are equal, and the three currents are balanced: the conditions for balanced currents are,

$$\gamma = \epsilon = 1/2, \beta = 1/2 \sqrt{3}, \gamma^2 + \beta^2 = \epsilon^2 + \beta^2 = 1 \quad (11)$$

$$\left. \begin{aligned} \dot{I}_1 &= -I(1/2 + j1/2\sqrt{3}) \\ \dot{I}_2 &= I \\ \dot{I}_3 &= -I(1/2 - j1/2\sqrt{3}) \end{aligned} \right\} \quad (12)$$

if  $\dot{E}_3 = E(\pi + j\zeta)$  the condition for equal voltage is

$$\left. \begin{aligned} \dot{E}_1 &= E(\pi + j\zeta) \left( -1/2 + j1/2\sqrt{3} \right) \\ &= E \left[ (-1/2\pi - 1/2\zeta\sqrt{3}) - j(1/2\zeta - 1/2\pi\sqrt{3}) \right] \\ \dot{E}_2 &= E(\pi + j\zeta) \left( -1/2 - j1/2\sqrt{3} \right) \\ &= E \left[ (-1/2\pi + 1/2\zeta\sqrt{3}) - j(1/2\zeta + 1/2\pi\sqrt{3}) \right] \\ \dot{E}_3 &= E(\pi + j\zeta) \end{aligned} \right\} \quad (13)$$

Combining (8), (11) and (13) we have:

$$\left. \begin{aligned} R_a &= \frac{R_a + R_b + R_c}{3} - 2/3(\alpha - 1)X\sqrt{3} \\ &= R_{av} - 2/3(\alpha - 1)X\sqrt{3} \\ R_b &= \frac{R_a + R_b + R_c}{3} = R_{av} \\ R_c &= \frac{R_a + R_b + R_c}{3} + 2/3(\alpha - 1)X\sqrt{3} \\ &= R_{av} + 2/3(\alpha - 1)X\sqrt{3} \end{aligned} \right\} \quad (14)$$

if we call  $\frac{R_a + R_b + R_c}{3} = R_{av}$ .

The three resistances of total power consumed by each phase are:

$$\left. \begin{aligned} R_1 &= R_{av} - 1/6(\alpha - 1)X\sqrt{3} \\ R_2 &= R_{av} \\ R_3 &= R_{av} + 1/6(\alpha - 1)X\sqrt{3} \end{aligned} \right\} \quad (15)$$

The total power input is  $3I^2 R_{av}$ , but we see that the total power consumed by phase 1 is smaller than that consumed by phase 2 by an amount  $I^2/6(\alpha - 1)X\sqrt{3}$ . The total power consumed by phase 3 is larger than that consumed by phase 2 by the same amount.

Subtracting from phase 1 and adding to phase 3

the transformation power  $\frac{I^2(\alpha - 1)X\sqrt{3}}{2}$  we have

finally for the power delivered to the furnace by phase 1, 2 and 3

$$\left. \begin{aligned} W_a &= I^2(R_{av} - 2/3(\alpha - 1)X\sqrt{3}) \\ W_b &= I^2 R_{av} \\ W_c &= I^2(R_{av} + 2/3(\alpha - 1)X\sqrt{3}) \end{aligned} \right\} \quad (16)$$

if  $\dot{E}_3 = E(\pi + j\zeta)$   $\dot{E}_3^2 = E^2(\pi^2 + \zeta^2)$

combining this last equation with (8) and (11) we have

$$\begin{aligned} E_3^2 &= E_2^2 = E_1^2 = 3I^2(R_{av}^2 + (\alpha + 2)^2 X^2/9) \\ &= 3I^2(R_{av}^2 + X_{av}^2) \end{aligned}$$

where  $X_{av} = X \frac{(\alpha + 2)}{3}$

If we replace in (6)  $R_1, R_2, R_3, X_1, X_2, X_3$  by their respective values we have

$$\begin{aligned} Z_1 &= R_{av} - 1/6(\alpha - 1)X\sqrt{3} - j \frac{(1 + \alpha)}{2} X \\ Z_2 &= R_{av} - j X \\ Z_3 &= R_{av} + 1/6(\alpha - 1)X\sqrt{3} - j \frac{(1 + \alpha)}{2} X \end{aligned}$$

$X_{av}$  represents the average of the three reactances just as  $R_{av}$  represents the average of the three load resistances, and  $3I^2 X_{av}$  is the total reactive power as would be registered, for instance, by the reactance side of a double R A Max. demand meter.

If we are only interested in the total power without paying any attention to the unbalancing of the individual phases, the general equations are reduced to the equations of a three-phase balanced circuit. Since the currents are balanced we can introduce without error, the resistance of the conductors and if desired the impedance of the transformer.

In this case

$$\begin{aligned} R_{tot} &= \frac{R_a + R_b + R_c}{3} + R_{cond} + R_{transf.} \\ &= R_{av} + R_{losses} \end{aligned}$$

and  $X_{tot} = \frac{(\alpha + 2)}{3} X + X_{transf.}$

$$Z_{tot} = \sqrt{R_{tot}^2 + X_{tot}^2}$$

Table I gives the values of the resistance per phase  $R_{tot}$ , the reactance  $X_{tot}$ , the power factor  $\cos \varphi = R_{tot}/Z_{tot}$ , the power input  $W_{tot} = 3I^2 R_{tot}$ , the current  $I$  and the voltage  $E$  when three of these quantities are given. Multiplying  $W_{tot}$  by  $R_{av}/R_{tot}$  gives the power delivered into the furnace.

TABLE I  
(The Symbol  $I_{tot}$  is Omitted)

	Given	$E =$ in volts	$I =$ in amperes	$X =$ in ohms	$R =$ in ohms	$W =$ in watts	$\cos \phi =$
1	$E I X$	$E$	$I$	$X$	$\sqrt{\frac{E^2}{3I^2} - X^2}$	$I \sqrt{3 E^2 - 9 I^2 X^2}$	$\sqrt{1 - 3 \frac{I^2 X^2}{E^2}}$
2	$E I R$	$E$	$I$	$\sqrt{\frac{E^2}{3I^2} - R^2}$	$R$	$3I^2 R$	$\frac{R I \sqrt{3}}{E}$
3	$E I W$	$E$	$I$	$\sqrt{\frac{E^2}{3I^2} - \frac{W^2}{9I^4}}$	$\frac{W}{3I^2}$	$W$	$\frac{W}{E I \sqrt{3}}$
4	$E I \cos \phi$	$E$	$I$	$\frac{E}{I \sqrt{3}} \sqrt{1 - \cos^2 \phi}$	$\frac{E \cos \phi}{I \sqrt{3}}$	$E I \sqrt{3} \cos \phi$	$\cos \phi$
5	$E X R$	$E$	$\frac{E}{\sqrt{3(X^2 + R^2)}}$	$X$	$R$	$\frac{E^2 R}{X^2 + R^2}$	$\frac{R}{\sqrt{R^2 + X^2}}$
6	$E X W$	$E$	$\sqrt{\frac{E^2 \pm \sqrt{E^4 - 4W^2X^2}}{6X^2}}$	$X$	$\frac{2WX^2}{E^2 \pm \sqrt{E^4 - 4W^2X^2}}$	$W$	$\frac{WX \sqrt{2}}{E \sqrt{E^2 \pm \sqrt{E^4 - 4W^2X^2}}}$
7	$E X \cos \phi$	$E$	$\frac{E \sqrt{1 - \cos^2 \phi}}{X \sqrt{3}}$	$X$	$\frac{X \cos \phi}{\sqrt{1 - \cos^2 \phi}}$	$\frac{E^2 \sqrt{1 - \cos^2 \phi} \cos \phi}{X}$	$\cos \phi$
8	$E R W$	$E$	$\sqrt{\frac{W}{3R}}$	$R \sqrt{\frac{E^2}{WR} - 1}$	$R$	$W$	$\frac{\sqrt{WR}}{E}$
9	$E R \cos \phi$	$E$	$\frac{E \cos \phi}{R \sqrt{3}}$	$\frac{R \sqrt{1 - \cos^2 \phi}}{\cos \phi}$	$R$	$\frac{E^2 \cos^2 \phi}{R}$	$\cos \phi$
10	$E W \cos \phi$	$E$	$\frac{W}{E \cos \phi \sqrt{3}}$	$\frac{E^2 \cos \phi \sqrt{1 - \cos^2 \phi}}{W}$	$\frac{E^2 \cos^2 \phi}{W}$	$W$	$\cos \phi$
11	$I X R$	$I \sqrt{3(R^2 + X^2)}$	$I$	$X$	$R$	$3I^2 R$	$\frac{R}{\sqrt{X^2 + R^2}}$
12	$I X W$	$I \sqrt{3X^2 + \frac{W^2}{3I^4}}$	$I$	$X$	$\frac{W}{3I^2}$	$W$	$\frac{W}{\sqrt{9I^4 X^2 + W^2}}$
13	$I X \cos \phi$	$\frac{I X \sqrt{3}}{\sqrt{1 - \cos^2 \phi}}$	$I$	$X$	$\frac{X \cos \phi}{\sqrt{1 - \cos^2 \phi}}$	$\frac{3I^2 X \cos \phi}{\sqrt{1 - \cos^2 \phi}}$	$\cos \phi$
14	$I R W$	undeterm.	$I$	undeterm.	$R$	$W$	undeterm.
15	$I R \cos \phi$	$\frac{I R}{\cos \phi} \sqrt{3}$	$I$	$\frac{R}{\cos \phi} \sqrt{1 - \cos^2 \phi}$	$R$	$3I^2 R$	$\cos \phi$
16	$I W \cos \phi$	$\frac{W}{I \cos \phi \sqrt{3}}$	$I$	$\frac{W}{3I^2 \cos \phi} \sqrt{1 - \cos^2 \phi}$	$\frac{W}{3I^2}$	$W$	$\cos \phi$
17	$X R W$	$\sqrt{\frac{W(X^2 + R^2)}{R}}$	$\sqrt{\frac{W}{3R}}$	$X$	$R$	$W$	$\frac{R}{\sqrt{R^2 + X^2}}$
18	$X R \cos \phi$	undeterm.	undeterm.	$X$	$R$	undeterm.	$\cos \phi$
19	$X W \cos \phi$	$\sqrt{\frac{WX}{\cos \phi \sqrt{1 - \cos^2 \phi}}}$	$\sqrt{\frac{W \sqrt{1 - \cos^2 \phi}}{3X \cos \phi}}$	$X$	$\frac{X \cos \phi}{\sqrt{1 - \cos^2 \phi}}$	$W$	$\cos \phi$
20	$R W \cos \phi$	$\sqrt{\frac{WR}{\cos^2 \phi}}$	$\sqrt{\frac{W}{3R}}$	$\frac{R \sqrt{1 - \cos^2 \phi}}{\cos \phi}$	$R$	$W$	$\cos \phi$

*Numerical Example.* A 3000-kv-a. transformer bank with taps for 75, 85 and 100 volts with 44,000 volts high-tension voltage feeds a three-phase electric furnace. The bus bars are connected delta, so that the transformer voltage, is also the voltage between phases. The transformer losses at full-load are 2 per cent, its reactance 6 per cent at the highest tap. We assume that the magnetizing current is negligible.

The following quantities have been measured by instruments:

High-tension line current: 40 amperes per phase

High-tension voltage: 44,000 volts between phases

The high tension is connected to give 100 volts on the low tension

Total power input high tension 2600 kw.

Using Case No. 3 of Table I, we find

$$R = \frac{2600 \times 10^3}{3 \times 40^2} = 542 \text{ ohms}$$

The resistance per phase on the secondary side is

$$R_{tot} = \frac{542 \times 100^2}{44000^2} = 0.00280 \text{ ohms}$$

The low-tension current is

$$\frac{40 \times 44000}{100} = 17600 \text{ amperes}$$

$$X_{tot} = \sqrt{\frac{100^2}{3 \times 17600^2} - \frac{2600^2 \times 10^6}{9 \times 17600^4}}$$

The full-load current of a 3000 kv transformer = 0.00171 ohms

bank for 100 volts is 17,300 amperes in the furnace conductors, so that with 2 per cent resistance and 6 per cent reactance

$$R_{transf.} = \frac{3000 \times 10^2 \times 2}{3 \times 17,300^2 \times 100} = 0.000067 \text{ ohms}$$

$$X_{transf.} = \frac{3000 \times 10^3 \times 6}{3 \times 17,300^2 \times 100} = 0.0002 \text{ ohms}$$

assume that  $R_{cond}$  has been figured to be 0.000133 ohms so that  $R_{transf.} + R_{cond} = 0.0002$  ohms.

$$R_{av} = 0.00280 - 0.0002 = 0.0026 \text{ ohms}$$

$$X_{av} = 0.00171 - 0.0002 = 0.00151 \text{ ohms}$$

$$\text{Efficiency} = \frac{0.0026}{0.0028} = 92.8 \text{ per cent}$$

$$\text{Aver. power factor} = \frac{2600 \times 10^3}{100 \times 17,600 \times \sqrt{3}} = 0.853$$

$$\text{Power input into furnace} = 2600 \times \frac{92.8}{100} = 2412 \text{ kw.}$$

After operating a while the furnace at 100 volts it is decided to change the taps to 85 volts. What will be the new conditions for the same high-tension current?

At 85 volts with 40 amperes high-tension current, the low-tension current will be  $\frac{40 \times 44,000}{85} = 20,720$

amperes.

Using Case No. 1 of Table I:

$$E = 85 \text{ volts} \quad I = 20,720 \text{ a.} \quad X_{tot} = 0.00171 \text{ ohms}$$

$$R_{tot} = \sqrt{\frac{85^2}{3 \times 20,720^2} - 0.00171^2} = 0.001643 \text{ ohms}$$

$$R_{av} = 0.001443$$

$$W = 3 \times 20,720^2 \times 0.001643 = 2114 \text{ kw.}$$

$$\text{Power input into furnace} = \frac{2114 \times 0.001443}{0.001643} = 1856 \text{ kw.}$$

$$\text{Efficiency} = 87.9 \text{ per cent}$$

Power factor

$$= \sqrt{1 - 3 \cdot \frac{20,720^2 \times 0.00171^2}{85^2}} = 0.693$$

It can easily be shown that with increasing current the power input passes through a maximum for  $R_{tot} = X_{tot}$ . After this point any further increase in current means a decrease in power.

Taking, in case 5,

$$W = \frac{E^2 R}{X^2 + R^2},$$

where  $E$  and  $X$  are constant.

The condition for maximum power is

$$\frac{dW}{dR} = 0 = \frac{E^2 (X^2 + R^2 - 2R^2)}{(X^2 + R^2)^2}$$

$$0 = X^2 - R^2 \quad \begin{aligned} X^2 &= R^2 \\ X &= R \end{aligned}$$

$$\text{Power Factor} = \frac{R}{\sqrt{X^2 + R^2}} = \sqrt{2/2} = 0.707$$

$$1 = \frac{E}{\sqrt{3(X^2 + R^2)}} = \frac{E}{X\sqrt{6}}$$

In our case, the power input is a maximum for  $R = 0.00171$  ohms.

$$I = \frac{85}{0.00171 \cdot \sqrt{6}} = 20,310 \text{ amperes}$$

$$W = \frac{3 \times 0.00171 \times 20,310^2}{1000} = 2116 \text{ kw.}$$

$$\text{Efficiency} = \frac{0.00171 - 0.00020}{0.00171} = 88.3 \text{ per cent}$$

Power factor = 0.707. Power delivered to furnace =  $2116 \times 0.883 = 1867$  kw.

The power delivered to the furnace passes also through a maximum but at a lower current as the total power input

$$W_{furn} = \frac{W \cdot R_{av}}{R_{tot}} = \frac{E^2 (R_{tot} - R_{losses})}{R_{tot}^2 + X_{tot}^2}$$

$$\frac{dW_{fce}}{dR_{tot}}$$

$$= E^2 \frac{R_{tot}^2 + X_{tot}^2 - 2(R_{tot} - R_{losses})R_{tot}}{(R_{tot}^2 + X_{tot}^2)^2} = 0$$

$$0 = X_{tot}^2 - R_{tot}^2 + 2R_{tot} \cdot R_{losses}$$

$$R_{tot} = R_{losses} + \sqrt{R_{losses}^2 + X_{tot}^2}$$

In our case:

$$R_{tot} = 0.0002 + \sqrt{0.0002^2 + 0.00171^2} = 0.0002 + 0.00172 = 0.00192 \text{ ohms}$$

$$I = \frac{85}{\sqrt{0.00192^2 + 0.00171^2} \cdot \sqrt{3}} = 19,120 \text{ amperes}$$

$$W_{input} = 3 \times 19,120^2 \times 0.00192 = 2104 \text{ kw.}$$

$$W_{fce} = 3 \times 19,120^2 \times 0.00172 = 1885$$

$$\text{Efficiency} = \frac{0.00172}{0.00192} = 89.6 \text{ per cent}$$

Power factor, (High-tension side) = 0.747.

It will therefore be more economical in our case to

drop the high-tension current to  $\frac{19,120 \times 85}{44,000} = 37$

amperes when we change the voltage from 100 to 85 volts on the low-tension side. This current will give us maximum power into the furnace at that voltage.

Problems like the above can easily be solved by the analytical method; nevertheless it is generally simpler to prepare sets of curves giving for each available low-tension voltage the power input in transformer and

furnace, the power factor and if desired the low-tension resistance in functions of the low or high tension-current, depending on the manner in which the measuring instruments are connected, and whether high or low-tension current is mostly used for computations.

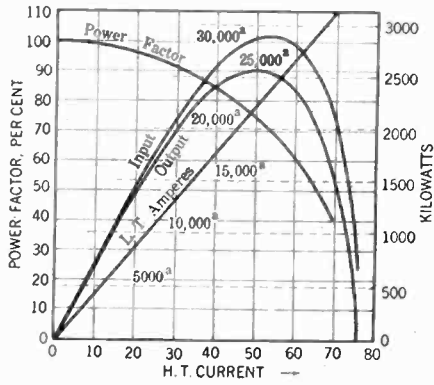

FIG. 1—CHARACTERISTICS OF ELECTRIC FURNACE FROM SIMPLIFIED CIRCLE DIAGRAM (SEE FIG. 2)

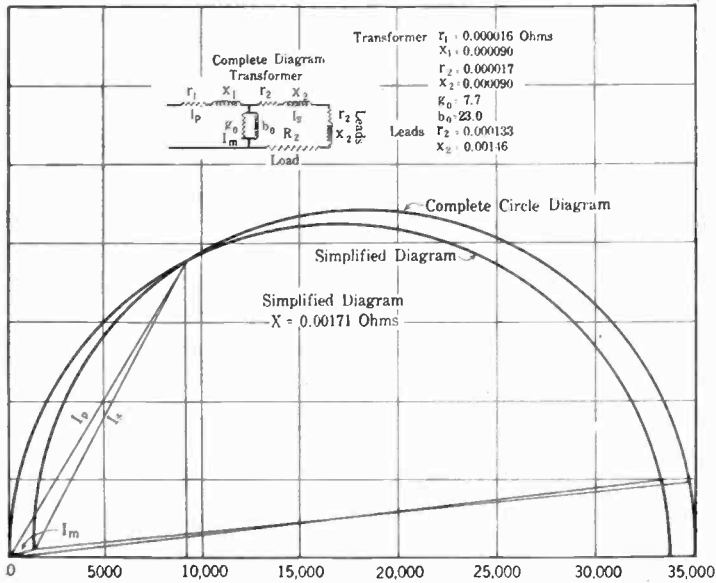

FIG. 2—COMPARISON BETWEEN SIMPLIFIED AND COMPLETE CIRCLE DIAGRAM

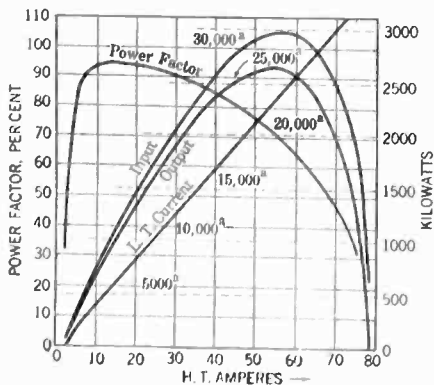

FIG. 3—CHARACTERISTICS OF ELECTRIC FURNACE FROM COMPLETE CIRCLE DIAGRAM

The two circle diagrams are so arranged that for 40 amperes high-tension current the kw. input and the power factor are the same. In comparing Figs. 1 and 3 one can see the error which is introduced by using a simplified diagram which neglects the magnetizing current.

Fig. 1 gives a set of curves for 100 volt low-tension voltage and  $X = 0.00171$  ohms. One can naturally, if greater accuracy is desired, draw an exact circle

diagram similar to the one used for induction motors, but it will generally be quite sufficient for practical purposes to use curves as shown above.

Fig. 2 shows a comparison between the simplified circle diagram corresponding to the curves on Fig. 1 and the theoretical diagram which takes the magnetizing current of the transformer into account. This last circle has been drawn so as to give the same values as the simplified circle for 40 amperes high-tension current.

INFLUENCE OF UNBALANCING

As will be shown later the value of  $\alpha$ , which is the ratio between  $X_{1,3}$  and  $X_{1,2}$ , can be taken as being between 1.2 and 1.3 according to the dimensions and arrangements of the leads. In the case of balanced current  $\beta = 1/2 \sqrt{3}$ .

The value of  $X_{av}$  will vary greatly, depending on the arrangement of the leads and the frequency. At 60 cycles, with well designed furnaces, values as low as 0.0015 were found, but in the same plant were furnaces with  $X_{av}$  as high as 0.0021. At 25 cycles these furnaces would have shown values of 0.000625 and 0.000875 ohms respectively.

In the previous example, we had found  $X_{av} = 0.00151$  but  $X_{av} = X \frac{(\alpha + 2)}{3}$ , and if we take  $\alpha = 1.25$

$$X = \frac{0.00151 \times 3}{3.25} = 0.001394 \text{ say } 0.00140 \text{ ohms}$$

introducing these values in the equation (7) we find that  $P_t = I^2 (\alpha - 1) \beta X = I^2 (0.25 \times \sqrt{3}/2 \times 0.00140) = 0.000303 I^2$

for  $I = 17,600$ .

$$P_t = \frac{17,600^2 \times 0.000303}{1000} = 94.5 \text{ kw.}$$

The total power consumed by each phase is

$$W_1 = I^2 (R_{av} + R_{losses} - 1/6 (\alpha - 1) X \sqrt{3}) = \frac{17,600^2}{1000} (0.0028 - 1/6 (1.25 - 1) 0.0014 \cdot \sqrt{3}) = 836 \text{ kw.}$$

$$W_2 = I^2 (R_{av} + R_{losses}) = \frac{17,600^2}{1000} \times 0.0028 = 867 \text{ kw.}$$

$$W_3 = I^2 (R_{av} + R_{losses}) + 1/6 (\alpha - 1) \times \sqrt{3} = \frac{17,600^2}{1000^2} (0.0028 + 1/6 (1.25 - 1) 0.0014 \sqrt{3}) = 898 \text{ kw.}$$

Total power input 2601 kw.

The losses per phase are

$$\frac{17,600^2}{1000} \times 0.0002 = 63 \text{ kw.}$$

The power delivered by each electrode to the furnace will be

Phase 1,  
 $W_a = 836 - 63 - 94.5 = 678.5$  kw. or 28.1 per cent  
 Phase 2,  
 $W_b = 867 - 63 = 804$  kw. or 33.3 per cent  
 Phase 3,  
 $W_c = 898 - 63 + 94.5 = 929.5$  kw. or 38.6 per cent  
 Total power delivered \_\_\_\_\_

to furnace 2412.0 kw.

The difference between the phases is therefore quite large, and would still be larger for furnaces with higher phase reactance.

Since it appears that the arc acts as a straight resistance, the arc voltage on each phase is easily calculated:

$$\begin{aligned} \text{Arc voltage phase 1 } & \frac{678,500}{17,600} = 38.55 \text{ volts} \\ \text{phase 2 } & \frac{804,000}{17,600} = 45.70 \text{ volts} \\ \text{phase 3 } & \frac{929,500}{17,600} = 52.8 \text{ volts.} \end{aligned}$$

Taking now the point where the power input on the high-tension side is a maximum, with the low-tension at 85 volts and the low-tension current 20,310 amperes, we have

	Total power consumed	Losses	Power due to transformer action	Power delivered to furnace	In per cent	Arc voltage
Phase 1.....	664	- 82.5	- 124.5	= 457	24.44	22.5 volts
Phase 2.....	705.5	- 82.5		= 623	33.33	30.7 volts
Phase 3.....	747	- 82.5	+ 124.5	= 789	42.23	38.9 volts
Total.....	2116.5 kw.			1869 kw.	100.00	

The lower the average power factor the larger are the differences between phases.

In the case studied above the value of  $X$  in equation (7) was 0.001394, this is rather low, and furnaces with larger values will be found, also  $\alpha$  may be larger than 1.25. It follows that the values calculated above are rather favorable and that much larger differences between phases are possible.

This difference of voltage and power input between the phases is detrimental to the good operation of the furnace. The stock will move much more rapidly around electrode No. 3, and have a tendency to stick around No. 1.

The difference in voltage may affect the uniformity of the product. It is therefore necessary to design the furnace and arrange the leads in such manner as to make the difference between phases as small as possible.

SUGGESTIONS TO REDUCE UNBALANCING

Equation (7) gives the value of the power transmitted from phase 1 to phase 3.

$$P_i = I^2 (\alpha - 1) \beta X$$

For balanced currents  $\beta = 1/2 \sqrt{3}$

$$\alpha = X_{1,3}/X \text{ where } X = X_{1,2} = X_{2,3}$$

For three parallel conductors, one of which carries the return current of the other two.

$$X_{1,2} = X_{2,3} = X = 2 \pi f \times 2 l (\log_e d/a + 1/4 - d/l) \times 10^{-9} \text{ in ohms}$$

If the three conductors are in the same plane, as assumed.

$$X_{1,3} = 2 \pi f \cdot 2 l \left( \log_e \frac{2d}{\alpha} + 1/4 - \frac{2d}{l} \right) \cdot 10^{-9} \text{ in ohms}$$

$f$  is the frequency

$l$  is the length of the circuit in cm.

$d$  the distance between center lines of adjacent phases in cm.

$a$  the geometrical radius of the conductor in cm.

This formula is only an approximation and assumes that  $d/l$  and  $a/d$  are small.

$$\alpha = X_{1,3}/X = \frac{\log_e \frac{2d}{a} + 1/4 - \frac{2d}{l}}{\log_e d/a + 1/4 - d/l} = 1 + \frac{\log_e 2 - d/l}{\log_e d/a + 1/4 - d/l}$$

$$\alpha = \text{approx. } 1.43 X - 0.34 d/l - 0.016 d/a \text{ for } d/l < 0.25 \text{ and } 6 < d/a < 10$$

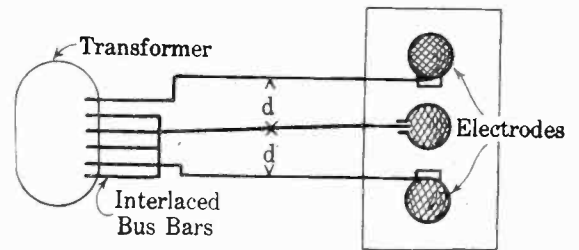

FIG. 4

$P_i$  can be reduced by reducing  $X$  or  $\alpha$

(1)  $X$  being proportional to the frequency, the same furnace will be more satisfactory at 25 cycles than at 60.

(2) The closer the furnace is brought to the transformer the better, since  $X$  is proportional to the length of the leads. In case the distance is given, the bus bars should be carefully interlaced as close to the furnace as possible.

(3) The leads should be as close together as possible.

(4) The conductors should be of large dimensions.

The use of extra flexible cables will often permit to reduce  $l$ .

To reduce the distance between leads the method shown in Fig. 4 is suggested. The distance between the leads is smaller than the distance between electrodes.

Where two water-cooled pipes are used to carry the

current they should be placed in a vertical rather than in a horizontal plane (Fig. 5).

The use of hollow conductors will help to increase  $\alpha$ . When using cables, they should form a hollow cylinder, each cable making a complete turn to avoid unequal current distribution (Fig. 6). The only way to reduce  $\alpha$  without at the same time increasing  $X$  is to make  $l$  small.

If the conductors could be placed so as to form the 3 edges of an equilateral prism  $\alpha$  would be equal to 1. Even if the ideal case cannot be attained, it would be possible to raise or lower conductor 2 out of the plane

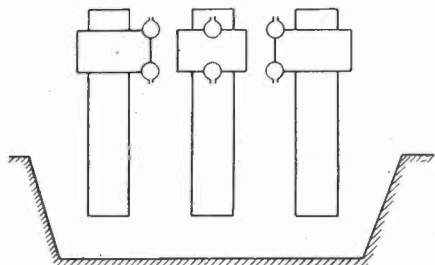

FIG. 5

1, 3, and it will often prove advisable to bring electrode 2 forward so as to make tapping easier.

It is interesting to study under which conditions the powers delivered by the three electrodes are balanced.

The condition for equal delivered power is:

$$I_1^2 R_a = I_2^2 R_b = I_3^2 R_c \quad (17)$$

1st Case.  $I_1 = I_2 = I_3$  that is balanced currents. From equation (17) it follows that  $R_a = R_b = R_c = R$ , the three load resistances are equal

The conditions for balanced currents is

$$\gamma = 1/2 \quad \epsilon = 1/2 \quad \beta = 1/2 \sqrt{3} \quad \gamma^2 + \beta^2 = 1$$

Introducing these conditions in equation (8), we get

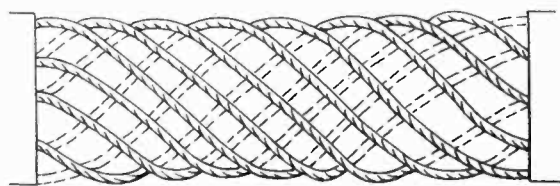

FIG. 6

$$\left. \begin{aligned} E_3 &= I \left[ - \left( \frac{3R}{2} + \alpha/2 \times \sqrt{3} \right) - j \left( R/2 \sqrt{3} - (2 - \alpha/2) X \right) \right] \\ E_1 &= I \left( \frac{3R}{2} - \alpha/2 \times \sqrt{3} \right) - j \left( \frac{R \sqrt{3}}{2} + (2 - \alpha/2) X \right) \\ E_2 &= I (\alpha \times \sqrt{3}) - j (-R \sqrt{3}) \end{aligned} \right\}$$

$$\left. \begin{aligned} E_3^2 &= I^2 (3R^2 + X^2 (\alpha^2 - 2\alpha + 4) + 2XR\sqrt{3}(\alpha - 1)) \\ E_1^2 &= I^2 (3R^2 + X^2 (\alpha^2 - 2\alpha + 4) - 2XR\sqrt{3}(\alpha - 1)) \\ E_2^2 &= I^2 (3R^2 + X^2 (3\alpha^2)) \\ E_3^2 &= I^2 X^2 (3R^2/X^2 + 3\alpha^2 + 2(\alpha - 1)[R/X\sqrt{3} - (\alpha + 2)]) \\ E_1^2 &= I^2 X^2 (3R^2/X^2 + 3\alpha^2 - 2(\alpha - 1)[R/X\sqrt{3} + (\alpha + 2)]) \\ E_2^2 &= I^2 X^2 (3R^2/X^2 + 3\alpha^2) \end{aligned} \right\}$$

Table II gives the value of the square root of the factor in parenthesis for different values of  $\alpha$  and  $R/X$ . To obtain the respective voltage multiply by  $IX$ .

TABLE II

$R/X$		$\alpha = 1$	1.1	1.2	1.3	1.4	$g$
0	$E_3$	1.7321	1.7349	1.7436	1.7578	1.7776	0
	$E_1$	1.7321	1.7349	1.7436	1.7578	1.7776	
	$E_2$	1.7321	1.9053	2.0785	2.2517	2.4249	
$\frac{1}{2\sqrt{3}}$	$E_3$	1.8028	1.8330	1.8682	1.9079	1.9519	$\frac{1}{3}$
	$E_1$	1.8028	1.7776	1.7578	1.7436	1.7349	
	$E_2$	1.8028	1.9698	2.1378	2.3065	2.4759	
$\frac{1}{\sqrt{3}}$	$E_3$	2.00	2.0518	2.1071	2.1656	2.2271	$\frac{2}{3}$
	$E_1$	2.00	1.9519	1.9079	1.8682	1.8330	
	$E_2$	2.00	2.1517	2.3065	2.4637	2.6230	
$\frac{2}{\sqrt{3}}$	$E_3$	2.6458	2.7221	2.8000	2.8792	2.9597	$\frac{4}{3}$
	$E_1$	2.6458	2.5701	2.4980	2.4269	2.3580	
	$E_2$	2.6458	2.7623	2.8844	3.0116	3.1433	
$\frac{3}{\sqrt{3}}$	$E_3$	3.4641	3.5511	3.6387	3.7269	3.8158	2
	$E_1$	3.4641	3.3779	3.2924	3.2078	3.1241	
	$E_2$	3.4661	3.5539	3.6497	3.7510	3.8575	
$\frac{5}{\sqrt{3}}$	$E_3$	5.2915	5.39	5.48	5.58	5.67	$\frac{10}{3}$
	$E_1$	5.2915	5.20	5.10	5.01	4.92	
	$E_2$	5.2915	5.35	5.42	5.48	5.56	
$\frac{10}{\sqrt{3}}$	$E_3$	10.1489	10.25	10.34	10.44	10.54	$\frac{20}{3}$
	$E_1$	10.1489	10.05	9.95	9.85	9.76	
	$E_2$	10.1489	10.18	10.21	10.25	10.29	
$\frac{100}{\sqrt{3}}$	$E_3$	100.0	100.1	100.2	100.3	100.4	$\frac{200}{3}$
	$E_1$	100.0	99.9	99.8	99.7	99.6	
	$E_2$	100.0	100.0	100.0	100.0	100.0	

These factors multiplied by  $IX$  give the voltage to be applied between phases on the low tension, to get balanced loads in the furnace with balanced currents.

Since the currents are balanced  $R$  may include the resistance of the conductors.

Example:

Take  $X = 0.00140^{52}$ ,  $I = 19,000$  amperes,  $\alpha = 1.3$  and  $R/X = 2/\sqrt{3}$  we shall include in  $R$  the resistance of the leads which is taken as  $0.000133$  ohms.

In this case

$$E_3 = 2.8792 IX = 2.8792 \times 26.6 = 76.5 \text{ volts}$$

$$E_1 = 2.4269 IX = 2.4269 \times 26.6 = 64.5 \text{ volts}$$

$$E_2 = 3.0116 IX = 3.0116 \times 26.6 = 80.1 \text{ volts}$$

The power delivered by each electrode is

$$W_a = W_b = W_c = \frac{19,000^2}{1000} (0.00140 \times 2/\sqrt{3} - 0.000133) \text{ kw.} = 537 \text{ kw.}$$

The losses in the leads are

$$= \frac{19,000^2}{1000} \times 0.000133 \text{ kw. per phase} = 48 \text{ kw.}$$

The power transmitted from phase 1 to phase 3 is

$$P_t = \frac{19,000^2}{1000} (\alpha - 1) \beta X \text{ kw.}$$

$$= \frac{19,000^2}{1000} (0.3 \times \sqrt{3}/2 \times 0.0014) \text{ kw.} = 131 \text{ kw.}$$

So that the total power consumed by each phase will be

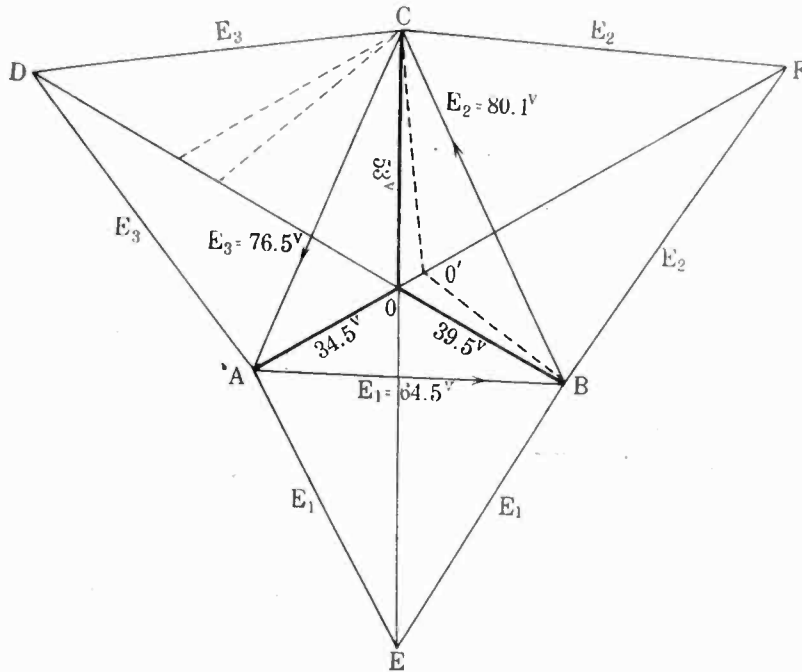

FIG. 7

	In	Per Cent	Voltage
$W_1 = 537 + 48 + 131 = 716 \text{ kw.}$	40.8	28.3	volts
$W_2 = 537 + 48 = 585$	33.3	28.3	volts
$W_3 = 537 + 48 - 131 = 454$	25.9	28.3	volts

1755 kw.

If the transformers were connected in delta on the low-tension, the voltages calculated above are the voltages which the three transformers should give at the chosen load. However since we assume balanced voltage on the high-tension, that is voltages which are 120 deg. apart, it is impossible to have 3 low-tension voltages which do not form an equilateral triangle. It follows that we cannot use the proposed method with a delta on the low tension.

If the transformers are connected in star on the low-tension one can always find three transformer voltages, 120 deg. apart, which will give the desired voltage across the star using special taps if necessary. The diagram in Fig. 7 will show how to find the three voltages.

Draw 3 equilateral triangles with  $E_1$ ,  $E_2$  and  $E_3$  as

bases. Join  $A F$ ,  $B D$ ,  $C E$ ; these 3 lines meet in one and the same point  $O$  and the angles  $A O B$ ,  $B O C$ ,  $C O A$  are equal to 120 deg.

$O A$ ,  $O B$ ,  $O C$  are the desired transformer voltages. The no-load voltage should be selected so as to give this voltage at the chosen load. The kv-a. on the high and low side of the transformers are equal if we neglect the magnetizing current; the three high-tension

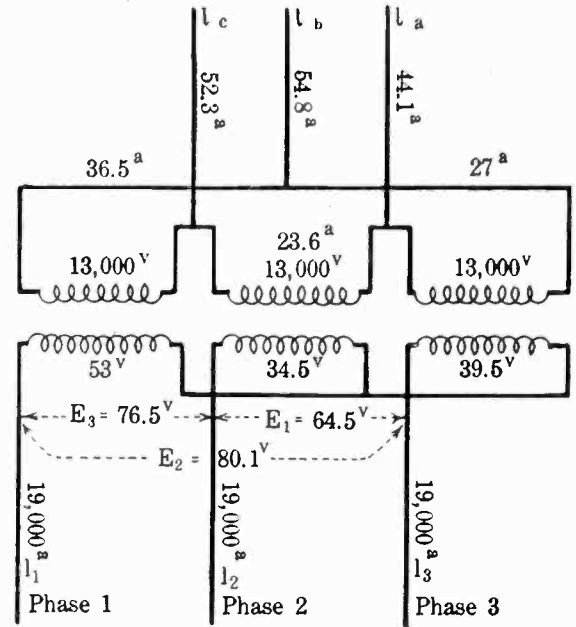

FIG. 8—DISTRIBUTION OF CURRENTS AND VOLTAGES

voltages are equal and 120 deg. apart, while the three low-tension currents are equal and 120 deg. apart. It follows that in each transformer high-tension current and low-tension voltage are proportional. The three low-tension transformer voltages do not necessarily form a closed triangle so that the only possible connection on the high side must be a delta, where the currents do not necessarily form a closed triangle.

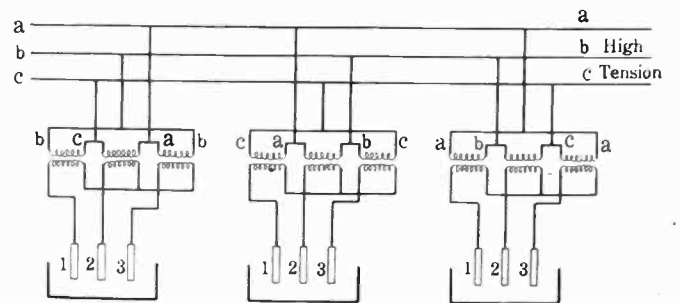

FIG. 9—DISTRIBUTION OF FURNACES TO KEEP HIGH TENSION BALANCED

We see therefore that the only combination which will permit us to use the proposed method of balancing the powers delivered to the furnace is star on the low side and delta on the high side.

The three line currents on the high side will be unbalanced, being proportional to the low-tension volts between phases. Fig. 8 gives a distribution of voltage and current in our case, assuming a high-tension voltage of 13,000 volts between phases. It is evident that any power company would object to any such unbalancing.



In a plant where there are several furnaces in operation this unbalancing can be corrected by connecting each high-tension line in succession to a different low-tension phase as shown in Fig. 9 being careful not to change the direction of phase rotation.

It may be objected that any change in load requires another value of the voltage. Since electric furnaces are mostly run at constant load, and changes are only of short duration, it would be quite satisfactory to keep the voltages unchanged.

If we plot in Fig. 7, the neutral point  $O_1$  in the furnace we see that it does not coincide with the neutral in the bus bars. There is a slight difference of voltage between these two neutrals. In all our investigations, we have assumed that the neutral in the bus bars is not grounded and that there is no connection between this point and the furnace bottom except through the regular leads.

*Second Case.* Instead of balancing the currents we can keep the three voltages balanced and arrange the currents so as to satisfy the condition for equal power on the three electrodes.

We have again  $I_1^2 R_a = I_2^2 R_b = I_3^2 R_c$ .

The conditions for balanced voltage is

$$\vec{E}_1 = \vec{E}_3 (-1/2 + j 1/2 \sqrt{3})$$

$$\vec{E}_2 = \vec{E}_3 (-1/2 - j 1/2 \sqrt{3})$$

introducing these conditions in (8), remembering that  $I_1^2 = I^2 (\beta^2 + \gamma^2)$ ,  $I_2^2 = I^2$  and  $I_3^2 = I^2 (\beta^2 + \epsilon^2)$ , and solving for  $\beta$  and  $\gamma$ , we get two equations of the third degree.

$$y^2 (4 - \alpha + 3 \alpha z) - 6 g y (z - 1) + (3 \alpha z - 4 + \alpha) (1 + 3 z^2) = 0$$

$$3 z^2 (\alpha y + g) - 2 z [(4 - \alpha) y + 3 g] + \alpha y - g y^2 - \alpha y + 3 g = 0$$

where  $g = \frac{2 R \sqrt{3}}{3 X}$ ,  $y = 1 - 2 \gamma$  and  $z = \frac{2 \beta}{\sqrt{3}}$

Solving for  $y$  and  $z$  leads to rather complicated expressions of the fifth degree.

Keeping  $\alpha$  constant and varying  $g$  from 0 to  $\infty$  gives one set only of continuous values for  $\gamma$  ranging from  $\gamma = 1$  for  $g = 0$  and tending towards  $\gamma = 1/2$  for  $g = \infty$ , the corresponding values of  $\beta$  being 0 for  $g = 0$  and  $1/2 \sqrt{3}$  for  $g = \infty$ .

For the special case where  $\alpha = 1$ , that is when the three reactances are equal, there are three sets on values forming continuous curves from  $g = 0$  to  $g = \infty$ ; the general solution is  $\gamma = \epsilon = 1/2$  and  $\beta = 1/2 \sqrt{3}$  for every value of  $g$ , it is the case of balanced currents.

But it is interesting to know that for every value of  $g$  there are besides this general solution, two other solutions which give equal powers under the three electrodes, but with unbalanced currents. For certain values of  $g$  there are two more additional solutions but the curves on which they lie extend only over a small range of  $g$ . Similarly when  $\alpha \neq 1$  there are values of  $g$  for which there are three and sometimes five solutions.

Of practical interest is only the one set of solutions which gives a continuous series of values from  $g = 0$  to  $g = \infty$ .

Table III gives the values of  $\beta$ ,  $\gamma$  and  $\epsilon$  for different values of  $g$ , and for  $\alpha = 1$  and  $\alpha = 1.25$ , while Table IV gives the corresponding values of  $\sqrt{\beta^2 + \gamma^2}$  and  $\sqrt{\beta^2 + \epsilon^2}$ .

Take as an example, the case of  $g = 2$ ,  $\alpha = 1.25$  when  $X = 0.00150$  ohms and  $E = 110$  volts.

$$g = \frac{2 R \sqrt{3}}{3 X} R = \frac{3 g X}{2 \sqrt{3}} = \frac{2.3 \times 0.0015}{2 \times \sqrt{3}} = 0.0026 \text{ ohms}$$

From Table III we find  $\beta = 0.513$ ,  $\gamma = 1.0825$ ,  $\epsilon = 0.9175$ . Introducing these values in (8), we find

$$\vec{E}_3 = I (-0.005517 + j (0.0022245))$$

$$\vec{E}_1 = I (+0.000836 - j (0.0059205))$$

$$\vec{E}_2 = I (-0.004681 + j (0.0036960))$$

TABLE III

$\alpha = 1$											
$g$	$\gamma_1$	$\epsilon_1$	$\beta_1$	$\gamma_2$	$\epsilon_2$	$\beta_2$	$\gamma_3$	$\epsilon_3$	$\beta_3$	$\gamma_4^1$	$\gamma_5^1$
0	+ 1.0	0	0	0.5	0.5	0.866	0.0	1	0	..	..
1	+ 1.23075	- 0.23075	0.295	0.5	0.5	0.866	0.2712	0.7288	0.288	..	..
2	+ 1.1425	- 0.1425	0.550	0.5	0.5	0.866	0.323	0.677	0.451	..	..
4	+ 0.9325	+ 0.0675	0.740	0.5	0.5	0.866	0.3766	0.6234	0.592	..	..
10	+ 0.6948	+ 0.3052	0.843	0.5	0.5	0.866	0.4333	0.5667	0.682	0.3025	- 3.25
$\infty$	+ 0.5	+ 0.5	0.866	0.5	0.5	0.866	0.5	0.5	0.866	..	..
$\alpha = 1.25$											
$g$	$\gamma_1$	$\epsilon_1$	$\beta_1$	$\gamma_2$	$\epsilon_2$	$\beta_2$	$\gamma_3$	$\epsilon_3$	$\beta_3$	$\gamma_4^1$	$\gamma_5^1$
0	1	0	0	0.5	0.5	0.635	0	1	0	..	..
1	1.1675	0.8325	0.302	0.4694	0.5306	0.620	0.3193	0.6807	0.34	..	..
2	1.0825	0.9175	0.513	..	..	..	..	..	..	..	..
3 168	0.9613	0.0387	0.634	..	..	..	..	..	..	..	..
4	0.897	0.103	0.678	..	..	..	..	..	..	..	..
10	0.701	0.299	0.7625	..	..	..	..	..	..	- 0.023	- 2.15
$\infty$	0.5	0.5	0.866	..	..	..	..	..	..	..	..

Values of  $\gamma$ ,  $\epsilon$  and  $\beta$  for various values of  $g$  and  $\alpha = 1$  and  $\alpha = 1.25$ .

1. Due to the negligible importance of these values the corresponding figures for  $B$  and  $E$  have not been calculated.  
 2. Where no figures are shown the values are not real.

TABLE IV

g	α = 1			α = 1.25			
	1	2	3	1	2	3	
0	I <sub>1</sub>	1.0	0	1.0	0.808	0	
	I <sub>2</sub>	1.0	1	1.0	1.0	1.0	
	I <sub>3</sub>	0	1.0	1	0	0.808	1.0
1	I <sub>1</sub>	1.268	1.0	0.3607	1.206	0.777	0.467
	I <sub>2</sub>	1.0	1.0	1.0	1.0	1.0	1.0
	I <sub>3</sub>	0.374	1.0	0.767	0.345	0.815	0.761
2	I <sub>1</sub>	1.208	1.0	0.555	1.198	..	..
	I <sub>2</sub>	1.0	1.0	1.0	1.0	..	..
	I <sub>3</sub>	0.568	1.0	0.813	0.519	..	..
3.168	I <sub>1</sub>	not calculated			1.152	..	..
	I <sub>2</sub>	..			1	..	..
	I <sub>3</sub>	..			0.635	..	..
4	I <sub>1</sub>	1.194	1.0	0.702	1.125	..	..
	I <sub>2</sub>	1.0	1.0	1.0	1.0	..	..
	I <sub>3</sub>	0.750	1.0	0.859	1.686	No values	No values
10	I <sub>1</sub>	1.093	1.0	0.808	1.025	..	..
	I <sub>2</sub>	1.0	1.0	1.0	1.0	..	..
	I <sub>3</sub>	0.897	1.0	0.887	0.818	..	..
∞	I <sub>1</sub>	1.0	1.0	1.0	1.0	..	..
	I <sub>2</sub>	1.0	1.0	1.0	1.0	..	..
	I <sub>3</sub>	1.0	1.0	1.0	1.0	..	..

Multiply by I to obtain I<sub>1</sub>, I<sub>2</sub>, and I<sub>3</sub>

It follows that  $E = I \times 0.00596$ . Since we have assumed E to be 110 volts we have

$$I = \frac{110}{0.00596} = 18,470 \text{ amperes}$$

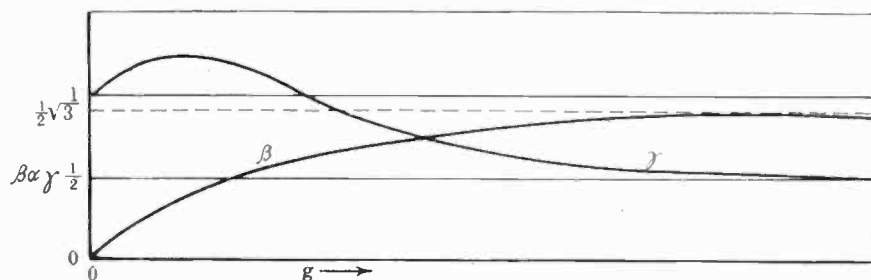

FIG. 10

from Table IV we find:

$$I_1 = 18,470 \times 1.268 = 22,140 \text{ amperes}$$

$$I_2 = 18,470 \times 1.0 = 18,470 \text{ amperes}$$

$$I_3 = 18,470 \times 0.568 = 9580 \text{ amperes}$$

Power delivered to furnace by each phase:

$$W_a = W_b = W_c = \frac{18,470^2}{1000} \times 0.0026 = 887 \text{ kw.}$$

$$P_t = I^2 (\alpha - 1) \beta X = \frac{18,470^2}{1000} (0.25) \times 0.513 \times 0.0015 = 65.6 \text{ kw.}$$

$$W_1 = W_a + P_t = 887 + 65.6 = 952.6$$

Power consumed by Phase 1

$$W_2 = 887.0$$

Power consumed by Phase 2

$$W_3 = W_c - P_t = 887 - 65.6 = 821.4$$

Power consumed by Phase 3

$$2661.0 \text{ kw.}$$

The arc on electrode 1 will have a voltage of

$$\frac{887,000}{22,140} = 40.1 \text{ volts}$$

The arc on electrode 2 will have a voltage of

$$\frac{887,000}{18,470} = 48.0 \text{ volts}$$

The arc on electrode 3 will have a voltage of

$$\frac{887,000}{9580} = 92.5 \text{ volts}$$

As in the previous case, but in a larger degree the high tension currents will be unbalanced.

When the high tension, and the low tension are both in star or both in delta the high-tension line currents will be proportional to the correspondent low-tension currents.

If the high tension is in star and the low tension in delta, the high tension line currents can be found according to the diagram of Fig. 12, and in the case of high tension in delta and low in star according to Fig. 14.

In Fig. 12 the low-tension transformer currents  $I_a, I_b, I_c$  pass through the center of gravity of the triangle formed by the low-tension line currents. Dividing  $I_a, I_b, I_c$  by the voltage ratio of the transformers gives the high tension line currents.

In Fig. 14,  $i_1, i_2, i_3$  are proportional to  $I_1, I_2, I_3$ . The lengths  $AB, BC, CA$  represent  $I_a, I_b, I_c$  respectively.

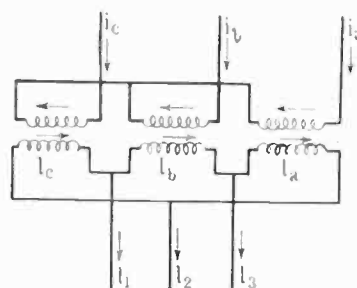

FIG. 11

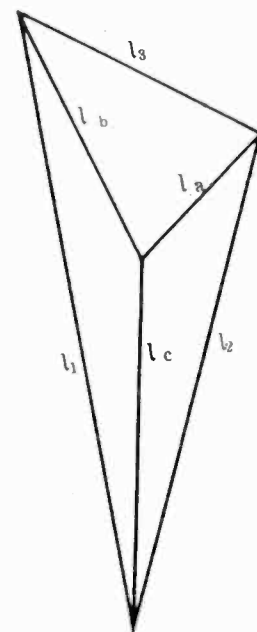

FIG. 12

Although this method of balancing the power delivered by the electrodes is easier to apply than the previous one,—balanced currents—it has two big disadvantages: First the currents on the high-tension side are very unbalanced, and secondly the 3 arc voltages are very different so that although the powers are the same, the conditions under the electrodes are different with their bad effect on the product.

Notwithstanding this rather negative result the investigation of this second case will show in which direction to go to correct partly for the unbalancing of

the loads. In a furnace under observation the difference in the loads was very large under balanced currents and showed badly on the electrode consumption, phase No. 3 using many more electrodes than 1 and 2. An increase of 10 per cent in the current of phase 1 and a somewhat larger decrease of 3 proved very successful.

INVESTIGATION OF OPEN DELTA CONNECTIONS

In order to study the distribution of currents in case the materials between electrodes should act as a resistor, and the energy should be consumed in that part of the furnace we can use equation (8)—setting  $R_b = 0$ . For reasons of symmetry  $R_a = R_c = R$ . Solving for  $\gamma$  and  $\beta$  we get:

$$\gamma = \frac{3R^2 + 3\alpha^2 X^2 + 2XR(2-\alpha)\sqrt{3}}{6(R^2 + \alpha^2 X^2)}$$

$$= 1/2 + \frac{2-\alpha}{3} \frac{R/X\sqrt{3}}{R^2/X^2 + \alpha^2}$$

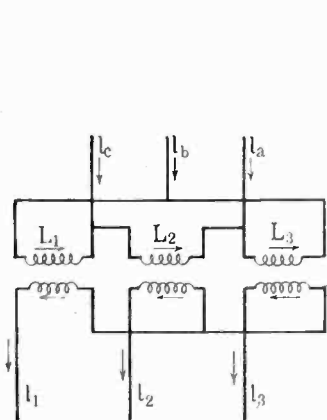

FIG. 13

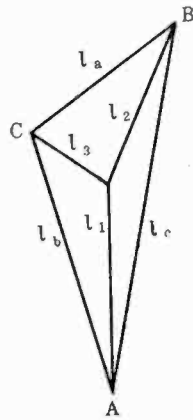

FIG. 14

$$\epsilon = \frac{3R^2 + 3\alpha^2 X^2 - 2XR(2-\alpha)\sqrt{3}}{6(R^2 + \alpha^2 X^2)}$$

$$= 1/2 - \frac{2-\alpha}{3} \frac{R/X\sqrt{3}}{R^2/X^2 + \alpha^2}$$

$$\beta = \frac{R^2 + X^2(4\alpha - \alpha^2)}{6(R^2 + \alpha^2 X^2)} \sqrt{3} = \sqrt{3}/6$$

$$+ \frac{2-\alpha}{3} \frac{\alpha R^2/X^2 \sqrt{3}}{R^2/X^2 + \alpha^2}$$

$$\gamma^2 + \beta^2 = 1/3 + \frac{2-\alpha}{3} \frac{2 + R/X\sqrt{3}}{R^2/X^2 + \alpha^2}$$

$$\epsilon^2 + \beta^2 = 1/3 + \frac{2-\alpha}{3} \frac{2 - R/X\sqrt{3}}{R^2/X^2 + \alpha^2}$$

$$I_1^2 = I^2(\gamma^2 + \beta^2)$$

$$I_2^2 = I^2$$

$$I_3^2 = I^2(\epsilon^2 + \beta^2)$$

$$I^2 = \frac{3E^2}{R^2 + X^2(4-\alpha)^2} \quad I = \frac{E\sqrt{3}}{\sqrt{R^2 + X^2(4-\alpha)^2}}$$

Table V, gives the values of  $\sqrt{\gamma^2 + \beta^2}$  and  $\sqrt{\epsilon^2 + \beta^2}$  for different values of  $R/X$  and  $\alpha$ . The factors given in the table when multiplied by  $I$  give us  $I_1, I_2$  and  $I_3$ .

TABLE V.

$\frac{R}{X}$	$\alpha = 1$	1.1	1.2	1.3	1.4	$\vartheta$	
0	$I_1$	1.0	0.910	0.839	0.780	0.733	0
	$I_2$	1.0	1.000	1.000	1.000	1.000	
	$I_3$	1.0	0.910	0.839	0.780	0.733	
$\frac{1}{2\sqrt{3}}$	$I_1$	1.051	0.956	0.878	0.814	0.760	$\frac{1}{3}$
	$I_2$	1.000	1.000	1.000	1.000	1.000	
	$I_3$	0.892	0.825	0.771	0.728	0.693	
$\frac{1}{\sqrt{3}}$	$I_1$	1.041	0.957	0.885	0.824	0.771	$\frac{2}{3}$
	$I_2$	1.000	1.000	1.000	1.000	1.000	
	$I_3$	0.764	0.727	0.695	0.669	0.648	
$\frac{2}{\sqrt{3}}$	$I_1$	0.951	0.897	0.847	0.801	0.759	$\frac{4}{3}$
	$I_2$	1.000	1.000	1.000	1.000	1.000	
	$I_3$	0.577	0.577	0.577	0.577	0.577	
$\frac{3}{\sqrt{3}}$	$I_1$	0.866	0.826	0.796	0.763	0.731	2
	$I_2$	1.000	1.000	1.000	1.000	1.000	
	$I_3$	0.500	0.512	0.522	0.532	0.541	
$\frac{5}{\sqrt{3}}$	$I_1$	0.764	0.744	0.724	0.704	0.685	$\frac{10}{3}$
	$I_2$	1.000	1.000	1.000	1.000	1.000	
	$I_3$	0.475	0.489	0.501	0.513	0.524	
$\frac{10}{\sqrt{3}}$	$I_1$	0.671	0.661	0.652	0.643	0.633	$\frac{20}{3}$
	$I_2$	1.000	1.000	1.000	1.000	1.000	
	$I_3$	0.505	0.514	0.522	0.529	0.537	
$\frac{100}{\sqrt{3}}$	$I_1$	0.586	0.585	0.584	0.583	0.582	$\frac{200}{3}$
	$I_2$	1.000	1.000	1.000	1.000	1.000	
	$I_3$	0.569	0.569	0.570	0.571	0.572	
$\infty$	$I_1$	0.577	0.577	0.577	0.577	0.577	$\infty$
	$I_2$	1.000	1.000	1.000	1.000	1.000	
	$I_3$	0.577	0.577	0.577	0.577	0.577	

Multiply by  $I$  to obtain  $I_1, I_2$  and  $I_3$ .

The table shows that the currents are quite unbalanced, especially for large values of  $R$ . Such an unbalancing does not appear in a furnace under normal operation. The assumption that in alloy furnaces the current passes from one electrode to the nearest one through the charge is not correct.

CONCLUSIONS

The above study shows that the general performance of a three-phase electric furnace can easily be determined in advance with a large degree of accuracy by using the simple equations of a balanced three-phase system. The only thing that is necessary is to have previously determined  $X$ , or the low-tension reactance per phase, which is an important characteristic of the furnace.

On the other hand, due to the particular construction of the furnaces the individual phases show large differences which may affect the quality of the products. These differences can be calculated and once their cause and importance are well understood methods can be devised for their correction.

# The Wave Antenna

## A New Type of Highly Directive Antenna

BY HAROLD H. BEVERAGE, CHESTER W. RICE, and EDWARD W. KELLOGG

(Continued from page 381)

Fig. 43 shows the relations between  $I_b$ ,  $I_a$  and the reflected current, for  $\theta = 180$  deg.

In Table V we have given the calculations for the directive curve of the compensated antenna. The magnitudes and phase angles of  $I_a$  and  $I_b$  are taken from Tables III and IV. Instead, however, of rotating  $0.119 I_a$  backward by 559 deg. and adding it vectorially

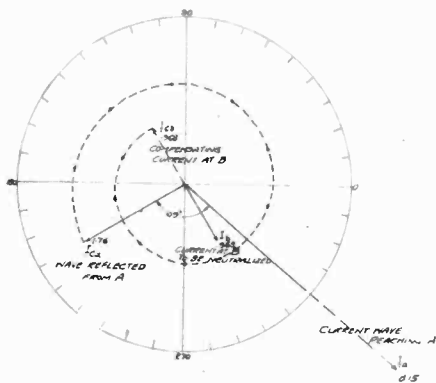

FIG. 43—VECTOR RELATIONS IN COMPENSATION PROBLEM

to  $I_b$ , we have rotated it 180 deg. less, and subtracted it vertically from  $I_b$ , which is an easier operation to perform and gives the same result. This backward rotation of 379 deg., is, for the purpose of finding the vector difference, equivalent to one of (379 deg. - 360 deg.) = 19 deg. The table shows the values of  $0.119 I_a$ , rotated backward 19 deg., and the vector difference found by subtracting this from the corresponding  $I_b$ . Thus to find the directive curve of any compensated antenna, we first choose the direction for which we wish to have zero reception. Then we compare  $I_a$  and  $I_b$  for this value of  $\theta$  deg. and determine the factor by which  $I_a$  must be multiplied and the angle through which it must be rotated to make it coincide with  $I_b$ . Then for each other value of  $\theta$  deg. we multiply  $I_a$  by the same ratio and rotate it through the same angle, and subtract the vector so found, vectorially from  $I_b$ .

Inspection of the table shows that in the example we have worked out, the effect of the reflection on the receiver current is negligible for values of  $\theta$  less than 90 deg. Therefore, the front end of the directive curve is not appreciably altered or the reception of the desired signal affected by the reflection we have been considering.

Fig. 44 shows the directive curve plotted from the calculations given above. This is for the same antenna and same conditions as Fig. 35, except that the "reflection balance" has been applied to give zero reception from the back.

In the case of an antenna producing relatively large

back end currents, as, for example, a quarter wave length antenna, the front end of the directive curve would be considerably affected by a reflection designed to produce zero back end reception.

*Effect of Reflection at Receiver End.* The effect of reflection at the receiver end of the antenna may be shown as follows:

Let  $I_b$  = Wave built up on wire by signal at end B (Equation 22)

$I_B$  = Total oncoming wave at B (Resultant of  $I_b$  and other waves traveling in same direction resulting from reflections at A.)

$I_R$  = Receiver current or total current at B, = resultant of total oncoming wave  $I_B$  and reflected wave at B.

$I_a$  = Current built up on wire at A by signal (Equation 23)

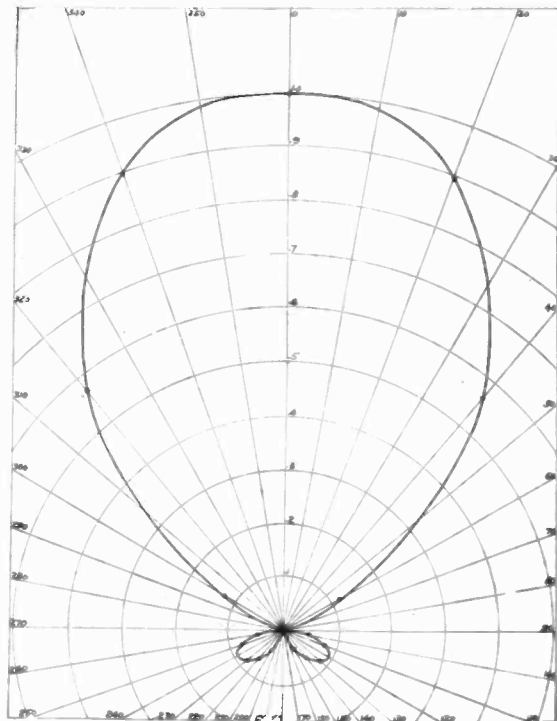

FIG. 44—DIRECTIVE CURVE OF WAVE ANTENNA. COMPENSATED BY REFLECTION FOR ZERO BACK END.  $\lambda = 12$  KM.,  $l = 12$  KM.,  $\alpha = 0.05$ ,  $u = 0.8 v$

$I_A$  = Total oncoming wave at A (wave moving in direction B to A) or resultant of  $I_a$  and other waves in same direction resulting from reflections at B.

$b$  = reflection coefficient<sup>16</sup> at B or vector ratio of reflected to oncoming waves at B.

16. The reflection coefficient is shown in equation (44) to be

$$I_2/I_1 = \frac{1 - Z_t/Z}{1 + Z_t/Z} \text{ in which } \begin{array}{l} I_1 = \text{current of oncoming wave} \\ I_2 = \text{current of reflected wave} \\ Z = \text{surge-impedance of line} \\ Z_t = \text{impedance of terminal circuit} \end{array}$$

TABLE V  
CALCULATION OF COMPENSATED ANTENNA

$l = 12$                        $\alpha = 0.05$   
 $\lambda = 12$                        $u = 0.8p$

I	XVIII	XIX	XX	XXI	XXII	XXIII	XXIV	XXV	XXVI
Signal Angle	Magnitude of $I_a$ Table IV Column X	Magnitude of Compensating Current - $I_c$ XVIII $\times 0.119$	Magnitude of $I_b$ Table III Column X	Angle of $I_a$ Table IV Column XV	Angle of $I_c$ XXI - 18.5	Angle of $I_b$ Table III Column XVII	Angle between $I_b$ and $I_c$ XXIII - XXII	Vector Difference $I_b - I_c$	XXV $\div 8.05$
0	0.97	0.115	8.15	-58.6°	-77.1	-400.1°	-323.0	8.05	1.00
20	0.778	0.093	7.18	-54.5°	-73.0	-386.9°	-313.9	7.12	0.883
40	0.333	0.040	4.61	-79.3°	-97.8	-352.8°	-255.0	4.62	0.573
60	0.623	0.074	1.44	-115.9°	-134.4	-291.7	-157.3	1.51	0.187
80	0.353	0.042	1.75	-76.2°	-94.7	-121.6°	-26.9	1.72	0.213
100	-0.175	-0.021	-0.353	-59.0°	-77.5	-13.6°	+83.9	0.343	0.043
120	-1.44	-0.172	-0.623	-111.7°	-130.2	+64.1	+194.3	0.79	0.098
140	-4.61	-0.55	-0.333	-76.8°	-95.3	+196.7°	+292.0	0.53	0.066
160	-7.18	-0.855	-0.778	-48.9°	-67.4	+283.5°	+350.9	0.16	0.020
180	-8.15	-0.970	-0.970	-40.1°	-58.6	+301.4°	+360.0	0	0

$d = b \epsilon^{-(\alpha + j\beta)l}$   
 $a =$  reflection coefficient at  $A$   
 $c = a \epsilon^{-(\alpha + j\beta)l}$

At  $B$  we have the oncoming wave  $I_B$  and reflected wave  $b I_B$  giving the resultant current

$I_R = I_B (1 + b)$  (26)

The wave  $b I_B$  reflected from  $B$  becomes  $b I_b \epsilon^{-(\alpha + j\beta)l}$  or  $d I_B$  when it reaches  $A$ . It combines with  $I_a$  (the wave built up on the wire toward  $A$ ) producing a total wave at  $A$

$I_A = I_a + d I_B$  (27)

Likewise the wave  $a I_A$  reflected from  $A$  becomes  $a I_A \epsilon^{-j(\alpha + j\beta)l} = c I_A$  when it reaches  $B$ . It combines with  $I_b$  (built up on the wire between  $A$  and  $B$ ) giving a total wave reaching  $B$

$I_B = I_b + c I_A$  (28)

From (28)

$I_A = \frac{I_B - I_b}{c}$

Equating this to (27)

$\frac{I_B - I_b}{c} = I_a + d I_B$

Solving for  $I_B$

$I_B - I_b = c I_a + c d I_B$   
 $I_B (1 - c d) = I_b + c I_a$   
 $I_B = \frac{I_b + c I_a}{1 - c d}$  (29)

From (26) the total current in the receiver is

$I_R = I_B (1 + b) = \frac{1 + b}{1 - c d} (I_b + c I_a)$  (30)

When there was no reflection at  $B$  we had a receiver current

$I_R = I_b + c I_a$

We now have a receiver current in which  $I_b$  and  $I_a$  are

combined in exactly the same manner, but their

resultant is multiplied by the factor  $\frac{1 + b}{1 - c d}$ , which

being a function of line length and terminal conditions only, and not a function of  $I_a$ ,  $I_b$ , or signal direction  $\theta$  deg. does not alter the directive properties of the antenna.

The relation shown in (30) is strictly true only for steady state conditions. Let us illustrate what occurs when a train of waves first reaches the antenna. To take a simple case we may assume  $I_a = 0$ , so that (30)

becomes  $I_R = I_b \frac{1 + b}{1 - c d}$  as the ultimate current.

When the first wave  $I_b$  reaches  $B$  and is reflected the total current at  $B$  is

$I_b (1 + b)$

The reflected wave reaches  $A$  with a value  $d I_b$ , is reflected back and reaches  $B$  with a value  $c d I_b$  giving a total wave  $I_b (1 + c d)$  which by reflection at  $B$  produces a receiver current  $(1 + b) I_b (1 + c d)$ .

After a second double reflection the total oncoming wave at  $B$  is made up of the wave  $I_b$  reaching the receiver for the first time, a wave  $c d I_b$  which has been reflected down the line and back, and a wave  $c^2 d^2 I_b$  which has been down the line and back twice. The total oncoming wave  $I_b (1 + c d + c^2 d^2)$  by reflection at  $B$  produces a receiver current

$(1 + b) I_b (1 + c d + c^2 d^2)$

After a large number of reflections the receiver current is

$(1 + b) I_b (1 + c d + c^2 d^2 + c^3 d^3 + c^4 d^4 + \dots)$   
 $= (1 + b) I_b \frac{1}{1 - c d} = I_b \frac{1 + b}{1 - c d}$  as given by (30)

If the reflection coefficient at either *A* or *B* is small (which is generally true) or if the line attenuation is high, *c d* will be small and the steady state value of receiver current is approached very quickly.

Let us apply equation 30 to the case of the compensated 12 kilometer antenna whose directive curve is shown in Fig. 44. Here in order to give zero reception for  $\theta = 180$  deg., we produced a reflection at *A* such as to give a current at *B* whose magnitude is 0.119 of that of *I<sub>a</sub>* and whose phase is 559 deg. behind *I<sub>a</sub>*. Hence

$$c = 0.119 e^{j(-559^\circ/57.3^\circ)}$$

Suppose that instead of the surge impedance at the receiver end, we have a transformer having 400 ohms inductive reactance and 100 ohms effective resistance. Taking the surge impedance of the antenna as 500 ohms (non inductive) the reflection coefficient at *B* will be

$$\begin{aligned} b &= \frac{1 - Z_t/Z}{1 + Z_t/Z} = \frac{1 - (0.2 + 0.8j)}{1 + (0.2 + 0.8j)} \\ &= \frac{0.8 - 0.8j}{1.2 + 0.8j} = 0.12 - 0.6j \\ &= 0.612 e^{j(-79^\circ/57.3)} \end{aligned}$$

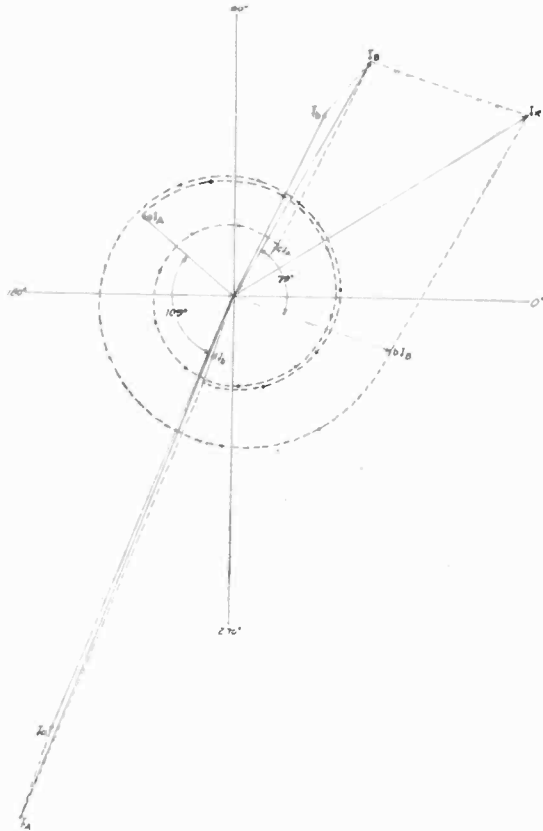

FIG. 45—VECTOR RELATIONS IN 'DOUBLE REFLECTION' PROBLEM

Since  $e^{-(\alpha + j\beta)l} = 0.55 e^{j(-450^\circ/57.3)}$   
 $d = b e^{-(\alpha + j\beta)l} = 0.336 e^{j(-529^\circ/57.3)}$

and

$$c d = 0.04 e^{j(-1088^\circ/57.3)} = 0.04 (\cos 1088^\circ + j \sin 1088^\circ) = 0.0396 - 0.0056 j$$

$$\begin{aligned} \frac{1 + b}{1 - c d} &= \frac{1.12 - 0.6j}{0.9604 + 0.0056j} = 1.163 - 0.63j \\ &= 1.323 e^{j(-28.5^\circ/57.3)} \end{aligned}$$

Without reflection at *B*, the receiver current of the compensated antenna, as shown in Column XVII of Table V was  $I_b + c I_a$  or  $I_b + I_a \times 0.119 e^{j(-559^\circ/57.3)}$

With the reflections caused by the receiver circuit we have just been considering the current in the transformer primary will be

$$1.323 e^{j(-28.5^\circ/57.3)} (I_b + I_a \times 0.119 e^{j(-559^\circ/57.3)})$$

or a current of 32.3 per cent greater for each value of  $\theta$  than that given in column XVII of Table V. The

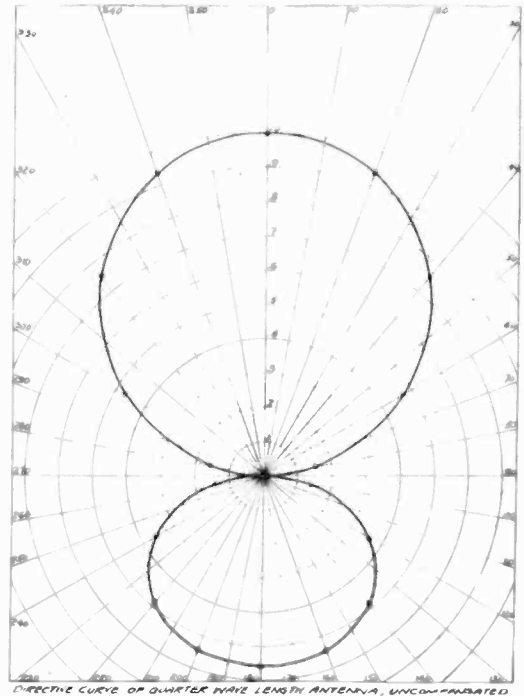

FIG. 47— $l = 3, \lambda = 12, \alpha = 0.5, n = 0.8$

directive curve or relative current for different values of  $\theta$  is the same as before. Fig. 45 shows the vector relations of the currents at the ends of the line, for the signal direction  $\theta = 120$  deg. Both *I<sub>b</sub>* and *I<sub>a</sub>* as given by formulas (22) and (23) have negative signs, and the negative signs are retained throughout rather than reversing the vectors in the diagrams, which would somewhat obscure the angular relations. If the entire diagram is turned 180 deg. (looked at up side down) the vectors appear in their true positions.

**Short Antennas.** The question of the possibility of obtaining in less space directive properties approaching those of a full wave length antenna is of considerable interest. Fig. 47 shows the directive curve of a quarter wave antenna without compensation. It is obvious that so long as there is considerable inequality in the size of the two lobes of a figure-eight directive curve such as Fig. 47, a back end zero can be obtained by compensation without entirely sacrificing the signal, or front end reception, but how favorable a total directive curve would result is not apparent until detailed calculations are made.

Among the first experiments tried on the Riverhead antenna was loading to give various propagation velocities. It was pointed out at that time by Rice that

reducing the velocity on a full wave length antenna to something less than the velocity of light would result in a sharper directive curve, but tests showed that the natural velocity of the line was so nearly equal to the best velocity that there was little to be gained by loading. The urgent problem at the time was to obtain the best possible reception of European signals, utilizing as much space as seemed conducive to this result. Tests had shown the half wave antenna, with back end compensation, to be definitely inferior to the full wave length antenna. The question of short antennas was therefore not investigated until some months later when the principal engineering problems connected with multiplex reception with the wave antenna had been worked out.

At the suggestion of Mr. R. H. Ranger, of the Radio Corporation, calculations were made by Kellogg of the directive properties of short antennas on which the velocity had been reduced by loading to the best value for the wave length and antenna length in question.

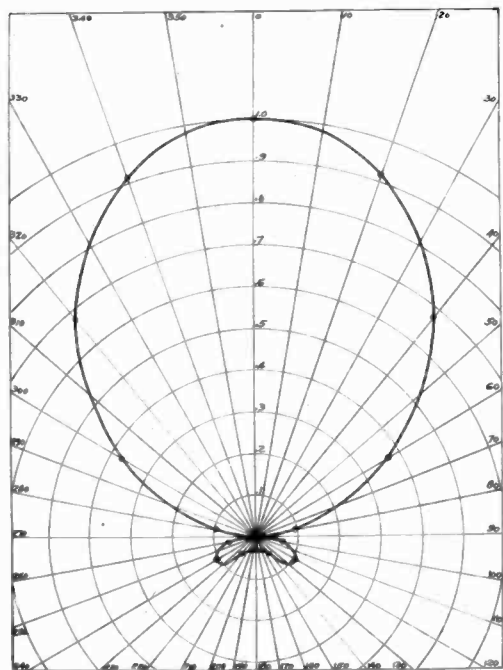

FIG. 48—DIRECTIVE CURVE OF SLOWED DOWN QUARTER WAVE LENGTH ANTENNA  $\alpha = 0.5, n = 0.333, l = 3, \lambda = 12$

Mr. Ranger reasoned that since reducing the velocity sharpened the directive curve of a full wave length antenna, it might be possible, by sufficiently reducing the velocity, to compensate for reduced length and perhaps obtain a good directive curve in very small space. The most favorable velocity was found to be that which gave zero (or minimum) reception at the back end, without compensation. The condition for this is that

$$v/u = \lambda/l - 1$$

in which  $l$  is the length of the antenna

$v$  is the velocity of light

$u$  is the antenna velocity

$\lambda$  is the wave length

Figs. 48 and 49 show directive curves for quarter and eighth wave length antennas with velocities equal to one

third and one seventh of that of light respectively in accordance with the above equation.

By way of comparison, the directive curves Figs. 50 and 51 have been calculated for compensated antennas without loading. The back end areas of these curves are seen to be slightly greater.

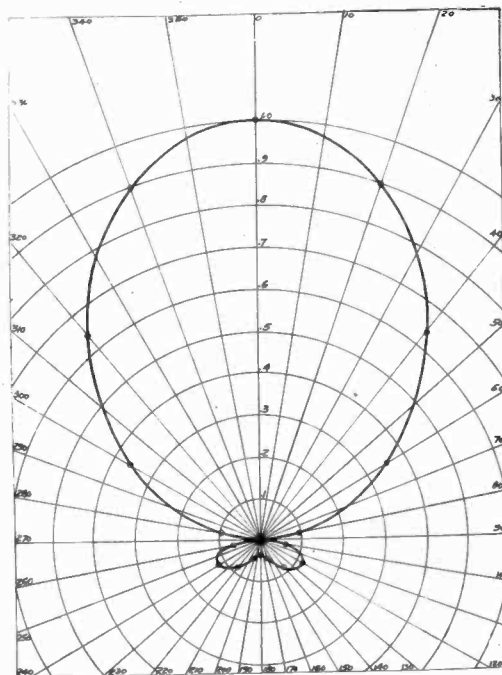

FIG. 49—DIRECTIVE CURVE OF SLOWED DOWN EIGHTH WAVE LENGTH ANTENNA.  $\alpha = 0.5, n = 0.143, l = 1.5, \lambda = 12$

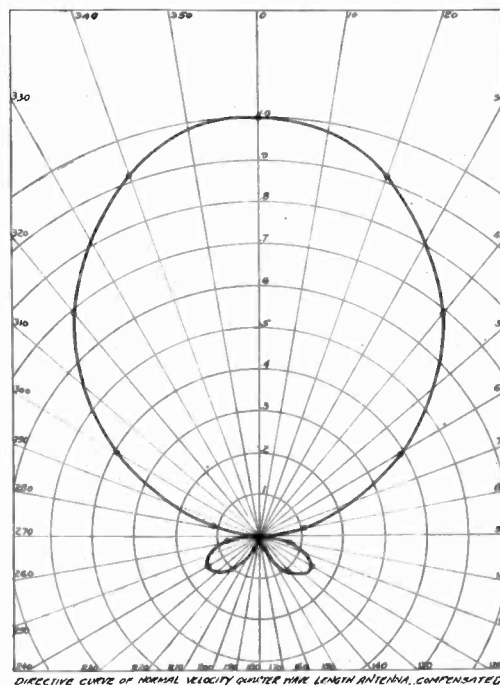

FIG. 50—DIRECTIVE CURVE OF NORMAL VELOCITY QUARTER WAVE LENGTH ANTENNA, COMPENSATED.  $l = 3, \lambda = 12, \alpha = 0.5, n = 0.8$

Multiplex reception with different compensation for each wave length is possible with the unloaded, compensated antennas. On the other hand, with the slowed down antenna, the velocity is right only for one wave length. In order to receive other wave lengths, compensation would be employed in addition to the loading.

Fig. 52 shows the directive curve for an 18 kilometer wave length of the slowed down antenna, whose directive curve for  $\lambda = 12$  kilometers is shown in Fig. 48. The dotted line A shows the directive properties without compensation and the solid line B is the directive curve with compensation. Fig. 53 shows the

satisfactory multiplex reception. The signal strength is of the same order of magnitude on both—considerably less than on an uncompensated full velocity antenna of the same length. The intensity factor or receiver current per unit value of the quantity  $\frac{E_0}{2Z}$  in equation

(22), is shown in Table VI for the short antennas whose directive curves are given in Figs. 47 to 53. The intensity factor for a full velocity, zero attenuation line is included for reference.

It will be observed that in all cases where unidirectional properties are obtained on an antenna a small fraction of a wave length long, there is considerable sacrifice of signal intensity. If this could be made up with amplification the disadvantage would not be serious. Residual voltages are, however, inevitable

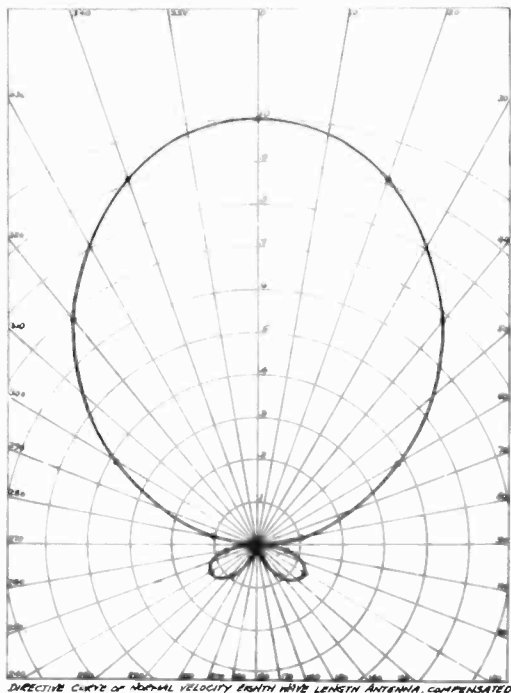

FIG. 51— $l = 1.5, \lambda = 12, \alpha = 0.5, n = 0.8$

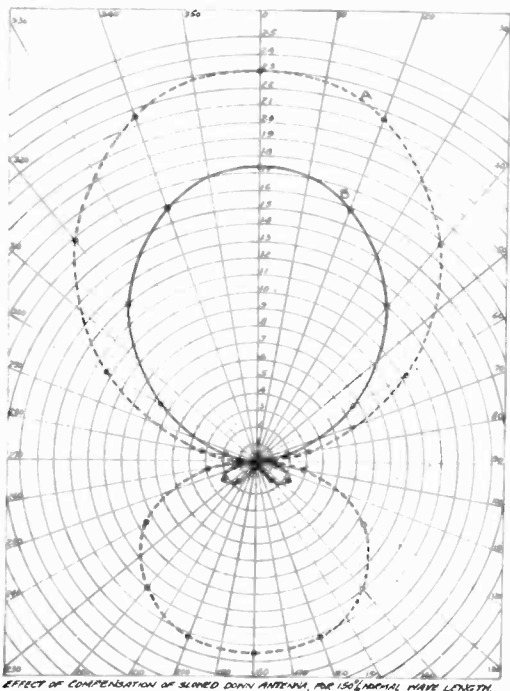

FIG. 52—A UNCOMPENSATED. B COMPENSATED.  $l = 3 \text{ KM.}, \lambda = 18, \alpha = .05, n = 0.333$

directive curve for the same antenna receiving an eight kilometer wave. We observe that the slowed down antenna can be multiplexed by compensation and receive longer waves than that for which its velocity is adjusted, but that for shorter waves it is unfavorable. Compared with the simple unloaded, compensated antenna, the slowed down antenna has a better directive curve at one wave length, but a narrower range of

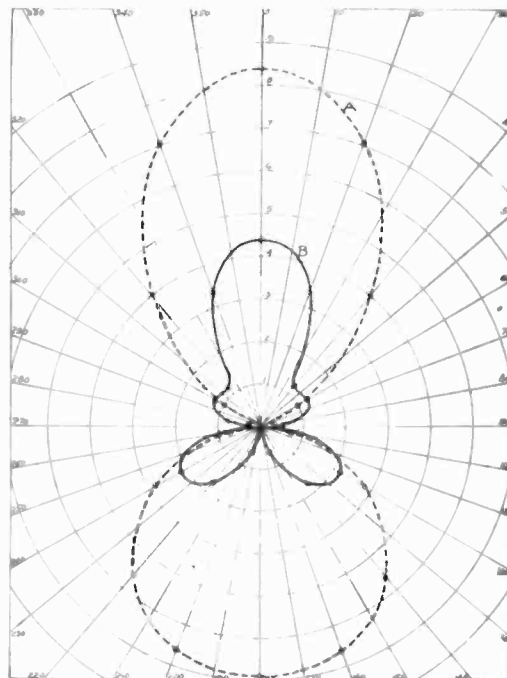

FIG. 53—A UNCOMPENSATED. B COMPENSATED.  $l = 3, \lambda = 8, \alpha = 0.5, n = 0.333$

in radio receiving systems. For example, electromotive forces are induced in the end verticals, of which no account is taken in the calculations given here; foreign circuits at crossings or unavoidable short parallels induce electromotive forces in the antenna wires, transmission lines used to carry signal or compensating currents are not absolutely quiet, transformer or receiving circuit coils pick up some disturbances, and where high amplification is employed tube noises are a factor. With strong signals such as obtained with full length antennas, these effects may, by careful engineering, be kept negligibly small compared with the signal, but if the signal produced by the antenna is weak, or if it is a small remainder after comparatively strong currents are combined to give neutralization for a certain direction, the directive properties actually obtained are likely to be decidedly inferior to those indicated by calculations, based on assumed ideal conditions.

Wherever possible, therefore, the writers have advo-



TABLE VI  
RELATIVE SIGNAL INTENSITIES ON SHORT ANTENNAS

	Antenna Length Kilometers <i>l</i>	Wave Length Kilometers $\lambda$	Velocity Ratio <i>n</i>	Attenuation Constant $\alpha$	Directive Curve Figure No.	Intensity Factor
Ideal Antenna, one eighth wave length long, Uncompensated.....	1.5	12	1.0	0.0		1.5
Average Unloaded Antenna, $l = 1/8 \lambda$ , Uncompensated.....	1.5	12	0.8	0.05		1.44
Same, Compensated for zero reception at $\theta = 180$ deg.....	1.5	12	0.8	0.05	51	0.33
Slowed-down Antenna $l = 1/8 \lambda$ , No compensation.....	1.5	12	0.143	0.05	49	0.44
Ideal, Quarter-wave-length Antenna, Uncompensated.....	3	12	1.0	0		3.0
Average Unloaded Antenna $l = 1/4 \lambda$ , Uncompensated.....	3	12	0.8	0.05	47	2.8
Same, Compensated to give zero reception for $\theta = 180$ deg.....	3	12	0.8	0.05	50	1.92
Slowed-down, Quarter-wave Antenna, $l = 1/4 \lambda$ , No Compensation.....	3	12	0.333	0.05	48	1.78
Same, Compensated to give zero reception at $\theta = 180$ deg., for $\lambda = 18$ .....	3	18	0.333	0.05	52	1.73
Same, Compensated to give zero reception at $\theta = 180$ deg., for $\lambda = 8$ .....	3	8	0.333	0.05	53	0.44
Average Antenna, one wave length long.....	12	12	0.8	0.05	35	8.15

cated building full wave length or at least, half wave length antennas for commercial reception.

FUNDAMENTAL EXPERIMENTS

While for the most part the experimental work on the wave antenna has been directed toward practical utilization, some tests have been carried out whose purpose was the verification of theory: That the waves built up on the wire in the direction of signal travel, as indicated by the mathematical analysis, had been shown qualitatively by Beverage's early data, some of which is given in curve form in Fig. 2. The series condensers also worked just as predicted by the theory.

*Tests Bearing on Wave Tilt Theory.* A question which was at first the subject of some discussion among those interested in the wave antenna was whether the collection of energy from the space wave depended on wave front tilt, or upon the height of the wire above the earth and the space potential corresponding to its position. If a signal causes a vertical potential gradient +  $G$  volts per meter, a wire  $h$  meters above earth would tend to assume the potential +  $Gh$ . A half wave length away where the potential gradient due to the signal wave is -  $G$ ; the wire would tend to assume the potential -  $Gh$ , and the potential difference along the wire would give rise to a current. According to such a picture the wave antenna would be equivalent to an infinite number of small static antennas whose charging current is carried over the line to the ends. If a formula for the end current is worked out on this basis it shows the same directive properties as the formula we have developed, except that the factor  $\cos \theta$  by which  $E_0$  is multiplied in (22) is omitted. Thus in Table II we should use the figures in column IX instead of column X to obtain the directive curve. The difference is especially marked in the case of a half wave length antenna with signals coming at right angles to the antenna. If the half wave length wave antenna were acting like a series of static antennas the reception for  $\theta = 90$  deg. would be about half of the full intensity or half that for  $\theta = 0$ . On the other hand if the wave antenna depends on wave front tilt the reception from 90 deg. to the antenna would be zero for all lengths. As a test of this the Belmar wave antenna was cut at a point about 5.8 kilometers from the station, giving a

short antenna, with the 200 kw. New Brunswick sending station ( $\lambda = 13,600$  meters) on the side. The reception of New Brunswick, only 50 miles away, was of the same order of intensity as European stations, thus indicating that the half wave antenna was substantially dead on the side.

When the new antenna at Riverhead was completed, it afforded an opportunity to test a long loop, as a receiving circuit. The two top wires which were 9 meters above ground were connected through from Riverhead to Terrell River or the full length of the antenna, and two of the lower wires which were about  $5\frac{1}{2}$  meters above ground, were similarly connected through. The upper and lower wires were connected together through a damping resistance at Riverhead (the north-east end), and the receiving set was connected between the upper and lower wires at Terrell River. European signals were extremely weak on this loop, as compared with intensity obtained when the receiving set was connected from either pair or wires to ground. In the latter case there appeared to be no choice between the upper and lower wires.

In other words there is no differential effect due to the difference in height of the wires. The effect of height was again tested at Schenectady using a wave length of 120 meters and a wire one wave length long at heights ranging from 0.8 meters to 2.9 meters. The received current was found to be practically independent of the height. This is what would be expected from an antenna which works by virtue of the forward tilt of the wave front. If the currents in the antenna were due to the space potential of the wire above ground the received current would be proportional to the height of the wire.

There is another conclusion which follows from the theory that the action of the wave antenna depends upon the tilt of the wave front. Low, wet ground, or salt marsh would be an unfavorable location so far as signal intensity is concerned. No experimental evidence on this point has come to the writers' attention. Before conclusions can be drawn from tests or comparisons it is necessary to make sure that conditions are the same in other respects. In one instance with which the writers are familiar, two antennas, in locations several miles apart were constructed parallel and as much alike

as possible. One followed a small stream and the other was over comparatively dry ground. The two antennas gave substantially equal signal intensities. Presumably in this case the low resistance ground was too restricted and local to have any appreciable effect on the tilt of the twelve to fourteen kilometer waves on which the observations were made. For ground of a given resistance the wave front tilt increases as the wave length decreases, and for short waves (less than 1000 meters) there is a substantial tilt, sufficient for satisfactory operation even over wet ground.

Zenneck<sup>17</sup> has worked out equations for the forward tilt of the wave front as a function of wave length, and the specific resistance and dielectric constant of the soil. The tilt is expressed as the ratio of the horizontal to the vertical potential gradient of the space wave.

In its general form Zenneck's formula is

$$X/Z = \sqrt{\frac{g + j \omega c}{g' + j \omega c'}} \quad (31)$$

in which

X is the horizontal potential gradient of the space wave

Z is the vertical potential gradient of the space wave

g is the leakage conductance between parallel faces of a centimeter cube of air

g' is the leakage conductance between parallel faces of a centimeter cube of ground

c is the capacity between parallel faces of a centimeter cube of air

c' is the capacity between parallel faces of a centimeter cube of ground

For all practical purposes the conductance g for air is zero, so that the formula becomes

$$X/Z = \sqrt{\frac{j \omega c}{g' + j \omega c'}} \quad (32)$$

Expressed in electrostatic units

$$g' = \frac{9 \times 10^{11}}{\rho}$$

$$c = \frac{1}{4 \pi}$$

$$c' = \frac{K}{4 \pi}$$

in which  $\rho$  is the specific resistance of the earth in ohms for a centimeter cube, and K is the dielectric constant of the earth. Average values of  $\rho$  and K as given in Fleming<sup>18</sup> are shown in Table VII.

TABLE VII.

	$\rho$ = Ohms per centimeter cube	k = Dielectric constant
Sea Water	100	80
Fresh Water	10,000 to 100,000	80
Moist Earth	1000 to 100,000	5 to 15
Dry Earth	1,000,000 and up	2 to 6
Wet Sand	100 to 10,000	9
Dry River Sand	very large	2-3
Wet Clay	100 to 10,000	
Dry Clay	1,000,000 and up	2-5

17: See "Principles of Electric Wave Telegraphy and Telephony" by J. A. Fleming, Third Edition, P. 801.

18. Principles of Electric Wave Telegraphy and Telephony by J. A. Fleming, Third Edition P. 800.

Fig. 55 shows the values of X/Z for various values of wave length  $\lambda$ , specific resistance  $\rho$  and dielectric constant K. With long waves and low-resistance soils  $\omega c'$  is negligible compared with  $g'$ , in which case

$$X/Z = \sqrt{\frac{j \omega c}{g'}} \quad (33)$$

This is a function of wave length and specific resistance, and is shown in the sloping lines of Fig. 55. On the other hand if the waves are so short and the soil resistance so high that  $g'$  is negligible compared with  $\omega c'$  we have

$$X/Z = \sqrt{C/C'} = \sqrt{1/K} \quad (34)$$

which is independent of wave length or soil conductivity and is shown for several values of K in the horizontal lines at the top of the figure. To find the value of X/Z for a certain wave length and a soil of a given resistivity and dielectric constant we use whichever curve (the sloping line of equation (33) or the horizontal line of equation (34) gives the lower value for X/Z. If near the intersection of the two straight lines we use the

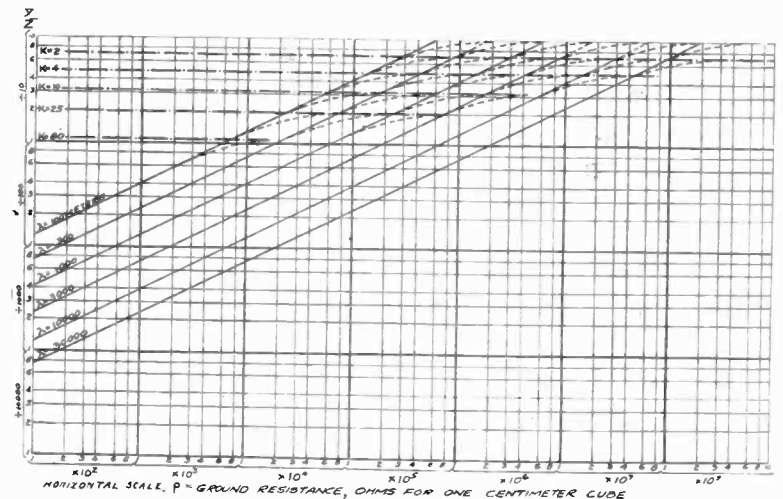

FIG. 55—WAVE FRONT TILT, X/Z BY ZENNECK'S FORMULA

transition curve which is shown dotted. To illustrate, if  $\lambda = 1000$  meters and  $K = 4$ , we find

- X/Z = 1.3 ÷ 10 for  $\rho = 1 \times 10^5$
- 2.5 ÷ 10 for  $\rho = 4 \times 10^5$
- 3.9 ÷ 10 for  $\rho = 1 \times 10^6$  (on transition curve)
- 4.9 ÷ 10 for  $\rho = 4 \times 10^6$  or greater. (On horizontal line for  $K = 4$ ).

It will be noted that in Zenneck's formula (32), the ratio X/Z is a vector quantity whose phase angle ranges from 0 deg. to 45 deg. By far the most common condition is that  $g'$  greatly exceeds  $\omega c'$  (i. e. the earth carries current by conduction rather than by capacity) in which case the phase angle is nearly 45 deg. The phase difference means that the vertical and horizontal potential gradients do not become zero simultaneously, but the electric field is a rotating one. Under these circumstances if a straight conductor is held in various positions in a vertical plane parallel to the direction of wave propagation, there will be no direction of the conductor in which the electromotive force induced in it is zero. This may account for the doubtful results

obtained in attempts to measure wave tilt by observing the angle of zero or minimum electromotive force in a straight conductor rotated in a vertical plane parallel to the signal direction. Wherever the tilt is considerable so that it might be readily measured, the minimum is correspondingly dull.

More satisfactory as a test of the theoretical conclusions, would be quantitative measurements of the relative magnitudes of the electromotive forces induced in horizontal and vertical conductors, for various wave lengths and ground conductivities. Determination of the phase relations would provide a further check.

An observation of relative signal intensities on a large loop and a wave antenna, indicated a wave tilt of the order of magnitude called for by Zenneck's formula, but little data of this kind have been taken. The large values of horizontal voltage gradient found in the measurements mentioned below by Beverage and Weinberger were at first considered greater than could be accounted for by wave tilt. Assuming probable values of ground resistance, the ratio of horizontal to vertical potential gradient according to Zenneck's formula is of the order of magnitude of one or two per cent, whereas the measured horizontal gradient was about 30 per cent of the vertical gradient calculated by Austin's formula. The space potential theory of action however is still less capable of accounting for the potentials observed. If we assume ground water to be 100 feet (30 meters) below the surface of the ground, and the earth above ground water level to have a specific resistance of  $2 \times 10^6$  ohms per centimeter cube, which is about the value found by measurement, we find for a 15,000 meter wave length that the potential difference between ground water and surface would be less than that corresponding to a difference of elevation of two feet in the space above ground. Considering the ground as constant potential, and expressing the vertical potential gradient as  $G \epsilon^{-j(2\pi x/\lambda)}$  (in which  $\epsilon^{-j(2\pi x/\lambda)}$  expresses the change of phase with distance  $x$  measured in direction of propagation) the potential of the wire at a height  $h$  with respect to ground would be  $h G \epsilon^{-j(2\pi x/\lambda)}$  and the potential

gradient along the wire would be  $\frac{d}{dx} h G \epsilon^{-j(2\pi x/\lambda)}$

$$= -j \frac{2\pi}{\lambda} h G \epsilon^{-j(2\pi x/\lambda)}$$

If the height of the wire is 10 meters and the wave length 15,000 meters the magnitude of the horizontal potential gradient would be

$$\frac{2\pi h}{\lambda} G = \frac{2\pi \times 10}{15,000} G = 0.0042 G \text{ or } 0.0042 \text{ of that}$$

of the vertical gradient, which is less than Zenneck's formula gives for the horizontal potential gradient due to wave tilt. Theoretical analyses agree moreover, that there is no electromotive force induced in a horizontal wire over a perfectly conducting earth, and

therefore the space potential picture of operation is untenable.

*Experimental Directive Curve.* Fig. 56 shows a directive curve obtained experimentally. A transmitting set was operated, supplying about 5 kilowatts to a small vertical antenna, at 120 meters wave length. On a field about 600 meters from the transmitting station a system of wave antennas was erected consisting of twenty-four lines each 55 meters long and about one meter above ground, radiating from a central point like the spokes of a wheel. By joining two opposite spokes together at the center, a wave antenna was obtained 110 meters long. Using the next pair gave a similar antenna 15 deg. from the last. A ground of about 20 ohms resistance was provided at each end of

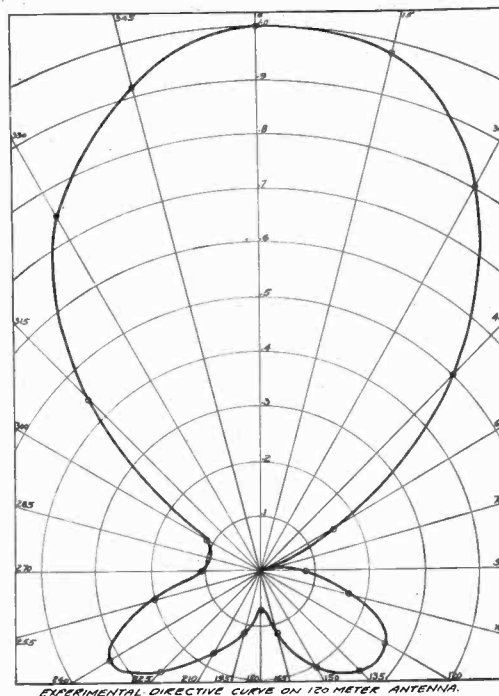

FIG. 56— $l = 110, \lambda = 120$

each antenna. The current at one end of the antenna was measured with a thermocouple and galvanometer, the opposite end being damped by a resistance. Measurements were taken successively on the several antennas, while the radiation was kept as nearly constant as possible. From the series of readings thus obtained Fig. 56 was plotted.

A number of factors was present to cause a difference between the shape of the experimental directive curve Fig. 56 and the curve A of Fig. 57 calculated by equation (22). The resistance used at the end opposite the ammeter was not the true surge impedance of the line, as determined by later measurements. The end verticals were high enough in comparison with the length of the antenna to cause currents of considerable relative magnitude, the ground was not perfectly level, and the divergence of the waves was appreciable on account of the nearness of the sending station. Additional observations had been planned, but the work was interrupted before another directive curve could be

obtained. As it stands the directive curve shown in Fig. 56 serves as a qualitative check on the theory.

During the same series of short wave tests, readings were taken to show the building up of the current in an antenna. A wire sectionalized every ten meters was used in the antenna which pointed toward the transmitting station. The line was broken successively at the sectionalizing points and the current read with the thermocouple and galvanometer. The values of current are plotted in Fig. 58. Humps such as appear in

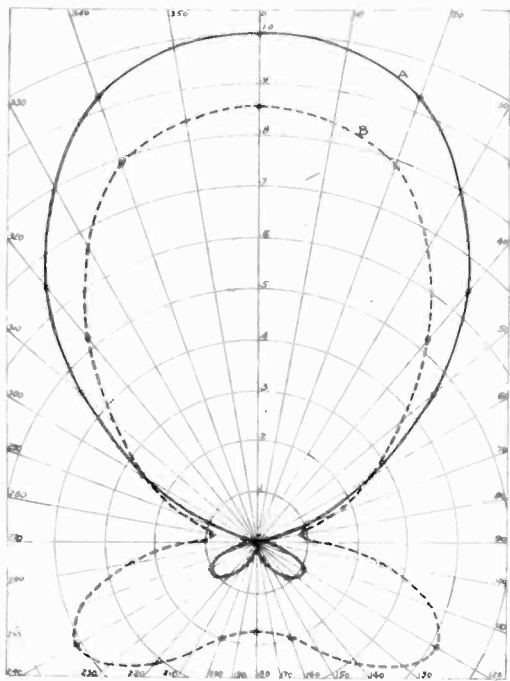

FIG. 57—CALCULATED DIRECTIVE CURVES FOR 120 METER ANTENNA. A—SIMPLE WAVE ANTENNA. B—CORRECTED FOR REFLECTIONS AND END EFFECTS.  $l = 0.12$ ,  $\lambda = 0.13$ ,  $\alpha = 2.0$ ,  $n = 0.865$ .

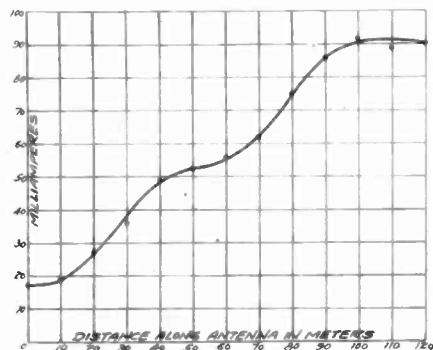

FIG. 58—OBSERVED CURRENT DISTRIBUTION IN 120 METER ANTENNA

the curve might be due in part to imperfect damping, but such humps are to be expected from the theory. The total current at any point  $X$  in the antenna Fig. 26 is the resultant of the forward wave built up on the part of the antenna between  $A$  and  $X$ , and the back wave from the part between  $X$  and  $B$ .

The complete expression for the current at a point  $X$  on an antenna of length  $l$ , then becomes,

$$I_x = \frac{E_0 \cos \theta \epsilon^{-j(2\pi x \cos \theta)/\lambda}}{2Z} \times$$

$$\left\{ \frac{1 - \epsilon^{-\alpha x} \epsilon^{-j \frac{2\pi x}{\lambda} (1 - n \cos \theta)}}{\alpha + j \frac{2\pi}{\lambda} (1 - n \cos \theta)} + \frac{1 - \epsilon^{-\alpha(l-x)} \epsilon^{-j \frac{2\pi}{\lambda} (l-x) (1 + n \cos \theta)}}{\alpha + j \frac{2\pi}{\lambda} (1 + n \cos \theta)} \right\} \quad (35)$$

Fig. 59 shows the current distribution in an ideal antenna one wave length long, calculated by equation (35). Thus the building-up curve found by measuring the current at various points in the line, is of different form from that found by changing the length of the antenna and measuring the end currents. The latter shows a continuous increase as shown in Fig. 29.

A measurement was made in May 1921 of the intensity of the received signals on the Riverhead antenna. Mr. Weinberger of the Research Department of the Radio Corporation, brought to Riverhead a calibrated oscillator, by which a known voltage at the desired frequency could be supplied to a circuit. By this

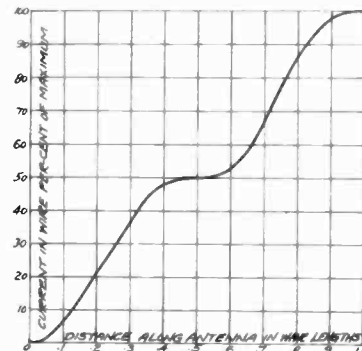

FIG. 59—CALCULATED CURRENT DISTRIBUTION IN WAVE ANTENNA

means a voltage of signal frequency was introduced in series with the damping resistance at the north east end of the antenna, and adjusted to give as loud a tone in the receiver as the European signal which was being measured. The results of Mr. Beverage's and Mr. Weinberger's observations were, P. O. Z. Nauen, Germany, 80 millivolts; M. U. U., Carnarvon, Wales, 54 millivolts.

These correspond to about 9 and 4 microwatts respectively of received energy on the antenna.

Since the antenna is 14.5 kilometers long the voltage readings indicate a horizontal potential gradient of 5.5 millivolts per kilometer for Nauen and 3.7 millivolts per kilometer for Carnarvon. These values represent normal receiving conditions. During fading periods the signals are much weaker.

#### ANTENNA CONSTANTS

The electrical constants of an antenna or line which are of most immediate interest, are the wave velocity  $u$ , attenuation constant  $\alpha$ , and surge impedance  $Z$ . These may be ascertained by measuring the input impedance of the line through a sufficient range of frequency, first with the far end of the line open, and then with it short-circuited, (or grounded, if we are

dealing with a ground return circuit). The ground connection must be of low resistance, for the equations which follow are based on the assumption of a short-circuit reflection, and all losses will therefore be attributed to the line attenuation.

As the frequency of the current supplied to the line is varied, a series of maximum and minimum current values are observed, corresponding to standing wave conditions which cause current loops and current nodes. A current maximum corresponds to an impedance minimum and a current minimum to a maximum impedance. The impedance may be determined from the supplied voltage and current or by the substitution method, which will be described. Only the maximum and minimum values of impedance are required for the present purpose.

Fig. 60 shows the input impedance of a 12-kilometer

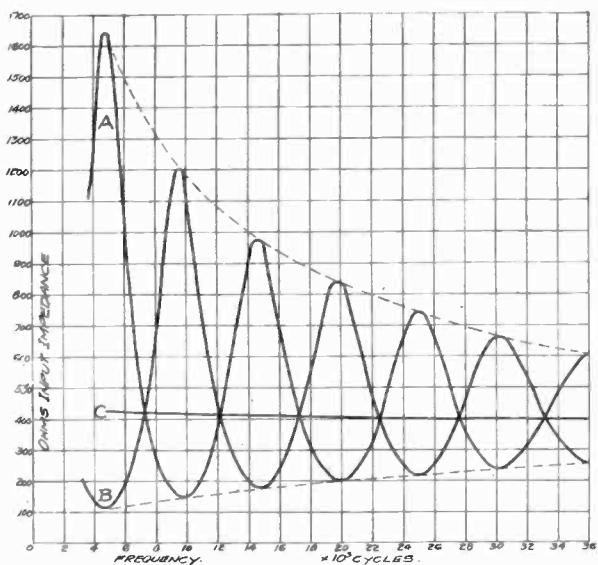

FIG. 60—INPUT IMPEDANCE OF TWELVE KILOMETER ANTENNA. A—FAR END GROUNDED. B—FAR END OPEN. C—GEOMETRICAL MEAN OF A AND B.

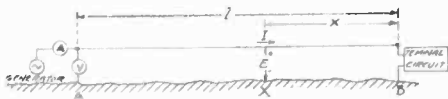

FIG. 61—REFERENCE FIGURE FOR DISCUSSION OF LINE IMPEDANCE

two-wire antenna as a function of frequency. A maximum input impedance when the far end is open is seen to occur at the same frequency at which the input impedance is a minimum when the far end is short-circuited. The frequencies at which the maxima and minima occur indicate the line velocity, while the ratio of minimum to maximum impedance gives a basis for calculating the attenuation.

### CORRESPONDENCE

#### MAGNETIC FLUX AROUND A CONDUCTOR

To the Editor:

The following three theorems may be new and may perhaps sometimes be of use. Many years ago the writer showed that if the diameter of the wire may be

neglected, the quantity of flux external to the wire, per ampere, per unit length of a circular circuit, is a constant; that is, it is independent of the radius of the circuit. The permeability is taken as unity. The proof, if necessary, is very simple. Ampere-centimeters, or ampere-feet, therefore are a measure of the flux. In the *MLT* system of dimensions, the product of the dimensions of current and of length, equals that of flux, if the "suppressed" factor, permeability, may be neglected, or if flux is represented by *BS* instead of *HS*, the permeability being unity.

But for strict accuracy the diameter of the wire cannot be neglected. Dr. A. P. Wills recently suggested to the writer that it might be true if the diameter of the wire increased in the same proportion as the diameter of the circuit. Dr. Leigh Page since proved a relation from which it follows that the theorem is then strictly correct, for round wires. It is true whether the internal flux is included or not, though the constant will then be a different one.

The second theorem found by the writer and easily proved to be strictly correct, applies also to a straight conductor, or with the return circuit far removed. If a round conductor, carrying a constant current, shrinks from a diameter *D* to a smaller diameter *d*, the ratio *D/d* being a constant, the flux thereby added externally, to the wire, is a constant, independent of the original diameter *D*.

The third theorem, which is also easily proved to be strictly correct for a conductor far removed from all others, is that the product of what is called the field intensity *H* (or the flux density *B* when the permeability is unity) at the surface of the wire, and the circumference (or diameter) of the wire, is a constant per ampere.

The flux encircling a conductor (together with the small amount in the interior) exerts a radial pressure on the conductor, known as the "pinch effect" tending to crush the conductor radially; that is, such flux exerts a mechanical force or pressure in terms of which it might therefore be measured. At the center of a round conductor far removed from all others, this pressure or force per unit area, in the absolute system of units, is equal numerically to the square of the current, divided by the cross section. The flux around an infinite straight wire, per centimeter of length, extends theoretically to infinity and cannot therefore be expressed in finite terms. The atmosphere of the earth likewise extends (theoretically) to infinity, but it can be expressed in finite terms by a property, namely its radial force per unit area on the surface of the earth, known as the atmospheric pressure. The above mentioned pressure of the flux on the conductor is thought to be an analogous case, and although the flux itself extends to infinity it seems that a property of that flux at the surface of the wire may be expressed in finite terms, and preferably, if possible, in mechanical units.

CARL HERING

Philadelphia, Mar. 15, 1923

# The Pallophotophone

BY C. A. HOXIE

Associate, A. I. E. E.  
General Engineering Laboratory  
General Electric Company, Schenectady, N. Y.

**Review of the Subject.**—The name pallophotophone has been given to a new device used both for permanently recording speech in a wavy trace on a moving photographic film, and for transforming the air vibrations of sound into exactly corresponding electrical vibrations for transmission directly, for example, to wireless broadcasting generators. The syllables "pallo" of this new word are taken from the Greek and with the following syllable indicate "dancing light." This particular function, involving a rapidly vibrating beam of light, seems to be the most distinctive one of the combination.

To explain the operations briefly perhaps it would be more illuminating to start with resemblances and differences as compared to the well known telephonic devices and talking machines.

The dark wavy trace, Fig. 6A, on the films corresponds to the wavy spiral of the victrola disk. "There is the resemblance." With proper translating means either device can reproduce the sounds recorded. In the translating mechanism is the difference between the two methods of recording speech. The victrola employs a needle set into vibration at one end of a lever, the other end of which is attached to the central point of a thin disk of mica. On the other hand, the dark wavy trace on the photographic film, moved in front of a slot, allows variable amounts of light to fall on a photo-electric cell. In turn, the photo-electric cell varies the electric current passing through it in direct proportion to the change in light. The lower diagram of Fig. 11 shows this arrangement. The human ear cannot hear the wavy light, neither can it hear the variations of current in the photo-electric cell, but if the variations of current are passed into a telephone receiver or loud speaker, either directly or through the intermediary of wireless waves, the diaphragm of the telephone transforms the electric vibrations into air vibrations of sound—"and there you are." As compared to the simple mechanism of Edison's talking machine, the pallophotophone seems to traverse a wide detour. Each, however, has its particular uses. The pallophotophone has its marked advantages—some of which are quite evident and others hidden until explained.

When the artist is available and at the broadcasting studio the pallophotophone dispenses with the record on a film and passes the energy of speech and music to light vibrations, and thence electric vibrations which pass directly to the wireless generators. Important to note, there are no microphones or other telephonic devices involved in these transformations.

Nevertheless, the nearest analogous operation to the pallophotophone transmitter is in the familiar telephone transmitter. The telephone has a mouth-piece at the end of which is a diaphragm which vibrates with the sound waves. So also has the pallophotophone. However, its diaphragm is much lighter in weight. But from there on the resemblance disappears. The diaphragm of the telephone receiver pushes against loose particles of carbon and changes their ohmic resistance, thereby giving an electric current proportional to the vibrations of the diaphragm. On the other hand, the diaphragm of the pallophotophone has attached to it, by a lever, a tiny mirror, the combined weight of which is about half that of the head of an ordinary pin. The diaphragm, the lever, and the tiny mirror are the sole mechanical parts which vibrate. The mechanism of the pallophotophone transmitter, being so exceedingly light in weight,

Lecture delivered at the Midwinter Convention of the A. I. E. E., New York, N. Y., February 14-17, 1923.

is capable of responding to the overtones of sound and music which give the fine distinctive quality and timber of different voices and instruments. While the telephone transmitter still has the practical advantage of compactness, simplicity, and a single step from sound vibration to electric vibrations, it has a greater mass and therefore is unable to respond to the distinctive overtones. While this loss of the overtones has little to do with clearness of speech it takes away from the cultivated enjoyment of musical qualities both of voices and instruments. The pallophotophone has this improving feature that will spread, still further than the telephone can, the emotional pleasures of a fine art.

In the pallophotophone the light from an incandescent lamp is focused upon the tiny mirror of the transmitter. The reflected dancing beam of light, illuminating more or less the photo-electric cell, induces a current in the cell corresponding to the frequency and intensity of the sound vibrations that impinge on the diaphragm of the transmitter. Thus the photo-electric cell in the pallophotophone performs a service corresponding to the carbon granules in the telephone transmitter. (Fig. 11).

In the realm of small dimensions there are features of interest in what the pallophotophone will accomplish. For example, the photo-electric cell will respond to a movement of the beam of light of one-thousandth inch (0.0024 cm.) at the cell opening, and this movement, too tiny to be visible to the naked eye, will give a fairly loud reproduction of speech or music in a pair of head-phones in the circuit of the first photron. Calculating back to the corresponding movement of the diaphragm, the resulting figures seem incredible. The diaphragm's movement is magnified two thousand times in the movement of the light on the photo-electric cell. Therefore, when the light has moved one-thousandth of an inch the diaphragm has moved only a half-millionth of an inch. In other terms, a movement of the diaphragm of only twenty-five times the diameter of a molecule will be reproduced in clear speech and music.

If instead of projecting the dancing light on to the photo-electric cell, to translate the dance of light into electric current, the reflected beam of light is caused to fall on a moving film the sound is, so to speak, "canned" photographically on the film for future use. This combination is shown schematically in Fig. 6. The reproduction of the voice either directly or through the means of a film is so identical that hundreds in audiences, who have been asked to decide which reproduction was from the voice directly and which from the film of the same voice, have been unable to distinguish between the two.

To follow briefly through the consecutive steps of the pallophotophone—first come the voice vibrations; second, the corresponding vibration of the diaphragm which carries the tiny mirror; and third, reflected from the vibrating mirror the vibration of light which falls either on the moving film to form a permanent record of the sound or, otherwise, on a photo-electric cell which gives faithfully perfect electric oscillations for wireless broadcasting or telephone receivers.

The foregoing description gives the essential elements—in addition, there are of course amplifiers of current, motive power for moving films, horns, and the various mechanical parts in detail which will be found described in the text following. The apparatus for reproducing speech from a film is shown in the photograph, Fig. 10.

THE pallophotophone is fundamentally a device designed to convert sound vibrations into corresponding electrical oscillations, by means of a beam of light. This beam can be made to produce the electric energy direct or to record the original vibrations on a photographic film by means of which the same variations of light can be reproduced, thus making it possible to obtain the corresponding electric oscillations whenever and as often as desired.

The conversion of sound waves into electric energy is brought about by causing a variation in volume of a beam of light entering a suitable light sensitive cell to correspond to the sound waves produced. By a light cell we mean a device that when placed in circuit with a suitable e. m. f. will give a freedom of current flow depending upon the amount of light entering the cell.

In order to show the method by which this is done we will refer to Fig. 1. In this figure a special incandescent lamp is shown at *l*. The light from this lamp is focused by means of the spherical lens *e* on to the small mirror *b* and is reflected through the cylindrical

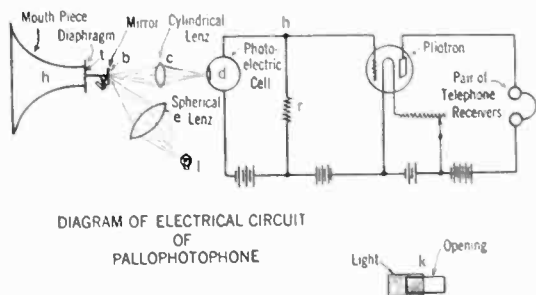

FIG. 1

A schematic diagram showing the elements of the pallophotophone used to translate sound into dancing light by means of a vibrating mirror, and then translate the dancing light into corresponding electric vibrations by means of a photo-electric cell. These currents, thus produced, are amplified and used either in the wireless antennas or any sound-reproducing apparatus such as telephone receivers and loud speakers.

lens *c* on to the light cell *d*, the shape of the light beam as reflected on the cell opening being shown at *k* (Fig. 1A). When the sound waves enter the mouth piece or horn *h* the diaphragm *f* and mirror are made to vibrate, causing the reflected light beam to move horizontally to and fro across the opening, thereby varying the light entering the cell. This in turn varies the current flowing through the resistance *r*, thus producing a change of potential at the point *h* that is in strict accordance with the sound waves entering the mouth piece. This varying potential may be applied to the grid of a pliotron in the usual way and amplified sufficiently to operate either a loud speaker, head phones or any other suitable electrical device.

The two principal pieces of apparatus on which the success of this device depends are (a) the vibrating elements and (b) the special light cell used. I will first give a brief description of the vibrating element. Referring to Fig. 2, *s* is the cross section of a small steel shaft having a knife edge which rests in two sets of jewels, one set of which is shown at *j*, set at right

angles as shown. The back of this shaft is connected by means of the small rod *i* to the diaphragm on which the sound waves impinge. The knife edge of the shaft is held firmly in the bottom of the V formed by the jewels by means of the permanent magnet *m*.

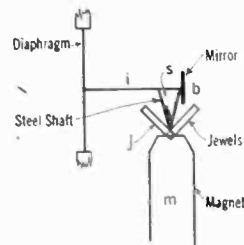

DETAILS OF VIBRATING SYSTEM

FIG. 2—DETAILS OF VIBRATING SYSTEM

The mirror *b* is fastened firmly to the steel shaft between the two sets of jewels. It is thus readily seen that as the diaphragm is moved to and fro by the impact of the sound waves a rocking motion is given to the mirror. The distance between the back of the shaft and the knife edge is considerably less than one one-hundredth part of an inch, so that it is seen that a very slight movement of the diaphragm will cause the mirror to move through a relatively large angle. This large amplification of motion is one of the principal features of this device. The movement of the light at the surface of the cell, which is only a few inches from the mirror is approximately two-thousand times the movement of the diaphragm. A movement of the light beam at the cell opening of 0.001 in. will produce a fairly loud reproduction of speech or music in a pair of head phones in the plate circuit of the first pliotron. This means that a movement of the diaphragm of only

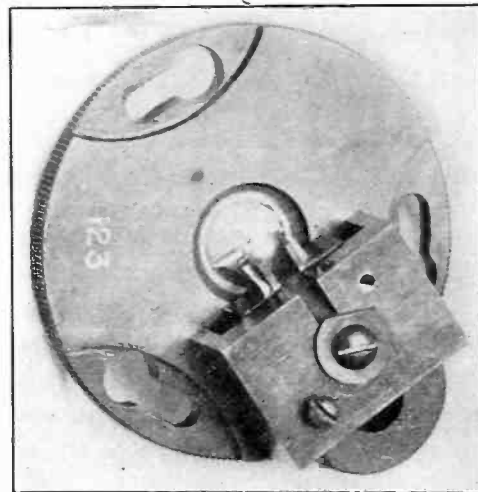

FIG. 3—PHOTOGRAPH OF DIAPHRAGM AND VIBRATING SYSTEM FOR PALLOPHOTOPHONE

0.0000005 in. or one two-millionth part of an inch, is necessary for the satisfactory reproduction of speech or music. Another remarkable feature in connection with the piece of apparatus is its extremely small moment of inertia. It is of interest to note that the combined weight of the diaphragm, the connecting rod, the steel shaft and the mirror is about nine milligrams, which is

equal to approximately one-half the weight of the head of an ordinary pin, or to put it another way, about one-twelfth the weight of the entire pin, and has a natural period of from 4000 to 5000 vibrations per second. This piece of apparatus, because of its small mass, comparatively rigid construction, high natural period and freedom to move when acted upon by the sound waves, is capable of responding faithfully to not only the fundamentals and the major oscillations, but also to the numerous harmonics that are necessary to more perfectly reproduce human speech and other complex sound waves. Fig. 3 is a photograph of the diaphragm and vibrating system complete.

Another advantage possessed by this device is that its moving parts or vibrating system can be made to meet any requirements of sensitivity desired without interfering with the quality of the reproduction. It can if necessary be made to easily reproduce whispered words spoken fifty feet from the instrument or to operate

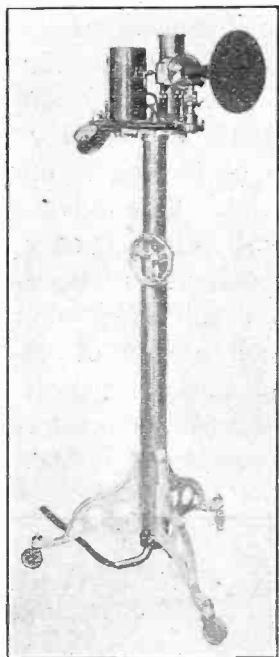

FIG. 4—PALLOPHOTOPHONE TRANSMITTER OR "PICKUP"

satisfactorily even though sounds of great volume are produced in its immediate vicinity, say such as playing by a band. Still another feature is the large range over which any one diaphragm will operate successfully. For example, if the sensitivity is such that it can easily pick up a whisper at twenty feet distant, words spoken loudly within a foot of the mouth piece will be perfectly reproduced.

The photo-electric cell used in connection with this device was recently developed by the General Electric Company and is extremely sensitive to slight variations of light. Unlike the selenium cell that is so commonly known, its response to changes of light is practically instantaneous. This is due to the fact that it depends for its action upon electron emission instead of the change in resistance as in the ordinary type, there being absolutely no appreciable lag in its action.

When used as a transmitter or pick-up device the

lamp, lenses, photocell, vibrating device and detector, the diagram of which is shown in Fig. 1, is mounted upon a pedestal as is shown in Fig. 4, which is a photograph of this device, the batteries, rheostats and other controls for the lamp, etc., being located in a separate cabinet

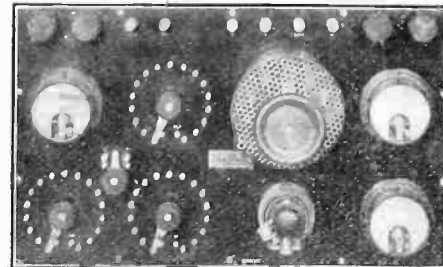

FIG. 5—CONTROL BOX FOR PALLOPHOTOPHONE TRANSMITTER OR "PICKUP"

as shown in Fig. 5, which can be located at some distant point.

The speech or music entering the mouth piece of the transmitter can readily be reproduced, as before stated, by means of some loud speaking device, if a suitable amplifying device be used in connection with it, or it can be used to operate the modulating tubes of a broadcasting station. An instrument of this kind is now installed at the General Electric Broadcasting Station, W G Y, at Schenectady, N. Y. as part of their regular equipment.

We will now show how the voice or other sounds are recorded upon, and reproduced from a photographic film, by means of the pallophotophone.

If a narrow opening, say about 0.001 in. wide be placed in front of a photographic film, as shown diag-

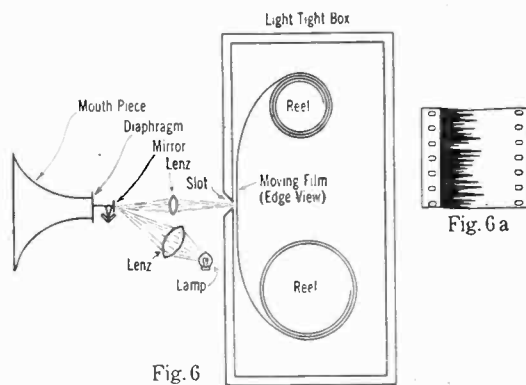

FIG. 6

Diagram of the elements of the parts of the pallophotophone used for making a permanent record of sound on a moving photographic film by means of light reflected from a tiny mirror which is connected by a lever to a very sensitive diaphragm placed at the small end of a mouth-piece.

FIG. 6A

Reproduction in ink of a short length of film (face view) showing, in black, the form of the record of vibrations of the beam of light which is reflected from the mirror, set into vibration by sound waves.

gramatically in Fig. 6, and the edge of the light, as represented at *k* in Fig. 1A is vibrated to and fro along the length of this slot while the film is running past at a uniform rate of speed, it is obvious that a sort of oscillogram or picture of the vibrations will be recorded upon the film, similar to that shown in Fig. 6A.



Fig. 7 is a photograph of the recorder as used in the recent records made at the General Engineering Laboratory and also at Washington, D. C. The speedometer located at the right of the machine, in conjunction with a rheostat, enables the operator to keep the

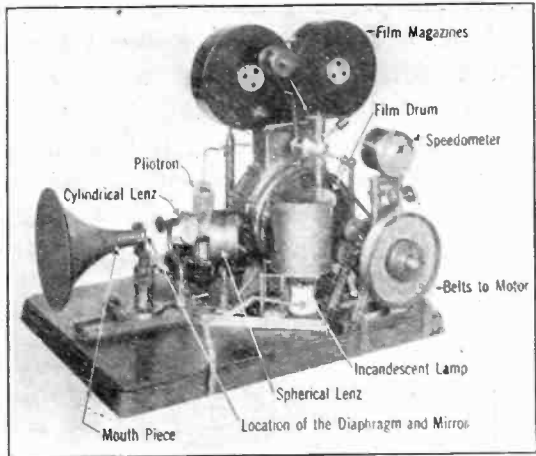

FIG. 7—PALLOPHOTOPHONE APPARATUS FOR RECORDING SOUND ON A MOVING FILM

speed of the film constant. After this film has been developed and dried it can be made to reproduce the sounds that were used in making the record in the following manner. Referring to Fig. 8, the narrow opening before described, shown at *o*, is now placed in front of a sensitive light cell *d* and the light of a lamp *l* located a few inches from this opening is focused by means of a spherical lens *c* on to this opening. The film is then made to move past the opening at the same speed at which the record was made. The result is that the variation of light entering the cell, which is governed by the light and dark places on the film, corresponds exactly to the sound waves produced while making the record. In this manner the variation of potential on the grid *g* is an exact duplicate of that which would have taken place if the change had been produced by the actual voice, as is the case when used as a transmitter direct. It might be well to state that compari-

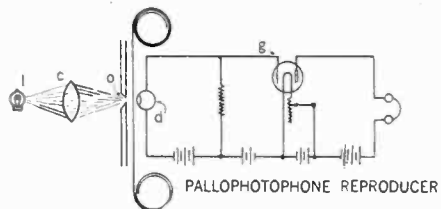

FIG. 8—DIAGRAM OF THE PALLOPHOTOPHONE REPRODUCER

sons have been made many times between the effects produced by talking directly into the transmitter and a reproduction of the same by means of the film record. This has been done by connecting the apparatus with an amplifier and loud speaker and then first varying the light by means of the voice direct and immediately producing the same words by means of a record previously made, and it has been impossible for even experts to note any difference between the two.

Fig. 9 is a photograph of a record made of the five vowels a, e, i, o, u. These records were made of large amplitude in order to make a better study of the characteristics. The record as actually used for speech reproductions has an amplitude of not more than one-eighth inch and several records may be made side by side on an ordinary moving picture film. In order to give an idea of how much more accurately this responds to not only the fundamental but the small harmonics that are produced by ordinary speech, the following comparison was made. An oscillogram of the word "souvenir" was made by means of a well known wave recording instrument designed for this purpose. When this oscillogram was made the film was running at a speed of three feet per second. A record of this same word was made by means of the pallophotophone on a film run at the same speed. The oscillations of the word as recorded by the former instrument was found to equal 340, whereas the number of oscillations in the same word by means of the more accurate record of the pallophotophone was approximately 2000. Another advantage of this system is that the modulation of the light enter-

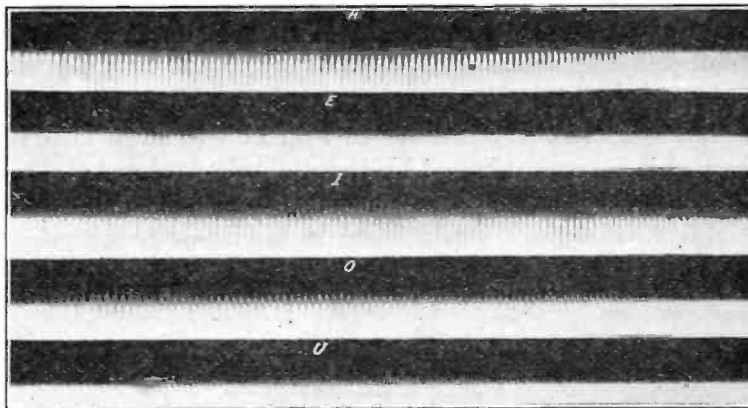

FIG. 9—THE VOWELS—A, E, I, O, AND U—AS REPRODUCED BY THE PALLOPHOTOPHONE

ing the cell can be made to equal 100 per cent if desired, that is, at one instant it is possible to have the light entirely cut off by the photographic image and the next instant it may receive the full value. Due to this condition, reproduced speech can be made to have a large volume with very little amplification.

By focusing the light so as to cover a very small area, therefore making it more intense, a very small amplitude of vibration can be used, the volume of sound being practically the same. An amplitude of one-sixteenth of an inch is enough to produce very clear speech or music. It is seen by this illustration that by using a space of one-eighth of an inch that eight records side by side could be made on a standard moving picture film. If this is run at the rate of one foot per second it would mean that on a standard 200 foot roll it would be possible to record a twenty-four minute speech.

Fig. 10 shows a photograph of the device when set up for reproducing speech from the film. The lamp and lens are seen placed in front of the revolving drum

which carries the film and in which the photocell is placed. The film passes from the magazine at the top from right to left or left to right, depending on which path on the film is being used. At the right is shown

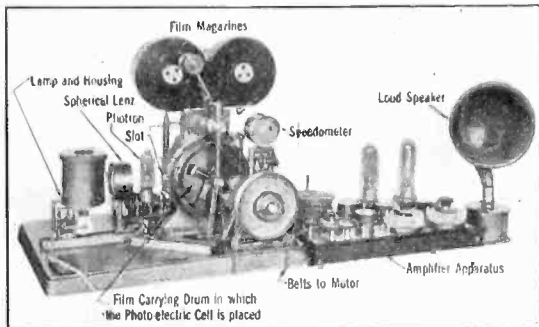

FIG. 10—PALLOPHOTOPHONE REPRODUCER. AMPLIFIER AND LOUD SPEAKER FOR REPRODUCING SOUNDS FROM A MOVING PHOTOGRAPHIC FILM

the amplifier and a loud speaker to reproduce the voice or music.

When this device is used in broadcasting many people have thought that the speech from the record was reproduced by a loud speaker and then picked up by a microphone in the usual way and thence to the modulating tubes of the radio transmitting station. This, however, is not the case. Reference to Fig. 11 will show clearly how this is accomplished by the pallophotophone. The diagram shown at the top gives a clear idea of how the

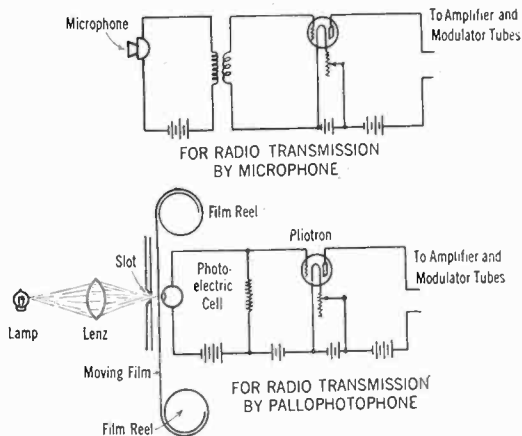

FIG. 11

The upper diagram shows the well known connections for using the microphone of telephone apparatus for translation of sound vibrations into the form of varying electric currents.

The lower diagram shows correspondingly in the pallophotophone, the light, horizontal slot, film, and photo-electric cell which perform the same function as the combination of the voice and microphone in the familiar telephone apparatus.

ordinary microphone is used in connection with broadcasting. The lower diagram in the same figure shows how the variable current from the pallophotophone is made to operate the modulating tubes. In this way it is readily seen that it is not at all necessary to convert the light waves into sound before the speech or music is broadcast, the variation of the light by means of the film serving to produce the electrical vibrations neces-

sary to operate directly the modulating tubes of the radio transmitter.

A lecture was recorded by Dr. William Gates regarding the language of the ancient Mayas, and talks which include the phonetic sounds used in all languages, by Dr. J. P. Harrington, Ethnologist at the Smithsonian Institute. Records made by Vice-President Coolidge and Secretaries Denby and Weeks were broadcast Christmas eve by the General Electric Company's Broadcasting Station, W G Y, at Schenectady, as also was a speech by General Pershing, New Year's night, and later the talk by Dr. Gates giving a brief history of the writings of the Mayas, sometimes called the ancient Egyptians of America. This race

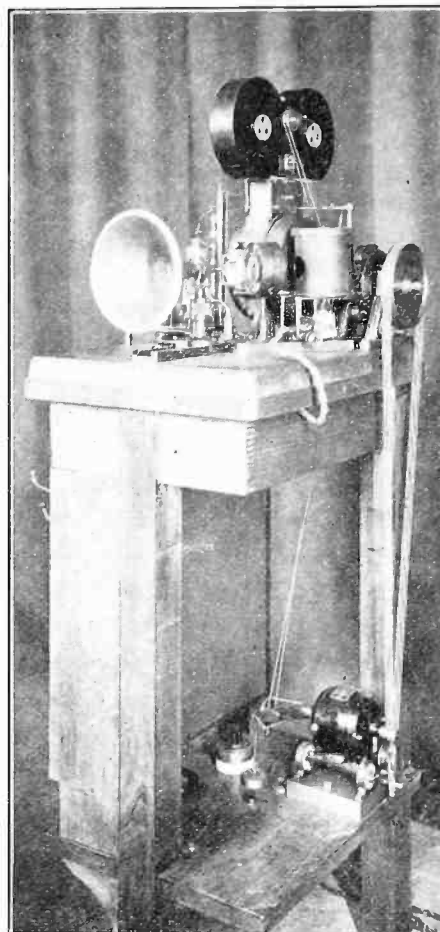

FIG. 12—PHOTOGRAPH OF COMPLETE INSTRUMENT FOR RECORDING SPEECH ON A MOVING FILM

inhabited the regions about the Peninsula of Yucatan. At the end of this lecture was recorded a reading by Cipriano Alvarado, a full blooded Kuiche Indian whose ancestors were of this race and who has been helping Dr. Gates in his study of the Indian tongue. This reading by Cipriano was in his own tongue. Dr. Gates while listening to the radio of this speech and reading by the Indian, claimed that the reproduction was perfect in every detail. Both Dr. Gates and Dr. Harrington believe that this device can be used to great advantage in the study of these ancient languages because of its faithful reproduction. Fig. 12 shows the instrument used in recording these speeches.

# Cable Geometry and the Calculation of Current-Carrying Capacity

BY DONALD M. SIMONS

Associate, A. I. E. E.

Standard Underground Cable Company, Pittsburgh, Pa.

**Review of the Subject.**—The main purpose of this article is to express the calculation of current-carrying capacity in simple formulas. The allowable current for underground cables is usually limited by the maximum permissible temperature of the insulation. The temperature rise is of course a function of the ability of the cable system to dissipate the heat generated. The chief difficulty in the calculation of current-carrying capacity is the determination of the thermal resistances of the path through which the heat must flow.

The main part of this paper deals with the errors in the standard formulas for calculating the thermal resistance and geometric properties between the conductors and the sheath. A graphical method of correcting the errors is obtained in terms of what is called the "geometric factor," the results are tabulated for 2, 3 and 4-conductor cables throughout the range of practical sizes and an empirical formula is given. The check between the results of the graphical correction method and the published experimental data on this subject is very satisfactory, and emphasizes the errors in the standard formulas.

The thermal resistance between the sheath and the duct is mentioned briefly, and an approximate method of finding the resistance between the duct and the region at base temperature is outlined.

The previous work is then combined into a simple formula giving the allowable current for  $n$ -conductor cables, there being any number

of similar cables in the duct bank. The formula is also enlarged to cover the case of cables in the metric and square inch systems, and cables buried directly in the ground. The method of including the effect of induced sheath currents in single-conductor cables and of dielectric losses is shown. Finally, the procedure to use in case the cables in the duct bank are not all of the same type is outlined.

In Appendix A the geometric factor for three-conductor cables under three-phase voltage is discussed, Russell's formula for this geometric factor being compared with the experimental determinations and an empirical formula for it is given. A formula is also given for the calculation of dielectric losses in three-conductor cables. The geometric factors for three-conductor cables in all other connections (i. e., the geometric factor for one conductor against the other two and sheath, or between any two conductors, etc.) are then derived in terms of the two geometric factors already obtained.

In Appendix B are given examples of the calculation of current carrying capacity under various conditions, and of dielectric loss.

In Appendix C an example is given which shows the error introduced by using an approximate formula for the calculation of the thermal resistivity of the insulation of a three-conductor cable based upon experimental measurements, the case taken up being a table in the Research on the Heating of Buried Cables.

## INTRODUCTION

THE limit in the current-carrying capacity of underground cables is the allowable temperature of the insulation at the hottest point, usually the conductor surface, (unless economic or other considerations are determining factors). For a given allowable temperature at the conductor surface and a known temperature of the earth, the allowable temperature rise is obtained. The allowable current is of course that current which is just sufficient to produce the allowable rise, due to the heat generated in the conductors as  $I^2 r$  loss, neglecting dielectric losses for the present.

The total temperature rise of a cable is usually divided into three distinct parts:  $T_A$ , the rise of the conductors above the lead sheath;  $T_B$ , the rise of the sheath above the duct;  $T_C$ , the rise of the duct above the base temperature of the earth. The thermal path may be considered as analogous to an electrical circuit with three resistances in series. In such an electric circuit the difference of potential across each of the elements would be equal to the product of its electrical resistance by the current flowing. In this thermal path, the difference of temperature across each of the elements will be equal to the flow of heat in watts, multiplied by the thermal resistance of the element in thermal ohms.

In the present paper, the  $T_A$  rise will be considered primarily, though the other ones will be mentioned

briefly, and it will be attempted to compare the various divergent methods of calculating  $T_A$ , pointing out the known errors in the various formulas, and a new method will be developed for graphically correcting them.

## THE GEOMETRIC FACTOR

The temperature rise between the conductors and the lead sheath, as stated above, is equal to the product of the total watts generated in the conductors by the thermal resistance between the conductors and the lead sheath, and our problem is to determine this thermal resistance.

For single-conductor cables the thermal resistance may be obtained in thermal ohms per unit length of cable by the standard formula

$$R_{th} = \frac{\rho \log_e (R/r)}{2 \pi} \text{ thermal ohms per unit length} \quad (1)$$

in which  $\rho$  is the thermal resistivity of the insulating material,  $R$  is the radius over the insulation, and  $r$  is the conductor radius. This formula is rigid and exact for homogeneous insulation.

For three-conductor cables several different formulas have been given, all in the form:

$$R_{th} = \frac{\rho \log_e F_1}{6 \pi} \quad (2)$$

in which  $F_1$  is a function of the dimensions of the cable

and is given in quite different form by different writers. The following are the various values of  $\log_{\epsilon} F_1$ :

$$\log_{\epsilon} F_1 = \log_{\epsilon} \frac{1 - \alpha\beta + \sqrt{(1 - \alpha^2)(1 - \beta^2)}}{\alpha - \beta}$$

Mie's formula (3)

$$\text{where } \alpha = \left( \frac{r + a}{R} \right)^3 \text{ and } \beta = \left( \frac{a - 3r}{a + 3r} \right), \alpha$$

$$\log_{\epsilon} F_1 = \log_{\epsilon} \frac{R^6 - a^6}{3R^3 a^2 r}$$

Russell's formula No. 1 (4)

$$\log_{\epsilon} F_1 = \log_{\epsilon} \frac{R^3 - a^3}{a^3 - (a - r)^3}$$

Russell's formula No. 2 (5)

In all the above formulas  $R$  is the radius of the cable under the lead sheath,  $a$  is the radius of the centers of conductors, and  $r$  is the conductor radius. It might be mentioned that Mie's formula has been also derived by Matsumoto. Reference to the source of these formulas is given in footnote 1.

It will be noted in formula (2) that the dimensions of the cable occur only in the logarithmic function, and we shall therefore call  $\log_{\epsilon} F_1$  the *geometric factor of the cable*, and use the symbol  $G_1$  for it.

#### ERRORS IN THE FORMULAS

The available formulas for  $G_1$  are based on certain stated assumptions. Unfortunately the values of  $G_1$  calculated by the various formulas are quite different for cables of ordinary makeup. This indicates that the assumptions on which the formulas are based are not valid for the usual cables.

Mie states that his formula is correct for very thick insulation with small conductors and also for very thin insulation. Russell says that his formulas are correct for the case of very small conductors very far apart. It has been noted that these qualifications have not in general been heeded, and in many cases the technical press shows that the formulas have been used regardless of the size of conductor. It is desired to show that the differences in these various formulas are very great in the range of practical cables.

Formulas (3), (4) and (5) contain three variables, but since the function in each case is a ratio, it can be expressed in terms of two parameters. These will be chosen as ( $\alpha$ ) the ratio of total insulation thickness between conductors and lead to conductor diameter or  $\frac{T + t}{d}$ , and ( $\beta$ ) the ratio of belt insulation thickness to conductor insulation thickness, or  $t/T$ , in which

$T$  equals the conductor insulation thickness,  $t$  equals the belt insulation thickness, and  $d$  equals the conductor diameter.

We may show the geometric factor for all cables of equal belt and conductor insulation thickness ( $t/T = 1$ ) if we plot the geometric factor as a function of

$\frac{T + t}{d}$ ; in other words, the thermal resistance of all

cables of a given kind of insulation having the same value of this function will be the same regardless of their absolute size. Careful examination has been made of the usual forms of cable, and also the unusual cases, and it has been found that practically all present day cables fall within the limits of about 0.2 to 2.0

for the ratio  $\frac{T + t}{d}$ . The geometric factors in this

range are plotted and shown in Fig. 1. In addition to the geometric factors from (3), (4) and (5), the geomet-

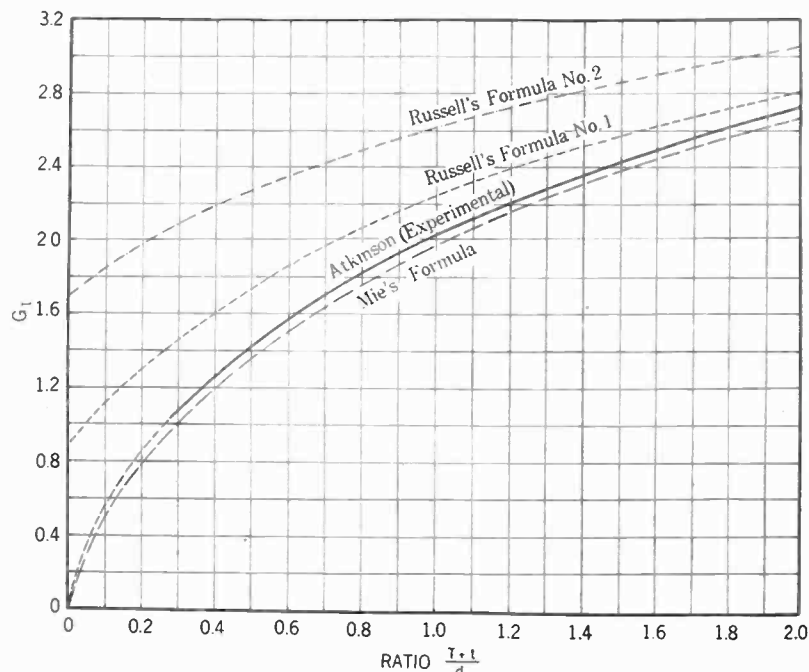

FIG. 1—GEOMETRIC FACTOR OF THREE-CONDUCTOR CABLES  
Comparison of calculated values by different formulas.  $t/T = 1.0$ .

ric factor obtained from Atkinson's experimental work is also plotted, concerning which more will be said later. The differences are obviously great.

Before proceeding further, it is of interest to examine Fig. 1 and attempt to determine the errors for extreme

cases. A ratio  $\frac{T + t}{d}$  equal to zero would mean a

cable (with finite conductors) of no insulation whatsoever. For this case, the thermal resistance and therefore the geometric factor must be zero, and thus both of Russell's formulas are seen to be in large error for small values of the ratio. For large values of the ratio, all the formulas approach the same correct value.

For instance for a ratio of  $\frac{T + t}{d}$  equal to 10, which

1. Mie, G., *Elektrotechnische Zeitschrift*, 1905, p. 137.

Russell, A., *Alternating Currents*, 1914, p. 187.

Matsumoto, H., *Electrotechnical Laboratory, Tokyo, Third Section*, 1916, Report No. 24.

is of course an improbable practical case,  $G_1$  has the following values for the formulas (3), (4) and (5) respectively; 4.35, 4.37 and 4.39. The most striking fact is that the curves for Russell's formulas do not pass through the origin as they should.

The errors in the various formulas are explained by their originators and are easily understood. If the twisting of the conductors is neglected, the problem is one of plane geometry, the figure to be solved being that of a cable cross-section, consisting of three circles in the vertices of an equilateral triangle, which represent the conductors, surrounded by a fourth circle representing the sheath. The approximate formulas which have been obtained have not used this actual

circles representing the conductors. For large values of the ratio  $\frac{T+t}{d}$  the substituted figure very closely approaches the three conductors.

Russell substitutes a different figure for the three conductors in his formula No. 2, his substituted figure being an oval inside the circle representing each conductor, and tangent to the conductor surface at the point nearest the cable center. For the sheath, he uses a figure tangent to the actual sheath at the points nearest the conductors and bending inward toward the cable center at the points between. Russell's formula No. 1 is derived by a different approximate

2 A

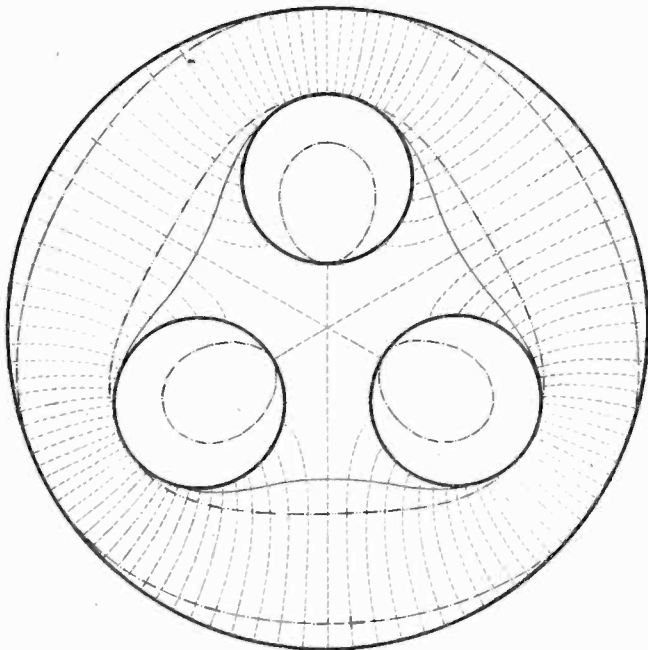

$$\frac{T+t}{d} = 0.5$$

$$t/T = 1.0$$

2 B

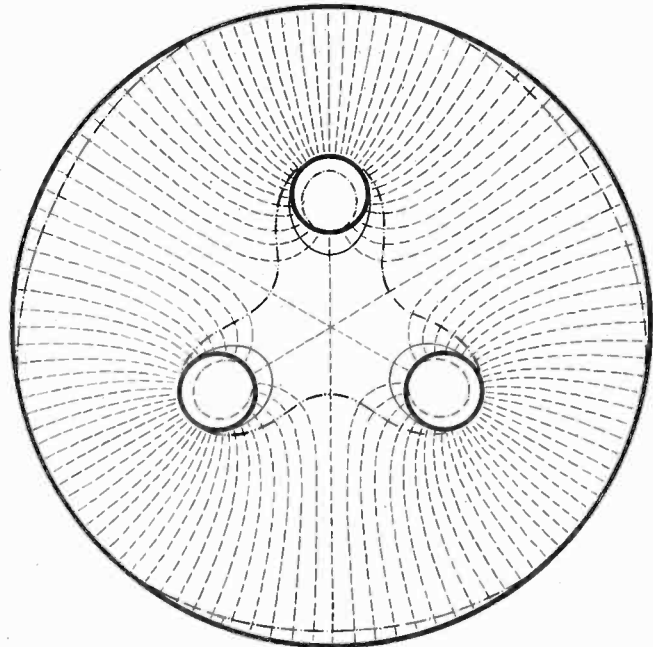

$$\frac{T+t}{d} = 2.0$$

$$t/T = 1.0$$

- the actual conductors and sheath.
- figure substituted for the conductors by Mie's formula
- heat flow-lines calculated by Mie's formula for them.
- figures substituted for conductors and sheath by Russell's formula No. 2.
- figure substituted for the conductors by formula (6), this formula using the same substituted sheath as Russell's formula No. 2.

FIG. 2—THE SUBSTITUTED FIGURES FOR THREE-CONDUCTOR CABLES  
Three conductors against the sheath.

figure, due to mathematical difficulties. Mie substitutes a figure for the three conductors, which coincides with the circles representing the three conductors at the regions nearest the sheath. His substituted figure consists of three ovals if the conductors are relatively small, and is a continuous curve dipping in between conductors if the conductors are relatively large. He uses the actual sheath. Knowing the equations of his substituted figure and of the sheath, Mie obtains a rigid expression for the thermal resistance between them. The error is of course due to the fact that the substituted figure is used in place of the three

method, the method of images, and no way has been devised here for graphically showing the errors in this formula.

The large error in Russell's formula No. 2 is easily explainable. The location of the greatest amount of flow of heat is undoubtedly between the conductors and the sheath through the shortest path between them and this is especially true for thin insulation. If substituted figures are to be used, the substituted sheath and substituted figures for the three conductors should be correct at this point to minimize the errors. A revision of Russell's formula No. 2 has therefore

been made with the condition that the figures representing the conductor's shall be tangent to the conductors at the points nearest the sheath rather than nearest the center of the cable, the substituted sheath being the same. This auxiliary formula has been derived for later purposes of checking, and has the following form:

$$G_1 = \log \epsilon \frac{R^3 - a^3}{(a + r)^3 - a^3} \quad (6)$$

The substituted figures are immediately understandable from Fig. 2 in which the actual conductors and sheath are shown as well as the substituted figures used in three of the formulas, Fig. 2A being a case of a relatively small value of the ratio, while Fig. 2B is for a large value of the ratio. The dotted lines are the flow lines of heat, which are defined as being lines normal to the isothermals, and such that the spaces between lines all have equal thermal resistances. The equations for these lines were obtained from Mie's formula for this purpose.

#### GRAPHICAL CORRECTION FOR THE ERRORS

The method devised for graphically correcting the geometric factor will now be explained. Mie's formula when applied to a cable contains errors, but it gives a *rigid solution* for the thermal conductance and geometric factor between his substituted figure and the sheath. Now the conductance between the three conductors or the substituted figure and the sheath is inversely proportional to the geometric factor. If therefore, we can by any means obtain the ratio of the conductance from Mie's substituted figure to the sheath to that from the three actual conductors for any particular cable, the product of this ratio by the geometric factor by Mie's formula will be the correct geometric factor of that cable. The same remark would of course apply to any other of the substituted figures, but since Mie's is the closest to the actual conductors, his formula and substituted figure have been chosen for this purpose.

The problem of correction is of course to graphically determine the ratio of the conductance from Mie's substituted figure to the true conductance. Due to the symmetry of a cable, it is sufficient to consider only one-half conductor. Fig. 3 shows 60 angular degrees, or one-half conductor, of the three-conductor cable shown in full in Fig. 2A. The flow lines shown were calculated by Mie's formula for them and are strictly the flow lines from Mie's figure to the sheath. Mie's equation for flow lines contains an auxiliary angle  $\eta$ ; the line for  $\eta$  equal to zero is the shortest line between conductor and sheath, while the line for  $\eta$  equal to 180 deg. is the one midway between conductors. In Fig. 3, the lines have been plotted for  $\eta$  from 0 deg. to 180 deg. by steps of 10 deg.

By the definition of flow lines therefore, the conductance between the substituted figure and the sheath is

the same along all of the paths between flow lines. If we take the conductance along any of these paths as unity, then the total conductance between Mie's figure and the sheath for this section would be 18 in Fig. 3.

The conductance from the conductor to the sheath must now be determined in the same units. Mie's figure coincides with the conductor for the first eight or nine paths, and each of these paths therefore has also a conductance of unity. For the subsequent paths, the conductance from the conductor to the sheath is through a longer path than from Mie's figure. Since conductance is inversely proportional to length of path, the conductance to the sheath for any particular path may be found by multiplying the conductance from Mie's figure (or unity) by the ratio of the average length of path from Mie's figure to its average length from the conductor. The conductance from the conductor to the sheath may therefore be determined

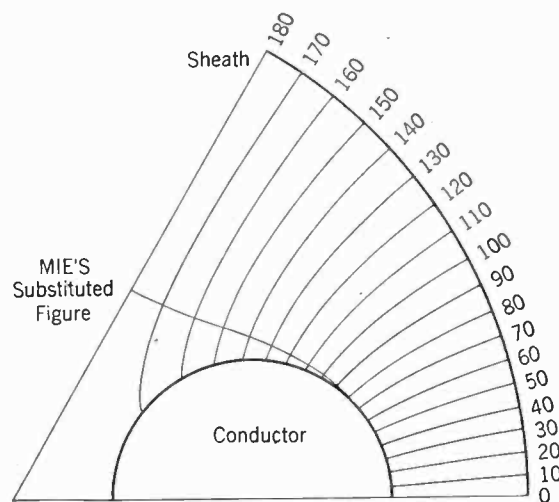

FIG. 3—FIGURE FOR GRAPHICAL CORRECTION OF THREE-CONDUCTOR CABLE

$$\frac{T + t}{d} = 0.5 \quad t/T = 1.0$$

path by path, the total conductance being the sum of the conductances of the 18 paths. This sum will be a number smaller than 18. If we now calculate the geometric factor for this particular cable by Mie's formula, and multiply it by the ratio of conductances, the correct geometric factor will be obtained.

The above method is described because of its clarity. The actual method used is based on the same principle though applied differently. The difficulty with the actual application of the method described is that a sufficient number of flow lines must be taken. It was found that the correction factor obtained by this method using 36 paths of flow instead of 18 as in Fig. 3 was slightly different, and that if 72 paths were used a still different geometric factor would be obtained, the answer obviously approaching a limit for an infinite number of flow lines. The calculation of flow lines is very laborious, since they must be plotted point by point, each point being obtained by solving an equa-

tion of degree equal to twice the number of conductors in the cable, and over forty separate figures of this kind were required.

The method actually used is the following, which is equivalent to using an infinite number of flow lines. A large figure was drawn for each case similar to Fig. 3 such that the radius of the sheath was equal to 10 inches, and the conductor, Mie's figure, and the flow lines for each 10 deg. of  $\eta$  were plotted on it. The length of each line from the conductor to the sheath and from Mie's figure to the sheath was carefully measured by a map measurer, and for each line the ratio of the length from Mie's figure to its length from the conductor was obtained, this being the true relative conductance along the line. The conductance from Mie's figure along each line was taken as unity.

The value of conductance between Mie's figure and the sheath was plotted against  $\eta$  as abscissa, the curve being of course a straight line parallel to the base. In other words, the conductance between Mie's figure and the sheath may be represented as the conductance

ratio of the two areas will be called the graphical correction factor.

This whole process was carried out graphically on a large scale for various proportions of  $\frac{T+t}{d}$  for equal

belt and conductor insulation thickness ( $t/T = 1$ ), for half belt ( $t/T = 0.5$ ), and for cables having no belt ( $t/T = 0$ ). In each case the geometric factor was calculated by Mie's general formula for an  $n$ -conductor cable, the graphical correction factor was obtained as described, and multiplying these two together a corrected geometric factor was obtained. This identical process was carried out for two (round duplex), three and four-conductor cables; the results are tabulated in Table I. For practical use, the data of Table I should be expressed in curve form,  $G_1$  being plotted

against  $\frac{T+t}{d}$ . A separate curve should be drawn for each value of  $t/T$ . In the remainder of the article,

TABLE I  
CORRECTED GEOMETRIC FACTOR BY GRAPHICAL METHOD

Belt ratio $t/T$	Ratio $\frac{T+t}{d}$	2-Conductor Cables			3-Conductor Cables			4-Conductor Cables		
		Calculated $G_1$ (Mie)	Graphical correction factor	Corrected $G_1$	Calculated $G_1$ (Mie)	Graphical correction factor	Corrected $G_1$	Calculated $G_1$ (Mie)	Graphical correction factor	Corrected $G_1$
1.0	0.15	0.602	1.057	0.636	0.668	1.089	0.727	0.728	1.094	0.796
	0.30	0.889	1.055	0.938	1.015	1.078	1.094	1.121	1.087	1.219
	0.50	1.179	1.042	1.229	1.369	1.063	1.455	1.524	1.072	1.634
	0.75	1.456	1.031*	1.501	1.710	1.052*	1.799	1.909	1.061*	2.025
	1.00	1.681	1.022	1.718	1.978	1.045	2.067	2.210	1.053	2.327
	1.50	2.023	1.012*	2.047	2.383	1.020*	2.431	2.661	1.035*	2.754
	2.00	2.280	1.006	2.294	2.681	1.014	2.719	2.989	1.021	3.052
	2.50	2.486	1.004*	2.496	2.916	1.009*	2.942	3.243	1.015*	3.292
0.5	0.15	0.604	1.057*	0.638	0.668	1.086*	0.725	0.725	1.094*	0.793
	0.30	0.891	1.055	0.940	1.009	1.073	1.083	1.107	1.088	1.204
	0.50	1.177	1.038	1.222	1.350	1.059	1.430	1.488	1.074	1.598
	0.75	1.451	1.025*	1.487	1.672	1.045*	1.747	1.845	1.057*	1.950
	1.00	1.669	1.017	1.697	1.921	1.035	1.988	2.120	1.048	2.222
	1.50	1.995	1.007*	2.009	2.297	1.014*	2.329	2.529	1.026*	2.595
	2.00	2.242	1.004	2.251	2.572	1.009	2.595	2.817	1.011	2.848
	2.50	2.440	1.002*	2.445	2.789	1.005*	2.80	3.050	1.008*	3.074
0.0	0.15	0.613	1.055*	0.647	0.668	1.082	0.723	0.721	1.094*	0.789
	0.30	0.896	1.042	0.934	1.000	1.069	1.069	1.085	1.088	1.180
	0.50	1.178	1.028	1.211	1.321	1.053	1.391	1.435	1.068	1.533
	0.75	1.454	1.015*	1.476	1.618	1.033*	1.671	1.753	1.045*	1.832
	1.00	1.651	1.009	1.666	1.846	1.020	1.883	1.995	1.031	2.057
	1.50	1.967	1.004*	1.975	2.187	1.008*	2.204	2.352	1.015*	2.387
	2.00	2.205	1.002	2.209	2.439	1.003	2.446	2.612	1.006	2.628
	2.50	2.396	1.001*	2.398	2.638	1.002*	2.643	2.820	1.003*	2.830

\*Interpolated value.

between opposite sides of a rectangle. The relative true conductances were then plotted on the same figure against  $\eta$ , the true total conductance of conductors to sheath being represented by the summation of all the ordinates of this figure. The area of the figure corresponding to Mie's conductance was calculated and the area corresponding to the true conductance was measured by a planimeter. The ratio of these two areas is the ratio of conductances from the two figures, which, multiplied by Mie's geometric factor for the cable, will give its true geometric factor. The

when it is stated that the value of  $G_1$  was obtained from Table I, it will be understood to mean from curves based on Table I.

The sources of error in the method will now be examined. The main difficulty is the fact that the flow lines are strictly the flow lines from Mie's figure and not the flow lines from the actual conductors. The more closely the substituted figure coincides with the three actual conductors, the smaller will this error be, and it was for this reason that it was decided to perform the graphical correction from Mie's formula. Another

error is the assumption that the conductances along any path are inversely proportional to the length, which would be true only if the flow lines were parallel. The flow lines, however, are quite closely parallel, and this error seems of negligible amount, especially since the method used is equivalent to the use of an infinite number of flow lines.

A certain amount of evidence in regard to the error of using incorrect flow lines may be obtained by the following method. The method described above consists in correcting Mie's geometric factor to the true geometric factor which is unknown. We have, however, two other formulas with substituted figures and *known* geometric factors, namely Russell's formula No. 2 and the auxiliary formula (6). The former contains very large errors and will not be used. We may, however, apply this same graphical method to the calculation of the geometric factor of the auxiliary formula, (which was derived for this purpose) and determine how closely this corrected value agrees with its actual geometric factor. In other words, on the diagrams used for the calculation of the true geometric factor of the cable, the figures substituted for conductors and sheath by the auxiliary formula may be drawn (they are shown in Fig. 2). The lengths of flow lines from Mie's figure to the sheath are compared with the lengths between the two substituted figures of this formula, and areas proportional to the relative conductances are obtained as before, the ratio of which is the graphical correction factor transforming Mie's geometric factor into the auxiliary geometric factor. This was done for three-conductor cables of equal belt and conductor insulation thicknesses for four values of

the ratio  $\frac{T+t}{d}$ .

Table II shows the actual geometric factor of the auxiliary formula, and its value obtained by graphically

TABLE II  
CHECK OF METHOD OF CORRECTION  
3-Conductor Cables,  $t/T = 1.0$

$\frac{T+t}{d}$	$G_1$ (Mie)	Graphical correction factor	$G_1$ of (6) by graphical correction	$G_1$ calculated by formula (6)	Error
0.3	1.015	0.764	0.775	0.769	+ 0.8%
0.5	1.369	0.824	1.128	1.125	+ 0.3
1.0	1.978	0.880	1.741	1.748	- 0.4
2.0	2.681	0.923	2.475	2.479	- 0.2

correcting Mie's formula, and it will be seen that the maximum error is only 0.8 per cent which is a very satisfactory check. A comparison of Table II with the corresponding section of Table I will show that the per cent error which has been corrected in Table II is many times greater than the error corrected for the actual cable. We cannot, however, assume from this that the corrected geometric factors of Table I are accurate to considerably more than 0.8 per cent, since

an inspection of the figures would indicate that Mie's flow lines are probably more nearly the flow lines of the substituted figures of the auxiliary formula than they are of the actual conductors. The check of Table II, however, at least indicates that the error in Table I is probably quite small.

#### COMPARISON WITH EXPERIMENTAL DETERMINATIONS OF GEOMETRIC FACTOR

Fortunately another method of obtaining the geometric factor is available. The geometric factor shown in formula (2) is exactly the same for the calculation of not only thermal resistance but also of electrical resistance or capacity, the only difference in the formulas being in the constants used. If, therefore, it should be possible to obtain any one of certain electrical quantities experimentally, this determination

TABLE III  
COMPARISON OF GEOMETRIC FACTORS FOR  
THREE-CONDUCTOR CABLES

Belt ratio $t/T$	Ratio $\frac{T+t}{d}$	Calcu- lated by Mie's formula	$G_1$ graphi- cally corrected from Mie's formula	From Atkin- son's ex- perimen- tal values	From Sacchet- to's ex- perimen- tal values	Per cent deviation of (4) from (5)
(1)	(2)	(3)	(4)	(5)	(6)	(7)
1.0	0.30	1.015	1.09	1.09	..	0.0%
	0.50	1.369	1.45	1.43	..	+ 1.4
	0.75	1.710	1.80	1.78	1.78	+ 1.2
	1.00	1.978	2.07	2.03	2.00	+ 2.0
	1.50	2.383	2.43	2.43	2.31	0.0
	2.00	2.681	2.72	..	2.54	..
	2.50	2.916	2.94	..	2.74	..
	3.18	3.168	..	..	3.00	..
0.5	4.55	3.543	..	..	3.42	..
	0.30	..	1.08	1.09	..	- 0.9
	0.50	..	1.43	1.44	..	- 0.7
	0.75	..	1.75	1.77	..	- 1.1
	1.00	..	1.99	1.98	..	+ 0.5
0.0	1.50	..	2.33	2.33	..	0.0
	0.30	..	1.07	1.07	..	0.0
	0.50	..	1.39	1.40	..	- 0.7
	0.75	..	1.67	1.68	..	- 0.6
	1.00	..	1.88	1.89	..	- 0.5
1.50	..	2.20	2.24	..	- 1.8	

would make it possible to find the geometric factor and thus all the other quantities. This has been done experimentally by Atkinson<sup>2</sup> and Sacchetto<sup>3</sup>, who measured the resistance between three conductors and the sheath (as well as in other connections) of three-conductor cable models, composed of three tubes uniformly spaced and surrounded by a fourth tube, all located in a tub of electrolyte. Various sizes of tubes and spacings were used, and both have obtained sets of curves, in terms of charging current for the former, and capacity for the latter; from these values, three conductors against the sheath, it is possible to calculate the geometric factor in terms of our parameters by formulas (21) and (19) given in Appendix A. This method of obtaining the geometric factor is

2. Atkinson, TRANSACTIONS A. I. E. E., 1919, page 971.
3. Sacchetto, l'Elettrotecnica, 1921, page 533.



theoretically correct, the only possible error being the experimental errors such as the location of the electrodes, which undoubtedly were reduced to a minimum. It is therefore possible to obtain values of the geometric factor by calculation from the experimental data of these two, and some of Atkinson's values have already been shown in Fig. 1.

Table III has been drawn up comparing the various experimental determinations of the geometric factor with the values obtained herein by correction from Mie's formula, shown in column (4). Column (5) shows the geometric factor obtained from Atkinson's experimental data, and column (6) that from Sacchetto's. The last two points shown in this column are for the actual values of the ratio used by Sacchetto while the others were obtained by drawing a curve through his points and reading off the values corresponding to our values of the ratio.

Column (7) shows the per cent deviation of our values from Atkinson's experimental values. The check seems quite good, especially when compared with the errors in the standard formulas as shown in Fig. 1. As to this small residual error, it is believed that in general

for the small values of the ratio  $\frac{T+t}{d}$ , where the

graphical correction is large, Atkinson's value is undoubtedly more nearly correct, while for the larger values of the ratio where the graphical correction is small, the new values are probably more nearly correct.

Referring to Sacchetto's values, it will be noted that the first one is quite close, while after that the values are low. Mie's value of the geometric factor is definitely always too small. The last five values from Sacchetto's data are 3 to 5 per cent lower than Mie's values and these values must therefore be definitely in error by at least that amount.

EMPIRICAL FORMULA FOR GEOMETRIC FACTOR

Since we have obtained the values of the geometric factor, it is of course immediately possible to derive empirical formulas which will coincide with the data of Table I. For three-conductor cables, the following formula (7) applies:

$$G_1 = (0.85 + 0.2\beta) \log_e [(8.3 - 2.2\beta)\alpha + 1] \quad (7)$$

$$\text{where } \alpha = \frac{T+t}{d} \quad \text{and} \quad \beta = t/T$$

Between  $\alpha = 0.3$  and  $2.5$ , this formula will give a value of the geometric factor agreeing to within 1.2 per cent with the values of Table I. Throughout most of the range, the check is within 0.5 per cent.

For an  $n$ -conductor cable it was thought that it would probably be more valuable to express a general formula at some sacrifice of accuracy than to obtain a very complicated expression or to have a different

formula for each number of conductors. Formula (8) has therefore been derived:

$$G_1 = \log_e \left[ \frac{n(8T+t)(T+t)}{4dT} + 1 \right] \quad (8)$$

where  $n$  = number of conductors in the cable.

TABLE IV  
PER CENT DEVIATION OF FORMULA (8) FROM  
GEOMETRIC FACTOR

$\alpha$	2-Conductor			3-Conductor			4-Conductor		
	$\beta$			$\beta$			$\beta$		
	1.0	0.5	0.0	1.0	0.5	0.0	1.0	0.5	0.0
0.3	-8.8	-12.4	-15.2	+1.1	-1.3	-3.9	+7.2	-0.3	+3.6
0.5	-4.1	-6.9	-9.3	+1.5	+1.2	-0.4	+4.2	+3.9	+5.0
1.0	-0.9	-2.3	-3.3	-0.9	+1.6	+3.3	-1.3	+1.3	+6.8
1.5	0.0	-0.5	-1.7	-0.7	+1.3	+4.3	-2.9	+0.9	+8.8
2.0	+0.2	0.0	-0.5	-1.5	+1.0	+4.8	-3.4	+1.5	+7.8

Table IV shows the error of this formula based upon the geometric factor as derived in this article. It will be noted by comparison with the correction factors shown in Table I that in most cases the error of formula (8) is much less than that of even Mie's formula, except for certain cases of non-belted cables. Cables without belts which are not in the Type H form are not of great practical importance, however, and it is believed that the simplicity and ease of application of this formula would make it convenient to use in cases where greater accuracy is not necessary. The simplicity is such that  $G_1$  may be readily calculated on the slide rule, while it is dangerous and laborious to do so with Mie's or Russell's formula No. 1, since they are sixth degree expressions for three-conductor cables. It is believed that such a formula as this will be valuable when properties of cables are investigated mathematically, where for instance, the maximum or minimum value of some function is desired.

The formula is exact for single-conductor cables, since when  $n = 1$  and  $t = 0$ , formula (8) reduces to:

$$G_1 = \log_e \frac{d + 2T}{d} = \log_e (D/d) = \log_e (R/r)$$

SECTOR-SHAPED CONDUCTORS

The expression "sector-shaped conductor" includes such a large variety of shapes that it seems necessary to obtain an approximate value of the geometric factor. It has been noted that the capacity of a sector cable is about 10 to 15 per cent greater than that of a cable of the same insulation thickness and same copper cross-section with round conductors. Approximate results can therefore be obtained if the geometric factor is obtained by reading a value from Table I on the basis of round conductors of the same area and the same insulation thickness, and then decreasing this geometric factor by 10 per cent.

It was hoped that a geometric factor might be obtained by the graphical method used for the case of round conductors. It was found; however, that Mie's

flow lines were so far from being the correct flow lines for the sector conductors that no consistent results could be obtained.

Russell has given an approximate formula for three-conductor cables with sector conductors, which also applies only to the case of very small conductors with very thick insulation. This formula is obtained by a transformation of his formula No. 2, and the geometric factor is given in the following form:

$$G_1 = \log_e \frac{2R^3 - (c^3 + b^3)}{c^3 - b^3} \quad (9)$$

in which  $R$  = the cable radius under the lead sheath  
 $c$  = the maximum distance from the cable center to the conductor surface  
 $b$  = the minimum distance from the cable center to the conductor surface.

It is difficult to state the exact error in formula (9), since our data are not definite enough for sector cables. However, it is quite interesting to note that although this formula is based on two approximations, the first being the approximation leading to Russell's formula No. 2 which introduces a large error, and the second being an approximation transforming his formula No. 2 into formula (9), these two apparently neutralize each other, with the result that formula (9) gives results for three-conductor cables with *round* conductors which are much more accurate than those obtained by either of his other formulas.

#### THERMAL RESISTANCE AND TEMPERATURE RISE BETWEEN CONDUCTORS AND SHEATH

Having obtained the values of the corrected geometric factor, it is immediately possible to calculate the temperature rise,  $T_A$ , of cables having from one to four conductors, and of course a similar process could be used to determine the geometric factor and temperature rise for cables with more conductors if desired. The formulas follow:

$$\text{Thermal resistance} = \frac{0.00522 \rho G_1}{n} \text{ thermal ohms} \\ \text{per foot of cable} \quad (10)$$

(Between the  $n$ -conductors and the sheath).  
 Temperature rise, conductors above sheath,

$$T_A = \frac{0.00522 W \rho G_1}{n} \text{ degrees } C \quad (11)$$

where  $G_1$  is obtained from Table I or from formulas (7) or (8)

$n$  = number of conductors per cable

$\rho$  = thermal resistivity of the insulation in watt-centimeter-centigrade units

$W = I^2 r$  loss in watts per foot of cable.

$$0.00522 = \frac{1}{2\pi \times 12 \times 2.54}$$

The thermal resistivity may of course be obtained

by inverting formula (11), if the temperature rise of the conductors above the sheath is known for a given loss in the conductors. It is especially important to use the correct value of the geometric factor for the determination of the thermal resistivity of cables, and it was thought that it might be interesting to illustrate this by a particular case, namely the Research on the Heating of Buried Cables. See Appendix C.

#### CURRENT CARRYING CAPACITY

The allowable current for underground cables is usually determined from temperature considerations except for very low-voltage cables where voltage drop may be the controlling feature. In certain cases, the laws of economy may determine the size of conductor, especially if the load factor is high. In what follows, however, only the temperature problem will be considered, but it should be borne in mind that in certain cases, the results should be tested for line drop and by Kelvin's Law.

The fundamental law on which the calculation of current carrying capacity as limited by temperature rise is based has been called "Ohm's Law for Heat." This may be expressed as follows: Temperature difference (centigrade) equals watts per foot times thermal resistance in thermal ohms per foot. This applies to a steady, continuous load, which is the only condition which will be covered in this paper.

So far the thermal resistance between the conductors and sheath is the only one that has been considered. Before giving a formula for the allowable current, we must determine the temperature rises,  $T_B$  and  $T_C$ , between the sheath and the duct, and the duct and base respectively. To do this, we must solve for the thermal resistances corresponding to these rises.

What may be roughly called the thermal resistance between the lead sheath and the duct, in other words a quantity which multiplied by the watts dissipated is equal to the temperature rise, (although it of course is not truly a thermal resistance) is primarily a function of the outside diameter of the cable and the thermal emissivity of the lead sheath. This thermal resistance may be expressed by the following formula:

$$r_{th} = \frac{0.00411 E}{D} \text{ thermal ohms per foot} \quad (12)$$

in which  $E$  is an approximate constant which might be called the surface resistivity of the sheath, almost independent of  $D$ , and expressed in degrees centigrade per watt per square centimeter, and  $D$  equals the outside diameter of the cable in inches. It might be thought that the size of the duct should be included in the formula for this thermal resistance. If the heat were transferred between the sheath and the duct by conduction, the size of the duct would enter in a marked degree. The transfer of heat, however, is by conduction in part only, and mostly by radiation and convection. The fact that  $T_B$  is almost independent

of the size of duct can be illustrated by saying that for the same loss the sheath rise in a small duct is not very different from the sheath rise of a cable suspended in free air.

The duct rise,  $T_c$ , is the most difficult to determine, and in the present state of knowledge complicated mathematical calculations would probably not be justified. We will let  $H$  be the thermal resistance per foot between the duct and the region at base temperature or "sink." For a relatively small cylinder buried in the earth, the thermal resistance per foot is proportional to  $\rho' \log 4l/D$ ,  $\rho'$  being the earth's resistivity,  $D$  the outside diameter of the cable, and  $l$  the distance between the cable axis and the surface of the earth. This formula due to Kennelly is practically standard in the calculation of the temperature rise of the sheath of a cable buried directly in the ground according to European practise. The temperature rise between a duct bank and the base is a similar problem, and an equivalent cylinder could be substituted for the duct. The ratio of the diameter of this cylinder to the depth below the surface would, however, be much greater than for the case of a cable buried in the ground, and errors in the formula would be greater. In fact, such a procedure is quite similar to using Russell's formula for the geometric factor for cables with large conductors and thin insulation. However, this is probably the best that can be done at present, and the errors and variations in the thermal resistivity of the soil are much greater than the errors which would be introduced by the formula. It is for this reason that the condensed rather than the full form of Kennelly's formula will be used.

We will therefore offer the following formula for  $H$ :

$$H = 0.00522 \times \rho' \times \log_e \frac{4l}{L} \text{ thermal ohms per foot of duct} \quad (13)$$

- in which  $\rho'$  = the thermal resistivity of the soil
- $l$  = the distance between the earth's surface and the center of the duct structure
- $L$  = the length of one side of a square duct bank.

If the duct structure is not square in cross-section, the geometric average of the two dimensions should be used for  $L$ .

Formula (13) is merely a first approximation, and may be used with the data of Shanklin<sup>4</sup> for the thermal resistivity of the soil. Its mathematical error has been investigated by calculating the temperature rise based on (13) and comparing it with the temperature rise calculated on the basis that the temperature rise of each duct is the rise due to the heat which it dissipates plus the rises due to the adjacent ducts, assuming that the thermal gradient as derived from (13) is true for short distances. It was also assumed that the duct

structure was homogeneous with the soil in thermal characteristics. For ducts buried from 2 to 8 feet below the surface of the earth and for structures containing up to 16 ducts, the maximum difference between the two methods was only 8 per cent. This method incidentally also makes it possible to approximate the thermal gradient within the duct structure.

Atkinson<sup>5</sup> states that  $H$  may vary between 0.6 and 1.6 depending on the size of duct structure and upon the nature of the surrounding soil, and that 1.0 seems to be a reasonably safe average figure for conduits containing up to about 16 ducts. This is borne out by formula (13), using average values of soil resistivity. For practical numerical calculation, where the constants of the soil are unknown, 1.0 may be taken as an average value for  $H$ , and this has been done in the numerical examples in Appendix B.

The total thermal resistance, conductors to base for cables in ducts is of course equal to the sum of the three thermal resistances,  $H$  being multiplied by the number of similar cables in the duct to express the thermal resistance in terms of the watts per foot of cable, since all the cables are effective in heating the duct. The total thermal resistance therefore is:

$$R_{th} = \frac{0.00522 \rho G_1}{n} + \frac{0.00411 E}{D} + N H \quad (14)$$

thermal ohms per foot

If we substitute 850<sup>6</sup> for  $\rho$ , 1200 for  $E$ , and 1.0 for  $H$ , (14) reduces to the following simple form:

$$R_{th} = \frac{4.44 G_1}{n} + \frac{4.93}{D} + N \quad (14')$$

thermal ohms per foot.

For armored cables buried directly in the ground, the total thermal resistance is given by a somewhat different expression. The thermal resistance between conductors and sheath is of course the same as for cables in ducts. Cables in the ground, however, usually have a protective covering of armor and jute wrappings around the lead sheath, whose thermal resistance is given by an expression similar to that for the insulation of a single-conductor cable. The thermal resistance between the outer surface of the cable and the region at base temperature is given by (13), using the outside diameter of the cable for  $L$ . If there are several cables buried fairly close together, there will in addition be an apparent increase of thermal resistance of one cable due to the presence of the others, and another term must be added represented by the summation sign,<sup>7</sup> which is intended to indicate that the process must be

5. Atkinson, JOURNAL of A. I. E. E., 1920, page 831.

6. This would apply to impregnated paper or varnished cambrie insulation, and 650 may be used for rubber.

7. This term is derived on the assumption that the temperature gradient is the same as that between two concentric cylinders of diameters  $4l$  and  $D$ , [an assumption mathematically justified by formula 13] which is undoubtedly closely true if the cables are not too far apart.

4. Shanklin, TRANSACTIONS of A. I. E. E., 1922, page 92.

performed for all neighboring cables, excepting the one under consideration, all the cables being supposed identical in dimensions.

The total thermal resistance, conductors to base, for cables buried directly in the ground is therefore the following:

$$R_{th} = 0.00522 \left[ \frac{\rho G_1}{n} + \rho'' \log \epsilon \frac{D'}{D} + \rho' \log \epsilon \frac{4l}{D'} + \rho' \Sigma \log \epsilon \frac{4l_n}{2x_n} \right] \quad \text{thermal ohms per foot} \quad (15)$$

The following symbols apply to (14), (14') and (15):  
 $G_1$  = the geometric factor from Table I, or formulas (7) or (8).

$\rho$  = the thermal resistivity of the insulation in degrees C/watt/cm.<sup>3</sup>

$\rho'$  = the thermal resistivity of the soil in degrees C/watt/cm.<sup>3</sup>

$\rho''$  = the thermal resistivity of protective coverings for armored cable in degrees C/watt/cm.<sup>3</sup>

$n$  = the number of conductors in each cable.

$N$  = the number of similar, loaded cables.

$D$  = the diameter over lead of the cable in inches.<sup>8</sup>

$D'$  = the outside diameter of an armored cable in inches.

$E$  = the surface resistivity of the sheath in degrees C/watt/cm.<sup>2</sup>

$H$  = the thermal resistance per foot of the duct from (13).

$l$  = the distance in inches between the earth's surface and the center of the cable buried in the ground.

$l_n$  =  $l$  of any other nearby cable.

$x_n$  = the distance in inches between the axis of the cable under consideration and that of any other cable.

The total temperature rise for a given current per cable, there being  $N$  similar cables in the duct bank, (or in the ground), can be found by multiplying  $R_{th}$  by the  $I^2 r$  loss per foot of cable, or the  $T_A$ ,  $T_B$  and  $T_C$  rises may be determined separately by multiplying each of the three terms respectively of (14) by the watts.

The more usual problem is to find the allowable current for a given group of cables. The allowable temperature rise can be determined by subtracting the ground temperature from the allowable temperature of the insulation as determined by the A. I. E. E. rule or otherwise; if this rise is divided by the total thermal resistance, the allowable  $I^2 r$  watts per cable are obtained. From the known conductor resistance, it is

8. The outside diameter of a 3-conductor cable with round conductors is of course the following:

$$D = 2.155 (d + 2T) + 2t + 2 \times \text{lead thickness.}$$

For sector cables, the outside diameter is equal to that of a round conductor cable of the same make-up minus from 0.3 to 0.4 times  $d$ , depending upon the shape of the sector.

therefore possible to calculate the allowable current. The entire process may be expressed in the following formula giving the allowable current for  $n$ -conductor cables, there being  $N$  similar cables in the duct:

$$I = 0.281 \times \sqrt{\frac{A (T_o - T_g)}{n R_{th}}} \quad (16)$$

where  $I$  = allowable current in amperes per conductor.

$T_o$  = allowable temperature of the insulation according to A. I. E. E. Standardization Rule in degrees cent.

$T_g$  = base temperature of the ground in degrees cent.

$A$  = cross-section of conductor in circular mils. and  $R_{th}$  is obtained from (14) or (14') for underground cables in ducts, from (15) for cables buried directly in the ground, and from (10) for submarine cables,  $T_A$  being the only rise in that case.

The constant in front of the radical is calculated in connection with the circular mils,  $A$ , so that the resistance is taken at 65 deg. cent. (an average operating value) including an increase of 2 per cent for stranding and 2 per cent for cabling. If the "skin" or "proximity" effects are appreciable, the constant should be divided by the square root of the ratio of a-c. to d-c. resistance. If  $A$  is expressed in square millimeters, the constant in front of the radical becomes 12.47 and if it is expressed in square inches, the constant becomes 317.0. The constant 0.281 is actually equal to  $0.40/\sqrt{\rho_0}$  where  $\rho_0$  is the resistivity of the copper in microhms per cm. cube (2.03 at 65 deg.), and from one point of view, the value of the resistivity at the operating temperature should be used. However, the variation of  $\sqrt{\rho_0}$  between 55 and 85 deg. cent. is only 5 per cent, corresponding to working pressures of 30,000 and about 110 volts. Furthermore, it has been stated<sup>5</sup> that this variation is in part at least compensated for by changes in the surface thermal resistivity of the sheath. The use of a constant 0.281 at an average temperature thus seems allowable.

Formula (16) is believed to present the advantage of applying to the general case of  $N$  cables, each of  $n$ -conductors, and if formula (8) is used for the geometric factor, the allowable current is expressed directly in terms of the cable dimensions. Since formula (14') is based on the constants used by Atkinson, and since the geometric factor of this paper agrees so closely with his geometric factor, this formula will give allowable currents for single-conductor, or three-conductor cables which will agree with those obtained by means of his tables<sup>5</sup>.

#### DIELECTRIC LOSS

The effect of dielectric loss may be included by assuming (1) that the power factor throughout the entire insulation is the same as that at the hottest point, and (2) that the loss is concentrated in the conductors and must flow through the entire thermal path. The second

assumption is of course correct for the sheath and duct rises. These two assumptions tend to give the maximum effect of dielectric loss, especially for low loss cables, though in certain cases, the effect may be greater. The assumptions do not lead to much error, since the whole effect normally is relatively small.

Since the allowable temperature of the conductor is known for a given voltage, the dielectric loss can be calculated in watts per foot by (22) based on the power factor of the insulation at that temperature. The temperature rise due to dielectric loss will then equal the loss in watts per foot multiplied by the total thermal resistance per foot from (14). The effect of the dielectric loss upon carrying capacity is obviously to diminish the temperature rise allowable for the  $I^2 r$  loss. Mathematically it can be conveniently included in the calculation by finding the temperature rise due to dielectric loss as explained and subtracting this rise from  $T_0$  in equation (16).

For the case of single-conductor cables, the first term of formula (14), should be divided by 2 for this purpose, since it has been shown<sup>9</sup> that the temperature rise of the conductor above the sheath of a single-conductor cable is *half* as great for a given dielectric loss as for the same loss in the conductor.

#### INDUCED SHEATH CURRENTS

In the case of single-conductor cables bonded at both ends, the heat due to the flow of induced currents in the sheaths may have considerable effect upon the current-carrying capacity. The additional heat is generated in the sheath and therefore does not affect  $T_A$ , but does increase the  $T_B$  and  $T_C$  rises directly. If the total effective resistance due to sheath currents be calculated by a standard formula<sup>10</sup> and the conductor resistance at the desired temperature be known, the allowable current may be calculated conveniently by increasing the second and third terms in (14) by the ratio of the total effective resistance to the conductor resistance. (See Example 4 in Appendix B).

#### DIFFERENT TYPES OF CABLE IN THE SAME DUCT BANK

Formula (16) refers specifically to the case where all the cables in a duct line are exactly the same. In practise, a duct bank often contains cables of different sizes and voltages, and this formula does not apply. For the case of two different types of cable in the duct bank, a formula giving the allowable current for one type in terms of the dimensions of the two types has been derived, but it is rather formidable looking, and the following method may be easier of application. Find the allowable rise for each type of cable by sub-

tracting the temperature of the earth from the allowable temperature of the insulation according to the A. I. E. E. rule. Express the total rise symbolically in terms of the unknown allowable watts per foot loss and the known thermal resistances. In each case, equate the total temperature rise to the allowable rise and obtain two equations for the two unknown watts per foot loss. These two equations are easily solved and the allowable watts for each type will be obtained. Note that the total rise for one type of cable is equal to the  $I^2 r$  watts of that type times the total thermal resistance from (14), plus the duct rise due to the other type of cable which will equal  $NH$  times the watts per foot of cable of the other type. Both watts are of course equal to  $n I^2 r$ .  $r$ , the conductor resistance per foot being known, the only unknowns will be the currents which may be solved from the watts. (For illustration see Example 2). The method will of course apply to any number of types of cable.

The effect of dielectric loss may be included by subtracting the temperature rise due to dielectric loss in each type from the allowable temperature for that type. The effect of induced sheath currents may be included by multiplying the terms in equation (14) corresponding to  $T_B$  and  $T_C$  by the ratio of total effective resistance to conductor resistance.

#### CONCLUSION

Inasmuch as the values of the geometric factor derived herewith are checked so closely by Atkinson's experimental values, it is believed that it may be stated confidently that the geometric factor, three conductors against the sheath, is known to an accuracy of 1 or 2 per cent, which seems quite sufficient since multi-conductor cables are actually not homogeneous due to the fillers. If it is desired to use a formula rather than to read the value from curves, formula (7) is by far the most accurate for three-conductor cables and (8) is fairly accurate for most practical  $n$ -conductor cables, up to  $n = 4$  at least. Both are quite simple and can be easily calculated by slide rule. Of the older more standard formulas, Mie's is much the most accurate, especially in its condensed form, and this has been recognized in this country by Powell<sup>11</sup> in his work on current-carrying capacity.

The data of the present article have been expressed in terms of a "geometric factor." Atkinson's data are given in terms of charging current and Sacchetto's in terms of capacity. The data might equally well be given in terms of insulation resistance, dielectric loss, or even thermal resistance. In whatever form the data are given, formulas may be written with equal ease by which all the other quantities can be determined. The difficulty is, however, that such formulas, while mathematically correct, tend to give a false physical conception, such for instance as a formula for temperature rise in terms of charging current. The geometric factor

9. Schering, *Archiv für Elektrotechnik*, 1922, Volume 11, page 68.

10. See: Fisher, A. I. E. E., 1909, page 747.

Clark and Shanklin, A. I. E. E., 1919, page 917.

Capdeville, *Revue Générale de l'Electricité*, 1920, vol. 8, page 177.

Sacchetto, *l'Elettrotecnica*, 1922, page 667.

11. Powell, A. I. E. E., 1916, page 1017.

has been introduced in order that all the formulas may be written directly in terms of the fundamental specific qualities of the insulation and a factor which is purely dimensional.

The writer would like to emphasize here that no possible criticism is offered of Mie's or Russell's formulas, not only because both writers have carefully stated the limitations of their formulas, but also because he is an admirer and constant user of the latter's works in general and of this particular article of the former. His desire has been to show the magnitude of the errors which will occur if the formulas are used outside of the range for which they were intended, and to determine an alternative formula which will apply to the case of the more usual cables.

### Appendix A

#### GEOMETRIC FACTORS OF THREE-CONDUCTOR CABLES FOR OTHER CONNECTIONS

In the body of this article the geometric factor three conductors against the sheath is the only one which has been considered, inasmuch as this is the only one of interest in connection with heat flow. When calculating dielectric losses and capacity, however, it is necessary to know the geometric factor under three-phase voltage, as well as under other connections, and while this has no direct bearing on current-carrying capacity, (except for the calculation of dielectric losses) it is so related to the geometric factor itself that this phase of the matter seems to have a proper place in this appendix. The geometric factor under three-phase voltage will first be discussed and then formulas will be given to obtain the geometric factor for the other connections in terms of the two geometric factors already obtained, all for three-conductor cables only.

#### GEOMETRIC FACTOR UNDER THREE-PHASE VOLTAGE

The usual formula for the geometric factor under three-phase voltage is given by Russell in a form which may be expressed as follows:

$$\log_{\epsilon} F_2 = \log_{\epsilon} \left[ \frac{3 a^2}{r^2} \cdot \frac{(R^2 - a^2)^3}{R^6 - a^6} \right] \quad (17)$$

In order to simplify the constants in the formulas to be given, we will define the *geometric factor under three-phase voltage* as  $(3/2) \log_{\epsilon} F_2$ , symbolized as  $G_2$ . As in the case of Russell's formula No. 1 for the geometric factor three conductors against the sheath, formula (17) was obtained by the method of images, and it has not been possible to graphically correct the errors. This formula is theoretically correct only for the case of small conductors far apart, and it seems worth while to investigate the magnitude of the errors for the case of the usual practical cables.

While no graphical correction has been devised, it is possible to calculate this geometric factor also from the experimental work of Atkinson and Sacchetto. In Fig. 4 are plotted the geometric factors for cables with

equal belt, belt equal to half the conductor insulation thickness, and no belt, as calculated by Russell's formula, and as obtained from Atkinson's data. The three points obtained by Sacchetto within the range of practical cables are also shown by points surrounded by circles.

Fortunately Russell's formula for the geometric factor under three-phase voltage gives values much closer to the experimental values than his formula for the geometric factor three conductors against the sheath, though the per cent error becomes fairly large

for small values of the ratio  $\frac{T+t}{d}$ . As in the case

of his formula for the geometric factor three conductors against the sheath, Russell's curves do not pass through the origin, but they come much closer in this case than in the former. It might be mentioned that one of Atkinson's points seems to be in error, namely his curve for 14 milliamperes, and since a continuous curve could

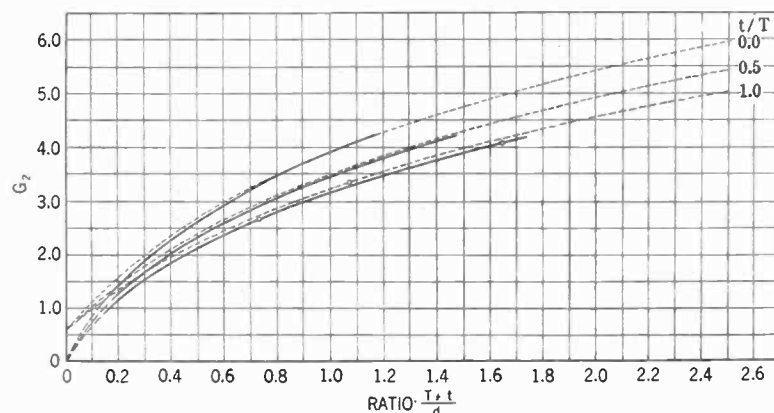

FIG. 4—THE GEOMETRIC FACTOR OF THREE-CONDUCTOR CABLES, UNDER 3-PHASE VOLTAGE

The full lines are from Atkinson's Experimental Data. The broken lines are calculated by Russell's Formula. The three points surrounded by circles are from Sacchetto's Experimental Data. The dot-dash lines are an interpolation between zero and Atkinson's lowest point.

not be drawn including data from this curve, this one value has not been included in the curve shown.

Since Atkinson's experimental data for the geometric factor between three conductors and the sheath has been so closely checked by the geometric method shown in the body of this article, and since his curves approach Russell's curves in the region where they should, it is believed that his data may safely be taken as correct for this geometric factor. Further evidence of Atkinson's correctness is that two of the three points obtained by Sacchetto shown in Fig. 4 fall exactly on his curve, the other point being not far off. Sacchetto's other two points (not shown) are for values of

$\frac{T+t}{d}$  much larger than ever found in practical cables

and where Russell should be accurate; they do not seem to be as close to Russell's values as would be expected.

The best determination of this geometric factor can be obtained by continuing Atkinson's curves to the right and making them asymptotic to Russell's values. If such a series of curves be drawn, it will be found that the geometric factor may be expressed by the following empirical formula:

$$G_2 = 3/2 \log_e F_2 = 2.475 \log_e \{ (0.52 \beta^2 - 1.70 \beta + 3.84) \alpha + 1 \} \quad (18)$$

in which 
$$\alpha = \frac{T + t}{d}$$

and 
$$\beta = t/T$$

For  $\alpha$  from 0.3 to 2.5, the maximum error is - 3 per cent (for  $\alpha = 0.3$  and  $\beta = 1.0$ ). For most cases the error is less than 2 per cent.

GEOMETRIC FACTORS FOR THREE-CONDUCTOR CABLES IN OTHER CONNECTIONS

Knowing  $G_1$  and  $G_2$ , we can express the geometric factors for all other connections in terms of them, using Russell's relationships:

let  $G_1 = \log_e F_1 =$  geometric factor, 3 conductors against sheath (from Table I) and

let  $G_2 = \frac{3 \log_e F_2}{2} =$  geometric factor under three-

phase voltage (from Fig. 4). Then

$$G_3 = \text{geometric factor, No. 1 vs. No. 2} = 2 G_2$$

$$G_4 = \text{geometric factor, No. 1 vs. No. 2 and No. 3} = 1.5 G_2$$

$$G_5 = \text{geometric factor, No. 1 vs. sheath (No. 2 and No. 3 insulated)} = \frac{3 G_1 + 2 G_2}{3}$$

$$G_6 = \text{geometric factor, No. 1 vs. No. 2 and sheath (No. 3 insulated)} = \frac{G_2 (6 G_1 + G_2)}{3 G_1 + 2 G_2}$$

$$G_7 = \text{geometric factor, No. 1 vs. No. 2, No. 3 and sheath} = \frac{9 G_1 G_2}{6 G_1 + G_2}$$

$$G_8 = \text{geometric factor, No. 1 and No. 2 vs. sheath (No. 3 insulated)} = \frac{6 G_1 + G_2}{6}$$

$$G_9 = \text{geometric factor, No. 1 and No. 2 vs. No. 3 and sheath} = \frac{4.5 G_1 G_2}{3 G_1 + 2 G_2}$$

where No. 1, No. 2 and No. 3 represent the three conductors respectively

The following formulas for three-conductor cables

based on the standard formulas, can be written in the terms of the geometric factors.

$$\text{Capacity} = \frac{0.0508 K}{G} \text{ microfarads per 1000 feet} \quad (19)$$

$$\text{Insulation resistance} = 0.330 \rho_1 \times G \times 10^{-6} \text{ megohms per mile} \quad (20)$$

$$\text{Charging current} = \frac{0.319 E \times f \times K}{G} \text{ milliamperes per 1000 feet} \quad (21)$$

$$\text{Dielectric loss} = \frac{0.000958 E^2 \times f \times K \times \cos \varphi}{G_2} \text{ watts per foot} \quad (22)$$

where  $G$  = the geometric factor for the connection used.

$K$  = specific capacity or permittivity of the insulation.

$\rho_1$  = resistivity of the insulation in megohms per centimeter cube.

$E$  = voltage in kilovolts (voltage to neutral if  $G_2$  is used).

$f$  = frequency.

$\cos \varphi$  = power factor of the insulation (for a given voltage, frequency and temperature).

Formulas (19), (20) and (21) can be used for any connection. If for instance, the charging current between one conductor against the other two conductors and the sheath is desired, the value will be obtained by substituting  $G_7$  in equation (21). If the constants under three-phase voltage are sought,  $G_2$  will of course be used, and the capacity and insulation resistance will be to neutral. Ordinarily the dielectric loss is of interest only under three-phase voltage, and this has been indicated by the symbol  $G_2$  in formula (22). The same formula, however, may be used to determine the dielectric loss in other connections, if the constant in formula (22) is divided by 3, and the proper  $G$  is used.

Formulas (19) to (22) may be used for single-conductor cables also, by using  $\log_e R/r$  for  $G$  or  $G_2$ , and dividing the constants in the first three formulas by 3, and by 9 in the case of equation (22). In this case,  $E$  must be the voltage between conductor and sheath, and the dielectric loss will be obtained in watts per foot of cable.

Appendix B

Example 1. What is the allowable current for four three-conductor cables, 4/0 A. w. g. round, insulated with 9/32 inches plus 4/32 inches impregnated paper, 1/8 inch lead for 25,000 volts working pressure?

$$T = 0.281 \text{ inches, } t = 0.125 \text{ inches, } d = 0.528 \text{ inches, } D = 2.85 \text{ inches.}$$

$$\therefore t/T = 0.45, \text{ and } \frac{T + t}{d} = 0.77.$$

From Table I,  $G_1 = 1.76$  [or 1.77 by formulas (7) or (8)]. Now  $T_0 = 85 - 25 = 60$  deg. cent. Assume  $T_c = 20$  deg. cent.  $A = 211,600$  circular mils,  $n = 3$ , and  $N = 4$ . Therefore from formula (14'),

$$R_{th} = \frac{4.44 \times 1.76}{3} + \frac{4.93}{2.85} + 4 = 8.34$$

thermal ohms per foot

By (16)

$$I = 0.281 \sqrt{\frac{211,600(60-20)}{3 \times 8.34}} = 164$$

amperes per conductor

*Example 2.* A duct bank contains four three-conductor cables, 1/0 A. w. g. round, insulated with 9/32 inches plus 9/32 inches impregnated paper, 9/64 inches lead, for 25,000 volts working pressure, and five two-conductor cables (round duplex) 500,000 circular mils round, insulated with 3/32 inches plus 3/32 inches impregnated paper, 9/64 inches lead, for 4000 volts working pressure. What are the allowable currents?

We will call the first cables Type No. 1, and the latter Type No. 2. The earth temperature will be taken as 20 deg. cent. The following are the constants,  $T_0$  being equal to 85 minus the working pressure:

	No. 1	No. 2
$\frac{T+t}{d}$	1.51	0.23
$t/T$	1.00	1.00
$G_1$	2.43	0.81
$n$	3	2
$N$	4	5
$D$	2.86	2.48
$T_0$	60	81
$A$	105,500	500,000

The thermal resistances for the two types separately are 9.33 and 8.79 thermal ohms per foot by (14').

Let  $W_1$  and  $W_2$  be the allowable watt losses per foot, and  $I_1$  and  $I_2$  the allowable currents.

$$\text{Then } \begin{cases} 9.33 W_1 + 5 W_2 = 60 - 20 = 40 \\ 4 W_1 + 8.79 W_2 = 81 - 20 = 61 \end{cases}$$

$$\text{Solving } \begin{cases} W_1 = 0.75 \\ W_2 = 6.60 \end{cases}$$

$$\text{But } \begin{cases} W_1 = 3 I_1^2 r_1 \\ W_2 = 2 I_2^2 r_2 \end{cases}$$

the numerical coefficients at the end being necessary to include the number of conductors in the cable, if  $r$  is the resistance per foot of conductor.  $r_1$  and  $r_2$  may be calculated from resistance tables and are 0.000118 and 0.0000267 ohms per foot respectively at the operating temperatures, including increases of 2 per cent for stranding and 2 per cent for cabling.

Therefore

$$I_1 = 46.1, \text{ and } I_2 = 352 \text{ amperes per conductor.}$$

*Example 3.* What is the dielectric loss in a three-conductor cable, 350,000 circular mils sector, insulated with 19/64 inches plus 7/64 inches paper, 9/64 lead for

33,000 volts working pressure, 60 cycles, assuming a permittivity of 3.3 and a power factor at operating temperature of 0.015?

$T = 0.297$  inches,  $t = 0.109$ ,  $d = 0.681$ ,  $t/T = 0.37$ ,  $(T+t)/d = 0.597$ . From Fig. 4,  $G_2 = 2.63$  [or 2.68 by formula (18)]. Diminishing the latter by 10 per cent, because the conductors are sector-shaped  $G_2 = 2.37$ . By formula (22),

$$\text{Dielectric loss} = \frac{0.000958 \times (33/\sqrt{3})^2 \times 60 \times 3.3 \times 0.015}{2.37}$$

$$= 0.43 \text{ watts per foot.}$$

*Example 4.* As a final example, the case of a current-carrying problem including dielectric loss and sheath loss will be given. Find the kv-a. carrying capacity of a line composed of four single-conductor cables (one being a spare) to operate at 110,000 volts, three-phase with the neutral grounded, the frequency being 60 cycles. The conductors are 400,000 circular mils, insulated with 40/32 inches impregnated paper, 5/32 inches lead. The cables are arranged in the vertices of an equilateral prism, the distance between centers of cables being 6 inches, and they are bonded at both ends at least. It will be assumed that  $k = 3.3$  and that the power factor of the insulation is 0.015 at the operating temperature.  $T = 1.25$  inches,  $d = 0.728$  inches, and the outside diameter of the cable,  $D = 3.54$  inches. The geometric factor,  $\log_e R/r$ , therefore equals 1.49. There are three loaded cables in the duct, and therefore  $N = 3$ , and of course  $n = 1$ . The allowable temperature will be taken as 50 deg. cent., and the earth temperature as 20.

By formula (22), the dielectric loss is 0.86 watts per foot of cable, remembering that for single-conductor cables, the constant of that formula must be divided by 9. The total thermal resistance for dielectric loss, conductor to base, by (14') equals 7.7 thermal ohms per foot, the first term in (14') being divided by 2, as stated in the text, for single-conductor cables. The temperature rise due to dielectric loss is therefore  $7.7 \times 0.86 = 6.6$  degrees.

The additional effective resistance due to induced sheath currents is (by Clark and Shanklin's formula) equal to 0.0108 ohms per 1000 feet, figuring the lead resistance at 30 deg.; the conductor resistance itself calculated at 50 deg. and increased 2 per cent for stranding is equal to 0.0295 ohms per 1000 feet. The ratio of total effective resistance to conductor resistance is therefore 1.37.

Formula (14') may now be applied as follows:  $R_{th} = 4.44 \times 1.49 + 1.37 \times 4.93/3.54 + 1.37 \times 3 = 12.6$  thermal ohms per foot. Therefore from (16),

$$I = 0.281 \sqrt{\frac{400,000(50-20-6.6)}{1 \times 12.6}} = 242$$

amperes per cable.



The kv-a. carrying capacity of the group is therefore 46, 100 kv-a.

### Appendix C

In the text, it was mentioned that formula (11) may be used for calculation of the thermal resistivity of a cable, if the temperature rise between the conductors and sheath be measured for a known  $I^2 r$  loss in the conductors, and it was stated that it was especially important to use the correct geometric factor in such a determination. An illustration of the errors introduced by the use of the incorrect geometric factor in such a measurement may be of interest.

In Table III of the Research on the Heating of Buried Cables<sup>12</sup> is given a tabulation of the calculated values of the thermal resistivity of paper insulated cables, single-conductor, concentric multiconductor, and cabled multi-conductor in type. The average values of thermal resistivity obtained were 1000, 950 and 600 respectively for the three types of cable. The first two were calculated by accurate formulas. For the case of the cabled multiconductor cables, the resistivity was calculated by means of Russell's formula No. 1 for round conductors, and by his formula (9) for the sector. The difference between the results is striking, and of course part of the discrepancy can be explained as due to the use of Russell's formulas as will be shown, though there will still remain a considerable difference.

Due to the limits of space, we will not show all the details of our calculations, but it may suffice to say that the correct geometric factors were obtained by the data in this article, decreasing the value by 10 per cent for sector cables as stated in the text, and using the full graphical correction for the case of the two six-conductor cables. A corrected value of thermal resistivity was then obtained by multiplying the given values by the ratio of the geometric factor by Russell's formula to its correct value.

The average value of thermal resistivity of the multi-conductor cables as published in the research was 600. If the values are corrected, the average is 720 or 20 per cent higher than the average published value. It might be added that the minimum error was - 6 per cent, and that in the case of cables No. 11 and No. 27, the errors were - 28 per cent and - 26 per cent respectively.

### AN ELECTRICALLY DRIVEN SHIP

Sea trials of the Standard Oil Company's first Diesel electric driven tanker "Standard Service" were completed off San Francisco April 2 and have been pronounced eminently successful by both the builders and the owners.

The normal speed of the propeller is 130 rev. per min. but during the builder's trial it was operated at about 145, and the load was less than 1000 amperes, whereas full-load rating on the motors is 1065 amperes.

During the owners trial the craft was well loaded and the full-load current was approximately 1000 amperes with the propeller turning at 145 rev. per min.

Readings taken on four different occasions when the control was thrown from full speed ahead to full speed astern showed that at no time did the load go above 1000 amperes. The change from full speed ahead to reverse took from ten to twelve seconds. During the reversal, all vibration was eliminated and unless one were observing the instruments he would have no indication of what was taking place on the propelling equipment. One of the directors of the Standard Oil Company who was steering the boat with one hand and operating the controller with the other was asked to throw the controller from full speed ahead to full speed astern and was amazed at both the simplicity and the perfect control.

Principal dimensions of the "Standard Service" are:

Loaded displacement.....	2,725 tons
Deadweight.....	1,875 tons
Cargo-tank capacity.....	12,400 bbls.
Cargo-hold capacity.....	225 tons
Fuel-tank capacity.....	585 bbls.
Length.....	210' 0"
Beam moulded.....	40' 0"
Depth.....	16' 6"
Block coefficient.....	0.76
Mean loading draft.....	15' 0"
Propelling motor power.....	600 b. h. p.
Estimated speed, loaded.....	9 knots
Fuel consumption, running.....	(24.5 bbls. per 24 hrs.)
Cruising radius.....	24 days
Fuel consumption, pumping out.....	15 gals. per hr.
Pumping-out time.....	6 hrs.

The tanker is driven by propelling units consisting of two General Electric 300-h. p. motors mounted on the same base and with a common shaft and driving a single propeller. Current is supplied by two G-E 245 kw., d-c. generators with a 30-kw., exciter connected to each, each generator and exciter being direct connected to a 400 b. p. h., six-cylinder four-cycle Pacific-Werkspoor Diesel engine.

The main control equipment consists of a control panel in the engine room on which are installed the various switches, field rheostats, instruments, contactors and relays; a panel in the pilot house carrying instruments for indicating propeller speed, line amperes and motor field amperes; a controlling rheostat for varying and reversing the shunt field current of the two generators; and a propeller speed magneto connected electrically to the speed indicators on the panels.

As the same generating sets which supply the motive power of the craft furnish power also for the cargo pump motors for discharging the cargo, no auxiliary plant is needed. The equipment is capable of discharging the entire cargo in about six hours. Sets of lubricating oil, cooling water, bilge and other pumps are driven by each engine. A storage battery and a small auxiliary generating set is furnished for supplying light when the boat is not in operation.

12. JOURNAL of A. I. E. E., 1921, vol. 59, page 181.

# The Production of Porcelain for Electrical Insulation—II.

BY FRANK H. RIDDLE

Associate, A. I. E. E.  
Champion Porcelain Company  
Jeffery-Dewitt Insulator Company

**Review of the Subject.**—This article deals with ceramic raw materials, chiefly clays, quartz and feldspar.

**CLAYS.** The physical properties of clays are of interest. Plasticity is one of the principal properties of clays. The cause of plasticity is probably to be sought in the dispersed nature of the fine clay particles which have the properties of a suspension colloid. Small amounts of alkalis, when added to clay suspensions, cause a marked increase in fluidity. In other words a mass of plastic clay, by adding these alkalis, can actually be converted into a fluid capable of being poured into molds. This application is of great importance commercially since it enables us to form clay articles of a very homogeneous structure without the use of excessive amounts of water and without the high drying shrinkage which would accompany the use of much water.

The reactions which take place in firing clay are described. Firing ranges of clays can be determined by the drop in porosity and increase in shrinkage as the firing temperature increases. Continued firing of a clay after it has vitrified produces softening of the mass and produces internal changes including the formation of sillimanite ( $Al_2O_3$ ,  $SiO_2$ ) crystals. Continued firing releases gases which produce a porous or vesicular structure known as

overfiring. The longer the firing range of a clay the better it is suited for commercial purposes.

**QUARTZ.** Ground quartz which is practically pure silica, ( $SiO_2$ ) in porcelain, serves as a refractory skeleton which increases the stiffness of the mass during firing. Quartz undergoes molecular changes at different temperatures. There are eight forms. Each change is accompanied by a definite volume change. The specific volume starting with the lowest form, increases continuously and abruptly at the inversion points until a final total increase in volume of about 20 per cent is reached when the quartz is fused.

**FELDSPARS.** Used for porcelain contain potash and soda as their fluxing elements. They fuse to glasses at about 1230 deg. cent. (2246 deg. fahr.) Their chemical compositions approximate  $Na KO Al_2 O_3 6Si O_2$ . They are used as glass forming fluxes in porcelain to cement and unite the other ingredients.

Other minerals are also used:—

1. Those which replace feldspar such as alkaline earths.
2. Those which replace quartz and which are preferably constant in volume such as sillimanite, zircon, etc.

Porcelains are now being used in which natural and synthetic sillimanite replace quartz, and alkaline earths replace alkalis.

## PHYSICAL PROPERTIES OF CLAYS

THE most outstanding quality of clay is its plasticity, that is, the ability to be molded and to change its shape under pressure without breaking. It is found that clay when forced from a cylinder through an orifice requires a definite pressure before flow is started. It has been attempted to employ the value of this initial pressure applied under standardized conditions as a means of estimating plasticity, since materials vary greatly in this respect. This probably is the most promising method chosen from many others, most of which are faulty or are only indirect. Of all the physical properties of materials, plasticity is one of the most difficult to define and to measure.

The cause of plasticity is probably to be sought in the dispersed nature of the fine clay particles, which have the properties of a suspension colloid.<sup>1,2</sup> This view is plausible because many phenomena observed on clays are those exhibited by colloidal substances. Among these may be noted the power of clay to absorb salts both organic and inorganic from their solutions, the hygroscopic nature of dried clay, the migration of

1. Colloids are dispersed systems of very finely divided particles; the diameter of the particles in typical cases lies between one ten-thousandth and one one-millionth of a millimeter. These particles pass through filters readily, cannot be seen through the microscope and show the Tyndall cone effect; solutions of electrolytes either disperse or coagulate them. There is no reason why every substance may not be produced in the colloidal state. Colloidal silver may be produced by arcing fine silver wires under water.

2. A colloidal system of solid dispersed in liquid is a suspension colloid system; one of liquid in liquid, emulsoid.

the particles in a dilute suspension to the positive electrode and the profound effect of small quantities of electrolytes<sup>3</sup> upon the fluidity<sup>4</sup> of a clay-water system. These properties may be illustrated by the absorption of dyes like malachite green, which has been suggested by Ashley<sup>5</sup> as a means of estimating plasticity, by the power of dried clays of removing water from sulphuric acid solutions, by the Schwerin process in which clay is removed electrically from suspension and deposited on a revolving metallic electrode and by the fact that heavy, thick suspensions may be instantly made very fluid through the addition of a minute amount of alkali. The phenomenon last mentioned embraces also the action of acids and salts upon clay suspensions according to which these may be thickened by such additions. We have then the fact that alkalis cause a marked increase in fluidity of a clay suspension while acids and salts bring about a thickening. These phases correspond to the deflocculation and coagulation<sup>6</sup> of

3. An electrolyte is a compound which in water solution dissociates into positively and negatively charged molecules termed ions.

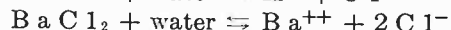

Such a solution conducts electricity. Nearly all salts, strong acids and bases are electrolytes.

4. Fluidity is the measure of the tendency of substances to flow; viscosity the measure of the resistance to flow.

5. United States Geological Survey, Bulletin No. 388.

6. Clay held in suspension by alkali in a fine grained and jellylike mass is in the state of deflocculation; acids and salts operate to collect (coagulate) the clay into larger masses. These settle leaving a clear supernatant solution; the clay is in the state of flocculation.

colloidal systems and it is interesting to note in this connection that the coagulating or deflocculating effect depends upon the nature and valency<sup>7</sup> of the electrolyte. These facts are made use of industrially, especially in the casting process where a heavy suspension of a density as high as 1.8 can be produced with a water content not appreciably greater than that of the plastic mass through the addition of a small amount of sodium silicate and sodium carbonate. In other words a mass of plastic clay, by adding these alkalis, can actually be converted into a fluid capable of being poured into molds. This application is of great importance commercially since it enables us to form clay articles of a very homogeneous structure without the use of an excessive amount of water and without the high drying shrinkage which would accompany the use of much water. What actually happens is not known with certainty but the prompt and effective action of the alkalis suggests a direct chemical combination. In casting we produce the deflocculated state in which the clay sets free part of the water which it must have held in something like solid solution or absorption. Anything that interferes with the deflocculation, like the presence of acids or salts prevents the proper application of the casting process.

EFFECT OF HEAT

Upon heating clay to 110 deg. cent. (230 deg. fahr.) its hygroscopic water is driven off. At higher temperatures above 500 deg. cent. (932 deg. fahr.) it loses its chemical water and the molecule is broken up in an endothermic process which absorbs about 10.8 calories per gram molecule or 258 grams of clay. This brings about a profound change which is indicated by the expansion of the mass shown by the drop in density and the loss of plasticity. At this point clay shows its greatest porosity since there is left not only the volume left vacant by the pore water but also the pore space due to the water of combination. Mechanically the mass is weak and friable<sup>8</sup>. As the temperature rises above 800 deg. cent. (1472 deg. fahr.) an exothermic change occurs which by some is thought to be due to polymerization and by others to the formation of sillimanite. At still higher temperatures the clay begins to contract in exterior volume and the porosity decreases. The point at which this action begins and the rate at which it continues vary with the

nature of the clay. In pure clays this temperature is higher than it is for the more impure ones and the rate of porosity drop is much slower. The greater the amount of fluxes, such as the alkalis, lime, magnesia and iron oxide, the more rapid are the progress of shrinkage and decrease in porosity. The cause of the contraction is to be sought in the incipient fusion of the fluxing constituents which progresses as the temperature rises. These fluxes dissolve more clay and quartz and consequently the amount of material which softens becomes greater and greater. The result must be that the rigidity or viscosity of the system is decreased and with it the resistance to the surface tension which acts inward from the surfaces of the clay tending to contract it. This powerful tension at a sufficiently high temperature finally closes the entire pore system and we say then that the clay is vitrified.

The drop in porosity and the increasing shrinkage, coordinated with the rising temperature, are often shown graphically and such a diagram expresses the rate of vitrification. In this manner the course of the vitrification process in its various stages is shown clearly and from the graph we can predict with certainty the heat behavior of the clay. The slope of the curve or its tangent,  $dy/dx$ , then expresses the rate of porosity drop, characteristic of the material in question. The shrinkage curve is the converse of the porosity graph, it rises as the latter drops. Such a diagram is shown in Fig. 4. In this manner it is quite easy to differentiate

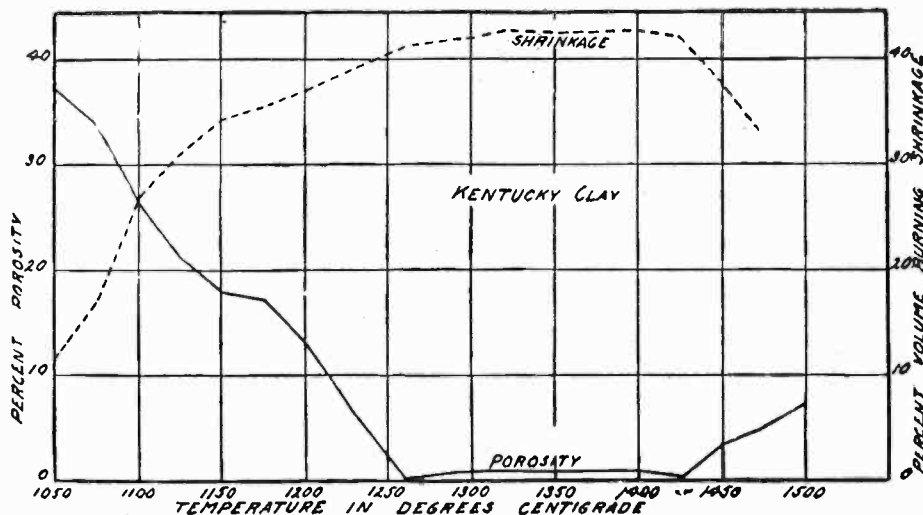

Fig. 4

Diagram showing the volume and porosity changes developed in a clay upon firing. The maturing range of a clay is determined by the temperature range at which it remains at constant volume with the minimum porosity.

7. Valency is expressed by the number of charges the ion carries.

- K<sup>+</sup> — valency is one
- Ba<sup>++</sup> — valency is two
- Al<sup>+++</sup> — valency is three

8. *Electrical Porcelain*, E. E. F. Creighton, A. I. E. E. TRANS. Feb. 1915.

a slowly vitrifying, refractory clay from one which is higher in fluxes and shows a rapid drop in porosity.

After a clay has vitrified and the temperature continues to rise, softening of the mass becomes more and more marked and internal changes in structure appear. It has been found that the clay substance crystallizes at the higher temperature and is decomposed according to the reaction.



The crystalline material produced is sillimanite of the composition  $Al_2O_3 \cdot SiO_2$  which usually appears as needle-like crystals. This material, of course, may exist in the amorphous or the crypto-crystalline form long before the visible crystals are developed. At some stage of the high temperature treatment many clays release gases previously held in the absorbed or dissolved condition and such oxides as those of iron are decomposed yielding oxygen. These gases produce a porous structure very similar to the rising of bread dough, which causes a decided loss in the strength of the material. Clays in this state are said to be overfired.

The more readily they are subject to the formation of the vesicular structure the less suited they are for

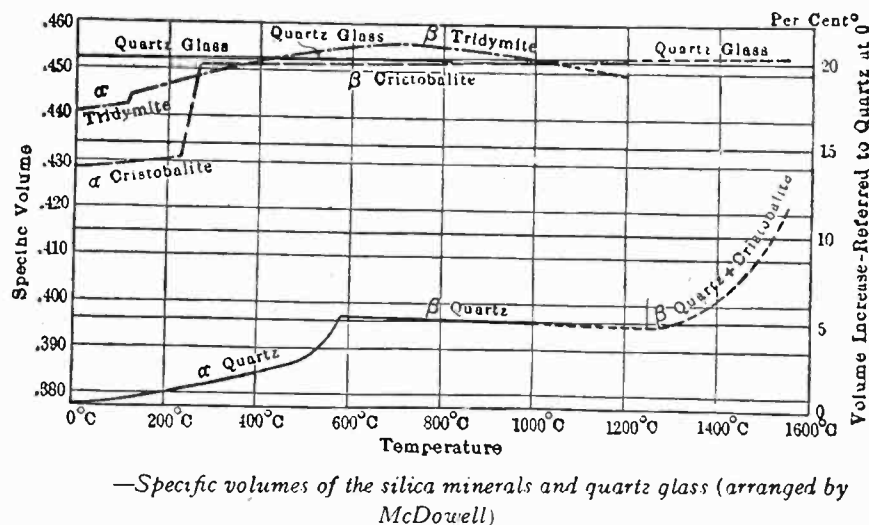

FIG. 5

Specific volumes of the silica minerals and quartz glass. It is evident that porcelain, which has a fairly low and constant volume change must undergo some severe internal strains upon heating and cooling on account of the high content of quartz which follows the volume changes shown above.

commercial utilization. This increase in porosity is plainly shown in the porosity-temperature graph. Certain clays are so prone to produce this structure that they give rise to it even before they are fully vitrified. Such materials are usually of but little industrial value.

Finally, if the temperature is raised high enough the clay gradually fuses until it has melted into a pool of a slaglike mass. Clays have no definite melting point but progress more or less slowly towards the stage of fusion. The final temperature at which complete deformation has taken place varies widely according to the nature and composition of the materials. Pure kaolins melt at the fusion temperature of platinum, 1755 deg. cent. (3191 deg. fahr.) *i. e.*, white heat.

In the study of the effect of heat on clays and in industrial practise temperature measurement becomes a very important factor. This is accomplished either with the use of platinum, platinum rhodium thermo-couples and indicating instruments, or the use of the Seger cones, small tetrahedra made of mixtures of kaolin, feldspar, calcium carbonate and quartz

which deform by bending at fairly definite temperatures and thus give evidence that a certain point has been reached. The interval between the cone numbers is about 20 deg. cent. (36 deg. fahr.). While these pyrosopes do not indicate the temperatures with accuracy they do show the effect of heat work, that is, the joint effect of temperature and time, which is often more useful than the indication of temperature alone. In all ceramic work the influence of the time of heat treatment is exceedingly important since the same result may be accomplished, within limits, by increasing the temperature more slowly to a lower point as by raising it faster to a higher point.

#### QUARTZ

The function of ground quartz in porcelain is to serve

as a refractory skeleton which increases the stiffness of the mass during the firing process and thus prevent excessive deformation. The mineral is, of course, non-plastic. Its composition is nearly 100 per cent of silica. Quartz possesses the peculiar property of undergoing molecular changes at different temperatures, evidenced by changes in the character of crystallization and in density. Some of these inversions are rapidly and others sluggishly reversible. Alpha quartz is taken to be the stable form at ordinary temperatures which at 575 deg. cent. (1067 deg. fahr.), *i. e.*, low red heat, inverts to the beta quartz. Upon cooling the beta quartz reverses rapidly to alpha quartz. At about 1470 deg. cent. (2678 deg. fahr.) beta quartz undergoes another inversion and becomes beta cristobalite. This crystalline form likewise has an alpha modification whose inversion tem-

perature is about 230 deg. cent. (446 deg. fahr.). Theoretically the beta quartz should invert to still another form of crystalline silica at 870 deg. cent. (1598 deg. fahr.) namely,  $\beta_2$  tridymite, but practically owing to the sluggish transformation beta cristobalite results at 1470 deg. cent. (2678 deg. fahr.). But on long continued heating very silicious compositions like silica brick do finally become largely tridymite. There are three forms of the latter, alpha,  $\beta_1$  and  $\beta_2$  tridymite. Finally, at very high temperatures the silica fuses and we have what is known as quartz glass. We might say then that there are eight forms of silica, namely, alpha and beta quartz, alpha and beta cristobalite, the three modifications of tridymite and glass. The specific volume, starting with alpha quartz, increases continuously and abruptly at the inversion points until we finally observe a total increase in volume of about 20 per cent. These changes are shown in the diagram of McDowell,<sup>9</sup> Fig. 5.

Quartz occurs in nature in various forms, in the form of massive crystals, as quartz schists, sand-stones, sand and quartzite. There are also crypto-crystalline forms

9. American Institute of Mining Engineers, Bulletin 119.

such as flint, chert and chalcedony. These differ widely as regards their rates of inversion. There should be mentioned also the forms of silica which represent the residue of marine organisms, such as tripoli, randannite and kieselguhr and finally, the colloidal forms of silica, like opal, hyalite, geyserite, etc. In these materials we have represented a series of minerals and rocks from those in which the crystalline character is well developed to materials which are crypto-crystalline or entirely amorphous. The source of the free silica introduced in the body is hence a matter of considerable importance since both its solution by feldspar and its rate of inversion are dependent upon the original structure.

#### FELDSPAR

The feldspathic minerals with which we are concerned are the potash and soda feldspars, orthoclase, microcline and albite. The first two are crystalline modifications of the same composition,  $K_2O \cdot Al_2O_3 \cdot 6SiO_2$ , while the last corresponds to the formula  $Na_2O \cdot Al_2O_3 \cdot 6SiO_2$ . Owing to their alkali content the feldspars are comparatively fusible minerals, the deformation or softening point being approximately 1230 deg. cent. (2246 deg. fahr.) for the potash and 1200 deg. cent. (2192 deg. fahr.) for the soda feldspar. These minerals cannot be said to have definite melting points but change gradually from the crystalline to the isotropic state. They sluggishly form a viscous glass which may be transparent as in the case of the pure potash feldspar or more often white and opaque. It is evident that the molecular friction of the fusing mass is very high. There is a distinct difference between the orthoclase and the albite with reference to their viscosities in the fused state. The latter attains a much greater fluidity and it also appears that there might be a viscosity minimum somewhere near the eutectic between potash and soda feldspar. The gradual fusion of the feldspar and its high viscosity are desirable properties inasmuch as this permits the firing of a porcelain body to gradual vitrification without having to fear undue deformation of the mass under the heat treatment.

Like most silicates fused feldspar shows an increase in molecular volume over its volume in the crystalline state. It likewise shows in the molten state electrolytic conductivity. Its power to dissolve silica and silicates when fused has already been referred to.

In nature neither of the feldspars occurs in the pure state but practically all potash spars contain soda and the soda minerals potash. For the purposes of porcelain making the potash feldspars are preferred since they possess a higher viscosity at the kiln temperatures than the soda mineral and it is believed result also in porcelains of higher mechanical strength, although this point has not as yet been proved conclusively. It has been observed that porcelains made with soda feldspar give, when struck, a duller sound than when potash feldspar is used.

Summarizing, we may say then that feldspar is used

as a glass forming flux, the purpose of which is first to unite and cement the more refractory constituents and finally, to start to dissolve and take them into solution or combine with them.

#### MISCELLANEOUS MATERIALS

Besides the raw materials already mentioned there may be used two types of constituents: First, substances which are fluxes and hence replace the feldspar, and second, components which are substituted for the quartz.

Among the former there may be mentioned the alkaline earths represented by calcium carbonate, magnesite, dolomite and barium carbonate. Occasionally these constituents are not introduced in the form of the carbonates but may be previously calcined with kaolin and quartz to form synthetic silicates, approaching somewhat the structure of the feldspars but without their alkali content. The use of such artificial fluxes is especially desirable for electrical porcelains subjected in use to higher temperatures, where the electrolytic conductivity of the feldspar would be objectionable.<sup>10</sup>

The replacement of quartz may likewise be desirable on account of the several crystalline transformations and volume changes which it undergoes and which will always impair the development of the greatest possible strength and resistance to thermal shock. It is obvious that the replacing substances should be free from the crystalline inversions of quartz and should be as constant in volume as possible. A number of materials is available for this purpose of which there may be mentioned sintered or fused alumina, natural or artificial sillimanite, zircon, zirconium oxide, etc. When previously calcined or fused to constant volume these substances are practically free from crystalline inversions and porcelains made from them should likewise be practically volume constant and should possess a steady coefficient of thermal expansion. Porcelains are now being produced in which synthetic and natural sillimanite replaces quartz and to some extent the mineral zircon,  $ZrO_2 \cdot SiO_2$ , has been applied successfully for the same purpose. Synthetic sillimanite is produced by the calcination to a high temperature of a mixture of 258 parts by weight of kaolin and 102 parts of anhydrous alumina. This product shows no heat effect, has a density of about 3.00 and yields little or no solid solution. The natural sources of sillimanite are andalusite, cyanite and sillimanite. The mineral zircon is used in its natural state.

#### TESTS OF WELDED RAIL JOINTS

Two welded 7-in. rail joints were recently tested for the Welded Rail Joint Committee of the American Electric Railway Association and the American Bureau of Welding. One of the joints, a thermit weld, failed at an ultimate load of 600,000 lbs. The other joint, of the welded fish plate type, failed at about 200,000 lbs. Transverse tests were also made on similar welds.

10. *Journal American Ceramic Society*, Vol. 2, No. 7, 1919.

## ILLUMINATION ITEMS

By the Lighting and Illumination Committee

### RELATIVE PERFORMANCE OF TUNGSTEN FILAMENT LAMPS UNDER TEST UPON ALTERNATING AND DIRECT-CURRENT CIRCUITS

Drawn wire tantalum filament lamps suffered from crystallization and offsetting so seriously as to restrict their use very generally to direct-current circuits, where these effects were not so pronounced. Drawn wire tungsten filament lamps suffer from similar effects of alternating-current operation, although the manufacturers of Mazda lamps have succeeded in treating the filament in such a manner as to diminish the difficulty to a point where it is of academic rather than practical interest.

Tests of sample lamps chosen at random from various Mazda lamp products have been made upon both alternating and direct current at Electrical Testing Laboratories for the Lamp Committee of the Association of Edison Illuminating Companies in recent years, with results which are recorded in this paper in the form of relative performances at efficiencies adjusted to correspond with an average life of 1000 hours for lamps

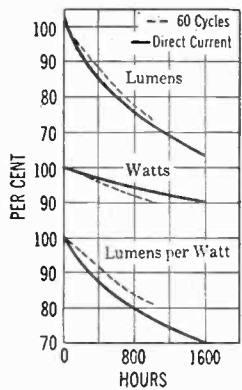

FIG. 1

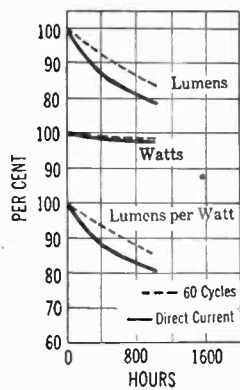

FIG. 2

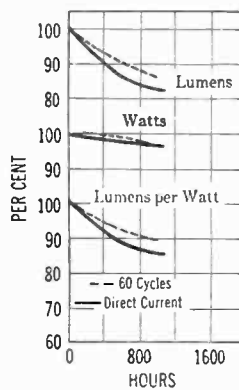

FIG. 3

PERFORMANCE THROUGHOUT LIFE AT INITIAL EFFICIENCIES TO YIELD 1000 HRS. TOTAL LIFE UPON 60-CYCLE CURRENT.  
 FIG. 1—50 WATT TUNGSTEN FILAMENT VACUUM LAMPS  
 FIG. 2—75 WATT TUNGSTEN FILAMENT GAS FILLED LAMP  
 FIG. 3—100 WATT TUNGSTEN FILAMENT GAS FILLED LAMPS

operated in the laboratory upon 60-cycle current. In general these show that the life of 50-watt Mazda B lamps is about 60 per cent longer on direct current than on alternating current for the same initial lamp efficiencies, but that when operated upon direct current, the lamps maintain their efficiencies less well, the mean throughout life being about 9 per cent lower on direct current. Thus in use upon direct current the lamp life is longer, but the efficiency is lower and the customer gets about the same service value whether the lamps are operated upon direct or alternating current.

Among gas filled or Mazda C lamps of the 75 and 100-watt sizes, it has been found that the life is but slightly longer upon direct than upon alternating current, when the lamps are operated at the same initial efficiencies and the mean efficiency throughout life, while longer upon direct current, is not so much lower, as in the case

of the vacuum type lamps. The following summary of average relative lamp life and efficiency values contains the gist of the test results:

### RELATIVE PERFORMANCE OF MAZDA LAMPS UPON DIRECT AND ALTERNATING CURRENT

	60-Cycle Alternating Current	Direct Current
50-watt Mazda B Lamps		
Average hours total life.....	1000	1600
Relative mean lumens per watt throughout life in per cent of that at initial.....	100 per cent	91 per cent
75-watt Mazda C Lamps		
Average hours total life.....	1000	1043
Relative mean lumens per watt throughout life in per cent of that at initial.....	100 per cent	97 per cent
100-watt Mazda C Lamps		
Average hours total life.....	1000	1108
Relative mean lumens per watt throughout life in per cent of that at initial.....	100 per cent	95 per cent

The average performance characteristics of these Mazda lamps are presented in Figs. 1, 2, and 3, while curves showing per cent survivals throughout life for

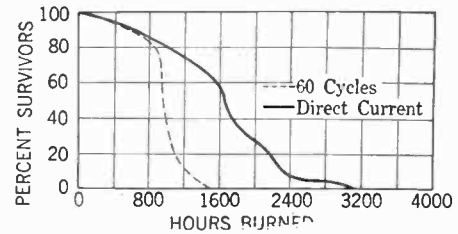

FIG. 4—SURVIVORS THROUGHOUT LIFE OF A GROUP OF 50 WATT TUNGSTEN FILAMENT VACUUM LAMPS

the 50-watt vacuum type lamps and for the 100-watt gas filled lamps appear in Figs. 4 and 5 respectively.

In conclusions it should be said that these data do not show commercial life values but are rather laboratory data corrected to the initial efficiency necessary to provide a performance of 1000 hours life upon 60-cycle

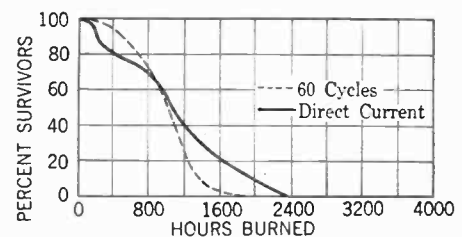

FIG. 5—SURVIVORS THROUGHOUT LIFE OF A GROUP OF 100 WATT TUNGSTEN FILAMENT GAS FILLED LAMPS.

current. Mazda lamps give service of substantially equal satisfaction upon either direct or alternating-current circuits.

In the testing of incandescent electric lamps it is important to secure performance data under various conditions, including those upon both direct and alternating current, where the difference has been found to be of an order which is of interest to lamp engineers rather than to the public.

### EFFECT OF LIGHT ON THE DRAWING POWER OF THE SHOW WINDOW

The practise of providing illumination in show windows during the evening hours has long been accepted by merchants as a successful method of promoting sales. However, in the past, there have been few data available which showed the magnitude of the drawing power of different levels of illumination. An investigation was therefore made to provide facts from which the actual value of poorly or brightly illuminated windows could be determined with a reasonable degree of accuracy. The results of this investigation are given in a paper "Effect of Light on the Drawing Power of the Show Window" by Walter Sturrock and J. M. Shute, presented at the annual convention of the Illuminating Engineering Society, September 1922, together with a detailed account of the method of carrying on the investigation and typical log sheets of individual tests.

In conducting such an investigation, many details had to be considered, such as the location of the store, the weather, the hour of the evening, etc. The authors of

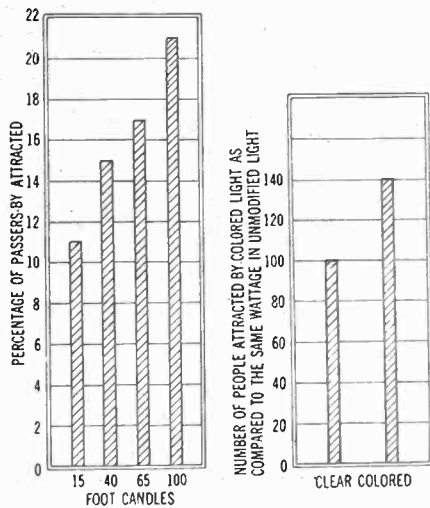

FIG. 1

FIG. 1—WITH AN INTENSITY OF 15-FT. CANDLES, 11 PER CENT OF THE TOTAL NUMBER OF PASSERS-BY WERE ATTRACTED, WITH AN INTENSITY OF 40 FT. CANDLES 15 PER CENT STOPPED, UP TO 100 FT. CANDLES 21 PER CENT STOPPED.

FIG. 2—WITH A HIGH INTENSITY IT WAS FOUND THAT BY USING COLOR CAPS WITH NO INCREASE IN WATTAGE 40 PER CENT MORE PASSERS-BY STOPPED TO EXAMINE THE DISPLAY.

the paper, having had considerable experience in carrying on such investigations, took every precaution to eliminate the effect of extraneous factors so that their final results indicate the true drawing power of light alone. Representative stores similar in character in Cleveland, Ohio and Newark, N. J., were used in the investigations. The levels of illumination were varied from 15 foot-candles to 100 foot-candles while the necessary data were obtained. Another series of tests was conducted to determine the effect of colored light on the drawing power of the show window.

Complete results of the entire investigation are shown in the accompanying charts. Chart No. 1 shows the actual percentage of total passersby attracted by the different intensities above 15 foot-candles. Chart No. 2

shows the comparative drawing power of colored light over clear unmodified light from an equal wattage.

In view of the widespread use of show window lighting, this series of 106 tests on unmodified light and 36 tests on colored light though quite extensive, constitute a relatively small sample under certain metropolitan conditions. Except for the remarkable consistency of the results obtained by two different corps, at considerable distances apart, the drawing of definite conclusions might be unwarranted. However, under the limitations of the investigation it was clearly evident that:

1. As compared to 15 foot-candles, the drawing power of these windows was increased greatly by the use of higher intensities.

2. At the same wattage the use of colored light noticeably increased the drawing power above that obtained from clear unmodified light.

These experiences lead naturally to the more general conclusion that in any class of show window lighting more of the people on the street can be made to look at the display by increasing the intensity of the light or through the use of color or spotlight effects.

### PROPER USE OF MILL-TYPE LAMPS

Mazda B mill-type lamps, available in the 25 and 50-watt size in the 115-volt class, and in the 50-watt size in the 230-volt class, are designed to fill the need for a lamp which will operate satisfactorily where the service is too severe for Mazda lamps of the regular construction. To those classes of service where severe vibration is encountered are the mill-type lamps particularly adapted.

Because the durability of mill-type lamps is obtained by a form of construction which entails a small, but appreciable, sacrifice in lamp efficiency, mill-type lamps should not be recommended, first, where Mazda B lamps of the regular construction will give satisfactory service, or, second, where the user can be induced to install a general lighting system which will obviate the need for the smaller local light sources. However, there is a vast number of carbon lamps in make-shift devices used in industrial plants throughout the country where Mazda mill-type lamps in proper reflectors will better the lighting conditions tremendously.

One of the commonest of these make-shift lighting units is a 32-candle-power 100-watt carbon lamp in a flat tin-cone shade. If energy costs four cents per kilowatt hour, this unit costs \$4.00 to operate for 1000 hours even if the lamp costs nothing. A 50-watt, 115-volt Mazda mill-type lamp will cost \$2.40 to operate for the same length of time if the lamp is bought at list price. If the mill-type lamp is equipped with a standard deep bowl reflector and a 1 3/8-in. socket extension plug is used to bring the filament to the proper position in the reflector, the mill-type lamp will furnish twice as much illumination as the carbon lamp unit at the work. Furthermore, glare, with its attending accident hazards, will be greatly minimized.

# JOURNAL OF THE American Institute of Electrical Engineers

**PUBLISHED MONTHLY BY THE A. I. E. E.**

33 West 39th Street, New York

Under the Direction of the Publication Committee

FRANK B. JEWETT, *President*

GEORGE A. HAMILTON, *Treasurer* F. L. HUTCHINSON, *Secretary*

**PUBLICATION COMMITTEE**

DONALD McNICOL, *Chairman*

E. E. F. CREIGHTON

WM. McCLELLAN

F. L. HUTCHINSON

L. F. MOREHOUSE

GEORGE R. METCALFE, *Editor*

Subscription. \$10.00 per year to United States, Mexico, Cuba, Porto Rico, Hawaii and the Phillipines; \$10.50 to Canada and \$11.00 to all other countries. Single copies \$1.00. Volumes begin with the January issue.

Changes of advertising copy should reach this office by the 15th of the month for the issue of the following month.

*The Institute is not responsible for the statements and opinions given in the papers and discussions published herein. These are the views of individuals to whom they are credited and are not binding on the membership as a whole.*

## A. I. E. E. Spring Convention

PITTSBURGH, APRIL 24-26

Plans for the Spring Convention of the A. I. E. E. have been well matured and as we go to press with this issue of the JOURNAL reports from the Convention Committee at Pittsburgh indicate an enthusiastic meeting with exceptionally good attendance. The subjects to be discussed at this meeting are largely devoted to electrical operation and are expected to prove of unusual interest, especially in the Pittsburgh district where the electrical operation of numerous industries is an outstanding feature.

A complete account of the meeting will be published in the June JOURNAL.

## A. I. E. E. Summer Convention Plans

**SWAMPSCOTT MEETING TO HAVE DIVERSIFIED PAPERS AND VARIED ENTERTAINMENT—ENGINEERING PROGRESS TO BE FEATURED**

New England's latchstring will hang outside the door for the American Institute of Electrical Engineers June 25-29, when the annual summer convention will be held at the New Ocean House, Swampscott, Mass., about fifteen miles from Boston and on the famous North Shore of the Bay State. The local convention committee has been very active in its preparations and has organized an attractive program of work and play for visiting delegates and guests. Local industrial plants, educational institutions and utilities are anticipating visits from many convention attendants; trips to the numerous historic and scenic

attractions of eastern Massachusetts are in contemplation, with an attractive program of sports and papers of large significance to the progress of both physical and engineering phases of electrical activity, and the comfort and enjoyment of the ladies are being carefully provided for.

Headquarters will be at the New Ocean House, through which all reservations for accommodations should be made. For this convention, rates at the New Ocean House per person per day, American plan, range in general from \$7 to \$10.

The keynote of the convention will be advances in equipment and plant design. Among the subjects to be covered will be modern developments in rectifiers; researches conducted upon the nature of insulation failures; artificial transmission lines; electric plant for commercial radio; transmission and distribution; a new type of lightning arrester; lamp quality; street lighting; and a whole session upon the important subject of station economics as affected by the proposed use of 1000 lb. steam pressure at the new Weymouth station of the Edison Electric Illuminating Company of Boston, and by new methods



NEW OCEAN HOUSE, SWAMPSCOTT, MASS., FROM AIRPLANE HEADQUARTERS OF THE A. I. E. E. ANNUAL CONVENTION, 1923

of conducting away heat losses in generating machinery. Electric welding will be considered, and other papers promised which may be included in the schedule bear upon heat balance and plant economy, duplication of electrical equipment, instrument specifications, and electrical instruments. At least one paper is planned expanding the ideas upon engineering education expressed at the Niagara Falls convention of the Institute in 1922.

It is planned to provide for inspection trips to plants in the Boston district on each day. Excellent facilities for golf, tennis, surf bathing, automobile touring, cards, dancing and other pleasures are to be taken advantage of, and the musical features of the convention will doubtless be a marked attraction. The program, including the assignment of papers to particular sessions will be published in the June issue. It is expected to open the regular sessions Tuesday morning, June 26, the convention closing on Friday afternoon. Aside from the convention meetings there are many interesting places and establishments in this region, including the historic and picturesque scenes of Boston, Cambridge, Salem, Concord and Lexington, the diversified and beautiful attractions of the metropolitan park system and shore drives, and the countryside lying in general within fifty miles of the Atlantic coast line. The Massachusetts Institute of Technology, Harvard University, Worcester Polytechnic Institute, Tufts College and many other educational institutions lie within easy reach of Boston proper.



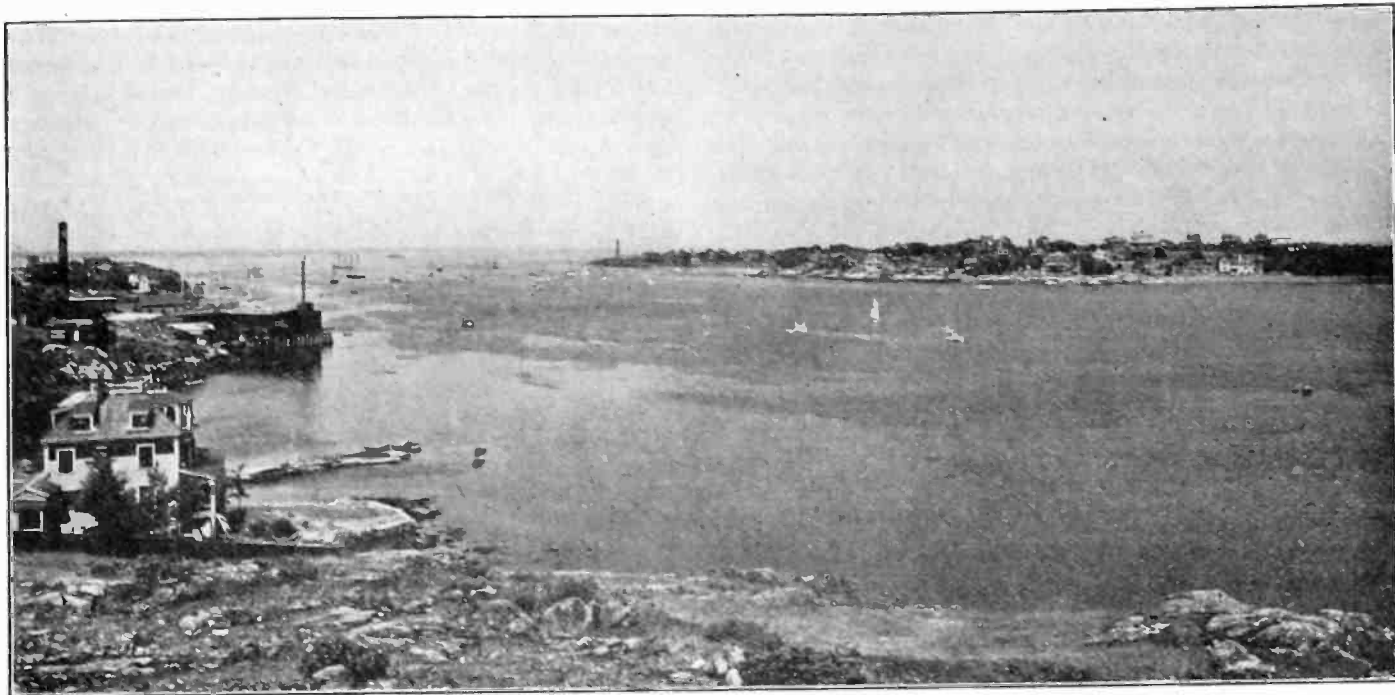

MARBLEHEAD HARBOR, A FAMOUS YACHTING CENTER ON THE NORTH SHORE NOT FAR FROM SWAMPSCOTT

In the main, the afternoons will be devoted to the social and recreational sides of the convention. The Boston Navy Yard, the Lynn Works (West and River) of the General Electric Company, the manufacturing plants of the Simplex Wire & Cable Company, Simplex Electric Heating Company, Holtzer-Cabot Electric Company, Condit Electrical Manufacturing Company, Albert & J. M. Anderson Manufacturing Company, Hygrade Lamp Company, Consolidated Lamp Company, B. F. Sturtevant Company, Walker & Pratt Manufacturing Company, S. A. Woods Machine Company, several radio apparatus makers and others of direct or related electrical interest lie in or close to Boston. Central station development and interconnection in this region are highly developed, as is electrical traction. As the headquarters of some of the foremost engineering, financing and operating organizations of the country and as the home of an alert and extensive electrical trade, Boston offers a wide range of attractions, and a large attendance is expected.

The Meetings and Papers Committee has about thirty papers under consideration for the June convention and the complete program will be decided upon at an early date.

#### THE SETTING OF THE SWAMPSCOTT CONVENTION

One of the chief attractions of the Swampscott convention of the Institute will be the beautiful surroundings which will form an appropriate setting for the activities of the delegates, enhanced as these are by a wealth of historical interest closely identified with the early days of our country. There is a charm about this historic atmosphere peculiar to New England; the old-time flavor of colonial days lingers despite the development of modern engineering civilization and New England's brilliant contributions to the later phases of American life and her share in the triumphs of the World War have never dimmed the glories of Lexington and Concord, Bunker Hill and Plymouth. Here were laid the foundations of liberty on this continent; here liberty is still sought amid the changing conditions of present-day industrialism. If the Past has done much for New England, the Present none the less sees her in the midst of a mighty development, and the peculiarities of this region but give added piquancy to its interest and its natural attractions.

Swampscott is a North Shore suburb of Boston, fronting on the open Atlantic. It adjoins Lynn so closely that there is no outward realization of the transition from one to the other. The convention hotel, the New Ocean House, faces seaward and

commands a beautiful view of the rocky peninsula of Nahant and the northern approaches to Boston Harbor. The main automobile highway to North Shore, Cape Ann and Maine points passes near the hotel and the entire region within a radius of 50 miles north west and south of Boston, with its thriving cities and towns, diversified countryside and extensive parkways



OLD STATE HOUSE, BOSTON

Outer walls built in 1712. Headquarters of all the royal governors of the Province and of the earlier governors of Massachusetts. Now a museum, containing a rich variety of early Bostoniana. Revolutionary relics, paintings and curiosities.

its bold and interesting coast line and its accessible hills, invites the summer tourist to prolong his stay and explore its recreational resources, its highly developed civilization and its ramifying territory.

It is impossible in the limited space available to do more than hint at the points of interest which Institute people will find worth

while this coming June at the convention. Boston, the capital city of Massachusetts and the metropolis of New England, is the center of an immediately tributary population of about 1,700,000. It was founded in 1630. Revolutionary history was made here. Gen. Washington took command of the American Army under an ancient elm still standing in Cambridge across the Charles River. The Battle of Bunker Hill took place within its present confines and the story of its occupation by the British and their later withdrawal from Dorchester Heights as a result of Washington's strategy is a thrilling one. From the tower of the Old North Church, Paul Revere received from Dawes the famous lantern signals which led to his historic ride through the Middlesex villages and farms to Lexington in order to alarm the countryside of the march of the British regulars toward Concord. From the balcony of the Old State House the Declaration of Independence was read to the people after the document was signed in Philadelphia. Faneuil Hall, the Cradle of Liberty; King's Chapel, the burying grounds on Tremont Street, Boston Common, old Beacon Hill, the Massachusetts State House with St. Gaudens Shaw Memorial bas relief monument directly across the way and the Hall of Flags within the capitol building are noted points of interest. In the State Library is preserved the original Bradford Manuscript depicting the early history of the Plymouth colony, and the town is replete with historic museums and monuments testifying the part Boston has played in the critical hours of America's development. Old Salem, within a few miles of

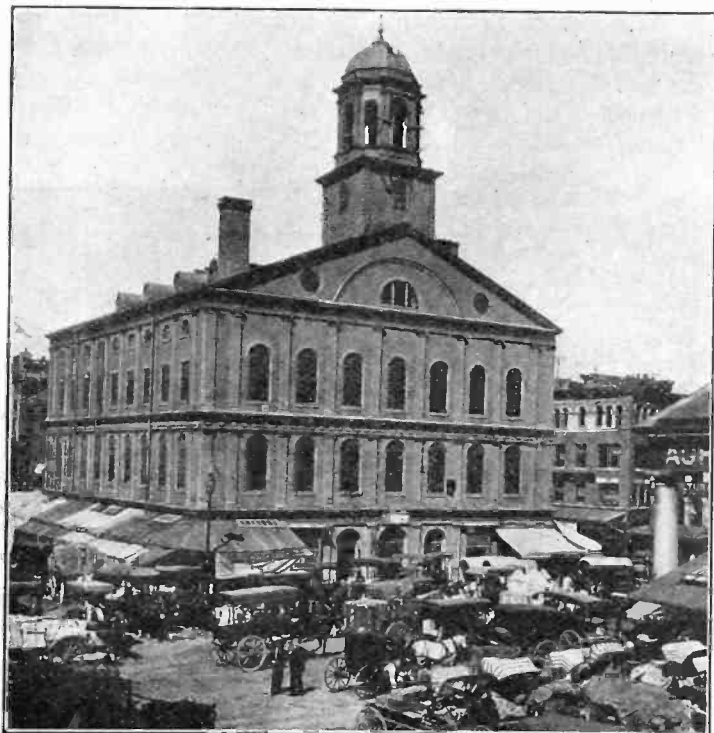

FANEUIL HALL, BOSTON

Built in 1762, remodeled in 1898. Instituted as a market place and today so used in part, later becoming a public town hall. A free meeting place and one of the most historic rostrums in America. During the siege of Boston a play "The Blockade of Boston," by Gen. Burgoyne, was given here by the British. Here Webster delivered his memorable eulogy on Adams and Jefferson, and here Wendell Phillips made his first anti-slavery speech.

Swampscott and the home of the Massachusetts Bay Colony, quaint Marblehead by the sea, the pastoral loveliness of Lexington and Concord—these and many other attractions lie practically at the door of the convention with the aid of the motor car, and are only a little farther removed by trolley or steam railroad. Boston is a center of some attractive coastwise steamer trips in addition to its overseas lines.

Visitors from the interior and those from the Far West will not find in New England the magnificent mountain ranges or im-

mense distances of the Trans-Mississippi region nor will they find the warmth of the South in the tang of the New England climate; but for charm and diversity of scenery, varied interest and attractiveness, New England will disappoint few visitors with an eye for the picturesque, a flair for the traditional and a bent for



CHRIST CHURCH, BOSTON

Oldest church edifice now standing in Boston. The signal lanterns of Paul Revere displayed in the steeple of this church April 18, 1775, warning of the march of the British troops to Lexington and Concord. Corner stone laid April, 1723.

the unusual. Here is a loyal and friendly group of engineers waiting for the chance to welcome all who may come, and it will not be the fault of New England hospitality if the 1923 Annual Convention fails to reward those who attend with pleasure as well as with intellectual profit.

### Pacific Coast Convention Change of Date

Attention is called to a change in date of the Pacific Coast Convention at Del Monte, Cal., from September 25-28 to October 2-5, 1923.

### A. I. E. E. Annual Meeting

The Annual Business Meeting of the Institute will be held in the Engineering Societies Building, New York, Friday afternoon, May 18, 1923, at four o'clock. The results of the annual election of Institute officers will be announced and the report of the Board of Directors for the year ending April 30 will be presented.

Prior to the Annual Business Meeting, the Board of Directors will hold a regular bi-monthly meeting. In the evening there will be a dinner to the members of the Board of Directors, the past-presidents, and the president-elect, for the purpose of affording an opportunity for an intimate discussion of the Institute and its development.

### Amendments to the Standards Rules

At the meeting of the Standards Committee on May 11, final action will be taken on the following minor changes in the Standards Rules, which have already been tentatively adopted by the Standards Committee.

Rule 4019 defining Synchronous Machine changed to read as follows:

A synchronous machine comprises a unidirectional magnetic field and an armature receiving or delivering alternating currents in synchronism with the motion of the machine; *i. e.*, having a frequency strictly proportional to the speed of the machine. Specific types of synchronous machines are defined in paragraphs 4020 to 4023.

Rule 4097 defining Regulation of Constant-Speed Motors changed to read as follows:

In constant-speed direct-current motors and induction motors, the regulation is the ratio of the difference between full-load and no-load speeds to the full-load speed.

## American Association for the Advancement of Science

### LOS ANGELES MEETING

The seventh annual meeting of the Pacific Division, American Association for the Advancement of Science to be held in conjunction with a summer session of the American Association for the Advancement of Science and the Southwestern Division at the University of Southern California, September 17, 18, 19 and 20, promises to be a unique event in scientific annals. The occasion of this meeting in southern California is primarily the total eclipse of September 10 which will draw to this locality astronomers from all parts of the world. It is estimated that that over 50 visiting astronomers will be present besides the local contingent from Mount Hamilton and Mount Wilson Observatories.

Besides a meeting of the American Astronomical Society and the Astronomical Society of the Pacific it is planned to arrange a symposium on some subject of astronomical interest.

Paleontology will also be featured in the general sessions illustrated by the wonderful discoveries of the Rancho La Brea beds.

The Society of Petroleum Geologists is planning to hold a meeting, also the American Meteorological Society, the American Society of Economic Entomologists, the American Phytopathological Society and the American Society of Agronomy.

The American Chemical Society will be represented by the California Section and the Southern California Section and the various affiliated societies of the Pacific Division and the Southwestern Division will be largely represented on the program.

Prof. E. C. Franklin, President of the Pacific Division, American Association for the Advancement of Science, will preside over the general sessions and deliver the presidential address.

The preliminary announcement will be issued about June 1. Secretaries of Sections and Societies which are planning to hold meetings are urged to mail their announcements to W. W. Sargeant, Secretary of the Pacific Division American Association for the Advancement of Science, Golden Gate Park, San Francisco, not later than May 5 for inclusion in the preliminary announcement.

### Future Section Meetings

**Baltimore.**—May 18, 1923. Subject: "Lighting of Factories and Office Buildings." Speaker: Earl A. Anderson, Engineer, National Lamp Works.

**Boston.**—May 15, 1923. Annual entertainment. Program to be announced.

**Cleveland.**—May 24, 1923. Annual meeting. Speaker: Dr. Jewett, National President, A. I. E. E.

**Detroit-Ann Arbor.**—May 11, 1923. Speaker to be announced. June, 1923. Annual meeting and election of officers.

**Eric.**—May 14, 1923. Subject: "Science of Musical Sounds." Speaker: Prof. Dayton C. Miller of the Case School of Applied Science.

**New York Section.**—On the evening of May 8, 1923, there will be a joint meeting of the four Metropolitan Sections of the A. I. E. E., A. S. M. E., A. I. M. E., and A. S. C. E. in the Audi-

torium, Engineering Societies Building, 33 West 39th St., New York at 8 p. m. The topic to be discussed should prove of intense interest to all engineers, "The Engineer in Public Affairs," particularly as the speakers are men of unusual prominence both in and out of the engineering field, Senator Stirling and Admiral Robinson, Chief Engineer, U. S. N.

**Philadelphia.**—May 14, 1923. Speaker: C. J. Russell. Subject to be announced.

June 11, 1923. Annual meeting, McCall Field, Highland Park, Pa.

**Seattle.**—May 16, 1923. Subject: "A Typical Installation of a Long Distance Telephone Toll Cable." Speakers: Members of the Engineering Staff of the Pacific Telephone & Telegraph Company.

**Washington, D. C.**—May 1923. Subject: "General Communications." Speaker: Gen. Geo. O. Squier, Chief Signal Officer, U. S. A.

**Worcester.**—May 17, 1923. Annual meeting. Subject to be announced. Speaker: Dr. Jewett, National President, A. I. E. E.

## Sir Alfred Yarrow Makes Gifts to Royal Society

News comes from London that Sir Alfred Yarrow has given 100,000 pounds to the Royal Society. His philanthropy is another step toward the identity of effort which engineers and men of science are striving to accomplish throughout the Anglo-Saxon world.

The communication from London contained the text of Sir Alfred's offer to the Royal Society of 100,000 pounds, which has been accepted. "I have for many years held the view that the prosperity of England has been greatly hampered in the past for the want of better promotion to scientific investigation and its application to practical affairs. I am convinced that the future prosperity of England will be largely dependent upon the encouragement of original scientific research.

"The birth of new industries, and the development of existing ones, are due largely to the growth of science, thus securing employment and the welfare of the whole community being advanced. It is doubtful whether even yet it has been realized how completely this country would have been at the mercy of our antagonists in the late war had it not been for the research work done by our scientific men before the war and during its course.

"I desire to mark my sense of the value of research to the community by offering, as a gift to the Royal Society, 100,000 pounds, to be used as capital or income for the purposes of the Society, as the Council may think fit, because I recognize that conditions alter so materially from time to time that, in order to secure the greatest possible benefit from such a fund, it must be administered with unfettered discretion by the best people from time to time available. Care must, of course, be taken that a gift from the fund shall in no case lessen any government grant.

"I should like to record my firm conviction that a patriotic citizen cannot give money, or leave it at his death, to better advantage than towards the development of science, upon which the industrial success of the country so largely depends."

Sir Alfred Yarrow is a pioneer in the design and construction of high-speed vessels, such as torpedo-boat destroyers, and of vessels for the navigation of shallow waters.

This gift to the Royal Society has an analogy in this country in the \$500,000 gift of Ambrose Swasey of Cleveland for the establishment of the Engineering Foundation.

## AMERICAN ENGINEERING COUNCIL

### CHAIRMAN OF COMMITTEE ON COAL STORAGE APPOINTED

Appointment of W. L. Abbott of Chicago as chairman of a committee to make a nationwide coal storage survey in cooperation with the U. S. Coal Commission and the Department of Commerce is announced by the Federated American Engineering Societies. Other members of the committee will be named in the near future. The plan of the Commission was briefly outlined in the April issue of the *JOURNAL* of the A. I. E. E.

It is probable that the personnel will represent many groups, including coal mining, both bituminous and anthracite; transportation, public utilities, U. S. Bureau of Mines, chemical engineering, economics and equipment. It is proposed to complete the survey by November 1 of this year.

Chairman Abbott is a Fellow of the American Institute of Electrical Engineers and has been a leader in the engineering movement for government reorganization sponsored by the National Public Works Department Association.

Chairman John Hays Hammond believes that the engineers of the country are in a particularly advantageous position to aid the Coal Commission, according to President Mortimer E. Cooley. The question of engineering cooperation has been referred to the member societies of the Federation, and the response has been encouraging.

### FEDERAL SAFETY LEGISLATION

The United States Government sanctions working conditions that would not be tolerated by private employers, it is declared by the Federated American Engineering Societies, which appeal for a Federal safety program.

Congress is asked to enact safety legislation providing for the safe construction and equipment of buildings, regular inspection of conditions and the training of employees to observe proper precautions against accident. Creation of "some administra-

tive body with authority similar to that of industrial commissions in the several states for preventing unsafe conditions of work in the Federal establishments" is urged.

"The Government should, in its industrial plants, set an example to private employers, by providing for its own employees working conditions which are safe, hygienic and sanitary," says the statement issued by the engineering federation and prepared by Morton G. Lloyd, vice-president of the American Society of Safety Engineers, and member of the Board of Councillors of the Eyesight Conservation Council of America. Mr. Lloyd is chief of the Safety Section of the U. S. Bureau of Standards.

The engineers assert that these evils have been pointed out by Congressional Joint Commission on Reclassification of Salaries, but no remedy has been applied. Federal safety standards were drawn up during the war, it was said, but there is no officer with authority to enforce them. The statement continues:

"Although the U. S. Employees' Compensation Commission is now expending approximately \$3,000,000 per annum to alleviate the results of industrial accidents, it has no authority to take action of a preventive nature which might obviate the necessity for this expenditure and the loss of life and limb which it connotes."

The Federated American Engineering Societies also recommends the adoption by the several states of uniform legislation aiming at the creation of administrative officials who shall have power to make and to enforce regulations for the prevention of accidents and industrial diseases.

"Safe methods of practise in industry," say the engineers, "represent one of the ways to eliminate the waste of human life and of materials in manufacturing and productive processes, and it is a proper function of the state to safeguard the lives, the limbs and the health of those engaged in industry and gainful occupations of whatever kind."

The engineering federation has decided to support the plan for "Conservation Week." Its president, Mortimer E. Cooley, will appoint a delegate to work with the National Safety Council in carrying out the events.

## American Engineering Standards Committee

### PLAN FOR BETTER LIGHTING IN SCHOOLS

The lighting, building, education, health and social agencies of the country have joined hands in an effort to develop a nationally accepted code for school lighting which will correct the conditions partially responsible for the defective vision of 10 to 20 per cent of the school children.

The formulation of this code is being carried on under the auspices of the American Engineering Standards Committee, a federation of national organizations, government departments, and other agencies interested in standardization, whose official approval of a standard or code insures its ultimate acceptance by the principal interests concerned.

The conditions that make such a code necessary have been summarized as follows by a committee of the Illuminating Engineering Society:

"Examinations of thousands of school children, extending over many years, have shown that from ten to twenty per cent of the children suffer from defective vision, the result largely of continued use of the eyes in close work under unhygienic conditions. It is well established that defective vision is progressive and is therefore found to a larger extent among the older children.

"Many of the factors contributing to defective vision of children are closely connected with school life, and to this extent the causes are preventable and may be removed. Modern educational methods impose severe requirements upon the immature eyes of children and create the need for the very best working conditions.

"It is therefore essential that the lighting of school buildings,

both natural and artificial, should be of the best design. The status of the art of illumination is so well established that it is entirely feasible and practicable to prevent eye-strain by the proper design of school buildings and the installation of suitable lighting equipment.

"Economically, it is found that, in general, children with defective vision are retarded in their progress in school life, and also enter upon their life work seriously handicapped. It is right, therefore, that a state should concern itself to protect and conserve the vision of children from an economical, as well as a humanitarian standpoint."

The American Engineering Standards Committee has appointed the American Institute of Architects and the Illuminating Engineering Society joint sponsors for the code on school lighting. The sponsors will organize a representative sectional committee to formulate the code and will provide for the publication of the code after it has been approved by the A. E. S. C.

The American Institute of Electrical Engineers is among the fourteen organizations already cooperating in this work.

### A. I. E. E. A SPONSOR FOR RADIO STANDARDIZATION

Sponsorship for Radio Standardization has been assigned by the American Engineering Standards Committee to the Institute of Radio Engineers and the American Institute of Electrical Engineers, jointly. This action was taken in accordance with the recommendations of the large representative conference called by the Bureau of Standards.

## ENGINEERING FOUNDATION

### FATIGUE OF METALS

During the year 1922, definite and important progress was made in the experimental work of the Fatigue of Metals investigation at the Engineering Experiment Station of the University of Illinois. Engineering Foundation has continued its cooperation and the committee of National Research Council has advised on program and report. A second report giving results and conclusions in detail is on the press as Bulletin 136, of the Experiment Station. In slightly condensed form, this report will be printed also in the annual publication of Engineering Foundation, to be ready for distribution in May.

Extension for two years is assured by the provision of additional funds to the amount of \$30,000. The University of Illinois, the National Research Council and Engineering Foundation will continue to cooperate. The following industries will participate financially and in other ways: General Electric Company by a substantial addition to its preceding investment of \$30,000; the Allis-Chalmers Manufacturing Company, the Copper and Brass Research Association, representing the most important producers and manufacturers of copper and its alloys, and the Western Electric Company. Several other companies are expected to join, in addition to a number mentioned in the first report (Bulletin 124, of the Engineering Experiment Station), which contributed materials and services of considerable value.

The investigation continues under the immediate charge of Professor H. F. Moore and has the general supervision of Professor Arthur N. Talbot, as the head of the Department of Theoretical and Applied Mechanics, in the Engineering College of the University of Illinois.

### Meeting of American Electrochemical Society in New York

The American Electrochemical Society will hold a meeting May 3-5, in New York City, with headquarters at the Commodore Hotel. Technical sessions will be held on Thursday, Friday and Saturday, and an attractive program for entertainment has been announced. About thirty papers are listed for presentation.

### Revision of Illuminating Engineering Nomenclature and Photometric Standards

The work of the Nomenclature and Standards Committee of the Illuminating Engineering Society has contributed very greatly to uniformity of practise in this field, and the result of this work in the form of a report called "Illuminating Engineering Nomenclature and Photometric Standards" was approved as an American Standard by the American Engineering Standards Committee on July 11, 1922. Copies of this standard are now obtainable on application to the office of the Illuminating Engineering Society.

Further revisions of this standard will be made jointly by the I. E. S. committee and a sectional committee organized under the auspices of the American Engineering Standards Committee. The committees engaged in this work wish to make the standard as practical and as widely useful as possible, and in order to attain this end they wish to obtain criticisms from all who are interested in such subjects. It is therefore requested that suggestions and criticisms be sent either to the general offices of

the Society, 29 West 39th Street, New York City, or to the Secretary of the committee, Mr. Howard Lyon, Welshbach Company, Gloucester, N. J.

### Convention of the National Association of Manufacturers

The twenty-eighth Annual Convention of the National Association of Manufacturers will be held in New York City on May 14-16 at the Waldorf-Astoria Hotel. Some of the features arranged are the Industrial Production Session, Open Forum Session, Law and Order Session, Open Shop Session, a Special Fellowship Luncheon and Annual Banquet. It is expected that this meeting will be of far reaching importance to manufacturers all over the country and a large attendance is anticipated.

### The Technical Club of Oklahoma Organized

The Technical Club of Oklahoma has just completed its organization with 81 charter members. The objects of this new organization are stated as follows: The opportunity to meet technical men from all over the State of Oklahoma; technical library privileges; clearing house for engineering problems; clearing house for engineers; opportunity to meet prominent national speakers on subjects of general interest; opportunity to hear technical papers of the six national engineering societies; opportunity to see moving pictures on technical subjects; to furnish technical speakers for State schools and colleges; to discuss civic problems and lend cooperation. The membership is open to any engineer, geologist, chemist or architect who is a member of a national technical society or who has graduated from or attended for at least two years a technical college of recognized standing and to practical engineers who are managers and executors. Entrance fee is \$5.00 and annual dues are \$12.00 payable quarterly in advance. Officers: F. W. Freeborn, president; B. H. Lasky, vice-president; L. C. Moore, treasurer, R. L. Ginter, secretary, 208 Fisher Bldg., 110½ East Second St., Tulsa, Oklahoma.

### Westinghouse War Memorial Scholarships

Westinghouse Electric and Manufacturing Company has announced that applications can be filed for the 1923 War Memorial Scholarships. Four Scholarships are established annually by this company as a memorial to those employes who entered the service of their Country during the World War.

Each scholarship carries with it an annual payment of \$500 for a period not to exceed four years, such payment to be applied toward an engineering education in any technical school or college that the successful candidate may select with the approval of the Committee. The scholarships are granted for one year, but will be continued for the full course, provided the scholar maintains the academic and other standards required by the college or institution in which he elects to pursue his course of study.

These scholarships are allotted by means of competitive examinations to

(a) Sons of employes of the Company and its Subsidiary Companies who have been employed five years or more.

(b) Employes of the Company and its Subsidiary Companies who have been continuously employed for at least two years and who shall not, on September 1st, have exceeded the age of 23. Not more than two of these scholarships may be awarded annually.

## Addresses Wanted

A list of members whose mail has been returned by the Postal Authorities is given below, together with the addresses as they now appear on the Institute records. Any member knowing the present addresses of any of these members is requested to communicate with the Secretary at 33 West 39th Street.

- 1.—W. de V. Bealey, 410 Artisans Bldg., Portland, Ore.
- 2.—G. Byberg, 641 Van Buren St., Milwaukee, Wis.
- 3.—John Hamilton, 2610 Lawrence St., Butte, Mont.
- 4.—Young-Tsieh Huang, c/o J. W. Dietz, Western Electric Co., 195 Broadway, New York, N. Y.
- 5.—Albert H. Keys, Lawton, Okla.
- 6.—Daniel Maass, Compania de Luz Electrica de Sta. Ana, Rep. de El Salvador, C. A.
- 7.—T. H. McWhirk, 153 East 86th St., New York, N. Y.
- 8.—Karl W. Radcliffe, Apt. B, 174-13th St., Milwaukee, Wis.
- 9.—N. T. Sauerborn, 1206 Grape St., Syracuse, N. Y.
- 10.—Kalman C. Tissinay, Westinghouse E. & M. Co., Newark, N. J.
- 11.—James Wallace, 3951 Denker Ave., Los Angeles, Calif.
- 12.—Peter C. Winther, Jr., 174 Martin St., Milwaukee, Wis.
- 13.—Tobias F. Ziegler, Torrington, Wyo.

## PERSONAL MENTION

D. W. EATON has become connected with the Evans Electric Co., Kansas City, Mo. as Superintendent of Construction.

C. E. STUMCKE, formerly of Milford, Conn., is now Electrical Designer with Stone & Webster, Inc., Boston.

NATHAN B. AMBLER, for the last ten years Superintendent of the Toronto Power Co., Ltd. of Niagara Falls, Ont., has resigned to join McClellan & Junkersfeld, Inc., New York, N. Y.

K. E. HOBART, formerly engineer with Wm. G. Woolfolk, has accepted a position with the Commonwealth Edison Company as Superintendent of Overhead Lines.

OTTO E. HUEBNER who has been with the New York & Queens Electric Light & Power Co. for three and a half years, has resigned to manage Exide Battery Service Station in Flushing, L. I.

J. H. KLINCK, since 1904 associated with the Westinghouse Electric & Mfg. Co. in various important capacities, has been appointed Assistant Supervisor of Production of that company.

Z. E. MERRILL has terminated his connection with the Washington Coast Utilities, Wenatchee, Wash., to accept a position with the Mountain States Power Company, Albany, Oregon.

G. W. McIVER, JR., formerly President of McIver Import & Export Co., New York City, has accepted a position with Henry L. Doherty, Inc. at their New York City office.

R. H. McLAIN who has recently resigned from the Maine Electric Company, Portland, Me. as Sales Manager, is now connected with the General Electric Co. at their New York office.

F. L. REQUA severed his connection with the Cutler-Hammer Mfg. Co. February 1922, and since that time has been engaged in business for himself as a Welding Engineer.

DAVID ROSS is now associated with the Electric Bond & Share Co., New York, N. Y. He was formerly with the Hydro-Electric Power Commission of Ontario.

J. M. WAUCHOPE, until recently power plant superintendent of the Pacific Power & Light Co., is now shop foreman for Boyd's Electrical Shop, Walla Walla, Wash.

J. ROWLAND BIBBINS has begun private consulting engineering work in Transportation Development in Washington, D. C. He was formerly Manager of the Department of Transportation, U. S. Chamber of Commerce, Washington, D. C.

C. E. BURGOON has accepted a position with the Morris Fertilizer Company, Bartow, Fla., as Assistant Superintendent of Phosphate Mines. He was formerly with the Cuba Cane Corporation.

HERBERT A. CORDES has severed his connection with the Southern California Edison Company, where he held the position of Divisional Electrical Foreman, to enter the employ of the General Electric Co. at Schenectady.

HENRY D. JACKSON, formerly electrical and mechanical engineer with Monks & Johnson, has resigned to be associated with W. R. Templeton in the manufacture and sale of return and boiler feed traps.

G. E. SANDERSON, after three and a half years connection with the Eck Dynamo & Motor Co. of Belleville, N. J. has resigned to accept a position with the Westinghouse Electric & Mfg. Co. at Syracuse, N. Y. as salesman in the Industrial Division.

R. E. THOMPSON recently resigned as Manager of the Deming Ice & Electric Co., Deming, New Mexico, to become Power Superintendent for the Springfield Gas & Electric Company, Springfield, Missouri.

CLARENCE P. FOWLER, Consulting Engineer for Messrs. Graham, Parsons & Company, has for the second consecutive year, delivered a series of lectures upon the bases of strength which should underlie sound public utility and industrial investment securities.

MAURICE HOLLAND, who has been stationed at McCook field for several years and has been in charge of the industrial engineering branch, has resigned to accept the directorship of the engineering division of the National Research Council of New York.

DR. EDWARD P. HYDE, organizer of the Nela Research Laboratory in 1908 and for the past few years has been Director of Research of the National Lamp Works of the General Electric Company, has resigned to take a prolonged rest, effective June 30th.

JOHN KLEMM who was Assistant Superintendent of the Cia Agricola y de Fuerza Electrica del Rio Conchos, S. A. has been appointed Superintendent of Construction in charge of the 110,000-volt lines and substations that company is building between its La Boquilla power house and Chih. City.

WEBSTER TALLMADGE, who has been connected with the Westinghouse Electric & Mfg. Co. for several years and was recently with the Vacuum Oil Company, has become affiliated with the Donnelly Systems Company, New York City, in charge of sales and service.

WILLIAM R. BULLARD has severed his connection with the United Electric Light & Power Co. of New York City, after seven years service, and has accepted a position with the Electric Bond & Share Co., New York City, as assistant engineer in connection with the design and development of underground distribution systems.

CALVERT TOWNLEY, Assistant to President, Westinghouse Electric and Manufacturing Company, has been re-elected a Vice President of the American Engineering Council and has been appointed a member of its Finance and Public Affairs Committees. He has also been made a delegate of the American Electric Railway Association to the Annual Meeting of the U. S. Chamber of Commerce.

DR. CARY T. HUTCHINSON is now associated with Sanderson & Porter, and will direct the Department of Railroad Electrification of that firm. In 1891 Dr. Hutchinson, then associated with Sprague & Duncan, built for the electrification of the Chicago freight terminals, the first heavy electric locomotive constructed in this country. Dr. Hutchinson has also been engaged during his career as a consulting engineer by the Baltimore & Ohio Railroad, the Great Southern Railway and the Illinois Central Railroad. In 1920 he had charge of Railway Electrification Division of the Superpower Survey.

### Schuyler Skaats Wheeler

DR. SCHUYLER SKAATS WHEELER, engineer, inventor, President of the Crocker-Wheeler Company died suddenly of heart trouble April 20, 1923 at his home, 755 Park Ave., New York. Dr. Wheeler, who was President of the A. I. E. E. 1905-1906 was born in New York, May 17, 1860. He was educated at Columbia College; was awarded D. Sc. from Hobart in 1894 and M. Sc. by Columbia in 1912. In 1881 he left college to become assistant electrician of the Jablochhoff Elec. Light Co. Later he became one of Edison's engineering staff in charge of work at the first power station in 1883, when the incandescent light was introduced, and installed several other stations. In 1886 he left the Edison Co. and was connected with the C & C Motor Company, which with Charles G. Curtis and Francis B. Crocker he helped to organize. They were the pioneer manufacturers of small electric motors. In 1888 the Crocker-Wheeler Co. was organized with Dr. Wheeler as President. During his many years since then as the active head of that company he has been particularly prominent in the development of the electric motor and its application to machine tool drive. Dr. Wheeler was electrical expert for the Board of Electrical Control of New York, 1888-95. Among inventions of Dr. Wheeler's may be named the electric elevator, electric fire engine, series multiple motor control, paralleling of dynamos, etc. He received the John Scott medal of the Franklin Institute in 1904 for invention of the electric fan. Dr. Wheeler was one of the nine incorporators of United Engineering Society in May, 1904, being one of the three representatives of the American Institute of Electrical Engineers. He was Trustee of the U. E. S. from 1904 to 1907 and its treasurer for the year 1904-05. In 1901 he presented to the A. I. E. E. the remarkable collection of electrical books of the late Latimer Clark, of London, including practically every known publication in the English language previous to 1886. It was during his term as trustee that the Engineering Societies Building, 33 West 39th St., New York was erected by the U. E. S. At Milwaukee in May 1906 Dr. Wheeler delivered his presidential address on "Engineering Honor" and it was from this address that the ideas were taken for the "Code of Ethics" for Electrical engineers finally adopted by the Board of Directors in 1912. He always took an active interest in the work of the Committee on Code of Principles of Professional Conduct of which he was chairman at the time of his death. He was also member of the Edison Medal Committee 1911 to 1916, Research Committee 1920-22; Manager of the Institute 1887-1904, 1904-05; Vice-President 1890-91 and 1902-04; President 1905-06. He was also a member of the A. S. M. E., the University Club, the Chamber of Commerce, Automobile Club, St. Nicholas Society and Somerset Hills Country Club.

## Obituary

### A CORRECTION

Our apologies are hereby extended to Mr. Walter A. Schmidt, President and General Manager, Western Precipitation Company, Los Angeles, California, for an unfortunate error resulting in the inclusion of his name in our obituary column in the April issue of the JOURNAL, due to confusing his name with that of Mr. Walter Schmidt, of White Plains, New York, whose obituary is published in this issue.

GEORGE H. GUY, for the last forty years secretary of the New York Electrical Society, died of pneumonia on Sunday, April 1 at the Long Island College Hospital. He was 76 years old. Mr. Guy was born in England. He studied music at Leipsic. For several years he was interested in the sugar industry and for a long period conducted a scientific press bureau. He was a member of the Engineers Club and an Associate in the A. I. E. E. since 1893.

THOMAS E. CROSSMAN, official reporter for the American Institute of Electrical Engineers for many years, was stricken while reporting a meeting in Chicago of the American Railway Engineering Association, and died in that city on April 4. He served in a reporting capacity the National Electric Light Association and the Association of Edison Illuminating Companies. He was widely acquainted with A. I. E. E. members and engineers all over the country.

WALTER SCHMIDT, Associate A. I. E. E., died on February 22, 1923 in White Plains, N. Y. During his engineering career, Mr. Schmidt had been associated with the Westinghouse Electric & Manufacturing Co., Sanderson & Porter, Electric Bond & Share Co., and at the time of his death he was employed by the Brooklyn Edison Company.

ALEXANDER LODYGUINE, Member A. I. E. E. and Honorary Member R. I. E. E., died on March 16, 1923. He was born in Russia in 1847 and was a graduate of the Polytechnical Institute of St. Petersburg. He managed his own incandescent lamp factory both in Russia and France. In the United States he was connected with the Westinghouse Electric & Mfg. Company, The National Battery Co. of Buffalo, the Pressed Steel Company of McKee's Rocks, Pa. During the War he was in Russia in engineering work, but returned to this country, and at the time of his death he was a member of the engineering department of the Sperry Gyroscope Company.

JOSEPH H. BURKE, Member of the Institute since 1913, died on March 1, 1923. He was for many years connected with the Department of Water Supply, Gas & Electricity, of Long Island City, N. Y.

LIEUT. COL. CLARE F. BEAMES, Assistant to President of the Columbia Gas & Electric Co., and Fellow of the A. I. E. E. died suddenly at his home in Jackson Heights, Elmhurst, L. I. on April 22, 1923. He was in his fiftieth year. Col. Beames was born in 1873 at Tremont, N. Y., received his education in the public schools of New York City and by private study. He was connected with the Thomson-Houston Electric Company for four years, and in 1894 he went into the employ of the General Electric Company, where he worked under the direction of Dr. Steinmetz. Later he was sent to the Chicago office, and to Mexico and South America in the interests of this company. For several years he was in Mexico and later with the J. G. White Co. in Porto Rico. In 1911 he was made Chief Electrical Engineer to the Government of Mysore, India. While in India he was appointed Local Honorary Secretary of the American Institute of Electrical Engineers in that country. Col. Beames became an Associate of the Institute in 1895, and was transferred to Fellowship in 1913.

## Past Section and Branch Meetings

### PAST SECTION MEETINGS

**Akron.**—January 23, 1923. Subject: "Diversity and Economics in Electric Transmission and Distribution." Speaker: D. C. Hopper, Northern Ohio Traction and Light Co. Attendance 29.

February 13, 1923. Subject: "The Electron Theory of Radio Telephony." Speaker: Richard H. Ranger, Research Engineer of the Radio Corporation of America. There were slides and moving pictures. Attendance 400.

March 27, 1923. Subject: "Usual and Unusual Troubles in Electrical Machinery." Speaker: S. W. Sweet, of the Electrical Motor and Repair Co. Attendance 22.

**Baltimore.**—March 16, 1923. Subject: "Wired Wireless" (Carrier Current Telephony). Speaker: R. D. Duncan, Jr., Radio Engineer of the North American Company of New York. Attendance 45.

**Boston.**—February 20, 1923. Subject: "The Construction of the Caribou Hydroelectric Power Plant." Speaker: Albert A. Northrop of Stone & Webster, Inc. Attendance 75.

March 13, 1923. There was a dinner at which were present the Executive Committee and the speakers. The subject under discussion was "Transformer Design and Development," upon which papers were presented, by M. E. Skinner, of the Duquesne Light Co., and M. O. Troy, of the General Electric Company at Pittsfield, Mass. Attendance 100.

March 30, 1923. Joint meeting with the Illuminating Engineering Society. Subject: "The History of Artificial Illumination." Speaker: Dr. M. Luckiesh, of the National Lamp Works, Cleveland, O. Attendance 110.

**Chicago.**—March 19, 1923. Subject: "Industrial Research." Speaker: C. E. Skinner of the Westinghouse Electric & Mfg. Co. Attendance 200.

**Cleveland.**—March 22, 1923. Subjects: "Magnetic Clutches and Automatic Starters for Synchronous Motors," by H. W. Eastwood, of the Cutler-Hammer Mfg. Co. and "Motor Problems in Industry—Past, Present and Future," by A. M. MacCutcheon. Attendance 50.

**Columbus.**—March 12, 1923. Business meeting outlining future meetings and policies.

March 16, 1923. Subject: "Your Telephone Service and What It Should Cost." Speaker: Charles A. Wright, Professor of Telephone Engineering at Ohio State University. Attendance 39.

**Connecticut.**—March 27, 1923. Subject: "The Mercury Boiler and Turbine." Speaker: W. L. R. Emmet. Attendance 250.

**Denver.**—March 26, 1923. Subject: "The Construction and Operation of a Transmission System." Speaker: Norman Read, of the Colorado Power Company. Attendance 56.

**Erie.**—February 20, 1923. Subject: "The Application of Electric Motors from the Engineering Standpoint." Speaker: James Burke, of the Burke Electric Company. Attendance 83.

March 19, 1923. Subject: "Construction and Care of Transformers." Speaker: J. G. Corrin, of the Pittsburgh Transformer Company. Attendance 70.

**Fort Wayne.**—March 15, 1923. Subject: "Instrument Transformer Errors and Methods of Measuring Them." Speaker: Prof. L. D. Rowell of Purdue University. Attendance 50.

**Indianapolis - Lafayette.**—February 23, 1923. Subject: "Some Fundamentals of Patents and Trade Marks." Speaker: Geo. B. Schley. Attendance 48.

March 30, 1923. Subject: "Electric Power Transmission and Intermediate Line Insulation." Speaker: F. M. Crapo of the Hemingway Glass Co. Attendance 52.

**Ithaca.**—February 23, 1923. Subject: "The Electric Meter, Its Development and Present Day Applications." Speaker: R. C. Lanphier. Attendance 55.

**Lehigh Valley.**—April 5, 1923. Subject: "Carrier Current Telephony." Speaker: J. E. Allen of the Pennsylvania Water & Power Co., Baltimore, Md. Attendance 52.

**Los Angeles.**—February 27, 1923. There was a lecture by A. P. Hill, Radio Transformer Engineer of the Pacific Telephone & Telegraph Co. Attendance 77.

**Lynn.**—February 21, 1923. Subject: "Waterpower Development in New England." Speaker: Prof. H. K. Barrows, Consulting Engineer, Boston, Mass. Attendance 155.

February 28, 1923. Subject: "Genesis 1:4." Speaker: L. C. Kent. Attendance 155.

**Madison.**—March 28, 1923. Subject: "The Electricity Supply Industry and the Engineer." Speaker: R. F. Schuchardt, of the Commonwealth Edison Company of Chicago. Attendance 110.

April 2, 1923. Joint meeting of the A. I. E. E., N. A. S. E., and the Technical Club of Madison. Four reels of pictures were shown depicting the mining and manufacturing of asbestos. Attendance 115.

**Minnesota.**—March 16, 1923. Subject: "National and International Standardization." Speaker: M. E. Skinner. Attendance 54.

April 2, 1923. Subject: "Carrier Current Telephony and Telegraphy." Speaker: H. A. Affel, of the American Telephone and Telegraph Co. Attendance 115.

**New York.**—On the evening of Wednesday, April 11th, the New York Section of the A. I. E. E. was extremely fortunate in being able to listen to Dr. R. A. Millikan of the California Institute of Technology, Edison Medalist for 1922, talk on "Some of the Developments of Modern Physics." An appreciative audience of over 700 enjoyed his graphic presentation of his supposition of the construction of the atom, the revolution of the electrons in orbits about a central nucleus. He also dwelt upon the investigations that are now being made to determine if possible the existence of "hard rays" which would help explain questions in connection with radioactive substances. It is hoped the Doctor may be prevailed upon to write a paper along the lines of his talk for publication in the JOURNAL. Secretary A. E. Waller announced the election of officers of the Section for the administrative year 1923-24, as follows: Chairman, L. F. Morehouse; Secretary-Treasurer, E. B. Meyer; Executive Committee, F. N. Tucker and J. H. Morecroft.

**Oklahoma.**—April 4, 1923. Subject: "Steel Castings." Speaker: F. W. Stowe. A four-reel picture was shown on "How a Watch is Made." Attendance 78.

**Philadelphia.**—April 9, 1923. Subject: "A Survey of Lightning Disturbances on a Distribution System." Speaker: Malcolm MacLaren. Attendance 70.

**Pittsburgh.**—March 13, 1923. Subject: "The Use of Magnetic Clutches with Synchronous Motors." Speaker: Edward T. Foote, of the Cutler-Hammer Mfg. Co. Attendance 183.

**Pittsfield.**—March 29, 1923. Subject: "India." Speaker: Prof. B. C. Gupta, of the Bengal School of Engineering. Attendance 250.



**Providence.**—April 6, 1923. Subject: "The Engineer—An Apostle of Safety." By Charles B. Scott, General Manager of the Bureau of Safety, Chicago Ill., and "The Engineer as a Factor in Community Safety," by Lewis McBrayne, General Manager of the Massachusetts Safety Council. Attendance 60.

**Rochester.**—March 23, 1923. Subject: "Some Modern Relays and Their Application to the Rochester System." Speaker: E. K. Huntington, of the Rochester Gas & Electric Co. Attendance 60.

**San Francisco.**—February 23, 1923. Subject: "Carrier Current Communication Over High-Voltage Transmission Lines." Speaker: Dr. L. F. Fuller. Attendance 135.

March 30, 1923. Subject: "Great Western Power Company's New Bay Cable No. 4." Speaker: John A. Koontz, Jr. Attendance 70.

**Springfield, Mass.**—March 16, 1923. Subject: "Automatic Generating and Substations." Speaker: W. C. Dixon. Attendance 41.

**Toronto.**—March 9, 1923. Subject: "Insulation for 220,000-volt Systems." Speaker: A. O. Austin, of the Ohio Insulator Co. Attendance 110.

March 23, 1923. Subject: "Power Factor and Voltage Regulations." Speaker: F. F. Ambuhl, of the Toronto Hydro-Electric System. Attendance 113.

April 6, 1923. Joint meeting with the Hamilton Branch of the Engineering Institute of Canada. Subject: "Japanese Developments and Pacific Wanderings." Speaker: S. Q. Hayes of the Westinghouse Electric & Mfg. Co., Pittsburgh, Pa. Attendance 250.

**Urbana.**—March 1, 1923. Subject: "Carrier Current Telephone and Telegraph Systems." Speaker: H. A. Affel, of the American Telephone and Telegraph Co. Attendance 135.

March 23, 1923. Subject: "Operation of Large Steam Generating Stations." Speaker: A. D. Bailey, of the Commonwealth Edison Co., Chicago, Ill. Attendance 220.

**Utah.**—March 28, 1923. Subject: "The Vacuum Tube." Speaker: R. E. Syler of the Mountain States Telephone and Telegraph Co. Attendance 70.

**Washington, D. C.**—March 13, 1923. Subject: "Electrical Equipment on Automotive Vehicles." Speaker: Mr. J. H. Hunt. Attendance 163.

April 10, 1923. Subject: "Japanese Power Development." Speaker: Stephen Q. Hayes, of the Westinghouse Electric & Mfg. Co. Attendance 114.

**Worcester.**—March 15, 1923. Subject: "Time Service from Commercial Lighting Circuits." Speaker: H. E. Warren. Attendance 45.

#### PAST BRANCH MEETINGS

**Alabama Polytechnic Institute.**—March 17, 1923. There were talks on "Goat Rock Power Plant," by K. H. Stough, and "Progress of Education in Engineering" by Prof. A. L. Thomas. Attendance 11.

**University of Alabama.**—March 20, 1923. Mr. Merritt gave a talk based on extracts from the *JOURNAL* of the A. I. E. E., and Mr. Lang talked on various types of electric lamps. Mr. Graham, a student, told of his experience with moving picture machines. Attendance 10.

March 27, 1923. Mr. Farabee gave a talk on "Power Transmission," and Mr. Reed discussed an article in the *Electrical World* on electric street lighting of cities. Attendance 10.

April 10, 1923. Subject: "Carrier Waves. Radio and Radio Frequency Used in Telephone, Telegraph and Radio." Speaker: Prof. Maxwell. Attendance 13.

**University of Arizona.**—March 24, 1923. Subject: "Economics of Power Plant Operation in Arizona." Speaker: W. W. Jourdin, Chief Engineer, of the Inspiration Consolidated Copper Co. Attendance 16.

**Armour Institute of Technology.**—March 15, 1923. Subject: "Stage Lighting." Speaker: Morris Spector. Attendance 32.

**Bucknell University.**—March 21, 1923. Two lectures, illustrated by lantern slides, were given: "The Evolution of the Transformer," by Prof. W. K. Rhodes, and "Electrical Appliances in the Modern Garage," by Prof. G. A. Irland. Attendance 53.

April 9, 1923. Subject: "Arc Welding." Speaker: Voris B. Hall. Attendance 27.

**University of California.**—March 14, 1923. Joint meeting with the A. S. M. E. Subject: "Engineering Problems of the Hetch Hetchy Water and Power Project." Speaker: M. M. O'Shaughnessy, City Engineer of San Francisco. Attendance 295.

April 4, 1923. Subject: "Alternating-Current Generators." Speaker: Allan Jones, of the General Electric Company. Attendance 25.

**Carnegie School of Technology.**—March 8, 1923. Three seniors presented their theses on the following subjects: "Telephone Apparatus," by Mr. McKelvie. "Predetermination in Electric Railroad Engineering," by Mr. Marthens and "Interior Illumination," by Mr. Andrews. Attendance 19.

**University of Cincinnati.**—March 15, 1923. Joint meeting with A. S. M. E. Subject: "A Look at a Big Organization." Speaker: C. M. Ripley of the General Electric Company. Attendance 90.

**Clemson College.**—March 1, 1923. Subject: "Influence of Temperatures on Operation of Electrical Machinery," by E. B. Williams, "Heat Absorption and Flow," by Prof. F. G. Dargan and "Thermocouples for Measuring Temperatures," by Prof. S. R. Rhodes, "Electric Power Developments in 1922; What Will 1923 Mean to the Power Industry," by E. K. Anderson, and "Current Events," by J. H. Sams. Attendance 24.

March 15, 1923. There were papers on the following subjects: "The Future Distribution Systems," "Motor Applications in the Lumber Industry," "The Status of Railroad Electrification," "Hints on Job Getting," "Current Events." Attendance 25.

March 29, 1923. Subjects: "Individual Motor Drives Improve Shop Efficiency," "Some Elements of Air Flow in Electrical Machinery" and "Application of Electricity to Airplanes." Attendance 22.

**Colorado Agricultural College.**—February 26, 1923. Business meeting. Attendance 8.

**University of Colorado.**—March 1, 1923. Subject: "Electric Transmission on the Big Creek Development." Speaker: Mr. Roberts. Attendance 50.

**Cooper Union.**—March 16, 1923. Subject: "The Neutrodyne Circuit." Speaker: Prof. L. A. Hazeltine. Attendance 114. March 23, 1923. Subject: "The Signal and Interlocking System of the New York Subways, Including Automatic Train Control." Speaker: J. M. Waldron, Chief Signal Engineer, I. R. T. Attendance 43.

March 24, 1923. Joint meeting of branches of A. S. M. E., A. S. C. E. and A. I. E. E. Subject: "The Rapid Strides of Japan in Engineering," by Elmer A. Sperry. Three motion pictures were shown: "Sperry Gyroscope," "Manufacture of Cole Automobiles" and "Caribou Hydro Electric Power Station." Attendance 154.

**Iowa State College.**—April 4, 1923. Election of officers. Subject: "The Telephone Industry." Speaker: Mr. Dodson of the Northwestern Bell Telephone Co. Attendance 77.

**University of Iowa.**—March 5, 1923. Subjects: "New Type of Transformer," by G. K. Johnson, "Electromagnetic Forces," by J. W. Hummer and "Signal Corps Instruments," by Haynie Paul. Attendance 50.

March 26, 1923. Subject: "Electrical Waterproofing," by A. J. Kosbau and "Testing Transformer Oil" by J. G. Murphy. Attendance 50.

**Kansas State College.**—March 12, 1923. Subjects: "Safety Switches," by H. M. Low, "First Aid in Electrical Accidents," by C. F. Johnston, and "Public Safety Education," by O. F. Fulhage. Attendance 52.

March 26, 1923. Election of officers. There was a talk by Mr. Barrit, of the Westinghouse Electric & Mfg. Co. Attendance 73.

**University of Kansas.**—March 22, 1923. Business meeting. Attendance 64.

**Lehigh University.**—March 8, 1923. Subject: "Problems of Electrical Power Transmission and Distribution." Speaker: H. S. Phelps, of the Philadelphia Electric Company. Attendance 45.

March 19, 1923. Subject: "Japanese Power Developments." Speaker: S. Q. Hayes, of the Westinghouse Electric & Mfg. Co. Attendance 30.

**Lewis Institute.**—March 16, 1923. Shop trip through the factories of the Western Electric Company, Hawthorne, Ill. Attendance 25.

**Marquette University.**—March 8, 1923. Subject: "Wireless Telephony." Speaker: E. L. Cordes. Attendance 36.

**University of Michigan.**—February 27, 1923. Various phases of electrical engineering were touched upon by Prof. B. F. Bailey, J. M. Hipple, E. B. Roberts and Mr. Payne. Attendance 61.

March 7, 1923. Business meeting. Attendance 15.

March 23, 1923. Subject: "The Engineering Significance of the Rapid Advance in South America." Speaker: Calvin W. Rice, Secretary of the A. S. M. E. Attendance 650.

March 28, 1923. Subject: "Patents and Patent Law." Speaker: Prof. B. F. Bailey. Attendance 100.

**School of Engineering, Milwaukee.**—March 16, 1923. Subject: "Modern Alternating-Current Machinery." Speaker: F. K. Brainard. Attendance 52.

**University of Missouri.**—March 26, 1923. Subject: "Inductive Interference," by R. W. Linney. An educational moving picture was shown entitled "Big Deeds." Attendance 37.

April 4, 1923. Subject: "Mathematics in Engineering," by R. E. Doherty, of the General Electric Company. This meeting was held in conjunction with the Engineers' Club of the University of Missouri. Attendance 40.

April 5, 1923. Subject: "Simplified Methods of Analyzing Short-Circuit Problems." Speaker: R. E. Doherty of the General Electric Company. Attendance 28.

**University of Nebraska.**—March 14, 1923. Subject: "The Outstanding Differences Between Telephone Service and Other Public Utility Services." Speaker: Mr. Pratt, Vice-President of the Northwestern Bell Telephone Company. Attendance 35.

**Notre Dame University.**—March 19, 1923. Subjects: "The New Studebaker Power Plant," by C. J. Hartman, and "The Theory of the Reversing Motor," by W. J. Laughlin. Attendance 25.

**University of North Carolina.**—December 7, 1923. Subjects: "The Electron Tube," by B. E. Humphrey, "2300-Volt Distribution," by W. Thompson, and "Athletics for Engineers," by T. D. Wells. Attendance 34.

February 15, 1923. Election of Officers. Attendance 23.

March 1, 1923. Subjects: "A Non-Explosive Transformer," by E. L. Davis, "Electrical Construction Work," by J. F. Cheney and "New Developments in Oscillography," by W. C. Moore. Attendance 30.

March 29, 1923. Two moving pictures were shown: "Butte Anaconda and Pacific Railroad" and "Schenectady Works." Attendance 63.

**North Carolina State College.**—March 6, 1923. Subjects: "Commercial Aspects of Power Factor and Its Measurements," by Mr. Richardson of the General Electric Company, and "Human Elements in Engineering," by Mr. Rindge, International Secretary of the Y. M. C. A.

**University of North Dakota.**—March 5, 1923. Two reels of motion pictures were shown on "Good Roads" and "Trip Through the Panama Canal." Attendance 19.

**Northeastern University.**—March 30, 1923. Subject: "Electrical Problems of Today." Attendance 46.

**Ohio Northern University.**—March 21, 1923. Subject: "Modern Drafting Room Practise." Speaker: Prof. L. S. Campbell. Attendance 12.

April 5, 1923. Subject: "Wave Forms." Speaker: Dean Alden of the College of Engineering. Attendance 12.

**University of Pittsburgh.**—March 2, 1923. Subject: "The Manufacture of Glass." Speaker: W. C. Carl. Attendance 33.

March 9, 1923. Joint engineering meeting. Subject: "Advances of the Steam Locomotive." Speaker: S. Vauclan, President of the Baldwin Locomotive Works.

March 16, 1923. A joint engineering meeting. Subject: "The Editing of Engineering Magazines." Speaker: Mr. Oberg.

March 23, 1923. Subjects: "The History and Development of the Electric Furnaces," by G. J. Read and "My Experiences with the Duquesne Light Company," by D. W. Molter. Attendance 28.

**Purdue University.**—March 13, 1923. Subject: "Alternating-Current Machinery for Hydroelectric Installations." Speaker: R. B. Williamson, of the Allis-Chalmers Mfg. Co. Attendance 91.

March 27, 1923. Subject: "Power Plant Design," by G. T. Shoemaker, Consulting Engineer of the United Light and Railway Co. Attendance 85.

April 10, 1923. Election of officers. There was a lecture by O. S. Imes, of the Century Electric Company on "Electric Motor Construction and Operation." Attendance 57.

**Rutgers.**—March 15, 1923. There were two student papers: "Development of the St. Lawrence River," by J. J. Glatzel and a paper based on the November issue of the A. I. E. E. JOURNAL on the same subject by C. S. Beattie. Attendance 11.

**University of Southern California.**—April 5, 1923. Subjects: "Installation and Maintenance of Electrical Railways," by E. Heath, "Signal Systems and Automatic Control Devices," by Wm. Angermany, "Electrical Railroad Controls on City and Interurban Systems," by R. H. Cockfield, "The Future of Electrical Railways," by L. Biggs. Attendance 16.

**Stanford University.**—March 1, 1923. Business meeting. Attendance 12.

March 3, 1923. Inspection trip to central station and substation of the Pacific Gas and Electric Company. Attendance 13.

March 15, 1923. Subject: "Automatic Substations." Speaker: A. W. Copley. Attendance 30.

**Swarthmore College.**—March 23, 1923. Subject: "Operating Pilot Board and Load Dispatching System of the New York Edison Company." Speaker: John C. Fretz. Attendance 7.

**University of Texas.**—March 8, 1923. Subject: "Electrification of Railroads," by Prof. J. M. Bryant. Attendance 32.

**University of Virginia.**—March 30-31, 1923. Joint meeting with the A. S. M. E. Subjects: "Water Filtration Plant," by Lee H. Williamson, "Electrification of Steam Railways," by W. J. Clardy of the Westinghouse Electric & Mfg. Co., "New Opportunities for the Engineer," by Dean R. L. Hession, "Some Phases of Railway Motive Power Operation," by Houston Harriman. Average attendance 35.

**University of Wisconsin.**—March 14, 1923. Subject: "Superpower Developments." Speaker: Prof. J. T. Rood. Attendance 40.

March 28, 1923. Subject: "Central Station Practise," by Mr. Schuchardt, of the Chicago Commonwealth Edison Company. Attendance 100.

# Engineering Societies Library

The library is a cooperative activity of the American Institute of Electrical Engineers, the American Society of Civil Engineers, the American Institute of Mining and Metallurgical Engineers and the American Society of Mechanical Engineers. It is administered for these Founder Societies by the United Engineering Society, as a public reference library of engineering and the allied sciences. It contains 150,000 volumes and pamphlets and receives currently most of the important periodicals in its field. It is housed in the Engineering Societies Building, 29 West Thirty-ninth St., New York.

In order to place the resources of the Library at the disposal of those unable to visit it in person, the Library is prepared to furnish lists of references to engineering subjects, copies or translations of articles, and similar assistance. Charges sufficient to cover the cost of this work are made.

The Director of the Library will gladly give information concerning charges for the various kinds of service to those interested. In asking for information, letters should be made as definite as possible, so that the investigator may understand clearly what is desired.

The library is open from 9 a. m. to 10 p. m. on all week days except holidays throughout the year except during July and August when the hours are 9 a. m. to 6 p. m.

## BOOK NOTICES (MAR. 1-31, 1923)

Unless otherwise specified, books in this list have been presented by the publishers. The Society does not assume responsibility for any statements made; these are taken from the preface or the text of the book.

All the books listed may be consulted in the Engineering Societies Library.

### INTERIOR WIRING AND SYSTEMS FOR ELECTRIC LIGHT AND POWER SERVICE.

By Arthur L. Cook. 2d edition. N. Y., John Wiley & Sons; Lond., Chapman & Hall, 1923. 458 pp., illus., diags., tables, 7 x 4 in., fabrikoid. \$3.00.

Intended as a guide to modern practise in electric lighting and power applications, and in the design and installation of the wiring for these purposes. Written particularly for superintendents of electrical installations and for wiremen who may be called upon to extend or change existing installations and who need definite information upon the best method of procedure. It is also intended as a textbook for students in trade schools and as a handbook for architects.

### TEXT-BOOK OF PRACTICAL PHYSICS.

By W. Watson. Third edition, revised by H. Moss. Lond., & N. Y., Longmans, Green & Co., 1922. 635 pp., diags., tables, 8 x 5 in., cloth. \$3.50.

A reference book for the student working in a physical laboratory, which describes experiments that can be performed with the ordinary equipment. The aim of the book is to draw attention to those points that require care and to indicate the common sources of error. The experiments are not intended for beginners, but for students who have already worked through a more elementary course of experiments.

### STEAM-TURBINE PRINCIPLES AND PRACTISE.

By Terrell Croft. First edition. N. Y. & Lond., McGraw-Hill Book Co., 1923. (Power Plant Series). 347 pp., illus., 8 x 6 in., cloth. \$3.00.

Intended to provide the operating engineer and the plant superintendent with information required in everyday work. The topics treated are (1) those with which he must be familiar to insure the successful, economical operation of turbines, and (2) those which he must know in order to choose the proper turbines for any class of work. Design is not treated. The book is a clearly written account of steam turbines, written for the user, not for the designer or maker.

### HANDBOOK OF CHEMISTRY AND PHYSICS.

By Charles D. Hodgman and Norbert A. Lange. 9th edition. Cleveland, O., Chemical Rubber Publishing Co., 1922. 803 pp., tables, 7 x 5 in., fabrikoid. \$4.00.

Nine editions of this collection of physical and chemical data have appeared within nine years, an indication that many per-

sons have found it a convenient work of reference. The book is intended to provide accurate, contemporary information in the fields of chemistry and physics upon questions that recur frequently in practise. Many tables have been specially prepared for the book. The new edition has been thoroughly revised and considerably enlarged.

### DICTIONARY OF APPLIED PHYSICS. V. 3, METEOROLOGY, METROLOGY AND MEASURING APPARATUS.

By Sir Richard Glazebrook. Lond., Macmillan & Co., 1923. 839 pp., illus., 9 x 6 in., cloth. 63 s. (Gift of Macmillan Co., N. Y.)

Volume three of the Dictionary maintains the high standard of excellence shown in the first two volumes. It should be of interest to engineers in all branches of the profession, as it contains accurate scientific data and precise theoretical information on measuring instruments and methods of measurement. Among the important articles are: Surveying tapes and wires, by Sydney W. Attwell; Preparation of quartz fibers, by Charles V. Boys; Nomography, by Selig Brodetsky; Physics of the atmosphere, by David Brunt; Measurement of solar radiation, by William W. Coblentz; Watches and chronometers, by E. G. Constable; Design of scientific instruments, by Horace Darwin and Cecil C. Mason; Balances, by F. A. Gould; Meters, by Edgar A. Griffiths; Calculating machines, by Ellice M. Horsburgh; Comparators and line standards of length, by W. H. Johnson; Combination of observations, by H. L. Jolly; Mechanical means of integration, by Hyman Levy; Weighing machines, by George A. Owen; Gauges, by Frederick H. Rolt; Clocks and time-keeping, by Ralph A. Sampson; Metrology, by John E. Sears, Jr.; Humidity, by Sydney Skinner; Draughting devices, by Alma Turner; Micrometers, by H. H. Turner; and Atmospheric electricity, by C. T. R. Wilson. Ample cross-references and a good index are provided, and there are numerous references to other literature on many subjects.

### DIMENSIONAL ANALYSIS.

By P. W. Bridgman. New Haven, Yale University Press, 1922. 112 pp., 9 x 6 in., cloth. \$5.00.

The substance of this book was given as a series of lectures to the Graduate Conference in Physics of Harvard University in 1920.

The growing use of the methods of dimensional analysis in technical physics, as well as the importance of the method in theoretical physics, make it desirable that every physicist should have it at his command. The lack of any systematic exposition of the principles underlying the method, however, has been an obstacle that Professor Bridgman removes by the present book, the first orderly, general exposition of the subject in the English language. His statement of principles is accompanied by many illustrations of their applications, especially chosen to emphasize the points concerning which there is the most common misunderstanding. Some of these deal with important questions of electrical theory, aeronautics and other subjects of interest to engineers.

## ENGINEERING ECONOMICS.

By John C. L. Fish. Second edition. N. Y. & Lond., McGraw-Hill Book Co., 1923. 311 pp., tables, 9 x 6 in., cloth. \$3.00.

Contents: Introduction.—Analysis of the problem of investment.—Interest.—Preliminary analysis of first cost and of operation cost.—Practical analysis of first cost.—Business units.—Irreducible data of problem of investment.—Business statistics.—Miscellaneous forecasts.—Valuation.—Errors in estimating.—Engineering reports.

As the table of contents indicates, this book treats of the principles which underlie economic judgment in the business side of engineering. The present edition, which is practically a new text, assumes choice of investment to be the fundamental problem of engineering economics and proceeds to the analysis of this problem in a way that will give the student a working knowledge of the principles involved.

## THEORY OF SPECTRA AND ATOMIC CONSTITUTION.

By Niels Bohr. Cambridge, University Press, 1922. 126 pp., 9 x 6 in., cloth. \$3.00. (Gift of Macmillan Co., N. Y.).

The three essays which appear here all deal with the application of the quantum theory to problems of atomic structure, and refer to the different stages in the development of this theory.

The first essay, "On the spectrum of Hydrogen," was first published in 1914, when the formal development of the quantum theory was only at its beginning. The second essay, "On the Series Spectra of the Elements," published in 1920, continues the study of the problem and attempts to elucidate it by means of a general principle which postulates a formal correspondence between the fundamentally different conceptions of the classical electrodynamics and those of the quantum theory. The third essay, "The Structure of the Atom and the Physical and Chemical Properties of the Elements," appeared in 1921. It contains a survey of previous results concerning atomic problems and an account of the theoretical ideas of the quantum theory, and shows how these ideas lead to a view of atomic constitution which seems to offer us an explanation of the observed physical and chemical properties of the elements.

## THERMODYNAMICS AND THE FREE ENERGY OF CHEMICAL SUBSTANCES.

By Gilbert Newton Lewis and Merle Randall. N. Y. & Lond., McGraw-Hill Book Co., 1923. 653 pp., tables, 9 x 6 in., cloth. \$5.00.

The authors have attempted to meet the needs of three classes of readers: first, the beginner who wishes to learn what thermodynamics is and what sorts of problems in physics, chemistry and engineering can be solved by its aid; second, the reader who looks for the philosophical implications of such concepts as energy and entropy; third, the investigator who seeks the specific thermodynamic methods which are applicable to the problem of pure or applied science which he has attacked and the data required for its solution. The book is not a textbook in the ordinary sense of the word, although the authors trust that it will be useful in advanced chemical courses. It is designed rather as an introduction to research and as a guide to anyone who wishes to use thermodynamics in productive work.

## ELEMENTS DE MECANIQUE A L'USAGE DES INGENIEURS; STATIQUE CINEMATIQUE.

By Robert d'Adhemar. Paris, Gauthier-Villars et Cie., 1923. 254 pp., 10 x 6 in., paper. 16 fr.

This textbook reproduces the course of instruction given by the author at the Institute Industriel du Nord de la France. It contains the elements of kinematics and dynamics, and an elementary development of statics.

## BIOGRAPHICAL DIRECTORY OF RAILWAY OFFICIALS OF AMERICA, 1922.

N. Y., Simmons-Boardman Publishing Co., 1922. 717 pp., 9 x 6 in., cloth. \$6.00.

The 1922 edition of the Biographical Directory is the first edition since 1913. It includes, in alphabetical arrangement, concise professional records of more than five thousand railroad officials, revised to September 15, 1922. Only thirty-seven per cent of these appeared in the 1913 edition, and only thirteen per cent hold the same positions that they held nine years ago.

## BRIQUETTING.

By Albert L. Stillman. Easton, Pa., Chemical Publishing Co., 1923. 466 pp., illus., 9 x 6 in., cloth. \$6.00.

This is the first American work on the subject of briquetting, and is based, the author states, on many years' experience. The book opens with an account of the raw materials, which is followed by a chapter on briquette presses. Succeeding chapters describe the methods for briquetting various materials, such as steel swarf and turnings, cast-iron borings, non-ferrous metals, wood waste, peat, lignite, coals, flue dusts and ores. Binders are also discussed. Bibliographies and lists of patents on each subject are given.

## DESIGN OF STEAM BOILERS AND PRESSURE VESSELS.

By George B. Haven and George W. Swett. Second edition. N. Y., John Wiley & Sons; Lond., Chapman & Hall, 1923. 435 pp., illus., diags., charts, tables, 9 x 6 in., cloth. \$4.00.

This book is intended primarily to teach rational methods of boiler design, while at the same time it is intended to be an introduction to the study of machine design, a purpose for which the authors believe an analysis of the stresses existing in boilers and other pressure vessels has many advantages.

In general, the results here presented have been obtained by rational rather than empirical methods, the usages of current boiler-making practise having been kept constantly in view. Many graphs and tables are given which enable numerical results to be obtained without using formulas. The principles are illustrated by their application to the complete practical design of boilers and tanks of six different types.

## DROP FORGING AND DROP STAMPING.

By Henry Hayes. Lond. & N. Y., Isaac Pitman & Sons, 1923. (Pitman's Technical Primers). 108 pp., illus., 6 x 4 in., cloth. \$0.85.

In previous books on drop forging, attention has generally been concentrated upon a description of the plant used. A broader treatment has been attempted in this volume, particularly with a view to relating the mechanical with the metallurgical problems. The aim has been to provide an introduction to the equipment and methods of the drop-forge shop, to the principles underlying drop forging and to the heat treatment and hammer treatment of forgings. The question of dies is also discussed.

## PRACTICAL FACTORY ADMINISTRATION.

By Matthew Porosky. First edition. N. Y. & Lond., McGraw-Hill Book Co., 1923. 244 pp., diags., 8 x 5 in., cloth. \$2.50.

The purpose of this book is to present the accepted principles of modern factory administration and to show how they may be effectively applied to actual operating conditions. It is addressed to executives, salesmen, cost accountants and students of industrial administration. The principles, practises and forms that it gives are presented from the point of view of the average rather than the exceptionally large establishment.

# Employment Service Bulletin

**OPPORTUNITIES.**—Desirable opportunities for service from responsible sources are announced in this Bulletin, and no charge therefor is made.

**MEN AVAILABLE.**—Under this heading brief announcements will be published without charge to the members. Announcements will not be repeated except upon request received after a period of three months, during which period names and records will remain in the active files.

**NOTE.**—Notices for the JOURNAL should be addressed **EMPLOYMENT SERVICE, 33 West 39th Street, New York, N. Y.**, the employment clearing house of the National Societies of Civil, Mechanical, Mining and Electrical Engineers.

Notices for the JOURNAL are not acknowledged by personal letter, but if received prior to the 16th of the month will appear in the issue of the following month.

All replies to either "Opportunities" or "Services Available" should be addressed to the key number indicated in each case and forwarded to **EMPLOYMENT SERVICE**, as above.

Replies received by the bureau after the position to which they refer has been filled will not be forwarded, and will be held by the bureau for one month only.

## OPPORTUNITIES

**BOY**, age 14, to learn manufacture and design of motors, practically, commercially and theoretically (including research). Must have proven ability to learn technical subjects more rapidly than can be done in school routine, by learning some subject without adult guidance. Location, Worcester, Mass. V-1744.

**CHIEF OPERATING ENGINEER** for a flour mill and elevator. Mill has a capacity of 3000 barrels daily, storage and elevator 1,800,000 bushels. Power plant, 4400 h. p. Stirling boilers equipped with Westinghouse stokers, two 1250 kv-a. Allis Chalmers turbo generator sets and General Electric switchboard accessories. Will have complete charge of all steam and electrical production, as well as have charge of the heating, ventilating and mechanical equipment of the mill and elevator. Application by letter giving an outline of previous experience, salary expected, and prefer a photograph if one is obtainable. Flour mill experience essential. Location, West. V-3356.

**BETTERMENT ENGINEER.** Technical graduate with at least five years operating experience needed in conjunction with betterment work of public utility plants in Cuba and Panama. Man must be capable of analyzing plant operation and troubles, recommending and carrying to conclusions suggested improvements. Must be well grounded in thermo-dynamics, combustion of oil and general operation of turbines, condensers and auxiliaries. Knowledge of Spanish desirable, but not absolutely necessary, especially if applicant strong in other qualifications. Apply by letter giving full history, education and experience. State nationality, age, present and expected salary, also whether married and number of children. Headquarters, New York City. R-168.

**SALES ENGINEER** to sell insulating varnishes and compounds. Middle Western and Eastern territory. Application by letter stating qualifications and experience. R-223.

**ELECTRICAL ENGINEER** who has been in electrical sign business and has a knowledge of electrical supplies and manufacturing. Application by letter. R-731.

**INSTRUCTORS** in growing electrical engineering department of state institution of high rank in Middle West. Position will pay from \$160-180 per month, depending on experience and training of those selected. Well recommended graduates from good institutions of 1923 will be considered, but applications are desired for one of the openings from those with some teaching experience. Application by letter giving references in first letter and experience in chronological order. R-824.

**ASSISTANT SUPT.** of construction and repair department to large northern N. J. chemical plant. Capable of handling trained men, planning directing and executing variety of construction

and repair work, with or without plans and specifications. Previous experience in steam and electrical generation and distribution desirable. Hours 7-5. Age about 30. Application by letter giving references and salary expected. R-826.

**MECHANICAL ENGINEER** with two or three years' experience in power construction or operation for construction work. Application by letter. Salary not stated. Location, New York State. R-831.

**ASSISTANT PURCHASING ENGINEER.** Would like a man who has had a little experience in purchasing department and some engineering knowledge pertaining to the electrical field. Application by letter. Salary not stated. Location, Ohio. R-832.

**EXPORT SALES ENGINEER** with experience in selling iron and steel products abroad. Latin American experience preferred for service in U. S. Location, South. R-833.

**ELECTRICAL DRAFTSMAN** with power plant and substation experience. Should have about 5 years' experience. Application by letter. Salary not stated. Location, Pa. R-836.

**ELECTRICAL ENGINEER** with power house experience. Switchboard experience and auxiliary wiring experience essential. Application by letter. Salary not stated. Location, Pa. R-837.

**GRADUATE ENGINEER** who has extensive sales experience abroad on factory machinery for responsible position in Asia. Single man preferred. Must be an American citizen. Application by letter. Salary not stated. Location, Asia. R-839.

**YOUNG MAN** for editorial and research work in connection with market analysis. Statistical experience desirable. Application by letter. Salary not stated. Location, N. S. R-840.

**LARGE PUBLIC UTILITY** in Middle West wants young electrical engineering graduate on underground cable research work and other central station problems. Applicant should be well grounded in mathematics. Salary commensurate with ability, good opportunities. In reply give age, education and experience and enclose photo. Location, Middle West. R-841.

**CABLE INSPECTOR** to inspect cables at factory for public utility. Must have this experience. Application by letter. Location, N. Y. C. R-848.

**TRANSMISSION LINE ENGINEER** for estimating, design and construction of high-voltage steel tower lines. Application by letter. Salary not stated. Location, Canada. R-849.

**DESIGNING DRAFTSMAN** with mechanical experience in quantity manufacture, such as electric controlling devices. Application by letter. Salary not stated. Location, Wisconsin. R-854.

**SUPERVISOR OF TESTS** in development laboratory. Electrical or mechanical graduate for test of electrical devices. Practical shop

experience and ability to improve details of apparatus under test will be of value. Application by letter. Salary not stated. Location, Wisconsin. R-855.

**2-3 ENGINEERING DRAFTSMEN** experienced along elevating and conveying machinery lines if possible. Men with personality to eventually develop into salesmen. Application by letter. Salary not stated. Location, New York State. R-856.

**RECENT GRADUATES** for making time studies, statistical work, etc. No experience necessary. Application in person. Salary not stated. Location, New Jersey. R-866.

**SALES ENGINEER** for electric motors and appliances. Application by letter. Salary not stated. Location, Central New York. R-870.

**ELECTRICAL ENGINEER** experienced on power plant, electrical equipment and transmission lines, for construction and design work and technical problems connected with the operation of a large public utility corporation. Give details, education, experience, personal characteristics, references and salary desired. Application by letter. Location, W. Va. R-872.

**ELECTRICAL DRAFTSMAN** for power house and substation layout work. Application in person. Salary not stated. Location, N. Y. C. R-874.

**INSTRUCTOR IN ELECTRICAL ENGINEERING.** Work consists of electrical engineering laboratory and a class in either radio or telephony. Prefer a man with from 1 to 3 years' experience. Salary depends on qualifications. Application by letter. Location, South. R-879.

**ESTIMATOR AND SALESMAN** to be located in Springfield. Prefer man with some experience in the boiler business and some engineering ability. We desire man not too well along in years, who could grow with our business. Application by letter. Salary not stated. Location, Ill. R-884.

**ASSISTANT ENGINEER** with experience on centrifugal pump design. One capable of handling all details of design under supervision of chief engineer. Give experience, education, age and references. Application by letter. Salary not stated. Location, Ill. R-886.

**STATIONARY ENGINEER** for summer hotel in Conn. Open June 1st. Must be able to look after repairs and maintenance. Application by letter. Salary not stated. Location, Conn. R-887.

**TWO HIGH GRADE MECHANICAL DRAFTSMEN** for Pittsburgh district. The kind of men wanted are thoroughly well educated mechanical engineers with at least 10 years' experience along the lines of cranes, marine machinery or steam engines and boilers. Application by letter. Salary not stated. Location, Pa. R-901.

**TECHNICAL GRADUATE** prefer electrical engineer with considerable experience on design

and layout of electrical apparatus in electric power houses. Experience in electric transmission work, although not essential, will be valuable. The work embraces interior layout of electrical apparatus on proposed new power plants and substations. Salary depends on qualifications, initiative and possibilities of development. Application by letter. Salary not stated. Location, New York State. R-904.

**SALESMAN**, should have a working knowledge of the application of time records to manufacturing costs and a clear idea of the principles of electricity as applied to magnetic circuits. He must be situated to approach and work with executives of large organizations and in a position to work on a strictly commission basis. Application by letter. Location, Ill. R-906.

**STRUCTURAL ENGINEER** with experience in design and construction of reinforced concrete and other structures, for public utilities. Application by letter. Salary not stated. Location, Texas. R-907.

**ELECTRICAL ENGINEER**, technical graduate with experience in the design and inspection of overhead and underground electrical distribution and transmission systems, substation and steam electric generating station in the engineering department of a large public utility. Application by letter. Salary not stated. Location, Texas. R-908.

**ELECTRICAL ENGINEER** familiar with steam and hydroelectric plant designs. Man about 10 years out of college with office and construction experience. Application by letter. Salary not stated. Location, Ohio. R-913.

**INSPECTOR** for manufacturers of electric commercial vehicles. Application by letter. Salary not stated. Location, N. Y. C. R-918.

**COMPETENT DESIGNERS** with steam power plant or refinery experience. Immediate work. Application by letter. Salary not stated. Location, Kansas. R-933.

**SALES ENGINEER GRADUATE** for New England territory. Power plant and industrial furnace experience essential. Should know New England trade. Application by letter. Salary not stated. Location, New England. R-937.

**ELECTRICAL ENGINEER** familiar with electrical practices in the coal mining industry. Application by letter. Salary not stated. Location, Pa. R-948.

**ELECTRICAL ENGINEER** experienced alternating high-tension currents, preferably in connection with X-ray work. R-951.

**TRANSMISSION AND DISTRIBUTION ENGINEER**. Duties: Reconstruction, distribution and transmission system, including designing, laying out and overseeing construction of same, also estimating cost of all such work, keeping maps up to date, and other such transmission work. Application by letter. Salary not stated. Location, Pa. R-957.

**GENERAL FOREMAN**. Duties: Assisting superintendent of distribution, overseeing all work of construction and maintenance, line gang, substation operation, etc. Application by letter. Salary not stated. Location, Pa. R-958.

**DISTRICT SUPERINTENDENT**. Duties embrace entire charge of a district including the electrical construction, maintenance, and operation of substation, etc. Also knowledge of artificial gas plant and its operation. Technical graduate preferred. Personality and executive ability required, because of contact with customers. Application by letter. Salary not stated. Location, Pa. R-960.

**COMBUSTION ENGINEER** to take care of our steam plant during the night hours. Application by letter. Salary not stated. Location, Ohio. R-964.

**INSTRUCTOR** in electrical department. Recent graduate considered. Application by letter. Salary not stated. Location, South. R-966.

**ELECTRICAL ENGINEER** as acting Professor. Application by letter. Salary not stated. Location, South. R-967.

**YOUNG ELECTRICAL ENGINEER**, 2-3 years' sales experience, for selling electric rivet heaters. Application in person. Salary not stated. Location, New York City. R-973.

**RADIO ENGINEER**, technical education, electrical engineering experience in testing electrical apparatus, and qualified to conduct tests of remotely controlled apparatus. Application by letter. Salary not stated. Location, R. I. first 10 months, thereafter Mass. R-977.

**YOUNG ELECTRICAL ENGINEER**, 1-2 years' practical experience. Preferably with generating or substation work. Spanish essential. Application by letter. Salary not stated. Location, New York City. R-988.

**ELECTRICAL ENGINEER** about 25 years old, as desk man in the contracting department of public utility. Should be of pleasing personality, able to make up statistical reports, keep records and to give information to customers. Essential that the person employed quickly grasp the requirements of giving electrical service to house lighting customers, particularly. Also will be required to relieve department manager of details of paper work and routine and must carry out instructions as given him without having to be followed up. Application by letter. Salary not stated. Location, Pa. R-996.

**POWER PLANT AND TRANSMISSION LINE DRAFTSMEN**, mechanical, electrical and civil. Reply giving full details of training and experience. Application by letter. Salary not stated. Location, Pa. R-997.

**MAN** having had electrical engineering experience and plant accounting experience. Application by letter. Salary not stated. Location, New York City. R-998.

**ENGINEER** preferably with legal training for cost, rate and contract work in public utilities. Application by letter, stating age, education, and experience in detail. Salary not stated. Location, New York State. R-1008.

**YOUNG ENGINEER** with millwright, boiler room and stationary engine experience. Capable of securing operating engineers' license to develop into maintenance superintendent. Application by letter. Salary not stated. Location, not stated. R-1011.

**YOUNG ENGINEER** for power salesman with large public utility company. Require a man with electrical engineering education and preferably one having previous experience with customers and prospective customers relative to the most advantageous installations. Application by letter. Salary not stated. Location, New York State. R-1016.

**INSTRUCTOR** to teach machine design, internal combustion engines and M. E. laboratory in Southern university. Prefer man with practical or teaching experience in these subjects. Must be technical graduate. Work lasts 9 months starting Sept. Small classes. R-1017.

A large steam electric power system has an opening for an engineer-draftsman. The applicant should be a technical graduate and should be experienced in designing and laying out the mechanical details of steam power stations. Permanent position. Location, N. Y. C. R-1039.

#### MEN AVAILABLE

**EXECUTIVE** available as general manager, work manager, or supervising engineer for financial, utility or industrial corporation. Broad experience organization, financing, administration, production control, economical operation, cost accounting and analysis. E-4250.

**POWER AND MAINTENANCE ENGINEER**, technical graduate, 12 years' experience in power plant and industrial power investigation layout and operation; departmental distribution of power, steam and costs. Thorough acquaintance with steam and electrical equipment. Desires position with industrial organization. Executive and business ability. Location near Philadelphia or New York preferred. E-4251.

**CORNELL ENGINEER**, G. E. Test man, four years' designing, construction, organizing, operating experience, east and west, terminating three year foreign service with commercial selling house, managerial experience, this summer. Desires new foreign service connections. E-4252.

**ELECTRICAL ENGINEER** experienced in design of switchboards and relay protection. Desires position with opportunity for advancement. Good knowledge of transmission lines. E-4253.

**ELECTRICAL ENGINEER**, age 32, 6 years' experience with a utility corporation in connection with the construction and equipment of substations, power houses and electrical railways. Also two years of valuation work, wishes to connect with a valuation or construction concern with chance for advancement. E-4254.

**TECHNICAL GRADUATE**, electrical engineering course, 1917, age 29, married, desires connection with public utility. Five years' experience as manager of steam generating plant. E-4255.

**TEACHER** in high school or college in any of the following subjects: Mathematics, Physics, Mechanical Drawing. Have been at the Bureau of Standards for four years as Assistant Physicist. Have the degrees of M. A. and M. S. E-4256.

**ELECTRICAL ENGINEER**, age 29, graduate leading Southern university. Four years' teaching and two years' general engineering experience. Prefer position with a power and light company or industrial concern but would consider desirable teaching position. Opportunity for advancement and future primary importance. Available June 15th. E-4257.

**ELECTRICAL ENGINEER**, graduate, age 28, married, broad education, former U. S. Army Lieutenant and aviator, 6 years' practical electrical experience desires opening in North Carolina or immediate vicinity, with municipal plant, electrical railway or electrical contractor. E-4258.

**PROFESSORSHIP IN ELECTRICAL ENGINEERING**, desired by technical graduate, Mem. A. I. E. E., with broad commercial, engineering and teaching experience, particularly interested in advanced courses in electrical machinery, electric railway engineering, and power transmission. Salary \$3000-3600, depending on location and opportunities. E-4259.

**ELECTRICAL ENGINEER**: Technical graduate, B. S., age 27, single. Three years teaching State university. Experienced wireman. Location immaterial, available on short notice. Desires location with future. E-4260.

**ELECTRICAL MOTOR DESIGNING ENGINEER**, technical education, age 42 years, married. Assoc. A. I. E. E. Experience in design of medium size polyphase induction and direct-current motors; desires position with an electrical motor manufacturer, as motor designer. Experience: 20 years in the development and testing of motors, investigation and service work, and electrical construction. Also three years as motor designer. Minimum salary, \$3600 per year. E-4261.

**SUPERINTENDENT OR CHIEF OPERATOR OF HYDROELECTRIC PLANT**, transmission and distribution system, wishes to make change. Technical and practical experience, competent to take entire charge of plant, construction, operation and maintenance. Married, age 41, references upon request. E-4262.

**MANAGER ENGINEER**, married. Twenty years' experience in preliminary surveys, construction of hydraulic works and complete electrical plant transmission and distribution system, operation of large and medium sized hydroelectric and steam-electric systems and electric traction in North and South America and the Far East. Have had much foreign experience. Location desired, preferably abroad. Desires engineering management. Willing to investigate and report on foreign properties. Member, A. S. C. E. A. I. E. E. Available anytime. E-4263.

**EXECUTIVE ELECTRICAL ENGINEER**, 37 with 17 years' experience in design, construction and operation of power and substations, industrial buildings, transmission systems, radio stations, electrolysis surveys, handling scientific research problems, in connection with electromagnetic apparatus, illumination and dielectrics, appraisals of plants and handling costs and operating characteristics of electrical and mechanical apparatus. Unquestionable references furnished. Member A. I. E. E., I. R. E., I. E. S. E-4264.

**ELECTRICAL ENGINEER**, age 28, married, 10 years' practical experience on construction, operation and maintenance of central stations and isolated plants also small amount of street railway experience, and one year teaching. Available immediately, eastern locality preferred. E-4265.

**ENGINEER**, 26 years old, desires connection preferably with electrical concern or engineering firm. Technical training; engineering mathematics, drafting, power house experience and languages. In 1921 traveled in Spain, Portugal, France, England, Turkey, Russia, Egypt, Albania and other countries in the capacity of freight solicitor for export and shipping firm now insolvent. At present employed but desire change where ability and training can be utilized to full advantage of employer and employee. Salary open. E-4266.

**ENGINEERING EXECUTIVE**, long experience with high voltages, power transmission hydroelectric installations, design, construction management, desires responsible position along similar lines or would act as consultant. Fourteen years with last connection on various large power propositions, holding leading positions from engineer to general manager. E-4267.

**GENERAL MANAGER**, sales manager or advertising manager. Graduate electrical engineer and post graduate work in business administration. Has built successful record in sale and advertising of several mechanical products. Can take charge of established products or develop new ones to manufacturers or dealers. Capable of rendering valuable assistance in perfecting design and standardizing products. Handles men successfully and smoothly and coordinates inter-departmental relations. Age 29, available July 1. Residence Ohio, location, Los Angeles or New York City. E-4268.

**TECHNICAL GRADUATE**, B. Sc. in electrical engineering, Class of 1918. Four years' experience, one in shop management, two in testing and one in central station commercial work. Would like to locate with a consulting firm or as engineer for a manufacturing concern in or near New York City. E-4269.

**INSTRUCTOR IN ELECTRICAL ENGINEERING** in large mid-western university wants summer employment about June 10th. Three years' teaching experience in the dynamo laboratory and one year steam engine work in the U. S. Navy. Operation or construction work preferred and would consider permanent appointment if conditions prove satisfactory. Salary wanted \$40 per week. E-4270.

**ELECTRICAL DESIGNER**, constructor, operator of switchboards, underground distribution systems, substations, power plants, industrial building layouts, light, power, etc. Technical graduate. Fourteen years' experience. Position desired in middle western states with engineering or industrial firm. E-4271.

**SALES ENGINEER**, technical graduate, eight years' experience in manufacture and sales of electrical apparatus desires to represent one or more manufacturers in the middle west preferable Detroit and surrounding territory. E-4272.

**ELECTRICAL ENGINEER**, technical graduate, age 35, married, desires position as general superintendent or assistant to general manager of public utility. Comprehensive experience in design and operation of power plants, transmission and distribution systems. Well informed as to rates and ratemaking. Completed Alexander

Hamilton Institute business course. At present employed but available on reasonable notice. E-4273.

**ELECTRICAL ENGINEER**, age 27, Armour graduate, three years' each radio and electrical engineering experience; one years' course Western Electric Company's manual and machine switching school; one and one quarter years' instructor of electrical and radio engineering subjects, desires position with some reliable, growing engineering company. Chicago or Western States preferred but others also considered. Associate A. I. E. E. Associate I. R. E. Available August 1, 1923. E-4274.

**ELECTRICAL ENGINEER**, M. I. T. '22 with nine months' experience in illuminating engineering and lighting service department of large public service corporation desires position as electrical or illumination engineer involving some commercial work and selling. At present employed. Location desired, New York City. E-4275.

**ELECTRICAL ENGINEER**, age 27, 1 1/2 years on test, 6 years' experience in design and construction of hydroelectric power plants and substations. Desires position in engineering department of smaller or medium sized public utility or consulting engineering corporation where opportunity of advancement is given. East or Middle West preferred. E-4276.

**EXECUTIVE SALES ENGINEER**. Briefly stated my technical education and broad business experience has afforded me the opportunity of establishing an excellent sales record having held a position of district manager for seven years and the work has been such as to bring me in close contact with the personnel of consulting engineers, railroads, industrial plants, and central stations covering a territory from New York to Baltimore. Wish to join sales organization or control agency for manufacturer of electrical or mechanical apparatus of merit. Location, New York. E-4277.

**ENGINEERING EXECUTIVE**, 7 1/2 years, experience since graduation in evolution, maintenance and production, desires position with growing company. For past three and a half years in engineering department of large, well known company. Eighteen months in charge of design of one of heavy machines manufactured. Two years in charge of electrical engineering and controller design department. Have just completed reorganization of shop controller assembly department whereby work is now on a real production basis. Position preferably to comprise commercial or productive work rather than pure engineering, and must provide opportunity for expansion. E-4278.

**POWER SUPERINTENDENT OR CHIEF ENGINEER** to take charge of operation and maintenance of one or more power plants, steam or hydro electric or both. 14 years' experience, 5 years' as superintendent and chief operating engineer. Wide experience on large high voltage power systems, large turbines, boilers, stokers fuel oil, etc. Good education, thorough knowledge of combustion and thermodynamics. Age 33, married. Available 15 days after agreement. Location immaterial. E-4279.

**OPPORTUNITY IN PUBLIC UTILITY**. Will graduate in June B. Sc. in E. E. Studied central stations, power transmission, advertising the technical product, sales and business. Wants chance to start in public utilities. E-4280.

**ELECTRICAL ENGINEER**. Graduate 1919. Age 27, married. Assoc. A. I. E. E. 10 months standardizing and repairing electrical instruments and meters, also steam and pressure gages. G. E. test, including railway. 18 months designing and drafting substation, switching structures, and towers for transmission system for voltages up to 110 kv., also distribution and customers stations. Desires position offering possibilities of advancement and a future with either an industrial concern or a power company preferably in construction work. E-4281.

**STUDENT** in the last year of an evening course in electrical engineering, age 23, desires position in New York City with electrical concern. Considers advancement and training of primary importance. Past experience, drafting and mechanic. Available on one week's notice. E-4282.

**EMBRYO ELECTRICAL ENGINEER** receiving B. S. in E. E. in May desires position where mathematical and analytical ability is desirable. Has a good grounding in physics, 6 months' experience in drafting and production methods. E-4283.

**BEFORE** the War, I represented German firms in countries where British interests predominated. After a comprehensive study of American modern business methods I offer myself to American firms engaged in export trade for service in the U. S. A. or abroad. Qualified electrical mechanical engineer, age 32, possessing the operator's viewpoint after years of supervising construction and operation on silver-gold-coal-tin and nitrate of soda mines. Speak Spanish and English. Widely traveled, used to meeting executives as well as operators, with confidence and assurance. E-4284.

**YOUNG MAN**, 25, single, graduated in electrical engineering, 1921, is looking for a career with some organization and is willing to break in on some phase of engineering work. Manufacturing, testing or public utility desirable. At present employed but will be available May 1st. Will go anywhere. E-4285.

**ELECTRICAL ENGINEER**, age 30, technical graduate desires position along qualified lines. Experience includes Westinghouse test, testing and research at Bureau of Standards, three years responsible charge of experimental and testing laboratory in motor manufacturing concern, and past two years engaged in teaching electrical engineering and physics. Has studied accountancy and cost accounting. Available within reasonable time. E-4286.

**ELECTRICAL ENGINEER**. B. S. 1921, E. E. 1922, with practical experience in accounting and cost work desires connection with responsible concern as junior executive. Can act as valuable assistant to executives. Ambitious and can grasp facts quickly. E-4287.

**SWITCHBOARD SPECIALIST, TRANSMISSION AND DISTRIBUTION ENGINEER**. Technical graduate with B. S. and M. S. Degrees, age 27, single, Associate in A. I. E. E. with over six years, experience in combined installation, testing, design, research and teaching in Electrical Engineering. E-4288.

**ELECTRICAL ENGINEER**. Technical graduate, 1914, experience consists of operating engineer in power plant, installation of electrical equipment, motors, and motor control systems. Distribution system layout, and motor sales engineer. Desires permanent and responsible position with a public utility company in the sales or engineering department, or with a manufacturer who is in need of a technical man to handle the electrical and mechanical equipment. Location immaterial. Salary dependent upon location. E-4289.

**PRACTICAL INVESTIGATOR** of manufacturing problems and industrial engineer. Machinist, technical graduate, foreman, superintendent, manager. Permanent connection preferred. Age 42. Married. E-4290.

**SALES ENGINEER**. Experienced technical graduate desires position as salesman, representative, well established company offering a high grade product, preferably along electrical lines. Salary and commission. E-4291.

**ELECTRICAL ENGINEER** with American and European experience, speaking English, French, Italian, German and Dutch fluently, good salesman with representative and executive abilities, knowing thoroughly the European market and trade, wishes to represent American electrical or mechanical manufacturer in Europe. E-4292.

## MEMBERSHIP — Applications, Elections, Transfers, Etc.

- ASSOCIATES ELECTED APRIL 13, 1923**
- ADAMS, IRA J., Head of Patent Dept., Radio Corporation of America, 64 Broad St., New York, N. Y.
- AIRD, ALANSON W., Engineer in Charge, Radio Corp. of America, Port Jefferson, N. Y.
- ARKINSON, THOMAS J., Power Plant Engineering Dept., New York Telephone Co., 104 Broad St., New York, N. Y.
- ARMSTRONG, THOMAS W., Asst. Supt. of Construction, Penn. Public Service Corp., 222 Levergood St., Johnstown, Pa.
- \*ASHLEY, DAVID PEIRCE, Laboratory Assistant, New York Edison Co., 92 Vandam St., New York; res., Brooklyn, N. Y.
- AVENDANO, JULIO, Export Division, Radio Corp. of America, 233 Broadway, New York, N. Y.
- \*BANISTER, WILLIAM CONSTABLE, Student, Electrical Engg. Dept., Marquette University, Milwaukee, Wis.
- \*BANK, MARTIN LUTHER, Junior Engineer, Commonwealth Edison Co., 72 West Adams St., Chicago, Ill.
- BARRON, DONALD WYANT, Engineer, Albert F. Ganz, Inc., 511-5th Ave., New York, N. Y.
- BARTON, FREDERICK BERTRAM, Chief Electrician McGill University, Montreal, Que., Can.
- \*BASS, ALEXANDER HEUREUX, Technical Apprentice, Westinghouse Elec. & Mfg. Co., South Philadelphia; res., Chester, Pa.
- \*BASS, PERCY BRUCE, Cadet Engineer, Public Service Electric Co., 80 Park Place, Newark; res., Jersey City, N. J.
- \*BAUM, EDWIN KENNETH, Student, Stanford University, Stanford University, Calif.
- BEGOON, GEORGE FLORY, Salesman, Westinghouse Electric International Co., 165 Broadway, New York, N. Y.
- BELKNAP, J. HARRISON, Asst. Professor of Elec. Engg., Oregon State Agricultural College, Corvallis, Ore.
- BELL, EMERSON DeWITT, Power Equipment Engineer, Western Electric Co., 397 Hudson St., New York, N. Y.
- BENZ, BERNHARD, Transmission Engineer, Pacific Tel. & Tel. Co., Telephone Bldg., Portland, Ore.
- \*BEREJKOFF, ANATOL PETROVICH, Radio Engineering Dept., General Electric Co., Schenectady, N. Y.
- BEST, GERALD MARTIN, Telephone Engineer, The Pacific Tel. & Tel. Co., 507 Sheldon Bldg., San Francisco, Calif.
- BEVERAGE, HAROLD HENRY, Radio Engineer, Radio Corp. of America, 233 Broadway, New York, N. Y.; for mail, Belmar, N. J.
- BISSIRI, ALFIO, Electrical Draftsman, So. California Edison Co., 2nd and Boylston Sts., Los Angeles, Calif.
- \*BLACK, JOHN CLINTON, Representative, Electric Storage Battery Co., 1508 Federal Reserve Bank, St. Louis, Mo.; res., Bentonville, Ark.
- BLAIN, JAMES G., Inspector, Western Union Telegraph Co., 606 Sloan Bldg., Cleveland, Ohio.
- \*BREWSTER, LOUIS C., Division Transmission Engineer, The Ohio Bell Telephone Co., 97 Lincoln St., Akron, Ohio.
- BRIGGS, ELMER CURTIS, Engineer, Ohio Bell Telephone Co., 4300 Euclid Ave., Cleveland, Ohio.
- BROACH, KEATOR THOMPSON, Estimator, Krug Electrical Construction Co., 35 Murray St., New York, N. Y.; res., Ridgewood, N. J.
- BROOKS, GUY W., Switchboard Engineering Specialist, General Electric Co., 1100 Electric Bldg., Buffalo, N. Y.
- BROWN, MELVIN P., Chief Estimator, Post & Powers, 70 E. 45th St., New York, N. Y.
- BROWNING, KENNETH WALKER, Draftsman, Service Dept., Utah Power & Light Co., 133 South West Temple St., Salt Lake City, Utah.
- BUCKHEIT, WILLIAM, Foreman, Croker Fire Prevention Co., 22 W. 30th St., New York, N. Y.
- BUCKLEY, HARRY GUNNING, JR., Journeyman Electrician, 314-11th St., Brooklyn, N. Y.
- BULLEN, CHARLES V., Instructor in Elec. Engg., Oklahoma Agricultural and Mechanical College, Stillwater, Okla.
- BURGETT, JAMES EARL, Tester, The Foundation Co., Power; for mail, Warwood, W. Va.
- BURKHOLDER, JOHN CHARLES, JR., Telephone Engineer, Western Electric Co., 463 West St., New York, N. Y.
- CADWALLADER, ASA GLENN, Engineering & Drafting, Columbus Railway, Power & Light Co., 104 N. 3rd St., Columbus, Ohio.
- CARROLL, G. REES, Asst. Electrical Superintendent, Jones & Laughlin Steel Co., Woodlawn, Pa.
- CASE, EVERETT WALTER, Head of Electrical Dept., Ralston Industrial School, 15th & Penn. Ave., Pittsburgh; res., Wilkinsburg, Pa.
- CHATHAM, FRANCIS MARION, JR., Test Dept., Eastern Shore Gas & Electric Co., 107 Main St., Salisbury, Md.
- CHESEBRO, MILTON E., Asst. Wireman, Spokane & Eastern Ry. & Power Co., Inland Empire R. R. Co., Spokane, Wash.
- CHITTICK, WILLIAM ALFRED, Sales Engineer, Allis-Chalmers Mfg. Co., Milwaukee, Wis.
- CLARK, ORSON BRUCE, Automatic Control Work, Duquesne Light Co., 3708-5th Ave., Pittsburgh, Pa.
- CLARKE, EDITH, Engineer in Lighting Dept., General Electric Co., Schenectady, N. Y.
- COLE, HOWARD WILLIAM, Foreman, Inside Construction Dept., Pennsylvania Power & Light Co., 803 Hamilton St., Allentown, Pa.
- COLLETTE, REGINALD C., Service Engineer, Westinghouse Elec. & Mfg. Co., 467-10th Ave., New York, N. Y.
- COMISKEY, WALTER V., Electrician, Richmond Light & Railroad Co., Livingston, S. I.; res., New York, N. Y.
- CONNERY, ALDER F., Printing Telegraph Expert, Postal Telegraph-Cable Co., 253 Broadway, New York; res., Springfield, N. Y.
- COOLEY, JOHN ROGER, Operating Engineer, Standard Oil Co., Elizabeth; res., Plainfield, N. J.
- COOPER, ALFRED M., Instructor, Electrical Machinery Dept., Lathrop Trade School, 13th & Central, Kansas City, Mo.
- COSMENKY, G. FRANCIS, Electrical Detailer, McClellan & Junkersfeld, 45 William St., New York; res., Stapleton, S. I., N. Y.
- COX, FRANCIS A., Development Engineer, Western Electric Co., 463 West St., New York, N. Y.
- CUNNINGHAM, ALLAN, President & Manager, Allan Cunningham Co., Inc., 7500 Carleton Ave., Seattle, Wash.
- CURETON, FRANCIS HUMPHREY, Elec. Tester, Motive Power Dept., Interborough Rapid Transit Co., 600 W. 59th St., New York, N. Y.
- DEAN, CHARLES E., Telephone Transmission Research, Western Electric Co., 463 West St., New York, N. Y.
- DEAN, CHARLES H., Sales Engineer, Westinghouse Elec. & Mfg. Co., 10 High St., Boston; res., Woburn, Mass.
- de ARELLANO, JUAN R., Electrical Engineer, Mexican Light & Power Co., Necaxa, Puebla, Mexico.
- DONAHUE, JOHN C., General Foreman, Electrical Construction, Charles H. Tenney & Co., 200 Devonshire St., Boston, Mass.
- DREHER, CARL, Radio Receiving Engineer, Radio Corp. of America, Riverhead; res., New York, N. Y.
- DREYER, JOHN F., JR., Instructor, Stevens Institute of Technology, Hoboken, N. J.
- DYKE, MINOR BOWLES, Substation Dept., Northern Ohio Traction & Light Co., Akron, Ohio.
- \*EATON, EARLE, Equipment Dept., American Tel. & Tel. Co., 118 Clifford St., Detroit, Mich.
- \*EGE, WILLIAM W., Substation Operator, Commonwealth Edison Co., 72 W. Adams St., Chicago, Ill.
- ELLIS, WILLIAM G., Electrical Engineer, Charles E. Bonine, 713 Franklin Trust Bldg., Philadelphia, Pa.
- EVERIST, THOMAS B., Laboratory Assistant, Leeds & Northrup, 4901 Stenton Ave., Philadelphia, Pa.
- FALKNER, FRANK B., Radio Engineering Dept., Westinghouse Elec. & Mfg. Co., East Pittsburgh, Pa.
- FELL, ROBERT A., Electrical Tester, Westinghouse Elec. & Mfg. Co., East Pittsburgh; res., Wilkinsburg, Pa.
- FEY, CHARLES F., Asst. Engineer, New York & Queens Electric Light & Power Co., Bridge Plaza, Long Island City, N. Y.
- FITCH, JAMES HUBER, Chief Clerk to Asst. General Manager, Cleveland Electric Illuminating Co., 1123 Illuminating Bldg., Cleveland, Ohio.
- FITZGERALD, JOHN, Works Accountant, General Electric Co., 42 Center St., W. Lynn, Mass.
- FLYE, WILLIAM L., Section Layout Engineer, American Tel. & Tel. Co., 195 Broadway, New York, N. Y.; res., Glen Ridge, N. J.
- GARRISON, DWIGHT, Engineer, Bell Telephone Co. of Pennsylvania, 261 N. Broad St., Philadelphia, Pa.
- GERRINGER, HAROLD LeROY, Electrical Draftsman, Philadelphia & Reading Railway Co., Reading, Pa.
- \*GILBERT, MERT G., Service Man, Empire District Electric Co., Picher; res., Hockerville, Okla.
- GLENDING, WILLIAM RALPH, Superintendent, Nelsonville Electric Co., Nelsonville, Ohio.
- GRAHAM, RHODES T., Station Chief, Southern California Edison Co., Porterville, Calif.
- GRAHAM, TOM, Superintendent of Lines, Eastern Shore Gas & Electric Co., Salisbury, Md.
- GRANAU, EDGAR LUCIAN, Engineering Dept., Blackstone Valley Gas & Electric Co., 1-3 Clinton St., Woonsocket, R. I.



- GRIFFITHS, CLARENCE M.**, Radio Engineer, Radio Corp. of America, 233 Broadway, New York, N. Y.  
**\*GUENTHER, FELIX GUSTAV HERMAN**, Student, Engineering Dept., University of Wisconsin, Madison, Wis.  
**GUSTAFSON, EDGAR H.**, General Commercial Engineer, Ohio Bell Telephone Co., 4300 Euclid Ave., Cleveland, Ohio.  
**HAGEN, ROY CHARLES**, Local Sales, General Electric Co., Electric Bldg., Butte, Mont.  
**HALPERN, HENRY H.**, President, Phi Electric Co., 110 W. 40th St., New York; res., Brooklyn, N. Y.  
**HAMILTON, HAROLD CYRLE**, Head of Electrical Testing Div., Edison Electric Illuminating Co. of Boston, Roxbury; res., Boston, Mass.  
**HAMILTON, NANCE L.**, Chief Electrician, Federal Glass Co., Columbus, Ohio.  
**HAND, ELLSWORTH JOSEPH**, Asst. Operator of Substation, Potomac Electric Power Co., 512-11th St., N. W., Washington, D. C.  
**HANSELL, CLARENCE WESTON**, Radio Engineer, Radio Corp. of America, 233 Broadway, New York, N. Y.  
**\*HANNUM, DANE M.**, Telephone Systems Laboratories, Western Electric Co., 463 West St., New York, N. Y.  
**HARTER, LESLIE JOHN**, Telephone Engineer, American Tel. & Tel. Co., 4300 Euclid Ave., Cleveland, Ohio.  
**\*HAUG, ANDREW JOHAN**, Electric Power Station Operator, City Light & Power, 2117 Ravenna Blvd., Seattle, Wash.  
**HEISTAD, ROLF**, Electrical Draftsman, Southern California Edison Co., 2nd & Boylston Sts., Los Angeles, Calif.  
**HERZOG, EUGENE**, Testing Dept., United Electric Light & Power Co., 514 W. 147th St., New York, N. Y.  
**HEWLETT, FRANK GURLEY**, Electrical Engineer, Allison Lumber Co., Inc., Allison, Ala.  
**HIGASHIJIMA, KOZO**, Electrical Engineer, Ujigawa Electric Co., Sonesaki Naka 2-Chome Kitaku, Osaka, Japan; for mail, New York, N. Y.  
**HILL, ARTHUR PAUL**, Transmission Radio Engineer, Pacific Tel. & Tel., 740 S. Hope St., Los Angeles, Calif.  
**HILLEGASS, JONATHAN BERTOLET**, Co-Motor Engineering Dept., General Electric Co., Erie, Pa.  
**HILLIER, CLIFFORD GRAY**, Manager, Merchandising Div., Westinghouse Elec. & Mfg. Co., 10 High St., Boston, Mass.  
**\*HOBBS, GEORGE VERNON**, Asst. Engineer Mt. Vernon Woodberry Mills, Inc., Hampden Station, Baltimore, Md.  
**HOBSON, C. C.**, Plant Engineer, The Pacific Tel. & Tel. Co., Portland, Ore.  
**HOLM, CHARLES LEWIS**, Electrical Engineer, Cleveland Electric Illuminating Co., Public Square, Cleveland, Ohio.  
**HOLMAN, JOHN ALBERT**, Directory Manager, The Ohio Bell Tel. Co., 4300 Euclid Ave., Cleveland, Ohio.  
**HOPSON, WILLIAM H.**, Construction Foreman, Portland Railway, Light & Power Co., Hawthorne Bldg., Portland, Ore.  
**\*HUMRICKHOUSE, RALPH R.**, Asst. to Division Traffic Engineer, Ohio Bell Telephone Co., 4300 Euclid Ave., Cleveland, Ohio.  
**HUNTINGTON, ERNEST KYLE**, Relay Engineer, Rochester Gas & Elec. Corp., Rochester, N. Y.  
**HURD, HOWARD HARTWELL**, Radio Research Engg. Dept., National Lamp Works of General Electric Co., Nela Park, Cleveland, Ohio.  
**HUSTON, CLAUDE B.**, Power & Mining Engineering Dept., General Electric Co., Schenectady, N. Y.  
**HUTCHESON, JAMES PARKS**, Manager, Electrical Engineering Mfg. Co., 422 Union Bldg., Cleveland, Ohio.  
**\*IRVINE, CHARLES NES**, Electrical Engineer, 5 Schultz Opera Block, Zanesville, Ohio.  
**JENKINS, PAUL S.**, Designing Engineer, Square D Co., 6060 Rivard St., Detroit, Mich.  
**JEYNES, PAUL H.**, Cadet Engineer, Public Service Electric Co., 80 Park Place, Newark, N. J.; res., Ansonia, Conn.  
**JOHANSEN, THEODORE ROCKWOOD**, Asst. Electrical Engineer, Interborough Rapid Transit Co., 600 W. 59th St., New York, N. Y.  
**JOHNSTON, JACK FRANK**, Draftsman, Portland Railway, Light & Power Co., Electric Bldg., Portland, Ore.  
**JUFER, WALTER**, Draftsman, General Electric Co., Schenectady, N. Y.  
**KASSOY, NATHAN**, Meterman, Bronx Gas & Electric Co., 43 Westchester Sq., New York, N. Y.  
**KELLER, JOSEPH MYERS**, Electrician, General Electric Co., Erie; res., Harbour Creek, Pa.  
**\*KEMPSON, JAMES M.**, Student Engineer, Testing Dept., General Electric Co., Schenectady, N. Y.  
**KENT, HAROLD DEAN**, Engineer in Charge, Radio Corp. of America, Aeolian Hall Sta., 6th Ave. & 42nd St., New York, N. Y.  
**\*KERR, CLARENCE LEROY**, Testing Dept., General Electric Co., Schenectady, N. Y.  
**\*KETCHAM, E. D.**, Central Y. M. C. A., Albany, N. Y.  
**KING, ELMER DAN**, Asst. Property Engineer, The Detroit Edison Co., 2000-2nd Ave., Detroit, Mich.  
**KINNEY, CLAIR Y.**, Electrical Foreman, Fisher Body Corp., West End & Fort St., Detroit, Mich.  
**KINZIE, P. ALEXANDER**, Senior Engineer Draftsman, United States Reclamation Service, 300 Wilda Bldg., Denver, Colo.  
**KISHPAUGH, ARTHUR W.**, Engineer, Western Electric Co., 463 West St., New York, N. Y.  
**KNIGHT, MONTGOMERY**, Aeronautical Engg. Dept., Massachusetts Institute of Technology, Cambridge, Mass.  
**KNOWLES, ARTHUR W.**, Chief Repairman, New England Tel. & Tel. Co., 26 Mechanic St., Worcester, Mass.  
**KUHN, CLARENCE WILBUR**, Drafting Engineer, Union Gas & Electric Co., Cincinnati; res., California, Ohio.  
**LANG, HAROLD CLYDE**, Chief Electrical Engineer, Clarksburg Gas & Electric Co., Clarksburg, W. Va.  
**LEACH, DALLAS A.**, Asst. Building & Equipment Engineer, Ohio Bell Telephone Co., 4300 Euclid Ave., Cleveland, Ohio.  
**LEAVELL, GEORGE HENRY**, Electrician, Oregon Electric Railway, Salem, Ore.  
**LECONTE, ROBERT A.**, Engineering Dept., Western Electric Co., 463 West St., New York, N. Y.  
**LENZ, ANDREW H.**, Telephone Engineer, American Tel. & Tel. Co., 4300 Euclid Ave., Cleveland, Ohio.  
**LEWANDOWSKI, OTTO H.**, Engineering Draftsman, New York Central Railroad, 466 Lexington Ave., New York; res., Freeport, N. Y.  
**\*LEWIS, AMOS L.**, Director of Manual Arts, Holdenville High School, Holdenville, Okla.  
**LOVING, ORVILLE ORAN**, Powell, Wyo.  
**LUND, CARL EDWIN**, Engineering Dept., Western Electric Co., Chicago, Ill.; res., E. Orange, N. J.  
**MACLEOD, HECTOR JOHN**, Assoc. Professor of Electrical Engineering, University of Alberta, Edmonton, Alberta, Can.  
**\*MAGNUSON, JOHN E.**, Draftsman, Phoenix Utility Co., Glencoe Bldg., Duluth, Minn.  
**\*MARQUIS, VERNON M.**, Student Engineer, General Electric Co., Schenectady, N. Y.  
**\*MARSHALL, WALTER WILLIAM**, Student Engineer, Electrical Construction, Allis-Chalmers Mfg. Co., 431-63rd Ave., W. Allis, Wis.  
**MARTIN, GEOFFREY EDWARD**, Electrical Engineer, Bombay, Baroda & Central India Railway, Churchgate St., Bombay, India.  
**MATHES, CHARLES E.**, Sales Engineer, General Electric Co., 820 Spitzer Bldg., Toledo, Ohio.  
**MATTSON, WALTER AXEL**, General Electric Co., W. Lynn Works, W. Lynn, Mass.  
**McKAY, HERBERT**, Chief Electrician, Lincoln Mills, Ltd., Merriton; res., St. Catharines, Ont., Can.  
**McNEILL, CLARENCE ESBIN**, Electrical Designer, Philadelphia Electric Co., 1000 Chestnut St., Philadelphia, Pa.  
**McNERNEY, ADELBERT M.**, Electrical Engineer, Cleveland Electric Illuminating Co., 826 Cleveland Electric Illuminating Bldg., Cleveland, Ohio.  
**MECHLING, EUGENE BURLINGAME**, Engineering Assistant, Bell Telephone Co. of Penna., 261 N. Broad St., Philadelphia, Pa.  
**MESLO, CLARENCE EDWARD**, Chief Electrician, C. R. Wilson Body Co., Clay Ave., & G. T. R. R., Detroit, Mich.  
**MITCHELL, CLAIR DETOS**, Radio Physicist, Westinghouse Lamp Co., Bloomfield, N. J.  
**MONTGOMERY, JOHN ALVIN**, Draftsman & Engineer, Columbus Railway, Power & Light Co., 104 N. 3rd St., Columbus, Ohio.  
**MOODY, HARRY LAWRENCE**, Manager, Central Station Division, Westinghouse Elec. & Mfg. Co., 1442 Widener Bldg., Philadelphia, Pa.  
**MOORE, CHARLES EDGAR, JR.**, Requisition Engineer, General Electric Co., 1900 Washington Blvd., Baltimore, Md.  
**MORGAN, KENNETH F.**, Transmission Engineer, The Pacific Tel. & Tel. Co., 740 S. Olive St., Los Angeles, Calif.  
**MORSE, WILLIAM ORSON**, Engineer, A. C. Design, General Electric Co., Schenectady, N. Y.  
**\*MOULTON, BRUCE S.**, Engineering Dept., Consumers Power Co., Jackson, Mich.  
**MUEHLIG, RALPH E.**, Asst. Supt., Elec. Div., Service Dept., Westinghouse Elec. & Mfg. Co., 12 Farnsworth St., Boston; res., Lawrence, Mass.  
**\*MURPHY, MATTHEW F.**, Draftsman, Portland Railway, Light & Power Co., 623 Electric Bldg., Portland, Ore.  
**MURRAY, FREDERICK JOHN**, Asst. Engineer, New York Telephone Co., 104 Broad St., New York, N. Y.  
**MYERS, WARREN KNODE**, Testing Dept., Raystown Water Power Co., Huntingdon, Pa.  
**NEUBER, OTTO**, Master Mechanic, Cohen Friedlander & Martin Co., Orange & Erie Sts., Toledo, Ohio.  
**NOERTKER, JOSEPH ANTHONY**, Engineering Dept., Cincinnati Traction Co., Cincinnati; res., Newport, Ky.  
**O'BRIEN, LAURENCE A.**, Engineer, Federated Engineers Development Corp., 154 Ogden Ave., Jersey City; res., S. Orange, N. J.  
**OLMSTED, IRL L.**, Draftsman, Portland Railway, Light & Power Co., 623 Electric Bldg., Portland, Ore.  
**\*ORR, ROBERT CALVIN, JR.**, Supervising Foreman, Construction Dept., New York Tel. Co., 227 E. 30th St., New York; res., Brooklyn, N. Y.  
**\*OSTROM, CYRUS W.**, Electrical Engineer, C. Kirk Hillman Co., 315-1st Ave. S., Seattle, Wash.  
**PEACOCK, THOMAS EDWARD**, Superintendent of Distribution, Arizona Power Co., Clarkdale, Ariz.

- PENNELL, ROBERT OTIS, Traffic Engineering, American Tel. & Tel. Co., 195 Broadway, New York, N. Y.
- PFAUTZ, CHRISTIAN E., Receiving Engineer, Radio Corp. of America, Riverhead, L. I., N. Y.
- PHILLIPS, FRANK D., Electrical Engineer, General Electric Co., Schenectady, N. Y.
- POWELL, CARROLL ARTHUR, Captain, Signal Corps, U. S. Army, Yale University, New Haven, Conn.
- PROSSOR, DONALD KEMP, Wire & Cable Dept., Electrical Testing Laboratories, 80th St. & East End Ave., New York; res., Brooklyn, N. Y.
- QUIGLEY, WILLIAM JAMES, Supervisor, New York Telephone Co., Bay Shore, N. Y.
- RADEL, LADA F., Telephone Engineer, Ohio Bell Telephone Co., 4300 Euclid Ave., Cleveland, Ohio.
- REARDON, KENNETH NORMAN, Senior Student, Harvard Engineering School, Cambridge; res., Boston, Mass.
- REED, THOMAS CLIFFORD, Superintendent of Underground Cable, Bell Telephone Co., 225 E. 4th St., Cincinnati, Ohio.
- RICE, HARRY JAMES, Secretary, Tiffany Electric Co., Inc., 131-143 Howell St., Jersey City, N. J.
- RICHARDSON, JOCELYN ARTHUR ST. CLAIR, Electrical Engineer, The English Electric Co., Queens House, Kingsway, London W. C. 1; res., Surbiton, Eng.
- RILEY, JAMES RUSSELL, Asst. Engineer, New York Telephone Co., 104 Broad St., New York, N. Y.
- ROEVER, FRANK HUGO, Foreman of Testing, Allis-Chalmers Mfg. Co., East Norwood; res., Cincinnati, Ohio.
- ROLOFF, DELBERT F., Floor Engineer, Transformer Dept., General Electric Co., Ft. Wayne, Ind.
- ROOKS, ALFRED WENDELL, Electrician, Chevrolet Motor Co., of Michigan, Flint, Mich.
- ROSS, JOSEPH PAUL, Asst. Plant Engineer, The Steel & Tube Co. of America, Evanston Plant, Cor. Dempster St. & Dodge Ave., Evanston, Ill.
- ROSSRUCKER, EDGAR A., Chief Clerk to Chief Engineer, The Ohio Bell Telephone Co., 4300 Euclid Ave., Cleveland, Ohio.
- \*ROWE, NORMAN OEHL, In Charge of Electrical Drafting Dept., Adirondack Power & Light Corp., Schenectady; res., Amsterdam, N. Y.
- RUDOLPH, PAUL CLIFTON, Distribution Engineering Assistant, Indiana Service Corp., 122 E. Wayne St., Ft. Wayne, Ind.
- \*RUSSELL, HOWARD CHRISTIAN, Private Secretary to Production Manager, Bishop Babcock Co., E. 49th St. & Hamilton Ave., Cleveland, Ohio.
- SCHOTT, JOHN THEODORE, Development & Research Dept., American Tel. & Tel. Co., 195 Broadway, New York, N. Y.
- SCHULENBURG, EDWARD J., Electrician, M. & E. Dept., Iowa Railway & Light Co., Cedar Rapids, Iowa.
- SCHULTZ, OTTO HENRY, Jr., Sales Engineer, Westinghouse Elec. & Mfg. Co., 1333 Candler Bldg., Atlanta, Ga.
- \*SCHULZE, RAYMOND P., Line Construction Foreman, Pacific Gas & Electric Co., 445 Sutter St., San Francisco, Calif.
- \*SCOTT, HOYT SOUTHWICK, Engineer, Ohio Bell Tel. Co., 4300 Euclid Ave., Cleveland, Ohio.
- SEELY, KENNETH BAYARD, Electrical Draftsman, Stone & Webster, Inc., 147 Milk St., Boston; res., Melrose, Mass.
- SHARMAN, FRANK HENRY, Inspector, Western Electric Co., 104 Broad St., New York; res., Brooklyn, N. Y.
- SHAW, RALPH MARTIN, Jr., Inspector, San Joaquin Light & Power Co., Fresno, Calif.
- SHREVE, CHARLES TRAVIS, General Foreman, Telegraphs & Signals, Pennsylvania Railroad Co., 438 E. State St., Trenton, N. J.
- SHUTOW, TOKUCHIYO, Electrical Engineer, c/o Mitsui & Co., 65 Broad St., New York, N. Y.
- SMITH, FRANK STEED, Engineer, Ohio Bell Telephone Co., 4300 Euclid Ave., Cleveland, Ohio.
- SMITH, EVERETT HARRISON, Telephone Equipment Engineering, Western Electric Co., 463 West St., New York, N. Y.
- SMITH, HARRY S., Designing Electrical Engineer, Westinghouse Elec. & Mfg. Co., E. Pittsburgh; res., Wilksburg, Pa.
- \*SPOFFORD, FRANKLIN D., Traffic Engineer, The Beeler Organization, 52 Vanderbilt Ave., New York, N. Y.
- STERNE, WILLIAM CHARLES, President & General Manager, Municipal Properties Investing Co., 1065-67 Gas & Electric Bldg., Denver, Colo.
- \*STEWART, RONALD BOWMAN, Transmission Engineer, Pacific Tel. & Tel. Co., 835 Howard St., San Francisco, Calif.
- \*STEVENSON, WILLIAM NELSON, Draftsman, Stone & Webster, Inc., Boston, Mass.
- ST. MARTIN, ALGERNON SHELTON, Power Station Engineer, Simla Municipal Electricity Dept., Chaba, Simla, N. India.
- \*STOKES, BENJAMIN BOULWARE, JR., Wireman, American Tel. & Tel. Co., 1422 Hurt Bldg., Atlanta, Ga.
- STORMZAND, HAROLD ADRIAN, Teacher, Case Technical High School, 1021-2nd St., Detroit, Mich.
- \*STRAUSS, JACOB S., Electrical Inspector, New York, New Haven & Hartford R. R., Van Nest Electric Shops, Van Nest & Mathews Aves., New York, N. Y.
- \*STRONG, LEWIS B., Electrical Tester, Brooklyn Rapid Transit Co., 500 Kent Ave., Brooklyn, N. Y.
- STRUSS, FREDERICK C. C., Chief Operator, Power Plant, Boston & Maine R. R., Franklin, N. H.
- STUART, ROBERT BRUCE, Asst. Supt., U. S. Naval Communication Service; Radio Material Office, Navy Yard, Mare Island, Calif.
- SUDZUKI, TSUNEO Z., Apprentice, Westinghouse Elec. & Mfg. Co., East Pittsburgh; res., Wilksburg, Pa.
- SUMMERS, EDWIN S., Electrician, Foundation Co., Power; res., Warwood, Wheeling, W. Va.
- SYDNON, CLAUDE S., Electrician, R. F. & P. Railroad, 3609 Hull St., S. Richmond, Va.
- \*TEICH, QUINTIN C., Construction Dept., General Electric Co., Monadnock Block, Chicago, Ill.
- TESCH, WALTER L., Engineer, Radio Corp. of America, Port Jefferson, N. Y.
- THORBURN, JAMES MILTON, Broadcasting Engineer, The Union Trust Co., 614 Euclid Ave., Cleveland, Ohio.
- TISCHER, HERMAN A., Supt. Electrical Repair Shop, Service Dept., Westinghouse Elec. & Mfg. Co., Cincinnati, Ohio.
- TROWBRIDGE, EUGENE LANCASTER, Manager, Inter-mountain Sales Company, 309 Barclay Block, Denver, Colo.
- TRURAN, WALTER WEATHERBY, Asst. Engineer, New York Telephone Co., 104 Broad St., New York, N. Y.
- TUTTLE, HOWELL ALFRED, Lecturer, Mechanical Engineering, University of Toronto, Toronto, Ont., Can.
- UTT, ORVILLE GLENN, Service Representation, Westinghouse Elec. & Mfg. Co., 515 Hanna Bldg., Cleveland, Ohio.
- \*VAILE, HORACE S., Western Representative, *Electrical World*, 1570 Old Colony Bldg., Chicago, Ill.
- \*VALLEDEJULY, RAMON RODRIGUEZ, Electrical Instructor, Baldorioty Technical School, San Juan, P. R.
- VARNEY, HERBERT VINCENT, Asst. Chief Electrician, The Toledo Edison Co., Acme Station, Toledo, Ohio.
- VENNING, F. J., Superintendent of Operation, Mississippi River Power Co., Keokuk, Iowa.
- VICTOREEN, JOHN A., Designing Radio Engineer, Victory Radio Co., 6513 Cedar Ave., Cleveland, Ohio.
- VOGEL, FREDERICK M., Asst. to Production Manager, West Lynn Works, General Electric Co., W. Lynn; res., Cliftondale, Mass.
- WADE, ELMER JOSEPH, Lightning Arrester Engineer, General Electric Co., Pittsfield, Mass.
- WAGER, LEWIS BORDEN, Operator, Hydro-Electric Station, Pennsylvania Water & Power Co., Holtwood, Pa.
- WALSH, JOSEPH F., Asst. Engineer, New York Telephone Co., 104 Broad St., New York; res., Brooklyn, N. Y.
- WATSON, LEROY FRANKLYN, Engineer, Long Lines Dept., Pacific Tel. & Tel. Co., 835 Howard St., San Francisco, Calif.
- WILES, GLENN EDWIN, Engineer, Power Engg. Dept., Westinghouse Elec. & Mfg. Co., E. Pittsburgh; res., Wilksburg, Pa.
- WILSON, CARL HIRST, Superintendent of Maintenance, Chevrolet Motor Co., Detroit, Mich.
- WILSON, RAY HESS, District Sales Engineer, Sangamo Electric Co., Springfield, Ill.; res., Tulsa, Okla.
- WITTHUN, WILLIAM CRAIGMILE, Electrician, Canadian Westinghouse Co., Ltd., 113 Dagenais St., Montreal, Que., Can.
- \*WOLFSON, HENRY M., Electrical Engineer, Foote, Pierson & Co., 160-62 Duane St., New York, N. Y.
- WOOD, HARRY GARDNER, Switchboard Engineer, Westinghouse Elec. & Mfg. Co., 165 Broadway, New York, N. Y.
- WOODHEAD, JOHN WILLIAM, Asst. to District Engineer, Canadian General Electric Co., 1065 Pender St., W., Vancouver, B. C.
- \*WOODWARD, GUY F., Asst. to General Superintendent, Worcester Electric Light Co., 66 Faraday St., Worcester, Mass.
- \*WRIGHT, CLAUDE B., Distribution Dept., Duquesne Light Co., 421 Semple St., Oakland Station, Pittsburgh, Pa.
- \*YELTON, PAUL HAGEMEYER, Senior Student, The Southern Sierras Power Co., Riverside, Calif.
- YOUNG, J. HAROLD, Asst. Engineer, New York Telephone Co., 104 Broad St., New York, N. Y.
- YOUNG, LOUIS H., Chief Engineer, Potlach Lumber Co., Elk River, Idaho.
- ZIEGLER, EDWARD FREDERICK, Electrical Contractor, 4 Cornelia St., Brooklyn, N. Y.

Total 241

\*Formerly Enrolled Students.

**ASSOCIATES REELECTED APRIL 13, 1923**

- CLARKE, DACOSTA MOORE, Erecting Engineer, General Electric Co., Witherspoon Bldg., Philadelphia, Pa.
- FEATHER, ROBERT JOHN BOOTH, Electrical Engineer, Columbus Railway, Power & Light Co., 104 N. 3rd St., Columbus, Ohio.
- HAMMOND, HERBERT H., Sales Representative, Warren Clock Co., 308 Boylston St., Boston, Mass.
- HODGE, WILLIAM EDWARD, Laboratory Assistant, General Electric Co., West Lynn; res., Lynn, Mass.

**KAISER, ALEXANDER A.**, Senior Engg. Assistant, Bell Telephone Co. of Pa., 1230 Arch St., Philadelphia, Pa.  
**LARSON, I. JOHN.** Part Owner, W B L Radio Corp., 94 Norfolk St., New York, N. Y.; res., E. Orange, N. J.

**ASSOCIATE REINSTATED APRIL 13, 1923**

**PUTNAM, JOSEPH WARREN,** Contractor, The Engineer Co., 17 Battery Place, New York, N. Y.

**MEMBERS ELECTED APRIL 13, 1923**

**CAPEN, WILLIAM HENRY,** Telephone Engineer, Western Electric Co., Inc., 463 West St., New York, N. Y.  
**CLEMENT, LEWIS MASON,** Radio Engineer, Western Electric Co., 463 West St., New York, N. Y.  
**CONRAD, FRANK L.,** Junior Partner, William G. Woolfolk, 72 W. Adams St., Chicago, Ill.  
**DIXON, WALTER C.,** Electrical Engr., General Engg. Dept., Westinghouse Elec. & Mfg. Co., East Pittsburgh, res., Wilkinsburg, Pa.  
**FARNSWORTH, ARTHUR J.,** Patent Attorney & Consulting Engineer, 1123 Story Bldg., Los Angeles, Calif.  
**HOOVER, WILLIAM JOHN,** Operating Superintendent, Kaministiquia Power Co., Ltd., Ft. William, Ont., Can.  
**HUBBARD, FRANCIS ALLEY,** Telephone Transmission Engineer, Western Electric Co., Inc., 463 West St., New York, N. Y.  
**PIERCE, GLEN KENYON,** Instructor, Electrical Engineering Dept., State University of Iowa, Physics Bldg., Iowa City, Iowa.  
**READ, BENJAMIN STALKER,** President, The Mountain States Tel. & Tel. Co., 1421 Champa St., Denver, Colo.  
**SARNOFF, DAVID,** Vice-President & General Manager, Radio Corp. of America, 233 Broadway, New York, N. Y.

**TRANSFERRED TO GRADE OF FELLOW, APRIL 13, 1923**

**KEPLER, LEONARD,** President Ward Leonard Electric Co., Mt. Vernon, N. Y.

**TRANSFERRED TO GRADE OF MEMBER, APRIL 13, 1923**

**AFFEL, HERMAN A.,** Engineer, Dept. of Development and Research, American Telephone & Telegraph Co., New York, N. Y.  
**BROWN, R. A.,** General Superintendent, City Electric Light & Street Railway Departments, Calgary, Alberta, Canada.  
**CLAYTOR, EDWARD M.,** Electrical Engineer, Westinghouse Electric & Mfg. Co., East Pittsburgh, Pa.  
**DEANS, WILLIAM,** Chief Engineer, Sundh Electric Co., Newark, N. J.  
**JOHNSON, ARTHUR F.,** Chief Electrical Draftsman, Brooklyn Edison Co., Brooklyn, N. Y.  
**MAYER, GEORGE H.,** Supt. Telegraph, Minneapolis, St. Paul & Saulte Ste. Marie R. R. Co., Stevens Points, Wis.  
**NOTVEST, G. ROBERT,** Electrical Engineer & Manufacturer's Agent, Cleveland, O.  
**ROWLAND, HERBERT R.,** Chief Engineer, Moody Engineering Co., Inc., Secretary, Moody Construction Co. Inc., New York, N. Y.  
**SCHEALTER, SAMUEL R.,** Associate Professor of Electrical Engineering, Lehigh University, Bethlehem, Pa.  
**SPOONER, THOMAS,** Research Engineer, Westinghouse Electric & Mfg. Co., East Pittsburgh, Pa.  
**WATTS, EGBERT M.,** Patent Work (Temporarily), Canadian General Electric Co., Toronto, Ont.

**RECOMMENDED FOR TRANSFER**

The Board of Examiners, at its meeting held April 9, 1923, recommended the following members of the Institute for transfer to the grades of membership indicated. Any objection to these transfers should be filed at once with the Secretary.

**To Grade of Fellow**

**GOODWIN, HAROLD, Jr.,** Engineering Staff, Sanderson & Porter, New York, N. Y.

**To Grade of Member**

**AHEARN, WILLIAM H.,** Principal Assistant to John A. Beeler, New York, N. Y.  
**BELT, THOMAS A. E.,** Engineer, Northwest Coast District, General Electric Co., Portland, Ore.  
**FULLER, FLOID M.,** Electrical Engineer United Service Corp., Scranton, Pa.  
**GRATWICKE, WALTER,** Engineer, British Aluminum Co., Ltd., New York, N. Y.  
**KELLEY, WALTER F.,** Engineer, Apparatus Design Dept., Western Electric Co., New York, N. Y.  
**KETCHAM, H. H.,** Head of Electric Dept., Extension Division, United Y. M. C. A. Schools, New York, N. Y.  
**KNIGHT, EDWARD D.,** Vice-President & Chief Engineer, Virginia Electric, Inc., Charlestown, W. Va.  
**KOOPMAN, THOMAS O.,** General Superintendent, Electrical & Mechanical Dept., Submarine Boat Corp., Newark, N. J.  
**LANDGRAF, THEODORE H.,** Division Plant Engineer, Southern Bell Tel. & Tel. Co., Atlanta, Ga.  
**LESCARBOURA, Managing Editor,** Scientific American, New York, N. Y.  
**MORRIS, GLEN S.,** Research Engineer, Kansas City Power & Light Co., Kansas City, Mo.  
**NIXON, HENRY,** Deputy Commissioner of Electricity, City of Chicago, Chicago, Ill.  
**SILLS, GEORGE F.,** Branch Manager, English Electric Co., Ltd., Manchester, England.

**APPLICATIONS FOR ELECTION**

Applications have been received by the Secretary from the following candidates for election to membership in the Institute. Unless otherwise indicated, the applicant has applied for admission as an Associate. If the applicant has applied for direct admission to a higher grade than Associate, the grade follows immediately after the name. Any member objecting to the election of any of these candidates should so inform the Secretary before May 31, 1923.

**Adams, B. W.,** Univ. of Arkansas, Fayetteville, Ark.  
**Allen, R. H.,** Brooklyn Edison Co., Brooklyn, N. Y.  
**Arnold, W. H.,** Bureau of Pr. & Lt., Los Angeles, Calif.  
**Austin, H.,** U. S. Signal School, Camp Alfred Vail, N. J.  
**Barnett, A. H.,** General Elec. Co., Ft. Wayne, Ind.  
**Bassett A.,** Euclid Crane & Hoist Co., Euclid Villages, Ohio  
**Berastegui, E.,** Western Elec. Co., New York, N. Y.  
**Biggin, H. L.,** General Elec. Co., Schenectady, N. Y.  
**Black, A.,** Western Elec. Co., New York, N. Y.  
**Boeson, P. J.,** The Beeler Organization, New Orleans, La.  
**Boyd, H. H.,** (Member), Mt. Hope Finishing Co., N. Dighton, Mass.  
**Brown, H. E.,** Western Elec. Co., Inc., Jersey City, N. J.  
**Burke, R. P.,** W. E. & M. Co., E. Pittsburgh, Pa.  
**Carleton, R. J.,** S. Calif. Edison Co., Los Angeles, Calif.  
**Carlisle, A.,** W. Kootenay Pr. & Lt. Co., Oliver, B. C.  
**Carlson, E. E. A.,** Public Service Elec. Co., Newark, N. J.  
**Casey, J. E.,** Eastern Conn. Pr. Co., Uncasville, Conn.  
**Caton, E.,** (Fellow), Winnipeg Elec. Ry. Co., Winnipeg, Man.  
**Chappell, W. T.,** Duquesne Lt. Co., Pittsburgh, Pa.  
**Child, B. L.,** American Tel. & Tel. Co., New York, N. Y.  
**Clark, P. C.,** Student, Stanford Univ., Calif.  
**Colby, J. B.,** (Member), Western Union Tel. Co., Denver, Colo.  
**Conover, T.,** Puget Sound Pr. & Lt. Co., Seattle, Wash.  
**Cooke, H. W.,** Stone & Webster, Inc., Quincy, Mass.  
**Crenshaw, M. W.,** (Member), Banks Supply Co., Huntington, W. Va.  
**Crosier, H. W.,** Philadelphia Elec. Co., Philadelphia, Pa.  
**Currier, P. M.,** General Elec. Co., Schenectady, N. Y.  
**Curtis, C. C.,** (Member), Cape Breton Elec. Co., Ltd., Sydney, N. S.  
**Curtis, E. F.,** Highland Falls, N. Y.  
**Davidson, J. A.,** Western Elec. Co., Chicago, Ill.  
**Day, S. H.,** Bureau Foreign & Domestic Commerce, Washington, D. C.  
**De Monte, R. W.,** Western Elec. Co., New York, N. Y.  
**Dickinson, D. C.,** Western Elec. Co., New York, N. Y.  
**Doran, J. Y.,** Toronto Transpt. Comm., Toronto, Ont.  
**Fantry, G. W.,** Western Elec. Co., New York, N. Y.  
**Fassett, C. W.,** Pacific Tel. & Tel. Co., San Francisco, Calif.  
**Flint, A. D.,** Union Gas & Electric Co., Cincinnati, Ohio.  
**Gaitan, L. H.,** General Elec. Co., W. Lynn, Mass.  
**Garverich, R. E.,** Harrisburg Lt. & Pr. Co., Harrisburgh, Pa.  
**Gilford, E.,** T. E. Murray, Inc., New York, N. Y.  
**Gillooly, F. J.,** Philadelphia Elec. Co., Philadelphia, Pa.  
**Gray, H. F.,** Strong, Carlisle & Hammond Co., Cleveland, Ohio  
**Hager, R.,** Western Elec. Co., New York, N. Y.  
**Hamister, V. C.,** National Carbon Co., Cleveland, Ohio  
**Hanson, O. E.,** Edison Co., Chicago, Ill.  
**Hepburn, W.,** N. Y. Edison Co., New York, N. Y.  
**Hill, S. W.,** G. Elliott Hill Estate, Bethlehem, Pa.  
**Hirsch, J. G.,** (Member), Benham Engg. Co., Kansas City, Mo.  
**Hodge, H. V.,** Fairbanks, Morse & Co., Cleveland, Ohio  
**Hodgkins, H. C.,** Adirondack Pr. & Lt. Corp., Schenectady, N. Y.  
**Hoffman, J. P.,** Duquesne Lt. Co., Pittsburgh, Pa.  
**Hohl, W. C.,** Elec. Engg. Lab., Lehigh, Pa.  
**Hudler, W. C., Jr.,** Monticello Tel. Co., Monticello, N. Y.  
**Jackson, H. O.,** Brooklyn Rapid Transit Co., Brooklyn, N. Y.  
**Jerabek, E. H.,** (Member), Elec. Engr., New York, N. Y.  
**Jocey, E. G.,** New England Oil Ref. Co., Fall River, Mass.  
**Johnston, R. E.,** Penn. Public Service Corp., Philipsburg, Pa.  
**Kane, E. W.,** American Tel. & Tel. Co., Philadelphia, Pa.  
**Kane, J. W.,** Fire Alarm Tel. Bureau, Newark, N. J.  
**Kerr, G. E.,** Brooklyn Edison Co., Brooklyn, N. Y.  
**Killingsworth, H. T.,** American Tel. & Tel. Co., Atlanta, Ga.  
**La Mond, W. H.,** Simplex Wire & Cable Co., Boston, Mass.  
**Lamb, G. E.,** U. S. A., Construction Service, Washington, D. C.  
**Larios, S.,** Allis-Chalmers Mfg. Co., Milwaukee, Wis.  
**Lawless, J. J.,** Electrician Atlantic City, N. J.  
**Lawson, G. T. T.,** Julius Jacobs, Brooklyn, N. Y.  
**Lawton, E. H.,** Hartsville Oil Mill, Hartsville, S. C.

- Le Count, C. M., General Elec. Co., San Francisco, Calif.
- Lewis, F. T., General Elec. Co., W. Lynn, Mass.
- Mather, W. E., Elec. Heating & Mfg. Co., Seattle, Wash.
- McBride, B., Coyne Trade & Engg. School, Chicago, Ill.
- McDonald, J. D., General Elec. Co., Lynn, Mass.
- McGrath, W. M., Western Elec. Co., New York, N. Y.
- Merrill, E. C., General Elec. Co., Bloomfield, N. J.
- Mitcham, E. H., Brooklyn Edison Co., Brooklyn, N. Y.
- Mitchell, D. L., General Elec. Co., Schenectady, N. Y.
- Monson, J. G., General Elec. Co., Schenectady, N. Y.
- Morrell, N. G., E. Penn. Pr. & Ry. Co., Pottsville, Pa.
- Morse, A. A., Interborough Rapid Transit Co., New York, N. Y.
- Mosher, S. H., Public Service Co., No. Ill., Waukegan, Ill.
- Mueller, C. P., Allis-Chalmers Mfg. Co., W. Allis, Wis.
- Munroe, F. H., General Elec. Co., Boston, Mass.
- Murphy, T. H., N. Y. Edison Co., New York, N. Y.
- Musgrave, A. F., Ohio Public Service Co., Lorain, Ohio
- Murray, E. K., Dwight P. Robinson & Co., Inc., Springdale, Pa.
- Murray, J. V., Murray & Jones, Chicago, Ill.
- Ness, C., Brooklyn Edison Co., Brooklyn, N. Y.
- Nichols, B. H., Oregon State College, Corvallis, Ore.
- Nichols, E. D., Reliance Elec. & Engg. Co., Cleveland, Ohio
- Noel, C. W., The Ideal Elec. & Mfg. Co., Mansfield, Ohio
- Nordmeyer, W. F., Nassau Lt. & Pr. Co., Glenwood, L. I.
- Noyes, W. A., Western Elec. Co., New York, N. Y.
- Oberle, H., Public Service Elec. Co., Newark, N. J.
- Oparin, B. J., W. E. & M. Co., E. Pittsburgh, Pa.
- Owens, R. H., The Foundation Co., Power, W. Va.
- Page, G., Orilla Water, Lt. & Pr. Co., Hydro Glen, Ont.
- Paschal, R. S., Century Elec. Co., St. Louis, Mo.
- Peirce, W. T., American Steel & Wire Co., Worcester, Mass.
- Pierce, H. W., Moloney Elec. Co., St. Louis, Mo.
- Pimm, C. J., Portland Ry. Lt. & Pr. Co., Portland, Ore.
- Pinkerton, E. M., General Elec. Co., Minneapolis, Minn.
- Porter, H. J., N. Y. Tel. Co., New York, N. Y.
- Powers, W. O., T. E. Murray, Inc., New York, N. Y.
- Procter, D. E., W. E. & M. Co., E. Pittsburgh, Pa.
- Purnell, L. J., Wilberforce Univ., Wilberforce, Ohio
- Redus, J. B., Harrisburg Lt. & Pr. Co., Harrisburg, Pa.
- Rein, P. K., Electrical Contractor, Brooklyn, N. Y.
- Romaine, B. M., Western Elec. Co., New York, N. Y.
- Roxbury, W. R., N. Y. Edison Co., New York, N. Y.
- Russell, H. G., Worcester Elec. Lt. Co., Worcester, Mass.
- Schneider, M. S., Union Gas & Elec. Co., Cincinnati, Ohio
- Schnulle, G. A., Illinois Bell Tel. Co., River Forest, Ill.
- Schuler, L. R., Public Service Co. of No. Ill., Crystal Lake, Ill.
- Schwab, E. C., The Scioto Valley Trac. Co., Columbus, Ohio
- Scott, H. W., (Member), W. E. & M. Co., St. Louis, Mo.
- Schumard, C. C., Commonwealth Edison Co., Chicago, Ill.
- Searl, F. L., Cleveland Elec. Ill. Co., Cleveland, Ohio
- Simpson, R. E., Jr., N. Y. Tel. Co., New York, N. Y.
- Smainin, G. A., Levant American Comm. Co., New York, N. Y.
- Smedberg, O. L., American Car & Foundry Co., Depew, N. Y.
- Smith, A. E., General Elec. Co., San Francisco, Calif.
- Snell, F. E., Cleveland Ry. Co., Cleveland, Ohio
- Soulen, R. B., Wisconsin Tel. Co., Milwaukee, Wis.
- Speer, J. W., (Member), The Wellman-Seaver-Morgan Co., Cleveland, Ohio
- Steinmetz, C. K., Harrisburg Lt. & Pr. Co., Harrisburg, Pa.
- Stephens, F. M., Ohio Bell Tel. Co., Cleveland, Ohio
- Steuve, W. H., Grand River Gravel Co., Muskogee, Okla.
- Suchanek, F. V., Engineer, New York, N. Y.
- Taylor, A. S., Hydro-Elec. Pr. Comm. of Ont., N. Hamilton, Ont.
- Twelves, C. M., (Member), Puget Sound Tel. Co., Everett, Wash.
- Teichert, F. P., The Foundation Co., Wheeling, W. Va.
- Tilden, C. D., General Elec. Co., Erie, Pa.
- Valle, P. B., Nat'l. Elec. Condenser Co., New Haven, Conn.
- Walker, J., Brooklyn Edison Co., Brooklyn, N. Y.
- Wannag, F., W. E. & M. Co., Newark, N. J.
- Weeks, G. McD., Jr., N. Y. Tel. Co., New York, N. Y.
- Whitaker, J. C., Bell Tel. Co. of Pa., Philadelphia, Pa.
- Wiggin, S., (Member), Consumers Pr. Co., Alma, Mich.
- Williamson, E. J., General Elec. Co., Schenectady, N. Y.
- Zabel, E. O., Alexandria Lt. & Pr. Co., Alexandria, Va.
- Zsiba, A., Jr., Western Elec. Co., New York, N. Y.
- Total 141
- Foreign**
- Ade, G. C., Cerro de Pasco Copper Corp., Oroya, Peru, S. A.
- Carey, P. T., China Elec. Co., Peking, China
- Clarke, C. G. T., Cerro de Pasco Copper Corp., Oroya, Peru, S. A.
- Daly, M. J., Ketchikan Pr. Co., Ketchikan, Alaska
- de Graff, A., Philips Glow Lamp Works, Ltd., Eindhoven, Holland
- Downey, J. C., Hawera County Elec. Co., Hawera, N. Z.
- Ebbert, R. O., (Member), Evan Jones Coal Co., Jonesville, Alaska
- Garcia, G., Empresa Electrica, Guatemala, C. A.
- Ono, H., Mitsubishi Elec. Works, Kobe, Japan
- Sahgal, G. R., Mahalazmi Mills, Bangalore, India
- Tree, F. G. W., Glasgow Corp., Glasgow, Scotland
- Total 11
- STUDENTS ENROLLED APRIL 13, 1923**
- 16980 Gotsdanker, Alexander, Cooper Union
- 16981 Hoffman, Henry J., Cooper Union
- 16982 Bayers, Charles, Cooper Union
- 16983 Meiers, Walter W., Cooper Union
- 16984 Manyan, V. Subrah, Mechanical Engineering School (Bangalore)
- 16985 Geary, Timothy E., Rhode Island State College
- 16986 McCauley, Joseph F., Rhode Island State College
- 16987 Judd, George L., Case School of Applied Science
- 16988 Blom, Reuben J., State College of Wash.
- 16989 Margolin, Samuel, Brooklyn Polytechnic Institute
- 16990 Green, Cecil H., Mass. Institute of Tech.
- 16991 Cummings, Alan P., Mass. Institute of Technology
- 16992 Jackson, Russell R., University of Illinois
- 16993 Bullock, Ellis W., Georgia School of Tech.
- 16994 Kirkwood, Thomas A., Georgia School of Technology
- 16995 Gore, Calvin W., Georgia School of Tech.
- 16996 Jones, George G., Georgia School of Tech.
- 16997 Summers, Clay B., Georgia School of Technology
- 16998 Johnson, James T., Jr., Georgia School of Technology
- 16999 Smith, E. Karl, Pennsylvania State College
- 17000 Ellis, Franklin A., University of Toronto
- 17001 Bright, John W., University of Illinois
- 17002 Chase, Clarence N., Syracuse University
- 17003 Milne, Frank E., Wentworth St. Technical School
- 17004 Israel, Dorman D., University of Cincinnati
- 17005 Dougherty, Francis E., Rhode Island State College
- 17006 Gates, Henry S., Rhode Island State Coll.
- 17007 Rundle, Wilmot L., University of Toronto
- 17008 Grady, Robert E., University of Santa Clara
- 17009 Justice, Charles J., University of Pennsylvania
- 17010 Loughery, George B., Jr., University of Pennsylvania
- 17011 Frank, Arnold S., University of Penn.
- 17012 Irwin, Ralph E., University of Penn.
- 17013 Paxson, Houston R., University of Penn.
- 17014 Sabina, John R., University of Penn.
- 17015 Manz, Otto W., Jr., University of Penn.
- 17016 Reed, Russell O., Oregon Agricultural Coll.
- 17017 Swindell, Rolla A., University of Colorado
- 17018 Raymond, Hubert, University of Colorado
- 17019 Bromley, Jerome H., University of Colorado
- 17020 Grow, Robert C., University of Colorado
- 17021 Myers, Jacob L., Pennsylvania State Coll.
- 17022 Craver, Theodore G., George Washington University
- 17023 Thornton, Paul, University of Missouri
- 17024 Mueller, Russel A., University of Missouri
- 17025 McBroon, Henry E., University of Toronto
- 17026 Caverley, Loyst C., State College of Washington
- 17027 Erd, Bruner C., University of Kentucky
- 17028 Colby, Donald C., Armour Institute of Technology
- 17029 Chun, Herbert H., Armour Institute of Technology
- 17030 Owens, Stanley, Armour Institute of Tech.
- 17031 Carlson, Easr L., Armour Institute of Technology
- 17032 Niemeyer, Herbert F., George Washington University
- 17033 Johannessen, Vaughn L., George Washington University
- 17034 Kleinberger, Alfred, Cornell University
- 17035 Isbell, G. Terrill, Oklahoma A. & M. Coll.
- 17036 Messier, Joseph A., Northeastern University
- 17037 Anderson, Dan, McGill University
- 17038 Bond, George W., University of Kansas
- 17039 Couse, H. A. C., Queen's University
- 17040 Leonard, Emery M., Pennsylvania State College
- 17041 Coggins, Ralph L., University of Arizona
- 17042 Heffelman, Malcolm C., University of Arizona
- 17043 Maloney, James P., Drexel Institute
- 17044 Allen, Hugh E., State College of Wash.
- 17045 Ross, M. V., McGill University
- 17046 Green, George E., Lewis Institute
- 17047 Waldner, Charles E., Cornell University
- 17048 Baldwin, Millard W., Jr., Cornell Univ.
- 17049 Burke, Charles T., Mass. Inst. of Tech.
- 17050 McGinnis, Raymond C., University of Denver
- 17051 Dingman, Cecil A., University of Denver
- 17052 Brewington, Gale P., University of Denver
- 17053 Butts, Charles A., University of Denver
- 17054 De Haven, Edward E., University of Denver
- 17055 Diller, Charles G., University of Denver
- 17056 Duke, Vernon J., University of Denver
- 17057 Fuller, George P., University of Denver
- 17058 Graves, Joe P., University of Denver
- 17059 Herskind, C. Curtis, University of Denver
- 17060 Hoover, Ray, University of Denver
- 17061 Horiuchi, Tomosada, University of Denver

- |   |  |   |
|---|--|---|
| 17062 Horsley, Wendell R., University of Denver               | 17079 Agnew, Edward J., Syracuse University                  | 17095 Edwards, Miles L., Oregon Agricultural College  |
| 17063 Johnson, Terryl F., University of Denver                | 17080 Klenke, John, Jr., Clemson Agricultural College        | 17096 Fisher, Ernest A., University of Missouri       |
| 17064 Muntwyler, Edward, University of Denver                 | 17081 Kenney, Mahlon W., University of Illinois              | 17097 Fisher, Benjamin A., University of Mo.          |
| 17065 Patten, Asher H., University of Denver                  | 17082 Whittaker, Bertram A., Drexel Institute                | 17098 Colyer, Hollis J., University of Michigan       |
| 17066 Shores, Gail C., University of Denver                   | 17083 Inman, Merrill B., University of Colorado              | 17099 Bell, Edwin H., University of Michigan          |
| 17067 Schuler, Burch F., University of Denver                 | 17084 Antliff, James C., McGill University                   | 17100 Hadley, D. L., University of Michigan           |
| 17068 Thorpe, Andrus, University of Denver                    | 17085 Mongan, Charles E., Jr., Mass. Institute of Technology | 17101 Misson, William H., Oregon Agricultural College |
| 17069 Williams, Howard I., University of Denver               | 17086 Brongersma, Cornelius, Michigan Agricultural College   | 17102 Yarmack, John E., Mass. Institute of Tech.      |
| 17070 Williams, Joseph W., University of Denver               | 17087 Munro, David J., McGill University                     | 17103 Moline, Lawrence E., University of Minn.        |
| 17071 Wallis, Charles G., Colorado State Agricultural College | 17088 Rorke, Charles B., McGill University                   | 17104 Moreno, Gerardo, University of Minnesota        |
| 17072 Nichols, Milton C., Northeastern University             | 17089 Peters, Arthur W., McGill University                   | 17105 Krause, F. E., University of Minnesota          |
| 17073 Huffman, Harold H., Colorado Agricultural College       | 17090 Siddall, Walter D., Mass. Institute of Technology      | 17106 Taylor, George Y., University of Illinois       |
| 17074 Brown, Weston A., Ohio State University                 | 17091 Ellsworth, Bertram E., University of Nebraska          | 17107 Bean, Leslie H., Iowa State College             |
| 17075 Abbott-Smith, Henry B., McGill University               | 17092 Carville, Ellsworth M., University of Maine            | 17108 Markley, Eugene C., Pennsylvania State College  |
| 17076 Gilkeson, Charles L., Mass. Inst. of Tech.              | 17093 Misz, Donald F., Oregon Agricultural Coll.             | 17109 Cleveland, Harry R., Jr., McGill University     |
| 17077 Sidwell, Leonard W., University of Utah                 | 17094 Winslow, Marion J., Oregon Agricultural College        | 17110 Drysmid, Anthony R., University of Cal.         |
| 17078 Mansur, Clyde N., Worcester Polytechnic Institute       |  | 17111 Meissner, Earl R., University of California     |
|   |  | Total 132   |

### OFFICERS OF A. I. E. E. 1922-1923

- |                               |                   |
|-------------------------------|-------------------|
| <b>President</b>              |                   |
| FRANK B. JEWETT               |                   |
| <b>Junior Past-Presidents</b> |                   |
| A. W. BERRESFORD              | WILLIAM McCLELLAN |
| <b>Vice-Presidents</b>        |                   |
| N. W. STORER                  | G. FACCIOLI       |
| C. G. ADSIT                   | W. I. SLICHTER    |
| F. W. SPRINGER                | R. F. SCHUCHARDT  |
| ROBERT SIBLEY                 | H. W. EALES       |
| F. R. EWART                   | H. T. PLUMB       |
| <b>Managers</b>               |                   |
| L. E. IMLAY                   | R. B. WILLIAMSON  |
| F. F. FOWLE                   | A. G. PIERCE      |
| L. F. MOREHOUSE               | HARLAN A. PRATT   |
| HAROLD B. SMITH               | H. M. HOBART      |
| JAMES F. LINCOLN              | ERNEST LUNN       |
| E. B. CRAFT                   | G. L. KNIGHT      |
| <b>Treasurer</b>              |                   |
| GEORGE A. HAMILTON            |                   |
| <b>Honorary Secretary</b>     |                   |
| RALPH W. POPE                 |                   |

### LOCAL HONORARY SECRETARIES

- Carroll M. Mauseau, Caixa Postal No. 571 Rio de Janeiro, Brazil.  
 Charles le Maistre, 28 Victoria St., London, S. W., England.  
 A. S. Garfield, 45 Bd. Beausejour, Paris 16 E., France.  
 H. P. Gibbs, Tata Sons, Ltd., Navsari Building, Fort Bombay, India.  
 Guido Semenza, N. 10 Via S. Radegonda, Milan, Italy.  
 Lawrence Birks, Public Works Department, Wellington, New Zealand.  
 W. Elsdon-Dew, P. O. Box 4563, Johannesburg, Transvaal, Africa.

### A. I. E. E. COMMITTEES

(A list of the personnel of Institute committees may be found in the January issue of the JOURNAL. Will be reprinted in the June JOURNAL.)

#### GENERAL STANDING COMMITTEES AND CHAIRMEN

- EXECUTIVE, Frank B. Jewett  
 FINANCE, L. F. Morehouse  
 MEETINGS AND PAPERS, E. E. F. Creighton  
 PUBLICATION, Donald McNicol  
 COORDINATION OF INSTITUTE ACTIVITIES, W. I. Slichter  
 BOARD OF EXAMINERS, H. H. Norris  
 SECTIONS, A. W. Berresford  
 STUDENT BRANCHES, C. Francis Harding  
 MEMBERSHIP, R. B. Howland  
 HEADQUARTERS, E. B. Craft  
 LAW, H. H. Barnes, Jr.  
 PUBLIC POLICY, H. W. Buck  
 CODE OF PRINCIPLES OF PROFESSIONAL CONDUCT, Schuyler S. Wheeler  
 SAFETY CODES, H. B. Gear  
 STANDARDS, Harold Pender  
 EDISON MEDAL, Edward D. Adams  
 RESEARCH, John B. Whitehead

### TECHNICAL COMMITTEES AND CHAIRMEN

- EDUCATIONAL, W. E. Wickenden  
 ELECTRICAL MACHINERY, B. A. Behrend  
 ELECTROCHEMISTRY AND ELECTROMETALLURGY, J. L. Yardley  
 ELECTROPHYSICS, F. W. Peek, Jr.  
 INDUSTRIAL AND DOMESTIC POWER, H. D. James  
 INSTRUMENTS AND MEASUREMENT, G. A. Sawin  
 IRON AND STEEL INDUSTRY, E. S. Jefferies  
 LIGHTING AND ILLUMINATION, G. H. Stickney  
 MARINE, G. A. Pierce, Jr.  
 MINES, Graham Bright  
 POWER STATIONS, Nicholas Stahl  
 PROTECTIVE DEVICES, H. R. Woodrow  
 TELEGRAPHY AND TELEPHONY, O. B. Blackwell  
 TRACTION AND TRANSPORTATION,  
 TRANSMISSION AND DISTRIBUTION, Edward B. Meyer

### A. I. E. E. REPRESENTATION

(The Institute is represented on the following bodies; the names of the representatives may be found in the January issue of the JOURNAL and will be published again in the June issue.)

- COUNCIL OF THE AMERICAN ASSOCIATION FOR THE ADVANCEMENT OF SCIENCE  
 AMERICAN BUREAU OF WELDING  
 AMERICAN COMMITTEE ON ELECTROLYSIS  
 AMERICAN ENGINEERING COUNCIL OF THE FEDERATED AMERICAN ENGINEERING SOCIETIES  
 AMERICAN ENGINEERING STANDARDS COMMITTEE  
 BOARD OF TRUSTEES, UNITED ENGINEERING SOCIETY  
 ENGINEERING FOUNDATION BOARD  
 FRANCO-AMERICAN ENGINEERING COMMITTEE  
 JOHN FRITZ MEDAL BOARD OF AWARD  
 JOSEPH A. HOLMES SAFETY ASSOCIATION  
 LIBRARY BOARD, UNITED ENGINEERING SOCIETY  
 ELECTRICAL COMMITTEE, NATIONAL FIRE PROTECTION ASSOCIATION  
 ENGINEERING DIVISION, NATIONAL RESEARCH COUNCIL  
 U. S. NATIONAL COMMITTEE OF THE INTERNATIONAL ILLUMINATION COMMISSION  
 U. S. NATIONAL COMMITTEE OF THE INTERNATIONAL ELECTROTECHNICAL COMMISSION  
 COMMISSION OF WASHINGTON AWARD

### A. I. E. E. SECTIONS AND BRANCHES

A list of the 47 Sections and 70 Branches of A. I. E. E., with the names of their officers, may be found in the April issue of the JOURNAL.

# DIGEST OF CURRENT INDUSTRIAL NEWS

## NEW CATALOGUES AND OTHER PUBLICATIONS

*Mailed to interested readers by issuing companies.*

**Motors.**—Bulletin 132, 20 pp. Describes the Wagner "Pow-R-Full" motor. Wagner Electric Corporation, St. Louis, Mo.

**Uniflow Boilers.**—Bulletin 23-A, 24 pp. Describes Uniflow horizontal return tubular boilers. Lebanon Boiler Works, Lebanon, Penn.

**Electric Drills.**—Bulletin 106, 16 pp. Describes "Hisey" Portable Electric Drills and Reamers. The Hisey-Wolf Machine Company, Cincinnati, O.

**Protective Relays.**—Bulletin 417-2, 24 pp. Describes protective relays and accessories for electrically operating switch gear. Condit Electrical Manufacturing Company, South Boston, Mass.

**Wiring Devices.**—Bulletin, 16 pp. A manual of electric wiring devices in two inch solid partitions and other installations for use in limited space. Arrow Electric Company, Hartford, Conn.

**Rivet Heaters.**—Bulletin, 4 pp. Describes the "Calorac" electric rivet heater, which is made in various sizes, the largest designed to heat 1200 rivets per hour. The Humil Corporation, 52 Vanderbilt Avenue, New York.

**Induction Voltage Regulators.**—A series of bulletins, Nos. 65401-A to 65433, illustrating the construction details of each type of induction voltage regulator manufactured by the General Electric Company, Schenectady, N. Y.

**Principles of Radio Communication.**—A series of bulletins outlining the theory of radio transmission and audibility amplification. Voltamp Electric Manufacturing Company, 406 Jasper Street, Baltimore, Md.

**Vibrating Reed Tachometers.**—Bulletin, L-105, 8 pp. Describes "Aimco" Vibrating Reed Tachometers for measuring speed of rotating machines such as turbines, motors and generators, ranging from 800 to 12,000 r. p. m. American Electrical Instrument Corporation, 147 Palisade Ave., Union Hill, N. J.

**Insulating Varnishes and Compounds.**—Catalog, 40 pp. Describes "Ajax" insulating varnishes and compounds, outlining best practise in applying. Refers to more common troubles encountered in use of varnish and how they may be obviated, and gives methods of testing. The Sherwin-Williams Company, Cleveland, O.

**Meg Insulation Tester.**—Pocket manual No. 1010-J, 32 pp. entitled "Concerning Insulation Testing, with Special Reference to the Meg." Contains interesting data relative to the subject of insulation testing and also describes a new instrument for such service. James G. Biddle, 1211 Arch Street, Philadelphia, Penn.

**Frequency Meters.**—Bulletin L-107, 8 pp. Describes "Aimco" Vibrating Reed Frequency Meters wherein the indications of the frequencies are obtained from the vibrations of certain units of tuned steel reeds. The instruments possess no revolving parts, springs or bearings requiring lubrication and it is claimed for them that recalibration is never necessary. American Electrical Instrument Corporation, 147 Palisade Ave., Union Hill, N. J.

**Portable H. V. Testing Equipment.**—Bulletin 1010. Describes a new portable high-voltage testing set for testing cables, electrical machinery, porcelain, rubber, oil and other material requiring high-voltage insulation tests over a period of time. An exclusive feature of these sets is the voltage regulator by which the voltage is automatically advanced in one per cent. unbroken increments. The American Transformer Company, 176 Emmet Street, Newark, N. J.

## NOTES OF THE INDUSTRY

**Diamond State Fibre Company, Bridgeport, Penn.**—The New York district office is now located at 423 Broome Street.

**The Rubber Insulated Metals Corporation** have removed their executive and sales offices to their factory, 18 Oliver Street, Newark, N. J.

**The American Copper Products Corporation** have removed their general sales offices to 233 Broadway, New York. This is the Woolworth Building, on the twenty-sixth floor of which the company's offices are located.

**The Combustion Engineering Corporation, Ltd.**, and the Uehling Instrument Company have recently entered into an agreement whereby Uehling interests in the Dominion of Canada and Newfoundland will be handled exclusively by the Combustion Engineering Corporation, Ltd. with principal offices located in Toronto, Montreal, Winnipeg and Vancouver. The Uehling line includes such fuel economy equipment as C O<sub>2</sub> and S O<sub>2</sub> recorders, draft recorders, combined barometer and vacuum recorders, absolute pressure indicators, etc.

**The British American Tube Company** and the British American Metals Company have removed their general sales offices to 233 Broadway, New York.

**The Cutler-Hammer Manufacturing Company, Milwaukee, Wis.**—The Pittsburgh office of the central district of this company was moved on May 1st from the Farmers Bank Building, to the Century Building. A. G. Pierce is manager of the central district, with headquarters in Pittsburgh.

An agency arrangement has been affected with O. T. Jenkins, 1002 Pacific Avenue, Dallas, Texas, covering the sale of wiring devices, radio apparatus and standard industrial heating apparatus. The territory covered is the states of Texas and Oklahoma.

**The American Insulated Wire & Cable Company, Chicago, Ill.**, is now manufacturing magnet wire, having begun operations April 1. Its products are sold under the trade name of A-1 Magnet Wire. Equipment of the latest type, designed by its own engineers, has been provided for the manufacturing processes. A factory manager has been secured who has had twenty years' experience in this field and has developed magnet wire for two of the largest wire companies in the United States. During that period he has supervised the production of upward of sixty million pounds of magnet wire to meet every condition of use, having both technical and practical knowledge of the uses of wire as well as of its manufacture.

**The DeForest Radio Telephone & Telegraph Company** has been sold to the Jewett Radio & Phonograph Company, of Detroit. As a result of the purchase, the Jewett Company comes into possession of 181 radio patents, among them the basic rights to the three-electrode audion bulb, which is an essential part of long distance radio receiving or sending sets. Among the other patents are several covering radio equipment in general use, as well as a large number representing more recent developments and research by Dr. Lee DeForest. The purchase also includes the new plant of the DeForest Company at Jersey City, at which the DeForest inventions are manufactured commercially. Dr. DeForest remains with the company under a long-time contract, as consulting engineer, and is now giving a large share of his attention to the perfection of equipment by which the human voice is synchronized and reproduced in connection with moving pictures.

The affairs of the DeForest Company will be administered from Detroit, but no immediate change in the personnel or operating methods of the Jersey City factory is contemplated.



**KERITE**

**TIME IS THE  
GREAT TEST**

**THE MOST  
EFFICIENT AND  
PERMANENT  
INSULATION  
KNOWN IS  
KERITE**

**KERITE  
INSULATED  
WIRE & CABLE  
COMPANY  
NEW YORK-CHICAGO**

Please mention the JOURNAL of the A. I. E. E. when writing to advertisers.

# IRVINGTON SEAMLESS BIAS

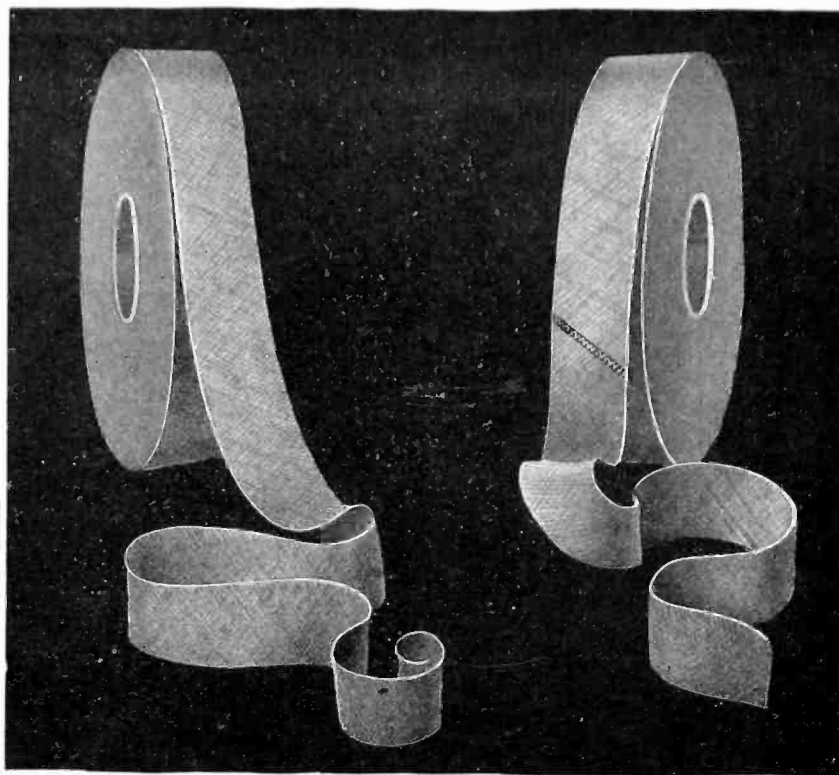

SAVES TIME  
ELIMINATES WASTE  
PRODUCES SMOOTH WINDINGS  
CAN BE APPLIED BY TAPING MACHINE

**I**RVINGTON seamless bias varnished cambric Tape is made in widths of  $\frac{1}{2}$  in. and wider. Length 36 and 72-yd. rolls. Thickness .007 to .015 in. The advantages of a SEAMLESS over a sewed bias tape are: It can be continuously wound without the necessity of stopping to cut out a seam. Absence of seam avoids air pockets and the consequent lowering of dielectric at that spot. Can be wound with a taping machine. Will successfully supplant method of insulating with linen tape and the subsequent impregnation with insulating varnish. Seamless bias can be wound with lap instead of butt joint.

**Irvington Varnish & Insulator Company**  
IRVINGTON, NEW JERSEY

*Sales Representatives:*

Mitchell-Rand Mfg. Co.  
New York

T. C. White Electric Supply Co.  
St. Louis

E. M. Wolcott  
Rochester

L. L. Fleig & Co.  
Chicago

Consumers Rubber Co.  
Cleveland

Clapp & Lamoree  
Los Angeles

F. G. Scofield  
Toronto

ESTABLISHED 1905

*Largest Manufacturers of Varnished Cambric in the World*

Please mention the JOURNAL of the A. I. E. E. when writing to advertisers.



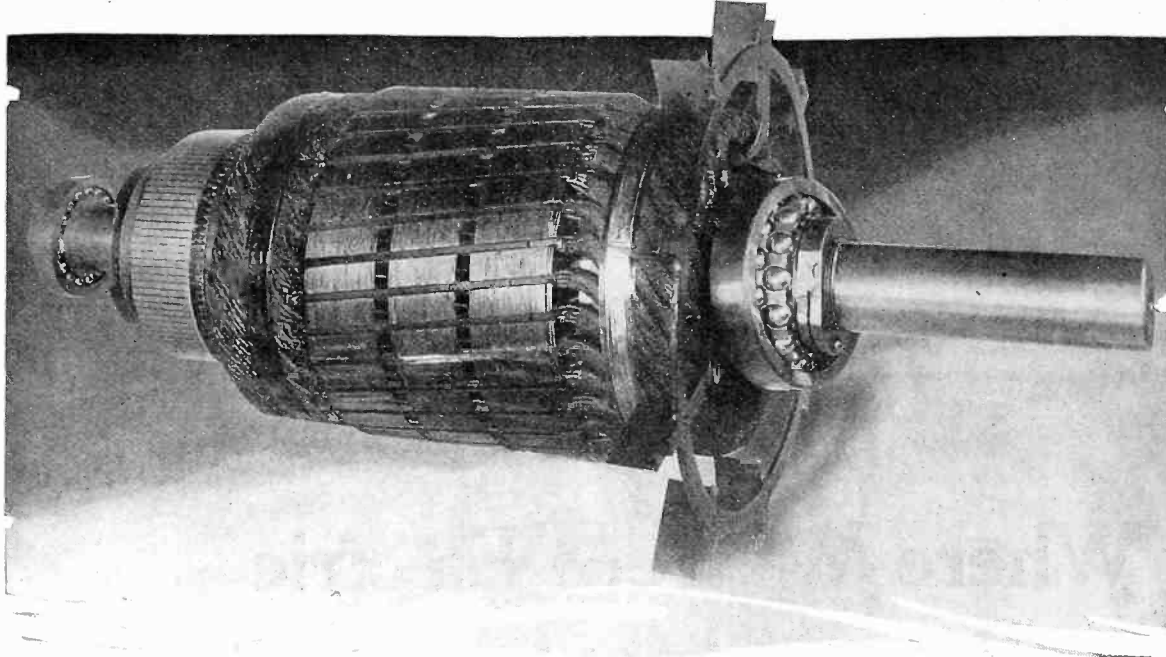

## Ball Bearings on Electric Motors Prevent Chatter and Improve Commutation

ONE of our large railways found that with anti-friction bearings on its direct-current blower motors, the interval between the times when commutators had to be turned down was three times as long as when the motors were equipped with plain bearings.

This better performance with **SKF** marked self-aligning ball-bearing equipment is due to the fact that bearing wear is prevented. As a result high and low

spots on commutators of electric motors due to variations in brush pressure, are prevented as chatter does not occur.

Protect the users of your motors against the frequent heavy expense of interrupting production to turn commutators and undercut mica, by adopting ball bearings as standard equipment.

Our engineering service will gladly be extended to you as an aid in solving your particular bearing problems.

### THE SKAYEF BALL BEARING COMPANY

Supervised by **SKF** INDUSTRIES, INC., 165 Broadway, New York City

935

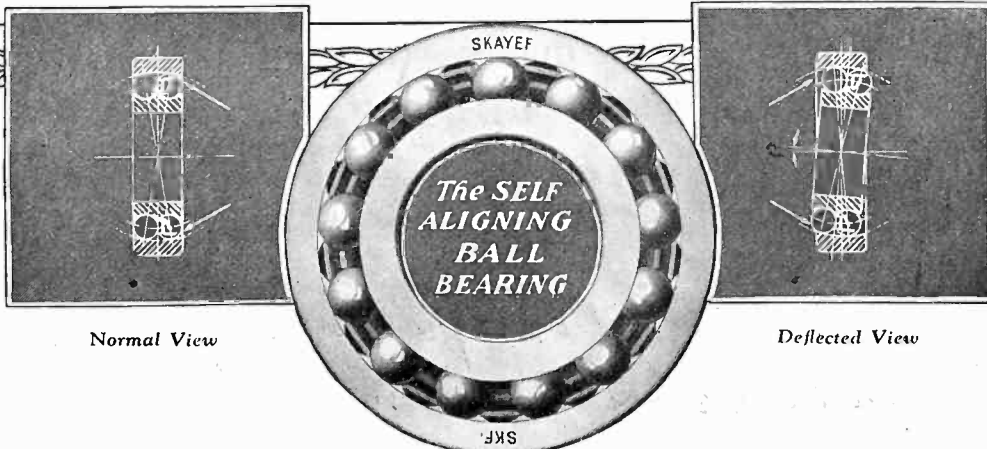

Normal View

Deflected View

**BALL BEARINGS**  
The Highest Expression of the Bearing Principle

Please mention the JOURNAL of the A. I. E. E. when writing to advertisers.

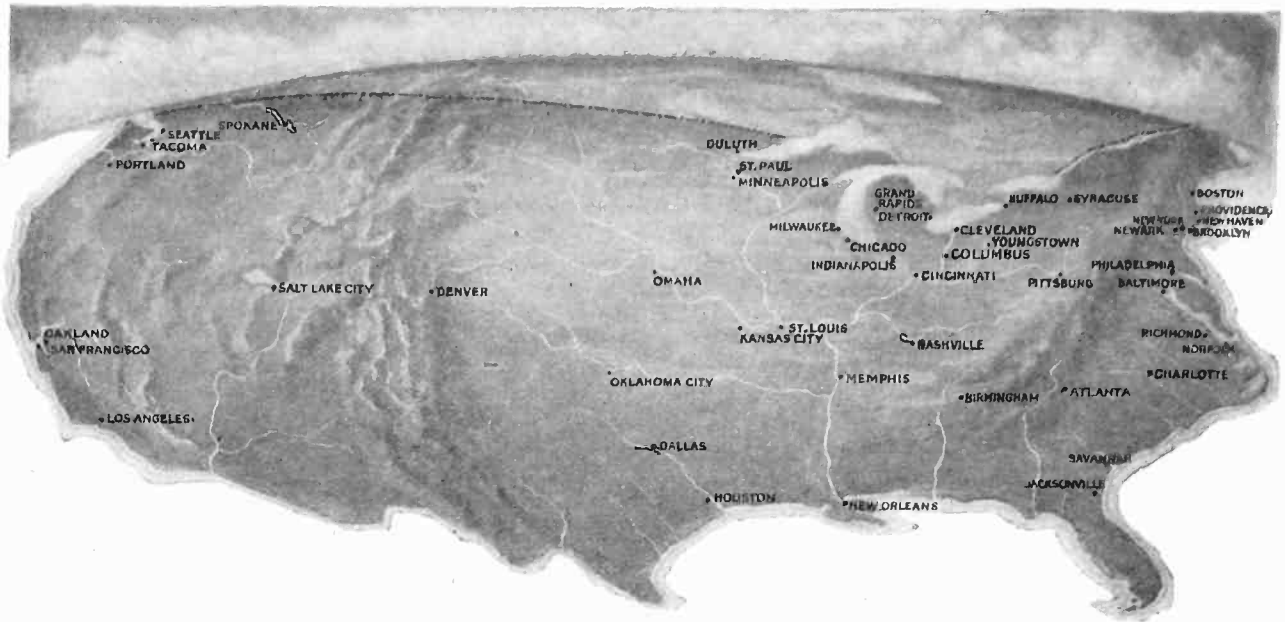

## Where Western Electric Puts Distribution on the Map

In any community a well ordered supply service providing everything electrical is a vital money saving service to the industries in that community.

To render this service is the function of our 48 Distributing Houses.

They can provide exactly the materials you'd specify to assure correct performance.

Their stocks are made up of the products of manufacturers whose goods are and have been standard in this Industry for years.

One of these Houses is near you. It has the goods you need and the goods have the quality you demand.

A  
NATIONAL  
ELECTRICAL  
SERVICE

# Western Electric Company

OFFICES IN ALL PRINCIPAL CITIES

Please mention the JOURNAL of the A. I. E. E. when writing to advertisers.

# - The Complaint -      - Our Reply -

Rockwood Mfg. Co.,  
Indianapolis, Indiana.

Gentlemen:-

We are shipping to you 1 - 16 x 12 x 2-3/4" bore paper pulley which you furnished on our St. Louis purchase order GP-2877. This was sent back to us by our customers who told us that pulley was in use only about three weeks and did not give satisfaction, as the iron center let loose.

They feel that they are entitled to credit.

We are passing this to you for inspection, and ask that you let us have your advices concerning it.

Yours very truly,

Dear Sir:

Replying to your letter of January 26, we have not yet received the pulley originally furnished on your St. Louis purchase order GP-2877, but will advise you results of our inspection as soon as the pulley arrives.

Kindly advise if you wish the pulley replaced or credit issued in case the fault is found to be with us.

Yours very truly,

The Rockwood Mfg. Co.

**Note Liberal Attitude on Replacement or Credit**

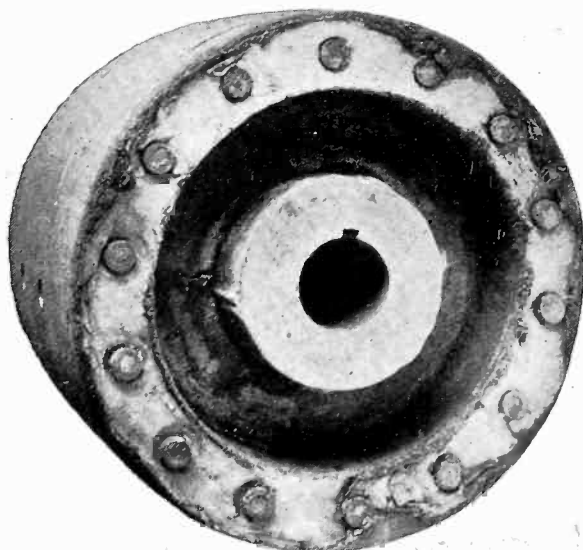

## But the Pulley Wasn't a Rockwood

**T**HE PULLEY shown above which was returned to us is not a Rockwood Paper Pulley. It is an inferior imitation—merely a shell or semblance of the reality—built by a manufacturer to make sales based on the enviable reputation which Rockwood has built into Paper Pulleys through forty years of manufacture.

For your own protection remember—not all paper pulleys are Rockwood Paper Pulleys. To avoid imitations, order Rockwood Paper Pulleys by name only—and see that the pulleys you get carry the Rockwood label and the Rockwood serial number stamped on the metal hub.

THE ROCKWOOD MANUFACTURING COMPANY  
1948 English Avenue      Indianapolis, U. S. A.

All the Power—All the Time  
**ROCKWOOD, PULLEY SERVICE**

Please mention the JOURNAL of the A. I. E. E. when writing to advertisers.

# ALLIS-CHALMERS

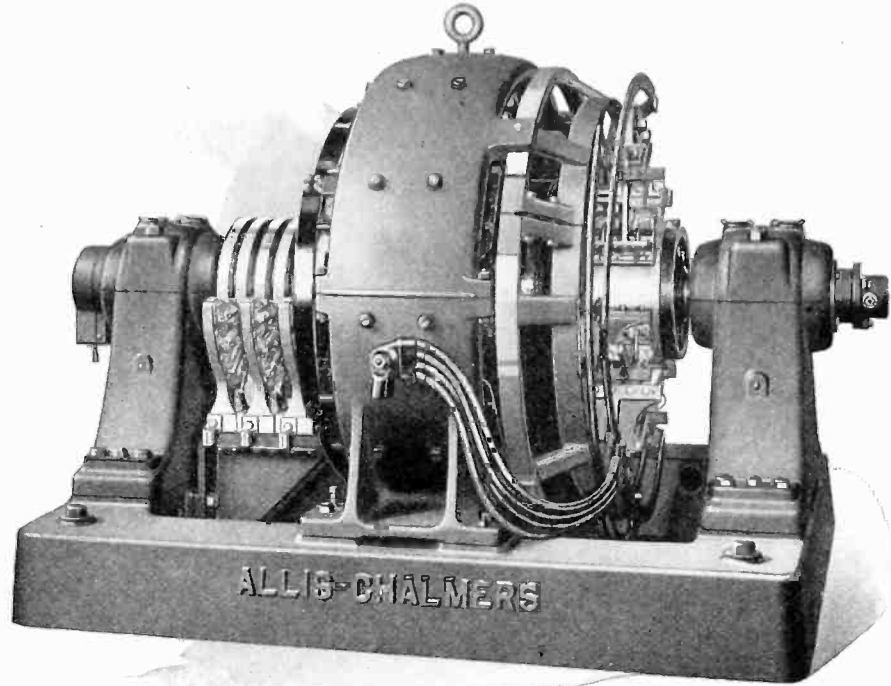

## Rotary Converters

*for Industrial  
and Mine Service*

For convenient, economical and reliable distribution of direct current from alternating current supply. Made in any capacity for 60 or 25 cycle systems.

*Send for Bulletin*

## ALLIS-CHALMERS-MANUFACTURING COMPANY

Milwaukee, Wisconsin

*District Offices in All Principal Cities*

Please mention the JOURNAL of the A. I. E. E. when writing to advertisers.



### PRODUCTS:

Electrical Machinery  
 Gas Engines  
 Steam Engines  
 Steam Turbines  
 Condensers  
 Oil Engines  
 Hydraulic Turbines  
 Pumping Engines  
 Centrifugal Pumps  
 Mining Machinery  
 Metallurgical Machinery  
 Crushing Machinery  
 Cement Machinery  
 Flour Mill Machinery  
 Saw Mill Machinery  
 Air Compressors  
 Air Brakes  
 Steam and Electric Hoists  
 Farm Tractors  
 Power Transmission Machinery

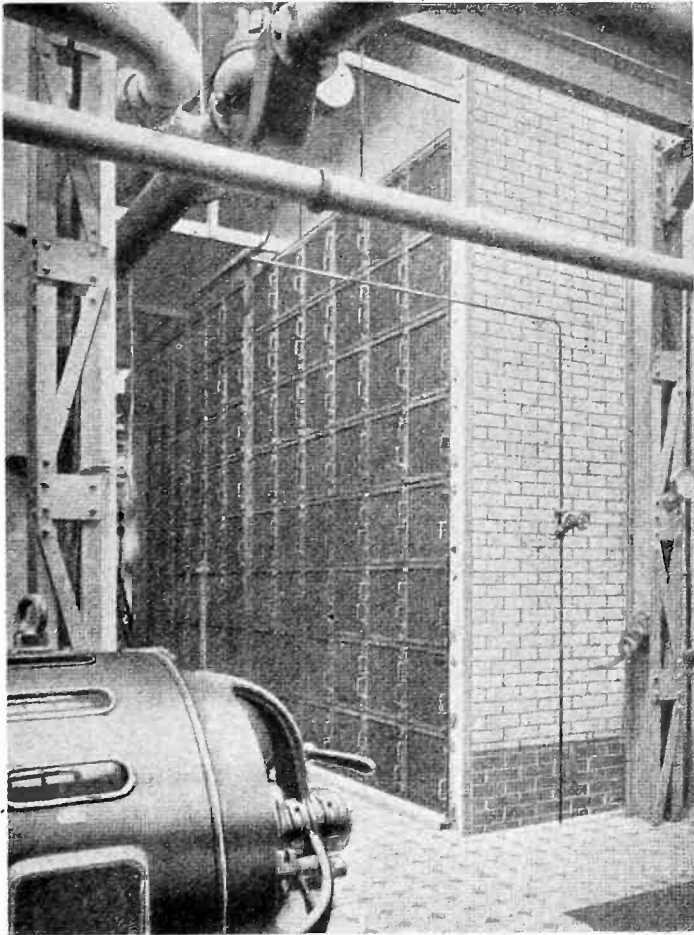

## Time Has Told

the story of MIDWEST AIR FILTERS—and told it well. It is now eight years since this air filter was first offered to solve the problem of handling dirt and dust, and with positive results obtained from 4000 installations, and the fact that

this air filter now has an international record of repeated success—That constitutes the world's stamp of approval on

## Midwest Unit Air Filters

During this time, there have been exhaustive studies in the field—as well as in laboratories—coupled with our close supervision and observation of actual installations.

As a result of all this work and with over 40,000,000 cubic feet of air per minute now being cleaned of dirt and dust, it is quite natural that for this type of air filter, certain standards of efficiency—capacity—resistance and velocity have been established.

To adhere to these standards is one of the fundamental principles of our endeavors—to raise or lower these for the sake of price—or orders—is inviting inefficient results.

All Midwest users have adhered to our standards, and that satisfactory results have been obtained is best verified by our customers.

With an able and skilled staff of engineers of long experience, coupled with years of actual experience, it is our keenest desire to advise you right—to tell it once but tell it right; therefore our service and results, known in every part of the world, means that you will be well advised if you consult Midwest.

For turbo-generators—transformers—ventilation—paint spray—air compressors—food products—and wherever dirt and dust is a destructive or objectionable factor—secure Midwest advice and follow it.

Get the  
Book

“They Know Us”  
and  
Descriptive Folder  
F1

**MIDWEST STEEL & SUPPLY COMPANY**  
(INC.)

Executive Offices: 100 East 45th Street, New York City

*Branches in all Principal Cities*

# MIDWEST STEEL & SUPPLY CO. INC.

Please mention the JOURNAL of the A. I. E. E. when writing to advertisers.

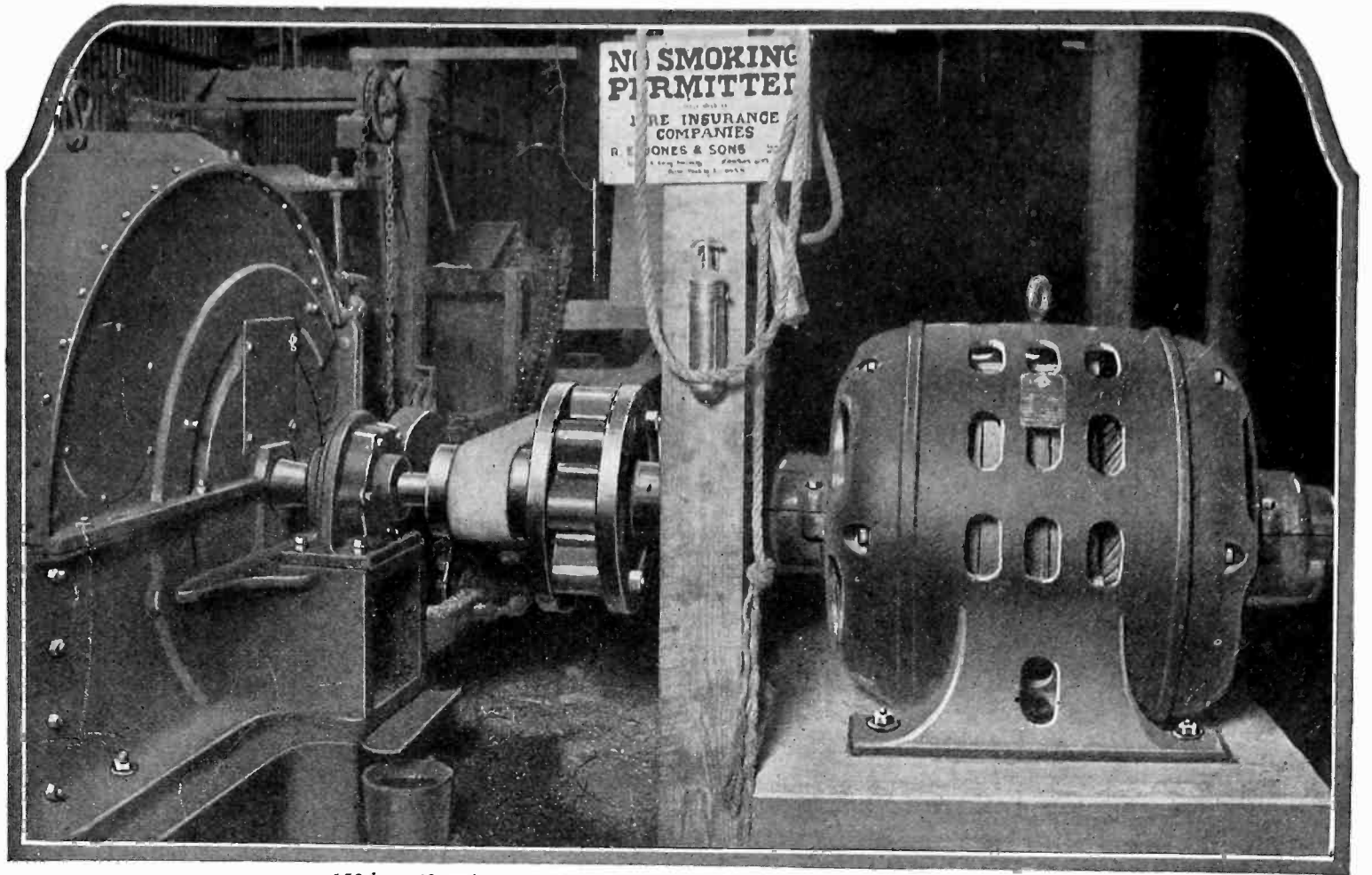

150 hp.—60 cycle—440 volt Type BR. Wagner Motor operating alfalfa chopper

## “Coolest-running motor I have ever seen” —says superintendent

**S**ERIOUS motor troubles are generally due to overheating. The bearings or the windings get hot—result, the bearings “freeze” or the insulation burns out, involving delay and expense in either case.

Cool-running is therefore a mighty important characteristic in a motor.

That is why the remark of the superintendent of the plant in which the above-pictured motor is installed, is especially significant of Wagner Motor quality when he says, “The Wagner Motor operates the coolest of any type motor I have ever seen on similar outfits”. Ask for Bulletins 1226 and 1276.

# Wagner, Quality Motors

WAGNER ELECTRIC CORPORATION, SAINT LOUIS

Please mention the JOURNAL of the A. I. E. E. when writing to advertisers.



### WAGNER ACHIEVEMENTS

*Producers of the*  
FIRST COMMERCIALY  
SUCCESSFUL  
SINGLE PHASE MOTOR

UNITY POWER  
FACTOR MOTOR

*Pioneers in*  
HIGH VOLTAGE POWER  
AND  
LIGHTING TRANSFORMERS  
AUTOMOTIVE STARTING  
LIGHTING AND IGNITION  
SYSTEMS

DIRECTED DRAFT MOTORS  
(The Pow-R-full)

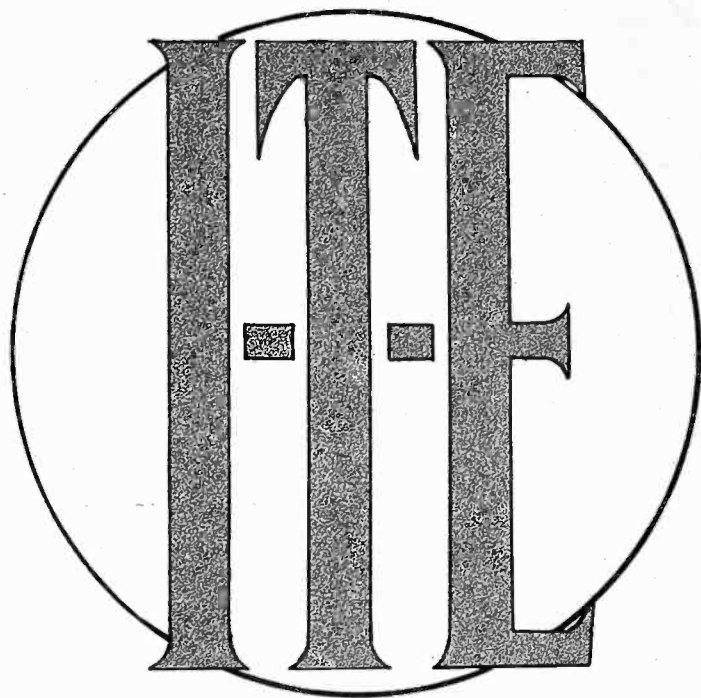

A Consulting Engineer said to one of our big competitors the other day: "You've got to hand it to Cutter when it comes to Circuit Breaker problems—they've got you all skinned." Not elegant perhaps but true.

The fact is that thirty years is an invaluable asset to an engineering organization trained to be satisfied with nothing but the best.

Power can be and is supplied by prime movers and generators of every conceivable make and type but, when it comes to the problem of protection and distribution where human intelligence with mathematical certainty is required, nothing less than I-T-E Circuit Breakers will do.

**CUTTER** *The* **COMPANY**  
ESTABLISHED 1888  PHILADELPHIA  
1829 HAMILTON STREET

# “—without prejudice”

There are some bearings which can only be lubricated with oil. Some only with grease.

Then there are some which, apparently, may be lubricated with either—but the correct selection of the type of lubricant used may determine the operating efficiency.

Engineers and oil buyers have to face this question, and when they meet it they will do well to consult with a representative of The Texas Company.

He can advise without prejudice.

The Texas Company manufactures Texaco Lubricants in all useful forms.

Thus a general outline will include:

TEXACO STRAIGHT MINERAL OILS

TEXACO COMPOUNDED OILS

(containing fixed oils in correct proportions for the lubrication of Steam Cylinders and for similar purposes)

TEXACO LIQUID GREASES

TEXACO SEMI-SOLID GREASES

TEXACO SOLID (HARD) GREASES

and

In a class by themselves:

TEXACO THUBAN COMPOUNDS

a lubricant for light, fast running gears.

and

TEXACO CRATER COMPOUND

a remarkable, pure, heavy lubricant for heavy gearing, wire ropes, etc.

We cite this with the thought in mind that though our readers may know that The Texas Company is a Complete Cycle, (controlling every operation from the time a well is drilled until the refined product leaves our warehouses) they may not all be aware of the completeness of the line of Texaco Lubricants.

In other words, the statement:

“There is a  
TEXACO LUBRICANT  
for every purpose”

is an actual fact.

And a fact of value to the user of oil, because Texaco can and does meet every lubricating requirement on any kind of machine or prime mover in every field of mechanical endeavor.

So when you have a problem of lubrication (and every engineer has them once in a while) put it up to Texaco and be advised without prejudice.

# TEXACO

**Engine Oil - Marine Oils - Turbine Oil**  
**Steam Cylinder Oil - Gear Lubricants - Greases**



THE TEXAS COMPANY

TEXACO Petroleum Products

Dept. EE, 17 Battery Pl., New York City

HOUSTON - CHICAGO - NEW YORK

Offices in Principal Cities



Please mention the JOURNAL of the A. I. E. E. when writing to advertisers.



# PIONEERS

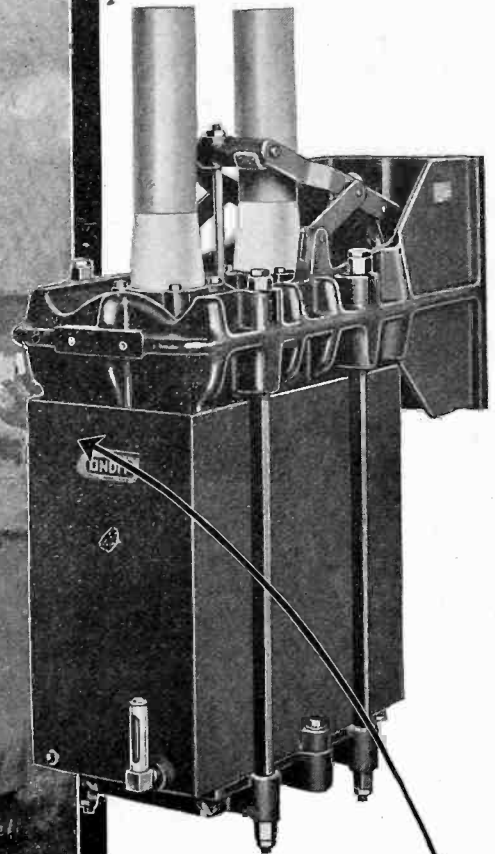

Today—as for years past—Condit Engineers are looking forward to the possibilities of the future. At every stage Condit practice and design have kept a step in advance of the need of the moment.

For high-power systems, Condit blazed the way by introducing the type D-17, with its self-contained oil separator and “spill-tank”—minimizing fire hazards.

Consider the rugged construction of the D-17, its resiliently suspended tanks, its whole design—features that enable it to withstand the heavy mechanical shocks incident to the interruption of heavy short circuits.

For more dependable and safer switchgear “Keep in touch with Condit.”

## CONDIT ELECTRICAL MFG. CO.

*Manufacturers of Electrical Protective Devices*

**Boston 27, Mass.**

*Northern Electric Company*

LIMITED

Sole Distributor for the Dominion of Canada

Type D-17 showing path of hot oil and gas vapors on interrupting heavy short circuits.

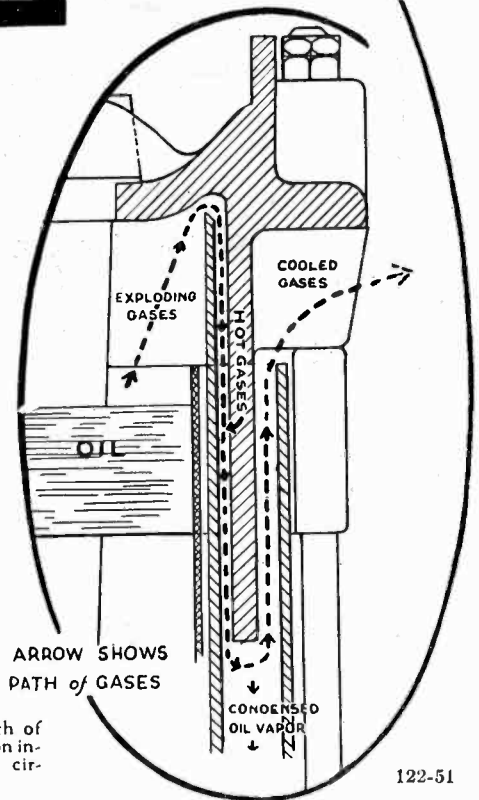

*Specifications:* 1, 2, 3, or 4 pole, 1600 amperes or less, 15,000 or 25,000 volts. Interrupting capacity 5,000 amperes at 15,000 volts.

# CONDIT

Please mention the JOURNAL of the A. I. E. E. when writing to advertisers.

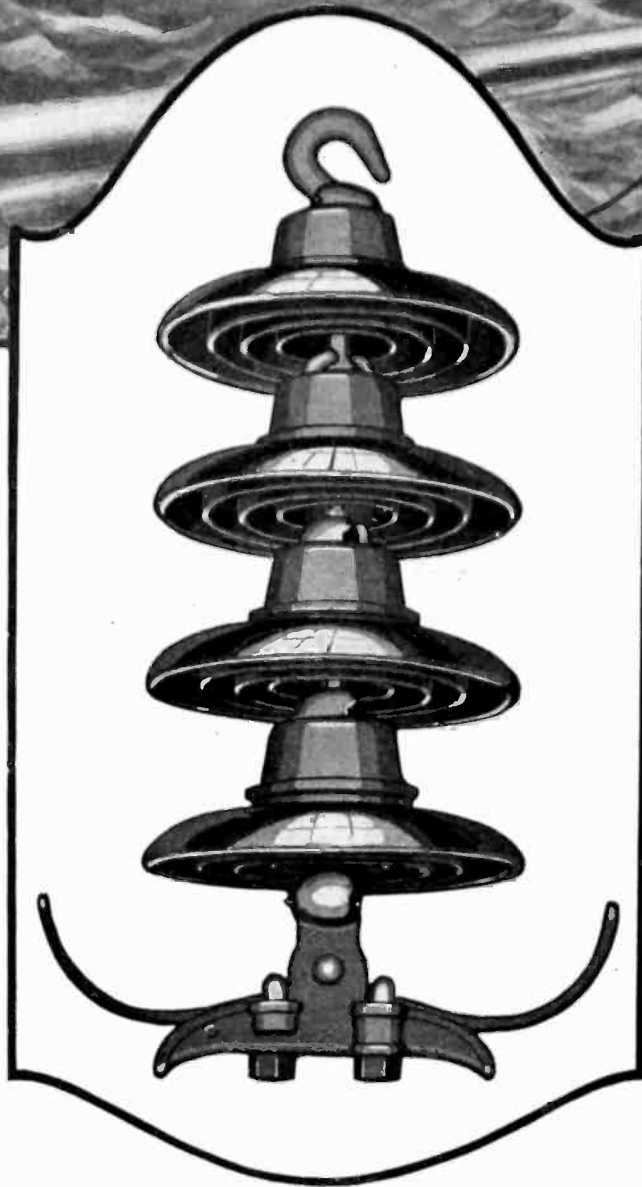
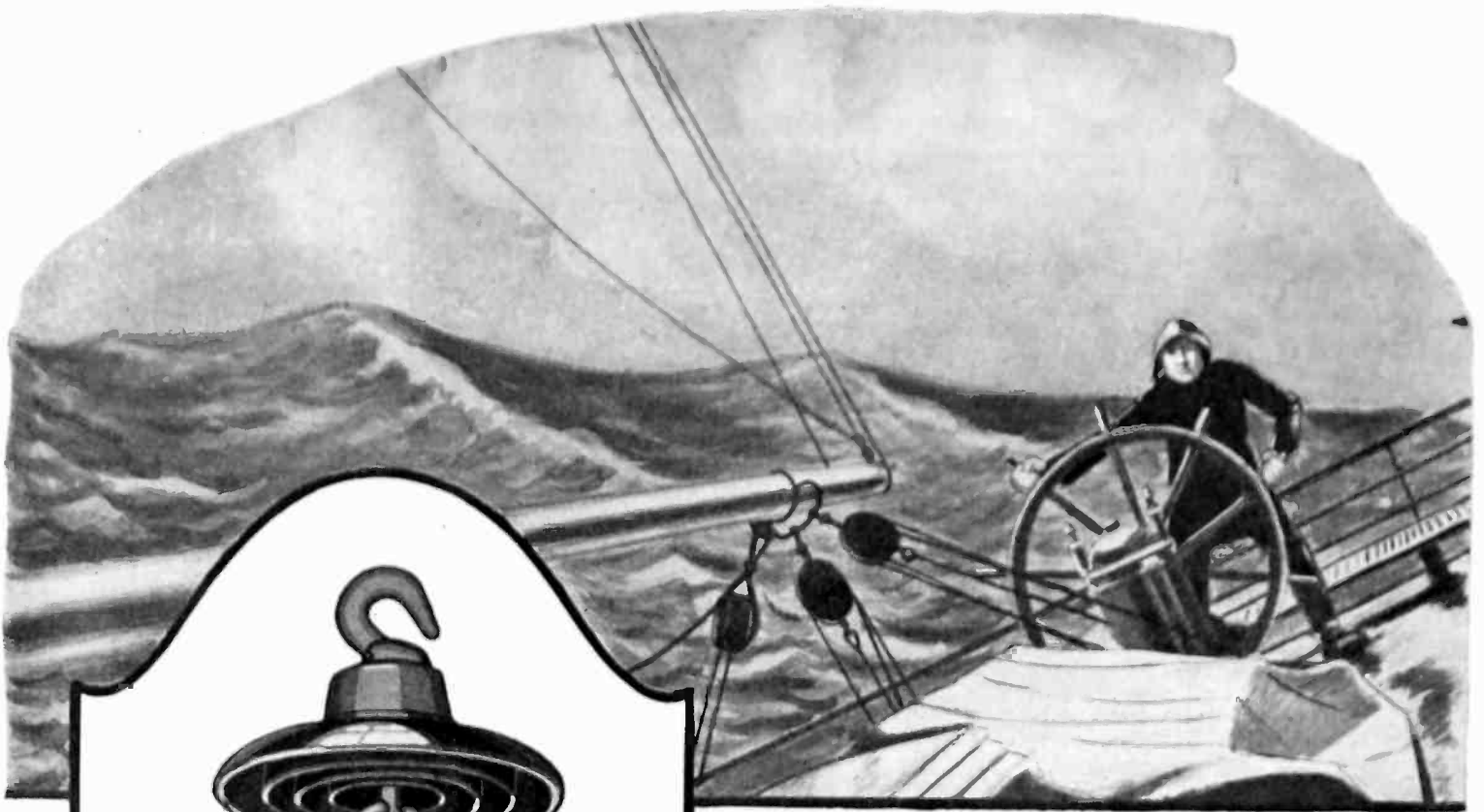

O-B Designs *Improve* the Lines

## INDIVIDUAL RESPONSIBILITY

**P**LOWING through tossing seas, perhaps with dangerous rocks or shoals on the lee, the fate of ship, passengers, and crew is in the hands of the pilot. If he is derelict to duty for a single minute, the safety of all is at hazard.

On the long transmission line, stretching across rugged country for hundreds of miles, the continuity of a service representing millions of dollars invested, depends on every individual string of insulators doing its part every moment. The failure of a single string would interrupt service on the whole system.

Through summer's heat and lightning, through winter's cold and wind and sleet, hundreds of thousands of strings of O-B Insulators have been carrying this individual responsibility for years, and have showed a degree of reliability that was unknown before the O-B "High Efficiency" types of insulators were produced.

103

The **Ohio** **B** **Brass** Co.  
Mansfield, Ohio, U.S.A.

New York Philadelphia Pittsburgh Charleston, W. Va. Chicago Los Angeles San Francisco Paris, France  
Products: Trolley Material, Rail Bonds, Electric Railway Car Equipment, High Tension Porcelain Insulators, Third Rail Insulators

Please mention the JOURNAL of the A. I. E. E. when writing to advertisers.

# First!

—first to brand Butt-Treated poles for the protection of the buyer.

—first to use a butt-treating process that insures a deeper penetration of the preservative throughout the ground-line area.

—first to give a written guarantee specifying a definite depth of penetration.

## The "P & H" Guaranteed Penetration Process

is the original and strongest Guaranteed Penetration Process of butt-treatment. We agree to refund, without quibbling, the entire butt-treating price on every pole that does not show the specified half inch uniform penetration.

For longest pole life---for greatest satisfaction and economy---insist on the "P & H" --- the original Guaranteed Penetration Process.

We produce and sell butt-treated and untreated Northern White and Western Red Cedar Poles; --- we can give you any form of butt-treatment; --- and we are the originators of the Guaranteed Penetration Process---the "P & H".

**Prompt Shipment** - yards conveniently located throughout the North Central and Western States.

Get the facts about Butt-Treatment  
Write for illustrated booklet.

Copyright, 1922 by P & H Co.



*"still in the  
lead"*

*"P. & H." Guaranteed Penetration Process Poles in lines of Nebraska Power Co., Omaha, Nebraska.*

# PAGE AND HILL CO.

## MINNEAPOLIS, MINN.

New York, N. Y. 50 Church St.  
Chicago, Ill., 19 So. LaSalle St.

Grand Rapids, Mich., Powers Bldg.  
Kansas City, Mo. 717 Bryant Bldg.  
Omaha, Neb., 513 Electric Bldg.

Houston, Texas, 1111 Carter Bldg.  
Dallas, Texas, 311 Sumpter Bldg.

Buffalo, N. Y. 950 Ellicott Sq. Bldg  
Louisville, Ky. 1416 Starks Bldg.

Please mention the JOURNAL of the A. I. E. E. when writing to advertisers.

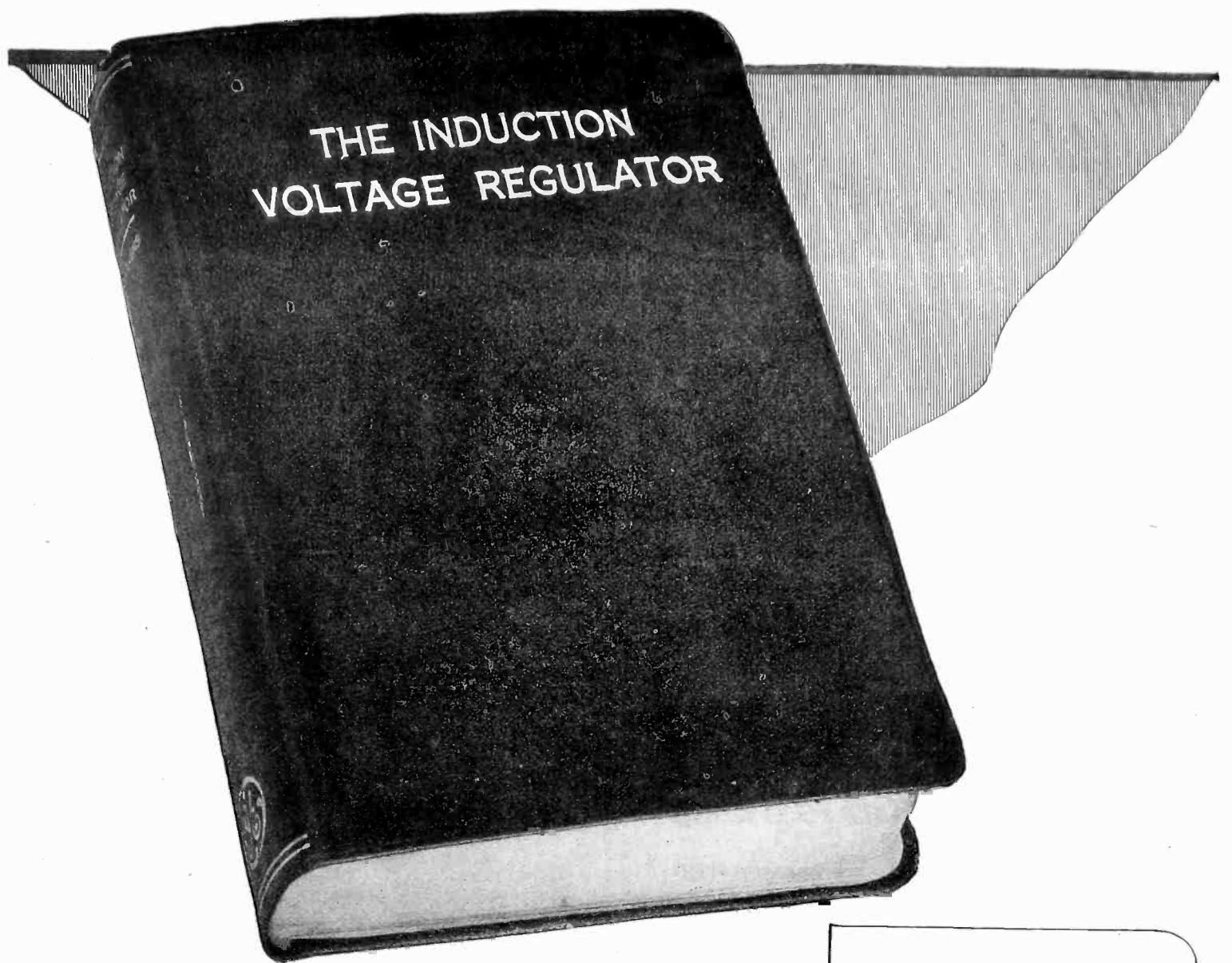

This book has been issued to fill the need for a single authoritative publication devoted to a comprehensive discussion of feeder voltage regulation. It summarizes much of the material previously published, incorporating only the essentials. The author has aimed also to demonstrate:

That induction regulators, with their auxiliaries for automatic operation, are exceedingly simple and from an operating standpoint require no more care or attention than any other class of electrical apparatus.

That, although the automatic regulation of voltage has been viewed as a refinement, it is of real benefit to the central station as it results: in the increase in the sale of energy, in reductions in the cost of line construction, in furnishing uniform service, and in the economical interconnection of generating systems.

### THE INDUCTION VOLTAGE REGULATOR

Its Development, Design,  
Characteristics, Use,  
and Application

BY

**E. F. GEHRKENS**

*Engineer, Feeder Voltage Regulator Department  
General Electric Company*

FIRST EDITION

PRICE \$3.50

PUBLISHED BY

GENERAL ELECTRIC COMPANY  
SCHENECTADY, N. Y., U. S. A.

1923

JANUARY, 1923

Y-1977

*The book is being sold at \$3.50 a copy.  
Send orders to G-E Sales Offices.*

# General Electric Company

General Office  
Schenectady, N.Y. Sales Offices in  
all large cities

33B-43

Please mention the JOURNAL of the A. I. E. E. when writing to advertisers.

## As a penny goes in a slot machine

**Y**OUR penny slips smoothly into the slot machine. Now try to drop a nickel in the same opening! It can't be done unless you file, or pound and hammer the coin.

The same thing is true of winding coils. You can use lumpy, uneven wire that must be forced into place by hammering down the bulges. Or you can use Acme Wire—the wire that *goes in the space*.

Old hands at winding coils, men who have tried and know every kind of wire, usually swear by Acme because they know they can wind more coils and hence make more money by using this wire.

They can not only wind more coils, but more that will

pass inspection. They can do this because Acme wire winds easily, without any kinks or bulges or expensive loss of time and labor.

Each spool of Acme Wire must come up to the high Acme standard. It must be even, uniform, perfectly sized, and absolutely free from lumps and all imperfections. The insulation must be smooth, unbroken, and of high dielectric strength.

For years this company has specialized in the aim of making a better wire for one purpose—winding coils. It will pay you to find out why, despite its slightly higher first cost, Acme wire usually reduces winding costs wherever it is used.

THE ACME WIRE CO., New Haven, Conn.  
NEW YORK      CHICAGO      CLEVELAND

# Acme Wire

*“It goes in the space”*

Please mention the JOURNAL of the A. I. E. E. when writing to advertisers.



### Some Users of Acme Magnet Wire

Atwater Kent Mfg. Co.  
Azor Motor Mfg. Co.  
Century Electric Co.  
Dayton Engineering Laboratories Co.  
Delco-Light Co.  
Diehl Mfg. Co.  
Domestic Electric Co.  
Eisemann Magneto Corporation  
Electric Auto-Lite Corp.  
Electric Specialty Co.  
Electrical Products Mfg. Co.  
Eureka Vacuum Cleaner Co.  
Ford Motor Co.  
Gray & Davis, Inc.  
Hamilton Beach Mfg. Co.  
Holtzer-Cabot Electric Co.  
Hoover Suction Sweeper Co.  
Klaxon Co.  
Robbins & Myers Co.  
Sangamo Electric Co.  
Sunlight Elec. Mfg. Co.  
U. S. Auto Supply Co.  
Wagner Electric Corporation  
Western Cartridge Co.  
Westinghouse Elec. & Mfg. Co.

### Acme Wire Products

“Enamelite,” plain enameled Magnet Wire; “Cottonite,” Cotton-covered Enamelite; “Silkenite,” Silk-covered Enamelite; Single and Double Cotton Magnet Wire; Single and Double Silk Magnet Wire. We also have a complete organization for the winding of coils in large production quantities.

### Acme Electrical Insulations

Flexible Varnished Tubing in all standard sizes and colors.

### Acme Radio Specialties

Audio Transformer windings.  
Radio Frequency windings.  
Magnet windings for Head Sets.

Enameled wire—especially the finest sizes, 40-44 B & S gauge.  
Silk and cotton-covered magnet wire.

Enameled Aerial wire—single wire and stranded.

*Illustrated Catalog will be sent upon request to Purchasing Agents and Engineers.*



## PUBLICATIONS

### JOURNAL. Published monthly.

An engineering periodical containing technical papers and discussions thereon presented before meetings of the Institute and its Sections and Branches; descriptions of new developments characterized by notable advances, and items relating to the activities of the Institute.

Subscription price: **\$10.00** per year. Agents, publishers and dealers are allowed 20 per cent discount; a special discount of 50 per cent is allowed on single subscriptions received directly from college or public libraries.

Postage to Canada on annual subscription **\$0.50** additional, and to foreign countries, **\$1.00**. (Postage should not be included when computing discounts.)

### TRANSACTIONS. Published annually.

Contains such of the technical papers and reports published by the Institute in the JOURNAL and elsewhere as are selected and authorized by the Publication Committee; also the discussions on the technical papers. The TRANSACTIONS form a permanent record of the progress of electrical engineering.

Volumes for years 1920 and 1921 (and 1922 when ready for distribution) may be purchased by non-members at **\$10.00** per year in either paper or cloth binding. Volumes covering the years 1902 to 1920 inclusive, may be obtained at reduced prices which will be quoted upon request. The 1919 edition of the TRANSACTIONS is out of print, as are a number of the volumes for the years previous to 1902; a price list of those available will be furnished upon application.

Members of the Institute may purchase the TRANSACTIONS for 1921, in cloth binding, at **\$3.00**, and may subscribe to the 1922 volume, now in course of preparation, at **\$2.00**. Available back volumes published prior to 1921 may be obtained by members at a cost of **\$1.50** per book.

College and public libraries are allowed a discount of 50% from non-member prices upon direct subscription to Institute headquarters; publishers and subscription agents, 20% from non-member prices.

### SEPARATE PAPERS AND DISCUSSIONS.

Most of the recent papers and discussions contained in the TRANSACTIONS can be furnished separately at the following prices: Single copies of any paper, usually with discussion, **\$0.50**. Five or more copies of any paper, each **\$0.40**.

Discount of 20 per cent allowed to publishers and subscription agents; 50 per cent is allowed from the above prices to Institute members and college and public libraries.

### STANDARDS. 1922 Edition.

Gives definitions of electrical terms, technical data, standard performance, specifications for tests of electrical machinery, standard voltages and frequencies, and general recommendations as adopted by the Standards Committee and approved by the Board of Directors of the A. I. E. E. It also contains, as an appendix, the rules for electrical machinery of the International Electro-technical Commission, adopted in October 1919. Price per copy, flexible cover, **\$2.00**.

Discount of 25 per cent allowed to members, libraries, publishers, subscription agents, and purchasers of ten or more copies.

### MARINE RULES. 1921 Edition.

Recommended practise for electrical installations on shipboard. Drawn up to serve as a guide for the equipment of merchant ships with electrical apparatus for lighting, signalling, communication and power, but not including propulsion. The rules indicate what is considered the best engineering practise with reference to safety of the personnel and of the ship itself, as well as reliability and durability of the apparatus. The Marine Rules are intended to supplement the Standards of the A. I. E. E., which should be followed wherever applicable. Price per copy, flexible linen cover, **\$1.00**.

Discount of 25 per cent allowed to members, libraries, publishers, subscription agents, and purchasers of ten or more copies.

### YEAR BOOK. 1923 Edition.

A directory, published annually in March, of the membership of the A. I. E. E. Gives in alphabetical order, the names, occupations and addresses of all members. The membership is also listed in geographical order. The Year Book contains general information regarding the scope and activities of the Institute, including the Constitution and By-Laws, lists of Sections and Branches, the various committees, governing body, etc. Price per copy, linen cover, **\$2.00**.

Discount of 20 per cent to publishers and subscription agents; 50 per cent to college and public libraries. Single copies will be supplied to members without charge upon application.

**American Institute of Electrical Engineers**  
**33 West Thirty-ninth Street, New York, N. Y.**

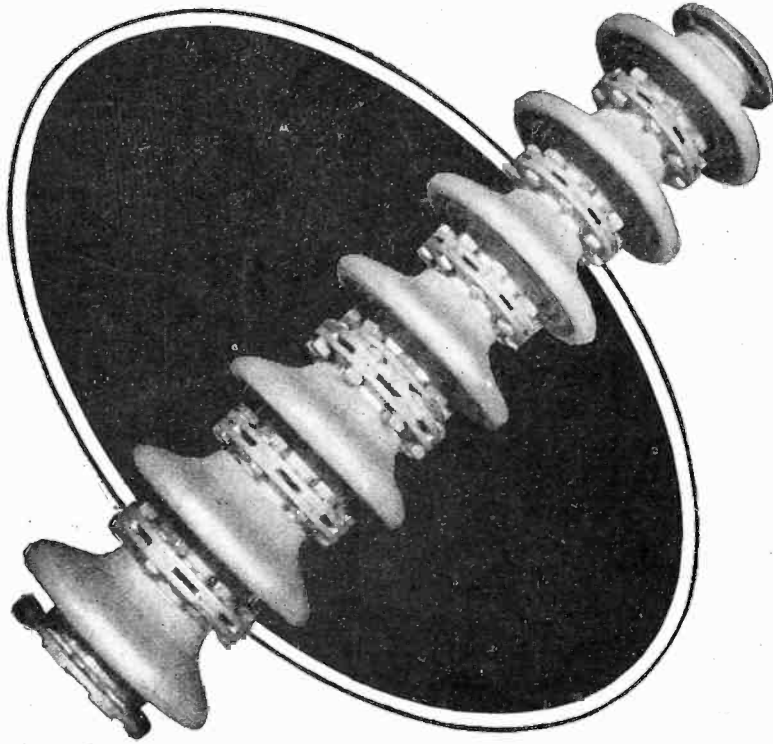

## Higher Cantilever Strength With J-D Composite Posts

Many engineers are meeting the need for extra mechanical strength, imposed by high voltage out-door switching and the like, by specifying composite posts of Jeffery-DeWitt super-flange and standard flange insulators.

These composite type pillars are made up of our super-flange insulators at the bottom and standard flange insulators at the top.

This combination gives a post of much higher cantilever strength than heretofore, without sacrificing the superior electrical characteristics that mark the J-D product.

Consequently these composite posts are

giving excellent satisfaction where stacks of flange type insulators are needed for 110,000 volts or higher. The extreme rigidity and high mechanical values in flexure—so desirable for this work—are assured whether the mountings be vertical, inverted, or at 45 or 90 degrees.

Permanent rigidity, combined with high electrical and mechanical values, explains in large measure the preference being shown for all types of J-D posts.

Advise our engineering department in detail regarding the service required and recommendations will be promptly sent you.

*No cement to crack or crumble under vibration or mechanical impact*

### Jeffery-DeWitt Insulator Company

Kenova, W. Va.

Executive Sales Offices: 50 Church Street, New York City

JEFFERY-DEWITT  
INSULATOR CO.  
KENOVA, W. VA. U.S.A.

## Thirty Years

For three decades Kuhlman Transformers have served the electrical industry, and have played an important part in its remarkable development.

In that time they have achieved a reputation for honesty of manufacture and reliability of performance, of which we are justly proud.

*"Built to Fit the Need"*

## FOR RELIABLE POWER

# KUHLMAN TRANSFORMERS

SINCE 1893

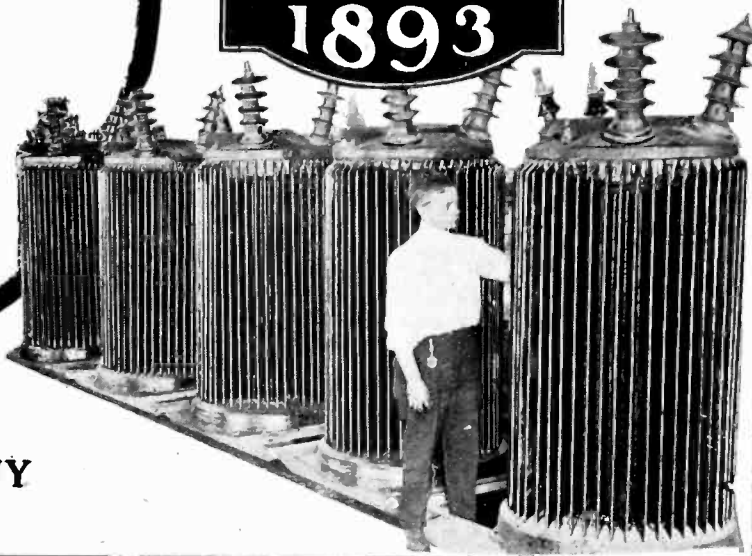

### KUHLMAN ELECTRIC COMPANY

Main Office and Factory: Bay City, Mich.



#### CABLE TERMINAL DEVICES



#### DISCONNECTING POTHEADS

The advantages of the disconnecting pothead should always be considered carefully before definite decision to use any other is made. The disconnecting feature adds little to the cost and its benefits are almost without limit, depending entirely upon the extent to which you take advantage of them.

The disconnecting pothead is the basis of a system of distribution that is more flexible than any other which could be installed or maintained or operated at anywhere near as low a cost.

Where potheads are to be installed near other manual switches the non-disconnecting pothead or plain cable seal is properly chosen, the disconnecting pothead is often used in connection with automatic switches, cutouts, etc., as it provides a disconnect which can be used in case of repairs or renewals being necessary.



#### POTHEADS, DISTRIBUTION BOXES

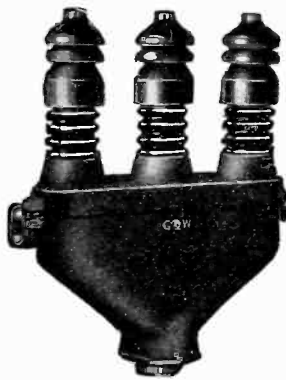

#### ON LINE EXTENSIONS OR IMPROVEMENTS

In planning for expansion and improvement of your distribution systems take advantage of the G and W Pothead Idea.

The value of your installation is dependent upon the adaptability of your distribution system at a time of sudden need.

Both normal conditions and the requirements of sudden demands, at a time of service interruption can be successfully met with a G and W equipped system. The experience of the G and W staff is at your service in planning complete equipment to meet the needs of specific installations.

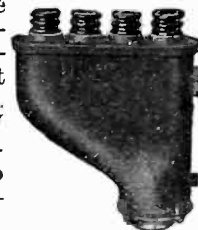

#### G & W ELECTRIC SPECIALTY CO.

Chicago Illinois

Representatives in All Principal Cities

# G & W ELECTRIC SPECIALTY CO.



# Prominent Engineering Concerns

*Specify and Purchase*

## SPRACO "VERTICAL"

**Air Washing and Cooling Equipment**

**for the New Enclosed System of Ventilation for turbo-generators**

(Stone & Webster,—Byllesby Engineering and Management Corp., and J. G. White Engineering Corp. are three of the prominent engineering concerns that have specified and purchased SPRACO Type "V" Air Washers for numerous installations)

Our Engineering Department will submit, without obligation, recommendations, with proposal on a washer for the enclosed system of ventilation, on receipt of essential information. The Spray Engineering Company are also pioneer manufacturers of Horizontal Air Washers (non-recirculating air type) for conditioning the ventilating air for turbo-generators.

*For full particulars  
Write Dept. AW-69*

Engineers for  
Spray Cooling Systems  
Irrigation Systems  
Aerating Reservoirs  
Air Conditioning  
Gas Washing



Manufacturers of  
Air Washing Equipment  
Spray Cooling Equipment  
Paint Spraying Equipment  
Flow Meters  
Park Sprinklers  
Self Cleaning Strainers

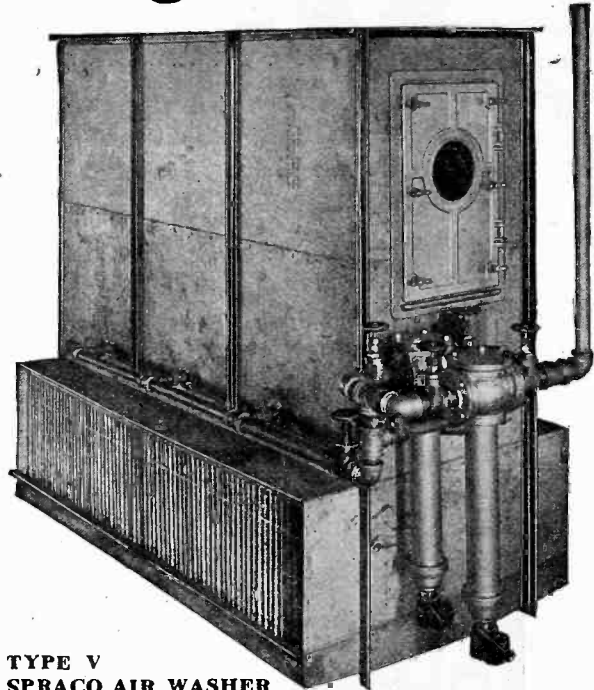

**TYPE V  
SPRACO AIR WASHER**  
Uses same air over—rewashing and recooling.  
Enables generator to run indefinitely without cleaning.

## SPRAY ENGINEERING COMPANY

60 High Street, Boston, Mass.

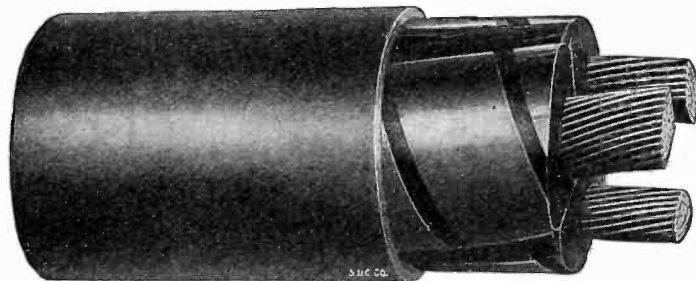

STANDARD Type H Cable for 25000 Volt Service (1/2 actual size)  
Note copper tapes around each core

**STANDARD Type H Cable** is the new cable which may solve that installation problem for you and secure greater economy and dependability in your underground system. It will pay you to investigate.

The invention and development of new and improved types of electric cables and cable accessories has been our exclusive study for over 40 years. This specialized knowledge and skill is a perpetual guarantee of the superior quality and efficiency of STANDARD products.

Factories at Perth Amboy, N. J., Pittsburgh, Pa., St. Louis, Mo., and Oakland, Calif., afford exceptional facilities for meeting your requirements promptly.

*Catalogues and prices on request to our nearest office.*

### Standard Underground Cable Co.

Boston	Philadelphia	Atlanta	Detroit	St. Louis	Seattle
New York	Washington	Pittsburgh	Chicago	Los Angeles	San Francisco
		Kansas City			

For Canada: Standard Underground Cable Co. of Canada, Limited, Hamilton, Ont.

Please mention the JOURNAL of the A. I. E. E. when writing to advertisers.

# MOLONEY TRANSFORMERS

for

## Power and Substation Service



The exacting service required of transformers in the Large Power and Substation Field calls for Quality of the highest order.

Moloney Power Transformers are designed and built with the idea of not just meeting, but of *exceeding* the requirements of this field of service. Supreme Quality is built into every part of a Moloney Power Transformer.

Write for Catalogs No. 217 and 218 describing Moloney Power Transformers.

### Moloney Electric Company

Manufacturers of Transformers Only

Factories:

St. Louis, Mo.

Windsor, Canada

Offices in All Principal Cities

## You have complaints to settle—



Bristol's Recording Ammeter

Every Central Station manager does.

TRADE MARK  
**BRISTOL'S**  
REG. U. S. PAT. OFFICE.

**Recording Ammeters**

are unsurpassed for settling complaints, you can tell every fluctuation and quantity of current, together with the length of time. Keeps you informed of exact conditions in the Central Station and on distributing lines. Write for Catalog BC-1501.

**THE BRISTOL COMPANY**

Waterbury, Conn.

Branch Offices:

Boston    New York    Philadelphia    Detroit    Pittsburgh  
Chicago    St. Louis    San Francisco



For testing insulation resistance of generators, motors, transformers, switchboards, insulators, cables, etc., there is only *one best way*, and that is to use our approved

### MEGGER-METHOD

The first cost of a Megger Testing Set or Bridge-Megger is small by comparison with the saving in time and upkeep which results *invariably* from intelligent use of one of these valuable instruments. They are apt to "*pay for themselves*" very soon!

The subject warrants careful investigation.

Write for illustrated Catalog J-985.

**James G. Biddle**

1211-13 Arch Street, Philadelphia

Please mention the JOURNAL of the A. I. E. E. when writing to advertisers.

# Portable High Voltage Testing Equipment

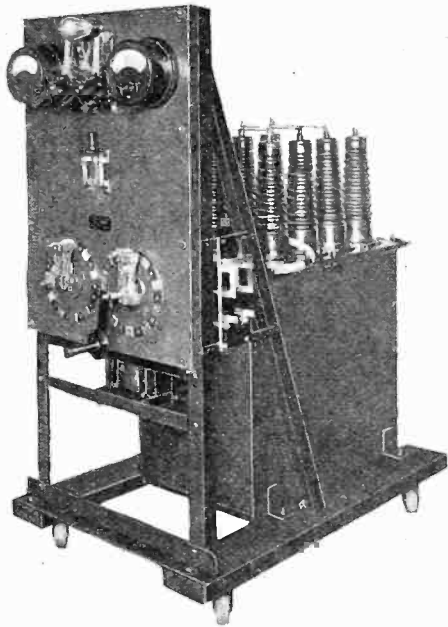

Type TS-10



For Difficult Transformer Problems

A VERY convenient and an exceedingly accurate method for testing cables, electrical machinery, porcelain, rubber gloves, oil, mica, varnish, paper,—in fact, any material requiring high voltage insulation tests over a period of time, is provided by this portable apparatus. It combines all essential equipment in a single unit mounted on a platform, with large castors, so that it can be easily transported.

An exclusive, patented feature of such American Transformer equipment is the voltage regulator, whereby two radial switches, one provided with ten 10% taps and the other with ten 1% taps, automatically and smoothly advance the voltage in one per cent unbroken increments, from zero to maximum.

We shall be glad to forward to those interested, complete technical description of such testing sets, which can be modified and adapted to individual requirements, for all capacities. Send for Bulletin No. 1010.

**The American Transformer Company**  
176 Emmet Street, Newark, N. J.

**To Radio Engineers and Enthusiasts.**—The new AmerTran,—audio frequency amplifying transformer, has less distortion and far greater amplifying power than any similar device now on the market. Send for Bulletin 1005, containing an unusual chart of audibility amplification of the transformer, and musical scale. The AmerTran is moderately priced and is distributed through jobbers and dealers.

## Type 193 Decade Bridge

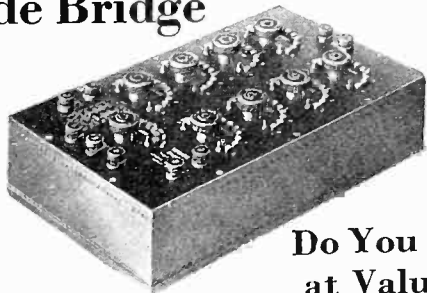

**Do You Guess  
at Values of  
INDUCTANCE and CAPACITANCE?**

Hardly necessary when it is so EASY to MEASURE, and measure accurately if you have a General Radio Co. Decade Bridge.

This bridge has three resistance arms, two of which consist of four-dial decades, with a range of 0.1 to 1111 ohms. The Ayrton-Perry Method of winding produces units, the resistances of which are nearly independent of frequency.

Mounted in a polished walnut cabinet, fitted with a copper shield to protect against outside electrostatic fields.

**PRICE \$125.**

For use with this bridge—

**Standards of Inductance  
Standards of Capacitance  
Standards of Resistance**

All fully described in Bulletin 404-E sent free on request.

**GENERAL RADIO CO.**

Manufacturers of  
**RADIO AND ELECTRICAL LABORATORY APPARATUS**  
Massachusetts Avenue and Windsor Street  
**CAMBRIDGE 39 MASSACHUSETTS**

5300



Dimensions  
4 in. x 5 in. x 2 in.  
Weight 20 oz.

## It Goes in Your Pocket

Roller-Smith Type HD voltmeters, ammeters and volt-ammeters for direct current are small enough to go in your pocket, compact enough to take up little space, light enough for convenience, accurate enough for all ordinary tests, and, above all, durable enough to stand the hardest kind of work. Ranges up to 200 amperes and 300 volts. Send for Bulletin No. AE-110.

**ROLLER-SMITH COMPANY**  
Electrical Instruments, Meters and Circuit Breakers

MAIN OFFICE  
12 Park Place, NEW YORK



WORKS:  
Bethlehem, Penna.  
Offices in Principal Cities in U. S. and Canada

Please mention the JOURNAL of the A. I. E. E. when writing to advertisers.

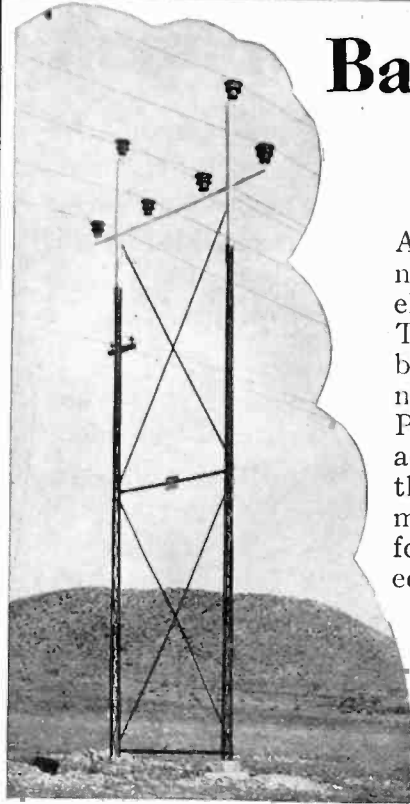

## Bates Steel Poles

Are used by recognized leaders in the electrical industry. They have found it both logical and economical to buy Bates Poles—poles of a character consistent with the high standard demanded and specified for the rest of their equipment.

*Bates engineers will gladly co-operate with you in your planning.*

*There's a Bates Pole for Every Pole Purpose.*

**B**ates **E**xpanded **S**teel **T**russ **C**o.

ILLINOIS MERCHANTS BANK BLDG., CHICAGO, ILL.

# DUDLO

## Magnet Wire and Windings

have for over twelve years been standard among electrical manufacturers due to their dependable quality and reasonable price. Find out the economy and improvement we can effect for you.

*Write today for prices and samples.*

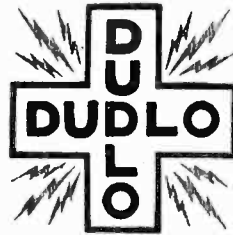

**Dudlo Manufacturing Company**

Fort Wayne, Ind.

## OVERHEAD GROUND LINES

*are constructed correctly with*

# "COPPERWELD"

TRADE MARK REG. U. S. PAT. OFF.

(Made by the Molten Welding Process)

Most objections to overhead ground lines have arisen from troubles following rusting of the wires.

A life at least equal to the power conductors is now recognized as the foremost requirement in the selection of an overhead ground wire.

Copperweld wire does not rust.

*Xtra-Hi-Tensile Strength Copperweld now available*

Technical Data, Wire Tables, Sag Charts sent on request

RURAL DISTRIBUTION — TELEPHONE WIRE

LONG TRANSMISSION SPANS

RADIO ANTENNAE

GUY STRAND — SERIES LIGHTING

## COPPER CLAD STEEL COMPANY

NEW YORK SALES OFFICE:  
30 CHURCH STREET, NEW YORK

CHICAGO SALES OFFICE  
129 S. JEFFERSON ST., CHICAGO

MAIN OFFICE AND WORKS: BRADDOCK P. O. RANKIN, PA.

## ANACONDA BARE COPPER WIRE

STRANDED CONDUCTORS OF ANY DESIRED CAPACITY

TROLLEY WIRE

Anaconda Copper Mining Company

ROLLING MILLS DEPT.  
545 Conway Bldg., Chicago

*From Ore to Finished Product*

# Rubber Covered Wires and Cables

National Electrical Code Standard

FOR  
FACTORIES AND  
OFFICE BUILDINGS

FOR  
SCHOOLS AND  
PUBLIC BUILDINGS



Complete detail specifications for your files upon request.  
Ask for Simcore Specifications No. 2053.

## SIMPLEX WIRE & CABLE CO

MANUFACTURERS

201 DEVONSHIRE ST., BOSTON 9  
15 SOUTH DESPLAINES ST., CHICAGO  
612 HOWARD ST., SAN FRANCISCO



# MINERALLAC INSULATING COMPOUND No. 78

In the Testing Laboratory and in actual service, under unusual operating conditions, No. 78 has proved its worth.

For Cable Joints and Potheads on high-tension lines, it has many special points of merit as an insulating material. We recommend its use.

## MINERALLAC ELECTRIC COMPANY

1045 Washington Blvd., Chicago

# ROCKBESTOS

Asbestos Insulated Wires and Cables

**E**VEN if a wiring system fulfills its purpose 100% right, it is not entirely successful unless this efficiency has been obtained and can be maintained, with a minimum of expense and labor.

The purpose of the Rockbestos Engineering Department is to assist contractors and plant electricians in accomplishing such results in their installations.

No charge is made for this service—nor does a consultation with a Rockbestos Engineer obligate you in any way whatsoever. Write us if you wish to take advantage of this offer—or if you wish any information about the following Rockbestos Products.

Heater Cord	Magnet Wire
Fixture Wire	Stove Wire
Switchboard Wire	Motion Picture Cable

*Also Improved*  
Radio Head Set Cords

## ROCKBESTOS PRODUCTS

C O R P O R A T I O N

Sales Promotion Department G

NEW HAVEN, CONN.

# New Departure Ball Bearings

## Do Ball Bearings Mean Anything to You?

"These bulletins are invaluable for their engineering data, and will offer many suggestions in designing," the engineer of a Milwaukee manufacturer of electrical equipment.

EVERY electrical engineer will sooner or later recognize that motors and generators can be improved by ball bearings to the same extent that automobiles and other machinery have been improved.

You owe it to yourself to keep informed of this important development. Just drop a line on your Company's letterhead and get a copy of the New Departure Engineering Reference Book with the monthly supplements.

The New Departure Manufacturing Company  
 Detroit Bristol, Conn. Chicago

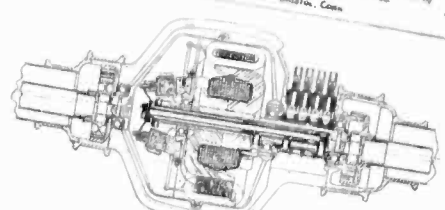

**NEW DEPARTURE BALL BEARINGS AND THEIR UNIVERSAL APPLICATION**  
 ENGINEERING INFORMATION  
 No. 130.  
 New Departure Mfg. Co. Bristol, Conn.

**Small Electric Vehicle Motor and Rear Axle Assembly.**  
 The above design shows the power plant of a small automobile. A four-cylinder four-cycle, air-cooled gasoline engine, directly connected to a generator, charges the storage battery. This unit weighs about 100 pounds complete and is portable, being readily dismounted and left in the garage, if it is not desired to charge the batteries on the road.  
 The driving motor shown is mounted in the rear axle, the complete assembly weighing but 100 lbs.  
 The field and armature both revolve, in opposite directions. Due to doubled rotation speed of rotation of the two members this gives a doubled power output compared to a motor of the same weight with fixed field. This type of motor renders a differential unnecessary, and may be used as a brake as well.  
 The current is carried to the commutator by slip rings as shown.  
 One shaft is driven by the field housing and the other by the armature shaft. In both cases an eccentric crank, with a 7/8 inch throw drives a planetary gear, mounted on the eccentric on rollers. In one case a spur planet gear, fastened to a flexible jointed shaft, runs around inside a stationary internal sun gear. In the other case, it is the internally toothed gear which is mounted on the eccentric and drives the shaft by revolving around a stationary external gear. The reduction is 2 1/2 to 1.  
 If this design were mounted on plain bearings, the slightest wear would quickly render the whole mechanism inoperative through sagging and misalignment. Nor could any suitable means of lubrication possibly be devised. With ball bearings, however, there is no wear and a light packing of grease at proper intervals, suffices for lubrication. These silent ball bearing features very definitely make an otherwise impossible design quite practical.

## THE NEW "MARTIN" A.C. to D.C.

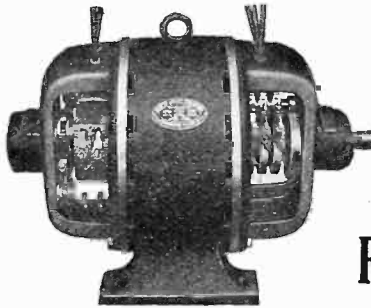

### Rotary Converter and Synchronous Motor

A self-starting and most efficient machine, that cuts conversion losses to a minimum. Designed to operate on 110, 220, 440 volts; 25, 30 and 60 cycles. Delivers D. C. of any desired voltage up to 250. Made in capacities from 100 Watts up to 100 Kw.

**FOR** MOTION PICTURES  
 ARC WELDING  
 BATTERY CHARGING  
 Bulletins on request.

### NORTHWESTERN ELECTRIC COMPANY

Also Mfrs. of "AK" Variable Speed A. C. Motors  
 409 So. Hoyne Avenue, Chicago, Ill.  
 Minneapolis—8 N. Sixth St. Kansas City, Mo.—1924 Grand Ave.  
 Toronto, Can.—308 Tyrell Bldg., 95 King St., E.

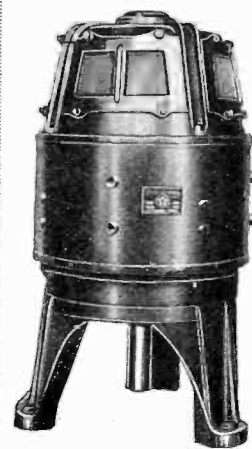

## STAR Ball Bearing Motors For All Purposes

Horizontal-Vertical

- D. C. Interpole Motors for hard usage—1 to 40 hp. Sparkless commutation at all times.
- A. C. Polyphase Motors squirrel cage induction and slipping—all cycles, 1 to 40 hp., 110 to 550 volts.
- A. C. and D. C. Generators and Motor-Generator Sets

Write for Bulletins.

### Star Electric Motor Co.

Miller St. and N. J. R. R. Ave., Newark, N. J.

A MOTOR THE WORLD CAN DEPEND ON

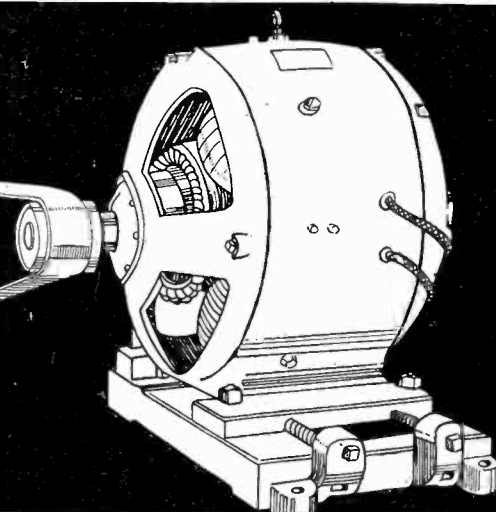

## ELECTRO DYNAMIC COMPANY

BAYONNE, N. J.

Sales Offices in Principal Cities

# Alcohol is a Conductor!

## Have You Ever Used BOPAD or COPAD?



STERLING BOPAD and Sterling COPAD are distinctive. They contain no alcohol and are therefore insulators wet or dry. They are the only oilproof, hydro-carbon solvent air drying varnishes on the market.

Sterling BOPAD gives a brilliant glossy black coat when used as a finish.

Sterling COPAD has a rich mahogany color similar to that obtained with a clear baking varnish subjected to high temperatures.

The Sterling catalog No. 20, which is accepted as a text book on insulating coatings, gives complete specifications of these materials. Write for a copy today.

If information on liquid or solid insulators is desired, our engineers can advise you intelligently *what* to use and *how* to use it.

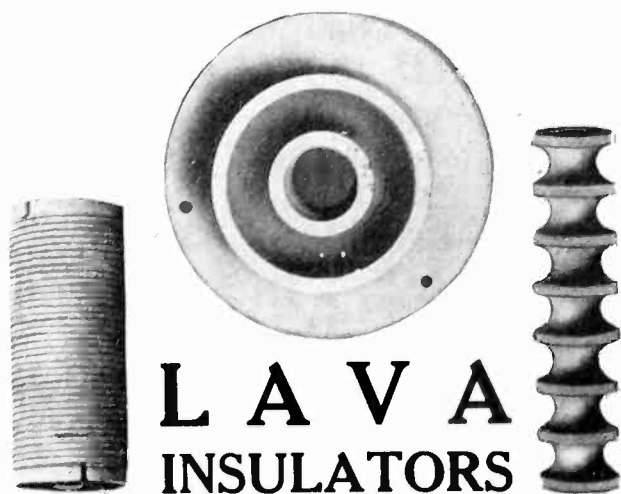

## L A V A INSULATORS

To Manufacturers of  
Electrical Appliances:

YOUR insulation problems will receive the attention of our engineering department, with no obligation on your part, if you will submit sketch, sample or blue print.

**AMERICAN LAVA CORPORATION**  
27-67 Williamson Street  
CHATTANOOGA, TENNESSEE  
*Manufacturers of Heat Resistant Insulators*



*Divisions of*  
**BAKELITE CORPORATION**

**BAKELITE**  
General Bakelite Co.  
8 West 40th St. New York

**Condensite**  
Condensite Co. of America  
Bloomfield, N. J.

**REDMANOL**  
Redmanol Chemical  
Products Co.  
636-678 West 22nd St.  
Chicago, Ill.

**Finished — in a Single Operation**

The case enclosing this Exploring Coil was formed, polished, and embossed in the mold — an advantage made possible by Condensite phenol resin.

Permanently strong, both mechanically and dielectrically, this non-absorbent, molded phenol resin is the ideal insulating material, obtainable only under the trade-marks Bakelite — Condensite — Redmanol.

Write for a copy of Booklet D.

**BAKELITE CORPORATION**  
*Address the Divisions*

*The Material of a Thousand Uses*

**"AMERICAN BRAND"**



**Weatherproof Copper Wire and Cables**

**COST**



You can buy weatherproof wire cheap, but is it worth what it costs?

"American Brand" gives you more mileage per dollars with a longer life on the line.

Get a sample and satisfy yourself.

**"AMERICAN BRAND"**  
WEATHERPROOF WIRE AND CABLES  
HAS NO EQUAL

**American Insulated Wire & Cable Co.**  
954 West 21st Street, Chicago



**ATLANTIC**  
**INSULATED WIRES**

**DOLPHIN Insulated Wire**

A code wire of high quality known for its great dielectric strength and resiliency, and used for its dependability and maximum service. Built on the same lines as the widely known and used "Triton"—Intermediate Grade 25%; and "Neptune"—30% para.

**ATLANTIC Insulated Wire & Cable COMPANY**

*General Sales Office*  
52 Vanderbilt Avenue New York, N. Y.  
Factory, Stamford, Conn.

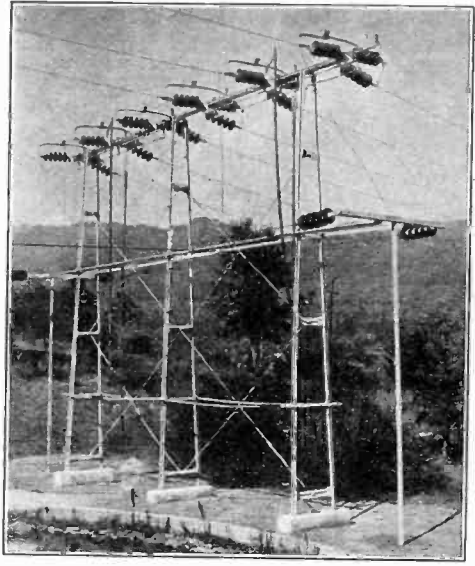

**Simpler—  
Stronger—  
Better—**

Installation K-P-F  
60 KV. Switches,  
San Joaquin Lt. &  
Pwr. Corpn., Calif.

K-P-F POLE TOP SWITCHES consist of fewer parts, are more rugged and require less labor and material for installation than any other.

Each pole becomes a self-contained unit. Switches are shipped ready to bolt on to cross-arm in place of line insulator.

One crossarm supports it. Contacts are far removed from insulators and a unique device prevents sticking or freezing.

Send for bulletin K105 containing full details.

**K-P-F ELECTRIC CO.**  
855-859 Howard St. San Francisco



**Lapp Insulators  
do not fail**

**LAPP INSULATOR CO., Inc.**  
LE ROY, N. Y.

*Sales Representatives*

SAN FRANCISCO, S. H. Lanyon, 509 New Call Bldg.  
DENVER, O. H. Davidson Equip. Co., 1633 Tremont St.  
ST. LOUIS, Commercial Electrical Supply Co., Broad & Spruce Sts.  
MINNEAPOLIS, J. E. Sumpter Co., 222 Security Bldg.  
DETROIT, F. R. Jennings Co., 805 Ford Bldg.  
INDIANAPOLIS, W. D. Hamer Co., 518 Trac. Terminal Bldg.  
PITTSBURGH, Union Electric Co., 933 Liberty Ave.  
BUFFALO, Robertson-Cataract Electric Co.  
CHARLOTTE, N. C., J. W. Fraser Co.  
PHILADELPHIA, Rumsey Electric Co., 1007 Arch St.  
NEW YORK CITY, Shield Electric Co., 149 Broadway  
BOSTON, Wetmore-Savage Co., 76 Pearl St.  
WELLINGTON, New Zealand, Jas. J. Niven & Co.

**WIRE PRODUCTS**  
**For Varied Applications**

We manufacture many types of wires, cords and cables for specific uses. Among them are:

Rubber Covered Wire—Solid Conductor, Stranded Conductor, Flexible Conductor, Extra Flexible Conductor.  
Lamp Cords, Reinforced Cords, Heater Cord, Brewery Cord, Canvasite Cord, Packinghouse Cord, Deck Cable, Stage Cable, Border Light Cable, Flexible Armored Cable, Elevator Lighting Cable, Elevator Operating Cable, Elevator Annunciator Cable. Switchboard Cables, Telephone Wire, Flameproof Wires and Cables, Railway Signal Wires, High Voltage Wires and Cables. Automobile Ignition Cables, Automobile Lighting Cables, Automobile Starting Cables, Automobile Charging Cables. Moving Picture Machine Cable.

**Boston Insulated Wire & Cable Co.**  
*Main Office and Factory:*  
Dorchester District Boston, Mass.  
Canadian Branch, Office and Factory, Hamilton, Ont.

When designing that large Transformer or Generator bear in mind that we are now furnishing

**Square and Rectangular Conductors**  
in the same eternally good

**Cotenamel**  
TRADE MARK

insulation that has stood between you and so much trouble with windings made of round wire.

**Belden Manufacturing Company**  
Magnet Wire Department  
4625 WEST VAN BUREN STREET, CHICAGO  
Eastern Office and Warehouse, Metuchen, N. J.

Please mention the JOURNAL of the A. I. E. E. when writing to advertisers.



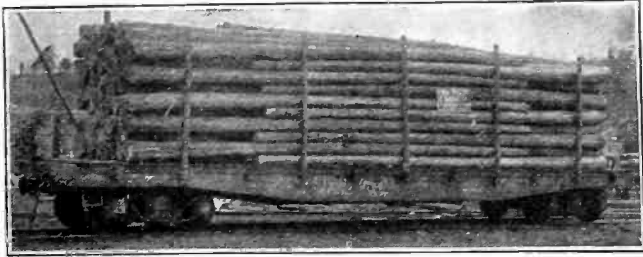

**CEDAR POLES** NORTHERN WHITE  
WESTERN RED  
PLAIN OR BUTT-TREATED  
*Satisfaction Guaranteed*  
**THE MAC GILLIS & GIBBS COMPANY**  
Milwaukee, Wis.

# CEDAR POLES

NORTHERN WHITE CEDAR  
WESTERN RED CEDAR

PLAIN OR TREATED BUTTS.

Prompt shipments guaranteed.

*Ask for our delivered prices.*

**T. M. PARTRIDGE LUMBER CO.**  
729 - 32 Lumber Exchange,  
MINNEAPOLIS, MINN.

# LOCKE



The distribution of electrical energy is too vitally allied with the welfare of the nation to be guarded by any but the highest grade insulators.

**Locke Insulator Corporation**  
Victor, N. Y.

*Over a quarter of a century manufacturers of electrical porcelain for high-tension electrical power transmission.*

**FACTORIES**

Victor, N. Y.                      Baltimore, Md.

# INSULATORS

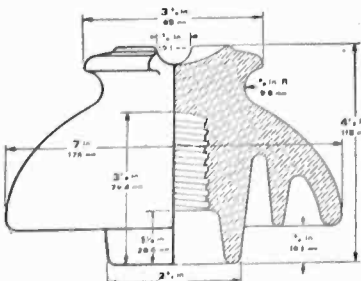

Catalog No. 1157-8.

Nominal Rating  
**23,000 Volts**

No. 1157--1" Pin Hole  
No. 1158--1 3/8" Pin Hole

Write for Blue Sheet of "THOMAS QUALITY" Insulators No. 1157-8.

**THE R. THOMAS & SONS CO.**

EAST LIVERPOOL, OHIO

New York      Boston      Chicago      London

## The Line that R. and I. E. Co. Builds!

This is the

Forged Steel Pin—four 1/8" holes on a 3" bolt circle in base

That supports the

Insulators used on R. & I. E. Equipment have largest factors of safety over operating voltage in flash-over values

That holds the

Pressed Steel Cap—four 1/8" slots on a 3" bolt circle in plate, spot welded to top of cap. No clamps, no set screws

That makes up the

R. & I. E. Interchangeable Insulator Units are exact duplicates. They are made to fit. Therefore they're easy to install. Their applications are unlimited.

### Interchangeable Insulator Unit that R. and I. E. Co. Builds

R. & I. E. Interchangeable Insulator Unit Equipment for outdoor service includes Bus Supports, Disconnecting Switches, Air Break Horn Gap Switches, Choke Coils, Fuse Holders, Lightning Arresters, Substation Combinations and Outdoor Steel Substations.

Manufactured by

**Railway and Industrial Engineering Co.**  
Greensburg, Penna.

Sales Offices in: New York · Boston · Pittsburgh · Chicago · Cincinnati

1



## ELECTRICAL WIRES

AND CABLES

WIRE ROPE                      WIRE STRAND  
WELDING WIRE

**John A. Roebling's Sons Co.**

Trenton, New Jersey

# PROFESSIONAL ENGINEERING DIRECTORY

For Consultants in the Fields of Engineering, and Related Arts and Sciences

*Established 1857*  
**ALEXANDER & DOWELL**  
 Attorneys at Law  
 PATENT, TRADEMARK AND  
 COPYRIGHT CASES  
 802 F Street, N. W. Washington, D. C.

**CHEYNEY AND WESCHLER**  
 CONSULTING ENGINEERS  
 Electrical Utility Systems. Power  
 Plants. Mechanical and Electrical  
 Equipment of Buildings and  
 Industrial Plants.  
 MILLS BLDG. WASHINGTON, D. C.

**MONTAGUE FERRY**  
 RADIO ENGINEERING  
 38 South Dearborn Street Chicago  
 60 Church Street New York

**AMBURSEN DAMS**  
 Hydroelectric Developments  
 Water Supply and Irrigation Dams  
 DAMS ON DIFFICULT FOUNDATIONS  
 AMBURSEN CONSTRUCTION CO.  
 Incorporated  
 Grand Central Terminal, New York  
 Kansas City, Mo. Atlanta, Ga.

**WALTER G. CLARK**  
 Consulting Engineer  
 Electrical, Mining and Industrial  
 Reports  
 Supervision of Organization and Arrange-  
 ments for Financing  
 8 WEST 40th STREET NEW YORK

Edward F. Croker Ex-Chief N. Y. Fire Dept.  
 Chas. W. Mitchell Electrical Engineer  
**FIRE PROTECTION ENGINEERS**  
 Fire Alarm Engineers & Contractors  
 Fire Drills, Fire Appliances and Equipment  
 22 W. 30th St. New York, N. Y.

**THE AMERICAN APPRAISAL CO.**  
 Valuations and Reports  
 of  
 Public utility, industrial  
 and all other properties  
 Rate Cases Reorganizations  
 Condemnation Suits Liquidations  
 NEW YORK MILWAUKEE  
 1896 And Principal Cities 1922

**EDWARD E. CLEMENT**  
 Fellow A. I. E. E.  
 Attorney and Expert  
 in Patent Causes.  
 Soliciting, Consultation, Reports,  
 Opinions.  
 McLachlen Bldg., Washington, D. C.  
 700 10th St., N. W.

**FORD, BACON & DAVIS**  
 Incorporated  
**ENGINEERS**  
 115 Broadway, New York  
 Philadelphia Chicago San Francisco

**THE ARNOLD COMPANY**  
 Engineers  
 Constructors  
 Electrical - - Civil - - Mechanical  
 CHICAGO  
 105 So. La Salle St.

**DAY & ZIMMERMANN, Inc.**  
 Engineers  
 Power Plants, Sub-Stations,  
 Transmission Lines, Industrial Plants,  
 Examinations and Reports, Valuations,  
 Management of Public Utilities.  
 611 CHESTNUT ST., PHILADELPHIA  
 New York Chicago

**THE FOUNDATION COMPANY**  
 Engineering Construction  
 120 LIBERTY ST. CITY OF NEW YORK  
 Offices in Principal Cities  
 Steam and Hydro-electric Developments  
 Transmission Lines Railway Structures  
 Industrial and Chemical Plants  
 Superstructures as well as Substructures

**ROBERT BAHAMON**  
 Mechanical and Electrical Engineer  
 Assoc., A. I. E. E.  
 Consulting, Contracts, Construction  
 and Agencies  
 BOGOTA, COLOMBIA, S. A.

**ROBERT E. DENIKE, Inc.**  
 Electrical Engineers  
 and Constructors  
 NEW YORK CITY

**FRANK F. FOWLE & CO.**  
 Electrical and Mechanical  
 Engineers  
 MONADNOCK BUILDING CHICAGO

**LESTER E. BARRETT**  
 Patent Lawyer  
 Validity, Infringement and Preliminary  
 Investigations  
 629 F Street, North West  
 Washington, D. C.

Fellow A. I. E. E. Member A. S. M. E.  
**W. N. DICKINSON**  
 Consulting Analyst  
 BUSINESS AND ENGINEERING  
 PROJECTS ANALYZED  
 Aeolian Hall, 33 W. 42d St., New York City  
 Telephones: Longacre 8196 Longacre 8645

**JOSEPH D. R. FREED**  
 Consulting Radio Engineer  
 Designs — Reports — Tests  
 255 FOURTH AVE. NEW YORK

**W. S. BARSTOW & CO.**  
 Incorporated  
 Consulting and  
 Construction Engineers  
 Public Service Properties  
 Financed and Managed  
 60 Pine St, New York.

**CHARLES C. EGBERT**  
 Engineer  
 Hydroelectric Power Development  
 Reports, Construction, Supervision  
 NIAGARA FALLS, N. Y.

**FREYN, BRASSERT & COMPANY**  
 Chicago Philadelphia  
 Consulting and Constructing  
 Engineers  
 Gas, Steam and Hydro-Electric Power Plants  
 Electrification of Rolling Mills  
 Fuel, Oil, Tar, Gas Combustion Engineering  
 Design and Construction of  
 Electric Furnace Installations

**BATTEY & KIPP**  
 Incorporated  
**ENGINEERS**  
 Complete Industrial Plants  
 Power Plants & Electrical Installations  
 Engineering Reports, Analyses & Appraisals  
 123 W. Madison Street CHICAGO

**DAVID V. FENNESSY**  
 Consulting Power Engineer  
 MILLS BUILDING EL PASO, TEXAS

**FULLER ENGINEERING  
 COMPANY**  
 Engineers and Constructors  
 Designs Estimates  
 PULVERIZED COAL PLANTS  
 and burning equipment for Steam Boilers,  
 Locomotive Boilers and Industrial Furnaces  
 FULLERTON, PA.  
 60 Church Street New York

Please mention the JOURNAL of the A. I. E. E. when writing to advertisers.

# PROFESSIONAL ENGINEERING DIRECTORY

For Consultants in the Fields of Engineering, and Related Arts and Sciences

**WILLIAM S. HIGBIE**  
 Electrical Engineer  
**ENGINEERING AND PURCHASING SERVICE**  
 Design—Manufacture—Construction  
 Own Shops  
 Own Yard for Handling  
 114 LIBERTY ST. NEW YORK CITY

**EFFECTIVE ADVERTISING**  
 —Your Card in This Directory  
**SMALL COST**  
 —\$40 per year—12 insertions

**SARGENT & LUNDY**  
 Incorporated  
 Mechanical and Electrical Engineers  
 1412 Edison Bldg., 72 West Adams Street  
 CHICAGO, ILLINOIS

Dugald C. Jackson  
 Edward L. Moreland  
**JACKSON & MORELAND**  
 CONSULTING ENGINEERS  
 387 Washington St. Boston, Mass.

**NEILER, RICH & CO.**  
 Electrical and Mechanical Engineers  
 Consulting, Designing and Supervising  
 Manhattan Building - - - Chicago

**ADOLF P. C. SCHRAMM, E.E.**  
 Mem. S. A. E. Assoc. A. I. E. E.  
 Consulting Engineer  
 Fractional Horse Power Motors  
 Designs  
 Manufacturing Methods and Processes  
 Labor Saving Devices  
 ADRIAN, MICHIGAN

**J. KAPPEYNE**  
 Consulting Engineer  
 Valuations, Examinations and Reports.  
 Operating and Rate Investigations  
 909 Comstock Ave., SYRACUSE, N. Y.

**OPHULS & HILL, Inc.**  
 Formerly Ophuls, Hill & McCreery, Inc.  
**CONSULTING ENGINEERS**  
 112-114 WEST 42d ST., NEW YORK CITY  
 Ice Making and Refrigeration  
 Investigations and Reports

**SESSIONS ENGINEERING COMPANY**  
 Engineers on  
 Power Plant Design & Industrial  
 Betterments  
 Electrification  
 140 SO. DEARBORN ST. CHICAGO

**E. S. LINCOLN, INC.**  
 Consulting Electrical Engineers  
 Designs Investigations Reports  
 Electrical Research Laboratory  
 534 Congress St. PORTLAND, MAINE

**I. S. PRENNER**  
 of the Philadelphia Bar  
 Mem. A. I. E. E., S. A. M. E.  
 Technical Patent Expert  
 404 Penfield Bldg.  
 1328 Chestnut St. PHILADELPHIA

**FREDERICK G. SIMPSON**  
 Electrical Engineer  
 Reports, Designs, Specifications.  
 Electric Power  
 and  
 Industrial Developments.  
**RADIO COMMUNICATION SYSTEMS,**  
 Telegraph and Telephone.  
 3301 L. C. Smith Bldg. Seattle, Wash.

**J. N. MAHONEY**  
 Consulting Engineer  
 Fellow A. I. E. E. Mem. Am. Soc. M. E.  
 Design, Supervision, Specifications, Reports  
 Specialist in Electrical Power Switching and  
 Protective Equipment, Industrial and  
 Railway Control and Brake  
 Equipment  
 618-77th STREET BROOKLYN, N. Y.

**PUBLIC SERVICE PRODUCTION COMPANY**  
 Engineers and Constructors  
 Design and Construction of Power Plants,  
 Substations and Industrial Plants.  
 Examinations and Reports, Valuation and  
 Management of Public Utilities.  
 80 PARK PLACE NEWARK, N. J.

**SPRAY ENGINEERING CO.**  
 Engineers and Manufacturers  
 Spray Cooling Systems - Irrigation Systems  
 Aerating Reservoirs - Air Conditioning  
 Gas Washing Pneumatic Paint Spraying  
 Spray Problems of All Kinds  
 Consulting Laboratory  
 60 HIGH STREET BOSTON

**McCLELLAN & JUNKERSFELD**  
 Incorporated  
 Engineering and Construction  
 New York Philadelphia  
 45 William St. 112 South 18th St.

**RICHARDSON & GAY**  
 CONSULTING ENGINEERS BOSTON  
 220 Devonshire Street  
 Steam, Electrical, Hydraulic, Industrial  
 Developments—Building Equipment—  
 Investigations—Reports.  
 Edward B. Richardson Harry Gay

**JOHN A. STEVENS, Engineer**  
 Power Plants  
 Transmission Lines — Sub-stations  
 Hydro-electric Stations  
 Consultation — Analysis — Design  
 Supervision of Construction  
 Purchased Power Contracts Negotiated  
 LOWELL, MASSACHUSETTS  
 Cleveland Fall River

**W. E. MOORE & CO.**  
 Engineers  
 Plans and Specifications for  
 Hydroelectric and Steam Power Plants  
 Industrial Plants and Electric Furnaces  
 Union Bank Building Pittsburgh, Pa.

**DWIGHT P. ROBINSON & COMPANY**  
 Incorporated  
 Design and Construction of  
 Power Developments, Electric  
 Railways, Industrial Plants  
 125 East 46th Street, New York  
 Chicago Youngstown Philadelphia  
 Los Angeles Montreal Rio de Janiero

William M. Stockbridge Victor D. Borst  
**STOCKBRIDGE & BORST**  
 Patent Lawyers  
 41 PARK ROW NEW YORK CITY

**N. J. NEALL**  
 Consulting Engineer  
 for  
 Electrical and Industrial Properties  
 12 PEARL STREET BOSTON, MASS.

**SANDERSON & PORTER**  
 Engineers  
 Reports Designs  
 Construction Management  
 Hydro-electric Developments  
 Railway, Light and Power Properties  
 Chicago New York San Francisco

**STONE & WEBSTER**  
 Incorporated  
 Examinations Reports Appraisals  
 on  
 Industrial and Public Service  
 Properties  
 NEW YORK BOSTON CHICAGO

# PROFESSIONAL ENGINEERING DIRECTORY

For Consultants in the Fields of Engineering, and Related Arts and Sciences

## PERCY H. THOMAS

Consulting Engineer  
ELECTRIC POWER  
Generation - Transmission  
Applications  
120 BROADWAY NEW YORK

## THE J. G. WHITE ENGINEERING CORPORATION

Engineers—Constructors  
Industrial Plants, Buildings, Steam Power  
Plants, Water Powers, Gas Plants, Steam &  
Electric Railroads, Transmission Systems.  
43 EXCHANGE PLACE NEW YORK

## EUGENE C. WOODRUFF, Ph.D.

Member A.I.E.E. and A.E.R.A.  
Fellow A.A.A.S.  
Electric Railway Engineering  
Automobile Engineering  
STATE COLLEGE PENNSYLVANIA

## UNITED GAS & ELECTRIC ENGINEERING CORPORATION

Engineers Management  
Construction Appraisals  
Reports, Estimates and Specifications  
Now supervising the Engineering  
and Operation of 32 Public Utility  
Properties located in 12 states  
61 BROADWAY NEW YORK CITY

## GARDNER S. WILLIAMS

Mem. Am. Inst. Cons. Eng. Mem. Am. S. C. E.  
Consulting Engineer  
Hydroelectric Developments  
Investigations and Reports  
Cornwell Bldg. ANN ARBOR, MICH.

## J. G. WRAY & CO.

Engineers  
J. G. Wray, Fellow A.I.E.E. Cyrus G. Hill  
Utilities and Industrial Properties  
Appraisals Construction Rate Surveys  
Plans Organization Estimates  
Financial Investigations Management  
1217 First National Bank Bldg., Chicago

## VIELE, BLACKWELL & BUCK

Engineers  
Designs and Construction  
Hydroelectric and Steam Power Plants  
Transmission Systems Industrial Plants  
Reports Appraisals  
49 WALL STREET NEW YORK

## WOODMANSEE-DAVIDSON ENGINEERING COMPANY

Consulting Engineers  
784 Continental & Commercial Bank Bldg.  
CHICAGO, ILL.

*To be printed in the following  
issue, copy for cards must be  
received by the 15th of the month.*

## ELECTRICAL TESTING LABORATORIES

80th Street and East End Ave.  
NEW YORK

### Inspections — Tests — Research

Tests may be used by the purchaser for the following purposes:

- (1) To determine the quality of competing samples. This enables the purchase of the best quality for the money.
- (2) To make sure that shipments comply with specifications. This makes possible the assurance to the customer that shipments match buying samples.
- (3) To furnish an impartial decision in case of disputes between purchaser and manufacturer.

Testing place the whole buying problem on a sound basis.

## A Great Engineering Library

THE Engineering Societies Library, 33 West 39th St., New York, is a reference library for engineers, directed by the national engineering societies. It contains 150,000 volumes and receives 1500 periodicals relating to civil, mining, mechanical and electrical engineering, metallurgy and industrial chemistry. A staff of experienced investigators is available

to make searches upon engineering subjects, prepare lists of references and translate engineering publications from foreign languages.

The Library can also supply photoprint copies of any articles appearing in engineering journals, old or recent. Prices for any services will be quoted on application.

## At Your Service



Is your  
name on our  
mailing list for  
bulletins and  
catalog?

# Morganite Brushes

Morganite  
Brush Co., Inc.  
519 W. 38th St.  
New York

Please mention the JOURNAL of the A. I. E. E. when writing to advertisers.

**THE ROWAN A.C. STARTING SWITCH**  
**PUSH BUTTON OPERATED**  
**OIL IMMERSED**



FOR  
**STARTING AND STOPPING SMALL SQUIRREL CAGE**  
**MOTORS THAT CAN BE THROWN ACROSS**  
**THE LINE**

**ROWAN CONTROL**  
 THE ROWAN CONTROLLER CO., BALTIMORE, MD.

**Why Do the Leading Power Companies Specify the T&M Disconnecting Switch?**

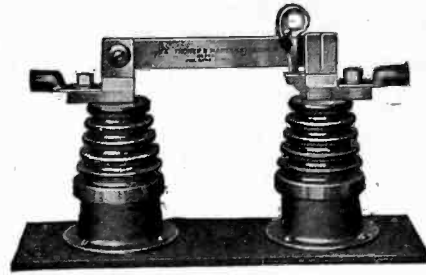

Because of its absolute dependability for the exacting service required of it. Because of its sturdy construction, its reasonable price, and the quick deliveries obtainable.

Made in any size up to 3000 amperes, 15,000 volts, as well as in special sizes.

Write us on any high or low tension switch problem. Our designers will submit sketches and cost.

**THONER & MARTENS**  
 463 Commercial Street, Boston, Mass.

**The Public Service Co. of N. J.**

have 7 STATES meter test tables in operation in their Jersey City plant.

**Accurate**  
**Flexible**  
**Dependable**  
**Saves Current and Time**

**THE STATES COMPANY**  
 74 Francis Ave.  
 Hartford, Conn.

Ask for Cat. No. 1, Section 3



**DUNCAN**  
**MODEL E**

The ideal direct current watt-hour meter. A pioneer in the service with a record for unstinted accuracy, and a reputation for dependability under all conditions that naturally recommends it to fastidious engineers who demand the best in the art.

**DUNCAN ELECTRIC MFG. CO.**  
 Lafayette, Ind.

**SPHERICAL PHOTOMETERS**

40"-60" and 80" SPHERES

Using the Built In  
**SHARP-MILLER PHOTOMETER**

Scale range 40 - 4500 lumens

Calibrated by The Electrical Testing Laboratories  
 No dark room required

COMPLETELY EQUIPPED FOR  
**MULTIPLE AND STREET SERIES LAMPS**

**CENTRAL STATIONS**

MAINTAIN YOUR STREET LIGHTING REQUIREMENTS UP TO STANDARD

Send for Catalog No. 32

**Foote, Pierson & Co., Inc.**  
 160-162 Duane St., New York City

Classified Advertiser's Index for Buyers—Continued.

**INSULATING MATERIALS—Continued**  
*Paper*  
 Irvington Varnish & Ins. Co., Irvington, N. J.  
*Silk*  
 Irvington Varnish & Ins. Co., Irvington, N. J.  
*Slate*  
 Structural Slate Co., The, Pen Argyl, Pa.  
*Tape*  
 Belden Mfg. Co., Chicago  
 Minerallac Electric Co., Chicago  
 Okonite Co., The, New York  
 Western Electric Co., All Principal Cities  
 Westinghouse Elec. & Mfg. Co., E. Pitts-  
 burgh  
*Varnishes*  
 General Electric Co., Schenectady, N. Y.  
 Irvington Varnish & Ins. Co., Irvington, N. J.  
 Minerallac Electric Co., Chicago  
 Sterling Varnish Co., Pittsburgh

**INSULATORS, HIGH TENSION**  
*Composition*  
 General Electric Co., Schenectady, N. Y.  
*Glass*  
 Hemingray Glass Co., Muncie, Ind.  
*Porcelain*  
 General Electric Co., Schenectadv. N. Y.  
 Jeffery-Dewitt Insulator Co., Kenova, W. Va.  
 Lapp Insulator Co., Inc., LeRoy, N. Y.  
 Locke Insulator Mfg. Co., Victor, N. Y.  
 Ohio Brass Co., Mansfield, O.  
 Thomas & Sons Co., R. East Liverpool, O.  
 Western Electric Co., All Principal Cities  
 Westinghouse Elec. & Mfg. Co., E. Pitts-  
 burgh

**INSULATORS, TELEPHONE & TELEGRAPH**  
 Hemingray Glass Co., Muncie, Ind.  
 Western Electric Co., All Principal Cities

**LAMP GUARDS**  
 Western Electric Co., All Principal Cities

**LAVA**  
 American Lava Co., Chattanooga, Tenn.

**LIGHTNING ARRESTERS**  
 Electro Service Co., Marietta, Ga.  
 General Electric Co., Schenectady, N. Y.  
 Railway & Industrial Engg. Co., Greens-  
 burg, Pa.  
 Western Electric Co., All Principal Cities  
 Westinghouse Elec. & Mfg. Co., E. Pitts-  
 burgh

**LOCOMOTIVES ELECTRIC**  
 General Electric Co., Schenectady, N. Y.  
 Westinghouse Elec. & Mfg. Co., E. Pitts-  
 burgh

**LUBRICANTS**  
 Texas Co., The, New York

**MAGNET WIRE**  
 Acme Wire Co., New Haven, Conn.  
 Belden Mfg. Co., Chicago  
 Dudlo Mfg. Co., Ft. Wayne, Ind.  
 Roebing's Sons Co., J. A., Trenton, N. J.  
 Western Electric Co., All Principal Cities

**METERS, ELECTRICAL**  
 (See INSTRUMENTS, ELECTRICAL)

**METER LOADING DEVICES**  
 States Co., The, Hartford, Conn.

**MOLDED INSULATION**  
 Bakelite Corporation, New York  
 Belden Mfg. Co., Chicago  
 Condensite Co. of America, Bloomfield, N. J.  
 General Bakelite Co., New York  
 Redmanol Chemical Products Co., Chicago  
 Westinghouse Elec. & Mfg. Co., E. Pitts-  
 burgh

**MOLYBDENUM**  
 Fansteel Products Co., Inc., North Chicago,  
 Ill.

**MOTORS**  
 (See GENERATORS AND MOTORS)

**PANEL BOARDS**  
 (See SWITCHBOARDS)

**PATENT ATTORNEYS**  
 (See PROFESSIONAL ENGINEERING  
 DIRECTORY)

**PHASE MODIFYING APPARATUS**  
 States Co., The, Hartford, Conn.

**PHOTOMETERS—SPHERES**  
 Foote, Pierson & Co., Inc., New York

**PLUGS**  
 General Electric Co., Schenectady, N. Y.  
 Western Electric Co., All Principal Cities  
 Westinghouse Elec. & Mfg. Co., E. Pitts-  
 burgh

**POLES, STEEL**  
 Bates Expanded Steel Truss Co., Chicago  
 Western Electric Co., All Principal Cities

**POLES—TIES, WOOD**  
 MacGillis & Gibbs Co., Milwaukee, Wis.  
 Page & Hill Co., Minneapolis, Minn.  
 Partridge Lumber Co., T. M., Minneapolis  
 Western Electric Co., All Principal Cities

**POTHEADS**  
 G & W Electric Specialty Co., Chicago  
 Standard Underground Cable Co., Pittsburgh  
 Thoner & Martens, Boston  
 Western Electric Co., All Principal Cities

**PROTECTIVE DEVICES**  
 Metropolitan Device Corp., Brooklyn, N. Y.  
 Western Electric Co., All Principal Cities

**PULLEYS, PAPER**  
 Rockwood Mfg. Co., The, Indianapolis

**PUMPS**  
 Allis-Chalmers Mfg. Co., Milwaukee  
 Goulds Mfg. Co., Seneca Falls, N. Y.

**PUMPS, SPIRAL**  
 Cramp & Sons Ship & Eng. Bldg. Co., The  
 Wm., Philadelphia

**PYROMETERS**  
 Leeds & Northrup Co., Philadelphia

**RADIO LABORATORY APPARATUS**  
 Acme Apparatus Co., Cambridge, Mass.  
 General Radio Co., Cambridge, Mass.  
 Westinghouse Elec. & Mfg. Co., E. Pitts-  
 burgh

**RAILWAY SUPPLIES, ELECTRIC**  
 General Electric Co., Schenectady, N. Y.  
 Ohio Brass Co., Mansfield, O.  
 Western Electric Co., All Principal Cities  
 Westinghouse Elec. & Mfg. Co., E. Pitts-  
 burgh

**REACTANCE COILS**  
 Metropolitan Device Corp., Brooklyn, N. Y.

**RECTIFIERS**  
 General Electric Co., Schenectady, N. Y.  
 Wagner Electric Corp., St. Louis  
 Western Electric Co., All Principal Cities  
 Westinghouse Elec. & Mfg. Co., E. Pitts-  
 burgh

**REGULATORS, VOLTAGE**  
 General Electric Co., Schenectady, N. Y.  
 States Co., The, Hartford, Conn.  
 Western Electric Co., All Principal Cities  
 Westinghouse Elec. & Mfg. Co., E. Pitts-  
 burgh

**RESISTANCE ELEMENTS**  
 General Electric Co., Schenectady, N. Y.

**RHEOSTATS**  
 Biddle, James G., Philadelphia, Pa.  
 General Electric Co., Schenectady, N. Y.  
 Western Electric Co., All Principal Cities  
 Westinghouse Elec. & Mfg. Co., E. Pitts-  
 burgh

**ROPE, WIRE**  
 Roebing's Sons Co., John A., Trenton, N. J.

**SEARCHLIGHTS**  
 General Electric Co., Schenectady, N. Y.  
 Westinghouse Elec. & Mfg. Co., E. Pitts-  
 burgh

**SLATE**  
 Structural Slate Co., The, Pen Argyl, Pa.

**SLOTING EQUIPMENT, COMMUTATOR**  
*Hand and Motor Driven*  
 Martindale Electric Co., The, Cleveland

**SOCKETS AND RECEPTACLES**  
 General Electric Co., Schenectady, N. Y.  
 Western Electric Co., All Principal Cities  
 Westinghouse Elec. & Mfg. Co., E. Pitts-  
 burgh

**SOLENOIDS**  
 Acme Wire Co., New Haven, Conn.  
 Belden Mfg. Co., Chicago  
 Dudlo Mfg. Co., Ft. Wayne, Ind.  
 General Electric Co., Schenectady, N. Y.  
 Westinghouse Elec. & Mfg. Co., E. Pitts-  
 burgh

**STOKERS, MECHANICAL**  
 Westinghouse Elec. & Mfg. Co., E. Pitts-  
 burgh

**STONES, COMMUTATOR**  
 Martindale Electric Co., The, Cleveland

**SUB-STATIONS**  
 Electro Service Co., Marietta, Ga.  
 General Electric Co., Schenectady, N. Y.  
 Railway & Industrial Engg. Co., Greens-  
 burg, Pa.  
 Westinghouse Elec. & Mfg. Co., E. Pitts-  
 burgh

**SWITCHBOARDS**  
 Allis-Chalmers Mfg. Co., Milwaukee, Wis.  
 Condit Electrical Mfg. Co., So. Boston, Mass.  
 General Electric Co., Schenectady, N. Y.  
 Metropolitan Device Corp., Brooklyn, N. Y.  
 Western Electric Co., All Principal Cities  
 Westinghouse Elec. & Mfg. Co., E. Pitts-  
 burgh

**SWITCHES**  
*Automatic Time*  
 Ferranti, Ltd., London, Eng.  
 General Electric Co., Schenectady, N. Y.  
 Minerallac Electric Co., Chicago  
 Westinghouse Elec. & Mfg. Co., E. Pitts-  
 burgh  
*Disconnecting*  
 Condit Electrical Mfg. Co., So. Boston  
 General Electric Co., Schenectady, N. Y.  
 K-P-F Elec. Co., San Francisco  
 Pacific Electric Mfg. Co., San Francisco  
 Railway & Ind. Engg. Co., Greensburg, Pa.  
 Thoner & Martens, Boston  
*Fuse*  
 General Electric Co., Schenectady, N. Y.  
 Metropolitan Device Corp., Brooklyn, N. Y.  
 Thoner & Martens, Boston  
*Knife*  
 Condit Electrical Mfg. Co., So. Boston  
 Cutter Company, The, Philadelphia  
 General Electric Co., Schenectady, N. Y.  
 Western Electric Co., All Principal Cities  
 Westinghouse Elec. & Mfg. Co., E. Pitts-  
 burgh  
*Oil*  
 Condit Electrical Mfg. Co., So. Boston  
 General Electric Co., Schenectady, N. Y.  
 Pacific Electric Mfg. Co., San Francisco  
 Western Electric Co., All Principal Cities  
 Westinghouse Elec. & Mfg. Co., E. Pitts-  
 burgh  
*Remote Control*  
 Condit Electrical Mfg. Co., So. Boston  
 General Electric Co., Schenectady, N. Y.  
 Railway & Ind. Engg. Co., Greensburg, Pa.  
 Rowan Controller Co., Baltimore  
 Western Electric Co., All Principal Cities  
 Westinghouse Elec. & Mfg. Co., E. Pitts-  
 burgh

**TACHOMETERS**  
 Biddle, James G., Philadelphia

**TANTALUM**  
 Fansteel Products Co., Inc., North Chicago,  
 Ill.

**TELEGRAPH APPARATUS**  
 Foote, Pierson & Co., Inc., New York  
 Western Electric Co., All Principal Cities

**TELEPHONE EQUIPMENT**  
 Western Electric Co., All Principal Cities

**TESTING LABORATORIES**  
 Electrical Testing Labs., New York

**TOWERS, TRANSMISSION**  
 Bates Expanded Steel Truss Co., Chicago  
 Western Electric Co., All Principal Cities

**TRANSFORMERS**  
 Acme Apparatus Co., Cambridge, Mass.  
 Allis-Chalmers Mfg. Co., Milwaukee, Wis.  
 American Transformer Co., Newark, N. J.  
 Duncan Elec. Mfg. Co., Lafayette, Ind.  
 Ferranti, Ltd., London, Eng.  
 General Electric Co., Schenectady, N. Y.  
 Kuhlman Electric Co., Bay City, Mich.  
 Moloney Electric Co., St. Louis  
 Pittsburgh Transformer Co., Pittsburgh  
 Wagner Electric Corp., St. Louis  
 Western Electric Co., All Principal Cities  
 Westinghouse Elec. & Mfg. Co., E. Pitts-  
 burgh  
*Factory*  
 American Transformer Co., Newark, N. J.  
 Kuhlman Electric Co., Bay City, Mich.  
 Moloney Electric Co., St. Louis, Mo.  
 Pittsburgh Transformer Co., Pittsburgh  
 Wagner Electric Corp., St. Louis  
 Western Electric Co., All Principal Cities  
*Furnace*  
 Allis-Chalmers Mfg. Co., Milwaukee  
 American Transformer Co., Newark, N. J.  
 Moloney Electric Co., St. Louis  
 Pittsburgh Transformer Co., Pittsburgh  
*Metering*  
 American Transformer Co., Newark, N. J.  
 Ferranti, Ltd., London, Eng.  
 Pittsburgh Transformer Co., Pittsburgh, Pa.  
*Mill Type*  
 Pittsburgh Transformer Co., Pittsburgh  
*Street Lighting*  
 Kuhlman Electric Co., Bay City, Mich.  
 Western Electric Co., All Principal Cities

Please mention the JOURNAL of the A. I. E. E. when writing to advertisers.

# STANDARDS

OF THE A. I. E. E.

1922 Edition

THE Standards give definitions of electrical terms, technical data, standard performance, specifications for tests of electrical machinery, standard voltages and frequencies, and general recommendations, as adopted by the Standards Committee and approved by the Board of Directors of the A. I. E. E.

A number of changes and additions have been made in the 1922 edition, the most important of which are mentioned below.

A new chapter is included presenting standards for Storage Batteries.

In Chapter I an additional class of insulating materials has been provided.

Definitions have been given in Chapter III of "power factor," distinguishing between "momentary" and "average" power factor, and of the "normal voltage of a system." The term "Oersted" has been adopted for the unit of magnetic inductance, and the term "electrical tension" has been adopted for use as an alternative to "voltage" in cases where the electric potential is not expressed in volts.

In Chapter VI a distinction is made between "full capacity taps" and "reduced capacity taps" of transformers.

To Chapter VII there have been added a considerable number of definitions of different types of power control relays and of the qualifying terms applied to them. A slight modification has been made in the temperature limits for circuit breakers, relays and switches.

In Chapter VIII the Corona voltmeter is recognized as a satisfactory form of crest voltmeter.

To Chapter XII have been added a number of definitions, for the most part referring to machine switching telephone apparatus.

The Rules for Electrical Machinery of the International Electrotechnical Commission, adopted October 1919, are given in an appendix.

Flexible fabrikoid leather cover, 192 pp. Indexed. Price \$2.00 per copy, with 25% discount to members of the A. I. E. E., and to dealers and purchasers of ten or more copies.

American Institute of  
Electrical Engineers



33 West 39th St., New York

# "NORMA" PRECISION BALL BEARINGS

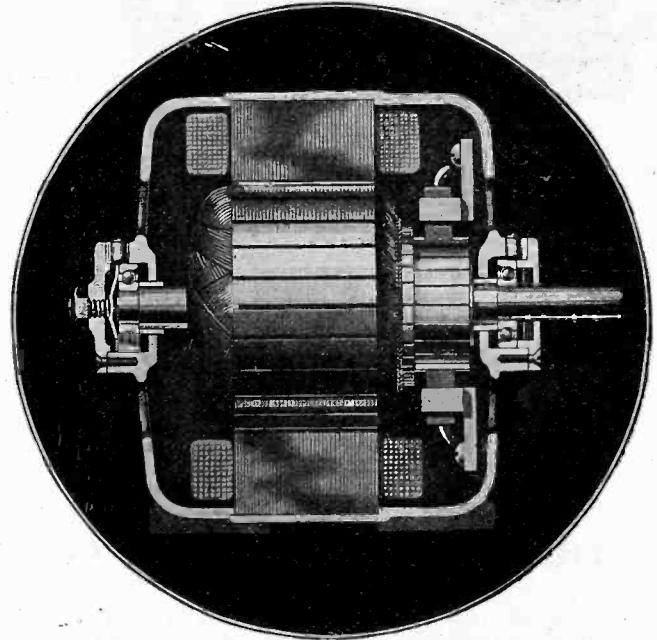

IN

# FRACTIONAL H.P. MOTORS

Minimize the Attention Needed

Each bearing unit is packed with lubricant sufficient for months of operation without renewal. This is assurance against the wear and loss of efficiency due to neglect or failure to supply lubricant. The method of mounting guards against the escape of lubricant, making for cleanliness, guarding against damages resultant from throwing oil. A "NORMA" equipped motor is economical of lubricant and maintains its initial high efficiency indefinitely.

This is one of many distinctive advantages described in the booklet "Good Motors Made Better" — sent on request.

THE NORMA COMPANY  
OF AMERICA

Anable Avenue

Long Island City

New York

BALL, ROLLER AND THRUST BEARINGS



**BENNETT**  
SURGE  
ARRESTERS

Ideal Protection  
Ruggedness  
Simplicity

Write for  
Bulletins and  
Questionnaire

Electro **SERVICE** Company  
MARIETTA, GA.



**Use Diamond Fibre**

Wherever the job in hand demands a tough, service-giving material of great strength, light weight and high dielectric qualities, use Diamond Fibre. We produce this remarkable raw material in easy-to-handle

**SHEETS - RODS - TUBES**

ready for all machining processes or fully machined to your own specifications. Write for samples and full information.

**Diamond State Fibre Company**  
Bridgeport (near Philadelphia), Pa.  
In Canada: Diamond State Fibre Company of Canada, Limited,  
245 Carlaw Ave., Toronto, Ont.

**Pyramid Brand**  
**ELECTRICAL SLATE**

for  
Switchboards, Panelboards, Fuse  
Blocks, Bus Bar Supports, etc.



**THE STRUCTURAL SLATE CO.**  
Pen Argyl, Penna.

Comprehensive Data on Electrical, Chemical and  
Physical Properties of Pennsylvania Slate sent on request

**PUMPS**

INDUSTRIAL-AGRICULTURAL-MUNICIPAL-RESIDENTIAL  
A TYPE FOR EVERY SERVICE

Bulletins on Request

**THE GOULDS MANUFACTURING COMPANY**  
Seneca Falls, N. Y.  
Agencies in all principal cities

**GOULDS**

## Classified Advertiser's Index for Buyers—Continued.

### TROLLEY LINE MATERIALS

Ohio Brass Co., Mansfield, O.  
Western Electric Co., All Principal Cities  
Westinghouse Elec. & Mfg. Co., E. Pitts-  
burgh

### TURBINES, HYDRAULIC

Allis-Chalmers Mfg. Co., Milwaukee  
Cramp & Sons Ship & Eng. Bldg. Co.,  
The Wm., Philadelphia.

### TURBINES, STEAM

Allis-Chalmers Mfg. Co., Milwaukee, Wis.  
General Electric Co., Schenectady, N. Y.  
Western Electric Co., All Principal Cities  
Westinghouse Elec. & Mfg. Co., E. Pitts-  
burgh

### TURBO-GENERATORS

Allis-Chalmers Mfg. Co., Milwaukee, Wis.  
Westinghouse Elec. & Mfg. Co., E. Pitts-  
burgh

### VALVES

*Johnson Hydraulic*  
Cramp & Sons Ship & Eng. Bldg. Co.,  
The Wm., Philadelphia

### VARNISHES, INSULATING

General Electric Co., Schenectady, N. Y.  
Irvington Varnish & Ins. Co., Irvington, N. J.  
Minerallac Electric Co., Chicago  
Sterling Varnish Co., Pittsburgh  
Westinghouse Elec. & Mfg. Co., E. Pitts-  
burgh, Pa.

### WELDING EQUIPMENT, ELECTRICAL

General Electric Co., Schenectady, N. Y.  
Ohio Brass Co., Mansfield, O.  
Westinghouse Elec. & Mfg. Co., E. Pitts-  
burgh

### WIRELESS APPARATUS

Acme Apparatus Co., Cambridge, Mass.  
General Radio Co., Cambridge, Mass.  
Westinghouse Elec. & Mfg. Co., E. Pitts-  
burgh

### WIRES AND CABLES

*Armored Cable*  
Belden Mfg. Co., Chicago  
Boston Ins. Wire & Cable Co., Boston

General Electric Co., Schenectady, N. Y.  
Kerite Ins. Wire & Cable Co., New York  
Okonite Company, The, Passaic, N. J.  
Roebling's Sons Co., John A., Trenton, N. J.  
Standard Underground Cable Co., Pittsburgh  
Western Electric Co., All Principal Cities

### Asbestos Covered

Belden Mfg. Co., Chicago  
Rockbestos Products Corp., New Haven,  
Conn.

### Auto

Belden Mfg. Co., Chicago  
Boston Ins. Wire & Cable Co., Boston  
General Electric Co., Schenectady, N. Y.  
Kerite Ins. Wire & Cable Co., New York  
Roebling's Sons Co., John A., Trenton, N. J.  
Standard Underground Cable Co., Pittsburgh  
Western Electric Co., All Principal Cities

### Bare Copper

American Ins. Wire & Cable Co., Chicago  
Anaconda Copper Mining Co., Chicago  
Belden Mfg. Co., Chicago  
Copper Clad Steel Co., Rankin, Pa.  
Roebling's Sons Co., John A., Trenton, N. J.  
Standard Underground Cable Co., Pittsburgh  
Western Electric Co., All Principal Cities

### Copper Clad

Copper Clad Steel Co., Rankin, Pa.  
Standard Underground Cable Co., Pittsburgh  
Western Electric Co., All Principal Cities

### Flexible Cord

Belden Mfg. Co., Chicago  
Boston Ins. Wire & Cable Co., Boston  
General Electric Co., Schenectady, N. Y.  
Okonite Company, The, Passaic, N. J.  
Roebling's Sons Co., John A., Trenton, N. J.  
Standard Underground Cable Co., Pittsburgh  
Western Electric Co., All Principal Cities

### Fuse

General Electric Co., Schenectady, N. Y.  
Roebling's Sons Co., John A., Trenton, N. J.  
Western Electric Co., All Principal Cities

### Lead Covered (Paper and varnished cambric insulated)

Atlantic Ins. Wire & Cable Co., New York  
General Electric Co., Schenectady, N. Y.  
Kerite Ins. Wire & Cable Co., New York  
Okonite Company, The, Passaic, N. J.  
Roebling's Sons Co., John A., Trenton, N. J.  
Simplex Wire & Cable Co., Boston  
Standard Underground Cable Co., Pittsburgh  
Western Electric Co., All Principal Cities

### Magnet

Acme Wire Co., New Haven, Conn.  
Belden Mfg. Co., Chicago  
Dudlo Mfg. Co., Fort Wayne, Ind.  
General Electric Co., Schenectady, N. Y.  
Rockbestos Products Corp., New Haven,  
Conn.  
Roebling's Sons Co., John A., Trenton, N. J.  
Standard Underground Cable Co., Pittsburgh  
Western Electric Co., All Principal Cities

### Rubber Insulated

Atlantic Ins. Wire & Cable Co., New York  
Belden Mfg. Co., Chicago  
Boston Ins. Wire & Cable Co., Boston  
General Electric Co., Schenectady, N. Y.  
Kerite Ins. Wire & Cable Co., New York  
Okonite Company, The, Passaic, N. J.  
Roebling's Sons Co., John A., Trenton, N. J.  
Simplex Wire & Cable Co., Boston  
Standard Underground Cable Co., Pittsburgh  
Western Electric Co., All Principal Cities

### Trolley

Anaconda Copper Mining Co., Chicago  
Copper Clad Steel Co., Rankin, Pa.  
Roebling's Sons Co., John A., Trenton, N. J.  
Standard Underground Cable Co., Pittsburgh  
Western Electric Co., All Principal Cities

### Weatherproof

American Ins. Wire & Cable Co., Chicago  
Copper Clad Steel Co., Rankin, Pa.  
General Electric Co., Schenectady, N. Y.  
Kerite Ins. Wire & Cable Co., New York  
Okonite Company, The, Passaic, N. J.  
Roebling's Sons Co., John A., Trenton, N. J.  
Simplex Wire & Cable Co., Boston, Mass.  
Standard Underground Cable Co., Pittsburgh  
Western Electric Co., All Principal Cities

Please mention the JOURNAL of the A. I. E. E. when writing to advertisers.



**T**UNGSTEN contact points have proved superiority in many applications. Fansteel tungsten points have been standard for quality for eight years.

FANSTEEL PRODUCTS  
COMPANY, INC.  
NORTH CHICAGO, ILL.

(Tantalum,  
Molybdenum  
Wires and  
Sheets.  
(Send for  
Data Sheets,  
Care Dept. EE

## Multiply your ideas of Fibre Service by three



We have such confidence in Vul-Cot Fibre that we guarantee it to be free from impurities. We know that Vul-Cot Fibre is good fibre. From the selection of the rag stock to the completion of the finished tubes and sheets we have had its production under our own supervision.

- You can drill Vul-Cot.*
- You can stamp Vul-Cot.*
- You can thread Vul-Cot.*
- You can turn Vul-Cot.*

Three huge factories manufacture Vul-Cot Fibre and Vul-Cot Fibre parts—with three times ordinary facilities for speedy production and delivery. Let us confer with you about the use of Vul-Cot Fibre in your business.

**National Vulcanized Fibre Company**  
Wilmington, Delaware



# VENUS PENCILS

*The largest selling Quality  
pencil in the world.*

“Pencils of Precision,” engineers call them; perfect tools for producing the graphic language of sketch, plan and blueprint; as hard as you like; as soft as you please—and always smoother than you dreamed.

### 17 Black Degress 3 Copying

For bold, heavy lines  
6B-5B-4B-3B

For writing, sketching  
2B-B-HB-F-H

For clean, fine lines  
2H-3H-4H-5H-6H

For delicate, thin lines  
7H-8H-9H

Plain Ends, per doz. \$1.00

Rubber Ends, per doz. 1.20

*At Stationers and Stores  
throughout the World*

**American  
Lead Pencil Co.**  
204 Fifth Ave., N. Y.  
and London, Eng.

### VENUS ERASERS



**O**F the same superlative quality that has made the VENUS Pencil famous; soft, gray rubber that erases clean without a smudge.

*Made in 12 sizes.  
Sample on Request.*



# Century Repulsion Start Induction Single Phase Motors

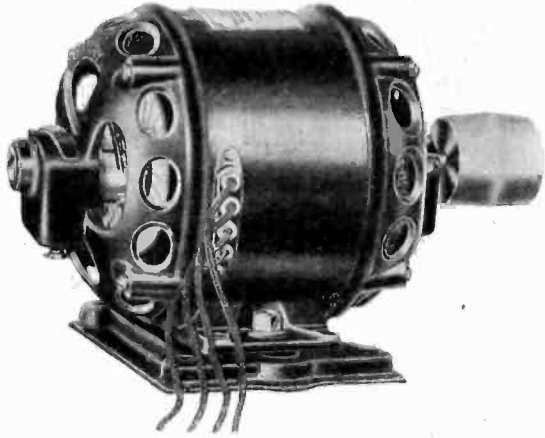

1/8 Hp. and larger

Temperature Rise Not More Than  
40° Centigrade

A fuse which will protect the motor while running and carrying its load, is usually of ample capacity for starting, due to the low starting current and quick acceleration.

For this reason these motors are particularly desirable for automatically controlled installations such as carbonators, household refrigerating machines, air compressors, and similar apparatus which must be started under load.

**Century Electric Company**  
St. Louis, Mo., U. S. A.

Sales Offices and Stocks in Principal Cities

## ALPHABETICAL LIST OF ADVERTISERS

	PAGE		PAGE		PAGE
Acme Apparatus Company	39	Fire Protection Engineers	28	Page & Hill Company	13
Acme Wire Company, The	15	Foote, Pierson & Company, Inc.	31	Partridge Lumber Company, T. M.	27
Alexander & Dowell	28	Ford, Bacon & Davis, Inc.	28	Pittsburgh Transformer Company	39
Allis-Chalmers Manufacturing Co.	6	Foundation Company, The	28	Prenner, I. S.	29
Ambursen Construction Company, Inc.	28	Fowle & Company, Frank W.	28	Public Service Production Company	29
American Appraisal Company, The	28	Freed, Joseph D. R.	28	Publications of A. I. E. E.	16
American Insulated Wire & Cable Co.	26	Freyn, Brassert & Company	28	Railway & Industrial Engineering Co.	27
American Lava Corporation	25	Fuller Engineering Company	28	Redmanol Chemical Products Company	25
American Lead Pencil Company	37	G & W Electric Specialty Company	18	Richardson & Gay	29
American Transformer Company	21	General Bakelite Company	25	Robinson & Company, Inc., Dwight P.	29
Anaconda Copper Mining Company	22	General Electric Company	14	Rockbestos Products Corporation	23
Arnold Company, The	28	General Radio Company	21	Rockwood Manufacturing Company, The	5
Atlantic Insulated Wire & Cable Co.	26	Goulds Manufacturing Company, The	36	Roebing's Sons Company, John A.	27
Bahamon, Robert	28	Higbie, William S.	29	Roller-Smith Company	21
Bakelite Corporation	25	Irvington Varnish & Insulator Company	2	Rowan Controller Company, The	31
Barrett, Lester E.	28	Jackson & Moreland	29	Sanderson & Porter	29
Barstow & Company, W. S.	28	Jeffery-DeWitt Insulator Company	17	Sargent & Lundy, Inc.	29
Bates Expanded Steel Truss Company	22	Kappeyne, J.	29	Schramm, Adolph P. C.	29
Batley & Kipp, Inc.	28	Kerite Insulated Wire & Cable Co.	1	Sessions Engineering Company	29
Belden Manufacturing Company	26	K-P-F Electric Company	26	Simplex Wire & Cable Company	23
Biddle, James G.	20	Kuhlman Electric Company	18	Simpson, Frederick G.	29
Boston Insulated Wire & Cable Co.	26	Lapp Insulator Company, Inc.	26	S. K. F. Industries, Inc.	3
Bristol Company, The	20	Leeds & Northrup Company	39	Spray Engineering Company	19, 29
Century Electric Company	38	Library U. E. S.	30	Standard Underground Cable Company	19
Cheyney & Weschler	28	Lincoln, Inc., E. S.	29	Standards of A. I. E. E.	35
Clark, Walter G.	28	Locke Insulator Corporation	27	Star Electric Motor Company	24
Clement, Edward E.	28	MacGillis & Gibbs Company, The	27	States Company, The	31
Condensite Company of America	25	Mahoney, J. N.	29	Sterling Varnish Company, The	25
Condit Electrical Manufacturing Co.	11	McClellan & Junkersfeld, Inc.	29	Stevens, John A.	29
Copper Clad Steel Company	22	Metropolitan Device Corporation	40	Stockbridge & Borst	29
Cutter Company, The	9	Midwest Steel & Supply Company, Inc.	7	Stone & Webster, Inc.	29
Day & Zimmerman, Inc.	28	Minerallac Electric Company	23	Structural Slate Company, The	36
Denike, Inc., Robert E.	28	Moloney Electric Company	20	Texas Company, The	10
Diamond State Fibre Company	36	Moore & Company, W. E.	29	Thomas, Percy H.	30
Dickinson, W. N.	28	Morganite Brush Company, Inc.	30	Thomas & Sons Company, The R.	27
Dossert & Company	Outside Back Cover	National Vulcanized Fibre Company	37	Thoner & Martens	31
Dudlo Manufacturing Company	22	Neall, N. J.	29	United Gas & Electric Engineering Corp.	30
Duncan Electric Manufacturing Co.	31	Neiler, Rich & Company	29	Viele, Blackwell & Buck	30
Egbert, Charles C.	28	New Departure Manufacturing Co., The	24	Wagner Electric Corporation	8
Electrical Testing Laboratories	30	Norma Company of America, The	35	Western Electric Company	4
Electro Dynamic Company	24	Northwestern Electric Company	24	Westinghouse Electric & Mfg. Co.	33
Electro Service Company	36	Ohio Brass Company, The	12	White Engineering Corp., The J. G.	30
Engineering Directory	28, 29, 30	Okonite Company, The	Inside Back Cover	Williams, Gardner S.	30
Engineering Foundation	39	Ophuls & Hills, Inc.	29	Woodmansee-Davidson Engineering Co.	30
Fansteel Products Company, Inc.	37			Woodruff, Eugene C.	30
Fennessy, David V.	28			Wray & Co., J. G.	30
Ferry, Montague	28				

(For classified list of Advertisers see Pages 32, 34 and 36)

Please mention the JOURNAL of the A. I. E. E. when writing to advertisers.

# Pittsburgh Transformer Company

Largest Manufacturers of Transformers exclusively  
in the United States

Pittsburgh, Pennsylvania

## TRANSFORMER SPECIALISTS

We are pleased to quote  
prices and delivery on trans-  
formers singly or in quantity

### Acme Apparatus Co.

198 Massachusetts Ave.

Cambridge, 39, Mass.

*Transformer Engineers and Manufacturers*



### THE SILSBEE CURRENT TRANSFORMER TESTING SET

is a compact *portable* set for  
making precision tests of cur-  
rent transformers in position.  
Checks ratio and phase angle.

*Described in Bulletin 715F.*

LEEDS & NORTHRUP CO.

4901 S'enton Ave. Philadelphia



# ENGINEERING FOUNDATION

Established 1914

Joint Research Instrumentality of the American Societies of  
Civil, Mining and Metallurgical, Mechanical and  
Electrical Engineers

## ANNUAL REPORT FOR EIGHTH YEAR

Available in May, contains chapters on

**Fatigue Phenomena of Metals**  
**Graphitic Corrosion of Cast Iron**  
**Internal Stresses in Metals**  
**The Year's Work**

*For copy of this Report and other information, please address*

ENGINEERING FOUNDATION

29 West 39th Street, New York.

Please mention the JOURNAL of the A. I. E. E. when writing to advertisers.

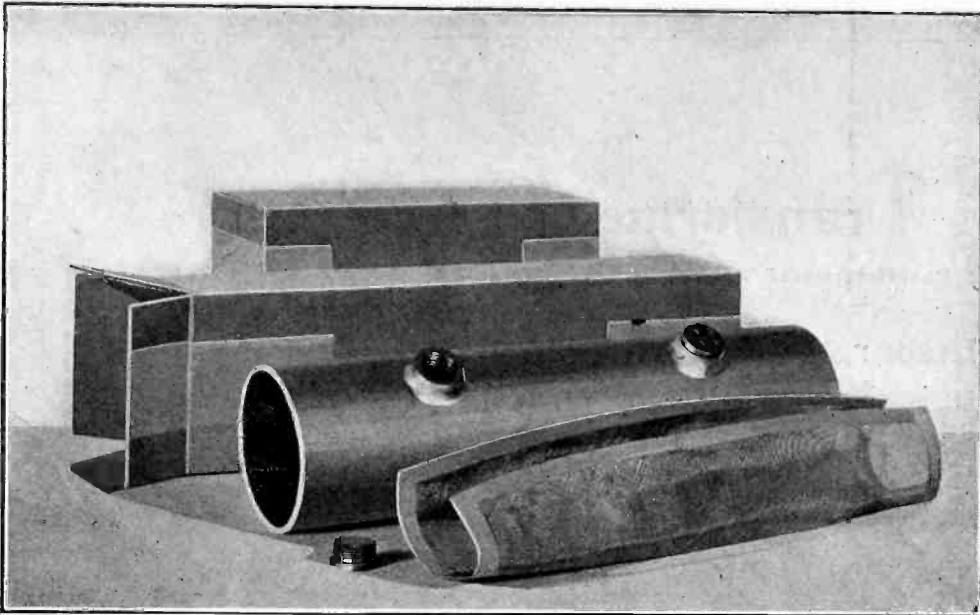

Metropolitan Protective Devices (Murray Patents)

*This standard package cable joint saves material. There is nothing to waste. It saves time. No trips need be made for materials forgotten. It saves money, being portable and easily installed.*

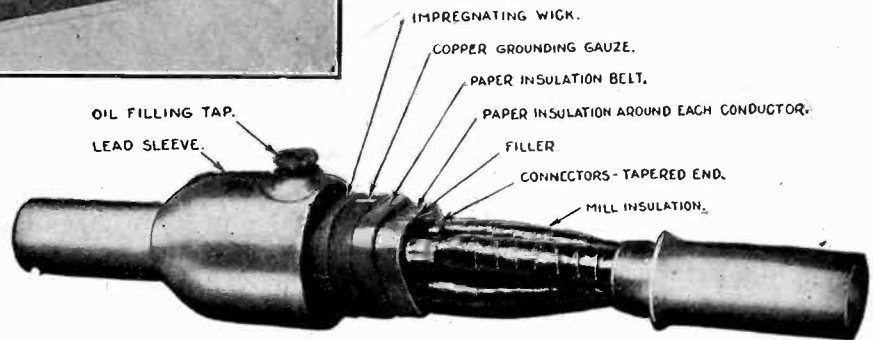

Detailed View Metropolitan Oil-Filled Cable Joint

## A New Standard Package Oil Filled Cable Joint that Requires No Vacuum Filler

### Contents of Standard Package

Lead Sleeve  
Sleeve Stocking  
Compound  
Paper Insulation  
Impregnated Wicking  
Rove Filler  
Connectors  
Emery Cloth  
Waste Ends  
Gummed Paper  
Muslin  
Bar 50-50 Solder

When the "OIL FILLED CABLE JOINT" was originally developed, the specifications for cables did not include bending tests, with the consequence that cables then produced were more susceptible to damage by bending than the modern cables built in accordance with the National Electric Light Association specifications, which call for two complete bending cycles, 180° and reverse, on a drum diameter 12 times that of the cable. The application of the vacuum with the "oil filled" cable joints caused the oil to travel a considerable distance into the cable at both sides of the joint, thereby healing any damage sustained at the cable ends by the bending and handling of these ends while splicing and racking the cable, or even in winding on the inner portion of the reel.

With modern, improved cables, we can now omit the vacuum process by using an improved grade of filling oil which gives practically as perfect penetration of the oil from the joint into the cable as formerly with the old type of oil, with vacuum. Our new oil, without vacuum, insures perfect uniformity of saturation between joint and cable ends, superior to any other type of joint filling compound. Therefore, with the improved oil we have removed the necessity of applying the vacuum thereby greatly simplifying the use of the "OIL FILLED CABLE JOINTS" but still retaining all of the numerous advantages and many points of superiority of this type of joint.

### Other Metropolitan Products

Network Protectors  
High and Low Tension Fuses  
Junction Boxes  
Standardized Switches  
High Tension Cable Joints  
Primary Cutouts  
Subway Sectionalizing Units  
D.C. Cable Testing Ammeters  
High Tension Cable Joints  
Cable Racks

### METROPOLITAN DEVICE CORPORATION 1250 Atlantic Avenue, Brooklyn, N. Y.

Gentlemen:—Please send full information on Metropolitan Standard Package Cable Joints.

Name..... Company.....  
Address..... Title.....

And kindly check any of the items at the left on which you desire information.

Please mention the JOURNAL of the A. I. E. E. when writing to advertisers.

**WINDSOR POWER PLANT**  
**POWER, W. VA.**

Equally owned by  
**WEST PENN POWER CO.**  
and  
**AMERICAN GAS & ELECTRIC CO.**

*Engineers Sanderson & Porter - Sargent & Lundy*

**OKONITE RUBBER and VARNISHED**  
**CAMBRIC WIRES & CABLES**

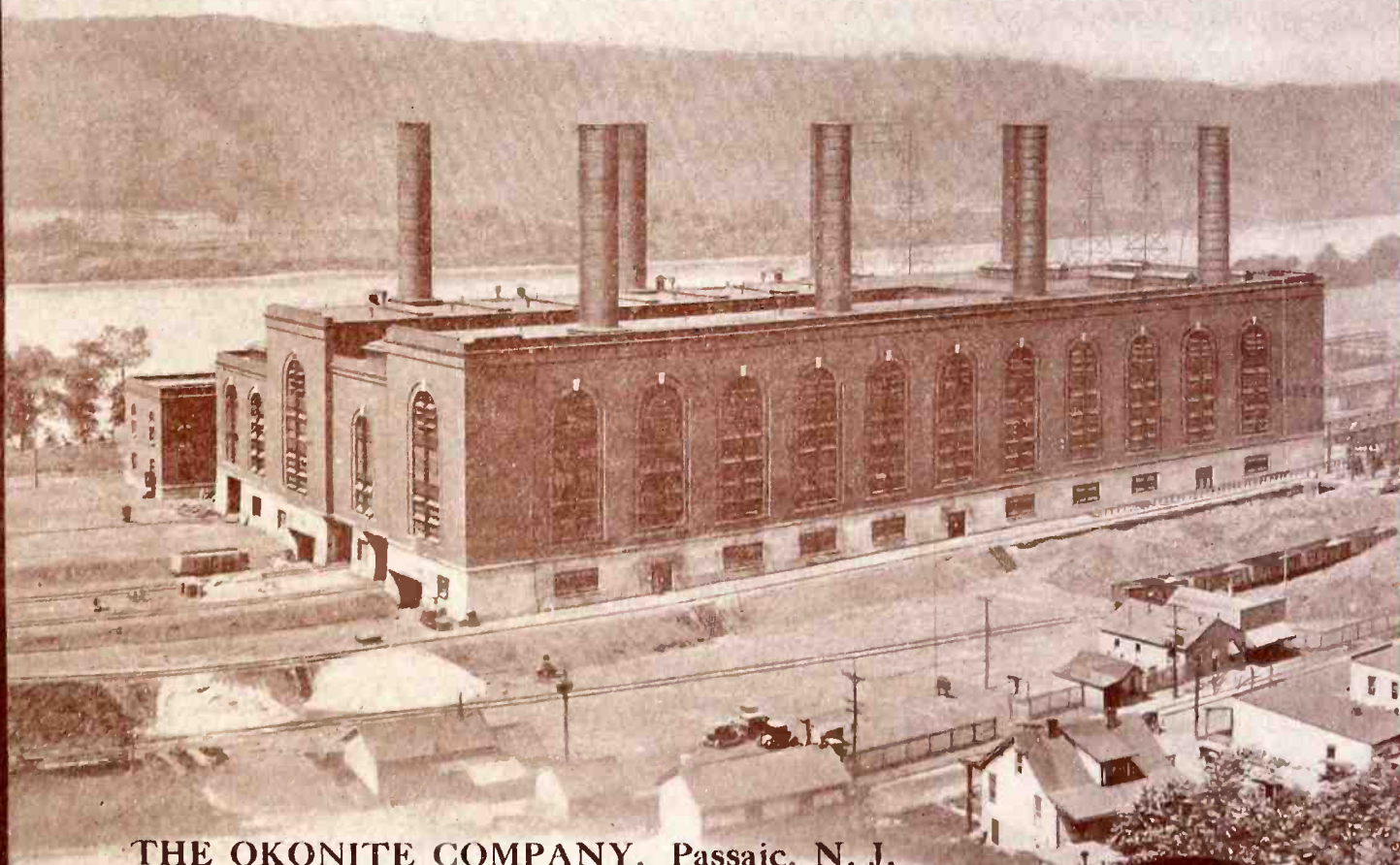

**THE OKONITE COMPANY, Passaic, N. J.**

INCORPORATED 1884

Sales Offices

New York

Atlanta

San Francisco

Central Electric Company Chicago, Ill. General Western Agents

F. D. Lawrence Electric Co. Cincinnati, O.

Novelty Electric Co. Philadelphia, Pa.

Pettingell-Andrews Co. Boston, Mass.





# DOSSERT

## Solderless Connectors

are furnished in every required size and type for conductors from No. 14 B & S gauge, to large cables of 3,000,000 cir. mils. They are the adopted standard in

**Central Station Practice**



# DOSSERT

## Solderless Connectors

Tests which have been made from time to time by users of Dossert connectors show that the connectors run at as low temperature as enabled by the wires connected to them.

*Send for Catalog Fifteen*

**Dossert & Company**

H. B. LOGAN, President

242 West 41st Street, New York

