

Electronics Today

INTERNATIONAL



MAY 1989
\$3.95
NZ \$5.50
(inc GST)

NDD

ETI



**ROGER
HARRISON
RETURNS**

ELECTRONICS • TECHNOLOGY
INNOVATION



**BUILD THE
WORLD'S
FASTEST
MODEM**





Adilam Electronics

COMPONENT SPECIALIST

**SHORT FORM
CATALOGUE
AVAILABLE**



ADILAM OFFICES

MELBOURNE Suite 7
145 Parker St.
Templestowe VIC 3106
P.O. BOX P O Box 131.
Bulleen, VIC 3105
PH: (03) 846 2511 (4 lines)
FAX: (03) 846 1467
TELEX: AA 151369

SYDNEY Suite 1.
Ramsgate Plaza.
191 Ramsgate Rd.
Sans Souci NSW
PH: (02) 529 2277
FAX: (02) 529 5893

ADELAIDE
N.S. Electronics (S.A.)
59 Wood Ave.
Ridleyton SA 5008
Ph: (08) 468 531
Fax: (08) 340 1456

BRISBANE
St Lucia Electronics
24 Campbell St
Bowen Hills QLD 4006
Ph: (07) 252 7466
Fax: (07) 522 862

CANBERRA
Electronic Components Pty Ltd
Unit 10,
Fyshwick Plaza,
Wollongong St.,
Fyshwick 2609
Ph: (062) 80 4654
Telex: 62468

PERTH
Prospec Distributors
Helidom House
31 Adrian St.
Welshpool WA 6106
Ph: (09) 362 5011
Fax: (09) 361 7592

DISTRIBUTORS

READER INFO No. 1



Page 34

TECHNOLOGY

Modern modem technology They're getting faster, higher, stronger	18
Towards the tapeless studio New recording techniques	28
Steering in the right direction Four-wheel steering demystified	34
Blowing away the cobwebs Australian defence business	40
Vive les valves A short history	44
The final voyage Voyager heads for Neptune	52

ELECTRONICS

ETI — 299 Voice-operated relay	61
ETI — 1622 Turbo modem	68
ETI — 1430 Power amplifier	80
Feedforward	86

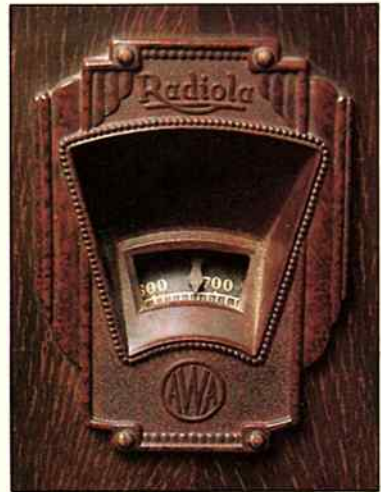

Page 44

INSTRUMENTATION

Company profile: Tech Rentals	100
Tektronix CRO	103
Solder cleaner	108
Kenwood RZ-1 receiver scanner	110



Page 108

DEPARTMENTS

Editorial	5
News digest	6
Kilohertz comment	15
Communication News	16
Videotex news	24
Politics	60
Advertiser index	65
New products	92
Dregs	114

SOUND INSIGHTS

Industry news	116
Sight and sound news	120
Hitachi VT 588E review	122
Danish delight	126



Page 126

R.F. DEVICES

PTY. LTD.

SUITE 1/A, 9 LYN PARADE, LURNEA, NSW 2170

PO Box 161, Miller NSW 2168

Sydney

Tel: (02) 607 8811

Telex: AA127948

Fax: (02) 607 3763

OSCILLOSCOPES

R.F. DEVICES CAN NOW OFFER A COMPLETE RANGE OF OSCILLOSCOPES TO 60 MHz.

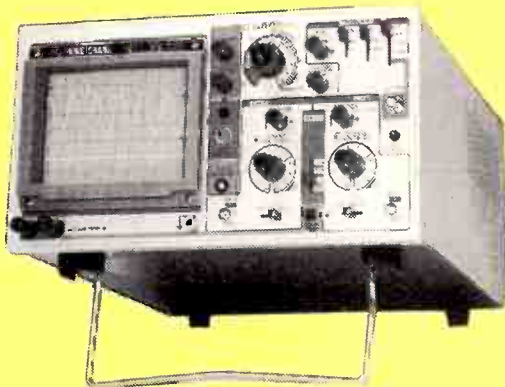

20MHz



15MHz

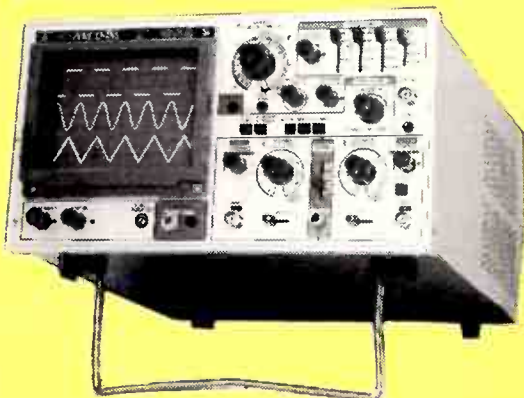

35MHz

ILLUSTRATED ARE SOME OF THE OSCILLOSCOPE RANGE

Full catalogue available on request.





ROS BROMWICH

The return of Roger

In only my second editorial I have good news to impart. Long-time readers and followers of *ETI* will recall the name Roger Harrison, editor in the earlier part of this decade, who now, along with son Jamye and others of his team from the Apogee Group, will be contributing regularly. For many of you, Roger needs no introduction. With his wide experience in many facets of the electronics industry and in the scientific field, and years of writing for consumers, professionals and enthusiasts at all levels, we welcome his unique touch and ability to focus on the latest and most interesting developments.

Roger became well known for the style of often trendsetting and popular projects he attracted or developed, and with his help *ETI*'s project section will have renewed vigour. To start things off with a bang, this very issue contains something of a scoop, the first build-it-yourself modem to be available anywhere, at an amazing price of \$1499! Given the sophisticated nature of this technology it's a fairly complicated piece of work, but as we always try to provide something for every standard of project builder there's also a simple voice-operated relay system and, extending our traditional high quality audio projects, a power amp to make.

Jamye Harrison, although only 19, has a wealth of experience which many older people would envy. He has been writing articles since 1982 and is an acknowledged expert in the computer-aided drafting (CAD) field, having had visitors from overseas, among others, admire his development work and extensive library of symbols.

Roger's background has included work in manufacturing, R & D instrumentation, communications and documentation. He spent a year in Antarctica early in his career, followed by shorter sojourns in Papua New Guinea and the Cocos Islands. He has been writing for technical magazines the world over since the early 1960s, winning several awards. He has written for *ETI* since 1971, our first year.

Starting off on this optimistic note, the mood is bolstered by the apparently satisfactory outcome of the 124-nation ozone layer conference held in London shortly before the time of writing. The news bulletins and newspaper reports cheerfully declared that with many of the participating nations now committed to banning the use of destructive chlorofluorocarbons by the year n (usually 2000 - nice round number) we could all relax and crack open another refrigerated beer. Environmental catastrophe averted - phew.

But wait, do we hear a few small voices of dissent there? Of course we do. It's all right for us in the developed countries to look for alternative propellants for our aerosols and coolants for our fridges, but what about our less technologically advanced neighbours who haven't yet had the benefits of these things, and want them?

China, for example. The Chinese are planning a massive increase in their output of domestic fridges and they declare, with some justification, that the developed countries which have already released most CFCs into the atmosphere must make the greatest cuts in production before developing countries like theirs join a worldwide ban. It is a difficult stand to argue against, except on environmental grounds of course, but it may provide the necessary jolt to the developed societies to fund research into safe alternatives, fast.

The Chinese delegation actually proposed an international ozone protection fund, to be financed by the main producers and consumers of CFCs, which would support the research and even provide a free transfer to new technologies to all signatories of the Montreal Protocol on reducing the gases.

The resulting favourable publicity was obviously a boost to the Thatcher government's newly found "green" posture but its antidote came soon after in a report from the Friends of the Earth which clearly indicated, without hyperbole, that the UK is still the dirtiest country in Europe, with little government movement on environmental issues that wasn't forced on it by the insistence of the EEC. This is tempered, however, by the growing awareness among traditional Conservatives of conservationism, which goes a long way to explain the new Mrs Green.

EDITOR

Rosalind Bromwich

PRODUCTION EDITOR

Anne Lawton

EDITORIAL STAFF

Terry Kee B.Sc (Hons), M. Phil

DESIGNER

Clive Davis

ART STAFF

Ray Eirth

PRODUCTION

Mal Burgess

ADVERTISING PRODUCTION

Brett Baker

SECRETARY

Nina Stevens

ACOUSTICAL CONSULTANTS

Louis Challis and Associates

ELECTRONICS EDITOR

Roger Harrison VK2ZTB

ELECTRONICS SECTION

Compiled by The Apogee Group

EDITORIAL ASSISTANTS

Adam Searle

Jamye Harrison

DRAFTING

Graeme Knight

Jamye Harrison

Enquiries to The Apogee Group on

(02) 555 1646; fax (02) 818 2949.

MANAGING EDITOR

Brad Boxall

PUBLISHER

Michael Hannan

HEAD OFFICE

180 Bourke Road,

Alexandria, NSW 2015.

PO Box 227, Waterloo, NSW 2017.

Ph: (02) 693 6666.

Federal Facsimile: (02) 693 9935.

ADVERTISING

New South Wales: Damien Prins, Kim Bucknole, Jonathan Poynter, The Federal Publishing Company, 180 Bourke Road, Alexandria, NSW 2015. Ph: (02) 693 6666. Facsimile: (02) 693 9997.

Victoria and Tasmania: Valerie Newton, The Federal Publishing Company, 221a Bay Street, Port Melbourne, Vic 3207. Ph: (03) 646 3111. Facsimile: (03) 646 5494.

Queensland: Graham Smith, The Federal Publishing Company, 26 Chermiside Street, Newstead, Qld. Ph: (07) 854 1119. Facsimile: (07) 252 3692.

South Australia and Northern Territory: Michael Mullins, C/- Federal Publishing, 98 Jervois Street, Torrensville, SA 5031. Ph: (08) 352 8666. Facsimile: (08) 352 6033.

Western Australia: Des McDaniel, 48 Cleeveden Street, North Perth 6006 WA. Ph: (09) 444 4426.

New Zealand: Rugby Press, 3rd Floor, Communications House, 12 Heather Street, Parnell, Auckland. Ph: 796 648. Telex: NZ63112. "Sportby".

Britain: Peter Holloway, C/- John Fairfax & Sons, 12 Norwich Street, London EC4A 1BH. Ph: 353 9321.

Printed by Hannanprint, Sydney.

Distributed by Newsagents Direct Distribution, Alexandria, NSW 2015.

*Maximum and recommended Australian retail price only. Registered by Australia Post. Publication No. NBPO4Q7. ISSN No. 0013-5216. COPYRIGHT © 1989.



Industry News

NEC Information Systems Australia Pty Ltd has appointed Leigh Weber to the position of Victorian sales manager, Commercial and Retail. He comes to NEC from Linx Computer Systems where he was sales and marketing manager for Unix application software.

In his new position he is responsible to the Victorian state manager for NEC, Robert Barker.

NEC/ISA has also appointed Peter Galante to be Victorian sales manager, Manufacturing and Distribution. Prior to this appointment, he was involved with large systems-manufacturing at Fujitsu.

Zenith Data Systems (Australia) Pty Ltd has opened an office in Melbourne after an initial year of trading in Australia with sales exceeding \$9m. The company has appointed David Graham as regional accounts manager responsible for Victoria, South Australia, Western Australia and Tasmania.

Graham was with the RAN for eight years working on specialist computer simulations before leaving in 1985 to become a PC systems support analyst for NZI.

Following Amber's recent appointment as a 3M distributor, Peter O'Connor has joined Amber Technology as the manager responsible for its distribution of the 3M range of magnetic media products, which include Scotch video tape, audio tape, logging tape and audio recording products.

Prior to his appointment, O'Connor was with 3M Australia.

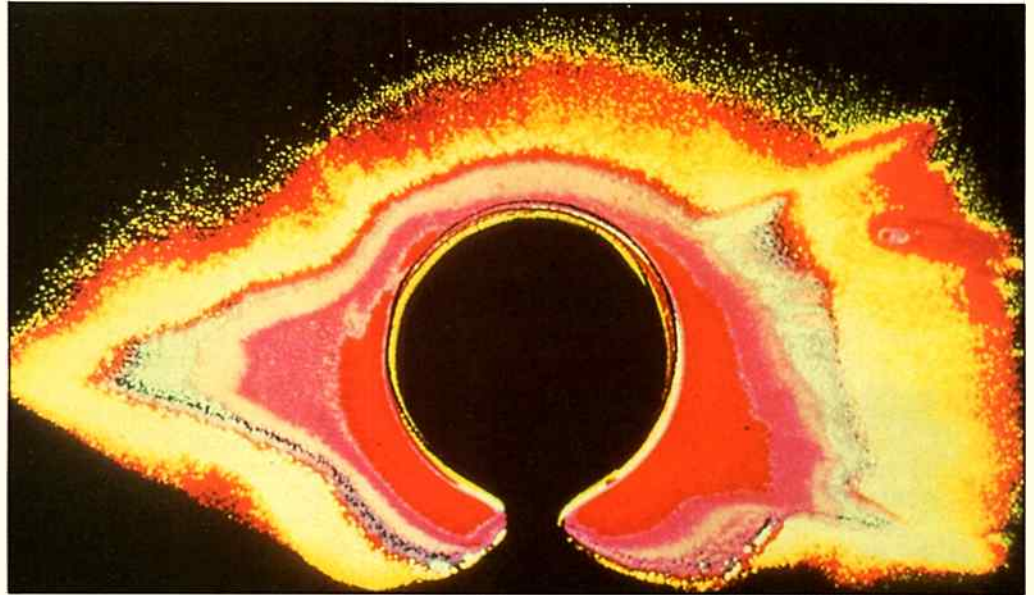

Solar cycle activity reviewed

THE number of sunspots during 1988 rose rapidly, and the December 1987 yearly-smooth sunspot number of 51.4 was superseded by the December 1988 number estimated at about 130.

This period went from lowest solar conditions in 1987 close to what are highest solar conditions. Flares have risen dramatically; there were 2M class flares in December 1987, and more than 49 significant flares in December 1988. Flares' strengths also increased during the year. X class flares are growing in number, and the largest X-ray flare of these, an X5.6 was seen on June 24. It was also the largest seen for more than four years.

The year's feature was an intense geomagnetic storm centred on February 22, when the day's index reached 67, the highest daily value since the cycle began, and the highest since February 8 1986. Strong magnetic field activity expands the auroral oval seen on the South Magnetic Pole and on

February 22 an aurora was reported from as far north as the Sidings Springs Observatory in the central west of NSW. The most concentrated magnetic storm was on May 6, with an A value of 63. For a few hours it reached K = 9, the highest on the scale. Another strong magnetic storm was on October 10.

April was the stormiest month of last year. Geomagnetic activity began with a major storm on April 4 (A value of 57) and followed two days later with another major storm having an A value of 43. More major storm levels occurred on April 23.

Higher levels of solar activity throughout the year have been reflected in higher frequencies and improved ionospheric propagation. Solar flares increased in number, many associated with significant disruptions associated with short-wave fadeouts.

The sunspot number is expected to rise during this year, although the rate of rise may level off towards the year's end.

Then the sunspot number should be near its peak value, or by that time readily predicted. There is still no agreement in the estimates the cycle's amplitude will reach, nor about the time this will happen. Some scientists predict a high amplitude, perhaps comparable with the record Cycle 19 which peaked in 1957 with a sunspot number of 202. The IPS predicts a peak amplitude of about 160, close to that for Cycle 21. If this is so, the solar highest will be likely within the next year.

We can expect to see more frequent severe magnetic disturbances associated with sun flares, and more aurora sightings are likely this year, with a few as far north as Sydney.

Continued sunspot number rise and 10 cm flux will be associated with a continued increase in the number of flares and corresponding flare-induced short-wave fadeouts. In between those flareouts ionospheric propagation should be spectacularly good.

Maritime radio integrating

MARINE Navaid Systems of Rosebery, Sydney commissioned a \$200,000 integrated marine radio system for Sydney, Newcastle and Port Kembla in March.

Port control officers of the MSB (Maritime Services Board), at the control tower in Sydney, now have instant access to a range of frequencies. To achieve this the system uses Syncomp Computers' machines for the control and radio equipment designed and made by Uni-Lab Telecommunications of Perth. The computer-controlled system is said to be more compact and flexible than the older one it replaces.

Three duplicated transceivers,

covering 99 VHF marine, are being installed at Shepherds Hill, Newcastle; Bellevue Hill, Sydney and Saddleback Mountain, south of Port Kembla. Operators in the Sydney tower can remotely select frequencies on all radios and each transceiver will go through the computer so the one with the ship's strongest signal captures the circuit.

Radio transmission will effectively extend 50 km out to sea. Transceivers along the NSW coast will integrate the three centres, handling both the port operations network and the Sydney maritime network which all ships approaching Sydney begin communicating on for entry formalities.

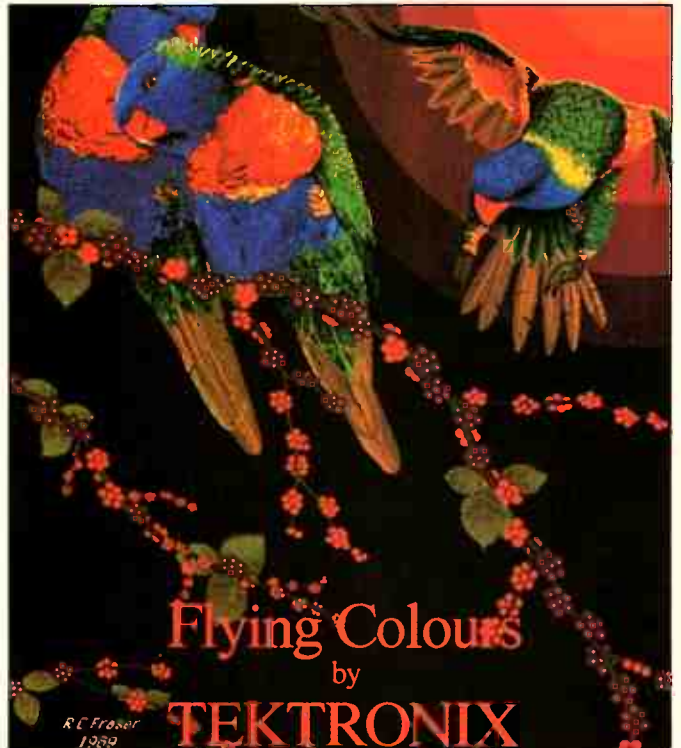

This brilliant colour print, Flying Colours, was made available to eager media persons at the launch of Tektronix new colour PostScript-compatible printers at the PC/89 exhibition in Sydney. The picture was prepared by hand in PixelPaint and printed on the new laser thermal quality wax printer.

Mobile communications research

THE industrial market research company, BIS Shrapnel, has recognised the potential of the mobile communications market with the first detailed study into its size, the reputations and market shares of its suppliers, and its trends.

The study, Mobile Communications Equipment, will involve questioning 700 users and potential users on their needs. BIS Shrapnel and its sister company, the electronics business consultancy BIS Mackintosh, will together undertake the study. Organisations able to assess the effects of changes on the market would be able to take full advantage of

the opportunities offered.

The study's objectives will be to: identify trends in the rate of adopting mobile communications; identify current and potential owners; develop strategies to target the market and potential market; determine the size of each segment, and market share; forecast demand by segment; assess the reputation of equipment and suppliers; assess the rate of change in technology; and provide an overview of international trends. BIS Shrapnel expects the study to be available in April or May. Details from BIS Shrapnel ☎ (02) 412 3266.

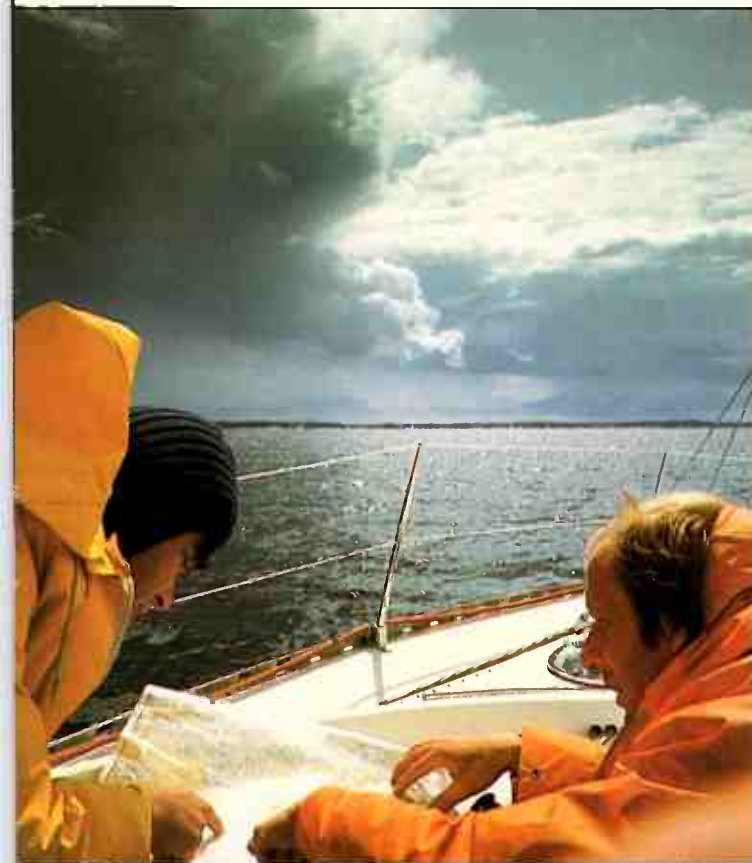

Industry News

Emona Instruments, the Sydney-based supplier of test and measuring instruments, has opened an office 5 km from the centre of Brisbane. Bruce Ibbotson, who was state manager for Hewlett-Packard in Queensland from 1974 to 1984, has been appointed state manager for Emona, moving from his previous post as marketing manager for one of Emona's Queensland distributors.

After training with Telecom, he spent a number of years working in television broadcasting in Melbourne and Brisbane and also spent time in Hong Kong establishing HK TVB on-air operations, training and maintenance.

He moved to a sales career with HP in the early 1970s, becoming involved in test and measuring instruments, and was then transferred to establishing HP's analytical and medical products in Queensland.



Vital but frustrating, the job of federal intruder watch coordinator, held for many years by Bill Martin, VK2COP, (who resigned last year), has been filled by Bill Horner, VK4MWZ.

The American Radio Relay League (ARRL) has appointed the Wireless Institute of Australia's Federal Awards manager, Ken Gott, VK3AJU as its Australian certifying manager. Previously, Australian amateurs seeking the ARRL's popular WAS ("worked all states") award had to send their QSL cards to the ARRL in the USA to apply for the award certificate.

Now, Australian amateurs seeking the WAS certificate can send their application and cards to Gott. He has also been appointed as the Australian certifying manager for the ARRL VHF/UHF Century Club award.

Satellites help fight floods and fires



AUTHORITIES tackling bushfires and floods will be able to track their progress with greater precision following the installation of systems in Canberra and Alice Springs which receive and process data from two new-generation, high-resolution satellites.

The systems have been installed on equipment operated by the Federal Government's Australian Centre for Remote Sensing (ACRES). Accurate digital and photographic images of natural disasters will be sent on magnetic tape, as film or by microwave link to emergency services organisations after being captured by the US Landsat 5 and French SPOT satellites.

Don Gray, manager of the Remote Sensing Unit of the Australian Surveying and Land Information Group, said, "Information gathered by the satellites will be used by a wide variety of Government and private sector organisations. The ability to monitor fires and floods

will play a critical role in helping to save people's lives and property."

One of the key features of SPOT is a steerable mirror which can be tilted up to 27 degrees, allowing satellite users to target an area within a 950 km-wide strip centred on the satellite ground track which will permit frequent surveillance of areas of particular interest.

"This pointing facility will be an invaluable tool during natural disasters. Authorities handling major bushfires and floods will be able to map the extent of damage and monitor the recovery of the land, both important factors in compensation and relief considerations," Gray said. "It will also help organisations monitoring crops and searching for finite and renewable resources."

Perhaps even more importantly, preventative measures can be taken to reduce disaster damage, including planning controlled burning using data gained

from monitoring the build-up of fuel on forest floors and the placement of levees using information provided by mapping earlier flood plains.

Major day-to-day customers are oil and mineral exploration companies, research organisations, universities and Federal and State Government agencies involved in natural resources as well as organisations carrying out research into crop yields, land degradation, the salinity of rivers, and pasture improvement programs.

Other applications include shallow water and urban mapping, surveying the Great Barrier Reef and gathering data for use by the fishing industry.

CSA was awarded the \$1m contract by Macdonald Dettwiler, the Canadian company which upgraded the ACRES facilities. Gary Cruth, manager of CSA's Business Systems Division said, "An important factor in the installation of these systems is that CSA, an Australian company, was able to compete in the international marketplace for this contract. It demonstrates Australian industry has the skill, experience and knowledge to complete high technology projects as advanced as any in the world." The system was completed five weeks ahead of schedule.

The CSA system catalogues raw data, which arrives at the centre on magnetic tape, and processes orders for standard and special order image products.

When customers place orders through online terminals or telephone, DIPCS searches the catalogue and issues orders on the laboratory for production of images on magnetic tape, diskette or film. DIPCS, which uses ORACLE data management software, also produces statistics on the types of images ordered.

CSA and Macdonald Dettwiler are exploring the possibility of exporting these systems to Europe, China, South-East Asia and South America.



ENTER THE AMP 'BEYOND 2000' AWARDS IN SCIENCE AND TECHNOLOGY, NOW!

Make your mark on the world of science and technology with your big idea and enter the 1989 AMP 'Beyond 2000' Awards. If you are a resident Australian under 19 on November 1, 1989, you are invited to compete by creating a working example of how science and technology can contribute to daily life. Prizes include a first prize in the Principal Award of a \$20,000, 12-day trip for the winner and a chaperone to the USA,

visiting prominent science related institutions and \$1,000 spending money each. There are prizes for State and Territory winners and finalists, a Group Award, two Under 14 Awards, plus many merit prizes. Entry forms, which give full details of the competition and rules, can be obtained from

AMP offices and agents, from science teachers at secondary schools, principals at primary schools, or you can fill in coupon below, and mail postage-free.



AMP IS ONCE AGAIN PROUD TO BE A SPONSOR OF THESE IMPORTANT AWARDS AND TO BE ASSOCIATED WITH THE AUSTRALIAN SCIENCE TEACHERS' ASSOCIATION AND THE SCIENCE TALENT SEARCHES AND SCIENCE FAIRS OF ITS MEMBER ASSOCIATIONS, THE AUSTRALIAN COUNCIL FOR EDUCATION THROUGH TECHNOLOGY, THE AUSTRALIAN TELEVISION NETWORK AND THE POPULAR PROGRAM 'BEYOND 2000'.

NAME _____ ADDRESS _____ P/CODE _____
 (Please Print) Address your envelope to: John Martin, AMP 'Beyond 2000' Awards in Science and Technology,
 TELEPHONE _____ FREEPOST 111 AMP, GPO Box 2527 SYDNEY, NSW 2001 [NO POSTAGE REQUIRED] P578

READER INFO No. 3



10 MHz XT* TURBO MOTHERBOARD

Increase the performance of your sluggish XT* approximately four times with this super fast motherboard.
 ● 8088-2 running at 10 MHz, no wait state
 ● Turbo/Normal selectable
 ● 640K fitted
 ● 8 Expansion slots
 ● 4 Channel DMA
 ● Keyboard port

Excluding RAM . \$199
 Including RAM) . \$749

BABY AT* MOTHERBOARD (WITHOUT MEMORY)

● 6/10 MHz system clock with zero wait state. 12 MHz, 1 wait state.
 ● 80286-10 Microprocessor
 ● Hardware and software switchable
 ● Socket for 80287 numeric data co-processor
 ● 64K ROM
 ● Phoenix BIOS
 ● 8 Expansion slots

X18200 (excl. RAM) \$689
 X18201 (incl. 2MB RAM) \$1,649

386 25MHz MOTHERBOARD

● Processor 80386-25
 ● Cache controller 82385-20
 ● Speed: 25 MHz or 20MHz
 ● Memory: 32KB Cache memory (35ns)
 ● 2 M/Byte RAM fitted (70ns)
 ● 2.8 M/Byte RAM/available plus optional 32 bit memory card
 ● Expansion slots: 1 x 32 bit, 5 x 16 bit, 2 x 8 bit
 ● Intel* Combo Chip set: 82230, 82231
 ● BIOS: AMI
 ● Landmark Test: 43.5 MHz
 ● LED display for speed indication
 ● Ability to run OS/2, MS/DOS, XENIX
 ● Real time clock/calendar with battery back up
 ● Baby AT* size board

X18105 \$4,395

386 MAIN BOARD

● Intel 80386 CPU (20MHz)
 ● Socket for 80387 Math co-processor
 ● 32 bit BUS system, 1 M/Byte or 640K on board memory
 ● Built-in speaker attachment
 ● Battery backup for CMOS configuration table and real time clock.
 ● Keyboard controller and attachment
 ● 7 Channel DMA
 ● 16 Level interrupts
 ● 3 Programmable timers
 ● 8 System expansion I/O slots:
 5 with a 36 pin and a 62 pin expansion slot 2 with only the 62 pin expansion slots 1 with two 62 pin expansion slots (32 bit BUS)

X18103 without RAM \$1,995
 X18107 2 M/Byte RAM \$2,995

EXTENDED 3-5 M/BYTE CARD

● AT* compatible only
 X18056 Without RAM \$299



E-NET INTERFACE NETWORK CARD

● Fully compatible with Novell NE-1000 Ethernet card
 ● Built-in 15 pin D type connector
 ● 10 Mbps transmission rate
 ● Meets the IEEE 802.3 standard

Cat. X18160 \$489

R-NET/S INTERFACE NETWORK CARD

● Fully compatible with SMC, Novell* Aenet card
 ● Star-burst topology through RG-62 A U coaxial cable
 ● Zero wait at 20MHz or higher 80386 machine
 ● 2.5 Mbps transmission rate

Cat. X18162 \$312

SERIAL/PARALLEL/GAMES CARD

● PC*/XT*/AT* compatible
 ● 1 Parallel port three port addresses selectable (378, 278, 3BC) and disable.
 ● Serial port: 2 serial ports available, both can be set to address comm 1, 2, 3, or 4
 ● Game adaptor: 2 joysticks can be connected. Paddles must be 0 - 100K range.

X18151 \$115



MULTI I/O & DISK CONTROLLER CARD

This card will control 2 x double sided, double density drives, and features a serial port, a parallel port, and a joystick port or games port. It also has a clock/calendar generator with battery backup.

Cat X18040 \$145

NEW!

INTELLIGENT 6 PORT I/O CARD

An intelligent front end communication adaptor featuring 6 asynchronous RS232C ports and communication co-processor. With many driver routines supported for various operating systems, this card lets your AT* (and compatibles) be connected with ASCII terminals, modems or other serial devices operating UNIX-V like systems (eg: M/S XENIX, SCO XENIX, Microport Unix) or DOS environment. With either Xenix/Unix or DOS configurations, your AT* can be turned into a full scale super microcomputers that rivals or exceeds the performance of systems costing much more.

X18152 **\$995**



FLOPPY DISK DRIVE CONTROLLER CARD

These cards will control up to 2 or 4 double sided 360K IBM* compatible disk drives.
 X18005 (2 Drives)...\$52

FLOPPY DISK DRIVE CONTROLLER CARD

● Supports 1-44MB, 1-2MB, 720K, 360K
 ● PC*/XT*/AT* compatible
 ● 5 1/4" and 3 1/2" drives

X18009 \$139

4 WAY DISK CONTROLLER

● PC*/XT*/AT* compatible
 ● 1-44 M/B, 1-2 M/B, 720K, 360K Drives

X18006 \$159

HARD DISK CONTROLLER CARDS

X18060 (XT) \$190
 X18140 (AT) \$290



RS232 (SERIAL) CARD (WITHOUT CABLE)

This RS232 card supports 2 asynchronous communication ports. Programmable baud rate generator allows operation from 50 baud to 9600 baud. Fully buffered. First serial port is configured as Comm. 1 Second serial port is optional and configured as Comm. 2.

Cat. X18026 \$49

RS232 & CLOCK CARD (WITHOUT CABLE)

This RS232 card supports 1 asynchronous communication ports. Programmable baud rate generator allows operation from 50 baud to 9600 baud. Fully buffered. Clock includes battery back-up and software.

Cat. X18028 \$49

CLOCK CARD

Complete clock card including battery back-up and software.

Cat. X18024 \$55



GAMES I/O CARD

Features two joystick ports. (DB15).
 Cat. X18019 \$29

I/O PLUS CARD

Provides a serial port, a parallel port and a joystick port, and even a clock calendar with battery backup!
 Cat. X18045 \$119

PRINTER CARD

This card features a parallel interface for Centronics printers. Included is printer data port, printer control port, and printer status port.
 Cat. X18017 \$29

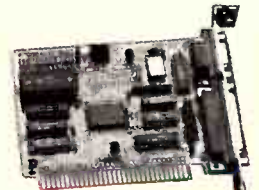

GRAPHICS CARD

● Hercules compatible
 ● Interface to TTL monochrome monitor
 ● One Centronics parallel printer port
 ● 2K-Static RAM, 64K Dynamic RAM
 ● Display Mode: 720 dots x 348 lines
 Cat. X18003 \$139

COLOUR GRAPHICS CARD

This card plugs straight into I/O slot and gives RGB or composite video in monochrome to a monitor.
 Colour graphics: 320 dots x 200 lines.
 Mono graphics: 640 dots x 200 lines.
 Cat. X18002 \$99

ENHANCED GRAPHICS ADAPTOR CARD

● Auto switch CGA, EGA, & Hercules*
 ● Full 256K video RAM
 ● Flicker free scrolling
 ● Standards: 320 x 200, 640 x 200, 640 x 348, and 720 x 348.
 ● Short slot
 ● XT* & AT* compatible
 X18070 \$330

VGA CARD

● PC*/XT*/AT* compatible
 ● 256K RAM
 ● Excellent Value
 X18071 \$655

VGA CARD

● PC*/XT*/AT* compatible
 ● 512K RAM
 ● Hardware zoom, pan, window
 X18072 \$825

EPROM PROGRAMMER CARD

● Programs 2716, 2732, 2732A, 2764, 2764A, 27128, 27128A, 27256, 27256A, 27512, 27512A, 27C64, 27C128, 27C256, 27C512
 ● Programs 1 M/Byte EPROMS
 ● Software set program voltage: 12.5, 21, 25
 ● Software: Write, read, verify, blank, check, copy, files, process.
 ● Intelligent programming method:
 2716 6 sec. 2732 12 sec.
 2764 24 sec. 27128 48 sec.
 27256 96 sec. 27512 300 sec.
 ● 4 Textool Sockets
 X18022 \$345

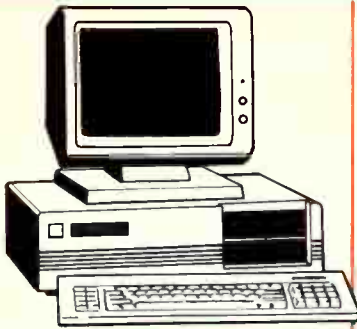

IBM* XT* COMPATIBLE COMPUTERS FROM \$995

Check these features and our prices. They're exceptional value for money!

- Final assembling and testing in Australia!
- Fast TURBO Motherboard
- AT* style keyboard
- Tested by us for 24 hours prior to delivery!
- 8 Slot motherboard
- 12 months warranty!
- 150W power supply

*** \$995 WORKSTATION COMPATIBLE COMPUTER**

256K RAM Single Drive, Graphics and Disk Controller Card. \$995

640K RAM TURBO COMPATIBLE COMPUTER

2 x 360K Disk Drives, Multifunction Card, Colour Graphics, Disk Controller, 1 Serial, Parallel Port. (Includes Timer Disk). \$1,195

WITH 20 M/BYTE HARD DISK:
& single 360K Floppy Disk Drive...\$1,495
& dual 360K Floppy Disk Drives...\$1,695

WITH 40 M/BYTE HARD DISK:
& single 360K Floppy Disk Drive...\$1,695
& dual 360K Floppy Disk Drives...\$1,895



COLOUR MONITORS

QUALITY RITRON MONITORS AT BREAK THROUGH PRICES!!

- CGA \$445
 - EGA \$645
 - VGA \$945
- (EGA MONITOR ILLUSTRATED)

IBM* COMPATIBLE EXTENDED KEYBOARD (101 KEYS)

These new keyboards are both XT* and AT* compatible!

- 12 Dedicated function keys
- Enlarged "Return" and "Shift" key
- Positive feel keys
- Low Profile Design, DIN standard
- Separate Numeric and Cursor control keypads
- Additional Functions: Key-in-Lock, Previous Word, Next Word, Fast Repeat, Line Feed, Pause, Reset, Clear Screen

Cat.X12022. only \$109

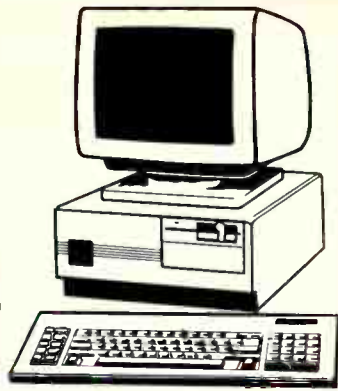

BABY AT* COMPATIBLE COMPUTER!

2 M/B RAM \$2,695

- Final assembling and testing in Australia!
- 4 M/Byte Main Board, 2 M/Byte fitted
- Switchable 8/10/12 MHz
- 1.2 M/Byte Floppy Disk Drive
- 80286 CPU
- Colour Graphics Display Card
- 8 Slots
- Floppy & Hard Disk Controller
- Printer Card and RS232
- Keyboard
- 200W Power Supply
- Manual
- 6 Months Warranty
- Size: 360(W) x 175(H) x 405(D)mm

WITH 20 M/BYTE HARD DISK . \$2,695
WITH 40 M/BYTE HARD DISK . \$2,895
WITH 80 M/BYTE HARD DISK CALL

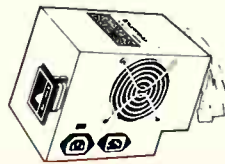

150W SWITCH MODE POWER SUPPLY FOR

IBM* PC*/XT* & COMPATIBLE

DC OUTPUT: +5/13A, -5V/0.5A
+12V/4.5A -12V/0.5A

Cat. X11096 \$129

180W SWITCH MODE POWER SUPPLY FOR

BABY AT* COMPATIBLES

Cat. X11098 \$199

200W SWITCH MODE POWER SUPPLY FOR

IBM* AT* & COMPATIBLE

DC OUTPUT: +5/16A, -5V/0.5A
+12V/5A -12V/0.5A

Cat. X11097 \$199

BABY AT* STYLE COMPUTER CASING

Our latest computer casing, featuring security key switch, 8 slots, and mounting accessories etc.

Size: 360(W) x 175(H) x 405(D)
Cat.X11093 ONLY \$99

IBM* XT* COMPATIBLE CASE AT* STYLING

Now you can have the latest AT* styling in a XT* size case. Features security key switch, 8 slots, and mounting accessories.

Size: 490(W) x 145(H) x 400(D)
Cat. X11091 \$99

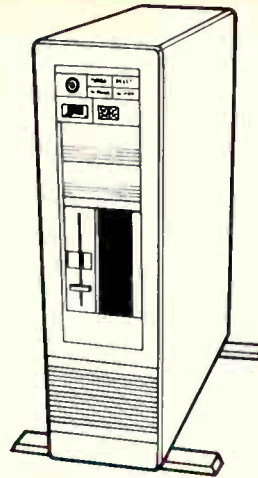

386 TOWER PC

The 386 Tower PC is a high performance system that's IBM* AT* compatible. However, the 386 Tower PC gives you 2-5 times the performance.

FEATURES:

- Intel 80386-16MHz microprocessor
- Switchable 16/20 MHz
- 2 M/Byte fitted. Total memory expandable up to 16 M/Bytes.
- Up to 2 M/Byte or 8 M/Byte RAM modules on system board or on RAM card
- Option for 80287 & 80387 co-processor socket
- Operates in page mode with interleave memory subsystem
- Shadow RAM supported to allow system BIOS to be executed on system memory instead of slower EPROM
- Four 16-bit I/O slot. Three 8-bit I/O slot, and one 32-bit memory slot.
- 8042 keyboard controller interface for AT* compatible keyboard
- Seven direct memory access (DMA) channels
- Chips and Technology chip set
- AMI 386 BIOS / Phoenix 386 BIOS / AWARD 386 BIOS (AMI fitted)
- 50 M/Byte hard disk. Fast access. Formatted to 42 M/Byte.
- 3 1/2" Disk drive, 1-44 M/Byte
- EGA card

..... \$5,995

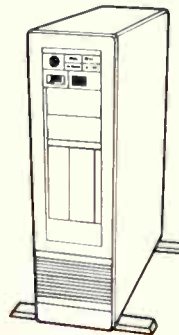

TOWER COMPUTER CASING

Features security key switch, and mounting accessories etc.

Size: 165(W) x 600(H) x 500(D)
Cat. X11105 \$295



IBM* XT* COMPATIBLE CASE

XT* size and styling. Features security key switch, 8 slots, and mounting accessories.

Size: 490(W) x 390(D) x 140(H)
Cat. X11090 \$69

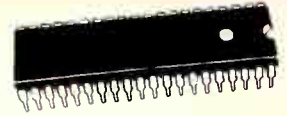

8087 CHIPS

GENUINE INTEL CHIPS

- 8087-3 (4.77MHz) \$245
- 8087-2 (8MHz) \$350
- 8087-1 (10MHz) \$475
- 80287-6 (6MHz) \$375
- 80287-8 (8MHz) \$555
- 80287-10 (10MHz) \$690
- 80387-16 (16MHz) \$995
- 80387-20 (20MHz) \$1460
- 80387-25 (25MHz) \$1860



ROD IRVING ELECTRONICS

MELBOURNE: 48 A Beckett St.
Phone (03) 663 6151

NORTHCOLE: 425 High St.
Phone (03) 489 8866

SYDNEY: 74 Parramatta Rd, Stanmore
Phone (02) 519 3134
Fax (02) 519 3868

CLAYTON: 56 Renver Rd.
Phone (03) 543 7877

MAIL ORDER & CORRESPONDENCE:

P.O. Box 620, CLAYTON 3168

Mail Order Hotline:

STD Orders: 008 33 5757 Orders only

Local Orders: 543 7877

Inquiries: (03) 543 7877

Telex: AA 151938

Fax: (03) 543 2648



MAIL ORDER HOTLINE 008 335757

(TOLL FREE, STRICTLY ORDERS ONLY)

LOCAL ORDERS & INQUIRIES (03) 543 7877

POSTAGE RATES:

- \$1 - \$9.99 \$2.00
- \$10 - \$24.99 \$3.00
- \$25 - \$49.99 \$4.00
- \$50 - \$99.99 \$5.00
- \$100 plus \$7.50

The above postage rates are for basic postage only. Road Freight, bulky and fragile items will be charged at different rates.

All Wholesale and Sales Tax Exempt inquiries to:

RITRONICS WHOLESALE,
56 Renver Road, Clayton.
Phone: (03) 543 2166 (4 lines)
Fax: (03) 543 2648

Errors and omissions excepted. Prices and specifications subject to change
IBM* PC* XT* AT* are registered trademarks of International Business Machines. Apple is a registered trademark.
*Denotes registered trademarks of their respective owners



Industry News

Zenith has achieved market prominence for its current generation of 8088, 80286 and 80386-based laptop computers. However, a large proportion of its sales are of desktop computers and monitors.



Greg Norton-Smith has been appointed marketing services manager of Email to co-ordinate the Marketing Services and Advertising activities of this division, to encompass Electronics and Controls Operation (Incorporating Bellco Controls, Total Electronics and Email Relays) and the Petroleum Equipment Operation.

He has a marketing and advertising background in the manufacturing industry, predominantly in the electrical and industrial sector, and was a senior executive for some years with a management consulting and recruitment company.

In addition, Klaus Bachmaier has been made quality manager. He joins Email from Siemens Ltd. Responsible for quality assurance at the two key Victorian manufacturing facilities (the Petroleum Equipment Operation, Kilsyth and Electronics and controls operation at Huntingdale), he brings with him experience as quality manager in the electrical and mechanical disciplines having spent a number of years with the major suppliers to the automotive industry. He will continue Email's program for adoption of the Australian Standard AS.3901.



The WIA decided, after analysing the administrative workload, to appoint an assistant general manager and has awarded the position to Ross Burstal, VK3CRB.

Burstal is an active amateur who has retired early from a senior banking position and is familiar with the WIA through having been federal treasurer for several years.

New \$500m cable group

AFTER a \$160m buyout of minority holdings, Metal Manufacturers Ltd has grouped all its substantial cable interests, including Austral Standard Cables (ASC), Cable Makers Australia (CMA), Pyrotenax, Austral Data Networks (ADN) and MM Metals-Energy Cables, into a new, wholly-owned division to be called MM Cables.

In New Zealand, Associated British Cables Ltd (ABCAL) and ASC (NZ), are also part of the new division.

This combined division will market all MM Cables products, instead of only part of the range, will employ around 2200 people and have an annual turnover of about \$5m a year.

Factories and service centres are located throughout Australia and New Zealand, including all State capitals and Cairns, Rock-



MM Cables chief executive Tony MacCormick (left), and general manager—marketing, Peter Macdonald.

hampton, Newcastle, Wollongong and Port Kembla, among others. Operations will be conducted through business units reflecting MM Cables' main markets: wholesalers; commercial and engineering construction; electricity supply and Government; mining; export; electronic and data; special markets; household products; data

networks; Pyrotenax; and telecommunications.

It is claimed the new division will comprise the best qualities of its constituent parts. For example, CMA is Australia's largest supplier of energy cables and accessories; and Pyrotenax is Australia's only producer of mineral insulated electrical products.

Australia left behind in CRT?

AUSTRALIA could be left behind in the development of cellular radio services unless it adopts the European standard GSM (Group Standard Mobile), warns BIS Mackintosh, the electronics business consultancy.

The company's latest research demonstrates enormous growth for digital cellular radio (DCR) in Europe between 1991 and 1996. Growth in analogue cellular radio (ACR) will be much more subdued, claims the company.

Australia currently operates an analogue system based on the US standard, AMPS, and no commitment has yet been made to develop DCR.

BIS' Australian representative, Maurice Dobbins, said, "In our view, the Europeans are well-advanced in developing and introducing DCR, in comparison with the confusion in the USA." He claimed the USA analogue system was generally inefficient as users could not make calls outside local areas and also experienced congestion.

"Australia has adapted the US system with conspicuous success to enable calls to be made and received throughout the continent," said Dobbins. "But a question mark remains on the long-term viability within current frequency allocations."

Dobbins claimed digital technology had compelling advantages: it will be cheaper in the long run, it will be ISDN-compatible, and it will enable calls to be made internationally, including from passenger aircraft.

Chief among its advantages, however, is that it would avoid the congestion found in the usage of ACR. ISDN compatibility will mean enhanced data handling for facsimiles and voice messaging systems.

One of the first major decisions to be made by Austel was whether to permit a second competitive cellular radio network, and whether it should be digital or analogue. European authorities had chosen digital for the operator to assist the devel-

opment of digital technology and so reliance on existing analogue networks did not become a vested interest, Dobbins claimed.

Another problem for the Government, he said, was that the frequency spectrum used by DCR, based on the DCR system, was already in use and would have to be cleared to develop the GSM system. But he does not feel that the degree of importance to which current users put the spectrum is such that it should delay development of DCR.

Dealership terminated

AST Research has ended its agreement with Imagineering to distribute its products in Australia and New Zealand.

AST said there was no disagreement with Imagineering but that it believed it could distribute its products better itself.



Technicians at Hughes Aircraft Company's Los Angeles plant complete final tests on the Galileo Probe which is scheduled to enter the atmosphere of Jupiter in late 1995. Weighing around 330 kg now, the probe will experience deceleration forces so great on encounter with Jupiter's atmosphere that its weight will increase to the equivalent of a DC-10 aircraft. Carrying scientific instruments, it will parachute through the fiery atmosphere for about an hour, transmitting valuable data to the Galileo Orbiter spacecraft which will carry it into space in October.

Amateurs lose 576 MHz band

BECAUSE of the Federal Government's TV equalisation program, the Wireless Institute of Australia (WIA) has been told by the Dept of Transport and Communications that the 576 to 585 MHz band will no longer be available to amateurs.

The band has been primarily allocated to broadcasting and secondarily to the fixed and mobile services. Amateurs were allowed to use it until it was needed for broadcasting. Some time ago, the WIA asked about continuing the use of this band and were given a limited assurance of three years' use. That time has now expired.

Options discussed included using an adjacent channel to the 576 MHz band but there is no such spectrum space available on an Australia-wide basis. However, existing amateur TV repeater stations in the band may carry on until the spectrum space is wanted for the respective area.

The WIA said that groups proposing a new ATV repeater should opt for either an in-band 70cm repeater or a repeater output on 23 cm. This latter band has proved popular in the UK and USA where the technology has been demonstrated.

Record earnings for Hughes

THE Hughes Aircraft Company, manufacturer of Australia's first and second generation of Aussat satellites, had a record turnover of US \$7.4b in 1988, boosting total revenue of its parent, GM Hughes Electronics Corporation, to a

record US \$11.2b in the same period.

Landing two major contracts, potentially worth US \$1.5b for its HS 601 body stabilised satellite, all-time high sales for Hughes Network Systems, its ground station subsidiary and the purchase of three Westar spacecraft, (making it the largest private satellite company in the world with nine craft in orbit,) contributed to this result.

Hughes' annual turnover lifted by US \$400m with its sister company Delco Electronics contributing US \$3.8b, an increase of US \$300m on the previous year's outcome.

Overall, GMHE maintained its position as one of the world's leading suppliers in advanced automotive, defence and space electronics by lifting its profit by 19.7% from US \$670m in 1987 to US \$802.1m in 1988. Total turnover in the period rose by 7.3%, from US \$10.5b to US \$11.2b.

Lynwood Pacific in joint venture

LYNWOOD Pacific Pty Ltd has announced a joint venture with Oceonics SPL, a leading European supplier of TEMPEST peripheral equipment. According to Roger Bromley of Lynwood Pacific, the venture would provide the company with a world standard capability in addition to the facilities, disciplines and infrastructures to carry out local manufacture.

Through links with Lynwood UK and Oceonics, Lynwood Pacific claims to offer the world's leading technology in secure systems, and is one of the leading companies in TEMPEST products in the Pacific region. For further information contact Roger Bromley, ☎ (02) 439 5433.

The MAESTRO 2400XR

Here's a fully-featured, Hayes compatible 1200 & 2400 bps full duplex modem for just

\$369 (incl. tax).

This modem uses the LATEST in DSP chip Set Technology and microprocessor control, bringing you the future Today.

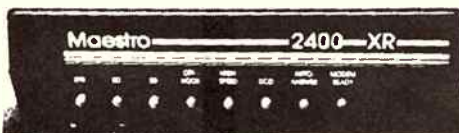

Super price on a super V.22/V.22 bis Modem!

The MAESTRO 2400 ZXR
4 Speed Version **\$399 (incl. tax).**

Don't Wait! RING NOW (043) 68 2277 or 68 2278

Maestro Distributors
Calool St. South Kincumber, NSW 2256

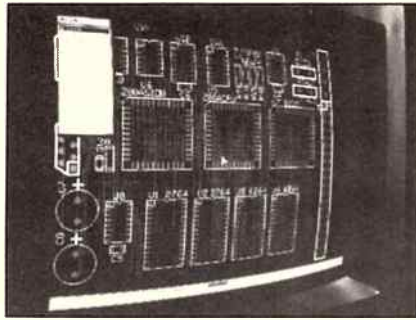

TOP OF THE LINE IN PCB DESIGN

PROTEL-AUTOTRAX: \$1395

Full-featured professional PCB layout for both through-hole and SMD designs. Auto component placement from Netlists. Interactive and Full Autorouting. Support for popular printing/plotting formats including Gerber format photoplots.

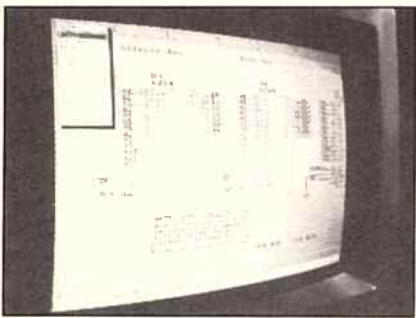

QUICK START CIRCUIT DESIGN

PROTEL-SCHEMATIC: \$995

Flexible, easy-to-use schematic capture program for both digital and analog circuit designs. Netlist transfer to PROTEL-AUTOTRAX completes a powerful end-to-end circuit board design system.

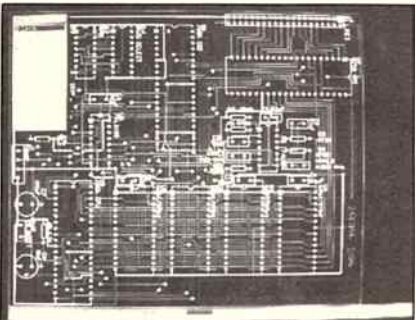

EASY, LOW-COST PCB DESIGN

PROTEL-EASYTRAX: \$495

Easy to learn, easy to use manual PCB design package. Capable of producing professional artwork for multi-layer, through-hole boards to 32 x 32 inches. Host of powerful editing features make efficient PCB lay-out a breeze. Gerber and NC Drill output.

PROTEL PHOTO PLOTTING We now offer complete photoplotting and board manufacturing services. Phone David Warren for details.

PROTEL TECHNOLOGY PTY LTD
Incorporated in Tasmania A Member of CRITEC CORPORATION



G P O Box 536F Hobart, TAS 7001
Telephone (002) 73 0100 International +6102 730100
Facsimile (002) 73 1871 International +6102 73 1871

Brisbane firm in US laser venture

LAWS Laser, a Brisbane sign manufacturer, is moving into the large Californian market using a Queensland-made cutting system. A joint venture between Laws Laser and two American partners has opened in San Jose in February.

The partners believe the computer-controlled Australian laser is superior to US systems. The new Californian company, Dimensional Laser Products, is a partnership between Laws' managing director, Ken Laws and Americans Keith Belcher and Fred Gunther.

The third Gold Coast-designed LDL laser profiling system sold to the US in the past 12 months is now being installed at DLP's new San Jose premises. Geoffrey Laws is currently helping LDL technicians install the new system in San Jose and training local operators.

After building up his company over the last five years, today, sign-making is only half of Laws' business. His staff has grown from five to thirteen. He now has a second \$200,000 500 watt laser cutting system in Brisbane, also made by Laser Dynamics.

Laws examined alternatives to the LDL system when he needed a second laser, especially in the signs and light industrial cutting business in the US, and claims he is convinced that the LDL system represents the best value-for-money, and that it is superior to any comparable American product.

Sanyo to make Acorn RISC chips

ACORN, which designed the Acorn ARM RISC chip set for its Archimedes Reduced Instruction Set Computer systems, has appointed Sanyo as an alternate manufacturer for the chip.

Julian Barson, managing

director of Barson Computers, which distributes the systems throughout Australasia, claims the Sanyo Licensing is a further ratification of the acceptance of Acorn's RISC technology.

He also said that the ARM technology had great potential for embedded controller applications and that about 20 design teams around the world were looking at using the devices in the near future.

International publishers, Prentice Hall, would publish a family data manual for the chip set which would help establish it as an industry standard, he said.

For further information, contact Barson Computers ☎ (03) 419 3033; Fax (03) 419 2892.

HK electronics fair goes international

THE Hong Kong International Electronics Fair this year will admit overseas exhibitors for the first time. It moves to a new venue at the HK Convention and Exhibition Centre, which has two halls, each twice the size of a football field.

The fair, on October 16-19, will take up one hall with 350 exhibitors expected. The electronics industry is HK's second largest in export value. The colony produces consumer electronics from audio including CD players to colour TV receivers, calculators, household appliances (including microwave ovens and feature telephones) and toys and games.

HK has developed specialists in data processing and telecommunications equipment, making PCs, computer peripherals, printers, photocopiers and fax machines. In components HK claims expertise at post-wafer processes, with a skilled workforce needing the least instruction and capable of high precision detail, and advantageous for small orders.

More information from the Hong Kong Trade Development Council, 71 York St, Sydney, NSW 2000 ☎ (02) 26 8343.



ARTHUR CUSHEN

SID CAUSES HAVOC FOR LISTENERS

Solar flares, causing sudden ionospheric disturbance (SID), are blocking out shortwave reception for minutes or even hours at a time. Arthur Cushen explains the phenomenon.

Few signals coming through

The increasing sunspot count, which is expected to peak in September when the 11 year cycle reaches its maximum, has been causing problems recently for daytime listeners.

When listeners turn on their shortwave receivers during the daylight hours they find there are very few signals coming through. It is generally not the fault of the receiver, but a change in reception patterns due to a sudden ionospheric disturbance. The disturbance, caused by a solar flare on the sun and the energy which results, hurtles towards the earth and completely blocks out shortwave reception for minutes or even hours. It is a phenomenon which generally only affects the lower frequencies, but a severe disturbance will blot out the entire short-wave spectrum. Listeners will find that if a SID occurs the lower frequencies will generally fade out first; therefore tuning to the higher frequencies will result in stations still being received.

Listeners in the southern hemisphere will be aware of the aurora disturbance at night when pink flares arc across the southern sky, but this type of interference can be predicted several hours before it eventuates, due to the flutter fading on

the signal. SID happens without any prior warning.

The 11 year cycle, in which the sun is near its maximum point, means that high frequencies are more active at present, and as we approach the maximum and pass the peak point (which can spread over three to four years), the sun will have such tremendous energy that we will tend to get more SIDs. Listeners will learn to have patience with this type of disturbance and realise that when signals are not available on the higher frequencies it is a matter of waiting anything from 20 minutes to a couple of hours before reception returns to normal.

India expands shortwave service

A powerful new shortwave complex has been built near Bangalore in India. When fully completed it will house six 500kW transmitters and be the biggest complex of its type in Asia.

Extensive aerials are to be used, with the North African beam in its reverse path, providing transmission to Australia. At present, two of the 500kW transmitters are in operation and the additional four units are expected to be on air in two years time, carrying the programs of All India Radio, originating from

the studios in New Delhi and with support services from Bombay and Madras.

All India Radio broadcasts to Australia in English 1000-1100UTC on 11860 and 15335kHz. A transmission for our morning reception 2045-2230 is on 7265, 9550, 9910 and 11715kHz. The address is All India Radio, External Service, P.O. Box 500, New Delhi 110001, India.

High power BBC

THE BBC relay base on Ascension Island in the South Atlantic, which came into operation 25 years ago, is to have additional transmitters installed. Two new 250kW transmitters and four high gain antennas are being installed which will benefit listeners in South Africa and the southern part of South America. The installation is due in September.

The BBC has planned to replace much of its older equipment over a 10 year period, and old, low-powered transmitters have been replaced by more high-powered transmitters. In the United Kingdom four new 300kW transmitters have replaced some six World War II 100kW transmitters.

The well-known BBC frequency of 18080kHz, which carried the World Service and is well received in Australia during the evenings, is to cease in July as this frequency is outside the new World Administrative Radio Conference designation of the 16 metre band, which has been extended at the lower end. Stations above 17900kHz are no longer allowed to use these frequencies. The old channel has been used with the agreement of the British Post Office, but will be replaced in July with one which is within the recognised 16 metre band, now 17550-17900kHz.

And elsewhere

AUSTRIA: The Austrian Radio at Vienna is now being re-broadcast by Radio Canada International to provide better reception into North America. The transmission in English is 0500-0600 on 6015kHz.

CHINA: Radio Beijing programs are also being relayed by Radio Canada International and this transmission is 0300-0400 on 11845 and 0400-0500 on 5960kHz.

GARCON: Africa No. 1, the huge transmitting complex at Moyabi, is being used to relay programs of Radio Japan for reception in Africa 0300-0330 on 9645kHz, and to Europe from 0700 on 21695. At the same time the English transmission of Radio France International 0135-0345 is carried on 9790kHz.

NEW ZEALAND: Radio New Zealand International is now operating 1830-2105 11780, 15150; 2345-0145, 0330-0730 15150, 17705; 1000-1205 9850, 11780; Saturday/Sunday 0145-0330 carries the Sporting Service, so that the transmission is continuous 2345-0730 on those days. The transmitters are now operated by Radio New Zealand Ltd. and as from July 1 will be under the control of the Ministry of External Affairs.

SOUTH AFRICA: The SABC program Radio 5 which is an English commercial service, is being received on 11880 kHz at 0600. There is a 5 minute news bulletin, and then a morning commercial program, for listeners within South Africa.

This item was contributed by Arthur Cushen, 212 Earn St., Invercargill, New Zealand. He would be pleased to supply additional information on medium and shortwave listening. All times are quoted in UTC (GMT) which is 10 hours behind Australian Eastern Standard Time.



STUART CORNER

ISO TACKLES DISTRIBUTED PROCESSING

New information processing standards being developed

The ISO aims to develop standards which will permit a higher level of integration between different computer systems. Stuart Corner brings us up to date.

Work is now starting to develop international standards that will one day permit computers in different locations and different organisations to exchange data and share complex processing tasks. These standards for open distributed processing are part of the evolving Open Systems Interconnection (OSI) standards for information processing.

The OSI model for data interchange was conceived over 10 years ago as a means of allowing communication between computer systems from different vendors. Since that time, significant progress has been made and there are now products on the market which implement the OSI standards for electronic messaging - the Message Handling System (MHS), also known by its CCITT designation, X.400.

The companion standard for directories in electronic mail systems, X.500, has also now been completed and products should start to come on the market within the next year or so. X.500 will allow a user on an electronic mail system to communicate with someone on a different system without knowing that person's electronic address. For example the name, location or department of that individual could be specified on the

sender's terminal. This information, in standard form, would be passed to the electronic mail host system of the recipient of the message and that individual's electronic address retrieved from an electronic directory configured according to the X.500 standard.

Higher integration level

Now the ISO is working on standards which will permit a much higher level of integration between different computer systems. This work is aimed at creating standards for true distributed processing. The ISO group working on the project had its inaugural meeting in Sydney last December as part of the meeting of the OSI Standards Committee. OSI standards are the responsibility of Sub Committee 21 of Joint Technical Committee/1 (JTC/1). JTC/1 has representatives from the International Standards Organisation (ISO) and the International Electrotechnical Committee (IEC). The meeting was hosted by Standards Australia, which represents Australia in the ISO.

The new working group responsible for distributed processing (WG7) is chaired by Joost van Griethuysen from the Netherlands. The project is seen as one of great importance: 17

national standards bodies and 7 international organisations are participating in the group. It aims to develop a complete Reference Model for Open Distributed Processing (RM-OOP) by 1995.

The processing of information is now an intrinsic part of any business enterprise. This information, van Griethuysen said, must be made available, stored, and used in many different locations. It will be duplicated for security, distributed to facilitate speedy access, processed in parallel to allow rapid solution to large and complex problems and copied to different parts of an organisation. The objective of an Open Distributed Processing standard is to allow this process to take place in a reliable way.

When this distributed processing takes place within a single organisation, there will be a single authority able to control the activity of the entire system. However, van Griethuysen pointed out that with the development of electronic trading and the increased exchange of information between different organisations there will be no such control. So the standards for ODP must be capable of allowing these independent entities to interwork without any of them jeopardising their individual interests.

Japan prepares to dominate database industry

THE online database industry is in the doldrums, according to delegates at the Online '89 conference in Sydney in January. However, the Japanese are gearing up to be major players in the industry. The Japanese Government in 1984 established a Database Promotion Centre and in 1988 issued a White Paper which made a detailed analysis of databases in Japan and outlined the Government's plans for the future of the database industry.

Online databases are huge repositories of information. The largest online information service in the world, Dialog in the USA, was founded in 1972 and now carries 350 databases and about 200 million records. Databases provide historical as well as up-to-the-minute information. Newspapers are placed online simultaneous with printing. For example, the *Australian Financial Review* can be read online in London before it hits Australian doorsteps.

In spite of the timely access to massive amounts of information which online databases make possible, speakers at the conference reported that many databases were underscrutinised and unprofitable. They forecast a shakeout in the industry.

The Japanese, however, are much more bullish about the future of online databases. The 1988 White Paper concluded that "the database industry has begun to flourish as an information industry which has created new business out of accumulated data. It is to be

expected that this will stimulate the further development of the information industry and contribute significantly to the advent of an affluent and appealing society... A variety of industrial perspectives suggest that the database industry will come to assume an important role in the achievement of an even more affluent society."

The White Paper suggests that as primary and secondary industries decline with the transfer offshore of manufacturing enterprises these industries will gain a new lease of life by participating in the information business. "The knowledge and technology accumulated by enterprises in existing industries over long years is likely to provide a powerful means for entering the information industry. It is wholly feasible for information of an advanced and specialist nature which a company has already acquired to become the basis for a venture into information vending."

Japan's intentions, according to the White Paper, are that the country's database industry will be very much an international industry. "With the growth in Japanese technical and economic power, Tokyo has become one focus of an international financial market. This situation means there is an increasing and pressing need for international standards to be established in respect of information in Japan... It is necessary that Japan take active steps to develop databases for the outside world. This in turn is likely to stimulate activity in the Japanese database market."

The presence of the Database Promotion Centre at Online '89 was only one of a series of overseas activities aimed at promoting awareness of Japan's databases and database industry. DPC has been holding international symposia on databases since 1985. It has sent missions to investigate database developments in the US, Europe, Australia, China and the ASEAN nations. In 1987 it organised a

major conference in the UK, participated in Online '88 in New York in October and SEARCC '88 in New Delhi in November.

One major factor which is likely to have a significant impact on the database industry is the integration of expert systems and artificial intelligence with database technology. The techniques can be used to facilitate access to online information. Many online services require highly skilled operators to make full use of them. Also, an expert system requires a database of expert knowledge. As the Japanese White Paper says: "It can be expected that databases will find extremely broad applications in AI technologies, the production of knowledge database systems, the design of databases, the production of operational expert systems, the simplification of data input... it is likely that the connection between AI and databases will grow even deeper in the future."

First national EDI network

CSIRONET, a subsidiary of the New Zealand based Paxus Corporation has won a contract to set up an Australia-wide electronic document interchange network for the import and export industries. It is claimed to be the first in the world with nationwide coverage. The system, Tradegate Australia, will be accessible to every organisation involved in the import and export industries. These include customs agents, the Australian Customs Service, shipping agents, freight forwarders, shipping lines, port authorities, banks, airlines, importers and exporters and road transport companies. Estimates have predicted there could be 85,000 terminals on the service after five years.

The basic network will provide message routing, electronic mail and electronic interchange of standard documents conforming

to the international edifact format as well as access control and user authentication and security features. According to the project co-ordinator, Neil Perry, the success of the network will depend on it attracting a large number of value added services important to the import and export industries.

These are expected to be services such as cargo booking and tracking, electronic funds transfer, customs and quarantine functions, news and information services, carrier information and vehicle booking services. There are already plans to provide for electronic clearance of export cargos through the Australian Customs Services' recently established Exit EDI network. A videotex system operated by Telecom Australia in conjunction with major shipping companies provides information on vessel and container movements. Content of the Daily Commercial News, a newspaper aimed primarily at the shipping industry, will also be available through the network.

The principal users have formed a joint management company, to set up and operate the network. As other users come on they will become partners in the company. Csironet will provide the network infrastructure, computer hardware and software to run the service. According to Perry, this will ensure that control of the system remains in the hands of the users, and that a neutral backbone network is provided to carry competitive value-added services.

Csironet will use the Istel Edict system which runs on IBM mainframes and is already well established in Europe. Users will be linked either by Telecom Australia's national packet switched network, Austpac, or Csironet's proprietary packet switched system operating over leased lines. Csironet will provide facilities on a Bureau basis for value-added service providers and software and services to users to access the network from personal computers or larger mini and mainframe systems.

Speech technology gets smarter

NEW standards for speech digitisation will pave the way for higher quality voice over the telephone and cheaper international phone calls. A number of years ago the bandwidth of speech for use in telephone systems world wide was set at 3.4 kilohertz. This is much narrower than the bandwidth of the human voice, and is the reason why voices on the telephone always lack clarity.

When the world's telephone networks started to employ digital technologies in the 1960s, a standard was adopted to encode this 3.4 kilohertz signal as a digital signal of 64 kilobits per second. This standard is in use today throughout the world's public telephone networks and many office PABX telephone systems. The conversion of the analogue signal to digital is now carried out on a single chip.

The international telephone standards body, the CCITT, at its Plenary Meeting in Melbourne in November 1988, adopted new international standards for digitising the 3.4 kilohertz signal into 32 kilobits, half the previous bandwidth. These standards will permit the capacity on costly international telephone circuits to be substantially increased. They will also permit the basic 64 kilobit channel to carry a number of calls simultaneously.

Another standard was established to encode a 7 kilohertz signal into 64 kilobits per second. If this were used in the telephone network it would greatly increase the quality of voices over the phone.

Proprietary technologies have been developed which are capable of much greater reduction in the digital bandwidth needed, although there is some sacrifice in voice quality.

Stuart Corner is a former editor of C in C News, and a regular writer on computers and communications.



TECHNOLOGY

Before 1983, if you wanted to dial-up another computer or an on-line public or subscription data base, your only choice was an acoustic coupler modem. Running at 300 bits per second, they were cumbersome, inconvenient and not wholly reliable.

When Telecom "deregulated" data communications conditions pertaining to the public switched telephone network in 1983, direct-connect modems hit the market and developed rapidly. In October 1982, ETI published Australia's first direct-connect modem project, contributing to the then pressure being brought to bear for deregulation.

Basics

Samuel Morse developed digital communications over long wires some 140 years ago. His on-off coded keying predated Alexander Bell's telephone, an

analogue communications system. As things transpired, the telephone system burgeoned, being a communications system which the general public could exploit.

With such a communications system well established world wide by the time the microcomputer revolution arrived, it was only natural developers turned to it as a cheap, ready-access computer communications medium.

Being meant to convey voice frequency signals, the telephone network is not meant to carry on-off digital signals. So, a system of using audio tones was developed. To convert the data to be sent into audio tones, a device called a *modulator* is used. To convert the tones received into digital signals a device called a *demodulator* is used. The term modem is an acronym from MOdulator/DEModulator.

This data signal used by your computer is typically a sequence of serial pulses like that

MODERN MODEM TECHNOLOGY

Dial-up data communications has become a billion dollar industry world wide, and it's still growing. Year by year, communications speeds, features and functions of computer modems leap ahead. This is Part 1 of a feature aimed at bringing you up to date with modern modem technology. By Roger Harrison, Jamye Harrison and Adam Searle.



Netcomm is due to release its new SmartModem M5 this month or next. It features operation in all standard modes to V.32 (9600 bps) full duplex, Hayes command set, auto-ranging to adjust speed to that of the incoming call and it also incorporates the MNP error correcting protocol.

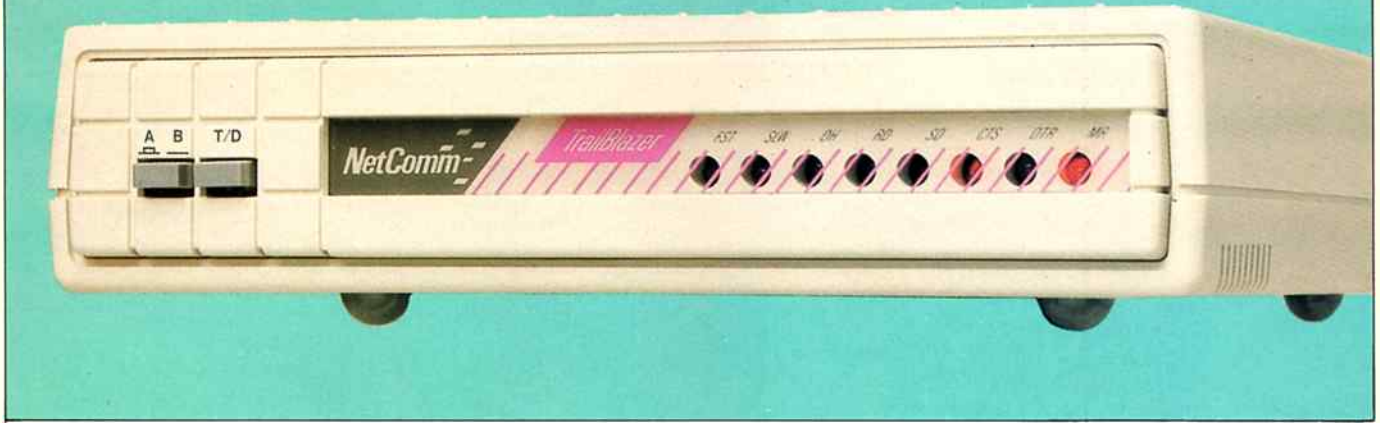

Netcomm's Trailblazer, from Telebit Corp., is a very sophisticated modem with advanced features, and priced accordingly. A pair of Trailblazers is able to analyse the prevailing line characteristics and adapt to suit the conditions.

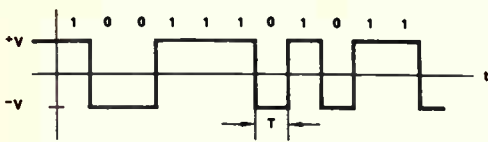

Figure 1: typical form of serial data on an RS232 link between computer and modem.

shown in Figure 1. Any signal has certain characteristics. Firstly the type of information it is representing, analogue or digital. Also its bandwidth, frequency and amplitude. A certain range or set of frequencies at various amplitudes and phases makes up any particular signal. The range of frequencies used is called the *bandwidth*.

This brings me to the first restraint in transmitting a signal. Any signal which is transmitted through a medium has a restriction placed on the range of frequencies it can use. With modems this means the twisted pair of wires between them. Now, the public switched telephone network (PSTN) was used for the transmission of voice only which uses a range of frequencies between 300 and 3000 Hz, a bandwidth of just 2700 Hz. The human voice, of course, is an analogue signal. (We won't discuss the Xhosa language of West Africa here, which employs an array of violent clicks and glottal stops, nor the sign language for the hearing impaired - a "truly digital" form of communication?)

Hence, modem technology is restricted to using this bandwidth, and that requires some "tricks" to be used to overcome the limitations this would otherwise impose. The signal modulated by the modem consists of a *carrier tone* which is modulated, or changed, in some way to convey the digital data.

The carrier can be modulated in a number of ways: by varying its amplitude (AM, or amplitude modulation), by varying its frequency (FSK, or frequency shift keying), by varying its phase (PSK, or phase shift keying), or a complex combination of these.

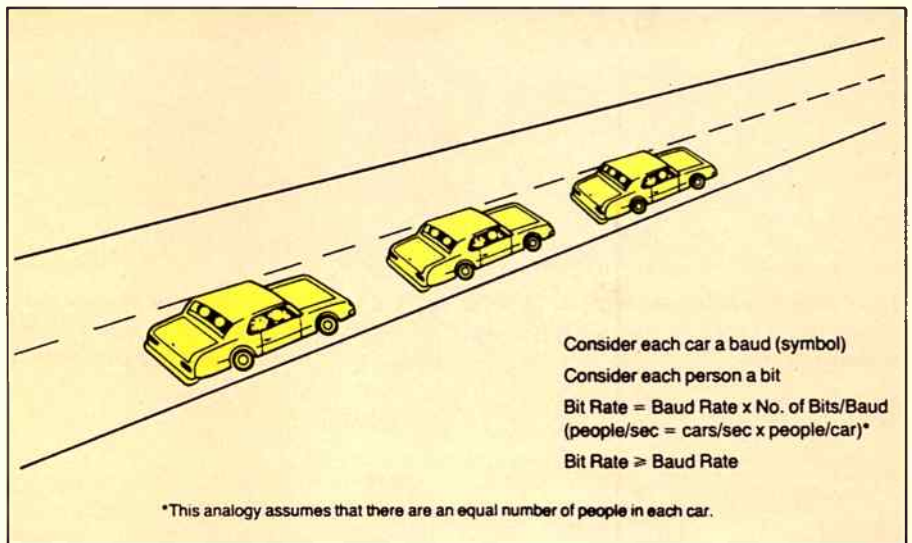

Figure 2: Illustrating bit rate and baud rate.

Voiceband Modems

Speed	2-Wire Mode	Modulation	Specs
0-300bps	Full Duplex	FSK, Asynchronous	Bell 103/113 CCITT V.21
0-1200bps	Half Duplex (with Back Channel)	FSK, Asynchronous	Bell 202 CCITT V.23
1200bps	Full Duplex	DPSK, Synchronous	Bell 212A CCITT V.22 Vadic 3400
2400bps	Half Duplex (with Back Channel)	DPSK, Synchronous	Bell 201 CCITT V.26
2400bps	Full Duplex	QAM, Synchronous	CCITT V.22 bis
4800bps	Half Duplex	DPSK, Synchronous	Bell 208 CCITT V.27
9600bps	Half Duplex	QAM, Synchronous	Bell 209A CCITT V.29

TABLE 1: the common operational standards or recommendations for modems. Further standards for 9600 bps operation and beyond (eg, V.32) are not yet finalised.



Smart modems using the Hayes command set, which enables control of the modem operating configuration and other functions, rapidly gained acceptance here a few short years after direct-connect modems were first permitted, and multi-speed smart modems became big sellers. The Bit Blitzer series, imported and marketed by Mike Bourne Electronics, is a popular range.

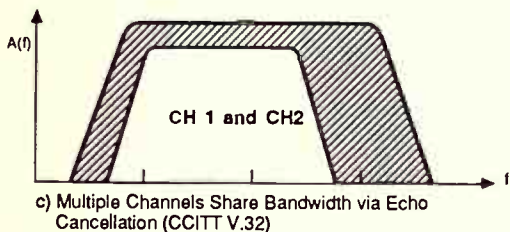
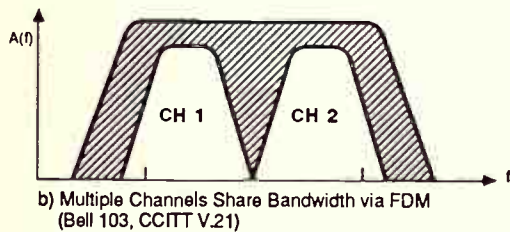
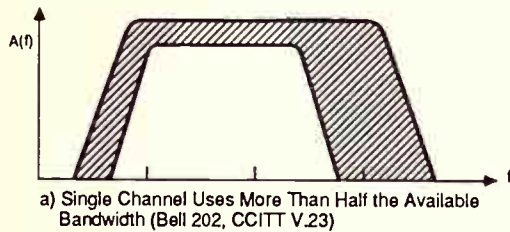

Figure 3: bandwidth usage of the telephone line in modem communications.

Modems are usually characterised by speed and modulation techniques which have various standards (Table 1). Low speed modems (up to 1200 bps) are implemented using frequency shift keying (FSK) modulation. Medium speed modems (9600 bps) are also implemented using QAM. PSK is really a special case of QAM.

Such modulation techniques differ in the way they encode data onto an analogue carrier (frequency, phase, amplitude), the number of bits encoded per modulation interval (baud), transmission efficiency, frequency spectrum usage, and the complexity of the circuitry required for its implementation. The method of carrier data encoding and the rate at which this modulated carrier changes determines the frequency bandwidth needed.

The rate of change is the *symbol interval* or *baud rate*. A symbol may represent one or more bits. By way of an analogy, look at Figure 2. The phone line is represented by the highway, the people represent bits and the cars, bauds. The bit rate equals the baud rate (number of cars per second) times the number of bits encoded per baud (number of people per car).

The phone line has a usable bandwidth which can be used by modems in various ways. A single high speed channel can use

all the bandwidth by operating in different parts of the spectrum (Figure 3a), or several lower speed channels can share the bandwidth by operating in different parts of the spectrum (Figure 3b). This latter method of sharing bandwidth is called frequency division multiplexing, or FDM.

Frequency shift keying

FSK is a modulation technique encoding one bit of the data stream per baud. A logic 'one' in the bit stream places a mark frequency (F_m) on the phone line. A logic 'zero' places a space frequency (F_s) on the line. As the bit

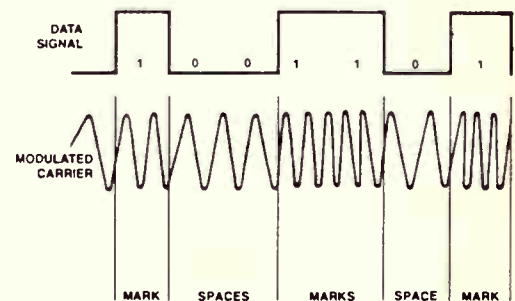

Figure 4: illustrating frequency shift keying (FSK). The 1 pulse shifts the carrier to one frequency, the 0 pulse shifts it to another frequency.

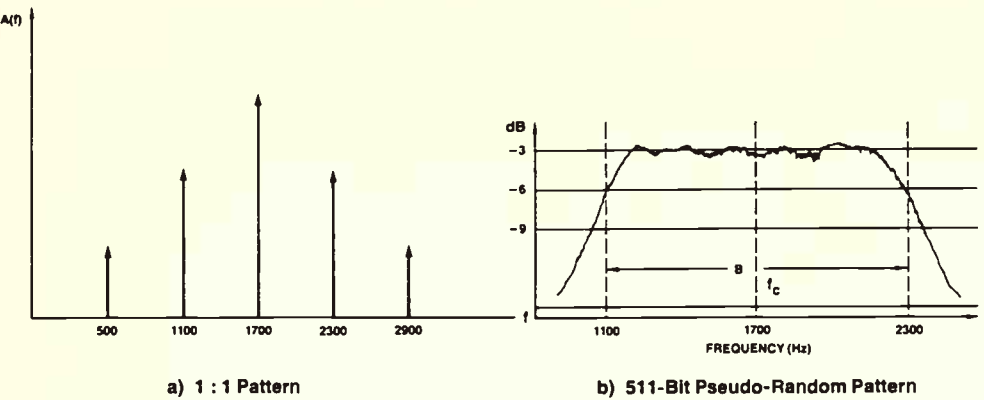

Figure 5: spectrums of FSK signals.



One of the first direct-connect modems on the Australian market was the locally-designed and made Avtek Multi Modem which was released in both do-it-yourself kit form and as a ready-built unit. It used the CCITT V.21 and V.23 modes, and some Bell modes which allowed dialling the US. An upgrade followed, the Multi Modem 11, shown here, which included a pushbutton phone, auto-answer and other features.

stream switches between one and zero, the analogue signal on the line modulates between F_m and F_s (Figure 4).

This modulation process generates energy not only at these two frequencies but over a broad spectrum which depends on the sequence of bits in the data stream. An alternate one/zero pattern (1:1 or square wave) generates a simple line spectrum represented by Figure 5a. A broadband spectrum (Figure 5b) is approximated by a 511-bit pseudo-random pattern of data bits, a good representation of most data transferred through a modem.

By encoding only one bit per baud, FSK

uses around one Hertz of bandwidth for each bit per second of data rate. For example, a substantial portion of the phone line bandwidth is used at a rate of 1200 bps, allowing only a single channel to be transmitted. Two independent channels at 300 bps can be accommodated within the line's bandwidth using FDM. FSK usually requires the least amount of hardware for its implementation, although it is the least efficient bandwidth.

Phase shift keying

This is a modulation technique encoding more than one bit of the serial data stream into a modulation symbol. In the data stream, sequential bits are grouped in pairs or triplets. When in pairs, a two-bit code (dibit) is formed which selects one of four phase shifts to be applied to a carrier on the phone line. A three-bit code (tribit) selects one of eight phases. Encoding more bits per symbol allows a higher rate for a given bandwidth. This is because spectrum usage is determined by the symbol or baud rate.

Figure 6 shows the encoding of two bits per baud and the corresponding phase shifted carrier. Such phase shifts for modem specifications are generally indicated as *point constellations*, illustrated in Figure 6. The constellation for the dibit encoding of Figure 6 is shown in Figure 7a.

Using FDM at a rate of 1200 bps spectrum use for two-bit PSK encoding allows two independent channels in the phone line bandwidth. Another way to use the bandwidth with two-bit encoding is a single

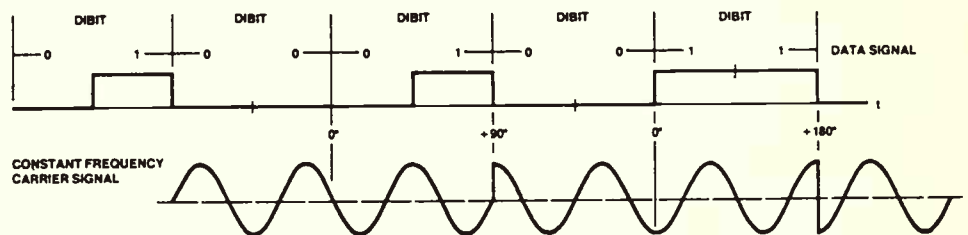

Figure 6: phase shift keying modulation. This diagram illustrates two-bit (dibit) encoding (DPSK) with 4-phase angles.

channel at 2400 bps. Three-bit encoding permits a single channel at 4800 bps. The bandwidths of 2400 and 4800 bps DPSK signals is shown in Figure 8.

PSK demodulation from the phase-shifted carrier into two- or three-bit codes needs more sophisticated hardware than FSK demodulation. It is more sensitive than FSK to phone line distortions. These can be compensated for by more complex and costly processing in the modem. Higher data rates usually mean higher expense.

Quadrature amplitude modulation

As well as encoding multiple data bits into a modulation symbol like PSK, QAM modulates its amplitude and phase shifts the carriers on the line. Four sequential bits are encoded into a constellation as is shown in Figure 9. With this, a single channel at 9600 bps can be provided on the line. Figure 11 shows the bandwidth used by a typical QAM signal.

QAM is even more sensitive to line distortions than PSK. Automatic equalisers are required to compensate for such distortions. This kind of modem is the most complex and expensive to implement.

Asynchronous and synchronous transmission

The serial data stream enters and exits a modem either asynchronously or synchronously. An asynchronous data stream may have a symbol rate (baud or bit) which varies from zero to the maximum allowed by the modulation technique being used. Data determines the bit rate. There is no separate clock signal to qualify the bits in the data stream. FSK modems are asynchronous.

A synchronous data stream has a fixed bit rate (with some small percentage variation) determined by the modulation technique. Timing circuits or "clocks" are used at the transmit and receive ends to synchronise the data streams so that what comes out faithfully represents what goes in. PSK and QAM modems employ synchronous modulators. An asynchronous interface is incorporated so that the modem can "talk" to the computer via its serial link, which is asynchronous.

Replacement audio & video parts service

Drive Belts

Belt kits to suit all popular VCRs.

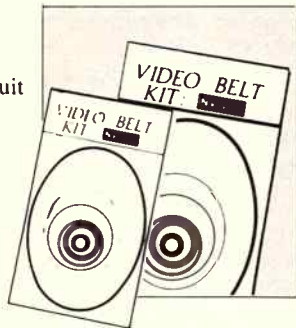

Square section belts for tape recorders. Flat section belts to suit most audio applications including turntables. **READER INFO NO. 65**

Video Heads

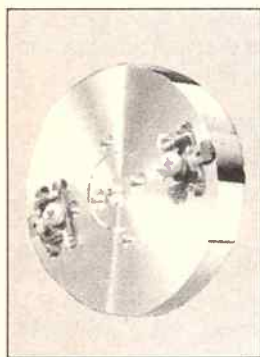

For National, Akai, Sharp, Sanyo etc.

We stock over 50 types to suit all popular VCRs.

READER INFO NO. 66

Integrated Circuits

Including AN, BA, HA, LA, LM, MB, STK, TA, TDA and UPC.

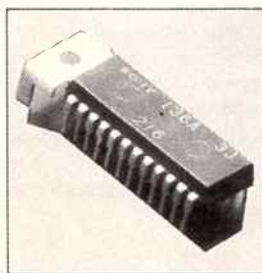

Other popular European and Japanese ICs and a wide variety of transistors are also available. **READER INFO NO. 67**

Wagner Electronics
305 Liverpool Rd
Ashfield, NSW 2131
Ph (02) 798 9233
Fax (02) 799 7051



TRADE ENQUIRIES WELCOME

Modern modem technology

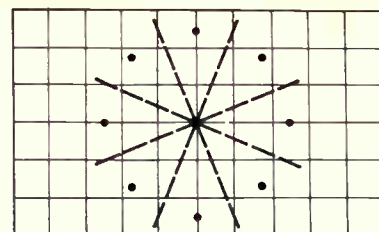
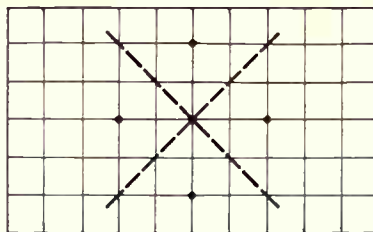

Figure 7: point constellation diagrams for DPSK modulation.

Half and full duplex

Communications may be one way or two way. One way communication is called simplex communications; duplex communications is two way.

Full duplex communications allows simultaneous data transmission by two modems at the same speed in different directions. Half duplex data transmission is where two modems communicate in only one direction at a time; the line is "turned around" when transmission in the other direction is required. In some cases, a *backward channel* is used, allowing data to be transmitted at a low data rate in the reverse direction to the main transmission. Viatel employs half duplex transmissions; 1200 baud from the Viatel computer, 75 baud in the back channel from your computer.

The smarts

This brings us to the way in which a modem is controlled. Some people will remember the days of acoustic couplers where you pushed rubber cups over the phone's ear and mouthpiece, dialled the number and switched everything manually. The world of data communications was revolutionised when we were graced with the advent of direct-connect modems, the first of which were manually controlled by switches on the front panel. You still had to dial the phone yourself, but hookups were considerably easier. For casual use, manual modems still represent good value for money. Then came

auto-dial and auto-answer modems, controllable by simple software loaded into your computer.

Modern modems are usually software controlled using an internally resident program. The most common method of controlling a modem in this way is the Hayes protocol; hence the term Hayes-compatible. It was developed by US modem manufacturer Hayes and became the de facto industry standard.

This method is basically a set of mnemonic commands usually conveyed to the modem via the computer serial port, along with the data to be sent. The modem then "interprets" these commands and acts upon them. This of course led the way for more automated communications sessions, expanding the facility and application of modems. The Hayes standard is the most popular world wide today.

There are of course exceptions to every rule and standard. As new technology presents more options in the operation of a modem, variations and additions to the Hayes set are adopted, slowly.

Standards

There are two sets of standards which define the signalling parameters of modems, so that they can talk to each other. These are, firstly, the CCITT recommendations, from an international consultative committee, and secondly the Bell standards, from North America. While CCITT recommendations are meant to be just that (i.e., recommendations)

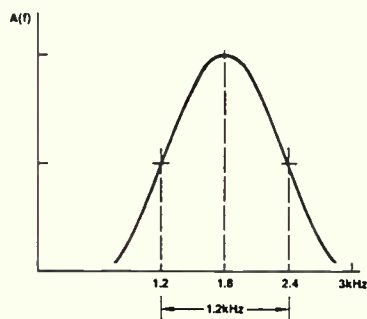

a) 4-angle DPSK (2400bps)

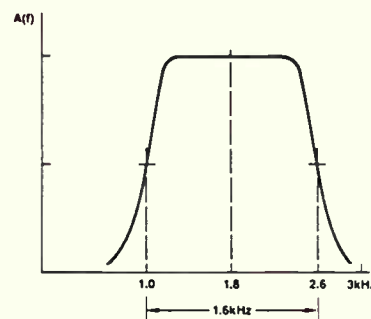

b) 8-angle DPSK (4800bps)

Figure 8: the (idealised) bandwidths for two different DPSK signals.

they tend to carry the same impact as "the word from on high"; in some countries it is unlawful to use modems not complying with CCITT recommendations.

As with the more technical aspects of modulating and demodulating data, the CCITT's pronouncements become much more involved when "ruling" on high speed data communications. Particularly in the area of 9600 bps communications, technology has surpassed guidelines set out by the CCITT. For this very reason we are encumbered with two standards governing the usage of 9600 bps, specifically the V.29 and V.32 standards.

Most facsimile machines, which are after all digital data communications devices, employ modems internally and these comply with the V.29 standard defining half-duplex transmissions at 9600 bps. On the other hand, the V.32 standard outlines full-duplex communications at 9600 bps.

As previously discussed, the need to transmit data bi-directionally, and at higher speeds, increases the need for greater bandwidth. Therefore, to achieve full-duplex communications at 9600 bps and above,

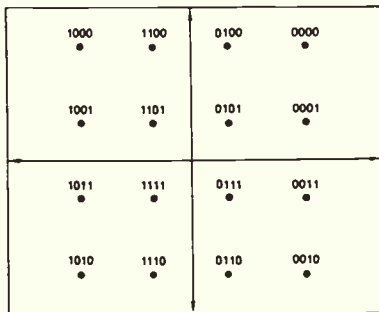

Figure 9: point constellation diagram for quadrature amplitude modulation (QAM).

more advanced software and hardware techniques are required. This generally translates into increasing costs.

To keep costs down, modem manufacturers have utilised a variety of methods to emulate full-duplex operation. Because of this we see a plethora of modems using the so-called 'ping-pong' method. Modems using this technique alternate between sending and receiving information in order to emulate full-duplex operations while actually only communicating half-duplex at any given time. The drawback is the turnaround time, which at best, takes around quarter of a second.

Another method is to combine ping-pong communications with the *fallback* technique. When both modems have information in their respective buffers, they drop down to a lower speed, full-duplex mode.

Another method, utilised in the famed



Local manufacturers have played a big part in the data communications industry in Australia. Maestro's first "Supermodem", a three-speed unit with Hayes compatibility, appeared in 1986 and sold well, both in kit form and as a ready-built unit. Last year they released the 2400 ZXR, which features all speeds to 2400 bps full duplex and an extended set of Hayes commands.

TrailBlazer, from local firm NetComm, is multi-carrier modulation. In this technique the line bandwidth is divided into a set of channels (the Trailblazer uses 512), the channel frequencies are continually analysed, the best channels being available under prevailing line conditions. By using a selection of these channels, and distributing the information between them, the modem can modulate signals across the channels without needing to modulate each signal in such a complex manner. A modem using this and the ping-pong technique can imitate full-duplex operation at higher speeds than those employing just the ping-pong method.

The questions relating to standardisation of communication techniques used in equipment operating at speeds of 9600 bps and beyond are being addressed by a special study group established by the CCITT. However, they are not expected to formulate any concrete decisions until 1992. The speed with which new technology is usually accepted will probably dictate a de facto standard before then.

Fighting errors

Noise is a fact of life on the public telephone network; you've no doubt noticed it yourself in ordinary telephone conversations, clicks and burrs and burbles and other conversations. Noise, or interference, is any *unwanted* signal on the line. While you are quite able to sort speech from noise in a telephone call, modems can get "fooled" or otherwise upset by noise. Integrity of the data transmitted is of utmost importance in data communications, so a lot of attention has been paid to it.

While modulation and demodulation techniques can do a certain amount to obviate problems with noise, they only go so far. One major performance parameter of a modem is characterised by the rate of errors in bits received (the bit error rate, or BER) as a function of the signal-to-noise ratio (in dB). A number of ways of dealing with the digital data have been developed to

improve the bit error rate in the presence of noise, known as transmission or link protocols.

Basically, what happens is, the data transmitted is first specially encoded into blocks of data and the receiving modem checks the incoming data stream and actually applies corrections where the data has been corrupted. But this has its limitations too, so a technique was developed that first encodes the data into blocks, and at the receiving end when a corrupted block is detected, the receiving modem sends a "request" to the transmitting modem to re-send that block. This is generally known as *automatic repeat request*, or ARQ.

An additional method, designed to avoid retransmission, may also be used. Called forward error correction (FEC) coding, the transmitted data has redundant bits added to it before transmission. At the receiving end, the redundant bits are regenerated from the incoming data stream and compared with the redundant bits. Where a discrepancy occurs, a decoding procedure selects the data set most likely to have generated the received data stream.

Probably the most widely used error correcting protocol used in modems today is the Microcom Networking Protocol, or MNP. Like so many other things in the computer industry, a proprietary technique has evolved into an industry standard. Its popularity arises not just out of its error correcting facility, but the fact that it speeds data throughput. 

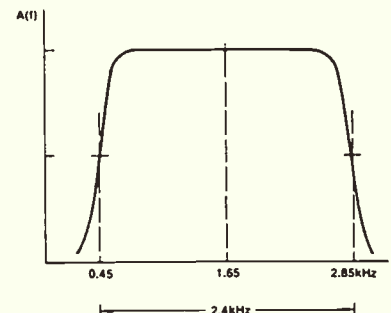

Figure 10: showing the bandwidth of a 9600 bps QAM signal.



PAUL BUDDÉ

US\$1 million for electronic casino

"Rabbitjack's Casino", the most frequently used game section on QuantumLink's original Commodore-oriented service, accounted for more than \$US1 million in connect time during its first year of operation. The game combines full-colour graphics and animation with real-time player action. The casino offers on-line versions of poker, blackjack, slot machines and bingo and lets players and observers "talk" while the software on each user's Commodore computer provides graphics so players can see and hear the bidding, "betting" and card-handling.

Skyphone aims at business plane market

Racal's Skyphone is really taking off in the business aeroplane market. Together with the satellite organisation, Inmarsat, Racal has developed telecommunication equipment to be used in the aviation industry. The turnover in the business market is at present much higher than in the public aviation market - a trend that is likely to continue over the next year or so.

Fax for direct marketing/business application

A Dutch company, Racom, has been very successful in establishing a direct marketing fax

service. Over the last few years it has gathered a range of interesting marketing information about companies with faxes in the Netherlands.

A fax message has a much higher appeal than a letter. It seems to have the same status as a telex message. This was the reason for Racom to start its direct marketing services. Organisations can use the creative services of Racom as well as their extensive fax-user database. This might also be a good idea for an entrepreneurial Australian organisation.

Teletext penetration in Netherlands

25% of all TV households in the Netherlands now have access to Teletext. The service is very popular. Top four services are:-

- weather;
- sport;
- stockmarket;
- airline arrivals.

Teletext also opens up a market for interactive hybrid services with a range of new technological breakthroughs that will make it possible to use teletext in combination with cable TV and telecommunication networks.

Telebanking at the post office

The Commonwealth Bank Telebanking service is now also available at post offices in Melbourne. A special computer network links all the post offices into the telebanking service enabling clients to transfer money, pay bills etc. By the end of this year some 104 post offices will be linked to the network in Victoria and Tasmania.

New views on teleshopping

At a recent conference in Amsterdam, European and American Value Added Services organisations discussed the teleshopping phenomenon.

There are basically two new trends:-

•Teleshopping on USA cable TV stations. Mainly a one-way service with telephone response (telemarketing). By far the most successful with over 50 million users in United States and Canada. Last year, Channel 9 tried something similar on Australian TV but did not have the same success.

•Teleservices, a new trend that describes a number of services, where ordering is just one element.

It is this last trend that is going to be used on new VANS which will include a range of technical facilities as well as marketable VAS. For too long, teleshopping has been closely related to mail order services. But the parameters of these two markets are miles apart:-

Mail-order users

Income average to low
Education low
Age 30-65
Sex female
Geographic countryside

Teleshoppers

Income average to high
Education average to high/computer literate
Age 20-40
Geographic cities

World Directories in Europe

World Directories (80% owned by ITT and 20% Bell South) is launching a videotex version of

its business directories in France and later in Belgium. The online service is already operational in the Netherlands in both voice and videotex form.

In France, a regional professional directory will be launched in Lyons this spring; ultimately, the service will be extended nationwide. Belgium will be the next country where the online version is to be introduced, and by 1990 the three services (Netherlands, France, Belgium) are to be interconnected.

Although no schedule has been determined for extension throughout Europe, the idea is to develop the service in the seven EC countries where ITT is present, hopefully by 1992. Following Europe, the service is to be launched worldwide in other countries where ITT is active.

In the Netherlands, "Business to Business", was launched last November. It is accessible via the national videotex service, Viditel. Combined with videotex access is the print form version: 537,000 directories of professional contacts listing 150,000 suppliers have been distributed. The printed edition is indispensable for the development of the electronic service, especially in countries where the installed base of videotex terminals is small. It is expected that the print version will be predominant during the next 7 to 8 years, until on-line access becomes totally accepted. At any rate, videotex will be a source of complementary information.

Videotex as Pay-TV

The people of Westminster in the UK can select the Prestel videotex service from their TV set without the need for any special device.

This is possible on the fibre optic "switched star" network. 6,000 people are connected to the new network. At present, videotex users can only use a numeric keypad. If there is more demand for videotex-alike services, updates can be made to also allow for alpha inputs.

Fax, telex, teletex update

There are now over two million faxes in use worldwide. The majority of these faxes are in Japan, where it was seen in the early eighties as an excellent alternative to telex. The Japanese character set is of course much easier to capture on fax than on telex. In Australia, an estimated 100,000 faxes are now installed - a spectacular growth since 1985, when only 21,000 fax installations were recorded. Telex is on its way out. There are now 1.5 million telexes worldwide (Australia: 42,000). This number is decreasing by approximately 5% pa.

From the 1st of July, telex will be deregulated in Australia. So far there have been no supporters who have gone to Telecom for a license to sell their telex products and services. For over 50 years telecommunication authorities have had the monopoly on this market. This is the main reason why the product has never been upgraded to a more marketable one. It is now too late for deregulation to save this product.

Apart from Germany, teletex did not get off the ground. Some 18,500 users are linked to this service - 15,000 of these are in Germany. Australia has 200 users - mainly Telecom employees.

New products, such as PC Fax and Fax Manager are filling this gap. Not that these products will replace the stand alone fax, but they will be able to enhance the service and fit into niche markets. Australian banks are using PC Fax to generate a pc based financial message to fax them to their clients.

Also pc-to-pc communication could be done through pc faxes.

Incoming messages from other sources (eg hand written) are at present a problem for PC Fax.

Fax Manager can reside on computer systems (Wang, Digital, IBM, Prime). The computer workstations can create faxes and through a management system, these forms can be authorised, prioritised, signed, etc. In the USA the price of a fax machine is now down to US\$600.

Bell Canada's "Alex"

Alex-Bell, Canada's NAPLPS videotex gateway service - will debut in Montreal in December, with about 20,000 households expected to sign up during the first test phase next year. The Toronto service is expected to begin in 1990. More than 80 information/service providers have already agreed to put their online packages aboard the Alex system, which will be accessible via a terminal that Northern Telecom is building or via personal computers with a special emulation software package. Bell does not plan to charge for the PC software.

Alex terminals will be leased for CAN\$7.95 (\$8.50) per month and distributed at Bell Teleboutiques. Usage fees will generally range from CAN\$0.12 to CAN\$0.45 per minute, with a rate schedule broken into five categories. Bell will offer an electronic phone directory and information and transaction services. The directory will be free for the first three minutes of use per call, then CAN\$0.15 per minute; customers can search listings by full or partial name, by phonetically speed name or by catalogue.

2,000,000 ASCII videotex users in USA

The so-called ASCII videotex services in the USA (videotex without the user friendly features, as for instance on Viatel in Australia) are booming. The market grew in 1987 by 17.7% to 2.1 million users.

The fastest growing markets are the semi-professional services, such as Genie-BIX and InfoService. There is hardly any further growth in financial services.

International videotex No Problems Club

Italy is the only country using the Prestel videotex standard, which is changing its policy to encompass Minitel-alike services, the Kiosque billing system.

The Italian Telecom organisation, SIP and Marconi Italiana, have developed a scenario to attract mass markets. Last month the Prestel based public videotex countries (including Telecom Australia), members of the International Videotex No Problem Club, met in Singapore to discuss co-operation, interconnectability and new developments.

Most Prestel countries, however, were in favour of sticking to the business market and could not find enough reasons to follow some of the French strategies. It was argued by those in favour of the changes that the role of the PTTs and Telecom was to serve the public market rather than niche markets, a role that these telecommunication organisations in general leave to private companies. As was suggested, it would be better in those niche markets to sell off the public videotex arm of the Telecom organisations to private companies.

Italy and the Netherlands are going to discuss the interconnection of their videotex services. The Netherlands already have a link with the Deutsche Bundespost (Germany), and Germany was forced by court order to link its network to the French network. France has several computer links, eg with the UK and Spain.

Italy will upgrade its Prestel videotex system to a multi-standard network (a Value Added Network) with a range of extra facilities such as X29 host

connect, protocols X400 message services, flexible billing, facilities for VAS providers, Electronic Yellow Pages and wants to play an active role in the international market to create export opportunities for the Italian VAS providers.

Sell off: oldest electronic service

The world's oldest electronic service, Dialog, from the aerospace giant, Lockheed, is for sale.

The price tag is US\$200 million. According to Wall Street, this price is too high, but communication industry experts think it is US\$50-US\$100 million too low!

Dialog dates back to the sixties and has some 320 on-line databases available to its 88,000 users. Revenue for 1988 is expected to be US\$100 million with a profit margin of US\$19 million. Revenues in 1986 and 1987 were US\$708 million and US\$80 million.

New media boom in Germany

Last year Germany saw spectacular growth in the usage of videotex (Bildschirmtext), fax and car telephones. Many times in the past Germany has predicted spectacular growth, but it has never materialised. The number of installed fax machines grew from 43,000 to 84,000. An estimated 20,000 unregistered faxes should be added to this! Bildschirmtext grew by 68% (50% in 1986) to over 100,000 subscribers. The car telephone market increased by 35,000 units to 53,000.

Paul Budde specialises in the marketing and management of electronic services and communications networks.

WIN A BOSE 901 SERIES VI

Here's your chance to win a truly magnificent speaker system. The Bose 901 Series VI speaker system represents the ultimate in home hi-fidelity reproduction.

Universally praised by audio critics and audio enthusiasts alike the Bose 901 Series VI, through its innovative technology will give your listening room an unprecedented sense of concert hall realism.

BOSE
Better sound through research.

You automatically enter the draw by subscribing or extending your subscription to Australia's premier electronics and technology monthly ETI. 12 month subscription only \$45.

For more information including a copy of Dr Amar Bose's research paper "Sound recording and reproduction" contact Bose (Aust) Inc, 11 Muriel Ave, Rydalmere, NSW 2116. Ph: (02) 684-1022.

"The Bose 901 may well be the finest speaker in its class" Hi-Fi Stereo France.

"The high efficiency and dynamic range of the Bose 901 will impress even the most sceptical listener" Audiovisione Italy.

"In terms of musical veracity, the Bose 901 ranks with the finest and is convincing with any type of music" The New York Times USA.

Simply fill out the coupon attached and put in the reply paid envelope supplied — if the coupon and envelope are missing, send your name, address, phone number and cheque, money order or credit card details (card type, card number, expiry date and signature) to Freepost No. 4, P.O. Box 227, Waterloo, NSW 2017. Any enquiries can be made by phoning (02) 693-9515 or 693-9517. Unsigned orders cannot be accepted.

1. The competition is open to Australian residents authorising a new/renewal subscription before last mail July 31st, 1989. Entries received after closing date will not be included. Employees of the Federal Publishing Company, Bose (Aust) Inc, and their families are not eligible to enter. To be valid for drawing subscription must be signed against a nominated valid credit card, or, if paid by cheque, cleared for payment. 2. South Australian residents need not purchase a subscription to enter, but may enter only once by submitting their name, address, and a hand-drawn facsimile of the subscription coupon to The Federal Publishing Company, P.O. 227, Waterloo, NSW 2017. 3. Prizes are not transferable or exchangeable and may not be converted to cash. 4. The judges decision is final and no correspondence will be entered into. 5. Description of the competition and instructions on how to enter form a part of the competition conditions. 6. The competition commences on April 17, 1989 and closes with last mail on July 31, 1989. The draw will take place in Sydney on August 4, 1989 and the winner will be notified by telephone and letter. The winner will also be announced in The Australian on August 8, 1989 and a later issue of this magazine. 7. The prize is: a Bose 901 Series VI Speaker System worth \$3870. 8. The promoter is The Federal Publishing Company, 180 Bourke Road, Alexandria, NSW 2015. Permit No. TC89/000 issued under the Lotteries and Art Unions Act 1901: Raffles and Bingo Permit Board Permit No. 89/000 issued on 00/00/89: ACT Permit No. TP89/000 issued under the Lotteries Ordinance, 1964.



SPEAKER SYSTEM

VALUED
AT \$3870





TECHNOLOGY

Derek Powell takes a peek behind the scenes of commercial audio production. Not surprisingly, he finds digital techniques are becoming the way of the future.

The evolution towards digital audio has been fascinating from the consumer's point of view. Compact discs have been the flag bearer of the digital age, making inroads into traditional hi-fi, car audio and portable audio. Now, consumer digital recording is finally on the doorstep with R-DAT, and waiting in the wings is satellite-delivered digital broadcasting.

The quantum leap in the calibre of sound available to consumers has raised demand for quality audio.

Suddenly, radio commercials sound decidedly fuzzy when played back-to-back with the latest CD release. Television and film soundtracks suffer the same comparisons. This has left audio producers and engineers scrambling to catch up with production and replay facilities to match the new, cleaner sound of digital.

It's interesting to look behind the scenes of commercial audio production to see just

where the quest for cleaner sound is leading. Not surprisingly, digital techniques are finding increased application in the way sound is now produced, stored and replayed.

Simply replacing analogue tape recorders with digital tape recorders, however, has not proved to be the answer for all. Digital tape recording yields marginally superior quality but systems are expensive, inflexible and present problems with worldwide standardisation. There are at least three major (and incompatible) digital tape systems, including the much delayed R-DAT format.

In addition, the power of digital processing is not really tapped by a linear, tape-based format. For exactly the same reasons that computers abandoned magnetic tape for data storage in favour of random access disks, audio components utilising disk-based recording media are quietly preempting tape-based formats altogether. We are heading towards the era of the tapeless studio.

TOWARDS THE TAPELESS STUDIO

The quest for cleaner sound



The Opus workstation combines the functions of mixer, multitrack recorder and edit controller, all entirely in the digital domain.



Job: JOB 1 Reel: REEL 1 02-04-88] 20:20:00] Record/Play

STOP		Locate:	Reel:	External:
		00:50:02:00	00:50:02:22	00:00:00:00
Ch.	Tk			
1	1	*****DIALOG*****	*****	
2	9	***ANNOUNCE*****	***ANNOUNCE*****	
3	12	*****MUSIC L*****	*****MUSIC L*****	
4	13	*****MUSIC R*****	*****MUSIC R*****	
5	14	**FOOTSTEP**		
6	15	**FOOTSTEP**		
7	16	*****SURF L*****	*****	
8	17	*****SURF R*****	*****	
	2	=====BACKGROUND=====	=====BACKGROUND=====	
	3	=====BACKGROUND=====	=====BACKGROUND=====	
	4			
	5			

SRC REELS CONFIGURE LIST ADVANCED DONE

The record/play screen of the Opus workstation displays up to twelve tracks at once. Audio segments move across the screen and are heard as they pass the stationary vertical line in the centre.

Hard disk stores now have the speed and capacity to handle significant amounts of digitised audio and the advantages are many. No linear searching means instant access to any track. A number of users can simultaneously utilise a central music or sound library without needing to make multiple copies. Program editing is faster and easier as material can also be inserted or deleted without having to re-record. Also, as technology improves, advances in storage systems can be quickly taken up and there is a large base of manufacturers already working on digital storage media. Finally, and for the first time in the audio industry, full back-up is simple and economical.

Film and video post production is rapidly embracing random access disk-based audio workstations and a barrage of new products is being developed for this market. At the simpler end of the scale, floppy disk-based recorder/players are starting to replace analogue machines for spot replay in radio.

While these applications may seem somewhat specialised, they are interesting to examine in the light of the direction that digital audio may be heading.

Digital audio production

The pace of production in today's audio studios, especially those servicing film and television, has become frantic indeed. Two distinct strands of development have led to digital products serving this market.

The first strand came from the digital music synthesisers and samplers. For companies like our own world leader in the field, Fairlight Instruments, manipulating, storing and retrieving real world sounds was a natural extension to the way musical notes were treated in the revolutionary Fairlight Computer Musical Instrument.

Fairlight's MFX (music and effects) console is used to create soundtracks for TV and film by sampling, modifying and editing sounds with the synthesiser section and then recording a mix onto a hard disk which is locked in synchronisation to the video.

The console has 24 sound keys with velocity-sensing circuitry which are used to trigger sound effects in real-time while watching video. The associated software records the timecode reference and how hard the keys are pressed (which can then be used to control the level of each sound effect). The operator may then call up a listing of the sounds which he has triggered. This is displayed on-screen for editing.

'Suddenly, radio commercials sound decidedly fuzzy when played back-to-back with the latest CD release'

At this point, new events can be added, sounds replaced without re-recording or disturbing the others, and individual effects may be 'nudged' (shifted relative to each other) or changed in level. Because the system is musically based, the sounds can be varied in other ways. Pitch can be altered to create doppler effects or give a new quality. (A barking dog, for example, might be changed from an Alsatian to a Pekinese.)

Sounds can be recorded on a variety of drives linked to the computer by a Small Computer System Interface (SCSI) buss. These include hard disks, storing about 50 track minutes per drive for multi-track recording and

optional WORM (Write Once Read Many) drives for economical storage of vast sound libraries.

Fairlight MFX consoles are already being used by several post production companies in Australia, including Audio Loc Sound Design and Albert's in Sydney.

The demands for faster production methods have also struck a chord with traditional audio component manufacturers, particularly those already producing digital effects. Based very much on the look and feel of mixers and multi-tracks, digital workstations use new methods which treat digitised sound exactly as though it was computer data.

David Hudson, ex engineering manager at EMI's Studio 301 and now marketing manager for Amber Technology, describes the new techniques as "word processing with sounds". Digital audio workstations can instantly access any sounds or sound sequences held on Winchester disk. Just like working with text using a word processing package, sounds can be copied, moved, inserted between other sounds or deleted instantly.

The Lexicon Opus digital workstation exemplifies this approach. At first glance, the array of faders and level meters suggest a mixing console, which it surely is. On closer inspection, the keyboard and monitor suggest a sophisticated computer with the ability to keep track of, and graphically display (complete with on-screen descriptive labels), hundreds of soundtracks. Finally a shuttle control like that on the finest tape recorder gives the clue to its third function as a digital multitrack recorder/player.

To gain some insight into the creative freedom and fast production that random access disk can provide, compare the operations required to re-lay soundtrack elements using a conventional eight track

The tapeless studio

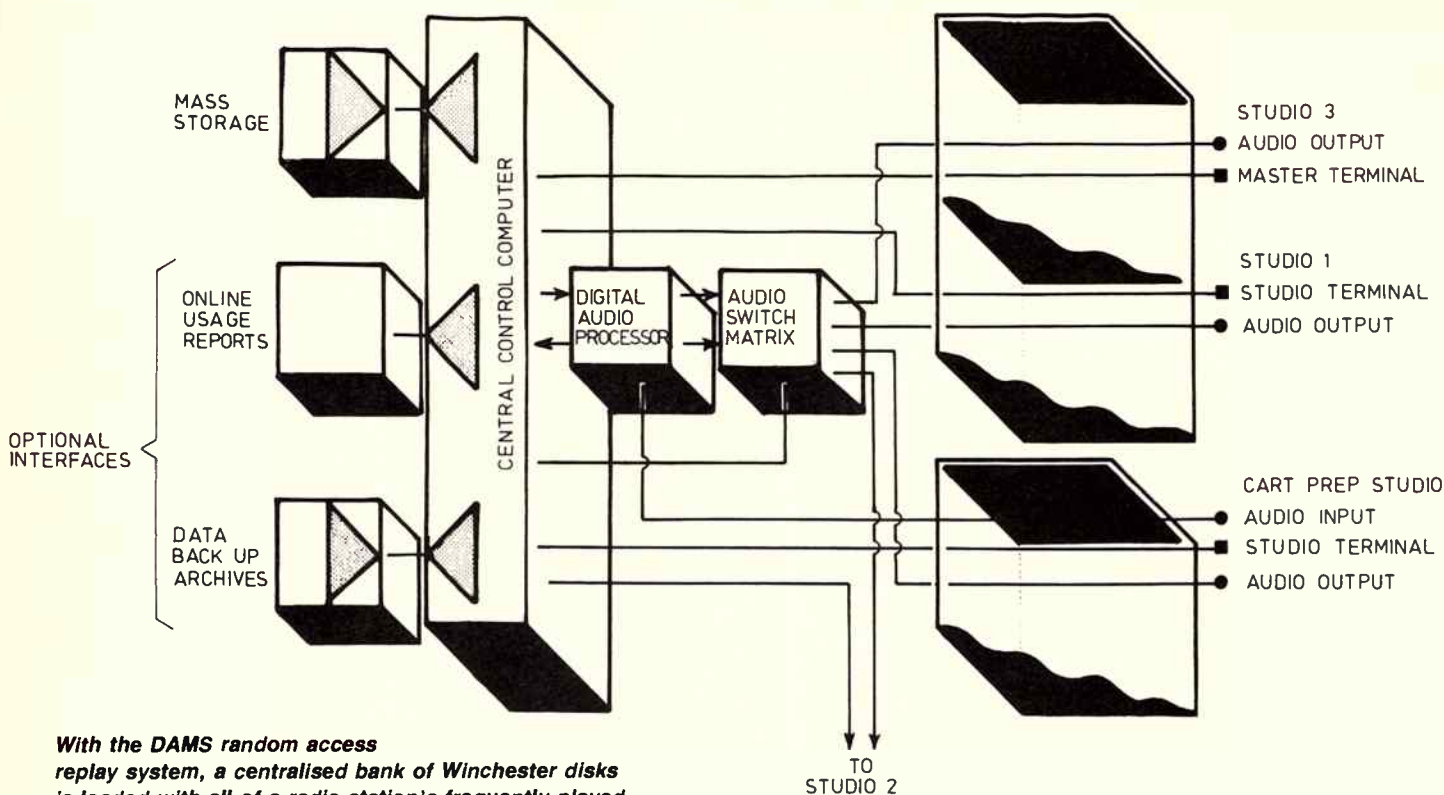

With the DAMS random access replay system, a centralised bank of Winchester disks is loaded with all of a radio station's frequently played program material.

recorder, with the same operation on the digital workstation.

First, all the soundtrack elements – music, dialogue, announcer, background sounds and sound effects are recorded onto the hard disk (or onto separate tracks of the eight track recorder). So far the time required is about the same. But then, when the soundtracks are played back in sync with the pictures, the power of the random access workstation becomes apparent.

With the eight track, to change, say, the background music, another track must be recorded over the existing track, in real time, then replayed to judge the effect. If a decision is made to go back to the original, more time must be spent re-recording and re-synchronising the music track. If the music must be edited to fit the time slot, considerable skill is needed to "punch-in" at exactly the right spot. A fraction of a second's error and the entire track must be re-laid before another attempt can be made.

On the digital workstation, a few keystrokes replace one music track with another, without real time re-recording. The effect can be judged instantly and, if required, the original can be re-inserted just by issuing the appropriate commands.

The key to the workstation's power is that the material on the hard disk is never actually altered, even if the operator chooses to shorten a music track by editing out a section in the middle. Instead of actually creating a break in the music, the computer notes the in

and out points for the edit in an edit journal. Then, whenever replay of that edited segment is required, the machine instantly skips over the marked portion creating a real time edit. The advantage is that edits can be instantly redefined without having to re-record in real time.

What's more, any element (such as sound effects) can be moved in relation to the others to synchronise with the vision, without having to re-record on another section of the tape.

'All the soundtrack elements — music, dialogue, sound effects — are recorded onto the hard disk'

Needless to say, the quality of the digital recordings is such that the frequency response and distortion specifications are of academic interest only and there is no significant limit on the number of generations which can be recorded.

Replay systems

Now to something simpler. For years, radio and TV stations have relied on NAB cartridge tape systems for replay of all short audio segments – advertising, jingles, sound effects and so on. The NAB cart consists of special back-

lubricated 6.25mm (1/4 inch) tape wound into a plastic cassette and spliced to form a loop. One or two tracks on the tape carry the audio signals while another is used as a control track, with cue tones laid down to mark the start of each segment.

The cart player mechanism is quite conventional, with a solenoid actuated pinch roller and capstan to pull the tape across the audio and cue heads. A large flywheel is generally employed on the capstan to get the tape up to speed quickly when the pinch wheel engages so that the audio can be cued tightly to the start point without wow as the tape starts.

In use, a pre-recorded cart is simply placed into the player and is instantly ready for use. After replay of a segment the replay machine continues through the loop until it detects the start tone, whereupon it automatically stops, leaving the segment cued ready for instant start again.

Whilst this system is unquestionably an industry standard, and great strides have been made in quality improvement (in which the former Consolidated Electronic Industries, an Australian manufacturer, was at the forefront) the cart has some basic limitations. The tape loop is wound in a tortuous path and suffers problems of jamming, stretch and irregular tension. Wear is a problem and frequently used carts need regular replacement.

Thus, the digital replacement of the venerable cart has been the subject of considerable research effort. Some systems

have employed DAT cassettes, but problems remained in accessing particular tracks, particularly when multiple cues were recorded on the same cassette. A much more elegant solution has been devised using floppy disks as the storage medium.

Ferroglyph, an old, established name in analogue recorder technology, marketed a digital cartridge system based on Bernoulli floppy disks with a capacity of up to 20Mb each. According to Ferroglyph's managing director, Peter Brannighan, analogue tape recorders have been developed about as far as they can go. Digital recording on disk followed naturally from a need to provide improved quality and better, simpler random access and editing functions.

The recorder units use 16 bit PCM (pulse code modulated) digital conversion sampled at 32kHz to record up to 18 minutes of stereo

sound. The random access facility allows the storage of multiple recordings on one disk, which can be cued instantly in any order.

The super fast re-cue and start-up time has led to their use in Australia as effects replay devices for the major musical productions *Cats*,

and *Les Miserables*. The conductor, from a remote start control, can cue effects recorded digitally precisely on the beat with a response time, quality and reliability not achievable from conventional carts.

Digital carts are already used by the BBC

World Service, and their application is being closely studied by Australian broadcasters. Other products in the Ferroglyph range use WORM optical disks for extended recording time. The 5 1/4 inch disks can store 72 minutes of ultra high fidelity stereo music and are ideal for archiving purposes.

The Ferroglyph digital recorders use the proprietary CSX data compression algorithm to increase the recording time for a given disk capacity. Interestingly, the CSX data reduction technique was developed by CompuSonics (USA) in response to a brief from the American AT&T telephone company.

AT&T was working on a scheme whereby, instead of purchasing records, a pop music fan could simply dial a telephone number and the latest Top 10 hits would be down-loaded via the phone line to a home recording device. Charges for the service would be added to the

'Whatever the future, it seems that the place of digital audio is secure'

Block diagram of the centralised random access storage for radio studio application.

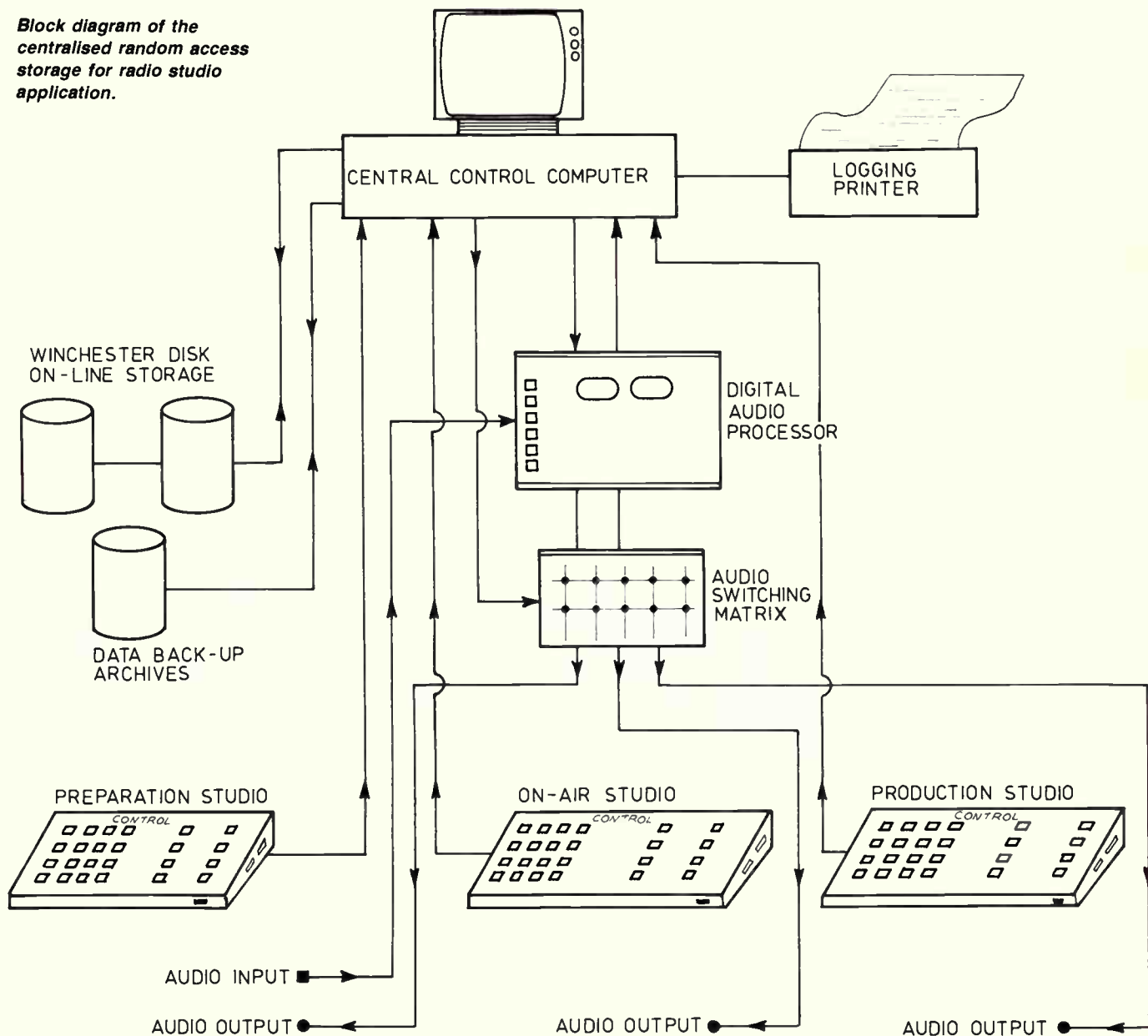

The tapeless studio

subscriber's phone bill (much like Telecom's O55 Inpho services). The scheme did not go ahead, but the compression algorithm remained.

The next step beyond floppy-based replay is an integrated and centralised replay system using a local area network of audio workstations accessing a bank of Winchester disks. Such a system, the Alldesign Services DAMS, has been under trial in Western Australia and is already in use by Capitol Radio London and Radio Luxembourg, two of Europe's largest broadcasters.

Sophisticated file server software allows simultaneous record and playback by a number of users and the 9 hour total capacity enables virtually all of a radio station's advertisements, promos and so on to be stored on the system. Total disk complement for 9 hours storage is twelve 780 Mb drives, with full redundant memory and automatic backup.

Whatever the future, it seems that the place of digital audio is secure. Many Australian users are hanging off, waiting for the no-moving-parts recorder which records directly to RAM chips. This is obviously not too far in the future as solid state video recorders are already a reality (albeit with record capacities measured in minutes, not hours).

Just one fervent plea, though. There is a trend towards naming equipment that I feel should be arrested. For example, the latest offering

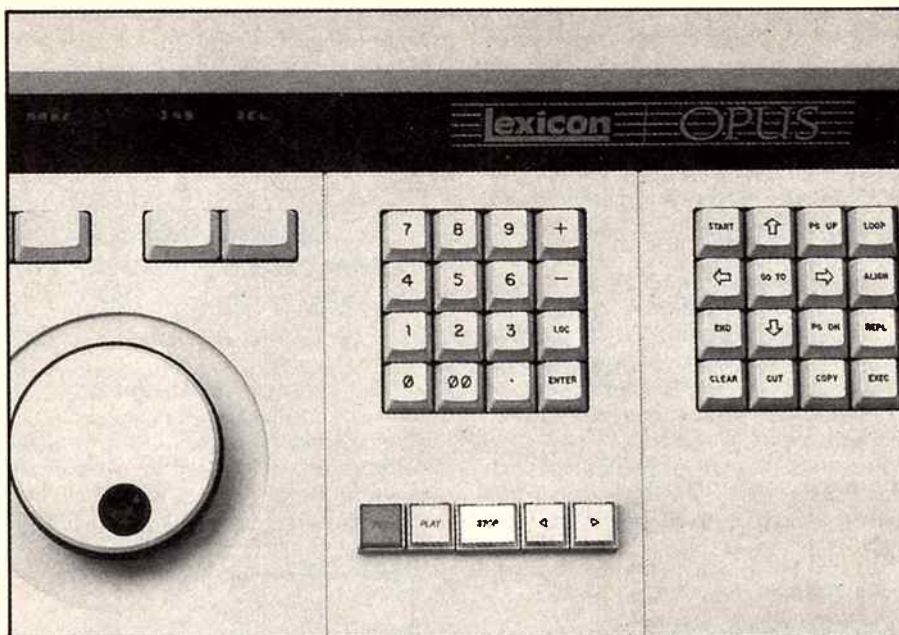

To perform an Opus edit, you choose segments, tracks or reels and mark the exact edit points.

from Adams Smith is an audio editor which displays the soundtrack as a graph on the monitor screen. It is called the C: Sound system (See sound - get it?). Now, while that may be just acceptable, how can we take seriously an

offering from the Chicago-based Chytchen Labs which synchronises a CD player to video? They've named it - wait for it - the Chytchen Synch. With an American mid-west accent that's pronounced Kitchen Sink, pardner! **eti**

Turn your hobby into a profitable career in computers.

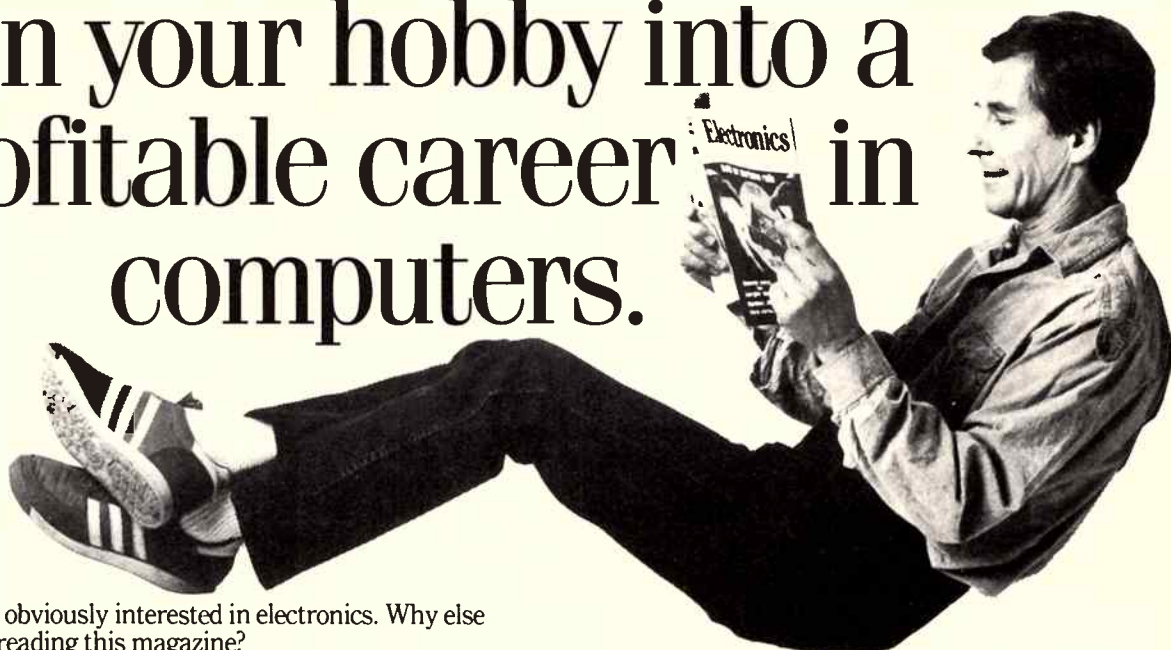

You're obviously interested in electronics. Why else would you be reading this magazine?

But have you ever considered turning your interest into a rewarding career as a computer maintenance engineer?

The Computer Power Training Institute can help you fulfil your goal in the shortest possible time by teaching you such subjects as basic electronics, microprocessors, data communication, disk drives and machine language programming.

We then help you further by helping more than

Sunford Vick 2676

90% of our graduates get their first jobs in this exciting, expanding industry.

Don't delay, contact Computer Power Training Institute now. Sydney 438 1300, Melbourne 820 2211.



COMPUTER POWER TRAINING INSTITUTE

An educational service of Computer Power Education Pty Ltd (Inc. in Victoria)

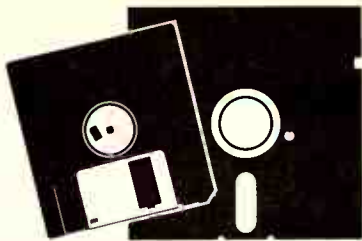

"NO BRAND" DISKS!

Now you can buy absolute top quality disks that are also the cheapest in Australia! They even come with a lifetime warranty, which indicates the quality of these disks. So why pay 2-3 times the price for the same quality?

Packs of 10, D/S D/D without boxes, or brand name, just their white paper jacket, and index labels. (5 1/4" disks includes write protects).

5 1/4" 2S/2D "NO BRAND" DISKS

10+ DISKS \$6.50^{ea}	100+ DISKS \$6.25^{ea}	1,000+ DISKS \$6.00^{ea}
-----------------------------------------	------------------------------------------	--------------------------------------------

(ALL PRICES PER 10 DISKS)

5 1/4" HIGH DENSITY DISKS (DOUBLE SIDED)

10+ DISKS \$21^{ea}	100+ DISKS \$20^{ea}	1,000+ DISKS \$19^{ea}
---------------------------------------	----------------------------------------	------------------------------------------

(ALL PRICES PER 10 DISKS)

3 1/2" 2S/2D "NO BRAND" DISKS

Suitable for IBM, PS/2, Macintosh, Atari, etc.

\$21

(ALL PRICES PER 10 DISKS)



MICRODOT DISKS!

DESCRIPTION	1-9 BOXES	10+ BOXES
3 1/2" 2S/2D	\$23.95	\$22.95
5 1/4" 2S/2D	\$11.95	\$10.95
5 1/4" 2S/HD	\$21.00	\$20.00



VERBATIM DISKS!

(ALL PRICES PER BOX OF 10 DISKS)

DESCRIPTION	1-9 BOXES	10+ BOXES
3 1/2" 1S/2D ..	\$39.95	\$37.95
3 1/2" 2S/2D ..	\$46.95	\$43.95
3 1/2" 2S/HD ..	\$99.00	\$89.00
5 1/4" 1S/2D ..	\$22.00	\$21.00
5 1/4" 2S/2D ..	\$26.00	\$24.00
5 1/4" 2S/4D ..	\$75.00	\$70.00
5 1/4" 2S/HD ..	\$41.00	\$39.00



EXTERNAL PS/2* COMPATIBLE 5 1/4" DISK DRIVES

Capacity: 360K formatted
MTBF: greater 10,000 hours
● External 37 pin connector cable
● Installation Guide
Cat.C11907 **\$495**



20 M/BYTE HARD DISK
Drive with controller card. IBM* compatible. 12 month warranty.
X20010 **ONLY \$449**

40 M/BYTE VOICE COIL HARD DISK

IBM* compatible. 28 msec access. 12 month warranty
Without controller .. **\$895**

80 M/BYTE VOICE COIL HARD DISK

IBM* compatible. 25 msec access. 12 month warranty.
Without controller. **\$1,595**

330 M/BYTE VOICE COIL HARD DISK

IBM* compatible. 18 msec access. ESDI. 12 month warranty.
Without controller **\$3,200**

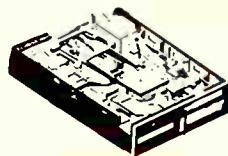

QUALITY JAPANESE DRIVES!!

5 1/4" 360K DRIVE
● 500K unformatted.
● IBM* XT* compatible
Cat.C11901 **\$239**

5 1/4" 720K DRIVE
● 1 M/Byte unformatted
● IBM* AT* compatible
Cat.C11906 **\$269**



3 1/2" 1.44 M/BYTE DRIVE
● Switchable 1.44 M/Byte formatted or 720K formatted
● Double sided, double density
● Power supply adaptor provided
● 5 1/4" mounted
Cat. C11911 **\$225**

CONTROLLER CARD TO SUIT
X18009 **\$139**



DISK STORAGE UNITS
5 1/4" x 100 (C16020) **\$12.95**
5 1/4" x 50 (C16025) **\$14.95**
3 1/2" x 40 (C16035) **\$14.95**
3 1/2" x 80 (C16038) **\$19.95**
3 1/2" x 120 (C16039) **\$21.95**

World Radio History

QUICK MOUSE



MICROSOFT* COMPATIBLE!

- Auto-selection and auto-transfer between mouse system system PC mouse mode and Microsoft serial mouse mode
 - Microsoft Serial Mouse and Mouse System compatible
 - Super high tracking speed: 600mm/sec
 - Super high resolution: 200 D.P.I. (0-12mm/dot)
 - Silicon rubber coated ball
 - Optical rotary encoder
- Cat.X19952 **\$94.95**



IBM* PC*/AT* EXTENSION BOARD

This allows the user to raise add on cards above the motherboard for ease of repair and testing.

- + 5 Volt fuses as power protection.
 - IBM* PC* AT* edge connector.
 - IDC connector for expansion to other interfaces via ribbon cable.
- H19120 **\$99.00**

IBM* PC*/XT* EXTENSION CARD

This card will fit in the standard IBM* PC*/XT* expansion slot and allows you to repair and test IBM* PC*/XT* add on cards. It extends the add-on cards above the motherboard for easy access. Standard IBM* PC*/XT* bus edge connector
H19115 **\$69.00**



STAR NX-1000 COLOUR PRINTER
● 120 C.P.S.
● Near Letter Quality
● Colours: Red, Violet, Blue, Green, Yellow, Orange, Black
C22045 **\$695**



RITRON EGA COLOUR MONITOR
Quality monitors without the exorbitant price tag!
Display Tube: 14 inch 90° deflection dot type black matrix. Standard persistence phosphor
Active Display Area: 240 x 180mm
Resolution:
64 Colour: 720 dots(H) x 350 lines
16 Colour: 640 dots(H) x 200 lines
X14527 **only \$645**

ROD IRVING ELECTRONICS

All sales tax exempt orders and wholesale inquiries to:

RITRONICS WHOLESALERS
56 Renver Road, Clayton.
Phone: (03) 543 2166 (3 lines)
Fax: (03) 543 2648

SYDNEY: 74 Parramatta Rd.
Stanmore, 2048.
Phone (02) 519 3134
Fax (02) 519 3868

MELBOURNE: 48 A Beckett St.
Phone (03) 663 6151

NORTHCOTE: 425 High St.
Phone (03) 489 8866

CLAYTON: 56 Renver Rd.
Phone (03) 543 7877

MAIL ORDER & CORRESPONDENCE:
P.O. Box 620, CLAYTON 3168
Order Hotline: 008 33 5757
(Toll free, strictly orders only)
Inquiries: (03) 543 7877
Telex: AA 151938
Fax: (03) 543 2648



ORDER HOTLINE
008 335757
(TOLL FREE)

STRICTLY ORDERS ONLY
LOCAL ORDERS & INQUIRIES
(03) 543 7877

POSTAGE RATES:
\$1 - \$9.99 **\$2.00**
\$10 - \$24.99 **\$3.00**
\$25 - \$49.99 **\$4.00**
\$50 - \$99.99 **\$5.00**
\$100 plus **\$7.50**

The above postage rates are for basic postage only. Road Freight, bulky and fragile items will be charged at different rates.

Errors and omissions excepted. Prices and specifications subject to change.

IBM*, PC*, XT*, AT* are registered trademarks of International Business Machines. Apple is a registered trademark. Denotes registered trademarks of their respective owners.



ROD IRVING ELECTRONICS

MOTORING



BRIAN WOODWARD



Two wheel steering is a compromise some car makers are no longer prepared to accept. Japan is leading the way in the charge towards 4WS. By Brian Woodward.

STEERING IN THE

A photograph of a blue car driving on a wet road, splashing water. The car is on the left side of the frame, and the water is being splashed up and to the right. The background is a dense line of green trees.

Like Mary's little lamb, where the front wheels go, the rear are bound to follow – well, that's the theory. In reality, the rear wheels of a car often behave as if they've a mind of their own.

When turning a corner at low speed, a driver quickly learns to swing slightly wide so that the rear wheels don't take a shorter line than the front and bump the kerb. At higher speeds a driver quickly learns (often at great cost) that the rear wheels simply want to travel straight on when the front wheels have been turned enthusiastically to avoid an accident.

Japan's fledgling car industry copies much from the USA, rather than Europe. The result was an entire generation of small cars with American-style handling. The soft, boulevard ride, beloved of a nation spoiled by billiard table highways, proved inappropriate when applied to small cars. In Europe, the home of the successful small car, chassis refinement, handling and roadholding are greater considerations than a marshmallow ride.

It has taken Japan a long time to realise that the problems of poor handling cars must be addressed. Now, to Japan's credit, the solution emerging is not one of simply slavishly copying Europe, but involves the development of an entirely new technology.

Catching up

The reason? Simply that when Japan researched the problems with an open mind, engineers discovered that catching up with Europe would require 20 years of refinement. The engineers also discovered that the proper solution meant more than simply copying Europe and refining the concept.

The geometry and mathematics of a car turning a corner can potentially create either a minefield or a can of worms. The solution? Simply to make all four wheels follow the direction they should, at appropriate speeds.

The result is a charge towards four wheel steering (4WS) by Japan's car makers. Techniques differ between the various combatants in this new, technological warfront, but the concept is identical.

At low speed, a car needs the rear wheels to turn in the opposite direction to the front wheels. This way they follow a similar path to those at the front. However, at higher speeds

RIGHT DIRECTION

4WS

this isn't necessary. Once speed has built up, (eg. on the highway), the car is not as restricted for space and what is needed is more immediate response to driver input. (Driver input merely means "turning the steering wheel"). What is needed at high speed is the ability for fast and precise lane changing.

At present only two cars on Australia's roads have four wheel steering - the Honda Prelude and the Mazda MX-6 Turbo. Both are high performance coupes and the

advantages which come from 4WS are meant to enhance the sporty nature of these cars.

4WD would actually be ideal on delivery and commercial vehicles where maneuvering in tight loading bays and crowded streets would be a terrific advantage. But these vehicles are often bought by beancounters with little concern for the benefits which may accrue to a delivery driver. 4WS is expensive and its cost can be hidden in a sporty or cult car.

Different techniques

The techniques used by Honda and Mazda differ widely. Honda's is a relatively simple mechanical system while Mazda has a Heath-Robinson array of hydraulic pumps, computer-controlled servo motors and mechanical gears and linkages.

Honda's system works like this (and it is so simple Honda deserves praise for the design): when the steering wheel is turned a little in either direction, the rear wheels turn in the same direction. When the steering wheel is

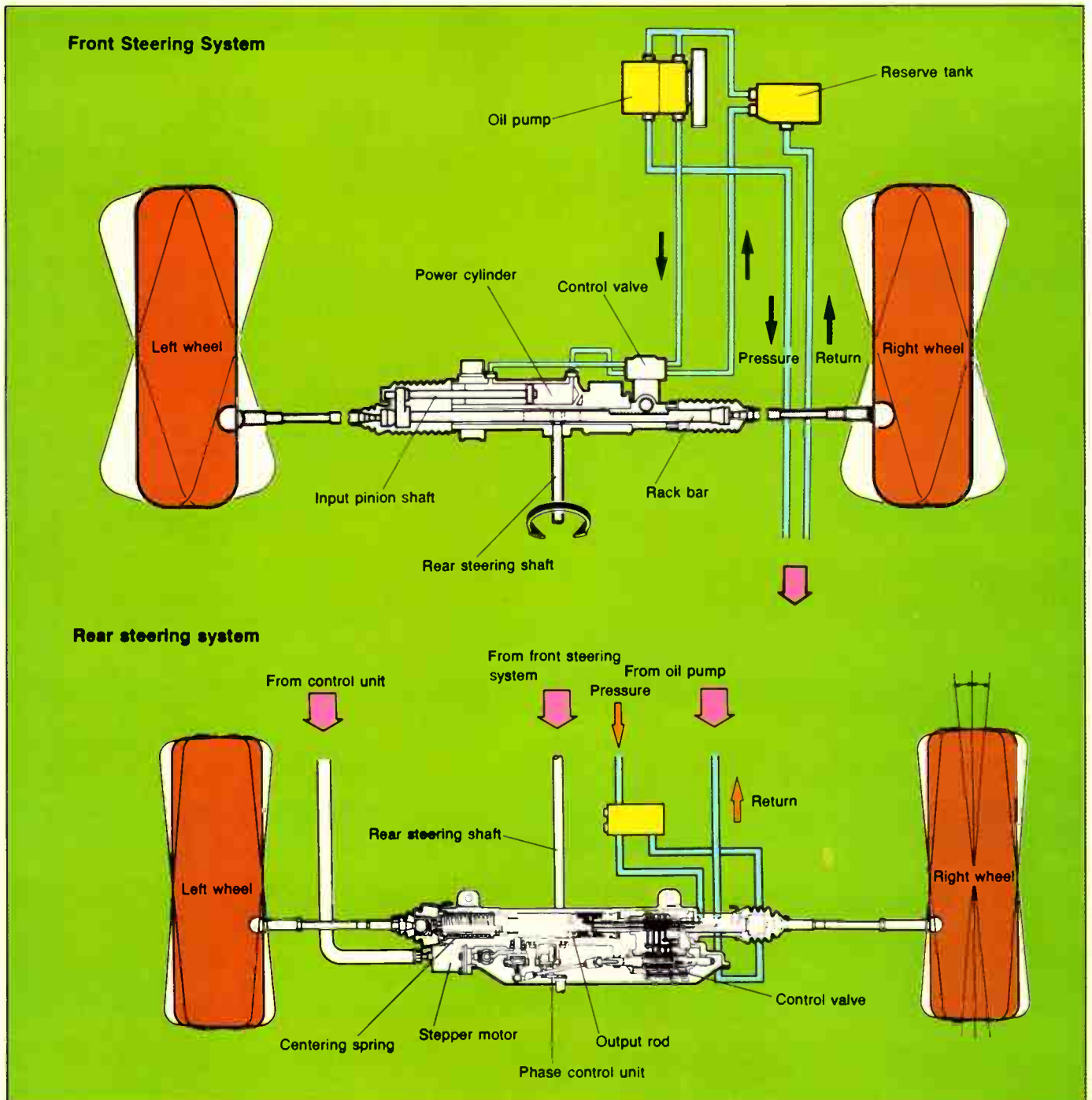

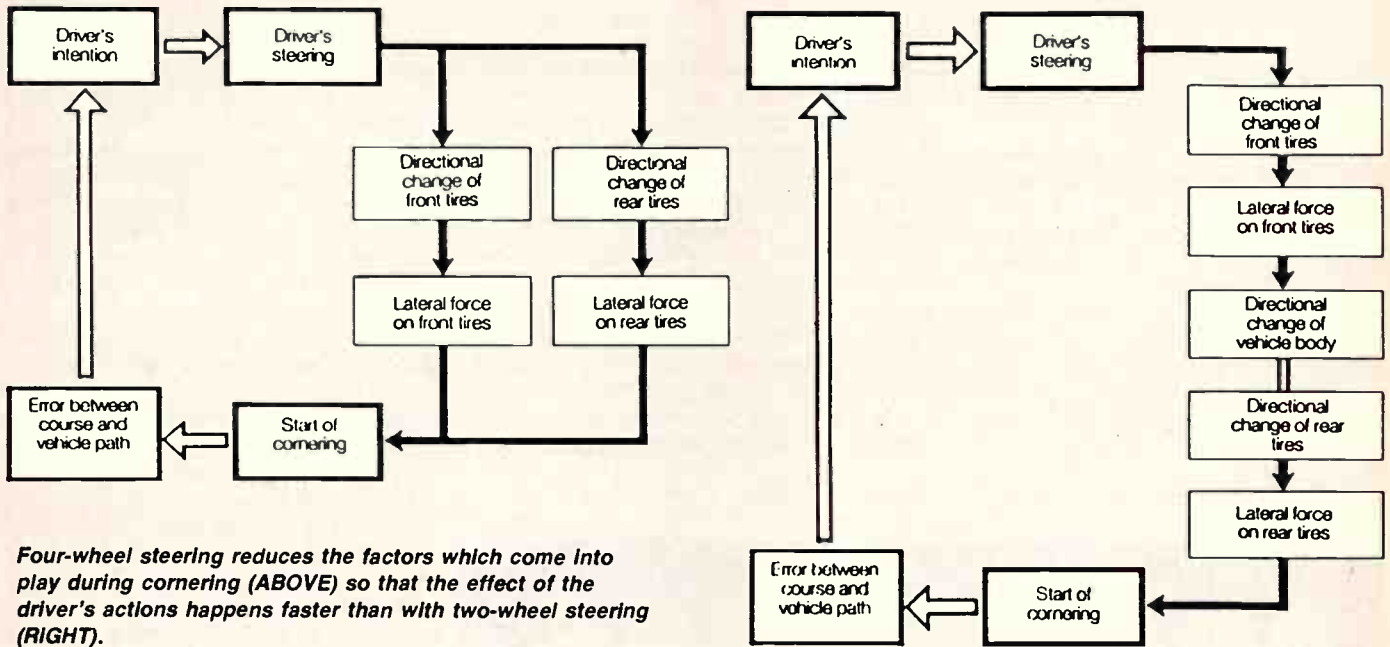

turned a lot in either direction, the rear wheels come back to the centre and progressively turn further in the opposite direction to the front wheels.

In more precise terms, when the steering wheel is turned up to 127 degrees from the straight ahead position, the rear wheels move in the same direction to the extent that when the steering wheel is in this position the front wheels are deflected 0.8 degrees and the rear wheels 1.5 degrees in the same direction. After 127 degrees the effect on the rear wheels diminishes to the stage where, when the steering wheel is 246 degrees from the straight ahead, the front wheels are deflected 15.6 degrees and the rear wheels are at zero. After that the rear wheels start to turn in the opposite direction to the stage that when the front wheels are at full turning deflection (about 30.3 degrees) the rear wheels are at 5.3 degrees opposite to the front.

The rationale behind this compromise is that, at small steering wheel deflections the car is likely to be travelling at high speeds. Large steering wheel deflection is more likely at low speeds. If a car has the steering wheel 360 degrees away from the straight ahead and it's travelling fast the driver's already in so much trouble that even nine wheel steering wouldn't help!

More complicated

Mazda's system is more complicated but the effect is the same. The key to Mazda's system is a computer. The computer senses the vehicle's speed and provides an output to a stepping motor attached to the rear

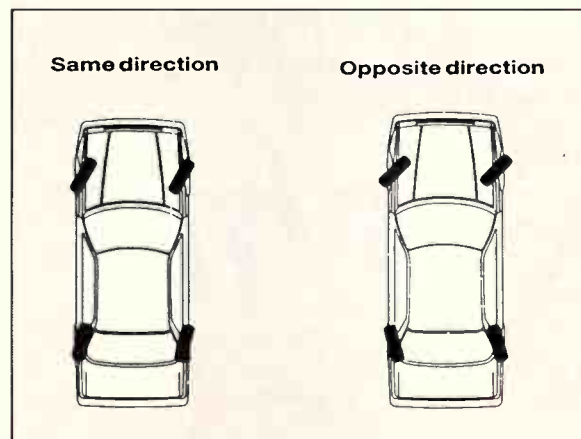
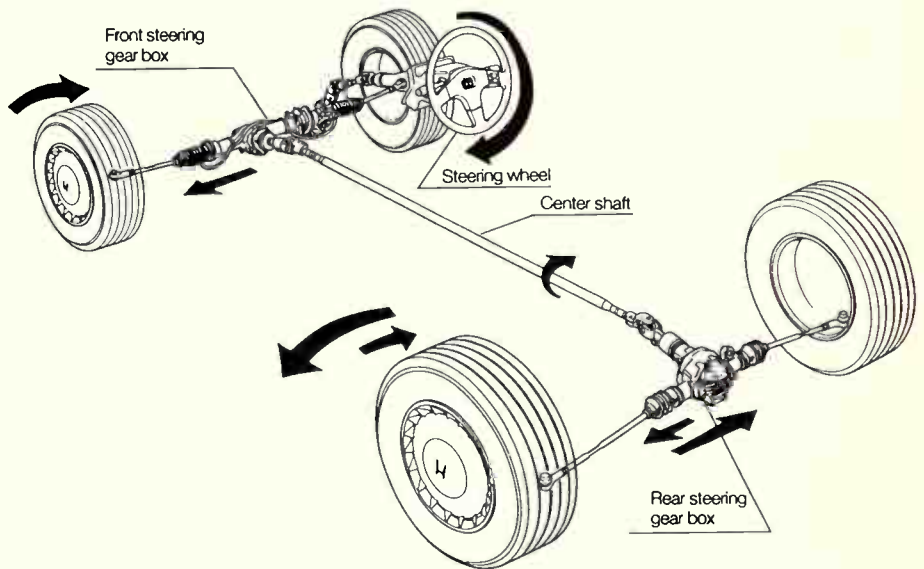

Construction of Honda's four-wheel steering system.

(LEFT) Steering angles. The angles of the front and rear wheels have been exaggerated better to illustrate the function of Honda's four-wheel steering.

4WS

steering box. This stepping motor alters the relationship between the power assisted mechanical components so that at speeds below 30 km/h the rear wheels turn in the opposite direction to the front and at speeds above 30 km/h they begin to turn in the same direction as the front.

The computer makes this transition stepless and has also been programmed with some clever "worst scenario" software so that a vehicle which is out of control is not likely to become more so because the steering changed its mind.

Like the Honda, there is a direct link from the front steering box to the rear. The difference is that the gearing on the rear steering box can change its ratio and direction according to the signal it's given by the stepping motor.

New system

Mitsubishi has also developed a system which is yet to go on sale in Australia. Mitsubishi's is different again in that it uses the suspension components to change the attitude, or direction, of the rear wheels. On one side of either suspension trailing arm is a jointed section. By moving this jointed section the rear wheels steer. The movement is achieved by a centre-zero hydraulic ram connected to each of the pivots. When the pressure changes the car's front wheel power steering hydraulic system, pressure changes either side of the rear ram. This actuates rods which push or pull the pivots and change the attitude of the rear wheels.

However, all is not harmonious in the 4Ws capital of the world. Honda has gone down

a path towards simplicity, imagining that in 10 or 15 years time, a very complex system may present problems to the service industry. Mazda acknowledges this, but maintains that its complexity is the computer, which would be cheap to repair or replace.

Mitsubishi has doubts about the whole exercise. Its system does not work in reverse gear at all and does not operate at speeds below 50 km/h. Even more significant is that Mitsubishi's system is a same-direction only rear wheel steering box. It does not turn in the opposite direction at low speeds. Mitsubishi claims extensive research has shown that opposite direction rear wheel steering at low speeds has few benefits.

While the academic argument cannot be settled until all three systems are tested side-by-side, the two already on sale in Australia can provide some answers. In fact, they are difficult to tell apart.

Where a driver does notice a difference with 4WS is when changing lanes at relatively high speeds. Less movement of the steering wheel is needed and, more importantly, the car needs less correction to regain a straight line if the lane-change is carried out as part of an emergency. In the avoid-and-recover manoeuvring which precedes a potential accident, there is no doubt that rear wheel steering responds very well indeed.

'The key to Mazda's system is a computer'

At low speeds in parking lots, the turning circle isn't so dramatically smaller that a driver would cry, "Hosanna!" The same effect could be achieved with front wheel steering with changed geometry.

On the dirt

One area where 4WS really shines is on the dirt. It isn't known if Japan carried out extensive testing on Australia's dirt roads, but certainly under country, gravel road conditions the effect of the rear wheels turning with the front wheels at high speeds is dramatic. The 4WS cars turn-in well and follow a much more predictable line.

Criticism

In fact, if there was any criticism of 4WS at all it would be the huge benefits which are evident in fast, dirt road driving. Sounds strange? Well, while it is hard to criticise a positive safety feature, this very feature really only confers benefits on unskilled drivers who may be driving beyond their skills. For a skilled driver, 4WS takes the fun out of the sliding and drifting one usually enjoys on dirt roads.

No doubt the car makers of Japan will not lose any sleep over this criticism. 4WS is with us and likely to become a feature of more and more Japanese cars in the future. 

MODEMS AT WAREHOUSE PRICES

Buy direct from Australia's leading manufacturer and save on quality AVTEK Modems.

A range of 16 internal & external modems from low priced manual to fully automatic 2400 bps models complete with power supply, instructions and telephone connections.

Designed and built in Australia, all Avtek Modems are guaranteed, with service and technical support available direct from Avtek.

FROM ONLY \$179

**CALL TODAY ON
008 25 2754 or (02) 888 5333**

TOLL FREE

SYDNEY RESIDENTS

For further information and to see how much you can save on the best modem for your needs.



AVTEK
DATA COMMUNICATIONS

(A Member of the NetComm Group of Companies)

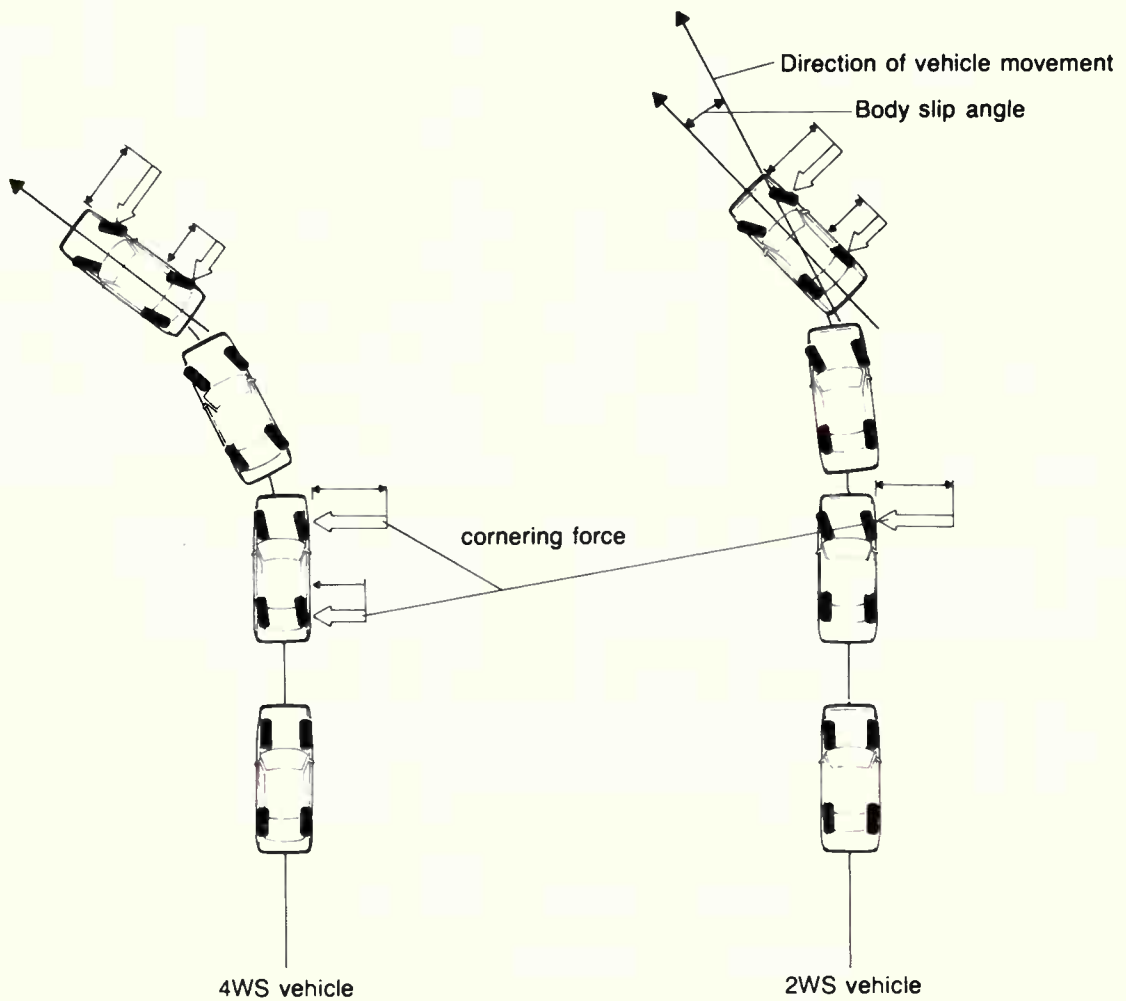
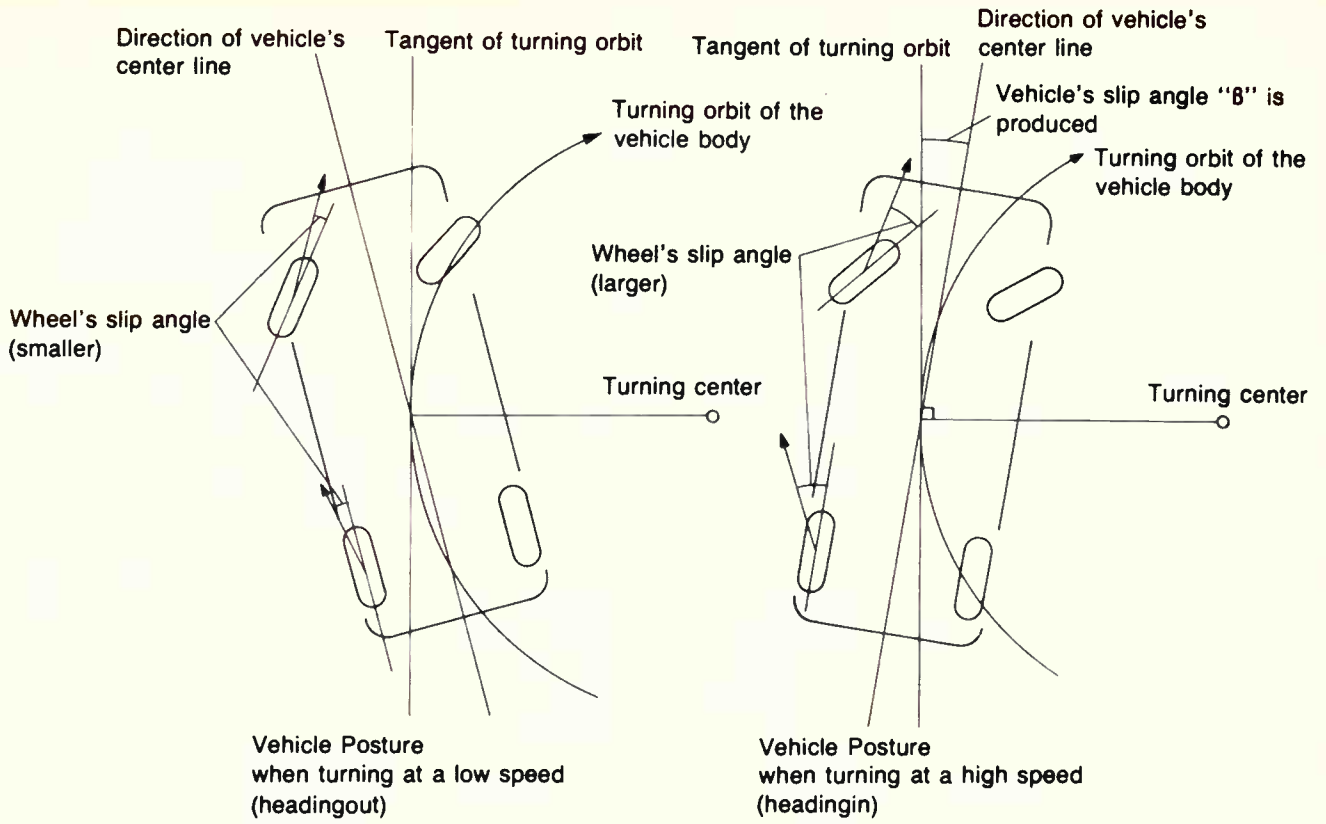



ANNA GRUTZNER

Export dollars speak loudly and persuasively when an economy such as Australia's is groaning under the burden of a balance of trade deficit - which is why Defence Minister Kim Beazley was finally able to talk an indecisive Cabinet around to the merits of kick-starting the export potential in the defence sector through major reforms to the industry's export regulations.

The introduction last year of a new policy which will actively promote certain defence exports to a wider overseas market came two years after Beazley considered a report on the subject from defence consultant, Dr Robert Cooksey.

Defence exports would double to \$500m within five years of the removal of a plethora of secretive, bureaucratic and complex guidelines, his report argued. That estimate is now considered to be extremely conservative and exports may actually quadruple to around the \$1b mark by 1993.

Revitalisation of defence export regulations could mean the quadrupling of export earnings by 1993, according to a report by defence consultant, Dr Robert Cooksey. Anna Grutzner writes on developments by Government so far.

according to defence sources. After all, the sale of a single ANZAC frigate to New Zealand would earn Australia more than \$350m.

The liberalised policy, first and foremost, makes economic sense. It allows for economies of scale by enabling bigger production runs of locally-produced defence

'The list of politically-acceptable customers is no longer restricted to the NATO countries'

goods; it gives industry a more balanced workload; it boosts employment and work-force reskilling opportunities, and it earns precious export dollars.

Strategically, an export-revitalised defence sector will secure local production of major capital requirements, thereby safeguarding the doctrine of greater self-reliance. It will also increase Australian influence in the region as a key supplier and will ensure our neighbours' equipment is complementary. Cooksey suggested security concerns may have, in the past, been used as a shield for inactivity on the export front.

It is worth briefly recounting the history of defence production and exports in this country, if only to illustrate how even the slightest improvement will have dramatic impact. The system was actively counter-productive to export approvals. Cases waiting for the go-ahead were handled in a time-consuming, case-by-case manner by

the Minister for Foreign Affairs. Departments such as Industry, Commerce and Technology or Austrade played virtually no role whatsoever.

Under the new policy, the onus to sell the product rests, where it should, with its private enterprise manufacturer. Gone are the days of Government-owned shipbuilding, armaments and aircraft factories and all their bureaucratic inefficiencies. However, the Government remains closely involved in the export process, supplying, at a cost, Defence Science and Technology Organisation (DSTO) research, advising on its own requirements, assisting in trials and putting the finished product through its paces for potential customers.

Today, the bulk of export applications is handled at the departmental level, not by the minister. Moreover, the onus is not on the exporter but on anyone opposing a licence to establish a case. The guidelines are public, clear and unambiguous while applicants are promised a decision within three weeks.

The list of politically-acceptable customers is no longer restricted to NATO countries. However, some existing bans on exports remain intact. Iran, Iraq, South Africa, the Soviet Union and Eastern Europe remain on the prohibited list for a variety of military and human rights reasons. Last December, the Government strengthened its resolve to ban sales to the Soviet Union and its Warsaw Pact allies by signing Australia into the secretive Coordinating Committee on Multilateral Export Controls (COCOM). The international agreement is designed to block the movement of strategically sensitive equipment to

BLOWING AWAY THE COBWEBS

A clear run for the money-spinner



the Soviet bloc. In return, the approval for US-imported components in Australian-made defence products destined for re-export will be streamlined and hastened.

The rest of the world is open slather. However, sensitive cases will still go to ministerial level. For example, the former Minister for Foreign Affairs and Trade, Mr Hayden, whose department was the only one to strongly oppose the new policy, stopped a proposed sale of armed patrol boats to one country on the strength of anticipated public opposition. Plans to sell personnel booby traps or land mines to a regional force not known for its human rights were also thwarted. Other sales have a cost-benefit price; for instance, weapons sales to the Middle East may earn big money but jeopardise an even bigger market for agricultural products to other countries in the region.

Yet, as the Government and industry are at pains to stress, many 'defence' items are not lethal. A water purification system, an infra-red surveillance system (Vision Systems), the Barra sonobuoy (AWA-Plessey), fire detection units (Wormald), computer software, trucks, heavy plant equipment, night

The best outlook for Australian defence products remains in the region. New Zealand has struck up a deal with Hawker de Havilland to buy PC-9 trainers (above), and is also buying the Army's new Hamel howitzer artillery gun (below), at bargain terms.



Blowing away the cobwebs



The versatile Nomad — critics say the venture scarcely broke even and that the aircraft was plagued by problems during trial testing.

vision goggles and specialised clothing form the bulk of Australian defence products for sale. The Jindalee over-the-horizon radar (principally AWA) and hopefully the MHI minehunter catamaran (Carrington Slipways) have export potential in the longer-term. Defence overlaps with other industries, such as the automotive, chemical, metal, communications, electronic and engineering sectors, opening up the technological gates for a range of export projects with both civil and military applications.

As Cooksey strongly emphasised, the future of all such exports will depend heavily on commercial exploitation of research and development. The revamped DSTO is well-placed to sell private enterprise the fruits of its diverse and innovative activities. The exchange rate will be another critical factor. While the dollar has been relatively stable over the longer term, customers may well be deterred during periods when currency is strong.

Defence exports can take a number of forms, from simple cases of Australian-developed technology being used to produce products for overseas markets, to co-operative ventures with foreign partners, to the supply of logistical support or

maintenance services, to foreign defence manufacturers using Australia as a production or marketing base to penetrate the blossoming regional market. Several companies, such as the unsuccessful West German tenderers for the Navy's \$3.9b submarine project and the still hopeful AMECON frigate consortium, hope to sell their West German-designed, Australia-built products in Asia. South East Asian countries would regard Australia as a secure base with none of the transportation problems faced by suppliers in Europe.

'The best outlook for Australian defence products remains in the region'

Success stories under the old policy were rare. Hawker de Havilland managed to sell aircraft components (both military and civilian) overseas and it played the offsets game rather well. Its principal activity had long been the overhaul, modification and repair of aircraft locally and within the region. In 1985, the company opened a Beijing office

after winning a major contract to supply spare parts and to overhaul jet engines in China. Yet, when given the opportunity to undertake big projects such as the BlackHawk and SeaHawk helicopters, it was unable to cope with both. The more complex naval helicopters have gone back to Sikorsky's US factory for assembly.

The development of the all-Australian minehunter well exemplifies the pitfalls lurking on the path to an exportable defence project. No-one envisaged the problems the catamaran MHI would experience, nor imagined that it would remain at the testing stage 13 years after the Navy approved the project. While the design remains unique, the huge market opening that existed in 1976 has slowly closed with the development of a range of minehunters overseas.

Nevertheless, the Gulf War has served as a powerful reminder of the lucrative market for countermine forces in the Middle East. The shipbuilders, Carrington Slipways, has, in fact, focussed its marketing efforts there and in South East Asia. The company has teamed up with the Navy on several trade missions to the Middle East and solicited some interest, though no firm offers. The budget minehunter would appeal to small regional

countries and other would-be customers running defence on a shoe-string. Yet its very specialised purpose probably would preclude its purchase as a multipurpose vessel for offshore sweeping, surveillance and general coastal patrol.

The Nomad aircraft venture proved that Australia could produce and export an aircraft to international standards. Although the project was embarked on at a time when the market was becoming overcrowded, the Nomad had market appeal. The versatile plane, with both civil and military utility, was sold all over the world, even in the highly-competitive United States aviation market. Its diverse purchasers for the three most popular Nomad N22 and N24 models - the Commuterliner, Missionmaster, Searchmaster - included the US Coast Guard, the Royal Thai Airforce, the Indonesian Navy and the PNG national mapping provincial air services. The Chinese even continued its production in the form of the Y11 light transport aircraft after buying Australian-made Nomads for \$1.2m each, or less than half the production cost.

Critics say the Nomad venture scarcely broke even and that the aircraft was plagued by problems during trial testing. But it earned Australia \$40m in export earnings and gave employment to some 2000 people. The point is, however, that the Nomad could have done better. A large slice of the blame for the failure of the highly-marketable aircraft to win more foreign orders can be laid at the feet of the bureaucracy. While countries like India were talking about acquiring and possibly co-producing some 190 Nomads, the Commonwealth stuck doggedly to approving production lots of 25 aircraft. A delegation from the United Arabs Emirates left empty-handed because future production of the Nomad could not be guaranteed. GAF (Government Aircraft Factory) was in a Catch-22 situation where it was unable to take foreign orders because production was uncertain, and production was uncertain precisely because the

Government wanted firm offers on the table before it determined the aircraft's continued manufacture.

Many of the problems which plagued the Nomad have been eradicated in the rationalisation of the defence industry. The GAF, then an inefficient operation hamstrung by bureaucracy and outdated work practices, has been privatised to become Aerospace Technologies Australia (ASTA). Unwieldy Government production and export regulations have been scrapped.

Despite the clean sweep, other hurdles lie in wait for Australian products competing for markets abroad. A trade mission to Saudi Arabia, Kuwait, Oman and other Middle East countries late last year is believed to have concluded that sales would be difficult unless

'As the Government and industry are at pains to stress, many defence items are not lethal'

the Government could provide low-cost loans to customers to help finance major purchasers. Such deals are frequently offered by other arms-producing nations in the competitive marketplace. But the Government has stuck to the long-held and sound principle that a subsidised arms export industry is an industry not worth having.

The best outlook for Australian defence products remains in the region, both the Pacific and Asian markets. Prevaricate as it has over participation in the \$4.5b ANZAC frigate project, New Zealand remains the single, brightest prospective market for Australian defence products. The neglect of its capital equipment needs for the last decade and its expulsion from ANZUS, while less than satisfactory for the strategic security of the region, have made New Zealand far more reliant on Australia.

The urgency with which the Royal New Zealand Navy must replace its surface

combatant fleet, for instance, has thrown the country into the lap of Australia's revitalised shipbuilding industry. The frigates could prove the first in an ongoing co-operative venture to construct ANZAC warships. Hawker de Havilland, also, has struck a deal to equip New Zealand (as well as the RAAF) with PC-9 trainers, tying (though not reluctantly) our trans-Tasman ally to training on Australian aircraft and access to logistic support facilities.

Both projects, however, highlight the tensions in the new policy between maintaining the production program for the local market and securing foreign orders. In both cases, Australian production schedules will be forced to accommodate the foreign customer's needs as Government and industry alike go to extraordinary lengths to woo overseas customers. New Zealand is also buying the Army's new Hamel 105mm howitzer artillery gun at bargain terms. The first artillery gun to be produced in Australia since World War II, 24 are being manufactured at below market price for New Zealand (\$15.5m) on the end of a 105-gun production run for Australia (worth \$139m).

Other, poorer countries in the region are being wound into the Australian defence net as defence aid recipients. The Pacific patrol boat project under the Defence Co-operation Program has put Australian-made vessels in our neighbour's harbours, established a logistical support relationship, and lain the goodwill that may foster them as paying customers down the track.

The attitude of Government and industry will play a big role in determining the export policy's success. The Cooksey report sadly noted: "It is unfortunate that Australians generally seem to suffer from what has been called a 'technological cringe' that leads to a distrust of Australian inventions - the reverse of the NIH (not invented here) factor which makes the US market so difficult to penetrate."

ETI

Anna Grutzner is the Canberra-based defence correspondent for The Australian.

NEW

PC VOICE CARD

- * GENERAL PURPOSE SOUND/ MUSIC RECORD STORAGE AND PLAYBACK
- * EXCELLENT SOUND FIDELITY:
- * NON-STOP PLAYBACK FROM HARDISK
- * PERSONAL SOFTWARE ENTRIES WITH OPEN I/O SUPPORT

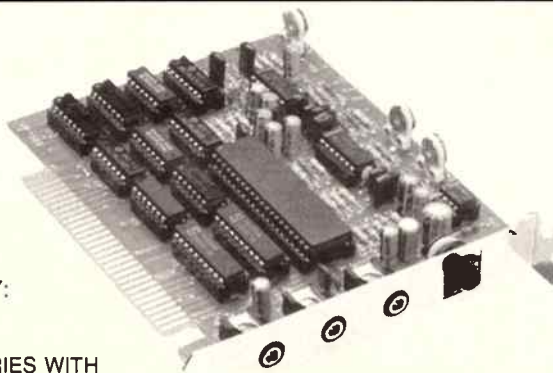

- * DIGITAL VOICE DECODER - VP 1000
- * RECORD AND PLAY-BACK - VP 2500



For further information contact:

ZENOLOGY PTY. LTD.

SUITE 1, 1ST FLOOR
245 SPRINGVALE ROAD,
GLEN WAVERLEY VIC. 3150
TEL (03) 232 0599/233 5764
FAX (03) 233 4146
AGENTS: (08)212 5999; (03)427 0833



TECHNOLOGY

Call them "valves", the more sentimental "bottles", the American term "vacuum tubes", "electron tubes" or whatever you wish, they collectively ushered in the age of electronics.

All the tricks of radio reception, transmitters, amplitude modulation, frequency and phase modulation, frequency-shift-keying, pulse and other forms of modulation and demodulation, radar, TV, VHF and UHF, phase-locked-loops, hi-fi audio amplifiers, negative feedback, timers, operational amplifiers, integrators, oscilloscopes, tape-recording and playback, video amplifiers, regulated power supplies, opto-couplers, light modulation systems, electron-multipliers, radioactivity detectors, analogue computers, even the beginnings of digital computers were born and nurtured using the now despised valve.

Valve history

All humans yearn to know their roots and we, the modern electronic bods, can benefit by looking back into the origins of the circuit configurations and design philosophies developed in the valve environment of the past.

The valves, transistors, FETs or whatever are simply instruments for regulating the circuit current. It is the circuit which holds the secrets. Thomas Alva Edison, the "wizard of Menlo Park", found in 1885 that charged particles are emitted from a hot filament in an evacuated space such as within a vacuum electric lamp. He discovered that a hot lamp filament always loses any negative charge placed upon it. Edison noted this effect in his diaries and that these particles were attracted to a positively charged plate

placed within the lamp, but foresaw no useful applications. What an opportunity missed!

It remained for other scientists such as Richardson, Du Bridge and Fleming to apply the principles of physics to the phenomenon and pursue it with serious scientific research. Richardson called the particles "thermions", for thermally-emitted charged ions. He found they could be attracted by any positive electric field nearby. Following a liquid-gas analogy, it was said that particles were "evaporating" from the hot wire. Richardson used the word "thermionics" applying to all studies and uses of thermions.

Since Michael Faraday's classic theories on electrolytes being composed of many discrete positive and negative charged particles, and following Johnstone Stoney's 1874 naming of these negative particles as "electrons", the charge on one electron was known, albeit not very accurately.

By 1897, J.J. Thomson, working at the Cavendish Laboratory in Cambridge, had extended the thermionic work making cathode ray tubes, the precursor of the cathode ray oscilloscope. They called the thermionic stream "cathode rays" and measured the mass of and the charge

We call them valves, the Americans call them tubes — whatever you call them, their significance in the history of electronics cannot be underestimated.

By Rae Jon.

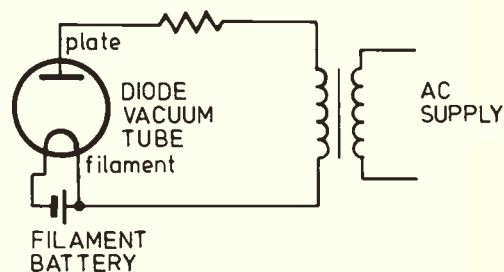
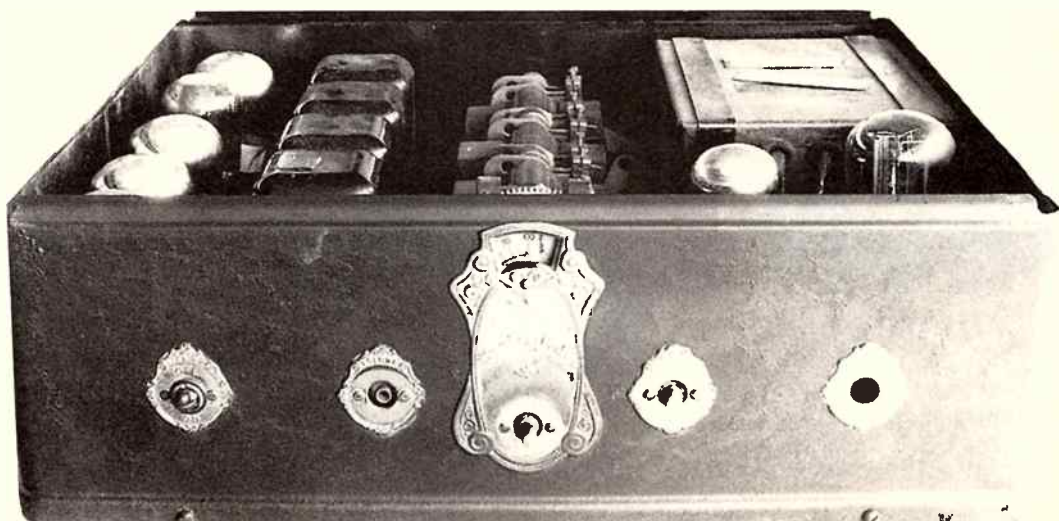

Figure 1: AC rectifier diode.

VIVE LES VALVES!



Stromberg Carlson radio of the 1920s — seven valves, four gang tuning capacitor, mains-operated, rectifier type 280 on extreme right.

ETI MAY '89

44

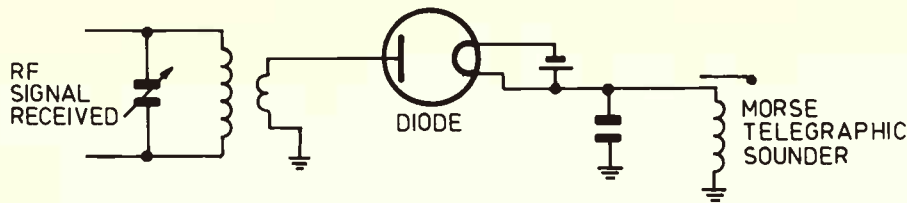

Figure 2: RF detector diode for Morse telegraphy.

carried by each thermion, finding the value of each charge to be the same as the charge on one charged ion in an electrolyte.

Thus the thermions and cathode ray particles were first identified as being electrons.

English scientist, Sir John Ambrose Fleming, continued work on the primordial electronic valve. The number of electrons escaping from the hot wire was found to increase approximately exponentially with its absolute temperature. At temperatures around 5000° roughly one electron in every 200 in the filament was escaping, which means a very large number of electrons. This stream is a real electric current, a fact known to the early researchers.

Fleming saw that, as the electrons would flow to the anode only when the anode was positive, if alternating current was applied to the anode, unidirectional current would flow on each positive half cycle, and nothing would happen on the negative half cycle. He had invented the fundamental rectifier circuit by 1904. (See Figure 1.)

Regarded as a sort of one-way valve, to borrow an hydraulic analogy, the name "valve" thereafter stuck to all electronic vacuum tubes. The Americans stuck to the title vacuum tube, or electron tube, but interestingly, in the USA today, the large high-power silicon thyristor groups (up to 800,000 volts and 10,000 amps) and the newly resurrected mercury-arc rectifiers are often called valves, technically quite correctly.

For power frequencies, around the turn of the century, there were rotary methods for the conversion of ac to dc, but Fleming took one giant leap forward and applied alternating current at radio frequencies to his one-way valve.

His great contributions to electronics began in 1904 when he built a vacuum tube diode having small enough capacitance to be able to rectify small radio frequency currents. Thus was born the first high-sensitivity RF signal detector, opening the way for longer distance radiotelegraph communications as in Figure 2. Rectified RF currents could now directly operate a telegraphic electromagnetic morse code sounder.

The triode valve

Vast improvements in radio communications derived from the inventive mind of Lee de Forest, who in 1907 added to the vacuum tube diode a small wire grid between filament and anode. He found this acted as

a control grid, with voltage varying the number of electrons flowing, hence varying the anode current as in Figure 3. By placing a high value resistor or inductance or transformer in the anode circuit the anode current causes a varying voltage drop across this component. Because this varying voltage across the anode circuit impedance is larger than the little voltage signal applied to the grid, voltage gain is achieved. Thus was born the triode amplifying tube, known at first as the "De Forest Audion" and following De Forest to broadcast a concert by Enrico Caruso from New York in 1910 using amplitude modulation. The amplification property was the essential link which made high power transmitters, long distance reception and sensitive radio and TV receivers possible, as well as enabling the early invention of voice, and music modulation methods.

The triode turned out to be a very linear amplifier tube, amplifying signals with little distortion effect. For this the triode remained in use for threequarters of a century. The name "triode" comes from this tube's use of three fundamental electrical elements: filament (or cathode), control grid and plate.

Application of this vacuum triode tube, called the "audion", to an RF oscillator circuit

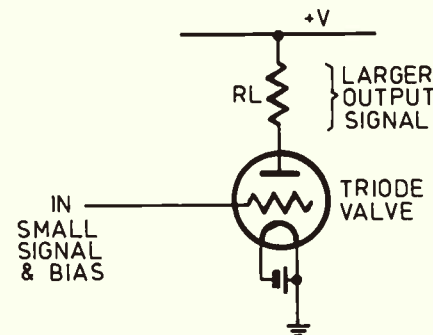

Figure 3: basic triode amplifier tube.

by De Forest and Edwin Armstrong in 1913 enabled radio transmitters of controllable frequency and bandwidth to replace the sledgehammer-like spark transmitters of early radio. By the next year vacuum tube triode amplifiers made possible undersea intercontinental telephone circuits.

Sadly, however, it was found that the gain of all vacuum triodes is less at high frequencies. Another failing of the vacuum triode RF amplifier was the way its low output (plate) resistance loads an RF tuned circuit.

(See Figure 4(a.)) Valve output resistance or plate resistance means how much the anode voltage drops as a consequence of a change in anode current, a fundamentally important property of every valve.

Tetrode valves

Walter Schottky is a name known to all modern computer buffs (whose state-of-the-art computers use solid state 54/74LS series Schottky high speed TTL digital logic). In 1916 he gave us the tetrode vacuum tube, which has an extra grid element interposed between the control grid and anode. This results in operation quite different from that of a triode, (see Figure 4(b.)) With its much higher plate resistance the tetrode (four electronic elements) does not load the following tuned circuit as much as a triode RF amplifier.

Because of this, the quality factor or "Q" of the tuned circuit can be much higher, vastly improving RF amplifier stages by narrowing their bandwidth, ie, raising the selectivity and giving sharper tuning. This advance allowed many more radio stations to be on the air without interference.

That valve sound

Even today there are guitarists who prefer the "valve sound" in their high-powered stage amplifiers. This philosophy persists, particularly among bassists and 12-string artists, those using the two extremes of the frequency range.

If this preference has real foundation one place to look for a technical reason could be the elusive TIMD, transient intermodulation distortion, which is certainly more prevalent in solid state audio amplifiers than in valve amplifiers. Not that there is any good reason why this should be the case - it's just a habit some slack solid-state designers have allowed to creep in.

Let us now look into just why valves work. A few valves still survive in today's fast and miniature world. The survivors are specialised valves: very big ones for large radio transmitters and strange looking ones for extremely high frequency work, and of course CRO tubes, TV picture and camera tubes. There are also a few little valves in positions where a low-level signal of a couple of microvolts must be amplified by an amplifier having extremely high input impedance in the gigohm region. Such a situation occurs in areas like neuropharmacological or neurobiological research establishments.

How it works

The innards of a valve is mostly nothing; most of the volume of the vacuum tube is just that. It uses the properties of a free-moving electron stream generated by electron emission from a hot surface, as in Figure 5.

Such electrons are attracted and accelerated by a positive anode some-

Vive les valves!

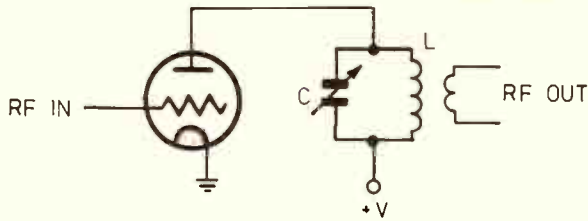

Figure 4(a): a triode RF amplifier, because of the low value of plate output resistance, loads the following tuned circuit, L,C. This reduces the Q of the tuned circuit, spoiling the tuning characteristics.

where, and along the way the stream of electrons is controlled in number by being made to pass through a sparse grid carrying control potential.

Figure 5 shows the fundamental operation of all amplifying vacuum tubes. The hot surface at the left is called the "cathode", symbol K, because it is the more negative end of the electron stream. The cathode cylinder (in most vacuum tubes) is heated by a filament inside.

The cathode surface is coated with materials such as caesium and thorium oxides. The hot cathode emits copious quantities of electrons which gather in a cloud around the cathode.

When a high positive potential applied to the anode causes a strong electric field between anode and cathode, this field accelerates some of these negative electrons towards the anode. But when travelling between cathode and anode within the evacuated tube such current does not obey Ohm's law.

On the way the electrons in the stream go

through the very open mesh grid of wires called the "control grid", G1. If this grid has no potential, the electrons just shoot straight through it on their way to the anode.

Control grid

If we apply a small negative potential to the grid it interferes with the large anode-cathode electric field and reduces the number of electrons in the stream. Thus the anode circuit current is reduced as in Figure 6.

A +250 volt supply is connected via a load resistor RL, to the anode. The electron stream from grounded cathode to positive anode within the valve continues outside the tube as an ordinary electric current in the wires and the resistor RL, up to the positive supply rail at +250 volts potential.

Outside the valve this current does obey Ohm's law, causing a voltage drop across RL proportional to current. Electrons, being negative, are flowing up from cathode K through the valve, via the anode and the resistor RL to the +250 volt rail. We still speak

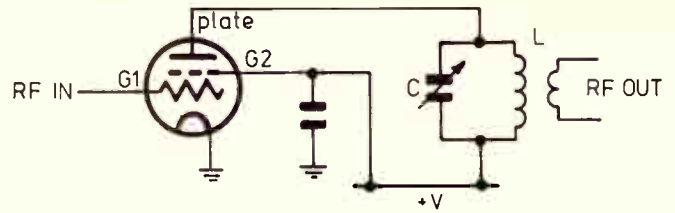

Figure 4(b): tetrode valves, with screen grid G2, have higher output resistance at the plate, giving less loading of the tuned circuit, L,C. Thus, tuned circuit Q is higher, giving sharper tuning.

in the conventional terminology saying that "conventional" current is flowing in the other direction, ie, from the +250 volt rail, down through RL and the tube to the grounded cathode.

The more positive the grid the larger is plate current, producing a larger voltage drop across RL, ie, plate voltage reduces. Therefore we say the valve produces signal inversions.

The controlled electron stream within the vacuum tube becomes a controlled electric current passing through load resistor RL. This produces a controlled voltage drop across load resistor RL which can be much greater than the controlling potential applied to valve control grid G1. The ratio of change in the control grid potential to the resultant change in voltage drop across RL is the significant (inverted) voltage gain of this valve and circuit.

Thus the valve and associated circuit can be a voltage amplifier having considerable voltage gain.

Cold cathode tubes

Electrons can also be made to leave the cold cathode surface of suitable materials in vacuum by bombarding such cathodes with light of suitable wavelength. This is the photoelectric effect in which the emitted charge carriers were first identified as being electrons by Lenard in 1899.

The frequency and wavelength of the incident light, as in Figure 7, must be such that the energy of each photon of light is greater than the energy an electron of the cathode surface material must acquire before it can escape (work function).

The energy of each photon is proportional to the frequency (colour) of the light, not its brightness, as Einstein declared in 1905.

Cold cathode rectifiers

Electrons can be made to leave a solid cathode by other methods, for example, the attraction of a strong positive electric field, or cathode heating by energetic gas ion bombardment.

Commercial examples once used included the RCA gas-filled cold cathode rectifier tube. This tube, Figure 8, required a minimum voltage of 300 volts peak to begin ionisation



Part of Stromberg Carlson's 7-valve radio. RF section on the left, tuned coils in centre, 4 gang tuning capacitor on the right. Mains-operated, valves are 4 pin or 5 pin.

of the gas. Then the energy of gas ions heated the cathode causing it to emit electrons which travelled to whichever anode was positive (but not to the other negative anode). Thus rectification of high voltage ac was performed.

Common vacuum tubes

In vacuum tube days thermionic emission of electrons from a hot filament or an indirectly heated cathode was by far the most commonly used method of producing the electron stream in evacuated tubes. Thousands of vacuum tube types were manufactured and used.

The simplest tube in common use in 240 volt ac powered equipment was the hot-filament-cathode full wave vacuum rectifier tube type 80 (at first called type 280) with its 4-pin base, or the equivalent type 5Y3G (octal base), and the 5Y3GT.

Original American naming for vacuum tubes was an almost random numbering system; other rectifiers included types 83, 83-V and 84, but the trouble was that the numbering system told the user nothing about the tube.

For example tubes types 40, 41, 42 and 45 were all utterly different, ranging from a small battery operated triode with 5-volt filament (type 40) through the power output pentode with 6.3-volt heater (type 42) to the larger power triode with 2.5-volt heater (type 45).

Valve numbering system

After a while the Americans got sick of such confusion and invented a new numbering system. An example is the full wave rectifier type 5Y3GT, in which the first figure "5" denotes that the filament requires 5.0 volt supply; "Y" is an identification; "3" says that the tube contains three electrical elements (one filament and two anodes in this case); "G" indicates a glass envelope and lastly the addendum "T" means a "bantam" or small glass envelope.

Furthermore, most tubes carrying "G" or "GT" endings were octal (8-pin with central keyed tongue) base types. The octal base was an attempt to rationalise the sockets used, as the old type-numbered valves might have four, five, six, seven or eight pins as required, hence the socket manufacturers had to make five different types of sockets.

Vacuum tubes having metal envelopes (rather than glass) were popular in the USA but were seldom seen here until the war disposals market gave us millions of types 6SR7, 6H6, 6SJ7, 6J7, etc. The metal envelopes could be grounded, making an excellent electrostatic field.

Two of the above tubes include an "S" before the identifying letter, which signified a "single-ended" tube, meaning that the grid connection was via a base pin, rather than a top grid-cap. Thus tube type 6SR7 was a

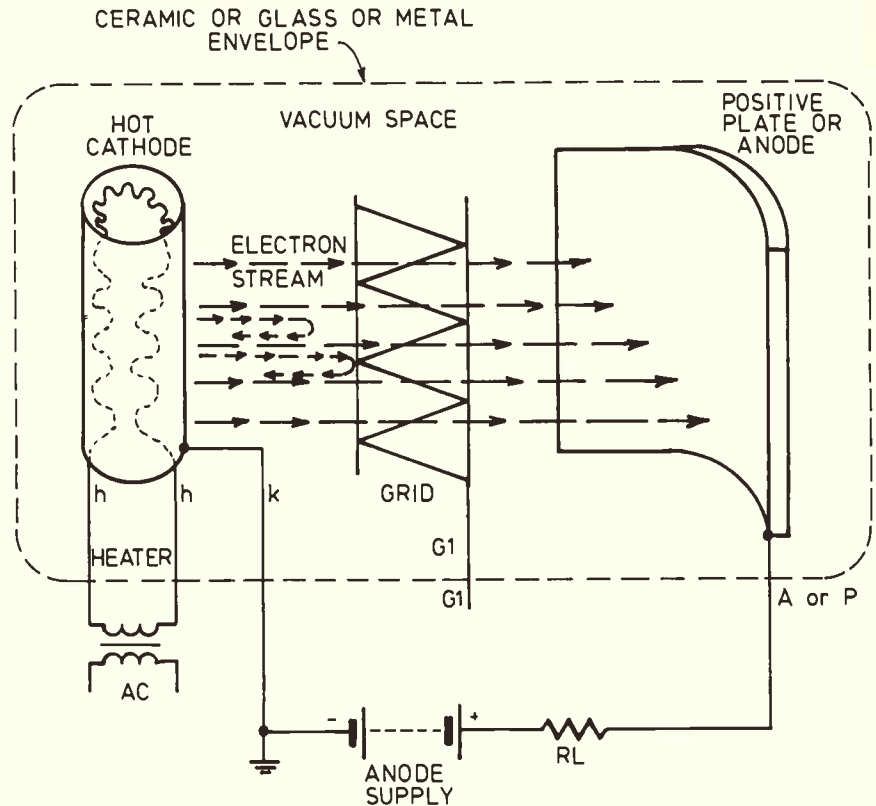

Figure 5: fundamental triode vacuum tube, electron stream and control grid. Grid potential controls the number of electrons arriving at the plate.

development from the pre-war 6R7 (metal), 6R7G (glass) and 6R7GT (small glass envelope).

The single-ended idea arose during World War 2, doubtless because the flying lead to the top grip cap of the pre-war double-ended types was vulnerable to damage. To be complete we had better say that the 6SR7 contained seven elements (as the final character in its type name denotes), being heater, cathode, control grid, anode and two small diode anodes for diode AM demodulation and AVC rectification. The metal envelope shield counts as the seventh element.

Power supply circuit

A commonly used circuit for the type 80 or 5Y3GT full wave rectifier tube is shown here as Figure 9. But first, lest modern electronics bods (so used to low voltage solid state technology) be caught by the high voltages inherent in valve equipment, let me repeat that all mains operated valve equipment uses dangerous, lethal voltages.

The mains transformer has a 700 or 770 volt secondary winding centre tapped. The centre tap becomes the negative output, so is grounded. Each side of the secondary feeds one rectifier plate while the isolated 5 volt ac secondary winding supplies the 5Y3G filament which (acting as cathode) becomes the positive output.

Each rectifier plate (anode) conducts

when positive by attracting electrons emitted by the hot filament. The tube has a large voltage drop between anode and filament, and also the inductance L has considerable resistance. So a 700 to 770 volt transformer secondary produces a smoothed DC output from the filter of about 250 volts, depending on load current. Incidentally those transformers were known as 350-CT-350 or 385-CT-385 power transformers – the figures 700 or 770 volts were never expressed. Another common size was 285-CT-285 volts.

For higher voltages and currents the rectifier types 5Z3, GZ34/5AR4, 83V, 5V4 or 5U4GB were also used.

As more new valve types were developed manufacturers soon used up the alphabet

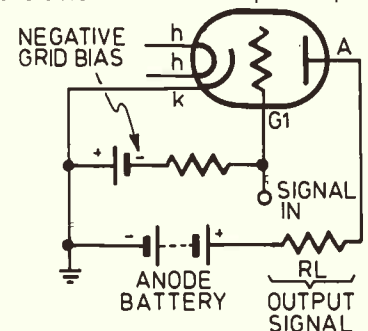
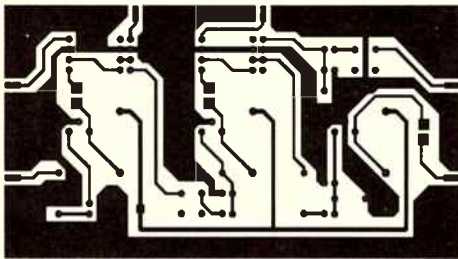

Figure 6: negative bias voltage on G1 reduces number of electrons in stream, so reducing the anode current and hence output voltage.

PCBreeze II



PCBreeze is a sophisticated tool for designing Printed Circuit Boards. It allows a board to be created, viewed and modified on an IBM compatible computer.

PCBreeze has been designed with ease of use in mind. Most commands are at most two keystrokes away, with additional information asked for explicitly. A pop up menu system is available. The menus make PCBreeze easy to learn and use but does not hinder the experienced user.

The system uses a 50 mil (1.27 mm) grid. This resolution is more than enough for most tasks. It has two layers for the artwork as well as text and component overlay. With board area sizes of up to 400 square inches there is plenty of room to work.

There is a variety of common pad and line sizes to choose from. Also standard is a DIP and SIP command to put down these pad patterns. User defined pad patterns may be saved and used as libraries later.

Included in PCBreeze is an Autorouter. This will lay down a track between two points marked out by the user or accept a netlist.

Hardware Supported

IBM PC/XT/AT/PS2 or compatible
CGA, EGA, VGA and Hercules graphics
HP-GL, DM-PL, Roland Plotter Output
Postscript, Epson FX/LX/LQ Printers
Microsoft Mouse

\$295

Kepic Pty Ltd

4 Steinbeck Place
Spearwood 6163
Western Australia
Ph: (09) 418 5512

Dealer Enquiries Welcome

READER INFO No. 10

Vive les valves!

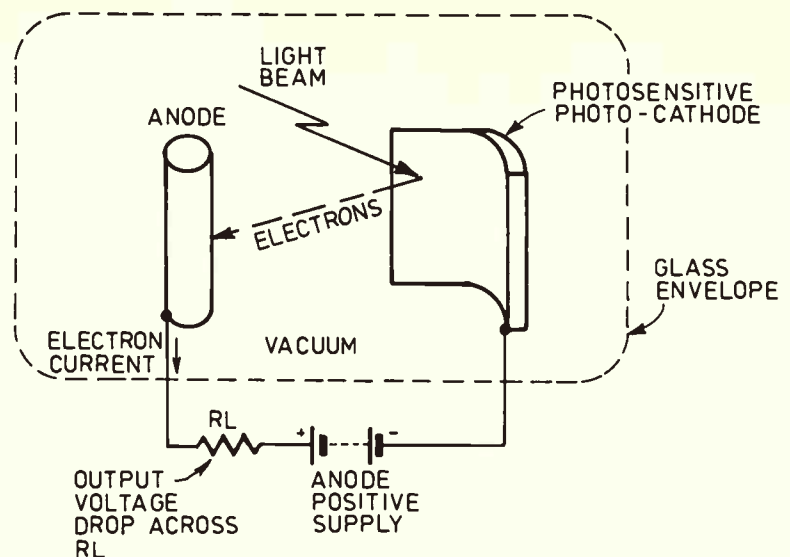

Figure 7: cold cathode photo tube. Light falling on photo-sensitive photocathode causes electrons to be emitted. These electrons are attracted to the anode, forming an electric current which produces output signal proportional to light intensity.

so for further new types two distinguishing letters had to be used. An example is the 5AR4 full wave vacuum rectifier tube which has a cathode sleeve over the 5 volt heating filaments to obviate the reduction of heating filament metal by electron and ion loss.

European valves

The Europeans, mostly Philips and Mullard, always had their own valve type-numbering systems, consisting of a letter denoting heater voltage, followed by one, two or three letters describing the tube type and function. Then follows a two figure distinguishing number. Examples were type DL96 where "D" told us that the filament voltage was 1.4 or 2.8 volts, "L" said that this tube was an output power pentode, and the "96" was its distinguishing number.

Another tube was the ECC84, "E" for 6.3 volts heater, "C" for double triode structure and "84" to distinguish it from all the other ECC-types. An "F" denoted pentode, "CF" a triode-pentode double tube etc.

They had a neat way of denoting a premium quality long life tube by swapping the order of characters in the name. Thus

type ECC83 denoted an ordinary quality double triode while E88CC was a special quality long life construction.

New tube constructions

Late in the valve era we saw the introduction by most manufacturers worldwide of "baseless" tubes without any bakelite base, the pins just protruding through the glass tube bottom. There were 9-pin and 7-pin types in this very popular series, known in Europe as "noval" or in America as "miniature" tube types.

Many of the American efforts in this construction had type numbers beginning with "6C", such as the highly successful small video power pentode type 6CL6. A full lineup of noval/miniature tubes filled most positions in the last valve-operated radio and TV receivers sold in Australia.

The rectifier tubes of this construction were often the "EZ" types (Z for full wave rectifier). One of these types became infamous for its habit of metal-plating the inside of the glass base by a vacuum metal-sputtering-deposition (which of course wasn't supposed to happen). The result was metal plating

COLOUR, FREQUENCY AND WAVELENGTH OF LIGHT

Colour	Frequency	Wavelength
Far ultraviolet	3,000,000 GHz	100 nm
Near ultraviolet	750,000 GHz	400 nm
Violet	714,000 GHz	420 nm
Blue	652,000 GHz	460 nm
Green	536,000 GHz	560 nm
Yellow	509,000 GHz	589 nm
Orange	476,000 GHz	630 nm
Red	413,000 GHz	725 nm
Near infrared	300,000 GHz	1.0 micron
Mid infrared	3000 GHz	100 microns
Far infrared	300 GHz	1.0 mm

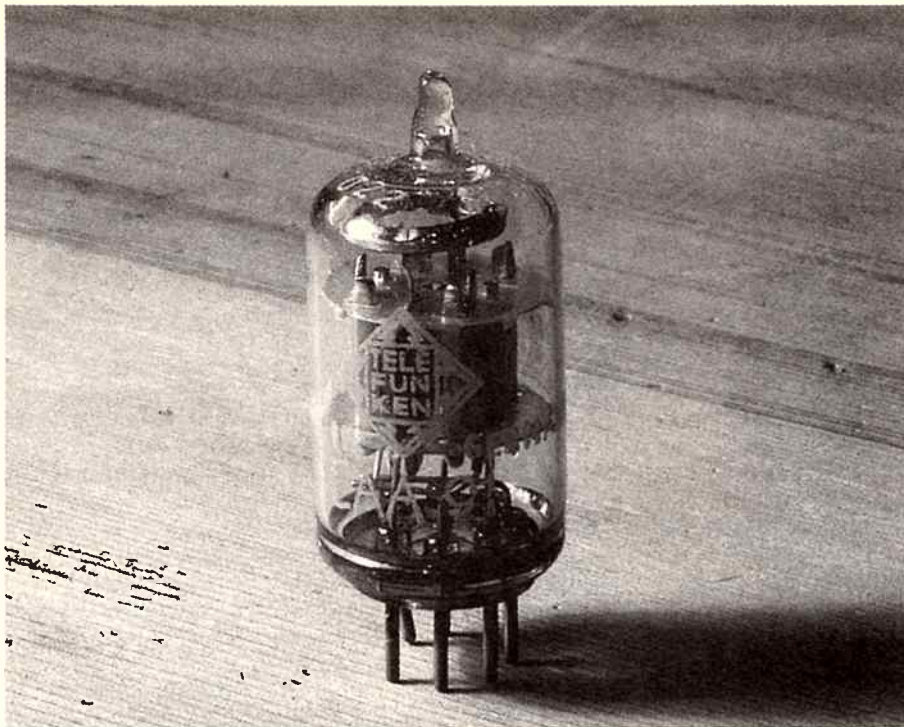

The cold cathode rectifier type OZ4G.

electrolytic capacitor to prevent loss of stage gain, otherwise signal voltage developed in this cathode resistor is in fact negative feedback.

But in some high-class negative feedback audio amplifiers, such as one version of the famous Williamson amplifier, the cathode resistors were left un-bypassed to avoid the low frequency phase shifts which bypass capacitors introduce. The resultant small loss of gain was made up by more stages.

While the grid remains at ground potential, a positive (to ground) potential applied (by voltage drop in RK) to the cathode is equivalent electrically to a negative bias on the grid (as seen by the cathode).

Many circuit-design techniques used in today's solid-state equipment are simply following the ideas developed by valve engineers. For instance modern amplifiers using a solid state JFET transistor make use of a bypassed source resistor to apply negative bias to the gate of the JFET. **et:**

around all pins inside the tube, bridging them all together, shorting out the whole power transformer secondary winding, resulting in a burnt-out power transformer and sometimes a fire. Quickly an improved tube appeared on the market, but not before many radio servicemen replaced a multitude of power transformers and rectifier tubes.

Voltage amplifiers

Using the Philips style "EF" series, or the American tubes like the famous 6J7G, thousands of high gain audio amplifier stages were built across the world by hi-fi enthusiasts. These types were all pentodes, ie, five element tubes, containing 6.3-volt heater, cathode, control grid G1, screen grid G2, suppressor grid G3 and anode. The heater was not counted in the number of tube elements as it played only a thermal (non-electronic) role.

Small audio signals input at A in Figure 10 were capacity coupled to the control grid G1, from which a grid leak resistor RG1, usually 0.5 megohm, held the grid at dc ground potential. As the grid took almost no input current, RG1 has negligible voltage drop across it. The anode was connected to the +250-volt rail through load resistor RL, which was quite highly valued, often 56,000 ohms.

Plate current was usually about 2.0 milliamps under control of the negative grid-cathode bias applied. This bias voltage was often derived, as Fig 10 shows, by causing a DC voltage drop across a resistor RK in the cathode to ground return path. This resistor RK developed a DC voltage drop, typically 2.5 volts, positive at the cathode terminal.

Often this resistor was bypassed using an

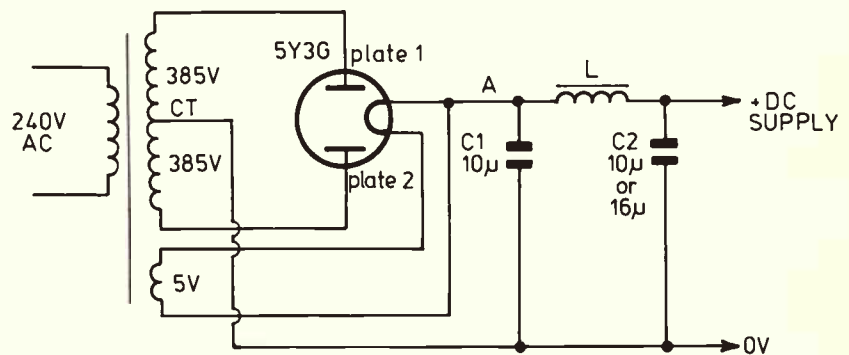

Figure 9: a standard circuit for dc supply using 385-CT-385 transformer and capacitor input filter. In earlier years the 385/385 transformer was popular as the loudspeaker field coil (which has considerable resistance) was used as the filter choke.

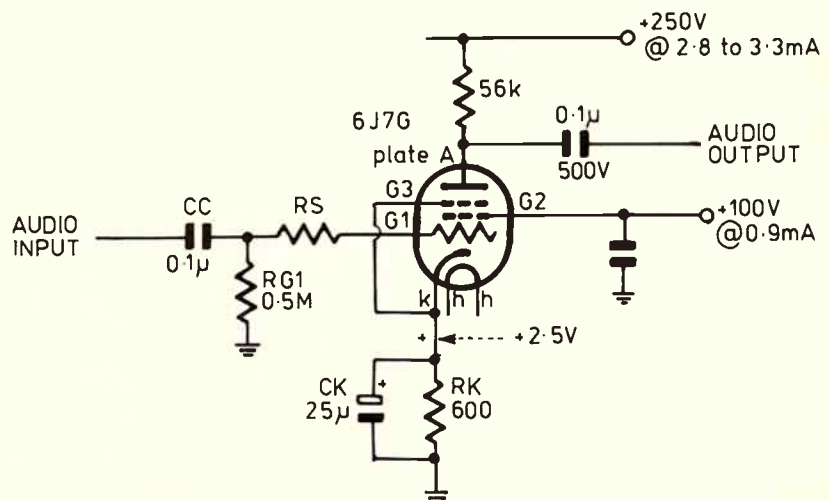

Figure 10: pentode audio voltage amplifier using the common old 6J7G tube. Fit grounded valve shield around tube. G1 is a top cap. RS is a parasitic stopper carbon resistor.



TECHNOLOGY

A growing body of enthusiasts is learning to appreciate the style and quality of workmanship found in old valve radios. Yesterday's junk can be today's pricey treasure. Roger Harrison reports.

Resurrecting the technology of yesteryear – principally wireless sets – may be a pleasant and rewarding pastime for some. But for others, restored radios are like restored cars, furniture or the bric-a-brac of daily life “back then” – collectable, and worth increasing sums of money.

The birth of broadcasting in the 1920s ushered in a remarkable and sophisticated technology that had far-reaching influences on daily family life and society as a whole. The technology broke down invisible barriers of time and distance, and brought experiences to people that they were otherwise denied. A wireless set was a major purchase for a household in the early years and many local manufacturers vied to provide attractive models with ‘unique’ features, having designs in keeping with the style and fashions of their period.

It wasn't so long ago that old valve radios were regarded as just so much junk, dross from an unremembered era. Now, restored, they can fetch prices ranging from a few hundred to a few thousand dollars! What are the

factors that interest people so much that they spend hours painstakingly stripping down and refurbishing these vintage sets and months searching for elusive original parts; why would collectors pay such prices, far higher than the modern, functional equivalent?

Why do it?

Well, it depends on who you talk to. It's generally a combination of factors, rather than one or two alone. However, nostalgia and aesthetics seem to head the list. Some people have an interest in stylistic and functional comparisons; investment potential is another factor; while others simply appreciate vintage radios for their durability and quality of workmanship.

The “wireless era” ran from the mid-1920s through to about 1950. A decade later, valves were no longer being used in new receiver designs as transistors and transistor receiver designs had been developed to the point where they were cheaper and more easily manufactured. As the 1960s advanced, valve radios were pensioned off or discarded, replaced by the new technology.

Valve radio designs reflect the character and style of their era. Indeed, the age of a particular set can be readily placed by its design. As an item of household furniture, a radio design only had to conform to providing a few functional features – a few knobs and a dial – leaving the rest to creative imagination and experiment. And boy, did they experiment. Hundreds of styles appeared, which are now generally categorised under a few groupings, such as the late-30s “cathedral” style sets, the fascia panels of which look rather reminiscent of the main altar wall of a cathedral. The loudspeaker was concealed behind the “windows”.

Floor-standing console radios allowed plenty of scope to design the unit as a piece of furniture. Indeed, some manufacturers went so far as to make the radio a functional piece of furniture! They concealed receivers in writing desks, slideboards, occasional tables – all sorts of things. A 1930s console radio, in working order and featuring a fully restored french-polished wood veneer cabinet can readily fetch \$1000, perhaps \$3000-plus for

something very stylish and perhaps a little rare.

Common sets of the 30s and 40s, restored and in good order, may set you back \$200 to \$400; for a table or mantel set, up to \$600 or even more for a console model. Nostalgia has its price. If you have restored an old house and stylistically recreated a certain era, either throughout the house or just in a room or two, carefully obtaining furniture and fittings from the era, then a wireless set from the era is the final touch (hence the price).

Enthusiasts who rescue and restore valve radios just for the love of it, for the comparison of the older technology with the new, and/or through an appreciation of the quality and reliability exhibited by many valve radios, get their satisfaction from these factors, not because their work represents investment potential or through any specialised appreciation of knowledge of their design aesthetics.

It is not uncommon to find an elderly valve radio still in working order, untouched by servicemen, some 30 or 40 years after its original purchase.

For those touched by the nostalgia surrounding vintage radios, a disappointment is always present – you can't pick up those old programs!

Back then

Once broadcasting got under way in the 1920s, products were quickly manufactured to meet the forecast demand. There were literally dozens of manufacturers, big and small, throughout Australia and New Zealand in the 20s and 30s, although they dwindled in the depression and up to World War II. They call it industry rationalisation these days.

In Australia, AWA, STC, Stromberg Carlson, Kreisler (alright – who made that joke about “ethnic radio!”) and Breville were among the “big names”. Imports appeared here, too. Brand names such as Western Electric, Ekco, Philco and Atwater Kent may be found. An estimated 200,000 to 300,000 sets went on the market in Australia between the mid-20s and about 1950, according to one source. How many are left is uncertain, but valve radios are hardly rarities.

The first low-cost receivers were crystal sets. Typically, they cost twenty five shillings

BRINGING BACK THE GOOD OLD DAYS

Rediscovering vintage radio

ETI MAY '89

50



A venerable collection! At top rear is an RCA Model 60, circa 1927-28, featuring a polished wooden cabinet; it was fully imported and very expensive in its day. The large cabinet to the left, with the basket of flowers design, is an RCA Model 106 loudspeaker that came with the Model 60 receiver. The basket of flowers was an RCA trademark. Atop this cabinet is a "variometer" tuning coil from a receiver of the 1920s era. In front of the RCA speaker, with the black cabinet sporting a circular fretwork front, is an Amplion loudspeaker, circa 1923-24. To its right are several valves of the era. The black horn on the right is a Browne horn speaker of 1925. Just behind this is an Atwater Kent Model 56 receiver of 1928. It is ac-powered and features eight valves and a metal cabinet. Atwater Kent was a very large US manufacturer. To the rear of this receiver, hiding partly behind the RCA speaker, is an Atwater Kent Model 3E speaker of 1927-28.

(\$2.50) a big bite from the breadwinner's take-home pay of about three pounds (\$6) in the mid-1920s. AWA's Radiola set of 1924 cost fifteen guineas (fifteen pounds, fifteen shillings – about \$31.50). In other words, about six weeks' wages. Its 1925 crystal set cost six pounds, about two weeks' wages.

Top-of-the-line receivers were expensive indeed! You could pay the equivalent of five to six months' wages for a four-valve AWA-made set. The company released two models in 1925, priced at fifty six pounds ten shillings and sixty eight pounds. If average annual earnings these days are around \$30,000, that's like paying \$12,500 and \$15,000! Who said today's hi-fis were

expensive? Sales figures for the AWA sets are not revealed.

So, if you see prices over the thousand dollar mark for restored sets, consider the bargain you're getting.

Contacts

Sydney and Melbourne sport a growing band of restoration enthusiasts and vintage radio collectors, but others are in evidence all round the country. In New Zealand, Auckland, Christchurch and Wellington seem to support a goodly gang of enthusiasts, although, like Australia, enthusiasts and collectors are to be found all over.

In Sydney, auctions, particularly auctions of goods and chattels from deceased estates, provide a steady stream of raw material, and there has been a thriving informal swap market between enthusiast-collectors for many years. Some "old wares" traders sell vintage radios, usually at prices well above their worth so they're given a wide berth by knowledgeable enthusiasts and collectors.

Victorian collectors and enthusiasts are well catered for by two retail stores specialising in valve wireless sets. One is Nostalgia Wireless in Union Rd, Surrey Hills, and another Resurrection Radio at 51 Chapel St, Prahran.

If you're keen on meeting others of like interest, the Early Wireless and Sound Society of NSW can be contacted by writing to John Murt, PO Box 623, Lane Cove, NSW 2066. In Victoria, there's the Historical Radio Society of Australia. Contact the membership convenor, Rex Wales, at 49 Sharon Rd, Springvale Vic 3171.

ETI



This Colmovox receiver, from 1923-24, was made in Australia by the Colmovox brothers. It is a Model 5 (or Model 6). It is a tuned radio frequency design, note the three vernier dials — each stage had to be tuned separately (a three-handed job!) The valves in front are typical of the types used in such receivers.

Information to compile this feature was gleaned from chief technician, bottlewasher and salesman, Jack, at Resurrection Radio in Victoria; from Andrew Kay of The Vintage Wireless Radio Company in Sydney; and John Murt of the Early Wireless and Sound Society of NSW.



Australian made! This is a Fisk AWA Model 55 receiver, an upright console style of 1929-35, made by Amalgamated Wireless Australia (AWA) headed by Ernest Fisk, who was later knighted for his contribution to the industry.



The 70-metre dish at J

World Radio History

THE FINNA

ETI MAY '89

52



TECHNOLOGY

If you know what you are doing, and are very careful about it, it's possible in space travel to get something for nothing. Well, not nothing precisely but you can do a good trade: weight for speed. Spacecraft are light; planets heavy. So space navigators refer to the slingshot effect: as a spacecraft encounters a planet, they can trade gravitational energy. The result: the spacecraft speeds up (a lot) and the planet slows down (a little).

This is interesting, perhaps, but of no real consequence unless you happen to be in the business of trying to get a spacecraft flying very fast. And if you are thinking of travelling right across the solar system, then speed is of the essence.

In the 1960s it occurred to NASA planners that a space mission to the outer solar system would be a worthwhile and technologically feasible goal. What's more, towards the end of the 1970s the planets would be aligned in such a way that the slingshot effect could be used to send a spacecraft out to the remotest planets.

With the kind of rocket technology available it would take a spacecraft 30 years to reach Uranus following the most energy-efficient course. With gravity assist, that could be reduced to nine. In addition, the opportunity would not recur for another 175 years.

The result of such rumination was a proposal to build a special craft to do the job. Inexcusably, Congress vetoed the plans, preferring to put men rather than robots into space.

However, all was not lost. NASA modified the plans of its highly successful Mariner craft and went back to Congress with plans for a cheap four-year mission to Jupiter and Saturn. The Voyagers were launched on 5 September and 20 August, 1977.

The result was a golden age of space exploration. Enhancing the trail-blazing work of the earlier Pioneer 10 and 11, Voyager 1 and 2 sent back splendid images of Jupiter and Saturn, providing more knowledge in a few short years than had been painfully acquired in the preceding few hundred.

Moreover, both spacecraft continued to perform splendidly so NASA, doing science on a real shoestring, decided to send at least one of the Voyagers on its original intended mission. Voyager 2 was sent speeding off towards Uranus. In a whirlwind encounter that

lasted a few brief hours in 1986, it revealed for the first time that planet's rings, the surfaces of its major (and a few minor) satellites and the so-called Shepherd moons that control the ring system.

It also sent the spacecraft speeding off for its next, and final encounter, with Neptune in August, 1989.

Voyager

The most prominent feature of Voyager itself is the large radio antenna, which is always pointed back at the Earth. Two receivers and transmitters, six small computers and a few scientific instruments are bolted on to its back. Power is provided by heat generated by the decay of radio isotopes.

Each of the computers consists of a central processor surrounded by 44k of memory. All the hardware on board is military standard NMOS semiconductor material.

The computers are organised into three groups of two each. There is the Computer Command Subsystem (CCS), the Flight Data

'If you're thinking of travelling right across the solar system, then speed is of the essence'

Subsystem (FDS) and the Attitude and Articulation Subsystem (AACs) which is responsible for maintaining the orientation of the spacecraft, tracking the sun and stars and operating the camera platform.

The CCS is the linchpin of the electronic architecture of Voyager. It controls all the other parts of the craft including the other electronic subsystems. It is responsible for the allocation of power and computing resources around the craft.

The standard method of operating Voyager is via a 'load' transmitted to the CCS. A CCS load consists of a series of instructions that can control all aspects of spacecraft performance. These programs are written in a custom language that is composed of words that detail firstly the subsystem, then the activity it is to perform. As a result of this, mission control does not directly fly the craft. It instructs the CCS, which does the actual operation. This is the simplest way of operating the spacecraft.

Engineers at Tidbinbilla and Parkes are preparing for the last hurrah of Voyager 2, its encounter with the planet Neptune. Jon Fairall backgrounds the event.

L VOYAGE

Apple Macintosh and 80386 PC Memory Upgrade!

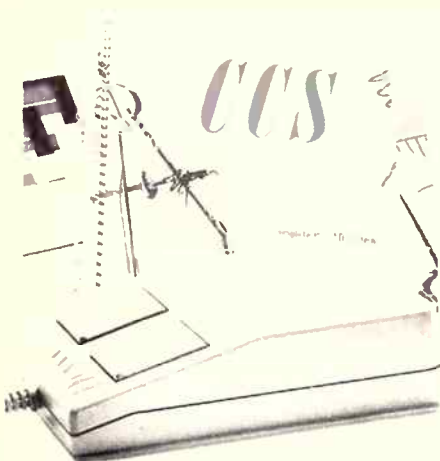

High power CAD Package only \$179

Now you can create detailed, professional quality designs and drawings quickly, easily and inexpensively

CCS Designer comes with many of the same powerful features found in CAD systems costing thousands of dollars. All you need is an IBM PC/XT/AT or compatible computer with 512K RAM. You'll be creating designs in under 30 minutes.

Use it for dozens of applications. Architectural designs, organisational charts, mechanical designs, business graphics, electronic circuit layouts, interior designs, landscaping, flow charts, floor plans. Built in drivers support 180 mice, 52 input devices, 77 plotters, math co-processors and most display cards. An optional utility allows conversion to and from AutoCAD file format so you can exchange files with AutoCAD and read CCS Designer drawings into Desktop Publishing programs.

CCS Designer produces high quality output on matrix and laser printers - you don't need an expensive plotter for good results.

Use CCS Designer with our Symbol Libraries.

Symbol Library Volume One: Electrical, Electronic and Plumbing symbols.

Symbol Library Volume Two: Home design and home furnishing symbols for creating floor plans and interiors.

Symbol Library Volume Three: Flow chart symbols for drawing professional quality flow charts.

FEATURES

- Enlarge • Rotate • Zoom in and out
- Paint/fill • Undo • Redo • Flip • Move, copy, delete and save sections • Plot to a dot matrix printer • Arcs and curves • Adjustable grid and snap gravity point • Multiple character sets • 8 line types with adjustable thicknesses
- Clearly written manual and on-line help
- Create your own symbol libraries • Retrieve symbols at any size, angle, or location • 16 colour high resolution display and output • Auto dimensioning and scaling • Single keystroke commands • Point XY command • Point Polar command • Repeat copy section • Gravity move
- Ortho line • Static zoom

CCS Designer \$179
Symbol Libraries \$79.00 each
Logitec Mouse \$130.00

Plus \$10 00 postage and packing

Note money back guarantee does not apply to software

Dealer Enquiries Welcome

Electronic Solutions have done it again! Unbeatable deals on Macintosh Memory Upgrades. We use the latest high speed (100ns) 1-megabit RAM chips to ensure the highest reliability and an upgrade path for Mac Plus, Mac SE, Mac II and beyond. These SIMMs are the lowest high-profile types available, designed and manufactured right here in Australia.

All memory upgrades are covered by our exclusive 2-year warranty.

Upgrades

1-megabyte SIMMs each \$ 575.00
 Two SIMMs for: \$1100.00
 Four SIMMs for: \$1950.00

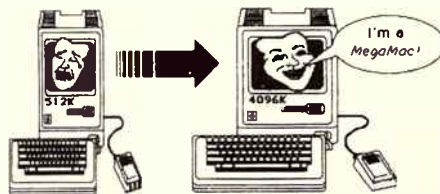

Also available for 80386 machines in 80ns and 100ns versions. Call for pricing.

COMPLETE RANGE

MOTHERBOARDS

MB1600	10MHz XT M-Board,0K RAM	* 99 00
MB286120K	Baby 286 M-Board,12MHz/0K	* 545 00
MB286161M	Baby 286 M-Board,16MHz/1M	1645 00
MB2861611M	Baby 286 M-Board,16MHz/1m	1495 00
MB286201M	Baby 286 M-Board,20MHz/1M	1895 00
MB386202M	Baby 386 M-Board,20MHz/2M	4500 00

CHIPS

IC256K12	256K RAM Chip - 120ns	23 00
IC256K15	256K RAM Chip - 150ns	19 90
IC256K80	256K RAM Chip - 80ns	29 50
IC28710	80287, 10MHz Co-processor	549 00
IC2876	80287, 6MHz Co-processor	315 00
IC2878	80287, 8MHz Co-processor	450 00
IC64K12	64K RAM Chip - 120ns	9 00
IC64K15	64K RAM Chip - 150ns	7 50
IC8087	8087-2, 8MHz Co-Processor	275 00
ICV20	NEC V20 Chip	29 00
ICV30	NEC V30 Chip - 10MHz	49 00

DISK DRIVES

DD1037A	Disk Drive,NEC 720K,3 5in	* 199 00
DD1053	Disk Drive, Japanese 360K	175 00
DD1137H	Disk Drive, NEC 1.44M	*199 00
DD1157C	Disk Drive, NEC 1.2MB	199 00
DD3146H	Hard DD, NEC 40MB, 35ms	695 00
DD5126	Hard Disk Drive, NEC 20MB	399 00
DD5146H	Hard Disk Drive, NEC 40MB	645 00
DD3142H	Hard Drive, NEC 42MB 28ms	745 00

SYSTEMS

SY28612	System 286,12MHz, 1MB RAM	1745 00
SY28616	System 286, 16MHz, 1MB RAM	2195 00
SY28620	System 286, 20MHz, 1MB RAM	2395 00

SOFTWARE

SW410	MS DOS V3.2 - (NEC)	80 00
SWCCSD	CCS Designer	179 00
SWPAINT	CCS Paintshow	55 00
SWSL1	CCS Symbol Library No. 1	79 00
SWSL2	CCS Symbol Library No. 2	79 00
SWSL3	CCS Symbol Library No. 3	79 00
SWMM	Wordmagic, Wordprocessing	139 00

KEYBOARDS

KB101	Keyboard, 101 Keys XT/AT	* 115 00
KB84	Keyboard, 84 Keys XT/AT	* 99 00

ACCESSORIES

AC2MP	Printer Cable, 2M, 25 pin	12 00
AC3MP	Printer Cable, 3M, 25 pin	15 00
AC5400	14 EGA Colour Monitor	* 695 00
ACDA	9 pin Designer Adaptor	10 00
ACDM	Designer Mouse (290 DPI)	99 00
ACLA	25 pin Logitec Adaptor	10 00
ACLM	Logitec Mouse	130 00
ACM2	NEC Multisync II Monitor	1249 00
ACMA	Monitor - TTL Amber	199 00
ACMAT	Mouse Mat	7 50
ACMG	Monitor - TTL Green	199 00

PRINTERS

PR2200	NEC P2200 Printer	695 00
PR22CSF	Cut Sheet Feeder - P2200	155 00
PR30	Printer, Olympia 9 pin	425 00

CONSUMABLES

COD1200	Diskette, box of 10, 1.2M	50 00
COD360	Diskette, box of 10, 360K	20 00
CODB1200	Diskette, 1.2M, Bulk Pack	6 00
CODB360	Diskette, 360K, Bulk Pack	2 50
COMD720	Micro Disk.Box of 10,720K	66 00

I/O CARDS

IO1005	Multi I/O Card - XT only	* 129 00
IO1009	Parallel Printer Card	* 27 00
IO1010	Serial RS232 Card,XT only	55 00
IO10102P	Serial RS232 X 2, XT only	79 00
IO1014	I/O Plus Card - XT Only	* 106 00
IO2210	Serial/Parallel Card - XT	* 75 00
IO2230	I/O Plus Card - AT Only	* 125 00
IO2240	Multi-Serial Card, 4P - AT	245 00
IO2250	Multi I/O, 2S, 1P, 1G, AT	* 299 00
IO2280	Multi-Serial Card, 8P - AT	645 00
IOCHIP	Chip Set for IC1010	25 00

VIDEO CARDS

VC0800	VGA Card, 800 x 600	545 00
VC1024	VGA Card, 1024 x 768	895 00
VC1623	Turbo Colour Graphics Cd	* 99 00
VC1625	Colour Graphics/Mono Card	* 115 00
VC1629C	EGA Card, W/Hercules Mode	* 225 00
VC1633	Turbo Mono/Graphics Card	* 99 00
VC1635	Turbo/Mono Printer Card	* 115 00

DISK CONTROLLER CARDS

DC1004A	Floppy Disk Card, 4 Ports	* 55 00
DC1220	1.2M/360K 720K/1.44M FDC	* 99 00
DC1240	Disk Cont. 2in, 2.5k, or 4in	* 130 00
DC2200	Hard Disk Controller - XT	145 00
DC2210	HDD/FDD Cont/Board - XT	175 00
DC2300	Hard Disk Controller - AT	245 00
DC2310	HDD/FDD Controller - AT	249 00
DC2340	2HDD/4DD Controller - AT	299 00

POWER SUPPLIES

PS9150CB	150W PSU, Circuit Board	85 00
PS9150S	150W Switching PSU - XT	* 124 00
PS9180	180W Switch PSU - Baby AT	* 145 00
PS9180L	180W PSU, Baby AT, L Type	* 145 00
PS9200	220W Switching PSU - AT	220 00

CASES

CAAT	Case, hinged AT	155 00
CAATB	Case - Baby AT, hinged	* 125 00
CAEX3	3.5 Ext. Case + Cable	99 00
CAEX5	5.25 Ext. Case + Cable	99 00
CAMCASE	5.25 Case for 3.5 Drive	25 00
CATOWER6	Case, Tower for 6 Devices	* 399 00
CAXT	Case, hinged XT	95 00

INTERFACE CARDS

IF045	Serial RS-422 Adaptor	135 00
IF046	Industrial I/O Card	445 00
IF054	Universal Wire-wrap Card	125 00
IF055	Dual Serial RS-422 Card	195 00
IF2865	80286 Speed-up Card	595 00
IF488	IEEE 488 Interface Card	* 399 00
IFADDA12	A-D/D-A Conv. 1 Channel	* 199 00
IFADDA14	A-D/D-A Conv. 2 Channel	* 449 00
IFCLOCK	Clock Card - XT	50 00
IFEPROM	EPROM Writer Card	245 00
IFTEGA	Orchid Turbo EGA Card	950 00

RAM CARDS

RC1015	Universal RAM Card,0K RAM	99 00
RC2000	2MB EMS Memory Cd, OK RAM	* 245 00
RC2000EEA	2MB RAM Cd, OK LIME/MS AT	295 00
RC2000EEX	2MB RAM Cd, OK LIME/MS XT	295 00
RC2350	3.5MB M/Funct Cd - OK RAM	495 00
RC2500	2.5MB RAM Cd, 1S, 1P - AT	345 00
RC3350	3.5MB RAM Cd, OK RAM - AT	235 00

*OK RAM MEANS ZERO RAM FITTED

* STAR SPECIALS ONLY WHILE CURRENT STOCKS LAST!

CAT DD1053

Japanese manufacture 360K 5.25 inch floppy drive

Standard double sided double density featuring brushless DC motor design

- Track to track access 3ms
- Transfer rate 250Kbits/sec
- Recording method FM/MFM
- Dimensions 41mm (H) x 146mm (W) x 203mm (D) (not including front panel)
- Power consumption +12V/390mA (startup), 210mA (idle), +5V/460mA

price only **\$175.00**

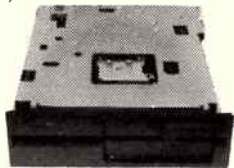

CAT DD1157C

NEC 1.2MB/360K 5.25 inch floppy drive

This dual standard high/low density drive features a brushless DC motor for high reliability Head positioning is via a steel band and stepper motor for high accuracy

Specifications:

- Track to track access 3ms
 - Transfer rate 500Kbits/sec
 - Dual speed design enables reading of 48 tpi and 96 tpi media
 - Recording method FM/MFM
 - Dimensions 41mm (H) x 146mm (W) x 203mm (D) (not including front panel)
 - Power consumption +12V/390mA (startup), 210mA (idle), +5V/460mA
- only **\$199.00**

READER INFO No. 74

CAT DD1137H

1.44MB 3.5 inch slimline micro-floppy drive

This high reliability drive features low power consumption and high reliability It incorporates an autoshutter and head load solenoid to protect media

Specifications:

- Data transfer rate 500 kbits/sec
 - Power dissipation 0.015W standby, 1.5W steady state
 - Seek time 3ms
 - Size 101.6mm (H) x 25.4mm (W) x 130mm (L)
 - Weight 0.39kg
- price only **\$299**



CAT DD5126

20MB 5.25 inch half height hard disk drive

The DD5126 combines advanced technology with rugged design The DC servomotor and split steel band access mechanism provides an access time of 85ms A dedicated head landing zone, automatic carriage lock and low mass heads protect the media during shipment

- Access time track to track 8ms
- Average seek time 85ms
- Formatted capacity 20 1MB
- Data transfer rate 625Kb/sec
- Power consumption 20W
- Size 146mm (W) x 41mm (H) x 208mm (D)

price only **\$399.00 Limited stocks at this price.**

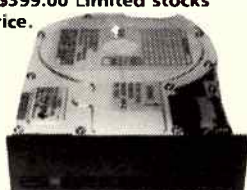

READER INFO No. 75

CAT DD3146H/DD3142H

40 Megabyte 3.5 inch hard disk drive

- Access time track to track 8ms
- Average seek time 35ms (28ms for DD3142H)
- Formatted capacity 40 3MB (43 3MB for DD3146H)
- Data transfer rate 625Kb/sec
- Power consumption 9 2W
- Non-operating shock 40G
- Size 41 3mm (H) x 101 6mm (W) x 146mm (D)

price only **(DD3146H) \$695.00 (DD3142H) \$745.00**

READER INFO No. 76

CAT CAMCASE

3.5 inch Tray

This adaptor tray enables a 3.5 inch slimline floppy drive to be mounted in the same space normally occupied by a 5.25 inch drive It comes complete with a 5.25 inch to 3.5 inch power adaptor cable

price only **\$25.00**

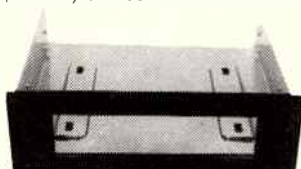

CAT CAEX5

5.25 inch External Drive Case

This case permits external mounting of a 5.25 inch hard or floppy drive It comes complete with 37 pin connector and cabling to connect to a controller with an external socket

price only **\$99.00**

CAT CEAX3

3.5 inch External Drive Case

This case permits external mounting of a 3.5 inch half height hard or floppy drive It comes complete with 37 pin connector and cabling to connect to a controller with an external socket

price only **\$99.00**

READER INFO No. 77

CAT DC2300

IBM Hard Disk controller

The DC2300 is a high performance hard disk controller card for IBM PC, AT or compatible computers

- Half size, suitable for the rightmost short slot
 - The most reliable Digital Phase Lock Loop circuitry
 - CRC and ECC functions ensure data integrity
 - On board copyright BIOS
 - Default 3 to 1 interleave Selectable from 1 to 9 by user
 - User-friendly on screen physical format, parameter settings
 - On-screen user selectable drive types
 - Shipdisk software included in the BIOS
 - Support 2 ST506-type drives The drives can be in different types
- Included 1 x 20 way cable, 1 x 34 way cable
- price only **\$199.00**



READER INFO No. 78



DISK DRIVE SOLUTIONS

NEC

Don't compromise!! Get NEC quality for the price of a "cheapy"!!

Whatever your disk drive needs, Electronic Solutions has the answer, with a complete range of floppy and hard disks, adaptors, external cases and compatible disk controllers. We sell the superb quality NEC drives - at prices as low as the "cheapies". Now you don't have to compromise! NEC make the most reliable and hard wearing drives in the industry. Don't settle for less!!

CAT DC2200

IBM XT Hard Disk Controller

The DC2200 is a high performance hard disk controller for IBM PC XT and compatible computers It is fully hardware compatible with the IBM XT hard disk controller

- Half sized card,
 - Uses highly reliable Digital Phase Lock Loop circuitry
 - CRC and ECC functions to ensure data integrity
 - On-board copyright BIOS
 - Default 3 to 1 interleave factor can be varied from 1 to 9 by the user
 - User-friendly on-screen physical format, parameter settings
 - On-screen user selectable drive types
 - Shipdisk software included in the BIOS
 - Supports 2 x ST506 type drives The drives can be different types
- price only **\$149.00**

CAT DC1240

Floppy Drive controller: 2 Internal/2 external or 4 internal drives

This is a high performance floppy disk controller card for IBM PC XT AT and compatibles The card can interface up to 4 floppy disk drives configured as 2 internal and 2 external or 4 internal The diskette drives can be the combinations of any of the following diskette drives

- 5.25inch 360K or 1.2Mb
- 3.5 inch 720K or 1.44Mb

An external drive can be added by purchasing the appropriate drive and case cable (part number CAEX5 CAEX3)

price is only **\$149.00**

READER INFO No. 81 RING US FOR OUR COMPLETE CATALOGUE

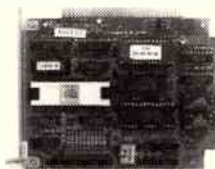

READER INFO No. 79

CAT DC2210

Hard Disk/Floppy Disk Controller Card



This card provides high performance of up to two (2) hard disks, while also controlling up to two (2) floppy disk drives, either 5.25" 360KB or 1.2MB, or 3.5" 720KB or 1.44MB, for the PC "XT" or compatible computer

- Digital Phase Lock Loop circuitry
- CRC and ECC functions ensure data integrity
- On board BIOS (copyright)
- Default 3 to 1 interleave factor Selectable from 1 to 9 by the user
- Shipdisk software is included in the BIOS
- It supports two (2) ST506-type drives The drives can be different types
- It controls up to two (2) floppy disk drives

The drives can be different types in any combination of 5.25" 360KB or 1.2MB, or 3.5" 720KB or 1.44MB

price only **\$175.00**

READER INFO No. 80

ELECTRONIC SOLUTIONS

Postal Address:
Box 426 Gladesville 2111
Phone (02) 427 4422
We accept: Bankcard, Mastercard & Visa.
Mail orders our speciality.
Prices include sales tax.

Note: Products may vary in appearance from those pictured. In all cases they will perform to the same or better standard.

- All products carry a 14 day money back guarantee
- All products carry a full 3 months warranty (excludes software)
- All cards come with full documentation
- Ring for quantity discounts and tax free prices
- Freight \$7.50 for first item, then \$2.50 for each extra item.

Dealer Enquiries Welcome

The final voyage

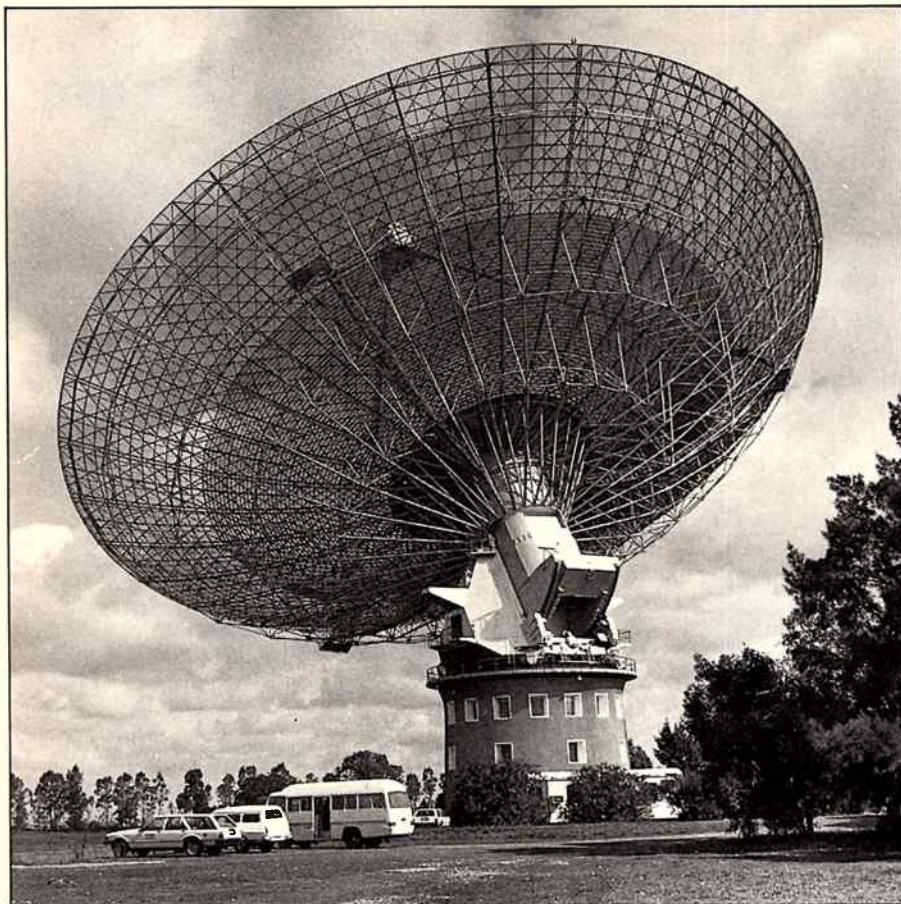

The 64-metre diameter radio telescope near Parkes, NSW.

Bear in mind that Voyager is currently four light hours from Earth, so it would take four hours for instructions to reach the craft, and then another four for an acknowledgement to come back.

Ten per cent of Voyager's total memory space is taken up with protection algorithms to prevent controllers on Earth damaging the craft. For instance, certain combinations of electronic load will tax the power supply, leading to the danger of overheating. If mission control attempts to switch in the wrong combination of load, the CCS can step in and stop it.

In addition, the CCS controls directly the digital tape recorder and the radios. When Voyager was launched, the tape recorder was a model of state-of-the-art engineering. It can store up to 96 video images as PCM data on its tape. Bit rates can be set between 7.2 kbits and 115.2 kbits.

The FDS is responsible for looking at information coming back from the sensors and converting it into a data stream for transmission to Earth. The sensors include twin cameras, a long-lensed 1500 mm device and a 200 mm wide angle. There is also a polarimeter, a pair of rabbit ears that form a radioastronomy experiment, infrared and ultraviolet sensors, a magnetometer for detecting magnetic flux and detectors for

plasma, low energy particles and cosmic rays.

Naturally, the most resource hungry of these devices is the camera system. Its 800 x pixel images, each 8 bits deep, require 5M to describe. It requires substantial amounts of time on the tape recorder and the down link to Tidbinbilla.

Just before the Uranus encounter, this requirement was alleviated somewhat by converting the algorithms in the FDS so that image data is now delta modulated. Since many Voyager pictures show little change in detail pixel by pixel, this method has proved extremely successful. More recently, other encoding and data compression systems have also been developed to increase the information content of the data system.

The AACs can be broken down into attitude sensors and thrusters. The attitude sensors consist firstly of gyros, secondly of a number of cameras that point at various astronomical objects. One usually points at the sun, another at the star Canopus and a third at another astronomical object. Using these three sensors, the AACs can accurately compute the craft's stability at any given time.

Attitude control can be accomplished in two ways. Corrections can be made by

exerting pressure on the axes of the gyros. A more powerful method is to use small thruster rockets on the craft. These use hydrazine fuel. Obviously, hydrazine is a non-renewable resource, so it is used sparingly.

Trouble

Voyager is by no means a new spacecraft. Things have gone wrong. Shortly after it left Earth, for instance, one of its two radio receivers failed and the other malfunctioned significantly. During the Saturn encounter, the belt that drives the camera panning platform jammed. Even worse, part of Voyager's brain, its on-board memory, has failed.

Trouble with the radio began on 16 April 1978, when a failure protection algorithm in the CCS detected that no radio communication had been received for a week. Interpreting this as a failed radio, it switched to its backup. This monumental blue was caused by Jet Propulsion Laboratory (JPL) controllers simply forgetting to talk to Voyager 2. At the time, Voyager 1 was undergoing a series of problems that distracted their attention. Interestingly, such simple but fatal mistakes seem to happen to all players: Moscow announced the complete loss of the Phobos 1 craft journeying to Mars for much the same sort of reason.

When JPL realised what had happened they immediately attempted to switch back to the primary receiver, only to find it had failed completely. To add to their woes, when the backup came back on line the automatic frequency control circuit had failed, depriving it of most of its bandwidth. Now Voyager is completely unable to drive its reception frequency up and down to lock on to the uplink from Earth.

Since mission control will never get its hands on the hardware, it's impossible to tell precisely what went wrong. However, all the current characteristics of both receivers can be explained by assuming a supply of dud capacitors.

In the meantime, controllers have learned to live with the crippled radio. They now adjust the uplink frequency to keep in touch. They have learned that the reception frequency is critically dependent on temperature and can now predict how the frequency will change as a result of spacecraft orientation, turning power on or off, and so on. Nevertheless, for the last seven years, engineers at JPL have been living on borrowed time. They have assumed that every communication will be the last, and in consequence, plans for a rudimentary encounter with Neptune have been in the spacecraft memory since the Uranus encounter. Soon, the waiting will be over.

Tidbinbilla

During the Neptune encounter the spacecraft will be mostly invisible from the

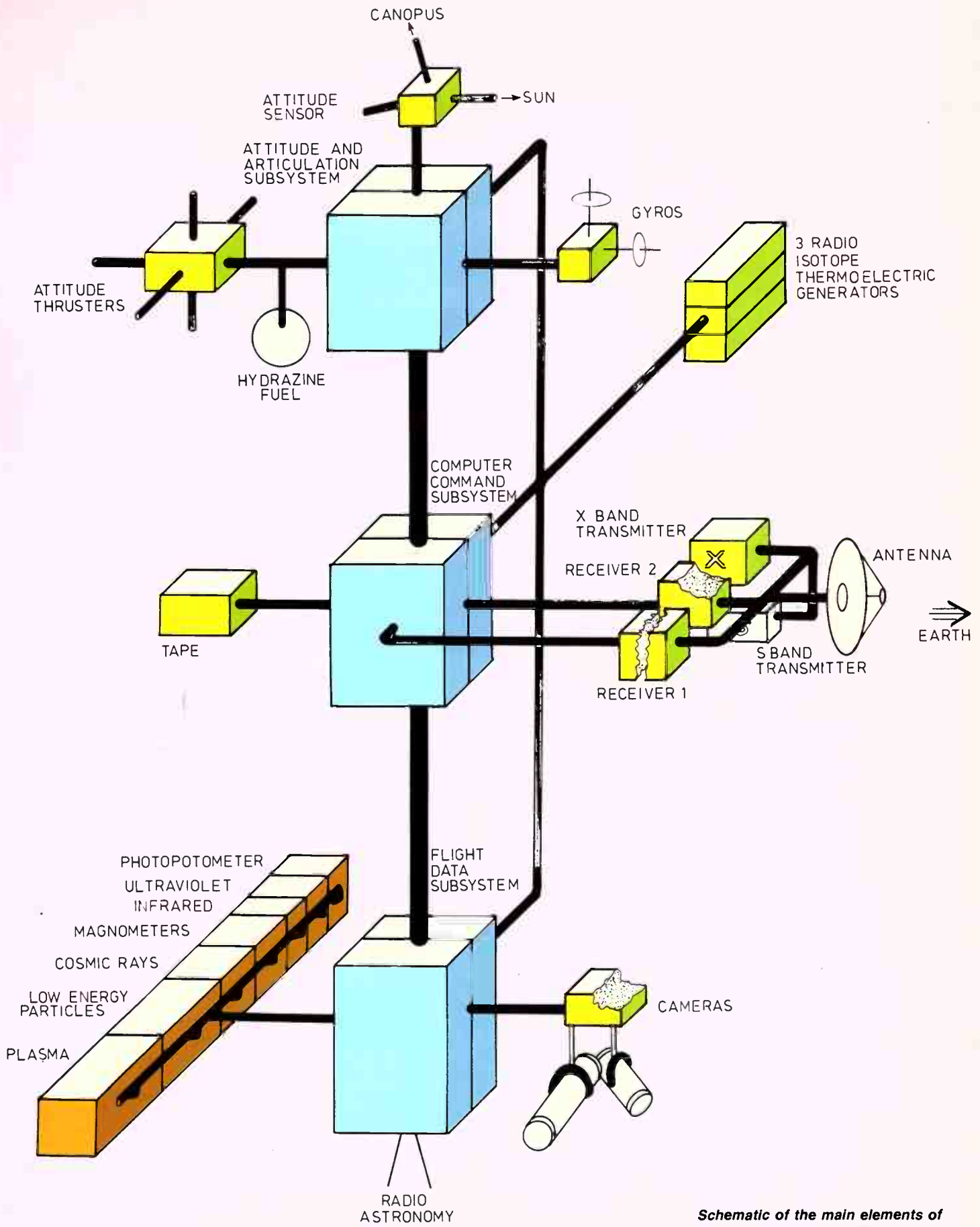

Schematic of the main elements of Voyager's computer system.

The final voyage

USA, but visible for most of the day from Australia. Thus NASA's receiving station at Tidbinbilla, just outside Canberra, is crucial to the success of the mission.

Since the Saturn encounter two factors have dominated NASA's strategy for getting usable signals from Voyager. Firstly, the spacecraft is moving away from the Earth. This is important because it means that Voyager's signal is becoming fainter as time goes by, thus more difficult to hear. The energy reaching Earth from Voyager's transmitter is only 10 per cent of what it was during the Saturn encounter.

The second factor to consider is that Voyager is also moving away from the sun. This means that Voyager's camera, its most important instrument, must make do with progressively less light. In Neptune's sky, the sun is just a rather bright star, casting a light only marginally brighter than a full moon here on Earth. This has profound implications for photography, because the camera must stay open for much longer to receive the same amount of light.

In spite of all the handicaps, Voyager pictures have not deteriorated much as it has mapped more and more distant landscapes. Scientists have invented new techniques to encode data from the spaceship. By reprogramming the FDS, it is now possible to send more information in the same period of time. Most importantly, engineers have been upgrading the receiving antennae so that it's easier to pick up the faint signals from the other side of the solar system.

At Tidbinbilla NASA has increased the size of the main dish from 64 to 70 metres and reshaped and recovered it to a much higher degree of accuracy. Much of the receiving gear has been ripped out and replaced by newer and more sensitive equipment. The dish at Tidbinbilla has been linked to the CSIRO's radio telescope at Parkes by a Telecom microwave line, thus doubling the receiving area available.

The signals from the two dishes can be combined and sent over a new optical fibre tail to intercept the main Canberra-Sydney optical transmission line. In Sydney the signals, still on optical fibres, are routed to the new OTC station at Oxford Falls outside Sydney, then beamed across the Pacific to the Jet Propulsion Laboratory in California. According to John Saxon, the operations manager at Tidbinbilla, the result is a realtime transmission system that is not bandwidth-limited in any way.

The net result of all this has been to more than double the sensitivity of the receiving system since the Saturn encounter in 1981. This is still not enough, by itself, to completely compensate for the reduced signal strength. Received power from the spacecraft is falling off at the inverse square of distance, so the power is now down 10 dB. Total



The Tidbinbilla tracking station is one of three that make up NASA's deep space network.

improvements to the reception system, including the addition of the Parkes dish, amount to slightly less than 4 dB. However, new coding techniques developed at JPL mean that more information can be squeezed out of the signal.

Neptune

The planet Neptune orbits the sun at an average distance of 4496 million kilometres, 30 times further away than the Earth. It has one large moon, Triton, and a small one, Nereid. Scientists, as is their wont, have developed a number of different models to account for their observations of Neptune.

We know little enough. At one stage it was thought that Uranus and Neptune were just smaller copies of the two large gas planets, Jupiter and Saturn. But the numbers do not add up. Neptune is huge compared to the Earth. It would take four Earths to fit into one Neptune. Even so it is small compared to Jupiter. On the other hand its density is intermediate between that of Saturn and the Earth. In fact, it turns out that Neptune has almost the same density as water. Whatever else may be the case, it is apparent that Neptune is neither wholly gas, like Saturn, nor wholly rock, like the Earth.

One plausible theory gives Neptune a rocky core, weighing perhaps six times as

much as the Earth. Above this is a mantle of water and above that again a deep ocean of hydrogen and methane. It is unlikely that there is any sharp division at the water/gas boundary. Under the enormous pressures at the bottom of the atmosphere, the methane and hydrogen will form a liquid.

However, this model assumes the core is relatively cool. If it is really hot then the bottom of the atmosphere may be so hot and compressed that the methane gas is breaking up into carbon and hydrogen atoms. The carbon atoms would presumably join together to form some carbonous material. Humorists among planet scientists have pointed out that large diamonds would fit the bill quite nicely.

Much more exciting than Neptune is its largest moon, Triton, one of the biggest in the solar system (probably about fourth in line) and, along with Saturn's Titan, one of two that have an atmosphere. It goes around Neptune in the direction opposite to that in which all the other satellites go around their parent planets. Calculations show that its orbit can't last for ever. Just as our moon is gradually moving further away from the Earth, so in Neptune's case Triton is gradually coming closer. Eventually, in a few hundred million years, it will spiral right into the planet.

In fact, Neptune's satellites seem to be part



South Wales made an infrared image of the Uranian rings themselves, proving they really did exist. Finally, Voyager 2 showed them in close-up detail. Thin, tenuous bands of ice, they are darker than charcoal.

Now interest centres on the rings of Neptune. Numerous teams around the world have tried to detail them. Observations made until now have been tantalising. Some groups have reported them, others not, so that now the favoured theory is that the rings of Neptune may well be clumping together, half way to forming a planet, in fact.

The future

Beyond Neptune there is nothing but the void of empty space. Some time within the next 30 years Voyager will cross the heliopause, the line where the outflow of particles from the sun meets the general intersellar environment. Its final job for its makers will be to find that line, and to sample directly the particles of galactic space.

According to the assistant project scientist, Ellis Minor, Voyager will continue to operate for many years, assuming its electronics holds up. JPL has identified five factors that will terminate spacecraft life: around the beginning of next century the sun lock will fail, making it difficult to keep the craft pointing back at the Earth. At about 2023 the supply of hydrazine for attitude correction will give out. The power unit will fail at about 2015. Downlink telemetry, at about 20 bps, will fail in 2165 assuming that no effort is made to build bigger dishes here on Earth. With the same antenna, it will be possible to uplink instructions to the craft until 2217.

It's interesting to contemplate the thought that future engineers at JPL, whose mothers aren't yet born, will one day be able to turn on the receivers of Voyager and make measurements of particle density. Perhaps, too, their astronomical contemporaries will watch with interest the carrier wave from Voyager's receiver.

The radio science experiment broadcasts a signal of precisely known frequency. By watching the way the frequency is Doppler-shifted it is possible to make extremely precise measurements of the spacecraft's speed away from us. Since Voyager's speed depends now entirely on the gravitational field in its vicinity it is, in effect, a gravitational sounding buoy. Some scientists hope that by tracking Voyager for another century or so we may find small deviations from its predicted path. They will tell us something about the dark matter that lies beyond the known solar system. Perhaps, in its final moments of glory, Voyager will point at the mysterious planet X, the tenth and as yet undiscovered planet of the solar system. If it does, it will be a fitting end to one of the greatest achievements of our time. 

of a puzzle that includes Pluto, Uranus and its satellites. Pluto is the planet that normally marks the edge of the solar system. However, its orbit is so highly excentric that it sometimes, as now, approaches the sun even more closely than Neptune. There are good reasons for supposing that Pluto and its companion, Charon, are escaped satellites of Neptune.

One theory devised by astronomers is that at some stage in the past the outer solar system was massively disturbed by the approach of another object, possibly a star or even a more remote, and as yet undiscovered, planet. This approach linked Pluto to Charon and sent them hurtling off into the void, upset the orbits of the remaining Neptonian satellites, and also disturbed Uranus.

Another enigmatic feature of Neptune is its rings, or arcs. Once, not so long ago, before the space age, scientists thought that only Saturn had a ring. We now know that they are a feature of all the outer planets. Voyager 1 sent back startling pictures of Jupiter that showed it has a ring system. In the late 1970s researchers detected rings around Uranus and in 1981 researchers at the University of Wollongong announced very small rings had been detected on Neptune. In 1984, astronomers at Siding Springs in New

— **PROTEL** —
AUTOTRAX \$1290
SCHEMATIC \$890

— **RACAL-REDAC** —
CADSTAR INTERACTIVE \$3600
CADSTAR SCHEMATIC \$900

— **PC-CADAT** —
ADVANCED SIMULATION \$6000

— **ORCAD** —
SCHEMATIC P.O.A.
DIGITAL SIMULATION from \$1900

— **PSPICE** —
ANALOGUE SIMULATION from \$1295
available now from

RCS CADCENTRES

03 499 6404

OR

02 805 1916

READER INFO No. 11

THE ULTIMATE HIGH PERFORMANCE BABY AT MOTHER BOARD — AT4000

Featured in ETI Aug, Sept, Oct '88.
Uses VLSI Technology inc. AT chipset.
(Used by IBM in the PS2-30/286)

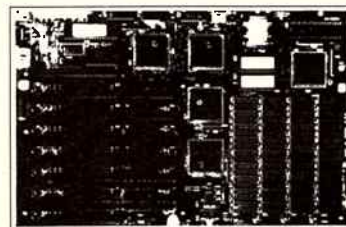

AT-4000

Features: • Socketed for up to 4 M Bytes of RAM
• 12 MHz Operation, Zero Wait States • Norton Speed Index 15.3. 6x16 & 2x8 Bit Slots, AMI BIOS. CMOS tech. Ideal upgrade for XT **\$598.80**

SPECIALS

EC-452 2 Serial & 1 PRN. assembled & tested. \$89
Featured EA May '88
EC-EGA + W/Centronics/Mouse port/SW \$275
EC-CGMA 640x400 CGA+, CGA, HGA, MDA.
Featured EA June '88 \$179
AT System — AT 4000 + 512K, CGMA, 452, 360/1.2mb, FDD, 200W P/S101 key Deluxe Keyboard \$1499

DISKETTES

5 1/4 DSDD pk10 \$6.19 3 1/2 DSHD 1.44 MB \$49.90
5 1/4 DSHD pk10 \$17.88 4164-150 100 up \$2.76 ea.
3 1/2 DSDD pk10 \$19.90 plus p&p inc. tax

26 Boron St, Sumner Park
Brisbane, Qld 4074
Phone: (07) 376 2955
Fax: (07) 376 3286
WELLINGTON, NZ:
(04) 85 8742 Fax: (04) 828 850

KEN CURRY
Managing
Director



energy CONTROL

READER INFO No. 12

ETI MAY '89

59

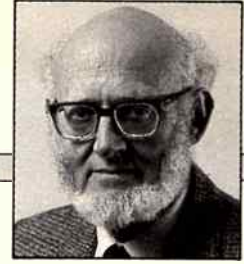

JOHN COULTER

LOSING THE COMMON THREAD

Of fires, fish and flying doctors. . .

John Coulter looks at several problems facing Australia today and offers an idea for one common solution. Why hasn't Government come to the same conclusion? The answer, Coulter believes, is sheer bureaucratic rigidity.

JK Galbraith, in his book *The New Industrial State*, clearly illustrates the ways in which both public and private bureaucracies attempt to protect themselves. Individuals working within the bureaucracy identify strongly with their organisation and see their security linked with its security.

From time to time, a country faces a number of apparently unrelated problems, each of which has a common solution. When these problems fall within the authority of different departmental bureaucracies and the implementation of the solution involves co-operation, or even more threatening, abandonment of power and control, then that solution has a difficult time being accepted.

This is the situation in Australia today.

Over twenty years ago, the Canadians developed an amphibious, fire-bombing aircraft, the Canadair CL 215. The aircraft has been in use ever since, has shown itself to be highly successful and reliable and has come into use in a number of countries. Best described as a large, multipurpose flying truck, it was developed initially as a water-bombing aircraft for bushfire fighting. In this mode, it

carries two three tonne water tanks which are filled in 10 seconds by skimming the surface of a river, lake or sea.

It requires approximately one mile to descend from 50 ft, scoop and return to 50 ft and can operate in seas up to 2 metres. Canada, Spain, France, Italy, Yugoslavia and Greece all have fleets of these aircraft for use as aerial fire fighters.

When in Greece recently, I visited the Air Force base just outside Athens from which the squadron of CL 215s operate. In that country, bushfire fighting comes under the control of the Ministry of Agriculture. If a fire becomes serious enough to warrant aerial attack the Air Force base is notified and four CL 215s are immediately dispatched. Being fully amphibious they are already loaded with water and take off from a normal airfield.

Consider three recent fires in Australia. The fire in the Royal National Park, just south of Sydney, occurred right beside the sea; the fire in King's Park, Perth, bordered both Perth Water and Melville Water on the Swan River; several years ago, fires at Mt. Remarkable in the mid-north of South Australia burnt for 5 days and caused horrendous destruction to a national park.

Spencer's Gulf was no more than 10 kms away. All these and many other Australian bushfires could have been quickly, safely and less destructively controlled if Australia had a fleet of CL 215s.

Why don't we have such a fleet? Although cheaper in the past, the current price is approximately \$13m each. A fleet of 20 would cost \$260m - about the price of 3 FA 18 fighter aircraft. These planes are too expensive as single purpose fire-fighting aircraft of course, and this is where the wrangle between the bureaucracies begins. These flying trucks are perfectly suited to a number of other tasks, mentioned below, which Australia presently performs badly - but multiple roles means abandoning some control to another authority. Ideally, the aircraft would be flown by the Navy Fleet Air Arm and would be called in by the various bushfire authorities as required, just as the Greek Air Force unit is called in. Computer studies carried out by project Aquarius on behalf of Australian fire authorities attempted to show that the CL 215 would not work in Australian bushfire conditions. The computer was programmed to make all drops from greater than 200 ft. When I mentioned this to

the Greek Air Force, they laughed. Drops in Greece, made just ahead of the fire, are at treetop height - between 30 and 50 ft. Fire authorities keep quoting the result of this computer study and thus keep their total control.

Australia has a long northern border. Fisheries incursions are common, drugs are transported by sea and air from Asia and introduction of exotic diseases may wreak havoc on our agricultural trade at any time. The problem has been labelled "Northern Surveillance". We send miniscule planes on scheduled routes at regular times to warn law-breakers that we know they're there and follow it up with a navy ship that takes four days to reach the rendezvous. By that time, the law-breaker is gone - possibly back into international waters.

Without replacing its water tanks, the CL 215, carrying a fully armed and equipped boarding party, could land near the offending vessel and arrest it then and there. Co-operation between Navy, Customs, National Parks & Wildlife and Agriculture would be required.

The CL 215 is also an excellent sea rescue craft with the ability to fly 890 kms out to sea, search for half an hour, land, pick up survivors and return. It could serve a number of other useful roles - servicing offshore lights and buoys, flying supplies to islands, acting as a flying doctor service to remote locations without landing strips and, in the event of war, being a useful amphibious troop carrier for quick deployment of troops and equipment.

Senator John Coulter is the spokesman for the Australian Democrats on Science and Technology.

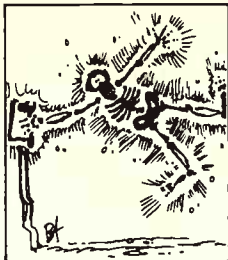

ELECTRONICS
ETI - 299

"Hands-free" operation of a transceiver or tape recorder can be mighty convenient. For making verbal notes while you're busy doing something, triggering the tape recorder by the sound of your voice leaves your hands free to write or do other things, as necessary. For radio amateurs and CBers, triggering the transceiver from your voice can make operating a pleasure, particularly in the rapid to-and-fro style of "net" contacts or DX chasing.

The voice-operated relay circuit, or VOX as it came to be known, rose to popularity

with the rapid development of single side-band among amateurs in the 1950s and 1960s. Many of today's HF and VHF/UHF SSB transceivers sport a VOX as one of the features.

The VOX principle

The block diagram in Figure 1 shows the general arrangement. An audio signal from a microphone or mic line is first amplified. The amplifier stage's output is then rectified, developing a dc output proportional to the input level. This dc level is then "held", or "delayed", for a short period and operates a relay driver which closes the contacts of a relay for the period of the "delay".

The delay stage is there so that the relay doesn't "chatter" with the variations in voice level and slight pauses that naturally occur in speech. So, when you cease speaking, the relay will "hold in" for a moment. The delay period may be set by a variable control, to suit the conditions and the application. Typically, the delay may be varied between about 50 milliseconds and a few seconds. In addition, the input level is usually variable too, to allow you to set the level at which the relay is triggered.

The relay contacts are connected, in the case of using the VOX with a transceiver, to the transmitter "keying" line; that is, the push-to-talk (PTT) switch connections, or when using the VOX with a tape recorder, to the "remote" switch socket. The tape recorder

is set into the RECORD mode and the PAUSE control operated. So, whenever the VOX relay operates, the tape immediately commences recording.

Note that there is always a slight delay when the relay operates, mostly because the relay itself will take typically 20 to 50 milliseconds or so to close the contacts. Hence the first syllable, or part of the first syllable, of a word may be "clipped". This can only be overcome by adding an audio delay circuit in the microphone line to compensate; but this complicates the circuitry and adds to the cost. In practice, you get used to it, by adding a short "um" or "ah" at the start, each time you speak.

Assembling the VOX

The VOX is assembled on a 110 x 30 mm printed circuit board. Whether you etch your own board or buy a ready-made one, you should first inspect the board to see that all the holes are drilled and of the correct size for the components. This particularly applies to the relay. If you are using preset controls for RV1 and RV2, drill the appropriate holes to take the components used. Note that only two connections are needed on the board, the other "leg" of each trimpot may be bent up out of the way.

When examining the board, also look for small copper "bridges" between closely spaced pads on the board, around the transistor positions and the IC. You should

VOICE-OPERATED RELAY

This project switches a relay when the audio level from a microphone or on an audio signal line reaches a predetermined level. Great for making a voice-operated tape recorder or arranging voice-operation (VOX) for a transceiver. By Roger Harrison.

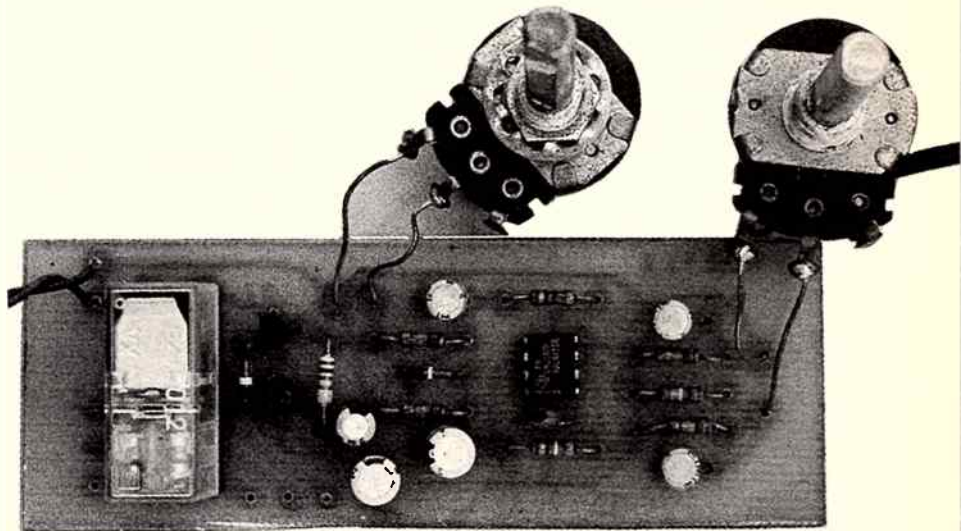

View of the completed project, prior to installation.

Voice-operated relay

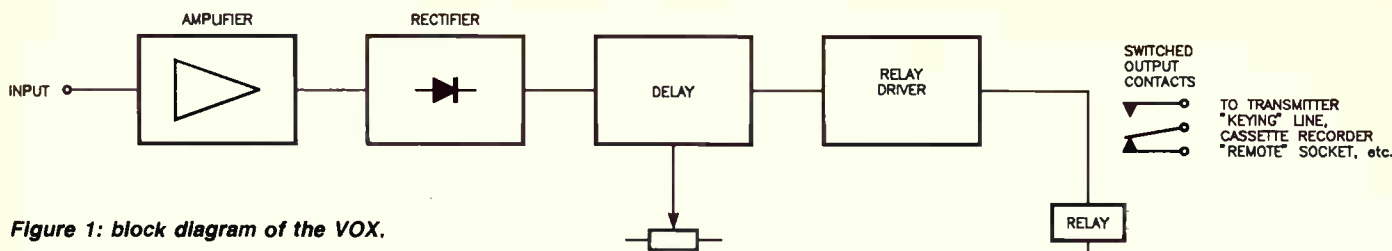
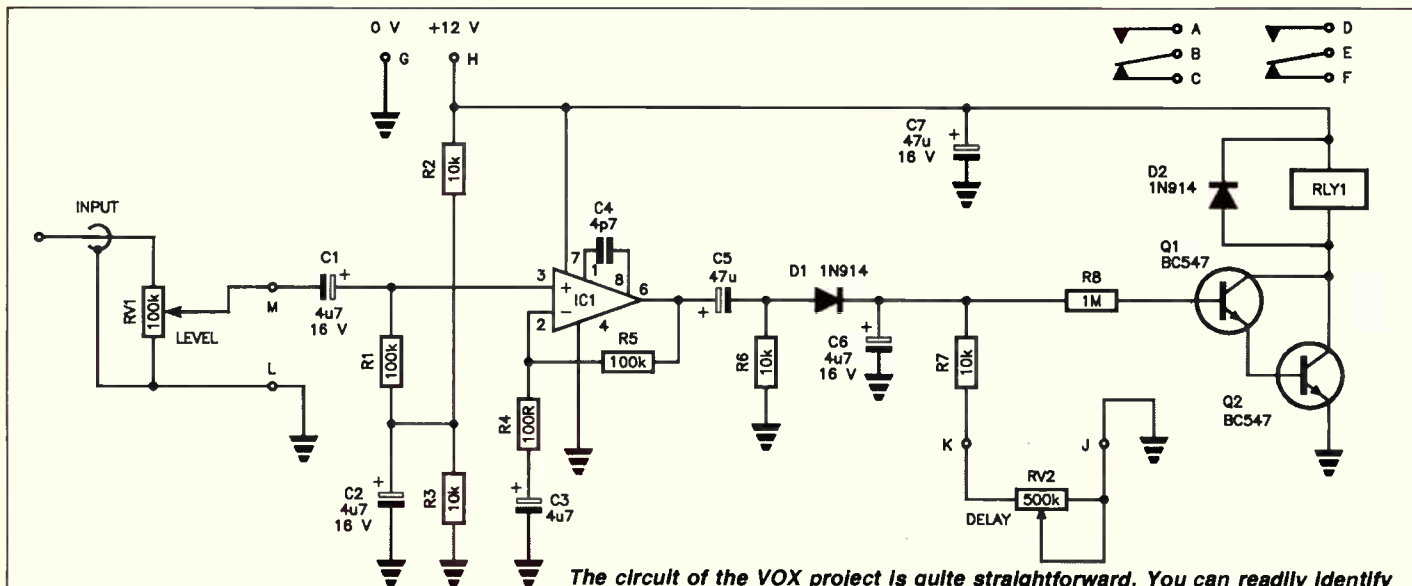

Figure 1: block diagram of the VOX.



The circuit of the VOX project is quite straightforward. You can readily identify the different stages with reference to the block diagram in Figure 1.

How it works

If you examine the circuit in conjunction with the block diagram, the various stages are easily picked out. The input is amplified by the 301 op-amp, IC1. Its output is rectified by D1 which charges a capacitor, C6. It charges very quickly when audio appears at the input, but discharges very slowly, via R7-RV2. The time taken to discharge C6 determines the delay.

The relay driver consists of a Darlington pair, Q1-Q2, with the relay in their collector circuit. The Darlington pair only requires miniscule base current, a microamp or less, and thus does not affect the discharge of C6 so that the delay time is determined principally by R7-RV2.

The input from a microphone, microphone line circuit or other audio signal circuit, is applied to potentiometer RV1, which sets the level sent to the amplifier stage, IC1. This stage amplifies the incoming signal by 1000, determined by the ratio of the feedback resistors, R5 to R4.

As a single supply rail is used for convenience, rather than dual +/− supply rails, the non-inverting input of the op-amp is biased up to half the supply rail voltage by the voltage divider R2-R3. This bias point is bypassed to the ac signal by capacitor C2. Hence, the input from RV1 is ac-coupled via capacitor C1.

The gain of the 301 is reduced to unity (1) at dc by virtue of capacitor C3 in series with R4. This increases the negative feedback around IC1 at low frequencies, finally falling to unity at dc. This reduces dc offset at the 301's output, which will actually be very close to half the supply rail voltage.

Typically, a few volts of audio will appear at the output of IC1, appearing across resistor R6. Capacitor C5 isolates the dc level on pin 6 of the 301, coupling just the ac signal to the rectifier, D1. The positive-going cycles will be passed by D1, charging C6 to the peak level of the signal.

As I said earlier, C6 will charge very quickly, typically within the first cycle or so of the audio being applied to the input. When the dc voltage across C6 reaches about 1.2 volts (the voltage necessary to turn on Q1-Q2), the relay will pull in as Q1-Q2 conduct. As the Darlington pair has a high input impedance and high gain (typically about 20,000), the circuit will provide enough collector current in Q2 to operate the relay coil, but the Q1-Q2 base current is so low that it does not materially affect the discharge of C6, and thus the "hang" time.

When the incoming audio ceases, C6 discharges comparatively slowly, and the relay will remain operated until the voltage across C6 falls below 1.2 volts, whereupon the base current to Q1-Q2 will not be sustained and they will turn off, releasing the relay.

A 12-volt supply is employed, although this may range between about 10 V and 15 V. However, if you use a supply rail below 12 V, make sure the relay will operate reliably. Most 12 V-coil types available will operate quite happily down to about 9 V. The project will draw around 50-80 mA with the relay operated, depending on the relay's coil resistance.

The supply rail is bypassed by C7. Diode D1 "snubs" the back-emf of the relay coil when it turns off, preventing damage to Q1-Q2. Capacitor C4 provides frequency compensation of the 301. The relay specified has two sets of changeover (DPDT) contacts, so that more than one circuit may be operated by the VOX.

The input level and delay potentiometers, RV1 and RV2 respectively, may be either panel-mount controls (as specified and used with the prototype), or preset trimpots where the project is built into another piece of equipment and the controls set for the required operation.

If you arrange the VOX to take its input from the output of a preamp or mic line amplifier stage, where the level is likely to be around 1 V RMS or more, the gain of the 301 here can be usefully reduced. Just drop the value of the feedback resistor R5 to, say, 470 Ohms. This gives a gain of 4.7, which should be more than enough for proper operation of the VOX.

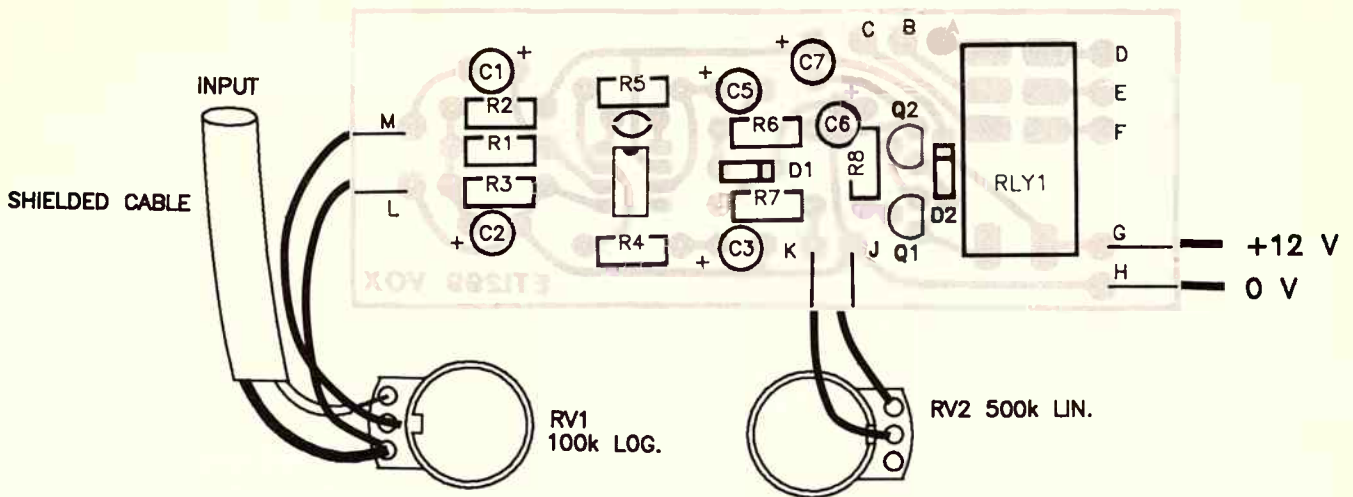

Overlay for the printed circuit board and wiring diagram, showing component placement and wiring to external components.

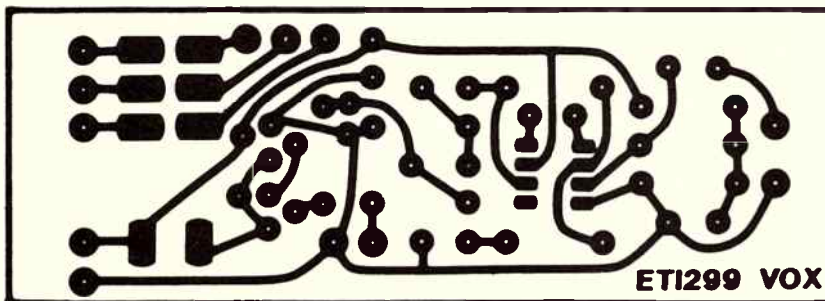

Full-size printed circuit artwork.

correct any pc board faults at this stage, before proceeding. Consider also where and how the project is to be mounted, so that you can plan and drill the necessary board mounting holes.

The resistors should be assembled and soldered into the pc board first, followed by the semiconductors - but take care to get them the right way round, as shown on the overlay diagram here. Then solder the capacitors in place. Note that all but C4 are polarised electrolytics and must be correctly orientated.

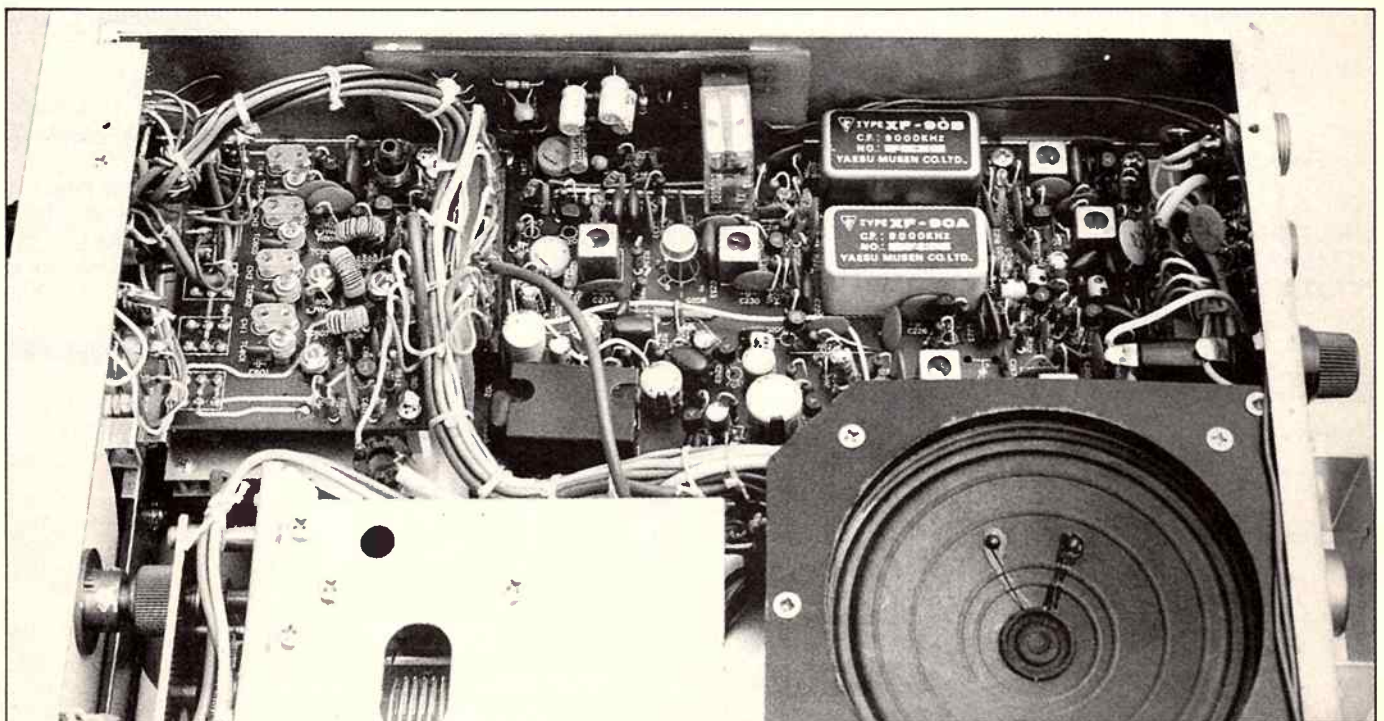

Here's the project mounted inside one of my rigs.

JOIN THE WIRELESS INSTITUTE OF AUSTRALIA

The Wireless Institute of Australia (W.I.A) represents radio amateurs in local and international matters and provides assistance, education and many other services. As a member you will receive:

- AMATEUR RADIO the monthly magazine of the WIA.
- News of DX, propagation, clubs, satellites, etc.

OTHER SERVICES INCLUDE:

- A world-wide QSL service
- Weekly news and information broadcasts
- Books and publications sales
- Classes for students for the Novice, Limited and Full Call Certificates
- Lessons by correspondence
- Participation in contests, seminars and field days
- Sole representation for amateurs at government level

Learn more about the W.I.A. and AMATEUR RADIO

Forward this coupon, or write to:

**W.I.A.
PO. BOX 300
CAULFIELD SOUTH
VICTORIA 3162**

Registered Address: 3/105 Hawthorn Road, Caulfield North

Please send a WIA membership form to:

NAME

Address

Postcode

BKP88/129A

READER INFO No. 16

Voice-operated relay

Mount the relay on the board and solder it in place next. Then attach hookup wire for all the off-board connections, having previously determined an appropriate length for them. Note that a shielded lead must be used for the signal input.

The two potentiometers on the prototype were simply connected with 22 gauge tinned copper wire as the VOX pc board was mounted inside one of my transceivers, with the pots mounted to the rear panel. You will need to cut the potentiometer shafts to length, to suit your arrangements and the knobs you use.

The VOX may be built up as a stand-alone unit, housed in a suitable case. This should be metal to obviate hum or stray RF pickup which might cause spurious operation of the VOX. The artwork for a suitable front panel is reproduced here, from which you can make a Scotchcal escutcheon.

Testing it

Before applying power for the first time, give your project a thorough visual check. See that all the soldered joints are OK; reheat any that look dodgy. See that there are no solder "dags" bridging the pads around the IC and transistors. Check the orientation of all the semiconductor and electrolytic capacitors. Once you're satisfied all is kosher, you can proceed.

You will need a dc power supply with an output of about 12V capable of supplying at least 100 mA minimum. It would be a good idea to be able to monitor the supply current. You will also need a crystal or dynamic microphone. Set RV2 (the DELAY control) fully clockwise, and RV1 (LEVEL) fully anticlockwise.

Apply power, check the supply voltage and see that only modest current is drawn (under 50 mA). Advance the LEVEL control about half way and speak one short word into the microphone. The relay should pull in immediately, then hang for some seconds after you've said the word. You may need to adjust the LEVEL control, depending on the sensitivity of the microphone used. The supply current will increase immediately the relay operates. For a typical 200 ohm relay, it will jump up about 60 mA or so.

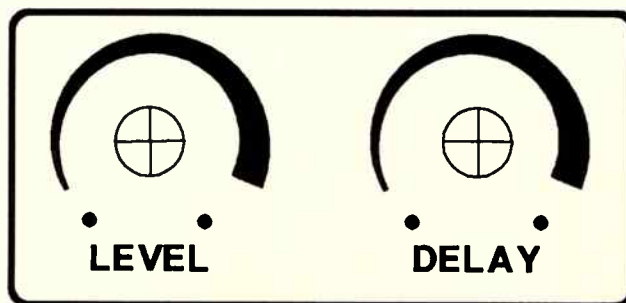

Artwork for a suitable front panel if you build the VOX as a stand-alone unit.

ETI-299

If the project doesn't behave as expected, switch off the supply and check the project for faults. See that you have the supply connected the right way round! Check for shorts on the board and check the pinouts of transistors Q1 and Q2. There is really very little to go wrong.

In use

The VOX is very simple to use. All you need do is set the LEVEL control so that the relay operates at a "normal" or "usual" speaking level, and the DELAY is set so that the relay doesn't drop out between the pauses normally encountered in your pattern of speech.

ETI

Parts list — ETI-299

SEMICONDUCTORS

D1, D21N914, 1N4148
IC1uA301, LM301 etc.
Q1, Q2BC547, BC548

RESISTORS, all 1/4 W, 5%

R1100k
R2, R310k
R4100R
R5100k
R6, R710k
R81M
RV1100k log. pot.
RV2500k lin. pot.

CAPACITORS

C1-C34μ/16 V RB electro
C44p7 ceramic
C547μ/16 V RB electro
C64μ/16 V RB electro
C747μ/16 V RB electro

MISCELLANEOUS

RLY112 V relay with DPDT contacts, pc mount or socket type.

ETI-299 pc board; hookup wire; length of single shielded audio cable; crystal or dynamic microphone (if required); any necessary mounting hardware, knobs, solder etc.

Approx. cost \$16-\$20.

IEEE-Z

Our Personal488™ IEEE (GPiB) interfaces for PC/AT/386 & PS/2s are packed with these easy-to-use features:

- DOS device driver loads at power-on
- Hewlett-Packard style commands
- Automatic error indication
- BASIC ON SRQ GOSUB capability
- DMA transfers over 300K bytes/s
- Up to four IEEE boards/computer
- NEC-7210 compatible software
- Serial/Parallel/IEEE port redirection
- DMA and interrupt channel sharing
- Compatible with popular languages (no extras to buy), including BASICA, GWBASIC, Quick BASIC, Compiled BASIC, Turbo BASIC, True BASIC, TBASIC, Turbo Pascal, Microsoft Pascal, Turbo C, Microsoft C, Aztec C, Lattice C, Microsoft Fortran, Lotus 1-2-3/Symphony/Measure, ASYST, DADiSP, Test Windows, AutoCAD, and many more.

LOtech



SCIENTIFIC DEVICES AUSTRALIA PTY. LTD.

Melbourne (03) 579 3622
 Fax (03) 579 0971
 Sydney (02) 958 8064
 Fax (02) 958 8890
 Adelaide (08) 281 3788
 Fax (08) 281 4194

ADVERTISER INDEX

Adlam	IFC
Alcatel STC Cannon	94
AMP	9
Avtek Electronics	38
Bose Australia	OBC
Coherent Electronic Systems	65
Control Data	32
Crestmore	126
Diamond Valley Micro Systems	83
Dynamic Components	98
Electronic Solutions	54/55
Falk ElectroSound	118/119
Hitachi	124
Jaycar	109
JED Microprocessors	93
Kalex	74
Kenwood	105
Kepic	48
Maestro	13
Meiko	59
Philips Scientific	73,75
Protel	12
RCS Design	59
RF Devices	4
Ritronics	10/11, 33
Scan Audio	128
Scientific Devices	65
Scope	89
Telecom	66/67
TMR	97
Tecnico Electronics	97
Tech Rentals	113
Vandata	74
WES Components	22
WIA	64
Yamaha	130/IBC
Zenology	43

IBM* PC/XT/AT compatible Universal Cross Assembler

8-bit is still alive

- Quality conditional macro assembler.
- Supports Z80, Z8, 8051, 6811 and all other 6800 family microprocessors.
- 15 day turnaround for any other 8-bit micro.
- Many other features included.

FROM \$200
 (ex tax)

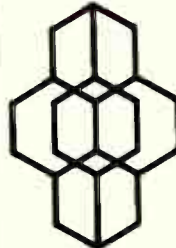

Coherent Electronic Systems
 GPO Box 2597W
 Melbourne Vic 3001
 Telephone: (03) 367 8799

*Registered trade name.

FOR ONLY **\$175** LET YOUR COM
 WORLD OF COMMUNICA
 GENERATION' SKILLS.

The image features a central figure of a person with spiky hair sitting in a director's chair, surrounded by a collage of various computer software screens. The screens display different interfaces, including text-based programs, graphics, and logos. Notable titles include 'COMMODORE 64', 'MICROTEX 666', 'COMPUTERS', 'TELESOF TWA', 'Micro Workshop', 'VIATEL', and 'TELE BANK'. The background is a colorful gradient from blue to red to green.

VIATEL SUBSCRIPTION FOR 1 YEAR	\$ 48.00*
MICROTEX 666 SUBSCRIPTION FOR 1 YEAR	\$ 66.66
MODEM	\$336.00
SOFTWARE	\$ 50.00
	\$500.66
	\$175.00

Please Note: VIATEL annual subscription does not include local call fees to connect to VIATEL (21 from anywhere in Australia), connect time charges or any frame charges you may incur.

IT'S ENOUGH TO BLOW THE MIND OF ANY COMPUTER ENTHUSIAST!

The AVTEK EXPLORER package contains a modem for the IBM PC and Compatibles or Commodore 64 and Commodore 128, Communications Software, VIATEL and Microtex 666 subscription for one year.

COMPUTER OPEN UP THE EXCITING OPPORTUNITIES AND ESSENTIAL 'NEXT'

the latest news on the computer industry, as well as advice from the experts. Microtex 666 also offers you entertainment, bargain shopping and a wealth of other services.

suitable for VIATEL and similar services, etc., and have telesoftware download capability, PLUS 300 bps full-duplex asynchronous communications to suit Electronic Mail, Bulletin Board Services, etc. Simple-to-use modems that are ideal for the first-time communicator.

MODEM

AVTEK 3+12 MODEM
FOR THE IBM PC AND
COMPATIBLES

OR

A MODEM FOR THE
COMMODORE 64 AND 128
These modems offer 1200/75 bps

COMMUNICATIONS SOFTWARE

The software has been designed to run on IBM PC XT, AT and the Commodore 64 and 128.

**ALL THIS
FOR
\$175**

The AVTEK EXPLORER communications package we are offering gives you everything you need to access VIATEL and Microtex 666.

VIATEL SUBSCRIPTION FOR ONE YEAR

Imagine from the comfort of your own home, being able to bet on the races, bank, pay bills, shop, play games, book holidays, purchase lottery tickets, send electronic mail, meet a multitude of people and much more! Well it's all possible through VIATEL. VIATEL, Telecom Australia's national videotex service is available to anybody with a telephone connection, a computer and a modem. The modem will simply and quickly connect your computer to the telephone line. VIATEL is simple to use and requires no special knowledge of computers or related terminology.

MICROTEX 666 SUBSCRIPTION FOR ONE YEAR

Computer Publications Pty Ltd's popular Microtex 666 (to be found only on VIATEL), offers a comprehensive service for PC users. Microtex 666 connects you and your computer to a nation-wide network of thousands of computer users. Microtex 666 lets you communicate with these users AND gives you MASSES of computer programs straight down the telephone line onto your PC. You can "download" software as often as you wish, any time of the day or night. Become an identity on the Microtex 666 bulletin boards, get



ORDER NOW

Please note your AVTEK EXPLORER package will include modem, connecting cables, software, Microtex 666 membership card, VIATEL membership. Sales tax and postage and handling is included in price.

TO ORDER:

Call credit card details through to AVTEK Data Communications on 008 252 754 for same-day dispatch.

OR

Simply fill out the coupon below and send it to: **AVTEK Data Communications
Freepost 16
PO Box 651
Lane Cove, NSW 2066**

My choice of modem is: (please tick)

- Modem 3 + 12 for IBM PCs & Compatibles Auto Dial Modem for Commodore 64 & 128 PCs

I currently have a: (please tick)

- IBM PC/XT/Compatible (25 pin D25 female connector) IBM/AT/Compatible & require a 9 pin connector
 Commodore 64/128 (Commodore interface)

PLEASE PRINT CLEARLY IN BLOCK LETTERS
DELIVER TO: (No PO. Box numbers, please)

NAME _____

ADDRESS _____

POST CODE _____

REGISTERED TELEPHONE NUMBER _____

CHARGE MY CREDIT CARD ACCOUNT OR PHONE THROUGH TO (008) 252 754

- BANKCARD VISA MASTERCARD

ACCOUNT NAME _____

CARD NUMBER _____ EXPIRY DATE _____

SIGNATURE _____

THE TURBO MODEM

**All speeds to
14,400 bits
per second!**

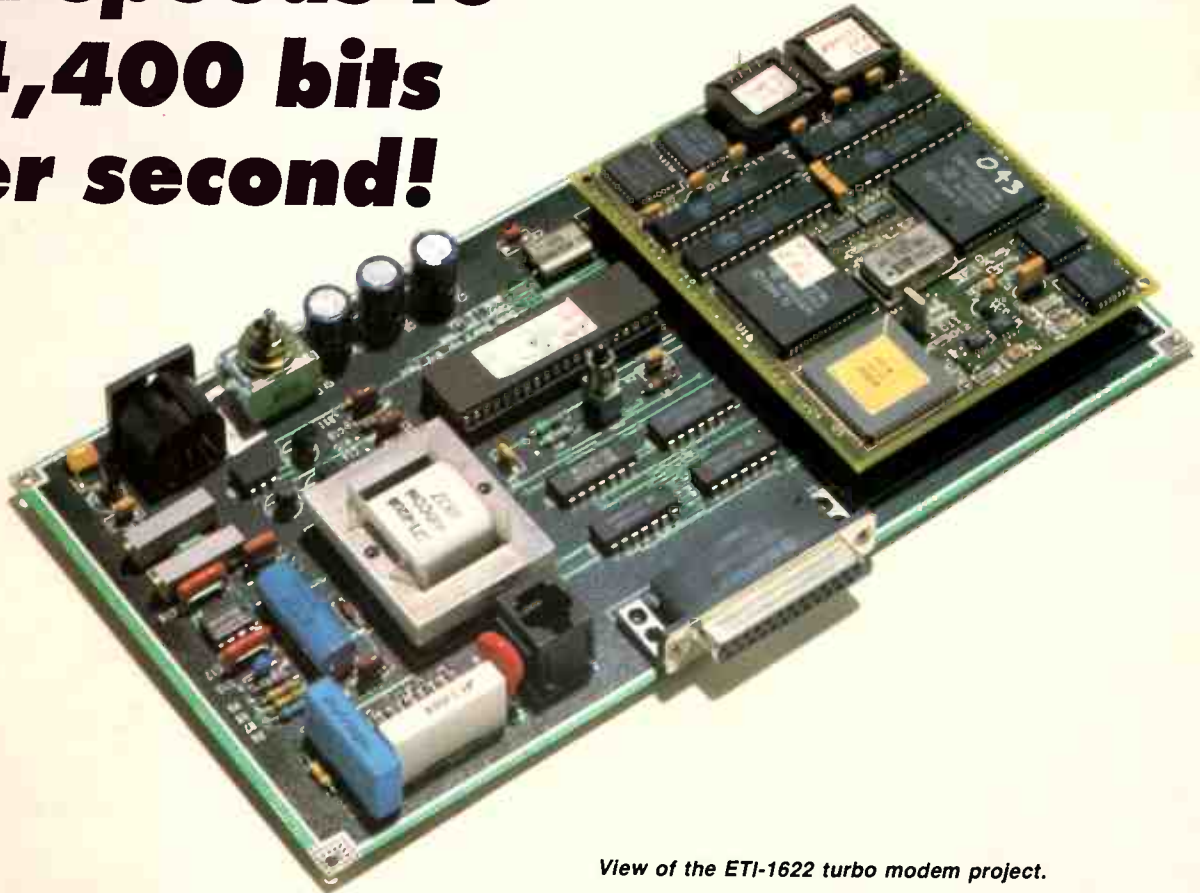

View of the ETI-1622 turbo modem project.



ELECTRONICS
E T I - 1 6 2 2

This project, right now, represents the fastest direct-connect modem you can build in the world. Based on some phenomenal new technology, it is a "smart" modem employing the Hayes command set, so that it can be entirely configured and controlled right through 1200, 2400, 4800, 9600 and 14,4000 bps. And it's available as a full kit. By Roger Harrison.

Last year, Ken Curry, proprietor of Energy Control – a major Brisbane-based importer/distributor of semiconductors and designer/manufacture of industrial electronics equipment – devised the concept of "technology demonstration projects". The PC/AT compatible motherboard described in ETI last year is a case in point. Simply put, these are projects which are designed to demonstrate the capabilities of emerging semiconductor technologies. As such, the projects may often

turn out to be the leading edge of current electronics technology and techniques, and this project certainly falls into that category. It is based on a Programmable Communications Module, the PHY-96, released last year by Phylon Communications Inc., which is based in Santa Clara (where else, but Silicon Valley?), USA.

Developments in electronics, and indeed in other spheres, depends on the emergence and application of "critical technologies", key devices or processes that spawn a rush of

ETI MAY '89

68

developmental activity resulting in new products or significant leaps in performance of existing products.

The development of the microprocessor was the critical technology that spawned the personal computer industry. The convergent development of very large scale integration (VLSI) and application specific ICs (ASICs), together with the development of compatible BIOS software (from Phoenix and Award, for example) that did not transgress IBM's PC BIOS copyrights gave rise to the burgeoning PC-clone industry.

The development of digital signal processing ICs and their application to computer modems, together with a parallel development in signal processing algorithms, are the critical technologies that have enabled a substantial leap in the performance of modems for both leased-line and dial-up applications.

Project overview

Heart of the project is Phylon's PHY-96 module, which I shall explain in detail presently. This is an 82 x 100 mm four-layer pc board, crammed with some 17 ICs with its on-board software contained in a pair of socket PLCC EPROM chips which permits future upgrades. The module comes ready-built and employs dual-in-line pin connections for easy mounting on the motherboard. The PHY-96 employs a series of surface-mount CMOS ICs which account for its small size and low power consumption.

The motherboard carries the interface circuitry that provides the connections between your computer and the line. The link to your computer is via a "standard" serial

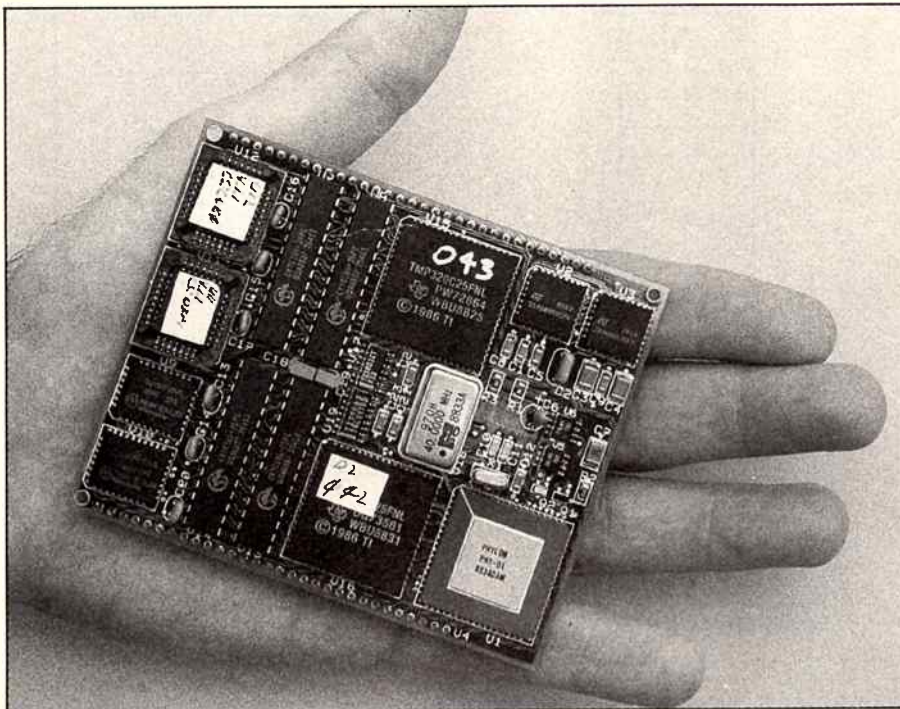

The Phylon PHY-96 module measures just 82 x 100 mm and fits readily in the palm of your hand.

APPROVAL OF DIRECT-CONNECT MODEMS

Any device which you intend to connect to a Telecom line must be "type-approved" as an attachment. It is an offence under the Telecommunications Act 1975 to attach any apparatus to a telephone line which is part of the public switched telephone network other than an approved device or an appliance leased from Telecom.

You are at liberty to construct and use the modem described here over, for example, an internal building intercom line or other private "twisted pair" line.

The electrical, electronic and physical design and layout of the project have been done to comply with relevant US type-approval specifications and for electrical safety. You may wish to substitute a locally-built, ready-made line interface or suitable other line interface components employed in locally-made modem line interfaces.

The Telecom specifications relating to this sort of equipment include documents 1050, 1053, 1222, 1240, 1302 and 1364. Authorisation for type approval must be made on Telecom's Form TS139 Data and Non-Voice Equipment Directly Connected to the Telecom Network.

Table 2: Analogue interface characteristics

Name	Type	Characteristics
TXA	AA	The transmitter output impedance is 604 ohms +/- 1%.
RXA	AB	The receiver input impedance is 66.5K ohms.
EYE	AC	The X & Y DAC output impedances are 10K ohms.

V.24/EIA232D (otherwise known as RS232C) interface using a 25-pin D connector.

A single chip microcontroller - a microprocessor with on board RAM and EPROM - that provides interpretation of the standard Hayes AT command set for configuration and control of the modem is linked with the PHY-96, and the serial and line interface circuitry. In other words, it's a "smart" modem. Auto-dial and auto-dial features are included, as you'd expect with any modern smart modem.

The line interface provides line isolation and

the auto-answer and the auto-dial circuitry. Power supply requirements are +5V and +/- 12 V at less than 200 mA total current drain. A functional block diagram of the project is illustrated in Figure 1.

Features include:

- Compatibility with the following CCITT and Bell signalling standards -

V.21	(0-300 bps)
V.22	(600/1200 bps)
V.23	(75/1200 bps)
V.22bis	(2400bps)
V.27ter	(4800 bps)
V.29	(4800/7200/9600 bps)
V.32	(4800/9600 bps)
V.32TCM	(9600 bps full duplex)
V.32bis	(12,000/14,400 bps full duplex)

Bell 103	(0-300 bps)
Bell 212A	(1200 bps)
Bell 201	(2400 bps)
Bell 208	(4800 bps)

Note that V.32bis is a Phylon proprietary mode. TCM stands for Trellis Code Modulation, a technique that permits very high speed full duplex communications with very low error rates at the sort of signal-to-noise ratios commonly encountered on the dial-up telephone network.

- Synchronous and asynchronous operation.
- Auto-dial and auto-answer.
- 27 S registers on-board.
- Automatic near and far end echo cancellation.
- Bulk delay compensation for satellite transmission.
- Transmit level max. of -10 dBm; transmit level adjustable in 2 dB steps.
- Receiver dynamic range of -43 dBm to 0 dBm.
- Equalisation: compromise equaliser in

Turbo modem

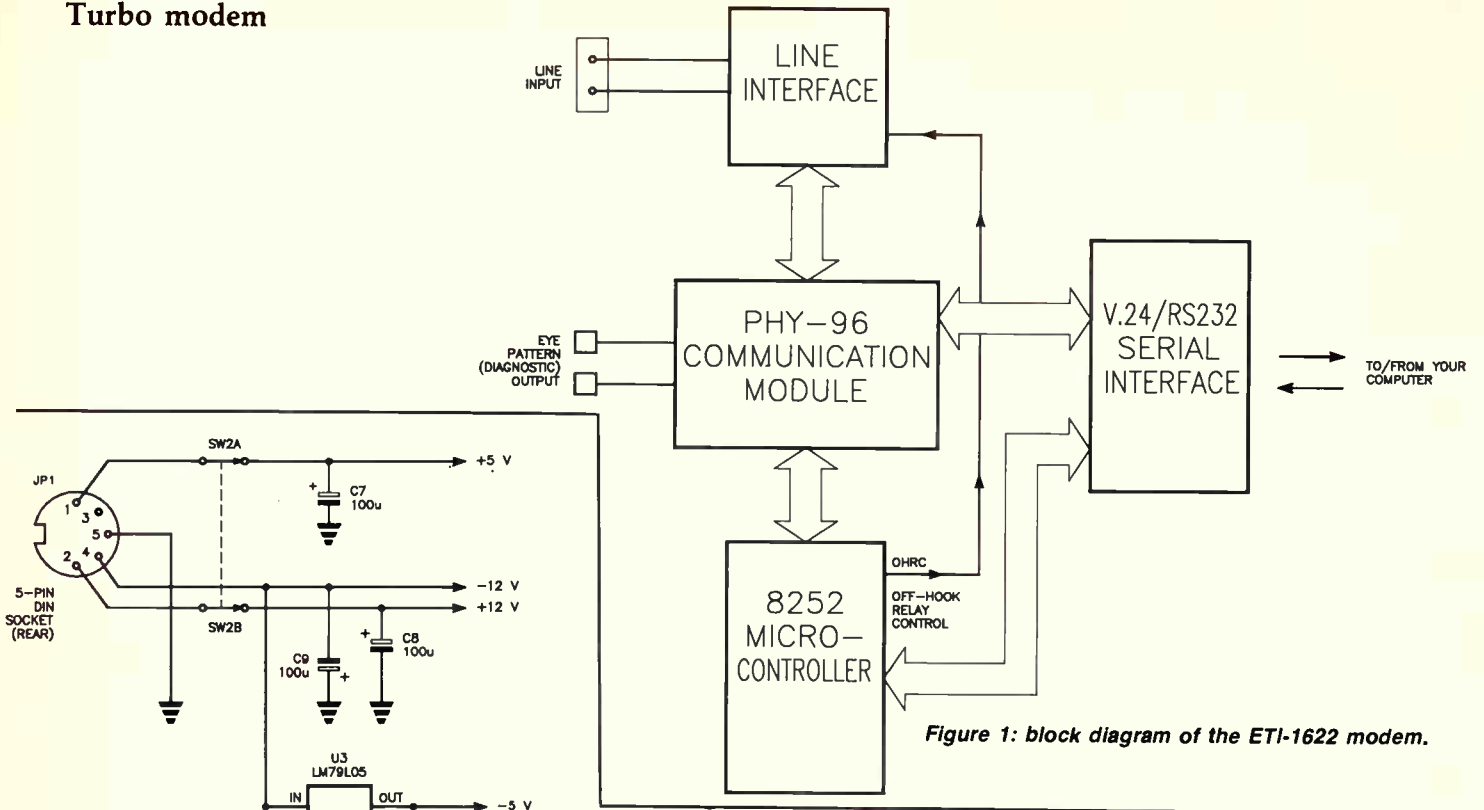
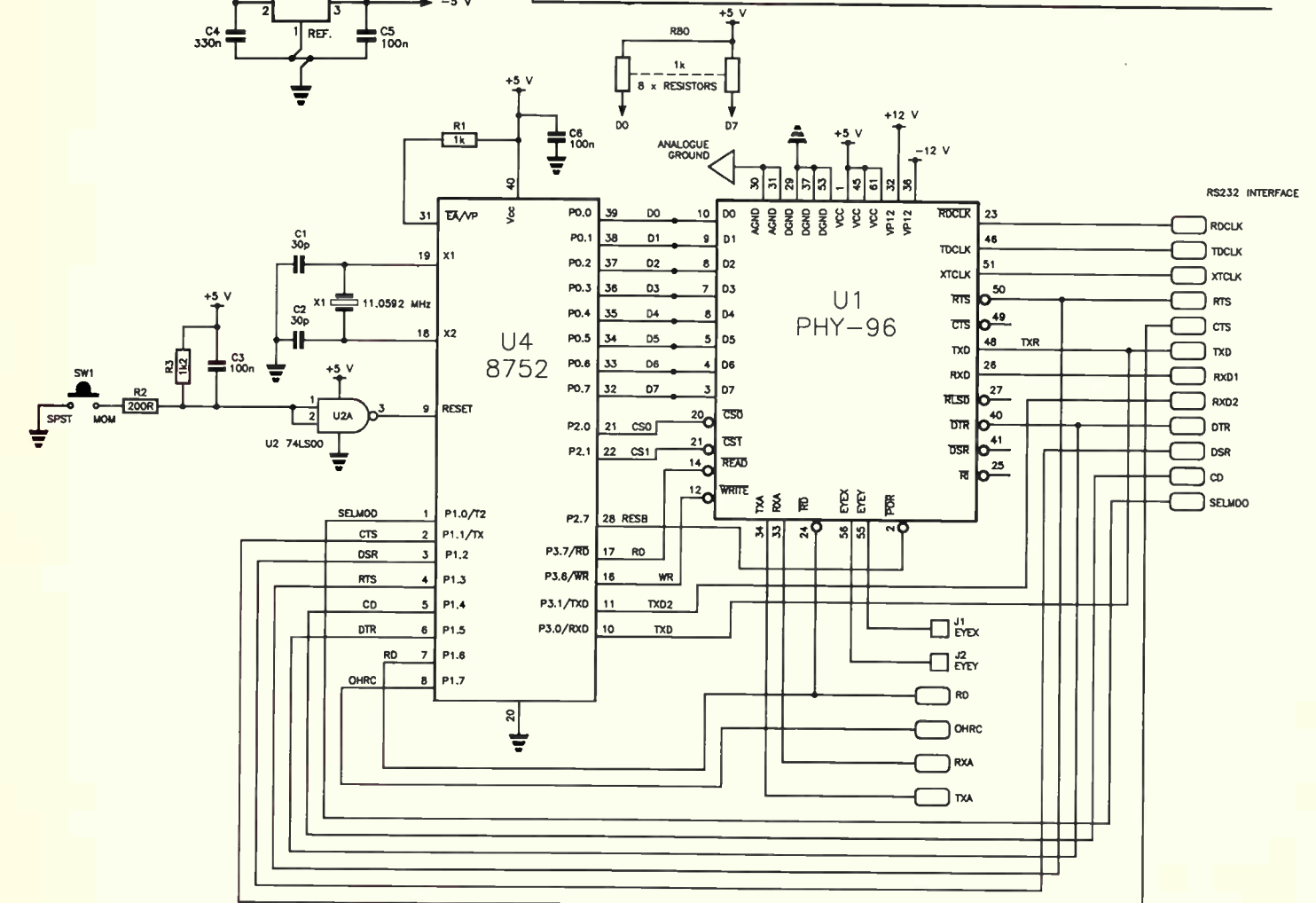

Figure 1: block diagram of the ETI-1622 modem.



The heart of the modem — PHY-96 and 8752 microcontroller.

transmitter, automatic adaptive equaliser in receiver.

- Internal diagnostics. (Eye pattern output for observing signal constellation on an oscilloscope).
- Loopback testing: local analogue loopback and remote digital loopback.
- Selectable computer-modem interface speeds of 1200, 2400, 4800 and 9600 baud.
- Auto baud rate selection. If you choose 9600 bps and the other modem is on 4800 bps, your modem will fall back to 4800 bps.

The 220 x 120 mm motherboard is a four-layer pc board with separate analogue and digital groundplanes on the inner two layers. The PHY-96 module and all the peripheral circuit components, the input/output connectors are mounted on the motherboard, making it an entirely self-contained unit. As this is a technology demonstration project, no cabinetry is specified. A complete kit, comprising all parts and the pre-built PHY-96 module, will cost \$1499; a fully-built modem is priced at \$1699.

The Phylon PHY-96

The PHY-96 is a programmable data communications module providing, according to Phylon "...the core signal processing for high speed data exchanges over voice-grade lines." Designed to operate over the public switched telephone network (PSTN) as well as leased lines, it is packaged in a small module with dual-in-line (DIP) connection for direct installation onto a 'host' printed circuit card.

The PHY-96 supports all the telecommunications requirements specified in CCITT recommendations V.33, V.32, V.29, V.27ter, V.22bis, V.22, V.23 and V.21 and is also compatible with Bell 212A, 208, 201 and 103 specifications. The PHY-96 can operate at speeds of 14400, 9600, 4800, 2400, 1200, 600 or 0-300 bits per second and is designed for use in ultra high speed data applications.

While there are modems available that boast speeds of 19,200 bps, they actually only emulate such speeds by using data compression; the actual signalling speed is lower (usually 9600 bps).

User selectable features allow the modem operations to be tailored to support a wide range of functional requirements. The modem's small size, low power consumption, serial/parallel interface, and DIP connection simplify system development and reduce production cost, according to Phylon. The interconnection diagram for the PHY-96 is shown in Figure 2.

For complete flexibility, the static RAM inside the PHY-96 can be loaded with any program and/or data required to support additional modes of operation. Under the control of the host processor, the modem can also generate voice-band tones from 0 to 4096 Hz with a resolution of 1 Hz. Tones

Table 1: PHY-96 Hardware interface signals

Name	Type	Pin No.	Description
OVERHEAD			
Ground (A)	AGND	30,31	Analogue ground return
Ground (D)	DGND	29,37,53	Digital ground return
+ 5V	PWR	1,45,61	+ 5 volt supply
+ 12V	PWR	32	+ 12 volt supply
- 12V	PWR	36	- 12 volt supply
POR	IA/OB	2	Power-on-reset
MICROPROCESSOR INTERFACE			
D7	IA/OB	3	8-bit Bi-directional Bus
D6	IA/OB	4	
D5	IA/OB	5	
D4	IA/OB	6	
D3	IA/OB	7	
D2	IA/OB	8	
D1	IA/OB	9	
D0	IA/OB	10	
CS0\	IA	20	Configuration 0 select
CS1\	IA	21	Configuration 1 select
READ\	IA	14	Read enable
WRITE\	IA	12	Write enable
IRQ\	OC	11	Interrupt request
V.24 INTERFACE			
RDCLK\	OA	23	Receive data clock
TDCLK	OA	46	Transmit data clock
XTCLK	IA	51	External transmit clock
RTS\	IA	50	Request-to-send
CTS\	OA	49	Clear-to-send
TXD	IA	48	Transmitter data
RXD	OA	26	Receiver data
RLSD\	OA	27	Received line signal detector
DTR\	IA	40	Data terminal ready
DSR\	OA	41	Data set ready
RI\	OA	25	Ring indicator
ANCILLARY CIRCUITS			
RBCLK	OA	22	Receiver baud clock
TBCLK	OA	47	Transmitter baud clock
TMXCLK	OA	43	Transmitter mux clock
LINE INTERFACE			
TXA	AA	34	Transmitter analogue output
RXA	AB	33	Receiver analogue input
OHRC	OD	35	Off-hook relay control
RD\	IA	24	Ring detect
DIAGNOSTIC			
EYEX	AC	56	Analogue output-X Axis
EYFY	AC	55	Analogue output-Y Axis

Turbo modem

ETI-1622

over 3000 Hz are attenuated. Dual-tone, multi-frequency (DTMF) tone generation allows the modem to operate as a programmable DTMF dialler.

Equalisation functions which improve performance when operating over low quality lines are also provided. Compromise equalisation is given by a digital finite impulse response (FIR) filter in the transmit section. This filter can be enabled or disabled by a bit in the configuration/command word. An automatic adaptive equaliser is provided in the receiver section.

In accordance with the applicable CCITT recommendations or Bell interface (depending on the selected configuration), the module incorporates a self-synchronising scrambler. Performance levels for received line signal levels from 0 dBm to -43 dBm are satisfied by the receiver. The received line signal level is measured at the Receiver Analogue (RXA) input.

The carrier recovery circuit can track a $\pm 0.01\%$ frequency error in the associated transmit timing source, and can track a ± 7 Hz frequency offset in the received carrier

with negligible degradation in the bit error rate (BER).

A data echo canceller with near-end and far-end echo cancellation is included for two-wire full duplex V.32 and V.32bis operation. The combined echo span of both cancellers is 33 ms, with the delay between near and far-end echoes being up to 1.7 seconds. The canceller can also compensate for ± 7 Hz frequency offset in the far-end echo.

An asynchronous-to-synchronous converter is provided in the transmitter and a synchronous-to-asynchronous converter is provided in the receiver. The converter operates only in serial mode; the asynchronous character format is 1 start bit, 5 to 8 data bits, an optional parity bit and one or two stop bits. Valid character sizes, including all bits, are 7, 8, 9, 10 and 11 bits per character.

These asynchronous characters are accepted by the transmitter on the TXD serial input and issued by the receiver on the RXD serial output. To configure the converters, you set up the appropriate bits in the set-up/configuration command from your computer.

The PHY-96 provides auto-dialling and auto-answering including DTMF or pulse dialling functions, along with ringing detection and a comprehensive supervisory tone detection scheme. These can be

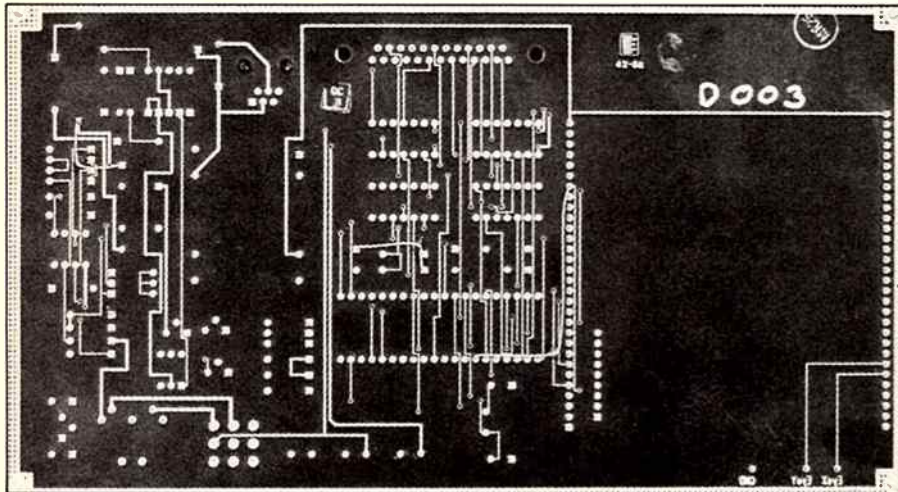

Underside view of the motherboard, showing the locations of the three links.

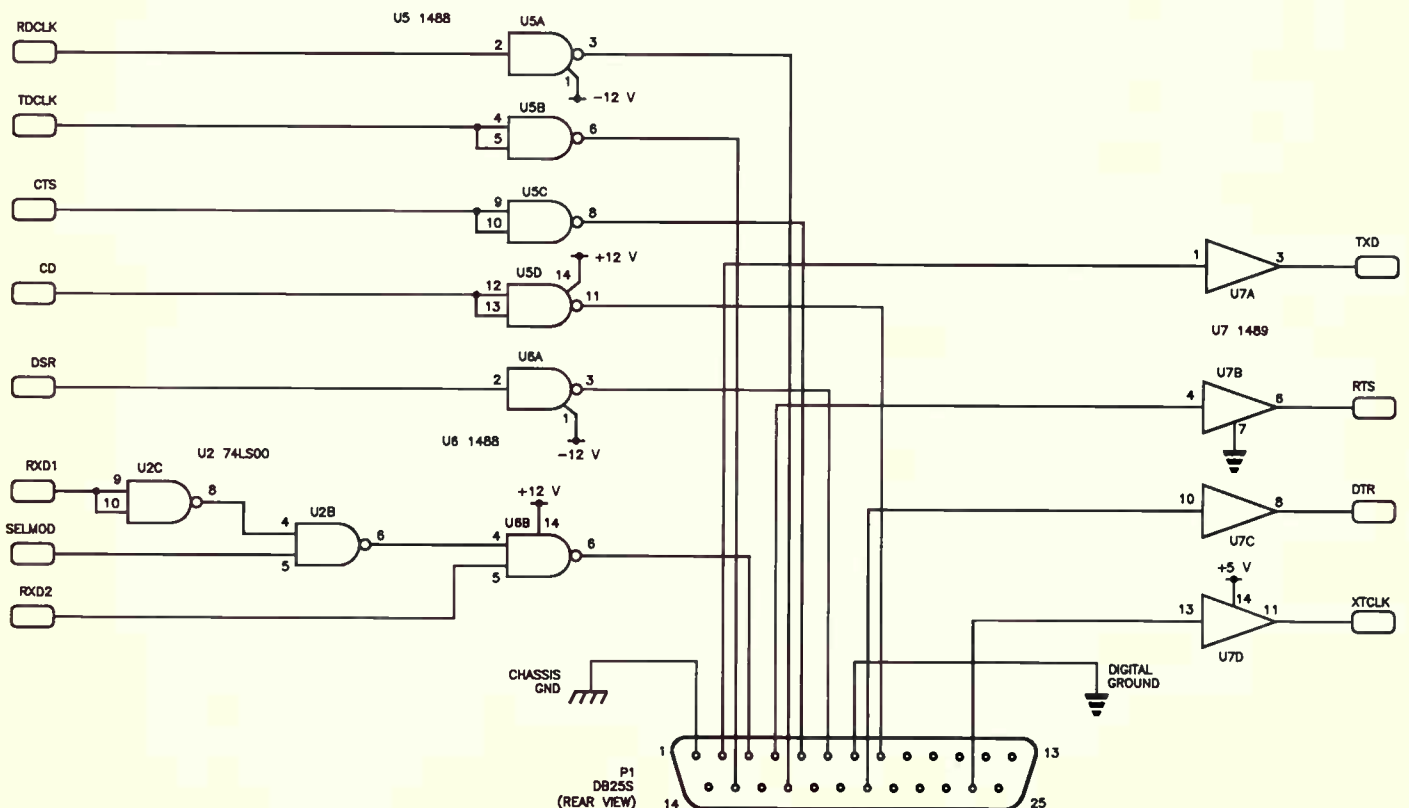

The RS232 serial interface circuit.

Something in the air . . .
Coming soon:

ETI'S GUIDE TO AUSTRALIAN ASTRONOMY

*An up-to-date, comprehensive guide to Australian Astronomy.
Find out about the people, the technology
and the theories that fuel the exciting
resurgence in sky watching.*

Plus

*Practical information on
buying a telescope and
finding your way around
the heavens.*

*If you're into
sky watching,
watch out for*

ETI's Guide to Australian Astronomy

ON SALE IN MARCH

For multiple communications at over 1000 meters. Forget current loops -

Go RS485

The OCTART . . . Intelligent octal PC plug-in card. Eight async. RS485 channels each up to 31 peripherals at up to 19.2 Kbs. 1 slot on any IBM.

The CIC . . . The intelligent coms interface card. Interfaces RS485 (optically isolated) to any of eight RS232 channels in half duplex mode.

Protocol conversions and special applications to order.

VANDATA

Suite 8, Midway Arcade
145 Maroondah Highway
Ringwood 3134
(03) 870 6078

62 AME

READER INFO No. 19

UV PROCESSING EQUIPMENT

KALEX LIGHT BOX

- Autoreset Timer
- 2 Level Exposure
- Timing Light
- Instant Light Up
- Safety Micro Switch
- Exposure to 22in x 11in

\$650.00

PCB PROCESSING KALEX ETCH TANK

- Two Compartment
- Heater
- Recirculation (by Magnetic Pump)
- Two Level Rack • Lid

\$650.00

3M Scotchal Photosensitive Riston 3400 PCB Material

All prices plus sales tax if applicable

KALEX 40 Wallis Ave
East Ivanhoe 3079
(03) 497 3422
497 3034
Fax (03) 314 7400



ELECTRONIC COMPONENTS & ACCESSORIES
• SPECIALIST SCHOOL SUPPLIERS

READER INFO No. 20

Turbo modem

programmed from your computer.

Figure 1 shows the typical module connections in a system. Any point which is active low is represented by a small circle at the signal point. Edge triggered inputs are denoted by a small triangle (eg. TDCLK). Open-Collector (open-source or open-drain) outputs are shown with a small half-circle, and active low signals are indicated with a \backslash (eg. POR \backslash).

A clock intended to activate logic on its rising edge (low-to-high transition) is called active low (eg. RDCLK \backslash), while a clock intended to activate logic on its falling edge (high-to-low-transition) is called active high (eg. TDCLK). When a clock input is associated with a small circle, the input activates on a falling edge. If no circle is shown, however, the input activates on a rising edge.

The hardware interconnect signals shown in Figure 1 are organised into six functional groups: overhead (including the power supply lines), host microprocessor interface, V.24 (serial RS232) interface, ancillary circuit interface, analogue (line interface), and diagnostic (eye pattern). These signals, together with their connector pin numbers and interface circuit types, are listed in Table 1.

When power is supplied to the module, it pulses Power-on-Reset (POR \backslash) low to begin the POR sequence. The module is ready to use 350 ms after the low-to-high transition of POR. The POR sequence is re-initiated any

time the +5 V supply drops below +3.5 V for more than 30 ms, or an external device drives POR \backslash low for at least 3 . POR \backslash low is not pulsed low by the module when the POR sequence is initiated externally. The POR sequence initialises the module configuration to default values which are:

- V.32 9600 TCM
- Asynchronous mode
- Originate mode
- Serial channel data
- -43 dBm receiver threshold
- Transmitter compromise equaliser enabled
- Automatic rate change enabled.

Thirteen control, bi-directional bus and interrupt hardware interface signals allow the module to be connected to an 8085 compatible microprocessor. With very little external logic, the interface is compatible with a variety of other microprocessors, like the 6502, 8080 or 68000.

This microprocessor interface allows a microprocessor to change the module's configuration and supervise its operation by writing control bits and reading status bits.

Eleven pins provide timing, data and control signals for implementing a CCITT V.24/EIA 232D compatible serial interface (that's "RS232" to you and me!). These signals are TTL compatible in order to drive the short wire lengths and circuits normally found within stand-alone modem enclosures or equipment cabinets. For driving longer cables, these signals can be easily converted

Parts list — ETI-1622

SEMICONDUCTORS

CR1, CR2	1N753A
CR3, CR4, CR5, CR6, CR8	1N4148
CR7	1N966
Q1	2N3904
Q2, Q3	2N2222
U1	PHY96
U2	74LS00
U3	LM79L05
U4	8752
U5, U6	1488
U7	1489
U8	1458
U9	4N35

RESISTORS, all 1/4 W 5%, unless noted

R1, R13	1k
R2	200R
R3	1k2
R4	4k53, 1%
R5	40k2, 1%
R6	330R
R7	570R, 1%
R8	20k, 1%
R9	7k3, 1%
R10	10M
R11	15k
R12	470R
R14	20k
R15	51k

R16-R18	not used
R19	V250LA10 varistor
R80	1k x 8 SIP pack
R81	5k, 10-turn trimpot
R82	1k96, 1%
R83	2k7
R84	100k, 10-turn trimpot

CAPACITORS

C1, C2	30p ceramic
C3, C5, C6	100n ceramic
C4	330n ceramic
C10	1n NPO ceramic
C11	5n6 NPO ceramic
C12, C14, C18	33n ceramic
C13	10n/1.5kV poly
C15	470n/250 Vac poly
C16, C17	100n ceramic

MISCELLANEOUS

J1, J2, J3	pc stakes
J4	RJ-11C pc-mount socket
JP1	DIN5, right angle pc-mount socket
K1	Reed relay
P1	DB25 socket, right angle pc-mount
SW1	SPST N/O momentary pushbutton
SW2	3PST toggle switch
T1	MIDCOM 671-8208 line isolation transformer
X1	11.0592 MHz crystal with pigtail leads

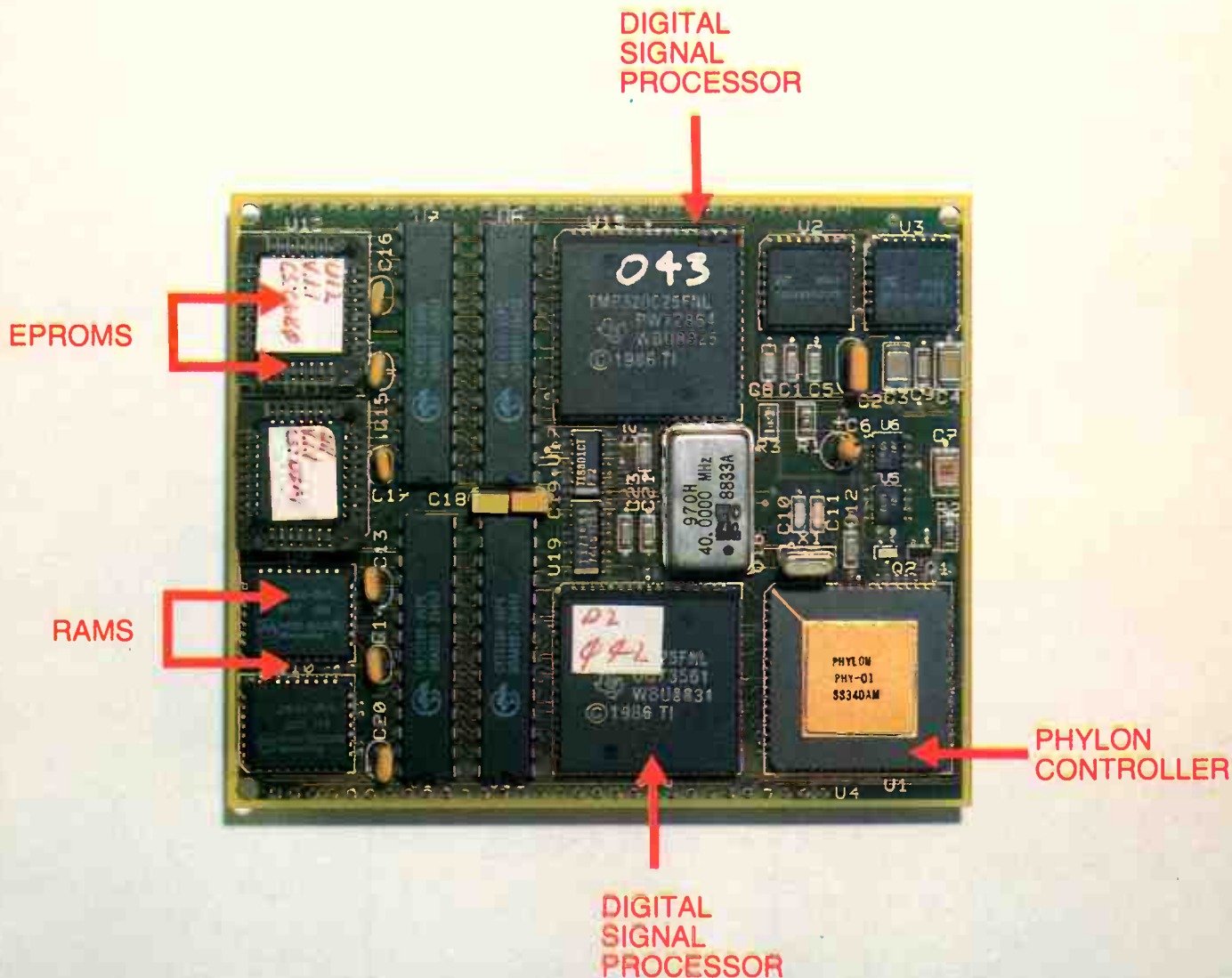

The PHY-96 module with the various features identified.

to RS-232-C voltage levels using 1489 receivers and 1488 drivers, or their equivalents.

The Transmitter Analogue (TXA) output and Receiver Analogue (RXA) input allow modem connection to either a leased line or the public switched telephone network through an audio transformer or a data access arrangement (DAA). The analogue characteristics of TXA and RXA are described in Table 2. TXA is a low impedance

amplifier output in series with an internal 604 ohm, 1% resistor to match a 600 ohm source. The maximum received signal at RXA is 0 dBm. The maximum near-end echo at RXA which the module can cancel in V.32 and V.33 modes is -5 dBm.

When interfacing directly with a transformer, Phylon recommends transient protection for TXA and RXA using either back-to-back zener diodes or a varistor across the transformer.

The Ring Detect (RD/) input is monitored for pulses in the range of 15 Hz to 68 Hz. Phylon says the circuit driving RD/ should be a 4N35 opto-isolator or equivalent which should not respond to momentary bursts of ringing less than 125 ms in duration, or less than 40 VRMS (15 Hz to 68 Hz).

OHRC (off-hook relay control) is an output designed to directly drive a 5 V reed relay coil with a worst case resistance of 360 ohms having a minimum pull-in voltage of 4.0 Vdc.

Turbo modem

A clamp diode integrated in the modem eliminates the need for a diode across the relay coil. To drive heavier loads, an external transistor can be used. OHRC is controlled by the module during auto dialling.

V.32 and full-duplex two-wire V.33 communications places high requirements upon the Data Access Arrangement (DAA) to the line. V.32 and two-wire V.33 use the same bandwidth for data transmissions in both directions. Any non-linear distortion generated by the DAA in the transmit

direction (near-end echo) cannot be cancelled by the modem's echo canceller and interferes with data reception.

Two analogue output signals provide the waveforms necessary to create an oscilloscope quadrature eye pattern which is simply a display of the received baseband constellation. Common line disturbances can usually be identified by observing this constellation. EYEX and EYFY provide two analogue outputs containing data for display on the oscilloscope X axis and Y axis,

respectively. The output impedance is high (10k), and suitable for direct connection to the input of an oscilloscope.

Software-wise, a host (or controlling) microprocessor communicates with the PHY-96 using 16-bit words transferred in two bytes. Each word either sets up the module, requests a specific action or requests some status information from it. Setting up the module involves choosing the modem type and configuration desired; for any additional mode(s), you have the option of loading

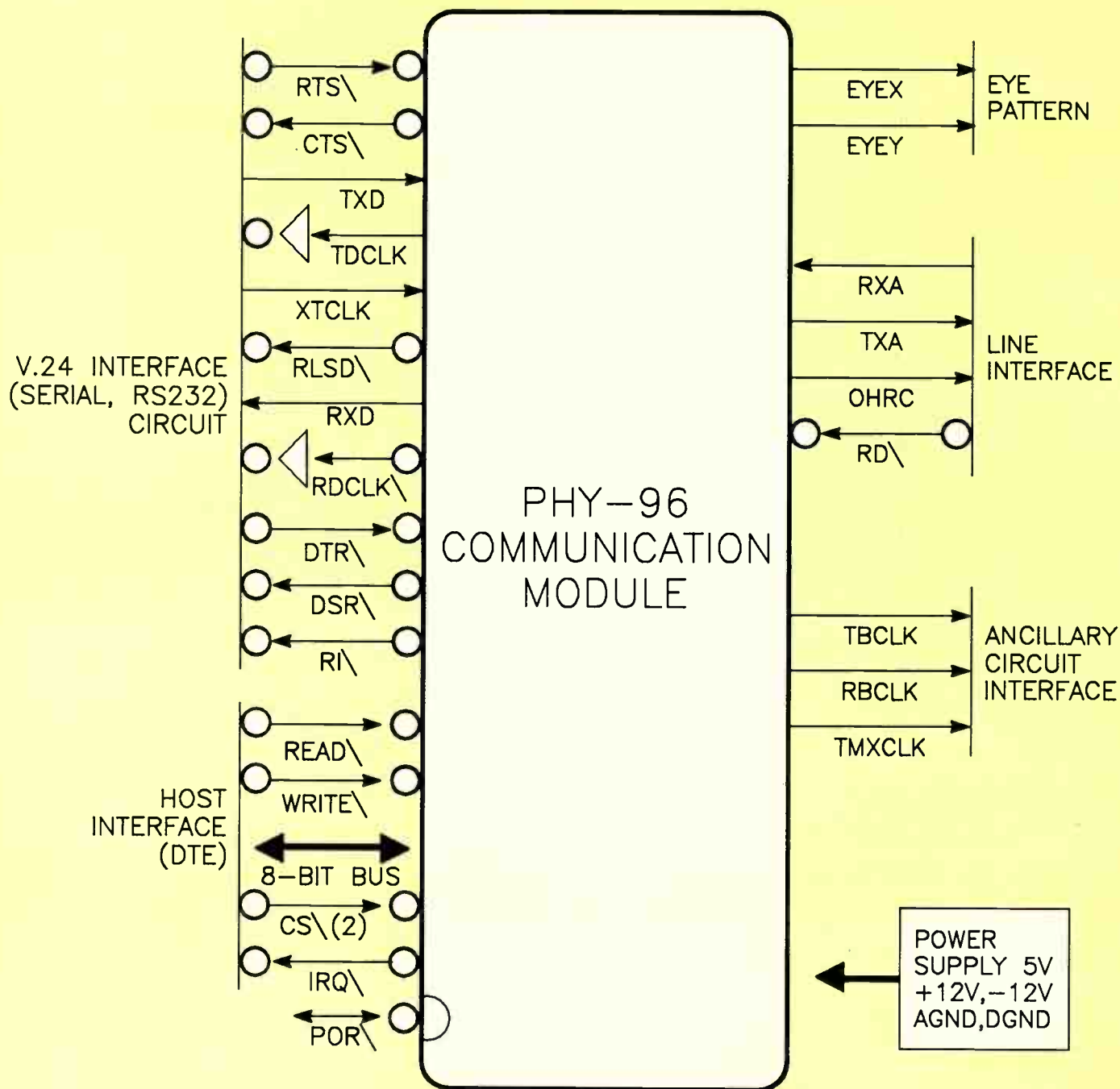
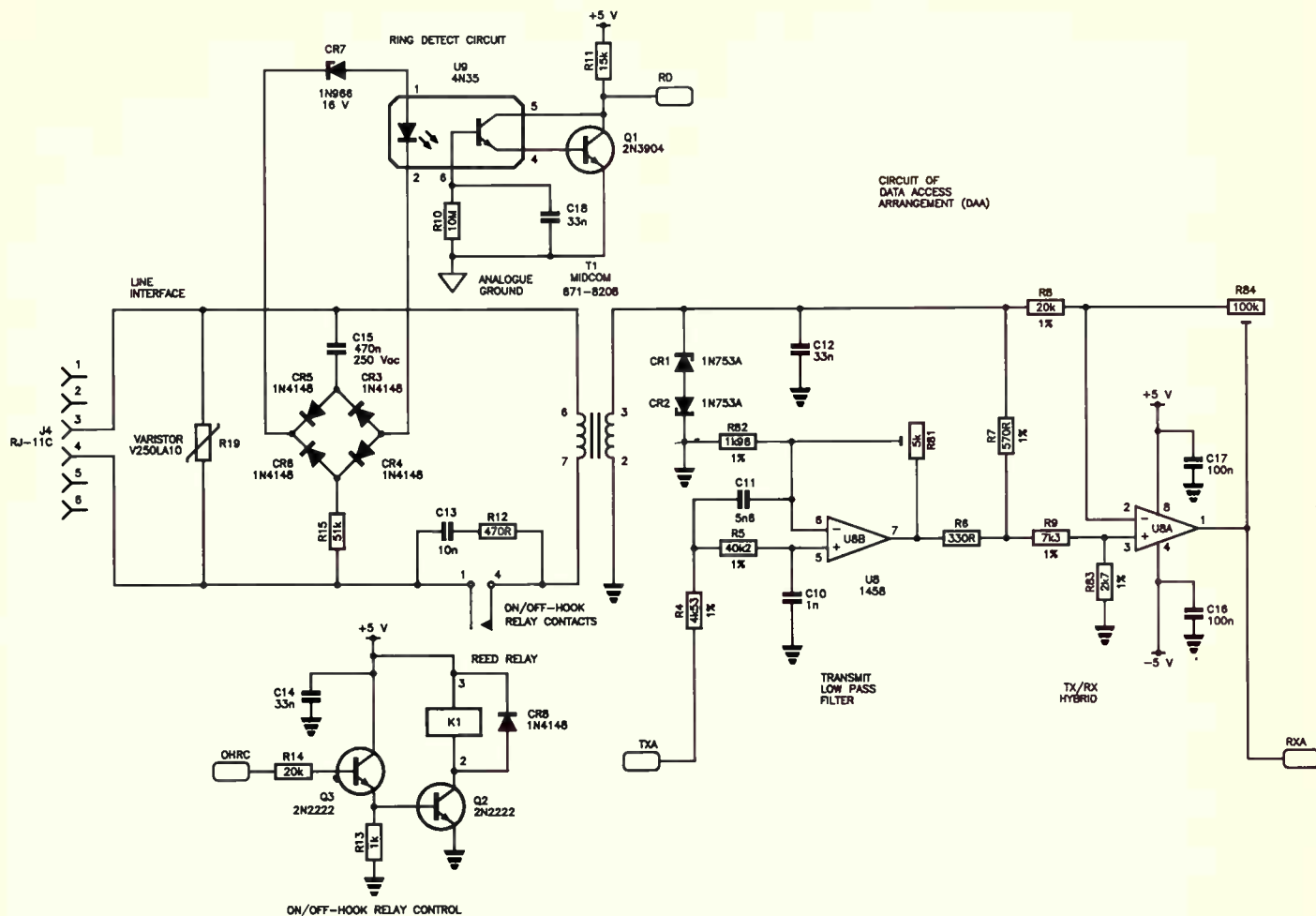

Figure 2: Interconnect diagram for the PHY-96 module.



The line interface (DAA) circuit, with the various sections identified.

and/or reading program and/or data to and from the two 8K x 16 SRAM banks on board and the internal data memory of the DSPs.

On accepting the word, the PHY-96 keeps a 16-bit word ready on the bus for the host to read if so desired. These 16 bits will always echo the first two bits of the command word in response to commands and information requests. When responding to such request, the remaining 14 bits contain the required data. An example of this is if the set-up/configuration command sent started with a 01 (in bits 15 and 14), then the response word starts with a 01 (in bits 15 and 14). Each word sent to the PHY-96 in the down-load mode is echoed back verbatim.

Circuit description

For clarity, the circuit diagram has been broken into three portions: the PHY-96 communication module and 8752 microcontroller, the data access arrangement (DAA) or line interface, and the serial interface to your computer. While its

operation is complex, the circuitry is simple enough.

The serial interface is arranged so that the modem looks like a DTE (data terminal equipment) unit, and implements six output lines and four input lines, plus signal ground and chassis ground. Not all input and output lines need be used by your computer, a "minimal implementation" with X-On/X-Off will work if required.

To conform with the EIA 232D (updated RS232C) +/- signal requirements, two 1488 line drivers (U5 and U6) and a 1489 (U7) line receiver are employed. A right-angle DB25 socket on the motherboard provides the serial interface link to your computer.

The DAA/line interface circuit provides line isolation via T1; a ring detect circuit based around U9, a 4N35 opto-coupler; on/off-hook relay control employing a reed relay (K1) with transistor drive (Q2-Q3), and a transmit/receive line hybrid and transmit filter based around U8, a 1458 dual op-amp.

The line connects via J4, an RJ-11C on-

board socket. Line transients are clamped by a varistor, R19. A bridge rectifier, CR3-CR6, coupled between the line pair via R15-C15, rectifies the incoming ring tone. The bridge output is applied to the optodiode input of U9 via a voltage-limiting zener diode, CR7. The phototransistor output of U9 is Darlington connected to Q1, the collector of which provides pulses in sympathy with the incoming dialling pulses at the RD terminal which goes direct to the RD/input of the PHY-96.

The OHRC signal from the 8752 (U4) microcontroller drives the base of Q3 via R14. When OHRC goes high, Q3 conducts, driving Q2 on and operating the reed relay. This circuit is used to set the modem for auto-answer as well as for pulse dialling. C13 and R12 provide spark suppression for the relay contacts.

The line isolation transformer, T1, couples the signal to the Tx/Rx hybrid. Back-to-back zeners, CR1 and CR2 clip excessive signal levels on the transformer secondary; C12

Turbo modem

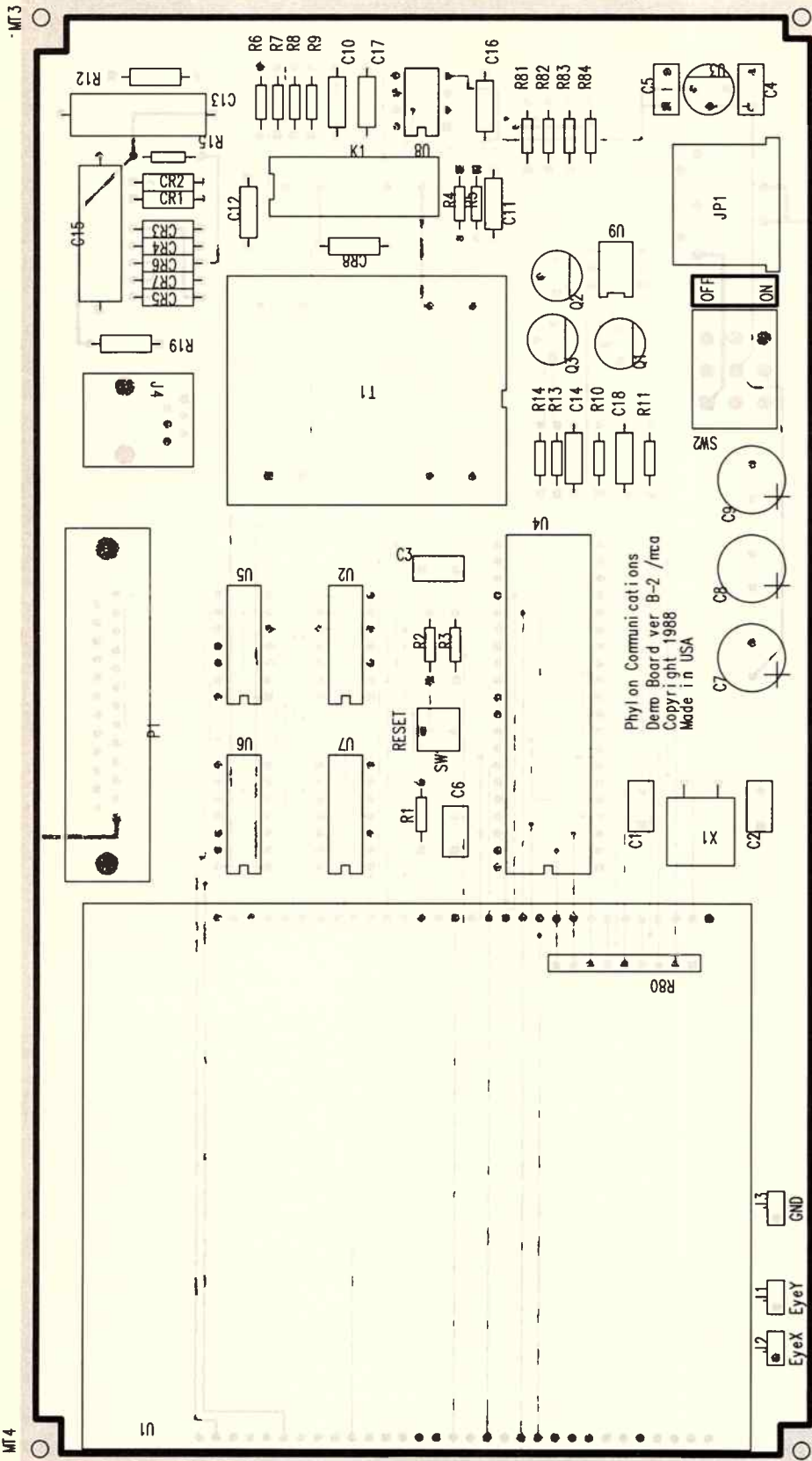

provides some roll-off at the higher frequencies.

The transmit tones from the PHY-96 come in on terminal TXA and are filtered by the active low pass filter using U8 B. Trimpot R81 provides for transmit line level adjustment. The output of U8B passes to the line via R6, R7 and then T1.

Incoming signals from the line are passed to the inverting input of U8A via R8. The outgoing transmit signal mixes with the incoming receive signal here, while the transmit signal is also applied to U8A's non-inverting input. The transmit signal at the inputs of U8A thus subtract, leaving the receive signal at U8A's output, pin 1, which is sent to the PHY-96 via terminal RXA. Trimpot R84 is used to null the transmit signal at RXA.

The section of the circuit involving the PHY-96 is easy to understand if you look at it in conjunction with the Figure 1 block diagram.

Functional configuration and control of the PHY-96 is handled by the 8752 microcontroller, U4. This connects to the PHY-96's host interface lines. The 8752's on-chip EPROM contains the control software. U2 provides a debounced reset pulse from SW1, a momentary action pushbutton mounted on the motherboard. The EYEX and EYEY eye pattern diagnostic signals are brought out to pins on the edge of the motherboard. A simple low-cost oscilloscope can be used to view the signal constellation points while the modem is in use.

Power for the circuitry is supplied to the board via JP1, a 5-pin right-angle pc-mount DIN socket. Three rails are required: +5 V, +12 V and -12 V. These can be derived from a simple low current supply. The +5 V and +12 V lines are switched by SW2, an on-board toggle switch. A low power three-terminal regulator, U3, provides a -5 V supply rail from the incoming -12 V supply. Capacitors C7, C8 and C9 provide bypassing for the three incoming supply rails. Capacitors C4 and C5 stabilise the input and output of U3.

Assembling the project

While assembly is very straightforward, we caution that it should only be undertaken by relatively experienced constructors. The PHY-96 module comes pre-built, and assembly only of the motherboard is required. This is a four-layer, through-hole plated board with soldermask and component annotation, which certainly eases assembly greatly. A fine-tipped, temperature controlled soldering iron is mandatory. Use fine-gauge resincored solder.

Start by identifying and laying out all the components. If you attack this in a methodical manner you'll have a greater chance of success first-off. Mount all the smaller components first - the resistors, diodes and smaller capacitors. Solder all

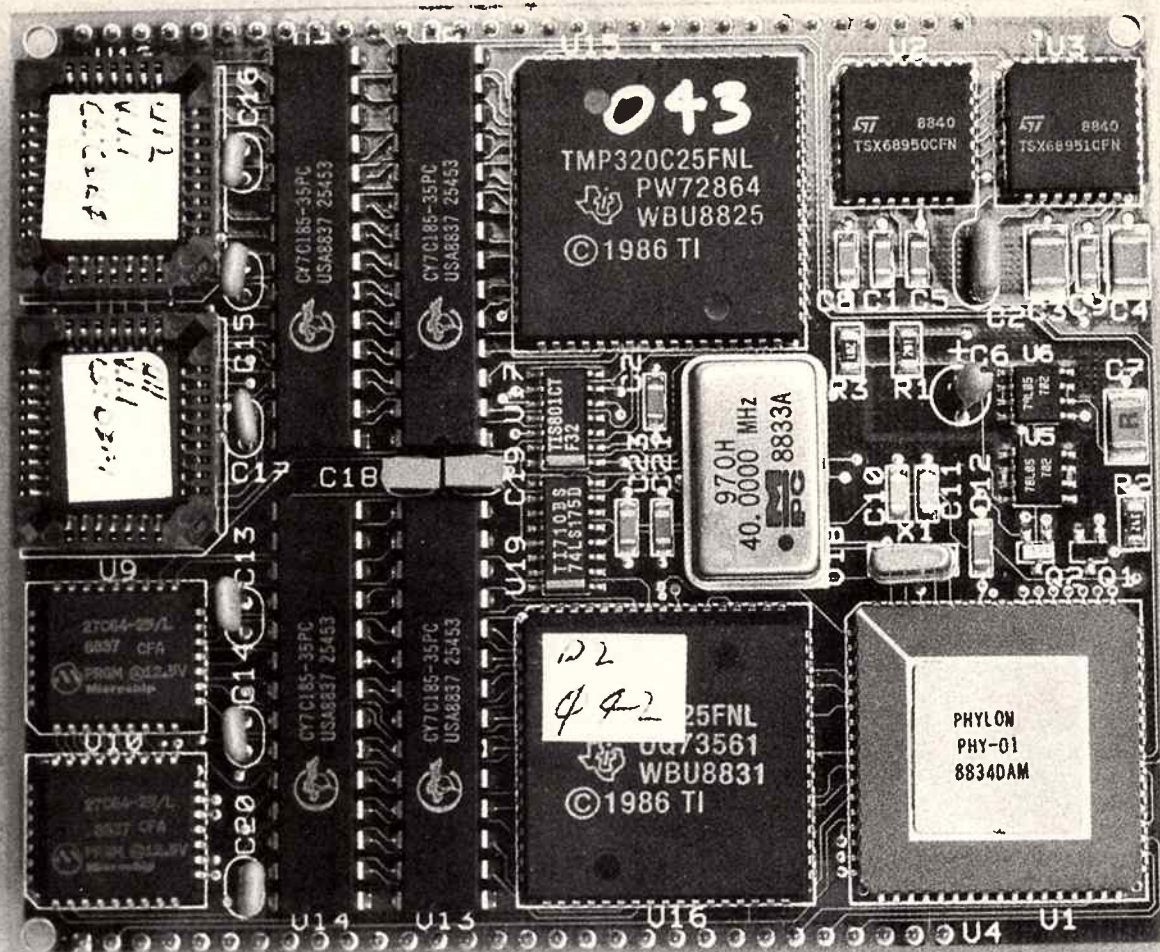

leads top and bottom, but use only the minimum amount of solder necessary. The three transistors, followed by U3, U8, U9 and X1 can be mounted next.

The rest of the ICs may be mounted now; they all have pin 1 orientated the same way –facing the PHY-96. Note that U4 is socketed. Only solder the socket on the underside of the board. Now you can mount the remaining components and the strip sockets for the PHY-96 module. Note that only two pins of the 10-turn trim pots R81 and R84 are used, the centre and rear pins. When you come to J4, the RJ-11C line socket, mount the varistor R19 first.

If you wish, the sockets and switches may be mounted off-board according to your requirements, the sort of cabinet you propose to use, etc. It is strongly recommended the project be housed in a suitably-sized cabinet. Do not mount the PHY-96 module or the 8752 yet.

There's one more little chore to complete.

There are three links to place on the rear of the board. The first links pin 1 of the reed relay (which is adjacent to C12) and the "line" end of C13. The second links the "free" ends of C3 and R3 (the ends not connected to the junction of R2-R3-C3). The third links pin 25 of the PHY-96 to pin 7 of the 8752 (U4).

Trying it out

Before you do anything, give the board a thorough visual inspection. Check all joints and look for the usual solder bridges, etc. Check the orientation of all the semiconductors and polarised capacitors. Fix any problems.

Before mounting the 8752 and PHY-96, check the supply rails for shorts using your multimeter. If this check proves OK, you can apply power and check the supply rails on each IC. If there are any problems, trace the fault now.

You can set up the Tx/Rx hybrid at this stage of the proceedings, using an audio

signal generator and a CRO or audio millivoltmeter. Apply a signal of about 2 kHz and level of about 0 dBm at the TXA point (R4) of the DAA circuit. Use the CRO to monitor the signal at pin 1 of U8A (RXA). Adjust R84 to null the signal level viewed on the CRO. You can adjust R81 to set the level at pin 3 of T1 (the cathode of CR1 is more easily accessible).

Disconnect the supplies, mount the 8752 and the PHY-96 and you're ready to fly! We assume that you will already have had some experience with a smart modem. If not, quickly make friends with someone who has.

The kit is supplied with a 12-page data sheet on the PHY-96 and a 20-page instruction "manual". The latter covers basic setup and operation and details of the AT command set, including the special ones employed in this project. 

Kits are available from Energy Control, 26 Boron Street, Sumner Park, Qld 4074.

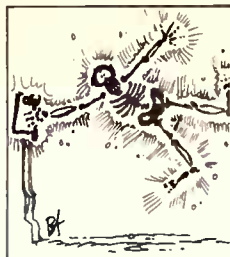

ELECTRONICS
ETI - 1430

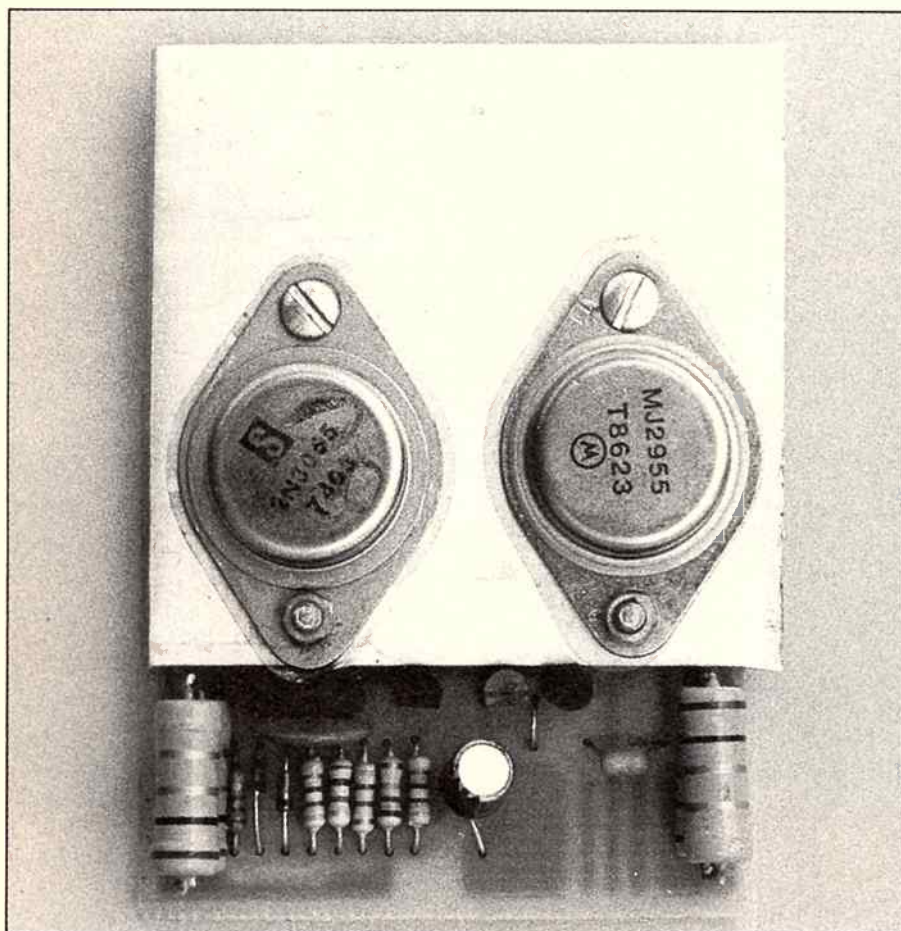

The ETI-1430 75/125 watt audio power amp module prototype; up to 125 watts output for \$30 or less! And it fits in the palm of your hand.

With the advent of modern digital audio devices such as the compact disc, digital audio tape (DAT), pulse-code modulation (PCM) and FM stereo sound on hi-fi VCRs, the quality of the audio source of music has improved dramatically. With this improvement in signal sources came the use of vented enclosures with typical efficiencies around 0.2%. This has placed a strain on the average domestic stereo amplifier to be able to provide enough headroom with adequate sound pressure levels. There are two solutions to the problem - spend megabucks on a commercial amplifier, or build your own.

Over the years there have been many power amplifier designs published for home construction; some have been complex, others difficult to build and set up and designs using MOSFETs, against all the theory and promises, have, in general, not been as reliable as some earlier bipolar designs. Some designs have been very good but there are virtues to a bipolar design, if nothing else the ready availability and low cost of output devices.

Without doubt, the most popular power amplifier module ever described and built worldwide is the original ETI-480, using 2N3055/MJ2955 output transistors, with an estimated 100,000 being constructed in one form or another. The 480 had only a few problems for constructors, and with the new DIGI-125 power amplifier these problems have been addressed and overcome.

The new design

The new DIGI-125, so named from the common use of digital sources and its 125 watts RMS capability, uses new techniques and old, well proven technology, some a little unusual.

When Sir Clive Sinclair designed his series of amplifier modules in the 1960s, he worked on the premise that small is good and his modules were very popular the world over. This project is smaller than Sir Clive's earlier efforts as I have used CAD (computer-aided

DIGI-125 AUDIO POWER AMP MODULE

**A 75/125 watt audio power amp module for around \$30?
Unbelievable! But here it is, by Graham Dicker.**

ETI MAY '89

80

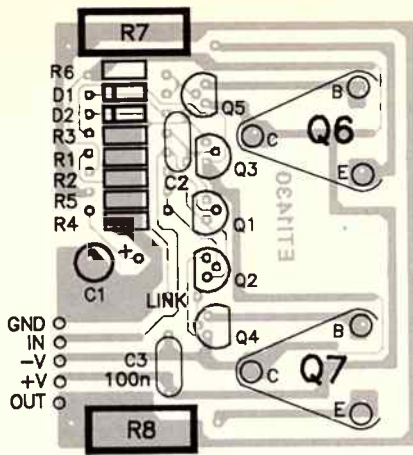

Component overlay, showing placement of the components on the printed circuit board and the supply, input and output connections.

draughting) for the pc board design; this makes the best use of board area while allowing simple construction. The whole module uses only 22 components and, unlike any other amplifier, this one has been specially designed for the easiest home construction and setup ever. The circuit in Figure 1 shows just how simple it is.

All the resistors and capacitors are assembled in a row so that there is no need to go looking to ensure the right component is in the right hole.

The board has been designed to mount to an aluminium bracket, secured by bolts holding the output devices, the base and emitter pins of which solder directly into the board. The bracket then mounts to a suitable heatsink.

All the low power transistors are placed in a single line and the pc board has been designed so that only one link is necessary. The board measures just 55 x 60 mm and has only 49 holes. The average time taken to assemble a complete amplifier is around 10 minutes and for a production run of 40 modules completed shortly before writing this article, it took an average of 3.5 minutes per module.

The design uses no supply rail fuses, and has no presets for quiescent current as in other designs, and as such is ready to go as soon as it is assembled. The project can be assembled in two versions, one with a pair of MJ802/MJ4502 transistors which will deliver 125 watts RMS into a 4 Ohm load from a +/- 35 volt regulated supply, or using the popular 2N3055/2N2955 pair the project will deliver 50 watts RMS into 8 Ohms or 75 watts RMS into 4 Ohms from a +/- 35 volt unregulated supply. The first system can be bridged for up to 250 watts RMS output into 8 Ohms. The module should be used with a heatsink with a thermal resistance of better than 10°C/watt, if it is required to run at full power continuously.

Assembly

First, check the printed circuit board for any shorts or open tracks, using a small magnifying glass if necessary. Of necessity, this board has some fine tracks and closely-spaced pads. When assembling it, you will need to use a fine-tipped iron, preferably featuring temperature regulation of the tip. In addition, use a narrow gauge (say, 20 gauge) resin-cored solder for best results.

The bracket is prepared from a 60 mm length of 50 x 50 mm by 3 mm thick right angle aluminium extrusion. You can use the pc board as a template to mark out three of the four hole positions for each transistor, then use the insulating washer to mark the position of the remaining holes. Centre-punch or otherwise mark the hole centre before drilling. Hole sizes are determined from the insulating washer and plastic bushes

**'Fewer than 25
components on a 55 x
60 mm pc board and no
setting up required'**

supplied with the transistor insulating kits. Don't forget to mark out and drill suitable holes for attaching the bracket to your heatsink.

Start assembling the board by soldering the low power resistors, the two diodes, the wire link and the three capacitors in place. Note the polarity of C1 and the two diodes. The wire link goes between the two holes

adjacent to Q2 and Q4. All components must be seated right against the pc board. Next insert the plastic low power driver transistors, ensuring that the right device is in the right hole. Note that Q5 and Q4 face the opposite way to the other three transistors. **WARNING:** some manufacturers' devices have differing pinouts, so it's wise to check the emitter-base-collector pinout of each of these transistors before placing them in the board.

It is easiest to solder the R7 and R8 resistors in last. Unless 2 W or 5 W 0.33 Ohm resistors are used here, you should first solder one 0.68 Ohm 1 W resistor in each place, positioning it about 2 mm above the board to allow some air flow. Then place the other 0.68 Ohm resistor on top, trimming the leads to a suitable length and soldering them to the leads of the first resistors.

The last stage is to assemble the output transistors and the bracket, as shown in the assembly diagram given here. Note that Q6 and Q7 are first mounted to the bracket and secured by one bolt and nut each, then the board is placed in position and the second bolts and nuts are secured. Then solder their base and emitter pins.

Power supply

The power supply circuit shown here is a universal design to provide +/- ("split") rails. The same supply is suitable for a 100 or 50 watt version of the project. If two 100 watt power amps are required it is suggested that two transformers be used, each with separate rectifiers and filters. This will improve the crosstalk and peak music power capability of the modules.

The design uses a conventional full wave bridge with centre tapped transformer to charge suitable reservoir capacitors on

ABBREVIATED DATA SHEET 2N3055/MJ2955, MJ802/MJ4502

The output devices employed in the ETI-1430 have been chosen for their availability, low cost and ruggedness, as much as for the specifications required for the job. Complementary pairs of silicon NPN/PNP devices are selected: the 2N3055/MJ2955 pair for the lower power version; the higher-rated MJ802/MJ4502 pair for the higher power version.

The devices are all housed in the common TO3 package, the pinout for which is given here.

DEVICE TYPE

NPN :	PNP :	Ic max.	Vceo	hFE at Ic	Pd at 25 deg. C
2N3055	MJ2955	15A	60V	20-70 at 4.0 A	115 W
MJ802	MJ4502	40A	100V	25-100 at 7.5 A	200W

Notes: Ic max. is the maximum continuous collector current permissible; Vceo is the minimum breakdown voltage between collector and emitter (base open-circuit); hFE is the dc current gain at a given collector current - maximums and minimums are given; Pd is the maximum permissible power dissipation of the device.

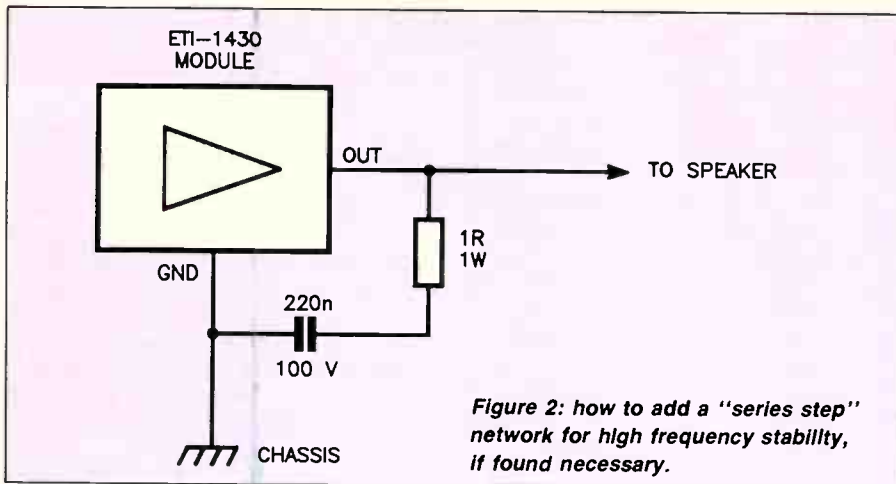

Figure 2: how to add a "series step" network for high frequency stability, if found necessary.

alternate cycles from each half of the transformer winding. Alternatively, two transformers may be used with their secondaries connected in series. The peak voltage appearing across the capacitors is given by:

$$VRMS \times 1.42$$

which gives +/- 38 volts when using a 28-0-28 V secondary transformer, such as the DSEO144 from Dick Smith Electronics and legions of similar trannies, or +/- 32 volts from a 24-0-24 V transformer. These voltages are within the specified working voltage of the electrolytics. Under load, these voltages will reduce as a result of the dynamic regulation of the design (owing to the internal resistance of the transformer and diodes).

The wiring diagram here shows how to wire

Figure 1: circuit diagram of the new power amp module — simplicity itself!

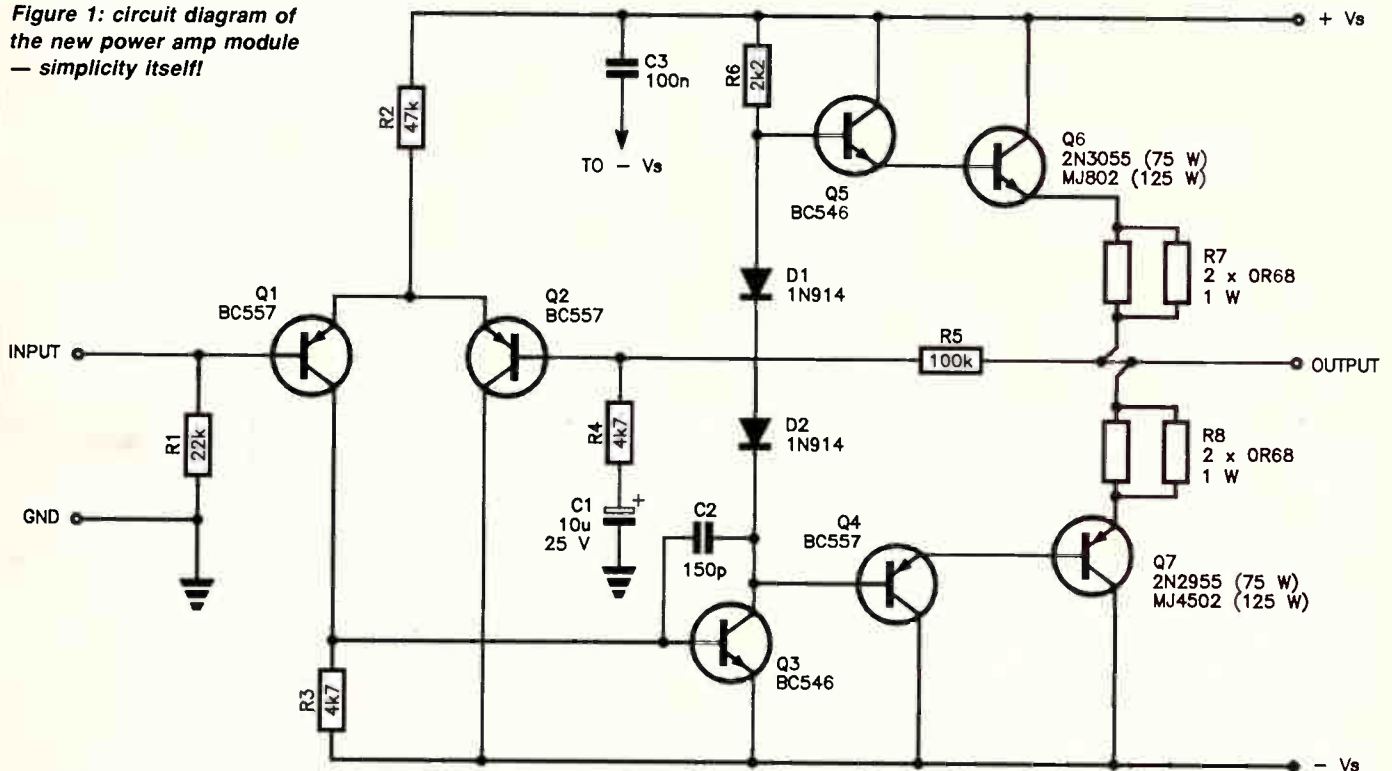

How it works

The circuit is shown in Figure 1. The input stage consists of two BC557 PNP transistors, Q1 and Q2, connected as a differential pair with Q1's base being ground referenced. This results in a slight output offset voltage of about 300 mV, but does not adversely affect performance or reliability; it does however allow for dc coupling to the audio source. It should be noted that many of the new CD players have frequency responses that extend down to a few Hertz (almost dcl), and it has been argued in the past about the benefits and disadvantages of a response this low. Needless to say, if it's there it can be reproduced.

The output of Q1's collector goes to the base of Q3, which is the main gain stage for the amplifier. This stage has a voltage gain of approximately 200 and unilateralisation and compensation is provided by C2. The two diodes D1 and D2 provide forward bias for the output stage to enable a quiescent current in the order of 40 mA to flow, to reduce crossover distortion. Resistor R6 provides current from the positive supply rail when Q3 is not conducting. Bootstrapping was initially tested in the prototype but the added components did not warrant the extra power available.

The output stage consists of a super-gain pair of output transistors in the familiar

complementary symmetry configuration. The 50 watt version uses 2N3055/MJ2955 output devices which have a Hfe of 20 at 1.5 amps collector current, whereas the MJ802/MJ4502 pair have a Hfe of 25 at 4.5 amps collector current. The salient characteristics of the devices are detailed in the accompanying data sheets.

It is here that economy of design can be made over the original EIT-480 design. Instead of using two pairs of devices for 100 watts and increasing the drive requirements, we actually decrease the drive requirements over the 50 watt design by using devices with higher gain at the normal operating conditions. Secondly, as the output stage of

up the power supply and module. While can-type (chassis-mounting) electrolytics are shown, pigtail types (either RB or axial) may be used and wired directly to the tagstrip. However, they should be mechanically secured to prevent fracture of the leads sometime in the future. The leads between the diodes and the electrolytics should be heavy duty hookup wire (at least 32 x 0.2 mm), and also the supply and ground leads to the module and speaker. Keep the supply and ground leads as short as possible, preferably shorter than 150 mm.

To improve the regulation, larger electrolytics and a transformer with a lower winding resistance (higher current rating) may be used. As a rule, the value of the electrolytic capacitor in such circuits is

approximately 4000 μ F per amp, and here a 1.5 amp \pm 38 V supply was required, hence the 5600 μ F capacitors. With audio it is wise to go by the adage "bigger is better", so you may wish to use some of the many secondhand computer grade capacitors about.

Should you be using two separate transformers in series instead of a single centre-tapped transformer, ensure that the windings are in phase (adding).

Testing

Check with an Ohm meter that the output transistors are insulated from the heatsink. If all is well, apply the supply voltage without an input and without a load. Measure the

output voltage; if it is close to zero volts, then all is well. You may now connect a load (loudspeaker or "dummy" 8 Ohm resistor load) and apply a sine wave input.

Check the output at a wide range of levels; if you can beg, borrow or steal an oscilloscope, view the output waveform. You should see a clean, well formed sine wave with no traces of high frequency oscillation at any output level. Try turning up the output until the waveform is "clipped"; the waveform should neatly square off top and bottom. If you are happy now, hook up a source of music and blow the cobwebs out of your speakers!

Load stability

The project has proved stable driving a wide variety of loads, including a 100 volt PA line output transformer. However, you may encounter some situations where the load causes high frequency instability, in which case either a HF damping network or a Zobel network (or both) connected to the module's output terminals will be called for.

Figure 2 shows how to connect a "series step" resistor-capacitor network to provide a high frequency load on the output. The resistor should be rated at 1 W and the capacitor should be a low inductance metallised polyester (MKT) or polypropylene

the new design has a voltage gain of 1 by using emitter followers (super alpha pairs) the output stage simply becomes a large current amplifier, whereas the ETI-480 design used common emitter configuration drivers and provided a voltage gain of the order of times 4. This is all very well but it results in two problems:

(1) nonlinearity in base drive impedances and currents in the pre-drivers which can result in increased distortion (try removing the ac feedback and observe the unequal voltage gains on positive and negative peaks), and (2) the driver stage is inefficient due to the load sharing and local negative feedback resistances in the circuit. This can result in a problem of obtaining sufficient drive for the output devices.

After years of experience in designing equipment for broadcast applications, one thing I have learnt is that symmetry is the best way of solving problems before they occur. If the device is full of worms to begin with, negative feedback will only hide the symptoms not cure the problem.

It is interesting to note that, in the development stages, all ac negative feedback was removed from the prototype amplifier and the distortion rose to only 0.12% and the resulting output was stable and symmetrical. In this case, the feedback applied is to stabilise the closed loop gain of the amplifier to 20 times, to compensate for parametric spreads in Q3, not to reduce distortion or other ills.

It is interesting to look at common current designs of amplifiers and note that very few designs use complete symmetry in all audio stages. Logically, if one does not use all fully symmetrical stages then local or overall negative feedback must be used within a design to overcome the problems caused by parametric spreads in components. It is my design philosophy that all stages, regardless of the signal levels involved, should

be of symmetrical design. This, in turn, will assist in the reduction of transient intermodulation distortion (TIM).

For those purists that still have a valve power/preamplifier combination, you should note that most valve amplifiers were of symmetrical designs and few had local feedback around stages to compensate for spreads in components. In most cases there was only 6-12 dB of feedback used overall in power output stages, mainly to improve the distortion figures and frequency response of the output transformers. This is negligible to an average stereo amplifier of today, with 60 dB of feedback in the magnetic cartridge preamp, 30-45 dB feedback in the preamp & bass/treble circuits, 40-60 dB feedback in the power amplifiers, and if opamps are used with open loop gains of around 110 dB for each opamp, then the overall feedback from three stages is staggeringly high. On listening tests, it is interesting to compare the sound quality of the DIGI-125 and other top-of-the-line commercial amplifiers.

Because of the reasons explained above, the BC546/BC556 drivers have a greater reserve of drive current in the 100 watt version than the BD139/BD140 devices used in the ETI-480.

Note that the output stage bias diodes are not mechanically coupled to the heatsink bracket. I found this mechanically cumbersome and, in practice, unnecessary - in defiance of conventional wisdom. With dozens of these modules installed and operating in differing applications, no thermal problems have been experienced; the bias does climb with increasing temperature, but it does stabilise and in any case, more bias improves performance, albeit slightly!

No supply rail fuses were incorporated as, from my experience, the balance of expediency tips in favour of not having them. Often, I found transistors failed and protected the fuses!

Flexeprom

Programming versatility at a competitive price.

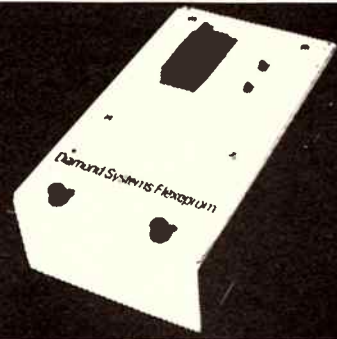

- ◆ Able to program just about any CMOS/NMOS EPROM, EEPROM, MPUS and TTL PROMS.
- ◆ Powerful easy to use host software provided - includes screen based editor.
- ◆ Intelligent and normal programming.

ALL AUSTRALIAN

- ◆ Designed and manufactured by

Diamond Systems

P.O. Box 105 Hurstbridge 3099
(03) 714 8269. FAX: (03) 714-8554

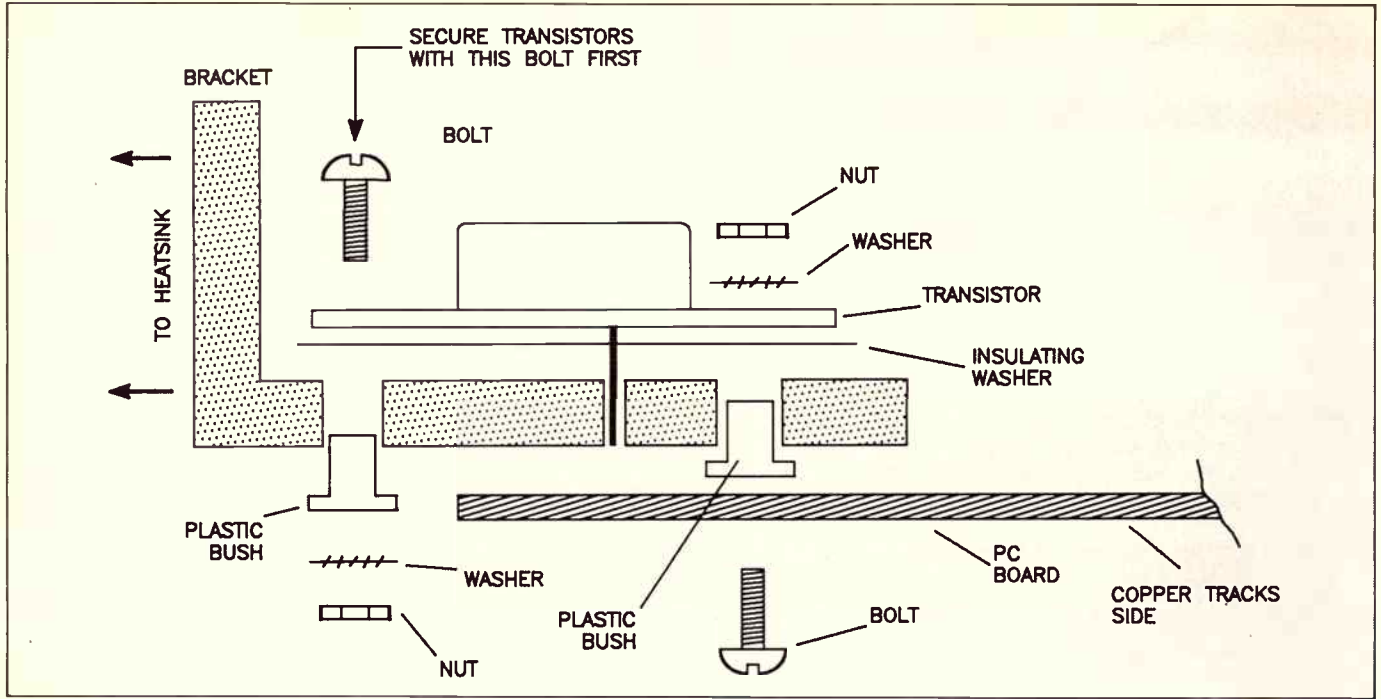

Assembly diagram showing how the transistors, heatsink bracket and pc board go together.

SPECIFICATIONS

Output devices	Supply voltage	Load	Output Power
2N3055/2N2955	+/- 35 V	8 ohms	50 W RMS
2N3055/2N2955	+/- 35 V	4 ohms	78 W RMS
MJ802/MJ4502	+/- 37.5 V	8 ohms	62 W RMS
MJ802/MJ4502	+/- 37.5 V	4 ohms	112 W RMS
MJ802/MJ4502	+/-35 V Reg.	4 ohms	131 W RMS

Total harmonic distortion at full rated output	0.35%
Total harmonic distortion at 10 watts RMS	0.0015%
Signal-to-noise ratio wrt full output	-115 dBm
Power bandwidth (-3 dB)	100 kHz
Frequency response (1 watt RMS)	2 Hz-110 kHz, +/- 1 dB
	1 Hz-120 kHz, +/- dB
Damping factor (8 ohm load)	90

PARTS LIST ETI-1430

AMPLIFIER

Resistors

All 1/4 W, 5% unless noted

R1	22K
R2	47k
R3, R4	47k
R5	100k
R6	2k2
R7, R8	OR33, 2 W (2x OR68 paralleled)

SEMICONDUCTORS

D1, D2	1N914, 1N4148
Q1, Q2	BC557
Q3, Q5	BC546
Q4	BC556
Q6, Q7	MJ802/MJ4502 or 2N3055/2N2955

CAPACITORS

C1	10 µF/25 V R8 electro
C2	150 pF/100 V ceramic
C3	100 nF/100 V ceramic

MISCELLANEOUS

ETI 1430 pc board; two TO3 transistor insulating kits; heatsink (each module) - eg. Rod Irving Electronics H10549 (100 W), H10535 (50 W); Dick Smith Electronics H-3426 (100 W).

Approx cost: \$20-27

POWER SUPPLY

D1-D4 - 1N5224, 1N5404; two 5600 uF/40 V electrolytics; T1 (mono 100 W, or stereo 50 W) - Rod Irving Electronics M21092 or Dick Smith D5E0144, two of these per channel for 100 W stereo setup.

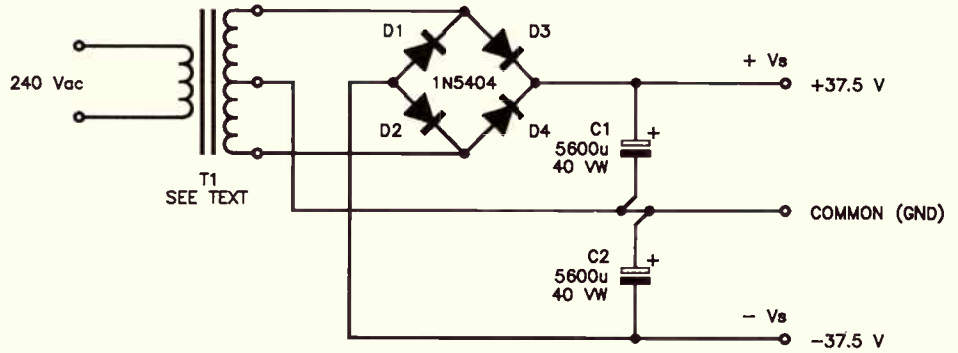

Power supply circuit.

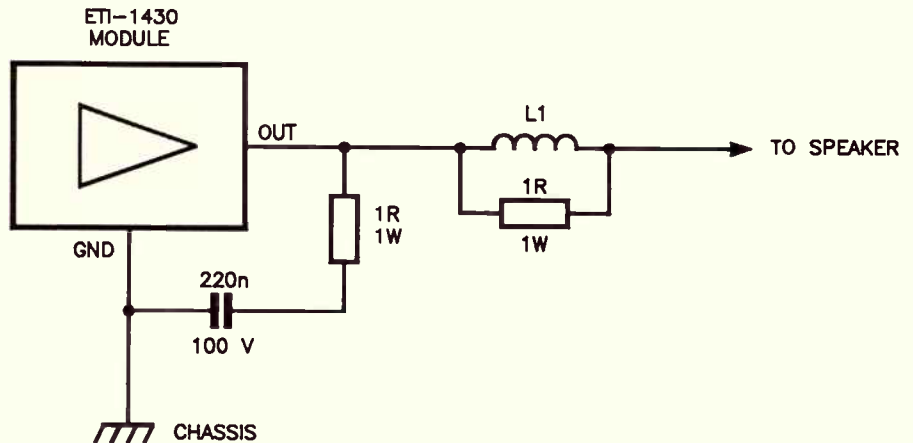
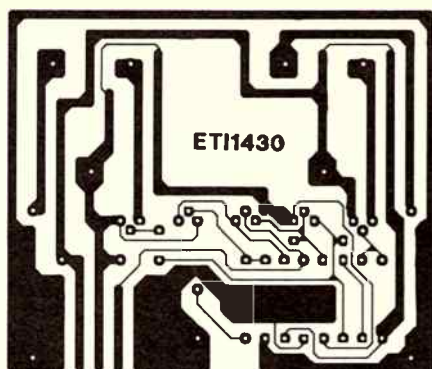



Figure 3: the addition of a Zobel (LR) network, in conjunction with a series step RC network, can solve stability problems with particularly "difficult" loudspeaker loads.



Full size artwork for the ETI-1430 pc board.

The author has retained copyright on the pc board so that constructors wishing to make boards for their own use may use this artwork for that purpose. Ready-made boards may be obtained from Graham Dicker at PC Computers, 36 Regent St, Kensington S.A. 5068, (08) 332 6513. Boards may be purchased singly or in small quantities, wholesale prices being available for larger quantities.

(MKP) type. Keep the leads as short as possible and solder the components directly to the tracks on the copper side of the pc board, the junction between the resistor and capacitor sitting in mid-air. The resistor may be any convenient value between 1 Ohm and 4.7 Ohms, while the capacitor may be any convenient value between 100nF (0.2 F) and 220n (0.22 F). It should be rated at 100 V minimum.

A Zobel network may also be added (useful with "difficult" speakers), comprising a coil with a parallel-connected capacitor, as shown in Figure 3. The coil can be wound with 1.0 mm diameter enamelled copper wire, using two 10-turn layers on a P24 potcore bobbin or a short length of 12 mm diameter wooden dowel. The network should be mounted close to the module to keep the lead between the module and the network short. 

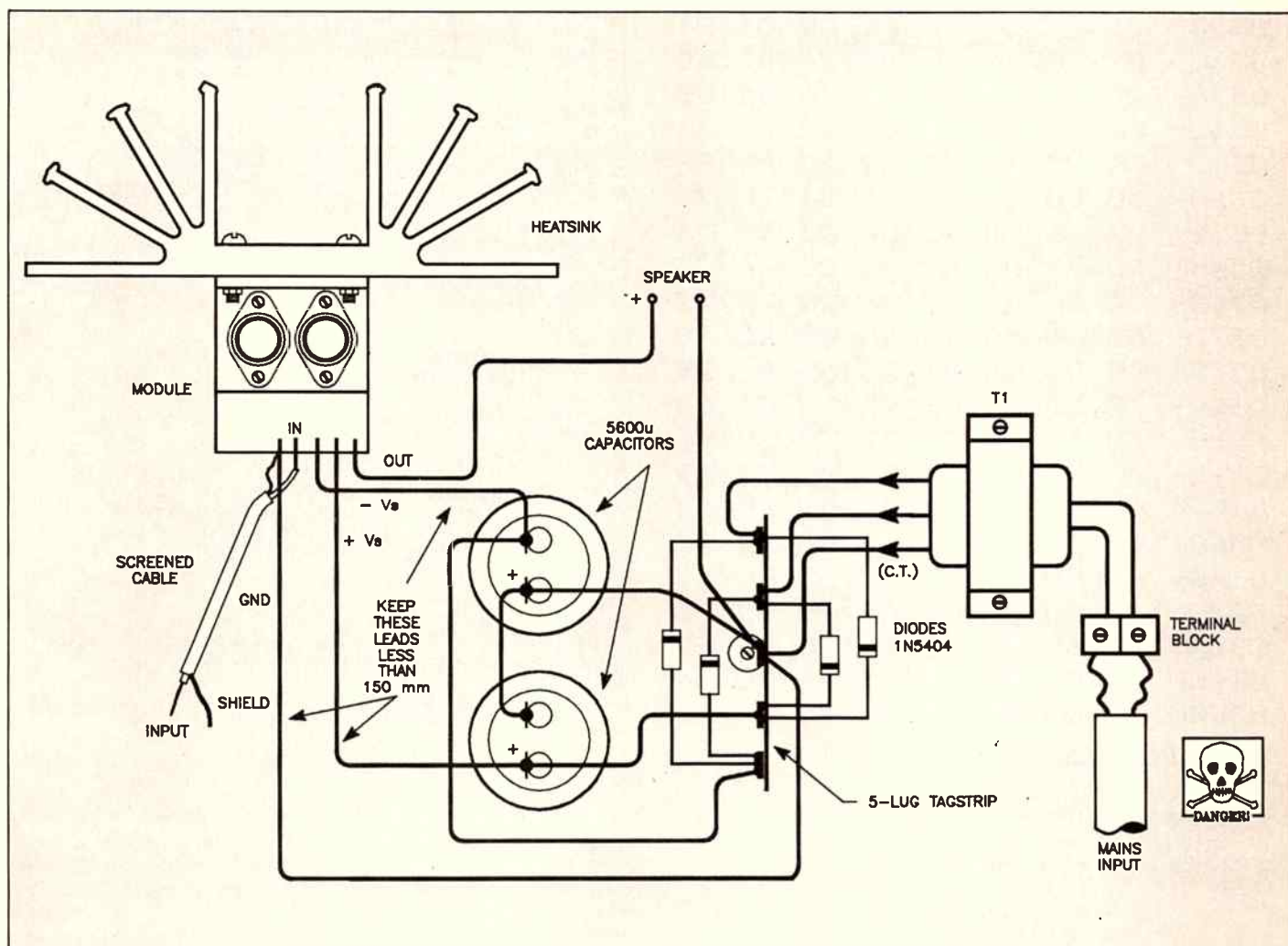

Wiring diagram for a single module and power supply.



Programs

Apple

300.3CD

```

0300- A9 88 8D FC 07 8D 79 C0
0308- 8D 5B C0 8D 78 C0 A9 2D
0310- 8D FE 03 A9 03 8D FF 03
0318- 58 85 D7 20 2F FB 20 58
0320- FC A9 02 85 22 85 25 4C
0328- 22 FC 2E FF 01 A9 01 24
0330- D7 F0 56 A9 08 24 D7 F0
0338- 0C A2 27 A5 FF 20 6A 03
0340- A9 AE 20 77 03 A2 24 A5
0348- FE 20 6A 03 A9 A0 A4 FF
0350- C0 50 B0 02 A9 BA 20 77
0358- 03 A5 FD 20 6A 03 A9 BA
0360- 20 77 03 A5 FC 20 6A 03
0368- D0 1F 48 29 0F 20 75 03
0370- 68 4A 4A 4A 4A 09 B0 48
0378- A9 04 24 D7 F0 05 68 29
0380- 7F D0 01 68 9D 00 04 CA
0388- 60 A9 02 24 D7 F0 3D 18
0390- A5 06 6D 2A 03 85 06 A5
0398- 07 6D 2B 03 85 07 F8 A5
03A0- FF 6D 2C 03 85 FF A5 FE
03A8- 69 00 85 FE C9 60 90 1C
03B0- A9 00 85 FE 65 FD 85 FD
03B8- C9 60 90 10 A9 00 85 FD
03C0- 65 FC 85 FC C9 24 90 04
03C8- A9 00 85 FC D8 40
    
```

Apple IIC clock

Here is the program listing that should have been published with the description of the Apple clock in the December 1988 issue of ETI.

**B. Murray,
Gorokan,
NSW.**

Commodore

```

1 REM *****
2 REM *          NUMBERSORT          *
3 REM *          DARREN YATES        *
4 REM *****
5 DIM NUM1(1000):N=0:D=0:TE=0:B=0:P=0:X=0:A=0:Z=0
6 COLOR1,2:COLOR0,6,0:COLOR4,3,2:GRAPHIC0,1
7 PRINT"
8 PRINT"          NUMBER SORT"
9 PRINT"
10 PRINT:PRINT" THIS IS A BASIC PROGRAM THAT CAN SORT"
11 PRINT"A SERIES OF NUMBERS INTO NUMERICAL ORDER"
12 PRINT"WITH HIGH SPEED FOR A COMMODORE MACHINE!"
13 PRINT:PRINT" TO USE THIS PROGRAM YOU MUST TYPE IN"
14 PRINT" EACH NUMBER FOLLOWED BY THE RETURN KEY"
15 PRINT" WHEN YOU HAVE FINISHED,PRESS <RETURN>"
16 PRINT"          UP TO 1000 NUMBERS CAN BE":PRINT"
          SORTED WITH SPEED"
17 PRINT:PRINT"TIME TO SORT 20 NUMBERS.....4.27 SECS"
18 PRINT"TIME TO SORT 50 NUMBERS.....19.11 SECS"
19 PRINT"TIME TO SORT 100 NUMBERS.....63.38 SECS"
20 PRINT"TIME TO SORT 200 NUMBERS.....227.14 SECS"
21 PRINT:PRINT"          PLEASE PRESS A KEY TO BEGIN":GETKEYZZ0:
          GRAPHIC0,1
22 REM *****
23 REM PROCEDURE GETNUMBERS
24 FORA=1TO1000
25 PRINT"NUMBER"A".....":INPUTNUM1(A)
26 IFNUM1(A)=0THEN28
27 NEXTA
28 A=A-1
29 REM END [GETNUMBERS]
30 REM *****
31 TI0="000000"
32 QW=PEEK(65286):POKE65286,PEEK(65286)AND239
33 FORZ=0TO7:X=21Z
34 IFA(X)THEN43
35 B=0
36 IF(B+X)=>ATHEN42
37 FORN=XTO1STEP-1:IFA-B<<2*X)THEND=(A-B)-X:ELSESD=X
38 FORP=(X+1)-NTOD+(X-N):IFNU(B+P)>NU(B+N)THEN39:ELSE40
39 TE=NU(B+P):NU(B+P)=NU(B+N+P):NU(B+N+P)=TE
40 NEXTP,N
41 B=B+(2*X):GOTO36
42 NEXTZ
43 POKE65286,QW
44 SCNLR:PRINT:PRINT"TIME TO SORT NUMBERS:"TI0:"TI      PRINT
45 PRINT:FORQ=1TOA:PRINTNU(Q):NEXTQ:PRINT:PRINT
46 PRINT" <1> END"
47 PRINT" <2> START AGAIN"
48 GETKEYAA:IFA0="1"THENEND:ELSECLR:GOTO5
    
```

Numbersoft

This program was written for the Commodore Plus 4 and C-16 but it can be easily modified for the C-64 and C-128. Basically, it takes a list of up to 1000 numbers and then sorts them into numerical order. The numbers can be either

integer or irrational which are then printed on the screen. Instructions to use it are contained in the program.

**D. Yates,
French's Forest,
NSW.**

Commodore

```

1 REM PLUGGER BY W.PUGH
10 SCNCLR
20 PRINTTAB(3)"TO LAND THE PLUG IN THE HOLE, PRESS"
30 PRINTTAB(3)"THE LEFT,RIGHT AND DOWN CURSOR KEYS"
40 PRINTTAB(3)"-----PRESS ANY KEY TO START-----"
50 GETKEY$
60 VOL7
70 S=P:P=0
80 SCNCLR:P=P+1:COLOR0,7,3:COLOR4,7,3
90 CO=19
100 RD=INT(37*RND(1))+1
110 COLOR1,8,6
120 CHAR1,0,19," " :REM RVS ON,40 SPACES
130 COLOR1,8,5
140 CHAR1,0,20," " :REM 40 SPACES
150 COLOR1,8,4
160 CHAR1,0,21," " :REM 40 SPACES
170 COLOR1,8,3
180 CHAR1,0,22," " :REM 40 SPACES,RVS OFF
190 PRINTTAB(1);"PLUG";P,,"SCORE";S
200 CHAR1,CO,1,"IL":REM SHIFT @ AND L
210 FORQ=2 TO 19:COLOR1,8,5
220 CHAR1,RD,19," " :CHAR1,RD,20," " :REM RVS ON,2 SPACES,RVS OFF
230 A=INT(2*RND(1))+1:COLOR1,1
240 IFA=1 AND RD>2 THEN RD=RD+1:IFRD>37 THEN RD=RD-1
250 IFA=2 AND RD<37 THEN RD=RD-1:IFRD<2 THEN RD=RD+1
260 CHAR1,RD,19," " :CHAR1,RD,20," " :REM RVS ON,CONTROL1,2 SPACES,RVS OFF
270 GETD$:IFD$=""THEN 270
280 CHAR1,CO,Q-1," " :REM 2 SPACES
290 IFD$=CHR$(157)ANDCO<0THENCO=CO-1
300 IFD$=CHR$(29)ANDCO<39THENCO=CO+1
310 CHAR1,CO,Q," " :REM SHIFT@ AND L
320 NEXTQ
330 IFCO<RDTHENFORQ=1000 TO 700STEP-25:SOUND3,Q,3:NEXTQ
340 IFCO=RDTHENFORQ=1000 TO 700STEP-25:SOUND1,Q,3:NEXTQ:S=S+1
350 GOTO00

```

Pluggger

This game was written for the Commodore Plus 4 but it will also run on the C-16. Instructions are included in the program.

**W. Pugh,
Werribee,
VIC.**

VZ 200/300

```

0 REM THERE ARE MANY DIFFERENT VERSIONS OF CAMEL FOR DIFFERENT
1 REM COMPUTERS. I HAVE CONVERTED CAMEL FOR THE VZ-200 & VZ-300
2 REM ORIGINAL IDEA FROM HEATH USERS GROUP.
3 REM *****
4 REM CAMEL OCCUPIES ABOUT 6K
5 REM 'CAMEL' CONVERTED AND REWRITTEN BY D.MAUNDER [C]COPYRIGHT
6 REM 06/02/89 FOR THE

```

```

7 REM V V V V V ZZZZZZ V V
8 REM Z Z V V Z Z Z
9 REM ! ! V V Z ! !
10 REM 2 3 V V Z 2 3
11 REM 0 0 V V Z 0 0
12 REM 0 0 V ZZZZZZ 0 0
13 REM VZ200/VZ300 COMPUTERS
14 REM *****
15 GOSUB214:PRINT" WELCOME TO CAMEL":REM INVERSE
16 PRINT
17 PRINT
18 PRINT" WOULD YOU LIKE INSTRUCTIONS?"
19 PRINT" Y/N"
20 T$=INKEY$
21 IFT$="N"THENGOTO36
22 IFT$="Y"THENGOTO25
23 IFT$("<")N"ORT$(">")Y"THENGOTO20
24 GOTO20
25 CLS:PRINT" C A M E L":REM INVERSE"
26 PRINT
27 PRINT"THE OBJECT OF THE GAME IS TO"
28 PRINT"TRAVEL 200 KILOMETRES ACROSS THE";
29 PRINT"GREAT GOBI DESERT."
30 PRINT"A TRIBE OF KNOCK KNEED DESERT PYGMIES WILL BE ";
31 PRINT"CHASING YOU."
32 PRINT"YOU HAVE TWO LITRES OF WATER WHICH WILL LAST YOU ";
33 PRINT"SIX DRINKS"
34 PRINT:PRINT
35 INPUT" PRESS <RETURN> TO CONTINUE";VZ$:REM INVERSE
36 POKE30777,35:FORB=1TO30
37 PRINT@384,;"**GOOD LUCK AND GOOD CAMELING**"
38 PRINT@384,;
39 PRINT"XXXXXXXXXXXXXXXXXXXXXXXXXXXXXXXXXXXXXXXXXXXXXXXXXXXX"
40 NEXTB
41 POKE30777,67:GOSUB213:CLS
42 GOSUB200:PRINT
43 PRINT"YOU ARE IN THE MIDDLE OF THE DESERT AT AN OASIS"
44 GOSUB213
45 IFC>60THEN141
46 Z=Z-1
47 IFZ=1THENPRINT"-----GET A DRINK"
48 IFZ=0THEN194
49 P=P+1
50 J=RND(10)+2.5
51 IFQ>0THEN111
52 IFF<4THEN60
53 D=D+J
54 IFD<THEN59
55 PRINT"THE PYGMIES HAVE CAPTURED YOU.."
56 PRINT"CAMEL & PEOPLE SOUP IS THEIR FAVOURITE DISH !!!"
57 GOSUB210
58 GOTO188
59 PRINT"THE PIGMIES ARE C-D KILOMETRES BEHIND YOU.."
60 PRINT"YOU HAVE TRAVELLED C"
61 PRINT"KILOMETRES SO FAR.."
62 PRINT:INPUT"WHAT IS YOUR COMMAND?";A$
63 POKE30777,67
64 IFA$="D"THENPRINT"DRINK FROM CANTEEN.":GOTO100
65 IFA$="M"THENPRINT"MODERATE SPEED AHEAD.":GOTO79
66 IFA$="F"THENPRINT"FULL SPEED AHEAD.":GOTO86
67 IFA$="N"THENPRINT"NIGHT STOP.":GOTO94
68 IFA$="S"THENPRINT"STATUS CHECK.":GOTO97
69 IFA$="H"THENPRINT"HOPE FOR HELP":GOTO73
70 IFA$="*"THENPRINT"COMMANDS":GOSUB200:GOTO62
71 PRINT"INVALID COMMAND."
72 GOSUB200:GOTO62
73 T=RND(10)+1
74 IFT<2THEN140
75 PRINT"HELP HAS FOUND YOU IN A STATE OF UNCONCIOUSNESS"
76 S=3
77 Z=4
78 GOTO45
79 F=F+1
80 IFF=8THEN138
81 GOSUB105
82 I=RND(10)+1
83 C=C+I
84 PRINT"YOUR CAMEL LIKES THIS FACE."
85 GOTO45
86 F=F+3
87 IFF>7THEN138
88 GOSUB105
89 I=2*RND(10)+1
90 C=C+I
91 PRINT"YOUR CAMEL IS BURNING ACROSS THEDESERT SANDS.."
92 PRINT
93 GOTO45
94 PRINT"YOUR CAMEL THANKS YOU!!!"
95 F=0
96 GOTO46
97 PRINT"YOUR CAMEL HAS 7-F GOOD DAYS LEFT FOR TRAVELLING."
98 PRINT"YOU HAVE S DRINKS LEFT IN YOUR CANTEEN"
99 PRINT"YOU CAN GO Z COMMANDS WITHOUT DRINKING.."
100 S=S-1
101 IFS<0THEN140
102 PRINT"YOU HAD BETTER WATCH OUT FOR AN OASIS."
103 Z=4
104 GOTO62
105 A=RND(20)
106 IFA>3THEN131
107 PRINT"WILD BERBERS ARE HIDDEN IN THE SAND HAVE CAPTURED YOU"

```

```

108 PRINT"LUCKILY THE LOCAL SHEIK HAS      AGREED TO THEIR "
109 PRINT"DEMANDS .....BUT.....WATCH OUT FOR THE PYGMIES!!!!..."
110 PRINT"YOU HAVE A NEW CHOICE OF SUB-  COMMANDS:"
111 PRINT"KEY      DESCRIPTION"
112 PRINT" E      :   ATTEMPT AN ESCAPE."
113-PRINT" W      :   WAIT FOR PAYMENT."
114 INPUT"YOUR SUB-COMMAND ??":B$
115 IFB$="E"THENPRINT"ESCAPE.":GOTO118
116 IFB$="W"THENPRINT"WAIT FOR PAYMENT.":GOTO126
117 GOTO114
118 I=RND(10)+1
119 IFI<5THEN123
120 PRINT"CONGRATULATIONS, YOU SUCCESS-  FULLY ESCAPED!!"
121 Q=0
122 GOTO45
123 PRINT"YOU WERE MORTALLY WOUNDED BY A  PIG STABBER WHILE"
124 PRINT"ESCAPING.."
125 GOTO166
126 I=RND(10)
127 IFI>5THEN148
128 PRINT"YOUR RANSOM HAS BEEN PAID AND  YOU ARE FREE TO GO.."
129 PRINT"THE LOCAL SULTAN IS COLLECTING..JUST WAIT...."
130 GOTO45
131 A=RND(10)+1
132 IFA>4THEN148
133 PRINT"YOU HAVE ARRIVED AT AN OASIS...YOUR CAMEL IS ";
134 PRINT"FILLING YOUR      CANTEEN AND EATING FIGS"
135 Z=4
136 S=6
137 RETURN
138 PRINT"YOU DIRTY RAPSCELLION!!YOU RAN  YOUR POOR CAMEL TO";
139 PRINT" DEATH!!"
140 GOTO166
141 PRINT"*****";
142 PRINT"*YOU WIN,A PARTY IS BEING GIVEN*";
143 PRINT"*IN YOUR HONOR.....THE PYGMIES *";
144 PRINT"*ARE PLANNING TO ATTEND..... *";
145 PRINT"*****";
146 FORT=1T06: SOUND0,2: SOUND23,2: SOUND0,2: NEXTT
147 GOTO188
148 I=RND(10)
149 IFI>5THEN160
150 PRINT"YOU HAVE BEEN CAUGHT IN A SAND-  STORM....GOOD LUCK!!"
151 M=RND(10)+1
152 N=RND(10)+1
153 IFN<5THEN156
154 C=C+M
155 GOTO157
156 C=C-M
157 PRINT"YOUR NEW POSITION IS"C"KILOMETRES SO FAR!!"
158 PRINT"THE PYGMIES ARE"C-D"KILOMETRES BEHIND YOU"
159 RETURN
160 I=RND(10)
161 IFI>5THENRETURN
162 D=D+1
163 PRINT"YOUR CAMEL HURT HIS HUMP."
164 PRINT"LUCKILY THE PYGMIES WERE FOOT-  WEARY!!!"
165 RETURN
166 U=RND(5)
167 PRINT"*****";
168 PRINT"*** YOU DIED IN THE DESERT ***";
169 PRINT"*****";
170 GOSUB210
171 IFU=1THENGOTO176
172 IFU=2THENGOTO179
172 IFU=2THENGOTO179
173 IFU=3THENGOTO181
174 IFU=4THENGOTO184
175 IFU=5THENGOTO187
176 PRINT"THE NATIONAL CAMELS UNION ISN'T "
177 PRINT"COMING TO YOUR FUNERAL"
178 GOTO188
179 PRINT"YOUR BODY WAS EATEN BY VULTURES &  IMPORTED CANNIBALS"
180 GOTO188
181 PRINT"THE LOCAL SHEIK NOW USES YOUR  SKULL AS A CHANGE"
182 PRINT"PURSE!!!!!!!!!"
183 GOTO188
184 PRINT"PEOPLE WITH LITTLE INTELLIGENCE  SHOULD STAY OUT OF"
185 PRINT"THE DESERT."
186 GOTO188
187 PRINT"TURKEYS SHOULD FLY,NOT RIDE     CAMELS!!!"
188 PRINT:PRINT
189 PRINT"WANT A NEW CAMEL AND A NEW GAME":A$=INKEY$
190 A$=INKEY$
191 IFA$="N"THENGOTO196
192 IFA$="Y"THENGOTO36
193 GOTO190
194 PRINT"YOU RAN OUT OF WATER....SORRY
195 GOTO166
196 PRINT"*****"
197 PRINT"***** CHICKEN *****"
198 PRINT"*****"
199 FORA=1T02000:NEXT POKE30845,199
200 PRINT"      COMMANDS":REM INVERSE
201 PRINT"KEY      DESCRIPTIONS"
202 PRINT" D      :   DRINK FROM YOUR CANTEEN"

```

```

203 PRINT" F      :   AHEAD FULL SPEED"
204 PRINT" M      :   AHEAD MODERATE SPEED"
205 PRINT" N      :   STOP FOR NIGHT"
206 PRINT" S      :   STATUS CHECK"
207 PRINT" H      :   HOPE FOR HELP"
208 PRINT" *      :   LIST OF COMMANDS"
209 RETURN
210 FORT=1T03: SOUND1,2: SOUND0,2: SOUND0,2: NEXTT
211 SOUND 1,6
212 RETURN
213 Z=4:S=6:C=0:D=0:F=0:P=0:Q=0:RETURN
214 POKE30777,67:CLS:COLOR8
215 PRINT0," _____ ";
216 PRINT450," _____ ";
217 FORB=32T0448STEP32
218 PRINT0B," # ";
219 PRINT0B+31," # ";
220 NEXTB
221 POKE29183,184
222 PRINT032;
223 RETURN

```

Camel

Camel is a popular game that is played by many people. There are many versions of the game. This is one. Instructions to play are included in the program.

**D. Maunder,
Quirindi,
NSW.**

Feed Forward needs your minds. If you have ideas for circuits that you would like to enter in our idea of the month contest, programs for the computing columns or just want a word with the editor, send your thoughts to:

Feed Forward
ETI, Federal Publishing,
PO Box 227,
Waterloo, NSW 2017

Contributors can look forward to \$20 for each published idea/program which should be submitted with the declaration coupon below.

Programs MUST be in the form of a listing from a printer. You should indicate which computer the program is for. Letters should be typewritten or from a printer, preferably with lines double spaced. Circuits can be drawn roughly, because we have a draughtsman who redraws them anyway, but make sure they are clear enough for us to understand.

'Idea of the month' contest

Scope Laboratories, which manufactures and distributes soldering irons and accessory tools, is sponsoring this contest with a prize given away every month for the best item submitted for publication in the 'Ideas for Experimenters' column — one of the most consistently popular features in ETI Magazine. Each month, we will be giving away a Scope Soldering Station (model ETC60L) worth approximately \$191.

Selections will be made at the sole discretion of the editorial staff of ETI Magazine.



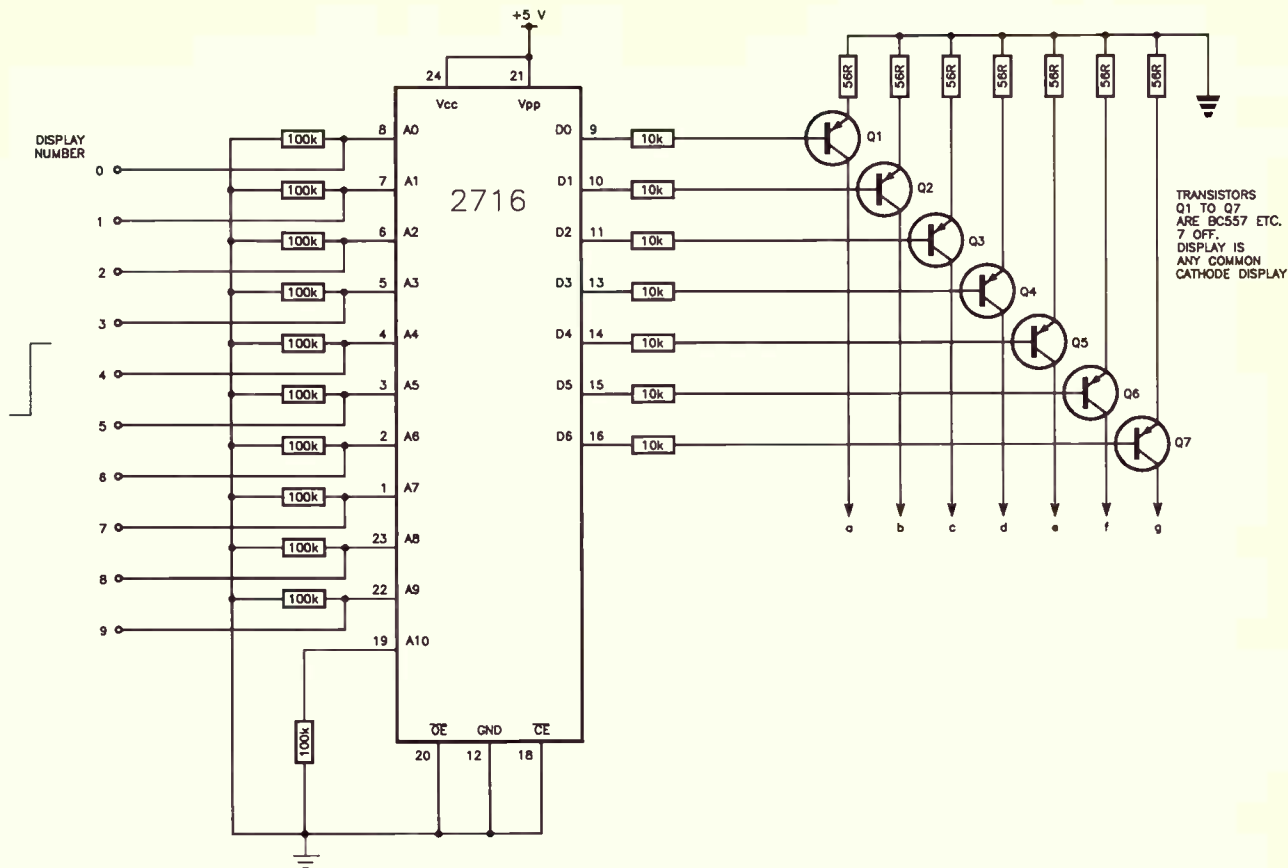

RULES

The winning entry will be judged by the Editor of ETI Magazine, whose decision will be final. No correspondence can be entered into regarding the decision.

The winner will be advised by telegram. The name of the winner, together with the winning idea, will be published in the next possible issue of ETI Magazine.

Contestants must enter their names and addresses where indicated on each coupon. Photostats or clearly written copies will be accepted. You may send as many entries as your wish.

This contest is invalid in states where local laws prohibit entries. Entrants must sign the declaration on the coupon that they have read the above rules and agree to abide by their conditions.

COUPON

Cut and send to: **Scope-ETI 'Idea of the Month' Contest/ Computing Column, ETI Magazine, PO Box 227, Waterloo NSW 2017.**

"I agree to the above terms and grant *Electronics Today International* all rights to publish my idea/program in ETI Magazine or other publications produced by it. I declare that the attached idea/program is my own original material, that it has not previously been published and that its publication does not violate any other copyright."

* Breach of copyright is now a criminal offence.

Title of idea/program

Signature Date

Name

Address

..... Postcode

Circuits

Idea of the month

Decimal to 7-segment EPROM convertor

PRESENTLY there is no chip available to convert decimal into 7-segment display code. A 2716 EPROM is used here to do this task. When I needed such a convertor, I found this to be a cheap alternative as EPROMS are readily available and relatively cheap.

The +5 volt inputs are fed into the appropriate address lines on the EPROM. The program then converts this data into 7-segment display type data with transistors Q1 to Q7 driving the display. If multiple address lines are taken high, no output will result.

The CE pin can be used to put the EPROM into its low power consumption mode by inserting a switch to switch CE either high

or low, or the CE pin can be driven by logic circuits to produce the same results. If low power consumption is not needed, CE should be tied low.

The program required is below. All addresses not shown must be programmed to 00.

ADDRESS	DATA	DISPLAY
0001	F3	0
0002	30	1
0004	E6	2
0008	76	3
0010	35	4
0020	67	5
0040	E7	6
0080	32	7
0100	F7	8
0200	37	9

Note: All other addresses must be burnt to 0.

**D. O'Dwyer,
Anakie,
VIC.**

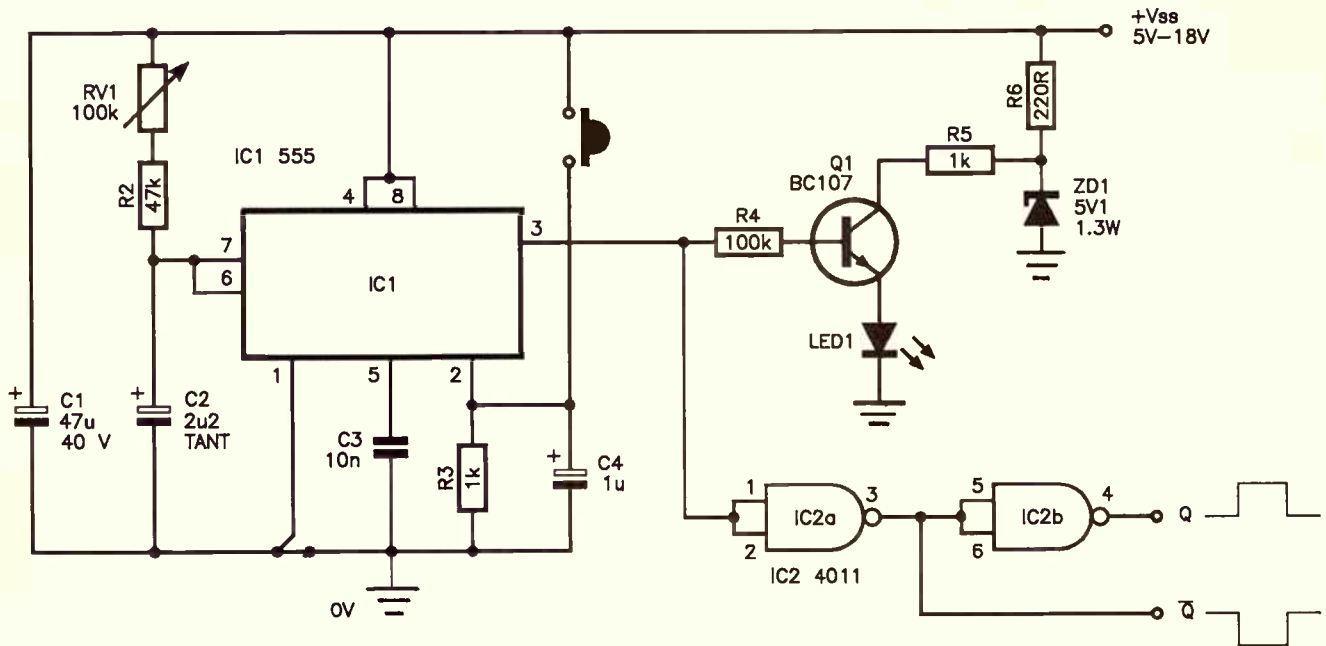

Single pulse generator

WHEN designing counting circuits in either CMOS or TTL it can be difficult to decipher rapidly changing outputs. This circuit

produces a single pulse of controllable width. A 555 is used as a monostable with the trigger input (pin 2)

decoupled to prevent false triggering. The LED pulse indicator is powered from a shunt regulator to allow any supply

from 5-18 V to be used. Note that SW1 must be a normally closed type. Outputs are buffered to ensure true logic level outputs.

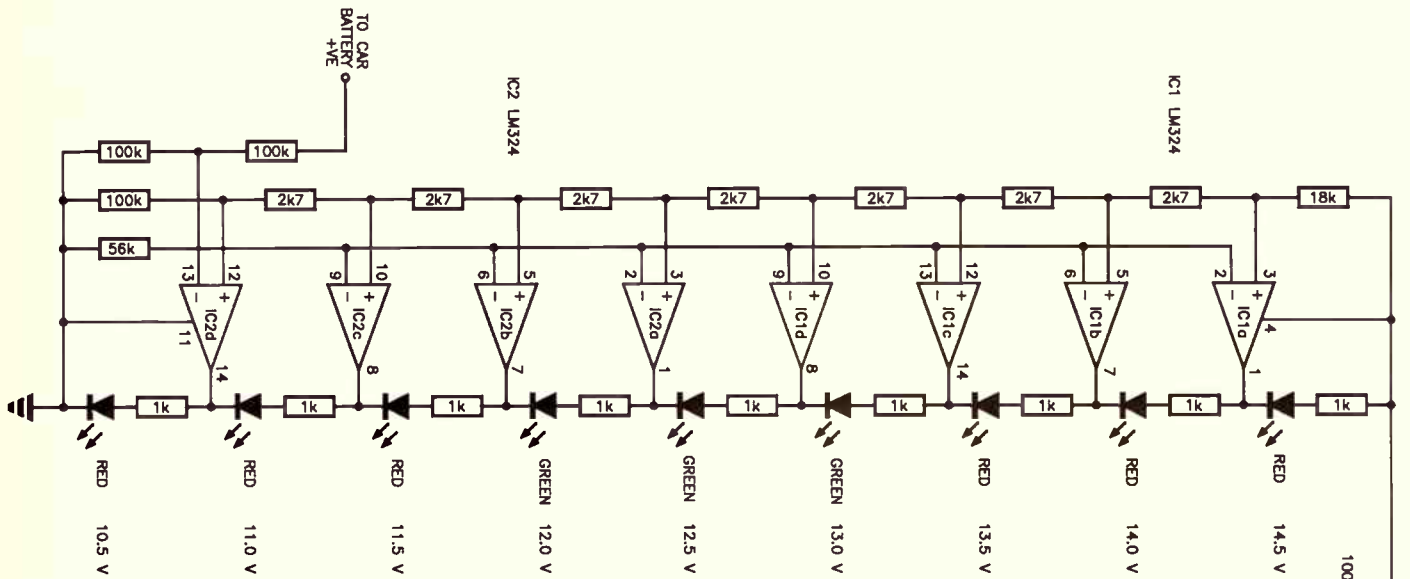

Car voltmeter

THE value of this circuit is that it provides a cheap alternative to the LM3915-series of led drivers, the total cost of this circuit being equivalent to one of the ICs.

The circuit is connected to the fusebox, interior light etc in your car. It will provide a dot-readout of the battery voltage between 10.5 and 14.5 volts. The circuit consists of eight comparators, the outputs being initially high.

The leds are connected between these outputs. The unregulated voltage is halved by the potential divider R1/R2 which is then fed into the eight comparators. As the voltage rises above the preset voltage derived from the resistor network connecting the non-inverting inputs, the output of that op-amp goes low while the op-amp above has a high output, so the

led turns on.

The op-amp output below is low, so the led below now turns off because both outputs are now equal in magnitude. Each led represents a 0.5 volt change in the battery voltage. Layout is not critical and it should be able to fit in any small zippy box.

**D. Yates,
French's Forest,
NSW.**

PC XT

FAST TURBO
640 KB RAM
360 KB FDD
101 KEYBOARD
P/S/G PORTS

\$950

STORAGE

20 MB Harddisk & Card	\$465.00
33 MB Harddisk & Card	\$539.00
42 MB Harddisk & Card	\$599.00
720K 3.5" FDD	\$165.00
1.44M 3.5" FDD	\$195.00

ACCESSORIES

12" x 12" Digitizer	\$849.00
Key Board Draw	\$85.00
Mouse with Software	\$88.00
Disket Storage Box	\$18.00
Quickshot Joystick	\$30.00



Avo Electronic Systems

188-192 Pacific Hwy.
(CNR. Bellevue Ave.)
Greenwich, N.S.W. 2065

PC XT

10 MHz CLOCK
360 KB FDD
20 MB HDD
HIRES MON
NLQ PRINTER

\$1950

PC AT

12 MHz 0/1 WS
SI = 16
1.2 MB FDD
20 MB HDD
101 KEYBOARD

\$1990

PC AT

1 MB RAM
SHADOW RAM
40 MB HDD
EGA CARD
EGA MONITOR

\$3200

DISPLAY

Dual mode card	\$108.00
EGA Card	\$280.00
VEGA VGA card	\$499.00
Dual mode monitor	\$180.00
Thomson 14" Colour	\$450.00
Thomson 14" EGA Mon	\$630.00
Thomson VGA Mon	\$720.00

PRINTER

10" 9 Pins NLQ	\$395.00
15" 9 Pins NLQ	\$599.00
10" 24 Pins NLQ	\$615.00
15" 24 Pins NLQ	\$1380.00

INTRODUCING

**386 PC 20MHZ 2 MB RAM
FROM \$4950**

Training, installation and problem solving specialist
Reliable repair and service by qualified engineer
Full 12 months parts and labour warranty

Telephone
(02) 906-2655

Fax
(02) 906-2735

NOTHING MATCHES THE DIC SC-5000 DESOLDERING TOOL FOR COMPACT SIZE, LIGHT WEIGHT, FEATURES AND PRICE

The DIC SC-5000 solder cleaner, unlike conventional desoldering stations, is so easy to handle because it has a vacuum pump built in and requires no connecting tubes or separate compressor. Just one power cord and that's all.

The integration of the suction nozzle and vacuum pump results in greater suction power. Due to it's powerful 60 watt ceramic heater, it heats rapidly and recovers immediately during use. Exact temperature control is accomplished by a zero-crossing feedback circuit, eliminating RF interference and preventing damage to integrated circuits, multi-layer boards and through-hole-plated PC boards. With the flick of a switch the DIC becomes a hot blow gun.

And at the recommended retail price of \$495 the DIC SC-5000 won't burn a hole in your pocket.

Available now in Australia exclusively through Tecnico Electronics and appointed Distributors.

SYDNEY 439 2200 MELBOURNE 235 3686
11 Waltham Street, Artarmon, NSW. 2064.



TECNICO ELECTRONICS
For electronic components & instrumentation

Get afloat with

modern
boating

Available monthly
at your newsagent or
subscribe now by
phoning (02) 693-9517

*Australia's
top-selling
Power and Sail
Magazine*

On sale now

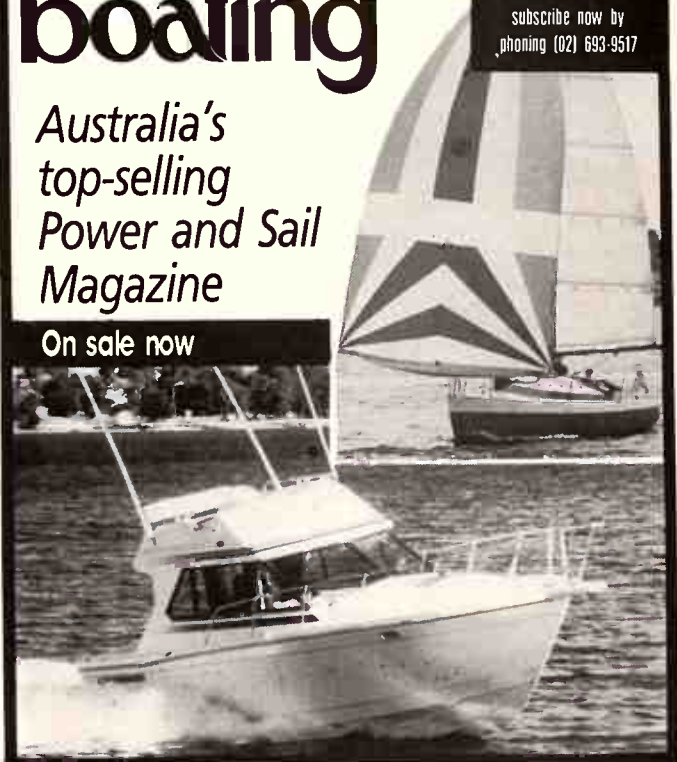



PC range enhanced



Olivetti Australia has launched a number of new personal computer models, ancillary hardware and software products to extend and enhance Olivetti's PC range. Two new printers, including a laser printer, are now also available.

The new products include an entry-level workstation, the M290, and three top-end personal computer models; the

Olivetti M380/XP1, M380/XP3 and M380/XP5, which are all based on the 80386, 220 MHz processor.

A new model M380/C, which is now compatible with OS/2, was also unveiled. This model is based on the 80386 CPU at 16 MHz and is designed for stand-alone and multi-user operation in a monotasking or multitasking environment. ☎ (02) 358-2655.

READER INFO No. 206

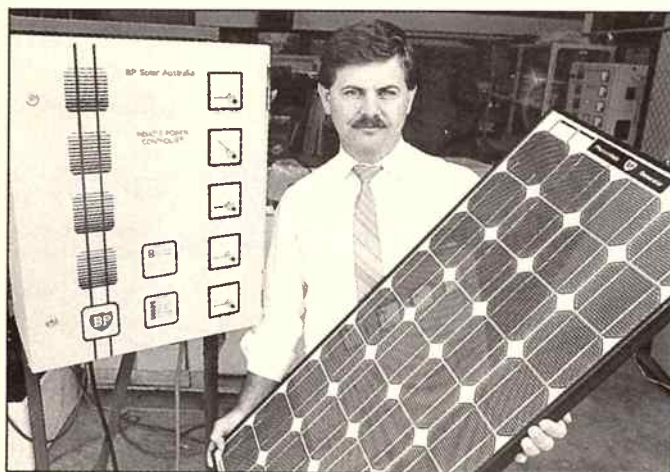
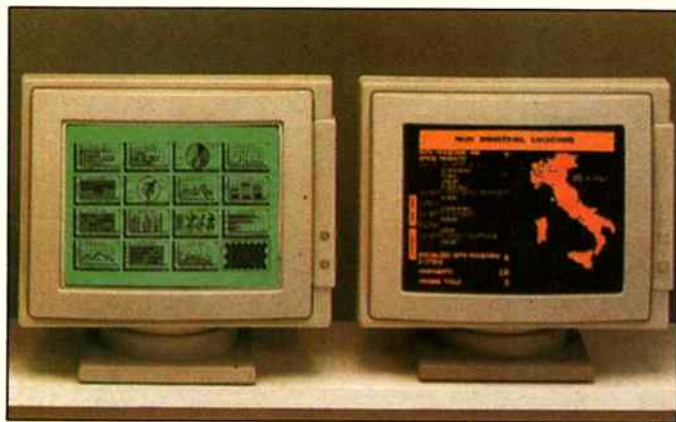

More power for less fuel



A NEW hybrid power Remote Area Power System has been released by BP Solar Australia, which, it claims, enables generator fuel bills to be cut by up to half.

"This new system can save up to 50% on generator fuel usage over generator only systems," said BP Solar Hybrid Power Systems (HPS) product manager, David Bartley.

It apparently does this by running generators for less time, and only when peak power is being used. The 10 kVA system, produced through the development of a new dc/ac

inverter system by BP Solar, gives higher peak output and reduces the dependency on generators.

The new inverter allows the system to deliver 24 hour power with only six hours of diesel operation per day, even if no solar modules are connected to the system. Diesel operation falls even further with them connected to the system.

BP Solar Australia guarantees all solar modules for ten years and PVStor batteries for five years. All components are designed and manufactured in Australia, and BP Solar HPS systems retail from \$7000.

READER INFO No. 207

Heat-shrinkable marker system

REMTEK has released the Qwik-Mark heat-shrinkable marker system for industrial and commercial use. Qwik-Mark is ideal for applications where flexibility and flame retardancy are important. Underwriters Laboratories recognition is under Standard 224.

Specifically designed for use with standard typewriters and computer printers, the marks are smear resistant after printing and become permatised when they are heated and shrunk. Qwik-Mark can also be marked with a pen. The printer element may be a ball, a wheel or a dot matrix. Best mark quality is achieved with a high quality carbon, non-correcting fabric ribbon.

Easy to use in printers and typewriters, Qwik-Mark can be friction

fed or tractor fed. The marker sleeves are supplied on a perforated carrier with spacing based on the standard typewriter and printer line advance of 4 mm (i.e., six lines to the inch).

Qwik-Mark is available in four sizes: 3 mm (0.125"), 6 mm (0.250"), 13 mm (0.5") and 25 mm (1.0"). The shrink ratio is 3:1. These sizes will accommodate most wire constructions in gauges 22 AWG through 0 AWG. Larger sizes are planned for future production.

Standard printable marker is 50 mm wide. Standard colour is yellow. A standard box of product contains 250 marker sleeves.

For further information contact Ian Pitts on (02) 648 1760.

READER INFO No. 205



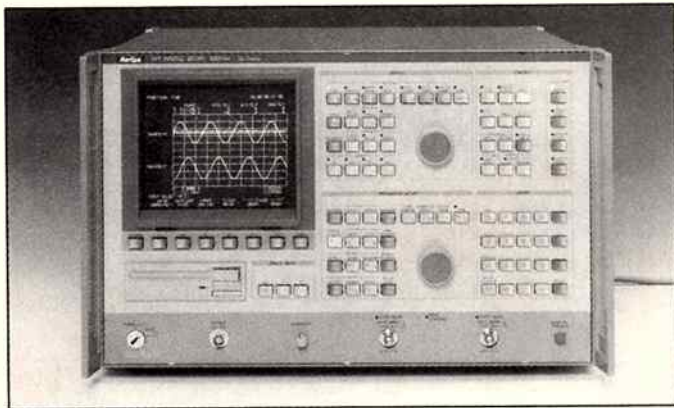

New digital oscilloscopes ▲

ALCATEL-STC has introduced two new Anritsu digital storage scopes, designed to meet demands of research and development in data storage, media and hardware, new materials and other leading edge technologies, the company claims.

They provide coverage from dc to 100 kHz (MS210A) or dc to 10 MHz (MS430A), and it is claimed that trace storage capability permits full analysis of even transient waveforms.

An optional in-built floppy disk drive allows the contents of the trace memory to be stored with up to 64 sets of operating parameters, and the MS210A and MS430A provide an IEEE 488 general purpose interface for connection to a video printer or plotter to provide a permanent hard copy record of display and parameter settings.

Unique triggering facilities of these scopes are said to increase their flexibility, and hysteresis triggering prevents false triggering on noise pulses.

Delay triggering allows the trigger point to be set up to 200,000 sampling points before or after the waveform to be captured. A pattern triggering facility allows complex sequences to be displayed by triggering the display on a particular pattern rather than just on the positive or negative slopes.

Other optional extras include a MG443B synthesised oscillator/level generator which can sweep frequencies from 10 Hz to 30 MHz in 1 Hz steps, and a MG418A pulse generator which can produce a continuous stream of pulses as short as 10 nanoseconds. Contact Alcatel-STC, Measuring Instruments, ☎ (03) 615 6666.

READER INFO No. 203

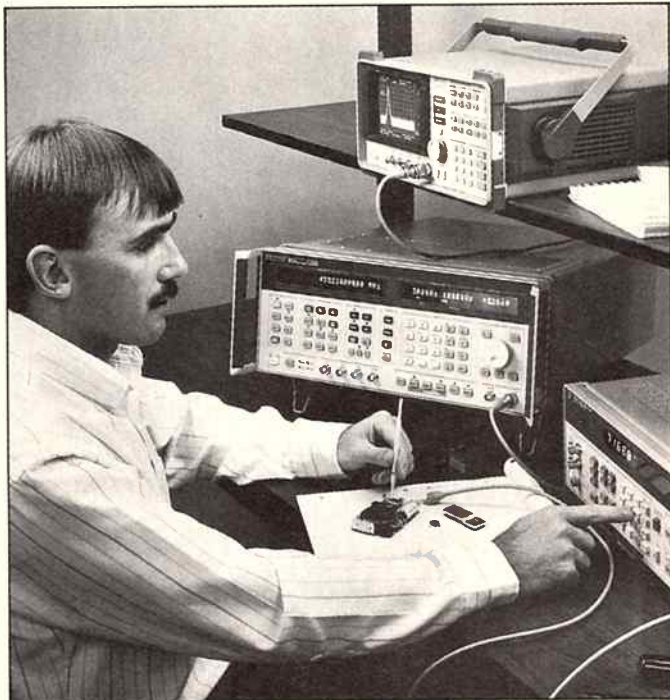

Synthesised sig-gennys ▲

TWO synthesised signal generators, aimed at lowering the cost of high performance RF communication applications, the HP 8644A and HP 8665A, provide low phase noise and spurious levels commonly needed in R&D manufacturing.

The HP 8644A covers a frequency range to 2 GHz and the HP 8665A covers a range to 4.2 GHz. Modular, these generators can be configured with various options so customers

can choose the performance.

Designed to offer the lowest phase noise and spurious output (spectral purity) beyond the 10 kHz offset, the generators can do out-of-channel tests on RF and low microwave communications systems. These tests are usually high performance tests such as receiver selectivity or intermodulation.

More information from Hewlett Packard, ☎ (03) 895-2895.

READER INFO No. 204

JED STD-CMOS Single Board Computer

Need an easy-to-apply computer for use either to build a system, or as the heart of a multi-card rack? How about this JED board, designed and built in Melbourne. Just look at the features:

- All CMOS system, Z-80 code.
- Eight, 10-bit analogue inputs, 0-5 volts.
- Thirty digital I/O, 8/12 power FETs.
- Two RS232 serial I/O, (+/- 10 volt swing).
- Optional RS485 for party line systems.
- Microwire interface for LCD, LED displays.
- Single supply, 5-volts at 90 mA.
- Mates with JED 2, 3, 5 or 10-slot racks and AC or battery powered motherboards.
- Clock/calendar with timed power-up.
- Up to 120 kBytes of CMOS RAM/PROM.
- CP/M emulation for compilers, or use inbuilt BASIC interpreter for fast programming.
- And best of all, it costs only \$500.

JED Microprocessors Pty. Ltd. (03) 762 3588
Office 7, 5/7 Chandler Rd., (PO Box 30), Boronia, Vic., 3155

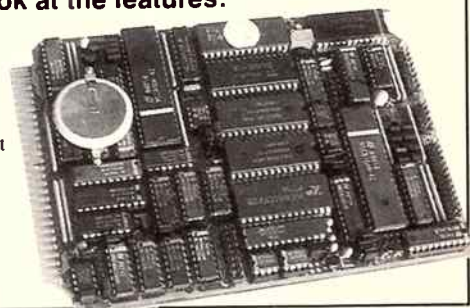

READER INFO No. 24

Problem Solvers

Take your pick of banana plugs and jacks, adaptors, shielded connectors and receptacles, moulded or diecast "black boxes," "Grabber" test clips, SMD test devices, static control products, test probes, patch cords, moulded breakouts, cable assemblies and instrumentation kits.

Manufactured by ITT Pomona Electronics (U.S.A.) and distributed in Australia by Alcatel STC-Cannon. Solve your test accessory problems by contacting your nearest sales office for further details.

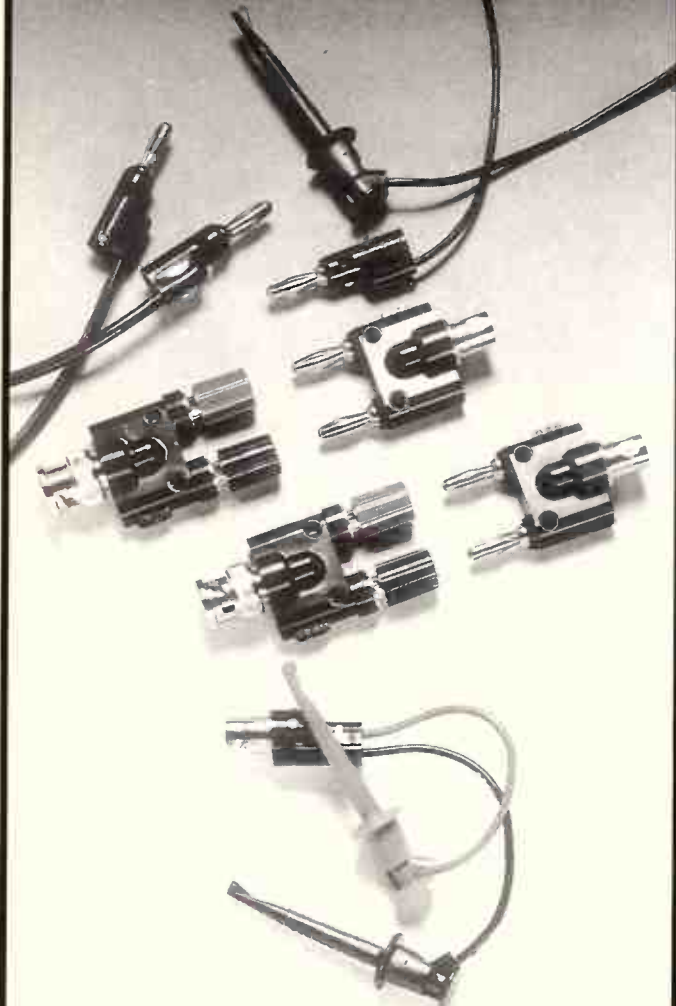

ALCATEL
STC-CANNON

248 Wickham Road, Moorabbin, Vic. 3189
Tel.: (03) 555 1566 Fax: (613) 553 3801 Telex: 30877
Sydney (02) 663 2283 Adelaide (08) 363 0055 Brisbane (07) 832 5511

READER INFO No. 68

NEW PRODUCTS

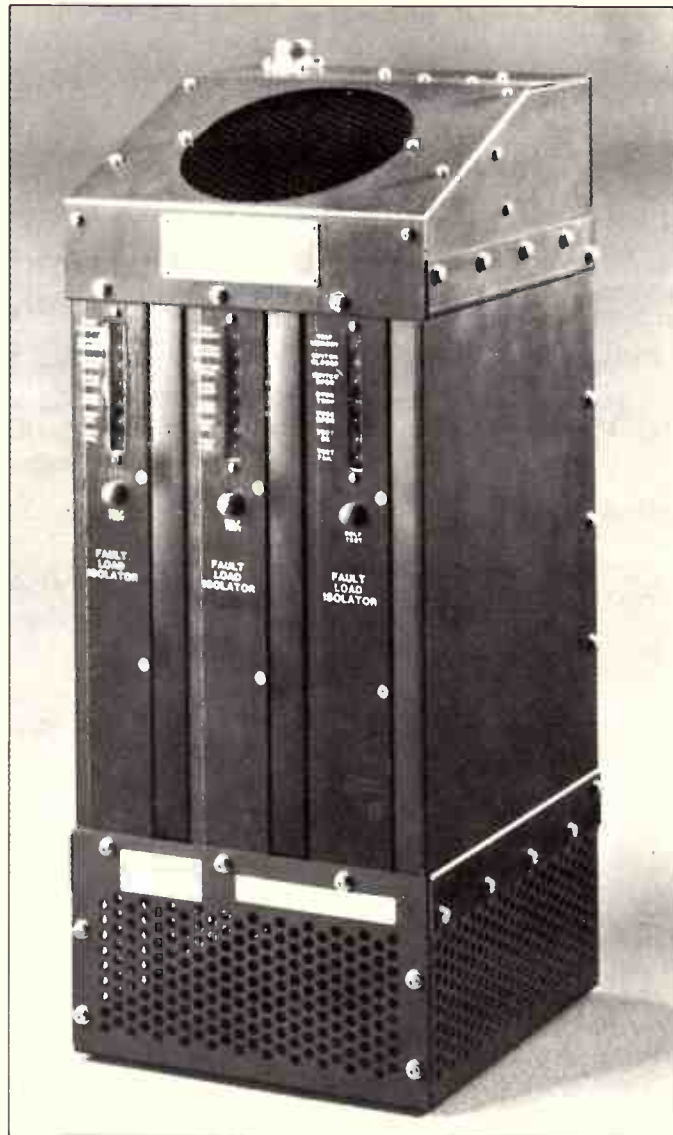

Power drive

AVAILABLE from the Pacific Power Generation Company is a new heavy duty eddy current motor drive produced by the MagneTek Louis Allis Division.

Called the EPF Type, the new range can be mounted on flanged motors in the 60 to 125 horsepower range, offers a speed of 1650 to 825 and operates on the principle of a constant speed ac motor which is magnetically coupled to an output shaft through an integral, variable speed current coupling.

This coupling consists of a constant speed drum directly connected to the motor rotor and an inductor directly con-

nected to the output shaft.

The output shaft is supported by its own bearings and passes through the hollow motor rotor shaft that is supported by a separate set of bearings. Adequate clearance between the inductor and the drum prevents metal to metal contact.

As the drum rotates, eddy currents are induced and magnetic attraction occurs between the drum and the inductor, transmitting torque from the former to the latter. Contact Mike Ford at Pacific Power Generation Company, ☎ (02) 638 5600.

READER INFO No. 208

ETI MAY '89

94

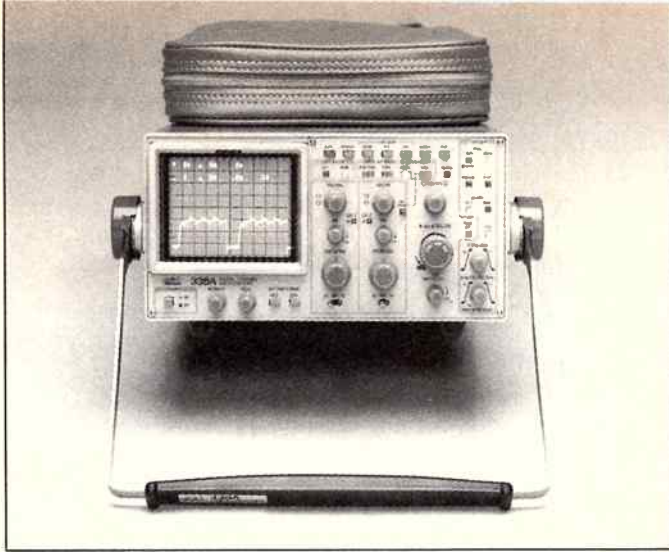

New Tek digital storage CRO

SAMPLE rate has increased to 20 MS/s, vertical resolution to 8 bits and expanded memory to 16 Kbytes in the Sony/Tektronix 336A handheld digital oscilloscope, which updates the model 336.

New features include auto setup, cursors, on-screen readout, GPIB, and the ability to save waveforms and up to eight front panel setups. Single-shot

bandwidth is 2.8 MHz and it has a menu-driven interface, auto setup and front panel setup.

It can display both non-storage and digitised waveforms simultaneously, using its dual-channel dc to 50 MHz vertical deflection system. The storage bandwidth for single sweep events is dc to 2.8 MHz. Ring Tektronix on ☎ (02) 888-7066.

READER INFO No. 209

Graphics to video in one step

THE Magni 4005 Series Video Graphics System from Amiga, said to be the only genlocker which fits inside the computer, claims to be able to combine the usual two-step process of converting computer graphics to video in one process.

Each system consists of two plug-in cards, a genlocker/encoder and a sync pulse generator card to pick up Amiga graphics signals and feed locking signals into the Amiga. This way the computer's RGB signal is locked to the video rate along with the encoded output, yielding a video output Amiga claims is up to true broadcast standards.

Before, the RGB signal had to be taken through an external encoder and scan converter to get NTSC or PAL-compatible signals, as the line and field frequency of the RGB signals produced from graphics software was solely dependent

on a computer's internal clock. Amiga says low-cost software is available for the 4005, and that the system can offer up to 4096 colours with keying possible on coloured backgrounds.

A remote control box is provided for downstream effects and a key output for upstream keying. A self-test routine is also supplied. Two versions are available, for NTSC and PAL.

Use of the Video Graphics System won't affect drawing speeds of the Amiga's on-board graphics program, or any other being used, and does not prevent concurrent use of the IBM bridge board, it is claimed.

Orders for the product have been received from the Victorian Ambulance Service and ATV 10 in Adelaide, among others, and can be obtained in Australia through Quinto Communications, Melbourne, Victoria, and Artarmon in Sydney, NSW.

READER INFO No. 210

ELECTRONICS TODAY

eti

ELECTRONICS · TECHNOLOGY
INNOVATION

Reader Information Card

On the reverse of this page you will find the Reader Information Card. This is a service ETI provides free to readers who want more information about products advertised or otherwise mentioned in the magazine. At the bottom of the article or advert you will find a RI number. Just circle that number on the card and send the card to us. We will pass on your

address to our contacts, either the advertiser or our source for the story, who will then inundate you with literature on the product of your choice. Another feature: to the right, there is a blank space. Why not use it to drop us a line, and let us know what you think of the magazine. We are particularly interested in ideas from readers on how we can improve things.

Note to the Editor:

Name:

Address:

.....

Postcode:

4000 count for new Metrix DMMs

ALL models of the Metrix 40 Series Digital Multimeters feature 4000 count resolution, auto-range with manual override, memory function, very fast peak hold (4mS response), water-proofing on models MX43, MX45 and MX47, diode test and audible continuity, and come with a 4 year warranty.

They measure voltage ranges from 0-400 mV to 0-1000 Vdc (750 Vac), current from 0-400 μ A up to 10A, ac and dc, and resistance up to 20M. The Model 47 also features direct temperature using a K-type thermocouple plus true RMS ac or and DC, especially useful in application where ac components are superimposed on a dc value (eg, the output of a thyristor).

Recessed input terminals and safety probes apparently make it impossible to touch live con-

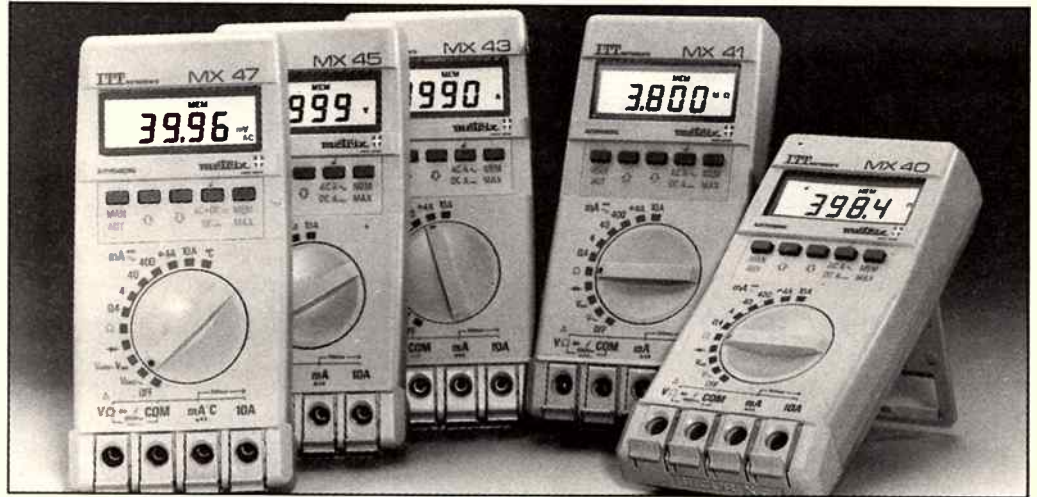

ductors, and each Instrument comes with "Secur X", a patented lead locking device that prevents accidental disconnection of the instrument.

Overload protection is said to be assured by metal oxide

varistors, PTC resistors and high-breaking capacity fuses. All models are housed in yellow coloured self-extinguishing material, and are shock and vibration tested to MIL-T-28800C.

A wide range of accessories is available to extend the capabilities of the 40 Series. For more information contact Paul Twigg, national distributor products manager for Elmeasco, (02) 736 2888, READER INFO No. 213



READER INFORMATION SERVICE COUPON



READER INFORMATION SERVICE

To find out more about the products and services in this issue, note the Reader Service Number from the advertisement or article, and circle the corresponding number in this coupon. Enclose it in an envelope and send to:

FREE POST No. 4
The Federal Publishing Company
P.O. Box 227, Waterloo, N.S.W 2017

No stamp required if posted in Australia.

- A. Engineer/Designer
- B. Technical Officer
- C. Technician
- D. Programmer/Analyst
- E. Manager
- F. Teacher/Lecturer
- G. Student
- H. Interested Consumer
- I. Other (please state).....

Please \checkmark the box that best fits you.

Name.....
 Address.....

..... P/C.....

1	26	51	76	101	126	151	176	201	226	251	276	301	326
2	27	52	77	102	127	152	177	202	227	252	277	302	327
3	29	53	78	103	128	153	178	203	228	253	278	303	328
4	29	54	79	104	129	154	179	204	229	254	279	304	329
5	30	55	80	105	130	155	180	205	230	255	280	305	330
6	31	56	81	106	131	156	181	206	231	256	281	306	331
7	32	57	82	107	132	157	182	207	232	257	282	307	332
8	33	58	83	108	133	158	183	208	233	258	283	308	333
9	34	59	84	109	134	159	184	209	234	259	284	309	334
10	35	60	85	110	135	160	185	210	235	260	285	310	335
11	36	61	86	111	136	161	186	211	236	261	286	311	336
12	37	62	87	112	137	162	187	212	237	262	287	312	337
13	38	63	88	113	138	163	188	213	238	263	288	313	338
14	39	64	89	114	139	164	189	214	239	264	289	314	339
15	40	65	90	115	140	165	190	215	240	265	290	315	340
16	41	66	91	116	141	166	191	216	241	266	291	316	341
17	42	67	92	117	142	167	192	217	242	267	292	317	342
18	43	68	93	118	143	168	193	218	243	268	293	318	343
19	44	69	94	119	144	169	194	219	244	269	294	319	344
20	45	70	95	120	145	170	195	220	245	270	295	320	345
21	46	71	96	121	146	171	196	221	246	271	296	321	346
22	47	72	97	122	147	172	197	222	247	272	297	322	347
23	48	73	98	123	148	173	198	223	248	273	298	323	348
24	49	74	99	124	149	174	199	224	249	274	299	324	348
25	50	75	100	125	150	175	200	225	250	275	300	325	350

For a prompt reply

POST TODAY

POST TODAY

POST TODAY

ETI MAY '89

FLUKE



PHILIPS

**Fluke-Philips
Alliance
Lowers the price
of gold.**



Good as Gold

Fluke Multimeters:

The shining standard by which others are measured.

FLUKE and PHILIPS

The global alliance in TEST & MEASUREMENT announce price reductions across the entire range of Fluke multimeters and accessories.

WHY SETTLE FOR LESS,

When you can afford the world's best multimeters?

FLUKE MULTIMETERS NOW FROM *\$128.00

*(recommended retail price of Fluke 73)

READER INFO No. 18

(ex tax)

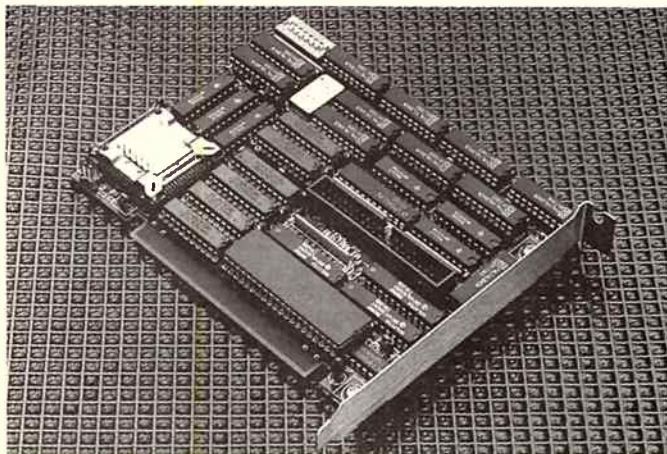

Hyperace II

A NEW range of accelerator boards developed for both the 8088 and 8086-based IBM PCs, XTs and compatibles has been launched by Hyperace Pty Ltd. Hyperace II, which is aimed to replace the computer's standard processor with its 80286 processor, consists of three products. Hyperace II-10, a 10MHz board, Hyperace II-12 (&12.5MHz) and Hyperace II-16, which runs at 16MHz.

The new range features support for LIM 4, the latest expanded memory specification and has an automatic slow-down facility for slow peripherals such as printers. Although designed for the compatibles market with an emphasis on the

Olivetti M24, Amstrad PC and IBM PS/2 Model 30 it is said to also run on a range of 8088-based compatibles.

Hypertec's original Hyperace range also has a new addition. The new board is Hyperace 286 Mega Plus featuring an 80286 processor running at 16MHz.

RRP prices for the new boards are - Hyperace II-10, \$1067; Hyperace II-12, \$1177 and Hyperace 16, \$1287. Original range prices are: Hyperace 286 Plus \$888; Hyperace 286 Super Plus, \$1133. All prices include sales tax. More details from David Cuneen at Hypertec Pty Ltd. ☎ (02) 816 1211.

READER INFO No. 216

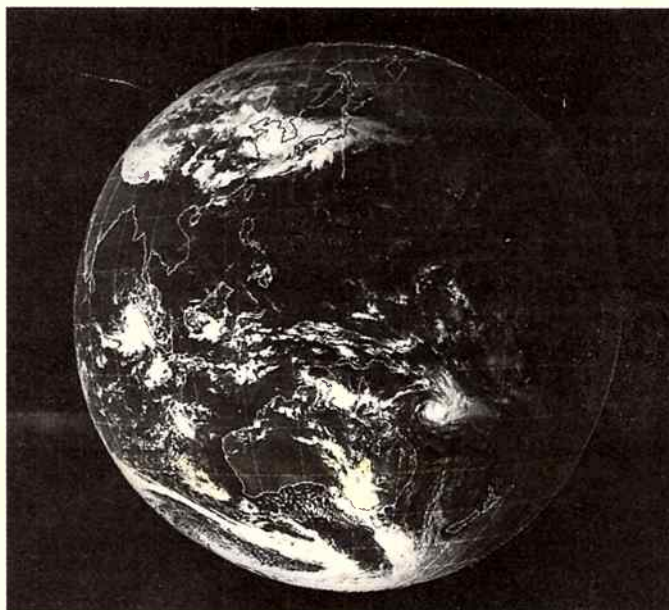

Weather pix from space

FROM the beginning of this year the Bureau of Meteorology has been receiving hourly photographs from Japan's Geo-stationary Meteorological Satellite (GMS), 35,7000 km above the equator directly north of Australia.

The pictures go to Melbourne where they are stored on a disk, where coastal outlines and grid lines are computer-added. The images are then transmitted digitally to the Bureau's centres in state capitals. There, an AT PC

using software developed by the Bureau, stores the information, displays it on high resolution monitor or prints hard copies on the Toyo TP6490 video printer.

Supplier, Amtex Electronics, said the TP6490 with 300 dots per inch resolution and 64 tones of grey catered well for the scientific and high performance market. There is a colour version, the TPG4300. For more details, contact Amtex Electronics ☎ (02) 805 0844.

READER INFO No. 217

Can't Find It? File It!

Special
Binder Offer

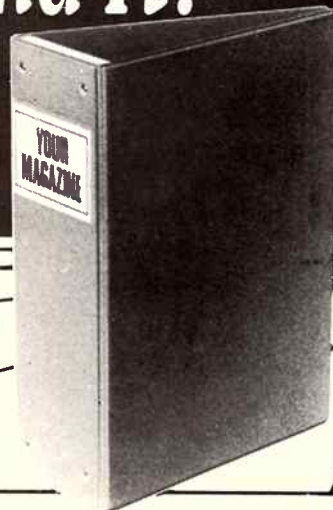

These attractive, ready to use, sky blue vinyl binders have been specially designed to hold and protect 12 of your valuable magazine collection in the easy clip-on fastener wires.

Please send me binders @ \$8.00 each = \$.....
PLUS postage and handling @ \$2.00 each = \$.....
For (Magazine Name) TOTAL \$.....

I enclose my cheque/money order (with this form in an envelope) for \$.....
Charge by Bankcard Mastercard

American Express Visa with \$.....

Card No. (10% discount for orders of 6 or more) Expiry Date /

.....

Signature..... (unsigned orders cannot be accepted)

Mail Post Free in Australia to: **Freepost No. 4**
The Federal Publishing Company
P.O. Box 227, Waterloo, N.S.W. 2017

Name:.....
Mr/Mrs/Ms/Miss Initial Surname

Address:.....

.....Post Code.....

Date of Order: / / Telephone: ()

FLUKE



PHILIPS

FLUKE 87

- 4½ digit mode
- True RMS
- Min Max Average recording
- Frequency, Duty Cycle, Capacitance
- 1000V RMS input protection
- Back lit display
- High Resolution Analog display
- 3 year warranty



READER INFO No. 58

WAS \$632.00
NOW \$480.00

FLUKE 73

- Rugged and versatile
- Volts, ohms, 10A, diode test
- Autorange
- 0.7% basic dc accuracy
- 2000 + hour battery life
- 3 year warranty



READER INFO No. 60

WAS \$167.00
NOW \$128.00

FLUKE 25

- Designed for rugged outdoor use and (Mine Safety)
- Analog/digital display
- 0.1% basic dc accuracy
- 100µV to 1000V ac and dc
- 0.1µA to 10A, all fused
- -15°C to 55°C operation
- 3 year warranty



READER INFO No. 59

WAS \$495.00
NOW \$389.00

ACCESSORIES

Here are some of the wide range of accessories available,

- ★ **80i — 410** READER INFO No. 61
 5 to 400A hall effect ac/dc clamp — on current probe.
 WAS \$310.00 NOW \$234.00
- ★ **80T — 150u** READER INFO No. 62
 Universal temperature probe
 WAS \$279.00 NOW \$218.00
- ★ **80TK** READER INFO No. 63
 Type K thermocouple module for use with interchangeable probes
 WAS \$142.00 NOW \$107.00
- ★ **C100** READER INFO No. 64
 Universal carry case for all handheld DMMS
 WAS \$84.00 NOW \$56.00

(All prices are recommended retail prices exclusive of Sales Tax)

Available from the following stocking distributors:

ACT: John Pope Electrical, (062) 80-6576. Aeromotive Maintenance Services, (062) 85-2377. NSW: Ames Agency, 699-4524. J. Blackwood & Son, 609-0111. George Brown & Co, 519-5855. DGE Systems, (049) 69-1625. Ebson, 707-2111. Macelec, (042) 29-1455. Obiat, 698-4776. Petro-Ject, 569-9655. David Reid, 267-1385. NT: J. Blackwood & Son, (089) 84-4255. Haymans, (089) 84-3422. QLD: Auslec, (07) 854-1661. Petro-Ject, (07) 252-2777. St Lucia Electronics, 52-7466. L. E. Boughen, 369-1277. Haytech, 844-9396. Thompson Instruments (Cairns), (070) 51-2200. Nortek (Townsville), (077) 79-8600. SA: Electech (08) 277-1533. Petro-Ject, 363-1353. TAS: George Harvey Electric, (003) 31-6533. Petro-Ject, 44-8400. VIC: Radio Parts Group, 329-7888. George Brown & Co, 878-8111. Electech, 482-1577. Petro-Ject, 877-4122. J. Blackwood & Son, 542-4321. Factory Controls, (052) 78-8222. Mektronics, 587-3888. WA: Atkins Carlyle, 481-1233. Dobbie Instruments, 478-1366

RENTING SOLUTIONS



Tech-Rentals has its own repair and calibration facilities with experienced engineers operating from well equipped major service centres in Melbourne and Sydney.

Contractors to the Queensland Railways are supplying 80 main line electric locomotives for coal haulage and high speed freight and passenger services. The order, which is the western world's largest rail electrification project, is nearing completion. As to date, 62 locomotives have been handed over with a further four completed ready for commissioning. Tech-Rentals provided heat and vibration measuring instruments for the trials. Data was collected on 14-track instrumentation recorders for replay into vibration analysers, all of which were supplied by Tech-Rentals, and a 100-point strain analysis on the locomotive chassis using an ORION data logger, also supplied by Tech-Rentals, was performed at the manufacturer's site.

Crisis is a familiar word to the people who answer the phones at Tech-Rentals' offices around the country. They hear it many times a day.

Dealing with other people's crises and emergencies without panic is Tech-Rentals' business, a business that has grown alongside Australia's electronics industry and the increasing use of technology in industry as a whole.

The company has offices in Melbourne, Sydney, Perth, Canberra, Brisbane and Adelaide as well as in New Zealand, Hong Kong and Singapore.

But whatever the location, there's the same buzz of suppressed excitement in the air. It's the nature of the business. Most customers have a problem that demands an instant solution – whether the need is for equipment as simple as a handheld multimeter or sophisticated as an infrared thermal video camera system.

The Tech-Rentals' people describe themselves as a hire pool with carpet on the floor and that is essentially true: the company hires out electronic equipment, computers and peripheral devices to companies which, either through breakdown, cost considerations or developments in technology, do not have their own.

The hire period can be as short as 24 hours or as long as 12 months or more. Some customers find the hired equipment becomes indispensable for day-to-day operations and end up buying it from Tech-Rentals at a reduced price.

This is especially true with microcomputers. Customers often hire to try out a new computer or to see if they really need a computer at all. Once they feel comfortable with the machine, they convert the hire agreement to a purchase.

Tech-Rentals evolved from a company called Jindra Electronics, which commenced operations in 1974 providing an independent repair and maintenance service for electronic test and measurement equipment. Paul Jindra was an experienced Czechoslovak electronics engineer, newly arrived in Australia.

He noticed a steady demand for replacements while his clients' equipment was being repaired, so he started lending and then renting his own test and calibration instruments.

From this modest beginning the company grew in size, number of offices and inventory, and is now the largest rental organisation for test and measurement instruments, personal computers and computer peripherals in the Southern Hemisphere.

Despite this record of successful growth Australian business did not at first take readily to hiring equipment. Paul Jindra recalls how after waiting anxiously for the first few months he sold most of his initial inventory. He had to rely on his service work for an income while the initial resistance to paying rental fees was overcome.

"Fees then were based on the same formula as they are today – a percentage

'Most of the big names count on Tech-Rentals for hiring equipment'

of the purchase price. But because few companies really considered the true cost of ownership – purchase price, maintenance costs and depreciation – rental fees seemed excessive. It was also an attitude of mind, as companies were so conditioned to buying their equipment and hiring staff to maintain it.

"A number of factors combined over a

fairly short period of time to change industry's attitude to hiring: the capital cost of equipment, wage costs, increasingly complex equipment that required correspondingly complex maintenance and the pace of development which quickly made machines obsolete.

"Companies now have a very progressive attitude to the cost of skilled manpower. Rental equipment is an effective way of increasing efficiency.

"New equipment is horrendously expensive and the cost of paying wages for someone to maintain it is enormous."

Tech-Rentals' service facilities are fully equipped with the latest electronic test gear and staffed by highly qualified personnel. In-house test facilities are among the best in Australia and include NATA calibration and certification laboratories in both Sydney and Melbourne.

Tech-Rentals now has over 4000 customers throughout Australia and millions of dollars are spent every year in updating inventory as new, high technology products become available. Most of the big names in Australian industry count on Tech-Rentals for hiring equipment.



The Department of Transport was recently faced with the enormous challenge of installing 150 Aussat satellite terminals throughout Australia.

COMPANY PROFILE — TECH-RENTALS

These include the mining giants like BHP and Comalco, aircraft manufacturer McDonnell Douglas, Telecom, Aussat and many more.

Tech-Rentals' general manager, Paul Brooker, has a simple rule of thumb in the hire versus buy arguments: "If a piece of equipment is to be used for less than 50% of the time, renting should be seriously considered; if it's to be used for more than 50% of the time, leasing or purchase would seem to be best.

"When the choice is leasing, our rental with an option to buy has advantages. The user has the opportunity to see if the equipment fully meets expectations and there is a four-month warranty after purchase.

"The argument is one of simple mathematics based on a five-year cycle. Yet when you consider that the pace of technological development will make some items of equipment obsolete in less than five years, the 50% use figure could be too conservative".

The fact that capital is not tied up unnecessarily, there are no maintenance or repair costs, no interest charges, no calibration downtime and no financial provision needs to be made for replacement, are all powerful arguments for rental.

There are also times when rental is the only solution; equipment evaluation before purchase, at times of peak demand, during an emergency, for a specific short-term project or when use patterns are uncertain.

"Cost-conscious managers now realise that there is no need to buy that expensive microcomputer system or laboratory test gear that will be used only rarely or for a short time.

"Buying equipment is often hard work. When you are spending tens of thousands of dollars on an item, careful evaluation takes time; delivery times too can be very long.



Paul Jindra

When you rent equipment, we take care of these problems."

Staff at Tech-Rentals need to know just about everything about technical equipment. Customers use the company not only as a source of equipment but also for information on a wide variety of topics to do with applications.

Staff pride themselves that they can generally help people on the spot, but where the expertise is not available, callers are referred to experts at universities, technical institutes and industry where Tech-Rentals has established an extensive network of contacts over the years.

The sales team particularly enjoys helping engineers from overseas with their service and commissioning projects in Australia.

In recent times, these have included American geophysicists doing a five-month tour of duty in central Australia and a team of engineers from a leading Japanese car manufacturer checking their vehicle's electronic fuel injection system.

The Japanese were gratified and a little surprised to be able to hire the same Amritsu measuring receivers that they had used in Tokyo.

Specialists from the British Rediffusion company were able to rent their preferred Solartron frequency response analyser when commissioning a flight simulator for the local airlines.

Another service that Tech-Rentals provides is matching expertise to its hire equipment - particularly with regard to the more exotic test and measurement items.

"Many customers call with a problem that requires not only the equipment but someone who is able to operate it," Paul Brooker explains. "We have built up an extensive list of consultants with a variety of qualifications."

Tech-Rentals aims always to have stock on the shelves so that emergencies can be met. Most stock in the inventory is budgeted to have an optimum utilisation of 66%; some of the more expensive equipment is expected to have much less. For instance, the inventory contains three of the most expensive data communications analysers in the business. One is budgeted for 100% use and the other two for only 10% so the chances are there's one in stock when a customer calls. However, it's common for equipment to be purchased within hours when the need is urgent and all models are out on rent. If a customer has a need for a specialised piece of test equipment for two or three months, this is often the catalyst to make it a regular item in the inventory.

As part of stock control management policy significant sales of ex-rental stock are made each year. Instruments and personal computers are sold and replaced by the latest high technology models.

This has two main benefits. First, use of resources is directed towards providing customers with the most efficient equipment for their needs and second, stock available for rental never becomes outdated.

Sales activities also include the distribution of IBM PC, APPLE and COMPAQ products. In fact, sales of new computer and ex-rental equipment has become a significant additional service to Australian customers in recent years. Specialised new test and measurement equipment sales are an important adjunct to the group's sales activities.

In Australia, the fully owned subsidiary company, Elmeasco, provides the nucleus of the group's sales organisation for new test and measuring equipment and computer peripherals, importing test equipment and representing leading overseas manufacturers such as Data I/O, Gould and Cipher.

The logo for Elmeasco, consisting of the letters 'eli' in a stylized, lowercase font.

Calibration to NATA certification level.



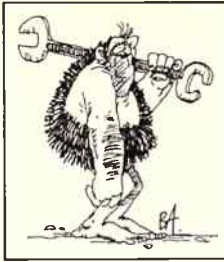

INSTRUMENTATION

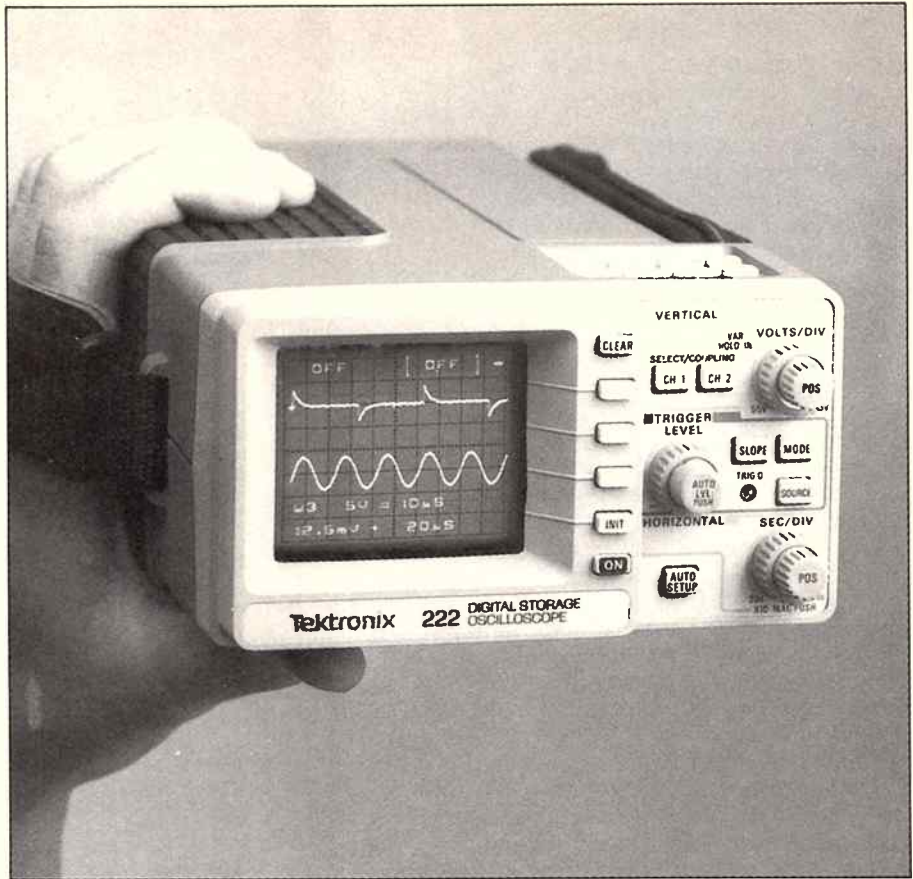

Jon Fairall looks at a little CRO with big features.

TEKTRONIX 222

The Tek 222 is the most impressive instrument I have seen for quite a while. Not because its specifications are over the top – they aren't. But as an example of exciting packaging and well thought out ergonomics, it's hard to beat.

First, a brief overview. It's small; in fact it's positively tiny. This is by no means the first hand-held CRO I've seen, but it is the first usable one. It's digital; this means it's slower than one would like, but it also has a range of marvellous features that make up for it. It's ergonomically sound. The operation is easier than that of many machines twice as big and as expensive.

At long last, an oscilloscope manufacturer has put together the elements of modern digital design in a way optimised for small size and battery operation. The 222 is just over 250 mm deep, 150 wide and only 86 high. It weighs barely 3 kg. When Tek says this is a hand-held CRO it really means it – this is the CRO you can climb Mt Everest with. (In fact the blurb sheet that comes with the 222 assures one that it will work at up to 15,000 feet, and survive a trip to 50,000 feet.) According to the same blurb sheet it has also been tested on a vibration table and

subjected to nearly $4g$ at 55 Hz. Presumably, this means it won't suffer too badly if you drop it from the top of a telegraph pole.

The genuine analogue-equivalent Nyquist bandwidth of the 222 is just 1 MHz. However, with the usual range of digital tricks this can be improved by an order of magnitude. Tektronix claims a bandwidth of 10 MHz on repetitive waveforms and a front end rise time of 15 ns.

Of course, this bandwidth is not going to set the world alight. However, the digital circuitry gives the 222 some terrific features. For a start, to prevent the front panel getting overcluttered, they have reduced the number of buttons on it to a sane number and used alphanumerics on the screen. For instance, to select a channel when you start up, you push the CH1 button. This causes the coupling alternatives (DC/AC/GND and OFF) to be displayed down the side of the screen, next to four buttons. Pushing one of the buttons will activate the appropriate coupling. Likewise, push the Mode button and four choices of triggering mode are displayed. All these buttons fit into a panel only 50 mm wide and 80 mm high. It's a testament to good design.

The trigger appears exceptionally good, although I wasn't able to check the manufacturer's specs (100 ns glitch capture). The trigger level is displayed by a small + symbol, and is set either automatically or from the front panel. As you would expect on a digital CRO it has a pre, mid or post trigger display mode, as well as a single shot mode. In single shot, the timebase can be triggered either from the front panel or via the level control.

The controls to save and recall the waveforms are on the top of the box, along with a trig position switch and a mode switch that will allow you to do things like X+Y or invert either channel. Saving and recalling is simple, so much so that I saved and redisplayed without recourse to the manual at all. The 222 will store four waveforms for later analysis as well, incidentally, as four front-panel setups you might wish to store.

There is also an RS232 port on the back and Tektronix supplies a driver for a PC so that one can transfer panel setup information and waveform data.

I had only a small number of complaints about the 222, all reasonably trivial. There is no graticule illumination. If you don't have a

light shining directly on to the screen, it can be difficult to make measurements. The stand seems a trifle flimsy. It's probably unnecessary and could have been eliminated. The probes are hardwired into the case and normally reside in a small pouch bolted to the side. It's a great idea but it's a pity there is no identification mark on either probe to tell you which channel it represents.

Should you buy one? Well the price, at about \$3000, is probably a bit on the high side, but there is obviously a premium for the size. Two kinds of people, I suppose, will be interested. Those with a genuine need for a portable CRO as a productivity tool, and those who place a high value on bench space. In the first role, a wide range of people might find it attractive. Power and communications workers need to get into odd places and will find it useful, provided it is not bandwidth limited. It's more than adequate for audio and most TV work, and I can imagine that techs doing repairs might be very interested, but radio workers will often find it lacking.

As to the question of bench space; well don't sneeze at it! It's rather nice to be able to shift the CRO around the bench like a multimeter. For once, the CRO can come to the breadboard, instead of the other way around.

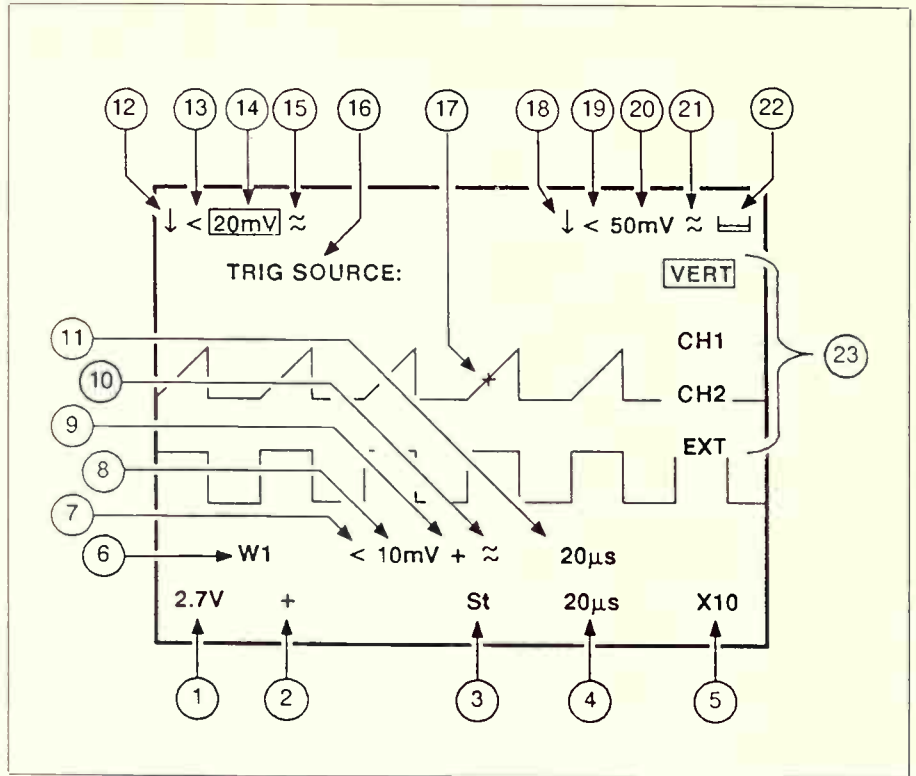

On-screen readout locations. Menus and waveform readouts are shown superimposed in the illustration; they are displayed separately in actual use.

Test & Measurement Equipment Rentals

(T. M. R. A DIVISION OF THE MAC RENT GROUP OF COMPANIES)

At last, a real alternative for instrument rentals

- Latest technology, market leaders in instruments.
- Our expert "NO HASSLE" service includes;
- **FREE** delivery and collection (within Metro. area).
- **FREE** advice and full support from our expert staff.

For all of your requirements in electronic test and measurement equipment, whatever you require...

Oscilloscopes, Chart Recorders, Logic analysers, Data analysers, Power supplies (including U.P.S.), Cable Locators, Mains analysers, Temperature Recorders, Transient recordersand much much more.

Call us now!!

PHONE: 905-5999

T.M.R



The ultimate in sophisticated golf reporting, colourful profiles, dramatic pictorial and penetrating expert instruction.

AUSTRALIAN

GOLF!

COMPULSIVE READING!



Available monthly at your newsagent or subscribe now by phoning (02) 693-9517 or 693-9515

KENWOOD

COMMERCIAL LINE UP

Kenwood's commercial lineup incorporates new standards of ruggedness and reliability. The use of rugged diecast chassis construction, high impact cases and high stability circuitry makes Kenwood the right choice when you need transceiving equipment that won't let you down.

UHF VHF HANDHELD TRANSCEIVERS



Optional DTMF Keypad shown

TK-300 TK-200

Crystal controlled handheld transceivers. Frequency coverage 450-520MHz & 403-420MHz (model TK300) and 150-174MHz (model TK200). Channel spread up to 5MHz (transmit). 6 channel capability. 5 watt maximum output (4 watts for model TK200) with HI/LO power switching. Low power setting. Diecast frame/chassis construction, high impact cases. Optional 810mAh battery. Options include Ni-cad batteries and chargers, speaker microphone, QT Tone coded squelch units.

READER INFO No. 50



TK-310 TK-210

Synthesised high performance handheld transceivers. Frequency coverage 450-512MHz (TK310) and 150-174MHz (TK210). Synthesised 12 channel capability. 5 watts maximum output with HI/LO power switching. 12MHz channel frequency spread (model TK210) for maximum channel flexibility. Diecast chassis frame. Twist lock battery system with optional 1600mAh heavy duty batteries.

READER INFO No. 51

UHF VHF FM MOBILE TRANSCEIVERS



TK-810 TK-710

Compact synthesised FM mobile transceivers. Frequency coverage 400-420MHz & 450-512MHz (TK810) and 138-174MHz (TK710). 4 channel capability. 25 watts output. 13.6VDC power (7A max). Rugged diecast construction. Compact, lightweight design. Heavy-duty front mounted speaker. 10MHz transmitter channel frequency spread (model TK810). Wide range of options, including control station system, QT coded squelch and digital QT coded squelch.

READER INFO No. 52



TK-820 TK-720

Rugged, high performance 32 channel (semi-duplex capable) synthesised transceivers. Frequency coverage 450-512MHz (TK820) and 150-174MHz (TK720). 25 watts output (adjustable). 10MHz transmitter spread. Front mounted heavy duty speaker. Broad choice of signalling options. Heavy duty die-cast chassis with modular construction. Metal case with high-impact moulded front panel.

READER INFO No. 53



TK-601S

Synthesised FM 32 channel low-band VHF transceiver. 29.7-50MHz, 66-88MHz. 25 watts output (adjustable). High performance noise blanker and heavy duty front mounted speaker. Professional quality microphone. QT quiet-talk coded squelch circuit. Ultra-rugged diecast construction, high impact case and covers. Wide range of options inc. Base power supply and microphone. DTMF microphone. Tone Encoded squelch.

READER INFO No. 54

**SOME MODELS SHOWN
HAVE D.O.T.C.
APPROVAL PENDING.**

VHF FM BASE STATIONS



TKB-620 TKB-720

Heavy duty synthesised VHF desk-top base station transceivers. 9 semi-duplex channel capability. Frequency coverage 29.7-50MHz (TKB620) and 150-174MHz (TKB720). Output power 50 watts. Heavy duty diecast modular construction. Large heatsink allows heavy duty cycle. Options include QT Tone coded squelch and Digital QT and QT Tone coded squelch. Power required 240VAC 230 watts max.

READER INFO No. 55

UHF DESKTOP REPEATER



TKR-820

High performance UHF desk-top repeater. State-of-the-art synthesised design using an E PROM for maximum reliability and flexibility. 2-20 watts output for wide range of repeater applications. Highly flexible repeater control unit. Built-in multiple-tone unit provides multiple QT digital QT tone combinations including cross tone or cross code. Rugged diecast construction and large heatsink area for heavy duty cycles.

READER INFO No. 56

KENWOOD ELECTRONICS AUSTRALIA PTY. LTD.

4E Woodcock Place, Lane Cove, Sydney NSW 2066. Ph: (02) 428 1455
Phone Kenwood for the name of your closest dealer.



YOU CAN NOW PURCHASE ANY OF FROM THE ETI

Titles cover a wide range of electronics, scientific, technical and computer topics and will be updated regularly to keep you abreast of the latest trends.

ELECTRONICS

Servicing Personal Computers: Second Edition, Michael Tooley

The revised and enlarged second edition contains a new chapter on the IBM PC, AT, XT and compatibles. 240pp. HEA012 **\$31.95**

Oscilloscopes: Revised Second Edition. Ian Hickman

This revised edition has been updated and enlarged to cover new instruments. Illustrated with diagrams and photographs of many more instruments, the book will appeal to everyone who wants to know about oscilloscopes, from the school student to the graduate, from the hobbyist to the technician. HEA016 **\$17.95.**

Practical Electronics Handbook: Revised Edition, Ian Sinclair

A useful and carefully selected collection of standard circuits, rules-of-thumb, and design data for professional engineers, students and enthusiasts involved in radio and electronics. HEA039 **\$21.95**

Practical Design of Digital Circuits: Ian Kampel

"This is a book which the reader will refer to repeatedly as a source of instruction and inspiration", What's New in Electronics. HEA017 **\$36.95**

Beginners Guide to Electronics: Fourth Edition, Owen Bishop

An essential and often reprinted book for the newcomer to electronics. The subject is treated with the minimum of mathematics. HEA019 **\$19.95**

Beginners Guide to Intergrated Circuits: Second Edition. Ian R. Sinclair.

"As before Ian Sinclair has managed to produce an outstanding book for the beginner to electronics." Everyday Electronics, reviewing first edition. HEA020 **\$14.95**

Newnes Radio and Electronics Engineer's Pocket Book: Seventeenth edition, Keith Brindley

An invaluable compendium of facts, figures and formulae which is indispensable to the designer, student, service engineer and all those interested in radio and electronics. HEA023 **\$19.95**

Newnes Television and Video Engineer's Pocket Book: Eugene Trundle

"A thoroughly up-to-date reference book on domestic TV/Video systems is very welcome and this book fulfils its aims admirably . . ." Television "a gem of a book . . . can be used by service engineers throughout the world". Elektor Electronics. HEA024 **\$29.95**

Newnes Computer Engineer's Pocket Book: Michael Tooley

'A very full and useful compendium . . . very practical . . . good value' NATFHE Journal HEA025 **\$29.95**

Newnes Engineering Science Pocket Book: J. O. Bird

'A wealth of information which will be most useful to students and engineers alike'. Elektor Electronics HEA026 **\$29.95**

Newnes Electronics Pocket Book: E. A. Parr

'An excellent and useful book for daily use that is unreservedly recommended to anyone with an interest in electronics' Elektor Electronics HEA027 **\$29.95**

Experiments in CMOS Technology: Dave Pronchnow

Experiments in Gallium Arsenide Technology: D. J. Branning

These books provide readers with everything they need: each project is complete with an accurate schematic diagram, parts list, and PCB template (where applicable). HEA002/003 **\$34.95**

The Laser Cookbook: 99 Practical Projects: Gordon McComb

McComb provides a good mix of laser history, theory, and applications in an easy-to-read format, with many illustrations. HEA003 **\$34.95**

50 CMOS IC Projects: Delton J. Horn

This book is a collection of 50 interesting and practical digital electronics projects based on the extremely popular CMOS ICs for electronics experimenters with intermediate or higher skills. 240pp HEA005 **\$34.95**

The Illustrated Dictionary of Electronics — 4th Edition. Rufus P. Turner and Stan Gibilisco

This handy guide defines more than 27,000 vital electronic terms, acronyms, and abbreviations — more than any other electronics reference. 656pp HEA009 **\$45.95**

Master Handbook of 1001 Practical Electronic Circuits. Solid State Edition. Kendall Webster Sessions.

"An ideal source book for the engineer, technician or hobbyist," (Electronics Today International). Thoroughly indexed, with more than 1000 illustrations. 420pp HEA010 **\$42.95**

The Encyclopedia of Electronic Circuits: Rudolf F. Graf.

Includes more than 1,300 designs. "An invaluable reference tool for every hobbyist, technician, student and design professional". 768pp HEA007 **\$59.95**

The Giant Book of Easy-To-Build Electronic Projects: Editors of Elementary Electronics

A huge variety of projects designed to be put together in only a few hours and at minimal cost. 352pp HEA008 **\$29.95**

Interfacing and Digital Experiments with Your Apple: Charles J. Engelsber

352pp HEA039 **\$29.95**

BOOK SHOP

BACK BY
POPULAR DEMAND

THESE SPECIALLY SELECTED BOOKS BOOK SHOP.

Commodore™ Care Manual: Diagnosing and Maintain Your 64 or 128 System: Chris Morrison and Teresa S. Stover
No special skill or knowledge are necessary — readers do not even need to know how to program. Complete listings for the program modules, written in BASIC are given in the appendices. HEA038 \$34.95

Delton T. Horn's All-Time Favorite Electronic Projects: Delton T. Horn
Horn has garnered countless favourable reviews over the years — Back Stage: "Delton T. Horn offers expert advice on achieving top performance for minimum price," and Hands-On Electronics: "Horn has avoided the temptation to become overly theoretical in his presentation. Instead, he has provided easy-to-follow explanations, supported by generous doses of drawings, diagrams and schematics." 96pp HEA006 \$15.95

25 Fun-to-Build Projects for Learning Electronics Theory: The Editors of Elementary Electronics.
Even elusive concepts are simple to understand and apply when they are incorporated in interesting projects such as these. 210pp HEA011 \$15.95

Digital Audio and Compact Disc Technology: Luc Baert, Luc Theunissen and Guido Vergult.
Written by staff at the Sony Service Centre (Europe), this definitive book on CD players and technology will be essential reading for audio engineers, students and hi-fi enthusiasts alike. 256pp HEA036 \$65.00

SCIENCE

Newnes Physical Science Pocket Book for Engineers: J. O. Bird and P. Chivers
"The selection of material is sensible and balanced" Times Educational Supplement. HEA028 \$29.95

Cosmology — The search for the order of the universe: By Charles J. Caes, Foreword by Charles R. Pellegrino 192pp HEA029 \$22.95

The Mysterious Oceans: by Jon Erickson
208pp HEA030 \$30.95

Particles in Nature: The Chronological Discovery of the New Physics: by John H. Mauldin
288pp HEA031 \$34.95

Superconductivity The Threshold of a New Technology: Jonathan L. Mayo
Written for the general science reader, this book explains the discoveries, explores the applications and examines the implications of the most exciting physical breakthrough since electricity. 160pp HEA001 \$26.95

Violent Storms: by Jon Erickson
240pp HEA032 \$34.95

TECHNICAL

The Robot Builder's Bonanza: 99 Inexpensive Robotic Projects, Gordon McComb.
A collection of tested project modules that can be mixed and matched to create a wide range of intelligent and workable robot creatures. 336pp HEA035 \$29.95

Communication Satellites — The technology of space communications: Larry Blonstein
A technical introduction to communications satellites that explains, giving dates and worked examples, how satellites work, how they are constructed and used, their capacity and relative costs, and the economics and optimization of space communications systems. HEA013 \$37.95

Advanced Commodore™ Graphics and Sound Programming: Stan Krute
416pp HEA0040 \$32.95

Build your own Laser, Phaser, Ion Ray Gun and other Working Space-Age projects: Robert E. Iannini
A guide to building a magnetic field distorter, working lasers, ultrasonic devices, more. 400pp HEA004 \$49.95

Build Your Own Working Fibreoptic, Infrared, and Laser Space-Age Projects: Robert E. Iannini
Provides complete instructions for building 10 sophisticated devices. 288pp HEA034 \$32.95

EASY TO ORDER

To order simply fill in the coupon, remembering to include the code numbers and \$5 postage and handling. If the coupon is missing, write down the names, code numbers and prices of the books you require. Include your name, address, telephone number, plus cheque, money order or credit card details (card type, card number, expiry date and signature) and send it all to: Federal Publishing, Book Offer, Freepost No. 4, P.O. Box 227, Waterloo, NSW 2017. No stamp required. And don't forget to sign all orders.



INSTRUMENTATION



Den-On's SC-5000 solder cleaner takes the strife out of desoldering. ETI's Jonathan Powers tests this handy tool.

DADDY'S LITTLE HELPER

Taking out the tedium

ETI MAY '89

108

World Radio History

For anyone involved with the construction or repair of electronic circuit boards, the most tedious and unwelcome job must surely be that of de-soldering components when things have gone slightly astray. I know all too well that moment of horror when you've just finished soldering in that expensive IC without using a socket only to find that it's in the wrong way round. Out come the solder sucker, de-soldering braid and worry beads as you try to coax out those 24 pins without cooking the chip or lifting half the tracks on the pc board. For the past couple of weeks I've had a little help in this department in the form of the SC-5000 solder cleaner from Den-On Instruments.

The SC-5000 is a self-contained, mains-powered de-soldering tool that comprises a hollow heating tip (similar to a soldering iron tip only with a hole in the middle) which is attached via a filter and solder collection chamber to a compact diaphragm type vacuum pump. The unit is pistol-shaped with a trigger switch to operate the pump.

The test unit came with a 1mm diameter

'Out come the solder sucker, de-soldering braid and worry beads'

tip but 0.8mm and 1.5mm tips are available as spares. The 1mm tip would, however, be suitable for most applications. A 2.5mm blow nozzle was also supplied which, combined with the ability to switch the pump direction, turned the unit into a hot air blow gun for use with heat shrink products or the like.

The heating element is a 60 watt ceramic type and has feedback temperature control which can be adjusted from 250 to 420°C.

I tested the unit on a wide range of applications from de-soldering 40 pin digital chips to lifting off heavy gauge wires from solder lugs. In all cases the SC-5000 proved very effective, particularly in removing ICs. The speed at which the solder could be cleaned off the joints ensured a minimum of heat transfer to the IC itself and minimised the danger of cooking the chip. Also, the

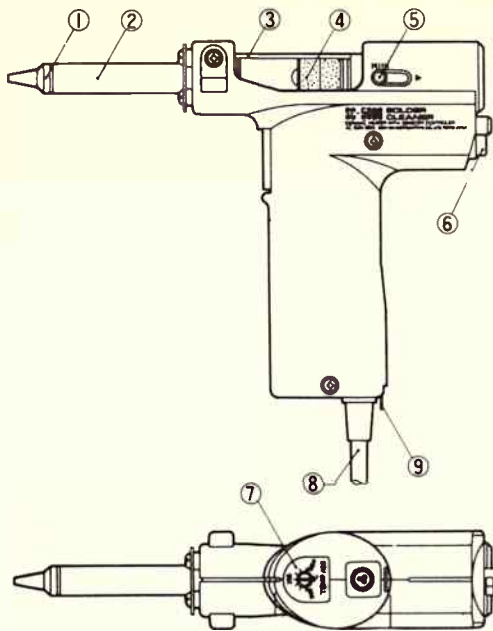

1. Tip
2. Heater holder
3. Filter pipe
4. Filter cartridge
5. Filter removing lever
6. Suction / Hot air change lever
7. Thermo sensor control
8. Electric outlet cord
9. Cleaning pin

on the pins tends to melt the plastic housing and make the plug useless. The SC-5000 had no trouble in successfully unhooking and restoring these plugs ready for re-use.

The solder that is sucked up through the tip is collected in a glass tube on top of the unit. In the end of the tube is a filter capsule which prevents any solder from entering the pump mechanism. The tube and filter assembly require periodic cleaning which is easily done as the tube lifts out and the filter capsule can be removed and cleaned. A spare filter was supplied with the unit. Tucked away in the handle was also a thin wire pin which could be used to clear the tip if it became blocked.

The unit is reasonably sturdy and well put together and comes, together with the accessories, in a moulded plastic storage case. My only criticism, albeit a minor one, was that the instructions supplied were a bit brief and written in the best tradition of Japanese-English. Thankfully, the operation is fairly straightforward. It would, however, be nice to have a bit more information on the maintenance side of things.

All in all, I found the SC-5000 an excellent unit and easy to use. It saved a great deal of time and anguish on the workbench and I was sorry to see it leave. There are other suction de-soldering tools available but many of these have the drawback of having a separate pump unit and the need for vacuum lines trailing all over the bench. The SC-5000 has the advantage of being quite compact and fully self-contained with the mains lead the only external connection needed.

The SC-5000, plus spare tips, is marketed in Australia by Tecnico Electronics. At a retail price of just over \$400 it may be out of reach of your average hacker but for any small (or large) electronics workshop, or for anyone involved in a deal of pc board construction or maintenance, the SC-5000 is definitely worth a look. 

temperature adjustment made it possible to choose a correct setting so as not to lift or damage delicate pc board tracks and pads. The unit also proved invaluable in cleaning up wire connections on plugs and sockets. I had some old 5 pin DIN plugs lying around that had been wired up incorrectly. With ordinary mechanical solder suckers and desoldering braid it takes a lot of care to disconnect the wires and clean up the terminals on these plugs, as excessive heat

Specifications:

- | | |
|--------------------------------------------------|----------------------------------------------------------------------|
| 1. Voltage: | AC 100 V 120 V 230 V |
| 2. Vacuum pump: | Diaphragm type |
| 3. Power consumption: | 12 watts |
| 4. Peak vacuum: | 600m Hg |
| 5. Arrival time of high vacuum: | 0.2 second after trigger |
| 6. Pump capacity (open): | 15 litres/minute |
| 7. Heater type: | 60 watts (ceramic heater with built-in thermal sensor) |
| 8. Control system: | Feed-back zero crossing system |
| 9. Temperature range:
(continual variability) | 250°C-420°C
(482°F)-(788°F) |
| 10. Tip diameter: | Standard 1.0mm
Option 0.8mm 1.5mm
(changeable screw type) |
| 11. Hot blow nozzle: | 2.5mm diameter |
| 12. Power cord: | 1.8m with 3 pin grounded connector |
| 13. Weight: | 350g (100 V), 430g (120 V) |
| 14. Accessories: | Hot blow nozzle, filter cartridge, cleaning pin, illustration sheet. |

DO YOU WANT TO SALVAGE SOME CASH?

**TURN YOUR SURPLUS
STOCK INTO CASH!!!**

Jaycar will purchase your surplus stocks of components and equipment. We are continually on the lookout for sources of prime quality merchandise.

Jaycar
ELECTRONICS

115 Parramatta Road
Concord 2137
or phone
(02) 747 2022
ask for Bruce Routley
or Mark Harris

Flightcases for Professionals

*** Technicians Flightcases**
These are available in lightweight "Maxima" series or our standard heavy duty range.

(as seen in April '89)
price \$199 inc. tax

***19" Rackmount Flightcases**
These are available from 4 units up to 30 units
All flight cases come in a choice of ABS or aluminium plywood laminates.

Custom Flightcases made to order

MEIKO
cases

937 Bourke St, Waterloo, NSW 2017
Ph: (02) 698-9702. Fax: (02) 699-9570

READER INFO NO. 28



The RZ-1 crams a host of desirable features into a small package and provides coverage of every 5 kHz channel from 500 kHz to 905 MHz, AM and FM reception, 12 Vdc operation, scanning between set limits or manual scanning with a knob and 100 memories, to name just a few. Reviewed by Brian Hammill.

SCANNER PLUS!

Kenwood's RZ-1 receiver

ETI MAY '89
110



INSTRUMENTATION

Kenwood set something of a precedent when this scanning receiver was released last year. Its continuous coverage from the AM broadcast band to the top end of the UHF band gives wider coverage than any other scanner previously released; you would otherwise require at least two or even three receivers to provide the same coverage. And its size allows you to fit it into a "standard" dashboard hole in the family car; when you tire of what's served up on the AM or FM broadcast bands, you can do a little scanning!

But it's not meant strictly for use in a car or other vehicles. Four small snap-in feet are provided so you can mount the RZ-1 on a table top or shelf.

The RZ-1's specifications indicate it requires a nominal 13.8 volt dc supply, although a range of 11 to 16 volts is allowable; for mains operation, therefore, a 12.5 or 13.8 Vdc power supply is required.

Description

The receiver's fascia and case top cover are black with a gold-coloured passivated steel base. Internally, it has a sturdy diecast chassis which makes for a very rugged unit. The front panel is a plastic moulding. The overall appearance is quite stylish, more like an upmarket car radio than a scanner.

Dominating the front panel is a multifunction liquid crystal display, which is lit from the rear. On the left hand side of the front panel are the volume and squelch controls. The volume control incorporates the power on/off switch, which operates when the control is turned fully anticlockwise. Beneath these two controls is a 2.5 mm jack headphone socket.

Moving to the right, there are three rectangular pushbuttons; the VFO/Memory Channel switch, the 'Scan' switch and the 'MSG' switch. No, the latter doesn't make the audio taste better! It allows setting of a "message" icon or symbol on the display.

Between these switches and the liquid crystal display is a 23 mm diameter knob. This is for manual tuning. It is not a continuous rotation control, but has a 24-position detent. Rotate it clockwise and you step up the channels in increasing frequency, anticlockwise and you step down the channels in decreasing frequency. Beneath this knob are two key switches, marked with up and down arrows. Pressing them brings in automatic stepping from channel to channel, as long as you hold the switch in.

Beneath the liquid crystal display is a line of 10 small pushbuttons, marked "1" through to "0". With these, you can enter

frequencies, channels and other functions.

To the right of the display are seven white pushbuttons; the six small ones provide selection of different functions, while the large one is an "ENTER" key.

Three leads hang out from the rear panel: the dc power lead, which incorporates an in-line fuse in the positive lead and is terminated in a polarised Molex plug, and two antenna leads. One antenna lead - ANT1 - is terminated in the usual 'car radio antenna socket, while the other - ANT2 - is terminated in an SO-239 line socket (on the end of a short length of RG-58A/U).

There are two slide switches on the rear panel. One is mounted next to the ANT1 lead and operates an input attenuator in this antenna input. The other slide switch is for antenna selection: you can choose to use either ANT1 or ANT2, or have automatic selection. With the latter function engaged, ANT1 is used for the bands below 60 MHz, ANT2 above that.

Two RCA sockets on the rear panel provide "line level" stereo output when "FM wide" reception is selected and you've tuned in to an FM broadcast station. A 3.5 mm jack socket near these sockets permits connection of an external speaker. An internal 50 mm diameter speaker is mounted on the top cover.

Internally, the RZ-1 is a tribute to modern technology. The main chassis is a solid diecasting. It features a separate integral section for the RF "front end". Surface-mounted components are widely used, and separate sections are on individual printed circuit subassemblies; I counted seven of them.

The overall impression is that of a thoughtfully designed, well engineered and manufactured product. The designers have even thought about the servicing: they have provided sufficient length to the wire to the internal speaker so that, when you take the cover off, it can be placed flat on the bench nearby, unrestricted by short wires.

There is copious room inside the chassis and plenty of test points and sockets, all clearly marked. This sort of attention to detail, plus the modular assembly, suggests that servicing should not present any particular problems.

Features

The basic features can be summarised as follows:

Frequency range: 500 kHz to 90.5 MHz.

Channel steps: 5, 12.5, 20 and 25 kHz.

Modes: AM, FM narrow, FM wide.

Memories: 100.

Power Requirements: 11-16 Vdc, 1A (max.).

Scanner plus!



Optional accessories: left, the SP-40 compact mobile speaker (4 ohms) and, right, the SP-50B mobile speaker (8 ohms).



The RZ-1's unique feature is the frequency coverage – from 500 kHz to 905 MHz. With one receiver you can cover the major sound broadcast bands (AM and FM), the shortwave broadcast bands, between 3 MHz and 30 MHz, and the myriad VHF and UHF bands, including the various two-way services, aeronautical and amateur radio bands.

Sensitivity specifications are good: Kenwood quotes 5 microvolts for 10 dB S/N on AM (less than 10 microvolts on the mediumwave broadcast band), less than 3 microvolts for 12 dB SINAD on FM narrow above 60 MHz, and less than 1 microvolt for 12 dB SINAD on FM wide at 83 MHz. Squelch sensitivity is given as less than 0.1 microvolt.

Audio power output is quoted as more than 2 W ohm load, 5% distortion, FM 1 kHz, $\pm 1 - 3$ kHz deviation). Stereo separation on FM reception is given as better than 30 dB at 1 kHz.

Any frequency within the range may be entered by means of the 10 numeric push-buttons beneath the LCD on the front panel. These are used to enter a "start" frequency for tuning, as well as limit frequencies for scanning.

The three reception modes are: AM, narrowband FM and wideband FM. The AM mode provides for reception on the AM broadcast band of 500 kHz to 1600 kHz, the shortwave band up to 30 MHz, and the 120 MHz aeronautical band. Select FM wide and you can listen to broadcast stations in the 88-108 MHz band and TV station sound channels. FM stereo reception is available, with output via two RCA sockets on the rear panel. You could link these up to a car stereo amp system. The FM narrow mode gives you reception of voice transmissions from VHF and UHF fixed, mobile and aeronautical stations.

From the handbook provided, US versions of the RZ-1 provide a TV reception option (NTSC), with output to a monitor via an added socket on the rear panel. A decoder for PAL TV reception is not available, unfortunately.

The liquid crystal display can show the selected frequency, always in MHz, a "message" of up to seven characters (part of the memory function), received signal strength, the mode of reception, channel step, scan mode, memory channel in use, programmable band operation, and one of

a set of six symbols. These are meant to be a reminder during memory operation. The symbols are a car, an aeroplane, a radio, a TV set, a yacht and a smiling face with what appears to be a microphone. Very cryptic.

Completing the phenomenal list of display functions is the stereo indicator that shows when FM stereo reception signal strength is sufficient to detect the stereo subcarrier.

There are 100 memory channels on the RZ-1 and you can program each to set up the receiver for a given frequency, mode, function, message and a symbol. The "message" can use up to seven characters and is shown on the receiver's front panel liquid crystal display instead of the frequency. Some 48 characters can be used to make up the message, using numbers from 0 to 9, plus the alphabet, and a variety of special characters. So, to monitor light planes on 120 MHz, I programmed in a number of frequencies and set the message to read VHF AM followed by the aeroplane symbol.

The RZ-1 features quite a variety of scanning modes and options. You can scan between set frequency limits, scan memory channels, automatically step up and down in frequency or across memory channel. Select VFO mode and use the tuning knob on the front for manual channel-by-channel tuning.

Using it

You have to make some concessions to functionality because of the unit's size; the volume and squelch controls are quite small, as are the numeric pushbuttons, but no smaller than found on many pocket calculators. The panel annotations are in grey, making them rather hard to read at any distance compared to white or yellow against black, but once you've learned where everything is, it's not really a problem. The pushbuttons all have a positive click action, so you know when you've pressed them. If using the RZ-1 mobile, frequency selection using the rotary knob would be by far the preferable method.

The backlit LCD dominates the front panel when power is applied. The illumination is subtle but quite adequate even with a fair amount of light falling on it. The lighting is yellow-white (from little "pea" lamps), except for the stereo indicator and the last few signal strength points, which light up red. In

use, the front panel gets a little warm.

The RZ-1 is quite simple to learn and a breeze to operate. Use of all the major controls is self-evident and it took me only a few minutes to get the hang of it. If you spend an hour with the instruction manual you'll be able to program all the memory, scan and special functions like a pro. The manual is clearly written, well laid out and has plenty of useful illustrations. A circuit is included.

I first tried it out on the AM and FM broadcast bands, with instant success. Emboldened by that experience, I launched into the shortwave bands, looking first for some "marker" transmissions: Radio Australia, Voice of America, the WWV and WWVH time and frequency standard stations, the AXM weather fax station, etc. So far, so good. Then, a bit of tuning around brought in some Asian and Pacific broadcasters, some Europeans and South American stations.

It's good, but single sideband reception was something I missed. The 5 kHz channel spacing can be a drawback on the high frequency bands, too. Either a "slider" or "clarifier" control would come in handy, or 1 kHz channel spacing. The IF bandwidth is good for broadcast band reception, but a bit wide on the shortwave bands, I felt.

The RZ-1 copes with strong signals quite well and crossmodulation was only evident under extreme circumstances where a strong signal was only a channel or two away from a much weaker signal. The two antenna inputs with automatic switching proved quite a useful feature; I set it up with two separate antennas.

On VHF and UHF it acquitted itself very well, too. I was able to log aircraft on the aeronautical bands, amateur radio repeaters and beacons on the two metre and 70 cm bands, and weather satellites on the 136 MHz band.

While I didn't have the time or equipment to measure the sensitivity in the different modes, the RZ-1's ability to pull in weak signals compared well with other equipment of mine, so I've no reason to doubt the specifications.

You'd have to put this receiver in the top shelf class, given the performance and the functions offered. It's not a straight scanner; it combines the functions and features of a scanner, a shortwave receiver and an AM/FM receiver – all in a car radio format. Brilliant idea, Kenwood!

It's simple to operate and, given the size constraints, quite functional. The only things I would like to add would be a variable (slider) tuning control (say $\pm 1 - 3$ kHz) and SSB reception.

Priced at around \$1100 retail, it represents very good value for money. The review unit was provided by Kenwood Electronics Australia, PO Box 348, Lane Cove, NSW 2066 (02) 428 1455.

eti

RENTAL

TECHNOLOGY WITHOUT OBSOLESCENCE

Hiring electronic equipment from Tech-Rentals makes a lot of sense. You get just what you need, when you need it and only for as long as necessary.

You get the widest choice of high technology instruments. Personal computer equipment is also available. All equipment is expertly maintained and calibrated. And technical staff are able to recommend the perfect package and equipment for every application.

From a few days to a month or more, hiring from Tech-Rentals is the ideal way to eliminate obsolescence in your inventory – and conserve valuable capital.

For your copy of the latest 64-page Tech-Rentals catalogue, contact your nearest Tech-Rentals office.

MELBOURNE	(03) 879 2266
SYDNEY	(02) 736 2066
BRISBANE	(07) 875 1077
ADELAIDE	(08) 344 6999
PERTH	(09) 470 3644
CANBERRA	(062) 57 4983
AUCKLAND	(9) 50 4759
After 1/5/89	(9) 520 4759
HONG KONG	5-833 9131
SINGAPORE	(65) 743 6911

Tech-Rentals

1989 Catalogue

1989
CATALOGUE
NOW AVAILABLE

TR **TECH
RENTALS**
AUSTRALIA'S INSTRUMENT
RENTAL COMPANY

Price & Payne 2338

READER INFO NO. 30



BUFFOONERY

RUDE AWAKENINGS AT WOOLLOOMOOLOO

And rude noises from the Navy

It has long been observed by those interested and involved in electronics, as well as by the public at large, that many electronic devices, and activities involving those devices, are not fundamentally compatible. That is, one thing will create interference with another, causing anything ranging from mild annoyance to catastrophic malfunction.

The modern term given to such phenomena is "electromagnetic compatibility", or EMC to acronymise it (how's that for a newspeak verb!). While the term does seem to be something of a misnomer (surely it should be *incompatibility*), acceptance decrees its general use.

Many readers will, no doubt, have observed from time to time "clicks" and "plops" in the hi-fi, whenever the refrigerator and/or freezer thermostat switches the compressor on or off. The surge of mains current and the relay arcing is conducted via the mains into the hi-fi.

In the days of the CB radio boom, around a decade ago, the public knew quite a lot about EMC – from first hand experience! Television receivers, record players, tape machines, mantel radios – you name it – suffered from nearby CB transmitters overloading their circuitry's hitherto slumberous existence. Mysterious voices were heard, TV screens went crazy and general bedlam abounded wherever a CB and the affected objects were in certain proximity. If the CB was in your household, BIG problem.

AM (amplitude modulation) rigs were the worst offenders; rectification in audio stages ensured faithful demodulation. Single sideband (SSB) rigs came over as a mysterious – and infuriating – "duck talk", for the most part unintelligible. *

Radio amateurs had known of this phenomena since, well, the year dot. Many schemes and devices have been devised over the years to obviate or overcome its effects. It's only in recent years that manufacturers of electronic devices and

machinery have come to appreciate that different devices have to live together, and have begun to address the problem, albeit slowly.

Personal computers were recognised as offenders early in the piece. The US government, in fact, slapped regulations on them, and their peripherals, too. So did other governments. Ever used your PC in the same room as your TV set? Try using a shortwave receiver near one! Some are much worse offenders than others (like the early Microbeest).

But I've moved forward too far.

As a lad in high school, I commandeered the family garage, or most of it, for storage of "radio" and "electronic" gear, and workshop space. (Eventually the car wouldn't fit, at which stage I managed to obtain an ignition coil from a Model A or Model T Ford, the one with the "trembler" primary circuit breaker attached. Great for making your own lightning, or decent sparks, anyway.

Having voraciously read all about Marconi and other pioneers and the days of early radio with spark transmitters, I decided to learn what the pioneers learned, all for myself. Yes, I connected one side of the Ford coil's secondary to the highly efficient earth stake driven into the ground and watered with copper sulphate, and the other end to the 30 metre (100 ft) length of wire I used for shortwave listening. A six volt battery, a Morse key, and I was on the air!

Could my school colleague hear me on the crystal set in my bedroom? Sure could! So did my mother – but on the console radio in the dining room, at great volume! Blaaart, biddledee blaaart blaaart brought her charging out to the garage in high dudgeon; followed by the lady next door walking up the driveway with a worried expression on her face.

A decade later, while working in Antarctica, I was reminded of the incident. Apart from the once-a-year ship bringing supplies and new expeditioners, and taking away last year's, all communication was by

HF radio. The transmitters and transmitting antenna arrays were situated some kilometres from the main buildings of the base, all operated remotely, while the receivers were situated in the base radio rooms and their antennas located quite close to the main buildings. They thought about EMC, you see.

Now, the excuse for the existence of Antarctic stations is "scientific research". The scientific research is genuine and useful enough, it's the excuse to have stations that I'm sceptical about. But I digress. One of the research programs involved taking measurements of the ionosphere, the electrified layers of the Earth's upper atmosphere. This required bouncing signals off the ionosphere directly overhead and recording the echoes. The machine used to do this was in fact a radar-like instrument that swept the transmitted pulses over the frequency range from 1 MHz to 20 MHz. It took the best part of a minute to make a sweep and it made a recording every fifteen minutes; three times on the hour. It's called an ionosonde.

If you happened to be a radio operator (thankfully, I wasn't), patiently listening with headphones firmly on for a signal from Sydney, or Mirny, or Mawson, or wherever, you had to watch the clock continually. If you forgot ... you'd be treated to a loud ffaarrt in your ears as the ionosonde swept by your frequency! It always brought images of my mother appearing at the garage door.

I guess, though, it was inevitable that somewhere, sometime, some incident would happen on a grand public scale.

It happened when the Australian Navy gathered in Sydney Harbour recently, as a prelude to sailing off for exercises off the coast.

The fleet was gathered off Garden Island, which is offshore from Sydney's infamous Kings Cross, Potts Point, Woolloomooloo area. They sailed at dawn.

One of the ships, or maybe all of them, turned on their radars. Megawatt pulses of microwave RF swept the harbour shores of inner Sydney. The residents and occupants of Kings Cross/Potts Point peninsula that morning were all awoken – to a person – by the grand cacophony created by hundreds of car alarms, burglar alarms, bedside clock radios, pocket pagers and every other assorted electronic device sounding off simultaneously, set off by the Navy's radars!

eti



SOUND NIGHTS

**JAMO'S
CONCERT 7
SPEAKERS**



INSIDE:

HITACHI VT588E RECORDER



MARY RENNIE

HI-FI INDUSTRY MUST CHANGE ITS TACK

Getting the people into the stores

The problem of marketing hi-fi is perennial. Promotion by advertising, exhibitions, shows and so on is consistently tried by manufacturers and dealers. But does it work? Mary Rennie writes.

I was surprised when an industry figure suggested recently that less than 3% of the population has even been into a hi-fi store.

I sought the views of some other hi-fi industry figures as to the truth of this statement and the consequences of the situation. Here are the responses of Andrew Goldfinch of Leisure Imports, a hi-fi distributor and retailer; Peter Cleary of the Music Room, a hi-fi retailer; Mike Dean, managing director of Arista Electronics, wholesaler of hi-fi products and accessories; and John Hogan of Hagemeyer, the Australian distributor of JVC products.

ANDREW GOLDFINCH: The figure 3% does not surprise me, and it is a problem which should be aired more within the audio industry. Most industries of our size have effective associations to promote their interests and work to improve standards to provide a better service to the public. In truth ours doesn't and we only have ourselves to blame. While we continue to take a fragmented approach to marketing hi-fi the public will continue to be confused and resist taking advantage of the wonderful sounds we have to offer.

The only real use of our industry

association is to provide sales information for the majors to send sales figures back to Japan. It does not represent a cross section of the industry and its attempt at product awards is so badly promoted many retailers and the buying public are not even aware of the awards.

Unfortunately, our problem goes back a long way. In the fifties and sixties when local industry was heavily protected by high tariffs, local Australian manufacturers fell well behind developments going on overseas. In the late sixties while Japan was starting to flex its muscles with silicon transistors and tape recorders the Australian public was more concerned about the cabinet quality of a Kriesler Multisonic than its sound quality. The rest of the world had stereo FM while we had a special tax on imported radios of \$20 which was added to the landed cost before we paid a hefty 45% duty.

When Whitlam arrived we saw big changes happen very quickly. The government revalued the dollar, cut duties, doubled our wages and introduced stereo FM at a time when hi-fi internationally was already advancing at a very fast



Cover of an Arista Electronics Catalogue — one of the approaches the company takes to promote itself to the public.

pace. As a result, the hi-fi market experienced a big boom. Confusion was great; many of the people who joined the industry had little knowledge of what they were selling and the buying public had little knowledge of components such as amplifiers, tuners and receivers. It is hardly surprising that the public became hesitant to enter hi-fi stores.

Since then, our industry has continued to reproduce its previous errors and, rather than educate the public to real hi-fi, it has sought only to upgrade the poor products that the public were previously used to.

For example, the Australian public continues to buy radiograms. Rather than promote smaller speaker boxes with better drivers and real cross-over, the industry has continued to

promote the furniture aspect and the "boom box" speaker which is designed to aesthetically match the size of the equipment rack. Using big, impressive-looking drivers the sound quality has failed to live up to the visual impression and is often well below the potential of the electronics sold with it.

Little has been done to help people understand how to get the best positioning for sound in their living rooms and the result is most speakers are left either side of the equipment cabinet, sounding little better than the old Multisonic. After the novelty wears off, the poor positioning and poor performance of this type of system does not attract a lot of regular use.

At Leisure Sound we have always given a lot of attention to consumer education such as

placement of hi-fi components. And while we have always been a leader in new technology, we take great care to explain these advantages in plain English, so as not to confuse our buyers with words they don't understand.

Rather than stock every hi-fi component available, we only stock items that we recommend and sell. It's much less confusing. We have become well-known for our high standards, and even if our clients buy our most economical systems they know they are getting good quality, good value and good sound.

We also do our best to elevate our clients to better sound. Very often people repeat previous mistakes by buying a variation of what they had before. Many people, on hearing tight, clean bass, often get the feeling that there is not enough bass. We help by explaining what to look for in good bass rather than the colouration that they previously thought was bass.

While the industry has a poor record in promoting hi-fi, we also have the situation where most of the major brands, after building up their names internationally, have sought to cheapen themselves on the Australian market. Ten years ago, Marantz, which had by then built up an excellent reputation, released a complete hi-fi system for only \$699. This was a good \$300 below the accepted price for hi-fi at the time. The system only had one power supply and used very poor speakers but rather than highlight the qualities of genuine hi-fi, other manufacturers bent over backwards to match the quality.

The public revelled in it, they all thought hi-fi had become cheap and they lowered their budgets, at great cost to the industry.

Most of the Japanese majors run two ranges of hi-fi and we see very little of their quality range here. The only real attempt to go back up has been by, of all companies, Marantz. Not only has it been successful, it is doing a great service to the industry.

PETER CLEARY: I agree. Hi-fi specialty stores are feared because of a lack of knowledge

as to how the equipment works.

The average consumer feels that the equipment is very expensive, and that he/she should know something about hi-fi before entering a specialty store.

There is very little media that is not aimed at the small section which knows about hi-fi or that has some special interest.

This is a problem for the hi-fi industry because it means there is a large, untapped market.

In order to reach these people, retailers and suppliers have to stop preaching to the converted and start converting these average consumers. They have to make them aware that a modest budget can still get them a good system. The way to achieve this is by using media areas that have a broad readership.

A logical way to pursue this is by a co-operative program between a couple of suppliers and their respective dealers – not, as has been done in the past, using one supplier and one product.

MIKE DEAN: Until about five years ago, the independent hi-fi shop was approached with trepidation by the average potential customer. Usually an initial "3-in-1" system had been purchased from an electronics store or via a department store credit system.

The move towards a second system or hi-fi "separates" saw hopefuls conducting research mainly by word of mouth from friends and associates. The usual response (to justify the enquiree's high purchase cost and satisfy his one-upmanship ego) was so bewildering as to turn the uninitiated non-enthusiast into a quivering mess. This, combined with the reputation of ex-car salesmen with no knowledge, baffling the would-be purchaser with technical terms unheard of outside NASA research laboratories, caused them to by-pass hi-fi shops and go to department stores which, whilst displaying merchandise, provided the exact opposite in knowledgeable sales staff. ("I don't know, but the price

is great, put it on your credit card".)

Invariably, instead of "buying" the product (which he would defend to the limit), the consumer was "sold" the product, which caused dissatisfaction (which he passed on).

At this stage, I would agree that only 3% of the population had visited a hi-fi store.

The advent of the multi store chains, department store hi-fi departments and franchise hi-fi shops, saw previously exclusive brand audio/hi-fi names broadening their distribution, becoming available in less formidable environments with easy credit already established and with plenty of quality media advertising: supermarket hi-fi had arrived. In addition, the formerly exclusive ranges of accessories were now available as simple off-the-peg items. Instructions for these accessories were also "de-hyped".

Therefore, I would now say that more than 50% of hi-fi users have visited a hi-fi store.

I do not feel that the hi-fi industry will suffer provided it continues to cater to consumer demands. The independent will not survive unless he can provide an environment which makes the consumer feel comfortable. Personal credit cards have now negated department store in-house credit and the level of service and personal attention available from independents should make them more attractive as a final choice. Sadly, I think that the independents will gradually give way to the more powerful groups.

Hi-fi shops, whether independent or department store, are capable of recovering a sizeable portion of overheads by offering an attractive mix of accessories to add on to hardware sales. Impulse buying will also generate much higher profits on some accessories than more expensive hardware separates.

In so far as our marketing strategies go, Arista Electronics is offering more than 3000 items, attractively colour-code packaged and presented in

categories or product groups. These accessories are promoted by the release of a 120-page consumer-oriented colour catalogue – at least one each year. More than 100,000 are made available to consumers through retailers, free of charge, as well as by insertion into national trade magazines.

JOHN HOGAN: I would like to know who conducted the research and what constitutes a hi-fi store? If the information is accurate then it is a problem for the hi-fi industry.

We at Hagemeyer are currently planning a nationwide campaign using TV and press with dealer tagging. Already, we have received very positive dealer support towards our campaign and, no doubt the figures will be very encouraging. However, if you can substantiate the 3% claim we then must consider helping our dealers more to increase their business potential.

The talk turns to tape

JAPANESE tape manufacturer TDK has released findings from an international survey of audio tape buyers. Using an unknown methodology they have discovered that:

- Men buy more tapes than women.
- People in all countries but one put quality as the top consideration when buying tape. Which one? In Japan, cost is the main consideration.
- Australians record from a variety of media, mostly records followed by radio and other cassettes. A relatively small amount of recording is done from the human voice and even less from CD. "as the market penetration of CD players is still very low".
- Despite the emergence of new media, the cassette tape is as popular as ever. It continues to be the most used means of providing audio entertainment anytime, anyplace.

ETI

NAD Digital Television had such a g

In the little-known town of Pforzheim in Germany, scientists found a way to transform television picture and sound signals into digital, or numerical form.

The result of this discovery was the Digital television, regarded by many international experts as the greatest technological leap since the change from black and white to colour television.

The respected magazine, 'Electronics Today International' predicted that the TV set of the future will use digital techniques for most, if not all of its functions. In fact, it even goes on to say: 'The smart money is betting that by the early 1990's, most of the TV sets sold around the world will have digital circuits!'

Closer to home, when the ABC was given the task of selecting TV and video systems for our new Parliament House, they chose a digital system identical to the NAD model.

So what makes the Digital Television so special?

To begin with, the entire operation of the set is controlled by just seven microchips instead of the 300 electronic components found in a conventional television.

So that's 300 less things to go wrong.

With the aid of these microchips, the picture and sound signals received from the transmitter can be processed digitally, and the electronic beams which 'write' the image onto the screen are also digitally controlled.

This digital technology guarantees that the picture always stays perfect.

All the data necessary for optimum picture reproduction are entered into an electronic memory. Whenever the TV is switched on, it compares the data received with the data stored.

If there is any deviation between the two, caused by the ageing of the picture tube or the electronic components, it automatically corrects it. In this way, the colour picture quality should always stay exactly the same as when the set was new.

This automatic colour tuning facility is like having your own TV repairman built-in to the TV set.

Another advantage of the digital television is its ability to cope with any disturbances to the signal.

These disturbances, which often occur during the normal method of processing picture and sound signals become totally ineffective. As long as the signal remains 'perceptible' the TV set can process and restore the signal exactly without any distortion or noise.

Then there's the videotext function. Since videotext itself employs digital technology, the videotext decoder becomes a standard component of the set and not an expensive extra, as is the case with other televisions.

The NAD Digital Television features a built-in 8 page text memory which automatically loads the 7 following pages when you select any Teletext page.

This means, for example that you can

ion. Never has a new great reception.

select the sports preview, then 'page thru' the individual pages filled with specific sports information by simply using the Plus/Minus keys. In addition, you are able to insert any Teletext information into the TV picture. The highly integrated 1-chip text decoder is able to differentiate between 8 languages, switching automatically to the character set needed.

Of course, all the technological advances in the world are worthless if what you see and what you hear aren't absolutely first-rate.

You won't see better pictures anywhere than you'll see on the NAD Digital television. A special flat, and square picture tube shows you all the big movies exactly as you would see them at the cinema. Undesired reflections of the surrounding light are reduced noticeably.

As for the sound, audio output is 2 x 40 watts (music power). Bass and treble reception can be varied by separate controls, and there are connections for headphones, external loudspeakers and a stereo system.

But this isn't just the television for today. It's also the television for tomorrow.

When cable television arrives, the inclusion of an Omni-system cable and antenna receiver means that you'll be ready for it. Altogether, 99 channels can be received, 60 of which can be stored and selected using the remote control device.

Of course, with a television this advanced, it would be a shame not to have a VCR just as advanced.

The NAD Digital VHS Video Recorder does things you just won't believe.

A multi-strobe picture divides the screen into 9 parts which means you can watch different phases of action from the same programme, or else view every television station at the same time.

A picture-in-picture function means you can watch a video and a TV programme at the same time, while a 3-step zoom lets you enlarge the picture up to 16 times.

At first it might seem a little unusual for a renowned high fidelity specialist like NAD to be selling televisions. It probably seems even more unusual that these televisions are only sold through specialist hi-fi outlets.

But then the NAD Digital is a very unusual television.

Once you see it in action, you'll soon understand why it gets such a great reception all around the world.

If you would like a clearer picture of the NAD Digital Television, ring (02)597 1111.

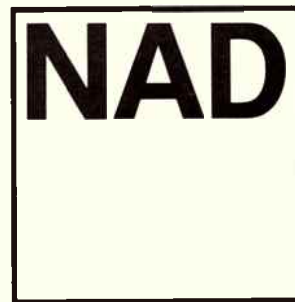

**"Ridiculously good.
Ridiculously cheap!"**



Boom for car CD players

PRICE Waterhouse has released figures which show that sales of car compact disc players in Australia increased by a massive 111.4% during January to June 1988 compared to the same period during 1987.

Pioneer's Rob Thompson attributes the rapid increase to the availability of a growing choice of CD player models, including the introduction of multi-player boot-mounted models such as Pioneer's CDS-M100.

"This type of system has proven a very successful mix of both convenience and safety factors," said Thompson.

"A common query we face from consumers is the seeming lack of price parity with home compact disc players. Yet many different technologies must be applied to the development of car CD players so that they can effectively withstand extremes in temperature, constant vibration and more significant dust levels compared to those handled by home models.

"In addition, the majority of car players are housed in a cabinet approximately one tenth the size of a home CD player, requiring the utilisation of the most up-to-date electronic miniaturisation."

READER INFO No. 197

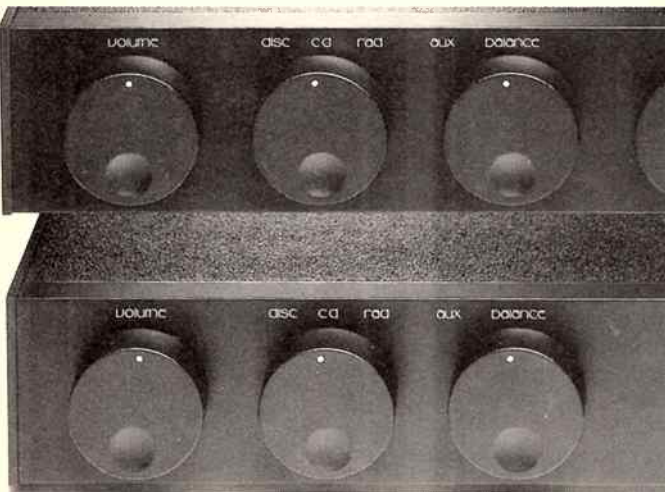

Budget amplifier range

TWO new integrated amplifiers from Cambridge Audio of England are now available. Both models have a sparse front panel with controls limited to volume, sound source selection, speaker balance, tape monitor, bass and treble and stereo/mono selection. There are five inputs and they can drive two sets of speakers. Speaker selection is on the rear panel. Substantial toroidal transformers are used in the

power supplies.

The P55 is a 70 watts (continuous sine wave both channels 1 kHz into 8 ohms) model. Provision for moving-coil and moving-magnet cartridges is incorporated in the shunt feedback equalisation stage. The P40 integrated amplifier is a 40 watts per channel model. Both are mid-sized at 436 mm wide.

Distributed by Symphonia HiFi.
☎ (03) 813 1292.

READER INFO No. 198

High output microphone

AMERICAN microphone manufacturer, Shure, has released the Beta 58, a supercardioid or unidirectional, dynamic microphone. It is a vocal microphone but equally useful for many instrumental applications and has the same sound as the SM58, the most widely used professional performer's microphone in the

world.

The Beta 58 differs from the SM58 in a number of respects. It employs a neodymium magnet (neodymium is a rare earth element which, when combined with iron, makes the strongest permanent magnets) to provide 5 dB higher output amounting to 51.5 dB, improved signal-to-noise ratio, and high gain before feedback in public address situations. A built-in humbucking coil reduces hum pickup in strong fields that may exist in broadcast stations or near power sources. A shock mount minimises handling noise. The Beta 58 is also 10% lighter than the SM58 at 265 grams.

An integral ball-type grille is designed to filter wind noise and pop (explosive breath sounds) for close-up speech or vocals, or when the microphone is used outdoors.

The Beta 58 adds to the Shure range rather than replacing the SM58 and its wireless version, and is available from Audio Engineers.
☎ (02) 29 6731.

READER INFO No. 199





Digital multitrack recorder ▲

POSTPRO is a computer-based direct-to-disk editing system by American recording technology company New England Digital, which developed the Synclavia. The new PostPro direct-to-disk multitrack recorder is available in standalone, remote operated 4, 8, and 16-track units. It is claimed to be a major breakthrough in digital recording.

New software provides fast, flexible, automated editing features unavailable in tape-based multitracks, and allows individual track offsets, auto fly-ins, and multiple loops on every track. The PostPro can locate and retrieve any piece of data from memory virtually instantaneously.

The workstation for the PostPro is a Macintosh 11 with a Winchester hard disk drive, customised graphics card and

19" monitor. Using MultiFinder software, any of the popular editing, synchronisation or sequencing programs can be run together with the PostPro package. Midi File Format allows greater transportability of data.

The monitor gives a complete visual display of all track information. A trackball allows identification of splice points with microsecond precision on the display, instructing the computer to digitally crossfade from section to section. Dozens of different edits can be made from the same material and you can A/B each one. Any track or cue information can be bounced again and again with no loss of fidelity.

From Dynamic Sound Vision, ☎ (02) 438 4074.

READER INFO No. 200



Universal remote control ▲

ONKYO has two battery-powered programmable remote control units which can take the place of virtually any infrared remote unit made by Onkyo or any other manufacturer. The RC-

AVIM lets you program up to 103 functions while the RC-AVIOM has 55 functions.

Distributed by Hi-Phon Distributors ☎ (02) 417 7088.

READER INFO No. 201



Digital amplifier ▲

PIONEER Electronics has released the A-91D Reference Digital Amplifier, its top-of-the-range integrated amplifier. This model features a built-in digital filter using four times oversampling and twin glitchless D/A converters for direct coupling to music sources. Five electrical and

In brief

optical digital inputs are provided.

Anti-resonance is the reason given for the honeycomb chassis and heatsink, along with the inclusion of large feet to further absorb vibration. RRP is \$2699.

READER INFO No. 202

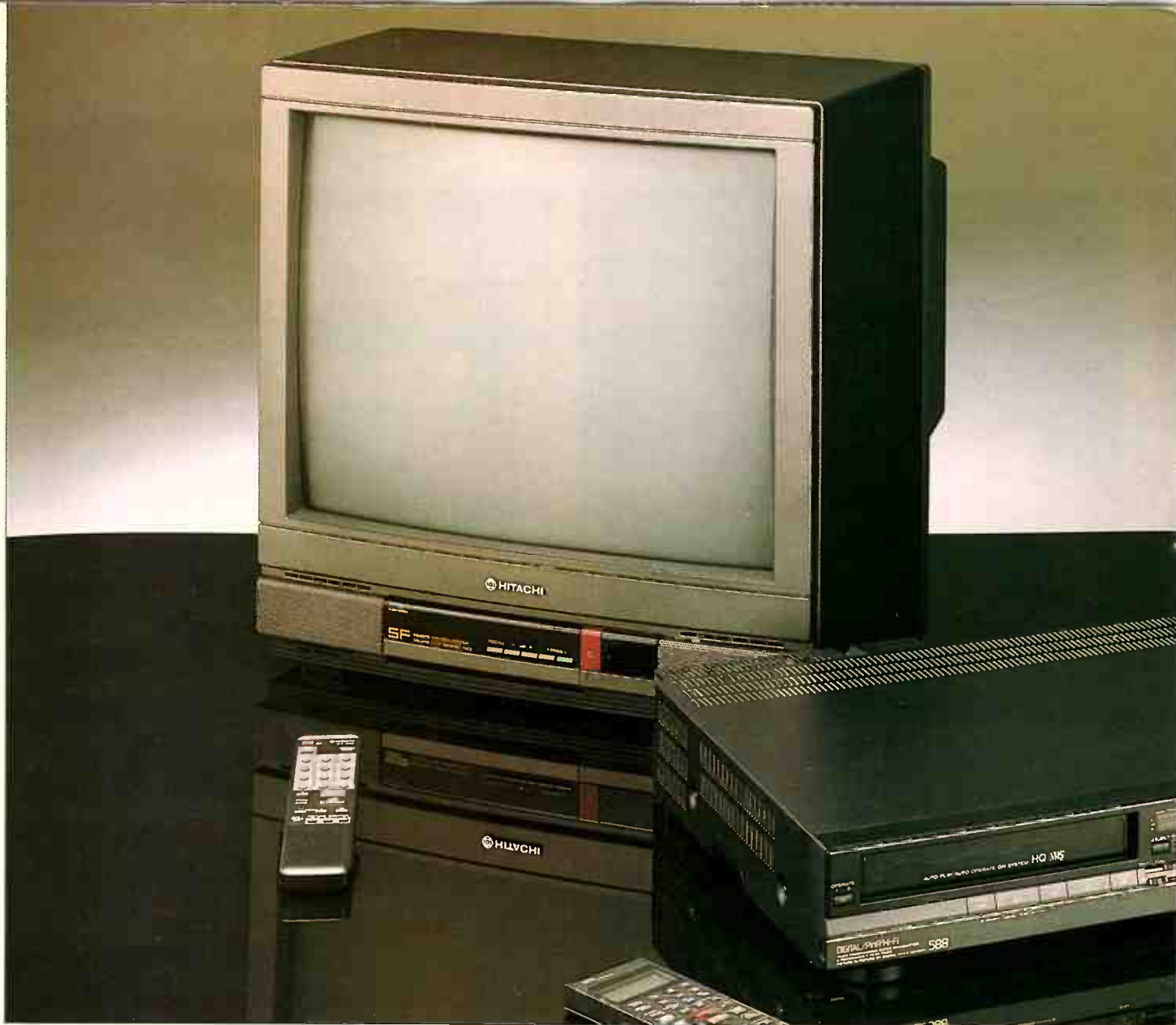

HITACHI'S VT-588E (AU)

Putting it through the hoops

When is a digital video cassette recorder not just a digital video cassette recorder? When it's the Hitachi VT-588E (AU) of course! Les Cardilini writes.

Until recently, we were prone to label any old appliance that had a digital clock or readout as being "digital". Perhaps, to some extent, we might have been led (pun unintended) up this path by the digital clock radio, which was one of the first appliances to feature the word digital prominently in its advertising.

In that case, however, digital would mean simply that the time of day is displayed using digits (numerals) instead of hands; the station frequency might also be tuned in and displayed digitally. The digital clock radio is typically just a radio with a digital clock and alarm.

But make no mistake; there is digital and there is digital in electronic equipment and the two should not be confused.

Real digital

The newer and more complex application of digital technology is where audio and video signals are encoded digitally for

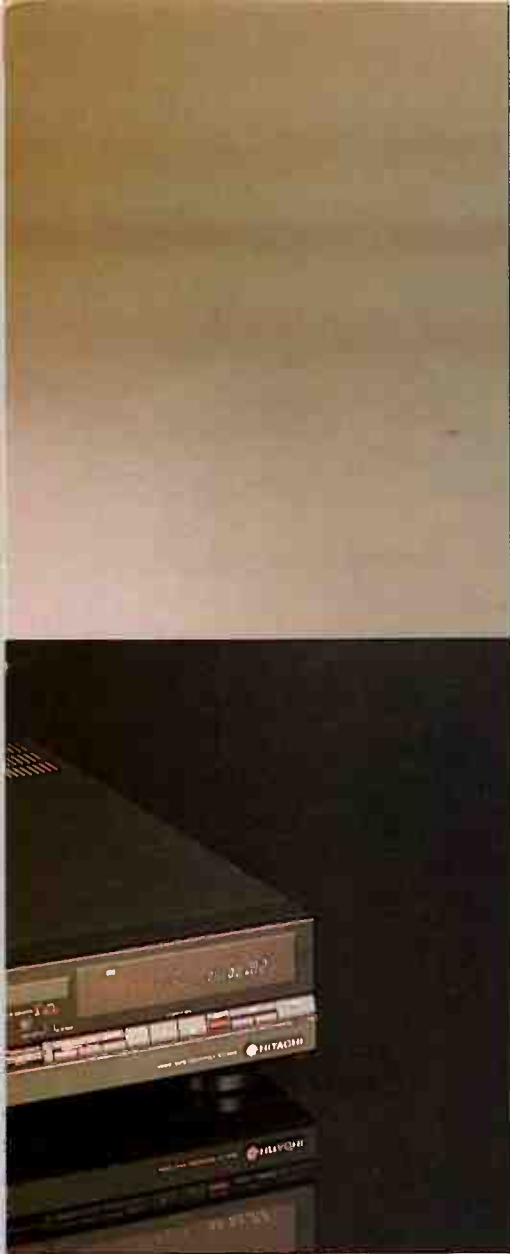

example, is still recorded in analogue format. Only the accompanying sound in the CDV system is digital.

The same basic principles used for digitising audio apply also to the digitising of TV and video signals. And now, when commercial television operators already use quite versatile – and proportionately expensive – digital video processing and effects equipment to make our TV screens more active and interesting, affordable modern domestic VCRs are also featuring digital video signal processing systems to improve the quality of, say, still pictures and slow motion sequences and to tease our imaginations with special video effects.

Currently, home digital VCRs still use traditional analogue techniques to record videotapes in the normal sense. In addition, however, they have what is called a digital frame store to capture in digital format a single screenful (or frame) of picture information, in essence an electronic snapshot from the screen. Basically, the picture on the TV screen is seen electronically by the digital system to comprise thousands of small mosaic dots, or pixels, that might be likened to the dots used to print pictures in newspapers and magazines. Viewed under a magnifying glass the individual dots in newspaper photographs are quite noticeable but when viewed at normal reading distance with the naked eye the dots integrate into a picture having many shades of grey.

In digital video systems each small element, or pixel, is given a digital code that represents its individual brightness and colour. The data codes for each pixel beginning with the pixel in the top left hand corner of the picture and, reading from left to right, across, and then down the screen, are stored sequentially in a silicon chip, or solid state, memory. Digitally-encoded pictures, when reproduced, also tend to have a coarse grain or mosaic appearance (like the newspaper photograph) when viewed close up, or when displayed on larger screens. Under casual viewing, especially at a distance or on small screens, however, the individual pixels on the TV screen tend to blend or integrate to give a more natural appearance to the picture.

The data representing the brightness, colour and where each pixel belongs on the screen can be retained indefinitely in the frame store, or memory, inside the VTR as long as the set is not switched off. The digital information can then be "read out" on command and displayed repeatedly on the screen to show the same, still, noise and flicker-free picture or frame – like a slide presentation – as required. For slow motion

the memory can be alternatively filled with picture or video data for a new frame and then displayed on the screen, in the same way, to give the impression of a slow moving scene.

There are a number of operational advantages to be gained by using frame stores rather than additional video heads and mechanical systems to display stills and slow motion in VCRs. To begin with, the sound can be left running in real time while the selected frame is "frozen" on the screen, if desired. In typical VCRs in the past the sound stops when the machine is put into the SLOW or STILL modes.

Digital stills do not require the video heads to wipe repeatedly over the same track on the videotape and so there is much less wear on both videoheads and tapes which should therefore have a greater life expectancy. And, since on digital VCRs fewer videoheads are needed to produce "noiseless" stills and slow motion scenes, the machines can be less complex mechanically so there will be fewer heads to change (and pay for) when the time comes for them to be replaced.

The new Hitachi

I recently had the opportunity to put Hitachi's new model VT-588E (AU) hi-fi VTR with digital video signal processing through its digital hoops and was surprised to see how quickly I changed my opinion that digital effects tended to be a bit on the gimmicky side.

For example, on replaying the videotape of a wedding it was apparent that some of the digital video "stills" of bust shots and larger subjects were perhaps sharp and stable enough to photograph. By utilising the Frame Advance the subject could be stepped forward until a suitable pose or shot appeared on the screen and then retained indefinitely while the scene was assessed for artistic merit and the film camera readied – try that in a live situation!

There can be other pressing and practical applications, such as freezing the TV picture on the screen while, say, a telephone number or Lotto numbers are flashed up and you have to run for a pencil and paper to copy them down before they disappear. The Hitachi VT-588E (AU) allows the TV picture, with the vital numbers intact, to be captured and stored by simply pressing the right button on the remote control, provided the system is using the stereo TV tuner. And, although the picture is frozen until you release or clear it, the sound in the program continues so you can keep track of the show while you deal with or analyse the stored frame. Alternatively, if you cannot find a pen you can record the still frame on the VCR and watch it again later.

recording or broadcasting, and this has nothing at all to do with digital clocks and panel displays. In digital audio or video processing, the analogue signal is first digitally encoded by converting it into a data format similar to computer code. The code is then recorded, or otherwise processed, and tends not to be degraded by the unwanted hiss, distortion, wow and flutter and timebase problems that, singly or in concert, plague traditional analogue systems like tape and vinyl LPs.

The now popular compact disc digital audio system is an example of digital – real digital – signal processing in domestic hi-fi and stereo systems. Digital audio came along first because the technical art of digitising and processing audio posed fewer problems than digitising video signals, which require a much greater bandwidth and considerably more memory to record or store the data, for a given playing time. Even the video on CD-video (CDV) discs, for

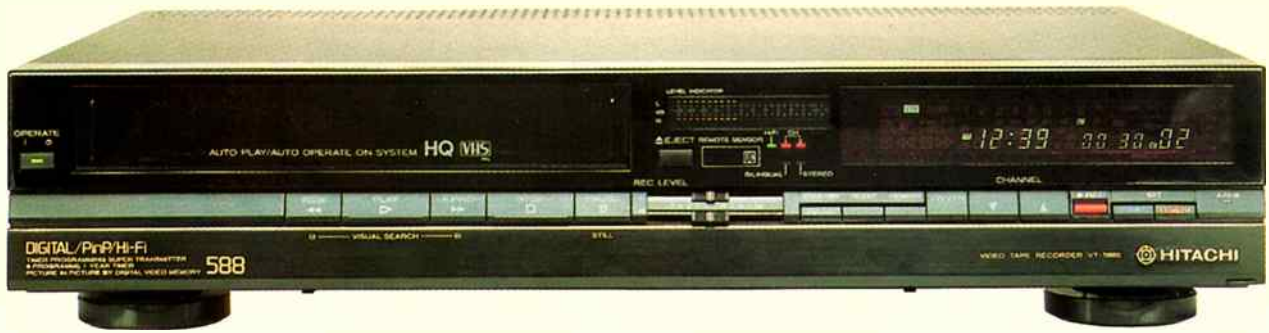

More features you'll never use than any other video.

The new Hitachi VT-588E digital VHS hi-fi stereo video.

If that seems impressive, wait till you take it out of the box. You'll tell yourself you'll never use all its features. Never.



Then opening the hidden front panel will really blind you with science.

But never is a long time.

To start, it's deceptively easy to use. You'll quickly master the basic playback operations. And enjoy the superb picture and sound which only Hitachi HQ circuitry can produce.

Now you'll be ready to venture further. Simply push two buttons and an inbuilt programme instantly demonstrates its features.

To begin exploring what's demonstrated, try the on-screen display menu. Just choose a feature and follow the step-by-step instructions.



We'll choose some for you:

Let's say you've mislaid the TV guide. Multi-channel search shows you everything that's on, splitting the screen into four, nine or 16 separate pictures.



Digital memory stores and slowly advances TV still-frames. Great for sport. Or copying down recipes or lotto results.



With picture-in-picture, you can watch a video but still catch a

newsflash on the small inset picture. Touching a button swaps the pictures.



Say you fancy Greg Norman's golf swing. Digital multi-strobe grids the screen for a stop-action sequence you can copy to a T.

Now imagine you've recorded your European holiday onto one tape. Multi auto index displays the first scene of each country and can insert this multi image at the tape's start, like a pictorial index.

By now you may be ready to play with special effects. There are three. Mosaic, solarisation or try both at once.

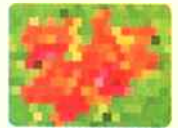

And while most VCR's come with a remote, ours comes with a super-transmitter. Which means you can do everything on this page from your chair.

Including titling. You can title your videos of weddings, parties and that European holiday.

There's more features still. Like audio dubbing, sound-on-sound, connection to your stereo system for simulcasts, 8 programme timer and a 40-page manual which is a feature in itself.

Of course, we have other, simpler models with fewer features but with the same advanced technology.

Either way, more than likely you'll be wanting to make your own videos. May we suggest our VM-600E professional camera?



Along with the VT-588E, you'll then have a complete production studio in your own home.

You've advanced from video viewer to video producer.

Then ask yourself, are there any features you haven't used.



VIC (03) 555 8722 FAX (02) 666 3088 QLD (07) 260 1344 SA (08) 268 7670 WA (09) 277 9955 TAS (002) 72 5651

Farman Foley Gill 9184

READER INFO No. 33

Hitachi review

This model, in fact, has several frame stores, and from four to 16 TV or video pictures at a time can be stored and displayed on the screen. In its Multi-Picture mode the set can also be programmed to sequence through programmed TV channels and, as it searches, display a picture from each channel, in turn, while "pasting" them up in groups of either four, nine or 16 panels on the TV screen – just the thing for dial twiddlers. In effect, you see a slow version of each program, without having to change channels at the set.

A similar multi-video function sets up sequences of up to 16 still pictures of the same action, in the same way a rapid exposure camera might capture an action shot such as a bowler in a cricket match, or a complicated high dive. The speed at which the shots are frozen and placed on the screen is variable and can be changed to suit the action. If a series of shots warrants keeping then the sequence of four, nine or 16 stills can be frozen on the screen and recorded on videotape for future reference.

Pictures from both the VCR while it is playing and the current TV channel can be displayed simultaneously. The main picture occupies the whole screen and the secondary picture appears as an inset towards one of the four corners of the screen (it is able to be shifted about). This Picture-in-Picture mode can be useful for keeping an eye on one program while watching the other. Either picture – TV or VTR – can be selected to be the main or secondary picture.

These were only a few of the video tricks I learned to play before I had to reluctantly hand it back; there were quite a few more, including On Screen Displays (OSD) and a digital demonstration of some of those other effects such as multichannel search and strobing, mosaic and solarisation of both off-air and videotaped pictures. In the OSD mode it is possible also to create and then record titles on a prerecorded tape. Other information such as which mode the VCR is in, the TV channel currently selected, tape remaining – even a calendar and preset programming details – can be brought up on the TV screen using the OSD pushbutton on the remote control.

HQ circuitry

But the new, digital video side of things tended to overshadow the fact that the set, like a number of its peers, also has HQ circuitry for higher quality analogue pictures and, importantly, VHS video hi-fi audio recording (up to eight hours of high quality stereo sound) and playback. Stereo soundtracks can be recorded directly from the TV tuner line outputs or from external left and right channel connections to a hi-fi system, tuner or deck. As well, the VHF/UHF



tuner in the VT-588E (AU) automatically decodes mono, stereo and bilingual audio formats according to our Australian stereo TV sound standards. It handles simulcasts, as well – in conjunction with an external AM-FM stereo. Regular, linear stereo audio tracks are also included, of course. A 20-pin euroconnector with stereo audio and video outputs and inputs is provided for connection to monitors and monitor-style stereo TV sets which allow the tuner to be bypassed, for better video quality.

Indexing data can also be recorded along the videotape for easier location of the start of separate programs and points of interest that might require replaying. The indexing is further tied in with the digital frame store

*'These were only a few
of the video tricks I
learned before I had to
reluctantly hand it back'*

feature, in that the pictures found at each index mark along the tape as it is searched can be displayed on the screen – just in case you forget which order they are in. Indexed frames can be displayed simultaneously on the screen, and this recorded on tape.

The cordless infrared remote control transmitter that comes with the VT-588E (AU) can be used to operate all functions on the set, including switching the VTR on and off. The 41 buttons are grouped according to their general functions and a liquid crystal display announces the day, date, month and time between other programming operations and checks. Eight programs on a weekly/daily schedule for one year can be programmed, through up to 79 preset channels.

User commands to the VTR from either the front panel or the remote control are acknowledged with a quiet beep from the VTR. This option can be disabled via a switch on the back of the set, if required. A Camera Pause socket is also available together with separate video and audio line inputs and switching. When used with a Hitachi video camera the remote control button on the camera can be used to start and stop the VTR and takes priority over the pause button of the VTR.

The front panel is tastefully simple, in black. The full featering of the VTR becomes more apparent when the full width flap under the front-loading cassette compartment on the control panel is opened to reveal the tidy array of pushbuttons, tracking controls and stereo headphone socket and level control. Another audio feature is the ALC (automatic level control) switch which can be turned off for wider dynamic range in hi-fi recording under the control of stereo recording level sliders and illuminated level indicators. The soft, blue illuminated display dims obligingly and displays the day, time and date when the set is switched Off but remains plugged into the 240 V ac mains. When the VT-588E (AU) is switched On the display brightens significantly and shows the system status, such as which channel is selected, tape remaining – in hours and minutes or by tape counter – and which mode is currently active. The display also changes to assist in the presetting of channels and programming.

The 40-page instruction manual is printed all in English and the mainly easy-to-follow instructions are generously supported by diagrams. Recommended retail price for the Hitachi Model VT-588E (AU) is \$1699. Further information can be obtained from Hitachi Sales Australia, 153 Keys Road, Moorabbin, 3189, (03) 555 8722. 

Surround

— the stereo of the future

Surround is a term which crops up more and more often in circles concerned with qualified sound reproduction. It refers to a number of speakers working together to create an acoustic "room" around the listener. You can recreate the space of a large concert hall of church, the enclosed, intimate atmosphere of a small jazz club, or the spirit and closeness of a rock festival. If you have seen a recent, technically advanced film (e.g. one of Steven Spielberg's) you have probably experienced surround stereo.

The difference between ordinary stereo and surround stereo is enormous. Much greater than that between mono and stereo.

A number of hi-fi manufacturers already have surround decoders, either as separate units or built into amplifiers or receivers.

When you connect your MDS System 2000 (or System 1000 with additional lateral speakers) to one of these your record collection steps into the future.

System 1000 consists of three parts — two small, easily positioned speakers for mid-range and treble with optional (and interchangeable) attachments, and a woofer having four bass units and a built-in filter.

System 1000 is the complete hi-fi combination for those who have very high demands regarding sound quality. And it doesn't dominate the room, but blends easily into its surroundings.

MDS System 1000

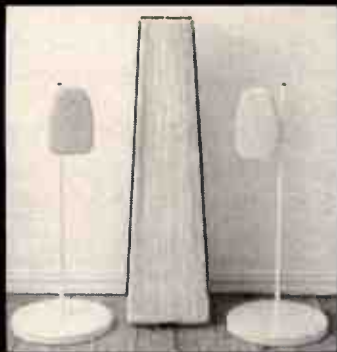

System 2000 consists of five parts — four small, easily positioned speakers for mid-range and treble with optional (and interchangeable) attachments, and a woofer having six bass units and a built-in filter with level control.

System 2000 opens up new possibilities. The four lateral speakers, when correctly positioned, give you the feeling that you are right at the centre of where the music is created. You are completely surrounded by music. Better sound dispersion through the room, more power and dynamics. 14 speaker units, perfectly controlled by a precision filter, provide you with awesome power and realism.

MDS System 2000



DANISH DELIGHT

The new range of Dalis

Pat Hayes takes a look at the latest Dalis, ribbons and all.



Crestmore Pty Ltd

P.O. Box 199, Turrumurra, N.S.W. 2074
Telephone: (02) 44 2155

READER INFO No. 31

ETI MAY '89

126

After years of listening to speakers made from a bewildering variety of materials and using technical concepts ranging from the basic to the bizarre, I have finally worked out what is the most important attribute needed by a speaker designer. Without doubt it is access to a large number of people who are willing to buy his (or her) new speakers.

I have heard many fine new speakers, written about them fulsomely, advised my friends to buy them, suggested to dealers that they stock them and then stood back and watched them disappear into a hi-fi black hole after a couple of months. The tasks of moving a good product out of the garage and into a factory, and of organising production, marketing and distribution, create so many obstacles that very few speaker designers (and not necessarily those with the best products) make it to the marketplace in a competitive state.

Peter Lyngdorf is a Danish speaker manufacturer who started out in 1976 with his built-in market firmly in place. His company, Audionord, distributed and also sold in its own retail stores the hi-fi products made by NAD, Denon, Threshold, Rega, Micro Seiki and Cerwin-Vega.

And even then he didn't try to sell his captive market an unknown brand. He called in some top audio engineers to design a speaker, got the approval of the NAD organisation to put its prestigious name on it, and sold lots and lots of them both inside and outside Denmark.

After a couple of years, using the NAD name created distribution problems in some countries so Lyngdorf created Danish American Loudspeaker Industries (so much for those of us who thought it was the name of a Viking god or that the technical adviser on the project was an eccentric Spanish artist).

The market which liked the Lyngdorf NAD speakers welcomed the Dali range, which offered better than average sound quality at an average price.

When Peter Lyngdorf visited Australia last year he said that for its first few years the Dali factory ran on a break-even basis. While the retail side of the operation made a normal profit from the speakers, the manufacturing side did not. The competitive edge of that ploy fuelled an aggressive export drive that gave him the numbers to chalk up another vital advantage for a speaker maker – he became the second-biggest customer for both Vifa and Peerless speaker components. That gave him the leverage to be able to specify the design of drivers that would suit his speaker designs rather than modify his designs to suit the available drivers.

Like any speaker enthusiast, Lyngdorf is fascinated by innovative designs and has spent about \$700,000 setting up a comprehensive research centre where speakers can be tested and evaluated by both human ears and precision instruments.

In Australia, the Dali speakers available fall into two basic camps – those with black vinyl finish and those with a choice of real wood veneer (although they can also be black).

The vinyl finish range, the Dali 1a, 2b, 3b, 4b, and 5a models, range in price from \$498 to \$1498 and slug it out, frequency for frequency, in the hi-fi shops with the better quality speakers, most of which, for reasons that escape me, are imported but which bear measurements remarkably similar to the optimums worked out at Sydney University by Small and Thiele.

This range of Dali speakers is basic, honest and, if the dealer is not offering run-out discounts on one of the lookalike competitors, good value for money. One advantage the Dalis with the "b" suffix have over some of the opposition is their excellent SEAS metal dome tweeter.

The second range of Dalis, those with real wood outside, are the more fascinating ones. These are the speakers that have emerged from the testing laboratory where computers and a willingness to try new approaches have resulted in some esoteric designs with true high fidelity.

It starts off with the Dali 1b, a fairly ordinary but nicely put together 30-watt bookshelf speaker at \$590, and then leaps straight into the esoteric class with the \$1990 Dali 15a. After that comes the 7a at \$2390, the 8a at \$2990, the 18 Mk II at \$3590, the 40 at \$7990 and, somewhere in between, the new hybrid ribbon speaker called the DaCapo which has a \$3990 price tag and is aimed directly at the classic music enthusiast.

The Dali 15 seemed to be the model that a keen music lover might be able to afford and match to an existing system so I took a pair home for a couple of weeks and set them up beside the electrostatics in my living room.

It wasn't a fair test; the forward attitude of



Indulge your senses.

JAMO Concert.



*Available now for audition at
authorised JAMO High-End
Dealers.*

*For further information and
name of your nearest dealer,
please contact Sole Australian Distributor:
SCAN AUDIO Pty. Ltd.
P.O. Box 242, Hawthorn, Victoria 3122.
Phone: (03) 429 2199 Fax: (03) 429 9303*

Jamo HI-FI 

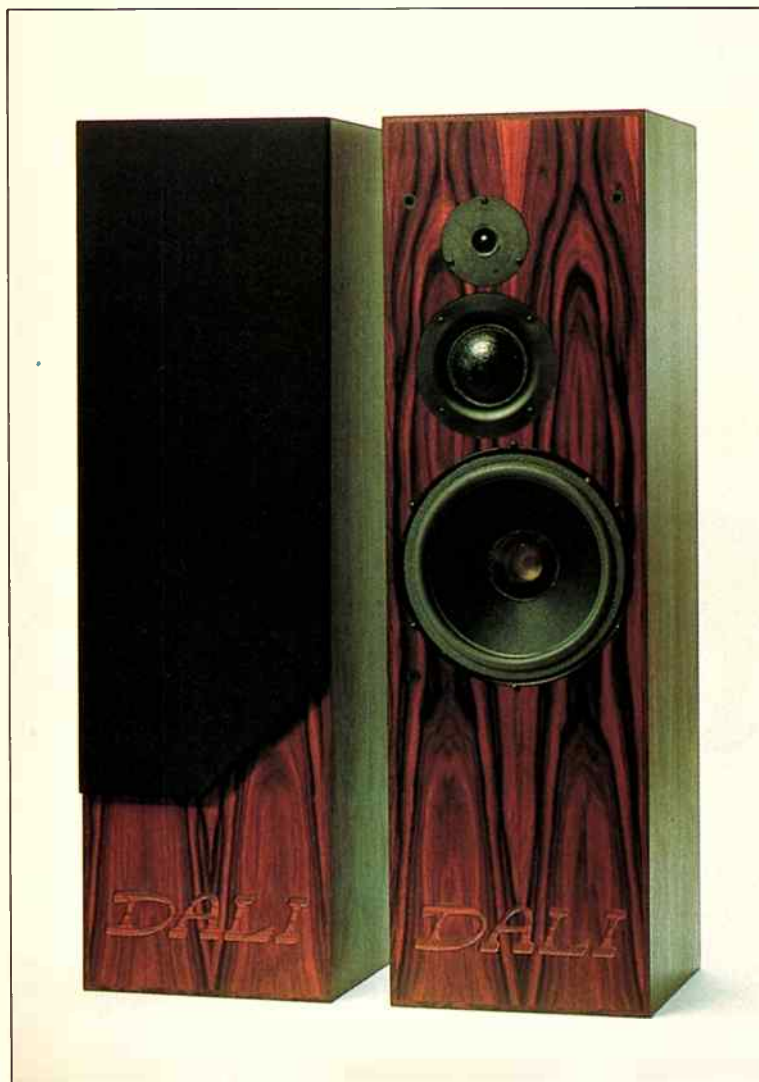

The Dali 7



The Dali 18



The Dali 15

the Dalis was quite different from the retiring nature of the electrostatics, but it did show up the good and bad points of both systems.

On a couple of jazz tracks, recorded live in a New York club, the Dalis took you right there so that you could smell the smoke, see the people responsible for the hubbub of background sound and almost taste the drinks in the clinking glasses. The music had a tingling immediacy. My speakers gave a well mannered view of the event from a discreet distance.

A string quartet however, had the Dalis reproducing a group of instruments while the electrostatics let me hear the more satisfying sound of four artists playing together. This slight murkiness in the higher ranges might well have disappeared by the time you read this. The newest version of the Dali 15 is being equipped with a SEAS metal dome tweeter which enthusiasts like for its transparent clarity and lack of the "edginess" that mars some metal domes.

The bass was excellent. The Dali 15 is designed for extended bass response (to below 34 Hz) when used with the NAD bass EQ amplifier but with any amplifier it slips down tightly to 43 Hz which is plenty low enough for most musical purposes.

On listening to other Dali speakers I came to the conclusion that they all shared the 15's basic characteristics - tight, deep bass, "forward" treble and accurate, well dispersed high frequencies. The use of quality drivers and well braced cabinets works well to counter any colouration.

I accept the argument that an orchestra should be listened to with the audience sitting where an audience sits and the musicians on the stage, and that speakers that drag the players right into the room with you are not reflecting reality. But recorded music is not reality and Peter Lyngdorf builds his speakers to put the music where people want to hear it.

The DaCapo, however, does things

differently. It has an eight-inch bass driver in a tall, slim cabinet along the length of which runs a metre of ribbon midrange/tweeter. The design is aimed at producing the subtlety and nuances of music; for rock and roll you select another model.

The Australian Dali distributor, Michael Henriksen, wins my award for sheer bravery in the face of the customer when he demonstrated the new model to dealers in the capital cities. He hired string quartets to play half a piece by Haydn before he pressed a button to play the rest from a CD through the DaCapos.

The reproduced sound was close enough to the real thing to impress the dealers and hold out a promise of joy to come for classic buffs who are not impressed by the modern trend towards punchy sound.

For more information about Dali speakers, contact Scan Audio, 52 Crown Street, Richmond, ☎ (03) 429 2199.

Victim fell here.†



Shot fired from here with an AVX-100.

at 2.30 a.m. Wednesday morning. It was a city apartment, the kind where someone else pays the rent. The T.V. was still on. I was impressed by the lifelike sound, the rich, moody music of the late night re-run. I spoke to the neighbours. Nobody saw anything, of course. But they'd all heard it. They'd been hearing it for the past three nights. The realistic dolby surround sound and atmosphere effects from her new Yamaha AVX-100 – so when the actual shot was fired, nobody noticed the difference. Isn't that the way these days – can't tell real life from the movies.

The D.A. approached me. "Where'd she buy it?" "In the chest", I replied.

Toying with the remote I changed the sound from concert hall, to smoky night club, to surround cinema, to natural surround and finally to the delayed acoustics of a church. I could have chosen another three or four sound treatments, but somehow that one seemed appropriate.

Next day I checked out the dealers. Just had to ring 008 331 635 for the nearest one. Heard the whole story, right down to the five year guarantee, then I got a tip that the D.A. had bought one.

100



AUDIO - VIDEO AMPLIFIERS • 5 YEAR WARRANTY

BOSE

The Bose 601™ Series III Direct/Reflecting® Loudspeaker System

Eose engineers have invested more than 25 years of ongoing research seeking one goal—re-creating the realism of a live performance.

The next best thing to hearing music live is hearing it through a Bose Direct/Reflecting speaker.

Drawing on the heritage of the internationally acclaimed Bose 901® speaker, the 601™ speaker gives you the best seat in the house—wherever you sit or stand.

Through our extensive acoustical research into live sound, we learned that focusing on only one musical parameter such as frequency response and expecting realistic sound is like trying to create a lifelike painting by concentrating solely on colour. As with visual images, live sound has perspective, clarity and proportion.

We designed our speakers based on the natural combination of direct and reflected sound. The difference between listening to conventional speakers and Bose Direct/Reflecting speakers is like the difference between viewing a movie on a television versus experiencing it in a theatre.

The 601 system brings a three dimensional sensation to music—giving the sound depth, height and width. In short, it seems to come alive!

In a live performance, the majority of sound reaches your ears after being reflected off the walls, floors and ceiling. With conventional speakers, you mainly hear only direct sound. Bose Direct/Reflecting speakers add the missing elements of music by bringing you the natural combination of direct and reflected sound (see diagrams at right). The result is a lifelike soundstage that's practically like being there.

The performance: Like a live performance

With most conventional speakers, you hear stereo in one or two parts of the room. Everywhere else, you hear primarily one speaker. The 601 system allows you to hear true stereo

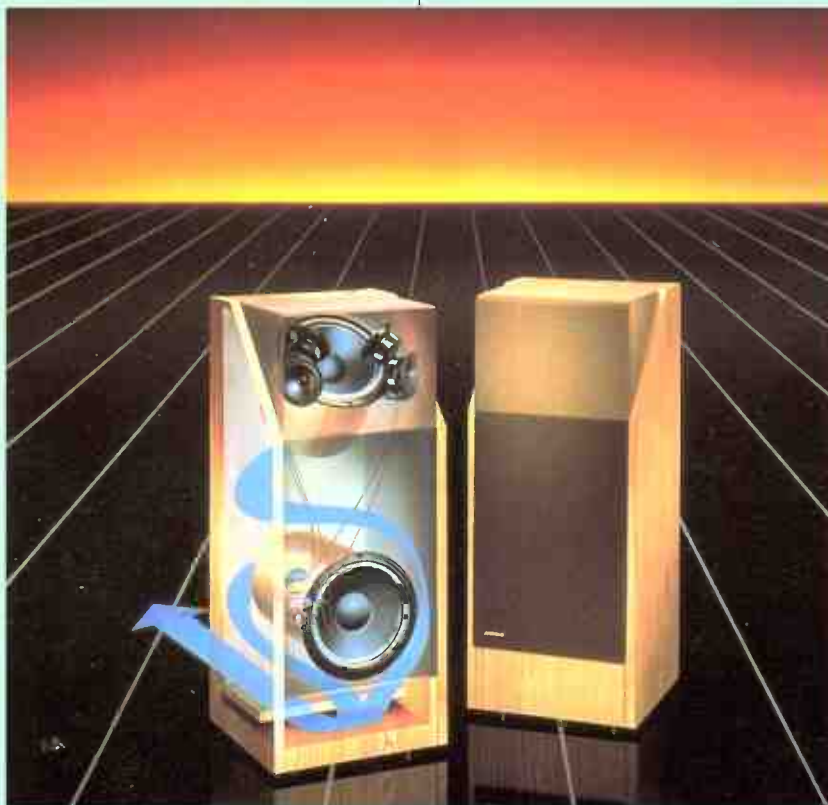

everywhere in the room—even when you are directly in front of one of the speakers.

The 601 system is the ideal cornerstone for a complete home entertainment system. It unleashes the full potential of your sound system, efficiently produces excellent sound and easily handles high power. This rare performance combination allows you to enjoy today's power-demanding sound sources such as digital audio at true-to-life volume levels.

The Bose 601 system also makes it possible to use your stereo system in a new way: as part of a total audio/video system. It is designed to produce greater realism with all video sound sources—especially stereo televisions, hi-fi VCRs and video disc players.

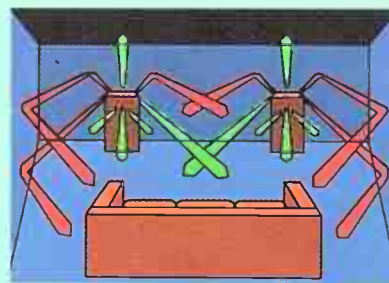

Bose 601 Direct/Reflecting® system.

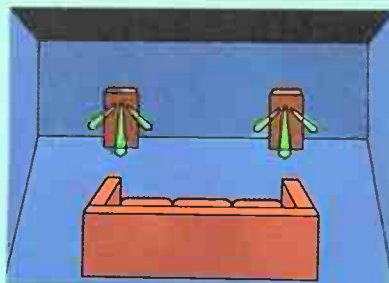

Conventional speaker system.

Bose Australia Inc., 11 Muriel Avenue, Rydalmere, NSW 2116 Telephone: (02) 684 1022, 684 1255

Bose Distributors:

NSW and VIC: Bose Australia (Reverse charge (02) 684 1022); QLD: Stereo Supplies (07) 229 7930; WA: Prosound (09) 325 1066; SA: Blackwood Sound (08) 278 1281; TAS: Chessman Distributors (003) 26 4622.

Bos017

READER INFO No. 37

World Radio History