

AUSTRALIA'S DYNAMIC ELECTRONICS MONTHLY!

WIN A  
20MHZ RDO IRVING  
OSCILLOSCOPE

# Electronics Today

INTERNATIONAL



\$2.95\* NZ \$3.75

MAY 1986

**HI-FI REVIEWS:  
DALI-8 SPEAKERS  
NEC's CD OFFERING**

**CONVERT YOUR VHF TV TO UHF**

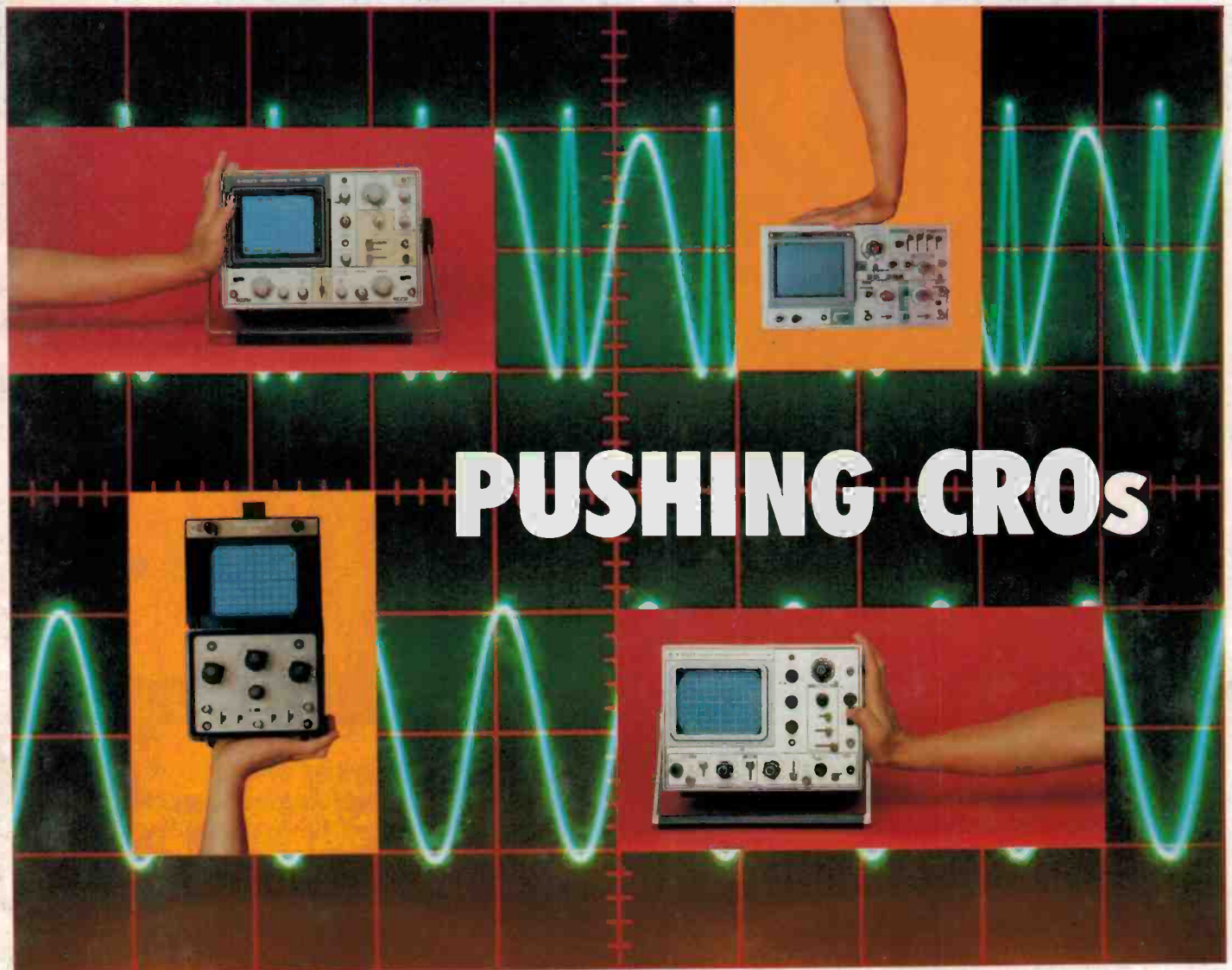

## PUSHING CROs

**GET YOUR AUSTRALIAN DICK SMITH CATALOGUE  
FREE THIS MONTH**

Registered by Australia Post Publication No. NRP0407



# Weller performance and reliability.



## Look-alikes aren't that simple.

You could buy a lower priced soldering station that looks very similar to the Weller WTCPN. But it wouldn't perform like it.

By changing the heat sensing tips, the Weller WTCPN automatically controls output and temperature in three stages (315°C, 370°C and 430°C). Once selected, you can be assured of constant, accurate temperature control without dials to turn or settings to

watch. To make working with sensitive components that safe and simple, Weller has incorporated state-of-the-art technology into an attractive impact resistance case, that's ideally suited for assembly work.

Don't be fooled by look-alikes.

Check with your Electronics Distributor.

## The Weller WTCPN



CRESCENT LUFKIN NICHOLSON PLUMB TURNER WELLER WIRE-WRAP WISS XCELITE

The Cooper Tool Group Limited, P.O. Box 366, Nungong Street, Albury NSW 2640, Australia, Tel: (060) 216866, Telex: AA 56995

# CooperTools

# Electronics Today

**EDITOR**

David Kelly B.Com.

**ASSISTANT EDITOR**

Jon Fairall B.A.

**EDITORIAL STAFF**

Mary Rennie B.A.  
S. K. Hui B.Sc. (Hons), M.Eng.Sc., MIEEE, MIREE  
Neale Hancock B.E.

**DRAUGHTING**

David Burrows

**ART DIRECTOR**

Vicki Jones

**ART STAFF**

Ray Eirth  
Denise Petreas

**ADVERTISING MANAGER**

Peter Hayes B.Sc.

**ADVERTISING PRODUCTION**

Wayne Hanley

**READER SERVICES**

Pam Todd

**ACOUSTICAL CONSULTANTS**

Louis Challis and Associates

**PUBLISHER**

Michael Hannan

**HEAD OFFICE**

140 Joynton Avenue, (PO Box 227)  
Waterloo, NSW 2017.  
Phone: (02) 663-9999 Sydney.  
Telex: 74488, FEDPUB.  
Federal Facsimile: 662-1007.

**ADVERTISING**

**New South Wales**

Peter Hayes, Mark Lewis (02) 663-9999

**Victoria and Tasmania**

Virginia Salmon (03) 662-1222

**South Australia and Northern Territory**

Dane Hansen (08) 212-1212

**Queensland**

Warren Tapner (07) 854-1119

**Western Australia**

Jim Wells (09) 328-9833

**New Zealand**

John Easton, 79-6648 (Auckland)

**OFFICES**

**New South Wales:** The Federal Publishing Company, 140 Joynton Avenue, Waterloo, NSW 2017.

**Victoria and Tasmania:** The Federal Publishing Company, 23rd Floor, 150 Lonsdale Street, Melbourne, Vic. 3000. Phone: (03) 662-1222. Telex: 34340, FEDPUB.

**South Australia and Northern Territory:** John Fairfax & Sons, 101-105 Waymouth Street, Adelaide, 5000. Phone (08) 212-1212. Telex: 82930.

**Queensland:** The Federal Publishing Company, 26 Chermiside Street, Newstead, Qld. 4006. Phone: (07) 854-1119.

**Western Australia:** Tony Allen & Associates, 7 Fore St, Perth, WA 6000. Phone: (09) 328-9833.

**New Zealand:** 3rd Floor, Communications House, 12 Heather Street, Parnell, Auckland, Box 37-291 PO Telex N263122. Phone 79-6648.



**ELECTRONICS TODAY INTERNATIONAL** is published monthly by the Electronics Division of the Federal Publishing Company Pty Limited, 140 Joynton Avenue, Waterloo, NSW 2017 under licence from Double Bay Newspapers Pty Limited, General Newspapers Pty Limited and Suburban Publications Pty Limited. Typeset and printed by ESN-The Litho Centre, Sydney. Distributed by Gordon and Gotch Limited, Sydney. \*Maximum and recommended Australian retail price only. Registered by Australia Post, Publication No NBP0407. ISSN No 0013-5216.

**COPYRIGHT** © 1985, Double Bay Newspapers Pty Limited, General Newspapers Pty Limited and Suburban Publications Pty Limited (trading as "Eastern Suburbs Newspapers").

**FEATURES**

<b>Pushing CROs</b> The constraints on oscilloscope design are under assault	<b>11</b>
<b>Behind the glitter</b> There was more to the Winter CES in Las Vegas than the shows	<b>23</b>
<b>A tale of ICs and hybrids</b> A sophisticated high tech industry growing up in Australia	<b>46</b>
<b>Starting electronics</b> The logic of digital	<b>76</b>
<b>Beyond the Torres Straits</b> Amateur radio in Indonesia	<b>95</b>

**PROJECTS**

<b>ETI-744: UHF tuner</b> Converts an old TV set to receive UHF	<b>52</b>
<b>ETI-1531: Brown-out protector</b> Prevents overloading of equipment in those dangerous brown-out periods	<b>58</b>
<b>ETI-1402: Digital sampler</b> Records short bursts of sound and can be used as a digital delay	<b>67</b>

**REVIEWS**

<b>Wider pastures</b> NEC's venture into CD player manufacture, the CD-509	<b>32</b>
<b>A lesson in listening</b> The Dali 8 loudspeakers offer instructive listening	<b>36</b>

**OFFERS**

Advertisers' index	88
ETI mail order books	88,89,90,91
ETI-Schools projects competition	83
ETI-Rod Irving Electronics CRO competition	64
Subscriptions offer	86

**DEPARTMENTS**

News Digest	5	Schools News	82
Sight and Sound News	30	Shoparound	92
New Equipment	43	VZ200/300 Column	93
New Components	50	Minimart	63
Ideas for Experimenters	84	Dregs	98
Idea of the Month	85		

**COVER:** Designed by Vicki Jones, photography by Mario Borg.



## SERVICES

**TECHNICAL INQUIRIES:** Technical inquiries by mail must be accompanied by a stamped self-addressed envelope. There is no charge, but we reserve the right to publish the inquiry and the reply in *Electronics Today* or any of its associated publications. We can only answer queries relating to projects and articles as published. We cannot advise on modifications, other than errata or addenda. Difficult questions may take some time to answer.

**GENERAL INQUIRIES:** For all inquiries about back issues, subscriptions, photocopies of articles, artwork or submitting articles, call (02) 663-9999 or write to: ETI Reader Services, 140 Joynton Avenue (PO Box 227), Waterloo, NSW 2017.

**CONTRIBUTIONS:** Submissions must be accompanied by a stamped, self-addressed envelope. The publisher accepts no responsibility for unsolicited material.

**COPYRIGHT:** The contents of *Electronics Today International* and associated publications is fully protected by the Commonwealth Copyright Act (1968). Copyright extends to all written material, photographs, drawings, circuit diagrams and printed-circuit boards. Although any form of reproduction is a breach of copyright, we are not concerned about individuals constructing projects for their own private use, nor by bands (for example) constructing one or more items for use in connection with their performances. Commercial organisations should note that no project or part project described in *Electronics Today International* or associated publications may be offered for sale, or sold in substantially or fully assembled form, unless a licence has been specifically obtained so to do from the publisher, The Federal Publishing Company, or from the copyright holders.

**LIABILITY:** Comments and test results on equipment reviewed refer to the particular item submitted for review and may not necessarily pertain to other units of the same make or model number. Whilst every effort has been made to ensure that all constructional projects referred to in this edition will operate as indicated efficiently and properly and that all necessary components to manufacture the same will be available, no responsibility is accepted in respect of the failure for any reason at all of the project to operate effectively or at all whether due to any fault in design or otherwise and no responsibility is accepted for the failure to obtain any component parts in respect of any such project. Further, no responsibility is accepted in respect of any injury or damage caused by any fault in the design of any such project as aforesaid.

A LARGE PART OF THE RESOURCES of this magazine is devoted to projects. The projects are read by people looking for circuit ideas with just as much interest as those who intend to build them.

While we make our own decisions about these projects there are also some to be made by the project builder. As a reader you have two main choices when buying up for a project. You can buy in kit form or scout around for the individual parts.

Often readers have something to say about the price and quality of available kit forms for the projects. While readers pass on their thoughts on prices to the kit suppliers I'm sure they often neglect to say what they really want to buy in terms of quality.

Buying in kit form will save you the frustration of the extinct component. Sometimes the shops can even arrange some saving on the cost of the individual parts. More often the cost of the kit will be around the individual part's cost plus something for packaging.

However, prices vary and it's up to you to decide whether you are getting value for money. It seems ironic, but often the most expensive part of the project will be the power supply and hardware items like the pc board, front panel, the box and switches.

As these items cost a lot, kit suppliers can decide to cut both the quality and the price. It is then up to you to decide what you want. Of course, if you continually ask the kit supplier for a price cut you know what you can expect.

The other way to buy up for a project is to purchase the component parts separately. This allows you to use parts you already have, and allows you to choose and design your own case and to change the quality of particular components.

The risk is that parts sometimes seem into be sent to extinction by the mere fact of publication.

Although many projects seem to last forever, it is the ones with the extinct component that cause the most frustration for our readers and ourselves. If you want to shop around you should start with the electronics shops. For the hard to find parts you can always ask the manufacturer for the name of a shop with stocks.

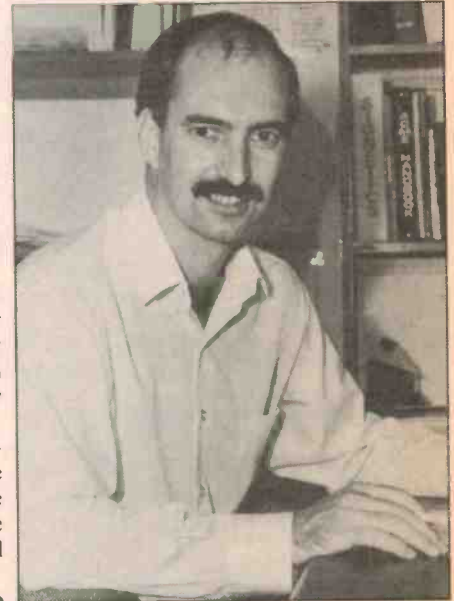

David Kelly  
Editor

### STARTING MICROPROCESSING

Next month we begin a new series designed to teach the interested reader what makes a computer tick. The series will embrace the electronics of the computer and a bit of programming. We start the series off by getting acquainted with the basic terms and concepts.

### OPTICAL FIBRES

Optical fibre cables are well and truly entrenched! Telecom is daily lengthening its Melbourne-Sydney link and the acceptance of this technology has stimulated both manufacturing of cable and peripherals. We check out what's happening.

### NEXT MONTH

#### PRINTED CIRCUIT BOARDS

We delve into all there is to know about pc boards. Well, at least we expose the secrets of pc board manufacture, their uses, soldering techniques and mounting.

#### REVIEWS

The two audio reviews scheduled for next month are of the most expensive car CD player on the market, the Alpine CD5900, and of the respected Tannoy M20 gold speakers. Look out for them.

### THE ETI MODEM OPUS

At the risk of 1200 bored readers, we had to postpone publication (again) of the hardware details of the modem last month. It's more difficult than we thought! We can only console ourselves — and readers — with the promise of a minimum of errata notes. June should bring the anticipated details.



# Next generation satellite

Aussat is calling for Registrations of Interest from suppliers for the manufacture of second generation satellites, satellite control facilities, and associated equipment.

Aussat's second generation system will provide replacement communications capacity for the first generation of satellites and prospectively a range of new communications and other satellite related services.

Mr Dick Johnson, Aussat's Deputy General Manager has suggested a comprehensive industry briefing for all interested parties to be held in Sydney later this year. "As was the case for the first generation Aussat, draft specifications for the system will be circulated for comment prior to a call for tenders," Mr Johnson said.

Aussat is aiming to issue a formal call for tenders in mid 1987 with the scheduled date for the finalisation of the contract by mid 1988.

"This will enable Aussat to launch second generation satellites in 1991 in good time to replace the first satellites which will be nearing the end of their seven year life," Mr Johnson confirmed.

He also mentioned that the substantial recent increases in

launch insurance premiums are a matter of great concern for satellite operators worldwide. Accordingly, one option of great interest to Aussat was the prospect of a single comprehensive contract to cover all aspects of the second generation satellite system procurement, including the launch phase and associated launch insurance, such that satellite delivery from the contractor to Aussat would take place in orbit.

Considerable interest will be raised by the prospect of substantial Australian industry participation in the new satellites. According to Wayne Knowland, head of the group specifying the new satellite, considerable Australian input was technically possible.

Meanwhile a basic design concept was being developed which would include, for consideration, a number of additional applications, such as the provision of meteorological capability, remote sensing, mobile communications services and scientific applications.

more power. As a result, OTC is getting into the provision of small dish earth stations with a vengeance. It unveiled its Satnet III system to the media on 4 March in Sydney; this system uses the extra power of Intelsat to reduce the size of the dish to the extent that the entire station can be carried up a building in a lift, or indeed, bolted to the side of it.

According to Equatorial Satellite Systems, which manufactures the system, most of the construction work will be done at its Melbourne plant. ESS is owned 90% by local interests, with the US parent owning the remaining 10% and supplying some of the proprietary bits and pieces involved in the spread spectrum reception.

One of the main impediments to the introduction of the system has been conflict between Telecom and OTC regarding the transmission of inter-Australian services. In January and February, Telecom personnel took in-

dustrial action against OTC to protest at the international carrier 'poaching' on internal traffic. The dispute was solved by OTC caving in. Thus international links and networks provided by the service will only have one Australian base.

Not that the 'poaching' is only one way. Aussat makes no secret of its plans to get into the international arena with the provision of services to New Zealand and the South Pacific. Initially, these services will all be contained within specific countries. New Zealand, for instance, will be using Aussat as part of the telephone trunk network. However, the pressure for technically obvious solutions to overseas communications problems will continue to provide a source of friction between the two organisations.

Other users are also getting into the swing with Intelsat V. The satellite is now carrying five TV channels that can be received with moderate sized

## Satellite news — May

Aussat announced in March the signing of a contract with SBS. Contracts signed to date soak up about half of the total planned Aussat capacity and include use of 15 x 12 watt transponders and 7 x 30 watt ones. The ethnic broadcaster will be using the satellite to reticulate signals around Australia as its network rapidly expands. SBS began transmission to Hobart on 16 March, putting it into all the major population centres on the east coast.

Aussat seems reasonably confident it can sell the rest of its capacity during the lifetime of the current satellites. Plans for the launch of the third satellite are now well advanced; the launch is scheduled aboard Ariane for the middle of the year.

Meanwhile at the more pedestrian C band, OTC is getting used to its shiny new Intelsat V, which took over from Intelsat IVA at last year's end. Like the IVA, the V is a Hughes built craft, but with considerably





# “With my HP CAD sail a boat that

Ask Ben Lexcen what his most valuable design tool is and he'll tell you it's his Hewlett-Packard Computer Aided Design system. Here he talks about his experience with the HP system and offers some salient advice to the new generation of designers who will follow in his wake.

**Have you always felt at ease working with computers?**

“No way! Really I was a latecomer to computers because I didn't have any formal training and I was frightened of them. In fact, I used to dream up some wonderful excuses to avoid getting involved with them.

“But, of course, I realise now that if you're going to be a leader in any field, not just design, you've got to utilise the leading technology. And really this HP stuff is so easy to use, I'm not sure what I was frightened of.”

**Which parts of a boat do you design with the help of the computer?**

“Virtually the whole lot, with the exception of tiny mechanical things. But we use it to design the shape and structure of the boat, and the sails.

“We use it to do all the hydro-dynamic considerations such as the total drag of the hull unit. Plus we use the computer to test different hull shapes.”

**What aspect of your involvement with Hewlett-Packard strikes you as being particularly beneficial?**

“Well, once you become involved with HP, you'll soon realise that apart from their technical excellence and innovation, one of their major strengths is that they have the people to help you get the best results from CAD.

“Because HP supply the hardware and the software, you've got a terrific advantage over the guy who tries to work with a lot of different suppliers. I mean it counts for a lot when the person who writes the software understands the workings of the processor.

“If you've got questions or problems, you can get answers and solutions from the one place. And believe me, that can save a lot of time and worry.”

**How has the HP equipment assisted in the day-to-day running of your office?**

“Well, it's staggering how much faster we can get things done since we plugged into HP. This is mainly due to the fact that the computer does so much of the calculation which we used to labour over manually.

LBV 7775 HEPL





# system I can virtually doesn't exist."

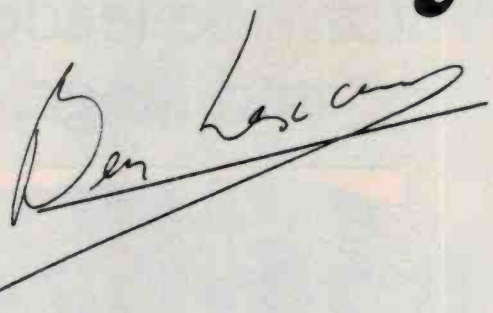

"For instance, now I can create the basic shape of a boat in a matter of hours whereas it used to take about a month. It might take me about ten minutes to do a keel whereas before it might have taken a week."

**Does saving so much time mean that you have to compromise on quality or accuracy?**

"Absolutely not. The equipment is dead accurate and I can do a more thorough job for far fewer man-hours.

"In fact, we are so confident in the HP equipment that when we've settled on the design of the boat to defend the America's Cup, we won't tank test it in Holland, we'll test it here in the computer. And when you're talking about a million dollar boat, you've got to be damn sure you've got the right equipment to do it."

**What of CAD in the future?**

"Look - I'm sure that if Australian designers don't grab CAD with both hands and run with it, the rest of the world will pass us by. And once we all realise its potential, you're going to see a lot of very happy and satisfied people in all sorts of design offices."

## You're on a winner with the HP DesignCentre

Our Computer Aided Design solutions work together in an integrated design environment called the HP DesignCentre. HP's renowned technical excellence shines brilliantly in the DesignCentre where our engineering workstations and quality graphics peripherals come to the fore. And it's well worth remembering that HP's reputation for unfailing backup and support has been well earned.

HP offers a comprehensive solution to your CAD. To obtain your free DesignCentre Management Kit or Technical Kit to help make your next design project a winner, call HP now toll free on (008) 03 3821 or send in the coupon below.



Please send me more information on  
HP's *DesignCentre*

Management Kit     Technical Kit

NAME \_\_\_\_\_

POSITION \_\_\_\_\_

COMPANY \_\_\_\_\_

ADDRESS \_\_\_\_\_

\_\_\_\_\_ P/CODE \_\_\_\_\_

POST TO:  
Hewlett-Packard Australia Ltd  
31-41 Joseph Street, Blackburn, Vic. 3130



**HEWLETT  
PACKARD**



# TRIO-KENWOOD

Worldwide leaders for performance, quality and range. Now, new for 1986.



**C S 1 0 6 5**

**60MHz**  
**3 channel 6 trace**  
 1mV/div.  
 12kV acceleration  
 5nS/div. sweep

Delayed sweep  
 Improved dynamic range  
 Automatic video synch.  
 Vertical axis signal output.  
 Variable hold-off.  
 Single sweep mode.

ETI READER SERVICE 128

**C S 1 0 4 5**

**40MHz**  
**3 channel 6 trace**  
 1mV/div.  
 12kV acceleration  
 10nS/div. sweep

Delayed sweep  
 Automatic video synch.  
 Vertical axis output.  
 Variable hold-off.  
 Single sweep mode.  
 Improved performance.

ETI READER SERVICE 129



**C S 1 0 4 4**

**40MHz**  
**2 channel 4 trace**  
 1mV/div.  
 6kV acceleration  
 20nS/div. sweep

Variable hold-off.  
 CH1, CH2, ALT,  
 CHOP, ADD  
 Vertical axis output  
 Automatic video synch.  
 Compact & lightweight.

ETI READER SERVICE 130



## And here's another twelve models to choose from:

CO 1303D - 5MHz	CS 1040 - 40MHz	CS 2110 - 100MHz
CS 1352 - 15MHz (Port.)	CS 1060 - 60MHz	CS 2150 - 150MHz
CS 1021 - 20MHz	CS 1100 - 100MHz	MS 1650B - Memory
CS 1025 - 20MHz	CS 2075 - 70MHz	MS 1660 - Memory

For maximum performance and quality at the best price, call us for details or demonstrations of Kenwood oscilloscopes. We are located at:

### SYDNEY:

Centrecourt  
 25-27 Paul Street North, North Ryde.  
 P.O. Box 261 North Ryde NSW 2113.  
 Phone (02) 888 8777. Telex AA25021

### MELBOURNE:

1064 Centre Road, Oakleigh South.  
 Private Bag No. 1, Oakleigh South 3167.  
 Phone (03) 575 0222. Telex AA33012

**PARAMETERS**  
 PERFECTION IN MEASUREMENT



dishes at the latitude of Sydney. These include all the American networks, a US Army network and a Japanese carrier. Dick Smith Electronics hopes to be selling a low cost system capable of bringing in these signals before the year's end.

Overseas, most interest is being generated by the ill fated British Aerospace ECS-1, which was built for Eutelsat, the European consortium that reticulates TV signals like those from Rupert Murdoch's Sky Channel. It's the first of five planned satellites that will link all of Europe together.

It was launched in July 1983, and commissioned in December of that year. However, by November 1985 about 1/5 of the way through its planned life-

time, signal strength started reducing. To date, this has been compensated for by increasing the strength of the transmit station by 3 dB. There is another 3 dB in reserve in the uplink, after which the receiver front end on the satellite will start distorting.

According to engineers at British Aerospace, the problem is probably in one of the 20 watt travelling wave tube amplifiers from the West German company, AEG, and not repairable. To add to the agency's problems, ECS 3, which would have taken most of the load off ECS 1, was lost on launch in September.

Remote sensing also continues to attract a considerable amount of interest. The French

Spot 1 was launched earlier this year. It has a resolution at visible and infrared wavelengths of about 10 metres, as opposed to the 30 metres of Landsat 5, the fifth in the Landsat series. Spot images will be sold to a company called Spot Image which was set up in 1982, and now employs distributors around the world. Landsat has also gone commercial, with the Earth Observation Satellite Co selling its images. Competition between the two systems is likely to be fierce, as the Americans fight to hang on to their lead in space technology.

In Australia, the processing of satellite images is probably the most advanced arm of the space industry. The CSIRO has now entered into a contract with

MPA of Melbourne for the sale of a system called Micro BRIAN, a system based on BRIAN, (Barrier Reef Image ANalysis) which used Landsat images to map the barrier reef. CSIRO and MPA have transferred the system to a micro-processor and packaged it for commercial release at a price said to be about half that of its rivals'.

Another development likely to be of concern to industry watchers is the fate of Aussat's tenders for the second generation satellites, which are being called now. The current generation will run out of steam in 1991, so Aussat is getting to work now. It is likely there will be significant Australian participation in the project this time.

## BRIEFS

### IBM/Intel split

In a somewhat surprising move, IBM which owns 20 per cent of Intel Corp and uses the Intel 8086 microprocessor chip, has announced its intention to sell as much as a third of its 22.5 million shares.

According to a recent US report, IBM has claimed a need to raise \$300 million, but the report suggests the move may have been prompted by Intel's move into the field of application specific ICs at the expense of RAM chips and microprocessor development. It suggests that IBM still considers RAM the main chip technology driver. Nevertheless, both companies expect IBM to remain a major Intel customer.

### The sportsman's special

Jaycar has released a new TV antenna for \$59.95 initially designed for the Sydney viewing area, but which can be used in other parts of Australia.

The idea behind it came about when Jeff Fenech had his big title fight in Sydney some months ago. The fight wasn't televised in Sydney, but it was in other areas, one of these being Wollongong. So Jaycar had an antenna designed and manufactured in Australia specifically to pick up channels 4 and 5A.

Jeff Fenech has his second title fight in Sydney in late May. So be ready!

### VCR course

If you are unable to attend a conventional night or day school course but want to learn more about video cassette recorders RMIT is offering a brief course designed to help those people that have to travel long distances or cannot afford the time to attend week long courses. A certificate will be issued on satisfactory completion. For more information or enrolment details contact Mr Rod Humphris or Mr Bob Blythe on 663-5611.

## NOTES & ERRATA

Ideas for experimenters, Camera timer, April '86: We advise that this circuit will work better if the positive rail is connected to the centre switch, SW3.

## COMPANY NEWS

Sprague Electric Company has expanded its Australian operation with the opening of an office at 11 Rushdale St, Knoxfield, Vic 3180. (03)763-8333.

Tony Currie has joined Sprague Electric and will be responsible for sales and technical support in Victoria.

A new company, Cliff Electronics (Aust) Pty Ltd, has been formed to distribute Cliff Plastic Products (UK) and Cliff Electronic Components (UK) throughout Australia. Products include jack plugs, jack sockets, knobs and cabinet accessories, handles, corners and feet, fuseholders, XLR connectors and pcb racks.

Cliff Electronics (Aust) will also be distributing a wide range of test equipment including Fluke, Aaron, Topward, Data-Com Northwest and Coline.

Information, catalogues and prices are available from Cliff Electronics, PO Box 732, Fortitude Valley, Qld 4004. (07)848-9714.

Melbourne company, Nitec has advised a change of address from North Fitzroy to 209 Richardson St, North Carlton, Vic 3054. The telephone number is (03)380-6993.

All Electronic Components, 118-122 Lonsdale St, Melbourne, has been appointed sole Victorian distributor of Jemal products. Services available include sourcing, supply and assembly of components, manufacture of printed circuit boards, panels, chassis and racks. Plated through hole pcb facilities and the latest membrane switch technology are available.

Dunas Electronics is a new firm on the Australian market specialising in the manufacture of printed circuit boards. It offers West-German high quality standards, with short delivery terms at reasonable prices (eg, single sided pcb from 8 cents per square centimetre, including material).

Dunas Electronics is contactable at 23 Victoria St, Burwood, NSW 2134. (02)747-5449.

STC Measuring Instruments has appointed Mr Ron Sinclair responsible for marketing Anritsu measuring instruments throughout NSW and Qld. Ron comes to STC from Telecom.



# Letters to the Editor

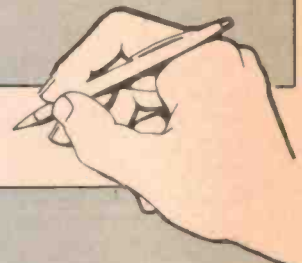

## Technicians' Association

IT IS REGRETTABLE that 'Name Withheld' (ETI, Nov '85) feels threatened by what I believe are despicable practices on the part of large companies.

Fortunately such companies are in the minority. I am in the same boat as Name Withheld and have turned my attention to the more reputable companies.

Three years ago most of the major Japanese companies saw the need to rationalise their spare parts services. There were many problems to begin with but now Toshiba, Sharp, AWA, Sanyo, NEC, Rank Arena and quite a few lesser names have a service equal to none. National did not make it, as action by the WA government has shown.

I hail the suggestion of an electronic service association. There is a saying, "If you see a need you're elected." Go to it, Mr Name Withheld, I'll be your second member.

M. de Bortella  
Hydra Electronic Service  
Derby, WA

## National replies

WE APPRECIATE the opportunity to respond to letters to the editor, which have criticised National Panasonic Australia on the supply of spare parts and video service manuals (Nov ETI, "National again," etc).

To help in the service of the approximately 1200 National, Panasonic or Technics models likely to be in the market at any time, a 3300 square metre central spare parts warehouse carrying 51,000 line items is operated by the service division administration office at Artarmon, NSW. This operation procures all spare parts for supply to our state service centres, which stock an average 9000-12,000 line items at the capital city branch offices.

Should customers encounter problems with spare parts supply or service, the service centre managers endeavour to resolve them at branch level, even to the point of exchanging a complete module (or pc board).

In any case, the central warehouse is able to despatch 90 per cent of all orders, if available, within 1-2 working days.

There are presently around 15 authorised wholesale outlets to supply members of the service industry who are not part of our network of 707 authorised service agents and service dealers. Obviously, this network alone creates a large demand for technical

information in the form of service manuals. However, we have undertaken to make available service manuals in the form of micro-fiche for approximately \$10 each. Micro-fiche readers are available from other sources from approximately \$80 upwards. In addition, we have provided copies to J.R. Publications to produce video manuals similar to the J.R. TV service manual.

As much as we try, with a large organisation such as ours, there is always the possibility that someone is going to experience a problem in going through the normal channels.

We wish to assure our customers and those in the service industry that they can bring their problems to the attention of the service centre manager for assistance in resolving the matter.

Brian Jones  
NSW Service Centre Manager  
National Panasonic (Australia)

## AM stereo

HAVING BEEN involved with car receivers and AM stereo reception since its official inception, your editorial in January ETI has prompted the following observations.

There can be little doubt that an AM stereo programme from a 'suitable' transmitter and heard via a wideband tuner can sound objectively very good and even rival FM stereo in its initial impact. However, car reception is another story. As soon as a vehicle is mobile, the rot sets in. Our company has tested and installed several leading brands of AM stereo receivers and we have yet to find one which we can unreservedly recommend to consumers.

For example, in the narrowband receivers, the poor audio sound quality and below average stereo separation (compared to FM) hardly serves to impress customers to pay more money for an apparent small improvement in sound dispersion.

With wideband sets, antennas have to be fully extended to minimise the annoying hiss levels and local fading, while interference from high tension SEC lines and trams tends to cause intermittent stereo dropouts. At night, 9 kHz whistles make the receiver unlistenable, and, to top this off, the wideband receivers reveal the vicious treble boost and 'edgy' distortion being broadcast by the AM stereo stations for those without AM stereo!

Additionally, modern varicap tuned receivers

with untuned broadband rf amplifiers inevitably suffer from poor cross-modulation performance, falling far short of the 'old-fashioned' permeability tuned designs.

In short, and despite the encouraging claims made by the stations and importers, AM stereo could be in danger of emulating the success of quadrophony and the Elcasette. To improve its chances of survival — remembering consumers did not 'demand' AM stereo — the stations must minimise their audio processing and allow a little more dynamic range in their programmes. They must encourage importers and manufacturers to offer sets with wideband facilities, whistle filters, improved AGC performance, and impulse noise blanking for AM.

Then, the listening public may willingly switch to the AM band again.

N. Hughes  
Hughes Communications  
Carnegie, Vic

## Saving lightbulbs

REGARDING YOUR article on protecting lightbulbs (ETI, Nov '85) from the thermal shock of the inrush current on a cold filament, may I suggest the use of a slightly modified standard household dimmer. If the rheostat is replaced with an identical value with a piggyback switch, the light can be switched off by turning the knob rather than flicking a toggle switch. This automatically holds the switch-on voltage to the bulb at the minimum dimmer output.

Another lurk to extend the life of the bulb is to place a resistor in series with the dimmer rheostat that prevents the full mains voltage being applied to the bulb. This is especially valuable to consumers who live close to a substation. If Aussie power authorities are anything like NZ power boards you just might find the substation output a teeny bit higher than the supposed maximum permitted, which can shorten the life of your lightbulbs significantly. There are pros and cons to this method because the lower light output, requiring a higher wattage bulb consuming more electricity, may be more expensive in the long run than the shortened life of the bulb.

Ian Orchard  
Christchurch, NZ



# PUSHING CROs

The difference between a good CRO and a bad one is usually the bandwidth, so that's the area of much development. But manufacturers are pushing analogue and digital technologies, as well as some finer points for all they're worth.

Jon Fairall

THE CATHODE RAY oscilloscope is one of the most venerated electronic instruments. Learning how to use it successfully is one of the most important tasks for the would-be designer or troubleshooter. But the CRO isn't perfect. It has limitations imposed by the circuit under test, the way it's built and nature itself. Modern CRO makers are pushing back these limits continuously.

The problem with oscilloscopes is essentially one of bandwidth. We would always like to be able to see events in a circuit more clearly, and by and large that means having more bandwidth. It is possible to get quite exceptional performance with modern day CROs, but only with some fairly exotic techniques. Another partially related problem is that we would like to exploit the advantages of digital circuitry, but this imposes extra bandwidth constraints on the design. Finally, we would like to make it all cheaper.

## Bandwidth

Bandwidth in a CRO, as elsewhere, is taken at the 3 dB point, ie, at the point where the amplitude of the displayed waveform has dropped to half in nominal voltage. Some of the cheapest oscilloscopes on the market, such as the DSE Q1280, have bandwidths around 6.5 MHz, which is quite adequate for audio work.

Oscilloscopes for serious work start at about 15 MHz, which is good enough for most TV troubleshooting, although most TV techs would probably be a lot happier with 35 MHz, a typical figure for general purpose work. Digital and rf work requires much wider bandwidths, 100 MHz at a minimum, and there is a growing market for high end equipment running at 350 MHz or so.

Bandwidth is the basic criterion by which oscilloscopes are judged. As a general rule, it's related to price more closely than any other parameter. This is not surprising, since the amount of design effort required multiplies in direct proportion to the speed things are to run. The limiting factor is most often the display tube. Essentially, the problem is that the higher the frequency re-

quired, the faster the trace must move from side to side, and the faster it must respond to up and down movements of the vertical amplifier.

The speed at which the trace will move depends on a number of factors. Most immediately, it depends on the gradient of the electrostatic field between the plates, ie, increase the voltage on the deflection plates and the trace will move faster. This works fine up to certain limits but it imposes all kinds of power supply and heat dissipation problems on the system.

A second alternative is to decrease the acceleration voltage on the beam itself. This follows because the actual deflection of any individual electron in the beam is a resultant of acceleration and deflection voltages, which work at right angles to each other. In terms of the amount of deflecting force acting on the electron, increasing one is the same as decreasing the other. The problem with this approach is that the acceleration voltage increases the energy with which beam electrons hit the screen. If you make it too low they won't emit any light when they strike the screen and there will be no visible indication of beam position. Not very useful, you might think.

A third alternative is to increase the aspect ratio of the tube, ie, the ratio of length to breadth. Other things being equal, the longer the tube, the smaller the angle through which the beam needs to be deflected and thus the smaller the deflection voltage needs to be. Of course, the longer the tube, the higher the voltage required on the accelerating plates, and the more difficult it becomes to mount the tube in a practical unit.

## Above 200 MHz

In practice, all these alternatives come up against limitations imposed by things outside the tube. There is a limit to how much voltage can be supplied, how quickly it can be supplied, a limit to length, and so on. It appears that by optimising all these elements, modern oscilloscopes can push back the 100 MHz barrier. To go faster, other methods need to be explored.

One way of doing it, which seems to dou-

ble the upper frequency limit to about 200 MHz, is post deflection acceleration. The basic principle here is to move the deflection plates backwards in the tube towards the cathode of the gun, and carry out the deflection on the tube while the electrons are moving with rather low energy. Only when they are pointing in the right direction are they accelerated.

The big problem here is one of linearity. ▶

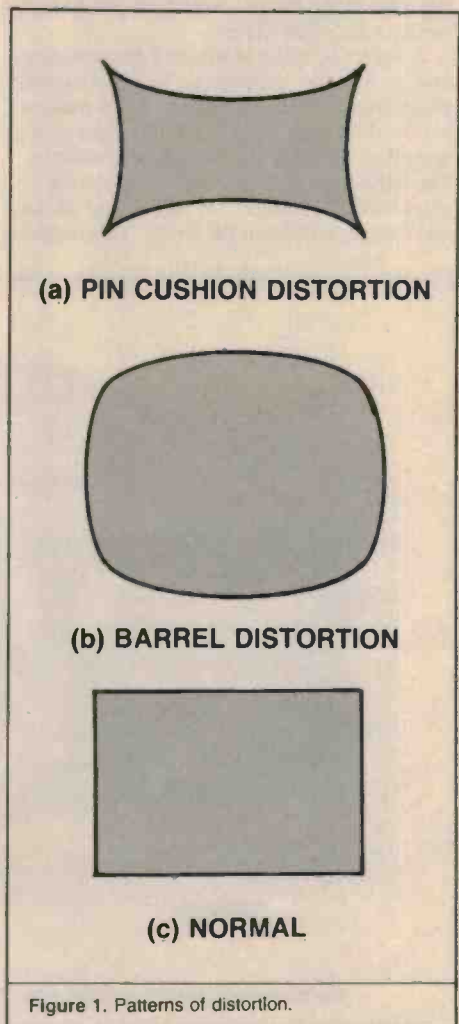

Figure 1. Patterns of distortion.



## FEATURE

The acceleration voltage operates parallel with the axis of the tube, but if the beam has already been deflected, it is travelling at some angle to the axis. The effect of the accelerating voltage is thus to bend the beam inwards, resulting in non-linearities like pin cushion or barrel distortion (see Figure 1). Curing this results in a complex array of voltage plates around the top of the tube, but it can be done reasonably successfully.

The death knell of normal electrostatic tubes is sounded when things are happening so fast that the time taken for individual electrons to move through the deflection fields becomes a significant percentage of the time taken to record an event on the screen. Imagine, for instance, if we wanted a single cycle of a very fast sine wave on the screen. If the period of the wave was exactly the same as the transit time of an electron through the field, the net deflection of the electron would be precisely zero.

An obvious way to reduce this problem is to reduce the size of the deflection field, thus reducing the transit time. This is fine except that it would also reduce the effect of the deflection plates, requiring yet higher voltages between them.

A better solution is to use a transmission line to do the deflecting. The deflection plates are divided into a number of narrow plates down the length of the tube connected to each other by a small inductor. The deflection voltage is passed from one to the other at precisely the same rate as an electron travels down the beam. This means

that at every point on its path down the tube, a given electron is subject to precisely the same deflection field. The limit to this technique is set by the frequency response of the LC circuits, formed by the inductors and the plates. It allows one to go up to about 500 MHz.

Other techniques can be used to make a CRO run faster than this, although they all have in common a method of matching the speed of the electrons in the beam with the propagation of the deflection information. Typical of these are travelling wave tubes. Using such techniques, it has been possible to push experimental CROs up into the gigahertz region.

The exigencies of practical design problems, things like weight and power supplies and so on, have meant that commercially available CROs have considerably lower bandwidths. Philips has recently released a 350 MHz CRO with travelling wave tube deflection for instance. There are a few current production CROs that go faster: the Tektronix 7104 and HP 54110D among them.

### Decoupling

There is one final method that can be used to extend bandwidth, and that is to attempt to decouple the screen from the input signal. In this method, the write speed of the tube has a variable relationship to the read time of the probe. One method of doing this is to use the profiled peristaltic charged couple device (PPCCD) made by

Philips. It loads the input signal into 256 semiconductor capacitors, referred to as wells. Clock pulses cause the wells to first store and then transfer the charge to the next well, clearing the first well for the next input. It is possible to do this very fast, thus information can be read in at speed and read out at leisure. The net effect of putting a signal through a PPCCD is thus to spread it out in time. It means a low frequency tube can be used to capture extremely fast signals.

Another, even more ingenious method, is to think through some of the basic objections to electrostatic tubes again. All of these problems can be alleviated if the tube screen is made very small. Of course, the problem is that you then can't see anything. Unless, of course, you magnify the screen-image in some way. One promising method is to present the output of a minitube to a CCD. The CCD output is then sent to a large screen for final display.

An even more radical departure is to question the necessity for a tube at all. The ideal here is that the CCD can be used as the basic sensing unit instead of the tube. Of course, this isn't something restricted to oscilloscopes. Almost everywhere tubes are used, people are trying to replace them with solid state technology.

The problem is simply one of developing a read and write system with sufficient definition to be practical. Current technology allows manufacturers like Tektronix to build CCD sensors with 1024 x 1024 resolu-



The Kenwood CS-1044 available from Parameters.



Yesterday  
you had no  
choice...

...today  
you haven't got  
one either!

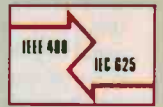

350 MHz  
SCOPES

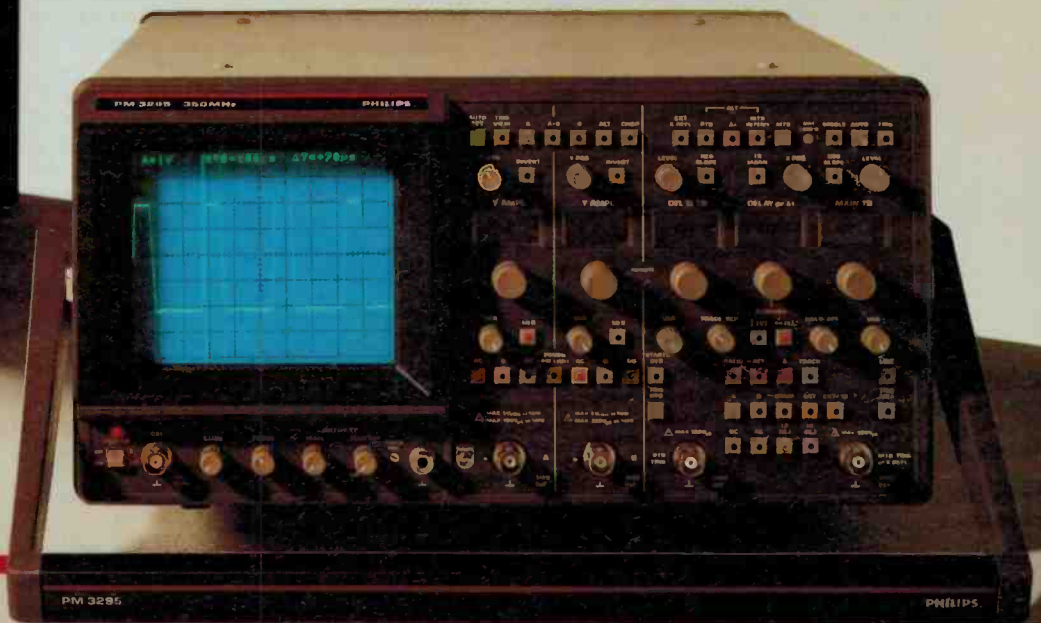

## Philips' new 350 MHz generation: performance that gives you no choice.

Now, the introduction of Philips' new 350 MHz generation means there's virtually no choice if you need today's most advanced technology in real-time high-frequency oscilloscopes.

These powerful instruments have a broad 350 MHz bandwidth and 1 ns risetime, representing leading-edge technology in real-time oscilloscope design. Writing speed is an ultra-fast 4 div/ns, ensuring secure capture and full waveform display of both single-shot and low-repetition signals.

### Advanced user features

Numerous advanced user features provide the simplest possible operation. Like intelligent beam-finding, enabling multi-parameter auto-

setting of amplitude, timebase, trigger functions and screen display position.

Buffered switching ensures that read-outs and indicators always show current status. Voltage/time cursors simplify direct amplitude and time measurements. Full LED/LCD indications show status at a glance. And on-screen read-outs provide full operator guidance.

### IEEE remote control option

Manual or remote control, via an IEEE remote control option, gives users the best of both worlds: flexible stand-alone operation, or programmable system-oriented applications.

### Portable and rugged

Easy portability, built-in ruggedness and a comprehensive range of purpose-built accessories are still more reasons why, after Philips' new VHF generation, you still have no choice in high-technology real-time scopes!

For full information about the new VHF generation from Philips, contact:  
Philips I & E, T & M Department,  
SYDNEY: Box 119, North Ryde 2113,  
Tel. (02) 888 82 22 or call free (008) 22 66 61  
MELBOURNE:  
Locked bag no. 5, Oakleigh South 3167,  
Tel. (03) 542 36 00 or call free (008) 33 52 95.

Philips new T & M Branches: Adelaide — Tel. (08) 363 0911  
Brisbane — Tel. (07) 44 0191



Test &  
Measurement

ETI READER SERVICE 104

PHILIPS



## FEATURE

tion, and to chase 2048 x 2048. If that could be translated into pixels on an LCD raster it would more than solve any imaging problems and extend bandwidth well into the gigahertz region.

### Digital oscilloscopes

Digital techniques have penetrated the oscilloscope market as everywhere else although it must be conceded, without the usual degree of success. It is still possible to get analogue CROs with incomparably better bandwidth performance than digital CROs at any given price, and there are no immediate signs of this improving. Notwithstanding this, modern digital design has resulted in some very fast digital CROs, if you can pay for them.

The problem is fundamental to the digital design. When a signal is read into the front end of a digital oscilloscope, it is first coupled and amplified in the normal fashion, and then fed to an analogue-to-digital converter (ADC). The ADC takes samples of the input waveform at a certain time interval, changes the voltage level of the signal into a digital word, (usually 8 bits long) and feeds it out into the rest of the machine where it can be subjected to all the advantages of digital circuitry. It can be stored, manipulated, displayed and so on, easily and cheaply.

The problem, however, is the speed at which the digitising process is done. This is set by the ADC, these days usually a fully integrated bit of circuitry. Common ADCs available in the shops have conversion speeds from a few milliseconds down to per-

haps a few microseconds and prices ranging from a few dollars up to perhaps \$20. In the extreme you can find ADCs with conversion speeds in the 20 ns range that will cost about \$130. To go much faster you need high quality industrial stuff, for which you may pay several hundreds of dollars.

In the extreme, the very best of ADCs will sample every few nanoseconds and cost hundreds of dollars. Now, to see how strong a constraint this is on oscilloscope performance, consider that typically, 40 or so sample positions are required to generate a convincing sine wave shape on the screen. This means a period of perhaps 80 to a hundred nanoseconds if the ADC can sample every 2 ns, or a frequency of 10 MHz.

This way of looking at digital CRO performance can generate a certain amount of confusion, however. Although the bandwidth is only 10 MHz in our example, the ability of the system to respond to transients is very much better than one would assume from this figure. In fact, it will respond to anything larger than the sampling period, say 2 ns or 500 MHz, and is likely to be limited by the amplifier or tube rather than the sampling. Of course, the displayed waveshape will have no necessary relationship to the waveshape on the inputs. All a single sample will allow you to infer is a spike. This all tends to mean that digital CROs are very good at looking at square waves, and indeed, this is where they find their major use.

There are a number of ways to improve the response of digital CROs to continuous waves. One method is to reduce the number

of samples and then to interpolate between points so that one generates a smooth wave on the screen. It has the advantage of making the wave look more like the input, hopefully, but at the cost of reducing the ability of the system to track transients.

In fact, some extremely sophisticated algorithms have been developed to allow curve fitting to extend the range of digital CROs. The latest Kikisuis, the 7000 series, use 20 ns ADCs, which should lead to a bandwidth of only 1.25 MHz if we use the 40 sample standard. However, the makers claim to be able to see single shot events up to 20 MHz and repetitive signals up to 100 MHz. The 20 MHz claim is close to the Nyquist frequency, and ensures that any voltage excursion will be detected in at least one sample. The 100 MHz limit is the result of continual correlation of the input signal over time; perfectly valid if the input is a sine wave.

The Hewlett Packard HP54201A/D takes samples continuously at 40 ns and then measures the phase relative to the trigger position. In this way the sample point is displayed at the correct point on the timebase. After sufficient repetitions, sufficient points will have been collected to make a sine wave. With this architecture, bandwidth is once again limited by amplifiers and displays, not the digitising process.

Another method is to increase the number of ADCs. The ADCs are connected in parallel, and made to sample the input one after the other. In theory, the only limitation on this is imposed by the speed of the system clock, and even this can be over-

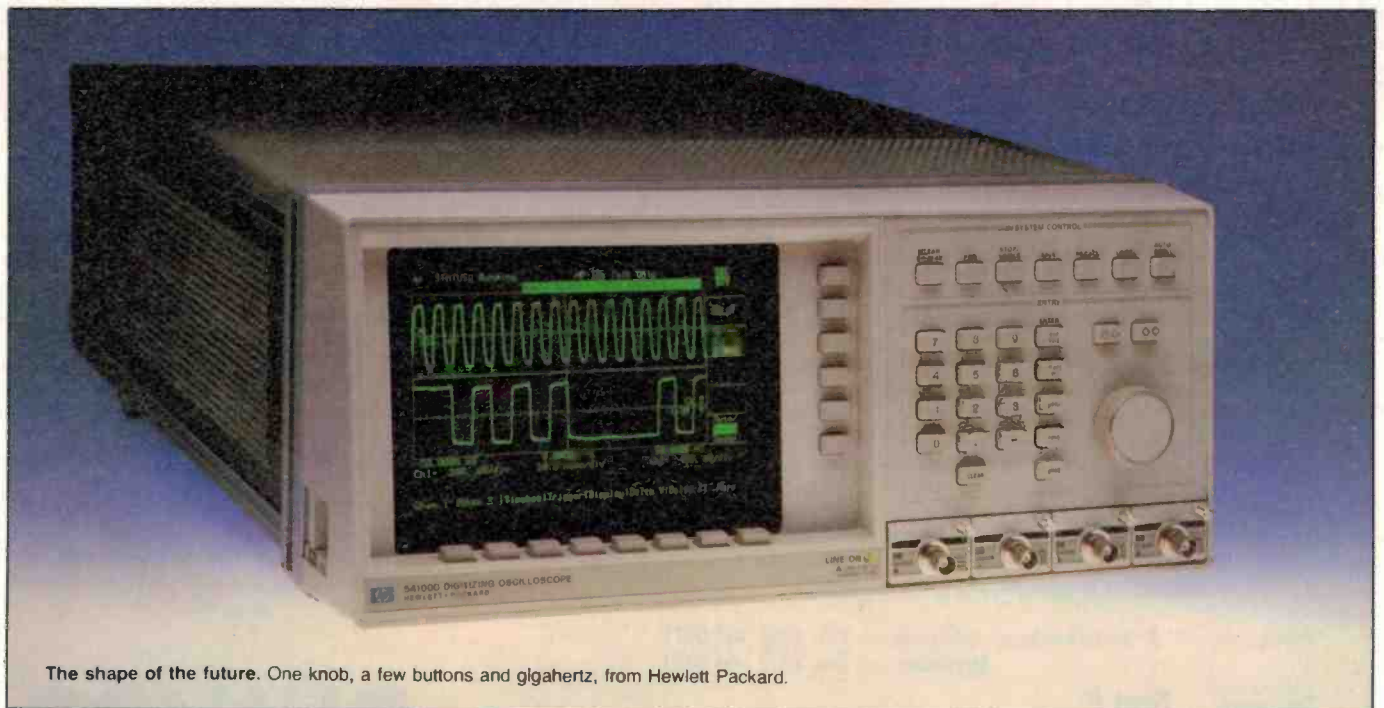

The shape of the future. One knob, a few buttons and gigahertz, from Hewlett Packard.



# Do you look for a standard HCMOS supplier or for the one that sets the standard?

Right now, we have a complete range of high-speed CMOS (HCMOS) logic IC's. And we have them in both DIL and in our space-saving SO-package, now a JEDEC world standard. For your HCMOS needs come to us, Philips Elcoma, the Australian source.

Plug our pin and function-compatible 74HCT IC's straight into your LSTTL sockets - often without redesign! LSTTL level compatibility with dramatically reduced power consumption. Without sacrificing system speed, and at the right price.

Using MOS already? Then look at our 74HCT for TTL-level CMOS and NMOS systems, or our 74HC for all-CMOS systems.

Or, design-in HCMOS and enjoy all of its benefits. Like freedom from latch-up and high

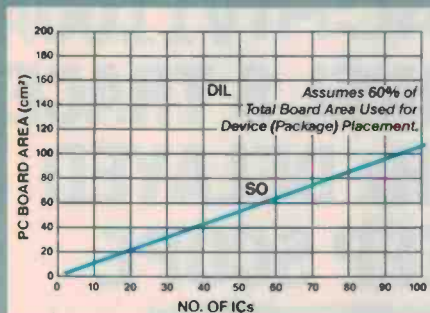
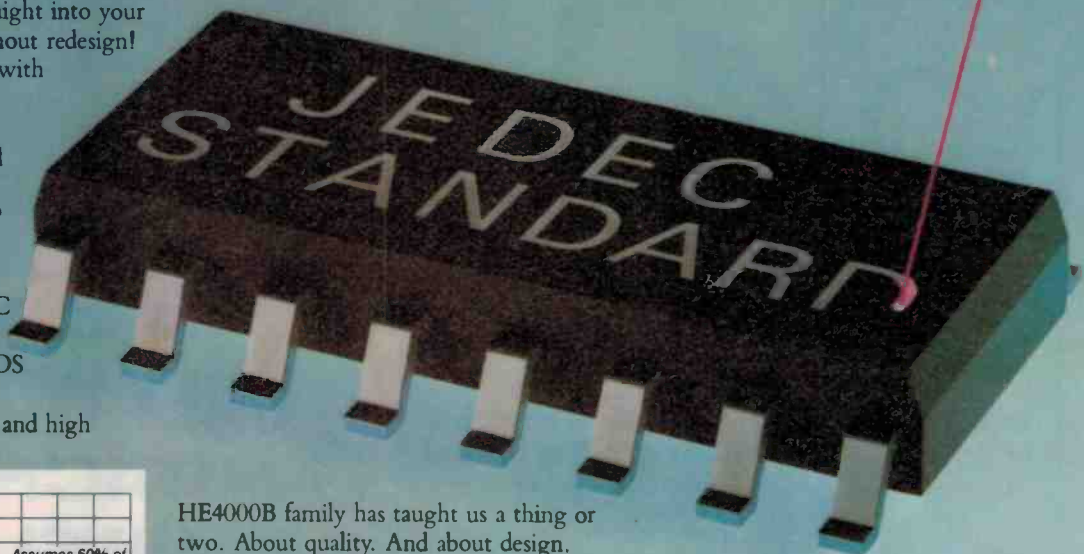

Save board space. Our SO-versions are up to 65% smaller than comparable DILs, and are up to 10 times lighter.

reliability (5 FITS). Noise immunity critical? Then think about 74HC.

Space and cost conscious? Then use SO-versions and benefit from Surface-Mounted Device (SMD) technology.

At Philips, we know about CMOS. Ten years as European leader with the

HE4000B family has taught us a thing or two. About quality. And about design. Our patented HCMOS input structure, for example, makes it possible for us to produce 74HC (CMOS input levels) or 74HCT (LSTTL input levels) with a single mask change. So the type range is available in both versions.

Need samples or data? Then call your nearest Philips Electronic Components and Materials office. We're ready with full technical support and documentation. Plus a User Guide, set to become the standard for designing with HCMOS.

**HCMOS**  
HIGH-SPEED LOGIC

The name is Philips  
The product is HCMOS

Philips Electronic Components  
and Materials  
11 Waltham Street,  
Artarmon, N.S.W. 2064  
Telex AA20165 AUSLCEC +

Sydney (02) 439 3322  
Melbourne (03) 542 3333  
Adelaide (08) 243 0155  
Perth (09) 277 4199  
Brisbane (07) 44 0191

the UN 279



Electronic  
Components  
and Materials

**PHILIPS**



# MICROPHONE OF THE MONTH

... A CLOSE LOOK AT ONE OF OUR 100



**SM5B**  
UNI-DYNAMIC



**SM83**  
OMNI-CONDENSER



**SM7**  
UNI-DYNAMIC



**SM82**  
LINE LEVEL CONDENSER



**SM91**  
HALF-CARDIOID CONDENSER



**SM81**  
UNI-CONDENSER



**SM87**  
SUPER-CARDIOID CONDENSER

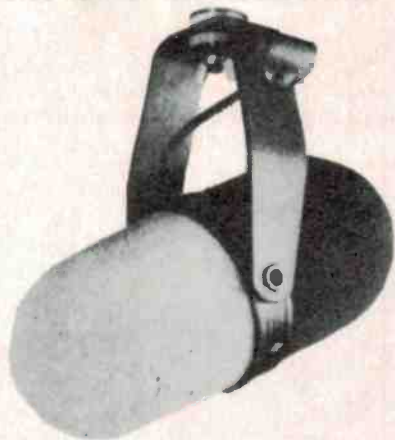

## SM5B

### Studio Cardioid Dynamic

**Gives you new freedom in maneuvering booms**

Specifically designed to provide maximum wind noise suppression during fast boom swings on television production and motion picture sound stages, or in outdoor locations. Highly effective layer of acoustically-transparent dense foam minimizes wind sounds while providing superb pickup of program material.

### Extremely "Forgiving"

An outstandingly uniform cardioid polar pattern—in all planes, and all frequencies—results in singular lack of off axis coloration, even at the low end. Gives the performer complete freedom of movement.

### Super Natural Sound

Smooth, wide range frequency response with a controlled presence rise makes it ideal for vocal pickup, scoring assignments, and accurate voice reproduction. (Radio D.J.'s love it.)

Humbucking coil, balanced circuit, and absence of transformers or response-correcting inductors suppress electrical noise due to hum fields. One of a kind... From Shure, of course.

Write:  
Audio Engineers P/L 342 Kent St.  
Sydney, 2000 (02) 29 6731  
Audio Engineers Qld. (07) 44 8947  
Marketec (WA) (09) 242 1119

Sound of the professionals

# SHURE®

# ALL YOU NEED TO KNOW IS ON SCREEN

Delay Setting 30 Char User Counter/ DVM Readout  
Comments

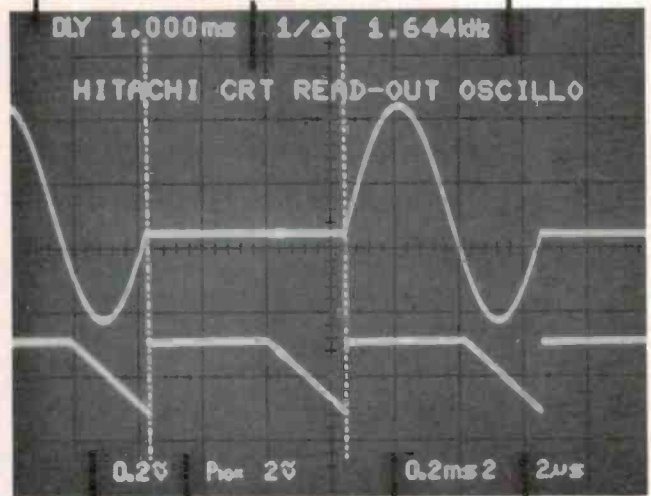

Ch 1 Vertical Input Probe Factors Ch 2 Vertical Input A Sweep Timebase B Sweep Timebase

## ONLY WITH THE HITACHI V1100A 4 CHANNEL 8 TRACE 100MHz DELAYED SWEEP SCOPE



- Built-in DVM and Counter
- Measures voltage and time differences and ratios between cursors and phase shifts
- Four independent channels
- User defined 30 character on-screen comments

Check the full spec and arrange a demonstration

# irh

COMPONENTS

## IRH COMPONENTS

SYDNEY: 32 Parramatta Road, Lidcombe 2141. Tel: (02) 648 5455  
TLX AA24949 FAX (02) 647 1545  
MELBOURNE: 74 Raglan Street, Preston 3072. Tel: (03) 484 5021  
TLX AA32422. FAX (03) 480 2772  
PERTH: 5/59 East Parade, East Perth 6000. Tel: (09) 325 9333



come by running several clocks at different phase angles. The LeCroy 9400 uses this method with 15 ADCs each sampling at 3 ns to give an effective time between samples of only 200 ps, equivalent to 5G samples/s. In such a situation it is possible to run into much the same sorts of problems that limit analogue CROs. In the case of the LeCroy, the three dB point is at 125 MHz and determined not by the sampling, but by either the preamplifier or the tube. But notice that in order to get this type of performance it's necessary to go to 15 ADCs, so that the

price of the ADC section probably adds considerably to the cost of the unit.

**Computers**

Another trend in modern digital oscilloscope design is to use the display and computing power of a small computer. In most cases this means developing a plug-in board for an IBM PC, or more likely, an IBM clone. At its simplest level, the board will contain the front end of a standard CRO, the preamps and ADCs, and probably a buffer, and then input this into the bus of

the computer for the manipulation required.

There are a number of spurs to this development. The most powerful is the good old bottom line; all things being equal it's cheaper, since half the CRO is already provided in the PC. The second is the wealth of manipulation software that can be provided very easily by the computer. It's no big problem to derive a numerical output giving voltages of various kinds, frequencies and period, spectrum analysis and so on.

It can also be interfaced very easily into ▶

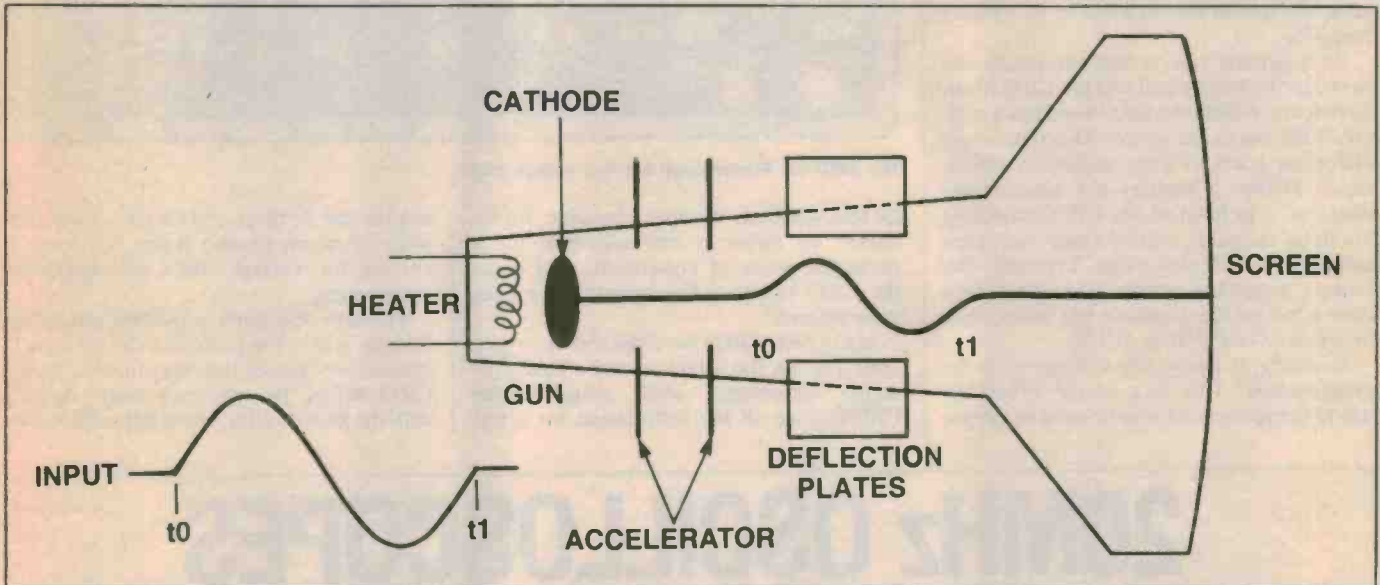
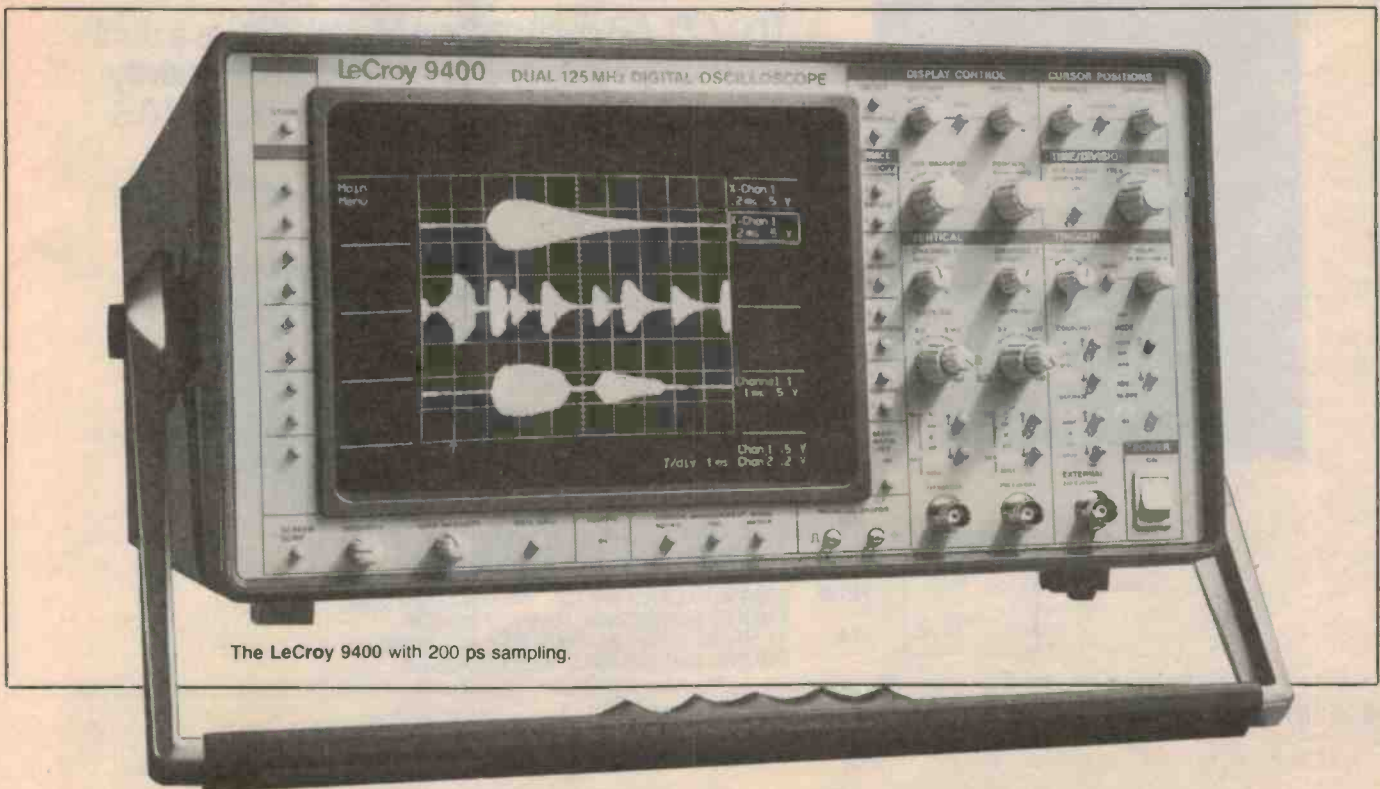

Figure 2. The path of an electron when its trip time through the deflection field is the same as the period of the input.





## FEATURE

the rest of a development system. This might contain all the normal development tools, logic analysers, in-circuit emulators and so on in addition to the oscilloscope, all contained in one box. In fact, many people see this as a logical extension of current technology. It becomes a one stop instrument, capable of making virtually any conceivable measurement.

### Composite CROs

The composite oscilloscope adopts the philosophy that while digital treatment of the signal path is difficult, the advantages of computerisation do not need to be entirely foregone.

As a general rule, a microprocessor sits between the front panel and the CRO itself, so that controlling the CRO becomes a matter of talking to the micro. This type of architecture leads to some important advantages. Firstly, it matters not whether the operator is in front of the CRO, twiddling knobs on the panel, or half a mile away connected into a telephone line. Typically, this remote control function is implemented over some of the standard test instrument interfaces like GPIB or IEEE.

Secondly, it allows the instrument to be programmed. This is a major advantage where the instrument is to be used in a regu-



The BWD 881 Powerscope II, a high voltage scope.

lar test situation. It is quite possible, for instance, to define a test sequence for a particular piece of equipment, and make the CRO set itself appropriately for each measurement.

Many such CROs have the ability to generate text on the screen as well. This gives added advantages with programmable CROs, since all the instructions for a test

routine can be displayed on the screen. Another common feature is the provision of cursors for voltage, time and triggering information.

Probably the most important advantage though, is that the processor can be used to intelligently preset the adjustments on the CRO before the operator starts fiddling with the knobs. Thus, when the oscilloscope

# 20MHz OSCILLOSCOPES

## With Component Tester



The APLAB oscilloscope Model 3132 is a dual trace 20 MHz scope with minimum sensitivity of 2mV/div and minimum sweep speed of 0.5 us/div.

Triggering modes include TV line or TV frame sync.

### Other features include:

- Built in triple DC source  
+5V +12V  $\pm$  12V
- Dual component tester  
comparator.



### SCIENTIFIC DEVICES AUSTRALIA PTY. LTD.

VIC. 2 JACKS RD., SOUTH OAKLEIGH. 3167  
PHONE: (03) 579 3622 TELEX: AA32742  
NSW: 559A WILLOUGHBY RD., WILLOUGHBY 2068  
PHONE: (02) 95 2064 TELEX: AA22978  
S.A. 31 HALSEY RD., ELIZABETH EAST. 5112  
PHONE: (08) 255 6575 TELEX: AA88125



# Now Kikusui puts great features and high reliability within the scope of your budget...

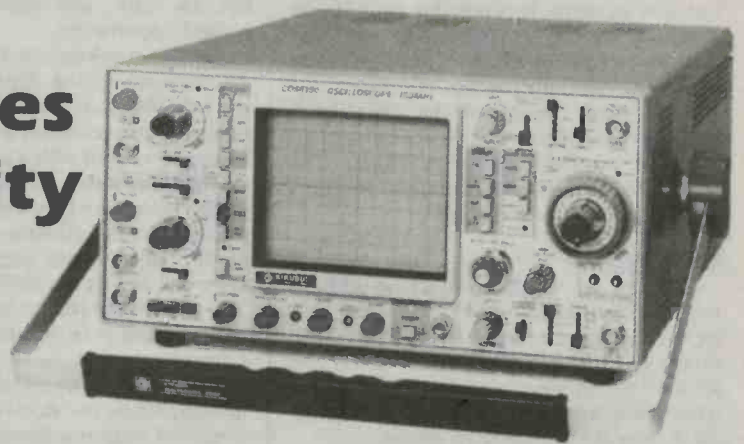

Model COS-6150

KIKUSUI'S 2 year warranty is a sign of the quality and reliability you can expect from either the professional 6000 series or the low cost, compact 5000 series oscilloscopes.

Our 6000 series 150MHz and 100MHz scopes give you 3 vertical channels – not just 2 – plus two simultaneous trigger views. And with peak-to-peak level-lock triggering there's no need to reset the trigger between measurements. KIKUSUI

also give you multiple X-Y modes for phase measurements, patented linear auto focus to maintain bright signal traces, and 2 nanosecond resolution on the timebase.

Our 3 channel 5000 series scopes offer eight traces (including a trigger view) and vertical triggering, to display asynchronous signals simultaneously; ideal for comparing 'good' and 'bad' signals from different units, when trouble shooting. All 5000

series scopes provide level-lock triggering and variable hold-off, so you can stabilize complex or aperiodic signals in digital or video circuits. With the addition of DC trigger coupling, even very slowly varying waveforms can be triggered with ease.

As you would expect, all KIKUSUI scopes come complete with a detailed user/service manual, 2 high quality probes and BNC to 4mm adaptors.

## PROFESSIONAL COS-6000 SERIES with 5 channels

COS-6150	150MHz, 5 Channels, 2nS/div, delay	\$4010
COS-6100A	100MHz, 5 Channels, 2nS/div, delay	\$3764

## COMPACT COS-5000 SERIES

COS-5100	100MHz, 3 Channels, 2nS/div, delay	\$3225
COS-5060A	60MHz, 3 Channels, 5nS/div, delay	\$2271
COS-5042	40MHz, 3 Channels, 5nS/div, delay	\$1645
COS-5041	40MHz, 2 Channels, 20nS/div, delay	\$1395
COS-5020	20MHz, 2 Channels, 20nS/div	\$629

- Price includes 2 quality probes with each unit. Warranty is 2 years.
- ADD sales tax to prices if applicable. Prices subject to exchange variation.

*We're not riding  
on a reputation.  
We're making one.*



## EMONA INSTRUMENTS

DIVISION OF EMONA ENTERPRISES PTY LTD

1st Floor 720 George Street  
Sydney, 2000.  
Phone: (02) 212 4599

### DISTRIBUTORS

NSW: Davred Electronics, Sydney, Phone: 267 1385 Geoff Wood Electronics Pty Ltd, Rozelle, Phone: 810 6845 Martin De Launay (Newcastle) Pty Ltd, Phone: 52 8066	VIC: Radio Parts Group, Melbourne, Phone: 329 7888 OLD: Baltec Systems Pty Ltd, Brisbane, Phone: 369 5900 Nortek (Townsville), Phone: 79 8600	SA: Int'l Communication Systems, Port Adelaide, Phone: 47 3688 Anitech (Adelaide) Pty Ltd, Phone: 356 7333
WA: Hinc Engineering Pty Ltd, Perth, Phone: 381 4477	ACT: Electronic Components Pty Ltd, Fyshwick, Phone: 80 4654	TAS: George Harvey Electrical, Hobart, Phone: 34 2233 Launceston, Phone: 31 6533



## FEATURE

receives an input, it is possible to have the processor set appropriately on time/div and volts/div so that something is displayed even before the operator touches anything.

Interestingly, many of the operational features of composite CROs are being reintroduced on fully digital machines. The HP54110D reduces all its functions to a keypad and single rotary knob.

### Storage

Probably one of the most useful add-ons to the conventional oscilloscope is the ability to store waveforms after they have been received on the input sockets. It comes into its own where signals occur only once, or where they occur so slowly that a meaningful display is impossible to obtain.

The two different types are, as might be expected, analogue and digital. Digital storage CROs develop naturally out of the types of digital techniques we have already discussed. Digital storage is achieved by the addition of some memory between the ADC and the tube. The storage imposes no special constraints on the design of the CRO, indeed, it follows naturally from its digital architecture to such an extent that digital oscilloscopes without storage facilities

are rare, and certainly represent a wasted opportunity.

Analogue storage, on the other hand, is a lot more interesting. Storage is achieved in the tube itself, and depends on special techniques of tube construction. A metal mesh, especially coated with a deposit of highly insulating secondary emission material, is placed immediately behind the screen. During display, the electron beam strikes part of the mesh. These parts emit secondary electrons and so are left positively charged. Thus, forms the pattern of charged particles on the mesh from a replica of the original screen pattern.

To re-display the information the mesh is illuminated by two flood guns. These send a stream of electrons down the tube, spraying all parts of the screen equally. Electrons are accelerated by the positively charged parts of the mesh on to the screen. The negatively charged parts of the mesh form an effective barrier to the flood guns, thus preventing them from getting to the screen.

The advantage of this method as with all analogue oscilloscopes is that it's fast. It also has the ability to capture as many waveforms as can be displayed on the screen. A digital CRO on the other hand, needs to

have special sections of memory defined to store a single waveform; often with a trade off between resolution and the number of waveforms stored.

On the other hand, the advantage of digital storage, and it's often a decisive advantage, is that it will store waveforms indefinitely. The charge on the mesh of an analogue CRO dissipates rather rapidly, and will generally disappear within an hour or so. Furthermore, it's easy to interface a digital CRO to mass storage of some type so that huge amounts of storage space become available for later display on the CRO or even for display on a computer screen.

As with ordinary CROs the cost of storage oscilloscopes is closely related to speed. At low levels the difference is not significant, and it seems that the extra cost imposed by the special tube of an analogue scope is matched by the extra cost of ADC and memory in a digital one. However, as speed increases, the problems inherent in ADCs start to assert themselves and prices rise far more quickly for digital oscilloscopes than their analogue equivalents.

*Special thanks to Philips, Hewlett Packard and Tektronix for information on oscilloscope theory used in preparing this article.●*

# TECNICO NEWS

"With over 40 major electronics component and instrumentation brands available through Tecnico in Australia there is a great deal of news. Each and every month, Tecnico will let electronics people know what's new in our comprehensive range.

Naturally, our staff can advise you on the best component for the job you have in mind. If you would like more information on any subject, fill in the coupon below:"

Please send me more information on:

Add my name to your mailing list for a copy of "Technicalities"

Name \_\_\_\_\_

Title \_\_\_\_\_

Organisation \_\_\_\_\_

Address \_\_\_\_\_

\_\_\_\_\_ Pcd \_\_\_\_\_ Phone \_\_\_\_\_

To: **Tecnico Electronics, 11 Waltham Street,  
Artarmon, N.S.W. 2064.**



**TECNICO ELECTRONICS**  
For electronic components & instrumentation.

## Rustrak...

### a 30 year track record

RUSTRAK miniature, pressure writing, trend recorders operate unattended for a month or more without changing paper. And that's only one of their features:

- Inkless, dry writing
- Operating mode easily changed from chart to roll
- Sliding access window permits operator to make notations on chart

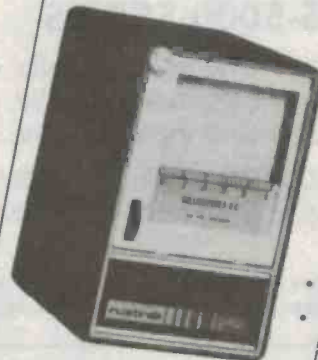

- Units are compact and lightweight
- In roll mode, chart may be unrolled for inspection and rolled quickly without loss of time accuracy during operation
- Clock work accurate chart drive
- Interchangeable gear trains permit a wide variety of chart speeds for each recorder within seconds
- Response times less than 1 second full scale
- Thumbwheel permits precise setting of timing lines on chart paper
- Rugged die-cast case

**SYDNEY 439 2200 MELBOURNE 542 3260**

**TECNICO ELECTRONICS**  
For electronic components & instrumentation.



# Be part of Today!

When we analyse the recent past and project the immediate future, computers and communications technologies play a vital part, but we must avoid the tendency to look only to the hardware level. The fact that technologists have appropriated words like 'communications', 'information' and 'data' and given them electronic rather than social meanings, should not disguise the fact that in the final analysis, communications involves people and ideas, not electronic bit and bytes.

People and Ideas . . . that's the side of Australia's Communications Revolution we tell about in this informal look at today's world of computers and telecommunications.

At your Newsagent now!

Or simply send \$4.95 plus \$1.00 post and packing to —  
Federal Marketing Book Sales, P.O. Box 227, Waterloo  
2017 NSW.



## 353 different ways to grab a hold

The HCK high quality, low cost range of test accessories is now available in Australia from Technico. You can hook, clamp, probe and connect with an amazing variety to allow you to test in complete safety. A full range of connecting leads and cables in PVC, TEFLON or SILICONISED rubber completes the picture. Get details and a data sheet by phoning your nearest Technico office today.



SYDNEY 439 2200 MELBOURNE 542 3260  
**TECNICO ELECTRONICS**  
For electronic components & instrumentation.

## Top-line filters for clean lines

When you need a filtered inlet for business machines, micro-computers, medical or test equipment then Technico have all the protection your circuitry will need with Belling-Lee filters. These compact, snap-in filters put a stop to mains borne interference, one even having a line fuse and double pole switch. There's much more in our comprehensive range.

**Belling-Lee Filters...  
there's simply  
no substitute.**



SYDNEY 439 2200 MELBOURNE 542 3260  
**TECNICO ELECTRONICS**  
For electronic components & instrumentation.

## ADVERTISERS' INDEX

Advanced Recruitment .....	25
Associated Controls .....	35
Audio Engineers .....	16
Bell IRH .....	16
Cooper Tools .....	IFC
Crusader Electronics .....	72
Daneva .....	27
Disco World .....	24
ETI books .....	88,89,90,91
Elmeasco .....	94
Emona .....	19
Energy Control .....	22
Fletcher Jones .....	97
Geoff Wood Electronics .....	26
Hewlett-Packard .....	6, 7
Jaycar .....	57, 66
L. M. Ericsson .....	40
Microbee Systems .....	74
Parameters .....	8
Pennywise Peripherals .....	92
Philips Components & Material .....	15
Philips Test & Measurement .....	13
Prepak Electronics .....	42
Rod Irving Electronics .....	28,29,45,48,49, 65
Rose Music .....	OBC
Scan Audio .....	38
Scientific Devices .....	18
Siemens Ltd .....	IBC
Tecnico .....	20, 21
Truscott Electronics .....	63
Subscriptions offer .....	86,87
Visionhire .....	81
VSI .....	55
Westinghouse .....	53

# WOW! IT'S HERE



**ASK FOR YOUR COPY TODAY \$3.95**

AN ELECTRONICS TODAY PUBLICATION

## Circuits COOKBOOK #5

**A BUMPER ISSUE  
PACKED WITH CIRCUITS  
AND IDEAS FOR THE  
ENGINEER TECHNICIAN  
& HOBBY ENTHUSIAST**

**COMPUTERS + AUDIO + RF  
ELECTRONIC MUSIC & MORE**

ALSO AVAILABLE BY MAIL ORDER  
\$3.95 plus \$1 postage

FEDERAL MARKETING  
P.O. BOX 227  
WATERLOO, N.S.W. 2017



Rockwell

**65XXX — 68000  
SAVE \$\$\$\$**

6500 SERIES	DISPLAY CONTROLLERS
R6502P .....	8.50
R6502AP .....	9.28
R6503AP .....	7.24
R6504AP .....	7.24
R6505AP .....	7.24
R6507AP .....	7.24
R6511Q .....	21.26
R6511AQ .....	23.28
R6520P .....	5.19
R6520AP .....	5.98
R6522P .....	6.77
R6522AP .....	7.55
R6532P .....	9.44
R6532AP .....	10.39
R6541Q .....	19.17
R6541AQ .....	21.09
R6545-1P .....	9.13
R6545-1AP .....	10.70
R6545AP .....	12.27
R6549P .....	60.58
R6551P .....	9.91
R6551AP .....	10.70
R6500C10 .....	11.02
10951P-50 .....	11.02
10938P .....	9.44
10939P .....	9.44
10941P .....	9.44
10942P .....	9.44
10943P .....	9.44
<b>16 BIT 68000 SERIES I.C.'s</b>	
R6800C10 .....	69.24
R6800Q10 .....	33.04
R68465P .....	16.52
R68C552P .....	27.07
R68561P .....	58.22
R68802P .....	61.37
<b>MEMORY I.C.'s</b>	
2114 .....	1.35
4116 .....	2.65
4164 .....	1.35
41256 .....	6.67
8116 .....	7.18
6264 .....	20.26
2716 .....	4.81
2732 .....	PDA
2764 .....	3.18
27128 .....	5.75
<b>CRYSTALS</b>	
32.768 KHz-C MOS	
Calendar .....	1.96
1.8432MHz .....	3.08
2.000MHz .....	3.08
2.4576MHz .....	1.96
3.6864MHz .....	1.96
4.000MHz .....	1.96
4.9152MHz .....	2.80
8.000MHz .....	1.96
12.000MHz .....	1.96
Quip Socket for R6511Q, R6800Q, R65F12, Modem I.C. ....	3.12
<b>HIGH LEVEL LANGUAGE CIRCUITS</b>	
R65F11P .....	32.42
R65F11AP .....	35.72
R65F12Q .....	42.33
R65F12AQ .....	46.58
R65FR1P .....	97.25
R65RT2P .....	97.25
R65FR3P .....	97.25
R65FK2P .....	10.70
<b>PROTOTYPING CIRCUITS — Emulators for Mask Programmable I.C.'s</b>	
R6500/1EAB3 .....	69.24
R65/11EB2 .....	62.94
R65/11EAB .....	69.24
R65/41EAB .....	69.24
<b>MODEMS</b>	
R1212M .....	358.05
R1212DS .....	267.51
R2424M .....	590.22
R2424DS .....	361.93

Please include \$6.50 for packaging and freight

All prices include sales tax

Prices subject to alteration without notification

**energy  
CONTROL**

73 Eric Street, Goodna Q 4300  
P.O. Box 6502, Goodna Q 4300  
Telephone (07) 288 2455  
Telex AA43778 ENECON



# BEHIND THE GLITTER

## — Winter CES Part 2

Behind the daunting displays of the latest hi-fi and computers lie some murky issues of policy, marketing and making the dollar. Louis Challis found that the new goods often meant old problems.

### Louis Challis

IN THE FIRST section of my Las Vegas CES report I highlighted some of the more eye-catching aspects of the show. There were also, however, so many other features of the CES that were aimed at the subliminal, intriguing the deeper thinking members of the technical and commercial world, who took the time and trouble to go to Las Vegas. This particular article attempts to examine many of these.

Probably the most serious issue raised by the Winter CES was the problem of copyright and software infringement in the USA. On the 9th January a 12-member congressional delegation, which was invited to CES for that specific concern, served as panelists in two special sessions. The first of those sessions was devoted to examining the legal implications of copyright issues and the second session examined the implications of copyright infringement in the domain of international trade.

As the largest and most auspicious congressional delegation to attend CES, the Congressmen and Senators had the opportunity to see first hand the state of the art in terms of audio, video and computer products whilst simultaneously being asked to state their position in the continuing US battle of audio royalty taxes.

Moves have been afoot in the US for some years now to tax all purchases of magnetic tape in its different formats (particularly compact audio and video cassettes) at the point of sale. The intent of that scheme is to collect a large purse of money which would then be shared amongst the producers of software (particularly the entertainers) to reimburse them (in part) for the loss of royalties resulting from illegal copying of programs.

But a little thought soon reveals the problems with such a proposal. It would be almost impossible to equitably distribute the

royalties in such a way as to recompense those people who suffer the greatest losses from pirating. This is because there really is no rational, sensible or legitimate way through which anyone could decide to whom and in what way, let alone where, such payments should be made.

What would most likely result from the scheme, would be a large top-heavy bureaucratic system capable of absorbing most of the money allocated to this purpose in paying members' salaries. What little money left after creating this new 'monster' might ultimately find its way to the wrong people. Recognition of these factors and the inequity of the current proposals has deterred the US government and the courts from jumping the veritable frying pan into the fire.

Both the recording industry staff as well as hardware manufacturers realise what dangers they face in any new meddling by the bureaucracy into the unregulated domain that they have so nicely carved up for themselves. They are really loath to propose any new system which does not positively protect their long term interests. The result of this present reticence on both sides

is something of a stalemate. Neither side in this Mexican standoff wishes to be the first to pull the trigger.

While the verbal arguments progress, both sides are lobbying strongly in Washington DC for change without really identifying the scope of such changes. In the meantime, the hardware manufacturers are producing millions of portable CD players which incorporate compact cassette players to simplify the task of copying CD discs straight on to tape. The third generation of double compact cassette players has been released, designed for both high speed and normal speed copying of compact cassettes. Last, but not least, the latest generation of hi-fi video recorders is now on the market and although ostensibly for hired software, the sales blurbs stress their ability to copy programmes straight off the inbuilt TV tuner or an associated video recorder.

The ironies of this peculiar situation are not lost on the market place where piracy has now tended to become the rule. Sales of conventional microgroove records in the US have dropped to an almost all time low and although sales of CDs are booming, this is primarily because of the 'new buyer' demands associated with new CD players. People are still digesting nearly all the discs that can be produced but this situation may well change dramatically because of piracy associated with the new hi-fi video (audio) recorders, video PCM recorders (like the latest Super 8 Sony unit) and the soon to be released digital audio recorders.

In Australia, plans for the first CD pro-



Milling about in Las Vegas





# Disco World Pty. Ltd.

## Showrooms:

300 Main Street, Lilydale  
 P.O. Box 509, Lilydale, 3140  
 Melb. Vic. (03) 735-0588  
 673 High Street, Preston  
 (03) 470 5822

**AMPLIFIERS**  
 ZPE Series II (600W) \$1950.00

**DISCO MIXERS**  
 Citronic SM 350 \$785.00  
 Arista with equaliser \$350.00

**JUMBO STROBE** \$179.19  
 Scanner \$120.45

**HELICOPTER**  
 2 ARM Spinner \$238.00  
 4 ARM Spinner \$395.28  
 6 ARM Spinner \$452.00  
 UFO Spinner \$1698.55



**PINSPOT**  
 Par 36 \$52.75  
 Par 46 \$70.79



**MIRROR BALLS**  
 MB 008-8" \$44.64  
 MB 012 \$77.49  
 MB 014 \$112.25  
 MB 018 \$112.25  
 MB 020 \$181.10

**SMOKE MACHINES**  
 Great for Special Effects  
 Hand Held 240V \$352.00

Dynamite Smoke Machine  
 Has remote control lead to operate off-stage. We are so excited about this that full money back guarantee will be valid for 10 days from purchase date  
 Our own product \$1800.00  
 Fluid—1 litre \$15.00

**MIRROR BALL MOTORS**  
 AC 240V \$35.50  
 Heavy Duty \$93.20

**ROLLING LIGHTS**  
 8 x 415 lamps \$1450.00

**AUDIO CHASER**  
 (DW4LC4000) \$295.00  
 Musicolour and chaser all in one!  
 Our own product

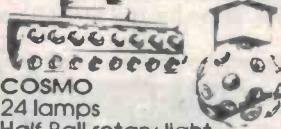

**COSMO**  
 24 lamps \$1990.00  
 Half Ball rotary light  
 6 lamps \$428.74

**LAMPS all colours, so cheap!**  
 No Warranty on Breakages  
 ES 240V 60W box of 25 \$75.00  
 BC 240V 40W box of 100 \$77.00  
 BC 240V 25W box of 100 \$75.00

Prices subject to change without notice. Items for hire or sale.  
 Power Cords not included. Trade Enquiries Welcome. Send S.A.E. with 60 cents postage for free price list.  
 Cut this out for 10% discount and post to us with your order and money.  
 Valid till 31/5/86.

ETI READER SERVICE 113

duction facility are now on the drawing board and we can expect that the Australian situation will soon mirror the American one. The Australian government has announced plans to modify the Copyright Act to provide maximum fines of \$250,000 for companies involved in film and record piracy. This amended legislation does not resolve the associated problems of home piracy.

## Hype

Nowhere was the impact of the CD player more evident at Las Vegas than on the stands of speaker manufacturers and to a lesser extent those of the amplifier manufacturers. One of the most important commercial aspects of what makes the CD player such a bonanza for the audio retailer is that it practically forces consumers to upgrade other parts of their stereo system. Speaker manufacturers are generally a very 'crafty' breed, they were amongst the first to use terms like "digital ready" and "CD compatible". These terms have little by way of factual meaning but that's no reason not to 'psyche' the consumer into believing so.

Cerwin Vega and Bose were amongst the latest American manufacturers to build their advertising campaigns around CD discs. The copy that they use is simple, direct and very effective. It explains that digital recordings create new demands on speakers and, as you might well guess, Cerwin Vega has discovered a "brand new technology" designed "specifically for digital audio". They are simultaneously heavily promoting the concept of "vertical line array" which places the mid range drivers in a vertical line with the tweeter and which they claim creates "symmetrical sound waves" and "wider dispersion".

Bose and Cerwin Vega devote less attention to the specifics than they do to the generalities of getting the most out of the CD. Now that the CD has become a mass market device, they have a whole new generation of potential speaker buyers to whom they can sell. Considering the way that CD players are now being sold in America, there is a strong chance that the salesman doesn't have time to tell buyers what kind of quality speakers or technical requirements are demanded by their new systems. As a consequence, ads have been prepared for hi-fi magazines, and even audio retail outlets' display boards stressing the new "digital ready" tag.

Cerwin Vega, Bose and many other manufacturers in the US are stressing the concept of "sound dispersion" while firms like JBL and Altrad Lansing are stressing the professional side of their sound equipment particularly the live concert end, where they have made such remarkable advances over the last few years.

Virtually all of the speaker manufacturers at the CES were stressing the need to up-

grade speakers to match the potential of the expanding dynamic range recorded on the new software. This was being stressed for car systems, as well as for home systems. These claims have recently been confirmed by the majority of those audiophiles whose speakers were designed and purchased in the halcyon days of microgroove recordings. Many of the less fortunate members of our society who purchased miniscule bookcase speakers which generally have pitifully little acoustical output below 100 Hz, have now found that they are generally incapable of reproducing programme content the dynamic range of which exceeds 50 or 60 decibels. When these speakers are faced with 80 or 90 decibels of dynamic range, terrible things often seem to happen inside these little 'shoe boxes'. Over the last two years, I have both seen and heard many stories of otherwise excellent speakers which have suffered an early demise under the awesome influence of CD players coupled to powerful amplifiers. It seems that many of these system owners have been beguiled into attempting to play the music at levels they believed appropriate. Obviously, these 'peccadillos' have created a significant market for new speakers.

The salesmen in the retail outlets both here and overseas have been quick to respond with advice on "more appropriate digital ready" speakers. But their perceptions of the way in which those speakers ought to perform are somewhat different from mine. It was my observation that the majority of salesmen and manufacturers, who used terms like "CD compatible" or "digital ready" to describe their wares, are all too often offering the very products you should most avoid.

The fundamental problem associated with a critical appraisal of the testing and specification requirements of loudspeaker systems for use with CD players was addressed by a number of papers presented at the CES. It is also an issue which many of the best known American hi-fi magazines are now taking up in their editorial pages. Although they have acknowledged the problem, the test procedures that they are using for speaker reviews have not yet stressed the need for appropriate safeguards to ensure the longevity of the speakers being tested. During discussions with four of the best known American hi-fi reviewers, they mentioned their intent to change this situation.

The International Electro-Technical Commission working group TC29 dealt with this problem back in 1979. That was well in advance of the release of CD players. The basic problem is, however, that neither Japanese, European nor American manufacturers have yet accepted those standards as the appropriate procedure for rating the power handling capacity of speakers intended for the consumer market.



## New disks

On a different tack, I saw very few releases of new magnetic materials at the CES. One notable exception was a new line of the micro disks being shown for the first time by TDK. Whilst you may well be aware of the 3.5" micro-floppies, it is unlikely that you will be aware of the new micro-miniature floppies that TDK has developed for potential audio, video and computer based applications. These particular floppy disks are only slightly larger than a 50 cent coin and use a new range of rare earth magnetic materials for the coated surface. They have been specifically designed to provide information densities substantially greater than those provided by the latest generation of Video 8 cassette recorders, which I thought were already state of the art in that respect.

Although I attempted to obtain more information from the TDK representatives at the show as to who the potential purchasers and users of these 'micro-floppies' might be, they were holding their cards very close to their chests. Judicious questions asked at the nearby 3M stand elicited that these particular floppies have been specifically developed to meet the requirements for a

new range of personal video products including still cameras and micro-miniature personal computers.

3M, as it happens, was releasing a brand new range of improved video tapes, as well as an exciting new range of professional and consumer colour films to directly compete with Kodak. Having evaluated samples of that film, I am now in a position to vouch for its quality and versatility.

## Computers

One area of the CES which I did not expect to see was the influx of computer peripherals, such as printers, laser writers and memory devices, and unusual computer developments which were being displayed at the show.

All of the major Japanese manufacturers appeared to be there, and most of them were displaying the next generation of low cost computer compatible printers with prices that were astoundingly low. Matsushita (National), Brother, Silver Reed, Sanyo and Epson were all displaying new printers many of which had exciting features and all of which claimed improvements in reliability when compared with the previous generation. Prices were as low as \$US299 with parallel interface capabilities, optional

memory cards, spell check capabilities, and many other features that only used to be found in printers at three times the price.

Small printers and plotters with multi-colour capability were there in large numbers and at selling prices well within the budget of the amateur user.

## Best buys

The last noteworthy feature of the Las Vegas CES was the amount of audio and video software that was being sold over the counter to the attendees at below wholesale prices. Obviously, the companies concerned considered that this was a good way to make sure that their products end up either in shops or homes of the most influential members of the marketing world. The result of this approach was, needless to say, remarkably successful with crowds vying to buy the latest software at less than one-third of the normal retail price.

The Winter Consumer Electronics Show at Las Vegas has many parallels with an American election campaign in terms of venue, style and political overtones. Although we are proud of our electronics shows in Australia, they are in no way comparable to the CES where the latest and greatest are on display for all to see. ●

# ELECTRONICS OPPORTUNITIES TODAY

Advanced Technology Recruiters has specialised in recruitment in the Electronics Industry for the last eight years. Our consultants all have considerable experience in different disciplines within the tremendous growth area of high-technology.

These vacancies are only four of the varied and interesting jobs we have available.

## ELECTRONICS ENGINEERS

Designing microprocessor based communications equipment used by a large international information provider. Hardware design skills are a necessity, this is a great opportunity for someone seeking to broaden their responsibilities.

## TEAM LEADER

This Australian company has developed several world-firsts in an exciting and unusual applications area and has many other leading-edge projects to be taken to completion. The ability to lead several teams in both micro and mini hardware design is a necessity.

## SERVICE TECHNICIANS

If you are a good diagnostician and enjoy field service in minis and peripherals then we have a great Australian third party maintenance company eager to meet you.

## PROJECT ENGINEERS

Today's buildings are being filled with silicon! Building Management Systems now control and monitor facilities such as air-conditioning, fire protection, lift controllers, security and access. Designing systems to cope with these disparate demands requires engineers who can integrate their thinking as well as several hundred micros.

If you are keen to pursue these or any other career opportunities please give **Mike Avey** a call on 238 2146 for more information or a confidential discussion.

Alternatively, send your resume to **Advanced Technology Recruiters Pty Ltd**, Level 66, MLC Centre, Sydney, NSW 2000. Total confidentiality is assured.

**ADVANCED TECHNOLOGY  
RECRUITERS**

# GEOFF'S MOVED!

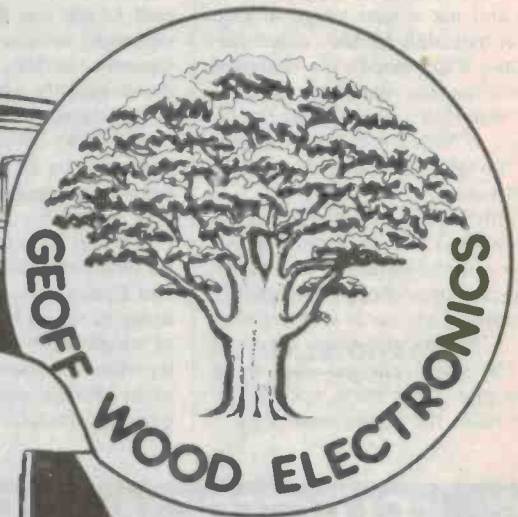
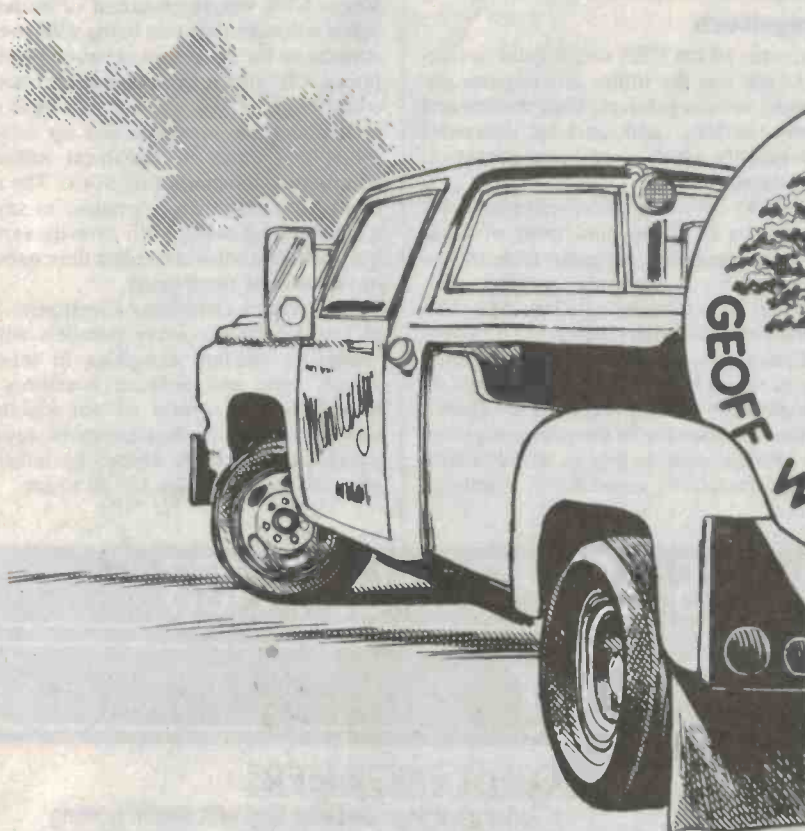

**Don't forget  
Wood for  
Chips!**

- **LARGER PREMISES**
- **BIGGER STOCKS**
- **EVEN BETTER SERVICE**

**GEOFF WOOD ELECTRONICS P/L**  
229 BURNS BAY ROAD  
LANE COVE 2066

TEL: **427 1676**

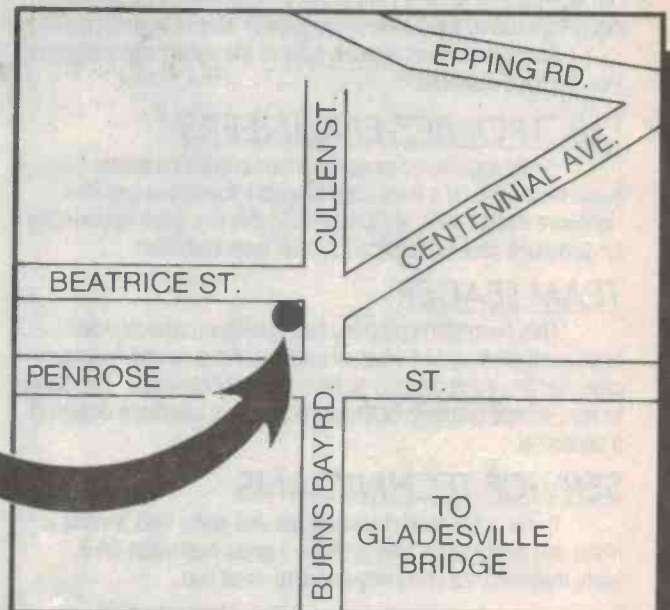



# at the leading edge

**100 MBYTE OPTICAL DISK DRIVE MAKES AUSTRALIAN DEBUT**  
US manufacturer, ISI, has commenced shipments of its model 525 IBM-PC compatible Write-Once/Read-Mostly drive. Supplied as a user installable kit the 525 is designed as a rapid access (100 msec) archiving and distribution medium for backing up hard disk drives as well as an Online Direct-Access storage for local and distributed databases. The removable cartridge will withstand electromagnetic fields, heat, light and even scratching offering a data integrity exceeding that of the Winchester drive it is designed to back up.

## **PRIAM CLUSTER TOWER SERVES UP TO 8 IBM PC COMPATIBLES**

Designed as a starter for those nearly at the stage of purchasing a local area network, but confused by the array of options, the Cluster Tower provides immediate shared storage up to 292 Mbyte and dual, concurrent printer support. At the same time it is designed to suit any DOS compatible LAN purchased in the future.

## **PRIAM RELAUNCHES ITS 14 inch DRIVE SERIES.**

Following an upsurge in demand for their 6650-10 Winchesters, with SMART, SMD or Priam interface, predictions indicate a record year for the line. Users are citing years of reliable service for the pioneer design a feat some users are claiming is not matched by more recent introductions. Daneva is preparing to restock the old trouper and would like to hear from Australian vendors needing support.

## **WHEN YOUR OUTA SPACE, INNER-SPACE FROM PRIAM**

Priam's Inner Space series offers high performance high capacity drives for the IBM-AT, XT and PC. The drives, which come complete with cables, software and mounting slides for slipping into the slots in the AT, are user installable and are available in formatted capacities of 42.7 and 59.8 Mbyte.

IBM-PC XT is the registered trade mark of International Business Machines.



daneva australia Pty Ltd

ETI READER SERVICE 115

66 Bay Rd. Sandringham, Vic. 3191  
P.O. Box 114, Sandringham, Vic. 3191  
Telephone: 598-5622 Telex: AA34439  
Suite 28, 47 Falcon Street  
Crows Nest, NSW 2065  
Telephone: 957-2464, Telex: AA20801

Distributors

Adelaide: DC Electronics (08) 223-6946  
Brisbane: Ballec (07) 369-5900

DAN006



# FLOPPY DISKS GALORE!!

All prices per 10 disk boxes!

Our Cat. Number	Product's Description	1-9 Boxes	10+ Boxes
-----------------	-----------------------	-----------	-----------

## XIDEX 3 1/2" DISKS

C12600	3012-3000 S/S	\$69.95	\$64.95
		(Normally \$75.00)	\$89.95
C12602	3022-3000 D/S	\$89.95	\$84.95
		(Normally \$99.95)	

## XIDEX 5 1/4" DISKS

C12401	5012-1000 S/S D/D 40 track	\$29.95	\$28.95
		(Normally \$37.50)	
C12410	5022-1000 D/S D/D 40 track	\$36.95	\$34.95
		(Normally \$47.50)	

## VERBATIM 3 1/2" DISKS

C12610	MF350 S/S D/D 80 tracks/135 TPI	\$69.95	\$64.95
C12612	MF360 D/S D/D 80 tracks/135 TPI	\$89.95	\$85.95

## VERBATIM 5 1/4" DATALIFE DISKS

C12501	MD525-01 S/S D/D soft sector 40 track	\$27.95	\$26.95
		(Normally \$44.95)	
C12504	MD550-01 D/S D/D	\$39.95	\$37.95
		(Normally \$49.95)	
C12505	MD550-10 D/S D/D 10 sectors 40 tracks	\$61.20	\$56.95
C12507	MD577-01 S/S D/D soft sectors 80 tracks	\$61.20	\$56.95
C12510	MD557-01 D/S D/D soft sectors 80 tracks	\$75.60	\$68.95

## VERBATIM 5 1/4" VALULIFE DISKS

C12421	S/S D/D	\$34.95	\$32.95
C12421	D/S D/D	\$37.95	\$35.95

## VERBATIM HIGH DENSITY 5 1/4" DISKS

C12520	MD/HD D/S H/D soft sector	\$99.95	\$89.95
		(Normally \$109.95)	

## VERBATIM 8" DISKS

C12811	DD34-4001 D/S D/D	\$63.60	\$57.50
C12814	DD34-4026 D/S D/D	\$66.00	\$59.95

## HEAD CLEANER DISKS

C12851	5 1/4"	\$10.95	
C12851	8"	\$14.30	\$11.95



### UV EPROM ERASER

Erase your EPROMs quickly and safely. This unit is the cost effective solution to your problems. It will erase up to 9 x 24 pin devices in complete safety in about 40 minutes (less for less chips).

- Features include:
- Chip drawer has conductive foam pad
  - Mains interlock
  - High UV intensity at chip surface ensures EPROMs are thoroughly erased
  - Engineered to prevent UV exposure
  - Dimensions 217 x 80 x 68mm

Cat. X14950 NORMALLY \$99.95  
**SPECIAL, ONLY \$89.95**



### CODE KEY PAD

- Telephone type digital keypad.
- Four digit, changeable code.
- Over 5000 possible combinations.
- Power consumption: 5mA standby, 50mA alarm.
- Two sector LED and 1 arm LED.
- Wrong number lockout.
- 12V DC operation.
- Relay output.
- Panic button.
- Normally open tamper switch.
- Dimensions: 145 x 100 x 37mm.
- ACP3 compatible.

Cat. A13014 NORMALLY \$69.50  
**SPECIAL, ONLY \$55.60**

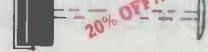

### ARLEC SECURITY BEAM

This compact security system transmits an invisible, modulated beam of infrared light which can be directed across a doorway, path or any other to be monitored. Anyone walking through the beam immediately causes an audible warning to sound. Suitable for shops, homes, factories etc.

- FEATURES:
- Small compact design
  - Infrared modulated beam
  - Prismatic reflector allows up to 10% misalignment
  - Effective range is 2 - 8 metres
  - Low voltage (3V) operation via S.E.C. approved adaptor
  - Negligible power consumption
  - Simplified wiring
  - Solid state electronic circuitry
  - Produces audible warning
  - Easy installation
  - 12 months guarantee

Cat. A15600 NORMALLY \$89.95  
**SPECIAL, ONLY \$79.95**



### TDK VIDEO TAPES AT BARGAIN PRICES!

VHS:	E60	\$12.50
	E120	\$12.50
	E180	\$11.80
	E240	\$22.40
BETA:	L250	\$13.50
	L500	\$14.40
	L750	\$17.50

### TDK AUDIO TAPE BARGAINS

Description	Cat. No.	1-9	10+
DC46 TDK	A11305	2.95	2.65
DC60 TDK	A11307	2.99	2.35
DC90 TDK	A11309	3.99	3.50
DC120 TDK	A11311	5.49	4.50
AD60 TDK	A11315	3.99	3.45
AD90 TDK	A11317	5.25	4.50
AD120 TDK	A11319	7.95	6.25
ADX60 TDK	A11320	4.95	4.25
ADX90 TDK	A11322	6.95	4.95
SA60 TDK	A11325	5.95	4.95
SA90 TDK	A11327	6.99	5.50
SAX60 TDK	A11329	6.69	5.77
SAX90 TDK	A11332	8.95	7.25
MAC90 TDK	A11335	8.29	7.25
MAC90 TDK	A11337	11.50	8.95
MAR60 TDK	A11340	13.50	10.95
MAR90 TDK	A11342	16.99	14.50



### JIFFY BOXES

Plastic boxes with aluminum tops, and available in four sizes. Very popular for projects and very economical!

H10101	150x90x50mm	\$ 3.25
H10102	195x113x60mm	\$ 4.50
H10103	130x68x41mm	\$ 2.75
H10105	83x54x28mm	\$ 1.95
H10110	120x65x38mm	\$ 2.95
H10112	120x65x38mm (Metal top)	\$ 2.95



### MINI UTILITY CASE

Features a clear plastic lid for instant inspection of contents. Up to five, adjustable lower compartments, plus a self elevating upper tray for smaller items.

Dimensions: 110 x 210 x 43mm  
Cat. H10087 NORMALLY \$7.95  
**SPECIAL, ONLY \$6.95**



### IC STORAGE CASE

Electro static charge proof plastic IC case with conductive sponge. Dimensions: 75 x 130 x 19mm  
Cat. H10095 NORMALLY \$8.95  
**SPECIAL, ONLY \$7.95**

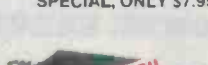

### MAGNETIC BULK ERASER

The best and by far the quickest way to erase tapes, cassettes and computer disks! Reduces noise levels below recorders own erase head level. On/Off switch located in handle 240V AC operation.

Cat. C14950 NORMALLY \$34.95  
**SPECIAL, ONLY \$29.95**

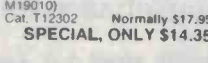

### POWERFULL MINI DRILL

Featuring a powerful 6000 r.p.m. motor, this lightweight (113gm) drill is ideal for many jobs. Perfect for PCB work! Has a 0.8 to 1.2mm chuck and 1mm drill bit. Requires 12V 1 AMP (use with M1910).

Cat. T12302 NORMALLY \$17.95  
**SPECIAL, ONLY \$14.35**

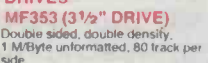

### MITSUBISHI DISK DRIVES

MF353 (3 1/2" DRIVE)

Double sided, double density. 1 MByte unformatted, 80 track per side.

Cat. C11953 \$280

MF351

3 1/2" Standard size disk drive. Single sided, double density.

Cat. C11921 \$225

M2896-63

Slimline 8" Disk Drive, Double sided Density No AC power required. 3ms track to track, 1.6 Mbytes unformatted, 77 track side 10x10 bit soft error rate.

Cat. C11916 \$550

Case & Power Supply to suit

Cat. X11022 \$159

M4854

Slimline 5 1/4" disk drive, Double sided, double density, 96 track/inch, 9621 bit/inch. 1.6Mbyte unformatted 3ms track to track access, 77 track/side.

Cat. C11904 \$350

Case & Power Supply to suit,

Cat. X11011 \$109

M4853

Slimline 5 1/4" disk drive, Double sided, double density, 1 Mbyte unformatted, 3ms track to track, 80 track/side, 5922 bits/inch.

Cat. C11903 \$260

M4851

Slimline 5 1/4" disk drive, Double sided, double density 500K unformatted, 40 track/side. Steel band drive system.

Cat. C11901 \$219

Case & Power Supply to suit

Cat. X11011 \$109

M4855

Slimline 5 1/4" disk drive, double sided, double density, 96 track/inch, 2.0 Mbytes unformatted.

Cat. C11905 \$385



### WELLER WTCPN SOLDERING STATION

The WTCPN Features:

- Power Unit 240 V AC
- Temperature controlled iron, 24 V AC
- Flexible silicon lead for ease of use
- Can be left on without fear of damaged tips!

The best is always worth having.

Cat. T12500 R.R.P. \$129  
**SPECIAL, ONLY \$99**



### ARLEC PC3

A professional quality, vented case with carry handle for portability when used for such projects as power supplies, battery chargers, inverters, audio amps, etc. Multiple slots and mounting positions, detachable top with plastic sides and metal back panel.

Cat. H10475 NORMALLY \$32.50  
**SPECIAL, ONLY \$29.25**



### AA NICADS (ROCKET BRAND)

Save up to 50% off the regular price of \$2.80!

1-9	10+	100+
\$1.75	\$1.65	\$1.40



### TELECOMMUNICATIONS AUSTRALIAN STYLE ADAPTOR CABLE

- Australian socket to plug/socket
- Length 10 metres

Cat. Y16015 NORMALLY \$15.95  
**SPECIAL, ONLY \$12.75**



### TELEPHONE CURL CORD

- U.S. plug to U.S. plug
- Replacement hand set cord
- Length 4.5 metres
- Colours: cream, dark brown.

Cat. Y16022 NORMALLY \$7.95  
**SPECIAL, ONLY \$6.35**

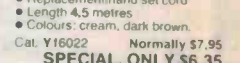

### TELEPHONE ADAPTOR

- Australian plug to U.S. socket
- Length 10cm
- Cream colour cable

Cat. Y16026 NORMALLY \$6.95  
**SPECIAL, ONLY \$5.55**

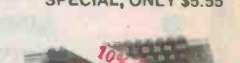

### REPLACEMENT KEYBOARDS

- For Apple
- 42 single key BASIC command
- One chip custom design encoder
- Made by ALPS, life time, 10 million operations
- Dimension: L340xW130xH42mm

Cat. K12010 NORMALLY \$79.50  
**SPECIAL, ONLY \$71.50**

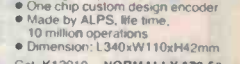

### DIGITAL SPEEDO/DIGITAL TACHO/SPEED ALERT

- Digital readout (LED) for both tacho and speed.
- Alarm with sound at variable preset speed.
- Audible beeper and visual indicator.
- In built light Indicator for night illumination
- Designed for 12 volt negative earth electrical systems.

- Speed: 0 - 199kph
- Tachometer 0 - 9900kph
- Speed alert: 40 - 120kph
- Complete with mounting hardware.

Cat. A15064 NORMALLY \$69.50  
**SPECIAL, ONLY \$55.60**

## 20% OFF ALL ARISTA PRODUCTS!

### AUDIO LEADS MIXERS CAR ACCESSORIES AUDIO PERIPHERALS etc

This applies only to our retail stores and is 20% off prices marked on them.



### ARLEC SUPER TOOL

A versatile 12V electric tool for:

- Sanding
- Engraving
- Grinding
- Polishing
- Cutting
- Drilling
- Milling
- Erasing etc.

Features:

- Operates on safe, low 12 volts from mains electricity via AC adaptor (supplied). Light and easy to handle with touch switch and lock for continuous running. High torque motor, 10,000 R.P.M. Can drill 2mm holes in steel 2 year guarantee

Contents:

- 12V Super Tool
- Plug/lead AC adaptor
- 1 spherical milling cutter
- 1 wire brush
- 1 grinding wheel
- 4 drill bits, 0.6, 0.8, 1.0, 1.2mm
- Set of 5 chuck collets
- 6 eraser sticks
- Instruction sheets

Cat. T12300 NORMALLY \$49.95  
**SPECIAL, ONLY \$44.95**

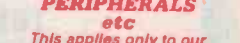

### FREE STANDING, FOLD UP MAGNIFIER

An ergonomically priced 'hands free' magnifier, lets you take care of all those tricky fine detailed jobs so often encountered in electronics, or any of many other practical uses such as home, work, hobbies etc.

Cat. T12083 NORMALLY \$14.95  
**SPECIAL, ONLY \$12.95**



### TTL MONITORS

Fantastic resolution! Enjoy a crisp, sharp image with the latest Ritron TTL monitor IBM compatible, green display, swivel and tilt base

Cat. X14510 NORMALLY \$265  
**SPECIAL, ONLY \$245**

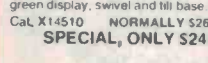

### APPLE COMPATIBLE SLIMLINE DISK DRIVES

Japanese Chinon mechanism, compatible with 2E and 2 plus

Cat. X19910 Only \$249

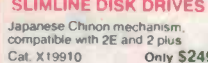

### APPLE COMPATIBLE SLIMLINE DISK DRIVES

Japanese Chinon mechanism, compatible with 2E and 2 plus

Cat. X19901 NORMALLY \$225  
**NOW \$199**



### COMPUTER PAPER

Quality paper at a low price! 2,500 sheets of 11 x 9 1/2", 60 gsm bond paper.

Cat. C21001 NORMALLY \$44.95  
**SPECIAL \$37.95**

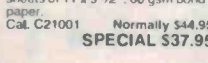

### IBM COMPATIBLE CARDS

NEW MOTHER BOARDS! XT compatible mother boards. 8 slots, room for 256K RAM

Cat. X18020 \$295

GAMES ADAPTOR CARD

Features 2 joystick ports

Cat. X18019 \$49



# PRE STOCK TAKE SALE!!



**CANON TYPE CONNECTORS**  
 Cat. No. Description Price  
 P10960 3 pin line male Was \$3.90  
**NOW \$2.70**  
 P10962 3 pin chassis male Was \$3.00  
**NOW \$2.10**  
 P10964 3 pin line 1 male Was \$4.20  
**NOW \$2.95**  
 P10966 3 pin chas. 1 female Was \$4.50  
**NOW \$3.15**



**DIP SWITCHES**  
 Cat. No. Description WAS NOW  
 S13402 2 Way \$1.50 \$0.75  
 S13404 4 Way \$1.70 \$0.85  
 S13405 5 Way \$1.90 \$0.95  
 S13406 6 Way \$2.30 \$1.15  
 S13407 7 Way \$2.40 \$1.20  
 S13408 8 Way \$2.50 \$1.25  
 S13410 10 Way \$3.00 \$1.50



**SCOPE 60W SOLDERING SYSTEM**  
 • Infinitely adjustable temp. 200 C to 470 C. Sliding control selects desired tip temperature (LED readout monitors tip temp.)  
 • Safety holder features ceramic burn-proof bush and can be converted to left-hand-side.  
 • Soft and cool hand grip in pliable rubber.  
 • Screw type connector prevents accidental plug removal and guarantees solid contacts.  
 • Temperature lock allows production supervisors to control soldering temperatures.  
 • Anti seize tip retention design reduces risk of thread seizure by removing locking nut to cooler end of barrel.  
 • Optional 30W soldering pencil is available for finer work.  
 Cat. T12900 Normally \$159  
**NOW \$149**



**PANEL METERS GALORE!**  
 We have a great range of panel meters at great prices!  
 Cat. No. Description Price  
 Q10500 MU45 0-1mA 12.50  
 Q10502 MU45 50-0.050uA 12.50  
 Q10504 MU45 0-100uA 12.50  
 Q10510 MU45 0-5A 12.50  
 Q10518 MU45 0-1A 12.50  
 Q10520 MU45 0-1A 12.50  
 Q10525 MU45 0-20V 12.50  
 Q10530 MU52E 0-1A 14.50  
 Q10533 MU52E 0-5A 14.50  
 Q10535 MU45 VU PMetre 14.95  
 Q10538 MU65 0-50uA 16.95  
 Q10540 MU65 0-1mA 16.95  
 Q10550 MU65 0-100uA 16.95  
 Q10560 MU65 0-20V 16.95



**BESWICK 88100 PROBE SET**  
 CONTAINS: Compensated probe lead with:  
 • Detachable 6 inch earth lead  
 • Retractable hook  
 • IC test tip  
 • Tip insulator  
 • BNC adaptor  
 • Trimming tool  
**SPECIFICATIONS:**  
 Bandwidth: 10:1 position 250MHz at -3dB into 20pF  
 Rise Time: 10:1 position less than 1.4ns nominal  
**Switch Function:**  
 (a) 10:1 attenuation +/- 1%, with oscilloscope of 1 Mohm input resistance.  
 (b) 1:1 attenuation with bandwidth of 10 MHz approx.  
 (c) Reference position, tip grounded via 9 Mohm, oscilloscope input grounded.  
 Input Capacitance: 16pF typical depending upon oscilloscope input capacitance.  
 Compensation Range: oscilloscopes of 15 to 60 pF input capacitance.  
 Working Voltage: 600V DC or peak AC



## IBM COMPATIBLES

**from \$899\***  
 Incredible deals to suit every one including special package deals!  
 \*256K RAM, single drive, graphics, disk controller and printer cards.  
 IBM is a registered trademark.  
**256K RAM:** Colour Graphics, Disk Controller Card, 1 parallel port, 2 disk drives and 3 months warranty only \$1,495  
**640K RAM:** Colour graphics, Multifunction Card, Disk Controller Card, 2 serial and 1 parallel ports, 2 disk drives and 3 months warranty only \$1,750  
**256K PACKAGE DEAL:** Includes Colour Graphics Card, Multifunction Card, Disk Controller Card, 2 serial and 1 parallel ports, a 120 C.P.S. printer and a monochrome monitor and 3 months warranty! only \$1,850  
**640K PACKAGE DEAL:** Includes Colour Graphics Card, Multifunction Card, Disk Controller Card, 2 serial and 1 parallel ports, a 120 C.P.S. printer, a monochrome monitor and 3 months warranty! only \$1,950  
 \*IBM is a registered trademark.



**CENTRONICS**  
 Cat. No. Description Price  
 P12200 36 way plug IDC \$12.50  
 P12201 36 way skt IDC \$13.50  
 P12203 50 way plug IDC \$14.50  
 P12204 50 way skt IDC \$15.50  
 P12207 24 way solder plug \$12.90  
 P12210 36 way solder plug \$ 9.50  
 P12211 36 way sidr line skt \$15.95  
 P12213 36 way sidr chss skt \$15.95



**SPRING RETURN TOGGLE SWITCHES**  
 WAS NOW  
 S.P.D.T. Cat. S11012 \$2.25 \$1.95  
 D.P.D.T. Cat. S11022 \$2.50 \$2.25



**BREADBOARDS**  
 Cat. No. Description Price  
 P11000 100 Holes \$ 2.75  
 P11005 640 Holes \$10.75  
 P11007 640+100 Holes \$13.00  
 P11009 640+200 Holes \$17.50  
 P11010 1280+100 Holes \$19.95  
 P11011 1280+300 Holes \$32.50  
 P11012 1280+400 Holes \$36.75  
 P11015 1920+500 Holes \$57.50  
 P11018 2560+700 Holes \$64.95



**10W HORN SPEAKERS**  
 White durable plastic, 8 ohms  
 Cat. C12010 Normally \$9.95  
**SPECIAL, ONLY \$8.95**



**FUSE SPECIAL 3AG**  
 Two values, 3 Amp and 1 Amp  
 1-99 \$1.80 \$1.50 1000+  
 8c each 6c each 5c each



**HORWOOD ALUMINIUM CASES**  
 H10382 3 x 4 x 2 inches \$ 5.50  
 H10383 3 x 4 x 3 inches \$ 6.50  
 H10384 3 x 4 x 4 inches \$ 7.50  
 H10385 3 x 4 x 5 inches \$ 7.95  
 H10386 3 x 4 x 6 inches \$ 8.50  
 H10387 3 x 4 x 7 inches \$ 9.50  
 H10388 3 x 4 x 8 inches \$10.50  
 H10389 3 x 4 x 9 inches \$10.95  
 H10390 3 x 4 x 10 inches \$11.95



**HOOK UP WIRE**  
 Cat. No. Description Price  
 W11251 13/12 TLD BLK  
 W11252 13/12 TLD BROWN  
 W11253 13/12 TLD ORANGE  
 W11254 13/12 TLD YELLOW  
 W11255 13/12 TLD GREEN  
 W11256 13/12 TLD BLUE  
 W11257 13/12 TLD WHITE  
**PRICES PER 100 METRE ROLL**  
 1-9 \$5.95 10- \$5.00  
 \$5.35 \$4.50



**ECONOMY TRANSFORMERS**  
 1-9 10-  
 2155 240V 6-15V 1A Cat. M12155 \$6.75 \$5.95  
 2156 240V 6-15V 2A Cat. M12156 \$9.50 \$8.95  
 2851 240V 12-6V CT 150mA Cat. M12851 \$4.50 \$3.50  
 6672 240V 15-30V 1A tapped Cat. M16672 \$9.95 \$9.30  
 2860 240V 15V CT 250mA Cat. M12860 \$4.95 \$3.95



**HIGH EFFICIENCY RADIAL FIN HEATSINK**  
 Black anodised with a thick base plate, this radial fin heatsink can dissipate large amounts of heat for maximum efficiency. Designed by Rod Irving.  
 105x30mm Cat. H10520 \$ 3.50  
 105x75mm Cat. H10525 \$ 3.50  
 105x100mm Cat. H10529 \$ 4.90  
 105x140mm Cat. H10534 \$ 6.50  
 105x150mm Cat. H10535 \$ 6.75  
 105x170mm Cat. H10538 \$ 7.95  
 105x195mm Cat. H10542 \$ 9.90  
 105x200mm Cat. H10543 \$ 9.90  
 105x225mm Cat. H10546 \$10.50  
 105x300mm Cat. H10549 \$12.00  
 105x600mm Cat. H10560 \$24.95

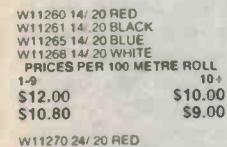

**BRAND NEW FANS**  
 Not noisy pullouts! Stacks of uses in power amps, computers, hotspot cooling etc. Anywhere you need plenty of air.  
 240V 47mm Cat. T12461 \$12.95  
 115V 45mm Cat. T12463 \$12.95  
 240V 3 1/2" Cat. T12465 \$12.95  
 115V 3 1/2" Cat. T12467 \$12.95  
 10+ fans (mixed) only \$10 each!



**CORDLESS RECHARGEABLE SOLDERING IRON**  
 • Built in solder point illumination  
 • Easy replacement of solder tip  
 • Protective stand which also functions as charging unit  
 • Sponge pad attach to stand  
 • Plug pack power adaptor  
 • Includes Nicad battery  
 • Instruction manual  
 • 12 months warranty  
 Cat. T12480 Normally \$59.95  
**SPECIAL, ONLY \$49.95**



**ARLEC SUPER TORCH**  
 A sophisticated rechargeable torch ideal for use in and around the home, the car, the boat, etc.  
**FEATURES:**  
 • Powerful built-in Nicad batteries.  
 • Reflector head swivel through 90 degrees.  
 • 3 position switch gives on/off and dim.  
 • Indicator lamp when recharging.  
 • Charges from mains, electricity or from a car battery.  
 • Supplied complete with (A) SEC approved battery charger (B) Plug and cord for car lighter socket. (C) Handy charging bracket with fixing screws.  
 • 12 months guarantee.  
 Cat. A15055 Normally only \$44.95  
**SPECIAL, ONLY \$39.95**

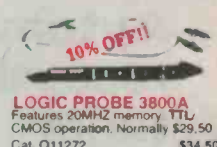

**LOGIC PROBE 3800A**  
 Features 20MHz memory TTL CMOS operation. Normally \$29.50  
 Cat. Q11272 \$34.50  
**SPECIAL, ONLY \$29.30**



**20% OFF FERGUSSON TRANSFORMERS!**  
 Applies only to our retail stores and to 'marked prices'

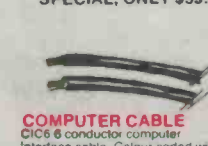

**COMPUTER CABLE**  
 CIC6 6 conductor computer interface cable. Colour coded with braided shield (to IE422 specifications).  
 Copper conductor 6 x 70, 16mm.  
 1-9 metres 10+ metres  
**\$2.50/m \$2.20/m**  
 CIC9 100 9 conductor computer interface cable. Colour coded with mylar shielding. 9 x 70, 16mm.  
 1-9 metres 10+ metres  
**\$2.95/m \$2.75/m**  
 CIC12 12 conductor computer interface cable. Colour coded with mylar shielding. 12 x 70, 16mm.  
 1-9 metres 10+ metres  
**\$3.50/m \$3.20/m**  
 CIC16 16 conductor computer interface cable. Colour coded with mylar shielding. 16 x 70, 16mm.  
 1-9 metres 10+ metres  
**\$4.50/m \$4.10/m**



**ROD IRVING ELECTRONICS**  
 425 High Street, NORTHCOTE, 3070 VICTORIA, AUSTRALIA  
 Phone (03) 489 8866  
 48 A Beckett St. MELBOURNE, 3000 VICTORIA, AUSTRALIA  
 Ph. (03) 663 6151  
 Mail Order and correspondence: P.O. Box 620, CLAYTON 3168  
 TELEX: AA 151938

**MAIL ORDER HOTLINE (03) 543 7877 (2 lines)**  
**POSTAGE RATES**  
 \$1-\$9.99 \$2.00  
 \$10-\$24.99 \$3.00  
 \$25-\$49.99 \$4.00  
 \$50-\$99.99 \$5.00  
 \$100-\$199.99 \$7.50  
 \$200-\$499.99 \$10.00  
 \$500 plus \$12.50  
 This is for basic postage only. Comet Road freight, bulky and fragile items will be charged at different rates.  
 Certified Post for orders over \$100 included "free"  
 Registered Post for orders over \$200 included "free"  
 All sales tax exempt orders and wholesale inquiries to RITRONICS WHOLESALE, 56 Renner Rd., Clayton Phone (03) 543 2166  
  
 Errors and Omissions Excepted.

NOTE: All 20% OFF HEADLINES ARE APPROX. ONLY



# Hi-fi VCR records TV & radio stereo

Akai has announced a new flagship to its video cassette recorder line up, the VS-606.

The Akai VS-606 is said to be state of the art video linked together with true hi-fi sound like having two decks in one — a high quality video deck, and an audiophile-class audio tape deck. The result is apparently superb hi-fi playback and not only in normal speed, but also in the long play mode.

The VS-606 boasts a built-in stereo tuner which enables the recording of TV programmes in stereo and converts current mono TV into a state of the art stereo TV.

A 'super still' picture has been achieved in the pause mode by having four heads, one for each recording and playback function. This feature reportedly gives exceptional picture quality in both normal and long play modes.

An interactive monitor system displays the operating instructions on the TV screen.

The slim line design of the VS-606 coming in both black and silver makes it an attractive addition to any home entertainment unit.

## Automatics improve reception on synthesised tuner

Onkyo's T-9090 quartz synthesised FM tuner, part of the Japanese audio company's top-of-the-line 'Integra' series, features an automatic precision reception system — a microcomputer-controlled system that automatically controls five different reception modes to obtain the best reception quality possible at all times. Onkyo claims good quality reception even in difficult reception areas.

The T-9090 provides preset tuning for 20 stations. An auto scan memory function automatically scans the FM

band and places every FM station above a certain signal strength in the memory.

Another feature incorporated in the T-9090 is the Delta Power Supply, which reduces distortion and noise and expands the dynamic range.

Also included are a multi-function digital display which shows memory channels, signal strength (in decibels), tuning levels and tuned frequency; and timer program tuning, allowing up to five different stations to be recalled for audio timer recording.



## New KEF loudspeaker range

KEF, Britain's largest manufacturer of loudspeakers has released a new range of high performance domestic speakers.

The C series uses a new type of polypropylene material in the cones to substantially improve efficiency and reduce colouration, as well as using a new enclosure design and computer applied technology in crossover development.

At the lower end of the price scale are the KEF C10 and C20 models designed for bookshelf use.

The next model in the range is the C30 which includes a new 200 mm polypropylene mid/bass unit for reportedly greater mid-range sensitivity and improved bass damping, and a new high sensitivity dome tweeter.

The C40 is generous in both

volume and drive units and is designed to operate as a floor or stand mounted model, preferably clear of room boundaries. A 200 mm polypropylene bass driver is used for bass frequencies while a similar sized unit is used for the upper bass/mid-range portion.

Top of the new C series of KEF speakers is a slim floor standing model, the C80. It draws significantly on the 104.2 design. The 25 mm tweeter is identical to that in the 104.2; though the complex double driver bass system of the 104.2 has been simplified with conventional drive technology.

KEF has re-employed the B139 bass radiator although upgraded and improved from its original design.



## BRIEFS

### Stereo double reverse cassette deck

The Teac W-880RX gives double auto reverse recording playback, continuous playback of two tapes, continuous playback of a selection of tracks (in the order of your choice), and of course a tape copying function.

### JVC autofocus VideoMovie GR-C2

The new GR-C2 offers TCL-IS autofocus which uses an image sensor module that reads and analyses visible light to determine proper focus, unlike infrared or ultrasonic systems. It also boasts a three-way power supply, automatic white fader, low light sensitivity of 15 lux, and automatic backspace editing.

### AXR series connectors

STC-Cannon has introduced a new series of audio connectors which upgrade the XLR range. The AXR series is suitable for audio/video and other low level circuit applications where reliability and elimination of rf and electromechanical interference is necessary. All AXR series connectors are interchangeable with XLR and XLB series. STC-Cannon is at 248 Wickham Rd, Moorabbin Vic 3189. (03)555-1566.

### Surround sound amplifier

The Nec AV-300E amplifier features three types of processors to achieve the surround sound of 'presence and expansion'. The Dolby surround provides optimum sound reproduction from Dolby stereo programs; the matrix surround reproduces stadium acoustics with stereo sound from four separate speaker systems; the hall surround provides optimum sound reproduction for music programs.

### New DSE car hi-fi

Dick Smith Electronics has launched a new range of car hi-fi equipment from Aspec. The range is headed by an AM/FM stereo, auto reverse cassette at \$399 and tapers to a budget priced stereo cassette which retails for around \$99. There are five radio/cassettes, a 100 W graphic equaliser and eight speakers in the range so far.

### Recording Society of Australia

This little known group is seeking a bit of public interest. It was founded in 1964 by a group of enthusiastic amateurs with a common interest in sound recording on magnetic tape. The society offers its members practical advice, demonstrations, displays and opportunities to gain experience in the proper selection and use of equipment. Each club year an annual tape recording contest is held. For more information contact the Secretary, RSA, C/- Box 23, Black Rock, Vic 3193. (03)589-5768.

### New Mordaunt Short loudspeakers

Concept Audio is distributing two new models of loudspeakers from Mordaunt Short of the UK. The MS.15 is a slim model suitable for positioning on rigid shelves or stands and sells for \$598 per pair. The MS.25TI is the successor to the MS.20 model and retails for \$698 per pair.

### NAD tuner

The NAD 4130 tuner uses a MOSFET front end that NAD claims is immune to strong signal overload. Other features of the tuner are the use of three ultra-linear ceramic IF filters for improved selectivity and wide stereo separation, and NAD's dynamic blend circuit intended to reduce noise in weak stereo signals.

## Colour video projection system

The industrial products division of National Panasonic (Australia), through GEC, has released a new Panasonic 3 m (120") colour video projection system. The PT-102, weighing 35 kilos, with dimensions 290 mm (h) x 576 mm (w) x 584 mm (d), presents a new brightness and lightweight portability in high resolution video projectors.

The PT-102 uses three liquid loaded CRTs. This liquid cooled system is more effective than air, therefore a stronger electron beam can be used to achieve greater brightness. Panasonic also claims to use specially moulded plastic lenses to maintain this high brightness projection, resulting in luminous flux of 400 lumens. High resolution is achieved with 550 lines using video input and 800 lines for RGB input.

The PT-102 provides full television signal format compatibil-

ity. Its 45-system capability enables display of CCIR or EIA standard signals in PAL/SECAM/NTSC colour formats and M-NTSC in videotape playback with 4.43 MHz subcarrier. Selection can be manual or automatic.

Computer text and graphics can be displayed with very high resolution. With RGB input the PT-102 can project a clear sharp image of up to 2000 characters in colour. When using RGB input you can also select 'Fine Blue' for greater clarity of blue characters or 'Blue Mono' which gives a white on blue display.

The PT-102 comes ready to be used for ceiling mounting and front projection, but it is an easy matter to adjust for floor mounting as well as rear projection. As well as being portable, the PT-102 offers variable screen size and a viewable picture can be projected on to most curved or flat screens ranging in size from

1.5 m (60") to 3 m (120").

Optional remote control allows the operator to turn power on and off, adjust the picture, select input, and switch between

display modes. Three sizes of cable (15 m, 30 m and 50 m) are also available, as optional extras.





# WIDER PASTURES



## — Nec's CD-509 player

The Japanese firm Nec, already well established in the field of computers, has ventured into the manufacture of CD players. Not an unexpected widening of activities, but NEC may have to check where the grass is greener.

Louis Challis

### NEC COMPACT DISC PLAYER CD-509 & REMOTE CONTROL AR-509E

Dimensions: 430 mm (wide) x 90 mm (high)  
x 320 mm (deep)  
Weight: 5 kg  
Manufacturer: Nec Corporation, Japan  
RRP \$539

NEC OF JAPAN is one of the many new manufacturers to enter the field of compact disc player manufacture. Because of its greater experience in the fields of computer and communication equipment, Nec has tended to stress its expertise in those fields in its consumer advertising in the USA and Europe. Whilst there is probably some technical association between these fields, that marketing approach does not conjure up the sort of persuasive images that some of Nec's competitors are able to generate.

#### Design and appearance

The CD-509E is a neat, modest and conservative looking CD player which does not share the brassy, bold or even flashy characteristics of many of its competitors. It comes with a very effective infrared remote control but unlike many other new CD player designers those at Nec believe that most purchasers want a minimum number of functional controls.

The controls and primary displays are arranged as a band across the upper section of the front escutcheon with silk screened lettering in contrasting orange and white. At

the lower left hand corner is the power ON/OFF and almost immediately above is the slide-out drawer for loading the compact disc. Adjacent to this is a reasonably large OPEN/CLOSE button with orange lettering to attract your attention.

In the middle of the band are two displays with the words DISC, REPEAT, A-B, and a large PLAY and MEMORY which indicate with reds and greens the operating mode of the player. To the right of this is a small green plasma display that indicates the track number, index number or the elapsed time in minutes and seconds for the track being played.

The display function mode is controlled by a small display button on the central band below the display module; three other secondary controls for MEMORY, CLEAR, and A-B REPEAT are also located immediately below the display. The MEMORY button provides the ability to memorise track sequences for replaying, the CLEAR button allows you to cancel all of those memorised sequences and the A-B REPEAT button allows you to select two points anywhere on the disc between which

the player will automatically cycle.

To the right of the display module is a large PLAY/PAUSE button featuring the now standardised play and pause symbols. To the right of this are four controls for indexing the disc forward or reverse in incremental track numbers below which are the more conventional FAST FORWARD and REVERSE buttons. At the lower right hand corner is a headphone VOLUME control adjacent to which is a conventional 6.3 mm tip ring and sleeve headphone socket and the detector for the remote control.

On the rear of the cabinet, a pair of RCA coaxial sockets provide outputs to a preamplifier or receiver and a matching colour coded interconnection lead is also provided. The remote control is extremely neat, light and soon proved to be very simple to use. It reproduces all of the main controls provided on the front panel with the exception of the OPEN/CLOSE button and combines the REPEAT/CLEAR button as a single functional key.

The cabinet is constructed from a combination of anodised aluminium extrusion,



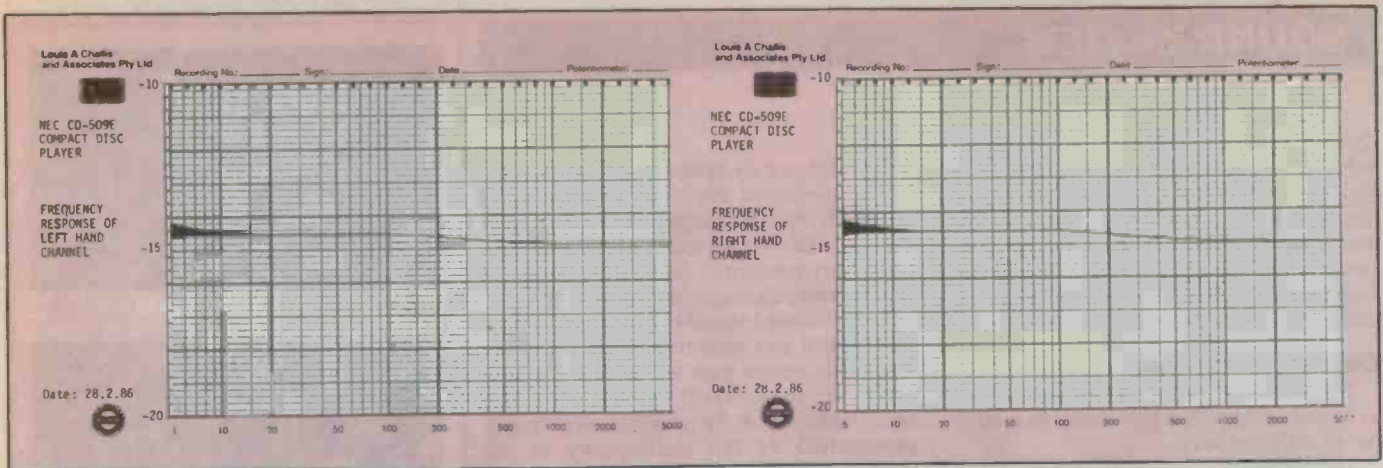

**MEASURED PERFORMANCE OF NEC COMPACT DISC PLAYER**  
**MODEL NO. CD-509**  
**SERIAL NO. 0520285**

1. **FREQUENCY RESPONSE** 20 Hz to 20 kHz  $\pm 0.5$  dB  
 5 Hz to 22.05 kHz  $\pm 0.6$  dB

2. <b>LINEARITY @ 1kHz</b>	<b>NOMINAL LEVEL</b>	<b>LEFT OUTPUT</b>	<b>RIGHT OUTPUT</b>
	0 dB	0.0	0.0
	-1.0	-1.0	-1.0
	-3.0	-3.0	-3.0
	-6.0	-6.0	-6.0
	-10.0	-10.0	-10.0
	-20.0	-20.0	-20.0
	-30.0	-30.1	-30.1
	-40.0	-40.1	-40.1
	-50.0	-50.1	-50.2
	-60.0	-60.4	-60.4
	-70.0	-71.3	-71.3
	-80.0	-85.5	-85.5
	-90.0	-101.7	-102.7

3. <b>CHANNEL SEPARATION</b>	<b>FREQUENCY</b>	<b>RIGHT INTO LEFT dB</b>	<b>LEFT INTO RIGHT dB</b>
	100Hz	-88.4	-89.1
	1kHz	-86.6	-87.3
	10kHz	-69.3	-71.6
	20kHz	-60.2	-61.8

4. <b>DISTORTION (@ 1kHz)</b>	<b>2nd</b>	<b>3rd</b>	<b>4th</b>	<b>5th</b>	<b>THD%</b>
Level 0	-85.3	-93.1	-109.5	-108.3	0.007
-1.0	-86.5	-93.6	-109.1	-	0.0052
-3.0	-89.4	-95.7	-107.3	-103.6	0.0038
-6.0	-92.7	-91.0	-	-92.1	0.0044
-10	-97.9	-86.8	-107.8	-90.1	0.0073
-20	-	-76.4	-	-85.2	0.016
-30	-	-67.7	-	-73.5	0.046
-40	-	-62.1	-	-60.4	0.18
-50	-	-48.2	-	-50.2	0.50
-60	-	-36.7	-	-40.9	1.72
-70	-	-25.4	-	-29.1	6.41
-80	-16.6	-13.1	-17.0	-14.3	35.8
-90	+10.9	-11.9	+5.0	-8.2	* * *
(@ 100 Hz)					
0	-84.9	-93.3	-114.5	-113.0	0.0006
-20	-	-76.9	-102.5	-86.0	0.015
-40	-	-64.8	-	-60.5	0.16
-60	-59.1	-36.2	-53.0	-43.3	1.70
@ 6.3 kHz					
0	-92.9	-82.4	-	-	0.0079

\* \* \* Indicate distortion greater than base level signal.

5. **EMPHASIS**

<b>Frequency</b>	<b>Recorded Level</b>	<b>Output Level (L)</b>	<b>Output Level (R)</b>
1 kHz	-0.37 dB	0.0	0.0
5 kHz	-4.53 dB	-4.2	-4.2
16 kHz	-9.04 dB	-8.6	-8.5

6. **SIGNAL TO NOISE RATIO**

Without Emphasis	94.1 (Lin)	99.2 dB(A)
With Emphasis	99.0 (Lin)	103.2 dB(A)

7. **FREQUENCY ACCURACY**

(19.999 kHz)  $\pm 3.0$  Hz for 20 kHz test signal

8. **SQUARE WAVE RESPONSE**

(See attached photos)

9. **IMPULSE TEST**

(See attached photo)

**DIRTY RECORD TEST**

**Interruption in Information Layer**

400 micrometer ;	Passed
500 micrometer ;	Passed
600 micrometer ;	Passed
700 micrometer ;	Passed
800 micrometer ;	Passed
900 micrometer ;	Passed

**Black Dot at Read out Side**

300 micrometer ;	Passed
500 micrometer ;	Passed
600 micrometer ;	Passed
800 micrometer ;	Passed
1 millimeter ;	Passed

plastic chassis and folded steel top, side and bottom covers. Inside the unit, you are immediately aware of the small number of transistors and ICs used and very much aware of the size and complexity of the 11 large scale integrated circuits mounted on the main mother board. Some of these are Nec manufactured; others are sourced from the other major Japanese manufacturers whose products we have recently reviewed. The layout is neat, clean and effective with

the absolute minimum number of interconnections, all of which are executed by means of plug-in sockets, colour coded wiring harnesses and matched by well designated printed circuit board annotation. A number of unused sections of the board indicate that it was designed to provide additional functions and potential in a more advanced model.

The CD player section uses a triple beam laser system which is undoubtedly one of

the most advanced that I have yet tested. Because of the increasing numbers of CD disc manufacturers (not all of whom have diligently followed the minimum standards of performance specified by Sony and Philips in the original "Red Book"), it has become expected of third generation CD players that they achieve higher standards of tracking accuracy when faced with sub-standard discs. The laser tracking system's control circuitry is located immediately ▶

## SOUND REVIEW

below the player section, which is constructed with a folded steel chassis and precision plastic mouldings. Although the unit appears to be relatively simple in its construction the test results indicate that considerable research and ingenuity has gone into its design and fabrication.

### Objective testing

The objective testing of the unit proved to be something of an eye opener in a number of different ways.

The frequency response is not as flat as that provided by most of the other third generation CD players which I have recently evaluated; it is more in keeping with the second generation of CD players. The response is 0.3 dB high between 5 Hz and 100 Hz, smoothly rolls through the 0 dB point at 1 kHz, is -0.1 dB all the way through to 17 kHz and then exhibits a +0.5 dB 'glitch' between 17.5 kHz and 22 kHz with the peak at 20 kHz. This degree of linearity is, however, perfectly acceptable and does not necessarily mean that the audible response would be impaired as a result of this characteristic.

The low frequency response is extremely flat and on the basis of the measured results extends well below 5 Hz, the lowest test frequency available to me.

The digital-to-analogue conversion linearity displayed by this player (and a second unit which I evaluated) is very unusual. The linearity is almost perfect down to -40 dB, starts deviating significantly between -50 and -70 dB, is 5.5 dB low at -80 dB and 12 dB low at -90 dB. In between -60 dB and -90 dB, the digital-to-analogue conversion is positively 'awry' and we obtained similarly bad results in the second unit. The second unit was 12 dB low at -80 dB which was even more disturbing than the 5.5 dB error of the first player. This characteristic left me a little disturbed because it only confirms my long held belief that not all CD players are equal — specifically in terms of digital-to-analogue conversion linearity and most particularly, in terms of measurable distortion.

The channel separation of the unit is good at 100 Hz and 1 kHz but drops fairly rapidly in the 10 kHz to 20 kHz region where the separation drops to 69 dB and 60 dB respectively. The distortion characteristics of the unit at 1 kHz are excellent down to -40 dB, adequate at -50 dB and unusually high at -60 dB. At the -60 dB level, this manifests itself as an unusually high level of distortion products at the 3rd, 5th, 7th, 9th, 13th and 15th order harmonics (see photograph). The measured distortion performance at -70, -80, and -90 dB revealed distortion values of 6.4%, 35% and more than 100% respectively. These are the highest distortion values that I have yet seen in a CD player and similar characteristics

were displayed by both of the units tested.

The measured distortion characteristics at 100 Hz were also higher than expected at the -40 and -60 dB levels which only reinforced my concern regarding the design of the digital-to-analogue converter.

The indicated signal-to-noise ratio of the player with and without emphasis is excellent being better than 96 dB (unweighted) and better than 100 dB (A-weighted). The measurements of this result, however, are accentuated by the non-linearity of the D-to-A conversion.

The frequency accuracy of the player is +3 Hz for the 19.999 kHz signal whilst the square wave and impulse responses are generally acceptable, although an unusual level of jitter was evident on the 100 Hz square wave signal.

The impulse test shows a clean response and the evaluation of the tracking mechanism with both the dirty test results, interruption in information level and black dot read-out capabilities were truly outstanding. The player did not display any sign or trace of 'glitches', inconsistency, or potential problems with the most demanding (worst) test CDs that I was able to provide. With eccentric discs beyond manufacturers' and "Red Book" acceptance tolerance, the Nec CD-509 behaved in a truly exemplary manner. Only when subjected to test discs with eccentricities greater than 1.5 mm did the tracking mechanism fail to perform. Under these conditions, the control mechanism spewed out the disc quite unceremoniously.

Apart from the peculiarities of the linearity test and a remarkable degree of distortion at low signal levels, the objective performance of the CD-509 was in all other respects excellent.

When it comes to operating characteristics, the Nec CD-509 has many good features in its favour. The choice of controls and the way that they have been structured by the designers makes this CD player one of the most convenient and ergonomically simple players to control that you could possibly buy.

Both the main control panel and the portable infrared remote control are top from the point of view of convenience. Nowhere did this show up better than in the laboratory testing and both my family and I found this to be equally true in the domestic situation.

### Subjective testing

When it came to listening, the CD-509 displays some vices as well as many attributes. I listened to a number of new test discs including Charles Dutoit playing Franz von Suppé's "Overtures" (Decca 414 408-2) which sounded just a little too strident. By contrast Julian Lloyd Webber's "Pieces" (Polydor 827 352-2) was smooth, exhilarat-

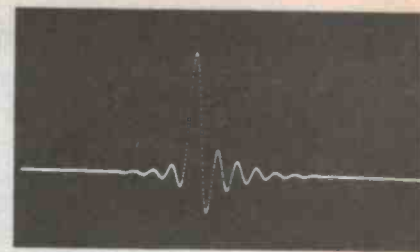

Impulse response.

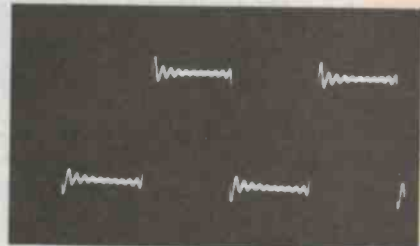

1 kHz square wave (with jitter).

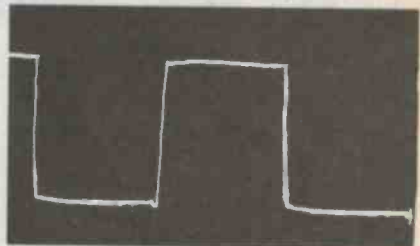

100 Hz square wave.

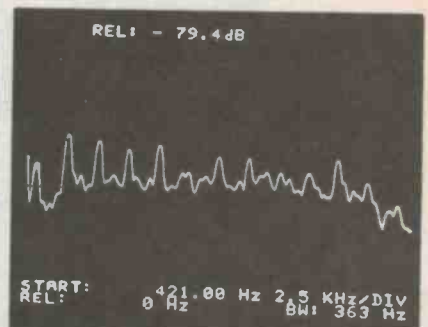

-60 dB on 1 kHz signal, showing 3rd, 5th, 7th, 9th, 13th and 15th harmonics.

ing and very exciting, although at low levels it displayed an unusual audible characteristic on which I couldn't quite put my finger.

The Nec CD-509 CD player is not the cheapest player on the market and doesn't really begin to match the outstanding third generation CD players available in terms of objective performance, but does offer an ergonomic, functional tracking performance which very few other players can outperform.

Nec's basic design in the CD-509 has all the ingredients that the intending purchaser is looking for. However, Nec will have to spend a little more time and effort in basic research in order to obtain a decent digital-to-analogue conversion LSI chip which really does work if it wants to get an "A" instead of a "C" on its 'report card'. ●



I just found a way to halve  
the size of our power supply.



So the product you're designing calls for a multi-character (or multi-line) display. If you must be able to read it at a distance or up close, in bright ambient light or with no ambient light there are really only two possibilities. LED displays or our Itron Vacuum fluorescents.

Itron Vacuum Fluorescents make real sense. The first thing they'll do is probably cut your power supply requirements in half when compared with LED's. Their low current requirements lower your manufacturing costs and make portable equipment smaller and lighter. They may even make battery power viable for you.

Then they have other advantages too! They come in an extremely wide range of configurations including full upper and lower case alphanumeric and dot addressable graphics. You can choose from three bright colours and with selective filtration you can get almost any colour you want.

When you only want a few look at our complete modules, all you have to do is send them the data and they'll display it for you. Or, if you'll need large quantities it is probably more economical to just take the display and drive it yourself. - That's flexibility.

So, if you need multi character displays call us for a brochure and compare the advantages of Itron Vacuum Fluorescents for yourself.



*Associated Controls*

In Sydney call Dorothy or Barbara on (02)709 5700  
In Melbourne call Jennifer or Sandra on (03)561 2966  
In Adelaide call Paul or Jeff on (08)297 2033

**ASSOCIATED CONTROLS**

# A LESSON IN LISTENING

## — Dali 8 loudspeakers

Somewhere between technical characteristics and sound impressions lies that hazy, irreducible area we leave to aesthetic response — or taste. Dali has mystifyingly exploited that gap with a product that should charm the listener.

### DALI 8 LOUDSPEAKERS

*Dimensions:* 965 mm (high) x 305 mm (wide) x 406 mm (deep)  
*Weight:* 35 kg  
*Manufacturer:* Danish American Loudspeakers, Denmark  
*RRP:* \$2200 per pair

### Louis Challis

WHEN YOU CONSIDER its size, Denmark appears to produce relatively more acoustic products than any other country in the world. Denmark is the home of Brüel & Kjaer, Ortofon, Bang & Olufsen, Jamo, Disa, Dynaudio, Peerless, Vifa and Scan Speak Loudspeakers, and much more recently a new firm, Dali, whose products are being introduced into Australia.

The reason for this interest in high fidelity, and most particularly loudspeaker development, is undoubtedly the large number of electronic and electro-acoustic engineers that are produced in Denmark's technical university on the outskirts of Copenhagen at Lyngby. There, laboratory facilities are almost second to none in Europe; the university receives almost unbelievable financial support and assistance from the Danish Government, as well as from Brüel & Kjaer, which still produces more than 50% of the world's primary acoustical instrumentation.

The people behind Dali (Peter Lyngdorf, Mike Gerutto and Christian Hoffman) have respectively been involved in the Denmark Hi-Fi Club, electrical engineering and reviewing for Scandinavian hi-fi magazines. They have their own laboratory facilities stacked with appropriate Brüel and Kjaer equipment and they have been able to apply both modern technology and more importantly comprehensive subjective assessments to produce six different models of loudspeakers ranging in size from the small Dali 2 to the rather large Dali 8. These speakers are relatively inexpensive in Denmark and are consequently able to compete effectively with local products, as well as imports.

### Design and appearance

The Dali 8 speakers are unusually tall with a wall veneered cabinet, over most of





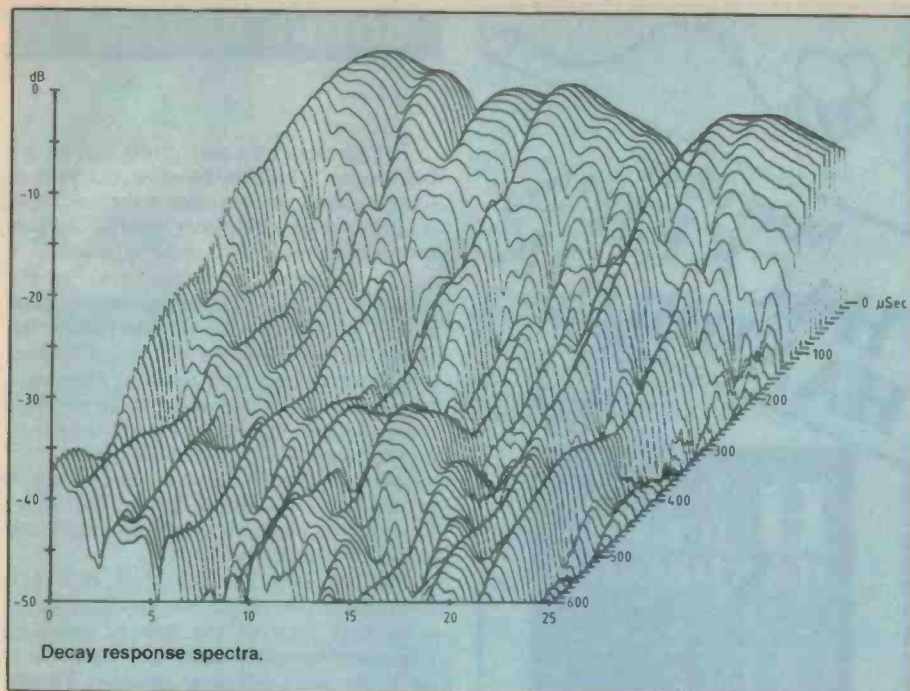

the face of which is a black cloth covered speaker grille. Behind the grille, which is retained by four plastic push-in clips, is an array of five speakers arranged in a four-way system. The Australian version differs slightly from the continental one as the bottom corner of the speaker grille is rectangular in shape, whilst the Danish market version is much more fancy with the name "Dali" deeply engraved into the woodwork at the bottom.

With the grille removed, your eyes are immediately assailed by the number speakers, which many purchasers may well find daunting. The two bottom speakers are a pair of 200 mm diameter woofers each arranged with a full rubber annular edge suspension ring. The designers claim these rings effectively attenuate the transmission of driver vibration into the main cabinet, as well as provide significant damping for the cast speaker basket frame. They also claim that this improves the bass response when compared with unisolated versions.

Of course, as we noted with the B&W 330s, this also provides a convenient means of increasing the total power handling capacity, the bass response and the relative sensitivity of the bass section of the speaker relative to the other drivers in the array. The mid range driver is a 110 mm diameter conventional paper cone speaker, the high frequency unit is a 35 mm dome tweeter, whilst the super tweeter has only an 18 mm diameter of almost miniscule proportions.

For some unexplained reason, the designers have set the mid range and tweeter arrays on one side of the cabinet for the left speaker and on the opposite side for the right speaker. Much to my surprise, the rear of the cabinet incorporates a loading port to provide the extended bass response. This particular approach, of placing the loading port at the rear of the cabinet, is one which

a large number of Australian radiogram manufacturers used in the late 50s and early 60s to provide a relatively inexpensive means of enhancing the low frequency performance of their speaker cabinets. Obviously, the distance between the back of the speaker and the wall surface behind can be of major significance. The position chosen for the loading port and the wall spacing behind provides a means of tuning the low frequency performance because of the increased path length provided by the surface between the back of the speaker and the adjacent wall.

Thiele's work on this subject indicates that this is not the most appropriate place for the loading port because of the phase cancellation that can result but the designers do not state why they have chosen to return to this long since discarded design.

In the terminal recess at the back of the speaker, the designers have placed an attenuator switch, which provides a -2 dB attenuation for the overall high frequency response. Why the designers chose to incorporate this particular control with such limited performance is not at all clear as I see few practical advantages for it. Had they chosen an attenuator with 3, 4 or 5 dB of attenuation, I would have been far happier. With only a 2 dB range of control, I doubt that very many of the intending purchasers will ever use the switch or even know when to use it.

The inside of the cabinet uses an open cellular polyester foam as the absorptive medium and the cabinet is reasonably braced to reduce the potential effects of cabinet resonance. The speakers are supplied with four stick-on plastic feet which are supplied loosely in the box for the owners to apply on those occasions when the speakers are to be mounted on hard flooring.

Tone burst response (for 90 dB steady state SPL at 2 m on axis). Upper trace is electrical input; lower trace is loudspeaker output.

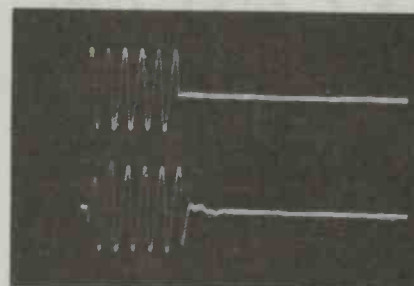

100 Hz (20 ms/div)

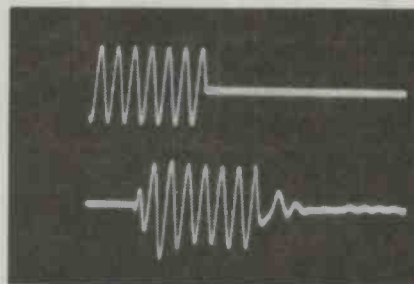

1 kHz (2 ms/div)

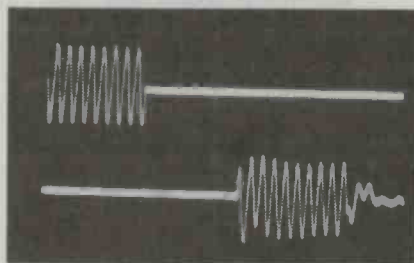

6.3 kHz (0.5 ms/div)

## Objective testing

I conducted the first series of laboratory tests in my anechoic room. They revealed an on-axis response which does not really resemble the "lovely smooth" curves published in the glossy brochure which the importers were kind enough to supply with the speakers.

The low frequency response, although not as smooth as the published curves, is nonetheless reasonably good and does provide an effective -6 dB point at 30 Hz (compared to the manufacturer's claims for a -6 dB frequency of 28 Hz). The associated claim that the frequency response is 3 dB down at 33 Hz was not substantiated in my measurements. The peaky response at 40 Hz would reasonably be expected to make the speakers sound 'rich' in the bass end, and the low frequency response below the 40 Hz is still reasonably good all the way down to 20 Hz. The mid and high frequency response is not particularly smooth, primarily because of the interaction between the individual drivers, and consequently, the overall frequency response curve is neither smooth nor exciting.



# DALI-8. THE NEW REFERENCE STANDARD.

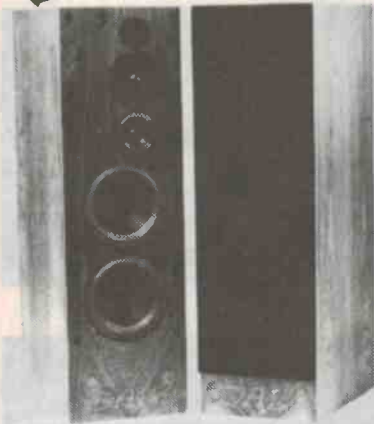

After 12 months of a most concentrated research and development programme, the new DALI-8 loudspeakers have just been released. They are large, extremely efficient, floor standing monitors with sonic qualities for which you might only expect to find in five to six thousand dollar area. The DALI-8s also eliminate the need to think about rock or classical speakers, because they will handle either variety of music with equal excellence. Overseas and Australian demand for these outstanding speakers for a lifetime. For a most comprehensive brochure and the name of your nearest DALI dealer, please contact the Sole Australian Distributor, SCAN AUDIO PTY. LTD. 52 Crown St, Richmond 3121. Telephone (03) 429 2199 Queensland Office: (07) 577 433

Stocked by:  
 VIC: Footscray Audio, Footscray  
 Hi-Fi Sounds, Dandenong  
 Hi-Fi Sounds, Marrickville  
 NSW: Apollo Hi-Fi, Marrickville  
 Bamback Electronics, Newcastle  
 SA: Blackwood Sound, Perth  
 WA: Osborne Park Hi-Fi, Perth  
 NT: Sound Spectrum, Darwin  
 TAS: Quantum Electronics, Hobart  
 QLD: Hand's Hi-Fi, Toowoong

# DALI

SA37868

ETI READER SERVICE 117

## Microbee HACKER'S HANDBOOK

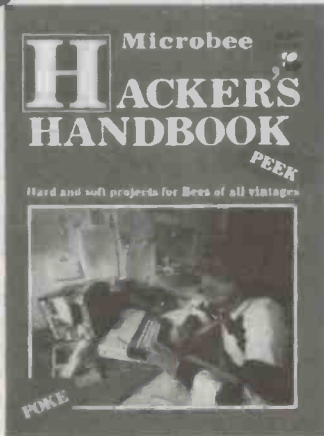

From the publishers of 'ETI'  
and 'Your Computer' magazines.

### The Microbee Hacker's Handbook will tell you how to:

- Get more from the Bee's graphics capabilities.
- Set up for telecommunications on the Bee.
- Play music on the Bee.
- Build a joystick and a light pen for the Bee.
- Get hardcopy — cheaply.
- Expand your 16K Bee to 32K.
- Make the Bee a better games machine.
- Turn your Bee into a facsimile decoder.
- Solve equations on the Bee ... and much more!

**\$6.50 at your newsagent now.**

OR you can obtain your copy by mail order direct from:  
**Federal Marketing Book Sales**  
 P.O. Box 227,  
 Waterloo, N.S.W. 2017  
 Please add \$1 to the cost of the magazine to cover postage and handling.

## SOUND REVIEW

The primary and underlying reason for the speaker's inability to achieve a smooth low frequency performance is the rear loading port, which will further 'mudfy' the performance in most residential situations.

The mid frequency performance of the speakers up to 7 kHz is reasonably good and, if it were not for the interaction between the outputs of the mid range, tweeter and super tweeter, the resulting frequency response would undoubtedly have been much flatter. The on-axis high frequency performance in the 10-20 kHz region is acceptable, although as soon as the microphone is off the direct axis of the super tweeter, the output droops quite markedly in the 15-20 kHz region.

The near-field measurements at 50 mm from the face of the individual speakers reveals that each of the drivers produces reasonably consistent outputs, whose overall levels are fairly well adjusted for the order of performance being sought. The level recording also displays the extent to which there is interaction between the speakers. It is evident that the low frequency drivers and the rear loading port output are likely to have substantially more interaction when evaluated in a conventional living room environment than shows up in our anechoic chamber evaluation.

A close examination of the impedance characteristic reveals that the lowest value of impedance has been sensibly controlled to 7.5 ohms and that the fundamental resonances occur at 18 Hz and at 52 Hz with somewhat lower peaks occurring at 500 Hz and 7 kHz. These values of impedance would not be disturbing to most amplifiers and these speakers could therefore be safely paralleled with most other 8 ohm speakers.

The phase response of the Dali 8 speakers shows two primary reversals and an overall phase response which, although reasonably good, is not really 'phase linear'. The reasons for this lack of phase linearity are not hard to find when you realise that the effective centres of radiation of each of the drivers cannot be correctly aligned in a speaker cabinet with a flat front. Improvements in phase alignment could only be achieved with a sloping speaker front panel, which is not currently a design feature in the Dali speaker range.

The assessment of the tone burst performance reveals that the acoustical outputs and transient characteristics are far from perfect, whilst the decay response spectra reveal an unusually lumpy primary response and a number of very significant resonances at different points across the spectrum. I have not seen many examples of moderately expensive speakers where the degree of non-uniformity of the primary decay response spectra energy is as pronounced as it is in this particular speaker system.

The number of fundamental 'rolling reso-



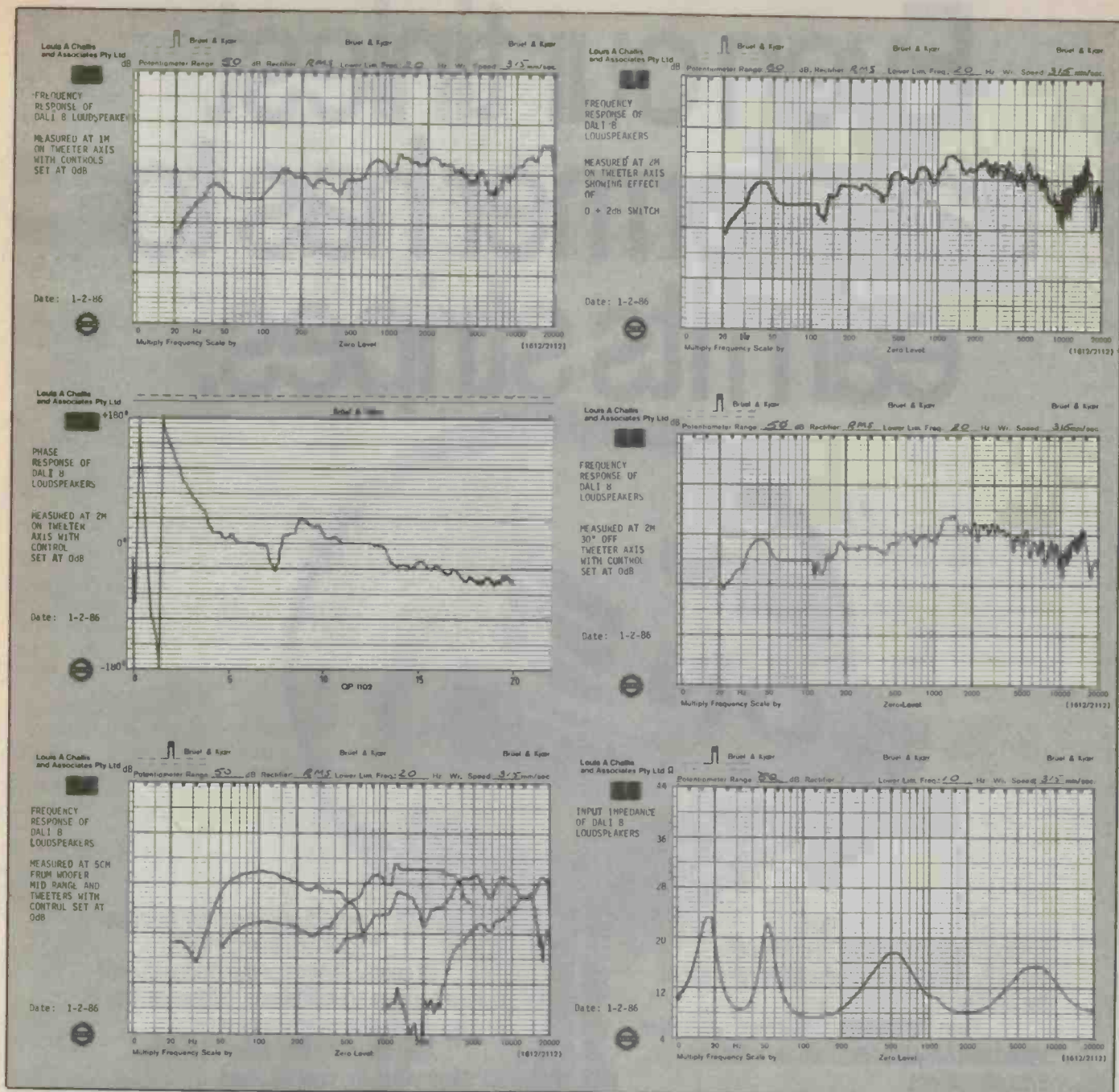

nances' like those exhibited at 5.5 kHz, 8 kHz and 18 kHz gives clear signs that the speaker is likely to have a pronounced colouration on some music, which will either please or disturb the owner according to taste.

By contrast, the polar plots of 1 kHz, 3 kHz and 6.3 kHz are good with more than adequate dispersion and balanced output. The 10 kHz polar response is different from that provided by most other speakers with a positive asymmetry evident, providing an almost flat response from  $-5^\circ$  through to  $+70^\circ$  for the primary arc falling between the expected speaker positions. If the left and right speakers were interchanged, the opposite effect would result and consequently the correct placement of each speaker pair

is of vital importance. The high frequency polar plots are particularly good and I would expect them to remain so for frequencies up to at least 15 kHz.

The measured distortion characteristics of the Dali 8 speakers are different from what I would have expected. With 90 dB output at 2 m (96 dB at 1 m) the distortion at 100 Hz is particularly low at only 0.92%, but the distortion levels at higher frequencies are conversely much higher (1.8% at 1 kHz) and early signs of voice coil 'softening' were detected at 6.3 kHz. This was most pronounced during the measurements of polar response.

As a result of the signs of thermal non-linearity in the tweeter, I was forced to perform the distortion measurements at

6.3 kHz at a reduced level of 86 dB (ie, 10 dB below the normal level). Even then, the level of distortion was 1.4% indicating that there might be problems in sustaining very high outputs if there were either consistent or unusual levels of high frequency content in the music.

### Subjective testing

The subjective testing of the speakers proved much better than I had suspected from the objective test results. I carried out the subjective evaluation over a period of three weeks using a wide range of classical and popular music.

The first series of tests that I performed used the standard voice content material on Elton John's CD "Ice on Fire" (Rocket 826 ▶

# Even our tiniest transformer has to earn its stripes.



The distinctive three striped Ericsson symbol is not handed out willy-nilly to any product that rolls out of the factory.

Even the tiniest transformers are torture tested and only the fittest are awarded the Ericsson stripes.

At Ericsson, we appreciate your reasons for insisting upon Quality and Reliability—we too employ our transformers in our other products.

The Ericsson Transformer range includes:

- Miniature audio transformers
- Telephone line isolation transformers
- High voltage isolation transformers
- General communication transformers
- Runway lighting transformers

- Telecom approved transformers
- Epoxy cast transformers

Of course, if our standard range doesn't quite meet your specifications, please feel free to consult our design advisory service.

After all, we've learned a lot about transformers in the past 45 years.

For further information, or the address of your nearest distributor, please contact

LM Ericsson Pty Ltd,  
61 Riggall Street, Broadmeadows,  
Victoria 3047. Phone (03) 309 2244.

**ERICSSON**   
It should come as no surprise.



## Polar response plots.

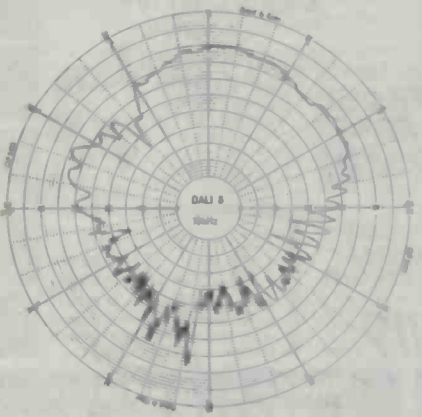
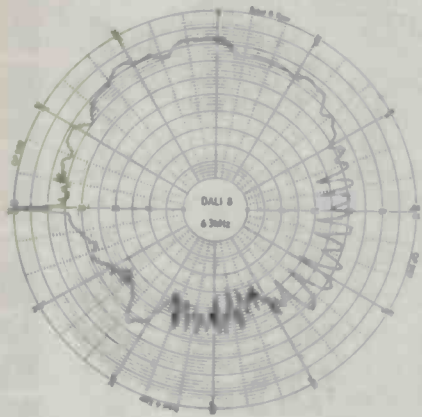
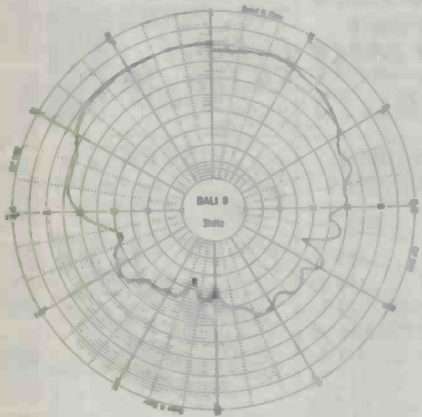
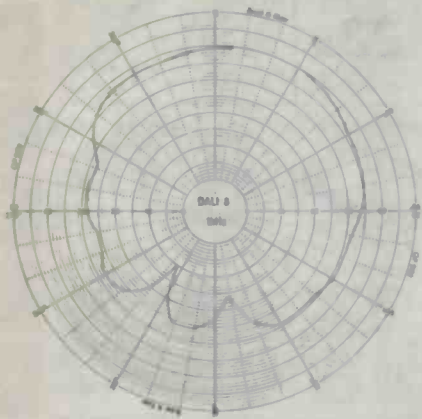

### MEASUREMENT PERFORMANCE OF DALI 8 SERIAL NO. 10420

FREQUENCY RESPONSE : 32 Hz

CROSSOVER FREQUENCIES : 500 Hz, 2.8 kHz, 13 kHz

SENSITIVITY : (for 90 dB average @ 2m)

8.0 VRMS = 8 Watts (nominal into 8 ohms)

#### HARMONIC DISTORTION :

(for levels as indicated)

	-96 dB @ 1m 100 Hz	-96 dB @ 1m 1 kHz	-85 dB @ 1m 6.3 kHz	
2nd	-43.0	-34.9	-51.3	dB
3rd	-44.7	-67.3	-37.3	dB
4th	-9.0	-73.3	-	dB
5th	-58.7	-	-	dB
THD	0.92%	1.8%	1.4%	

#### INPUT IMPEDANCE :

100 Hz	7.3 ohms
1 kHz	10.6 ohms
6.3 kHz	15.4 ohms
Minimum at 125 Hz 7.2 ohms	

213-2) and Ella Fitzgerald's and Louis Armstrong's "Porgy & Bess" (CD Verve 827 475-2) to evaluate voice realism.

The results of these tests were remarkably good and I started to understand more clearly why the Dali designers placed such a strong emphasis on subjective evaluation of their speakers. I listened to a number of other conventional recordings and CD discs of spoken voice and singers and was unable to shake my initial impression that the speaker performance on recorded voice is grade A.

The next series of subjective tests was an evaluation of response with selected low frequency content, the most important of which was the Swedish Hi-Fi Institute's "Ljud och hur det ska låta" record. The results were quite outstanding and the response at 100 dB was clean, deafening and most impressive. The speakers were able to induce window and glass panel resonances in my bookcase that I have never noticed before (and that is no condemnation of the speakers!).

In the classical field, I listened to two new outstanding CDs: Julian Lloyd Webber's "Pieces" (Polydor 827 352-2) and Herbert von Karajan's "Dvorak's New World 9th

Symphony". The audible characteristics of the speakers, although noticeably coloured at high frequencies were still unquestionably exciting and impressive. The speakers displayed excellent stereo imaging, excellent transient response and no audible signs of speaker distress at listening levels of up to 100 decibels. At higher levels, I was able to detect pronounced distortion in the mid frequency region but still no significant distortion at very high frequencies.

The Dali 8 speakers have a number of attributes which will endear them to intending purchasers. The most important is their subjective performance which I rate as being above average in most critical areas. The speakers do exhibit a pronounced colouration which most listeners are likely to find pleasing rather than disturbing, and this is supplemented by a speaker cabinet design which requires only a modest area of floor space and even though relatively tall, creates only a modest visual impact.

At a recommended retail price of \$2200 per pair, they are not cheap but if you have that sort of money to spend on speakers I would commend a full subjective evaluation, before purchasing an alternative system. ●



**computer**

**components**

**Unlimited**

**Avtex**  
 AUTO-ANSWER  
**\$399**  
**MULTI-MODEM**



**DIP SWITCH MINI RS232 PATCH BOX**  
 DB25 PLUG TO SKT  
 Dip switches allow easy match of most computers to their peripherals.  
 each \$29.50

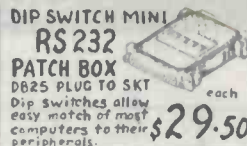

**UNIVERSAL RS232 PATCH LEAD**  
 DB25 PLUG + PLUG!  
 Dip switches in each plug - many various combinations - RF shielded - 2 metres in length.  
 each \$49.90

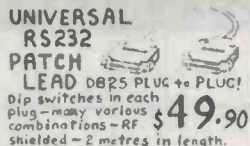

**RS232 mini Patch Box**  
 Male to female  
**\$22.50**  
 Easily interface RS232 device with 25 jumper leads + instructions



**RS-232 MINI-TESTER**  
 Male to female DB connectors 25 pin  
 All pins wired through  
 Dual-colour LEDs  
**\$33**



**FUJI FILM FLOPPY DISK**  
 MD2D MD2DD  
 BOXES of 10  
**LIFETIME GUARANTEE!**  
 Certified 100% error-free!  
 TAX FREE PRICES AVAIL!



**THIS MONTH ONLY**  
 5 1/2" SSDD 10 for \$29  
 5 1/2" DSDD 10 for \$39  
 5 1/4" DS4D 10 for \$75  
 8" DSDD 10 for \$55  
 3 1/2" SSDD 10 for \$65  
 3 1/2" DSDD 10 for \$85

**GENDER CHANGERS**  
 each \$17.90  
 Male to Male OR Female to Female

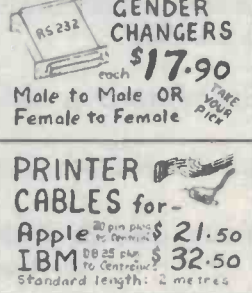

**APPLE COMPATIBLE SLIM-LINE DISK DRIVES**  
 Ready to go \$289.00  
**PARTS and ACCESSORIES!**  
 128K Ram Card \$280 AMBER  
 Parallel Printer Card \$75  
 RS232 Serial Card \$68  
 Super Serial Card \$142 GREEN  
 IEEE 488 Card \$175 MONITOR  
 80 Column Card \$109 \$209  
 2.80 CFM Card \$65  
 Pal Colour Card \$85  
 RGB Colour Card \$125  
 Disk Drive Card \$65



**IBM PC 256K COMPATIBLE**  
**\$2,100**  
 INCL. MONITOR and 2 disk drives  
**IBM ACCESSORIES**  
 512K Ram Board \$150 SALES  
 Mono Graphics card \$350 TAX  
 Mono Text card \$395  
 Floppy Disk controller \$120 INCL.  
 Hard Disk controller \$599 TAX  
 Multi-Function 384K \$289 FREE  
 135W Power Supply \$199 PRICES  
 Detachable keyboard \$205 ON  
 Metal Case 3 slots \$119 REQUEST



**Memories**  
 2716 \$4.95  
 2732 \$5.70  
 2764 \$5.95  
 27128 \$11.90  
 6116 \$2.85  
 6264 \$16.00  
 4116 \$2.50  
 4164 \$2.25  
 41256 \$10.90



**I.E.C. MAINS PLUG and SOCKET**  
 PLUG \$2.70  
 SOCKET \$2.50



**MAKE YOUR OWN... SHIELDED COMPUTER CABLES**  
 6 Conductor 41.50/m \$97.10/m  
 9 " 41.15/m \$77.10/m  
 12 " 41.80/m \$117.10/m  
 16 " 42.50/m \$163.10/m  
 25 " 43.95/m \$260.10/m

**COMPUTER HI-QUALITY RIBBON CABLE FOR I.D.C. CONNECTORS**  
 16 wire 2.20m 34 wire 3.90  
 26 wire 2.95m 50 wire 6.95

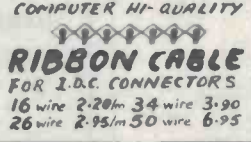

**FULLY APPROVED FOR AUST. 240v MAINS 6A NOISE FILTER \$39**  
 for computers, audio, industrial.



**5 1/4" DISK CASE**  
**\$17.50**  
 FLIP-TOP Holds 50 disk & dividers!  
**Floppy Disk cleaners**  
 5 1/4" Guard against data loss!  
 8" \$12.50 EACH \$19.50

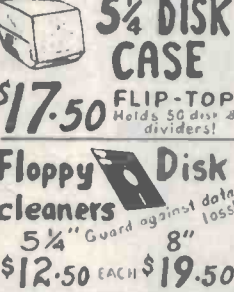

**COMPUTER TERMINAL WALL PLATES**  
 Wood-grain finish - suit standard electrical fittings  
 High Quality!  
 Tax-free prices on request.  
 DB25 SOCKET x2 \$17.95  
 DB25 SOCKET \$13.60  
 DB25 PLUG \$13.20  
 DB9 SOCKET \$9.90  
 5 Pin DIN SOCKET \$8.60  
 Send S.A.E. for full details.



**NEW PRINTER SWITCH (A-B) BOXES**  
 WITH DATA TESTER LEDS  
 2x IN 1x OUT or VICE VERSA!  
 Ideal for computer to 2 printers or printer to 2 computers - no power required!  
 RS232 SERIAL \$99.50 + Tax \$119  
 CENT. PARALLEL \$99.50 + Tax \$119

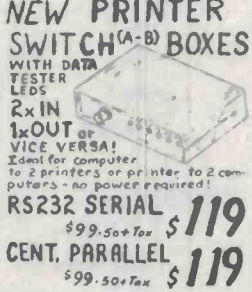

**IDC FLAT-RIBBON CONNECTORS**  
 DB25 MALE \$10.50  
 DB25 FEMALE \$10.90  
 CENTRONICS MALE \$13.50  
 CENTRONICS FEMALE \$13.90  
 34 Pin Edge for disk \$6.50  
 16 PIN SOCKET-FOR PCB \$2.50 ea  
 16 PIN SOCKET-FOR PCB \$3.30 ea  
 26 PIN SOCKET-FOR PCB \$4.40 ea  
 34 PIN SOCKET-FOR PCB \$6.50 ea  
 40 PIN SOCKET-FOR PCB \$6.95 ea  
 50 PIN SOCKET-FOR PCB \$7.50 ea

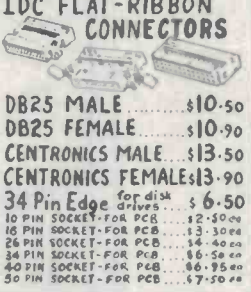

**DB25 SOCKETS**  
 High Quality gold-plated contact pins!  
 Only while stocks last!  
**\$1.50**  
**DIGITAL SPEEDO+ TACHO for Cars**  
 0-199 KPH 0-9900 RPM  
 Bright LED Display with SPEED SENTRY MONITOR \$69  
 Buzzer and light indicates excessive speed - adjust from 40-120 KPH.



See our huge range of TELEPHONE PLUGS, SOCKETS, ADAPTERS etc.  
 U.S. and AUSTR.  
**OVER 30 TYPES AVAIL.**



**CAR HEADLIGHTS "ON" REMINDER**  
 Easy to install with all parts and instructions  
 12V neg. gnd.  
 Light and buzzer \$13 ea



**WIPER DELAY FOR CARS**  
 NEW!  
 2-20 Sec. adjust.  
 12V neg. gnd.  
 Inst. supplied.  
**\$18.00 ea**

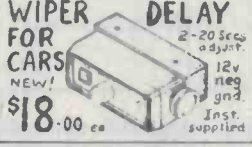

**WIPER DELAY and LIGHTS "ON" REMINDER**  
 Adj. 2-20 Sec.  
 12V, 12V neg. gnd.  
 Buzzer and light for headlights included.  
**\$24 ea**

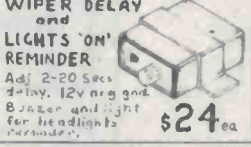

**ALARM CONTROL PANEL**  
 4 INPUTS - N.O. and N.C. instant or delay.  
 6 LED STATUS INDICATORS  
 Entry and Reset ADJUSTABLE DEL.  
 Inbuilt 24MR PANIC or FIRE alarm circuit.  
**NEW, IMPROVED MODEL!**  
 Dry cell or rechargeable 12V battery operation, heavy duty lockable steel cabinet, inbuilt siren and DC 12V power outputs. IDEAL FOR HOMES, SHOPS, OFFICES!  
**\$119**

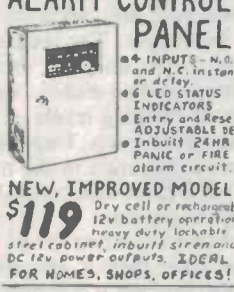

**DIGITAL CODE KEYPAD**  
 Relay output - 12Vdc  
 3 LED indicators  
 3 digit adjust. code  
 6 zero to number lockout  
 suits all alarms  
**\$65 each**  
**INFRA-RED BURGLAR DETECTOR!**  
 Passive infra-red is ideal for all home, office and shop alarms - LED indicator for, upto 12m



**RADIO CONTROL REMOTE SWITCH**  
 CAR alarm model \$110 with 2 transmitters.  
 Single or Dual CHANNEL for home, alarms, garage doors, industrial control etc. These have extended range to 100 metres, 13,000 programmable codes.  
 1CH + TRANSMITTER \$119  
 Extra Transmitters, each \$50  
 2CH + TRANSMITTER \$133  
 Extra Transmitters each \$48

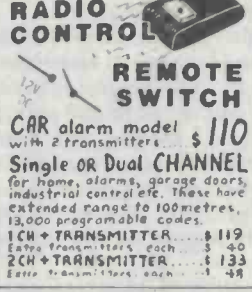

**ALL-PURPOSE BURGLAR ALARM CONTROL CENTRE with Digital Keypad!**  
 240V powered.  
**\$245**  
 6 N.O./N.C. SECTORS for independent alarm detection.

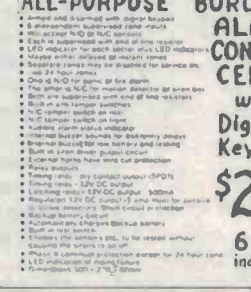

**NEW ULTRASONIC HOME ALARM DETECTOR**  
 Covers 40 sq metres  
 LED indicator and 3 sensitivity controls, 12V  
**\$69**

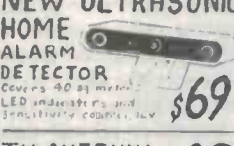

**INFRA-RED LIGHT BEAM DETECTOR**  
 Pulse sensor  
 139

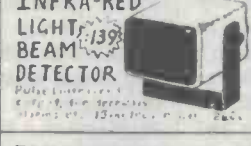

**ULTRASONIC CAR ALARM DETECTOR 12V**  
 Protects the vehicle  
 12V WERE \$49.50

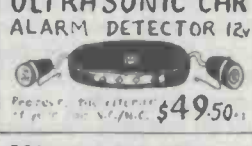

**ALARM OF EMERGENCY!!! STROBE FLASHER**  
 ORANGE \$21  
 BLUE, RED 12V WERE \$28.70



**FANTASTIC! CAR ALARM ULTRASONIC + RADIO KEY**  
 Interior motion detector, current door sensing, panic alarm button, inbuilt siren, delay, reset only  
**\$159**

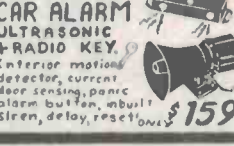

**TV ANTENNA AMPLIFIER \$19**  
 VHF/UHF an FM 6dB Gain  
 DUAL OUTP. II

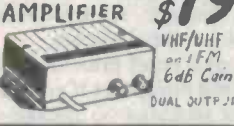

**FM WIRELESS MIKE and RECEIVER**  
 for P.A. etc 37-10MHz  
 Crystal control, 3 frequency channels, 100 mHz to 100 kHz, 100 mHz  
 Set \$89

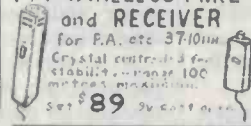

**RECHARGEABLE TORCH and NIGHT-LIGHT**  
 3 in 1 features -  
 Emergency light  
 Auto sensor LDC operated  
 Spot-light  
 each \$25.50



**FM WIRELESS HANDSET INTERCOM**  
 Wall or desk mount  
 Plugs into a 240V outlet.  
**\$119**



**NEW PACK/POST: \$3 Plus 5% ORDER VALUE.**  
 After 4 years at the old rate, our costs, now higher, must be passed on - we still subsidise pack/post costs.

**LEWIS-PAK electronics p/l**

**1a WEST ST, LEWISHAM, NSW**

**569-9797**

24 HR PHONE ORDER SERVICE

**Phone or mail order BANKCARD accepted**



# New generation signal generator

The new signal generator SMG from Rohde & Schwarz offers excellent modulation characteristics, with easy and universal sweep capabilities.

The SMG is a low-noise signal source with crystal-referenced signals in the range from 0.1 to 1000 MHz with 1 Hz resolution. It features a precise output level adjustable between -137 and +13 dBm (+16 dBm for special applications) in steps of 0.1 dB. Most applications are therefore for measurements on transceivers and aeronautical, telemetry, navigation and broadcasting equipment.

High frequency stability and resolution, low residual FM (1 Hz at 250 MHz) and sweep operation with phase-continuous frequency changes allow measurements even on narrowband test items and SSB receivers.

Particularly important for two-signal measurements is the low SSB noise of typically -126 dBc 20 kHz from the carrier at 500 MHz (bandwidth 1 Hz). SSB noise is reduced even more towards lower frequencies; it is

typically -140 dBc at 100 MHz.

The extremely short setting times of 15 ms for frequency and level are important for both test routines where time is at a premium and for fast sweep operation.

The signal generator offers versatile AM, FM, phase pulse and FSK modulation. For two-tone modulation, internal and external sources can be switched on simultaneously. The standard modulation oscillator (fixed frequencies) may be replaced by the AF synthesiser option SMG-B2 which can be used as an internal modulation source and also as an audio signal source (10 Hz to 100 kHz) for external applications. The AF output signal is selectable from 1 mV to 1 V with a resolution of 1 mV.

For further information contact Rohde & Schwarz, 13 Wentworth Ave, Darlinghurst, NSW 2010.



## Rechargeable soldering iron

One of the neatest little pieces of workshop equipment to come on to the market for some time is the Protac Rechargeable Soldering Iron. It is cordless and comes with a sleek black protective stand which also functions as the charging unit.

The soldering iron has built-in solder point illumination. Replacement tips come with an Allen key and cleaning pad, and the tips have very heavy gauge leads so they won't be affected by corrosion.

Power is supplied by a nicad battery which takes about 4 to 5 hours to become fully charged. However, when fully charged the soldering iron heats up ready for use in just 20-25 seconds.

The Protac is sold complete with the battery, a plugpack power adaptor, a leaning sponge and an easy-to-follow instruction pamphlet. It is available from Rod Irving Electronics, (03)543-7877 for around \$60, with a 12 months warranty.



## BRIEFS

### CCTV design service

AWA Rediffusion is offering a design and installation service for industrial and security television systems. Enquiries can be directed to offices in major capital cities; a full engineering facility is available at the NSW head office, 376 Eastern Valley Way, Roseville, NSW 2069.

### Audio monitor power amp

The MPA-2100 audio monitor amp released by Lenco has the following specifications. Frequency response: 1 Hz to 100 kHz  $\pm 0.5$  dB; power: 100 watts into 8 ohms and 400 watts into 8 ohms both channels (mono strapped); 0.005% thd, 8 ohms, 1 kHz, 100 watts.

### Intelligent portable programmer

The new SE-4943 portable programmer promises reduced programming times by at least a quarter with its new algorithms. Another attractive feature is the size of the programmer which will fit into a briefcase and weighs only 1.5 kg. Serial and parallel interface are standard. For more information contact Alfatron, 1761 Ferntree Gully Rd, Ferntree Gully, Vic 3156. (03)758-9000.



### Portable oscilloscope

The new 20 MHz Norma oscilloscope is a light, portable device with two channels designed for use in education and training, in the lab, and in development or test and field service. It features bright image and 2 mV sensitivity. Further information is available from Paton Electrical, 90 Victoria St, Ashfield, NSW 2131.

### Memory scope

Another scope around is the new 2 channel, 20 MHz Triop/Kenwood release which maintains the stored signal even when the power is off. It has a maximum digitising rate of 1  $\mu$ s per word with dual clocks and simple single button operation with GPIB communication. The scope can be operated in normal scope modes. For more information contact Parameters, in Sydney on (02)888-8777 or Melbourne on (03)575-0222.



### Micro-ohmmeter

Keithley Instruments has extended its range of precision measurement equipment with the model 580 micro-ohmmeter. This device offers 10 micro-ohm sensitivity with the ability to clamp the output voltage to 20 mV for 'dry circuit' applications. The meter is useful for contact and connector tests, in aerospace and defence applications and in electronic component and materials testing. More information is available from Scientific Devices, 2 Jacks Rd, South Oakleigh, Vic 3167. (03)579-3622.

### Modula-2 compiler for 8086/88

Logitech Inc has released version 2 of its Modula-2 compiler for 8086/88 microcomputers. Modula-2 is a modern language suitable for system design. Low level routines may be implemented efficiently without sacrificing the benefits of a high level modular programming language. Its advantages are flexible routines for data transfer between different types of variables; interrupt handling; and access to underlying hardware and operating software. For more information contact BJE Enterprises, 35 West Pde, Eastwood, NSW 2122.

### Hand-held cable fault finder

A hand-held fault finding device, the CL250 contact locator, is said to be able to locate faults in cables up to 25 km long. The simply operated device automatically carries out adjustment and calibration. For more information contact Electrical Equipment Ltd, 11-17 Wilmette Pl, Mona Vale, NSW 2103.

## 21A EPROM programmer

The 21A is a low-cost PROM programmer from DATA I/O. This small, compact self-contained programmer can program up to 256K MOS, CMOS or even EEPROMs. It is tailored precisely to suit companies with limited budgets. It may be a little inflexible compared with other more expensive programmers in the market, but why pay for expandable facilities, add-on programming capabilities which you don't need?

The unit has a built-in RS232 interface and an LED digit array display, allowing it to be connected to a host development system. The display shows the ROM type, command used, address and the checksum.

The entire keyboard only has 24 'soft-touch' keys for easy start but has the full capability to edit the data, give commands, address the RAM buffer etc.

All together these features make this a very useful, very

compact, (only eight inches from Anitech, 1-5 Carter St, wide, barely five pounds) unit. Lidcombe, NSW 2141. Data I/O products are available





# SERIES 5000

## INDIVIDUAL COMPONENTS TO MAKE UP A SUPERB HI-FI SYSTEM!

By directly importing and a more technically orientated organisation, ROD IRVING ELECTRONICS can bring you these products at lower prices than their competitors. Enjoy the many other advantages of RIE Series 5000 kits such as "Superb Finish" front panels at no extra cost, top quality components supplied throughout. Over 1,000 sold!

For those who haven't the time and want a quality hi-fi, we also sell the Series 5000 kits assembled and tested.



### POWER AMPLIFIER

WHY YOU SHOULD BUY A "ROD IRVING ELECTRONICS" SERIES 5000 POWER AMPLIFIER...

- 1% Metal Film resistors are used where possible.
- Aluminium case as per the original article.
- All components are top quality.
- Over 1000 of these kits now sold.
- Super Finish front panel supplied at no extra cost. Please note that the "Superb Quality" Heatsink for the Power Amplifier was designed and developed by ROD IRVING ELECTRONICS and is being supplied to other kit suppliers.

**SPECIFICATIONS:** 150 W RMS into 4 ohms  
**POWER AMPLIFIER:** 100W RMS into 8 ohms (+/-55V Supply)  
**FREQUENCY RESPONSE:** 8Hz to 20KHz +0/-0.4 dB 2.8Hz to 65KHz, +0/-3 dB. NOTE: These figures are determined solely by passive filters.  
**INPUT SENSITIVITY:** 1 V RMS for 100W output.  
**HUM:** 100 dB below full output (flat).  
**NOISE:** 116 dB below full output (flat, 20KHz bandwidth).  
**2nd HARMONIC DISTORTION:** -0.001% at 1 KHz (0.0007% on Prototypes) at 100W output using a +/-55V SUPPLY rated at 4A continuous -0.0003% for all frequencies less than 10KHz and all powers below clipping.  
**TOTAL HARMONIC DISTORTION:** Determined by 2nd Harmonic Distortion (see above).  
**INTERMODULATION DISTORTION:** 0.003% at 100W, (50Hz and 7KHz mixed 4:1).  
**STABILITY:** Unconditional.

Cat. K44771 ..... \$359

Assembled and tested \$549  
 packing and post \$10



### PREAMPLIFIER

THE ADVANTAGES OF BUYING A "ROD IRVING ELECTRONICS" SERIES 5000 PREAMPLIFIER KIT ARE....

- 1% Metal Film Resistors are supplied.
- 14 Metres of Low Capacitance Shielded Cable are supplied (a bit extra in case of mistakes).
- English "Lorin" switches are supplied (no substitutes here.)
- Specially imported black anodised aluminium knobs. Available Assembled and Tested. (We believe that dollar for dollar there is not a commercial unit available that sounds as good!)

**SPECIFICATIONS:**  
**FREQUENCY RESPONSE:** High level input: 15Hz = 130KHz, +0/-1dB  
 Low Level input-conforms to RIAA equalisation +0.2dB  
**DISTORTION:** 1KHz -0.003% on all inputs (limit of resolution on measuring equipment due to noise limitation).  
**S/N NOISE:** High Level input, master full, with respect to 300mV input signal at full output (1.2V) 92dB flat -100dB A-weighted. Mid input, master full, with respect to full output (1.2V) at 5mV input 50ohms source resistance connected -86dB flat/92dB A-weighted MC input, master full, with respect to full output (1.2V) and 200uV input signal: -71dB flat -75dB A-weighted.

Cat. K44791 ..... \$319

Assembled and tested \$599  
 packing and postage \$10



### THIRD OCTAVE GRAPHIC EQUALIZER

**SPECIFICATIONS:**  
**BANDS:** 28 Bands from 31.5Hz to 16KHz.  
**NOISE:** 0.008mV, sliders at 0, gain at 0 = 103dB0.  
**20KHz BANDWIDTH DISTORTION:** 0.007% at 300mV signal, sliders at 0, gain at 0, maximum 0.01%, sliders at minimum.  
**FREQUENCY RESPONSE:** 12Hz = 105KHz, +0/-1dB, all controls flat.  
**BOOST AND CUT:** 14dB

Cat. K44590 ..... 1 unit: \$219

2 units: \$429  
 packing and postage \$10

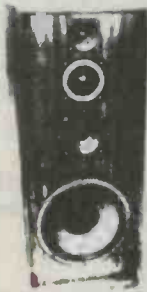

### SERIES 4000 SPEAKERS

- 8 Speakers ..... \$349
- 8 Speakers with Crossovers ..... \$579
- Speaker Boxes (assembled with grill and speaker cutout) ..... \$349
- Crossover Kits ..... \$249
- Complete kit of parts (speakers, crossovers, screws, innerband boxes) ..... \$899
- Assembled, tested and ready to hook up to your system ..... \$995

Errors and Omissions Excepted



SAVE!

### 12 CHANNEL STEREO MIXING CONSOLE

Loaded with professional features but simple to operate. A 3 position attenuation switch with -15dB, 0dB, +15dB, together with separate mic. and line inputs allows perfect matching with any input signal. Foldback with the pre-fade send or on stage monitoring. Includes bass and treble controls plus a left and right 5 band graphic equaliser. Other features include effect return panning, P.P.I. overload indicators and stereo headphone monitoring. Ideal for disco's with 2 stereo disc inputs with cross fade. A high quality 12 channel mixer for the professional enthusiast.

#### SPECIFICATIONS

**Inputs:**  
 12 x Mic -46dB at 47k ohm  
 12 x Line -20dB at 20k ohm  
 12 x Phone -52dB at 50k ohms (approx 2mV at 1kHz)  
 Effect Return -20dB at 50k ohm  
**Outputs:**  
 PGM Out 0dB at 10k  
 F/B Out 0dB at 10k ohm  
 Effect Send 0dB at 10k ohm  
 Rec. Out -4dB at 10k ohm  
 Headphones +10dB at 600 ohm (100 - 1k ohm)  
**Equaliser (Channel):** Bass+/-12dB (100Hz), Treble+/-12dB (10kHz)  
**Equaliser (Master):** 100/330/1k/3k/10kHz (5 band stereo) +/-12dB  
**Frequency Response:** 20 - 20kHz (+/-1dB, -3dB)  
**S/N Ratio (HF-A):** 120dB  
**T.M.D.:** 0.15% at 1kHz  
**Peak Indicators:** 12 x LED  
**Power Supply:** 240V AC 50Hz  
**Power Consumption:** 8W  
**Dimensions:** 662(W) x 356(D) x 105(H)mm  
**Weight:** 8kg  
**RRP \$1,375**



### CRYSTAL LOCKED WIRELESS MICROPHONE AND RECEIVER

**MICROPHONE SPECIFICATIONS:**  
 Transmitter Frequency: 37.1MHz  
 Transmitter System: crystal oscillation  
 Microphone: Electret condenser  
 Power Supply: 9V battery  
 Range: 300 feet in open field  
 Dimensions: 185 x 27 x 38mm  
 Weight: 160 grams

**RECEIVER SPECIFICATIONS:**  
 Receiving Freq: 37.1MHz  
 Output Level: 30mV (maximum)  
**Receiving System:** Super heterodyne crystal oscillation  
 Power Supply: 9V Battery or 9V DC power adapter  
 Volume control  
 Tuning LED  
 Dimensions: 115 x 32 x 44mm  
 Weight: 220 grams  
 Cat. A10452 ..... \$89



### OMNI-DIRECTIONAL WIRELESS MICROPHONE

**Tuneable:** 92 - 104MHz  
**Freq. Response:** 50 - 15kHz  
**Range:** Over 300 feet in open field  
**Modulation:** FM  
**Power Source:** 9V Battery  
**Type:** Electret Condenser  
**Dimensions:** 185 x 27 x 38mm  
**Weight:** 160 grams  
 Cat. A10450 ..... \$19.95



### UNI DIRECTIONAL MICROPHONE DM323

Low impedance microphones that must be the best value for money in microphones! Features on/off switch and available in the following colours: White, Blue, Red, Yellow, black and Gold.  
**Impedance:** 600 ohms  
**Frequency Response:** 100 - 15kHz  
**Sensitivity:** -76dB  
**Cord/Plug:** 2.9 metre, 6.35mm phone plug  
**Dimensions:** 50 x 200mm  
 Cat. A10133 ..... \$13.95

### UNI DIRECTIONAL LOW IMPEDANCE MICROPHONE DM905

Balanced line microphone with Cannon connector. With AKG insert.  
**Impedance:** 600 ohms  
**Frequency Response:** 50 - 18kHz  
**Sensitivity:** -77dB  
**Cord/Plug:** 5m, Cannon to 6.5mm  
**Dimensions:** 53 x 235mm  
 Cat. A10125 ..... \$108



### MIDRANGE HORNS

Use these quality, all metal, Piezo tweeters for great top end sound in your band speakers, disco sound system, etc. Rated at 30 watts RMS, in a system they will handle over 100 watts RMS.  
 Two sizes to choose from:  
 Size: 4" x 10 1/2"  
 Impedance: 8 ohms  
 Rating: 30 watts RMS  
 Response: 1.5kHz - 14 kHz  
 Dimensions: 102 x 267 x 177mm  
 Cat. C92082 ..... Normally \$49.95  
 This month only \$49.95

Size: 3" x 7"  
 Impedance: 8 ohms  
 Rating: 30 watts RMS  
 Response: 2kHz - 15 kHz  
 Dimensions: 76 x 177 x 145mm  
 Cat. C92084 ..... Normally \$29.95  
 This month only \$29.95  
 Dealers, OEM's, etc., phone (03) 543 2166 for wholesale prices



### SUPER HORN TWEETER

- Requires no crossover and handles up to 100W!
- Sensitivity: 100dB/0.5m
- Frequency Response: 3kHz-30kHz
- Impedance: 8 OHMS
- Size 96mm diameter

Cat. C12102 ..... normally \$17.95  
 On Special at \$14.95

OUR PRICE \$1,275

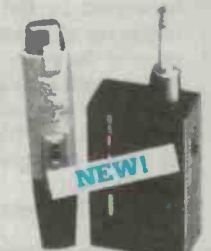

### WIRELESS MICROPHONE RECEIVER WA100

Made by Piezo (Azden) of Japan, this device will turn any microphone fitted with a Cannon Type male socket into a wireless microphone. The receiver will plug into any 6.35mm microphone input. Both transmitter and receiver can be tuned from 76 - 81MHz.  
**Freq. Response:** 50 - 16kHz  
**Tunable:** 76 - 81MHz  
**Field Strength:**  
 Transmitter 10uV/100 metres  
 Receiver 15mV (100%)  
**Battery:** Transmitter LR44 (1.5V)  
 Receiver 3 x UM4 (4.5V)  
 Instructions: Japanese (English not available)  
 Cat. A10520 ..... \$139



### MICROPHONE ECHO ADAPTER (SM100)

Gives microphones "depth" invaluable when using them in "dead" room/halls etc.  
 • Echo effects may be varied  
 • Volume control  
 • Power on LED  
 • Fits in line  
 • Standard 6.5mm socket and plug  
 • Power 9V battery  
 • Input low impedance  
 • Output 30mV (max)  
 • Signal/noise ratio 40dB  
 • Delay time up to 60m seconds  
 • Frequency response 50 - 15kHz  
 • Cord length 75cm  
 • Weight 220 grams  
 • Dimensions 115 x 32 x 44mm  
 Cat. A10530 ..... \$39.95



WE HAVE A FULL RANGE OF PLUGS & SOCKETS!  
**6.35mm STEREO CONNECTORS**  
 Socket Cat. P10223 ..... \$1.40  
 Metal plug Cat. P10125 ..... \$1.40  
 Plastic plug Cat. P10121 ..... \$1.00



### 2 WAY MID SIZED SPEAKER SYSTEM

Designed specifically for compact disc. Excellent bass response to fully utilize the output capabilities of a compact disc. 16" high, woodgrain finish cabinet with brown cloth grille.  
**SPEAKERS:**  
 Speakers: Woofers 6 1/2" carbon fibre reinforced polypropylene cone 10oz magnet. Tweeter 1" soft dome 6oz magnet, damped with ferro fluid.  
**Power Input:** 40 watts rms 85dB w/m  
**Impedance:** 8 ohms  
**Frequency response:** 50-20,000Hz  
**Size:** 250 x 400 x 240mm  
 Cat. C10762 ..... \$299



### 2 WAY MINI BOOKSHELF SYSTEM

Designed specifically for compact disc. This 2 way bass reflex system offers incredible audio performance for its size (9.5"). Woodgrain cabinet allows it to slot in with any audio or video system.  
**SPEAKERS:**  
 Speakers: Woofer - 4" carbon fibre reinforced polypropylene cone 10oz magnet. Tweeter 1" soft dome 6oz magnet, damped with ferro fluid.  
**Power Input:** 30 watts rms 82dB w/m  
**Impedance:** 8 ohms  
**Frequency response:** 80-20,000Hz  
**Size:** 150 x 240 x 160mm  
 Cat. C10760 ..... \$179



### ELECTRONIC RHYTHM BOX

NEW!  
 • 8 selectable rhythms, Trol, Rock, Disco, Bossanova, Waltz, Slow Rock, Cha Cha, Rumba  
 • Power 9V battery or AC adaptor  
 • Volume control  
 • Rhythm tempo control, 10 steps  
 • Power on LED  
 • Footswitch facilities  
 • Output level 150mV (max)  
 • Weight 750 grams  
 • Dimensions 190 x 52 x 132mm  
 Cat. A12048 ..... \$79.95



### DIGITAL ECHO CHAMBER

NEW!  
 Features 2 microphone inputs with 1 volume control, 1 line input with 1 volume control, volume controls for delay time, repeat and echo. Outputs for footswitch, delay and mix.  
 • Delay time 180m seconds  
 • Inputs Mic 1 and 2 -46dB  
 Line -20dB  
 • Input level 30mV (max)  
 • Frequency response 50 - 15kHz  
 • Signal/Noise ratio 40dB  
 • Power 9V battery or AC adaptor  
 • Power on LED  
 • Weight 950 grams  
 • Dimension 232 x 65 x 140mm  
 Cat. A12050 ..... \$95



### ECONOMY 4 CHANNEL MICROPHONE MIXER

VALUE!  
 Its size and simplicity makes this mixer very portable and easy to operate.  
**SPECIFICATIONS:**  
 • 4 low impedance 600 ohm microphone inputs.  
 • Individual gain control for each microphone.  
 • Master volume control  
 • Power on LED  
 • Inputs/Outputs - 6.3mm mono sockets  
 • DC operated (9V battery only),  
 • Input impedance 600 ohm  
 • Output impedance 1.5kohm  
 • Signal/noise ratio 55dB  
 • Frequency response 20Hz to 20kHz plus or minus 2dB  
 • Weight 320 grams  
 • Dimension 148 x 46 x 86mm.  
 • Torque variable range 1-220  
 • Input sensitivity 1mV  
 • Output level 50mV [at input 5mV]  
 • T.H.D. 0.01%  
 Cat. A12001 ..... \$39.50



### ROD IRVING ELECTRONICS

425 High Street, NORTHCOE, 3070 VICTORIA, AUSTRALIA  
 Phone (03) 489 8866  
 48 A Beckett St, MELBOURNE, 3000 VICTORIA, AUSTRALIA  
 Ph. (03) 563 6151  
 Mail Order and correspondence: P.O. Box 620, CLAYTON 3168  
 TELEX: AA 151938



### MAIL ORDER HOTLINE

(03) 543 7877  
 (2 lines)

POSTAGE RATES	\$2.00
\$1-\$9.99	\$3.00
\$10-\$24.99	\$4.00
\$25-\$49.99	\$5.00
\$50-\$99.99	\$7.50
\$100-\$199	\$10.00
\$200-\$499	\$12.50
\$500 plus	\$17.50

This is for basic postage only. Comet Road freight, bulky and fragile items will be charged at different rates. Certified Post for orders over \$100 included free. Registered Post for orders over \$200 included free.  
 All sales tax exempt orders and wholesaler enquiries to RITRONICS WHOLESALE 56 Renner Rd, Clayton, Victoria (03) 543 2166

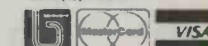

Errors and Omissions Excepted



# A TALE OF ICs AND HYBRIDS

In the '60s and early '70s the strength of the Australian electronics industry depended a good deal on significant barriers to imports. Out of the industry's collapse that followed the removal of those barriers has come a much more sophisticated trade.

Jon Fairall

JOHN WARD IS quite definite: "All this talk about a Technology Park I've heard before. We had one here ourselves. It used to be the case we produced everything we needed. If an engineer was making a radio, he could walk across the road and talk to a guy designing valves; turn left and find someone making switches. Now we've only got 110 people on the staff and we import just about everything."

In Adelaide, the old hands are less than impressed by the state government's new initiatives to attract high technology investment in the state. Time gives them the right to a certain cynicism. After all, those who remember the collapse of Australia's tariff barriers in the '70's, and the loss of jobs that followed, take government wisdoms with a pinch of salt.

Philips has been in South Australia for a



Philips' pick and place machine for surface mounting.

long time, almost since the beginning of electronics. It did indeed have a huge investment in a manufacturing plant at Hendon; like most other international companies of the period, Philips found it profitable to be there. At Hendon, it had begun the manufacture of semiconductors in the early '50s: initially diodes, then later transistors. At one stage the company produced a wider range, in smaller quantities, than almost any other plant in the world.

By today's standards it wasn't really an efficient way of organising manufacture, but in a world where trade links were much longer and more expensive than they are today, it made good economic sense. The plant treated jobs and capital on a large scale. As it became easier to move goods around the world, however, tariff barriers were increasingly seen as shoring up inefficient Australian industries rather than encouraging local production. It took the government of Gough Whitlam to grab the nettle and remove tariffs in the mid '70s. Within years the Australian industry was decimated by cheap imports, as local subsidiaries of overseas giants collapsed their local operation and became importers.

At Hendon manufacturing was reduced steadily from 1975 onward, to the extent that by 1980 there was real fear of the plant being closed. In that year, however, a decision was made to use the manufacturing base at Hendon for the production of hybrid circuits, and later for the manufacture of custom ICs. Given the mood of the times it was a courageous decision. In fact one suspects it may well have been a decision born of desperation as much as anything.

It was also the correct decision. Business, since the nadir of 1980, has boomed as the electronics industry learnt how to exist in a more competitive environment. Today, there is no doubt that the optimists rule in Adelaide. John Ward again: "In 1975 it looked like we didn't have a hope, but here we are in 1986, and business has never looked better". Ward is Technical Manager of the Philips plant in the suburb of Hendon, the only place in Australia, as he tells you with a certain pride, where they make both ICs and hybrids under one roof.

## Today's markets

Every year this decade Ward and his staff have watched the demand for their services



rise. Major customers, as might be expected, are Telecom with the Defence Department coming in a poor second. Among smaller companies, the security industry is heavily represented, but other small operators with designs for hybrids or ICs keep coming through the doors.

It is, nevertheless, a small market. On the other hand competition is also small. There are only two other hybrid makers, Plessey and Hybrid Microsystems, and one other custom chip house: AWA. According to Ward, the market is pretty segmented, with Plessey and AWA taking the lion's share of the defence business, and Philips getting most of the rest.

Ward says one of the major advantages Philips has over other operators in the field is the existence of both hybrid and chip factories under one roof. This means it can give impartial advice to the customer who is unsure of the most cost effective solution to a problem. For instance, one problem encountered at the beginning of any project is to find the best method of fabricating a circuit. Should it be done on a circuit board, on a hybrid, on a custom chip, or on some mixture of the two?

As a general rule, the more expensive the start-up cost, the less expensive the unit cost. So, it costs essentially nothing to

develop a printed circuit board from a schematic of a circuit, but the unit cost of manufacture, even in quantity, is substantial. The start-up costs of a hybrid are quite high, of the order of \$5000 or so, but unit cost is lower. Custom chips cost \$50,000 or so to set up, but the unit cost is negligible. Which is best in a given situation depends for the most part on the simple question of how many units will be sold. Increasingly, this quarter of Australian industry is coming to the belief that it can sell sufficient units to make the set-up costs worthwhile.

One of the big problems, according to the Manager of Philips Microelectronics, Dave Segal, is convincing prospective customers to leave a significant part of the manufacturing cycle out of their control. Since hybrids and chips are always part of some large manufacturing process, the entrepreneur has to be convinced that product will be available when required. In this regard there is no substitute for a convincing track record.

Does Australia really need this kind of competence? Ward argues strongly that it does. Microelectronics is inherently labour saving, he believes. And to the extent that labour costs are one of the big problems facing electronics in this country, microelectronics is on to a good thing.

There is no doubt but that industry as a whole has been slow to move to a new manufacturing technology. The reasons are probably more psychological than technical or financial; designers familiar with a technology are naturally reluctant to move into a new area if the old way still appears to work. To a certain extent, the future of hybrids is probably tied up with associated technologies like surface mounting. This technology is also growing slowly, for much the same reasons. If one goes well or disappears, they all will.

The interesting question is whether events here will move in the same direction as they have in the US, where the advent of these new technologies has meant the divergence of manufacturing and design functions. Like Australia, the US has been slow to adopt SMD techniques, in contrast to the Japanese who are racing into it. If it becomes widely accepted in Australia that design and manufacturing do not go hand in hand, then the future for hybrid and custom chip technologies will be assured. For Philips then, the challenge might be to ward off the new generation of manufacturers who come in under them.

If nothing else though, Philips is one of the great survivors and AWA one of the oldest firms in the country.

## NO READER INFORMATION SERVICE CARD LEFT IN THIS ISSUE?

Then photocopy this card, fill in details, enclose in an envelope and send to:  
**FREEPOST No. 4**  
 The Federal Publishing Company  
 P.O. Box 227  
 Waterloo, NSW 2017  
**No stamp necessary if posted in Australia**

# Electronics Today

## READER INFORMATION SERVICE

To find out more about the products and services in this issue, circle the **READER SERVICE NUMBER** from the advertisement and send this **FREEPOST card today!**

Please circle the category that best fits you.

- A) Engineer/Designer
- B) Technician
- C) Manager
- D) Hobbyist
- E) Interested Consumer

Name .....

Address .....

Postcode .....

1	26	51	76	101	126	151	176	201	226	251	276	301	326
2	27	52	77	102	127	152	177	202	227	252	277	302	327
3	28	53	78	103	128	153	178	203	228	253	278	303	328
4	29	54	79	104	129	154	179	204	229	254	279	304	329
5	30	55	80	105	130	155	180	205	230	255	280	305	330
6	31	56	81	106	131	156	181	206	231	256	281	306	331
7	32	57	82	107	132	157	182	207	232	257	282	307	332
8	33	58	83	108	133	158	183	208	233	258	283	308	333
9	34	59	84	109	134	159	184	209	234	259	284	309	334
10	35	60	85	110	135	160	185	210	235	260	285	310	335
11	36	61	86	111	136	161	186	211	236	261	286	311	336
12	37	62	87	112	137	162	187	212	237	262	287	312	337
13	38	63	88	113	138	163	188	213	238	263	288	313	338
14	39	64	89	114	139	164	189	214	239	264	289	314	339
15	40	65	90	115	140	165	190	215	240	265	290	315	340
16	41	66	91	116	141	166	191	216	241	266	291	316	341
17	42	67	92	117	142	167	192	217	242	267	292	317	342
18	43	68	93	118	143	168	193	218	243	268	293	318	343
19	44	69	94	119	144	169	194	219	244	269	294	319	344
20	45	70	95	120	145	170	195	220	245	270	295	320	345
21	46	71	96	121	146	171	196	221	246	271	296	321	346
22	47	72	97	122	147	172	197	222	247	272	297	322	347
23	48	73	98	123	148	173	198	223	248	273	298	323	348
24	49	74	99	124	149	174	199	224	249	274	299	324	349
25	50	75	100	125	150	175	200	225	250	275	300	325	350

For a prompt reply: Post today!

POST TODAY!



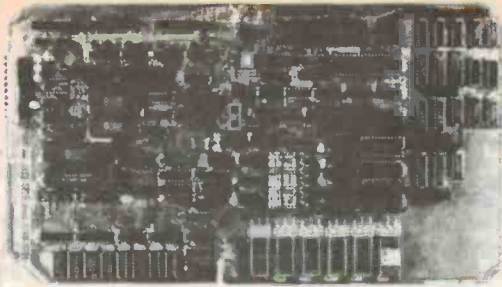

# BIG BOARD II

Jim Ferguson, designer of the "Big Board" distributed by Digital Research Computers, produced this stunning computer "Big Board II".

## FEATURES:

- **4 MHz Z80 CPU AND PERIPHERALS CHIPS:** The Ferguson computer runs at 4MHz. Its monitor code is lean, uses Mode 2 interrupts, and makes good use of the Z80-A DMA chip.
- **64K RAM + 4K STATIC CRT RAM 24K (E) EPROM STATIC RAM:** "Big Board II" has the three memory banks: the first memory bank has eight 4164 RAM's that provide of user space and 4K of monitor space. The second memory bank has two 2K and 8 SRAMs for the memory-mapped CRT display and space for six 2732s or 2K x 8 static RAMS, or pin compatible (E)PROMs, the third memory bank is for RAM or ROM added to the board via the STD bus. Whether bought as a bare board, a full Kit, or assembled and tested, it comes with 450nS2732A EPROM containing the monitor.
- **MULTIPLE DENSITY CONTROLLER FOR SS/DS FLOPPY DISKS:** The "Big Board II" computer has a multiple density disk controller, it can use 1793 or 8877 controller chips. The board has two connectors for disk signal with 34 pins for 5 1/4" drives, the other with 50 pins for 8" drives.
- **EXCELLENT ON BOARD VIDEO:** The "Big Board I" computer uses a 6845S CRT controller and 8002 Video Attributes controller to produce a display of quality terminals. Characters are formed by a 5 x 7 dot matrix on 15.75KHz monitors and a 7 x 9 dot matrix on 15.75KHz monitors. The display is user programmable with the default display 24 lines of 80 characters.
- **STD BUS CONNECTOR:** "Big Board II" brings its bus signals to a convenient place on the PC board where users can solder a STD socket, bus cards can be plugged directly into it, and it can as well be connected by bus cable to industry standard card cages.
- **A Z80-A S10/0 = EIGHT PROGRAMMABLE COUNTER/TIMERS:** The "Big Board II" has two Z80-A CTCs. One is used to clock data into and out of the Z80-A S10/0, while the other is for systems and application use.
- **PROM PROGRAMMING CIRCUITRY AND SOFTWARE:** The "Big Board II" computer has circuitry and drivers for programming 2716s, 2732(A)s, or pin-compatible (E)PROMS.
- **CP/M CAPABILITY:** CP/M with Russell Smith's CBIOS for the "BIG BOARD II" is available ..... (plus tax) \$295  
The CBIOS 5" or 8" is available separately ..... (plus tax) \$65

Cat. K41015 ..... (Excluding tax) **THIS MONTH, ONLY \$395**  
Assembled and Tested (excluding tax) **\$849**  
Less 10% for 3 or more!!

**NEW MENU DRIVEN EPROM PROGRAMMING SOFTWARE TO PROGRAM 2716, 2732, 2764**  
..... **\$49**

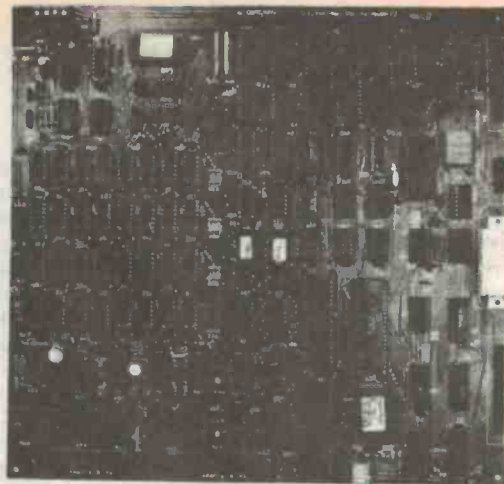

# 6809 UNIBOARD

Many software professionals feel that the 6809 features probably the most powerful instruction set available today on ANY 8 bit micro. Now, at last, all of that immense computing power is available at a truly unbelievably low price.

## CHECK THE FEATURES!!!

- 64K RAM using 4116 RAMS.
- 6809E Motorola CPU.
- Double Density Floppy Disk Controller for either 5 1/4 or 8 inch drives. Uses WD 1793.
- On board 80 x 24 video for a low cost console. Uses 2716 Char. Gen. Programmable Formats. Uses 6845 CRT controller.
- ASCII Keyboard parallel Input interface. (6522).
- Serial I/O (6551) for RS232C or 20 MA loop.
- Centronics compatible parallel printer interface (6522).
- Buss expansion interface with DMA Channel (6844).
- Dual timer for real clock application.
- Powerful on board system monitor. (2732). Features commands such as Go to, Alter, Fill, Move, Display, or Test Memory. Also Read and Write sectors Boot Normal, Unknown and General Flex.
- PC board is double sided, plated through solder masked, 11 x 11 1/2 inch.
- Includes the powerful 3rd generation Motorola 6809 Processor. Ideal for colleges, O.E.M.'s, industrial and scientific uses.

Blank PC board with PAL's and 2 EPROMS ..... **\$239**  
5 1/4" or 8" source diskette add ..... **\$25**

**COMPLETE KIT, fully socketed, all options are standard, no extras to buy!**  
..... (incl. tax) **THIS MONTH, ONLY \$399**  
(Please allow 4 weeks for delivery.)

**YOUR CHOICE OF DISK OPERATING SYSTEMS**  
FLEX tm from TSC ..... **\$359**  
OS9 tm from Microwave ..... **\$459**  
(Please specify 5 1/4 or 8 inch)

## COMPUTER PERIPHERAL KITS!!



**COMPUTER DRIVEN RADIO-TELETYPE TRANSCIVER**  
Here's what you've been asking for, a full transmit-receive system for computer driven radio teletype station. The software provides all the latest "whizz-bangs" like split-screen operation, automatically repeating test message, printer output and more. The hardware uses tried and proven techniques. While designed to team with the popular Microbee, tips are available on interfacing the unit to other computers. (ETI Nov. '84) ETI 755)  
Cat. K47550 **\$135**



**BIPOLAR PROM PROGRAMMER KIT**  
Every digital workshop should have one! Can be used to program the popular fusible-link PROMS like the 74S188-288, 82S23 & 82S123 etc (ETI June '83) ETI 688  
Cat. K46880 **\$69.95**



**EPROM PROGRAMMER EP1 KIT**  
No need for a Micro with EA's great Eprom Programmer suitable for 2716/2758 Eproms. (EA Jan. '82) 82EP1  
Cat. K82013 **\$79.95**  
(Including Textool Socket)



**EPROM PROGRAMMER KIT**  
If you have ever wanted to rewrite or extend the operating system of your microcomputer or if you're interested in dedicated microprocessor applications then this EPROM Programmer is just the thing. It is an inexpensive unit that uses readily available IC's, interfaces directly to the expansion bus on the back of all the popular 8000Z80 microcomputers and programs 2708's, 2716's, 2758's and 2732's. (EA July '80) 80PP71  
Cat. K80074 **\$79.50**  
(Horwood case supplied)

**"IBM AT STYLE" COMPUTER CASING**  
Our latest computer casing, featuring security key switch, 8 slots, and mounting accessories etc. Dimensions: 490(W)x145(H)x400(D)  
Cat. X11091 **\$139**



**PARALLEL PRINTER SWITCH KIT**  
Tired of plug swapping when ever you want to change from one printer to another? This low-cost project should suit you down to the ground. It lets you have two Centronics-type printers connected up permanently, so that you can select one or the other at the flick of a switch (ETI 666, Feb. '85)  
Cat. K46660 **\$79.95**

**Remember, Rod Irving Electronics have over 260 different kits for you to choose from!**



**ON SPECIAL SAVE \$30**  
**300 BAUD DIRECT CONNECT MODEM KIT**  
Modem? What do I want with a modem? Think of these advantages:  
● Can't afford a floppy disc? Use your telephone to access one for the cost of a call.  
● Bored with your old programs? Download hundreds of free programs.  
● Want to get in touch with fellow computer enthusiasts? Use "electronic mail".  
● Ever used a CP/M system? CP-DOS? UNIX? Well a modem will make it your computer a remote terminal on some of the most exciting systems around. Save on ready built modems. (ETI 699, May '85)  
Cat. K46990 **Normally \$129**  
**SPECIAL, ONLY \$99**  
(Short form without phone)



**KEYBOARD AND CASE**  
A stylish low profile case to give your system the professional look it deserves. Comes with an attached encoded, parallel output keyboard and provisions for 2 x 5 1/4" slimline disk drives.  
Cat. X11080 **Normally \$249**  
**SPECIAL, ONLY \$199**



**"IBM XT TYPE" COMPUTER CASING**  
Give your kit computer a totally professional appearance with one of these "IBM type" casings, includes room for 2 x 5 1/4 inch disk drives, connection ports and mounting accessories etc. Dimensions: 490 x 390 x 140mm.  
Cat. X11090 **Save \$20, Now \$99**



SAVE A HUGE \$24!

### 12-240V DC-AC INVERTER INCLUDING 300 WATTS TRANSFORMER

This EA inverter is capable of driving mains appliances rated up to 300VA and features voltage regulation and full over load protection.  
(EA June '82) 821V5  
Nominal Supply: Voltage 12V DC  
Output: Voltage see table  
Frequency: 50Hz ± 0.05%  
Regulation: see table  
Maximum Load: 300VA  
Current Limiting: 30A (primary)  
Efficiency: see table

Relative Load Watts	Output Voltage (RMS)	Input Current (A)	Efficiency (%)	Battery life 40Ah/20h Rate (minutes)
0	210	1.2	0	0
40	235	4.5	60	240
100	240	11.3	62	80
140	240	15.0	69	60
200	240	20.1	78	50
240	240	24.0	79	32
300	235	29.6	82	28

P&P \$10.00 Anywhere In Australia  
Cat. K82062 Normally \$219  
Now on special at \$195



SAVE \$4

### TRANSISTOR TESTER

Have you ever disordered a suspect transistor, only to find that it checks OK? Trouble-shooting exercises are often hindered by this type of false alarm, but many of them could be avoided with an "in-circuit" component tester, such as the EA Handy Tester. (EA Sept '83) 83T78  
Cat. K83090 Normally \$18.95  
SPECIAL, ONLY \$14.95

### OP AMP TESTER

The Op Amp Tester which could save you hours in agonising whether that old op amp that been sitting in the draw for the last year.  
(ETI April '85, ETI 183)  
Cat. K41830 \$26.95

### GENERAL PURPOSE AMPLIFIER CLASS B

One of the handiest "tools" for the electronics experimenter is a genuine purpose audio amp. This module will work from a wide range of supply voltages, has good sensitivity, is robust and reliable - easy to build too! (ETI 453)  
(ETI April '80)  
Cat. K44530 \$14.95

### RAILMASTER PULSE POWER TRAIN CONTROLLER

Here's an up-to-the-minute train controller offering all the most desirable features including inertia, full overload protection, walk-around throttle and excellent low-speed running characters. Probably the best controller available, regardless of the cost!  
(EA Sept '84) 84TC9  
Cat. K84091 \$79.50

### ZENER TESTER

A simple low cost add-on for your multimeter. This checks zeners and reads out the zener voltage directly on your multimeter. It can also check LEDs and ordinary diodes.  
(ETI May '83) ETI 164  
Cat. K41640 \$11.95

## KIT SPECIALS!



SAVE \$10

### 300W "BRUTE" AMPLIFIER

The "Brute" develops 300W into 4 ohms, 200W into 8 ohms! For many audio applications there's no substitute for sheer power - low efficiency speakers, outdoor sound systems, or maybe you like the full flavour of the dynamic range afforded by a high power amp. Whatever your requirement - this "super power" module should fill the bill. (ETI 466) (ETI Feb '80)

Cat. K44660 Normally \$89.95  
SPECIAL, ONLY \$79.95  
(Heatsink not included)

### TRANSFORMER TO SUIT (PF4363)

Cat. M21110 \$79.95



SAVE \$7

### 30V 1A FULLY PROTECTED POWER SUPPLY

The last power supply we did was the phenomenally popular ETI-131. This low cost supply features full protection, output variation from 0V to 30V and selectable current limit. Both voltage and current metering is provided. (ETI Dec '83) ETI 162

Cat. K41620 Normally \$54.50  
SPECIAL, ONLY \$47.50



SAVE \$10

### DUAL TRACKING POWER SUPPLY

Built around positive and negative 3-Terminal Regulators, this versatile dual tracking Power Supply can provide voltages up to 2A. In addition the Supply features a fixed +5V 0.9A output and is completely protected against short circuits, overloads and thermal runaway (EA March '82) 82PS2  
Cat. K82030 Normally \$109  
SPECIAL, ONLY \$99



SAVE \$6

### EA AM STEREO DECODER

AM stereo is now broadcast in Australia on an experimental basis. This add-on decoder works with the Motorola C-QUAM system.  
(EA Oct '84) 84MS10  
Cat. K84100 Normally \$26.95  
SPECIAL, ONLY \$20.95



SAVE \$5

### ELECTRIC FENCE

Mains or battery powered, this electric fence controller is both inexpensive and versatile. Based on an automotive ignition coil, it should prove an adequate deterrent to all manner of livestock. Additionally, its operation conforms to the relevant clauses of Australian Std 3129. (EA Sept. '82) 82EF9  
Cat. K82092 Normally \$19.95  
SPECIAL, ONLY \$14.95

### PLAYMASTER 300 WATT AMPLIFIER

This module will deliver up to 200 watts into an 8 ohm load and up to 300 watts into a 4 ohm load. Comprehensive protection is included and a printer circuit board brings it all together in a rugged easy-to-build module. It can be built in either fully complementary or quasi-complementary versions, so output transistor shortages should be no problem at all. (89PA6) (EA July '80)  
Cat. K80060 Normally \$109  
SPECIAL, ONLY \$99

### ELECTRONIC MOUSETRAP

This clever electronic mousetrap disposes of mice instantly and mercifully, without fail, and resets itself automatically. They'll never get away with the cheese again! (ETI Aug '84) ETI 1524  
Cat. K55240 \$34.95



### LOW OHMS METER

How many times have you cursed your Multimeter when you had to measure a low-value resistance? Well with the "Low Ohms Meter" you can solve those old problems and in fact measure resistance from 100 Ohms down to 0.005 Ohms.  
(ETI Nov '81) ETI 158  
Cat. K41580 \$39.50

### EXPANDED SCALE VEHICLE AMMETER

This "electronic ammeter" can be installed without disturbing the vehicles existing wiring, will operate on 12V or 24V systems and features an easy to read scale indicating charge and discharge currents up to 45 Amps.  
(ETI 329 ETI Feb '81)  
Cat. K43290 \$29.95

### GENERAL PURPOSE PREAMPLIFIER

A general purpose stereo preamplifier using a single LM382 IC which can be tailored for use with magnetic pickups, tape recorders or microphones by changing a few components. (ETI 745) (ETI July '76)  
Cat. K44490 \$9.95

### TELEPHONE EXTENDER

This simple project allows you to leave the phone unattended as you move about the your home or garden.  
(ETI 547, June '77)  
Cat. K45470 \$29.95

### PICTURE PLUCKER FACSIMILE DECODER

Print your own weather maps with your Microbee. This project allows you to decode the signals of shortwave stations transmitting "radio facsimile" weather maps and satellite pictures and then reproduce them on your dot-matrix printer.  
(ETI 736, ETI Sept '83)  
Cat. K47360 \$29.95

### MULTI SECTOR ALARM STATION

Protect your home and possessions from burglars with this up to the minute burglar alarm system. It's easy to build, costs less than equivalent commercial units, and features eight separate inputs, individual sector control, battery back up and self-test facility.

**Specifications:**

- Eight sectors with LED status indication.
- Two delayed entry sectors
- Variable exit, entry and alarm time settings: entry delay variable between 10 and 75 seconds; exit delay variable between 5 and 45 seconds; alarm time variable between 1 and 15 minutes
- Resistive loop sensing - suits both normally open and normally closed alarm sensors.
- Battery back-up with in-built charger circuit.
- Built-in siren driver

Complete kit including deluxe prepunched metal work and electronics for only...  
Cat. K85900 \$129

## NOW IN STOCK! SELECTED

# AEM KITS!

### AEM ULTRA FIDELITY PREAMP

Now in stock! This superb preamp includes: the case, components, prepunched front panel etc. There's nothing else to buy!  
(EA 6010, Oct/Nov '85)  
Cat. K90000 \$269

### LISTENING POST (AEM 3500)

Cat. K93015 \$37.95

### AEM DUAL SPEED MODEM

The ultimate kit modem featuring 1200/300 baud, case etc. Exceptional value for money!  
(AEM 4600 Dec '85)  
\$169

### STROBE KIT (AEM 9500)

Cat. K93018 \$59.95



### 1W AUDIO AMPLIFIER

A low cost general-purpose, 1 watt audio amplifier, suitable for increasing your computers audio level, etc. (EA Nov '84)  
Cat. K84111 \$9.95



### Sensational New Microbee Kit

### MICROBEE ENHANCER 1

This amazing kit for the Microbee is a must for all Microbee owners! Most expansion units up to this time offered at best only one or other features; and this made it impossible to run, for example, complex sound effects mingled with speech. The Enhancer 1 will do all this and much more as well. It is quite amazing how much has been shoe-horned into this compact unit!

- The Enhancer 1's many powerful features include:
- Two ATARIC/COMMODORE/COLECO/SEARS type joystick inputs
  - Two TRS COLOUR COMPUTER type joystick inputs
  - Allows the connection of Touch Pads, Paddles, Proportional Joysticks, Trackballs, Mice, temperature sensors, lights level sensors, transducers, etc, etc!
  - A 4 voice music/sound effects synthesizer
  - A real time clock
  - Unlimited vocabulary speech synthesizer (option)
  - Parallel printer interface (option)
  - A built-in speaker with volume control
  - Listings of all necessary routines for use
  - An impressive demonstration program package
  - Compatible to all Microbees
  - Digital recording and playback of speech and sound.
  - An 8 channel analog to digital converter with variable voltage or variable resistance type analog inputs and also user selectable resolution from 1 to 9 bits
  - A digital to analog converter with selectable resolution from 1-8 bits
  - Allows automatic data acquisition and logging
  - 5 digital input lines, 4 digital output lines
  - A voice input channel.
  - A 40 pin experimenter socket with all 8 analog inputs, 5 digital inputs, 4 digital outputs, 3.58 MHz buffered clock, sound output (so that you can play the sound effects through your Hi-Fi), 3 high resolution voltage comparators, DAC output etc.
- The amazing Microbee Enhancer is available exclusively from Rod Irving Electronics  
Cat. K86010 \$149

## LATEST KITS AT ROD IRVING ELECTRONICS!



### DIGITAL SAMPLER KIT

Digital sampling is at the core of many of the special sound effects used by modern musicians. A trigger input (usually a construction drum pad) triggers a prerecorded sound from the digital sampler. This sound has been recorded into the 4K of onboard memory and can be digitally manipulated so that it sounds completely different on playback. The unit has controls for gain, regeneration and mixing. It also gives a choice of a number of different triggering methods.  
(ETI 1402 May, June, July '86)  
Cat. K41420

Please phone for price and availability

### ELECTROSTATIC HAZARD DETECTOR KIT

It's called electrostatic hazard and it'll, or even its baby brother, jumps on the back of your IC or transistor, then the poor device is never likely to be quite the same again. So, out of a very ordinary collection of bits and bobs, ETI has fashioned a black box that will squat on a corner of your bench for years at a time and beep when ever high tension appears. It may save you a lot of trouble, particularly if you ever work with CMOS. (ETI 173 May '86)  
Cat. K41720

Please phone for price and availability

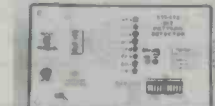

### BIT PATTERN GENERATOR KIT

In applications where you are required to look for a particular byte of information in a serial or parallel data path, short of a logic analyser or a storage oscilloscope, there is not a lot to help you. However, this Bit Pattern Generator gives you a simple and economical way to detect and display specific bytes of data. It may be used on both parallel and serial data paths.  
(ETI 172, May '86)  
Cat. K41720

Please phone for price and availability



### "HANDS FREE" OR LOUSPEAKER TELEPHONE ADATOR

This attractive desktop unit enables "Hands Free" two way conversation over the telephone. The advantages of being able to engage in a telephone conversation with both hands free to take notes, look up information, perform calculations or to operate a computer keyboard are both obvious and desirable. Now you can enjoy all the benefits for less than \$80!  
(EA Nov '85)  
Cat. K86030 \$79

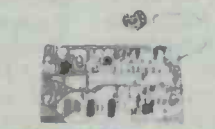

### VIDEO FADER CIRCUIT

Add a touch of professionalism to your video movies with this simple Video Fader Circuit. It enables you to fade a scene to black (and back again) without loss of picture lock (sync) or colour.  
(EA Jan '86, 85T10)  
Cat. K86010 \$19.95

### PLAYMASTER FM/AM STEREO TUNER

The new Playmaster FM/AM stereo tuner will out perform anything presently available on the market, regardless of price. As well as including a FM tuner section which is every bit as good as any other synthesised design, it is also the only unit featuring a genuine wideband, low distortion AM stereo tuner. Naturally, it has a digital readout, 12 station memory automatic seek and an optional infrared remote control.  
(EA Dec '85, Jan-Feb '86 85Lu12)  
Cat. K86020 \$399



### THE BUSKER PORTABLE AMPLIFIER

This handy amplifier is completely portable and is capable of operating from either the mains or a 12V battery. Main features include guitar and high-level inputs, an inbuilt loudspeaker, and bass and treble controls. It's just the thing for busking or for guitar practice.  
(EA Feb '85 85B2E)  
Cat. K85020 (excluding cabinet) \$99

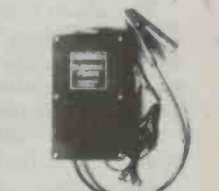

### ELECTRIC FENCE CONTROLLER

Restore discipline to the farm or allotment with this new electric fence controller. It features higher output power and lower current drain than the previous design for use in rural areas.  
(EA Dec '85, 85el11)  
Cat. K85110 \$44.95

### ROD IRVING ELECTRONICS

425 High Street, NORTHCOOTE 3070 VICTORIA, AUSTRALIA  
Phone (03) 489 8866  
48 A Beckett St, MELBOURNE, 3000 VICTORIA, AUSTRALIA  
Ph. (03) 563 6151

Mail Order and correspondence:  
P.O. Box 620, CLAYTON 3168  
TELEX: AA 151938

### MAIL ORDER HOTLINE (03) 543 7877 (2 lines)

POSTAGE RATES  
\$1-\$9.99 \$2.00  
\$10-\$24.99 \$3.00  
\$25-\$49.99 \$4.00  
\$50-\$99.99 \$5.00  
\$100-\$199 \$7.50  
\$200-\$499 \$10.00  
\$500 plus \$12.50

This is for basic postage only. Comet Rod freight, bulky and fragile items will be charged at different rates.  
Certified Post for orders over \$100 included "free"  
Registered Post for orders over \$200 included "free"

All sales tax exempt orders and wholesale inquiries to RITRONICS WHOLESALE, 56 River Rd, Clayton Phone (03) 543 2166

MasterCard VISA  
Errors and Omissions Excepted.



# Motorola: low-cost FET DIPs

Motorola has introduced a new line of medium power TMOS field effect transistors in single or quad configurations.

These devices — the IRFD1Z0/1Z3, IRFD110/113, and IRFD9120/9123 series of single FETs and the IRFE110/113 and IRFE9120/9123 series of quad FETs — designed for low-voltage, high-speed switching applications, are available in 4-pin (single) and 16-pin (quad) low cost plastic DIP packages.

The silicon gate design allows for fast switching speeds needed for today's demanding computer, telecommunications and consumer applications.

The quad TMOS FETs are available with the same electrical characteristics as the single FETs. These devices further in-

crease board component density while dissipating 1 watt per device (3 watts maximum per package).



## ELECTRICAL CHARACTERISTICS

Characteristic	Sym	IRFD1Z0	IRFD1Z3	IRFD110 IRFE110	IRFD113 IRFE113	IRFD9120 IRFE9120	IRFD9123 IRFE9123	Units
Breakdown Voltage Drain-source ( $V_{GS} = 0, I_D = 250 \mu A$ )	$V_{(BR)DSS}$	100	60	100	60	100	60	$V_{dc}$
Drain Current Continuous $T_c = 25^\circ C$	$I_D$	0.5	0.4	1.0	0.8	1.0	0.8	$A_{dc}$
Pulsed	$I_{DM}$	4.0	3.2	8.0	6.4	8.0	6.4	
On-Resistance Drain-Source ( $V_{GS} = 10V_{dc}, I_D = 0.8 A$ )	$r_{DS(on)}$	2.4	3.2	0.6	0.8	0.6	0.8	ohms

## Transparent plastic conductor

A new polymer that is both transparent and a good conductor of electricity has been designed, synthesised and characterised by researchers from the Institute for Polymers and Organic Solids and the department of physics at the University of California, Santa Barbara.

This novel material — poly(isothianaphthene), or PITN — is one of the earliest products from the new field of molecular engineering.

Synthetic polymers, commonly called plastics, are made by linking a large number of identical chemical building blocks, called monomers, into long molecular chains. The first material of this type, celluloid, was created in 1868. Since then plastics have been valued for light weight, pliability, mouldability and electrical insulation.

Until a few years ago the idea that an organic substance could

exhibit the electrical, optical and magnetic properties characteristic of a metal was considered something of a contradiction in terms. The first product made from a conducting polymer appears to be a lightweight plastic battery.

A preliminary description of PITN was published last June in the *Journal of Chemical Physics* and the results of further characterisation studies appeared in December in the *Journal of Synthetic Metals*. Briefly, the process of creating PITN began by modifying the chemical structure of polymer thiophene with the addition of a benzene ring to reduce the energy gap and therefore enhance conductivity. It was also found that PITN was electro-chromic, that is, similar to LCDs.

In conducting polymers the electron motion is mostly restricted to travel along the long

molecular chains. And as electrons move they cause the molecules to deform. By contrast, electrons moving through a metal or semiconductor do not affect the position of the atoms and are free to move in any direction. So, where electron movement in a regular conductor might be compared to rolling

steel balls on a hard floor, in the polymer case it is roughly analogous to rolling them on a soft mattress. Increasing the conductivity of such polymers involves the still imprecise art of altering their atomic structure to free up more electrons and reduce the molecule's resistance to electron motion.

## Fairchild 32-bit CMOS

Fairchild is entering the 32-bit CMOS microprocessor market with a three-chip module that offers five times the performance of a Digital Equipment Corp VXA-11/780.

The Clipper module executes instructions in 30 ns, or at a 5 million instructions per second clip. It will enable microprocessor-based systems to do tasks

that were until now only in the preserve of mainframes or superminicomputers: simulation and the design of very large scale integrated circuits, for example. The Mountain View company's module uses the basic elements of a reduced-instruction-set architecture and runs under the Unix operating system.



## BRIEFS

### Edgewise panel meters

Kuwano Electrical has released its series of edgewise panel meters featuring a flat, stackable design, with self-shielded ring core magnet movement. They are available from Paton Electronics, 90 Victoria St, Ashfield, NSW 2131.

### TI adds functions to Schottky families

Texas Instruments has announced the addition of 17 functions to its Advanced Schottky (AS) and Advanced Low Power Schottky (ALS) family of TTL devices. The new components include line drivers, comparators, parity generators/checkers, buffer/drivers, a shift register, hex buffers and 16-bit error detection and correction circuits. The total available AS/ALS products is now over 300.

### 12.5 MHz 80186 Intel microprocessor

Intel has introduced the 80186-12 microprocessor, a 12.5 MHz version of its 16-bit 80186. The new version offers higher speed, reduced interrupt latency time, reduced memory access latency time and greater than 6 Mbyte per sec-

ond bus transfer rate. For more information contact Intel at Level 6, 200 Pacific Hwy, Crows Nest, NSW 2065. (02)957-2744.

### Fairchild's 212 modem chip

Fairchild has introduced the  $\mu$ A212A monolithic IC which meets Bell 212A standards for 1200 baud modems, and includes a fall-back mode to 300 bps. The 28-pin switched capacitor  $\mu$ A212A also performs dialling, handles handshaking protocols and establishes operating modes under microprocessor control. With a small amount of external circuitry, RS232 and telephone lines can be interfaced.

### New project cases

Amalgamated Instrument Co is supplying a range of weather-proof enclosures for projects. The boxes were originally designed for swimming pool equipment using a plastic material, ASA, reputedly more resistant to ultra violet than ABS. The front is made of a toughened acrylic, also resistant to ultra violet. Four mounting brackets are supplied for surface mounting but it can also be panel mounted with some ingenuity.

The cases retail at \$22.50 from AIC, Unit 7, 21 Tepko Rd, Terrey Hills, NSW 2084. (02)450-1744.

## Precision op-amp

New style hermetically-sealed ceramic DIP (cerdip) versions of the industry-standard line of OP-07, OP-27, and OP-37 precision op-amps have been introduced by Analog Devices, Inc. Complementing the company's plastic DIP and TO-99 metal can versions, the 8-pin cerdip units meet the demand for applications requiring a hermetically-sealed DIP package.

Designated by a 'Q' suffix, the AD OP-07Q, AD OP-27Q and AD OP-37Q are said to offer the same high-performance guaran-

teed specifications as the metal can versions. In addition to facilitating the use of automatic handling equipment, the cerdip versions also guarantee performance for use in military as well as industrial environments. Applications for the op-amps include signal conditioning, data acquisition and use in instrumentation.

Each amplifier type offers grades characterised for different performance levels over temperature. Maximum specifications for offset voltage, off-

set voltage drift, and long-term stability are guaranteed for each type's best grade at 25  $\mu$ V, 0.6  $\mu$ V/°C and 1.0  $\mu$ V/month, respectively. The AD OP-07 is available in the 0 to +70°C and -55 to +125°C temperature ranges, the AD OP-27 and AD OP-37 in the -25 to +85°C and -55 to +125°C ranges.

Specified performance for bandwidth and input noise differentiate the amplifiers. The AD OP-07 specifies typical closed-loop bandwidth of 0.6 MHz and maximum input

noise of 0.6  $\mu$ V<sub>p-p</sub> (0.1 to 10 Hz). Maximum input noise for the AD OP-27 is lower at 0.18  $\mu$ V<sub>p-p</sub> (best grade) and guarantees a minimum gain-bandwidth product of 5 MHz (all grades). The AD OP-37 also guarantees noise of 0.18  $\mu$ V<sub>p-p</sub> (best grade), but additionally guarantees a minimum gain-bandwidth product of 45 MHz (all grades).

For further information contact Parameters, Centrecourt, 25-27 Paul St Nth, North Ryde, NSW 2113. (02)888-8777.

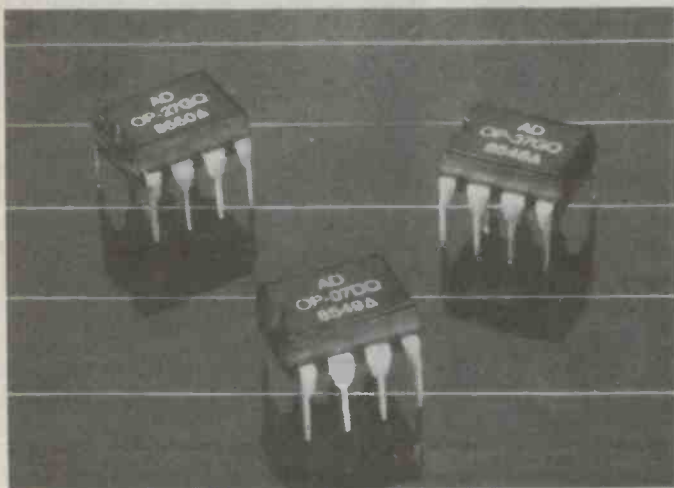

## FRAM gets going

Ramtron Inc of Colorado Springs has just signed a deal with General Motors to explore the possibilities of ferro electronic RAM in cars. Ramtron is a subsidiary of the Australian owned Newtech Development Corp.

FRAM features non-volatile memory, TTL level supply and signals, together with equal and very fast read/write times. Currently Ramtron is demonstrating 1K chips in which each memory cell is just 2 microns by 2 mi-

crons. In addition, Ramtron has also succeeded in demonstrating ferro electric transistors.

One of the developers of the process is Carlos Araujo, who says that there are many applications for non-volatile chips in cars, especially as they come more and more to depend on computer technology. He says applications in the near future include ignition control, control of variable gearing and the collection of service data.

# UHF TUNER

The government's intention to move TV stations from the VHF band to the UHF band became earnest fact when the special broadcasting service switched off its VHF transmitters. While ETI doesn't stand in the way of progress, it does sympathise with those clinging on to their old tellies who can't pick up UHF!

Gerry Nicholson



The finished product. The tuning pot is bottom right with

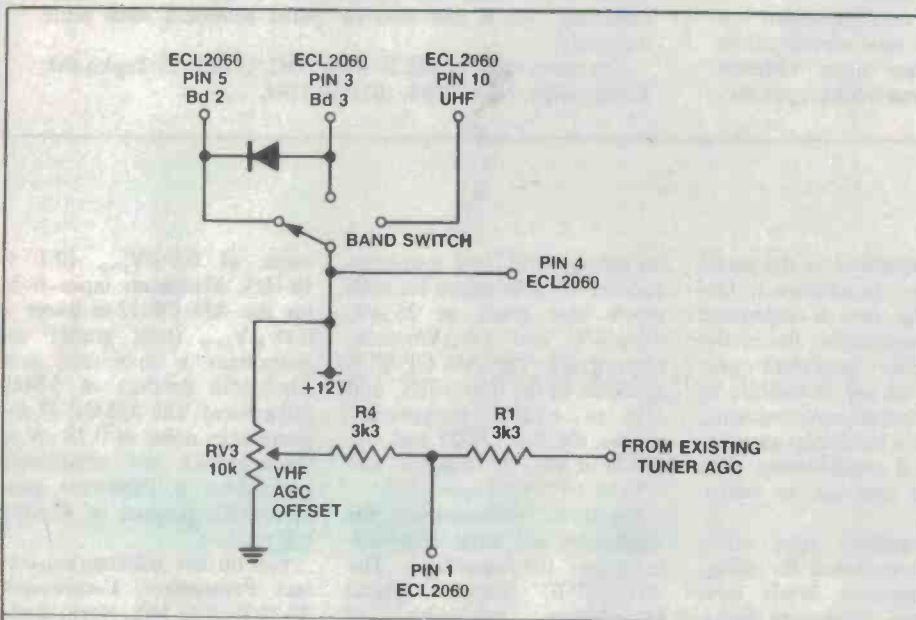

Figure 1. VHF option.

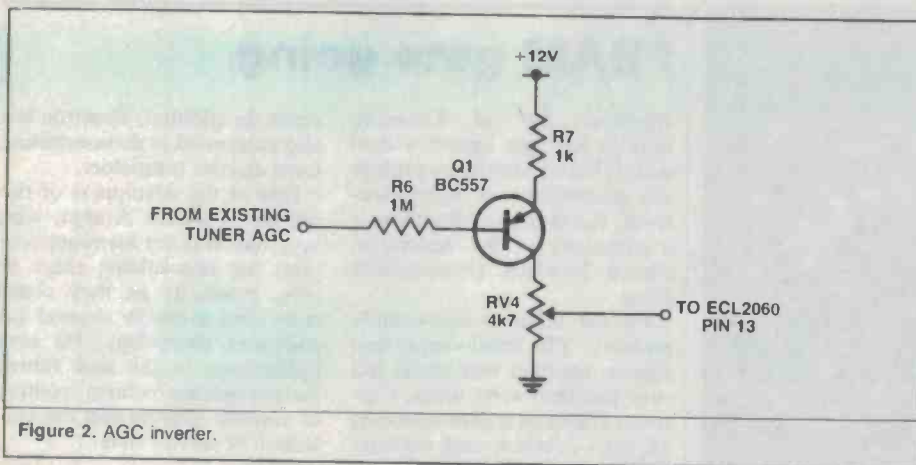

Figure 2. AGC inverter.

## LIVE CHASSIS CAN KILL

Many colour televisions imported into this country have live chassis. If you come into contact with such a chassis and some earth point at the same time, you will be electrocuted.

A live set is one which has the neutral of the mains connected directly to the chassis. In some cases, someone may have reversed the mains leads and the active will be connected to the chassis which is very dangerous.

Most live sets have a warning on the back. However this warning may be on a paper sticker which can come off.

The easiest way to recognise a live chassis is by the lack of a mains transformer. However the set may employ a switched mode power supply, in which case it will be isolated. In a rare case the set may employ an auto-transformer but it will still be live.

WITH THE DEMISE of SBS TV on VHF Channel 0, many people with early model receivers are now unable to receive this service unless they purchase a new set, a VCR or a down-converter. Alternatively, they can convert their existing sets. This article describes a method of converting an existing receiver for less than \$50 and still obtain perfect results.

The circuit described uses a Philips vari-cap tuner ECL 2060. This tuner covers bands 2 channels 0 to 4, band 3 channels 5 to 11 and bands 4 to 5 UHF. (Reconditioned ECL tuners can be purchased for \$25 from Nicholson Electronics, 48 Earnest St, Belmore, NSW 2192. (02)750-5242.)

## Construction

Although we are presently only interested in the UHF band, with the addition of a few parts (shown in Figure 1) you may tune all VHF channels as well. The circuit described is adaptable for most receivers. If ▶





SW1 above it.

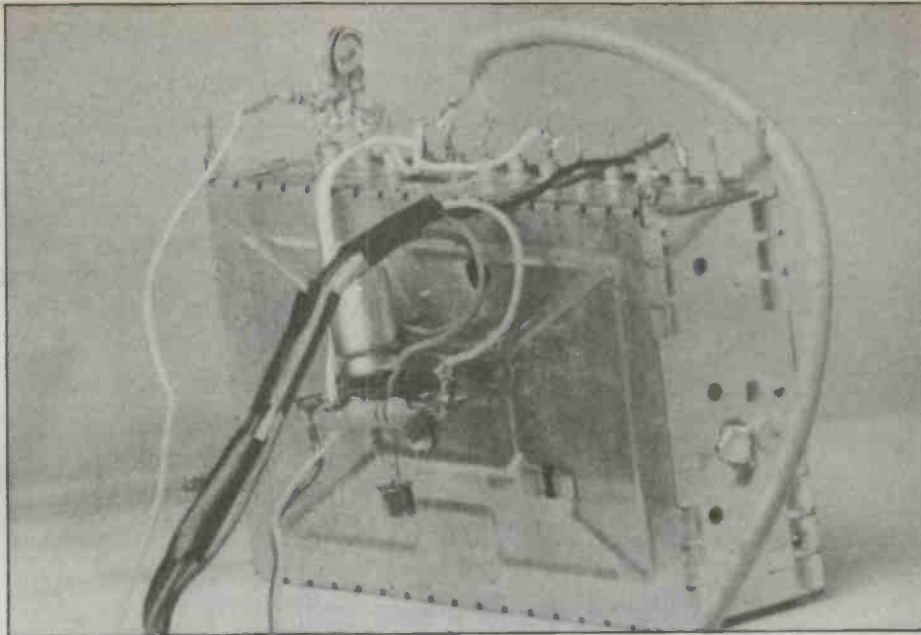

The tuner module. The tuning circuit is built on a tag strip in the middle while the AGC is built directly on to the pins.

The only way to really be certain whether the chassis is isolated or live, is to measure the resistance between the pins of the plug and the chassis. If the ground is connected to the chassis you have a conventional set. If not you have a problem. Either the earth is disconnected, or you have a live chassis set. You can determine which by measuring between the other two pins and the chassis. If either of them is connected directly to the chassis you have a live chassis.

The only safe way to work with a 'live set', is to use a 240 V to 240 V isolating transformer with a sufficient power rating to power the set in question. As mentioned in this article, if you are converting a live set, isolate the antenna input with high voltage capacitors, ie, 0.001  $\mu$ F/600 V and make sure the switch and potentiometer shafts are plastic or insulated with plastic.

### UHF TV

The Department of Communications has adopted a policy of switching all TV broadcasting in the country to UHF TV over the next 20 years. As a result, all expansion to the TV networks will take place in the UHF band.

The ethnic broadcaster, SBS, now broadcasts entirely on UHF. Its network is reticulated around the country from Sydney via the Aussat satellites, and can be received in all major mainland cities and Hobart.

In addition, the other networks are also moving rapidly on to UHF. Sydney has a full range of five services from the translator mounted on top of Kingsgate. In Wollongong, WIN TV is being forced to go UHF, in spite of screaming and kicking from station executives. The planned expansion of rural TV services will also take place on UHF. In all major cities, UHF translators receive signals from the main transmitters and beam them into

VHF shadows using VHF.

As with VHF, UHF reception depends on where you live, your aerial, and its connection to the TV. Obviously, the closer you are, the better. As a general rule, UHF is more susceptible to shadows caused by buildings, trees and hills than VHF. It also demands higher quality coax for the antenna feed. In addition, the use of splitters in the antenna cable creates extra problems at UHF frequencies, unless you find ones especially rated for UHF.

In strong signal areas, a VHF antenna may well do the trick but more than likely, you will need a new antenna. ETI published a practical, low cost project in March 1981 (ETI-728). We also published a masthead amplifier in April (ETI-729), so you might like to consider them as well if you find reception is poor.

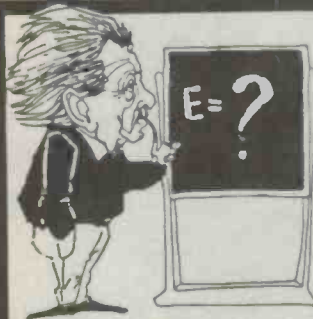

## Loss of memory can be disastrous especially in Computers. Install our **COMPUTER PROTECTOR**

... protects your computer memory against spikes, glitches, lightning, on-off switches, electric motors etc. Max peak surge current up to 4500 amps; transient energy absorption up to 75 joules.



### Westinghouse Systems

80-86 Douglas Pde., Williamstown, Vic. 3016. Tel: (03) 397 1033. Tlx: 37477.

N.S.W.: Bryan Catt Industries P/L. Tel: (02) 526 2222.

QLD: Colourview Wholesale, Tel: (07) 275 3188. S.A.: F.R. Mayfield P/L. Tel: (08) 212 3161.

W.A.: Geo. Moss P/L. Tel: (09) 446 8844.



PIF 3-1A 1AMP 2STAGE +E.L.C. \$82  
PIF 3-3A 3AMPS 2STAGE +E.L.C. \$85  
PIF 3-6A 6AMPS 2STAGE +E.L.C. \$90  
PIF 3-10A 10AMPS 2STAGE +E.L.C. \$95

Plus Sales Tax if applicable Add pack/post  
Plus Bankcard and Visacard. Vic & NSW only.

WS22

# Project 744

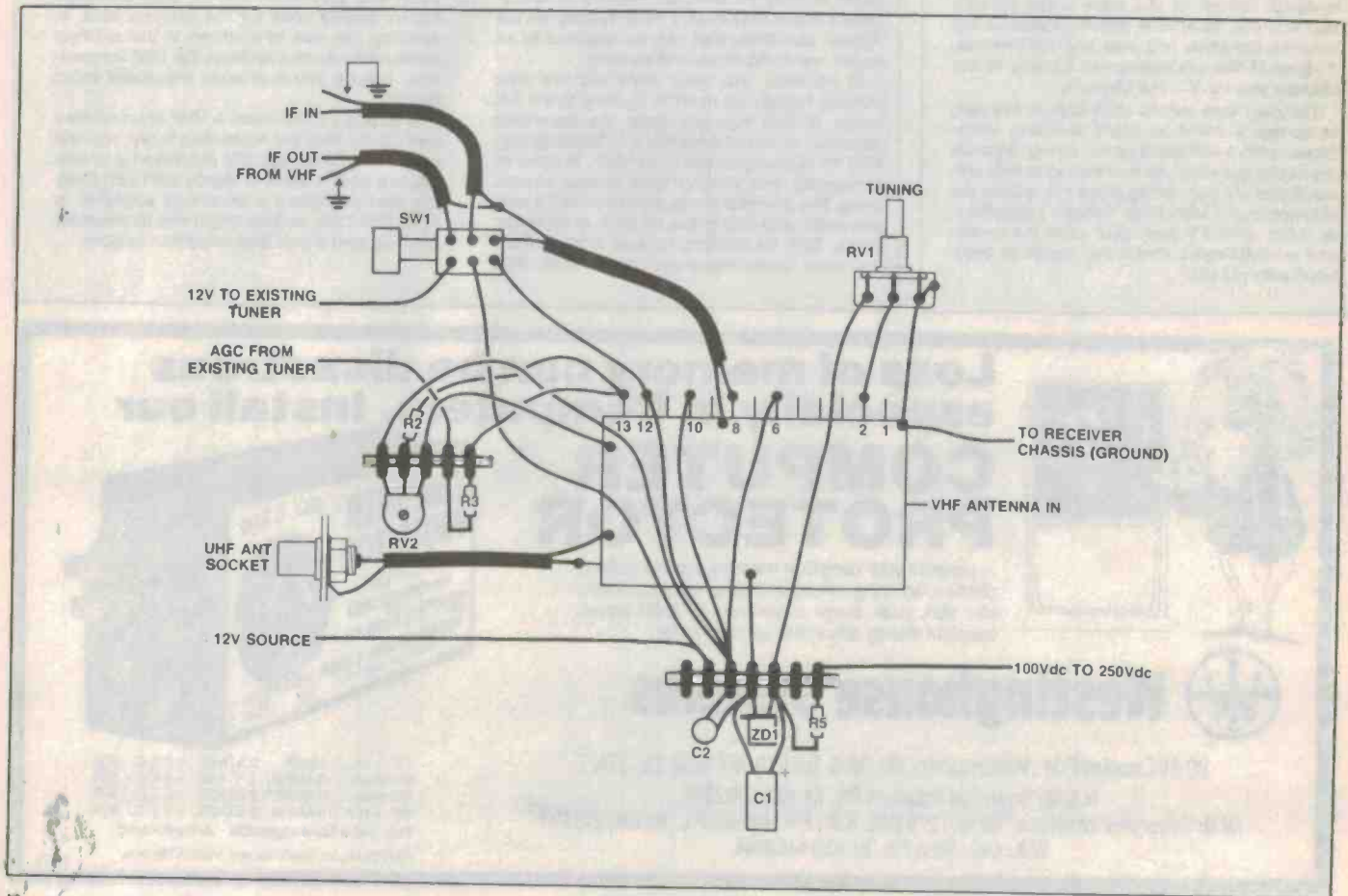
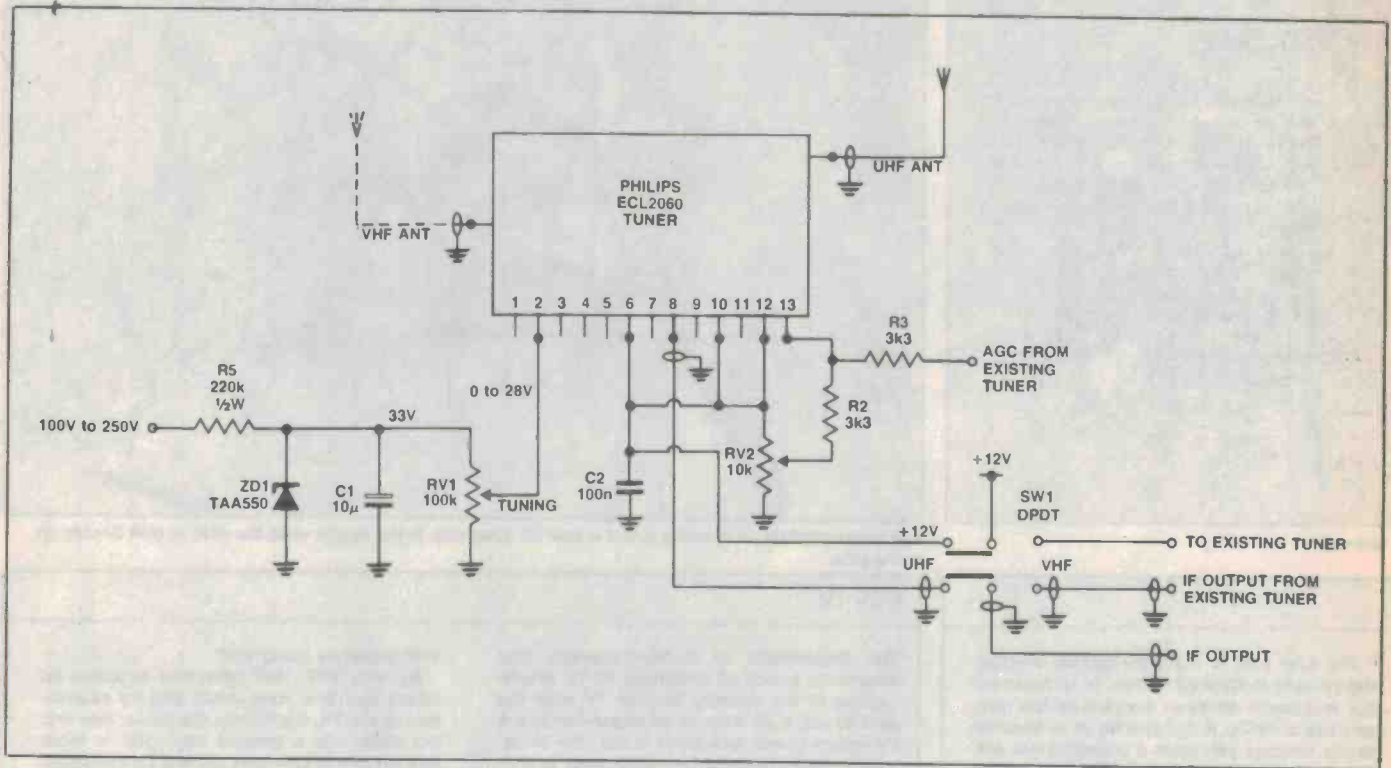



## HOW IT WORKS — ETI-744

Most of the work for this project is done inside the tin can, which is a standard UHF/VHF tuner design with electronic tuning. The VHF section forms an IF for the UHF, so there is only one output for both VHF and UHF tuning, but a separate input for both bands.

The high voltage connection formed by the TAA550 is a simple zener diode voltage regulator. When connected into RV1 it yields a nominal 0-28 volts for tuning.

R2, R3 and the pot RV2 condition the AGC from the set for input into the can. C2 is used for smoothing the 12 V supply.

## PARTS LIST — ETI-744

**Resistors**.....all 1/4 W, 5% unless noted

R1, 2, 3.....3k3  
 R5.....220k 1/2W  
 R6.....1M  
 R7.....1k  
 RV1.....100k potentiometer  
 RV2, 3.....10k trim pot  
 RV4.....4k7 trim pot

### Capacitors

C1.....10μ, 63 V electro  
 C2.....0μ1, 100 V

### Semiconductors

D1.....1N4147 or equiv  
 ZD1.....TAA550 regulator  
 Q1.....BC557 or equiv  
 SW1.....DPDT  
 SW2.....DPST

### Miscellaneous

1 Philips tuner ECL 2060; 7 lug tagstrip; 5 lug tagstrip; 75 ohm socket and coax cable; rainbow ribbon; knob for the pot.

**Price estimate: \$45**

*Note: With positive AGC, R6, R7, Q1 & RV4 are not required. With negative AGC, R2, R3, RV2 are not required. See text.*

you choose the UHF only option, the new tuner must be placed in parallel with the existing one. Alternatively, it is possible to remove the existing unit completely.

You may connect the antenna input in parallel with the existing input or supply a separate UHF input socket. If the chassis is live you will need to add suitable capacitors in series with both the braid and the centre lead of the UHF input cable and use a tuning pot with a plastic shaft or add a plastic extender. (See box.)

Firstly, you need to supply a variable voltage for tuning the tuner. This is achieved by placing 0 to 28 V on pin 2 of the module. The easiest way to do this is to locate a high voltage source of 100 Vdc to 250 Vdc. The supply to the video output stages is usually quite suitable. This voltage is dropped via a 220k resistor, R5, into ZD1 TAA550, a high stability 33 V regulator. C1 acts as a filter cap to form a simple zener

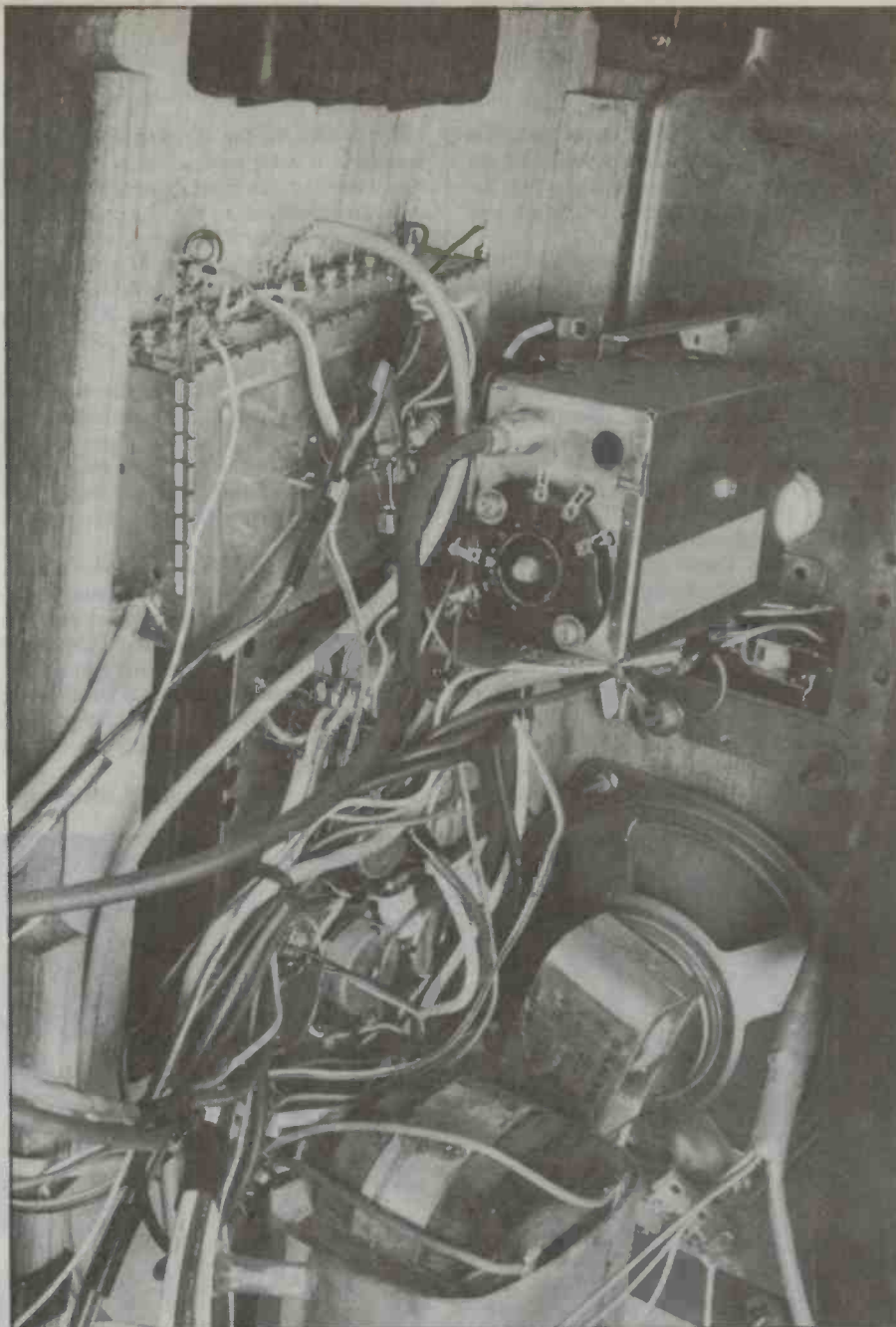

The complete unit installed. The existing tuner is to the right.

## Clearance sale

Your chance to buy well known Silver-Reed Daisy Wheel Printers still in manufacturers carton,

**EXP550 Parallel**  
**EXP550 Serial**

- Print speed 19 cps (max)
- First rate letter quality

Excl Sales Tax

\$380 EA  
 \$380 EA

Incl Sales Tax

\$420 EA  
 \$420 EA

- Bidirectional
- Paper width 432 mm (17 in)

WELL  
 BELOW  
 COST PRICE

For further details contact:- Roger Cotterell  
 VSI Electronics (Aust) Pty Ltd 16 Dickson Ave,  
 ARTARMON NSW 2064. Tel: (02) 439 4655

## Project 744

regulator circuit. If you have trouble locating a voltage of this value, any high voltage will do, provided you change R5 so that the current through it is between 0.5 mA and 1 mA.

RV1 (100k) tunes the complete UHF band. The pot can be mounted almost anywhere you wish on extended leads and tuned with a reasonable sized knob or by adding a vernier. In the former case tuning is slightly critical but with a little practice you should have no trouble. (We have converted quite a number of sets without verniers and have had no complaints.)

The 12 V supply can be developed by removing the 12 V supply to the existing tuner and wiring it via SW1a as shown in the circuit diagram. The IF input lead should be removed from the existing tuner and wired to the centre of SW1b as shown in the circuit diagram. If you decide to replace the tuner completely then, of course, you can eliminate SW1 and permanently wire the 12 V supply to the new tuner.

Finally the rf AGC should be connected. Most transistorised tuners used in early model colour receivers use forward AGC

control. That is, the forward bias to the rf transistor is increased with an increase in signal strength. In most cases the rf transistor is an npn device so the bias increases in a positive direction. This is just what we require. The tuner's existing AGC should be left as it is and connected via R3 to pin 13 of the ECL 2060. The 10k pot, RV2, is included to allow the UHF AGC delay to be adjusted.

In a rare case you may find that the existing VHF tuner uses a pnp transistor. If so, the rf AGC bias will increase from positive to negative and will need to be inverted to control the ECL 2060. Figure 2 shows how to do this replacing resistors R2, R3 and RV2.

It's not really worth the trouble to build a pc board for this project. We mounted the components on some tag strips as you can see from the photo. If necessary you could solder them directly on to the pins of the module. Another option might be to use a bit of veroboard bolted to the cabinet. How you actually do it will probably depend on how much space you have.

The tuner may be mounted in any suit-

able position but should be as close to the existing tuner as possible. If the receiver has a wooden cabinet the tuner's back cover can be screwed into position. If the cabinet is plastic use contact cement or double sided tape. Because of the wide variety of receivers about, the position of the tuning pot, the VHF antenna socket and the VHF/UHF switch is left to your discretion.

### Testing

Once you have completed the wiring you can switch the set on to test the conversion. Check that the VHF tuner operates as before, then switch SW1 to UHF and adjust RV2 for maximum snow on the screen (assuming no station is tuned). Turn RV1 fully anticlockwise then slowly clockwise until a UHF transmission appears. (Without a vernier you need to turn RV1 very slowly.) Keep turning slowly until the picture breaks into sound, then reverse until the picture and the sound are both clean. Finally, turn RV2 (AGC offset) anticlockwise until the picture becomes snowy then advance it until the snow just disappears. Then reassemble the set.

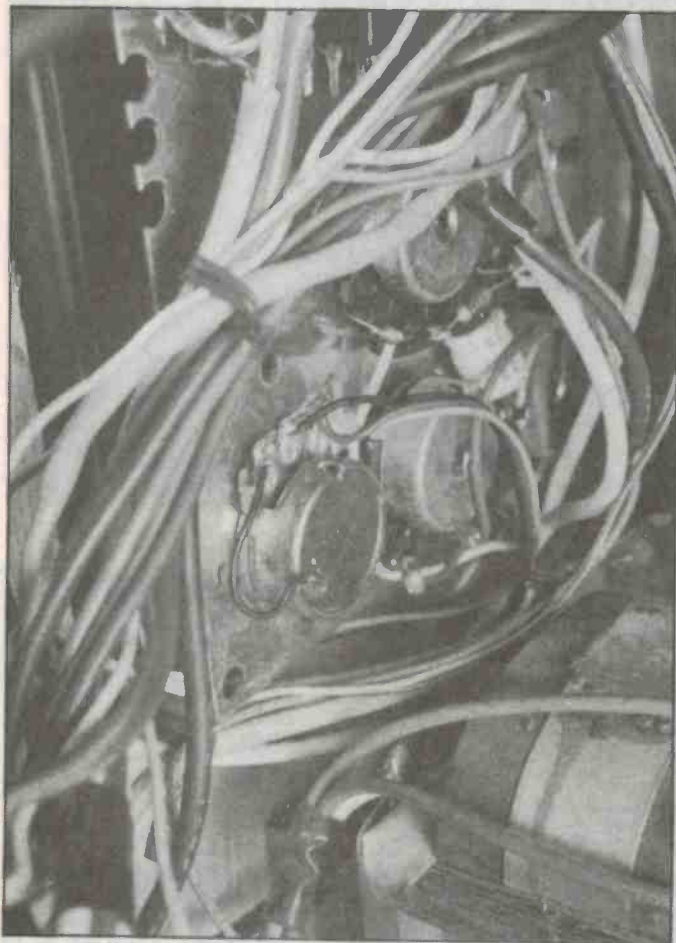

Pot RV1. Notice the earth wire on to the body of the pot. If you locate the pot differently be sure to take this wire to a valid earth.

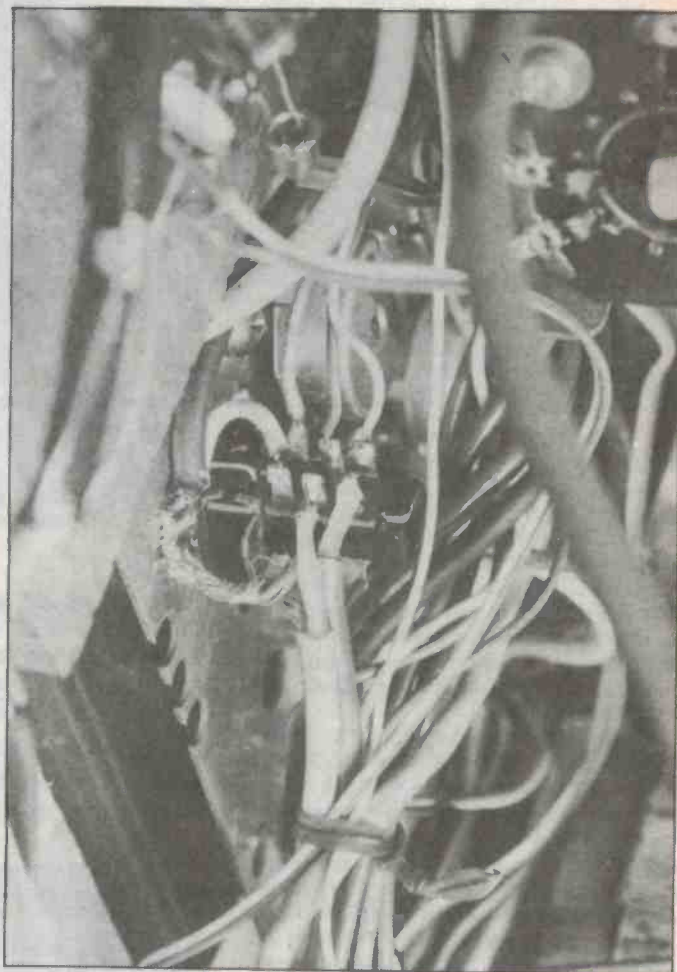

The back of SW1. Notice the shield earth is taken to the chassis.



# Jaycar

## ELECTRONICS

**CELEBRATING OUR NEW  
CATALOGUE WITH A**

**15%  
OFF**

**EVERYTHING  
SALE  
MAY  
ONLY**

To order from Jaycar Telemail - Simply phone (008) 022 888 Toll free and pay the price of a local call. If that's busy, use our Telemail Hotline (02) 747 1888 for orders and enquiries.

If you don't have a copy of our brand new 100 page 1986 Engineers Catalogue, send us \$2.00 and we will send you one. It's crammed with lots and lots of new products plus all the old favourites. And ANYTHING YOU BUY TAKE 15% OFF the price. 15% sale doesn't include freight/mail costs. No account sales, no backorders - goods must be in stock and shipped in May. We cannot accept orders to be shipped after May.

### LS CHIPS AT SILLY PRICES.

CAT	Description	WAS	SPECIAL	Qty 100
25 5000	74L500	80¢	40¢	90¢
25 5002	74L502	80¢	40¢	30¢
25 5008	74L508	1 10¢	55¢	42¢
25 5020	74L520	80¢	40¢	30¢
25 5074	74L574	1 25¢	62¢	50¢
25 5085	74L585	1 25¢	62¢	50¢
25 5109	74L5109	1 25¢	62¢	50¢
25 5125	74L5125	1 25¢	62¢	50¢
25 5139	74L5139	1 45¢	72¢	58¢
25 5148	74L5148	3 95¢	1 97¢	1 50¢
25 5153	74L5153	1 20¢	60¢	48¢
25 5164	74L5164	1 40¢	70¢	56¢
25 5174	74L5174	1 40¢	79¢	56¢
25 5175	74L5175	1 65¢	82¢	66¢
25 5244	74L5244	2 95¢	1 47¢	1 15¢
25 5273	74L5273	2 95¢	1 47¢	1 15¢
25 5393	74L5393	3 50¢	1 75¢	1 40¢

Prices include tax  
As these are so low already do not take 15% off.

### "UNIVERSITY OF HARD KNOCKS"

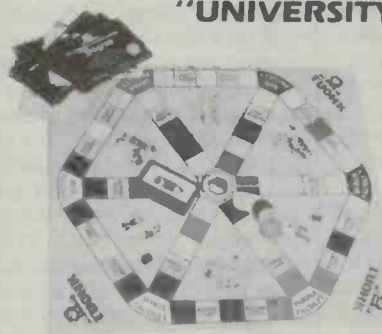

**Board game for VIC 64.**  
Load the cassette into your VIC 64 which contains 5000 questions. Then lay out the attractive vinyl covered playing board and play the game. Cat. X96000

**WAS \$49.95  
ONLY \$35.00  
SAVE 30%**  
(Do not take another 15% off.)

# Jaycar

## ELECTRONICS

Incorporating ELECTRONIC AGENCIES  
**NUMBER 1 FOR KITS**

Toll Free Hotline (008) 022 888  
MAIL ORDER HOTLINE (02) 747 1888

**N.S.W. SHOWROOMS**  
SYDNEY: 117 York Street Tel (02) 267 1614  
CARLINGFORD: Cnr. Carlingford & Pennant Hills Road Tel (02) 872 4444  
CONCORD: 115/117 Parramatta Road Tel (02) 745 3077  
HURSTVILLE: 121 Forest Road Tel (02) 570 7000  
GORE HILL: 188-192 Pacific Highway Cnr. Belmore Avenue Tel (02) 439 47950

**QUEENSLAND** BURANDA: 144 Logan Road Tel (07) 393 0777  
**MAIL ORDERS:** P.O. Box 185, CONCORD 2137  
**HEAD OFFICE:** 115-117 Parramatta Road, CONCORD 2137  
Tel (02) 747 2022 Telex 72293

**SHOP HOURS**  
Carlingford, Hurstville, Sydney & Brisbane  
Monday-Friday 9am - 5:30pm Saturday 9am - 12pm  
Gore Hill  
Mon-Fri 9am - 5:30pm Thurs 9am - 8:30pm Sat 9am - 12pm  
Concord  
Monday-Friday 9am - 8:30pm

**POST & PACKING**  
\$5 \$9.99 \$2.05  
\$10 \$24.99 \$3.75  
\$25 \$49.99 \$4.50  
\$50 \$99.99 \$6.50  
\$100 \$198 \$8.00



**MAIL ORDER VIA  
YOUR PHONE**

ROAD FREIGHT ANYWHERE IN AUSTRALIA ONLY \$13.50

# BROWN-OUT PROTECTOR

Herman Nacinovich

Fluctuations in mains power are sometimes startling: a shade lighter than the black-out comes the brown-out. This period of temporary power disruption can do dastardly things to your electrical equipment. But for those who suffer this sort of erratic problem, rescue is at hand with the ETI-1531 brown-out protector!

MOST OF US, I suppose, tend to take the mains power supply for granted. Indeed, ordinarily supply authorities maintain the supply voltage within strict limits but, unfortunately, significant voltage variations do occur, particularly during electrical storms. We have all observed the lights dimming and the television momentarily blacking out on a stormy night. Such periods of electrical disruption are commonly referred to as 'brown-outs'. Brown-outs may be caused, for example, by lightning, line faults, or overloading by nearby electrical equipment.

Any disruption to, or significant variation from, normal supply voltage can be particularly hazardous to motor operated equipment, such as refrigerators, air conditioners and compressors. Either too high or too low a supply voltage can cause a motor to overheat and, if not adequately protected, to eventually burn out. Momentary disruptions to the supply voltage can cause a motor to stall and, again if not adequately protected, the motor may burn out when power is restored.

The need for protection of electrical equipment against supply voltage disruptions or abnormal voltages is recognised by equipment designers. Appropriate protection systems are available, although presumably intended in the main for industrial equipment eg. multi-phase equipment but there is still a lot of electrical equipment around which seems to be inadequately protected. One reason for this might be cost. At the top of the scale, a microprocessor based system designed to protect against all conceivable kinds of fault would be very expensive indeed. Of course such a system would not be justified for, say, the domestic fridge, but even the simpler protection devices available are not cheap. To be fair, most domestic appliances do have some

form of protection, usually in the form of a circuit breaker or thermal cut-out switch which operates in the event of an overload. Such devices, however, generally respond to an over-current or over-temperature condition rather than to voltage and may react too slowly to prevent at least some stress in equipment if the power supply misbehaves. Consequently, what is needed is a dependable 'do it yourself' device which will protect the most vulnerable equipment.

The ETI brown-out protector will automatically switch off power for a few minutes to allow a system to equalise in the event of a power disruption. Designed to be connected between a 240 Vac outlet and a load (equipment to be protected), it senses when the supply voltage goes outside safe limits and then cuts out power to the load. When normal supply voltage is restored, there is a time delay before power is cut in again. Two front panel adjustments are provided, making this device suitable for a wide variety of applications. One adjustment, labelled RANGE, sets upper and lower limits of mains voltage at which the circuit will cut out power to the load. These limits (ie, threshold levels) are calibrated from  $\pm 5$  per cent to  $\pm 25$  per cent deviation from nominal 240 V. The other adjustment, labelled TIME, is calibrated from 1 to 60 seconds or minutes, depending on the position of a switch on the front panel.

There is no provision for trimming adjustments on the pc board. Any such adjustment, eg, to compensate for variations due to component tolerances, would require suitable test equipment and possibly involve fiddling with live mains voltages, something clearly to be avoided. Therefore, the calibration accuracy of the circuit relies on the use of close tolerance components where specified on the circuit diagram and parts

list. If these are adhered to, calibration should be within reasonable limits for all practical purposes.

Nevertheless, a TEST facility is included to enable a quick check at any time that the circuit is working properly. Pressing this button simulates a mains line voltage drop of approximately 33 per cent, which should trigger the circuit if all is in order. A visual indication is provided by an LED which turns on when the circuit is triggered and goes out when the circuit cuts back in. A second LED lights up continuously if the power is on, whether or not the circuit is triggered.

## Construction

The electronic circuitry for the prototype, including the transformer and power supply, is constructed on a single pc board and mounted in a large plastic instrument case. No special problems should be encountered in wiring up the board. Simply follow the circuit and the component overlay diagrams. The larger components, such as the relay and the transformer, might be mounted last as a matter of convenience.

Particular care should be taken with the external mains wiring to ensure that the right wires go to the right terminals on the board. The mains ACTIVE goes directly from the input cable to one terminal of the fuse holder and from the other to the appropriate terminal on the board. An external wire link is made from the ACTIVE terminal on the board to the LOAD terminal, which connects with one of the switch contacts of the relay. The other LOAD terminal goes to the ACTIVE terminal of the socket mounted on the back panel. In some special applications, the load may be another relay or device which requires an independent connection, in which case, the





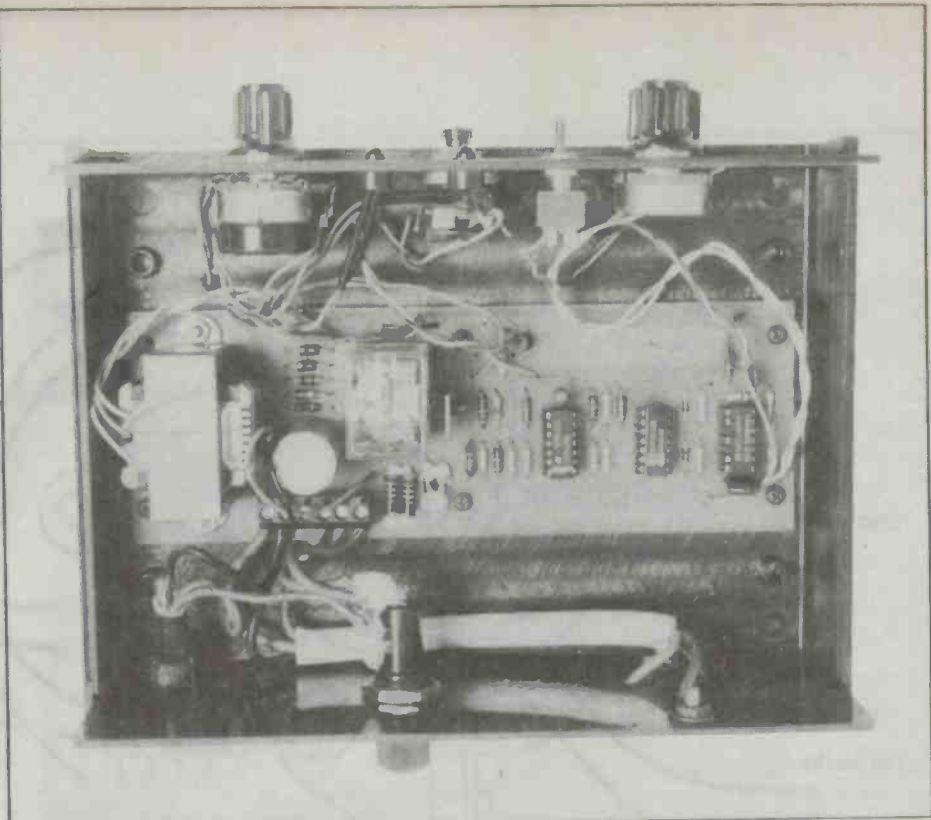

wire link between the ACTIVE and LOAD terminals should be omitted.

Be sure to use 240 V mains rated insulated cable for all external wiring associated with the mains. When wiring has been completed and everything has been double-checked, ensure that all exposed connections, particularly the fuse-holder terminals, are properly insulated to prevent shock by accidental contact.

### Testing

When everything checks out OK, plug into the nearest power point and switch on. Initially, both LEDs should light up then, after a delay set by the TIME setting, the TRIG LED should go out.

Press the TEST button and this LED should go on again for the selected time interval. Repeat this with a load, say a reading lamp, plugged into the back. In this case, the lamp should go out and then turn on again after a delay equal approximately to the TIME setting. If this test checks out OK, the unit should now be ready for use.

### Use

Using the unit is straightforward: simply plug it into any 240 V mains outlet and plug the load into a socket on the back panel. Then, adjust the front panel controls to the desired settings and switch on.

The optimum settings for different appliances may vary, so advice from the manufacturer, if available, should be consulted. Failing this, the following may be a useful guide. In a typical domestic situation, the normal mains voltage at the point of supply can be expected to be within, typically,  $\pm 6$  per cent of nominal 240 V. In addition, SAA wiring rules allow up to 5 per cent voltage drop in the wiring. This represents a total of +6 per cent and -11 per cent maxi-

### PARTS LIST — ETI-1531

Resistors.....	all 1/4 W, 5% unless noted
R1, 2.....	330k, 1/2 W 2%*
R3.....	8k2
R4.....	20k, 1%
R5, 9.....	39k
R6.....	220k
R7, 11.....	15k, 1%
R8, 10.....	12k
R12.....	820R
R13, 14, 15,	
16, 17, 24.....	22k
R18.....	15k
R19.....	10M, 10%
R20.....	1k8
R21, 22.....	1k, 1/2W
R23.....	100k
RV1.....	10k linear
RV2.....	1M linear
Capacitors	
C1.....	1000 $\mu$ 16 V electro
C2.....	10 $\mu$ 25 V tant
C3.....	1 $\mu$ 25 V tant
C4.....	10n poly
C5.....	47n poly
Semiconductors	
D1, 2, 3, 4, 5, 6.....	1N4004
D7, 8, 9.....	1N4148
LED1, 2.....	5 mm LT201R or sim

Q1.....	BC548, BC337, etc
IC1.....	7812
IC2.....	LM339
IC3.....	4001
IC4.....	4541

#### Miscellaneous

T1.....	2851
RLY1.....	12 V coil, 10 A/240 V contacts
PB1.....	momentary pushbutton
F1.....	3AG 5 A-10 A fuse

Panel mounting fuse holder; pcb terminal block (6 terminals); ETI-1531 pc board; 1 m flex with plug; 3-pin mains socket; LED mounting bezels; 200 x 145 x 75 mm case; front panel; 2 x 14-pin IC sockets (optional); 1 x 16-pin IC socket (optional); 6 self-tapping screws; hookup wire.

**Price estimate: \$55.18**

\* R1 and R2 may prove difficult to obtain. If you can't find 1/2 W, 2% types you may replace them with 180k, 1/4 W, 1%. If you do, R3 must also be replaced with a 160k, 1/4 W, 1% to preserve the comparator voltage.

mum deviation. Within these limits, the mains voltage may be considered normal. However, if the load is an electric motor, it will probably consume a heavy current on starting many times greater than the normal current rating of the motor. This imposes a temporary abnormal loading on the mains. The effect of this is offset, to some extent, by an inbuilt time constant in the sensing circuit which tends to ignore momentary

line voltage changes outside the set limits, provided that they are of very short duration. However, it is as well to allow a small margin to prevent false triggering due to motor start-up. With this in mind, a RANGE setting of between 15 per cent and 25 per cent would probably be reasonable for a typical appliance.

Please note that this brown-out protec-

# Project 1531

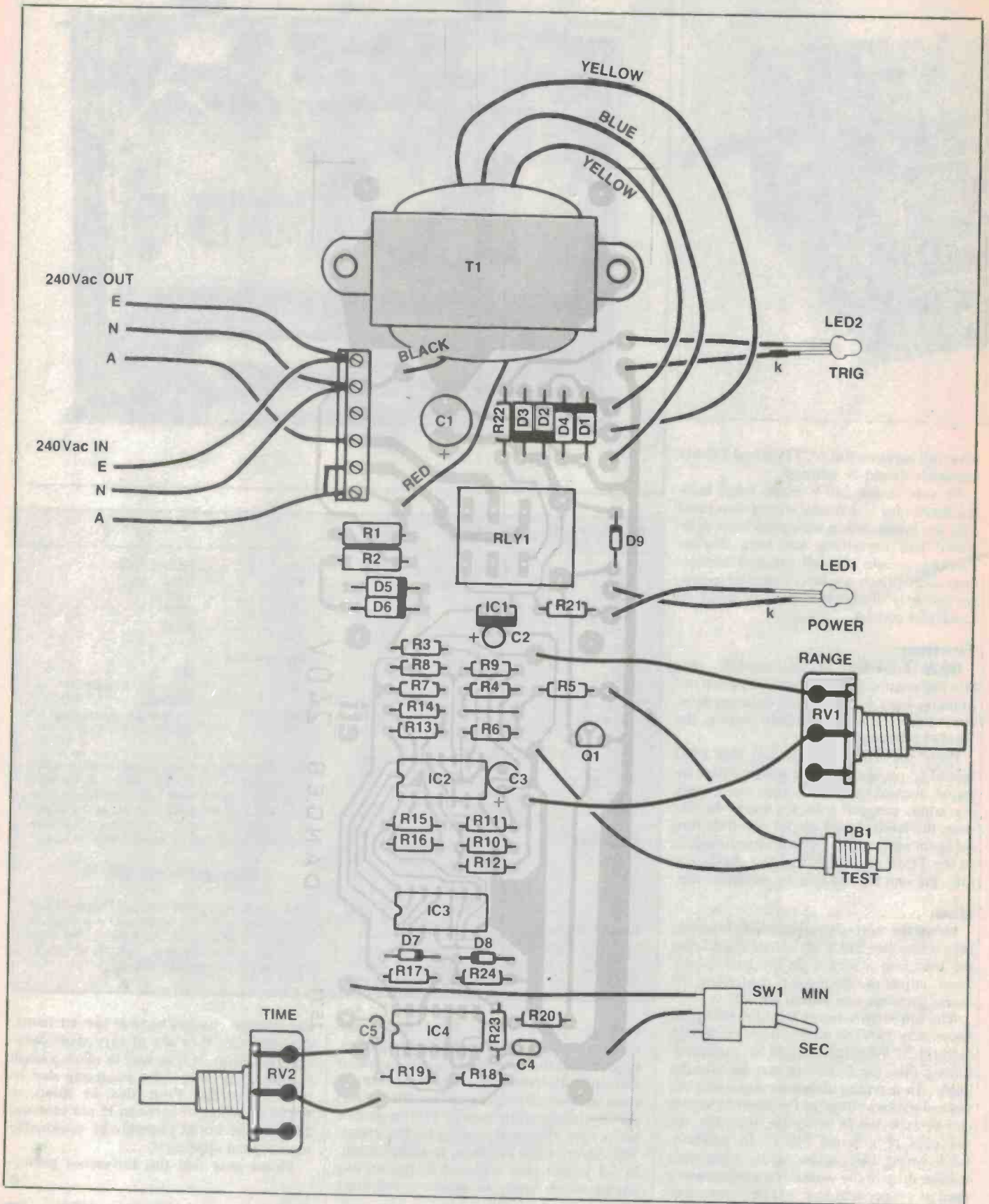



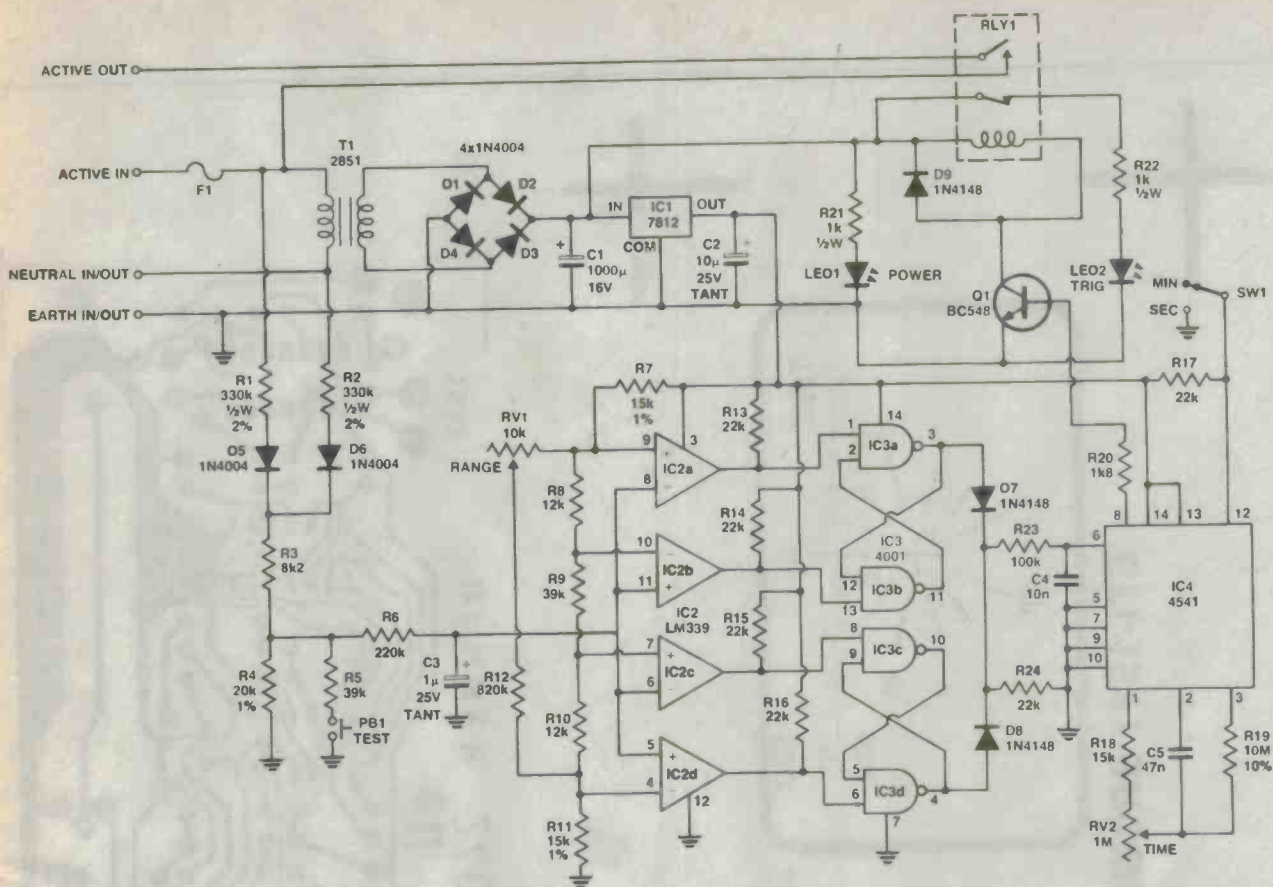

## HOW IT WORKS — ETI-1531

The circuit may be divided broadly into a comparator section and a timer.

The comparator section is unusual. It consists of four comparators IC2a to IC2d arranged in pairs, with the outputs of each pair connected to complementary inputs of a flipflop formed by CMOS NAND gates IC3a and IC3b or IC3c and IC3d, respectively.

An OR gate consisting of diodes D7 and D8 and resistor R15 connects the outputs of the two flipflops via R16 to pin 6 of timer IC4. R16 and C4 filter out transient voltage pulses which might otherwise falsely trigger the timer.

At the input side of the comparator, a potential divider, consisting of resistors R1, R3 and R4 and diode D5, is connected between mains ACTIVE and EARTH. This converts the ac mains voltage into a proportional dc voltage, which is filtered by R6 and C3 to remove ac ripple and goes to a common input of comparators IC2a to IC2d.

The remaining four comparator inputs go to respective points of a potential divider which is connected across the output of a voltage regulator, IC1. An optional resistor R2 and diode D6, corresponding to R1 and D5, are included so that the circuit will work if ACTIVE and NEUTRAL are reversed for any reason, but otherwise take no part in circuit operation.

You may be wondering why four compar-

ators and two flipflops are used in the comparator section when it appears, at first sight, that one or two comparators would be enough. The reason is that, unlike conventional comparator circuits, the comparator section is designed to respond to four input threshold levels. Two of these correspond to selected mains voltage levels above and below nominal 240 V, at which point the circuit will respond by cutting out power to the load. In addition, for each cut-out threshold level, there is a different cut-in threshold level. This gives the circuit hysteresis and hence a degree of immunity from noise on the ac mains.

The timer consists of a 4541 CMOS IC. This useful device includes an oscillator and a 16-stage binary counter all in the one package. A timing sequence is initiated when the pin 6 input voltage goes from logic high to logic low. The output (pin 8), initially in the low state, goes high after a time determined by the oscillator frequency, set by RV2, and the division ratio of the binary counter, which is set by the position of switch SW1. RV2 gives an oscillator frequency range of 1:60. SW1 selects a division ratio of  $2^{10}$  or  $2^6$ , which represents a timing ratio of  $2^6 = 64$ . Although not quite equal to a ratio of 60:1, it is enough for all practical purposes to allow two timing ranges to be calibrated, conveniently, from

1 to 60 seconds and from 1 to 60 minutes (approximately).

Consider now what would happen if the mains voltage were to go outside the upper and lower limits set by RANGE control RV1. The comparator section would detect this and generate a high output voltage at the pin 6 input of IC4. This will reset the internal binary counters and force the output (pin 8) of IC4 low. This output is connected by R20 to the base of Q1 which controls relay RLY1. So Q1 will turn off causing relay contacts SW2a to open, switching off power to the load. When the mains voltage is restored to normal, the voltage at pin 6 of IC4 will go low, initiating a timing sequence. At the end of the selected timing period, the output (pin 8) of IC4 will go high, causing the relay contacts to close and switch on power to the load.

A visual indication of circuit operation is provided by LED2. When the circuit is triggered by a mains fault condition, relay contacts SW2b close and LED2 lights up (provided mains power is available). The LED remains lit when normal mains voltage is restored, until the end of the timing period. This feature provides a useful check on circuit operation. In addition, LED1 acts as a POWER ON indicator.

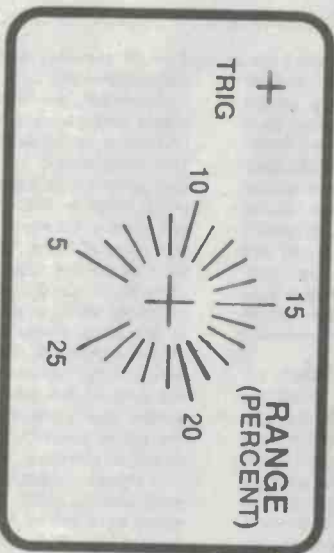
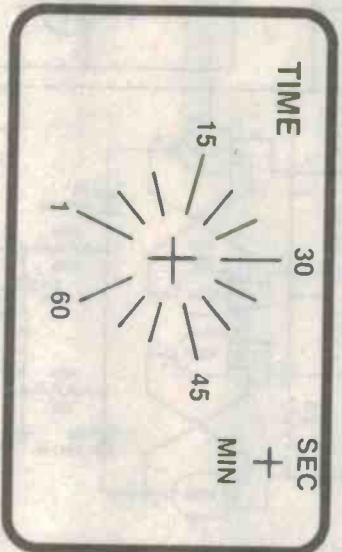
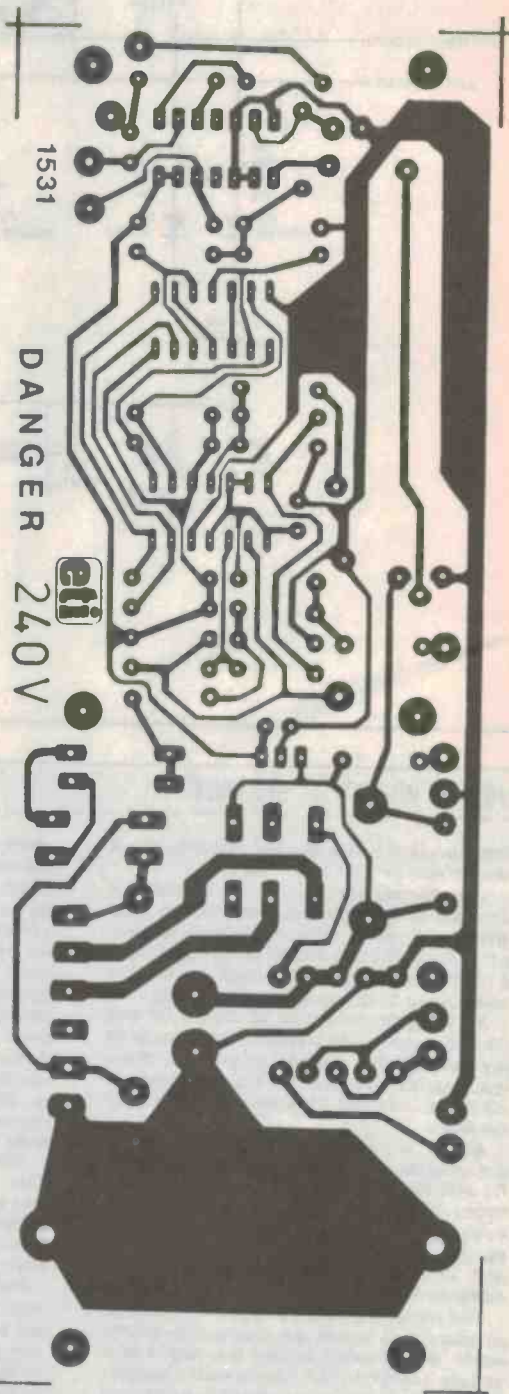

**ETI-1531 BROWN-OUT PROTECTOR**



tion unit is not intended to replace any existing protection devices in equipment, such as overload circuit breakers, which on no account should be removed from equipment. Neither is this unit intended, nor suitable, for use as a transient voltage protector for sensitive electronic equipment.

Acknowledgement is made of technical advice given by Mr Henningham of Ulan County Council, which assisted in the preparation of this project and is much appreciated. ●

## NEARLY BROWNE OFF

It is bad enough when an expensive home appliance fails because of some line or power supply fault, but when it is equipment upon which one's livelihood depends the consequences can be disastrous. This brings me to an experience I had a couple of years ago which provided the stimulus for this project.

I own a small orchard and, during the picking season, store fruit in a refrigerated cool-room prior to shipment to market. It is essential for fruit to be kept cold during storage as otherwise it may spoil. At that time, as in this last season there were quite a few electrical storms in the area with consequent disruptions to mains supply. On more than one occasion the refrigeration system motor stalled, started to overheat and finally was switched off by an inbuilt thermal cut-out unit before too much damage was done. The cut-out unit for this system has to be manually reset, so if someone had not been around on those occasions to reset it (or had not known how to), the result could have been a lot of spoiled fruit.

To understand how an electrical disruption causes the electric motor to overload, it may be helpful to look briefly at how a refrigeration system works.

A typical refrigeration system comprises an electric motor driving a compressor which, in turn, circulates a refrigerant fluid in a closed cycle around the system. In one part of the cycle the fluid is in a highly compressed, hot state. Heat from the fluid is dissipated into the atmosphere and the fluid liquifies. In another part of the cycle, the liquified refrigerant passes into a low pressure section (evaporator) in which it turns into a gas and absorbs heat from the surroundings in the process.

When going flat out, a typical compressor can generate pressures of 200 psi (1400 kpa) or more. Consider what would happen if the mains power cut out for a few seconds while the motor was running. The motor would stop, then try to restart when power was restored. But, if the pressure in the system hadn't had time to equalise, it might easily be enough to prevent the motor from starting again. Obviously, in this case, the motor would overload and possibly burn out unless the power is switched off very quickly. For that reason, refrigeration system manufacturers frequently warn that in the event of a power supply disruption the power should be switched off for a few minutes to allow pressure in the system to equalise.

## MINIMART

**WANTED:** 1981 ETI ISSUES of Mar, May, Apr, Jun, Aug, Oct. Will pay \$3 ea + post. Please write to T. Macha, PO Box 196, Sandy Bay, Tas 7005.

**FOR SALE:** VZ200/300 UNIQUE and first class software, monitor/debugger \$14.95, extended BASIC \$12.50, array utility \$14.95, protect utility \$14.95 and more. W. Obrist, 50 Cobham Ave, West Ryde, NSW 2114.

**FOR SALE:** MICROBEE BITS; serial to parallel Interface \$75; EPROM programmer \$50; printer cable \$30; EDASM on disk \$20; all ono. Ring Ron (02) 680-3453 (h).

**FOR SALE:** TEKTRONIX 2215 oscilloscope. 60 MHz, dual channel, delay timebase, as new condition still in box. Sell for \$2000 ono. Greg (03)359-2408.

**FOR SALE:** CROMEMCO Z2D. Fast 10M hard disk; 192K; terminal; printer; multi-user Unix-like O/S. Development software includes 8 languages and many utilities. \$6500. Ph Mark (03)481-6222 ah.

**FOR SALE:** ZX81 INCL RAM pack, recorder, green screen monitor, keyboard, software, magazine. \$300 the lot. Ring (03)49-5587 after 7 pm.

**FOR SALE:** SCANNER LISTING of Australian civil/military VHF/UHF aeronautical frequencies. Approx 500 sorted freq/location/service. \$5. D. Vale VK3CDI QTHR, PO Box 2395, Mildura, Vic 3500.

**WANTED:** CONTACT with someone with AM-STRAD 6128 programmes of Morse and RTTY. Charles Aston, PO Box 2, Blaxland NSW 2774. (047)39-2646.

**FOR SALE:** NATIONAL PROTOTYPE professional reel to reel b&w VTR. Could possibly work. Experimental value. \$60. If curious ring Peter (02)558-5137.

**WANTED:** SCIENCE FAIR "Globe Patrol", "SW Radio Kit" (No 28110) DX160, FRG7, Drake R-7, Icom, JRC, Trio etc receivers and handbooks, also old WRTVHs. (042)29-2573 Tony.

**FOR SALE:** COMPLETE SET of back issues of ETI 1976-1983. Free. Mr Salmon (02)51-3922.

**FOR SALE:** APPROX 200 valves all new, \$1.50 each. Send SAE for list. G. J. Birch, 2 Blackall Terrace, Nambour, Qld 4560. (071)41-2221.

**FOR SALE:** STC GENESIS G77 video terminal, amber screen, LAN networkable \$200; Philips PM1220 40 cm high resolution monochrome video monitor \$150. J. Wicks (03)547-7787.

**FOR SALE:** 2 ONLY TEAC FD50A-02-U disk drives \$150 ea; 2k x 8 static RAM 50 off HM6116P3 \$2.20 ea; flex disk plus folio for 6809 \$80. J. Wicks (03)547-7787.

● We'll publish up to 24 words free of charge for you. Copy must be with us by the first of the month preceding the month of issue. Please print or type advertisements clearly! Every effort will be made to publish all advertisements received, however, no responsibility for so doing is accepted or implied. We reserve the right to refuse advertisements considered unsuitable.

● Conditions: Your name and address plus phone number (if required) must be included with the 24 words. Reasonable abbreviations, such as 25 W rms or 240 Vac, count as one word. Advertisements must be private and relate to electronics, audio, communications, computing, etc — general advertisements cannot be accepted. Send your advertisement to:  
ETI Mini-Mart, PO Box 227, Waterloo NSW 2017.

Ian J. Truscott's

## ELECTRONIC WORLD MORE & MORE

People are discovering us each week. Both the home enthusiast through to the small manufacturer.

★ ★ ★  
COMPONENTS ●  
TOOLS ● KITS

In any quantity, buy one, or one thousand, we're happy to oblige

SCHOOLS ● CLUBS  
ETC.

Inquire about our bulk discount deals

Save yourself a trip to the city - come

30 LACEY STREET  
CROYDON

OR PHONE

(03) 723 3860/  
723 3094

Mail orders welcome.

ETI READER SERVICE 121

## ELECTRONICS — IT'S EASY!

A two volume set that's written for the intelligent layman as an introduction to electronics theory and methods. Volume 1 discusses electronics systems in general: what they do, how they do it and how a complex electronic system can be broken down into fundamentals. Volume 2 introduces digital instruments, computers and peripherals, and oscilloscopes.

Order yours now from:  
Federal Marketing Book Sales  
P.O. Box 227  
Waterloo, N.S.W. 2017 **eti**

\$5.95 per volume.  
Please add \$1 to the cost of each volume to cover postage and handling



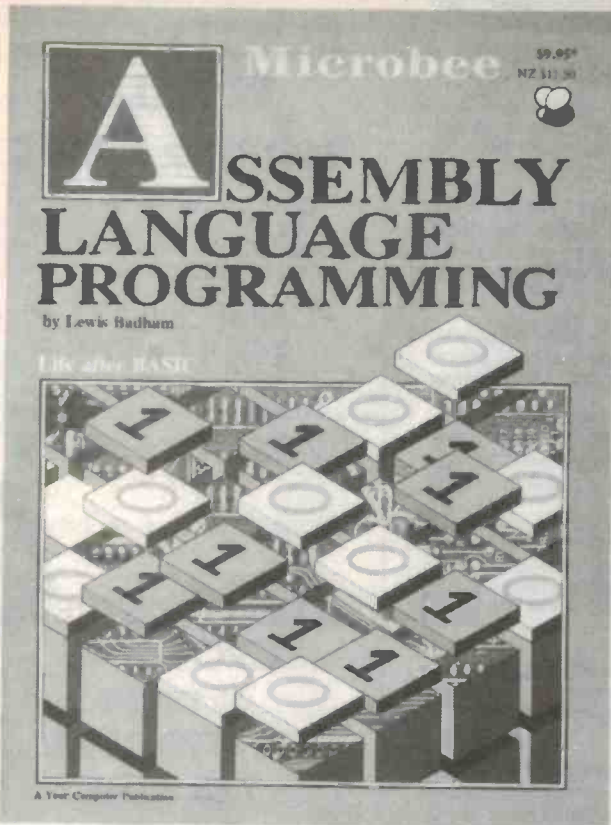

This book is intended for owners of Microbee computers who have become reasonably competent BASIC programmers, and now wish to explore the mysteries of assembly language. It is assumed that you already have an Editor-Assembler fitted to your machine so that you may 'learn by doing'.

Although many articles and books have been written on Z80 assembly and machine language programming, the author believes that none adequately deals with the initial steps, so that they leave the prospective programmer confused and disheartened. This book endeavours to guide the uninitiated step by step through the early stages of assembly language programming.

Although written specifically for the Microbee owner, it is also to a large extent applicable to any home computer which uses the Z80 CPU. In spite of starting at square one, by the end of the book you should be able to write mathematical programs, games programs with moving graphics, (Asteroids, Frogger, etc.), sound effects, and be able to drive a printer; all running many times faster than the equivalent BASIC programs. In addition, you will have a much better understanding of how the computer works, and will then be in a position to read more advanced texts on programming and operation.

**\$9.95 at your newsagent now!**



OR You can obtain your copy by mail order direct from:

**Federal Marketing Book Sales**

P.O. Box 227

Waterloo, N.S.W. 2017

Please add \$1 to the cost of the book to cover postage and handling.



# this **VERSATILE** **CRO** *It could be yours!*

suitable for education, hobby or service

**THE RITRON HUNG CHANG DUAL-TRACE  
20MHz OSCILLOSCOPE FROM ROD  
IRVING ELECTRONICS**

**GREAT FEATURES INCLUDE:**

- ★ Built-in in-circuit component tester
- ★ Z axis (intensity modulation)
- ★ very low power consumption
- ★ video sync filter

**THIS COMPETITION IS EASY TO ENTER, NO PURCHASE REQUIRED**

NAME .....

ADDRESS .....

.....

TELEPHONE .....



# Check our test equipment range!

**FREE FREIGHT ANYWHERE  
IN AUSTRALIA DURING MAY!**

**12 months  
warranty!**

**Includes  
two free  
probes!**

## HUNG CHANG (RITRON) 20 MHz DUAL TRACE OSCILLOSCOPE

- Wide bandwidth and high sensitivity
- Internal graticule rectangular bright CRT
- Built in component tester
- Front panel trace rotator
- TV video sync filter
- Z axis (Intensity modulation)
- High sensitivity X-Y mode
- Very low power consumption
- Regulated power supply circuit

**COMPONENT TESTER** is the special circuit with which a single component or components in circuit can be easily tested. The display shows faults of components, size of a component value, and characteristics of components. This feature is ideal to troubleshoot solid state circuits and components with no circuit power. Testing signal (AC Max 2 mA) is supplied from the COMPONENT TEST IN terminal and the result of the test is fed back to the scope through the same test lead wire at the same time.

**CRT**  
CRT: 6" (150mm) Flat-faced high brightness CRT with Internal Graticule.  
Effective display area: 8 x 10 div (1 div = 10mm)  
Acceleration potential: 2KV

**VERTICAL**  
Operating Modes: CH-A, CH-B, DUAL, ADD (CH-B can be inverted).  
Dual modes: Alter, 0.2uls - 0.5ms/div, Chop, 1ms - 0.5s/div  
CHOP frequency 200KHz approximately.  
Deflection factor: 5mV/div 20V/div +/- 3%, 12 ranges in 1-2-5 step with fine control.  
Bandwidth: DC - 20MHz (-3dB), AC: 10Hz - 20MHz - 3dB.  
Rise Time: Less than 17ns  
Overshoot: Less than 3%  
Input Impedance: 1M ohm +/- 5%, 20pF +/- 3pF  
Maximum Input Voltage: 600Vp-p or 300V (DC+AC Peak).  
Channel Isolation: Better than 60 dB at 1KHz

**HORIZONTAL**  
Sweep Modes: NORMAL, and AUTO  
Time Base: 0.2uls - 0.5s/div +/- 3%, 20 ranges in 1-2-5 step with fine control  
Sweep Magnifier: 5 times (5X MAG).  
Linearity: 3%.

**TRIGGERING**  
Sensitivity: INTERNAL: 1 div or better for 20Hz - 20MHz (Triggerable to more than 30MHz), EXTERNAL: 1Vp-p or better for DC - 20MHz (Triggerable to more than 30MHz).  
Source: INT, CH-A, CH-B, LINE and EXT  
Slope: Positive and Negative, continuously variable with level control PULL AUTO for free run.  
Coupling: AC, HF-REJ and TV. TV SYNC Vertical and Horizontal Sync Separator Circuitry allows any portion of complex TV video waveform to be synchronized and expanded for viewing TV-H (Line) and TV-V (Frame) are TV-V: 0.5s/div to 0.1ms/div. TV-H: 50uls/div to 0.2uls/div.

**X-Y OPERATIONS**  
X-Y Operations: CH-A: Y axis, CH-B: X axis Highest Sensitivity 5mV/div.

**COMPONENT TESTER**  
Component Tester: Max AC 9V at the terminal with no load, Max current 2mA when the terminal is shorted. (Internal resistance is 4.7K ohm)

**OTHER SPECIFICATIONS**  
Intensity Modulation: TTL LEVEL (3Vp-p). Positive ..... brighter.  
BANDWIDTH: DC - 1MHz MAXIMUM INPUT VOLTAGE: 50V (DC + AC Peak)  
Calibration Voltage: 0.5Vp-p +/- 5%, 1KHz +/- 5% Square wave.  
Trace Rotation: Electrically adjustable on the front panel.  
Power Requirements: AC: 100, 120, 220, 240V 20W  
Weight: 7kg approximately.  
Size: 162(H) x 294(W) x 352(D)mm.

Cat. Q12105 ..... **only \$695**  
(tax exempt only \$595)

Bulk orders, schools, please phone (03) 543 2166 for special low pricing

**FREE FREIGHT ANYWHERE  
IN AUSTRALIA DURING MAY!**

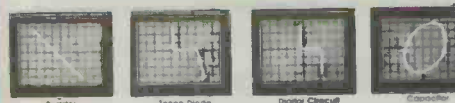

**605 3 1/2 DIGIT MULTIMETER**  
New replacement for YF1100. See specification tables below for details  
Cat. Q11035 ..... **\$79.95**



**705A 3 1/2 DIGIT MULTI/CAPACITANCE METER**  
See specification table below for details.  
Cat. Q11040 ..... **\$119**

### 605 & 705A SPECIFICATIONS

Capacitance		605	705A	Test Signal	Max Input
2nd	1pF			600mv rms	
20th	10pF				
200th	100pF	HC	35+4	512 Hz	3V DC peak AC on all ranges
2000th	1nF			400V rms	
20kth	10nF				

AC Current		605	705A	Burden Voltage	Overload Protection
Range	Resolution	Accuracy	%		
200µA	100nA	HC			
2mA	1µA	12+14	12+4	0.5V max	705A: 0.2A fuse up to 250V 605: 2A fuse up to 250V
20mA	10µA				10A range not fused
200mA	100µA				
10A	10mA	15+4	15+4	0.7V max	

Resistance		605	705A	Open Voltage	Overload Protection
Range	Resolution	Accuracy	%		
200Ω	100mΩ	1+2	1+2		
2kΩ	1Ω				
20kΩ	10Ω	60+1	60+1	10V 3.5V 10V 0.25V	250V DC rms on all ranges
200kΩ	100Ω				
2MΩ	1kΩ				
20MΩ	10kΩ	2+4	2+4		

DC Voltage		605	705A	Input Impedance	Overload Protection
Range	Resolution	Accuracy	%		
200mV	100µV				
2V	1µV	0.5+1	0.5+1	10MΩ	1000V DC peak AC on all ranges
20V	10µV				
200V	100mV				
1000V	1V	0.8+1	0.8+1		

AC Voltage		605	705A	Input Impedance	Overload Protection
Range	Resolution	Accuracy	%		
200mV	100µV				
2V	1µV	1+4	1+4	10MΩ on all ranges Capacitance > 100pF	750V rms on all ranges except 200mV AC range, 15 seconds max above 250V rms AC
20V	10µV				
200V	100mV				
750V	1V	2+4	2+4		

DC Current		605	705A	Burden Voltage	Overload Protection
Range	Resolution	Accuracy	%		
200µA	100nA	HC			
2mA	1µA				705A: 0.2A fuse up to 250V
20mA	10µA	1+1	1+1	0.3V max	605: 2A fuse up to 250V
200mA	100µA				10A range not fused
2000mA	1mA	15+4	15+4	HC	
10A	10mA	1+1	1+1	0.7V max	

NC = Not Connected



## ANALOGUE WORKHORSE KT370

- FEATURES:**
- Fuse and diode protection
  - hFE measurements 0 - 1000 (by x 10 range)
  - Mirror scale for more accurate reading

**SPECIFICATIONS**  
Ranges:  
DC Voltage: 0 - 0.1, 0.5, 2.5, 10, 50, 250, 1000V (20k ohm/V)  
AC Voltage: 0 - 10, 50, 250, 500V, 1000V (8k ohm/V)  
DC Current: 0 - 0.05, (50uA), 2.5, 25, 250mA  
Resistance: 0 - 2K, 20K, 2M, 20M ohm  
Load Current: 0 - 150uA, 15mA, 150mA  
Load Voltage: 0 - 3V  
Volume Level: -10 - +22dB - +62dB  
DC Current Amplification Factor (hFE) 0 - 1000

**ACCURACY**  
DC Voltage & Current: Within +/- 3% f.s.  
AC Voltage: Within +/- 4% f.s.  
Resistance: Within +/- 3% of arc  
Battery: 1.5V (um-3) 2pcs. 9V (006p) 1pc  
Fuse: 0.5A, 50 x 20mm  
Diode: 4148 x 2  
C.C. 0.4uF x 50V  
Size & Weight: 147 x 99 x 57mm & 400g approx.  
\*The same type as I have carried in my toolbox since I started in electronics 15 years ago. - Rod Irving

Cat. Q11030 ..... **\$34.95**



**BESWICK 88100 PROBE SET**  
CONTAINS: Compensated probe lead with...  
● Detachable 6 inch earth lead  
● Retractable hook  
● IC test tip  
● Tip insulator  
● BNC adaptor  
● Trimming tool

**\$34.95**  
(For specifications, see Page 29)



### METEX 3800 MULTIMETER

This instrument is a compact, rugged, battery operated, hand held 3 1/2 digit multimeter for measuring DC and AC voltage, DC and AC current, Resistance and Diode, for testing Audible continuity and transistor hFE. The Dual-slope A-D Converter uses CMOS technology for auto-zeroing, polarity selection and over-range indication. Full overload is provided. It is an ideal instrument for use in the field, laboratory, workshop, hobby and home applications.

- Features:**
- Push-button ON/OFF power switch
  - Single 30 position easy to use rotary switch for FUNCTION and RANGE selection.
  - 1/2" high contrast LCD.
  - Automatic over-range indication with the "1" displayed.
  - Automatic polarity indication on DC ranges.
  - All ranges fully protected plus Automatic "ZERO" of all ranges without short circuit except 200 ohm Range which shows "000 or 001"
  - High Surge Voltage protection 1.5KV-3KV
  - Diode testing with 1 mA fixed current.
  - Audible Continuity Test.
  - Transistor hFE Test.

**SPECIFICATIONS**  
Maximum Display: 1999 counts  
3 1/2 digit type with automatic polarity indication.  
Indication Method: LCD display.  
Measuring Method: Dual-slope in A-D converter system.  
Over-range Indication: "1" Figure only in the display.  
Temperature Ranges: Operating 0C to +40C  
Power Supply: one 9 volt battery (006P or FC-1 type of equivalent)  
Cat. Q91530 Normally \$99.95  
**SPECIAL \$79.95**



**ROD IRVING ELECTRONICS**  
25 High Street, NORTHCOE, 3070 VICTORIA, AUSTRALIA  
Phone (03) 489 8866  
48 A Beckett St. MELBOURNE, 3000 VICTORIA, AUSTRALIA  
Ph. (03) 663 6151  
Mail Order and correspondence: P.O. Box 620, CLAYTON 3168  
TELEX: AA 151938



**MAIL ORDER HOTLINE  
(03) 543 7877  
(2 lines)**

**POSTAGE RATES**  
\$1-\$9.99 ..... \$2.00  
\$10-\$24.99 ..... \$3.00  
\$25-\$49.99 ..... \$4.00  
\$50-\$99.99 ..... \$5.00  
\$100-\$199 ..... \$7.50  
\$200-\$499 ..... \$10.00  
\$500 plus ..... \$12.50  
This is for basic postage only. Comet Road freight, bulky and fragile items will be charged at different rates.  
Certified Post for orders over \$100 included "free"  
Registered Post for orders over \$200 included "free"  
All sales tax exempt orders and wholesale inquiries to RITRONICS WHOLESALE, 56 Renner Rd. Clayton Phone (03) 543 2166  
   
Errors and Omissions Excepted.





# DIGITAL SAMPLER

## Part 2 Getting it together

ETI acknowledges the back to basics school of rock and roll. But on to finer arts. We've a special interest here in electronic sound and music (funny about that!) and are proud to give you this tidy little device which records short bursts of sound and can be used as a digital delay. Vive la synthèse!

LAST MONTH SAMPLING theory and its implementation were discussed. This month we will develop a practical sampling system, putting some life into these ideas.

The first section to look at in this digital sampler is the gain block (see Figure 1). If a low sensitivity microphone is used as input it is possible for the signal to be as low as 30 mVp-p. On the other hand some synthesizers have outputs in the 1 and 2 volt range.

Now if the ADC requires a 0 to 5 V input (as is common), the gain will have to range between 167 and unity. Hence the op-amp IC1c, as shown in the circuit diagram, is arranged in non-inverting mode with a gain ranging from one to 278. When multiplied by the attenuation of the input summing network the gain is 193, which is sufficient.

Following the gain block we have a fourth order anti-aliasing filter. This is designed to



Glen Thurect  
& Andrew Robb

attenuate all input frequency components above 4 kHz by 24 dB per octave. This will in turn reduce any aliasing effects by a proportionate amount. In the circuit diagram the filter is implemented as two second order filter sections connected in series, IC1a and IC1b. This type of filter section is called an infinite-gain multiple-feedback circuit. Filter sections of this form use a minimum of capacitors and resistors and hence are most cost effective.

Next is the ADC. Much of the circuit design must start with the ADC since its conversion time dictates how fast the system may sample and hence the final bandwidth. The specification calls for a 4 kHz bandwidth so we must sample at greater than 8 kHz by the Nyquist theorem.

Hence:

$$\begin{aligned} \text{Conversion time} &< \frac{1}{8 \times 10^3} \\ &= 125 \mu\text{s} \end{aligned}$$

The ADC that has been chosen for this project is shown in the circuit diagram as IC2. The ADO820 is a relatively cheap converter but has a number of very desirable features. Firstly the conversion time is well below what is needed, in fact, it is approximately 2  $\mu\text{s}$ ! As well there is a built-in sample and hold amplifier. This gives an aperture time for the system of around 100 ns and is well within the limit of 160 ns that was calculated for a 4 kHz signal in Part 1.

In selecting the DAC we needed to find a chip that was both cheap and could run off a



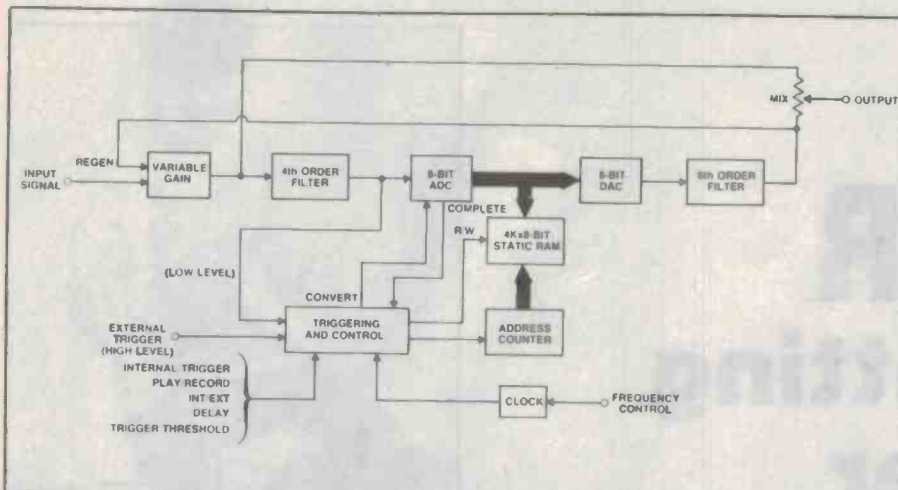
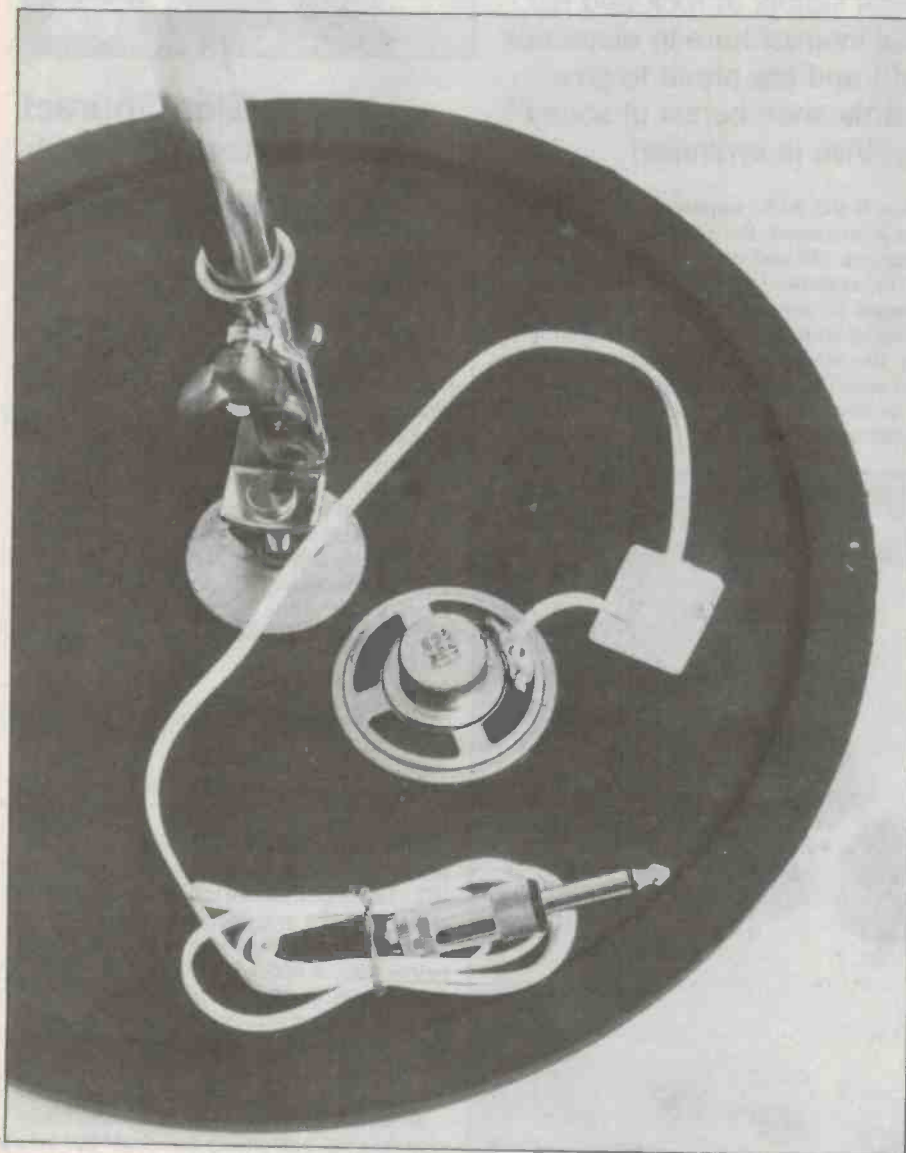

Figure 1. Block diagram.



## PARTS LIST — ETI-1402

<b>Resistors</b> .....	1/4 W.
R1.....	18k
R2, 3.....	82k
R4.....	1k8
R11, 12, 40, 33.....	100k
R13.....	4k7
R14, 36, 45, 48.....	1k
R24, 30.....	5k6
R25, 35, 37.....	220R
R26, 27, 38, 39,	
41, 44, 46, 47.....	10k
R28, 29, 31,	
42, 43.....	47k
R32.....	4M7
R34.....	56k 1/4 W.
R5, 6.....	10k
R7, 8, 9, 18, 19.....	8k2
R10.....	18k
R15, 16.....	39k
R17.....	27k
R20.....	20k
R21, 22.....	4k7
R23.....	15k
RV1.....	10k log
RV2.....	500k log
RV3.....	100k linear
RV4.....	20k linear
RV5.....	500k log
<b>Capacitors</b>	
C1, 6, 8, 15, 16.....	2μ2 35 V tant
C2.....	18n greencap
C3, 12.....	1n2 greencap
C4, 9.....	6n8 greencap
C5.....	1n8 greencap
C7.....	1μ 35 V tant
C10.....	220p polystyrene or ceramic
C11.....	8n2 greencap
C13.....	10n greencap
C14.....	2n2 greencap
C17.....	1000μ 16 V axial electro
C18, 20, 21.....	100n ceramic
C19.....	100μ 16 V axial electro
C22.....	1n ceramic
<b>Semiconductors</b>	
D1-8.....	IN4148, IN914 etc
ZD1.....	3V3
Q1, 2.....	BC549, 2N3904 etc
IC1, 4.....	TL074 or equivalent
IC2.....	ADC0820 National
IC3.....	ZN429 Ferranti
IC5, 6.....	HM6116
IC7.....	4040
IC8.....	4013
IC9, 11.....	4011
IC10.....	4001
IC12.....	4071
IC13.....	79L05
<b>Miscellaneous</b>	
SK1, SK2, SK3.....	6.5 mm standard phono socket
SK4.....	6.5 mm plastic (insulated) phono socket
SW1.....	DPDT switch
SW2, SW3.....	SPDT switch
PB1.....	momentary action pushbutton

5 knobs; diecast or zippy box 190 x 60 x 110 mm; 1 x 9 V battery; 1 x 9 V battery clip; battery holder; ETI-1402 pc board; 1 x 3.5 mm to 6.5 mm jack adaptor; 1 x 9 V plugpack (200 mA); stand-offs; nuts; bolts; washers; ribbon cable; rubber feet; front panel.

**Price estimate: \$118**



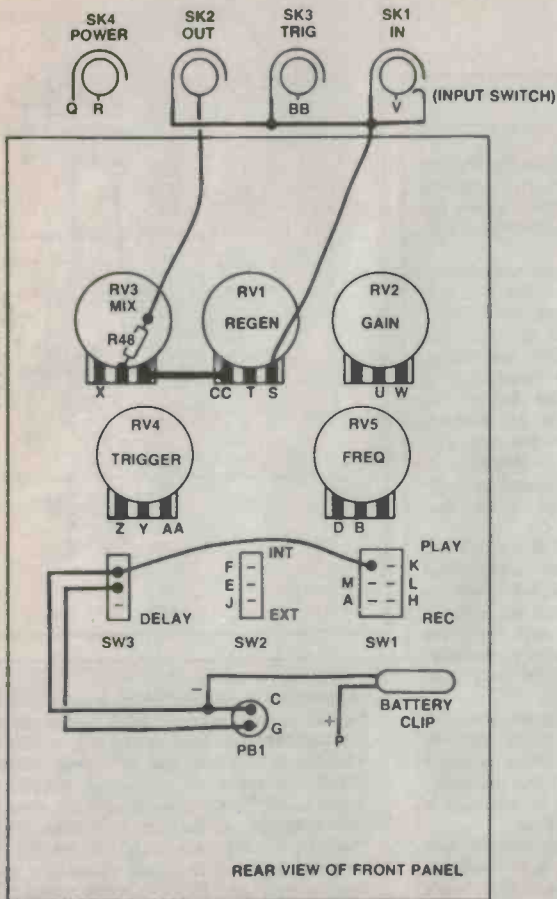

Letters refer to connections on the board.

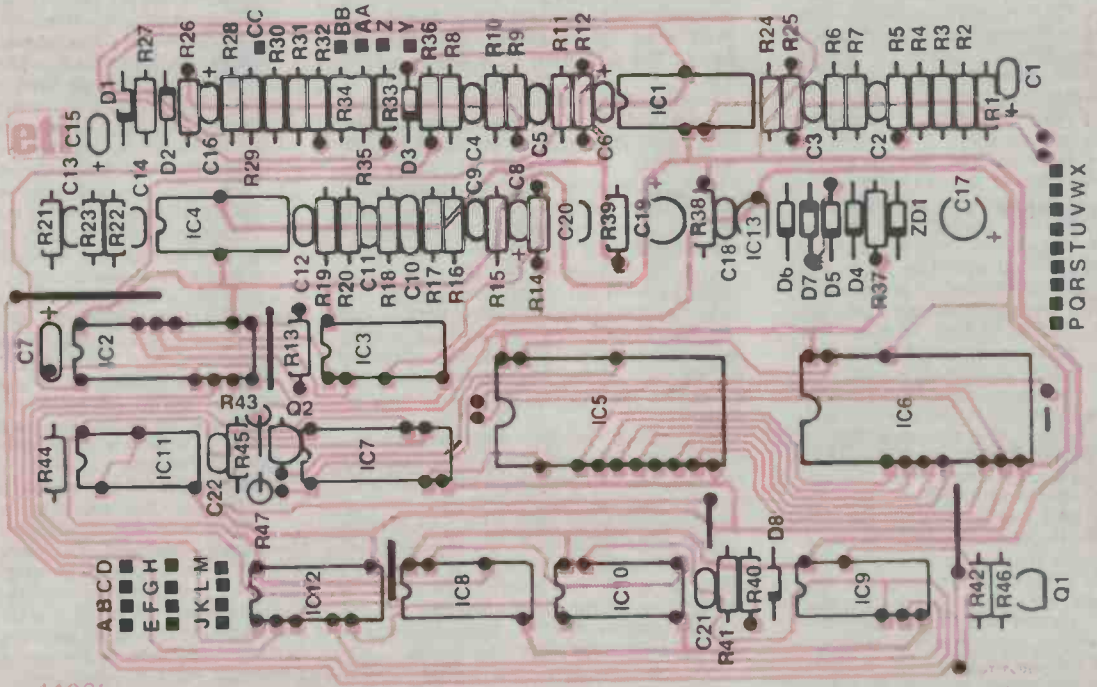
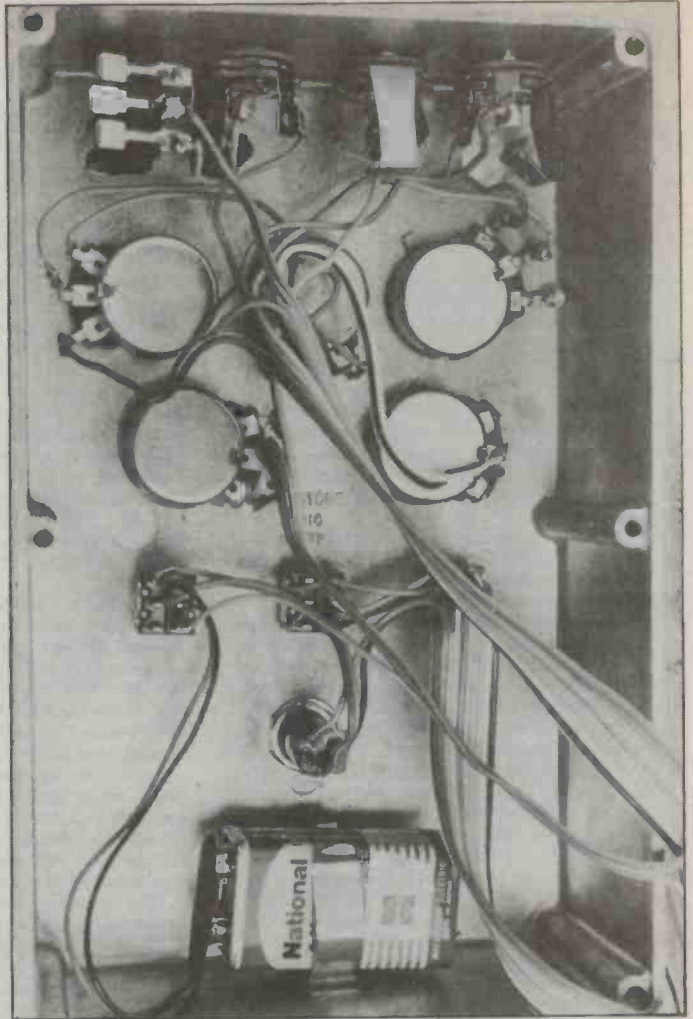

14021



## HOW IT WORKS — ETI-1402

The input signal is ac coupled via C1 to one point of the summing junction formed by R1, R2 and R3.

RV1 controls the amount of output fed back to the junction for regeneration. IC1c is configured to provide variable gain from unity to 278 via R4 and RV2. IC1a, IC1b and associated components form the two second order low pass filter sections, combining to give a fourth order anti-aliasing filter.

The band limited signal is then biased up to ½ V via C6, R11 and R12, as required by the ADC, IC2. C7 aids in reducing converter error in the lower range of input signals to the ADC.

After reconversion by the DAC IC3, the signal is coupled to the sixth order clock rejection filter formed by IC4a, IC4b, IC4c and associated components.

The output is then coupled via C15 to one side of the mix pot, RV3. The other side is a divided version of the input signal. R48 is included for current-limiting should the output be accidentally shorted. This is really only necessary when MIX is adjusted to give only the sampled signal.

IC4d, R26, R27, D1 and D2 form the precision rectifier (see text) required for the envelope following provided by C16 and R28. This signal is then summed via R29 with the EXTERNAL TRIGGER input via R30. The node is biased to approximately -20 mV by R31 and R32. The junction is fed to one side of comparator IC1d. Bias resistors R33, R34 and R35 enable the other input to be varied via RV4 between -10 mV and 1 volt. When set to -10 mV, a short circuit of the EXT TRIG input to ground will cause the comparator to switch, going positive. Thus a trigger signal is applied to the trigger network via current limiting resistor R36. Diode D3 prevents the line going negative when the comparator returns to the non-triggered, negative state. Similarly setting the threshold to a more positive level requires a higher level positive pulse from either EXT TRIG or the envelope following circuit for trigger signal generation.

Bypassing the triggering network for the moment, let's look at the control section. Assuming the system is in the rest state then STANDBY will be high (as will be shown later). The system clock is generated by the feedback loop of IC11a, IC11b and IC11d and associated timing components R44, R45, C22 and made variable between 1.2 kHz and 46.5 kHz by RV5. As STANDBY is high, the clock is gated off by IC12d. When a SYSTEM RESET signal is sent from the triggering network, meaning the device has been triggered, the 12-bit counter, IC7, and D type flipflop, IC8, are reset. This in turn sends STANDBY low, so the clock is gated on and begins driving the counter. The first 11 bits provide the memory addressing for both memories. Each memory is individually selected by bit 12. The chip select inputs are toggled via IC11b. (Q1, Q2 and associated resistors are simple inverters discussed later on.) Initially bit 12 is low and the first memory, IC5, is selected. The counter counts up through 2<sup>11</sup> or 2048 addresses and then bit 12 goes high. Memory IC6 is then selected and the counter's first 11 bits repeat the 2048 addresses. The in-

verted bit 12 is also fed back to the flipflop clock input. This effectively returns STANDBY to the high state after the counter/memories have completed their cycles.

So that takes care of memory addressing. The read/write side is also quite straightforward. Whilst in PLAY mode SW1 holds the clock gated off by IC12b. So the ADC does not receive a CONVERT command, thereby maintaining its bus outputs in a high-impedance state. IC12a holds the memories in READ mode. So all memory contents are read out on to the bus and through the DAC/output network. In RECORD mode the clock is passed through IC12b and to chip select (CS) and CONVERT.

On a negative transition of the clock the conversion will start. Upon completion COMPLETE will go allowing the clock to pass through IC12a and switch the memories into WRITE mode. The data from the ADC is then written into memory at the relevant address of that clock cycle. This then repeats until the memory is full.

Let's now examine the trigger network whilst set to PLAY. The only gates relevant are IC9b and IC10b. If TRIGGER is pressed the resulting low pulse causes the combination of C21, R41 and IC10b to produce a high pulse of about 1 ms duration.

This provides the SYSTEM RESET and initiates playback of whatever is in memory. If TRIGGER is re-pressed at any time, even before the cycle is finished, the system immediately re-initiates playback from the beginning. Alternatively, if an EXTERNAL TRIGGER signal occurs, whilst switch SW1a is set to PLAY, the output of IC9b will go low, causing a similar low-going trigger pulse via D8. D8 protects the output of IC9b from being grounded by the TRIGGER switch. R40 functions as a pull-up on the line.

When switched to RECORD the network is designed to only provide one RESET pulse, even if retriggering occurs during the cycle. This is achieved by using the STANDBY signal to gate the triggering signals off once recording. In INTERNAL mode the only gates of interest are IC9d, IC9a and IC9c. IC9b is held high by SW1a and consequently the EXTERNAL TRIGGER line is isolated. As soon as TRIGGER is pressed the output of IC9d goes high (STANDBY is still high, remember). This passes through IC9a and inverter IC9c to produce a SYSTEM RESET. Immediately STANDBY goes low so no later trigger pulses can pass through IC9d.

The DELAY function also requires the system to be in INTERNAL and RECORD mode. It operates exactly as above, but with the TRIGGER continually held low. As soon as STANDBY goes high after a recording, the SYSTEM RESET is sent high causing STANDBY to go back low and the whole thing to repeat. The inverter IC10a on the clock input to the counter ensures the recorded samples are one memory address location behind the playback samples.

Now the tricky part — EXTERNAL recording. This mode has an intermediate state where the system is armed and awaiting a

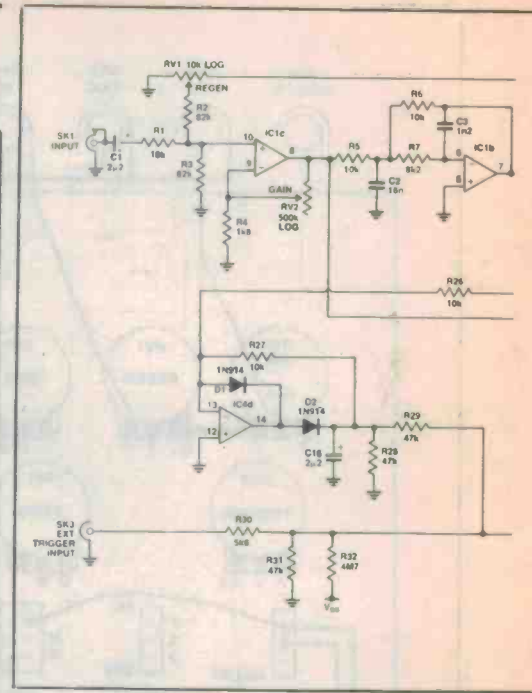

trigger signal. Before being armed SYSTEM RESET is low because both inputs to IC9d are high. Any pulses appearing on the EXTERNAL TRIGGER line will pass through IC10d but have no effect on RESET. As soon as TRIGGER is pressed IC9d, IC9a and IC9c change state and SYSTEM RESET goes high. Simultaneously the RESET high signal is applied to IC10c causing it to remain low, even after STANDBY goes low a few nanoseconds later. The system is now 'armed' and awaiting the next EXTERNAL TRIGGER pulse, which causes IC9a and IC9c to flip and RESET to go low. Immediately IC10c goes high, thereby preventing any further trigger pulses passing through IC10d. What could be simpler?

That leaves just the power supply. Two supplies are generated: analogue ( $\pm 4.5$  V) and digital (+5 V). They have separate commons to improve noise performance, coupled via C18. This provides for return currents when ac signals are transferred between analogue and digital commons.

Let's firstly assume there is no external supply. In this case only the memories must have power maintained. By keeping both chip selects high the memories stay in a low power consumption mode. The standby supply is labelled VA. ZD1 and D4 drop around 4 volts leaving 5 volts between VA and digital common. D5 prevents supply to any other part of the circuit. Therefore the two inverter transistors Q1 and Q2, having no base voltage, are off. Both chip selects are held at VA by pull-up resistors R42 and R43. If the battery is removed C17 maintains resistors R42 and R43. If the battery is removed C17 maintains supply via R37. This also limits initial charging current.

When full power is applied IC13, a -5 V regulator, maintains 5 V between +V and digital ground. Diodes D6 and D7 compensate for the additional voltage drop across D5 in keeping VA at 5 V. Because VA is held at 5 V, D4 is turned off, isolating the battery. R38 and R39 balance the analogue common between the two rails along with a large smoothing capacitor C19. Capacitor C20 is included to improve rf rejection.



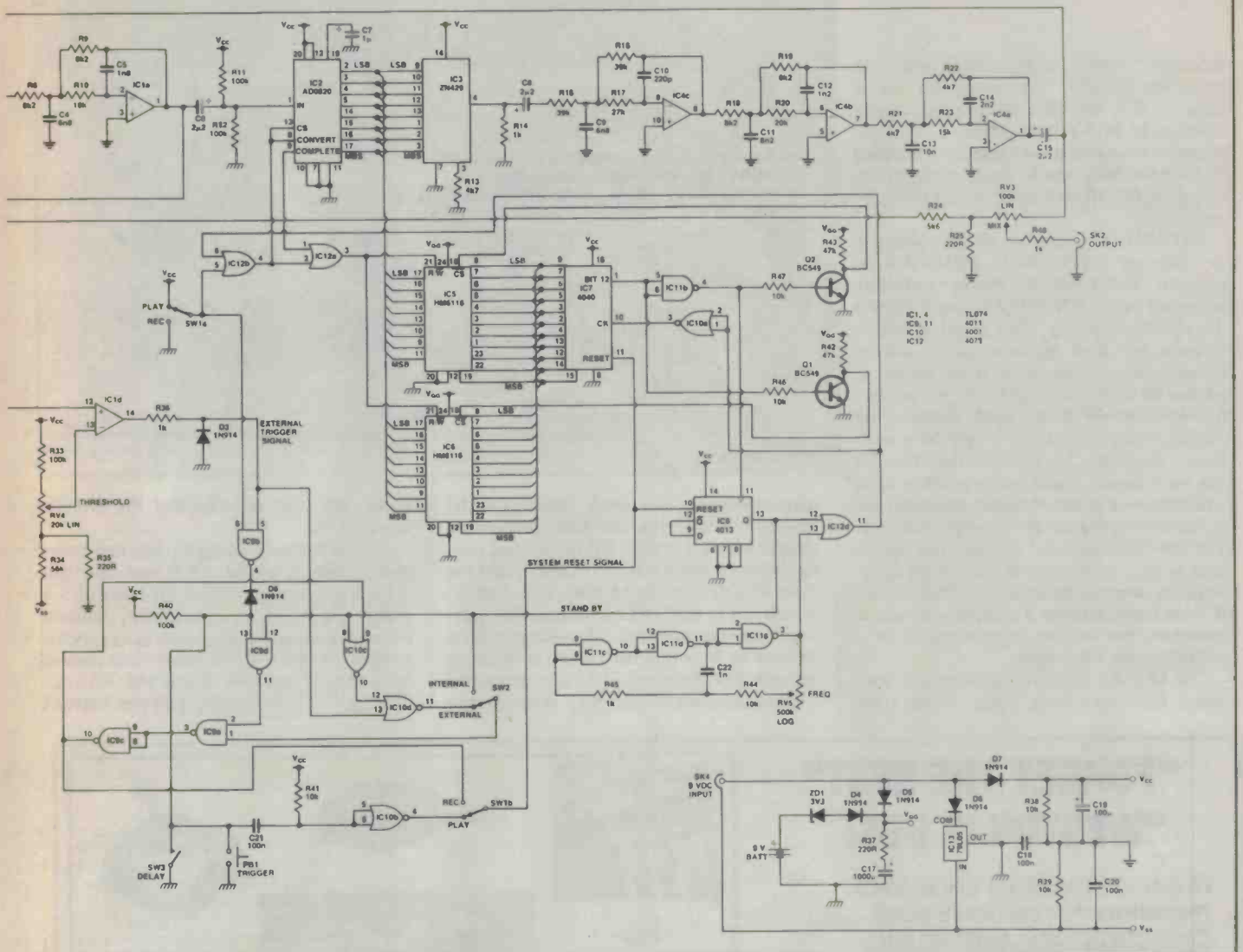

single 5 V supply. As a result the Ferranti ZN429 was chosen. The differential non-linearity is quoted at  $\pm 1/2$ LSB of the full scale and hence will be perfect for our needs.

Since one of the specifications calls for a memory power back-up to retain a sample after power-down we needed a RAM that has low standby current drain. This choice was rather simple since the 6116's (IC5 and IC6) are CMOS and readily available. Standby current is given as 20  $\mu$ A typically. Also the data organisation for this application is ideal, being 2048 word x 8 bits.

The output clock rejection filter was chosen to be sixth order. This gives a respectable 36 dB rejection at the Nyquist frequency. Again this is made up of three infinite-gain multiple-feedback sections shown as IC4a, IC4b, and IC4c. All the filter sections were designed so that the circuit element calculations gave preferred values within an error of 2%. Hence if close tolerance components are used in construction, the response should be maximally flat and

fall off at the desired frequency.

The mix control is used when the sampler is in delay mode. This controls the proportion of non-delayed sound with the delayed that appears at the output. By changing the mix you can vary the loudness of the echo that comes after the sound has been made.

Regeneration has two functions. Firstly, it provides multiple echoes, like those you would hear in a cave. The amount of regeneration then controls the number of echoes you hear or it can be used when you wish to over-dub on a sample already within the memory.

Probably the most unique section is the triggering and control. The ADC requires a CONVERT control signal to begin conversion and sends a COMPLETE signal when finished. The memory needs a READ/WRITE signal to control either reading out data from an address on to the bus or writing from the bus. The DAC requires no control, converting whatever is on the bus. Obviously some care must be taken to make sure both the ADC and memory

are not outputting at the same time, causing bus contention (the ADC outputs go high-impedance when not enabled). The whole conversion process, be it playback or record, is controlled by stopping or resetting the address counter.

In PLAY mode the ADC is effectively disabled and the memories held in the READ state. Upon triggering, the counter is reset and enabled. Counting up and consequent memory-reading continues until the counter completes its cycle and is disabled. Alternatively if re-triggered before the end of play the counter resets, beginning the cycle again. PLAY mode recognises all three trigger inputs.

In RECORD mode, once triggered, the cycle goes as follows:

1. ADC signalled to CONVERT;
2. COMPLETE indicates the converted sample is available on bus;
3. the data is then written into memory; and
4. the address counter is incremented.

This repeats until the memory's 4096 locations are filled. The control will not

## Project 1402

recognise another trigger input until the cycle has finished. The reason for this is clear — if it was able to retrigger at any time, as in PLAY mode, then if trying to record continuous noise (such as a whistle) the whole thing would keep retriggering. Consequently the recording would never be completed!

INTERNAL triggering allows recording as soon as INTERNAL TRIGGER is pressed. EXTERNAL allows recording whenever either EXTERNAL input crosses the threshold setting. This is adjustable to account for both positive going voltage changes of any size or a short circuit to ground on EXT TRIGGER. As will be seen further when we discuss applications of the project, there is a need to trigger off a waveform's envelope. To accommodate this the low level trigger signal which is taken after input filtering passes through a rectifier-filter section acting as an envelope follower. The non-linearities and voltage drop associated with a normal diode have been overcome by using a precision rectifier, IC4d. IC1d is configured as a comparator, which translates the various trigger pulses to a positive-going logic pulse.

The DELAY function operates in a continual record/playback cycle. Each cycle

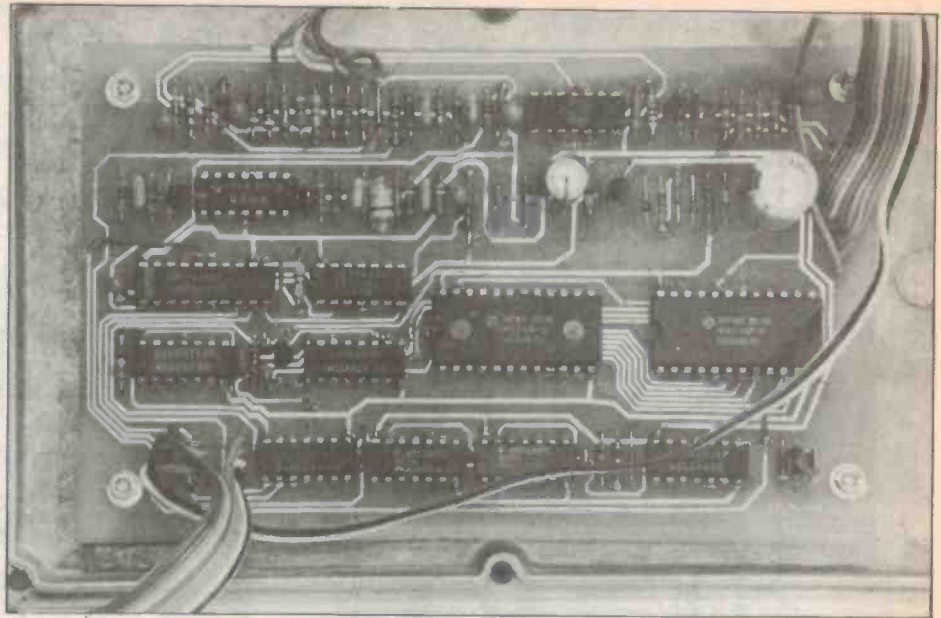

takes place over one clock period. On the first half of the cycle the ADC produces a sample which is stored. On the second half, the memory address is incremented and the content, a sample stored 4096 cycles before, is read out to the DAC. Consequently a delayed signal is produced. The delay length is defined by how fast the system is clocking through 4096 locations. The key step is the address increment half-way through the

cycle, achieved by inverting the counter clock, IC10a.

Finally the power supply. The system requires both a digital +5 V and analogue  $\pm 4.5$  V to be derived from the external 9 V supply. In order to achieve this, separate commons are necessary, with both supplies using the same +V rail. The +V is derived by a divider network across the 9 V rail. The  $\pm 4.5$  V is derived by a divider network

## “FORGET THE REST” “WESTON IS BEST”

WHEN IT COMES TO CHOOSING TRIMMING POTENTIOMETERS, JUST CALL CRUSADER AND WE WILL PROVIDE YOU WITH COST SAVING A1 QUALITY WESTON PRODUCTS. BEST SUITED FOR YOUR NEEDS WHETHER IT BE REPLACEMENT OR NEW PROJECT DESIGN. CHOOSE FROM THE COMPREHENSIVE RANGE OF CERMET-WIRE WOUND-MILITARY APPROVED-MILITARY QPL-NETRIM TRIMMER RESISTOR NETWORKS.

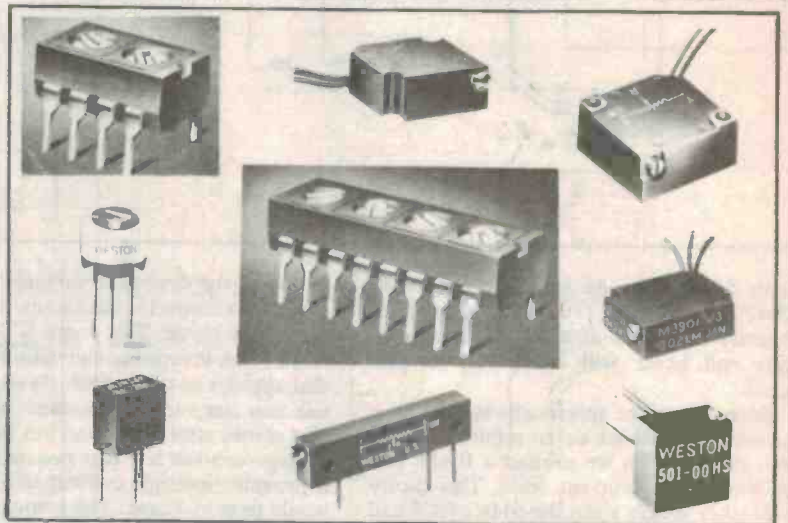

FREE SPECIFICATIONS AND DATA FROM:

**CRUSADER ELECTRONIC COMPONENTS PTY. LTD.**

81 PRINCES HWY, ST. PETERS NSW 2044 Phone 519 5030 516 3855 519 6685 Telex 23993 or 123993

### APPOINTED DISTRIBUTORS:

SYDNEY GEORGE BROWN & CO, PTY. LTD. PHONE 519 5855 GEOFF WOOD ELECTRONICS PTY. LTD. PHONE 810 6845  
WOLLONGONG MACELEC PTY. LTD. PHONE 29 1455 CANBERRA GEORGE BROWN & CO PTY. LTD. PHONE 80 4355 NEWCASTLE  
NOVOCASTRIAN ELECTRONIC SUPPLIES PHONE 61 6055 MELBOURNE R.P.G. AGENCIES PTY. LTD. PHONE 439 5834 JESEC  
COMPONENTS PTY LTD PHONE 598 2333 GEORGE BROWN & CO PTY. LTD. PHONE 419 3355 BRISBANE L.E. BOUGHEN & CO.  
PHONE 369 1277 COLOURVIEW WHOLESALE PTY. LTD. PHONE 275 3188 ST LUCIA ELECTRONICS PHONE 52 7466 ADELAIDE  
PROTRONICS PTY. LTD. PHONE 212 3111 D.C. ELECTRONICS PTY. LTD. PHONE 233 6946 PERTH SIMON HOLMAN & CO PHONE  
381 4155 PROTRONICS PTY. LTD. PHONE 362 1044



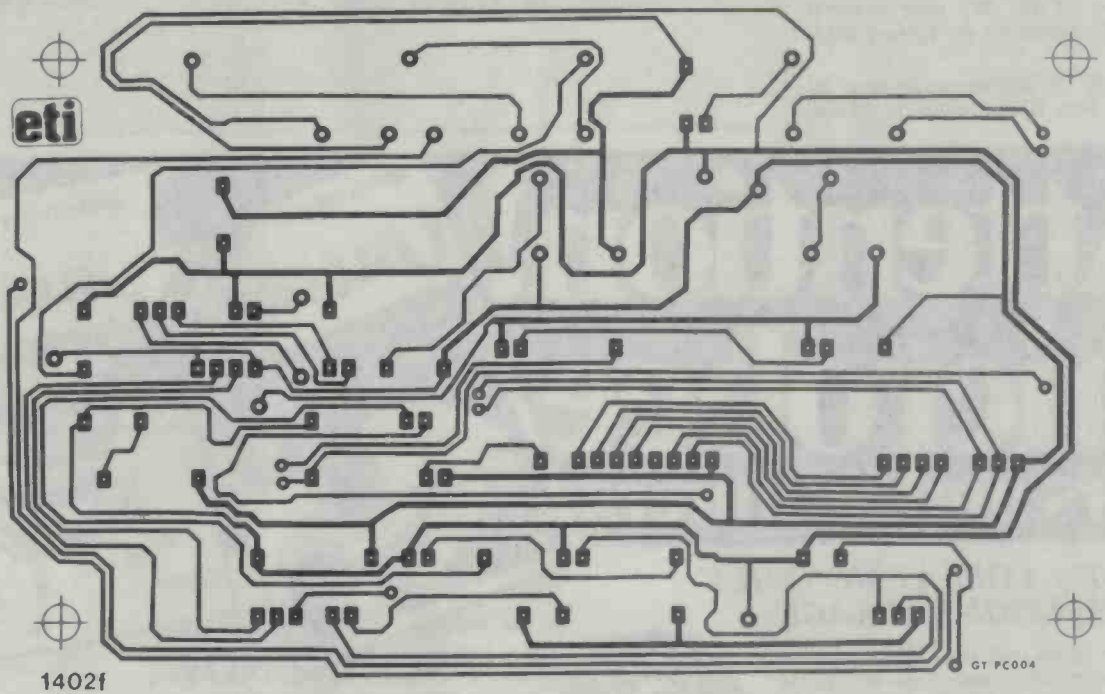
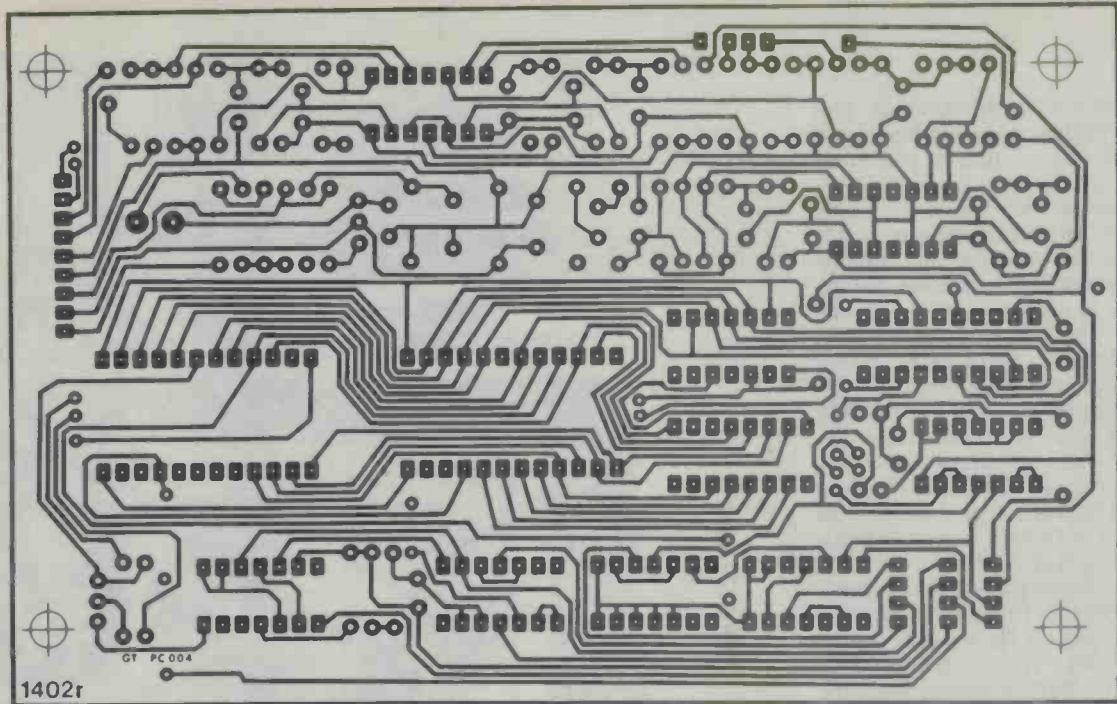

across the 9 V. This ensures the two voltages are equally balanced around analogue common regardless of supply fluctuations.

The battery-backup is configured to automatically come into use when the external supply drops below 9 V. This is a better alternative to using a socket switch, which allows the possibility of the supply being off while still plugged in. When using battery backup, power is supplied only to the memories and the circuitry required to keep both in the not-selected state.

### Construction

Assuming you have a drilled pcb and all components at hand we can start building.

Start with the six links, ensuring they are kept insulated over all top tracks. Note there are also seven single spot links as shown on the overlay. Next the 47 resistors and nine diodes go in (R48 is mounted off the board). Don't forget to solder on the top side where needed. All ICs go in next, taking normal CMOS precautions. Note that they all point the same way. Now the

capacitors go in, ensuring correct polarity for all tantalums and electrolytics. Finally the two transistors can be inserted. The pad layout for Q2 is a little different, so check it against the overlay.

Put the pcb somewhere safe and prepare the housing. We used a strong diecast box, but if you aren't going to be throwing it around, a plastic box may do. Do all drilling at once. There are 18 holes in all. (If you miss any now you'll have to drill them later and risk showering the pcb with metal fil- ▶

# Project 1402

ings). We used the box upside-down, with all controls in the base and the pcb mounted on the lid. The box can then be painted or decorated as desired.

Begin assembly with the three metal phono sockets. As all these connect to analogue common this means the box itself (if metal) will be at analogue common also. So a bit of care is needed in mounting the power socket, which has its negative pole at -V. As insulated 3.5 mm sockets are not readily available, you have three choices. You can cut the plug off and solder direct to the pcb (yuk); you can try and use nylon washers to insulate a metal 3.5 mm socket (yuk); or you can use an insulated 6.5 mm socket (Radio Spares carries them) and an adaptor (neat!). Of course if you can find a plastic 3.5 mm socket — use it!

Next, after trimming the shafts as necessary, mount the pots. Take care to get them all in the right place. (The log pots usually have a D code). Finally, fix the four switches and the battery holder. Note the PLAY/RECORD switch is DPDT, the other two are SPDT. We used a metal spring clip (RS again) for the battery holder.

As there are 26 interconnections to be made to the pcb, ribbon cable is recom-

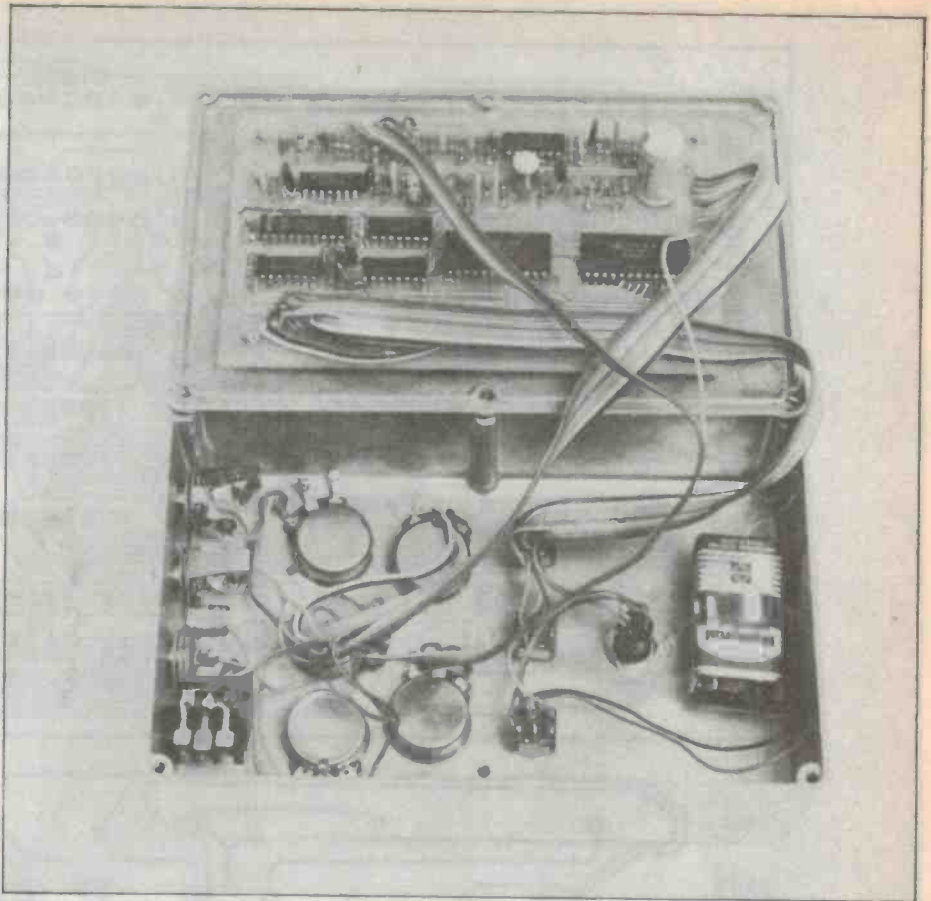

# Attention! microbee users and admirers

## ONLINE - A GREAT MONTHLY INFORMATION PACKAGE

For only \$25.00 per year, you can join the thousands of microbee owners who have found the way of keeping up to date and in tune with their microbee. Subscribers to Online, the microbee journal, are privy to the latest hardware and software releases, are entertained by a myriad of applications and are tutored in the latest languages.

Don't let your microbee rest! Put it through its paces with Online — your monthly upgrade kit in a magazine.

ONLY  
**\$25**  
YEARLY

  
microbee  
computer

Online



## SUBSCRIBE NOW!

**YES!** Please enter my subscription, as marked, to Online for one year (12 issues) at a cost of \$25.00.

Name: \_\_\_\_\_

Address: \_\_\_\_\_

Town/Suburb: \_\_\_\_\_ State: \_\_\_\_\_ P/code: \_\_\_\_\_

METHOD OF PAYMENT:  Money Order/Cheque

Please charge my

\_\_\_\_\_

Expiry Date: \_\_\_\_\_ Signature: \_\_\_\_\_

- Unless otherwise stated, your subscription will commence from the next issue to be published upon receipt of this form.
- Single copy price \$2.95 plus 30 cents p&h per issue within Australia.
- All subscriptions and enquiries should be addressed to:  
The Subscription Officer, Online, P.O. Box 41, West Gosford 2250.



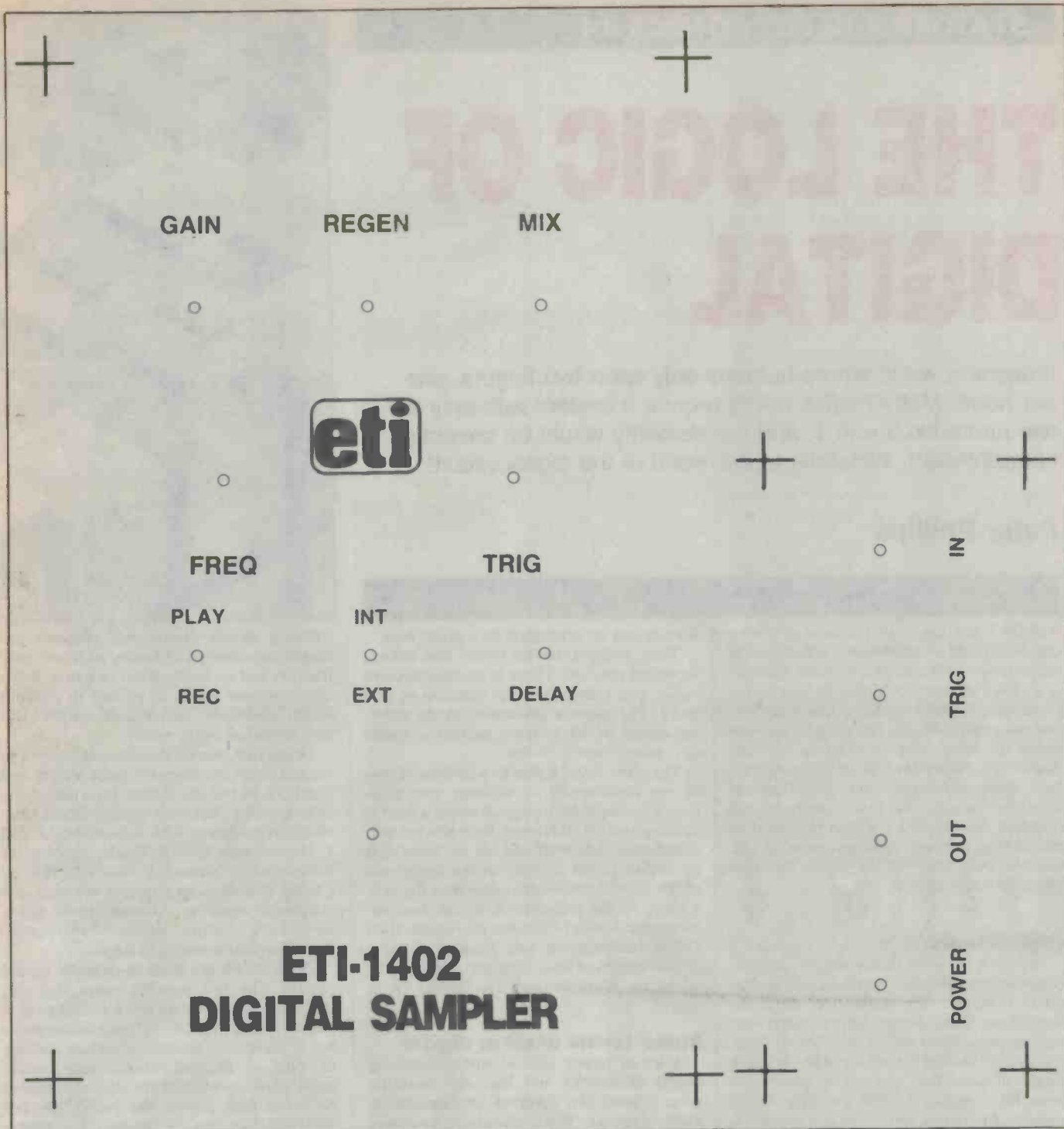

## ETI-1402 DIGITAL SAMPLER

mended. Before starting this, wire the three socket commons together. Note that the input socket switch should also be commoned. This ensures the input is grounded when not in use. There is also some wiring between pots, sockets and switches that should be done before beginning the ribbon wiring. R48 should be soldered directly to the mix pot wiper as shown in the wiring diagram.

Starting with a length of 12-way ribbon, separate the wires back about 2 cm and strip each one. These go into 12 pads in the top corner of the board, as seen from the

overlay/wiring diagram. Mark each wire colour on the diagram as you go. This will make the job a lot easier later. Now lay the board out end-on to the battery end of the box. Leave enough distance to allow any later board-handling to be done without needing to flip over the box too. Cut the cable to length — this lot goes mainly to the switches. Measure to the furthest switch and separate back as needed. The wiring diagram is based on toggle switches which connect the opposite pole to the direction they are switched. If you are using slide switches then you may need to reverse the outer pole

wiring. Repeat the ribbon wiring with a 5-way strip and a 9-way strip. (As we used all DPDT switches in the prototype, a spare terminal was used to anchor the positive battery lead.)

Now, check everything. Common slip-ups include incorrect pot wiring and weak or splayed ribbon/pot connections. If all looks good give the whole thing a brush down and, being truly optimistic, mount the board to the lid using standoffs.

In the next issue of ETI (June) we'll resume with details of the sampler's applications. ●

# THE LOGIC OF DIGITAL

Imagine a world where humans only sport two fingers, one per hand. Mathematics would require a system with only the two numerals 0 and 1, and our dexterity would be severely compromised. Welcome to the world of the digital circuit!

Peter Phillips

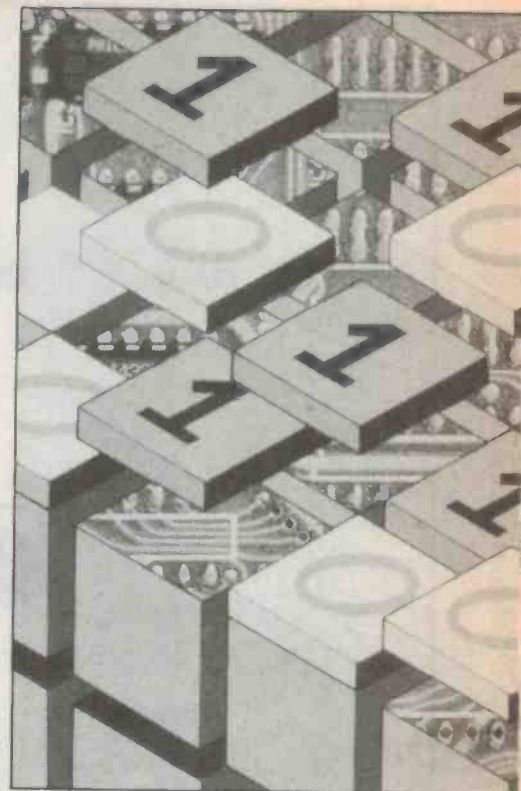

ASKING A CLASS of schoolboys what a digit is is a sure invitation for a few colourful suggestions. However, requests for a definition of the meaning of 'digital' as applied to electronics is likely to elicit a much less certain response although few people have not heard the word. Digital watches, records, dashboard instrumentation in cars and so on have made certain of that. The concepts embodied in a system that uses the digital principle has created a whole new field of endeavour, making possible most of the technological advances that make the term 'digital' commonplace.

## Digital logic

Before looking at the electronic aspects, consider a mechanical example that is digital in principle. The simplest of all is the music box. These devices have a barrel containing projections called pins. As the barrel rotates, each pin is arranged to 'twang' a finger of steel that vibrates to produce a note. By arranging the pins correctly, a tune results. In digital terms, a pin creates a sound, its absence results in silence. At any given moment, the comb containing the tuned reeds is presented with digital information. If the comb has eight reeds, then the digital code on the rotating drum must contain the same number of 'bits' of information positioned lengthwise along the cylinder. The 8-bit 'number' is continuously updated to create continuity in the tune.

To keep the same reed vibrating all the time, pins for this reed must be placed in line around the drum, spaced to allow the reed time to sound before being struck again. This means a time delay is necessary, representing the speed at which the infor-

mation can be processed by a given reed.

Thus, a digital device is one that utilises an on-off concept. There is no intermediate value, you either have the function or you don't. The pianola mentioned in the previous article of this series is another example of a purely digital device.

The term 'logic' refers to a method of reasoning consistently — without contradiction. For example, in logical terms a light is either on or off. If it is on, then it is not off. Conversely, when off, it's not on. Note that no consideration is given to the brightness of the light, levels don't enter into the reasoning. As the principle of digital electronics (or mechanics) only uses two states, then logical reasoning or just plain 'logic' is a perfect means of discussing and analysing its operation. Paraphrasing Dr Spock, "it is logical".

## Some terms used in digital

A lot of jargon is used when discussing digital electronics and like any scientific area, a particular form of mathematics is used in digital. When discussing analogue electronics, decimal arithmetic is appropriate. This is because the values of voltages and currents range from one number up to any other.

The same is not true in the digital field; there are no levels, just one output or another. Thus, a number system with only two characters is used. This type of arithmetic is called 'binary' arithmetic, and uses the first two characters, '0' and '1', from the familiar decimal (or ten based) system. Binary means simply 'two numerals'.

It is interesting to note that all mathematical functions that can be done with ten characters can be done with two. When

studying digital electronics, students are taught the elements of binary addition, subtraction and so forth. After practice, it becomes second nature to be able to perform binary arithmetic, and so gain insight as to how digital circuitry works.

Going one step further, just as algebra in conventional mathematics uses letters and numbers, so too the algebra for a digital circuit, known as Boolean algebra, utilises letters in conjunction with the numbers 0 and 1. Named after George Boole, this type of mathematical reasoning was adapted by Claude Shannon, an engineer working in a telephone exchange. George Boole was a nineteenth century logician, who introduced his mathematics to logic.

Other terms are used to describe digital signals. The two possible states that can exist in a digital circuit are referred to as a 'logic 1' and a 'logic 0'. When a binary number is present, it contains a certain number of 'bits'. A decimal number can contain many places, so just as the decimal number 4876 has four places, the binary number 1010 has four bits. A binary bit is always either a 1 or a 0. In any whole binary number, the right hand bit is known as the 'least significant bit' or LSB, and the left most bit becomes the 'most significant bit' (MSB). A decimal number uses the terms most or least significant digit.

In some circuits, particularly computers, bits are arranged as 'bytes'. The number of bits to a byte depends on the application, and computer enthusiasts may be aware that most computers use either eight or 16 bits to make up a byte. A 'nibble' is half a byte, so four bits in an 8-bit byte system become a nibble. A grouping of bytes is known as a 'word'.



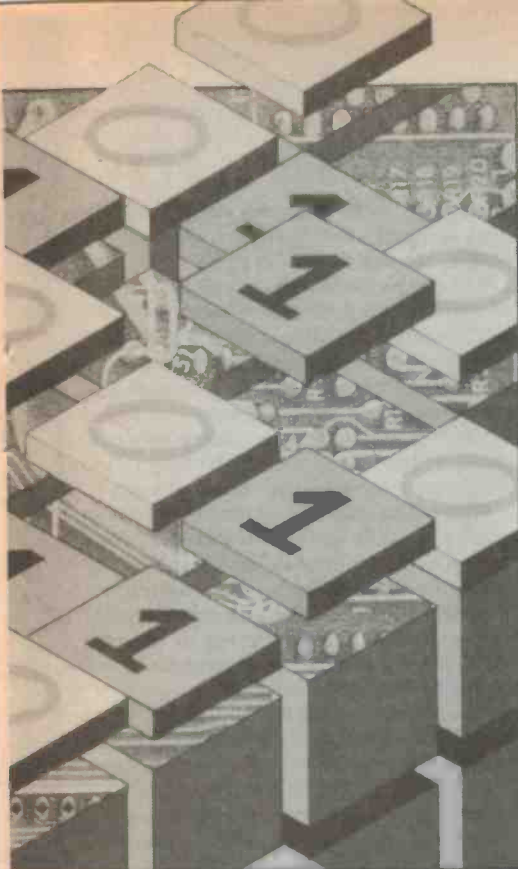

So, there you have it. Bits, nibbles, bytes, words, binary numbers, Boolean algebra, there're all part of the lingo used to describe the digital system. There are many more terms, but these will do for now.

### Digital's advantages

Many readers may have marvelled at some of the recent shots of Uranus, taken by the Voyager spacecraft as it hurtles into the never-never. This becomes more significant when you realise that many would be viewers despair at receiving a TV signal travelling less than 100 km. How then can a full colour picture travel millions of miles through space, impeded by solar activity and other distractions, sent on its journey by a transmitter with less power than the average domestic hi-fi set? Answer: as a digital signal.

In principle, the picture is digitised, with the receiving station on Earth looking for a signal made up of binary numbers. By also including error detecting and correcting information, and by allowing considerable time for the whole frame to be transmitted, an almost perfect picture can be constructed. This is despite signal strengths measured in microvolts, ravaged by interference and immense distances. An analogue signal, such as is normally used for local transmissions loses most of its information when it encounters the first hill.

Because the digital information relies on only two levels, equipment using this information merely needs to recognise and distinguish between either of these two. For tricky situations, extra data can be included to help the circuitry decide if a mangled binary bit is either a 1 or a 0. Thus, digital information can include codes that not only

tell the decoding circuitry that there is a problem, but to also help correct the error. The compact disc is one such domestic device that incorporates this type of technology.

### Analogue-to-digital

Having shown some advantages of digital, some means must be provided to allow conversion of any analogue quantity to a digital equivalent when the original information is in analogue form. (Many digital circuits work from data that is already digital, such as calculators and computers. Here, the digital code is generated by a key press from a keyboard. Each key has its own code, being represented by a particular binary number.)

Converting a signal that is normally represented by a changing voltage, such as the output of a microphone, requires that each discrete voltage level is portrayed as a binary number. The question is, how many individual numbers are required? This decision depends on how many binary bits are at the disposal of the designer. If there are only two, then arranging the available 1s and 0s will provide four individual codes. If eight bits are available, then 256 different codes can be generated. The calculation to determine how many codes a group of bits can produce is 2 raised to the power of the number of bits.

Figure 1 shows how a sine wave can be converted to a digital signal made up of a series of 3-bit binary numbers. This is done by applying the signal to an analogue-to-digital converter ADC. The output will be a binary number ranging from 000 to 111; the input voltage level determines which of the eight possible numbers is to appear at the

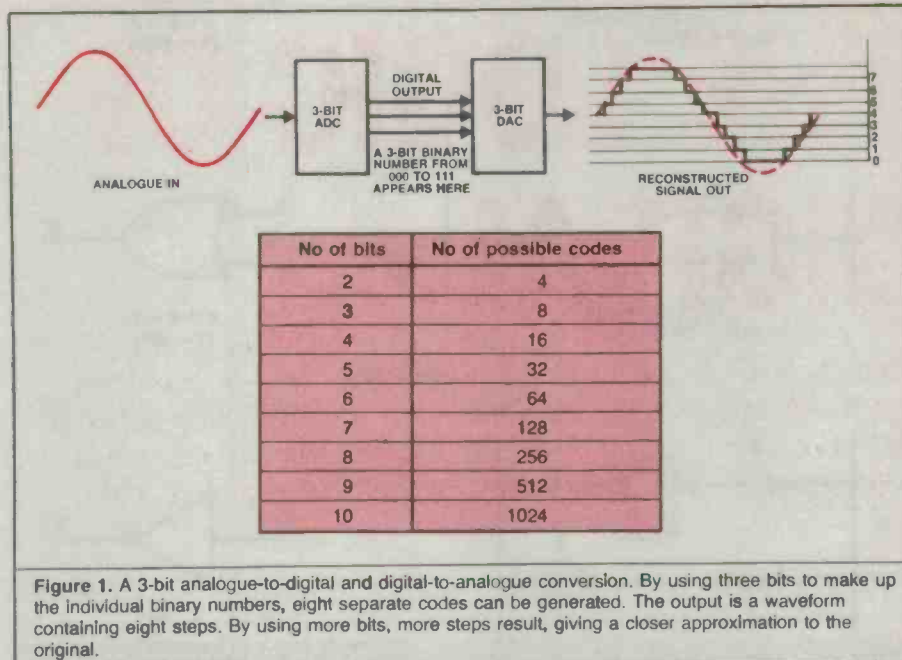

Figure 1. A 3-bit analogue-to-digital and digital-to-analogue conversion. By using three bits to make up the individual binary numbers, eight separate codes can be generated. The output is a waveform containing eight steps. By using more bits, more steps result, giving a closer approximation to the original.

output. The original signal can be recreated using a digital-to-analogue converter (DAC), an approximation of the original waveform is a signal made up of individual steps, in this case eight. The DAC produces a voltage at its output proportional to the value of the binary number present at its input.

Using four bits allows an analogue signal to be digitised into individual levels comprising 16 steps. If eight bits are used, 256 steps are available and the eventual reconstruction back to analogue form would result in a signal so close to the original that it wouldn't matter. Increasing the number of bits brings about a corresponding improvement in the reproduction, although practicalities limit how far this can be taken.

In sound recording, it is now commonplace for the master recording to be in digital form. The advantage gained is that all subsequent copies of the original master have the same quality. This means that, in the first place the master contains no noise or quality reduction due to tape problems, and that a number of masters can be made allowing disc manufacturing using these copies of the original; each copied master is as good as the first. Any subsequent problems are the result of the analogue discs made from the digital master. The CD system overcomes this by going one step further, and actually using digital information as the recording on the disc.

However, in the final result, an analogue signal converted to digital form for transmission or processing must eventually be reconverted back to an analogue form. So, despite the advantages of digital, the fact remains that most information is originally in analogue form, and must be presented in ▶

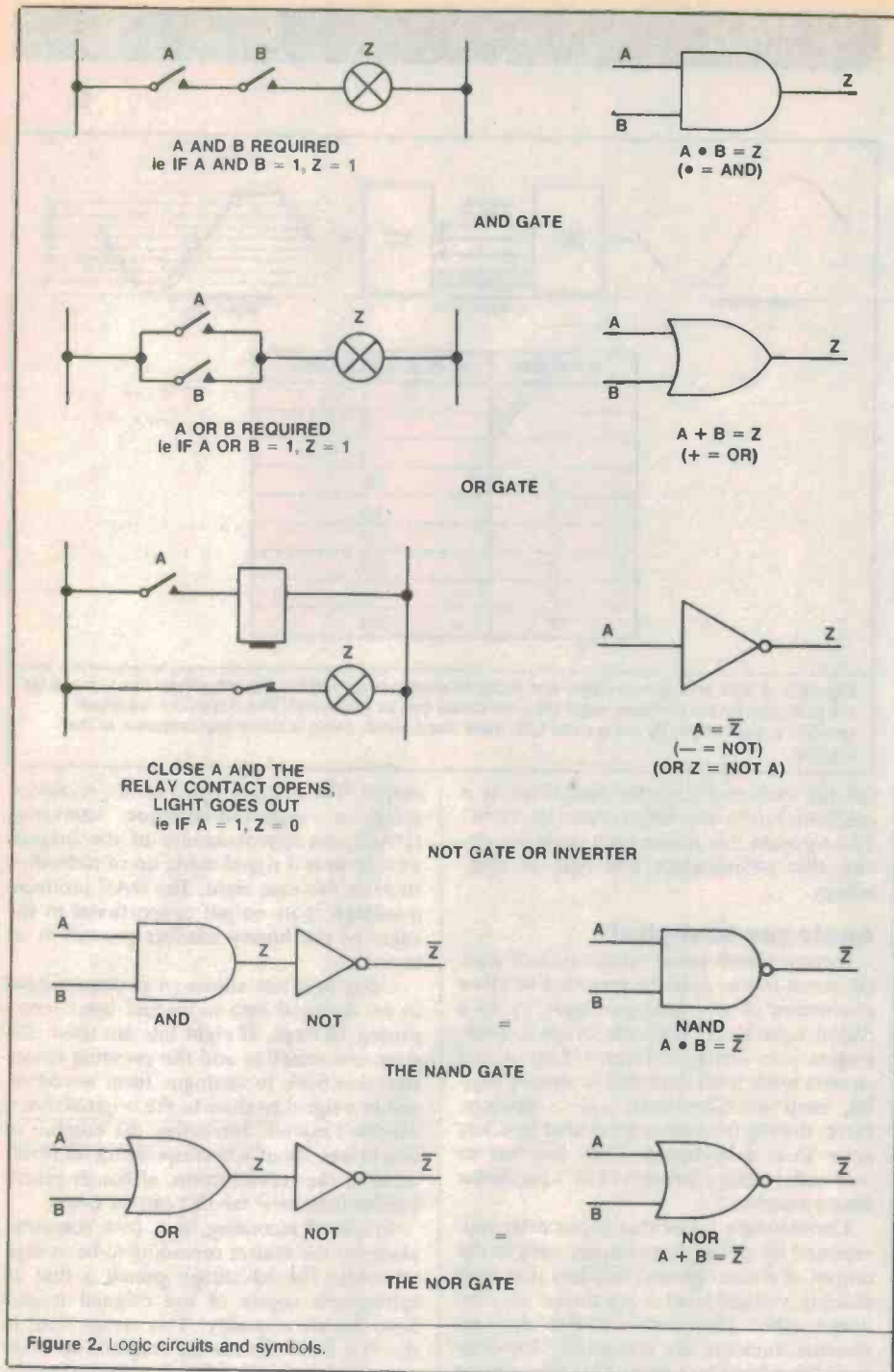

Figure 2. Logic circuits and symbols.

this form for human consumption. But the advantages lie in the intermediate steps, where all the processing requirements can be best achieved using digital techniques.

### Digital gates

The simplest digital circuit is a switch. A telephone exchange uses lots of switching mechanisms to route signals from point A to point B. Originally, mechanical switches in the form of relays and other configurations were used to provide the path allowing any two phones to communicate. Newer designs use devices called 'gates'.

A gate is a logic circuit that produces an

output of either 1 or 0 under certain conditions at its input terminals. As an analogy, consider a light being controlled by two switches. A number of possibilities are allowed depending on how the switches are connected. By connecting the switches in series, the light turns on if switch A and switch B are closed. That is to say, if both inputs equal a logic 1 the output (the light) is a 1. Parallel connection allows switches A or B to activate the light, meaning if either input equals 1 the output is a 1.

Less obvious is the arrangement that causes the light to *extinguish* if a switch is turned on. This would require a relay to be

energised, with contacts controlling the light to open when the relay operates. By placing the switch to operate the relay coil, a light can be turned off if a switch is turned on. This is called, in digital logic terms, the NOT function. In other words, if the switch is a logic 1 the light turns off. That is, input a 1, and the output becomes a logic 0. Figure 2 shows the circuits referred to. Closing a switch (either A or B) is analogous to applying a logic 1, and causing the light (Z) to illuminate symbolises an output of logic 1.

Figure 2 also introduces three logic circuit symbols, as well as some Boolean algebra. Alongside each switching circuit is the digital 'gate' symbol that the circuit represents, beneath which is the Boolean expression for that gate. A lot can be learned by studying these three examples, and understanding each gate function.

Combining the AND and NOT ideas gives the NAND gate, while the OR and NOT provide the NOR function. As it turns out the NAND and NOR gates are the most popular logic gates, as they can be used to operate as any type of gate by connecting them in various circuit configurations. This allows designers to most effectively utilise all the gates on a particular circuit, providing space and cost savings. A NAND gate is then an AND gate followed by an inverter, similarly, an OR gate is that whose output is inverted to a NOR gate.

Figure 3 summarises the five gates, by showing how the output responds to the inputs. These gates are the building blocks of digital electronics, and understanding their operation is the key to an overall appreciation of the subject in general.

### Digital flipflops

Logic gates can be considered as the 'active devices' of digital ICs. Virtually all the logic chips in current use employ an arrangement of interconnected gates, thus providing all the other functions used in digital circuits. The next most useful building block that results from such a collection of gates is the 'flipflop'. This device can be considered as a logic element that *remembers* an event. If you press a button to call a lift, or to operate the lights at a pedestrian crossing, it is sufficient to press the button once, and eventually the request is answered. The circuitry has remembered the input, and has responded after sequencing through its routine.

A variation on this is where an input is only allowed to be entered and remembered when the system says so. In a quiz show, the display circuitry indicating the contestant who pressed the button first needs to 'lock out' any other nearly simultaneous response. This requires that the other flipflops ignore their input. Timing becomes important in many other applications where causing a flipflop to respond to an input before its previous state was read and acted upon



could result in chaos. Thus, most flipflops have an input that allows the information to be entered when the circuitry allows it.

The timing signal is often called a 'clock', and most flipflops have a terminal intended to be connected to this signal. The name of this input varies, depending on how it operates. One variety calls it the 'enable', others simply the clock terminal. An enable input allows the data to be entered while this input is at a logic 1, and a clock input generally operates by entering the data during the time the clock input changes. Because the clock signal can change from a 1 to a 0, or vice versa, it is necessary to identify which change activates the device. Thus, a clock input can require either a positive or negative edge to allow the data to be stored, depending on the IC type.

There are two basic types of flipflops, and these are shown in Figure 4. The 'D' flipflop has one data input and two outputs. The outputs are labelled Q and  $\bar{Q}$ , with one being the opposite logic level to the other. The timing signal is applied to the clock terminal, and the logic level on the D input will appear at the Q output when the clock terminal allows it. If the clock is a single pulse, then the information will be retained until the clock is next activated, when the new information will be entered.

Some D flipflops use an enable rather than a clock input, meaning that the Q output will follow the D input when the enable is high. When used in this mode, the device is often called a latch. Notice that another input called the reset is shown. This is used to initialise the device by clearing the Q output to a logic 0. The clock terminal has no effect on this input; it is used normally as a means of starting everything up from a power-on condition to establish the initial conditions.

The other flipflop shown is the JK device. This flipflop has two inputs and is more sophisticated in its operation as a result. It becomes necessary to apply information to both inputs to ensure the desired output results. The way in which the output responds to the four possible variations of the inputs is shown beneath the JK symbol, remember of course that the outputs only respond when the clock terminal allows it.

## Counters and shift registers

In the same way that gates can be grouped to produce the flipflop, counters, shift registers and the like are simply a number of flipflops interconnected within the IC. Counters all do the same thing, they count digital pulses. Because the device is digital, the output of the counter will be a binary number. Most counters have four outputs, and are designed to count either from 0 to 9, (known as a decade counter) or from 0 to 15. Various features are often incorporated, with up or down counting; the

ability to preset the device to start counting from any number, reset to zero, etc is typical.

Counters are used in many ways, one possibility being as a frequency divider. A digital clock will often use counters to di-

vide the reference frequency (often 50 Hz from the mains) to give one pulse per second. Thus, a group of counters is connected to count from 0 to 49, with the last output, the fiftieth, being a unique binary number that a group of gates sees as the right code ▶

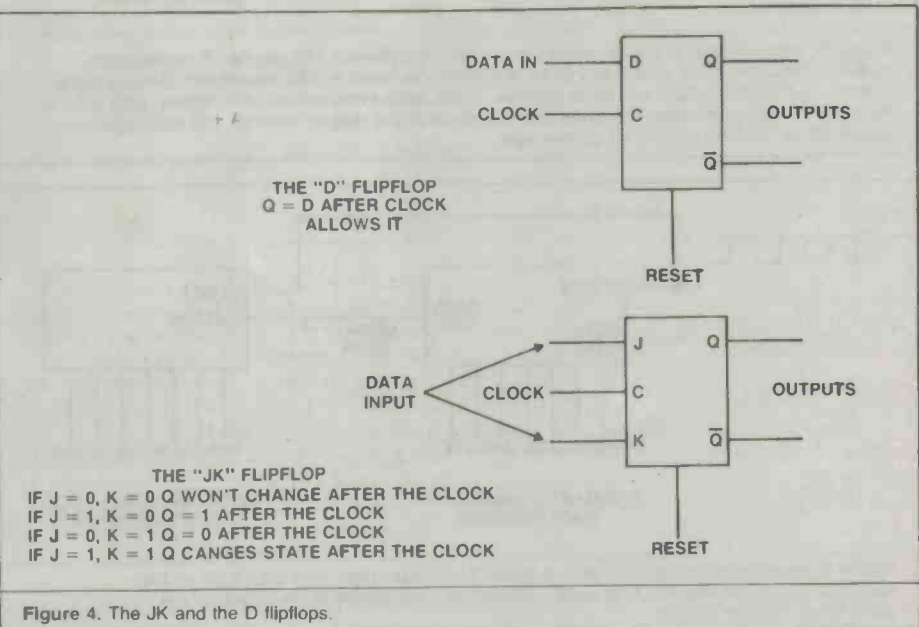
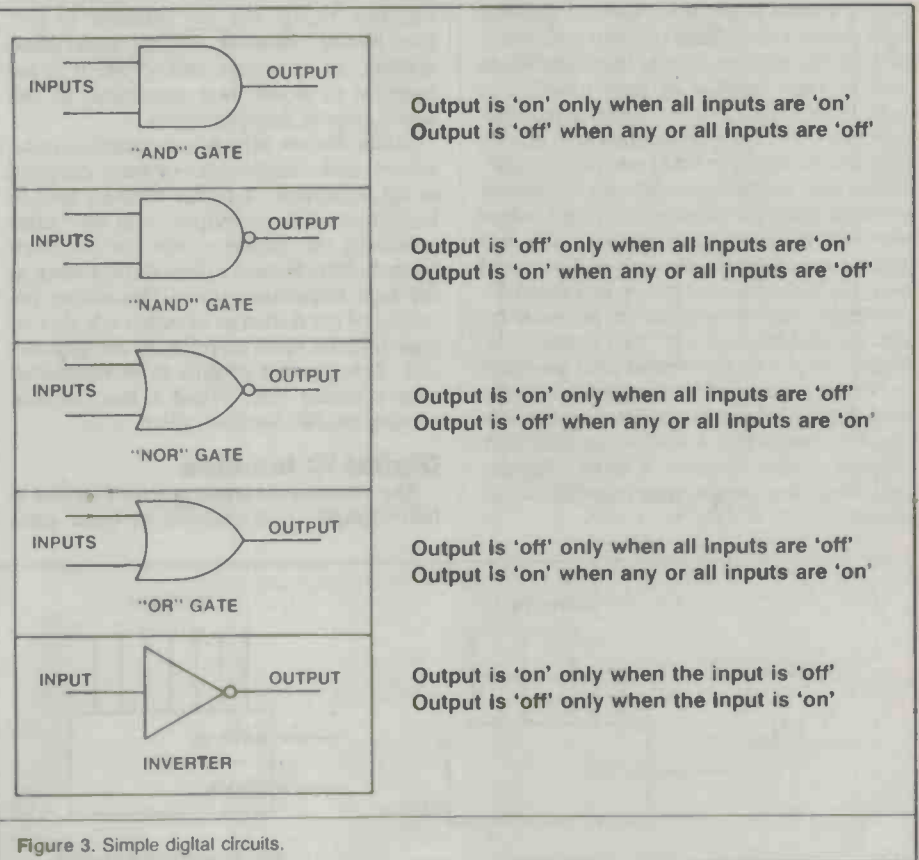

to output a 1. Subsequent counters will be used to count this pulse to give the minutes, hours, even years.

A shift register, of which there are various types, uses flipflops to allow digital data to be moved. A group of D flipflops can be connected to transfer a single binary bit of logic 1 around in a manner that can create a light chaser effect. Shift registers are identified by the number of bits they handle, as well as their method of data transfer. A light chaser would use a 'serial-in/parallel-out' type, as would any circuit that has to handle data that is entered one bit at a time. In this way, single binary bits can be entered until the required number is reached, when the shift register will contain all the bits gathered as a group. This group is referred to as parallel data, and can be processed accordingly. The reverse can be provided by the 'parallel-in/serial-out' shift register, allowing serial data (or one bit after another) to be sent between two points along a single wire. Figure 5 shows the block diagrams of a four bit counter and a serial-to-parallel shift register. Figure 6 shows a block diagram providing the serial data transfer mentioned.

## Other digital ICs

Digital ICs apart from those already mentioned range from simple decoders to extremely complex subsystems. A microprocessor is about the pinnacle for a digital subsystem, and way beyond the scope of this article. By way of a brief run down of the varieties, digital ICs are available to perform binary arithmetic, decode digital information, act as timers, and so on. It is not practical to detail their operation, as this would require many chapters.

Other devices include memories, data selectors, and various types of gates designed to act as buffers. A buffer allows a load to be connected to an output, with the buffer providing the driving power for the load. Some buffers feature a third state, known as the high impedance state. This allows the output of the device to be either a logic 1 or logic 0 in the usual manner, or an open circuit. This permits outputs to be connected to a common line, called a bus, without causing conflict between them.

## Digital IC families

The circuitry to create a gate function is fairly simple. It is possible to build gates

using discrete components, but this is rarely done as the IC offers so many advantages. As most digital chips are merely a number of interconnected gates, the circuitry is not necessarily complex, just repetitive. The active devices used within the IC identify the logic 'family' that the IC belongs to. There are a number of these families and their subgroups, of which the two most popular are CMOS and TTL. Each type has advantages and disadvantages that dictate when one or the other is used.

TTL stands for transistor-transistor logic, and uses transistors within the IC to produce the particular function. This type of logic is probably used more extensively than any other, as it has the advantage of being able to operate at speeds of around 30 MHz or more. The difficulty with TTL is its power consumption, although as it can drive loads requiring currents of around 16 mA or more it is able to interface to other devices fairly readily. A subgroup of this family is the very popular LS variety. The TTL LS types incorporate special diodes known as Schottky diodes to reduce the power consumption without reducing the speed of operation. LS stands for low power Schottky, and the power required for an LS chip is generally only 20% of that for a standard TTL type.

Both the TTL and TTL LS logic chips operate from a 5 volt supply. This voltage should not vary more than 5% either way, illustrating a difficulty with this family. Another problem is that considerable 'noise' is generated on the dc supply line by the ICs, mainly when they switch between states, and it becomes imperative to attach 'despiking' capacitors between the 5 volt line and earth at various points throughout the circuit. These capacitors are usually 0.1  $\mu$ F ceramics.

The CMOS family consists of ICs whose circuitry is made up of complementary MOSFETS. Several significant advantages result in using FETs as the active component within the IC, the main one being that very little power is consumed by the chip. Another advantage is that because minimal heat is generated within the integrated circuit, more complex circuits involving a larger number of devices can be built. Most of the fancy logic ICs are CMOS, including digital watches, calculators, microprocessors, memories, and special function types.

A problem with CMOS logic is that it can provide very little drive power to external devices, necessitating the use of 'buffer' ICs which connect between the load and the logic element. Other difficulties include a slow operating speed, typically 10 MHz, and the likelihood of a static voltage destroying the IC. Unlike TTL logic, CMOS has no stringent demands on the power supply, and can be used in equipment powered from batteries.

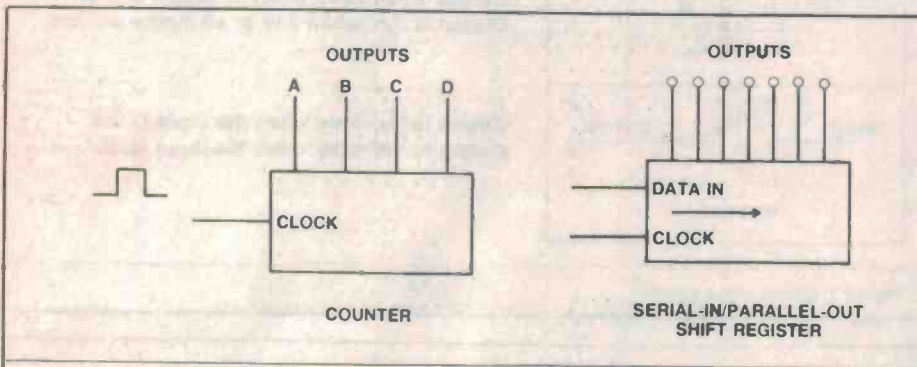

Figure 5. Block diagram of a 4-bit counter and serial-in/parallel-out shift register. A digital counter counts in binary the clock pulses that arrive at the clock terminal. A 4-bit counter will count no higher than 15, and will then return to zero to continue. In the serial-in/parallel-out shift register, data shifts to the right, moved by the clock. The serial data is entered at the 'data in' terminal, and after eight clock pulses will be restored as an 8-bit parallel byte.

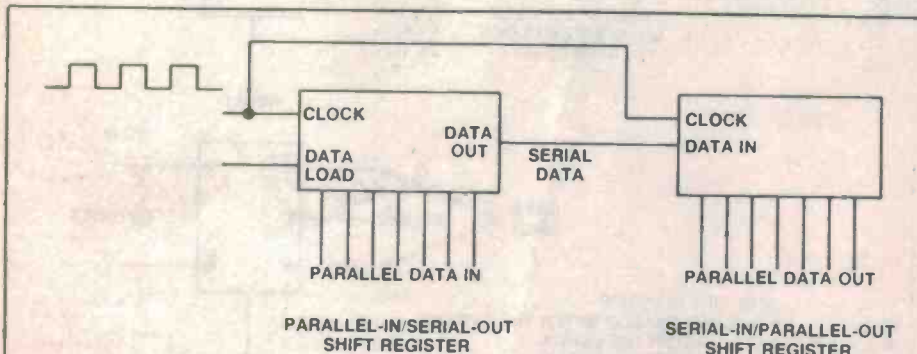

Figure 6. Serial data transfer. The data is loaded by activating the 'data load' input on the parallel-to-serial shift register. After eight clock pulses it will appear at the outputs of the serial-to-parallel shift register.



# Pre-loved Information Packages

Just:

**\$449.00\***

## Practicalities of digital ICs

Like all integrated circuits, digital ICs come in a range of package styles and type numbers. The 7400 series is the most common TTL numbering scheme, starting its numbering from 7400 and extending up to (currently) 74670. A standard TTL IC is simply identified as 74XX, where XX is the number containing up to three digits following the 74.

The LS subgroup is identified as 74LSXX and duplicates all the standard TTL chips. Many LS devices are not available as standard TTL types, and it is now becoming difficult to purchase many of the once available standard TTL devices. Such is the popularity of the LS varieties. Other TTL subgroups are manufactured, designated by letters after the 74.

Identifying a TTL IC can only be done with a data book. Most parts suppliers sell these, and all the information one could possibly want is contained within these books. Some text books give abbreviated data on the more popular TTL devices, and this method of obtaining information is sometimes better for those in a hurry or unable to understand the wealth of information provided by manufacturers' data books.

The CMOS family is represented by the 4000 series. Another is the 74C series, a range of CMOS devices pin compatible with the 7400 TTL family. The 4000 series contains the widest variety; the numbering commences from 4000, and enters the 4500 range, even up to 4700. Again, manufacturers' data is essential if use is to be made of these devices.

Other digital ICs that are special purpose devices have their own numbering schemes. Microprocessors and their support chips are usually special devices belonging to a small family created by a particular manufacturer. Memory ICs form yet another group, with type numbering often relevant to only one manufacturer. The list goes on, bewildering to all but the most ardent followers of the technology. Because new devices are appearing nearly every week or so, it is impossible to keep track of the whole field. The trick is to stay with the devices that have been around for some time.

The digital field is an enormous topic. Many excellent texts on the subject have been written, and much can be learned by reading electronics magazines. Because it differs so greatly from conventional electronics, it is possible for beginners to become fairly expert in digital, without even knowing Ohm's law. Designing digital circuits can also be accomplished with a limited knowledge, and a lot can be learned by experimenting with the gates and flipflops discussed in this article.

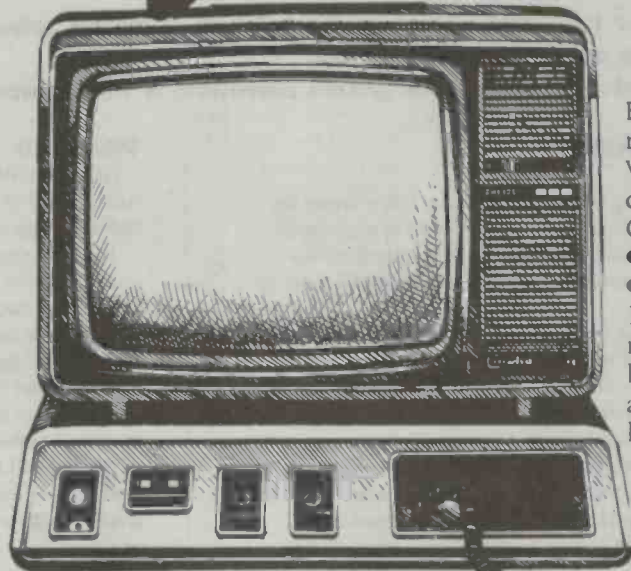

Ex-rental, expertly maintained, Philips Videotex package consists of: • RGB Colour Monitor – 14" • Videotex Decoder • Internal Autodial 1200/75 • Modem • All necessary connecting leads • Telecom approved. Ideal for home use or for parts.

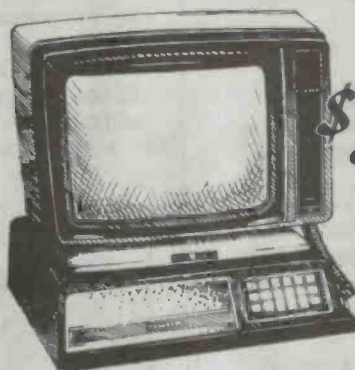

**\$349\***

Great Value Videotex Decoder. • Internal Autodial Modem 1200/75 • Infra Red Keypad • Connects to any UHF TV.

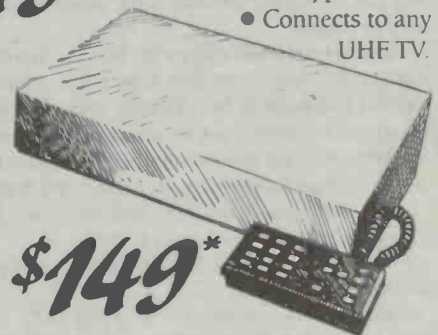

**\$149\***

Ex-rental, expertly maintained package consists of: • RGB Colour Monitor – 14" • Videotex Decoder • RS232 Connection • Numeric Keypad. (Package for connection to external modem.)

\* Packaging and delivery extra for interstate and country orders.

Return to base 90 day parts and labour warranty on all units.

For enquiries call  
SYDNEY (02) 959 6500 MELBOURNE (03) 699 3144

# ACTIVITIES FOR SCHOOLS

## Attention students!

Besides the ETI 1986 Schools Electronics Competition there's a lot out there in the electronics world happening in schools and for schools. In devoting a page each month in the magazine to school students we hope to arouse and maintain your interest in electronics.

So to that end we will use this page to publish details of other electronics competitions, design ideas and project ideas for our own 1986 Schools Comp. As well as this, we want to publish reports that tell us about your group, your schools, the problems you encounter with your projects — and of course the help you get. But this one is up to you. We need the information from you.

Other questions we have are: where are the girls? Have the sex roles changed? We'd like to hear some stories about girls out of the sewing room into the lab!

The address to send us details of your group's adventures is 140 Joynton Ave, Waterloo, NSW 2017.

## OTHER COMPETITIONS

### AMP/TOWARDS 2000

The AMP Society is offering Australia's largest science award for young people under 19. The award, to be offered in association with the televised programme "Beyond 2000" featured on the Seven Network, will be known as AMP's "Beyond 2000" Science Award.

The competition, with prizes totalling more than \$40,000, will be conducted in all states and territories later in the year with the assistance of the Australian Science Teachers Association.

Announcing the sponsorship, AMP's NSW Manager, Mr Ian Worner, said that the "Beyond 2000" television programme on the Seven Network in 1985 became one of Australia's most successful new programmes. This Australian-made production sparked a strong and positive reaction. A large section of the viewing public indicated interest in science and technology when presented in a dynamic fashion.

### Competition facts

The award competition is open to all Australians under 19 on 1 September 1986. Judging criteria are

- innovation;
- practicability;
- scientific and technological content.

The award aims at the working model type of entry or something that can be readily demonstrated. Research papers by themselves are not sought.

Entry fee is \$1 payable to the State or Territory branch of the Australian Science Teachers Association which will do the initial judging and assist in final judging. Only one entry per person will be allowed. Entries must be substantially the work of the entrant. Projects are to be delivered to the local branch of the Science Teachers Association advised on the entry form.

Entry forms, available from AMP branches and science teachers, must be received by 30 August, 1986.

First prize is a trip for two (the winner and parent, guardian or chaperone) to the US.

State/Territory winners receive \$500 and a trip to Sydney for final judging. The five State/Territory finalists will receive \$100 each.

Other prizes include:

- 80 merit prizes of \$25 each (five per region);
- 80 copies of the book "Beyond 2000" (five per region); and
- 8 school prizes for winners' schools (video tapes of certain "Beyond 2000" programmes).

### JACARANDA

Educational computing has escaped from the maths-science stranglehold of a few years ago if the entries in the 1985 Jacaranda National Educational Software Award are any indication.

The inaugural award of \$1000 was won by "The Tycoon Itch", a simulation that requires students to act as a shipping and commodity trading company's board of management. The program demands the use of skills in geography, economics and accounting as the board guides its ship from port to port. The authors, Cyril Balkisson and Sydney Sanders, both work at Bramfield Park Primary school on the outskirts of Perth. Their package will be published by Jacaranda Software in the middle of next year.

"Hume and Hovell", by Clive Millsum of Cranbourne, Victoria, won second prize because of its sensible combination of excellent graphics with a carefully researched historical recreation of the explorers' epic journey.

Dave Healy of Kingsley (WA) came third with "Numerama", a simple, challenging open-ended maths activity. The judges agreed that although the central idea of the program was not new, it was the only package of its kind suited for use in the middle primary school.

The judges were Di Ryall (Apple Computer), Tony Salvus (State Computer Centre, Melbourne), Eric Davis (Centre 2000, Brisbane) and Bruce Mitchell (Jacaranda Wiley Ltd).

For further information contact Bruce Mitchell on (07)369-9755.

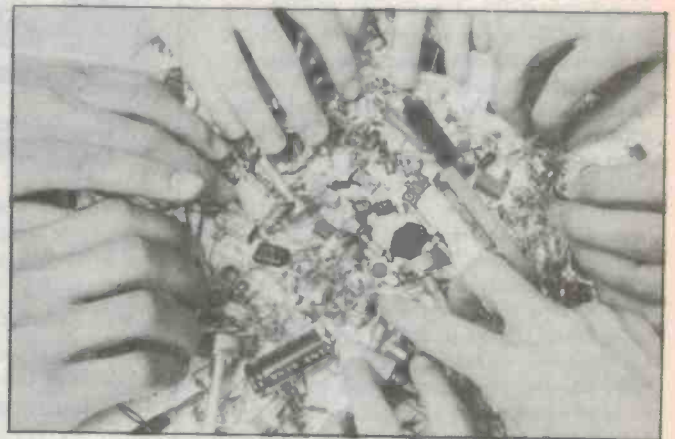



# 1986 SECONDARY SCHOOLS ELECTRONICS COMPETITION

**GET YOUR SCHOOL INVOLVED. YOU CAN HELP IMPROVE THE LEVEL OF AWARENESS AND UNDERSTANDING OF ELECTRONICS TECHNOLOGY AND WIN GREAT PRIZES FOR YOUR SCHOOL AT THE SAME TIME.**

To enter you will need to form a group at your school to build and possibly design an electronics project. The winning school entries will be judged on the way students were involved in the theoretical and practical aspects of the competition. The only limitation on the design is that the published cost of its component parts should be less than \$100.

To help schools get tutorial or financial assistance from local companies, Electronics Today will ensure any company's assistance is advertised in a special schools page in the magazine. Schools that let us know about the progress of their electronics group will also be reported in the magazine.

Where possible the students should be involved at a circuit design level, but the competition will be judged in a way which will not penalise groups that do not have the required electronics design skills. To help these groups, Electronics Today will publish a number of project designs which can be used to enter the competition.

A complete copy of the competition rules and objectives will be made available to any school that registers its interest in the competition. Just by registering you have a chance of winning electronics products for use by your school. Copies of the rules have also been sent to either the principal or science teacher at your school.

## GREAT PRIZES FOR YOUR SCHOOL

**\$2000 WORTH OF ELECTRONICS FROM DICK SMITH ELECTRONICS!** The winning school will get \$2000 worth of electronics for its lab. This would make a great start to an electronics lab or help equip an existing one.

**25 SOLDERING IRONS FROM SCOPE!** The first 25 schools to submit registration forms and then go on to complete the competition will get a soldering iron worth nearly \$30 from the leading Australian soldering tools manufacturer, Scope.

**25 PACKS OF SOLDER FROM MULTICORE SOLDERS!** Those first 25 schools to submit registration forms and go on to complete the course will also win packs of high quality, industrial grade solder worth \$30 from Multicore Solders.

**15 JUMBO COMPONENTS BAGS FROM DICK SMITH ELECTRONICS!** The first 15 schools to enter the competition, whether they complete the competition or not, will win a jumbo bag of components with a retail value of at least \$75. At your first electronics group meeting you can learn how to identify common components.

### MORE PRIZES THROUGHOUT THE YEAR!

Electronics Today will invite other electronics suppliers to join in and offer great prizes.

Sponsored by:  
Electronics Today  
Dick Smith Electronics  
Scope Laboratories  
Philips  
Multicore Solders



**eti**



## HOW TO ENTER

Schools should register their interest as soon as possible so we can keep them up to date — they will also have a chance to win electronics products just by registering. Registering brings no obligation on the school, but it allows us to supply free support material and to keep you up to date.

Entrants are required to submit a written report and hardware by August, 1986. Full details are available when you register. There will be one international winner and a finalist from each State, Territory and New Zealand. The judging panel will include members of the Australian Science Teachers Association, other science teachers, representatives of Electronics Today and Dick Smith Electronics. Electronics Today will have the responsibility of ensuring the fairness of the competition.

## REGISTRATION FORM

COMPLETE AND SEND TO "SECONDARY SCHOOLS COMPETITION", ELECTRONICS TODAY INTERNATIONAL, PO BOX 227, WATERLOO, NSW 2017.

SCHOOL .....

ADDRESS .....

GROUP LEADER'S NAME .....

SCIENCE TEACHER'S NAME .....

DOES YOUR SCHOOL ALREADY HAVE AN ELECTRONICS

GROUP OR COURSE? .....







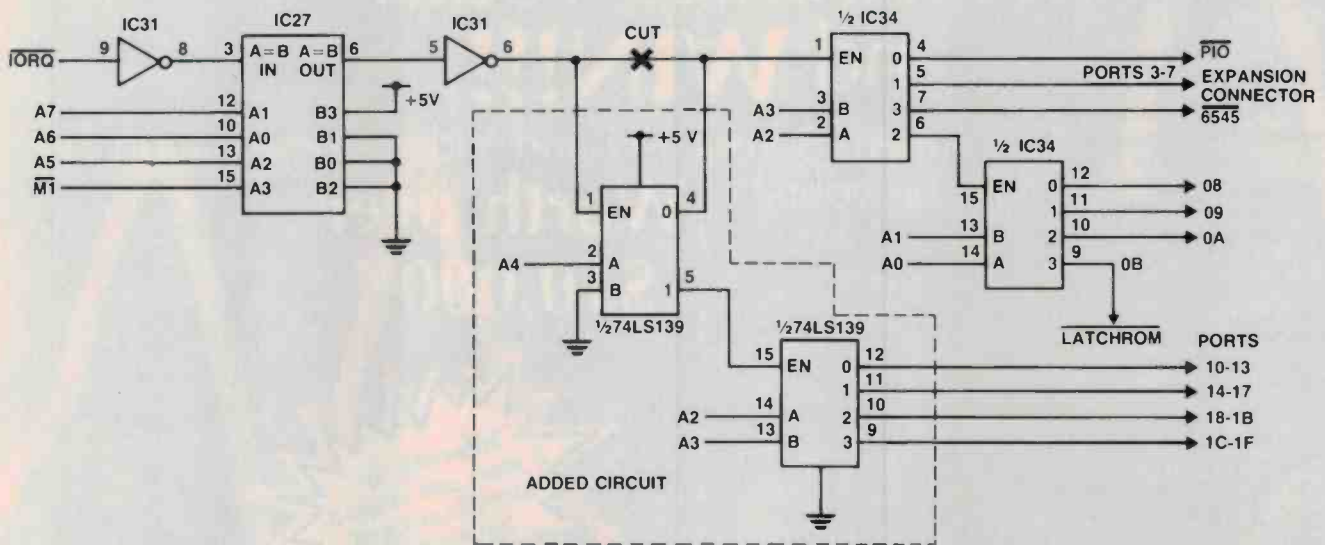

## An extra port for the Microbee

G. J. Martindale,  
Mill Park, Vic 3082

In the Microbee computer, on-board decoding of the group of ports in the range 00(h) to 0F(h) is accomplished by IC27 (a 74LS85 4-bit magnitude comparator), two sections of IC31 (a 74LS04 hex inverter), and IC34 (a 74LS139 dual 2-to-4 decoder) which determine that:

- (i) access to a port is required;
- (ii) by decoding of the Z80 system address bits 0 to 7, which particular port is required.

Address line A4 is not included in the port decode circuitry and therefore some duplication of decoded ports occurs — that is, instead of the exclusive range of ports 00 to 0F(hex), the duplicate ranges 00 to 0F and 10 to 1F are actually decoded. A READ or WRITE to say port 11(h) then produces the same effect as one to port 01(H), etc.

I have not yet found a routine

in BASIC ('old' version 5.10 on my machine) which accesses any of the Microbee's internals via the alternative port addresses in the range 10 to 1F(h), however.

Therefore, if address A4 could be introduced into the port decode procedure, it will eliminate internal port assignment duplication and should, with a minimum of fuss, make another group of 10(h) ports available for internal 'add-ons' such as a real time clock, etc.

The diagram shows the arrangement I used to accomplish the extra decoding.

A 74LS139 dual decoder is used as follows. The first half is controlled solely by the status of address line A4 and switches an ENABLE signal to either the normal on-board decoder IC34 (for A4=0) or to its own second half (for A4=1).

The range of ports decoded 'on-board' is now exclusively between 00 to 0F(h).

The second half of the added 74LS139 then functions in similar fashion to the on-board 'groups-of-four' decoder, enabling the appropriate output depending on the status of addresses A2 and A3. The range of ports decoded by this section of the IC is, however, exclusively in the range 10 to 1F(h).

I constructed the extra port decoder for my 'Bee on a small piece of Veroboard and fixed it to the underside of the main board with some double sided adhesive foam strip. Flexible wire leads then run to appropriate circuit pickup points, while the new port ENABLE outputs were made available at Veroboard pins for later connection to add-ons.

Note that the Microbee circuit board track running between pin 6 of IC31 and pin 1 of IC34 is required to be cut to implement the extra port decoding.

# Subscribe NOW to Electronics Today and **WIN!!!**

This superb Sony Hi-Fi and Video combination  
could be yours!

**Worth over  
\$10,000!!**

Subscribe for  
2 years and enjoy a  
special saving of  
almost \$6!

By subscribing to Electronics Today, you may very shortly be relaxing in front of your own Sony system, enjoying the superb listening pleasure that can only come from Compact Disc technology, and while basking in richer listening pleasure you could be watching, filming, or recording your selection using your new Sony Video-8 video system, both systems designed to be fully integrated with each other.

This magnificent Sony Component System represents true, leading edge, technology. The 100 watt RMS per channel integrated stereo amplifier will give you plenty of power and can reproduce the most demanding in CD fidelity. The discrete three head design stereo cassette deck will improve

the faithfulness of your recorded sound. Improved frequency response will be evident as your AM/FM precision quartz tuner eliminates interference. With 20 key direct music selection and infra red remote control, the Digital Compact Disc player satisfies your most demanding requirements in fidelity and convenience. The digital compatible APM speaker system has been specially designed to cater for near perfect CD reproduction. A 20" high resolution Profeel monitor, including speakers, represents the best in video display monitors while the complete Video-8 system combines quality with portability. To complete the finishing touches a tuner/timer for the PAK 88 system is included.



## IMPROVE YOUR LIFESTYLE BY MAXIMISING YOUR LISTENING AND VIEWING PLEASURE!

By subscribing to Electronics Today you will be kept up to date with feature-packed articles, the latest news and everything that Electronics enthusiasts, like you, need to know. There are always new techniques, new products and helpful stories to improve your knowledge and round-off your education.

Having Electronics Today delivered to you direct ensures you receive every issue without fail and saves you the time you would otherwise have to waste by having to go out and buy it.

### **YOUR FREE GIFT** — JUST FOR SUBSCRIBING!

Your Electronics Today team have gone to great trouble to select a special extra added bonus that you will find is really useful. This super-versatile Swiss Army Knife has seven different features — from a wire stripper to a can opener — and is that indispensable tool you'll find hard to do without.

The Swiss Army Knife features include a large blade, small blade, can opener, screw driver, cap lifter, wire stripper and key ring.

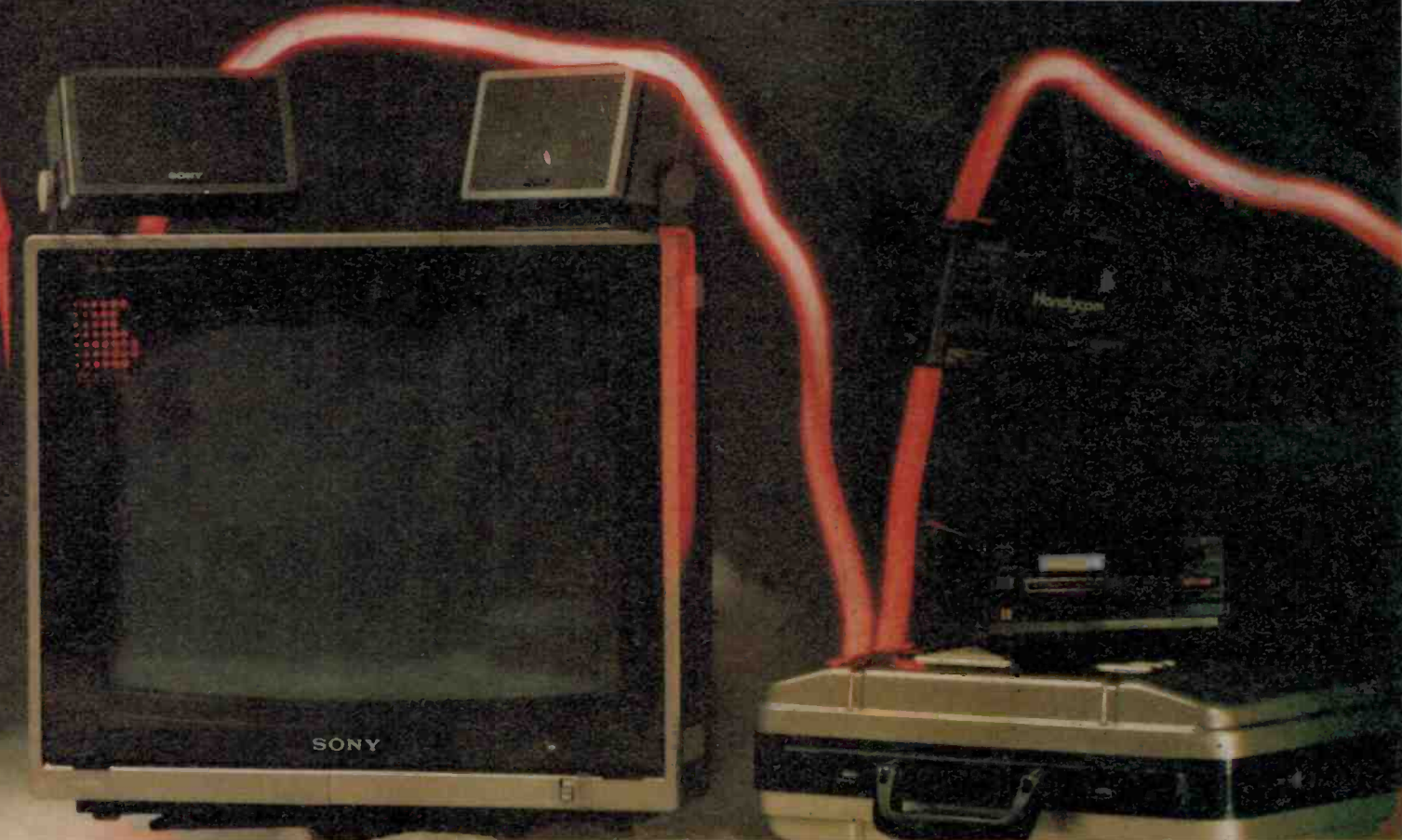

## WIN THE HI-FI/VIDEO SYSTEM OF YOUR DREAMS!

### **HURRY — THIS IS A LIMITED OFFER.**

Simply complete the subscription card in this magazine and send it FREE to us. Within six weeks you will receive your Swiss Army Knife and be enjoying articles in the first of your home-delivered ELECTRONICS TODAY magazine.

#### **YOUR NO-RISK GUARANTEE**

If, for any reason you are not completely delighted with ELECTRONICS TODAY . . . simply let us know, and we'll gladly refund the unused portion of your subscription.

### **YOU MUST ACT NOW**

NSW Permit No TC86/532 issued under the Lotteries and Art Unions Act, 1901  
VIC Raffles and Bingo permits Board Permit No 86/270 issued on 13/3/86  
ACT Permit No TP86/162 issued under Lotteries Ordinance.  
(Offer valid until 31 August, 1986.)

The exciting prize draw is also open to all subscribers who renew before the closing date. If the prize is not claimed within 12 months, a second draw will be run.



# BOOKS OF SPECIAL INTEREST . . .

## electronics textbooks

### ELEMENTS OF ELECTRONICS- BOOK 1

This five book series is an Introduction to modern electronics. All of the necessary mathematics is introduced and explained as required. The emphasis is on understanding concepts rather than digressing over the whole field. The author anticipates difficulties the beginner may have and explains them as they occur. BOOK 1 covers all of the fundamental theory necessary to understand simple electronic circuits and components. 209pp.

A0003B \$9.95 \$5.95

### HOW TO MAKE WALKIE-TALKIES

This treatise on low power transmitter-receivers (walkie-talkies) covers many aspects, from licensing requirements and bands, through practical circuitry and construction to the types of aerials that may be used. 104pp.

D0056B \$6.95

### LINEAR IC EQUIVALENTS AND PIN CONNECTIONS

This invaluable addition to any electronic enthusiasts's library shows the equivalents and pin connections as well as the country of origin, manufacture and functions of a user-oriented selection of linear integrated circuits. The selection has been based on usefulness and practicality to designers, hobbyists and service engineers. 247pp.

B0006B \$12.95

### PRACTICAL ELECTRONIC CALCULATIONS AND FORMULAE

For the practical person's workbench. Bridges the gap between practical theory and cut-and-dried methods which work but leave the experimenter unfulfilled. There's a strong practical bias and higher maths are avoided where possible. 249pp.

B0027B \$9.95 \$5.95

### INTERNATIONAL DIODE EQUIVALENTS GUIDE

Includes zener diodes, LEDs, diacs, triacs, thyristors, OCIs; photo, display, and simple rectifier diodes. 130pp.

B0339B \$6.95

## constructional projects

### BEGINNER'S GUIDE TO ELECTRONIC PROJECTS

This guide enables the complete beginner to tackle the practical side of electronics so that the projects featured regularly in popular magazines can be approached with confidence. The basics are covered in detail using practical examples in the form of simple projects. 107pp.

C0030B \$6.95

### RADIO CONTROL FOR BEGINNERS

Newcomers to the fascinating hobby of radio control will find this practical introduction invaluable. A number of constructional projects, many with complete board layouts, are included to help the beginner simply and successfully build up the circuits. 92pp.

C0034B \$6.95

### SOLID STATE SHORTWAVE RECEIVERS FOR BEGINNERS

Details the design and construction of several solid state shortwave receivers giving a high level of performance yet utilising few components. 93pp.

C0044B \$5.95

### REMOTE CONTROL PROJECTS

Primarily for the enthusiast who wishes to experiment with remote control. Full explanations of the how the circuits work are given and many of the designs can be adapted to circuits that have been published elsewhere. Covers remote control by ultra-sound and infra-red as well as radio control. 164pp.

D0046B \$7.95

### ELECTRONIC SECURITY DEVICES

Besides including both simple and sophisticated burglar alarm circuits using light, infra-red and ultra-sonics, this book also gives circuits for gas and smoke detectors, flood alarms, fire alarms, doorphones, etc. 102pp.

D0059B \$6.95

### HOW TO DESIGN ELECTRONIC PROJECTS

Tackles the problem of combining and integrating components into a complete working project with the minimum of trial and error and without advanced mathematics. Guides the reader through examples with circuit analysis, possible solutions and practical designs including component values. 101pp.

E0082B \$7.95

Postage and packing additional:  
Please refer to reply card for charges.

## test equipment and fault finding

### HOW TO GET YOUR ELECTRONIC PROJECTS WORKING

Helps you to overcome the problem of a circuit that doesn't work after assembly by indicating how and where to start looking. Covers most of the common faults that occur when constructing an electronic project. 81pp.

F0114B \$7.95

### TROUBLESHOOTING WITH THE OSCILLOSCOPE

Excellent for the professional service technician or serious hobbyist. It combines step by step procedures for using the 'scope with the specific nuts and bolts of television receiver troubleshooting. 92pp.

F0121P \$28.95

### USE OF THE DUAL-TRACE OSCILLOSCOPE

This programmed text breaks down the process of operating a 'scope into a series of logical steps. It starts with the deflection of the electron beam and continues through the proper use of the triggering controls to measure the phase difference between two waveforms. 246pp.

F0259H \$42.50 \$39.95

## electronic music and audio/video

### WORKING IN THE MUSIC BUSINESS

Gives realistic insights into the work and lifestyle found in the music business. Definitely of interest to anyone considering work in recording studios, record companies, music publishing and similar fields. 158pp.

G0279D \$11.95

### ELECTRONIC MUSIC PROJECTS

Provides constructors with practical circuits for the less complex music equipment including fuzz box, waa-waa pedal, sustain unit, reverb and phaser, tremolo generator, and the like. Text covers guitar effects, general effects, sound generators, and accessories. 106pp.

G0135B \$7.95 \$6.95

### AUDIO AMPLIFIER CONSTRUCTION

Provides a wide range of preamplifier and power amplifier designs including a low noise microphone, tape head and guitar preamps, and various tone controls. Written for those with limited experience in construction, but certainly useful for the more advanced hobbyist. 99pp.

G0132B \$7.95

### AUDIO

A theoretical study of sound waves and acoustical quantities which leads into a study of hearing and room acoustics. A discussion of microphones and loudspeakers is developed into sections on amplifiers and recordings, covers digital as well as magnetic and disc recording. 308pp.

G0332B \$8.95

### ELECTRONICS SYNTHESISER PROJECTS

For the electronic music enthusiast. This invaluable reference is full of circuits and information on how to build analogue delay lines, sequencers, voltage control oscillators, envelope shapers, etc. The author takes a clear and logical approach to the subject that enables even the beginning enthusiast to understand and build up what appear to be quite complex instruments. 81pp.

G0133B \$6.95

## computer hardware and techniques

### THE USER'S GUIDE TO COMMODORE 64 & VIC 20

The editors of Consumer Guide have compiled a thorough introduction to the Commodore 64 and Vic 20 computers, software and peripherals. With colour illustrations and a clearly written text, this reference will guide the newcomer through all phases of learning how to use the computer: From setting the system up, learning what each key does, expanding the system with peripherals, to buying new software. Specific exercises are included for each of the keys. Spiral bound, 80pp.

H0065G \$9.50 \$5.95

### EASY-TO-UNDERSTAND GUIDE TO HOME COMPUTERS

Confused by all those computer terms? This clearly written book from the editors of Consumer Guide tells exactly what computers are, how they work and why they are so amazingly useful, all in plain English. Here is all of the information needed to understand and use computers, and even to start programming. A special buying section compares the most popular home computers. This book is your ticket to the computer age! Spiral bound, 96pp.

H0066G \$9.50 \$5.95

### COMPUTER TERMINOLOGY EXPLAINED

Concisely explains the most common terms encountered by the home computer enthusiast as well as many of those used with mini- and mainframe computers. Includes tables of ASCII codes and BASIC control codes. 81pp.

H0143B \$5.95

### SPOTLIGHT ON COMPUTER AWARENESS

An introduction to speaking confidently about how computers work, their applications, their history (from abacus to IBM) and employment prospects in computer related fields. Includes a comprehensive glossary. 84pp.

H0145P \$6.95 \$4.95

### A PRACTICAL INTRODUCTION TO MICROPROCESSORS

Takes the reader through the construction of a simple microprocessor and experimenting with it to gain an insight into the complexities of microprocessing. The book assumes a general knowledge of electronics. 90pp.

J0158B \$5.95 \$4.95

**ORDER TODAY —**

**Simply return the coupon on page 91**



# AT NEW LOW PRICES...

## computer hardware and techniques

### AN INTRODUCTION TO Z80 MACHINE CODE

Starts with a general background to microprocessing and then details the full set of Z80/Z80A instructions. Also covers the use of address modes and gives machine specific listings and sample programs. 107pp. K0180B \$7.55

### FORTH PROGRAMMING

Describes both FORTH-79 and fig-FORTH and shows how to write software using these languages and how to add new operations (words) and manipulate the stack. Includes more than 50 useful programs. 246pp. K0298P ~~\$29.95~~ \$19.95

### ALMOST EVERYBODY'S PERSONAL COMPUTER BOOK

Written for the computing beginner to break the enormous barrier of jargon and mystique that seems to surround computers. With a highly readable approach, the author introduces the basic concepts and develops them into a general discussion on personal computers including choosing and caring for a PC. Also offers an introduction to BASIC programming. 160pp. H0144Z ~~\$8.95~~ \$5.95

### MICROCOMPUTING DESIGN & TROUBLESHOOTING

Explains designing microcomputer systems and making them work without expensive commercial development systems or the need for costly test instrumentation. Includes a complete description of two microprocessors—the 8085 and the 6502. 346pp. J0161P \$26.75

*Stock of some titles may be limited.*

### EASY ADD-ON PROJECTS FOR COMMODORE 64, VIC-20, BBC MICRO & ACORN ELECTRON

The simple and inexpensive projects include a pulse detector, model controller, light pen, lap sensor and more plus six projects that make up a weather station. 191pp. J0165B \$6.95

### A Z80 WORKSHOP MANUAL

Intended for those who want to progress beyond programming in BASIC to topics such as machine code and assembly language programming or who need hardware details of the Z80-based computers. 184pp. J0283B \$8.95

### SECRETS OF THE COMMODORE 64

A beginner's guide to the C64 with masses of useful information and programming tips as well as describing how to get the best from the powerful sound and graphics facilities. Includes two useful chapters on machine code. 109pp. J0297B \$5.95

### MICRO INTERFACING CIRCUITS: BOOK 1

Guides those who are unaccustomed to microprocessor techniques but have some knowledge of electronics, through a practical approach to address decoding, parallel and serial interfacing, analogue to digital and digital to analogue converters, etc. 96pp. J0325B \$6.55

### MICRO INTERFACING CIRCUITS: BOOK 2

Develops the practical side of interfacing introduced in Book 1. Discusses sound and speech generators, temperature and optical sensors, motor controllers, etc. 87pp. J0326B 6.55

### WILDCARDS 4

No tips, techniques or theory in this volume: It's mainly quality games with PCG graphics—games of strategy and games of fast reflexes, many of them taking full advantage of colour graphics. From simple Boxes (not so simple!) to Radio with complex scenery: This is a book that teaches the fun way. 109pp. K0024P \$15.95

### AN INTRODUCTION TO MSX BASIC

For those wanting to learn to program, Microsoft Extended (MSX) Basic offers a powerful and flexible version of the most popular computing language. This comprehensive introduction starts with the basics and progresses by stages to the more advanced programming techniques and includes coverage of advanced multicolour, sprite graphics, and the programmable sound generator. 88pp. K0047P \$6.95

*Prices subject to change without notice.*

### INSTANT PROGRAMMING ON YOUR SEGA SC3000 COMPUTER

Spiral-bound for easy use, this is THE Sega SC3000 beginner's book! In carefully explained, easy to follow steps, it covers the function of each key and all of the commands needed for super fast mastery of BASIC programming. This is a book for do-ers: The second part of the book teaches the real art of programming with plenty of examples and subroutines. 84pp. K0051P \$12.95

### THE BEST VIC/COMMODORE SOFTWARE

Trying to find the most suitable software for personal computers can be frustrating. The editors of Consumer Guide have compiled comprehensive reviews of VIC 20 and Commodore 64 programs based on ratings by user groups; further evaluation is given by the editors and Commodore software experts Jim and Ellen Strasma. Each review describes the program's purpose and features, detailing both the good points and bad. Each program has been rated for ease of use, clarity of written and on-screen instructions, and overall performance. The program's price, publisher, format and hardware requirements are also included. The reviews are presented in sets by topic: Word Processing, Business, Home, Education, Networking, Strategy Games, Arcade Games and Programming Aids. Spiral bound, 192pp. K0052G ~~\$8.50~~ \$4.95

### THE BEST APPLE SOFTWARE

Trying to find the most suitable software for personal computers can be frustrating. The editors of Consumer Guide have compiled comprehensive reviews of Apple II, II Plus and IIe programs based on ratings by user groups; further evaluation is given by the editors and Apple software expert Roe Adams. Each review describes the program's purpose and features, detailing both the good points and bad. Each program has been rated for ease of use, clarity of written and on-screen instructions, and overall performance. The program's price, publisher, format and hardware requirements are also included. The reviews are presented in sets by topic: Word Processing, Business, Home, Education, Networking, Strategy Games, Arcade Games and Programming Aids. Spiral bound, 160pp. K0060G ~~\$8.50~~ \$5.95

### DISCOVERING KNOWLEDGEMAN

According to prestigious Byte magazine, KnowledgeMan may be the most powerful relational DBMS currently available for microprocessors—and this is a powerful introduction! After a general overview, data management and spreadsheet capabilities are examined in eight sets of detailed lessons structured to give maximum learning benefits. 342pp. K0086P ~~\$34.95~~ \$29.95



### AN INTRODUCTION TO 6502 MACHINE CODE

Starts with a general background to microprocessing and then details all of the legal 6502 instructions. Also covers the use of address modes and gives machine specific listings and sample programs. 107pp. K0178B \$7.55

## amateur radio dx, communications

### HANDBOOK AND RADIO, TELEVISION, INDUSTRIAL AND TRANSMITTING TUBE AND VALVE EQUIVALENTS

There is no better equivalents handbook for amateurs and servicemen. Has more than 18,000 entries listing old and new valves from the United States, Britain and the rest of Europe, Japan and the military (CV) with commercial equivalents. 93pp. N0251B \$4.95

### 25 SIMPLE AMATEUR BAND AERIALS

Describes how to build 25 amateur band aerials that are simple and inexpensive to construct and perform well. Projects range from the simple dipole up to a mini-rhombic. 63pp. N0286B ~~\$6.95~~ \$5.95

### 25 SIMPLE SHORTWAVE BROADCAST BAND AERIALS

Describes concisely the design and construction of simple and inexpensive aerials that perform well: from simple dipole to end-fire arrays. Includes dimensions and other data for spacing and cutting phasing lengths. 63pp. N0362B ~~\$5.95~~ \$4.95

### THE WORLD IN MY EARS

This is THE basic manual for anyone with an active interest in shortwave listening written by Aurther Cushen M.B.E., world-reknown authority and broadcaster. In the first section, the book covers the historical development of shortwave broadcasting and the listening hobby that grew up with it. The second section covers the practical aspects: how to start out, how to erect antennas, all about time zones, DX clubs, reporting, news sessions, etc. 204pp. N0420C ~~\$10.95~~ \$7.95

## FEDERAL DIRECT BOOK SALES

PO Box 227, Waterloo 2017



# Can't find it?



**SAVE with SIX!**  
**6 Holders — only \$37.50**  
**6 Binders — only \$39.95**

**MAGAZINE BINDERS \$8.00**  
 Ready to use binders with easy, clip-in fastener, covered in soft, decorator brown vinyl. Holds 12 issues of Electronics Today.

**MAGAZINE HOLDERS \$8.00**  
 Big, easy to assemble holders, covered in soft, decorator brown vinyl. Holds 12 issues (at least) of Electronics Today.

So easy to order —

**Simply return the Freepost coupon on page 91**

Please allow \$1.95 per binder for postage and packing

**File it!**

# MORE SPECIAL BOOKS ..

## AUDIO ENTHUSIAST'S HANDBOOK

Covers the record/playback curve, stylus compliance, acoustic feedback, stereo tape track standards, compensating sideways drag, amplifier power ratings and more. \$2.75 Retail, 96pp.  
**G0383B Reduced to only \$2.00**

## CHOOSING AND USING YOUR HI-FI

Provides basic information on the technical specifications of hi-fi equipment. Offers advice on what to look for in equipment in order to obtain real high-fidelity sound and reproduction. \$4.95 Retail, 88pp.  
**G0385B ONLY \$3.95**

## THE 6809 COMPANION

This is not a beginner's introduction, but a thorough reference and discussion of the features of the 6809 microprocessor. An excellent reference! \$6.95rrp, 86pp.  
**J0154B Be quick at this price \$2.00**

## THE ART OF PROGRAMMING THE 1K ZX-81

The features of the ZX-81 are explained in some detail as background to programming. These include the random number generator, graphics facilities and timer. PEEK and POKE are also explained. The well-written section on programming should make anyone with a 1K ZX-81 a whiz! \$6.75 Full Price. 86pp.  
**K0226B A Ridiculous \$2.00**

## ELECTRONIC CALCULATOR USER'S HANDBOOK

Formulae, data, methods of calculations, conversions and just about all the etc's are explained in detail. Explains how to calculate with only a four function calculator, including trig functions, hyperbolics, square roots and powers. 207pp.  
**M0245B Hyperbollocks? \$2.00**



## MINI-MATRIX BOARD PROJECTS

This selection of 20 useful projects to build is an excellent introduction to constructing electronic projects. Those without any experience in electronics will find it easy to read and simple to follow. \$6.75 RRP, 102pp.  
**D0062B Priced to clear \$2.00**

## YOUR CALCULATOR AND YOUR MONEY

If you are interested in money and do even the simplest calculations, this book is a 'must.' It shows how to get the most practical use out of this efficient and powerful tool. The contents cover everything from simple arithmetic to compound interest, and depreciation. \$4.75 RRP, 174pp.  
**M0246B \$2.00**

## FUN & GAMES WITH YOUR ELECTRONIC CALCULATOR

Calculators might be a powerful and time saving tool, but they can also be an endless source of amusement and an excellent source of relaxation, as this book shows. What do 55 snakes in a 14 foot square pit do? (You'll have to read page 6 to find out.) \$2.50 RRP, 63pp.  
**M0370B \$2.00**

## THE BASIC BOOK OF HAM RADIO

This easy to read American Publication tells how the Amateur Radio Service works, how to obtain a Novice Licence, what to buy to get on the air and where the action is — awards, contests, public service, satellite communications, radio clubs and other ham activities. \$5.75 RRP, 128pp.  
**N0287R Only \$3.95**

**ORDER TODAY —**

**Simply return the order form on page 91**



# ... AND EVEN MORE BOOKS

## SON OF CHEAP VIDEO

Don Lancaster's sequel to The Cheap Video Cookbook, G0123P includes new and improved circuits to get alphanumeric and graphics video out of a micro-computer and on to an ordinary television screen.

G0345P \$17.95

## MICROCOMPUTER'S: A PARENT'S GUIDE

In clear, non-technical language that even the kids should understand, the authors explain what microcomputers are, what they can do, and what the future holds for the. \$13.75 RRP.

H0275J Reduced to only \$9.95

## HART'S DICTIONARY OF BASIC

Contains over 800 entries that summarise the actions of almost every statement, command or functions you are likely to meet. Each entry is clear, concise and jargon-free. \$15.75 RRP.

H0276J Almost one-third off! \$10.95

## ATARI PILOT FOR BEGINNERS

Shows how to make the Atari 400 and 800 home computers play music, display colourful animated pictures and do mathematics. Includes instructions in Pilot computer language. \$21.95 RRP.

H0308H Now only \$15.95

## INSIDE BASIC GAMES

A look at games from the inside out: Teaches the reader how to design his own error-free, interactive BASIC programs. Rules, algorithms and coding differences for the PET, Apple II and TRS-80 are also included. \$19.95 RRP.

K0189A Only \$14.95

## THE PASCAL HANDBOOK

Summarises the whole PASCAL vocabulary, including the variations introduced by the different commercial versions of PASCAL. Presented in an easy to use dictionary format. \$23.50 RRP.

K0200A Bargain at only \$16.95

## TRS-80 COLOUR COMPUTER GRAPHICS

Explores the creative and imaginative blending of computers and colour. Shows how to create dynamic and interesting graphics to enhance your programs. \$21.95 RRP.

K0201P Selling fast at \$15.95

## INTRODUCTION TO TRS-80 GRAPHICS

Beginning with the basic concepts of line drawing, the reader is soon lead on to geometric shapes, moving figure animation and more advanced topics. \$22.95 RRP.

K0202A Now only \$15.95

## MOSTLY BASIC: TRS-80

Excellent ready-to-use programs for the TRS-80 which have been completely tested and debugged. Programs included telephone dialler, digital stopwatch, spelling test, house buying guide, gas mileage indicator and more. \$19.95 RRP.

K0204P All that for \$14.95

## 32 BASIC PROGRAMS FOR THE PET

Each chapter fully documents a different bug-free program. With a working knowledge of BASIC, these form a good foundation to develop broader or more specific programs. \$29.95 RRP.

K0222A Only 60c a program! \$19.95

All telephone enquiries to  
Fulfilment Australia Pty. Ltd., (02) 816-2300

## YOUR MAIL ORDER COUPON

### ELECTRONICS TODAY INTERNATIONAL

### BOOK SALES

PLEASE ENCLOSE  
\$3.25 per book  
for postage, handling  
and insurance

For airmail to Papua  
New Guinea, New Zealand  
Oceania and  
Southeast Asia,  
add \$6.00 to these charges.

BOOK TITLE	BOOK NUMBER	QTY	PRICE TOTAL

### Please tick box to indicate method of payment:

Cheque\*/Money Order  \*Please make payable to the  
Federal Publishing Company Pty. Ltd.

Put your cheque or money order in an envelope with this order and send it to: Federal Direct, Freeport No. 4, P.O. Box 227, Waterloo, NSW 2017. No postage stamp required in Australia.

Mastercard  American Express  Bankcard   Tick

Credit Card No.

(Unsigned orders cannot be accepted)

Card Expiry Date..... Signature.....

Allow up to 6 weeks for delivery

Total price of books \$ .....

Add postage and handling \$ .....

(\$3.25 per book)

PLUS ..... Binders @ \$9.95 \$ .....

(inc P+P)

TOTAL \$ .....

NAME: .....

ADDRESS: .....

..... POSTCODE: .....

TELEPHONE: .....



## SHOPAROUND

### ETI-1402: Digital sampler

Now, for a fraction of the cost of the commercial product musicians can build this excellent sampler. The only likely difficult parts to procure are IC3, ZN429 available from Ferranti Computer Systems, 22 Mandible St, Alexandria, NSW 2015, (02) 698-5544, and IC2 the National AD0820 available from Geoff Wood. Both Jaycar (02) 745-3077 and Geoff Wood (02) 810-6845 will have the complete kit, possibly All Electronic Components as well. Boards will be available from Rod Irving (03) 543-7877, All Electronic Components (03) 662-3506 and RCS Radio (02) 587-3491.

### ETI-1531: Brown-out protector

The one thing you shouldn't do with ac motors is start them under load or operate them under reduced voltage. More common pieces of equipment like air-conditioners are designed not to start under load, but if there is a power interruption the result can be a burnt out motor. Enter the ETI brown-out protector. A complete kit will be available from Force Electronics in Adelaide (08) 212-5505 and you can try All Electronic Components (03) 662-3506. Boards will be available from Rod Irving (03) 543-7877 and RCS Radio (02) 587-3491.

### Artwork

For those constructors willing and able to make their own pc boards and/or front panels, we can supply same-size film transparencies of the artwork, positives or negatives as you require. From the list given below, select what you want and address your request/order to:

'ETI-xxx Artwork'  
ETI Magazine  
PO Box 227  
Waterloo, NSW 2017

When ordering, make sure you specify positives or negatives, according to the process you use. Your cheque or money order should be payable to 'ETI Artwork Sales'. Prices for the artwork for this month's projects are as follows:

ETI-1402 front panel .....	\$8
side panel .....	\$3
pc board .....	\$5
ETI-1531 front panel .....	\$5
pc board .....	\$5

You might also care to know that almost every pc board (and most front panels) ever published by ETI may be obtained from:

All Electronic Components  
118 Lonsdale St  
Melbourne, Vic 3000

RCS Radio  
651 Forest Rd  
Bexley, NSW 2207

For pc boards produced in recent years, the following suppliers either keep stocks on hand or can supply to order:

Acetronics  
112 Robertson Rd  
Bass Hill, NSW 2197  
(02) 645-1241

Jaetronics  
58 Appian Drive  
St Albans, Vic 3021

Jaycar  
117 York St  
Sydney, NSW 2000

Jemal Products  
PO Box 168  
Victoria Park, WA 6100

Mini Tech  
PO Box 9194  
Auckland, NZ

Rod Irving Electronics  
425 High St  
Northcote, Vic 3070

ENTER: ..... IPP-512 .....  
READ : INTELLIGENT PROM PROGRAMMER

### FEATURES INCLUDE:

- \* Computer or VDU control via RS 232 interface.
- \* Driver software included for most computers including IBM PC.
- \* Onboard processor with 64K RAM Buffer.
- \* Programs all single supply EPROMS from 2716 to 27512.
- \* Erase check — Read — Program — Verify.
- \* Gang operations from 1 to 4 PROMS.
- \* Fast programming algorithms.
- \* Up and down line load using Motorola, Intel, Tektronix, and ASCII formats.
- \* Requires only mains power.



MADE IN AUSTRALIA BY  
**PENNYWISE PERIPHERALS**  
518 Camberwell Rd. Camberwell Vic.  
PH. (03) 299 2877 — TLX. AA 31820

**PENNYWISE**  
A U S T R A L I A



## Balloon Safari, The Drop &amp; Flatten

Paul Sheppard,  
Christchurch, NZ

These three programs have been written for the standard VZ200/300 computers, in BASIC. They each have instructions within them. In the third program, SHFT appears in some program lines. This means one should type those letters in quotes in conjunction with the SHIFT key.

```

5 CLS:GOSUB7000:CLS
9 ' / "BALLOON SAFARI" \
10 ' \ BY PAUL SHEPPARD /
11 ' \ UZ-KIWISOFT. /
13 CLK=26624:BO=CHR$(95)
14 Z$="TTTTTTTTTTTTTTTTTTTTTTTTTTTTTTTT"
15 SHFT="T"
15 A$=" YJJJES " 'SHFT
16 B$=" IJJJJJ " 'SHFT
17 C$=" WJJJJF " 'SHFT
18 D$=" GYTF " 'SHFT
19 E$=" ITR " 'SHFT
20 BP=44
22 COLOR6:PRINT@480,Z$;
25 GOSUB5000
40 R=RND(3)
50 IFR=1THENBP=BP-1:IFBP<32THENBP=BP+2
70 IFR=3THENBP=BP+1:IFBP>52THENBP=BP-2
80 GOSUB1000
85 I$=INKEY$:I$=INKEY$
90 IF I$=" " AND KE=0 THEN SOUND(3),1:KE=1:DE=
BP+130:AM=AM+1:GOSUB5000
100 IF KE=1 THEN GOSUB2000:IFAM=20 AND KE=0 THEN
EN1000
110 IF SH=0 THEN GOSUB3000
120 GOSUB4000
130 GOTO40
1000 COLOR7:PRINT@BP,A$;PRINT@BP+32,B$;P
RINT@BP+64,C$;
1010 PRINT@BP+96,D$;PRINT@BP+128,E$;RETU
RN
2000 PRINT@DE," ":DE=DE+32
2005 IF DE>510 THEN DE=0:KE=0:SOUND(1,3:PRI
NT@480,Z$;:RETURN
2010 PRINT@DE,BO$;
2020 IF NOT(DE)=BL AND DE<=BL*4 THEN RETURN
2030 EX$="TEERTY " 'SHFT
2040 PRINT@DE," ":COLOR4:PRINT@BL,EX$;I
EX$=""
2050 FORT=1:TOT5:FOR T=1:TOT5:POKECLK,1:POK
ECLK,0:NEXT T,1
2060 DE=0:KE=0:KI=KI+1:GOSUB5000:RETURN
3000 BL=474:SH=1:SH$="YOOTY " 'SHFT
3010 RETURN
4000 BL=BL-1:COLOR1:PRINT@BL,SH$;FOR P=0
TOT5:NEXT
4010 IF BL<449,PRINT@BL," ":SH$=""
4020 RETURN
5000 PRINT@0,"GATORS ARROWED"KI" ARROWS
LEFT"20-AM
5010 IFAM=21 THEN ENDEL SER RETURN
7000 PRINTAB(9)"BALLOON SAFARI"
7010 PRINTAB(9)"-----"
7020 PRINT
7030 PRINT" THIS IS A SINGLE PLAYER GAM
E"
7040 PRINT"WHERE YOU, ALONG WITH DR BELL
ANY";
7050 PRINT"TRAVEL ACROSS THE AFRICAN PLA
INS";
7060 PRINT"IN YOUR BALLOON HIGH IN THE S
KY,";
7070 PRINT" IN SEARCH OF KILLER ALLIGATO
RS,";
7080 PRINT"(CALLED 'GATORS' BY THE LOCAL
S)";
7090 PRINT"WITH ONLY 20 ARROWS, YOU ARE
TO";
7100 PRINT"RID THE SWAMPS OF THESE FENES
!";PRINT
7105 PRINT"TO DROP YOUR ARROW ON THE GAT
OR PRESS THE SPACE KEY.
7110 PRINT@482," PRESS ANY KEY TO BEGI
N";
7120 I$=INKEY$:IF INKEY$=""GOTO7120
7130 CLS:PRINT@100," BY THE WAY, THE WIN
DS CAN MAKE"
7140 PRINT"YOUR BALLOON GO IN ANY DIRECT
ION"
7150 PRINTAB(7)"SO AIM CAREFULLY !?"
7160 PRINT@482," PRESS ANY KEY TO BEGI
N";
7170 I$=INKEY$:IF INKEY$=""GOTO7170
7180 RETURN
10000 FORT=1:TOT500:NEXT:CLS:PRINT"YOUR BO
MB SUPPLY IS EXHAUSTED.
10010 PRINT"YOUR SCORE IS"KI"MITTING"KI/
20*100"z."
10040 PRINT@484;:INPUT"PRESS RETURN TO
START":O$
10050 RUN

```

```

10 ' / "THE DROP" \
20 ' \ BY PAUL SHEPPARD /
30 ' \ UZ-KIWISOFT /
40 TS=28672:BS=29183
50 SC=0:BL=20:BA=15:EB=0:ET=0
60 GOSUB800
70 GOSUB500
100 'MAIN LOOP
110 GOSUB200
120 IFFL=1 THEN FL=0:GOTO900
130 GOTO100
200 'MOVE BALL
205 IF EB=20, BL=BL+1:ET=ET+1:EB=SC-20*ET
207 PRINT@45,BL;
210 FOR X=2:TO30
220 POKE TS+X-1,32*3,32
230 POKE TS+X+32*3,BA
240 A$=INKEY$:A$=INKEY$
250 IFA$=""GOTO300
260 NEXT X
270 POKE TS+X-1,32*3,32
280 GOTO200
300 'DROP BALL
310 FORT=TS+X+32*4:TOT5:FOR T=1:TOT5:POKE
320 DP=PEEK(T)
330 IF DP>4 AND DP<56 GOTO400
340 POKEY=32,32
350 POKEY,BA
360 NEXT T
370 POKEY=32,32:SOUND(ND(5),2)
380 BL=BL-1:IF BL<1 THEN FL=1:RETURN
390 RETURN
400 'CHECK NUMBER
405 POKEY=32,32
410 N=DP-48:SC=SC+N:EB=EB+N:FOR T=1:TOT50
420 POKEY,DP
425 FOR F=1:TOT21-T:NEXT F
430 POKEY,32:POKE26624,1:POKE26624,0
435 FOR F=1:TOT21-T:NEXT F:NEXT T
440 GOSUB700
450 PRINT@58,SC;
460 RETURN
500 'SET UP SCREEN
510 CLS
520 FORT=1:TOT30
530 PRINT@0,I,CHR$(143);
535 PRINT@64,I,CHR$(143);
540 PRINT@79,I,CHR$(143);
550 NEXT I
555 PRINT@510,CHR$(143);
560 FORT=0:TOT470:STEP32
570 PRINT@I,CHR$(143);
580 PRINT@1+31,CHR$(143);
590 NEXT I
595 POKE29183,239
600 PRINT@33,"BALLS LEFT=";
610 PRINT@51,"SCORE=";
620 FOR N=1:TOT9
630 GOSUB700
640 NEXT N
650 RETURN
700 'PLACE NUMBER
710 X=RND(30)+1:Y=RND(5)+10:PO=TS+X*(Y*3
2)
720 IF PEEK(PO)>32 GOTO710
730 POKEPO,N+48
740 RETURN
800 'INSTRUCTIONS
810 CLS:PRINT:POKE30886,31
820 PRINT" THE DROP
830 PRINT:PRINT:PRINT" DROP THE BALL ON
THE NUMBERS
835 PRINT:PRINT" EXTRA BALL FOR EVERY 20
POINTS
840 PRINT:PRINT" PRESS SPACE TO DROP THE
BALL
850 PRINT:PRINT:PRINT" PRESS ANYKEY T
O START
860 A$=INKEY$:A$=INKEY$:IFA$="" THEN 860
870 RETURN
900 'END
905 IF SC>HS,HS=SC
910 CLS:POKE30886,31
920 PRINT@139,"GAME OVER
930 PRINT@195,"SCORE ="SC" HIGH SCORE ="
HS
940 PRINT:PRINT" DO YOU WANT ANOTHER
GO ?"
950 A$=INKEY$:A$=INKEY$:IFA$="" THEN 950
960 IFA$="Y" THEN 10 ELSE END

```

```

10 REM / "FLATTEN" \
20 REM \ BY P. SHEPPARD /
30 REM \ UZ-KIWISOFT /
40 TS=28672:BS=29183:PS=TS+32+1:UR=30912
+ASC("I")
50 SS=191:GL=29151:L=32
60 GOSUB800
100 IF PEEK(30744) THEN NSP=32:BN=31 ELSE NSP=9
6:BN=95
110 CLS:PRINT"DIFFICULTY LEVEL (1-6)":SO
UND(3),1:POKE30873,1
120 OT=PEEK(30873):IFDI=1 THEN 120 ELSE OD=
1-40:IFD<1 ORD=6 GOTO110
130 IFD<6 GOTO150
140 PRINT"ARE YOU THAT GOOD (Y/N)":SOUN
D(3),1:POKE30873,1
145 A=PEEK(30873):IFA=GOTO145 ELSE IFA=89
POKEUR,2 ELSE POKEUR,4
150 CLS
160 GOSUB500
200 REM MAIN LOOP
210 GOSUB300
220 GOTO200
300 REM MOVE PLANE
305 POKE26624,1:POKE26624,0
310 PS=PS+1:IF PS>56 GOTO600
320 P=PEEK(PS)
330 IF P=55 GOTO600
340 A$=INKEY$:A$=INKEY$
350 IFA$="" AND FL=0 THEN FL=1:BO=PS:TU=0
360 IFFL=1 GOSUB400
370 POKEPS-2,SP
380 POKEPS-1,155:POKEPS,159
385 IF PS=1>32 GOTO700
390 RETURN
400 REM DROP BOMB
405 SB=PEEK(BO+32)
410 POKEBO,SP:REM PATH
430 BO=BO+32:IF BO>GL+32 THEN FL=0:RETURN
440 POKEBO,BN:REM BOMB
450 IF SB=70,POKEPS-1,SP:POKEPS-2,SP:PS=P
S-(INT((PS-TS)/L)*L)+L
460 RETURN
500 REM SET UP CITY
505 PRINT@7,"DIFFICULTY LEVEL"O":IFD=6 AND
DA=8 THEN PRINT"z"
510 FORT=1:TOT30
520 FORT=0:TOTRND(2+D)*32:STEP32
530 POKEGL-I-Y,SS
550 NEXT I:1+RND((7-D)/2)
560 NEXT I
570 FOKI=1:TOT25
580 POKEGL+1,70
590 I=I+RND(6)
595 NEXT I:RETURN
600 REM GAME END
610 FORT=PS-1:TOTGL:STEP32
620 POKEI-1,180:POKEI,176
625 FORT=1:TOT100:NEXT T
630 POKEI-1,SP:POKEI,SP
640 NEXT I
650 FORT=1:TOT500:NEXT
660 CLS:PRINT@202,"YOU CRASHED
665 SOUND(1,6):1,1,3,3,1,1,4,0,6
670 GOTO730
700 REM LANDED SAFELY
710 CLS
720 PRINT@192,"YOU LANDED SAFE, CONGRATU
LATIONS
730 PRINT@266,"ANOTHER GO?
735 SOUND(3),1
740 A$=INKEY$:A$=INKEY$:IFA$=""GOTO740
750 IFA$="Y"RUN
760 SOUND(1,5):END
800 REM INSTRUCTIONS
810 CLS:PRINT:PRINTAB(12)"FLATTEN"
820 PRINT:PRINT:PRINT"YOU MUST LAND YOUR
PLANE SAFELY
830 PRINT:PRINT" BY DESTROYING THE CITY
BELOW.
840 PRINT:PRINT" DROP BOMBS BY PRESSING
SPACE
850 PRINT:PRINT"GAIN EXTRA HEIGHT BY DES
TROYING
860 PRINTAB(9)"FUEL DUMPS ("CHR$(198)";
870 PRINT:PRINTAB(6)"PRESS ANYKEY TO ST
ART
875 SOUND(3),1
880 A$=INKEY$:A$=INKEY$:IFA$=""GOTO880
890 RETURN

```



# How to beat the high cost of cheap meters.

You get what you pay for.  
**So get the Fluke 70 Series.**

You'll get more meter for your money, whether you choose the affordable 73, the feature-packed 75 or the deluxe 77.

All of them will give you years of performance, long after cheaper meters have pegged their fishhook needles for the last time.

That's because they're built to last, inside and out. So they're tough to break. They don't blow fuses all the time. You don't even have to replace batteries as often.

And they're backed by a 3-year warranty. Not the usual 1-year.

Of course, you may only care that the world-champion 70 Series combines digital and analog displays with more automatic features, greater accuracy and easier operation than any other meters in their class.

You may not care that they have a lower overall cost of ownership than all the other "bargain" meters out there.

But just in case, now you know.

**FROM THE WORLD LEADER  
 IN DIGITAL MULTIMETERS.**

**FLUKE**



**FLUKE 73**

Analog/digital display  
 Volts, ohms, 10A, diode test  
 Autorange  
 0.7% basic dc accuracy  
 2000+ hour battery life  
 3-year warranty

**FLUKE 75**

Analog/digital display  
 Volts, ohms, 10A, mA, diode test  
 Audible continuity  
 Autorange/range hold  
 0.5% basic dc accuracy  
 2000+ hour battery life  
 3-year warranty

**FLUKE 77**

Analog/digital display  
 Volts, ohms, 10A, mA, diode test  
 Audible continuity  
 "Touch Hold" function  
 Autorange/range hold  
 0.3% basic dc accuracy  
 2000+ hour battery life  
 3-year warranty  
 Multipurpose hotster

Talk to your local distributor about Fluke

• A.C.T. Actec Pty Ltd (062) 80 6576 • George Brown 80 4355 • N.S.W. Ames Agency 699 4524 • George Brown (02) 519 5855 Newcastle 69 6399 • Bryan Catt Industries 526 2222 • Collier Tools 763 1888 • D.G.E. Systems (049) 69 1625 • Davred Electronics 267 1385 • W.F. Dixon (049) 61 5628 • Macelec (042) 29 1455 Ebson 707 2111 • Selectro Parts 708 3244 • Geoff Woods 810 6845 • N. TERRITORY Thew & McCann (089) 84 4999  
 • QUEENSLAND I.E. Boughen 369 1277 • Colourview Wholesale 275 3188 • Fred Hoe & Sons 277 4311 • Nortek (077) 79 8600 • St Lucia Electronics 52 7466 • Selectro Parts (Old) 394 2422 • S. AUSTRALIA Protronics 212 3111 • Trio Electrix 212 6235 • Redarc Electronics 278 7488 • A.W.M. Wholesale • TASMANIA George Harvey (003) 31 6533, (002) 34 2233 • VICTORIA A.W.M. Electrical Wholesale, • Radio Parts 329 7888 • G.B. Telepares 328 3371 • Browntronics 419 3986 • R.K.B. Agency 82 7704 • A.J. Ferguson 347 6688 • SIRS Sales (052) 78 1251 • Mektronics 690 4593 • W. AUSTRALIA Atkins Carlisle 321 0101 • Dobbie Instruments 276 8888 • Cairns Instrument Services 325 3144 • Willis Trading 470 1118

**ELMEASCO  
 Instruments Pty. Ltd.**

N.S.W. 15 McDonald St, Mortlake. Tel: (02) 736 2888  
 VIC. 12 Maroondah Hwy, Ringwood. Tel: (03) 879 2322  
 QLD. 243 Milton Rd, Milton. Tel: (07) 369 8688  
 S.A. 241 Churchill Rd, Prospect. Tel: (08) 344 9000  
 W.A. 46-48 Kings Pk Rd, West Perth. Tel: (09) 481 1500





YBØZAA's antenna farm is impressive but it also provides the solid foundation for an emergency communications centre.

# BEYOND THE TORRES STRAITS

Thomas E. King  
VK2ATJ

## Amateur radio in Indonesia

Amateur radio and politics often make strange bedfellows. This love/hate relationship is the situation in a number of countries, none more striking perhaps, than Indonesia where government recognition of the king of hobbies and the hobby of kings has gone full circle.

AUTHORISED AMATEUR RADIO activities began in Indonesia in 1936 with the licensing of YBØAU. Nearly 20 years later on a government directive, two Dutch-born hams and several local Indonesian amateurs were gaoled for three months on a charge of engaging in 'subversive activities'. During 1985, 30 years after this unwarranted action, the son of the current president of Indonesia, Sigit, YBØBVY, was among the DXers, antenna experimenters, rag chewers and certificate hunters living in a country that is literally exploding with amateurs.

The boom was prompted initially by the signing of a presidential decree on amateur radio by President Suharto. Although this official stamp of approval was given in 1968 it wasn't until 1980 with the introduction of the Citizens Band Radio Service that the idea of personal communications began sky rocketing in the world's fifth most populous nation.

Two other recent events have pushed the hobby forward at a greatly accelerated pace: the introduction of 2 metres in 1981 and the establishment of district branches of the Department of Tourism and Postal Communications in 1984. This latter action, which means that exams can be taken at telephone offices, coupled with a rise in disposable income and readily available amateur equipment, has stimulated the growth of the hobby from 12,000 hams in 1983 to well over 45,000 by the end of 1985.

This year is certain to see an even greater rise in Indonesia's amateur population as more and more CBers become hams. At a single exam conducted in Jakarta recently, 3600 enthusiasts — many of them disenchanted CBers — answered questions on rules, regulations and theory plus Morse code; about 2000 of them passed the exam becoming fully fledged licensed amateur radio operators.

There are three classes of amateur licences in Indonesia: YD, which allows a maximum of 10 W on 80 m and 2 m; YC, which permits 75 W operation on all bands except 20 m; and YB, the all-band 500 W non-restricted licence. YB licence holders make up only five per cent of Indonesia's amateur population with YC operators adding another 15 per cent. This leaves a whopping 80 per cent, or well over 30,000 YD hams, to populate the much populated 2 m band. (Eighty metres is of little interest because of a lack of equipment and limited space to erect an antenna.)

### At the Club

Several 2 m rigs were blaring away when I walked through the doorway of YBØZAA, one of the most active and best organised of the 21 local secretariat club stations in Jakarta. (To locate YBØZAA one travels from the high rise Sari Pacific Hotel, turning left at the Mandarin Hotel. One should look out for a 23 metre high tower crowned



with 4, 14-element 2 m Yagis!) YBØZAA is a good example of how club activity has not only kept existing enthusiasm strong, but has generated new interest in amateur radio.

Known as a 'local' club of ORARI (Organisasi Amatir Radio Indonesia), this amateur radio station in the Menteng region of Jakarta serves about 300 hams living in only a few square miles. "There should be 300 check-ins on tonight's nightly 145.550 MHz net," said Erlangga, YBØBZZ, one of the club's most vibrant members, "but we'll only get about 80-90 calls. It's a hot and humid Sunday evening in Jakarta so maybe some of our members are still at the beach."

While the net was in progress I sat drinking Indonesian brewed beer and looking at a wall full of QSL cards and the club's donated equipment. Meanwhile Hapsoro, YDØBBZ, and Toto, YCØIF6, were busy with the net and Erlangga was chatting with an expat Frenchman who was renewing his reciprocal licence.

With 87 check-ins duly logged the net came to a routine end. Not every net session is routine, however, as there have been telephone calls from government officials during net times requesting emergency communications. YBØZAA has been called

upon to provide link communications during events as diverse as floods, elections and religious festivals. The Menteng-sited station has also assisted on New Years Eve when 2 m mobile communications were needed to summon ambulances for traffic accident victims.

Not all of the club's activities are so sombre. Some time back YBØZAA members assisted in organising a combined ORARI fox hunt/field day/DX contest/bazaar. Some 15,000 people turned up for the big event to browse and buy.

And there were plenty of ways to spend rupiahs. ORARI-produced items were popular as a wide variety of merchandise from stickers and pins to jackets and caps was available at the bazaar. (The ORARI emblem is seen nearly everywhere which is one reason for the fairly widespread recognition of the organisation.)

The latest lineup of amateur radio equipment — primarily VHF gear from Icom, Kenwood and Yaesu — was also widely shown and sold at the ORARI field day. Contrary to what would normally be expected, the equipment didn't come directly from Japan. Nearly all VHF amateur gear shipped to Indonesia these days must arrive in knocked down condition according to

government regulation. It's assembled in an industrial area, 30 km south of Jakarta. Despite this channel for local employment, duty is a very stiff 200 per cent which puts the price, for example of a Kenwood 7950, at rupiah 420,000 (or about \$A525).

This hefty price tag hasn't deterred many Indonesian amateurs from making a transceiver purchase. But the low power VHF transceivers purchased have deterred most amateurs from making many DX contacts.

Indonesian amateurs aren't all that interested in working DX anyway as only 11 DXCC and one 5BDXCC certificates have been issued in 11 years.

To satisfy award requirements for these certificates, Indonesian amateurs have to contact 100 different countries and in the one case needed to verify 100 separate countries on five bands. Because of their proximity, at least a few Indonesian award seekers are certain to have contacted two countries which are no longer independent nations, but are ones that still make news.

The call signs of ZJ Dutch Irian Jaya and CR8 Portuguese Timor will never be heard again but that's because amateur radio and politics make strange bedfellows.

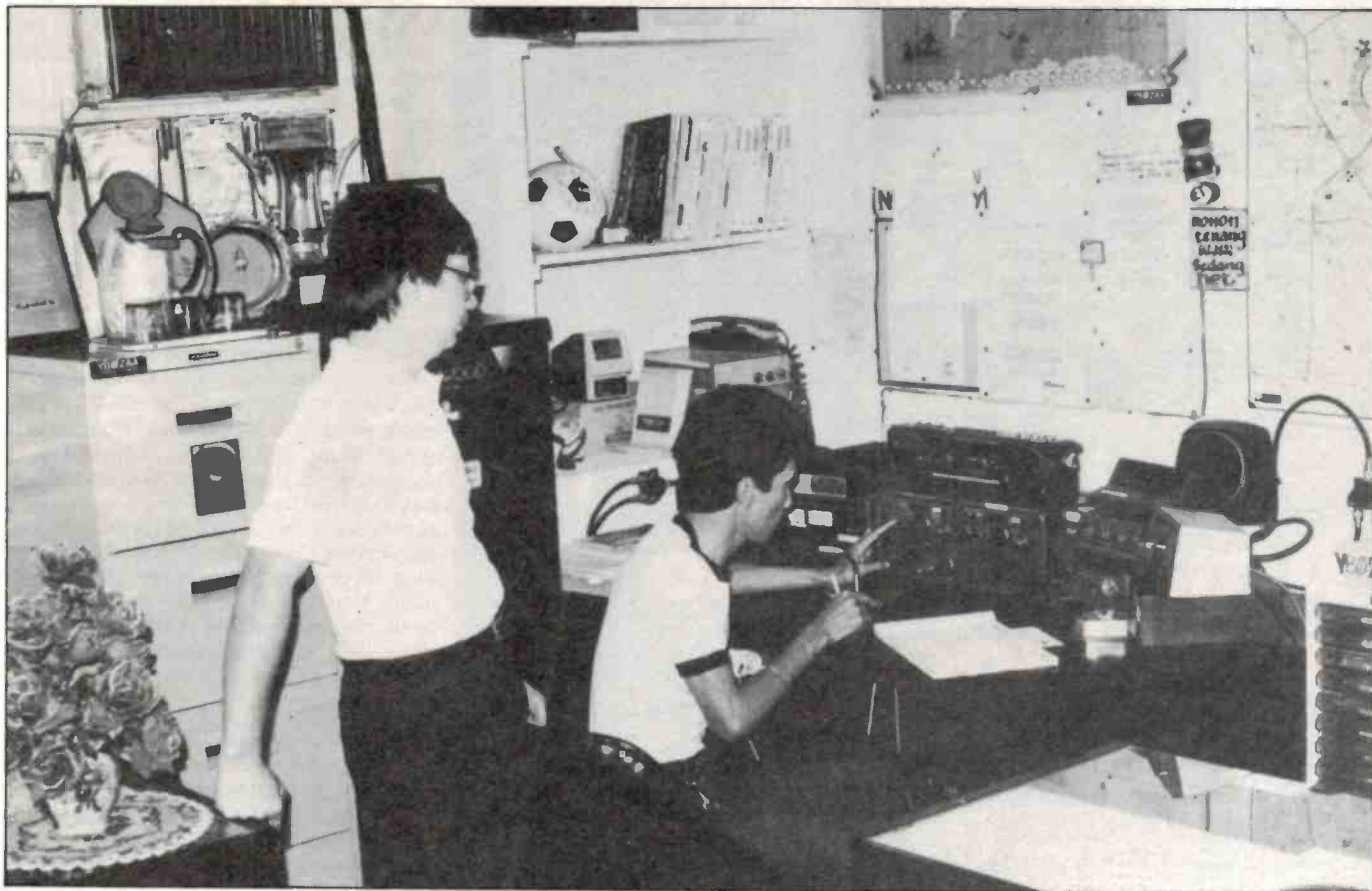

One of many nightly nets is operated at YBØZAA club station by Toto, YCØIFG, left and Hapsoro, YDØBBZ.





*Classic lines reflected through  
the warmth of rich Saxony  
Tweed, and the enduring  
style of flannel trousers.  
Jacket \$220. Trousers \$95.*



**YOUR ESTEEMED EDITOR** let the hack loose at the computer show, PC86, in Sydney recently. Spare a thought for him, planted at the Microbee stand in 'investigate' mode, trying to get sense out of a mind-numbed spokesman on the new Gamma, while being kicked, shoved, head-butted, kned in the groin and generally assaulted by a vast, unwashed mass of prepubescent boys. Where do they come from? Where do they disappear to? Do they ever solve their pimple problems? Do they have homes, with mothers who love them? Do they ever grow up? Probably not. They just get jobs selling for IBM.

The crowd watching the Commodore Amiga was generally better behaved. More glassy-eyed though. Do Commodores induce encephalitis, or is just plain silliness enough?

It was a relief to get around to the IBM stand, where a lady in obligatory black explained why IBMs aren't actually overpriced they just seem that way but you get a lot for the money don't you, and how cloners are totally immoral. Ah-hem. It does the heart good to know big blue is fighting back.

Speaking of which, readers of this column will be glad to know that ETI is in receipt of a communication datelined Taipei. This details news of the steam-rolling of 3000 fake computers by the government's anti-counterfeiting unit. A spokesman said the government was determined to crack down on fake products after complaints from its major trading partner. Important issues are raised by this missive: (a) what is a fake computer? (b) is Commodore worried at all? Keep watching this space as more news comes to hand.

### **Useless hardware dept**

The Australian College of Dermatologists has reported it has been unable to make hair regrow by using a laser-based product originated by Lasercare (Aust) Ltd. The company had claimed that hair regrowth was visible on 98% of clients. The College found no clinical evidence of regrowth in any subject during a 30 week study.

We publish this information as a public service to the ETI reader who forked out vast amounts of cash to have a laser shined on his pate. Stop looking in the mirror mate; those are burn marks, not new hair.

### **Useless software**

According to the Professors Dryfus, computers can't think as well as we can. This profundity comes to you from the Berkley campus of UCLA, where Profs Hubert L. and Stuart E. Dryfus (otherwise known as the Bobsy twins) both insist that: "an analytic, chunk by chunk approach is fine for limited problem solving, but the highest form of human thinking is characterised by

a fluid, experiential intuitive process that no machine has even approached".

In order to confirm their hypothesis, they set a highly experienced chess master against another less skilled master. The stronger skilled master was forced to add numbers while playing the game. He still won. This does not prove that the experienced player is better than the inexperienced player, no sir, instead it proves AI is impossible.

### **Useless astronomical phenomena?**

The hack staggered out of bed early one morning recently and bleary eyed confronted The Comet, then roared into work four hours earlier than usual and tried to look superior when the boss rolled up. So that's a comet. Was it more malevolent than usual this time around? Two dictators out of office in six months is less than a harbinger of doom. It should come by more often. ●

Anyone for chess?





# SIEMENS

## VARISTORS

**Australia's widest range.  
All applications. Biggest stocks.  
Lowest prices. Quickest delivery.  
What else?**

Siemens is now the biggest and best source of varistors in Australia with a full size range for all applications up to 70 kA. This is of special interest to the telecommunications industry.

Comprehensive stocks, plus Siemens position as one of the world's largest manufacturers of varistors underwrites our promise of quick delivery and suitability.

Siemens innovation aims at achieving substantial cost reductions across a wide spectrum in the following applications:

- Power engineering
- Electronic communications
- Power electronics
- Measuring technique
- Processing technique
- Office electronics
- RFI suppression
- Stepped protection

This wide range of varistors is available through Siemens newly strengthened national distributor network. For further information, post the coupon or phone your nearest distributor.

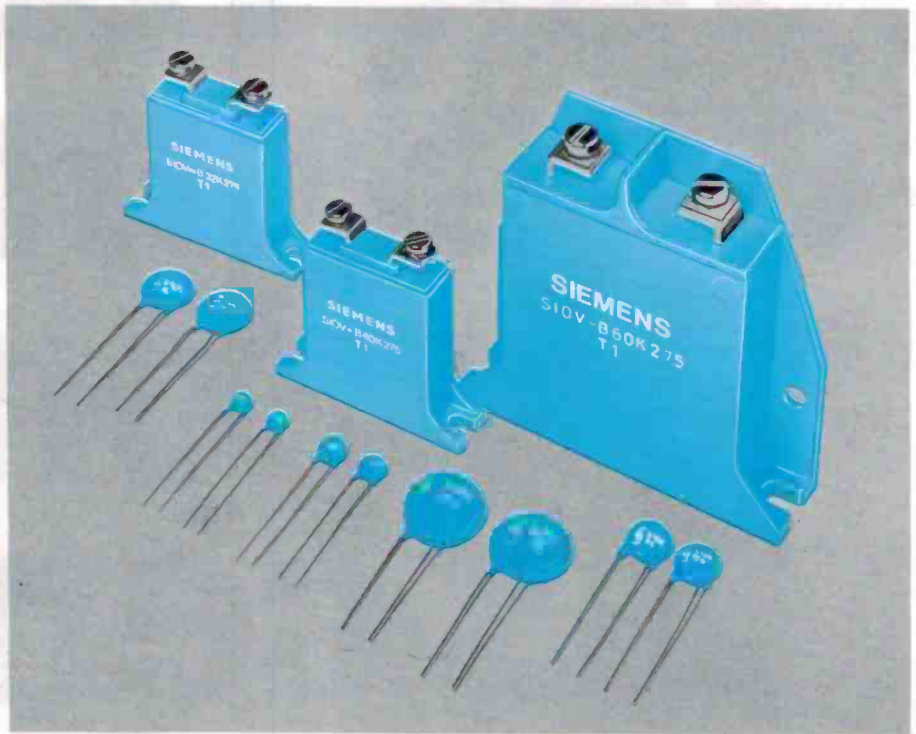

### Distributors

Victoria: Promark Electronics (Vic)  
(03) 878 1255

New South Wales: Nexus Electronics Pty Ltd  
(02) 439 5800  
New South Wales: Promark Electronics Pty Ltd  
(02) 439 6477

Queensland: ECQ Electronics  
(07) 376 5677

South Australia: R.G. Pank Pty Ltd  
(08) 51 2411  
South Australia: Protronics Pty Ltd  
(08) 212 3111

Western Australia: Reserve Electronics  
(09) 328 9755

New Zealand: Delphi Industries Ltd  
Auckland 563 259

### Siemens Ltd.

544 Church St., Richmond, Vic.  
Melbourne: 420 7318 Sydney: 436 8730  
Brisbane: 369 9666 Perth: 362 0123

Please mail me the new informative varistors brochure.

NAME .....

TITLE .....

COMPANY .....

ADDRESS .....

STATE..... POSTCODE.....

Post this coupon now to Siemens Ltd.  
Advertising Department, Melbourne.  
544 Church St., Richmond 3121.

## INGENIOUS ELECTRONIC ENGINEERING

ETI READER SERVICE 125

876/2394

# Get all of Yamaha's latest audio equipment for only 33 cents.



Fill in this coupon and you'll get Yamaha's free catalogue featuring the latest and complete range of compact disc players, cassette decks, turntables, cartridges, integrated amps, separate amps, tuners, receivers, graphic equalizers, headphones and system components. With each component comes something you wouldn't expect. **5 YEAR WARRANTY.**

Name \_\_\_\_\_

Address \_\_\_\_\_

Postcode \_\_\_\_\_

Yamaha Consumer Electronics Division, 17-33  
Market Street, South Melbourne, Victoria 3205.

\*Limited warranty.

