

AUSTRALIA'S DYNAMIC ELECTRONICS

WIN THIS PHILIPS STEREO HI-FI VCR!

# Electronics Today

INTERNATIONAL

January 1985

\$2.50\*  
NZ \$3.25



## CHATTERBOX

Low cost speech synthesiser

**MICROBEE  
KEYBOARD  
UPGRADE**

**REVIEWS:  
BUDGET  
BRITISH  
SPEAKERS  
ICOM  
RECEIVER**



**WHAT'S  
NEW  
FROM  
JAPAN**

**FABULOUS  
OFFER:  
DIGITAL  
MULTIMETERS**



**PROJECTS:  
SIMPLE DARKROOM EXPOSURE METER  
COMPUTER 'CURRENT LOOP' INTERFACE**

# ICOM IC-R71A

## The Best Just Got Better



IC-GC4  
World Clock

ICOM introduces the IC-R71A 100kHz to 30MHz superior-grade general coverage receiver with innovative features including keyboard frequency entry and wireless remote control (optional).

This easy-to-use and versatile receiver is ideal for anyone wanting to listen in to worldwide communications. Demanding no previous shortwave receiver experience, the IC-R71A will accommodate an SWL (shortwave listener), Ham (amateur radio operator), maritime operator or commercial operator.

With 32 programmable memory channels, SSB/AM/RTTY/CW/FM (optional), dual VFO's, scanning, selectable AGC and noise blanker, the IC-R71A's versatility is unmatched by any other commercial grade unit in its price range.

**Superior Receiver Performance.** Utilizing ICOM's DFM (Direct Feed Mixer), the IC-R71A is virtually immune to interference from strong adjacent signals, and has a 100dB dynamic range.



IC-RC 11  
Infrared  
Remote

Passband tuning, a deep IF notch filter, adjustable AGC (Automatic Gain Control) and noise blanker provide easy-to-adjust clear reception, even in the presence of strong interference or high noise levels. A preamplifier allows improved reception of weak signals.



**Keyboard Entry.** ICOM introduces a unique feature to shortwave receivers... direct keyboard entry for simplified operation. Precise frequencies can be selected by

pushing the digit keys in sequence of frequency. The frequency will be automatically entered without changing the main tuning control. Memory channels may be called up by pressing the VFO/M (memory) switch, then keying in the memory channel number from 1 to 32.

**VFO's/Memories.** A quartz-locked rock solid synthesized tuning system provides superb stability. Three tuning rates are provided: 10Hz / 50Hz / 1KHz.

**32 Tunable Memories.** Thirty-two tunable memories, more than any other general coverage receiver on the market, offer instant recall of your favorite frequency. Each memory stores frequency, VFO and operating mode, and is backed by an internal lithium memory backup battery to maintain the memories for up to five years.

**Options.** FM, synthesized voice frequency readout (activated by SPEECH button), RC11 wireless remote controller, CK1 DC adapter for 12 volt operation, MB12 mobile mounting bracket, two CW filters FL32 - 500Hz, and FL63 - 250Hz, and high-grade 455KHz crystal filter FL44A.

Discover a new deal with  
ICOM AUSTRALIA PTY. LTD.  
7 DUKE STREET WINDSOR 3181 VICTORIA, AUSTRALIA  
TEL: (03) 529 7582 TLX: AA 35521 ICOMAS

 **ICOM**  
The World System

**T**HE DECISION by the Minister for Communications, Michael Duffy, to defer the closure of channel 0 TV station transmissions in Sydney and Melbourne can only be seen as an expedient bowing to pressure from a well-organised lobby.

Originally scheduled for closure on the 1st of this month, closure has now been transferred to January 5, 1986. Oh well, only twelve months. But the Special Broadcasting Service has had more than ample time to educate viewers to move to channel 28 on UHF. Those left would move rapidly, if they value the service, when the VHF station closed down.

There exists a litany of reasons why these two stations should be closed down: severe interference between the two stations (particularly during the summer months) and interference with other services (in the case of the Sydney station) being paramount.

The UHF channel 28 transmissions are now of such a standard that the Melbourne station reaches over 90% of the population in the metropolitan area, while in Sydney, channel 28 coverage is similar to that of the ABC and commercial channels, according to the Department of Communications.

So why defer the closure another year?

Well, the Minister says this will "... give extra time for viewers to be fully informed of the closure and to buy UHF receiving equipment." Just about every modern TV set comes equipped to receive UHF. Converters are available for the older sets and plenty of retailers are geared to supply the appropriate equipment, including UHF antennas. Antenna installers had told the DoC that viewers were aware of the pending closure and were seeking UHF installations — this according to the Department's press release. So it seems the SBS's extensive campaign to move viewers to UHF has been quite effective.

So why prop up the slow coaches for yet another year? Viewers will procrastinate so long as you give them excuse to. Broadcasting spectrum space is scarce. This is just another ad hoc decision in a litany of bungles going back 20 years (see "Fixing the VHF/UHF Broadcast Bungle" this issue). Will it ever change?

Roger Harrison  
EDITOR



# QUICK INDEX

## FEATURES

Japan Inc.	
— long live "New Media" .....	16
Fixing the VHF/UHF broadcast bungle .....	24
Sanyo/ETI contest results .....	33
Satellite TV smorgasbord .....	36
Win a Philips hi-fi VCR! .....	52

## AUDIO/VIDEO

British potency	
— JPW P1 speakers .....	47

## PROJECTS

ETI-692 Current loop interface .....	68
ETI-677 Chatterbox .....	74
ETI-741 Radio mic., Part 2 .....	82
ETI-279 Exposure meter .....	91

## COMMUNICATIONS

Icom's star performer .....	105
The shortwave Babel .....	107

## ELECTRONICS

Ideas for Experimenters .....	100
Idea of the Month .....	101

## COMPUTING

Microbee keyboard upgrade .....	116
Commodore column .....	124

## SPECIAL OFFERS

Digital multimeters .....	13
Chatterbox voice synth .....	89

## NEWS

News Digest .....	8
Sight & Sound .....	41
Equipment .....	57
Component .....	63
Communications .....	103
Computing Today .....	111

## GENERAL

ETI books .....	99
Mini-mart .....	128
Dregs .....	130

## SERVICES

**TECHNICAL INQUIRIES:** We can only answer readers' technical inquiries by telephone after 4.30pm Mondays to Thursdays. The technical inquiry number is (02) 662-4267. Technical inquiries by mail must be accompanied by a stamped, self-addressed envelope. There is no charge. We can only answer queries relating to projects and articles as published. We cannot advise on modifications, other than errata or addenda. We try to answer letters as soon as possible. Difficult questions may take some time to answer.

**COPYRIGHT:** The contents of *Electronics Today International* and associated publications is fully protected by the Commonwealth Copyright Act (1968). Copyright extends to all written material, photographs, drawings, circuit diagrams and printed-circuit boards. Although any form of reproduction is a breach of copyright, we are not concerned about individuals constructing projects for their own private use, nor by bands (for example) constructing one or more items for use in connection with their performances. Commercial organisations should note that no project or part project described in *Electronics Today International* or associated publications may be offered for sale, or sold in substantially or fully assembled form, unless a licence has been specifically obtained so to do from the publisher. The Federal Publishing Company, or from the copyright holders.

**GENERAL INQUIRIES:** For all inquiries about back issues, subscriptions (\$24.00 for 12 months/12 issues), photocopies of articles, artwork or submitting articles, call (02) 663-9999 or write to: ETI Reader Services, 140 Joynton Avenue (PO Box 227), Waterloo, NSW 2017.

**CONTRIBUTIONS:** Submissions must be accompanied by a stamped, self-addressed envelope. The publisher accepts no responsibility for unsolicited material.

**LIABILITY:** Comments and test results on equipment reviewed refer to the particular item submitted for review and may not necessarily pertain to other units of the same make or model number. Whilst every effort has been made to ensure that all constructional projects referred to in this edition will operate as indicated efficiently and properly and that all necessary components to manufacture the same will be available, no responsibility is accepted in respect of the failure for any reason at all of the project to operate effectively or at all whether due to any fault in design or otherwise and no responsibility is accepted for the failure to obtain any component parts in respect of any such project. Further, no responsibility is accepted in respect of any injury or damage caused by any fault in the design of any such project as aforesaid.

**EDITOR**

Roger Harrison VK2ZTB

**EDITORIAL STAFF**

Mary Rennie  
 Jon Fairall B.A.  
 Geoff Nicholls B.Sc. B.E.  
 Peter Inhat B.E., B.Sc.  
 Robert Irwin

**ASSOCIATES**

David Tilbrook VK2YMI  
 Jonathan Scott  
 B.Sc./B.E. (Hons) VK2YBN

**DRAUGHTING**

David Currie

**PRODUCTION**

Chris Gerelli

**ADVERTISING SALES**

John Whalen (National)  
 Cathy Darnell  
 Bruce Burrel

**ART DIRECTOR**

Ali White B.A.

**ART STAFF**

Vicki Jones  
 Sharon Hill  
 Brian Jones

**READER SERVICES**

Elizabeth Barnett

**ACOUSTICAL CONSULTANTS**

Louis Challis and Associates

**MANAGING EDITOR**

Jamieson Rowe

**PUBLISHER**

Michael Hannan

**HEAD OFFICE**

140 Joynton Avenue, (PO Box 227)  
 Waterloo, NSW 2017.  
 Phone: (02) 663-9999 Sydney.  
 Telex: 74488, FEDPUB.

**ADVERTISING OFFICES AND AGENTS:**

Victoria and Tasmania: Virginia Salmon and Eric Baines, The Federal Publishing Company, 23rd Floor, 150 Lonsdale Street, Melbourne, Vic. 3000. Phone: (03) 662-1222 Melbourne. Telex: 34340, FEDPUB.

**South Australia and Northern Territory:**

The Admedia Group, 24 Kensington Road, Rose Park, SA 5067. Phone: (08) 332-8144 Adelaide. Telex: 82182, ADMDIA.

Queensland: Geoff Horne Agencies, PO Box 247, Kenmore, Old 4069. Phone: (07) 202-6813 Brisbane. Telex: AA41398 HORNAG.

Western Australia: Cliff R. Thomas, Adrep Advertising Representative, 62 Wickham Street, East Perth, WA 6000. Phone: (09) 325-6395 Perth.

New Zealand: Chris Horsley, 4A Symonds Court, Symonds Street, Auckland. Telex: NZ60753, TEXTURE. Phone: 39-6096. Auckland.

Britain: Pete Holloway, John Fairfax and Sons (Australia) Ltd, Associated Press House, 12 Norwich Street, London EC4A 1BH. Phone: (01) 353-9321 London. Telex: 262836, SMHLDN.

Japan: Genzo Uchida, Bancho Media Services, 5th Floor, Dai-Ichi Nisawa Building, 3-1 Kanda Tacho 2-chome, Chiyoda-ku, Tokyo 101. Phone: (03) 252-2721 Tokyo. Telex: 25472, BMSINC.

**ELECTRONICS TODAY INTERNATIONAL**

is published monthly by the Electronics Division of the Federal Publishing Company Pty Limited, 140 Joynton Avenue, Waterloo, NSW 2017. Typeset and printed by ESN-The Litho Centre, Sydney. Distributed by Gordon and Gotch Limited, Sydney. Cover price \$2.50 (maximum and recommended Australian retail price only; recommended New Zealand price, \$2.95). Registered by Australia Post. Publication No NBP0407. ISSN No 0013-5216.



COPYRIGHT © 1984, THE FEDERAL PUBLISHING COMPANY



Get your computer talking! p.74



Technological lust and the Icom IC-R71A receiver. p.105



WIN a fabulous Philips stereo hi-fi VCR p.52

**NEWS**

NEWS DIGEST	8
SIGHT & SOUND	41
EQUIPMENT	57
COMPONENT	63
COMMUNICATIONS	103
COMPUTING TODAY	111

**COLUMNS**

COMMODORE	124
-----------	-----

**DEPARTMENTS**

IDEAS FOR EXPERIMENTERS	100
IDEA OF THE MONTH	101
SHOPAROUND	
Sorry — no space this month.	

**MINI-MART 128**

• We'll publish up to 24 words (maximum) free of charge for you, your club or your association. Copy must be with us by the first of the month preceding the month of issue. Please — please — print or type advertisements clearly, otherwise it may not turn out as you intended! Every effort will be made to publish all advertisements received; however, no responsibility for so doing is accepted or implied. Private advertisements only will be accepted. We reserve the right to refuse advertisements considered unsuitable.

• Conditions: Your name and address plus phone number (if required) must be included with the 24 words. Reasonable abbreviations, such as 25 W RMS or 240 Vac, count as one word. Advertisements must relate to electronics, audio, communications, computing, etc — general advertisements cannot be accepted. Send your advertisement to:

ETI Mini-Mart,  
 P.O. Box 227,  
 Waterloo NSW 2017.

**MAIL ORDER BOOKS 73, 99****DREGS 130****SPECIAL OFFERS**

UNIVOLT  
 DIGITAL MULTIMETERS 13

CHATTERBOX  
 VOICE SYNTH. PROJECT 89

## FEATURES

- 13 **Univolt digital handheld multimeters — special offer!**  
Univolt agents, Benelec, are offering three great instruments.
- 16 **Japan Inc. — long live “New Media”**  
The Japanese have buried mass market hi-fi. Dennis Lingane reports.
- 24 **Fixing the VHF/UHF broadcast bungle**  
It will take the next 20 years to fix the bungles of the past twenty.
- 33 **Sanyo/ETI Betamovie contest results**  
Last August's contest turned up some beaut entries. And the winner is . . .
- 36 **The satellite TV smorgasbord**  
Lots of satellites occupy the geosynchronous ring at 36 000 km.
- 52 **Win a fabulous Philips VHS stereo hi-fi VCR!**  
A chance to win a super new video recorder which features great hi-fi sound.
- 81 **Special Offer — Chatterbox voice synthesiser project for \$75!**  
Get your computer talking.
- 107 **The shortwave Babel**  
Listening to language broadcasts on shortwave.
- 116 **Keyboard upgrade for the Microbee**  
It's relatively simple and the result just wonderful!
- 127 **Over the counter**  
ETI takes a look at Perth-based Altronics and the 'honest Irishman'.

## PROJECTS

- 68 **ETI-692: RS232/20 mA current loop interface**  
Hook those current loop peripherals to your RS232 port.
- 74 **ETI-677: Chatterbox voice synthesiser**  
“We are the Daleks. You must co-operate!” Fun and frolics with this low-cost project. (See offer.)
- 84 **ETI-741: Radio Microphone, Part 2**  
Getting it all together.
- 91 **ETI-279: Darkroom exposure meter**  
Simple project gives accurate indication of under, over or correct print exposure.

## REVIEWS

- 47 **British potency! — JPW P1 speakers**  
JPW is a small British firm with an equally small product range — but good.
- 105 **Icom's star performer — the IC-R71A**  
Technological lust and the reviewer's dilemma.

## ADVERTISERS' INDEX

Active Electronics	65
Altronics	27,28,29,30,31,32
Amtex	34
Aust. Government	51,66,67
Aust. School of Electronics	26
AWA-Thorn	58,59
Carbuhn	125
Centre Industries	124
Daneva	110
Delsound	106
Dick Smith	10,11,112,113
Dolphin Computers	124
Dream Disk	123
Electrical Equipment	123
Electron Alarms	23
Ellistronics	70,71
Emtronics	109
Energy Control	122
Ferguson	62
GFS	102
David Hall	60
Hewlett Packard	35
Hi-Tech Light & Sound	14,15
Icom	1FC
Imark	102
Jaycar	6,7,54,55, 96,97
Mayer Krieg	62
Micro Analog Gen.	123
W. Obrist	60
Philips	42,43
Prepak	72
Rod Irving	18,19,61 82,83,129
Rose Music	OBC
SME Systems	126
Sands	122
Scan Audio	22
Sonique	40
Sony	IBC
Tradepower	23
Truscott	60
Vanfi	44
W.I.A.	102
Warburton Franki	56

## NEXT MONTH

### THE CRO — A CLOSER LOOK

The time has come, the Editor said, to speak of many things — of triggers, traces and fast timebases, and other fancy things. So John Fairall has looked into the tricks and traces on modern oscilloscopes, giving a rundown on what they're all about. In the process, he surveyed what's available in CROs under \$3000. If you're looking to 'kick over the traces' (. . . stop, stop!), don't miss next month!

### PULSE-SHAPED CDI

Electronic ignition systems — in the form of transistor-assisted and capacitor discharge ignitions — have been popular projects for many years. TAIs are admittedly simple and save the points. But . . .

Most designs seen in the past certainly deliver *heaps* of grunt . . . and crossfire like blazes! Not good. On a slightly flat battery — they die! This project tackles the problems and delivers the goods. Not too much (no crossfiring problem), and when you want it (from a flat battery, and at peak thrust). It doesn't suffer the reliability problems of past

designs and can be used with either conventional or Hall-effect points. A neat feature is the burglar alarm cutout. *Vroom, vroom!*

### NAD 7155 STEREO RECEIVER

Louis Challis says, “If you like simple ‘no frill’ concepts then the NAD 7155 is most probably what you have been looking for. If you are looking for that type of subdued visual impression, combined with good RF sensitivity, selectivity and particularly good audio amplification capability, then you need look no further.”

# JAYCAR JANUARY SPECIALS

- WE HAVE NEVER BEEN SO DESPARATE!!!

## SAVE A FORTUNE



Ceiling Grilles  
for 8" speakers

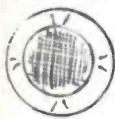

1-9 \$1.25

10 up \$1.00

Ideal for PA  
installers

Cat. AX-3560  
**MASSIVE SAVING**

**TAPE HEAD  
DEMAGNETISER**

Cat. AC-1600

Works on cassette and  
Reel-Reel. Special  
cushion head designed  
to get into tight corners

240V

NORMALLY \$5.95  
JANUARY PRICE

**\$3.95**

**SAVE  
\$2**

**8" WOOFER**

This superb Pioneer woofer will handle about 20 watts rms. Frequency  
response is 50 - 3kHz. These are usually worth \$15 each.  
Cat. CW-2112

**ONLY \$7.50 each**  
**SAVE \$7.50 each (50%!!!)**



EACH BAG  
CONTAINS HEAPS  
OF GOODIES  
FOR YOUR  
JUNK BOX  
AVERAGE  
WEIGHT IS 1kg!

STOCK MAY BE SCARCE FROM TIME  
TO TIME AS WE ONLY MAKE THEM  
WHEN WE HAVE NOTHING ELSE TO  
DO (AS THEY ARE BELOW OUR COST)

SORRY! PERSONAL SHOPPERS ONLY

**SWIVEL/TILT BASES FOR  
MONITORS - ARE WE CRAZY?**

NORMALLY  
\$29.95

**SAVE 1/3**  
THIS  
MONTH  
**\$19.95**



**GOING ON  
HOLIDAYS?**

DON'T GO WITH-  
OUT A "JETPHONE  
ADAPTOR",  
CONVERTS THE AIR  
TYPE HEADPHONE  
SOCKET IN A PLANE  
TO ELECTRIC. YOU  
CAN THEN PLUG  
YOUROWN PHONES  
IN & LISTEN IN  
COMFORT!

**1st CLASS!!**  
WERE \$8.95 &  
\$5 AT TIMES  
LAST YEAR  
THIS MONTH

**\$3.95**

ONLY A FEW  
LEFT - HURRY!  
SO BEFORE YOU  
FLY OUT, FLY IN  
& GRAB ONE!

Cat. AA-2040

**PIONEER 10" GUITAR  
SPEAKER**

Quality Pioneer brand - check the specs! Check the price!

★ Impedance 8 ohms ★ Voice coil diameter 1 1/2" ★  
Power rating 60 watts rms ★ Resonant frequency 80Hz  
★ Sensitivity 98dB(dB/W) ★ Response 80Hz - 7kHz  
★ Total flux 61,100 Maxwell ★ Flux density 8,300  
Gauss ★ Net weight 1.54kg.



**ONLY \$29.95**  
CATALOGUE PRICE \$39.95

SAVE AT  
JAYCAR

**SAVE \$15 ON**  
LOW-COST COMPUTER/  
AUDIO CASSETTE RECORDERS

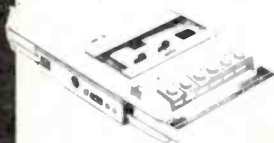

- WORKS WELL • MAINS/  
BATTERY OPERATED
- SPECIAL TAPE LOADING  
INSTRUCTIONS • TAPE  
COUNTER (a must) INBUILT
- ELECTRET MIC. • LED  
RECORDING INDICATOR

WERE \$39.95

Cat. XC-4905

**THIS MONTH ONLY \$24.95**

**110v COMPUTER  
GRADE FANS**

- NEVER TO BE  
REPEATED OFFER
- GERMAN MADE
- 'EBM' BRAND
- 80mm SQUARE (std) FITTING



**LIMIT STRICTLY 1 PAIR PER CUSTOMER**

**WHAT'S THE OFFER?**

**BUY ONE,**

**GET ONE FREE!!**

THAT'S RIGHT, 2 FANS FOR THE PRICE OF 1!  
THAT WAY YOU CAN USE THEM ON 240V  
(WIRE IN SERIES)

**\$14.95** for 2 Cat. YX-2508

**MOISTURE REPELLENT  
SPRAY**

400g CAN  
WERE SELLING FOR  
\$6.95 WE HAD THEM  
FOR \$3.95 LAST YEAR  
(BARGAIN!) STILL A  
FEW LEFT. ONE OF  
THE BEST BARGAINS  
ON THIS PAGE AT -

**\$2.95**  
Cat. NA1020  
A CAN



**Beautiful Brown 6" Twincone Speaker**

This 5 watt 8 ohm unit has a light brown  
curvelinear cone with a slightly darker whizzer  
cone. It is a true widerange speaker with treated  
cone surround for lower resonance.

Only  
**\$3.95** ea  
**\$3.50**  
10 up

Cat. AS-3013



**4 STATION INTERCOM**

3 SLAVE, 1 MASTER. COMES COMPLETE WITH  
LOTS OF WIRE, STAPLES & INSTRUCTIONS.  
RELIABLE SOLID STATE IC CIRCUITRY.

NORMALLY \$29.95 JAN ONLY \$19.95

**SAVE \$10.00** Cat. AI-5504

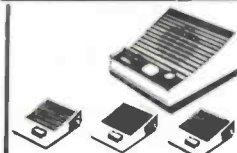

**START THE YEAR OFF RIGHT, WITH BARGAINS FROM JAYCAR!!**

**SAVE UP TO 66%**

1-9 \$0.99¢  
10 up \$0.50¢ ea

FROM **50¢**

Cat. LA-5270

INCREDIBLE  
TELEPHONE BELLS  
- TWO TONES  
- ADJUSTABLE LEVEL  
- BRAND NEW  
- AS USED IN 'GONDOLA' PHONE

WERE  
\$1.50 ea

**50% OFF SALE**  
IC INSERTERS & EXTRACTORS ETC  
- CMOS SAFE  
- BENT PIN STRAIGHTENER  
- ONE HAND OPERATION

	WAS	NOW	SAVE
TH-1810 8-20 pin IC inserter	\$5.95	\$3.95	\$2.00
TH-1808 14-16 pin IC inserter	\$5.95	\$3.95	\$2.00
TH-1812 22 pin IC inserter	\$6.50	\$3.50	\$3.00
TH-1814 24-28 pin IC inserter	\$6.95	\$3.95	\$3.00
TH-1816 36-40 pin IC inserter	\$8.95	\$4.95	\$4.00
TH-1818 8-40 pin extraction tool	\$2.95	\$1.95	\$1.00
TH-1824 auto wire stripper/cutter	\$9.95	\$7.95	\$2.00



**MICROCOMPUTER  
POWER SUPPLY**

REGULATED. BUILT AND TESTED UNIT  
INCLUDES GOLD ANODISED HEATSINK,  
WIRING INSTRUCTIONS AND SCHEMATIC  
DIAGRAM. TRANSFORMERS NOT SUPPLIED.  
OUTPUT VOLTAGES: +12V @ 1.5A; -12V @ 0.5A;  
+5V @ 6.0A; -5V @ 0.5A.  
Cat. MP-3024

WAS \$39.95

NOW ONLY **\$19.95**

NOW OPEN 144 LOGAN ROAD BURANDA QUEENSLAND

VHF/UHF ROTARY  
TUNERS - see previous ads  
for details  
WERE \$69.95

NOW \$39.95 Cat. DM-9004

SAVE \$30!  
SAVE OVER 40%  
For advanced  
experimenters only!

PIPER MOUSE ROBOT  
Fun KIT to assemble in the holidays  
WERE \$34.95

NOW \$19.95

Cat. KJ-6680

SAVE OVER 40%



**8" 3-WAY SYSTEM**

Superb 8" woofer with foam surround suspension and heavy magnet assembly with sealed back midrange and tweeter. System impedance 8 ohms. Power handling 40 watts rms. Crossover capacitors and connecting diagram and recommended 8" cabinet detail drawing supplied.  
Cat. CS-2453 (2 required for stereo)

SAVE \$5.00  
**\$24.95**

set



SAVE \$5.00

**\$34.95**  
set



**10" 3-WAY SYSTEM**

Once again, a high quality 10" woofer with high power, sealed back midrange and tweeter. System Impedance 8 ohms. In addition a quality Pioneer 3-way crossover is provided at no extra charge. Connection instructions are also provided as well as recommended 10" cabinet plans.

Cat. CS-2454 (2 required for stereo)

INCLUDES PIONEER 3-WAY CROSSOVER

**WHAT A FLOP!  
SOLDERING IRON TESTER**

NOW OPEN BURANDA QUEENSLAND

We thought that more people would want to know the temperature of their soldering iron - but they didn't! We imported a great little soldering iron temperature meter that was accurate. It just did not sell. It was put on the market at a very reasonable \$29.95 but all it did was stay on our shelves. We put them on special last year at \$19.95 and a few went. But not enough! So this month? An absolute bargain for the serious enthusiast.



Cat. QT-2100

THIS MONTH **\$12.95**

SAVE **POWERTRAN KIT** SPECIALS SAVE

**DIGITAL DELAY LINE KIT - 400mS**  
SAVE \$100 WAS \$449 THIS MONTH \$349

**"CORTEX" 16 BIT 16 COLOUR COMPUTER KIT**  
- HIGH RESOLUTION  
- 24K EXTENDED BASIC  
SAVE \$900 NO ROOM  
ORIGINALLY \$1299, ADVERTISED AT A LOWER PRICE LAST YEAR. FOR DEFINITELY BELOW COST AT \$399 - Cat. KJ-6630  
MONEY REFUNDED FOR THOSE WHO MISS OUT DETAILS

**"HEBOT" ROBOT  
TURTLE**

- Geared DC motors
- 4 touch sensors (90° apart)
- Hefty 1.8kg
- Speed 15 feet/minute
- Independent wheel control
- Complete with 10 1/2" diameter perspex dome

SAVE  
**\$100**

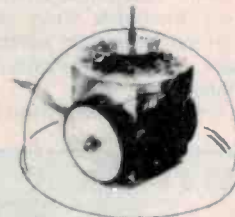

NORMALLY \$399 THIS MONTH \$299

PIEZO TWEETER - Popular PH1038 Horn. Normally \$10.95. This month \$7.50, will handle 50 watts rms and goes from 2-25kHz. Good for Hi Fi or PA. Cat. CT-1902

ONLY \$7.50



**Jaycar  
ELECTRONICS**

Incorporating ELECTRONIC AGENCIES  
NUMBER 1 FOR KITS

N.S.W. SYDNEY: 117 York Street Tel. (02) 267 1614  
SHOWROOMS CARLINGFORD: Cnr. Carlingford & Pennant Hills Road Tel. (02) 872 4444  
QUEENSLAND CONCORD: 115/117 Parramatta Road Tel. (02) 745 3077  
SHOWROOM HURSTVILLE: 121 Forest Road Tel. (02) 570 7000  
BURANDA: 144 Logan Road Tel. (07) 393 0777

MAIL ORDERS: P.O. Box 480, AUBURN 2144. Tel. (02) 643 2000  
HEAD OFFICE: 7/9 Rawson Street, AUBURN 2144.  
Tel. (02) 643 2000 Telex: 72293

SHOP HOURS	POST & PACKING
Carlingford, Hurstville & Gore Hill	\$5 - \$9.99
Mon-Fri 9am - 5:30pm, Thurs 8:30pm, Sat 12pm	\$10 - \$24.99
Sydney	\$25 - \$49.99
Mon-Fri 8:30am - 5:30pm, Thurs 8:30pm, Sat 4pm	\$50 - \$99.99
Concord	\$100 - \$198
Mon-Fri 9am - 5:30pm, Sat 4pm	Over \$199
	\$10.00

COMET ROAD FREIGHT ANYWHERE IN AUSTRALIA ONLY \$12



MAIL ORDER VIA  
YOUR PHONE

# Telecom sets low rates for national videotex service

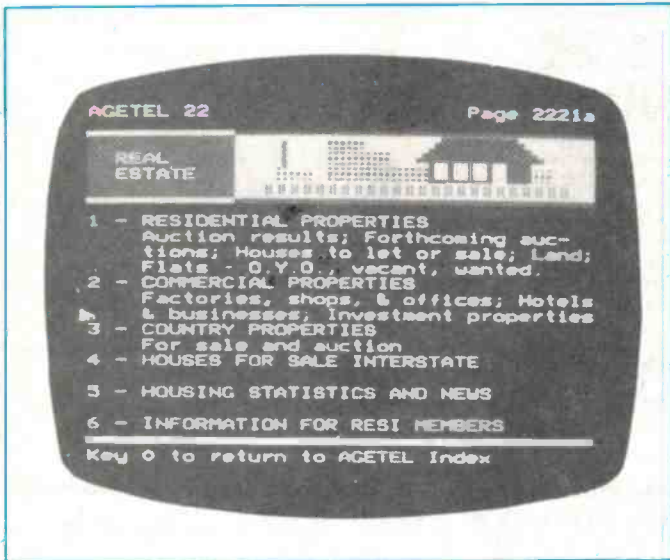

**F**ollowing strong comment that proposed charges for Telecom's national videotex service, Viatel, were too high (see ETI, Nov. '84, page 9 — *Videotex too expensive*), Telecom has announced prices well below the rates expected.

Announcing the prices, Telecom's General Manager Commercial Services, Dr Laurie Mackechnie, said that significant first year discounts were also being offered to attract current Videotex users in Australia to join Viatel.

"We believe that rates must be

set at a low level initially to encourage rapid growth in the industry — the best way to achieve profitability in the long term for Service Providers," he said.

Dr Mackechnie said that the low rates would not only apply to users of Viatel, but that costs for Service Providers had also been

set well below those expected.

"By doing this, Telecom expects that Service Providers will recruit users to the service and, in fact, the Service Provider's annual fee is reduced for each user recruited to Viatel," he said.

The rates for Viatel users are:

**Subscription** — \$12.50 for the first year of the Viatel service, then \$12.50 per month for business users and \$2.50 per month for non-business users.

**Connection** — 8c a minute from 8 am to 6 pm Monday to Friday and 5c a minute for all other times.

**Call charges** — As announced previously, Australia-wide access to Viatel will cost only a local call fee including access to gateway facilities.

Viatel Service Providers have the option to charge for frames viewed by users, however, it is expected that most frames on the service will be free.

Costs to Service Providers are:

**Basic Charge** — \$225 a month. This allows for 50 free frames. Additional frames are 40c a month dropping to 20c a frame a month for more than 5000 frames.

Telecom is also offering a packaged option, with some restrictions, to organisations to supply up to 50 frames of information on Viatel for only \$80 a month.

Dr Mackechnie said that this was expected to prove popular with smaller organisations and those wishing to assess the marketing opportunities in electronic information services.

"With these prices, we also expect Viatel to provide strong stimulus to the videotex industry in Australia."

Dr Mackechnie also pointed out that Viatel would have a 'gateway' facility.

"Gateways have been operational in Europe for some time," he said.

"They provide the opportunity — heavily promoted in France, for example — of giving users access to a range of external computers which can provide transactional services or special information. Among these are booking and confirming tickets for travel and entertainment, home shopping, home banking, access to airline guides, etc."

Dr Mackechnie said that by setting a price of only \$300 a month for gateway, Telecom expected that the range of services available through Viatel would expand rapidly.

## NOTES & ERRATA

Oct. '84, Pulse generator mod.p.94: The pole of the upper switch should be connected to BC (SQUARE(3) OUTPUT), switching between pin 7 of IC2 (BB) and the BNC socket — which is the Input, not output, as labelled.

Sept '84: ETI-1410 Bass Guitar Amp. p. 69 :  
The cut-off frequency of the filter network on the limiter output board is given

$$F_c = \frac{\pi}{2} (RV11 + R69 \times C6S)$$

This is Incorrect. The CORRECT formula is:

$$F_c = \frac{1}{2\pi (RV11 + R69) \times C5S}$$

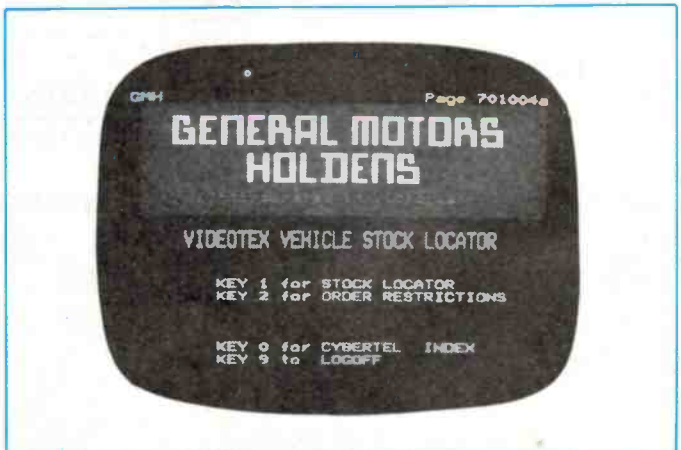





## Spacotel for c-band satellites

**S**pacotel, originally developed by Microtel Ltd of BC Canada for use with the Anik-C series of communications satellites on the 14/12 GHz or Ku band, has now been enhanced to allow it to communicate using domestic and international communications satellites on the 6/4 GigaHertz band or C-band as it is commonly called.

In addition to extending telecommunications networks, Spacotel can also be used in a number of other valuable applications such as delivering education programmes to rural areas using one-way video and two-way audio; for private commercial networks where it can provide a dedicated link between distant offices; and for outlying resource bases that can link with urban central offices. Spacotel also has broad potential public-safety and emergency-services applications by virtue of its extreme portability

and short set-up time.

The product consists of a remote unit with a satellite transceiving dish and the associated electronics for voice and data phone transmission. This is linked to a master control station at a central telephone exchange which introduces the remote signal into the existing telephone network. A person picking up a phone from any point where Spacotel is installed would instantly hear a dial-tone from the central exchange.

Spacotel was designed and developed by Microtel Pacific Research, Microtel's research and development arm, where development of the company's satellite telecommunications products is ongoing.

The research centre and Microtel's head offices are located in Burnaby, BC Canada. Spacotel is marketed by GTE Australia Pty Ltd, Melbourne.

## Briefs

Australian microcomputer and systems software distributor, Archives Computers, has moved its Melbourne and Sydney offices. The Melbourne head office has moved across the road to 64 Clarendon Street, South Melbourne, while the Sydney office is still located at 55 Lavender Street, Milsons Point, but has moved three floors to level 13. The phone numbers for the two offices remain the same at (03)699-8377 and (02)922-3188 respectively.

At a seminar in Sydney Telcon Australia unveiled a new ASC catalogue of cable and accessories for the computer industry. The catalogue is divided into four colour-coded sections: cable assemblies; cables; connectors and accessories; and charts and tables. A trade price list is included and the charts and tables section contains a handy glossary of terms. The catalogue is available to the trade from Telcon Head Office and all Telcon branches.

Pulsar Electronics Pty Ltd has moved as from 15 October to Catalina Drive, Tullamarine, Vic 3043. (03)330-2555.

Dr David Booker, Managing Director of Hewlett-Packard Australia Limited, has announced key organisational changes within its Australasian operation. Mr John Bieske, will move into the new position of Director of Sales. Mr Roger Kane, will become Marketing Manager. Heading the newly-formed Support and Distribution Group will be Mr Gray Morgan. Mr Richard Vincent will take over Mr Morgan's previous role of Area General Manager. Mr Bruce Graham will take over the position of Corporate Development Manager, Mr Bruce Marsh will replace Mr Graham as Area General Manager.

The Australian Hi-Fi and Video Shows in 1985 will take place in Sydney, June 21 to 23, Adelaide July 5 to 7, and Melbourne July 12 to 14.

Hagemeyer (Australasia) BV, who distribute JVC electronic products in Australia, recently announced a continuation of the agreement with the Victor Company of Japan to 31 December, 1986. The agreement was concluded during a recent visit to Japan by Mr Bob Raassen, the Group Managing Director of Hagemeyer. Mr Raassen said he was very happy for the association to continue and was excited about the future development of JVC products in Australia.

Warsash Pty Ltd has available copies of a paper in English written by Dr Karl Spanner and Dr Harry Marth at Physik Instrumente of West Germany on the use of piezoelectric translators for direct electrical to mechanical conversion for micropositioning systems. (To accompany the technical paper, and on request, Warsash Pty Ltd can provide literature covering both piezoelectric actuators and electro-mechanical precise positioning systems.)

Tecnico Electronics has been appointed Australian Distributor for E G & G Wakefield Engineering, USA, for their range of Heat Dissipation Products. E G & G Wakefield Eng has manufacturing plants in the USA and Mexico, and has over 20 years in the Electronics Industry. Tecnico Electronics has already received initial stocks for distribution into Australia.

Dick Smith has just released its 'Lockalarm', a combination key operated chain lock and burglar alarm. The alarm is set to go off the instant anyone attempts to open the door against the chain (without first unlocking and releasing it). The Lockalarm, designated as Cat L-5155, retails for \$13.95 from Dick Smith stores throughout Australia.



# GOODIES FOR THE HOLIDAYS...

SPECIALY SELECTED FOR YOU BY LITTLE DICK!!

## ZIPPY BOX ROUND-UP TIME!

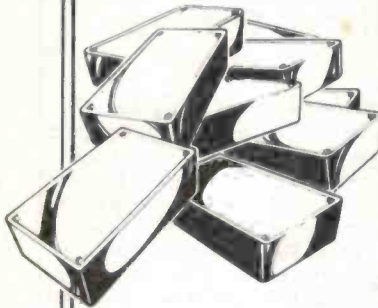

Summer projects are fun projects: but you'll need something to build them into! Your best choice is a Zippy Box: the original Zippy Boxes - and still the best, regardless of all those cheap and nasty imitations! Deep, full-length side ribbing for strength - and to let you mount PCB, etc without screws.

Dick Smith Electronics Zippy Boxes: the ones the magazines use!

Mini (29 x 54 x 83mm) Cat H-2755 **\$1.80** each  
 Midi (50 x 90 x 150mm) Cat H-2751 **\$2.80** each  
 Giant (60 x 113 x 196mm) Cat H-2752 **\$3.99** each



## SEE IN THE DARK WITHOUT CARROTS!

Lumi-Tabs: a great new invention helps you find that elusive power point or light switch even in the dead of night! Just stick them on or next to the p/p or switch - and they glow in the dark!!! Self-adhesive, luminescence lasts for yonks. Cat P-5350

**\$1.99** pack

## WANT A NEW POWER POINT TOO?

Replace that single with a double: much more convenient! Then you can stick new Lumi-Tabs all around it! Standard double power point. Cat P-5560



**\$850**

## AND JUST IN CASE OF MISTAKES:

Check your power points with this fantastic little gizmo: 3-pin plug lights up to tell you if your power point is wired correctly, or if there's no earth, etc etc. Don't get fried! check that power point! Cat P-5300



**\$4.95**

## REMEMBER WHEN POTS DIDN'T MEAN ...

What a pot! Sliding-tap type ceramic pot with a massive 200 watt rating! A few of these and you could make a room heater ready for winter ... or audio dummy loads, etc etc. 150 ohms end to end, tap wherever you like. Cat R-1999

**\$2.95**

## Electronics Dickshunary

Everything you always wanted to know about electronics but were afraid to ask in case they thought you were a cretin. Now you'll be able to find out why a flip flop flips (or flops). Cat B-3610 ONLY

**\$9.95**

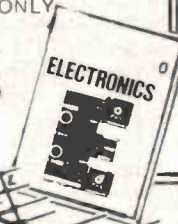

## FABULOUS NEW BEARCAT DX-1000 RECEIVER!

What a performer! What a magnificent set! And what a low, low price for today's up-to-the-minute technology!

Look at what it offers for the low, low price:

- An amazing 10kHz to 30MHz range (yes, 10kHz!!!).
- 10 memory channels INBUILT: nothing extra to buy!
- AC or DC operation (also has DC memory back-up)
- Better than 0.3uV sensitivity (800kHz up)
- Push-button operation or manual tuning
- Quality US made by Bearcat: the people who brought you Scanners!

Call in today for a test drive. No obligation (we'll even give you a 'Little Dick' Sticker!) Cat D-2830



**\$659.00**

DON'T MISS THE MAILER IN THIS ISSUE FULL OF HOBBYIST BARGAINS... IF SOMEONE'S ALREADY PINCHED IT, GET A COPY FROM YOUR NEAREST DICK SMITH STORE!

## TOP PERFORMER:

The best in VHF reception PLUS a built-in UHF section with corner reflector (maximum gain, minimum ghosting). Saves putting up two antennas! Cat L4018

**\$79.95**

## HUGE SCOOP PURCHASE... MANUFACTURER'S LOSS IS YOUR GAIN... HURRY IN FOR THESE BARGAINS!

Save your good turntable and cartridge for your good records: let the kids use one of these! Your choice of quality magnetic or ceramic cartridge models, ready to go - motor runs off 12V. Way below manufacturer's price: just look at these!!!

Turntable with quality ADC magnetic cartridge. Cat A-3010

**\$59.00**

Turntable with ADC ceramic cartridge. Cat A-3015

**\$27.50**

HURRY! LIMITED STOCK... IF YOU MISS OUT DON'T SAY YOU WEREN'T WARNED... HURRY!



## JUST A FEW LEFT: but hurry!

Our fantastic Strobe Flash innards bulk buy: probably about fifty bucks worth of bits: flashtube, reflector, dump capacitor, inverter, light metering circuitry, etc etc. Some work, some don't, but circuits are available for the experimenters. What a buy! Have you ever tried to buy spares for your flash? Cat J-1002 LIMITED STOCK

**\$14.95**

## WIN YOUR CLUB A UHF REPEATER - AND YOURSELF AN AMATEUR STATION!

Buy any item of Yaesu amateur equipment from Dick Smith Electronics this month or next and you could be a winner!!! Over \$8000 worth of prizes details at your Dick Smith store.

## GIVE YOUR CAR A PRESENT!

Fit a new Dick Smith top-of-the-line sound system - like this fantastic AM/FM/Stereo Cassette/Equaliser/Power Amp/Digital Clock/Etc! Yes, it's got THE LOT!

All this in a standard size unit (fits dash cut-out: throw out the junky model the manufacturers force on you and your ears will say 'thanks!') Cat A-6488



**\$225**

BONUS!!! Choose EITHER a set of top quality co-axial speakers Cat A-7000 - value \$44.95) OR an electric car radio antenna (Cat A-7360 - value \$25.00)

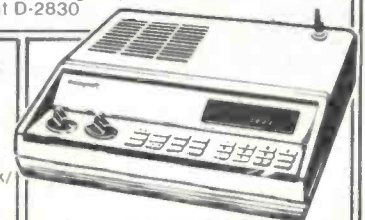

## A BUDGET SCANNER... WITH DELUXE FEATURES!

Everything you could want in a scanner: 9 bands right up to 512MHz (also includes aircraft!), 16 programmable channels plus scan and search facilities - and it operates from 12V so it's ideal for use mobile! (240V via optional adaptor). Catch all the action: with the Bearcat BC201FB! Cat D-2802

**\$399**

Optional AC adaptor to suit: Cat M-9530 \$22.50

## SUMMER TIME IS PARTY TIME

And what's a party without the barbie, the pool and some coloured lights? We can't help you with the barbie or the pool - but if you want fantastic coloured lights, try these: PAR38 150 watt type (pressed glass construction with internal reflector), Edison Screw base floodlights in four colours.



**\$7.85 EACH** (last for donkey's years)

BLUE Cat S-3854 GREEN Cat S-3856 YELLOW Cat S-3850 RED Cat S-3852  
 E/S base to suit (aim where you like!) Cat P-5620 **\$6.25**

# More Stores to give you even better service.

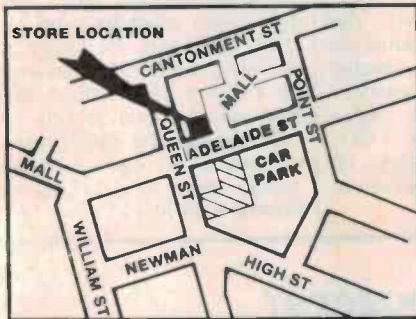

**FREMANTLE**  
66 Adelaide St  
T.B.A.

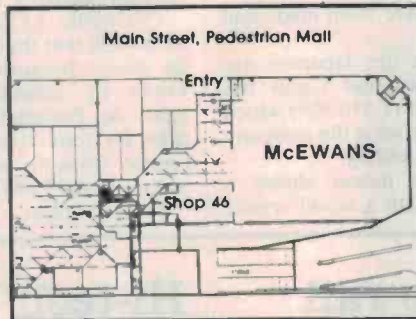

**BOX HILL**  
Shop 46, Box Hill Central, Main St  
Telephone: 890 0699

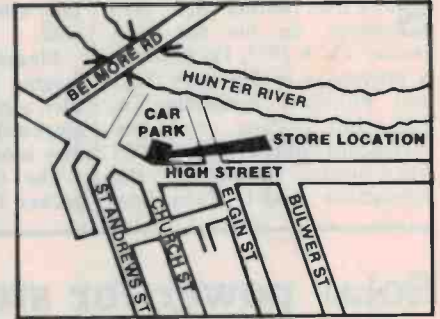

**MAITLAND**  
450 High St  
Telephone: 33 7866

## STORE LOCATIONS

### NSW

Cnr. Swift & Young Sts.  
Panamatta Rd & Melton St  
T55 Terrace Level  
Shop 1, 65-75 Main St  
613 Princess Hwy  
Dxford & Adelaide Sts  
531 Pittwater Rd  
Campbelltown Mall, Queen St  
Shop 3, 235 Archer St Entrance  
147 Hume Hwy  
162 Pacific Hwy  
315 Mann St  
4 Florence St  
Elizabeth Dr & Bathurst St  
450 High St  
173 Maitland Rd, Tighes Hill  
Lane Cove & Waterloo Rds  
George & Smith Sts  
The Gateway, High & Henry Sts  
818 George St

**Albury** 21 8399  
**Auburn** 648 0558  
**Bankstown Sq.** 707 4888  
**Blacktown** 671 7722  
**Blakehurst** 546 7744  
**Bondi Junction** 387 1444  
**Brookvale** 93 0441  
**Campbelltown** 27 2199  
**Chatswood Chase** 411 1955  
**Chullora** 642 8922  
**Gore Hill** 439 5311  
**Gosford** 25 0235  
**Hornsby** 477 6633  
**Liverpool** 600 9888  
**Maitland** 33 7866  
**Newcastle** 61 1896  
**North Ryde** 88 3855  
**Parramatta** 689 2188  
**Penrith** 32 3400  
**Railway Sq** 211 3777

6 Bridge St  
125 York St  
Tamworth Acde & Kable Ave  
263 Keira St  
**ACT**  
96 Gladstone St  
**VIC**  
Creswick Rd & Webster St  
145 McCrae St  
Shop 46, Box Hill Central, Main St  
Cnr Hawthorn Rd & Nepean Hwy  
260 Sydney Rd  
Nepean Hwy & Ross Smith Ave  
205 Melbourne Rd  
291-293 Elizabeth St  
Bridge Rd & The Boulevard  
Springvale & Dandenong Rds  
**QLD**  
293 Adelaide St  
166 Logan Rd

**Sydney** 27 5051  
**Sydney** 267 9111  
**Tamworth** 66 1961  
**Wollongong** 28 3800  
**Fyshwick** 80 4944  
**Ballarat** 31 5433  
**Bendigo** 43 0388  
**Box Hill** 890 0699  
**East Brighton** 592 2366  
**Coburg** 383 4455  
**Frankston** 783 9144  
**Geelong** 78 6766  
**Melbourne** 67 9834  
**Richmond** 428 1614  
**Springvale** 547 0522  
**Brisbane** 229 9377  
**Buranda** 391 6233

Gympie & Hamilton Rds  
Cnr Queen Elizabeth Dr & Bernard St  
Cnr Gold Coast Hwy & Welch St  
Bowen & Ruthven Sts  
Ingham Rd & Cowley St, West End  
**SA**  
Wright & Market Sts  
Main South & Flagstaff Rds  
Main North Rd & Darlington St  
24 Park Terrace  
**WA**  
Wharf St & Albany Hwy  
86 Adelaide St  
William St & Robinson Ave  
Centreway Acde, Hay St  
**TAS**  
25 Barrack St  
**NT**  
17 Stuart Hwy

**Chermside** 359 6255  
**Rockhampton** 27 9644  
**Southport** 32 9863  
**Toowoomba** 38 4300  
**Townsville** 72 5722  
**Adelaide** 212 1962  
**Darlington** 298 8977  
**Enfield** 260 6088  
**Salisbury** 281 1593  
**Cannington** 451 8666  
**Fremantle** T.B.A.  
**Perth** 328 6944  
**Perth** 321 4357  
**Hobart** 31 0800  
**Stuart Park** 81 1977

### Dear Customers,

Quite often, the products we advertise are so popular they run out within a few days, or unforeseen circumstances might hold up shipments so that advertised lines are not in the stores by the time the advert appears. And very occasionally, an error might slip through our checks and appear in the advert (after all, we're human too!) Please don't blame the store manager or staff; they cannot solve a dock strike on the other side of the world, nor fix an error that's appeared in print. If you're about to drive across town to pick up an advertised line, why not play it safe and give them a call first... just in case! Thanks.  
Offers available till 31-1-85 or while stocks last; rain checks apply also.

Dick Smith Electronics

### MAJOR RESELLERS

These are independent businesses which stock a large range of Dick Smith Electronics products. However we cannot guarantee they will have these items or at the price advertised.

**NSW** — Ballina: A. Cummings & Co. 91-93 River St 86 2284 ● Bowral: Barry Gash Electronics, 370 Bong Bong St 61 2577 ● Broken Hill: Hobbies & Electronics, 37 Dixie St 88 4098 ● Charlestown: Newtronics, 131 Pacific Hwy 43 9600 ● Coffs Harbour: Coffs Harbour Electronics, 3 Coffs Plaza, Park Ave 52 5684 ● Deniliquin: Deni Electronics, 220 Cressy St 81 3672 ● East Maitland: East Maitland Electronics, 99 High St 33 7327 ● Gosford: Tomorrows Electronics & HiFi, 68 William St 24 7246 ● Inverell: Lyn Wiling TV, 22A Evans St 22 1821 ● Lismore: Decro Electronics, 3A/6-18 Carrington St 21 4137 ● Port Macquarie: Hall of Electronics, Horton Centre, Horton St 83 7440 ● Orange: M & W Electronics, 173 Summer St 62 6491 ● South Tweed Heads: Shop 1, Inessa Court, Blundell Boulevard 36 1077 ● Swansea: Swansea Electronics, 184 High St 71 1674 ● Wagga: Wagga Wholesale Electronics, 89 Forsyth St ● VIC — Hamilton: John Thompson & Co. 138-148 Gray St 72 2000 ● Echuca: Webster Electronics, 220 Pakenham St 82 2958 ● Mildura: McWilliams Electronics, 110A Langtree Ave 23 6410 ● Morwell: Morwell Electronics, 95 George St 34 6133 ● Shepparton: G.V. Electronics Centre, 100 High St 21 8866 ● QLD — Atherton: Maarten's Music Centre, 55 Main St 91 1208 ● Bundaberg: P.M. Electronics, Takalvan St 72 8272 ● Cairns: Electronic World Shop, 27 K-Mart, Westcourt Plaza, Mulgrave Rd 51 8555 ● Gladstone: Purely Electronics Shop, 2 Cnr Herbert & Auckland Sts 72 4321 ● Mackay: Stevens Electronics, 42 Victoria St 51 1723 ● Maryborough: Keller Electronics, 218 Adelaide St 21 4559 ● Rockhampton: Purely Electronics, 15 East St 21 058 ● SA — Mt Gambier: Hutchesson's Comm. 5 Elizabeth St 25 6404 ● Whyalla: Eyre Electronics, Shop 2 Forsythe St 45 4764 ● WA — Albany: Micro Electronics, 133 Lockyer Ave 41 3432 ● TAS — Launceston: Advanced Electronics, 5A The Quadrant 34 1399 ● NT — Darwin: Ventronics, 24-26 Cavanagh St 81 3491

**HEAD OFFICE & DS XPRESS ORDER SERVICE**  
P.O. Box 321, North Ryde, N.S.W. 2113. Tel: 888 3200

**SPEEDY PHONE/BANKCARD ORDER SERVICE**  
Just phone your order and Bankcard — it's so simple! (02) 888 2105  
orders only on this number. Enquiries: (02) 888 3200

POST & PACKING CHARGES	Order Value	Charge	Order Value	Charge
	\$ 5.00-\$ 9.99	\$2.00	\$50.00-\$99.99	\$6.00
	\$10.00-\$24.99	\$3.50	\$100 or more	\$8.00
	\$25.00-\$49.99	\$4.50		

Terms available to approved personal applicants

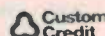

# DICK SMITH ELECTRONICS

PTY LTD

(SA Credit facilities available through Custom Credit Corp. 422 King William St. Adelaide)

## Japanese beat Sinclair

**S**ir Clive Sinclair first filed patents on his flat tube pocket TV in 1977. He unveiled a prototype in February 1981 and promised availability in 1982. But nothing more was then heard until September 1983 when Sinclair "introduced" the production model. Even now

only a few have been made and sold.

Meanwhile the Japanese are forging ahead and Casio has filed a patent (1 116 805) which gives a clue to what the company may soon be selling.

The Casio patent shows a pocket TV with a liquid crystal

display (LCD) panel, instead of the flattened cathode ray tube used by Sinclair's TV.

TVs with LCDs have the advantage that they consume little power because the display works by reflecting incident light. So batteries last longer than for tube sets. But LCDs cannot work in the dark, or where the light hits the screen at the wrong angle.

The Casio screen is a liquid crystal panel backed with an electroluminescent panel which emits light when fed with electricity. This way, the image produced by the LCD is illuminated by a diffuse glow from behind. Because the light travels only once through the panel, instead of twice as through a reflective panel, there is only half the normal light loss.

## Solar power for state rail

**A**lthough often under public fire from travellers and unions, behind the scenes the State Rail Authority is moving doggedly forward into the age of high technology.

The latest example of its modernisation program is the acquisition of 18 solar panels to power parts of its massive state-wide communications grid. The solar panels will power microwave transmitters at Roto, a spot on the western plains halfway between Condobolin and Ivanhoe.

The transmitters are a vital part of the railway's communications network on the Sydney to Broken Hill line, enabling communications between the two centres and with trains travelling the route.

The solar contract follows the successful performance of 16 other panels in powering another transmission terminal at Gum Lake on the same route.

The transmitter was previously powered by a gas driven generator.

But the gas bottles needed replenishment every month. When the panels are in place the SRA can virtually forget about going near the installation, except perhaps to replace a battery.

For further information contact Mr Jim Kuswadi, General Manager, Amtex Electronics, 36 Lisbon Street, Fairfield NSW 2165. (02)728-2121, the company which supplied the panels.

## Hi-tech boozers?

**T**he Coastline Hotels group has become the first in the hotel industry to go on line with Videotex, the revolutionary interactive technology which communicates instant, up-to-the-minute information.

Eddie Byrne, Coastline's Managing Director, says the company's move into Videotex is in anticipation of the time when Videotex will be the main means of information and 'shopping' for travel and accommodation. "I believe that this developmental period will give us a definite advantage by the time Videotex really gets going," he said.

Coastline currently has some 22 pages of information in the Hotelmaster system, comprising such data as hotel facilities; a

location guide and average times to the airport, city centre, etc; function room floor plans and capacities; corporate rates, normal rack rates and special rates; and an "internal details" file with restricted access listing such items as industry hot list and commercial client contacts.

Because the directory can be updated on a daily, even hourly basis, the system's users are assured of accurate, up-to-the-minute information. "Our commercial clients who are on Videotex will know that all rates and details are always up to date. And because the system is interactive, they can make a booking directly with the hotel, or request further information, at a much cheaper cost than on Telex or even STD."

## Microwave controller

**P**roducts that tell machines how to assemble, paint and pack themselves, or vehicles that announce their own arrivals and departures are just two of many developments made possible by a new microwave-based control system launched by Philips.

The system is called PREMID — for Programmable REMote IDentification.

The key to the system is an ID-plate, about the size of a packet of cigarettes, which can be attached to a product as it moves down an assembly line. The ID-plate is capable of storing up to 20 decimal digits of information, making it a tiny worklevel database.

A communicator, remotely transmitting microwave signals to the ID-plate, can program data into it or read its stored information. The information

might be orders concerning its manufacture, which the communicator would relay through a central control unit to computer-controlled machinery or industrial robots.

PREMID allows a manufacturer to effectively control every phase of a production process while closely monitoring the progress of every product. It enables a fleet operator to keep track of every vehicle and increase his operational efficiency.

The PREMID concept is based on advanced microwave technology, utilizing the penetrating and reflective properties of microwaves. Microwave signals pass easily through plastic material, wood and dirt, but are effectively reflected by a metal surface.

When data is to be programmed into or read from the



**P.PREM.ID:** The new microwave controlled database from Philips.

ID-plate, the communicator sends a microwave signal, which is reflected back to the communicator by the ID-plate. Data can be programmed into the ID-plate, deleted or changed whenever it passes a communicator.

In Munich, BMW has installed PREMID on a large scale, enabling it to offer a high

degree of customer specification. Every new car leaving the plant is now built according to customer requirements.

At the beginning of the production line, ID-plates are programmed to select left-hand steering or right-hand steering. Subsequently, additional data is programmed into the ID-plates. In the painting area, the final appearance of a car body is determined by a colour-code read from an ID-plate.

A Philips spokesman, Wal Stone, said the possible uses of the PREMID system extended as far as a user's imagination. "We can supply the software allowing any company to set up a system that caters for its particular needs," he said.

For more information contact Philips, 15 Blue St, North Sydney, NSW 2060. (02)925-3281.

**SPECIAL ETI READER OFFER**

# DIGITAL MULTIMETERS

FROM **BENELEC**

## THREE MODELS TO CHOOSE FROM —

*All 3½-digit LCD Meters Featuring 0.5% (dc) Basic Accuracy 'Professional' Instruments at a Hobbyist Price!*

BENELEC PTY LTD had such a resounding success with a previous offer made through Electronics Today that they approached us about launching two new multimeters in their Univolt range in the same way.

Univolt is no new brand to the Australian market. BENELEC has been distributing Univolt multimeters here for the past five years. The instruments are designed, developed, manufactured and marketed under the company name — no 'badge' engineering here. These meters are imported exclusively by BENELEC PTY LTD who warranty and service them here. They've been in the electronics business for over eight years and believe in handling quality products.

**Here's an incredible opportunity to get the sort of multimeter to suit your needs at virtually unbeatable prices!**

Univolt's continuing design and development program has brought two new models to the marketplace and this is the first time the DT-1000 and PD-1800 models have been offered here. The DT-860 was first offered two years ago and, as a sort of 'anniversary deal', Benelec are again offering the DT-860, but this time at a lower price!

## DON'T MISS OUT — ORDER NOW!

Send completed coupon to:  
Federal Marketing, BENELEC/ETI Multimeter Offer,  
PO Box 227, Waterloo NSW 2017.

*I don't want to miss out on this special offer.  
Please rush me the following:*

..... DT-1000 Multimeter(s) at \$ .....  
..... PD-1800 Multimeter(s) at \$ .....  
..... DT-860K Multimeter(s) at \$ .....

Sales Tax No: ..... (if applicable)  
Please add \$2.50 post and handling per unit ordered.

TOTAL \$ .....  
(allow up to four weeks for delivery)

Name .....

Address .....

Postcode .....

Signature .....

American Express  Bankcard  Cheque\*

\* Please make cheques payable to the Federal Publishing Company Pty. Ltd.

Credit Card No: .....

Expiry Date: .....

**OFFER CLOSSES LAST MAIL SUNDAY 31 MARCH**



### ◀ DT-860K AUTORANGING DIGITAL MULTIMETER

This popular LCD readout digital multimeter features 25 measurement ranges with autoranging on dc and ac volts and resistance. It incorporates a transistor gain measurement function as well as diode and continuity check functions. It comes complete with a carry case, 'safety' probes and transistor  $h_{FE}$  clip-probe.

All for only: \$70

(tax exempt); \$90 tax paid. 3½-digit LCD readout (1999 max.); dc voltage ranges — 200 mV, 2, 20, 200, 1000, 0.5% basic accuracy\* ac voltage ranges — 2, 20, 200, 750 V, basic accuracy 0.75%; dc and ac current ranges — 2, 200 mA, 10 A, basic 1% dc and 1.2% ac accuracy; resistance ranges — 200, 2k, 20k, 200k, 2M, 20M, 0.5% basic accuracy; transistor  $h_{FE}$  (NPN or PNP) to 1999 with  $V_{CE}$  of 1.2 V,  $I_B$  of 1  $\mu$ A. diode check reads forward voltage drop; continuity check sounds buzzer under 20 ohms; overload protected; power supply — 2 x 1.5 V (AA) cells (inc.).

### ▲ NEW! UNIVOLT DT-1000K DIGITAL MULTIMETER

Univolt's top-of-the-line handheld LCD multimeter. It features 30 measurement ranges, including dc volts, ac volts, dc and ac current, transistor  $h_{FE}$  (gain) plus diode check and audible continuity check (beeper). Range selection is via the single large rotary switch. The case features a prop-up stand and the whole unit comes with carrying case, probes and  $h_{FE}$  clip-probe for just: \$73.40 (tax exempt); \$95 tax paid.

3½-digit LCD readout (1999 max.); dc voltage ranges — 200 mV, 2, 20, 200, 1000 V, 0.5% basic accuracy; ac voltage ranges — as for dc but 750 V on top range, basic 1% accuracy; dc and ac current ranges — 200  $\mu$ A, 2, 20, 200 mA, 10 A, 1% basic accuracy on dc, 1.2% on ac; input impedance — 10M; resistance ranges — 200, 2k, 20k, 200k, 2M, 20M, 1% basic accuracy; transistor  $h_{FE}$  (NPN or PNP) to 1000 with  $V_{CE}$  of 2.0 V,  $I_B$  of 10  $\mu$ A; diode check reads forward voltage drop; continuity check sounds buzzer under 20 ohms; overload protected; power supply — 9 V No. 216 battery (inc.).

### ▲ NEW! UNIVOLT PD-1800 DIGITAL PROBE TESTER

Wow! — a tiny digital volt-ohm-continuity probe with the 3½-digit LCD readout built-in! Great for the toolkit, great for the beach! It features autoranging on volts and ohms as well as autopolarity indication. A beeper sounds in the continuity test mode. There are four dc and ac voltage ranges and four resistance ranges. It measures a tiny 163 mm long, 28 mm high and 19 mm deep! How much? \$50 (tax exempt); \$65 tax paid.

3½-digit LCD readout (1999 max.); ac and dc voltage ranges — 2, 20, 200, 500 V, basic accuracy 0.5% dc, 1% ac; resistance ranges — 2k, 20k, 200k, 2M, basic accuracy 0.7% (in-circuit test capability — uses 0.3 V on ohms range); input impedance — above 10M; power supply — 2 x 1.5 V (LR-44) cells (inc.).

This offer is exclusive to readers of Electronics Today and products can only be obtained by sending in the attached coupon (or a clear photostat or hand-copied facsimile). **90 DAY WARRANTY ON ALL METERS** (from date of despatch).

**ArtLit  
Lighting  
Equipment**



# HELICOPTERS

<b>4 HEAD</b>	<b>\$179.90</b>
<b>6 HEAD</b>	<b>\$219.90</b>
<b>8 HEAD</b>	<b>\$269.90</b>

**(COMPLETE WITH LAMPS)**



# Hi-TECH LIGHT AND SOUND

**HIRE \* SALES \* SERVICE**

63 Hardgrave Road, West End 4101  
 Postal Address: P.O. Box 377, West End  
 Phone: (07) 44 4971

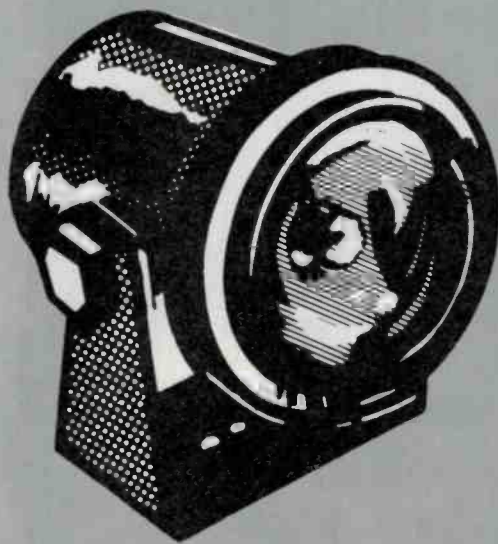

## PINSPOTS

**PAR36 \$29.90**

**PAR46 \$39.90**

**(COMPLETE WITH LAMP)**

**Mail Orders  
 + Installations  
 + Other Info**

**CREDIT CARDS**

Bankcard, M/Card, AGC Credit Line 

**CLUB INSTALLATIONS**

Excellent service through Australia.

**INSTALLERS**

Write to us for attractive Trade Terms.

**MAIL ORDERS (AUST)**

Add packing & post (P&P) as follows  
 (Aust. only) **MINIMUM MAIL ORDER \$25**  
 Goods \$25-\$49 ..... P&P\$3.50  
 Goods \$50-\$99 ..... P&P\$5.00  
 Goods \$100-\$149 ..... P&P\$7.50  
 Goods \$150-\$199 ..... P&P\$10.00

Goods \$200 + Add 5% to Order value  
 or otherwise by individual quotation.

Send to: **HI-TECH LIGHT & SOUND**  
 63 Hardgrave Rd.  
 West End Q. 4101.

# JAPAN Inc.

— long live New Media

Dennis Lingane

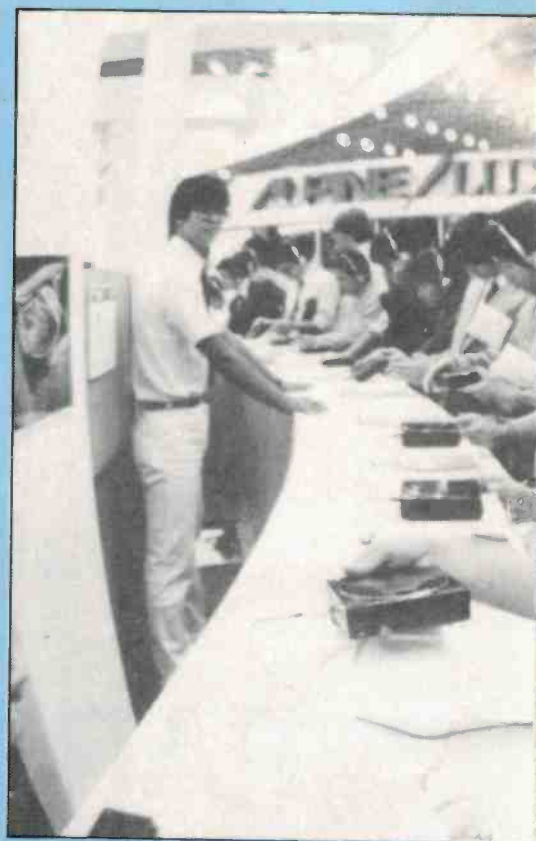

THE MAJOR Japanese manufacturers unceremoniously buried hi-fi as we know it at this year's 33rd annual All Japan Audio Fair. It appears that, as far as the main thrust of Japanese manufacturers is concerned, (there are too few exceptions) there is no future in pandering to the whims and wants of the "hi-fi maniac" as they call audiophiles in Japan. It's not a growth market, they say, so as far as Japan is concerned it's no longer of consequence.

Instead, they plan to concentrate on the age of "New Media" — a mish-mash of audio, video, and computers that has lots of

flashing lights, makes lots of noise, and offers vision as well as sound to batter your senses. No longer is there any real effort to try and solve the secrets of musical reproduction. Is that a piano, is it a harp, is it a violin?

No, it's a synthesiser.

So why worry about distortion when modern music is distortion anyway and all of it's electronic? The main buyers in Japan, after all, who buy all this technology are between 17 and 25, and they want modern synthesised music anyway.

So now we have the age of New Media

where you can have anything you like as long as it's black, has rows and rows of flashing lights, and can be integrated into a video and computer system as well.

By the way, the original term 'New Media' was used to describe integration of all media including cable TV, satellite TV, Teletext, Prestel, facsimile, as well as audio and video. Now it seems to be the catch cry of the new audio/video scene.

### The marriage with video

The only major difference from company to





Hi-fi is dead — long live 'New Media'! That was the message from the 1984 All Japan Audio Fair held in October last year along with the annual Japan Electronics Show. These annual shows plot the course the Japanese consumer electronics industry will take in the year ahead. Dennis Lingane, doyen of Australia's consumer electronics journalists, attends every year. Here's his report on the 1984 shows.

#### NAKAMICHI SHOW A CD RECORDER



Nakamichi, king of the cassette deck makers, has entered the compact disc field, not only with a CD player but also with a CD recorder.

Their CD recorder is actually a data storage system aimed at markets where high volume storage is required for office applications. But Nakamichi hasn't just produced a recorder. It is also a test machine that is capable of measuring the performance characteristics of many media applications including optical discs.

The asking price is around \$90 000 so there is hardly going to be a rush for it.

Nakamichi says that primary application is in research. It is a reliable means of characterising various optical recording systems which scientists can use, and it is obvious that it can be developed into a wide range of commercial products, Nakamichi says. It can be a base for any product that relies on low cost, high density digital storage.

In that you can lump digital audio recording because, at the show, that was just what was being demonstrated.

While the price may be outrageous now, it is a pointer to the fact that down the road will be a recording as well as playback compact disc when the technology is tamed price-wise. Moving onto the more realistic world of domestic compact disc players, Nakamichi has released the OMS 7 and OMS 5. Two players he unashamedly claims are the first capable of 'perfect' reproduction of the natural atmosphere of the original sound. Nakamichi points to the fact that he developed the digital analyser and recorder as an indication of his expertise in this new field.

If you can make a digital disc recorder that is bought by leading companies to analyse digital

storage then it's a piece of cake to make a player that is the best, the story goes; especially when you are already one of the world's leading authorities on sound, and manufacturer of the best cassette decks.

Nakamichi says that, in particular, he and his team have worked to eliminate the colouration found in most players that is referred to by audiophiles as 'digital sound'.

He has, it appears, adopted the Philips system of over-sampling by four times the norm — using 176.8 kHz instead of 44.1 kHz. He uses digital filters. Not all companies have started to use these yet, although Philips does, and they have direct-coupled, linear phase analogue signal processors to eliminate even the slightest cause of sound deterioration.

he says that true audiophiles and music lovers will for the first time find a CD system they can accept. Hearing is believing and it will be interesting to do some comparisons when these newcomers to the CD scene eventually hit Australia.

There is no doubt that these are sonic differences between players and it will be interesting to see what Nakamichi has come up with. It was impossible to do a proper listening session at this audio show.

Nakamichi has used separate digital-to-analogue converters (one for each channel), which is a step in the right direction, as has been proved by Sony and JVC. And even the analogue circuitry is totally separate, one for each channel, so he has spared no expense to get it right. The two players have all the usual search systems found on other players as well as remote controls.

company at this year's Tokyo Audio Fair was in the way the video and audio were married. JVC's 'Cross Media' system using a computer to create a number of graphics on TV is a winner and there are some manufacturers getting ready to copy. Akai has taken its U8 video/audio amplifier launched in Australia a year ago, and developed that into quite a sophisticated control centre complete with colour TV, and even more switching circuits than the current machine has got.

Sony is planning to create computer ports on future VCRs so that you can use an MSX



### CANNON TYPE AUDIO CONNECTIONS

We've sold 1000's because of their great value!!

3 Pin line male 1-9 10+  
Cat. P10960 **\$1.90 \$1.80**

3 Pin chassis male  
Cat. P10962 **\$1.90 \$1.80**

3 Pin line female  
Cat. P10964 **\$2.50 \$2.10**

3 pin chassis female  
Cat. P10966 **\$2.90 \$2.20**



### BULK CABLE 100M ROLLS

Cat. W11222 3C2V75 OHM **\$22.00**

Cat. W11224 5C2V75 OHM **\$35.00**

Cat. W11219 4 Core Shielded **\$49.00**



### MINI MODEM

300 baud full duplex  
Answer originate  
Plugs straight in (hardwired phone)  
Superior VLSI chip performance (identical to Multi Modem)  
Telecom Approval (C84/37/1173.)  
Incl. phone only **\$199**

### ALUMINIUM SHEETS .8mm

CAT.	SIZE	PRICE
H10770	150x150mm	\$1.75
H10771	150x300mm	\$2.50
H10772	300x300mm	\$3.95
H10773	300x600mm	\$6.90



### HEX KEY PAD

19 Keys, Unencoded, 76 x 95mm  
Cat. K46804 **\$42.50**



### RECHARGEABLE 12V GELL BATTERIES

Leakproof and in 3 convenient sizes, these long service life batteries are ideal for burglar systems, emergency lighting or as a computer backup power supply. Ideal for many power needs.

Cat. S15029 12V 1.2 AH **\$17.95**

Cat. S15031 12V 2.6 AH **\$34.50**

Cat. S15033 12V 4.5 AH **\$44.95**

### PRIME SPEC RED LEDS

We bought 100,000 so you can reap the benefits!

1-9 10-99 100+  
**\$0.10 \$0.09 \$0.08**  
Cat. Z10150

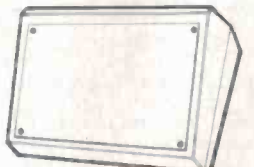

### NEW SLOPING CASES

Plastic with metal front panel, available in two sizes:  
Cat. H10450 **\$9.95**  
190x120mm  
Cat. H10455 **\$17.95**  
265x185mm  
(measurements are approx. only)

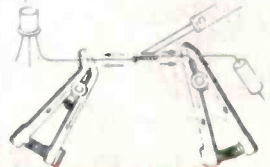

### HEAT STOPPERS

For protecting parts which have little resistance against heat when soldering. Normally \$3.50.  
Cat. T12440 **\$2.50**



### RS232 & 'D' TYPE CONNECTORS

PART	DESCRIP.	CAT. NO.
1-9		10-25
DE 9P	9 Pin Female	P10880
\$1.75		\$1.60
DE 9S	9 Pin Male	P10881
\$2.25		\$2.10
DE 9C	9 Pin Cover	P10882
\$2.55		\$2.45
DA 15P	15 Pin Male	P10894
\$2.10		\$1.95
DA 15S	15 Pin Female	P10895
\$2.25		\$2.10
DA 15C	15 Pin Cover	P10892
\$1.15		\$1.05
DB 25P	25 Pin Male	P10900
\$2.95		\$2.80
DB 25S	25 Pin Female	P10901
\$3.45		\$3.30
DB 25C	25 Pin Cover	P10902
\$1.20		\$1.10



### 36 WAY CENTRONICS CRIMP PLUG

Cat. P12200  
1-9 10-99 100+  
**\$6.50 \$5.95 \$5.50**



### SOLDER CENTRONICS PLUGS

Unreal price for absolute top quality. Normally \$14.95 (Our opposition charge up to \$19.95).  
1-9 10+ 100+  
**\$6.95 \$5.95 \$4.95**



### PIPER MOUSE ROBOT

This is a Super-Sonic robot, controlled by a super-sonic sound sensor and an electronic circuit. (1 channel). By using the whistle included with this Kit, Piper Mouse will obey your commands immediately turning to the left, stop, turning to the right, stop, advance and stop.  
Cat. K96680 **\$34.95**



DC +5V @ .5A, +12V @ .4A  
DC -5V @ .5A, -12V @ .4A  
Cat. M16680 **\$129**

### SWITCH MODE POWER SUPPLY

DC +5V @ .5A, +12V @ .4A  
DC -5V @ .5A, -12V @ .4A  
Cat. M16680 **\$129**



### JUMPER LEADS

Set of 10 high quality leads approx. 450mm long. Normally \$4.95.  
Cat. W12000 **\$2.95**



### NICAD BATTERIES

Save on carbon batteries with these Appolon Nickel cadmiums. Rechargeable up to 1000 times!

Cat. S150020 AA500 MA

Cat. S15021 C 1.8 AH

Cat. S15022 D 4 AH

1-9 10+  
**\$2.25 \$1.95**  
**\$4.95 \$3.95**  
**\$7.95 \$6.95**



### IC SOCKETS (LOW PROFILE) How cheap can they go??

1+	10+	100+	1000+
8 pin Cat			
15c	14c	12c	09c
14 pin Cat			
16c	15c	14c	10c
16 pin Cat			
17c	16c	15c	11c
18 pin Cat			
18c	17c	16c	13c
20 pin Cat			
29c	28c	27c	26c
24 pin Cat			
35c	33c	32c	28c
40 pin Cat			
45c	40c	35c	30c



### VERBATIM DISKS

"Lowest" price possible for "Highest" quality.

10-99 100+  
MD525-01 **\$3.25 \$3.00**  
MD550-01 **\$4.75 \$4.00**



### RELAY AND BASE

Can carry 10A at 28V DC or 5A at 240V AC. Supplied with Chassis Mounting Socket with screw terminals. Great for school projects and demonstrations, switching DC power supplies, central circuits and with contacts parallel up to 20A can be switched. Normally \$8.95  
Cat. S14074 This month **\$6.95**



### ELECTRONIC CASSETTE DEMAGNETISER

Save \$2. Rec. retail **\$19.95**  
Cat. A10006 This month **\$17.95**



### ECONOMY TOGGLE SWITCHES

Unbelievable Value!

1-9 10+ 100+  
S11010 (SPDT) **\$1.00 \$0.90 \$0.80**  
S11020 (DPDT) **\$1.20 \$1.00 \$0.90**



### 10,000uF 75V ELECTRO

25% more microFarads! Ideal for those who want a more powerful amp!  
1-9 10+  
Cat. R16587 **\$10.50 \$9.00**

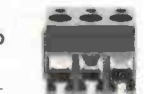

### NEW JOINABLE PCB MOUNTING SCREW TERMINALS

Less than half the price of the old ones!

2 way 1-9 10+  
Cat P10542 **\$0.50 \$0.40**

3 way  
Cat P10543 **\$0.75 \$0.65**  
(please note these are the new blue ones.)

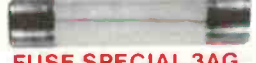

### FUSE SPECIAL 3AG

Two values, 3 Amp and 1 Amp  
1-99 100-999 1,000+  
8c each 6c each 5c each  
STOCK UP NOW



### PHILLIPS SPEAKER SPECIAL

Cat. C12030 AD01610 T8 **\$12.95**

Cat. C12040 AD02160 SQ8 **\$34.95**

Cat. C12045 AD70620 M8 **\$49.00**

Cat. C12050 AD12550 W8 **\$79.00**

You don't have to "Imagine" Phillips quality at these prices!



### SUPER HORN

Wide dispersion tweeter, handles up to 100W!  
Sensitivity: 105dB/0.5m  
Frequency Response: 3kHz-30kHz  
Impedance: 8 OHMS  
Size: 145x54mm  
Cat. C12103 **\$12.95**



### SUPER HORN TWEETER

Requires no crossover and handles up to 100W!  
Sensitivity: 100dB/0.5m  
Frequency Response: 3kHz-30kHz  
Impedance: 8 OHMS  
Size: 96mm diameter  
Cat. C12102 (Rec. Retail \$12.95) **\$11.95**

### CAR ANTENNAS

We stock a wide range of car antennas including auto up/down antennas.



### BLANK DATA CASSETTES

Brings out the best in any micro!  
1-9 10-99 100  
**\$1.10 \$1.00 \$0.90**



### FULL STRENGTH FERRIC CHLORIDE

This month only!

1-9 10+  
250ml **\$1.95 \$1.75**  
500ml **\$2.95 \$2.50**  
1 litre **\$4.95 \$4.50**



### RITRON (ZETA) DATASETTE

For data loading and saving, this Micron Datasette suits most home computers and features tape counter, monitor function for audio verification and slide volume control for output level.

Cat. C14900 **\$29.95**



### CAR ALARM

- ★ Fully Automatic System.
- ★ High Reliability, ease of Installation.
- ★ Multifunctional, prevents all doors, hood, trunk lid from being stolen.
- ★ Power Supply by DC 12 V (1 V-15 V) car battery.
- ★ Ear-bursting siren output 10 W/112 dB.

Normally \$49.95, this month **Cat. C14220 \$44.95**



### ARISTA HOUSE ALARM

House alarm security system. Electronic push button control module with programmable entry/exit code. Supplied with siren module and 4 sets of reed switches. Will allow up to 30 entry/exit points and additional siren modules. Complete with instruction book, cable etc. Battery operated.

Cat. M22461 **\$69.95**



### FAIRCHILD TTL DATA BOOKS

Just arrived! This book is the same as used in the Victorian Education System. Includes data on new Fast series. Limited stock 500 only.

Cat. B10050 **\$14.95**



### BRAND NEW FANS

Not noisy pullouts! Stacks of uses in power amps, computers, hotspot cooling etc. Anywhere you need plenty of air.

Cat. T12461 240V 4" **\$16.95**

Cat. T12463 115V 4" **\$16.95**

Cat. T12465 240V 3 1/2" **\$16.95**

Cat. T12467 115V 3 1/2" **\$16.95**

10 Fans (mixed) less 10%

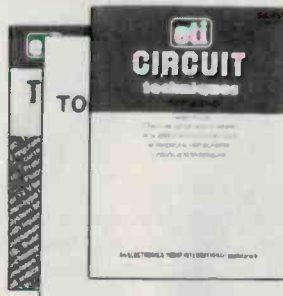

### ETI BOOKS

A must for any electronic enthusiasts!

Scanner's World **\$5.95**

Computer Projects Vol 1 **\$5.95**

Lab Notes and Data **\$7.95**

Electronics It's Easy Vol 1 **\$5.95**

Electronics It's Easy Vol 2 **\$5.95**

Test Gear Vol 1 **\$3.00**

Test Gear Vol 2 **\$3.95**

Test Gear Vol 3 **\$4.95**

Top Projects Vol 5 **\$3.00**

Top Projects Vol 6 **\$4.95**

Top Projects Vol 7 **\$3.95**

Top Projects Vol 8 **\$4.95**

Top Projects Vol 9 **\$4.95**

Top Projects Vol 10 **\$5.95**

ETI Circuits Vol 1 **\$2.95**

ETI Circuits Vol 2 **\$2.95**

ETI Circuits Vol 3 **\$2.95**

ETI Circuits Vol 4 **\$2.95**

Computers & Computing Year Book **\$4.95**

Computers & Computing Vol 3 **\$4.95**

Computers & Computing Vol 4 **\$5.95**

30 Audio Projects **\$3.95**

Audio Projects from ETI **\$5.00**

Simple Projects Vol 2 **\$2.95**

Simple Projects Vol 3 **\$5.95**

Circuit Techniques Vol 1 **\$4.75**

Circuit Techniques Vol 2 **\$4.75**

Circuit Techniques Vol 3 **\$4.95**

Circuit Techniques Vol 4 **\$5.95**

How to Build Electronic Games **\$3.95**

Electronic Projects for Cars **\$3.95**

Project Electronics **\$4.75**

Electronic Projects for Young Scientists **\$3.95**

Radio Experimenters Handbook **\$7.95**

How to Build Gold & Treasure Detectors **\$3.95**

Electronics & Music **\$5.95**

Electronic Projects for Cars **\$3.95**

Project Electronics **\$4.75**

Electronic Projects for Young Scientists **\$3.95**

Radio Experimenters Handbook **\$7.95**

How to Build Gold & Treasure Detectors **\$3.95**

Electronics & Music **\$5.95**

3 1/2" MAGNIFYING GLASS **\$7.95**

Ideal for close inspections of solder joints etc. **Cat. T12087 \$7.95**

## ★ TOOLS OF TRADE ★



### NATIONAL RECHARGEABLE DRILL/SCREW DRIVER E2505

- ★ Quick 1hr Charging
  - ★ 4 Stage Torque Control
  - ★ 2 Speed Switch
  - ★ Handle Storage Compartment
  - ★ Forward/Reverse Operation
  - ★ National Quality
  - ★ Spare Battery Pack Available
- Cat. T12320 **\$149.00**



### TRANSISTOR NIPPERS

Normally \$7.95! This Month **Cat. T12070 \$6.95**



### MICRO NIPPERS

Normally \$9.95 This Month **Cat. T12050 \$6.95**

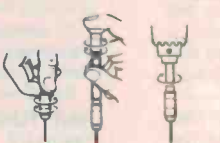

### PIN VICE

It's infuriating when all you need to do is drill one hole a little bit bigger and haven't got a drill that fits in your tool box. Buy one of these for drilling circuit boards. Will hold drill bits, taps, files, etc. up to 3mm.

Cat. T12352 **\$7.95**



### DIGITAL MULTIMETER

- YFE YF1100 FEATURES
- ★ Large, easy to read 3 1/2 digit display
  - ★ Facilities for transistor and diode testing
  - ★ Clearly laid out front panel
  - ★ 10A DC/AC range
  - ★ Priced to undersell the others!

Cat. A16025 **\$59.50**



### TAPERED REAMER

Great for enlarging holes that are a bit too small. Enlarges from 5mm to 20mm.

Cat. T12370 **\$6.95**



### UNIVERSAL SOLDERING IRON STAND

Cat. T11302 **\$5.95 slashed to \$3.95**



### LOGIC PROBE 3800A

Features 20MHz memory TTL/CMOS operation. Normally \$29.50 now only **1-9 10- \$19.50 \$17.50**



### WE HAVE DONE IT AGAIN!!

New multimeter at unbeatable value for under \$40! The new YU FONG YFE-1030C features:

- ★ Large 3 1/2 digit display, (1/2 inch high).
- ★ Autopolarity, "-" display for Negative input.
- ★ High over-load protection for all ranges.
- ★ Over-load display, highest figure "1" or "1" alone glows.
- ★ Power consumption 20mW approx.

Cat **\$39.95**



### WELLER WTCPN SOLDERING STATION

The WTCPN Features:

- ★ Power Unit 240 V AC
- ★ Temperature controlled Iron, 24 V AC
- ★ Flexible silicon lead for ease of use
- ★ Can be left on without fear of damaged tips!

The best is always worth having. **Cat. T12500 \$89.50**



### MICRON SOLDERING IRON

240V, 30 W general purpose for electrical and electronic soldering.

Cat. T12430 This month **\$10.95**



### CHASIS PUNCH

Absolutely essential for an enthusiast, prototyping technician or serviceman. Cuts holes in metal up to 16 gauge or 1.6mm. Essential for building kits. Punch Sizes: 16mm, 18mm, 20mm, 25mm and 30mm. Normally \$18.95 - Save \$3.

Cat. T12360 **\$15.95**

### POWERFUL MINI DRILL

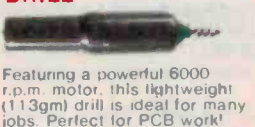

Featuring a powerful 6000 r.p.m. motor, this lightweight (113gm) drill is ideal for many jobs. Perfect for PCB work! Has a 0.8 to 1.2mm chuck and 1mm drill bit. Requires 12V 1 AMP (use with M19010)

Cat. T12302 **\$11.95**

Errors and Omissions Excepted

# rie

Rod Irving Electronics

425 HIGH STREET, NORTHCOTE VICTORIA. Ph:(03)489 8866 489 8131 48-50 A'BECKETT STREET, MELBOURNE VICTORIA. PH:(03)347 9251 Mail Order and correspondence: P.O. Box 235 NORTHCOTE 3070

### YOU WON'T GET BORED OVER THE HOLIDAYS WITH THESE GREAT SPECIALS!! GREAT 'IN STORE' BARGAINS TOO!

Call in at either 2 of our conveniently located stores: 48-50 A'Beckett St., Melbourne 425 High St., Northcote. Or take advantage of our Mail Order Department.

Write to:

MAIL ORDER CENTRE  
ROD IRVING ELECTRONICS  
P.O. BOX 235  
NORTHCOTE 3070

or phone ...

MAIL ORDER HOT LINE



481 1436



POSTAGE RATES  
\$1-\$9.99 ..... \$1.50  
\$10-\$24.99 ..... \$2.00  
\$25-\$49.99 ..... \$3.00  
\$50-\$99.99 ..... \$3.50  
\$100-\$199 ..... \$5.00  
\$200-\$499 ..... \$7.50  
\$500 plus ..... \$10.00

computer for editing tapes. Simply run through the tape, mark the scenes you want, indicate to the computer in what order you want the scenes and hit the return button. Then, sit back and the MSX computer will wind the tape back and forth hunting out the scenes you want and transferring them in sequence to a second VCR.

One thing is for sure, sound without vision in the future is going to be a no-no, but while Japan is convinced that this 'picture sound' is the way of the future they haven't sorted out what way that will be.

There are several systems for creating the pictures with sound. To start with we have the CD disc that by the middle of next year

will be offering graphics and text on CD

Still photographs are a long way off. That will need the equivalent of eighty 64K chips to hold enough information in RAM to produce a genuine photograph every 30 seconds. Think of eighty Commodore 64s piled one on top of the other. That makes it economically non-viable, not to mention huge. The graphics decoding is a lot easier. It needs a black box with 32K RAM and error correction circuits, and then a basic 64K home computer and you can have a graphic every few seconds.

At the other end of the scale is the Philips/Pioneer laser video disc. Pioneer has produced a machine that will play both CD

discs and Laser Video discs, and even better, they have developed a system of putting a digital sound track on the video disc along with the current analogue sound track.

They explained that they have 2 MHz of signal left and that a 16-bit digital audio signal takes only 1.7 MHz so they have plenty of room. Selling in Japan through Pioneer and Sony for around \$1200, this combination player would appear to be the ideal answer. Black boxes added later would produce digital pictures and graphics off CD. And anyway, there is no reason, using the video disc system, they can't store analogue still photographs on CD discs complete with digital sound.

## UPDATE ON CD

Any doubts that car CD players would not work were dispelled recently when I test drove a Sony test car in Tokyo. The car was fitted with the one piece Sony CD player and it performed faultlessly.

Sony claims the CD player will withstand up to 2.2g force before it mistracks, so I thought we'd give it a go, although some of the executives were far from cheerful about the prospect of me thrashing their expensive show limousine through Tokyo traffic!

I loaded a disc and took off through the Shinagawa traffic, finding any pot holes I could in the well-worn streets. I even stomped on the brakes and stood on the gas a few times to see if I could shake up the CD player — without luck. So far so good, but nothing really out of the ordinary that could properly test the CD player — until we got onto an expressway. There we found what I needed.

To ensure cars don't cross into on-coming traffic, the Tokyo road builders have a corrugated section down the middle of the road which has ridges around 12 cm (approx. five inches) high, spaced about 30 cm apart. Much to the concern of on-coming Japanese motorists, not to mention following traffic police, I ran the car onto the corrugations!

Like some mechanical, raging bronco it bucked and kicked violently as it tried to fight back to the relatively smooth tarmac surface. The only thing that mistracked was the car.

The CD player just played on.

Sony has managed to beat the problem of vibration mistracking by mounting the electronics and tracking mechanism on a chassis that hangs on four rubber suspension points inside the main body of the CD player. The only thing they say may beat it is a deep pothole that creates a G-force of around 100.

Sony says that it has tested the car with its player in most normal rough conditions driving on gravel, bush, and using snow chains. And Sony says that when it comes to heat problems it's not the CD disc that one has to worry about, but the laser diode. This they say can be damaged when working at temperatures in excess of 60°. So Sony has a temperature sensor that turns the laser off automatically when the temperature gets to around 55-57°C.

Pioneer also has a CD car player it released in October, just ahead of Sony. While the Sony is a one-piece unit, Pioneer's comes in two parts. The CD laser player mechanism is in one section, the electronics is in a separate box that mounts underneath the player. This was released on October 12 in Japan, and was expected to be released in Australia before Christmas in limited numbers — so get your pennies ready, they will be in short supply.

I didn't get to road test the Pioneer but thumped it pretty hard at the Audio Fair and it didn't mistrack either. No prices are known yet for Australia, but they will be priced around that of the top-of-the-line car cassette deck.

Heat and outback conditions apart, it looks like they have come up with a winner.

### NOT JUST A MUSIC MACHINE

Some people may argue against the logistics of a CD player in a car because of the dynamic range. When you get full dynamic range of, say, an orchestral piece the pianissimo is so quiet it is drowned out by the car noise, while the fortissimo is so loud it deafens you.

But there is another purpose for CD in a car, and that is as a navigational aid, and tour guide. NEC was displaying this concept in the Japan Electronics Show.

A CD player was mounted in a central sloping console. Obviously all cars will have to go to central sloping consoles eventually to cater for the

two-way radios, telephones, CD player, digital readout, and the video display screen.

On this NEC console the video display terminal was recessed so it could be seen in daylight, and on this was a map of the area with a flashing cursor indicating your journey. The idea is, instead of buying a street directory for a city, you buy a CD disc with all the pages on it. These are called up by you and then, using either a touch sensitive screen or a light pen, you indicate where you are on the map. From then on the on-board computer monitors your progress so you never get lost.

An extension of this will be a tourist guide by which every time you pass a landmark it will be displayed on the screen and a short run down on the points of interest about it.

So CD will be necessary for more than just sound in a car.

### FINE TUNING

Talking CD, enthusiasts will be happy to know that although the Japanese electronics manufacturers appear to be abandoning esoteric hi-fi en masse (if the Audio Fair this year is any indication) there are some companies working towards fine tuning CD players for better sonic performance.

*The NEC car cockpit — complete with CD and video display.*



## VHD — the Lazarus

With the marriage of these two laser technologies one would think that would be to the satisfaction of an already bemused market. Not likely.

Now think in terms of VHD which in the last year has gained a lot of ground in Japan because of its cheaper unit price, although still trailing laser.

When Pioneer announced laser digital video disc the VHD camp came up with its answer — AHD (bet you thought that had been buried — well so did I). Using a picture processor and a digital processor (both available as add-on units costing more than

the original VHD video disc player) is the offering to those mad enough to buy VHD digital sound with still pictures.

Really a poor man's choice when laser gives you digital sound with moving or still pictures.

## Add-in the computer

Finally we have the computer industry offering us a wide range of pictures from space age graphics to simple wall washes, and some modern electronic art reminiscent of French impressionist paintings done by a monkey. The days of 'chunky graphics' are gone.

The MSX computer system, adopted by all major electronic Japanese manufacturers a year ago so all machines would be compatible, had a high profile in the electronics show in Tokyo, but indications are that it really isn't doing that well.

Sharp and NEC have still refused to join the clan and without them the system really lacks credibility in the eyes of the computer enthusiasts because Sharp and NEC are the major brands in Japan in the personal and home computer market.

A Sharp spokesman says that MSX hasn't had the success the group had hoped for and now they are working on a higher level MSX.

Two companies I spent some time with in Japan discussing CD technology on this trip were Kenwood and Sony, and both have made some important strides forward to find those elusive harmonics that seem to be the main difference between CD and analogue sound, according to the 'golden ears'.

In fact, prior to these discussions, a few of us had sat down and worked out that, on a dollar-for-sound basis, up to around a \$5000 system there is no doubt that CD will give one better sound, not to mention convenience of operation. But over \$5000, a top-drawer hi-fi system with carefully selected vinyl LPs on a carefully matched tone arm, belt-drive turntable, moving coil cartridge, connected to an A-class amplifier and top quality hi-fi speakers is still ahead of CD.

But that is only because the CD technology is so young. There is a lot to be learned on all sides. The engineers have to learn how to use the recording techniques to their advantage, the artists have to understand the parameters, and the hardware manufacturers have to concentrate on the sonic performance rather than the features.

## GIMMICKS FOR SOME, PERFORMANCE FOR OTHERS

The main thrust of the industry seems to be gimmicks on players and the lowest possible price. Graphics, random search systems and colourful displays were the main priorities of the new machines in the All Japan Audio Fair. If the whole Japanese industry goes down that road then audiophiles would be left hanging with LP technology.

But I am relieved to say that after speaking to these Japanese companies there are some who, despite the obvious trend by Japanese manufacturers to forget audiophiles, are working on getting that ultimate sound quality from CD.

Kenwood, for example, is selecting its electronics on a sonic basis. In a small listening room in Tokyo they demonstrated some new players that as far as I could hear would be hard to beat, even using the ultimate in analogue systems. There was still that lack of detail on orchestral pieces with mass instruments, and you had to be listening through esoteric amplifiers and speakers worth several thousand dollars to pick it up.

Kenwood says that it still doesn't use a digital filter in CD players because of its opinion they aren't good enough yet. Mr Kenwood technical communicator, Mr H. Ishi, says that a digital filter has to be able to pass a signal through in seven nanoseconds before it can be considered good enough. This sort of technology has only just become available, he says, and has yet to be sonically proved.

Actually, the only companies using digital filters are Yamaha, Marantz/Philips, and NEC. And they also use over-sampling, varying from 88.2 MHz in the case of the Yamaha and its now many clones, and 176.4 MHz for the Marantz and Philips.

But down the road in Shinagawa, Sony has some dramatic breakthroughs heading for the market next year. There, I was shown a new linear tracking system for the optical laser scanner which uses an electro-magnetic motor instead of a gearing system. This, says Sony, will make for a faster random access time (one second as against three seconds), and less noise in the machine itself.

Sony will also introduce a digital filter in its next generation of players, but they will have a noise suppression system that will push the digital noise down 80 dB. Sony says that Philips' system suppresses the noise by 50 dB. Sony samples the signal off the compact disc at 44.1 MHz, passes this through the digital filter then suppresses the digital noise then samples at 88.2 MHz before passing it through the digital-to-analogue filter. The signal is then split into two stereo channels and passes through a



The Technics multiplay system consisting of a player that can take 51 compact discs, and four add-on modules that take 50 each!

seventh-order Butterworth analogue filter. This creates a 30 kHz top end limit.

In its top-line player Sony will have a separate digital outlet so upmarket audiophiles can use the motor of the player and use outboard digital-to-analogue converters. This is a good idea. Obviously the main gains as far as the audiophiles are concerned will be in this digital/analogue conversion and with direct digital line-out they will be able to upgrade their system as new technologies come along without changing the CD turntable.

One needs to emphasise that the specifications discussed in this article will mean nothing to the majority of buyers spending up to around \$5000 on a hi-fi system. Only the dedicated audiophile who listens for every fault will benefit from these new designs strides. And when you consider how few they are in relation to audio sales, it's great that some companies are still making an effort to cater for them.

The work being done by Kenwood and Sony can be likened to a mechanic fine tuning a Ferrari.

When we will see these new Sony machines is anyone's guess. Sony couldn't even give me a demonstration.

## AUDIO & ELECTRONICS SHOW

"The home computer technology is too young to have standardisation yet," he said. "It will happen eventually, but drawing up a standardisation format now is putting too low a ceiling on the technology. It must be allowed to develop."

But whether you talk to Pioneer, Sony, National, Toshiba or any other main line manufacturers, all add-on gimmicks to video and audio needing a computer interface is or will be MSX.

So they may get this system developed with Microsoft onto the world market yet, as peripherals for video and audio hardware.

### The 21st century in sound

But getting back to the Audio Fair, it was launched this year as "The 21st Century in Sound has begun". The pre-publicity said the show indicates the new priority of the Japanese audio industry — that of meeting the everyday needs of the consumer. In other words, to hell with audiophiles, let's get on with mass marketing music systems — albeit sophisticated ones.

The show offered mile after mile of black hi-fi systems in midi and mini, and less and less in full-size components. But the systems are no longer sold as components, they are totally integrated and no doubt it won't be long before they are all joined together in

one black box.

I suggested to one Japanese manufacturer a revolutionary idea: why not build the whole lot into a wooden cabinet complete with speakers, put legs on it and sell it as a radiogram!

Graphic synthesisers, like video control centres, are seen as a must because they have such nice pretty lights. Technics had a computerised graphics synthesiser that is touch sensitive. So you could literally draw with your finger on the touch sensitive face of the waveform you wanted and it was created.

Technics also has a new feature on upcoming CD players that enables you to cue in the tune you want to record. It goes into pause automatically, to wait for you to start the tape. Or, you can elect to have it seek not just the beginning of the track, but the first note of the tune instead, so you have no silent segments between tunes unless you put it into four-second mute.

So this year's Audio show was something of a disappointment for audiophiles — except Nakamichi's demonstration of a CD disc player that also records (with a price tag of \$90 000).

If you wanted real audio, as in reproducing music not noise, then you had to stroll 15 minutes to a small hotel where in almost church-like reverence the last of the esoteric hi-fi manufacturers, like Accuphase, Stax,

Harman Kardon, Seiko, Bose, and a few others, were preaching the gospel according to old values.

"Hi-fi maniacs" sat and stood hanging on every word and note issuing from multi-thousand dollar speakers.

Stax had a prototype belt-drive turntable that had a 24 inch (610 mm) platter and an 18 inch (460 mm) tone arm! Seiko was promoting a new belt-drive turntable with a 127 mm thick platter.

Electrostatic speakers and belt-drive turntables seem to be the name of the game, and the sound was so muted it was a pleasure to sit and listen in civilised surroundings to civilised music compared to the mayhem down the road in the two exhibition buildings bursting at the seams with the black New Media audio/video systems.

Only Accuphase and Bose were using CD players for demonstrating sound, and they tended to use Sony, Kenwood, and NEC which indicates the way these top companies are thinking.

### The wheel turns full circle

Maybe it wasn't goodbye to audiophiles after all. Maybe the wheel has turned full circle and the hi-fi industry with its discerning following will return to its pedestal, and the mass marketers will leave them alone to get on with marketing noise makers to the masses. ●

# REAL DANISH HI-FI . . .

Whether your music is classical or rock, JAMO's Professional Series will be the right choice.

JAMO's aim of accurate, uncoloured reproduction with a perfect stereo image has been achieved.

The speakers feature phase linearity, overload protection, acoustic attenuators and the unique CBR-system (Centre-Bass-Reflex) which eliminates cabinet resonances and distortion.

Quotes from reviews of JAMO Professional:

... "offer a performance bordering on the superlative. They are well suited for listening to both classical and rock music . . . well suited to the CD generation." Louis Challis, ETI.

... "we have rarely seen distortion readings as low as those of CBR 1303 from a dynamic speaker system." Julian Hirsch, Stereo Review.

... "Its sensitivity is the highest of any speaker we've tested in almost two years." High Fidelity, USA.

... "performs well on classical orchestra and organ and gives a good account of itself with rock music too. We would be quite happy to have a pair in our laboratory." Leo Simpson, Electronics Australia.

More information from  
SCAN AUDIO Pty Ltd  
P.O. Box 242, Hawthorn. 3122.  
Ph. (03) 819 5352.

JAMO HI-FI



The latest updated model.

JAMO CBR-1305  
Price: \$1195.00 per pair

# SECURITY ALARMS



\$75.00

## ULTRASONIC DETECTOR MONOSONIC

Has steady state rather than pulsed operation. Low power consumption (18ma) (11+15v). Operating frequency 22.3 khz quartz controlled. Protected area (adjustable) min 5 sqM — Max 30 sqM. R.F. immune. New patented engineering processes permit transmitter and receiver to be housed together.



\$96.00

## GULLIVER RADIO CONTROL

FOR USE WITH ANY WIRELESS REMOTE CONTROL. 1 OR 2 CHANNEL.  
 Operating frequency ..... 305 MHz  
 Working range ..... 80-100 m  
 Height ..... 6 cm  
 Width ..... 3.5 cm  
 Depth ..... 1.2 cm  
 Weight ..... 21 grams



\$75.00

## AVS PASSIVE INFRARED IR 127

Range — 12 metres. Slot — 90° on horizontal plane (on 11 x 2 rays). Twin element sensor built-in alarm memory. Computer design screening against spokes and RF.

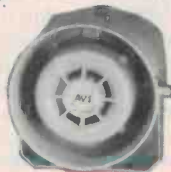

\$55.00

## AVS ELECTRONIC SIREN S 5

Feeding: 12 V dc. Current Consumption: 1.8 A Ferrite unit. Protected against polarity reversal sound level: 132 dB at 1 metre. Weight 1350 gr. Waterproof.

We stock a full range of security systems. For your security needs contact:

**ELECTRON ALARMS**  
 225 RAMSAY RD.,  
 HABERFIELD 2045

PHONE YOUR ORDER  
**(02) 799-4745**



MasterCard

VISA

# Optimize your system's sound quality with the...

## RTA-ONE REAL-TIME ANALYZER

Perfect sound could lie in the palm of your hand, with the new, affordable AudioSource RTA-ONE Real-Time Analyzer.

Whether adjusting your home stereo equalizer, or setting up a 10,000-watt auditorium sound system, the RTA-ONE allows instantaneous frequency-response analysis of the system.

The easily readable screen features red and green LEDs which display the relative level of each octave frequency band in the audible range. The RTA-ONE incorporates a built-in electret condenser microphone, professionally-calibrated controls, and is encased in a rugged metal housing. An optional Pink-Noise Generator, Remote Microphone, AC Adapter, and Carrying Case are available.

The RTA-ONE is the perfect measurement device to help you achieve optimal sound, wherever you go, at a price that is a revelation to behold.



**SPECIAL INTRO OFFER**  
**\$399**  
 Includes Pink-Noise Generator, AC Adapter and Carry Case P & P

## AudioSource

TRADEPOWER INTERNATIONAL PTY. LTD.

45 Glenvale Cres., Mulgrave, Victoria. 3170 Telephone: (03) 560 9111

SEND TO: Tradepower International Pty. Ltd.,  
 45 Glenvale Cres., Mulgrave, VIC. 3170

Please send . . . . AudioSource RTA-ONE Real-Time Spectrum Analyzer complete with PNG-ONE Pink-Noise Generator, AC Adapter & Carry Case at special intro. price to:

MR/MRS/MS

ADDRESS

Postcode

Enclosed is Chq/Money Order for \$  
 or charge my Credit Card:-

BANKCARD VISA MASTERCARD

No.

Signed

Exp. Date

\*Price includes Posting & Packing.

Allow 14 days for delivery.

Fixing the VHF/UHF

# BROADCAST BUNGLE

After twenty years of controversy, the moguls of Canberra have finally admitted they made a mistake in allocating frequencies for radio and TV broadcasting. For the next twenty years we will be putting it right.

Jon Fairall

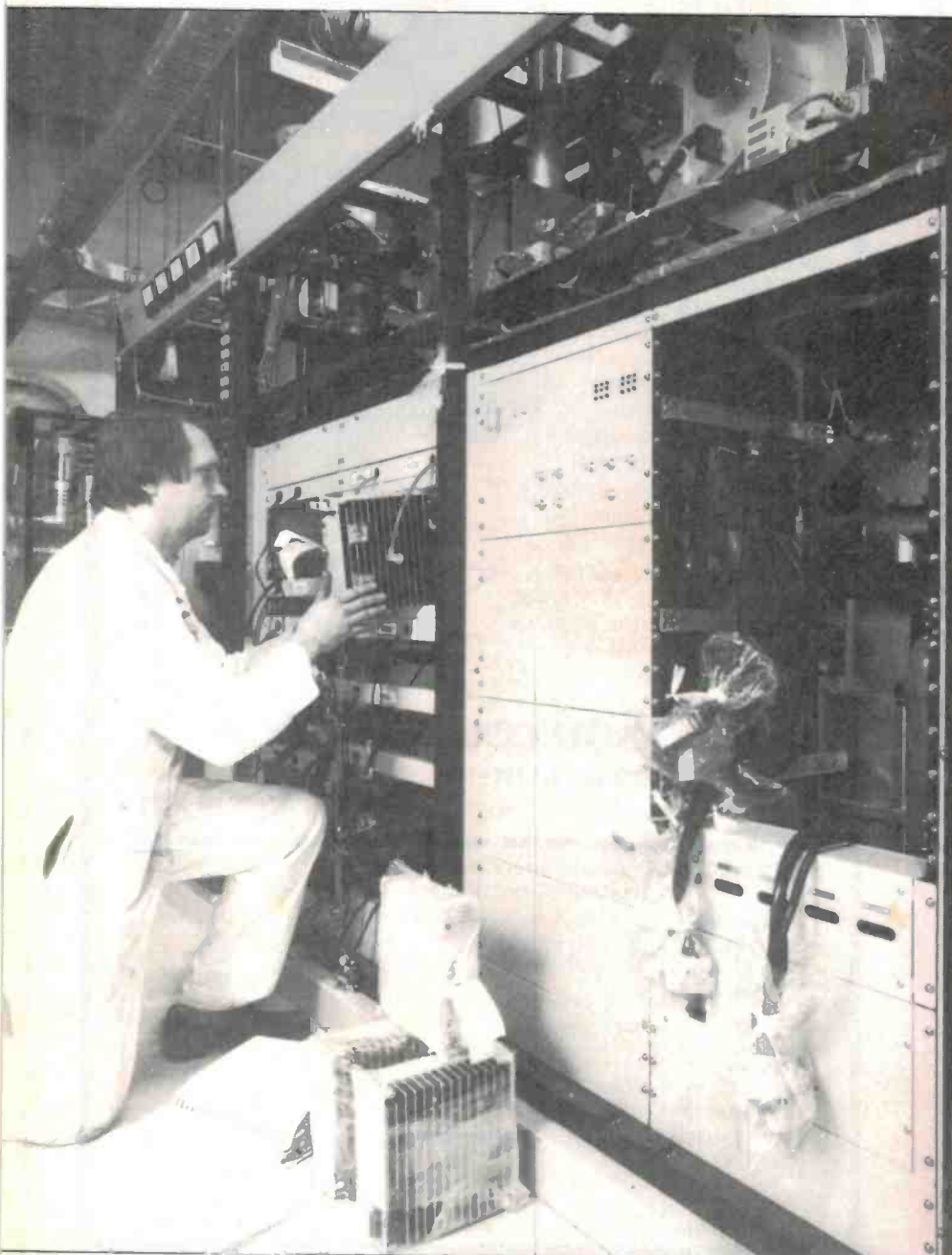

MAJOR CHANGES are planned in the allocation of frequencies to the broadcast services in Australia. An entire band currently used for TV is to be converted to radio use, and the Department of Communications (DOC) has advised that the future of TV broadcasting is to be centred firmly on UHF frequencies.

The reasons for the changes are rooted in the history of broadcasting in this country. Back in the late 50s and early 60s the government of R. J. Menzies ordained that the Band 2 TV frequencies, i.e: channels 3, 4 and 5, should sit across the region of the spectrum internationally reserved for FM radio. It was a contentious decision then, and has remained so ever since.

To be fair, the decision was not a stupid one, given the expectations and technology of the time. For a start, current wisdom was that Australia would never need FM radio. In 1962 the ABC ran an experimental FM transmitter and decided that there was no possible justification for its introduction. It worked all right, but it offered little that AM did not, and it used up a lot more bandwidth.

Equally important was the dismal performance of UHF television at that time. UHF TV began life in the USA during the 1950s. There was general agreement among industry pundits that it was worse than VHF TV on almost every count: the capital cost of installing the transmission equipment was higher, it was less reliable, receivers were less sensitive and consumers were reluctant to buy a second antenna for UHF working.

Engineers in Australia were almost unanimous that the most fruitful policy was to maximize the number of VHF channels assigned for TV and to leave UHF to various non-public broadcast services.

## Advances

However, in the twenty years since these decisions were made, the technology of broadcasting has changed out of sight. Both radio and television now require spectrum space far in excess of that envisaged in 1960.

Technical innovation has seen FM stereo become the big star of the radio world. FM was where the big push into stereo, high-fidelity, noise-free radio occurred. Fortunately, the big metropolitan centres have no TV channels in the VHF radio bands, so city



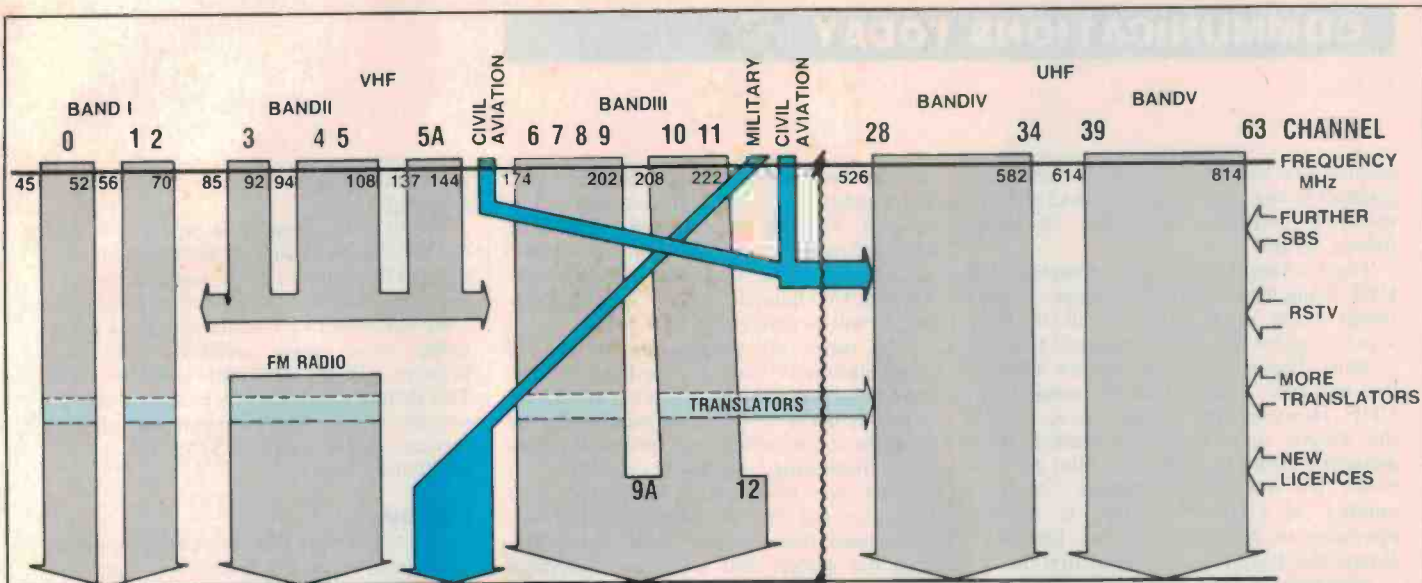

**Frequencies versus time.** This diagram gives you an idea of the pressures for change that occur (or will occur) as time progresses (time increasing down the page). TV channels 3, 4, 5 and 5A will vacate Band II, leaving it for FM radio and permitting military communications to move into the space vacated by 5A. Civil aviation will move to UHF. Channel 10 will move up 1 MHz and channel 9A will be 'inserted' between channels 9 and 10. All TV translators will move to UHF. Capital city channel 0 transmissions (currently assigned to the SBS) will move completely to channel 28 UHF, except for low power regionals.

Australians have been able to take advantage of this technology, but the smaller centres have not been so lucky. Many of them find they have space for only a very few FM broadcasters because of competition from TV channels.

### Demands

Even in the big cities, the FM band is becoming more and more crowded as diverse groups decide to jump on the bandwagon. The problem is not just that the population of Australia has grown during the last twenty years, but also that it has diversified tremendously. More than ever, different age, ethnic, social and cultural groups demand some share of the spectrum. A stop-gap measure, recently begun in Sydney, has been the licensing of very low-power stations on closely aligned frequencies. While this is probably a wise move politically, since it satisfies some of the demands of the special interest groups, technically it leaves a lot to be desired. Certainly the standard of reception is nothing like it should be.

Departmental spokesmen are hesitant to quantify the demand for new FM channels. According to Vic Jones, who is heading the DOC task force on frequency re-allocation, the number of applications for licences is not a good indication of the number of groups who would like broadcasting licences. People have heard how difficult it is to get a licence and as a result do not even bother to apply for one.

Against this background the ABC is trying to set up its second national FM network. There is also considerable pressure on the DOC to expand its supplementary licence scheme, which will allow all radio broadcasters a second licence.

The problems are equally great in the parts of the spectrum used for TV. Just how

bad it is in country areas is illustrated by the situation in Canberra.

Canberra at present has two TV broadcasters, the ABC and the local commercial channel. It's a common arrangement in the larger regional centres. Superficially, it might appear that there is plenty of spectrum space available on the VHF without recourse to any dramatic changes. But within a radius of a few hundred kilometres of Canberra every available channel is being used.

Channel 0 is used at Goulburn and Cooma, Channel 1 at Albury and Channel 2 at Wagga. Channel 3 is one of the Canberra stations. Channels 4, 5 and 5A cannot be used without interfering with existing radio transmitters. Channel 7 is the other Canberra transmitter, so neither of the adjacent channels (6 or 8) can be used. Channel 10 is used by a translator and likewise prevents use of either 9 or 11.

Incidentally, current DOC policy is that adjacent channels may not be used in close geographic proximity to each other because of interference problems. This does not apply to channel 9 and 10 because there is actually a gap of about 6 MHz or so between them.

### Overload

But if the present situation has resulted in pressure on the spectrum, technologies just around the corner are threatening to overload it. Of particular relevance to country areas is the domestic satellite, which will fly next year. This will make it possible to network TV signals into the remotest corners of the continent. Since the satellite will not be able to broadcast direct to consumers' homes, it will have to be received by a ground station, and then retransmitted for final reception.

Plans at the moment only allow the ABC

to use the satellite. Current broadcasting philosophy is that the big city networks will be severely limited in their excursions into the outback, in order to protect local operators. But the existence of the means to transmit nationwide will no doubt put pressure on succeeding governments to do something about the woeful coverage in the bush.

It is also possible to find 'holes' of poor or non-existent coverage in the cities. The answer to such problems is a translator, which receives and re-broadcasts the signal. But a translator requires its own transmission channel. If one cannot be found then people have to forego improved transmission.

### Yet more

Another problem waiting in the wings is RSTV, or radiated subscription TV, more commonly known as pay TV. Although there is no official policy yet on RSTV, various groups within the country have been looking at its application to Australia. There appears to be a general consensus that the only economically viable way for it to work in Australia would be as a national network. Experience overseas, notably in the US, has been that a very large population is needed to make it economically viable. Not even the big Australian cities have sufficient people to make it pay. If that is so, then the logical way to implement it seems to be via the satellite with local redistribution.

For all these reasons the decision has been taken to clear TV out of Band 2, and to extend the use of UHF broadcasting. After its premature introduction in the US, the technology came to maturity in Europe, using solid state techniques that lifted performance and reliability to acceptable levels. The Europeans also placed a lot of

## COMMUNICATIONS TODAY

emphasis on high gain, outdoor antennas, in contrast to the Americans who had tried to minimise consumer resistance by using indoor aeriars.

These changes led to the advantages of UHF being maximised. For instance, other things being equal, UHF tends to have superior ghost rejection compared to VHF systems. This is due to the capture angle of the antenna, which is much smaller on UHF. However, the penalty to be paid is that greater signal levels are needed. With modern transmitters this is neither an economic nor a technical obstacle. A small number of UHF translators is already operating in Australia, and the European experience has been confirmed first hand.

Although the DOC will not hand down its report until later in the year, the general outline of its recommendations is already clear. With Band 2 free it will be possible to increase the number of supplementary licences given to radio broadcasters for stereo broadcasting in FM.

### Yet to come

Current main TV broadcasting stations will continue to operate on the VHF. If they are currently using channels 3, 4, 5 or 5A they will have their frequencies moved to one of the unoccupied channels. Since this

will not be possible with the existing channel structure two new VHF channels will be created: 9A and 12. Channel 9A will be inserted into the gap between Channels 9 and 10, which is currently 6 MHz wide. Since a TV channel requires 7 MHz, channel 10 will be moved up by 1 MHz.

This move will require the removal of some other non-broadcast services. The frequencies assigned to channels 9A and 12 are currently being used by civil aviation for the location of navigation aids: specifically, Distance Measuring Equipment or DME.

DME was originally developed in Australia for use at this frequency, but was redesigned overseas for UHF operation. This has meant that overseas equipment being used in this country has had to be modified to allow for the frequency difference and also that aircraft travelling internationally have needed equipment that can handle both frequencies. Current plans are for the Department of Civil Aviation to bring themselves into line with international practice and move DME up to the accepted international frequencies. Although there will be major capital costs associated with this it will be cheaper in the long run since the costs of equipping aircraft will go down.

Military equipment also uses both these channels. However, the military has agreed

to vacate them in return for access to Channel 5A.

When this is done, it is expected that all the stations with current licences will have one VHF frequency. In some areas it is expected that translators that currently use VHF will have to be moved into the UHF to make more space available. All new licences will be applicable only to UHF. This includes translator licences for existing operators, all future expansion of SBS services (ethnic TV), RSTV and satellite redistribution.

### Policy

Current policy is that the changes will be introduced very gradually over the next twenty years to minimise the dislocation caused. In fact, this time delay will probably be of more benefit to broadcasters than to consumers. Just about all TVs and VCRs on the market today are capable of UHF reception so the only expense the consumer will incur will be the cost of a new aerial.

New licences will, of course, buy UHF equipment from the start, so the only people who will have to completely replace their gear are those who currently run VHF translators. A small price to pay, you might think, for more and better use of the electromagnetic spectrum. ●

# Master the Microprocessor

Learn how Microprocessors really work ... the practical way.

### The Purpose of this Course

There is a considerable, expanding and world-wide demand for people with a real knowledge of microprocessors and general computer technology. Such people are needed to design and evaluate systems and to assess and develop the enormous range of possible applications, both present and future, of microprocessors and to understand the installation and servicing of the main types of equipment of which they may form the most vital component.

(A microcomputer has already been produced to replace the mechanical programmer on a domestic washing machine, for example.)

This Course provides the necessary basic information to enable a student to really understand the functioning of microprocessors and their supporting circuitry,

usually referred to as the "hardware". This is backed up by showing how to program a microcomputer (or produce its "software") in the most fundamental form of computer language called "machine code". No previous knowledge of computers is necessary, though a little basic knowledge of electronics plus digital and logic circuits will be found helpful.

A special introductory short course is available to provide this back-ground information, if required by an individual student on the course without extra fee.

### Student—Tutor Contact

A qualified Tutor is available to every Student throughout this Course in order to deal with any queries which may arise and to assess certain questionnaires which are issued to Students throughout the period of training.

### Certificate

Issued to all Students completing the Course successfully. Course covers main requirements of the City and Guilds Certificates in Computers.

## Practical Self Study Course

### FREE COLOUR BROCHURE

Post coupon now: The Australian School of Electronics Pty Ltd, P.O. Box 108, Glen Iris, Victoria, 3146. Offices at: 219 Balaclava Rd., Caulfield North.

Please send your brochure without any obligation to:

Name .....

Address .....

Postcode .....



### How the Course is organised

The basis for the practical work in the Course is the Microcomputer. This is supplied completely assembled and ready to use. The Course text is carefully arranged in sequence so that each new section follows logically from previous work. Hardware description and programming technique progress together, so that the Student is discouraged from treating them as distinctly separate subjects. Following each section of descriptive text, detailed instructions are given in order to use the Microcomputer to provide a practical demonstration of each new function or technique. This provides a very powerful way of learning precisely how the system operates, and enables any possible ambiguities in the Student's mind to be quickly resolved.

FOR NEXT DAY JETSERVICE DELIVERY

BANKCARD HOLDERS—PHONE ALTRONICS TOLL FREE 008 • 999 • 007

# ALTRONICS 1985 SUMMER SALE



FOR NEXT DAY JETSERVICE DELIVERY

Dear Electronics Enthusiasts,  
 Over the last 3 years we have grown enormously — Warehouse now triple in size, Mail Order/Phone Order Department Sales up several hundred percent.  
 All this has been made possible by the enthusiastic support of countless 1,000's of Altronic Customers throughout every Australian State and (incredibly) many more in New Zealand, PNG, Fiji, Singapore even Pakistan!  
 As a very special thank you I've decided to run this Sale—as you look through these pages you'll notice dozens of incredible bargains, many 1/2 price, but **don't let our low prices put you off** — All items are genuine Altronic quality products and our famous 14 day money back satisfaction guarantee applies. Like all Sales the offers are valid whilst current stocks last. As I expect many items to sell out quickly, I urge you to phone your order right now. Remember our Toll Free Line (costs you a local call fee only) Phone—008 999 007 or if this is continually engaged 09 3281599  
 Our deep appreciation once again to all of you for your loyal support over the years.

JACK O'DONNELL and STAFF

*Jack O'Donnell*

## Incredible Price Savings Many Items 1/2 Price

Superb full 60 Key Computer Keyboard as used with Microbee Computer Brand New

"MICROBEE KEYBOARD"



ONLY \$19.50  
 D1510  
 \$29.95

**BICYCLE COMPUTER** INCREDIBLE 12 FUNCTION CAT D 2050 **WHY PAY \$90 NOW \$49**  
 The brilliant BIKOMP COMPUTER that is all the rage in USA is now available in Australia. For a few dollars more than a digital speedo this superbly accurate computer provides every actively readout the enthusiast cyclist is ever likely to require.



- ★ Instantaneous Average & Peak Speed Readouts
- ★ Measures Calories Used per Trip
- ★ Measures Distance
- ★ Clock Stopwatch and journey time (whilst Mobile)
- ★ Miles or Kilometres
- ★ Pacer Tone and Performance Monitor
- ★ Dual Display
- ★ Easy Removal for Security
- ★ Fits to Bike in minutes



**DAINICHI WIDE RANGE 25 Watt**  
 200mm (8"). This superbly smooth high power speaker comes from Dainichi, one of Japan's finest speaker manufacturers (they produce OEM Speakers for Pioneer). Max. input power 25W 8 OHM Z. Resonant for 60Hz.  
 C 2001 \$22.50

**\$15 \$12 ea.**

**VHS 3 hr. New Altronics Import**  
 We've tested the lot **Well how does ME stack up? — in a word superb**  
 Forget all about paying a premium for BASF or TDK — Altronics positively guarantee our new **ME Metallic** is equal to the very best — and that goes for mechanical construction as well as picture quality!

1 - 9 10 - 19 20 +  
**\$10 \$9 \$8**

**IMPORT SCOOP**  
 Quality Commonwealth Computer Fan 80MM - 240V



CAT F 1020  
**\$12**  
 4 or More  
**\$11**  
 Amazing Value

- ★ Super quiet
- ★ Sealed sleeve bearings for long life
- ★ Sturdy die cast frame
- ★ Operating range — 10 deg C to + 70 C

HIGH OUTPUT HIGH RESOLUTION  
 SUPER HIGH GRADE

**E-180<sup>ULTER</sup>HG**  
 SUPER METALLIC

**Don't Forget Altronics Famous Overnight Jetservice Delivery**

**Phone Order Right Now for Delivery to your Door Tomorrow ★**

★ Capital Cities and Suburbs—allow 24-48 hours additional for Country Centres.

BANKCARD HOLDERS—PHONE ALTRONICS TOLL FREE 008 • 999 • 007

FOR NEXT DAY JETSERVICE DELIVERY



**Runs forever without Batteries!**  
**Solar Powered Desk Calculator**

This superb Calculator could easily pay for itself during a lifetime without buying a single battery. Our exciting new all Solar Desk Calculator was not due for release until Feb 1985, but, with a little pleading with the maker, here it is just in time for Xmas. \* Runs equally well under office or home lighting as well as sunlight \* All standard calculator functions including memory function etc. A fantastic gift idea for Mum or Dad.  
Cat No. X 1060 ..... ~~\$19.95~~

Why not treat yourself? Now Just **\$15**

**Get Movie Theatre Stereo Sound from your Video Recorder**

Connect your VHS or Beta Video to your home Stereo System via. this superb Stereo Simulator



WHY PAY \$295?  
Our Price **\$99**

**Altronic Video Sound Processor Cat No A 9916**

Lets face it, the mono sound you get from your typical VCR is dull, colourless and boring. This is a crying shame, as these days, movie makers invariably add outstanding stereo sound and sound effects to the movies they produce. Next time you visit a modern movie theatre you will see (hear!) what we mean. Now a quite phenomenal enhancement to your VCR audio quality and impact realism can be achieved by feeding the Video sound O/P through your home HiFi system via. EA's simply brilliant VCR Sound Processor. Not only does it give simulated stereo but the inbuilt 5 stage graphic equaliser provides tonal depth for added realism and listening enjoyment.

Got an hour or two of spare time? Why not build the Kit Version.

- K 5820 only **\$55.00**
- K 5821 Opt. Whistle Filter **\$19.95**

**PRECISION ELECTRONIC FET MULTIMETER FOR LABORATORY OR WORKSHOP**

\* 10 Meg. Ohm input \* 12 Amp DC and AC Current Ranges \* Centre Zero Pointer Adjust for + and - readings LED indicator \* Transistor Tester inbuilt \* P—P calibrated scale.

Brilliant FET Volt/Ohm Meter includes Centre Zero needle setting — allows + and - readings. Meter Scale fully calibrated for + and - readings.

- DC VOLTS**  
Ranges  
0-0.3, 1.2, 12, 30, 120, 300, 1200V  
0- + 0.15, 0.6, 6, 15, 60, 150, 600V  
at Centre 0.
- AC VOLTS**  
Ranges  
RMS 0-3, 12, 30, 120, 300, 1200V  
Peak-peak, 0-8.4, 33, 84, 330, 840, 3300
- DC CURRENT**  
Ranges  
0-0.1 uA 0.3, 3, 30, 300mA, 12A  
Potential Drop  
300mV
- AC CURRENT**  
Ranges  
0-12A
- DC RESISTANCE**  
Ranges  
Rx1 0-1K ohm (Centre 10)  
Rx10 0-10K ohm (Ctr. 100 ohm)  
Rx100 0-100K ohm (Ctr. 1K ohm)  
Rx10K 0-10M ohm (C. 100K ohm)  
Rx1M 0-1000M ohm (C. 10M ohm)

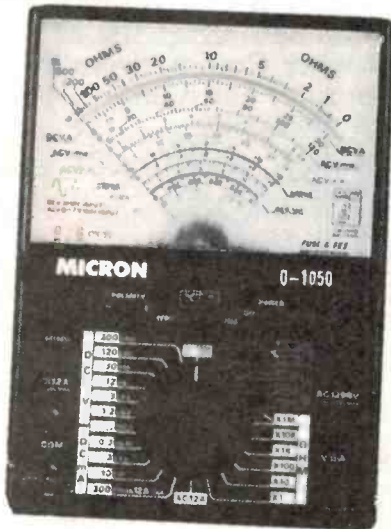

Q 1050 be quick **\$49**

**14 day Money Back Satisfaction Guarantee**

**Amazing Low Cost Smoke/Fire Detector**

Never again need you or your children risk death or injury thru house fire.

This Incredible low cost ceiling mount detector senses particles of combustion (smoke) at earliest stages of fire eg. smouldering \* Deafening Alarm \* Attractive ceiling Mounting type \* Dead easy to fit—you only need a screw driver \* Low cost 9V battery lasts approx. 1 year.

Don't let the low price fool you, this is a Brilliantly designed dual chamber ionization detector.

A 0090  
**\$14.99**

Were ~~\$59.95~~  
Scoop Purchase



**FAMOUS VOYAGER CAR COMPUTER**

Cat.No D 1000

Monitor your fuel economy as you drive in MPG & or Metric. Better than a \$700 plus unit optional in new cars. Many other features. All fitting hardware included.



WAS \$199

Now **\$125**

MADE IN ENGLAND! — QUALITY!  
FEATURES: • Instant fuel consumption in litres/100km and MPG (most others have only one of the above) just switch from one to the other as you drive along. • Instant speed, time and other fuel data. • visual and audible excess speed alarm.

**Just In! Home Telephone Extension Cords and Adaptors**

Now you can have your Telephone in the backyard or just on the other side of the lounge room with these nifty telephone leads. Double Adaptor allow two phones into the one line. Ideal for cordless phones etc.

- P 0990 5 Metre extn lead **\$14.95**
- P 0992 10 Metre extn lead **\$17.50**
- P 0994 20 Metre extn lead **\$24.95**
- P 0995 Phone Dble Adpt. **\$12.50**



Double Adaptor

Highly Recommended **Video Tape Repair Kit**



At Last!

A VHS/BETA Video Tape Repair Kit. No need to throw out your damaged tapes—this nifty splicing kit can save you a fortune (if you've got small children this kit will save you several fortunes!!)

All accessories included for joining tape and refixing leader ends etc.

A 9315 Fantastic Value **\$7.95**

**At Last! Head Cleaners That Really Do A 100% Job**



Our exciting range of head cleaners are the best we've seen and more importantly they are gentle on your heads. Why risk damaging your video or audio cassette player with inferior units.

**Audio Cassette**

Type A 9200  
Were \$5.95 Now **\$3.95**

**Beta Video**

Type A 9300  
Were \$17.50 Now **\$9**

**VHS Video**

Type A 9310  
Were \$17.50 Now **\$9**

BANKCARD HOLDERS—PHONE ALTRONICS TOLL FREE 008 • 999 • 007

FOR NEXT DAY JETSERVICE DELIVERY

BANKCARD HOLDERS—PHONE ALTRONICS TOLL FREE 008 • 999 • 007 FOR NEXT DAY JETSERVICE DELIVERY

FOR NEXT DAY JETSERVICE DELIVERY PHONE ALTRONICS TOLL FREE 008 • 999 • 007 BANKCARD HOLDERS

**DE-SOLDER BRAID**



T1230 ..... \$1

**HEATSINK COMPOUND**

Heat conducting paste facilitates heat transfer from semi to Heatsink. One tube good for up to 30 TO3 package semiconductors.



- H 1600...7.5g Pack..... **\$1.20**  
New trade pack
- H 1610...150g Pack..... **\$7.50**  
SAVE UP TO 33%

**SUPER TYPE GLUE**

New patented easy flow Dispenser and carry tube dispenses only when tube body is depressed—ensures no leaks. Many times the number of bonds over conventional tubes.

Sticks in seconds—1000' of uses



T 3010  
~~\$2.95~~  
**\$2**

**PROFESSIONAL QUALITY SOLDER SUCKERS**

Not to be compared with inferior Hobby types. Saves countless hours in fault finding and repair of complex PCB's.

- SINGLE HANDED OPERATION
- SELF CLEANING PLUNGER
- LONG LIFE TEFLON TIP
- DOUBLE DIAPHRAGM.
- DUAL O-RING SEAL
- 225mm x 20mm(d)
- 50mm STROKE
- POWERFUL SUCTION



**NOW \$7.50**  
T1240. only ~~\$11.95~~  
T1241. Replac tip. **\$1.95**

**Professional Nicad Rechargeable Batteries**

From **\$1.69**



- S 5020 "AA" Penlight 1.95 10+ ea 1.69
- S 5022 "C" Size 4.95 10+ ea 3.99
- 1.65 AH

**VINYL BINDER**

Holds 12 magazines, each on a spring out wire rod. Just the shot for each year's set of Electronics Australia, ETI or any of your favourite magazine.

Suits all A4 size publications (275 x 210). Very smart Royal Blue colour with beautiful gold embossing.

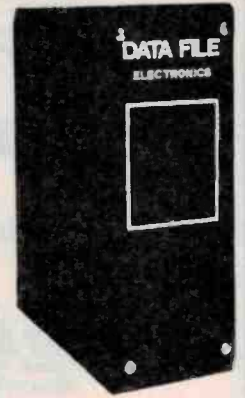

B 9999..... \$5.50  
**THIS MONTH \$5.00**  
4 or more \$4.50 ea.

**PROFESSIONAL AUTOMATIC WIRE STRIPPER**

Automatically adjusts to insulation / wire diameter. This absolutely brilliant stripper is the finest we've ever used.



T 1520  
~~\$9.50~~  
**\$5**

**All quality Altronics Imports — Not "Hobbyist" Seconds**



**LOOK Hardware Prices from less than 1 cent per piece**

**DIL SWITCHES**

GOLD PLATE SELF WIPING CONTACTS



From 80¢  
**Near 1/2 Price**

	ea.	25 Up
S 3050 4 way	90¢	80¢
S 3060 8 way	1.25	1.00
S 3065 10 way	1.50	1.35

**ULTRASONIC TRANSDUCERS**



D=16mm H=12mm

Ultrasonic transmitter and receiver transducers operating at 40KHz + or - 1KHz. Perfect for security applications etc. i.e. alarm sensors, counting sensors, remote control sensors and many other uses.

Sensitivity S 5115 TX 106db S 5110 RX 65db  
Dispersion angle 20 deg. Max Input voltage 20V  
RMS Impedance S 5115 500 Ohms S 110 30K Ohm. Operating range up to 9M.

S 5110 Receiver **\$4.95** 10 up **\$4.50**  
S 5115 Trans **\$4.95** 10 up **\$4.50**

**RUBBER FEET**

Packs 100

- H 0913 STD 13mm \$6
- H 0942 Stickon 12mm \$8
- H 0952 Stickon 20mm \$9



**Rubber Grommets**

- Chassis Hole 9.5mm
- Cable Size 5-7mm
- H 1450.... **60¢**

**Nylon Cable Clamps**

Cat. No.	Pack	Size	Price
H 1480	6	6mm	.55
H 1481	100	6mm	5.00
H 1485	6	9mm	.60
H 1486	100	9mm	6.00



**Nickel Plated Brass Spacers**

Packs 100

**TAPPED 4BA**

- H 1380 Length 9mm **\$8**
- H 1384 Length 12mm **\$10**
- H 1388 Length 25mm **\$15**



**UNTAPPED 4BA or 1/8" Clearance**

- H 1359 Length 6mm **\$7**
- H 1365 Length 9mm **\$8**
- H 1374 Length 12mm **\$9**
- H 1376 Length 25mm **\$12**



**FERRIC CHLORIDE BEADS 200g**

200 gram pack makes 1 litre — a powerful fast etching solution.

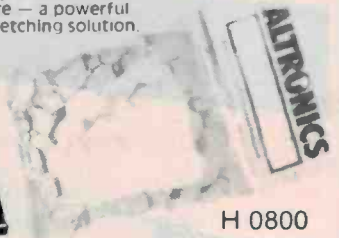

H 0800  
**NOW \$1.50**

**Cordgrip Clamps**

Packs 100

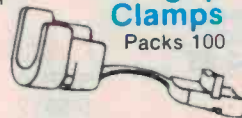

- H 1476 Cables to 9mm **\$9**
- H 1471 Cables to 6.3mm **\$8**

**Quality Plated Screws at less than Wholesale Prices**

Whitworth — Steel Nuts and bolts (Roundhead) Zinc Plated

	Length	Pack Qty	Price
H 1002	9mm	500	\$4.50
H 1007	12mm	500	\$4.50
H 1011	25mm	500	\$6.00
H 1022	Hex Nut	500	\$5.00
H 1032	S/Proof Washer	500	\$6.00

**BA Bolts Cheesehead Steel Nuts Brass**

H 1050	4BA/12mm	25	50¢
H 1060	6BA/12mm	25	50¢
H 1070	Nuts 4BA	25	90¢
H 1080	Nuts 6BA	25	90¢

# PRICE SENSATION

## Wire and Cable Sellout!!!

All Supplied on Sturdy Reels—Not those tanglesome Rolls!!

**Pro Grade Hook Up Wire**  
All on 100M Reels

**Light Duty**  
Tinned  
13/.012  
**\$5**

**Buy Eight Reels  
For Only  
\$30**

W 0250 Red W 0251 Black  
W 0252 Brown W 0253 Orange  
W 0254 Yellow W 0255 Green W 0256  
Blue W 0257 White

**Medium Duty**  
Tinned  
14/.20  
**\$8**

**Buy Four Reels  
For Only  
\$28**

W 0260 Red W 0261 Black  
W 0268 White W 0265 Blue

**Heavy Duty**  
24/.20  
**\$10**

**Buy Four Reels  
For Only  
\$30**

W 0270 Red W 0272 Black  
W 0274 Green W 0276 Brown  
W 0278 Blue

**Extra H/Duty**  
32/.20  
**\$15**

**Buy Two Reels  
For Only  
\$25**

W 0280 Brown W 0282 Blue

### SHIELDED AUDIO CABLES

Supplied on 100m reels (not Hanks). Eminently Suitable for microphone cables, chassis wiring, building wiring.

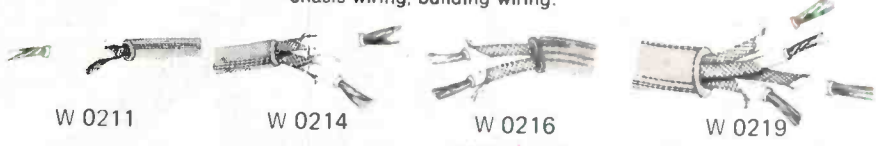

**SINGLE CORE  
\$18**

**TWIN CORE  
\$29**

**TWIN CORE  
Fig "8"  
\$29**

**4 CORE  
\$49**

### TV Feeder 300 Ohm

W 0220 Flat Ribbon **\$15**

### COAXIAL

W 0222 TV 75 Ohm STD **\$25**  
W 0224 TV 75 Ohm Low Loss **\$35**  
W 0226 RG 58 AU 52 Ohm **\$29**

### FIGURE "8" CABLE

For Speaker Wiring, Security Systems, PA Systems, Low Voltage Wiring etc. All include polarity trace.

W 0200 2X 14/.14 100m **\$6**      W 0201 2X 14/.19 100M **\$8**  
W 0204 2X 19/.193 Red Trace Band 200M **\$25**      W 0205 2X 19/.193 Black Trace Band 200M **\$25**  
W 0208 2X 24/.20 Red/Black 200m **\$30**

**FROM \$6**

**Phone your Order Toll Free  
On 008 999 007**

### IDC COMPUTER CABLE



	Per Metre	Per 10 Metres
W 0610 10 wire	.99	.89
W 0616 16 wire	1.59	1.39
W 0626 26 wire	2.59	2.29
W 0634 34 wire	2.99	2.69
W 0650 50 wire	5.99	4.99

### PHOTOGRAPHIC XENON TUBE



Great For Strobe Light Projects  
S 4050 ~~\$2.95~~  
**Now \$2.00**

### VELOSTAT



Non-Static sheeting for storing CMOS IC's, LSI's etc. 1000 times better than aluminium foil. Will store up to 150 IC's on one 225 x 150mm sheet.

H 0500 ..... ~~\$3.50~~ ..... **\$2.00**

### 2N3055'S SLASHED



**PRIME SPEC S.G.S.**  
1 - 9    10 - 24    25 - 99    100+  
**95¢   90¢   80¢   70¢**

### FUZES 3AG



1 - 9		10 - 99		100 plus		Mixed 500	
S 5940	100MA	S 5950	1A	S 5960	7.5A		
S 5942	150MA	S 5952	1.5A	S 5962	10A		
S 5944	250MA	S 5954	2A	S 5964	15A		
S 5946	500MA	S 5956	3A	S 5966	20A		
S 5948	800MA	S 5958	5A	S 5968	25A		
				S 5970	30A		

### FUSES M205

20 x 5mm		1 - 9		10 - 99		100 plus		Mixed 500	
S 5910	250MA								
S 5912	500MA								
S 5914	1A								
S 5916	2A								
S 5918	5A								

### MINI PCB RELAYS

Low Profile 14H x 20W x 12D

12V DC Bobbin  
1 AMP Contact Rating  
S 4060 SPDT **\$2.00**  
Now **\$1.80 10+ \$1.50**  
S 4061 DPDT **\$2.50**  
Now **\$2.00 10+ \$1.70**

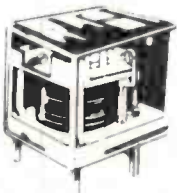
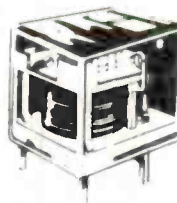

### MINI PCB RELAY H/D

Low Profile 15mm (H)

12V DC Bobbin 3 AMP Contact Rating  
S 4066 SPDT **\$2.75**  
10 Up **\$2.25**



"Save up to 60% on these prices"

### HEAVY DUTY RELAY

S 4074 ~~\$9.95~~

**Now \$7.00**



12V coil 10 AMP DPDT contacts OEM Quality. Heavy Duty Relay. Ideal for power supply and control circuit switch. Socket allows easy chassis mounting and quick cable connection to screw terminals.

### SCREW TERMINAL OCTAL SOCKET TO SUIT

S 4075 **\$3.95** 10 up **\$3.50**

BANKCARD HOLDERS—PHONE ALTRONICS TOLL FREE 008 • 999 • 007 FOR NEXT DAY JETSERVICE DELIVERY

BANKCARD HOLDERS—PHONE ALTRONICS TOLL FREE 008 • 999 • 007 FOR NEXT DAY JETSERVICE DELIVERY

FOR NEXT DAY JETSERVICE DELIVERY

BANKCARD HOLDERS—PHONE ALTRONICS TOLL FREE 008 • 999 • 007

FOR NEXT DAY JETSERVICE DELIVERY

BANKCARD HOLDERS—PHONE ALTRONICS TOLL FREE 008 • 999 • 007

### COMPONENT JOYSTICKS

Standard type (non-centering)

- Resistance 100K ohm
- Lever movement 60°
- Metallic knob
- For TV games, RC units
- Life 300,000 cycles

K 9680  
~~\$4.95~~



### Self Centering Type

Resistance 5K ohm suit ETI project for microbee Proportional Analogue Joystick Dec 1983

K 9689 ~~\$17.50~~ NOW \$7.50

### Micro Switch Bargains 250V 3A

Single Pole c/over Contacts



### Push Button Type

S 3255 \$2.00  
10 Up \$1.70



S 3250 \$1.25  
10 Up 95¢

### MINI TOGGLE SWITCHES

OEM QUALITY 250V 2 AMP RATED  
6mm mounting hole  
12mm x 12.7mm x 20mm (D)



SAVE 30%

ea. 10 Up  
S 1010 SPDT \$1.00 .90  
S 1025 SPDT Centre off 1.10 .90  
S 1020 DPDT 1.10 .99  
S 1030 DPDT Centre off 1.50 1.20

### STANDARD TOGGLE

Sturdy Reliable 125V/3 AMP Rating



S 1040 SPST \$1.00  
10 up .90  
S 1050 DPDT 1.30  
10 up 1.10

### HEAVY DUTY TOGGLE DPDT CENTRE OFF

125V/10A (250V AC/5A)  
Ideal for car antenna switch, automotive and marine electrical use.



S 1055 \$1.95

### SEALED PCB MOUNT ROTARY SWITCHES

Why Pay Over \$3?

1 - 9 \$2.00  
10-24 \$1.80  
25-99 \$1.60  
100 + \$1.40



"LorIn Style"

A real plus feature is the ability to set the number of stops to suit your own distinct requirements, e.g. A 1 pole 9 position is easily implemented using our S 3021

S 3021 1 Pole  
Configure from 1 pole 2 position through to 1 pole 12 position

S 3022 2 Pole  
From 2 pole 2 position to 2 pole 6 position

S 3025 3 Pole  
From 3 pole 2 position to 3 pole 4 position

S 3024 4 Pole  
From 4 pole 2 position to 4 pole 3 position

Remember Altronics deliver Next Day via JetService Courier to all Capital Cities and suburbs—Country Areas please allow extra 24-48 hours.

### Insulation Displacement Connectors

PCB Male Headers with Lock Levers

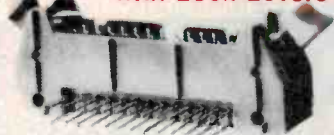

	Were	Now	10 Up
<b>90 Degree Type</b>			
P 0926 26 pin	3.95	2.50	2.00
P 0926 34 pin	4.95	3.20	2.95
P 0932 50 pin	6.50	3.90	3.40
<b>Straight Type</b>			
P 0939 26 pin	3.95	2.50	2.00
P 0941 34 pin	4.95	3.20	2.95
P 0945 50 pin	6.50	3.90	3.40

### Cable Mounting Socket (Female)

	WERE	NOW	10 UP
P 0952 26 pin	3.95	2.50	2.00
P 0954 34 pin	5.90	3.90	3.40
P 0958 50 pin	6.90	4.00	3.50

### IDC DIL PLUG HEADERS

	Were	Now
P 0917 14 pin	1.50	1.10
P 0918 16 pin	1.80	1.50
P 0920 24 pin	2.50	2.10
P 0921 40 pin	3.50	2.95

Amazing Value

EASY TO INSTALL • BUILT IN SIREN DRIVER—DIRECTLY DRIVES LOW COST 8 OHM HORN SPEAKERS, SIREN HORNS AND MECHANICAL BELLS • LOW POWER 12V DC OPERATION.



S5042  
Only \$39.50 **Now \$32.50**

### ALARM CONTROL MODULE

The AC-811 is a low cost professional burglary protection system which detects the presence of an intruder who breaks into your home, office or business. The system also allows connection of emergency panic buttons, wall vibration switches, smoke and heat sensors, as well as freezing or flooding detectors to form a complete protection system.

EXIT/ENTRY DELAY BOTH N/C AND N/O CONTACTS  
**Ideal for homes, offices, factories, shops, caravans, any area requiring protection.**

### MINI BUZZER 1.5-5V DC SENSATIONAL LOW PRICE



Handy little solid-state audio "Buzzer" or signalling device. Just the shot for communicator panels, or for timer alarms or in the car. Polarity conscious.

S5062 \$1.95 Now \$1

### 16 WAY PARTS DRAWER SET



See through acrylic parts drawer. Slide-in ident. card fronted drawers. Ident. cards supplied. **VALUE PLUS!**

H 0440 ..... \$17.50. Now \$15.00

### WEATHERPROOF SIREN HORN

12V DC operated — Deafening Siren wail. Super handy for audio signalling, security systems etc. Current drain 500MA approx. Completely weatherproof. Attractive off-white PVC finish.



S 5058 .. \$19.50 **NOW \$15.00 ea. STRENGTH!**

### PIEZO ALARMS

Similar to "Sonalert" type. Absolutely ear piercing sound. Recommended voltage 5-15V DC. Ideal for almost all audio signalling applications. i.e. fire, water and gas signalling, computer alarms, etc.



S 5066 \$4.95 Now \$3.50

**Dual Function Type**  
Pulsed or Continuous output  
S 5070 \$5.95 Now \$4.50

BANKCARD HOLDERS — PHONE ALTRONICS TOLL FREE 008 • 999 • 007 FOR NEXT DAY JETSERVICE DELIVERY

# EGAD!!

**Popular D Range Computer Connectors all 1/2 Price**

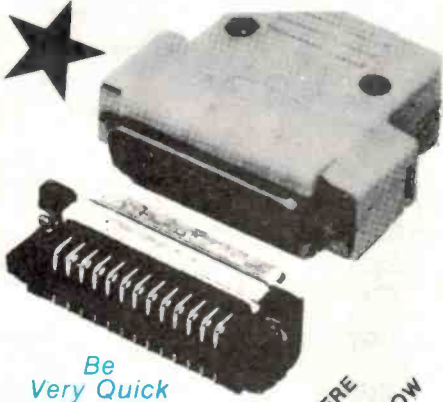

Be Very Quick This Month Only

	WERE	NOW
P 0880 DB 9 Male 9 Pin	2.50	1.25
P 0881 DB 9 Female 9 Pin	2.95	1.50
P 0882 DB 9 Male PCB Mnt	3.25	1.60
P 0883 DB 9 Female PCB Mnt	3.95	2.00
P 0885 DB 9 Backshell Cvr	1.80	.90
P 0890 DB15 Male 15 Pin	2.95	1.50
P 0891 DB15 Female 15 Pin	3.50	1.75
P 0892 DB15 Male PCB Mnt	3.95	2.00
P 0893 DB15 Female PCB Mnt	4.95	2.50
P 0895 DB15 Backshell Cvr	2.00	1.00
P 0900 DB25 Male 25 Pin	4.50	2.25
P 0901 DB25 Female 25 Pin	4.95	2.50
P 0902 DB25 Male PCB Mnt	4.50	2.25
P 0903 DB25 Female PCB Mnt	5.50	2.75
P 0905 DB25 Backshell Cvr	2.00	1.00

Stock Up Now and Save a Bundle



**SPEAKER 8 OHM**  
**2 1/4 INCH**

From 69¢

C 0610

1 - 9	10 - 99	100 up
<b>\$1</b>	<b>90¢</b>	<b>69¢</b>

## ECONOMY RACK CABINET

- \* Solid steel construction
- \* Black anodised front panel
- \* 3 unit (132mm)
- \* Conforms to International Standards
- \* Ventilated top and side panels

H 0400 ONLY

\$45.00

\$40

## LEDS

	ea	10 Up
Z 0140 Led 3mm Red	.14	.10
Z 0141 Led 3mm Green	.20	.18
Z 0143 Led 3mm Yellow	.22	.20
Z 0150 Led 5mm Red	.14	.10
Z 0151 Led 5mm Green	.20	.18
Z 0152 Led 5mm Yellow	.22	.20
Z 0154 Led 5mm Orange	.25	.22
Z 0159 Led 5mm Flashing FRL4403	.49	.45
Z 0160 Led Rectangular Red	.22	.19
Z 0162 Led Rectangular Green	.25	.22
Z 0164 Led Rectangular Yellow	.25	.22
Z 1072 Led Infra Red CQY89A	.55	.52

## DIODES SLASHED

MASSIVE SAVINGS

Z 0101 1N914/1N4148 Diode	.05	.04	.03
Z 0105 1N4002 100V 1 Amp	.06	.05	.04
Z 0109 1N4004 400V 1 Amp	.07	.06	.05
Z 0112 1N4007 1000 1 Amp	.08	.07	.06
Z 0115 1N5404 400V 3 Amp	.15	.12	.11
Z 0118 1N5408 1000V 3 Amp	.16	.13	.12
Z 0120 R250 A 400V 6 Amp	.60	.50	.45

## Technician's Multimeters 10K Ohm/Volt



Robust Meter Movement

NOW JUST HALF PRICE

Q 1015  
**\$9.90**

### Limited Stocks at This Price

DC Volts	5 ranges	.25 to	1000V
AC Volts	4 ranges	10 to	1000V
DC Current	3 ranges	100 MA	to 5A
Resistance	3 ranges	100 Ohm to 10K	centre scale

Positively 1st Class For the Field Tech or Bench Enthusiast

## Purchasing from Altronics Resellers

Please note that dealers have additional costs such as freight etc. and in most cases dealer prices will be somewhat higher than offered here. Dealer prices will, however, represent a considerable saving on our competitors prices

# ALTRONICS

105 STIRLING ST. PERTH — FOR 1. INSTANT SERVICE

**008 999 007** TOLL FREE  
**(09) 328 1599** PERTH METRO AREA & AFTER HOURS RECORDED SERVICE  
All Mail Orders: Box 8280 Stirling St Perth WA 6000

### PACKING AND DELIVERY CHARGES

**\$3.00 Delivery Australia Wide** - we process your order the day received and dispatch via Australia Post. Allow approx 7 days from day you post order to when you receive goods. Weight limited 10kgs

**\$5.00 Overnight Jetservice** - We process your order the day received and dispatch via overnight Jetservice Courier for delivery next day. Country areas please allow additional 24-48 hours. Weight limit 3kgs

**\$10.00 Heavy Heavy Service** - All orders of 10kgs or more must travel express Road - Please allow 7 days for delivery

**Insurance** - As with virtually every other Australian supplier, we send goods at consignees risk. Should you require comprehensive insurance cover against loss or damage please add 1% to order value (minimum charge \$11) when phone ordering please request Insurance

**Toll Free Phone Order** - Bankcard Holders can phone order toll free up to 6pm Eastern Standard Time. Remember with our Overnight Jetservice we deliver next day.

<b>WA</b> <b>COUNTRY ALBANY</b> BP Electronics 41 2681 <b>ESPERANCE</b> Esperance Communications 71 3344 <b>GERALDTON</b> K & B Electronics & Marine 21 2176 <b>KALGOORLIE</b> Tonday Electronics 21 2777 <b>MANDURAH</b> Kenronics 35 3227 <b>WYALKATCHEM</b> O & J Pease 81 1132	<b>ACT</b> <b>CITY</b> Electronic Components 80 4654 Scientronics 54 8334 Australis 47 5172 <b>VICTORIA</b> <b>CITY</b> Active Electronics 602 3499 All Electronic Components 662 3506 MacGraths Electronics 347 1122 <b>SUBURBAN BENTLEIGH</b> Absolute Electronics 557 3971 <b>DARWIN</b> Ventronics 81 3491 <b>ALICE SPRINGS</b> Abcom Electronics 52 1713 Farmer Electronics 52 2967	<b>SOUTH CROYDEN</b> Truicott Electronics 723 3860 <b>COUNTRY BENDIGO</b> K C Johnson 41 1411 <b>MILDURA</b> Electronic and Digital Services 23 3380 <b>MOREWELL</b> Morewell Electronics 34 6133 <b>SHEPPARTON</b> GV Electronics 21 8866	<b>QUEENSLAND</b> <b>CITY</b> Deikound P/L 2296155 <b>SUBURBAN FORTITUDE VALLEY</b> McGraths Electronics 832 3944 St Lucia Electronics 523547 <b>SALISBURY</b> Colourview Wholesale 2753188 <b>SLACKS CREEK</b> David Hall Electronics 2088808 <b>TOWONG</b> EQC Technics 3710879	<b>COUNTRY CAIRNS</b> Thompson Instrument Services 512404 <b>BUNDABERG</b> PM Electronics 728 272 <b>GLADSTONE</b> Purley Electronics 724321 <b>NAMBOUR</b> Nambour Electronics 411604 <b>PALM BEACH</b> The Electronic Centre 341248 <b>ROCKHAMPTON</b> Puls Electronics 21058 <b>TOWOOMBA</b> Hunts Electronics 329677 <b>TOWNSVILLE</b> Jaycar 722015	<b>COUNTRY MT. GAMBIER</b> South East Electronics 250 034 <b>PT. LINCOLN</b> West Coast Elect Supplies 824 346 <b>TASMANIA</b> <b>CITY</b> D & I Agencies 34 7877 <b>GEORGE HARVEY</b> Hobart 34 2233 Launceston 31 6533 <b>NSW</b> <b>CITY</b> David Reid Electronics 267 1385 Jaycar 264 6686 Radio Dispatch 211 0191 <b>SUBURBAN CARLINGFORD</b> Jaycar 745 3077 <b>DE WYBY</b> David Hall Electronics 982 7500 <b>HURSTVILLE</b> Jaycar 570 7000 <b>LEWISHAM</b> Prepac Electronics 569 9770 <b>MATTRAVILLE</b> Creative Electronics 666 4000 <b>COUNTRY ALBURY</b> Webb's Electronics 25 4066	<b>BATHURST</b> The Electronics Shop 31 4421 <b>BROKEN HILL</b> Crystal TV 4803 <b>COFFS HARBOUR</b> Coffs Harbour Electronics 52 5684 <b>GOSFORD</b> Tomorrows Electronics 29 7246 <b>KURRI KURRI</b> Sun Electronics 37 2141 <b>NEWCASTLE</b> D G E Systems 69 1625 George Brown & Company 69 6399 <b>NOWRA</b> Vimup Electronics 21 4011 <b>ORANGE</b> Sun Electronics 626 491 <b>PENRITH</b> Acorn Electronics 21 2409 <b>PORT MACQUARIE</b> Hall of Electronics 83 7440 <b>RAYMOND TERRACE</b> Atack Electronics 87 3419 <b>RICHMOND</b> Vector Electronics 78 4277 <b>TAMWORTH</b> Landing Communications 65 4622 <b>TOUKLEY</b> TES Electronics 96 4144 <b>WINDANG</b> MAGS Electronics 96 5066 <b>WINDSOR</b> M & E Electronics Communications 77 9535
------------------------------------------------------------------------------------------------------------------------------------------------------------------------------------------------------------------------------------------------------------------------------------------------------------------------	------------------------------------------------------------------------------------------------------------------------------------------------------------------------------------------------------------------------------------------------------------------------------------------------------------------------------------------------------------------------------------------------------------------------------------------	-----------------------------------------------------------------------------------------------------------------------------------------------------------------------------------------------------------------------------------------------------------------------	--------------------------------------------------------------------------------------------------------------------------------------------------------------------------------------------------------------------------------------------------------------------------------------------------------------------	-------------------------------------------------------------------------------------------------------------------------------------------------------------------------------------------------------------------------------------------------------------------------------------------------------------------------------------------------------------------------------------------------------	----------------------------------------------------------------------------------------------------------------------------------------------------------------------------------------------------------------------------------------------------------------------------------------------------------------------------------------------------------------------------------------------------------------------------------------------------------------------------------------------------------------------------------------------------------------------------------------------------------------------------------------------------------------------------------	----------------------------------------------------------------------------------------------------------------------------------------------------------------------------------------------------------------------------------------------------------------------------------------------------------------------------------------------------------------------------------------------------------------------------------------------------------------------------------------------------------------------------------------------------------------------------------------------------------------------------------------------------------------------------------------------------------------------------------------------------------------------------------------------------------------------------------------------------------------

Altronics Resellers wanted in all States of Australia (inc WA) Phone Steve Wroblewski 09 3817233 for Details. OEM's for bulk rates Ph 09 3817233 for super competitive rates

BANKCARD HOLDERS — PHONE ALTRONICS TOLL FREE 008 • 999 • 007 FOR NEXT DAY JETSERVICE DELIVERY



# SANYO and ETI Betamovie Home Video Contest Results

Our August issue contest certainly stirred up a lot of interest. The contest questions were fairly simple, all contestants had to do was find out a little about the Betamovie system and the Beta tape mechanism. Funny though, over half of you who entered didn't do your homework thoroughly! Tsk, tsk. Our contests aren't *that* hard. Question 1, on what is unique about the Betamovie system, could simply be answered if you were aware of the Betamovie promotion that commenced before we launched the contest. The Betamovie system uses a standard video cassette in the camera which, after recording, can be transferred direct to a VCR for instant replay. Question 2 was designed to make you seek out the information, from articles, or a dealer, etc. Inventive entrants 'phoned Sanyo's service department! The Betamovie system uses U-loading to take the tape from the cassette and wrap it around the head drum. Actually, these days, the system is more correctly called omega-loading, but we were looking for the better-known answer. Only a couple of entrants put down the omega-loading answer.

As for what you would do with the prize (in 50 words or less), well we were looking for well-expressed, imaginative answers and/or inventive applications. And plenty of you rose to the challenge. Some wanted to use the system to film expeditions to remote tropical islands, several radio amateurs wanted the system to pursue experiments with amateur TV transmissions, many of you wanted to record events around the home (the most popular application, by far). Just two contestants mentioned using the system in educating school children.

## AND THE WINNER IS:

Paul Buschenhofen  
of Jingili, in the Northern Territory.

## HERE'S PAUL'S WINNING APPLICATION:

"As a teacher I would use the Sanyo outfit for:  
recording plays written and acted out by students;  
recording productions of plays which students  
are studying;  
recording debates for later analysis;  
creative activities such as making advertisements; and  
recording picture sequences so that students can write  
stories for them."



## AND HERE ARE SELECTIONS OF OTHER CONTESTANTS' APPLICATIONS

"With this system I could document the traditional lifestyle of the Dyak tribes in the less accessible regions of Sarawak."

**P. Hassett, Butterworth Malaysia**

"I am a recognised cinema pioneer with 25 years' television broadcasting engineering experience of outside and studio cameras. I know an excellent camera when I see one. My family of six children want me to establish a tape library to which they can all contribute."

**F. Westaway, Mooroolbark Vic**

"Widen the educational experiences of the children I teach through the infinite uses of video recording/playback of events in the school day."

**R. J. Fluke, Eltham Vic**

"Fifty words is not enough to describe how I would like to record sword fighting tournaments in the medieval society, stunning masquerade costumes at the science fiction club, all the P76s rolling up for a car meeting, and . . . and . . ."

**R. Hryckiewicz, Richmond NSW**

"To record, review and reminisce our joys of today, tomorrow."

**D. J. Richards, Wollongong NSW**

"I work at a television station and have always been interested in television. I've always wanted to do some camera work in the way of experimentation. If the directors can do it, why can't I?"

**D. Clarke, Glen Waverley Vic**

"Have a look at the garbage available on tape these days: sex, violence and how-to shows! Who wants these when, with the Betamovie and Sanyo video recorder you can have your own home grown epics. When I have won this outfit my first epic will be 'The Phone Book'."

**P. J. Comey, Springvale Vic**

"I am a full-call licensed amateur radio operator who wants to extend into amateur television transmitting via our ATV repeater. If I owned a Betamovie outfit it would give me a perfect start to combine various activities and interests on tape to show other amateur enthusiasts."

**J. R. Gater, Belgrave Vic**

# LOW COST SWITCHERS

Here is a range of switching power supplies for the budget conscious user. They are designed especially for micro to medium computer system and use a series flyback design to provide multiple outputs.

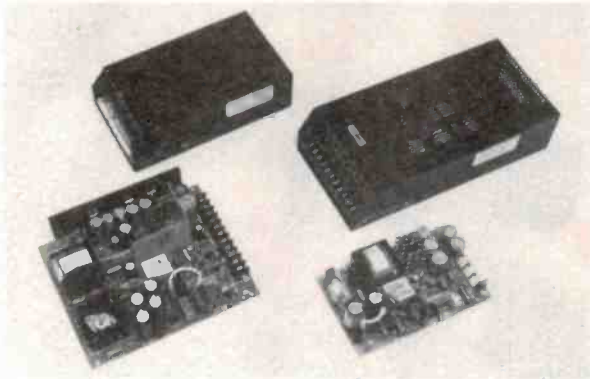

## FEATURES

- Single-ended flyback type switching power supplies.
- P.C. board, L-bracket & enclosed selectable constructions.
- Protection against failure short circuit & over power protection.
- Over voltage protection.
- Input surge current protection.
- 115/230 VAC input dual jumper selectable.
- UL recognised, VDE CSA safety design.
- Higher ambient temperature at least 24 hours burn-in.

## SPECIFICATIONS:

### INPUT:

Input Voltages..... 90V to 130V (115V Nominal), 180V to 260V (260V Nominal). Jumper Selectable.  
Input Frequency..... 47-440HZ

### CONSTRUCTION:

OPTION: Enclosed Frame: Aluminium Chassis and Safety Cover Open Frame: L-Shape Bracket or P.C. Board

### DIELECTRIC WITHSTAND:

2500VAC For 1 Minute Input/Output  
1500VAC For 1 Minute Input/Safety GND  
500VAC For 1 Minute Output/Safety GND  
0°C - 70°C (Operating).  
-20°C - 85°C (Storage).  
0.02%/°C on +5V  
0.05%/°C on Other Outputs

Ambient Temperature Range.....

70% (Typical)  
0°C - 50°C (Derated to 50% at 70°C)  
Convection  
16msec. Minimum at Full Load & Nominal Input Voltage.  
Output voltage returns in less than 1 millisecond max. Following a 50% load change.

Temperature Coefficient.....

Efficiency.....

Full Output Rating.....

Cooking.....

Hold-up Time.....

Transient Response.....

### OUTPUT:

Output Voltages..... See Rating Chart  
Output Current..... See Rating Chart  
Line Regulation..... 0.5% Maximum  $\pm$  10% Change)  
Load Regulation..... 0.5% Maximum on +5V, 5% Maximum on Other Outputs (At 50% to 100% of Rated Load).  
Cross Regulation..... 0.2% Maximum on +5V When Any Output Changed From 50% to 100% of Rated Load.  
5% Maximum on Other Outputs When +5V Output Changed From 50% to 100% of Rated Load.  
1% Maximum on Other Output When Any Other Output Excluding +5V is Changed From 50% to 100% of Rated Load.  
From 4.5V to OVP Trip Point on +5V  
Nominal Output Voltage  $\pm$ 5% on Other Outputs When +5V is Set at 5.00V  
Noise and Ripple..... Peak to Peak Typical 1%, Maximum 2%  
Minimum Load..... See Rating Chart  
Overvoltage Protection..... 6.2V  $\pm$ 0.4V on +5V  
Overcurrent Protection..... Maximum Current Cannot Be Drawn From All Outputs at The Same Time. The Overcurrent Protection Feature Will Reduce All Output Voltage to A safe Dissipation Level When the Average Power Rating Exceeds 125% Of Maximum Power. The Overload Feature Will Also Protect Against Short Circuit on Any Output.

## VOLTAGE/CURRENT RATING

MODEL	OUTPUT CURRENT						CONSTRUCTION AND SIZE (mm)	MAXIMUM POWER OUTPUT	PRICE
	+5V	-5V	+12V	-12V	+12V	+24V			
HSC30-21	3A		1.2A				PCB 100 x 160 x 34	30W	\$50
HSC40-20	3A		2.5A				PBC 100 x 160 x 50	40W	\$60
HSC40-31	2.5 A		2A	0.25A			PCB 100 x 160 x 50	40W	\$60
HSC55-41	6A	0.5A	2.5A	0.5A			ENCLOSED 113 x 204 x 59	55W	\$80
HSC75-32	3A			0.2A		2.2A	PCB 160 x 200 x 56	75W	\$95
HSC125-40	10 A		3.5A	0.5A	2.5A		ENCLOSED 127 x 267 x 66	125W	\$150

REMARK: Maximum current cannot be drawn from all outputs simultaneously, at no time should the average power (excluding transients) exceed the maximum continuous output power rating.

NOTE: Prices quoted do not include Sales Tax (20%) or freight. Delivery is ex-stock.

**AMTEX**  
ELECTRONICS

36 LISBON STREET  
FAIRFIELD, NSW 2165  
AUSTRALIA

TELEPHONE (02) 728-2121, 727-5444  
TELEX AA27922 ATTN AMTEX

A DIVISION OF **TELCON** AUSTRALIA PTY LIMITED  
(Incorporated in New South Wales)

**Now! \$1495\***

**One style: fully loaded  
One price: \$1495\*  
One source: Hewlett-Packard**

If putting a big dent in your instrumentation budget is not for you, the HP 3478A should prove ideal for your bench or system automatic measurements. For only \$1495\* you get a fully loaded six function DMM with HP-IB—not just a starter unit you have to pay later to upgrade.



**All the right features plus HP-IB.**

You can measure dc volts, RMS ac volts, dc current, RMS ac current, and 2- and 4-wire ohms. Plus, the HP 3478A is a fully programmable HP-IB system instrument. You have the convenience of switchable front/rear terminals, scanner advance, and external trigger input. You can even automate the HP 3478A's built-in electronic "no pots" calibration.

**Costs less to own.**

When it comes to reliability, the HP 3478A is one of the best. Our field-proven reliability figures indicate over 50,000 hr MTBF (equal to 25 operational years)\*\*. So intensive is our attention to quality, from design right through production, that once you install your HP 3478A chances are you won't have to repair it or worry about it for the life of your system.

**Call HP today.**

For full details on the cost-cutting reliability leader HP 3478A DMM, fill in the business reply paid card coupon opposite or ring your nearest HP office listed: Melbourne: 895 2895; Adelaide: 272 5911; Perth: 383 2188; Brisbane: 304133; Canberra: 804244; Sydney: 888 4444; Auckland: 68 7159. \*\* For 2,000-hour years, based on warranty data and other statistical projections. \* List price subject to change.

**System DMMs...HP's the right decision**



HP-IB: Not just IEEE-488, but the hardware, documentation and support that delivers the shortest path to a measurement system.



**HEWLETT  
PACKARD**

LBV 6675 HEP 90399



# THE SATELLITE TV SMORGASBORD

Considerable excitement is being generated by the launch in 1985 of the Australian domestic satellite. But it's not the first useful communications satellite to be used by Australians, and it won't be the last.

AT THE MOMENT there are about 650 000 Australians who receive no TV signal at all. Many of these have no radio except at night, and certainly no telephone. The reasons are quite simple — distance and money. There is too much of one and not enough of the other. One way around the problem is with a telecommunications satellite.

For the last few years politicians and people within the Department of Communica-

Jon Fairall

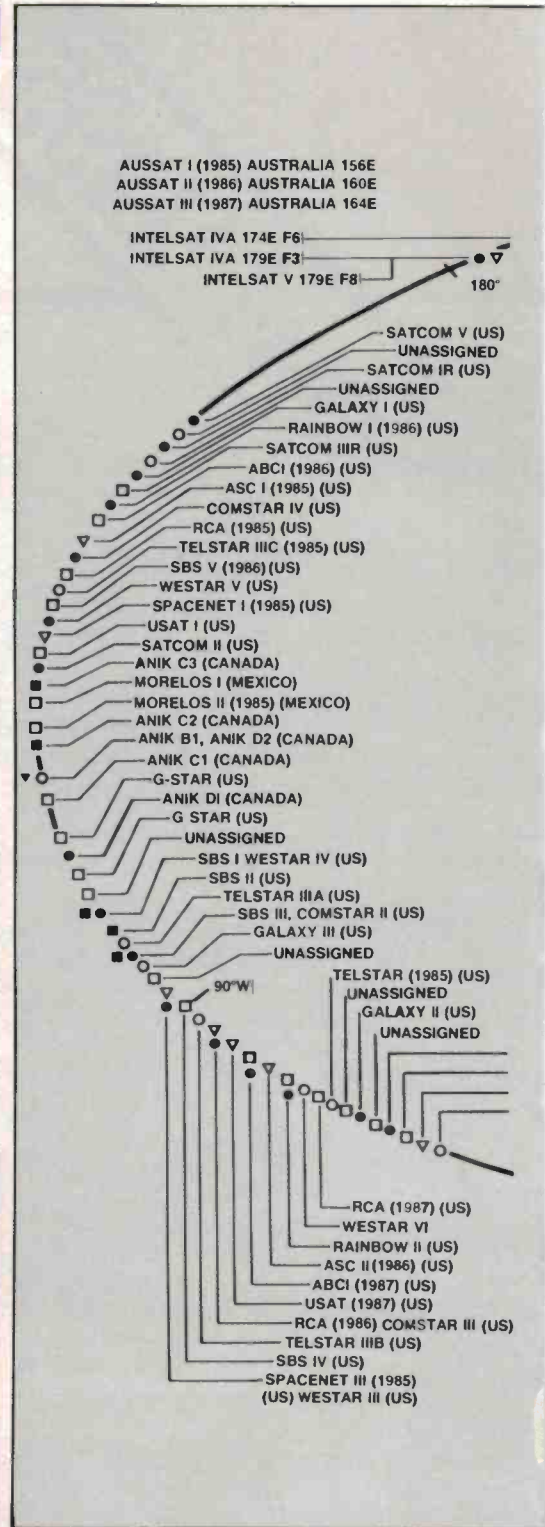
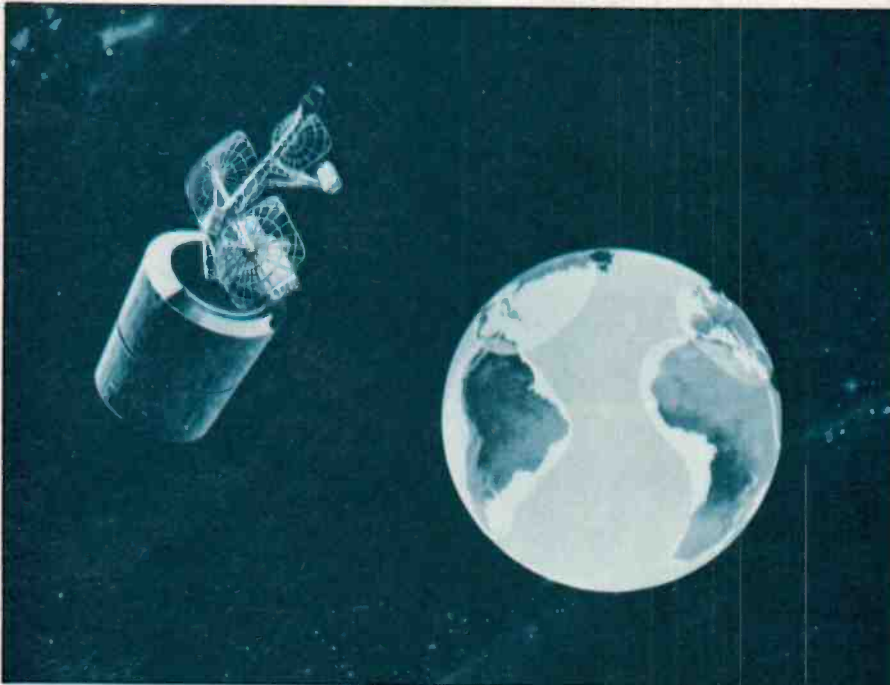

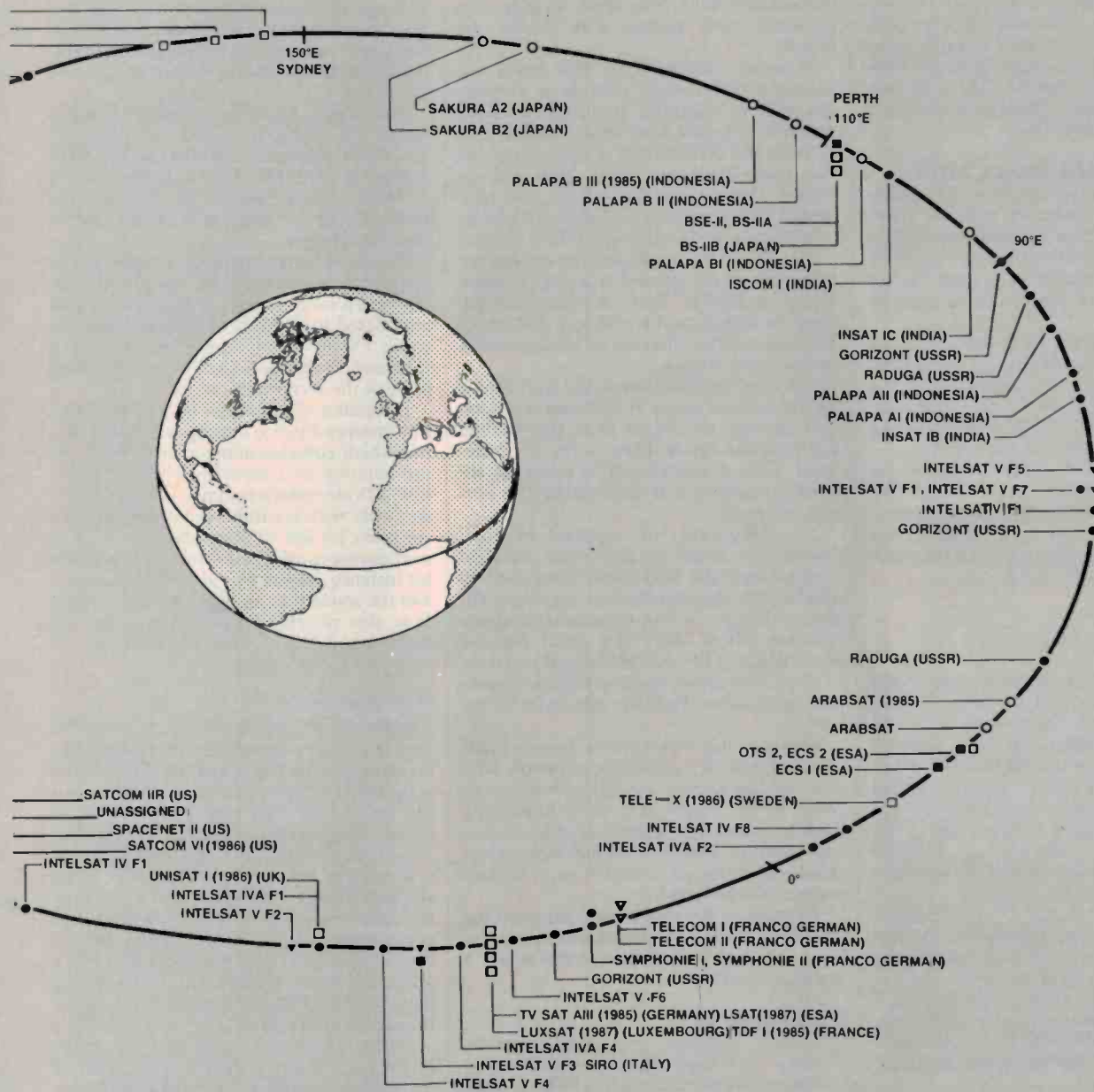

**The smorgasbord!** This diagram shows the names and positions of current and proposed satellites in synchronous orbit. As the table at right shows, some satellites use C-band (4/6 GHz), others use K-band (12/14 GHz), while some use both. Increased use is being made of K-band.

BAND	C	K	BOTH
EXISTING	●	■	▲
PROPOSED	○	□	△

INTELSATS ARE OWNED BY A HUNDRED NATION CONSORTIUM.

tions have been trying to work out the best way of solving the communications needs of the outback. The first step towards some sort of reality was the Remote Areas Telecommunications System (RATS). This uses the geosynchronous communications satellite known as Intelsat IVA.

## The geosynchronous orbit

Telecommunications satellites are essentially high flying repeater stations. They receive a signal from a ground station on one frequency and retransmit it on another. They move in an orbit of greater or less eccentricity around the centre of mass of the earth.

From our point of view there are two parameters of this orbit that are important. One is its radius, i.e. the distance from the centre of the earth out to the orbit. The other its inclination, i.e. the angle between the plane of the orbit and the equator.

Knowing the radius of the orbit, we can determine how long it will take the satellite to complete one orbit. If  $P$  is the orbital period in minutes and  $r$  the radius of the orbit measured from the centre of the earth (i.e. altitude plus 6375 km) then:

$$r = 6378 \left( \frac{P}{84.4} \right)^{\frac{2}{3}} - 6378$$

The lower limit of  $r$  is set by the top of the atmosphere, and is about 200 km above the surface of the earth. Because there is still appreciable atmosphere at this altitude, there tends to be quite a bit of friction and so the orbit decays rapidly and the satellite burns up very quickly. Increasing altitude results in longer lasting satellites and by the time altitudes of 1000 km are reached orbital decay is so slow it may be regarded as indeterminate.

The upper limit is set by gravitational instability, i.e. at some altitude the sun and the other planets will exert such a significant force on a satellite that no stable orbit is possible. Since the moon is in fact in a stable orbit, we can at least say that the maximum stable orbit must be longer than a lunar month and further away than the earth-moon distance.

Within this very large range there are a number of radial figures that are of interest. If, for instance, the orbital inclination is zero, we can use the equation above to solve  $r$  for a period of 23 hours 56 minutes (1436 min). This will yield a result of 35 814 km. Since any point on the Earth is also travelling around the earth at the same speed, such a satellite will appear stationary in the sky to an observer on the ground. This is the so-called geosynchronous orbit.

## RATS

Australia's first experience of geosynchronous communications satellites was Intelsat IVA, which hangs in space over the mid-Pacific island of Guam at 179°E longitude. This is by no means the only communications satellite visible from Australia. The

Indonesians have four aloft already, the Japanese have several and so do the Indians.

However Intelsat IVA has much the strongest signal when seen from virtually any point in Australia. It carries two ABC transmissions, one from Perth which is sent up from the OTC station at Carnarvon and one from Brisbane which goes up via Moree. There is also the Atlanta, Georgia-based US news network AFRTS. This latter is broadcast in the standard NTSC format.

The two ABC transmissions on Intelsat IVA plus all the ground reception stations constitute RATS. There are two principal ways the signal can be received. One is via Telecom and the other via an independently owned earth station.

Telecom has been associated with RATS for the last four years. A Telecom down station receives the signal from the satellite and demodulates it down to the TV baseband. Then it is remodulated up to the RF band 3 frequency and retransmitted for normal reception.

The equipment was supplied by NEC (Australia). Some 61 have been installed around Australia with power ratings of 10 and 100 W. They represent a very cost efficient solution to the telecommunications problem where there are small isolated communities with several hundred receivers in them. Places like Lightning Ridge, Birdsville and Coober Pedy are all served in this way.

However this still leaves a large market unaccounted for, consisting of people who live in really remote areas; one bush cocky living in his humpy two day's horse ride from his nearest neighbour does not represent much of a market for anything, never mind something as complex as a surface redistribution system.

The answer for such people has been the provision of individually owned Earth stations. For much of Australia this is not a technical problem.

## The Baby Q

A Sydney company, Acesat Ltd, run by Douglas and Olga Sawtell, distributes a complete system for around \$4500. It comprises a 3.5 m antenna from Hills (of Hills hoist fame). It is a metal impregnated fibreglass paraboloid that needs to be set up on concrete anchor pads and pointed correctly. Fine pointing is achieved by screw adjustments on the three legs of the stand plus alignment of the centre receiver. There is also adjustment for setting the elevation. A 5 m antenna can be purchased for marginal viewing areas.

The signal is brought to a focus at the feed horn where it is fed directly into a low noise amplifier. The LNA boosts the signal by 30 dB at a noise temperature of between 60 K and 90 K. The signal at this level however, is still in the order of micro volts, and so cannot withstand any attenuation. For this reason it is fed straight into the down converter before being applied to any

cabling, thus ensuring that the high frequency attenuation that plagues most copper based connection systems (coax for instance) does not have a chance to degrade the signal.

The signal from the satellite stretches across the spectrum from 3.7 to 4.2 GHz. The down converter puts this into the VHF region at 70 MHz with a bandwidth of 12 MHz. This signal is then fed into the Baby Q receiver where it is readied for its final distribution.

The Baby Q has a number of outputs. For conventional viewing there is a TV RF output which takes the composite video signal modulated to 70 MHz and feeds it directly to the TV set. This is then viewed on one of the band 11 channels (3, 4 or 5) depending on how the receiver is set up.

A number of other options are available. For instance there is a composite video output which contains unmodulated video for presentation to a monitor. There is also a filtered video which contains video information only with separate sound output. This can then be fed to a number of different configurations of display unit. It is possible for instance, to put the video into a monitor and the sound into an ordinary hi-fi system. It is also possible to put both video and audio into a VCR, which can then interact with it in the normal way.

## Performance

Exactly how well the system functions depends on a number of interrelated factors, particularly the size of the dish and the geographic position of the installation. All the communications satellites have directional transmission patterns. There is a small central area where signal strength is at a maximum known as the bore site. This strength decays with distance from the central point. So it is possible to define a series of concentric circles on the earth's surface where signal strength is acceptable for a given size of aerial known as the footprint. Obviously the bigger the antenna the bigger the radius of the circle.

With a standard 3.5 m dish it is possible to receive Intelsat IVA from just north of the latitude of Sydney. During demonstrations in Acesat's Sydney office, (in the southern suburb of Sutherland) the picture was badly degraded by noise, i.e. speckle. According to Acesat director Doug Sawtell, a comparable picture can be received with a 5 m dish in Melbourne. Moving northward improves things tremendously, and perfect studio-quality pictures are available in Brisbane with the 3.5 m dish.

Intelsat IVA is not the only satellite that can be received from mainland Australia. The footprint of the Indonesian PALPYRA satellites covers most of Northern Australia. Darwin, of course, lies within a few hundred kilometres of the Indonesian islands, so it is hardly surprising that they can obtain good reception. Apparently one of these satellites is devoted to English language movies in the evenings.

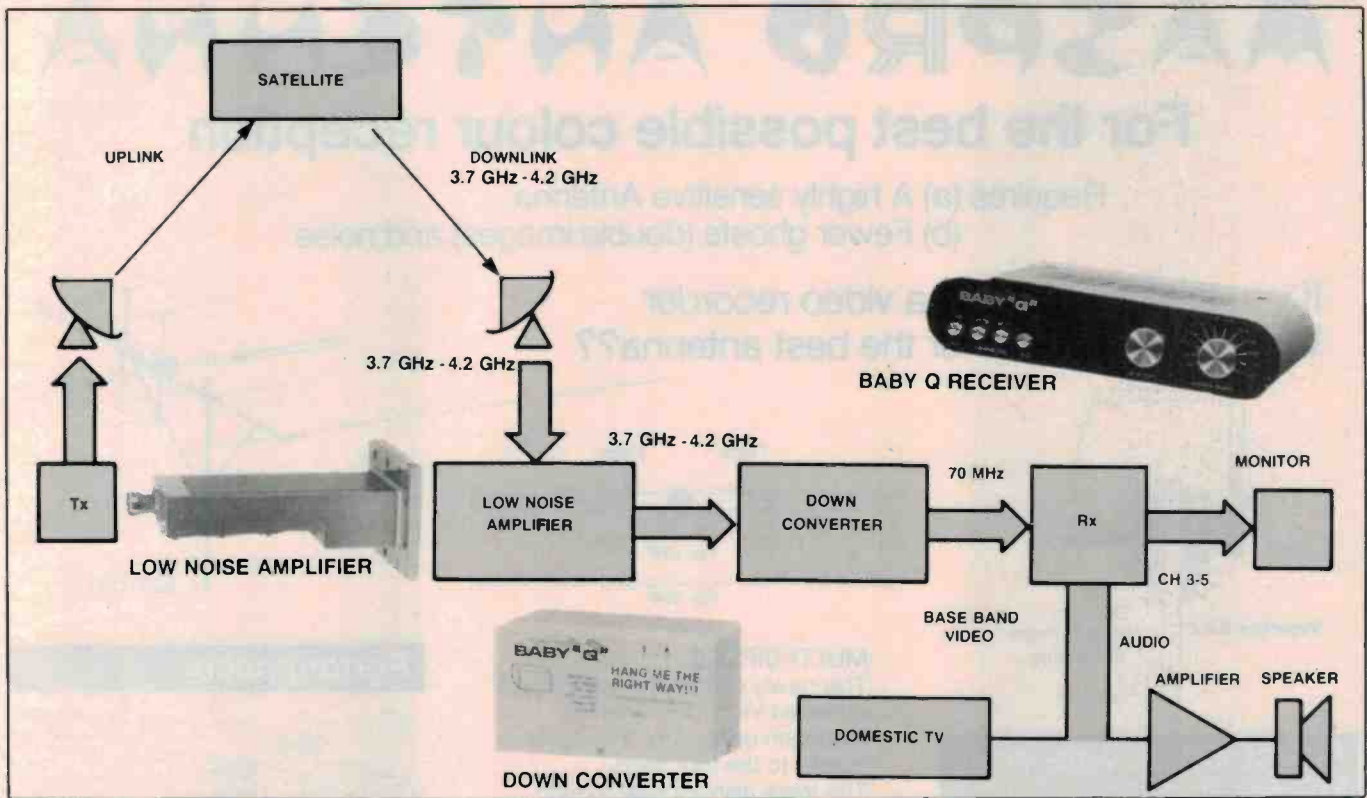

The bore site of the other satellites is far from Australia, in Japan or India, and so their signal strengths are very low. In theory there is no reason why their signals should not be received. However they would not be accessible with commercially available units like the Acesat system.

### Polar orbits

The geosynchronous orbit is not the only viable orbit for a communications satellite. If we increase the orbital inclination away from zero, then the satellite will begin to follow a sinusoidal course across the surface of the earth. The angle of inclination is the same as the latitude of its furthest northerly or southerly movement. When the inclination reaches 90 degrees the satellite is in a polar orbit, and it can then be overhead any point on the surface of the earth at some stage.

From the point of view of communications, the 'geosync' orbit has some very positive advantages. It is always in the same position in the sky, communications are continuous, and the antennae can be fixed parabolic dishes which need to be pointed only once. However there are a few disadvantages with the geosync orbit. One is that it is an awfully long way away, with all that implies in terms of antenna size, transmitter power and launch costs.

Useful polar orbits can be much closer, as any whole fraction of a 24 hour period can be used as the orbital period. If it was desired to have the satellite visible at the same time every evening, for instance, one could place it into a polar orbit 8177 km from the centre of the earth. That's only 1799 km above the surface. It would then complete five orbits of the earth every 24

hour period coming up due north or south every day at precisely the same time. The University of Surrey's UOSAT amateur radio satellites are in a very low polar orbit of this type and may be accessed by conventional Yagi type arrays.

As yet there has been little commercial interest in polar orbiting satellites for communications. But that situation may well change over the next few years, for at least one very practical reason: the geosynchronous orbit is getting full. There are literally hundreds of satellites occupying the orbit — many of course, with some dark military purpose. Those that are doing something useful are being squeezed into smaller and smaller slots.

Proponents of the polar orbits are dreaming of a whole constellation of polar orbiting satellites that could provide continuous communications over any given point in their orbit. Bill McFadden of Warsash, the Sydney based company representing Satellite International of the UK, believes the "low cost of building and launching satellites into low earth orbit, and the crowding problems in the geosynchronous orbit will make them very attractive in the future".

### Aussat

But if polar orbiting satellites are still a pie in the sky for some dreamers, the next step in the satellite story is very real, and very close to hand. Aussat will fly soon, and it will take over the functions of Intelsat IVA. According to recent statements by the Minister of Communications, Mr Michael Duffy, Aussat will carry the ABC and one commercial channel on each of the transponders, so the concept of local com-

munity stations that has guided government thinking on regional commercial stations for the last 20 years will be maintained.

The system will be called HACBSS (pronounced Hack-Bas) for Homestead and Community Broadcast System. The bad news about HACBSS is that it will use B-MAC (Multiplexed Analogue Complex). This is an advanced broadcasting standard developed in Britain by the Independent Broadcasting Authority and optimised for satellite transmission.

Unfortunately B-MAC is totally incompatible with the existing PAL transmission, so ordinary systems will not be able to receive it. Operators of the Baby Q and similar systems will find themselves looking at a blank screen. They won't even be able to adapt their system by fitting B-MAC converters since HACBSS will run at 12 GHz, as opposed to the 4 GHz Intelsat signal.

Exactly what will happen to Intelsat IVA is still a bit up in the air. The ABC is likely to keep the transponders operational for some time after Aussat flies, just as insurance against possible problems with the new system. In the long run though, Aussat will take over all its functions.

It might be that other countries will take an interest in using them. New Guinea is reported to be studying this option closely, as part of the development of their own television system. Other institutions in Australia are reported to be interested in the development of an RSTV service using Intelsat IVA.

Whatever happens satellite broadcasting is eventually coming of age in Australia. That is good news for people in the bush, and it has the potential to be good news for all Australians.

# MASPRO ANTENNA

## For the best possible colour reception

Requires (a) A highly sensitive Antenna  
(b) Fewer ghosts (double images) and noise

If you spend \$1200 on a video recorder  
Why not invest \$80 for the best antenna??

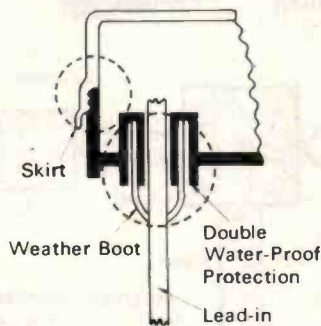

### Perfect dust and water-proof Matching Transformer Kit

- A screw-in type cover with a skirt on the matching transformer kit shuts out rain and dust completely. This design feature is **MASPRO**'s first in the world.
- Since the tap outlet for the lead-in is faced down and protected by a double water-proof protection, rain drops and dust are completely shut out.

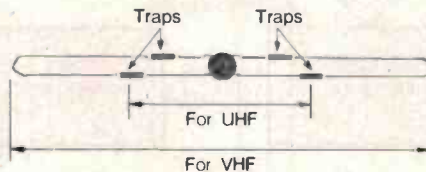

### MULTI-DIPOLE

This newly developed multi-dipole achieves VHF, UHF and FM reception using only one dipole, thanks to the four traps. The traps also exclude foreign interference such as CB's, being picked up by the antenna.

### FEEDER CONNECTION

The feeder balun is designed to accept both 300Ω ribbon or 75Ω co-axial cable.

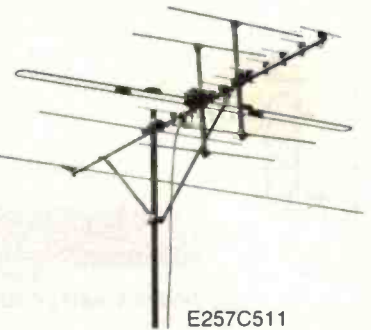

### Performance

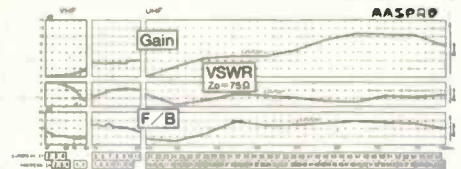

After extensive research and field testing, **MASPRO** have developed this unique antenna covering Ch 0-12 VHF and Ch 21-57 band IV & V on the UHF band.

## BES speakers



Bertagni Technology Professor José Bertagni, acoustic designer and engineer developed a polymer diaphragm using "state of the art" scientific principles to replace the myriad of cones, horns and enclosures of conventional speakers. He developed a loudspeaker that produced omnipolar dispersion with exceptional clarity, expanded dynamic range, lower distortion and greater power handling capacity than conventional speakers.

### The pulsating heart of the system

The heart of the BES System is the acoustic polymer diaphragm molded from a specially processed and patented material called Soniflex™.

### Low distortion

Bertagni Speakers need no enclosures, thus have no resonant frequency. They use no cones, thereby avoiding resonant peaks. They avoid phase distortion of multi-cone systems.

Built-in mechanical crossover eliminates complex crossovers required for conventional multi-driver systems.

### Dynamic range

Bertagni technology increases dynamic range by reducing the mass and number of moving parts, keeping losses to a minimum.

Power handling up to 250 watts RMS.

# Sonique

PTY. LTD.

112 James Street, Templestowe. Vic. Aust. 3106.

Phone: (03) 846 3022 Telex: AA33708.

Postal Address: P.O. Box 27, Bulleen. Vic. Aust. 3105



# Sony steals a march with the 'CD Walkman'

**S**ony managed to grab the headlines on the eve of the Tokyo All Japan Audio Fair with the announcement of a portable compact disc player that went on the market in Japan in November with a retail price of around \$250.

The player is battery operated and is only as wide and as deep as a CD disc. And it is about as thick as three CD discs stacked one on top of the other.

This player sits easily in the palm of your hand and can be taken to the beach and on picnics and used with headphones.

For home, a power adaptor is available so it can be used with a hi-fi system, and there is a 12 volt adaptor for using the new mini player in a car or camper.

For the home Sony has also done something quite unprecedented — it is using Bose speakers and a mini power amplifier also provided by Bose. The logo on the mini speakers (which incidentally are the Bose mini monitors), has "Bose for Sony".

For a Japanese company to give credit to a US company is quite staggering and is a credit to Sony that they don't suffer from the same closed minds as other main Japanese manufacturers.

Coupled with these Bose mini monitors and the Bose mini amplifier this unit is a very powerful system and will be popular with teenagers and enthusiasts wanting music in small rooms. However, this mini portable doesn't have the same high

specs as other home-based machines. But it is still far superior to cassette.

Although the player is mobile it doesn't really fit into the Walkman category yet. You wouldn't be able to jog with it. Excessive vibration makes the laser stop and start. So while it can be moved around, and should be able to work quite well in a moving vehicle, it won't take bumps too well.

In releasing this portable CD player Sony is demonstrating just how far ahead of the rest of the industry it is in miniaturisation of the CD technology. They have effectively jumped a development stage by going straight from home-base machines to a portable Walkman-type product.

I fully expected to see several manufacturers at this show demonstrating portable CD/radios in the format now popular in cassette radios. But there wasn't one, indicating that the rest of the manufacturers are a long way from miniaturisation of CD.

Sony and Pioneer announced that they had released CD car players into the Japanese market on October 21. They were both showing a lot of these machines



at the audio show. The rest of the manufacturers had the usual one prototype. So Sony has certainly stolen a lead on the rest of the manufacturers.

And I believe, although Pioneer wouldn't admit it, that Sony is supplying the new miniaturised chip, and servo system to Pioneer.

Both these companies now work closely together. They are rebels in Japan because they don't toe the Japan Club (or Japan Inc. as some people call it) line. This is a group of the major manufacturers who get together to make co-operative decisions.

Pioneer has been openly criti-

cised in the press in Japan for persevering with laser video disc, instead of abandoning it for the Japanese VHD system.

Sony also has had more than a few brick bats for its refusal to follow the Japanese edict. The company is run like a US company, hence the decision to do a deal with Bose.

Now Sony markets a laser video disc player made for them by Pioneer, and Pioneer markets a Beta hi-fi video machine made for them by Sony.

Pioneer's car CD player would also be a combined effort.

— Dennis Lingane

## Four-head stereo VTR

**H**itachi has released the HVT20E VTR. It features a built in stereo tuner for direct recording of stereo broadcasts. A switch on the panel allows this facility to be used as either a normal stereo receiver or a bilin-

gual receiver when this facility becomes available in Australia.

According to Hitachi, the four-head design means exceptional picture quality in the normal play mode, and allows them to institute a half-speed mode. This

mode will allow up to eight hours recording on one tape. It also allows stills, and various speed controls, like rapid picture search in both directions.

It also features a variety of timers. There is one that tells you how much time you have left to run on the current tape,

and another that lets you program up to five recording sessions over a fourteen-day period.

For more information contact Hitachi Sales, 153 Keys Rd, Moorabbin Vic 3189. (03)555-8722.



The difference between Philips Hi-Fi Stereo Video and a normal Low-Fi stereo VCR is something like watching a concert with only one eye and one ear open. You're missing out on half the action.

But slip a Hi-Fi video cassette of a favourite movie or concert into Philips Hi-Fi Stereo VCR, hook up your TV to your stereo speakers, and listen.

During the high notes your dog will sit up and howl. During the low notes the floor vibrations will curl your toes up. You'll hear sounds you've never heard before, effects that enhance the visuals with added realism. Because Philips Hi-Fi Stereo VCR represents the new dimension in home entertainment.

Not only will it out-perform most sophisticated sound systems, its slim-line compact design means you

can file it into your home entertainment rack.

You might even want to use it just for audio recordings. Where else can you record a 4 hour concert in Hi-Fi quality without running out of tape? Of course you can also record in stereo and mono as well as Hi-Fi. Alternatively you can play-back pre-recorded cassettes in Hi-Fi, stereo or mono. And Philips Hi-Fi Stereo VCR has more features than M.G.M. Typical of Philips, well thought out design is the Dockable Remote Control that's never further away than your finger tips.

Press the release button and the infra-red remote-control glides out from a concealed drawer. A clever idea that keeps your remote control where you can find it and safe from inquisitive little hands.

There's also many other labour-saving niceties.



We want you to have the best.

# Imagine a video you can file under audio.



Like automatic program location and repeat function, simple editing, automatic program search, 14 day/5 event timer recording, 3 video heads, still and frame advance, simulcast recording facility, Dolby\*B noise reduction on stereo, bi-lingual reception capability, and sound on sound facility.

If we haven't persuaded you already, here's an extra "arm-twister". As an introductory offer we're giving away a free video, in Hi-Fi, stereo of course, of either "The Empire Strikes Back" or "Star Wars". This is a limited offer until stocks run out.

Unfortunately superlatives can't do justice to Philips Hi-Fi Stereo VCR. So ask your Philips dealer for a demonstration. And discover what you've been missing out on.

Or write for a brochure: The Advertising Manager, Philips Consumer Products, 1092 Centre Road, Clayton, Vic. 3168.



**PHILIPS**

The recording of TV programmes is permissible where copyright or other rights of third parties are not infringed.  
\*Dolby is the registered trademark of Dolby Laboratories Inc.

PMPV 347

# Pick up the world's finest sound reproduction.

Delivering the world's finest and most accurate sound reproduction is no easy task.

Ortofon however, have made rather a reputation out of it.

As far back as the 1930's, they were involved in the design and production of cutterheads for the cutting of master records.

And in 1948, they developed and patented the world's first moving coil cartridges.

So with their dual experiences in record cutting and reproduction areas, it's hardly surprising that Ortofon have continually produced an enviable range of cartridges. And hardly surprising that they should now produce a cartridge design rated the best in the world for playback.

## The MC10 Super.

For a start, this moving coil cartridge allows the coils to adopt two positions. Which provides a finer and more exacting level of accuracy in the reproduction of signals.

And whilst the purchase of a moving coil has traditionally led to the additional cost of a transformer

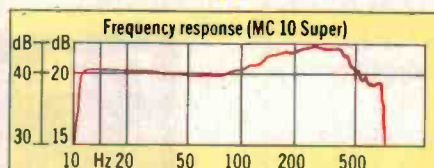

Technical data	MC 10 Super
Output voltage at 1000 Hz, 5 cm/sec.....	0.3 mV
Channel balance at 1000 Hz.....	1.5 dB
Channel separation at 1000 Hz.....	25 dB
Frequency response.....	20—20,000 Hz + 4 dB/-1 dB
FIM distortion at rec. tracking force, DIN 45,542.....	≤ 1%
Tracking ability at 315 Hz, rec. tracking force.....	> 60 μm
Dynamic compliance, horizontal/vertical.....	14/14 μm/mN
Vertical tracking angle.....	20°
Type of stylus.....	Elliptical, nude
Equivalent stylus tip mass.....	0.5 mg
Recommended tracking force.....	15 mN/1.5 g
Tracking force range.....	13—18 mN 1.3—1.8 g
Weight of unit.....	7 g
Internal impedance DC resistance per ch.....	3 ohm
Recommended load impedance per ch.....	≥ 10 ohm

or pre-amplifier, the MC10 Super negated this expense.

That's because its increased number of windings provide a higher output (0.3 mV, 5 amp) without needing a step-up device.

Ortofon technicians have also incorporated a newly-developed low equivalent tip mass of just 0.5 mg; a new magnet and improved damping system; a tiny nude elliptical diamond mounted on a light and rigid cantilever, and a technologically advanced linear phase.

All quite affordable. At your hi-fi or Ortofon dealer. All of which goes to make the Ortofon MC10 Super the best pick-up you'll ever get.

Distributed by Vanfi (Aust.) Pty. Ltd.

Melbourne: 297 City Road, South Melbourne, Vic. 3205. Tel. 690 6200.

Sydney: 283 Alfred Street, North Sydney, N.S.W. 2060. Tel. 929 0293.

**ortofon**  
accuracy in sound

## Portable video camera for schools

**A** portable television camera, only slightly larger than your hand, weighing about 1 kilo has been released in Australia by GEC Australia Ltd's Video Systems Division for school production units.

One of its appealing features is its ability to film at very low light levels. A new, high-sensitivity, 1/2" vicon tube is used in the A2 camera; this can film at light levels as low as seven lux — about the amount of light given out by a single candle. At the other end of the scale, the A2 series can be used in strong light sources previously considered either difficult or impossible.

A strap holds the camera firmly into the palm of the hand, and a flick of the fingers at the top of the camera operates power zoom, start/stop, play and record mode switch, date/time/stopwatch functions. Normal colour images can be changed to their visual opposites (positive to negative images) simply by pressing a button.

The camera can also be linked to a normal television monitor via videocassette recorder, although some recorders (in Beta format) may need a special adaptor.

A special title facility, allows teachers of the class to produce their own titles on the videotape. Two title frames, comprising any of the letters of the alphabet and the numbers 0 to 9 as well as some of the common punctuation marks can be displayed on the picture background in seven different colours. There is also an external title function that allows the class to include their own title cards or illustrations, also displayed in seven different colours.

Special demonstrations of the camera for school purchasers can be arranged. The A2 camera is only available to schools through GEC Australia Limited's Video Systems Division at 2 Giffnock Ave, North Ryde NSW or in any State capital city.

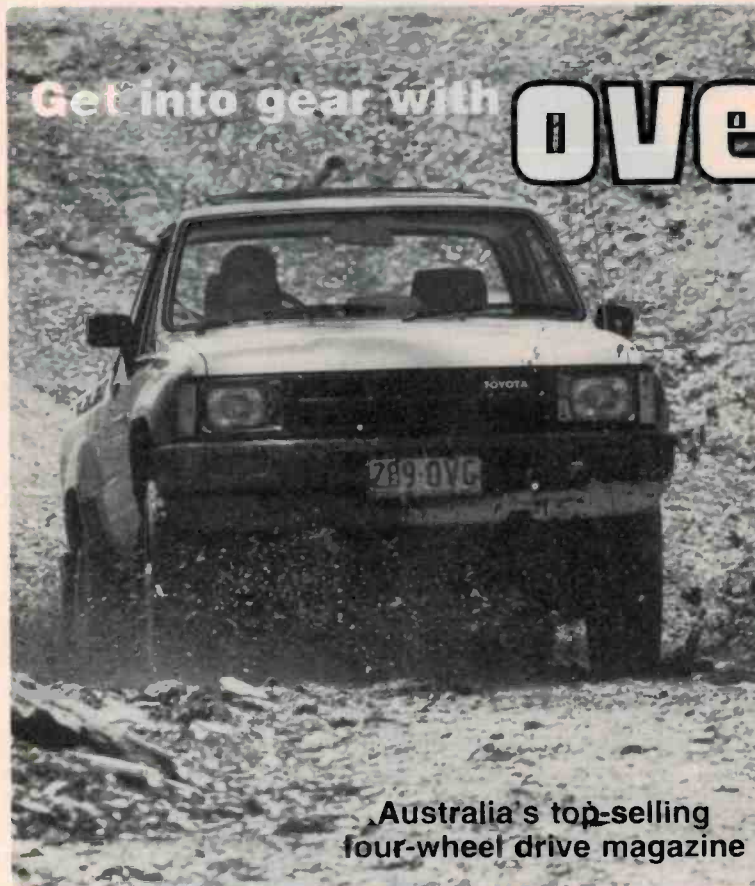

Get into gear with

# overlander

Can you tell the difference between an independent front end and a shot shock? Do you know an ARGO from a G-Wagen? Are you aware of seasonal road conditions on the Canning Stock Route?

**OVERLANDER** has the answers to these and hundreds of other questions about one of Australia's fastest growing leisure pursuits — four-wheel driving.

Each new 4WD vehicle released is treated to a comprehensive report, and usually a full road test, by some of Australia's top motoring writers.

Our excellent technical features, too, have earned **OVERLANDER** its reputation as the definitive voice on off-roading in Australia. Each month we cover several areas of significance to 4WD owners — suspension, differentials, wheels and tyres, CB radios and much more.

If you own a four-wheel drive, are contemplating buying one or are just interested in this exciting area . . . get into your newsagent now and get into gear with **OVERLANDER**.

**Don't go bush without it!**

Australia's top-selling  
four-wheel drive magazine

## Economy sound accessories

**T**hree economy priced hi-fi accessories have just been released by Goldring Audio Industries to protect and clean record discs and allow better sound reproduction.

The Goldring Carbon Fibre Record Brush, as its name implies, is an anti-static brush for cleaning records prior to playing. The anti-static cleaning brush contains millions of ultra fine carbon fibres which reach into the record grooves to remove even the finest dust particles. Additionally, the fibres, which are conducive to electrostatic charges, allow that static charge to pass along the fibres, through the handle into the hand. Static attracts dust which damages the stylus and generates noise and clicks.

Another accessory in the hi-fi battle against static is the Goldring Anti-Static Turntable Mat. Made from electrically

conductive carbon fibre, the mat allows electrostatic charges to discharge from the record to the turntable.

These two accessories are complimented by a low cost Pressure Clip Stabiliser. This clip acts as a stabiliser to exert pressure on the record to reduce the effects from warped and dished records. It also helps keep records true in alignment on the turntable.

The three Goldring accessories are priced at \$7.95 recommended retail price for the Carbon-Fibre Record Brush, \$9.95 recommended retail price for the G5-520 Turntable Mat and \$12.99 recommended retail price for the Pressure Clip Stabilizer and they are available from record stores.

For further information contact **Ken Tait, Goldring Audio Industries. (02)439-3100.**



## Hi-Fi VCR from AWA

**I**n recording and playback AWA VHS Hi-Fi claims to offer five major advantages in its AV400 VCR over conventional VCRs: wide dynamic range, better than 80 dB; low wow and flutter, less than 0.005%; extended frequency response, 20 Hz-20 kHz; harmonic distortion, less than 0.3% (total); channel separation, better than 60 dB.

The AV400 updates existing television sets by allowing reception of stereo TV transmissions whilst using the tuner in the AV400. The 2CH indicator

lights up when receiving a bilingual broadcast and stereo is lit when receiving a stereo broadcast. It is also possible to record simulcasts with the AV400 by connecting an FM tuner via an audio amplifier to the audio.

It also features a 26 function remote control, 14-day, 4-programme timer, one touch recording (OTR) by which a single touch of the OTR button will record automatically for 30 minutes, two touches for 60 minutes etc, and it comes pre-tuned to all major Australian metropolitan TV stations.



## New VCR offers 8-hour recording

**A**nother new VCR, the AV-51 is currently being marketed by AWA which offers hour recording, by converting a four hour tape into an eight hour tape with, the company claims, only a slight compromise in picture and audio quality. In addition it also features automatic front loading; compact design, only 11 inches deep (278 mm); infrared remote control; one touch recording (OTR) which will record automatically for 30 minutes with a single touch of the OTR button;

pretuning to all major Australian metropolitan TV stations.

The 4-programme, 2-week, all-channel timer lets you record one programme while you watch another . . . and catch up with your favourite serials after holidays. The timer also lets you record any channel automatically at the same time every day and the low noise speed search is directly accessible from the freeze-frame mode without going through 'stop' . . . useful for moving noise bars.

# BRITISH POTENCY

— the JPW P1 speakers



Some 19th century British political observer mused that the sun never set on the British Empire. But came the day that it did and Britain's military, industrial and commercial might collapsed like a blimp with a leak. These days however, if you look into the world of British hi-fi, you get the distinct impression that it's "The Empire Strikes Back". JPW has joined the intergalactic fleet with a weapon that just might have some impact.

## JPW P1 SPEAKER SYSTEM

*Dimensions:* 440 mm (height) x 260 mm (width) x 260 mm (depth)  
*Weight:* 7.6 kg  
*Manufacturer:* JPW Speakers, Plymouth, United Kingdom  
*Recommended retail price:* \$429/pair

EACH YEAR we hear of some new manufacturer of loudspeakers in the United Kingdom who has hung out his shingle and is offering either a "new, more exciting" or "more innovative" product. JPW is another example to join the illustrious group of manufacturers who are all leaving their 'veritable mark' on the world of high fidelity.

JPW is a very small firm with an equally

## Louis Challis

small product range. At the moment this consists of three products, the least expensive of which is the model P1 speaker system under review.

The managing director of JPW is also its founder, an engineer by the name of Peter Wanstall, a self-confessed hi-fi addict who has produced his own speakers and amplifiers for some years. Since 1978 JPW has been actively producing products for the British market and recently branched into the export field.

### What's in the box

The model P1 is a true bookshelf speaker system featuring a fully timber-veneered cabinet. The main driver is a 200 mm diameter woofer with an unusual diecast basket and 25 mm diameter long-throw voice coil manufactured by Vifa in Denmark. This driver is mounted in a sealed, solidly constructed enclosure of 18 mm thick double-veneered particle board.

The inside of the enclosure incorporates a 25 mm thick low density bonded acetate absorptive lining with a five element pi filter crossover mounted on the rear panel. This crossover operates at 2250 Hz to feed an unusual 19 mm diameter soft dome tweeter in which ferro fluid is used in the air gap for power handling enhancement. This tweeter is also manufactured by Vifa.

The cabinet is very well made and the front escutcheon features a neatly fabricated moulded hardboard frame with plastic retention caps surmounted by a dark brown open weave speaker cloth. The rear of the cabinet is painted and incorporates a pair of colour-coded universal terminals in a protected recess on the back panel.

### On test

The objective testing provided results which were substantially better than I would have expected from such a modest sized enclosure.

The on-axis frequency response of the enclosure is extremely smooth, lying within  $\pm 6$  dB from 80 Hz to 20 kHz. At 30° to the main axis there is a noticeable droop but only above 15 kHz whilst the crossover notch at 2.2 kHz becomes quite apparent. The close proximity measurements confirm

# SOUND REVIEW

*"The objective testing provided results which were substantially better than I would have expected from such a modest sized enclosure."*

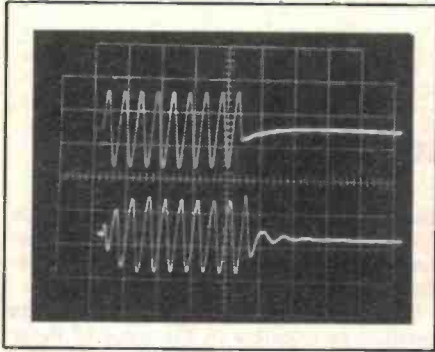

100 Hz  
(20 ms/div)

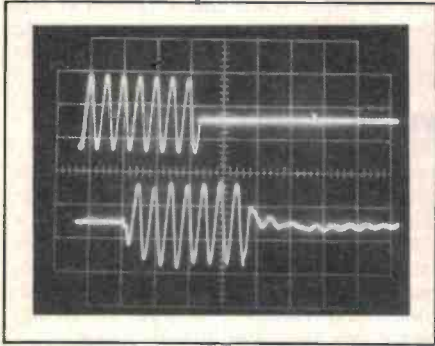

1 kHz  
(2 ms/div)

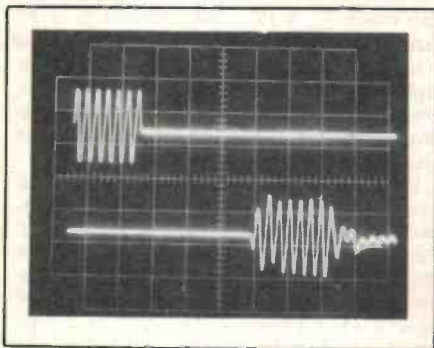

6.3 kHz  
(0.5 ms/div)

Tone burst response of JPW Model P1 (for 90 dB steady state SPL at 2 m on axis). Upper trace is electrical input. Lower trace is loudspeaker output.

Absolute copyright in this review and accompanying measurements is owned by Electronics Today International. Under no circumstances may any review or part thereof be reprinted or incorporated in any reprint or used in any advertising or promotion without the express written agreement of the Managing Editor.

JPW Model 1. Speaker characteristics as measured.

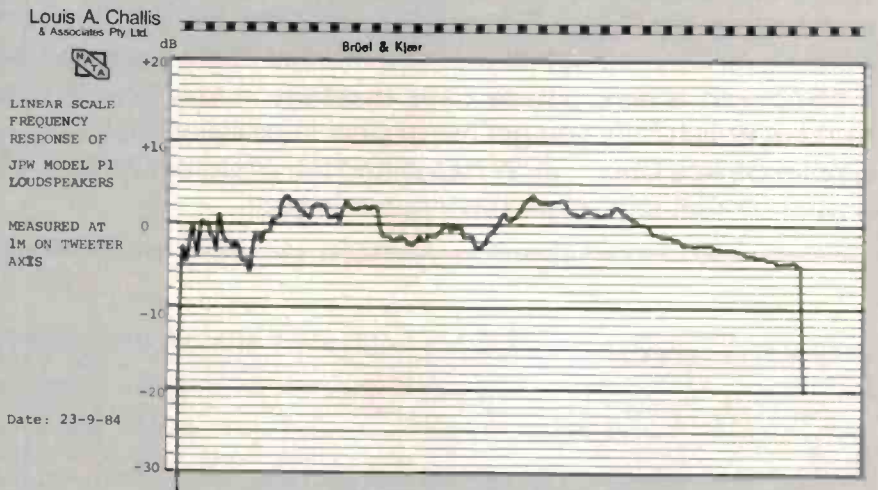
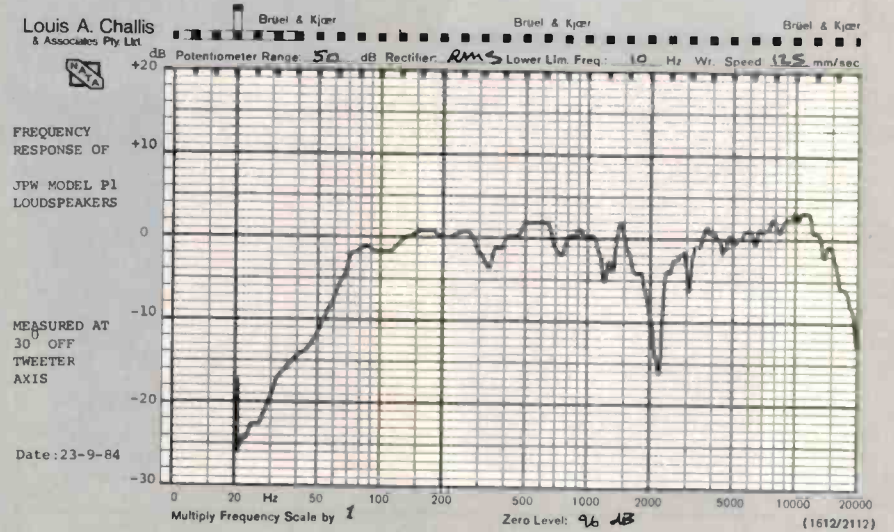
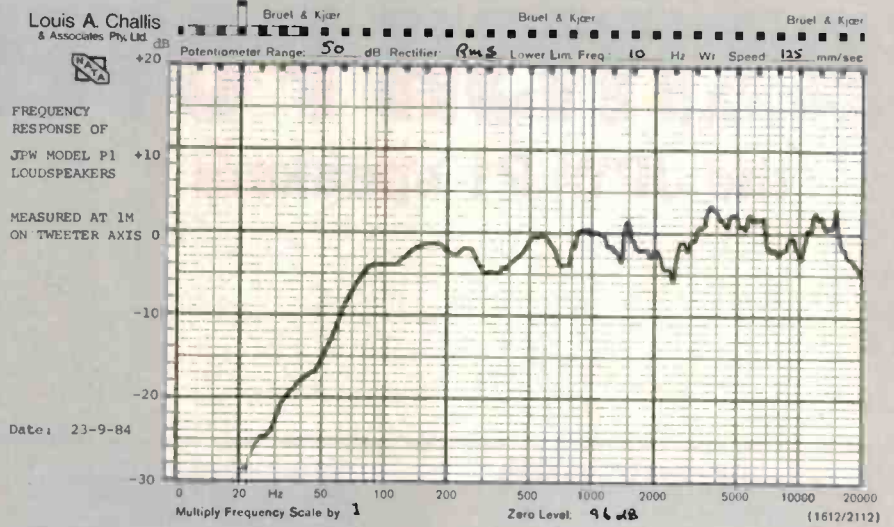



Louis A. Challis  
& Associates Pty Ltd

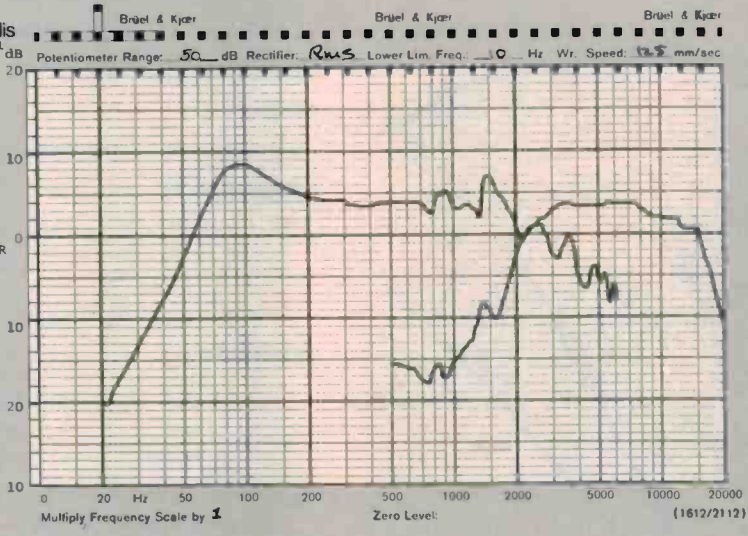

Polar response plots.

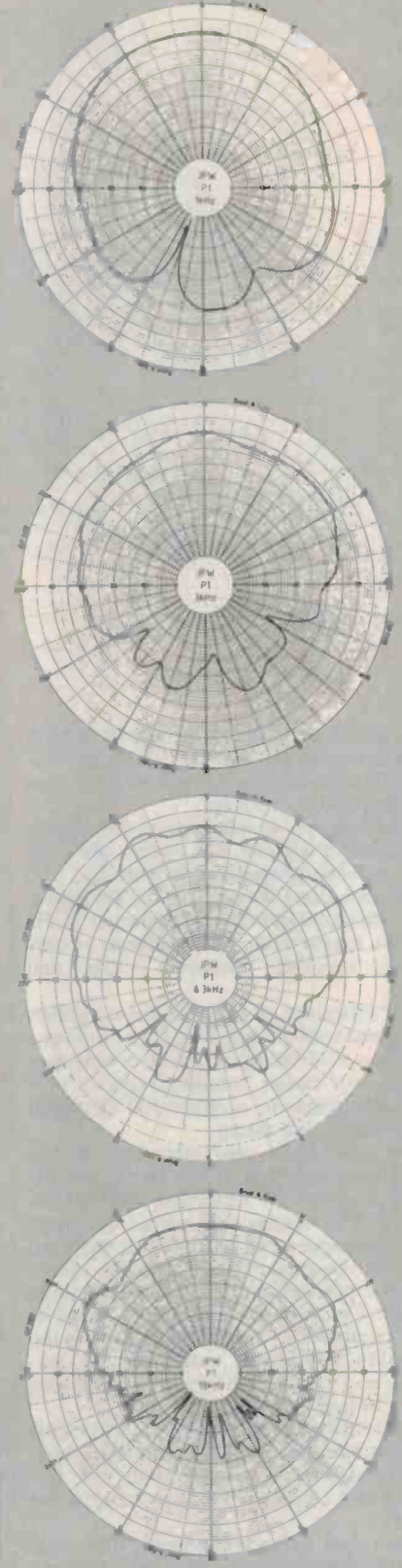

Louis A. Challis  
& Associates Pty Ltd

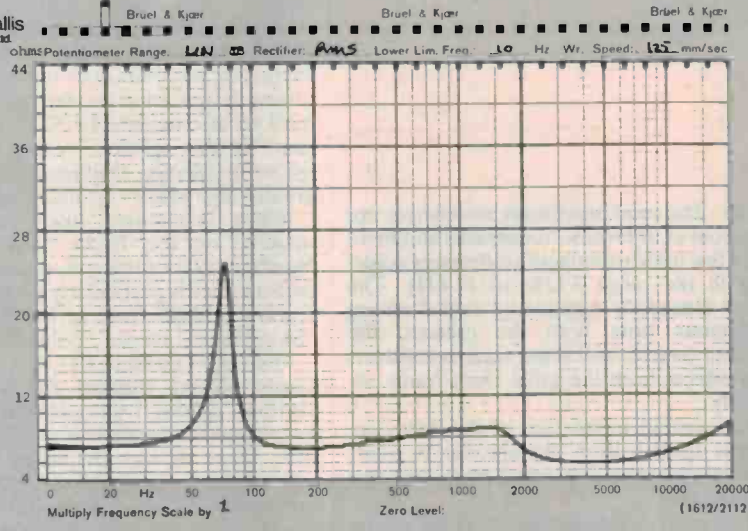

Louis A. Challis  
& Associates Pty Ltd

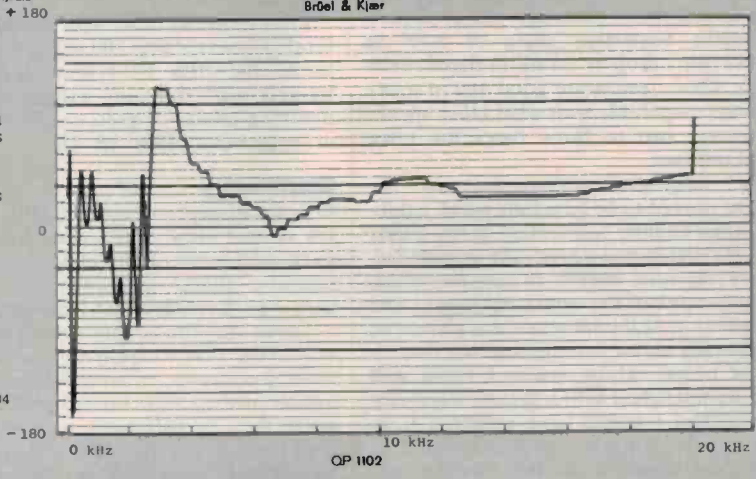

## SOUND REVIEW

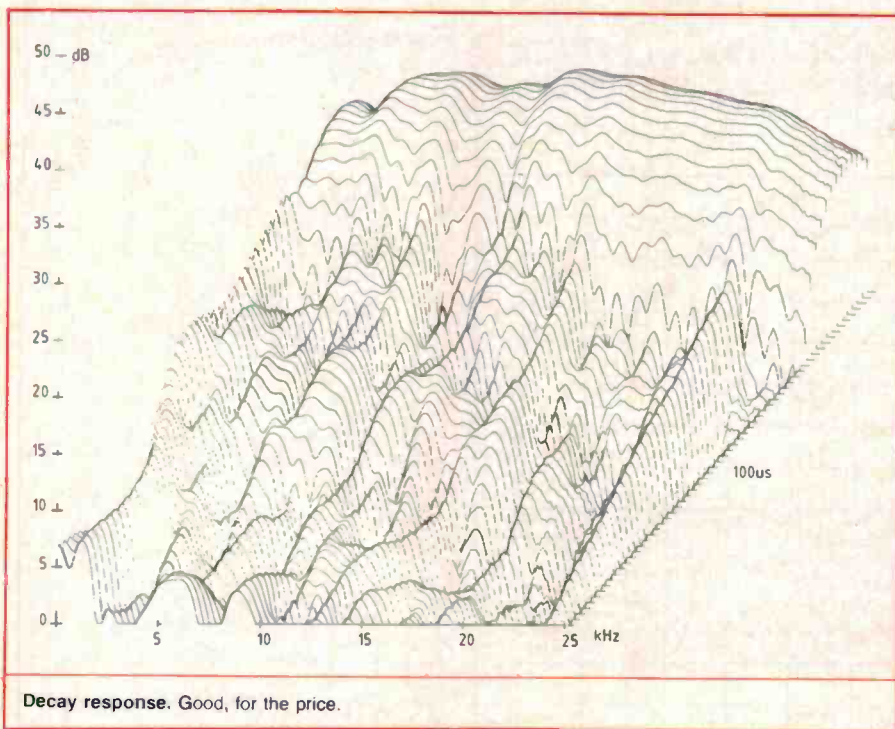

MEASURED PERFORMANCE OF: JPW Model P1

SERIAL NO: 03512

FREQUENCY RESPONSE: 80Hz - 20kHz (-6dB) on axis

80Hz - 16kHz (-6dB) at 30° to main axis

CROSSOVER FREQUENCIES: 2.2kHz

SENSITIVITY:

(for 96dB average at 1m) 5.5 Watts (nominal into 6 Ohms)

HARMONIC DISTORTION: 100Hz 1kHz 6.3kHz  
(for 96dB at 1m)

2nd	26.0	51.5	48.1	dB
3rd	37.0	46.0	62.8	dB
4th	59.6	-	-	dB
5th	51.8	-	-	dB
THD	5.2	0.56	0.40	%

INPUT IMPEDANCE:

100Hz	7.0	ohms
1kHz	8.3	ohms
6.3kHz	5.6	ohms
Min at 4kHz	5.5	ohms

POLAR RESPONSE AT 10kHz: nominally  $\pm 40^\circ$  to the main axis for -6dB

evaluation tracks was accommodated extremely well, with audible frequency doubling only occurring at sound pressure levels greater than 98 dB. Even though the frequency response does not extend to the lowest frequencies on the record, it was hard to discriminate between the performance of this speaker system and others whose frequency responses are generally greater and which cost much more.

When evaluating the latest digital material on the Telarc Sampler Record Number 1 (CD 80101), it was clear that the performance is particularly good. However, I noted a slight trace of harshness on the "Star Tracks" record (Telarc CD 80094).

With the Capriccio CD disc of Corno da Caccia playing trumpet and with Ludwig Guttler (10.008) it was clear that the stereo imaging of the speakers is excellent and that over most of the frequency region the colouration is reasonably inconspicuous and innocuous. Most of those who auditioned the speakers commented during our listening test that they were pleased with the lack of colouration produced, rather than being critical.

On maximum drive with sound pressure levels just exceeding 100 dB in the listening room, the JPW P1 system performs extremely well and only exhibits frequency doubling effects of gross audible distortion at frequencies below 100 Hz.

### Summary

My overall impression of the JPW P1 speakers is that they are a reasonably potent package capable of providing above average listening quality and adequate sensitivity with a performance that belies their size.

Given that the recommended retail price is \$429 the JPW P1 speakers constitute good value for money, proving well above average acoustic quality. From a practical standpoint they fit extremely well on to most bookshelves so that the resulting sound would make you think you had a speaker system three times the size.

the general smoothness of output of both the woofer and the tweeter, which are reasonably well matched considering the cost and size of the enclosure.

Whilst the phase response of the tweeter is reasonably smooth, the woofer does not quite achieve a comparable linearity. The impedance curve is typical of the configuration with one significant resonance at 75 Hz and the lowest value of impedance of only 5 ohms occurring between 3 kHz and 5 kHz.

The efficiency of the speaker is moderately good with 5.5 watts input to produce a signal level of 90 dB at 2 metres and thus the 70 watt power handling capacity provides the ability to produce 100 dB signal levels within that rating.

The distortion characteristics of the speaker are only fair at 100 Hz as a 96 dB signal produces 5% distortion which is just audible. The woofer only has a moderately efficient magnetic circuit and although the driver is designed for a reasonable excursion, the possibility of producing very high level low frequency signals falls beyond its basic capabilities. At higher frequencies the distortion figures are extremely low primarily as a result of the good performance of the 19 mm dome tweeter.

The tone-burst response of the P1 reveals a slight trace of carry-over at low frequency, a more significant carry-over at mid frequency and a somewhat longer carry-over at 6.3 kHz.

The initial decay components measured by the decay response spectra are remarkably smooth over most of the frequency

range. The most significant resonances are apparent at ultrasonic frequencies and there are a few quite prominent resonances occurring in the range 5 kHz to 12 kHz. The lower frequency resonances reveal strong reflections from both the cabinet, the speaker baskets and some traces of diffraction effects from the grille cloth frame assembly.

The overall impression of the decay response spectra from this speaker is good, particularly when one considers its cost and construction.

The polar response characteristics of the speaker are reasonably smooth at 1 kHz and 3 kHz. These clearly reveal the impact of speaker front panel diffraction effects at 6.3 kHz and rather pleasingly still produce a reasonable dispersion angle of  $\pm 40^\circ$  at 10 kHz (for a drop of -6 dB in signal sensitivity). These results are good and in many respects comparable with what other speakers costing two to three times the price would produce.

The subjective performance of the speaker proved to be generally good, exhibiting some audible colouration in the 1 kHz to 3 kHz region and a generally smooth frequency response, audible realism and integrity over most of the operating range. The reproduction of the human voice proved to be generally above average and the recordings of people whose voices I know well were accomplished with a greater degree of realism than I would have expected from such a modestly priced speaker system.

The reproduction of the Swedish Hi-Fidelity Institute test record low frequency

# WHAT HAS MORE COMPUTER POWER THAN MANY LARGE OFFICES AND FLIES AT MACH 2?



The F/A 18 Hornet tactical fighter has more on-board computer power than many large office installations.

The ground facilities to back up this phenomenal aircraft are truly staggering.

Communications, over-the-horizon radar and the computerised avionics fault tree analyser.

To keep it flying as it should we need technically minded young men and women to train as Electronics Technicians.

If you have successfully completed at least year 10 with passes in English, Maths and Science

(physics content) and you would like to have a full-time career working with the very latest in aviation technology, contact us now.

If you are an Australian citizen (or eligible to become one), aged 17-34, telephone your nearest Air Force Careers Adviser on: Sydney (02) 219 5555, Newcastle (049) 26 3011, Wollongong (042) 28 1855, Parramatta (02) 635 1511, Canberra (062) 82 2333, Melbourne (03) 697 9755, Geelong (052) 21 1588, Brisbane (07) 226 2626, Townsville (077) 72 4566, Adelaide (08) 212 1455, Perth (09) 325 6222, Hobart (002) 34 7077, Launceston (003) 31 1005, or write to Box XYZ in your capital city.



**JOIN THE ROYAL AUSTRALIAN AIR FORCE.**





We want you  
to have the best.

*Philips' VR6849 is not just a video recorder — but a sophisticated, high performance audio recorder as well. And the styling makes it at-home with your hi-fi system.*



You may enter as many times as you wish but you must use a separate entry form for each entry and include the month and page number cut from the bottom of this page.

You must put your name and address on the entry form and sign it where indicated.

Please read the contest rules carefully, especially if sending multiple entries.

**SEND YOUR ENTRY TO:**  
Philips/Electronics Today  
Hi-fi VCR Contest  
P.O. Box 227  
Waterloo, NSW 2017

**COUPON Philips/ETI hi-fi VCR contest**

Just answer the simple questions, complete the coupon and send it to the address given below:

**Contest closes 1 February, 1985.**

**Q1.** Why does the Philips hi-fi VCR have three video heads instead of two?

.....

**Q2.** What is unique about the infra-red remote control of the Philips hi-fi VCR?

.....

**Q3.** In 50 words of your own or less, tell us what is the difference between normal stereo and Philips hi-fi stereo recording technique?

.....  
.....  
.....  
.....  
.....  
.....  
.....

Name .....

Address .....

Postcode .....

• I have read the contest rules and agree to abide by their conditions. Signature .....

# WIN THIS FABULOUS STEREO HI-FI VIDEO CASSETTE RECORDER!

**DON'T DELAY —  
ENTER TODAY!  
PRIZE WORTH  
\$1349!**

*Philips, in conjunction with  
Electronics Today, is  
offering this fabulous hi-fi  
stereo video cassette recorder  
as a prize in this simple  
contest.*

## **RULES**

This contest is open to all persons normally resident in Australia with the exception of members of the staff of Philips Australia, the Federal Publishing Company, Eastern Suburbs Newspapers, The Litho Centre and/or associated companies.

Closing date of the contest is 1 February, 1985. Entries received within seven days of that date will be accepted if postmarked prior to and including 1 February, 1985.

The winning entry will be drawn by the Editor of ETI, whose decision is final. No correspondence will be entered into regarding the decision.

The winners will be notified by telegram the same day the result is declared. The name of the winner, together with the winning answers, will be published in the next possible issue of Electronics Today International.

Contestants must enter their names and addresses where indicated on each entry form. Photostats or clearly written copies will be accepted but if sending copies you must cut out and include with each entry form the month and page number from the bottom of the page of the contest. In other words, you can send in multiple entries but you will need extra copies of the magazine so that you can send an original page number with each entry form.

This contest is invalid in states where local laws prohibit entries.

Entrants must sign the declaration, accompanying the contest, that they have read the above rules and agree to abide by their conditions.

*The Philips VR6940 stereo hi-fi VCR can be considered the "flagship" model of the total Philips range. It encompasses all the technology and innovation found in other models in the Philips range, as well as incorporating the ability to record and playback in FM hi-fi sound through the addition of audio heads to the video drum which record hi-fi sound on the tape along with the video.*

*A major benefit of this VCR is the inclusion of linear stereo recording/playback facility. The addition of this audio mode was seen by Philips as being necessary in order to increase the compatibility of the machine with existing formats and give the consumer more usage flexibility. When it is considered that the bulk of pre-recorded stereo video cassettes available in video libraries throughout Australia have been recorded in linear stereo, the need for a VCR which incorporates this playback mode becomes apparent.*

*Another advantage of the inclusion of this facility is the ability to audio dub 'sound-on-sound' — a voice-over can be recorded in stereo on the linear track while leaving the hi-fi track unmarked. Also, recordings made on the Philips VR6940 can be played back in stereo on other machines which have just the linear track stereo facility.*

*Highlighting the emphasis Philips place on providing the consumer with a product which is functionally uncomplicated is the infra-red 'dockable' remote control handpiece. The 27-function handpiece (incorporating direct channel access) simply slides neatly back into the VCR when not in use and is easily located when required again. A unique feature.*

*The video performance of the VR6940 has been enhanced by the inclusion of an extra video head which provides excellent still pictures and frame advance capabilities. Also included are such features as Automatic Program Search (APS) which allows the user to automatically locate a particular recorded segment on a video cassette simply by inserting a segment number from 1 to 99. The Automatic Program Location and Repeat (APLD) function allows automatic continuous rewind and playback between two designated points on a pre-recorded cassette and is seen by Philips as a feature which has excellent application potential for such consumer/professional purposes as demonstration, education or advertising. The vast number of music video clips available today can be continuously viewed by activating this function.*

*The aesthetic presentation of the product is also an area Philips have paid special attention to. The slinline styling (just 93 mm high!) has been designed not only to be pleasing to the eye and compact, but also to blend in with audio products already in the home. Philips believe the VR6940 can be regarded not only as a video product, but also as a sophisticated audio product.*

*The inclusion of an audio/video switch lets you use the VCR simply as an audio recorder. Separate left and right channel volume recording level controls, a stereo headphone jack (including adjustable volume controls) makes the Philips VR6940 a highly sophisticated audio product. When it is considered this machine also includes all the other functions of more basic video cassette recorders, such as a 14-day/5-event timer, instant timer recording, video search and dolby B noise reduction for the stereo linear tracks, it clearly becomes evident that the VR6940 is at the very top end of audio/video performance.*

# UNBELIEVABLE KIT CLEARANCE SALE

JAYCAR IS CLEARING THE DECKS FOR NEW KITS IN '85

## SENSATIONAL PRICES ON 5000 AMP-SYSTEM KITS

Check the SPECIAL PRICES for the famous ETI 5000 series deal of a lifetime.

**FAMOUS JAYCAR "BLACK MONOLITH" SERIES AMP - NORMALLY \$319.00 THIS MONTH**

**\$295 SAVE \$24.00**

For further savings check the package deal below

**FAMOUS JAYCAR "BLUEPRINT" 5000 SERIES PREAMP - NORMALLY \$299 THIS MONTH**

**\$265 SAVE \$34.00**

Check below for package price FURTHER savings!

**FAMOUS JAYCAR 1/3 OCTAVE GRAPHIC EQUALISERS! (5000 SERIES) NORMALLY \$199 EACH THIS MONTH**

**2 FOR \$300!!**

For FURTHER savings check

\*\*\*\*\* THIS SPECTACULAR PACKAGE DEAL \*\*\*\*\*

### PACKAGE DEAL No.1

Buy the 5000 Black Monolith Power Amp and 5000 Blueprint Preamp TOGETHER for only \$498!

That's right, save over \$120 on normal prices or over \$60 if bought separately from this months SPECIAL prices!

### PACKAGE DEAL No.2

Buy the following:

Power Amp 5000 "Black Monolith"	NORMALLY \$319.00
Preamp 5000 "Blueprint"	\$299.00
Graphic 5000 Equalisers (2 off)	\$398.00
	NORMALLY \$1016.00

**THIS MONTH YOU GET THE LOT FOR ONLY \$699!!!**

THAT'S A MASSIVE SAVING OF \$317 (i.e. YOU VIRTUALLY GET THE "BLACK MONOLITH FREE) EVEN AT THE SPECIAL INDIVIDUAL PRICES IN THIS AD IT IS STILL A MASSIVE SAVING! - Special freight deal: anywhere in Australia \$12!! REMEMBER! WE TAKE NEARLY ALL THE CREDIT CARDS & FINANCE CAN BE ARRANGED ON THE SPOT.

## ARE WE FAWLTY?

WE'RE DOING IT ON PIANO KITS TOO!

**FAMOUS JAYCAR "LYREBIRD" 73 & 88 NOTE PIANOS AT THE LOWEST COST EVER**

Even lower than our low, low prices in September last year. We are phasing these kits out now for new lines in '85. They are still technically superior to many more expensive ready-builts AND have better tone, touch sensitivity etc for FAR LESS MONEY.

**73 NOTE: NORMALLY \$475 ON SPECIAL LAST SEPT. \$375 THIS MONTH \$325**

**SAVE AN ASTOUNDING \$150!!**  
**88 NOTE: NORMALLY \$589 ON SPECIAL LAST SEPT. \$425 THIS MONTH \$399**  
**SAVE AN UNBELIEVABLE \$190!!**

Remember each kit is the same quality as our normal kits. The kits contain a stand (similar BUT NOT THE SAME) as the one shown in the illustration. A beautifully imported Italian keyboard is part of each kit as well as a realistic looking soft (sustain) pedal (Imported from England) is also supplied. All pre-cut woodwork is supplied.



**GAD!**  
they've never been cheaper!!  
**JAYCAR**  
ELECTRONICS

## ARE WE BALMY? IS THE SUMMER SUN GETTING AT US?

This month you can grab the KJ-6655 Hall Effect kit for wait for it - ONLY \$19.95! That's right! \$10 off normal low price!

**NOW SAVE \$10 ONLY \$19.95**

## HALL EFFECT SWITCH VANE INTERRUPTED

**NORMALLY \$19.95 THIS MONTH \$16.95**



PCB to suit 84T19 \$3.45

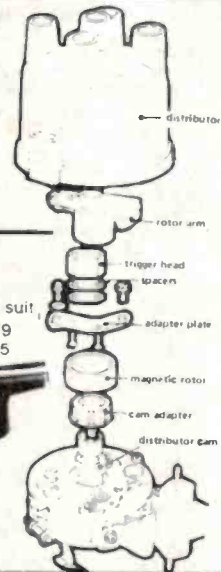

If you have a car that won't take the Jaycar KJ-6655 Hall Effect Kit (i.e. an Australian six or VB) this could be for you! It is the SIEMENS (Germany) made Hall Switch. It will operate from -30 to +130 C. A simple soft iron vane cut with appropriate slots will commutate the unit. Cat. HK-2101

**NOTE: If demand temporarily exceeds our ability to supply kits we may part ship. This will get you started on what is after all a fairly ambitious project. We will only honour the prices, however, if you order NOW. . .**

## 8 SECTOR BURGLAR ALARM KIT...

REF: EA Jan 1985

★ 2 delay sectors ★ 6 instant sectors ★ Steel box ★ Price includes battery ★ Siren driver ★ Variable exit/entry delay ★ Can use N.C. & N.O. on the one circuit!!  
Cat. KA-1580

**ONLY \$139**

**NEW KIT**



NOW OPEN BURANDA QUEENSLAND

## ELECTRIC FENCE

Ref: EA September 1982



**\$15.00**

Mains or battery powered, this electric fence controller is both inexpensive and versatile. It should prove an adequate deterrent to all manner of livestock. Additionally, its operation conforms to the relevant clauses of Australian standard 3129. (Kit does not include automotive ignition coil which is required).  
Cat. KA-1109

**CQAM STEREO DECODER KIT** - Ref: EA October 1984

Set of parts for this project including PCB, 10uH choke, MOC13020 IC (Whistle filter coil extra - Cat. EE-3814 ONLY \$19.95)

Cat. KA-1555 **ONLY \$19.95**

## DRILL SPEED CONTROLLER NEW

This brand-new design gives you better speed regulation over previous drill controller designs. It's also easier to make as all parts are mounted on the PCB. All parts supplied including special high voltage MR754 diode.

Cat. KA-1555 **ONLY \$24.95**

Ref: EA Dec 1984

**ETI 446 AUDIO LIMITER** - This simple

project is used as a volume compensator for P.A. etc

Cat. KE-4092 **GREAT VALUE AT \$12.00**

## RAILMASTER KIT

REF: EA SEPTEMBER 1984

This is the most up to date train controller kit we've seen in a long time. It offers all those wanted features including inertia, full overload protection and walk-around throttle. Kit includes front panel, correct console box and all parts.

Cat. KA-1560 **\$79.95**



# Fast talker with all the right answers MultiModem

Down the street or across the world, MultiModem speaks the language ★ 300 Baud full duplex, 1200 Baud half duplex or 600 Baud half duplex answer or originate ★ CCITT and Bell standards ★ Auto answer and connect ability ★ Plugs straight in (hardwire phone) ★ Superior VLSI chip performance: works reliably with -43dBm signal with S/N ratio of 6dB ★ Telecom approval CB4/37/1135

Cat. XC-4820



**only \$349 INCLUDING TELEPHONE**

## DELUXE METAL DETECTOR

REF: EA December 1984

This very sensitive unit works as well as units costing hundreds more! Features special English-made quality case and pre-wound and sealed head assembly. Looks just like the \$700 plus units! (All parts supplied).  
Cat. KA-1554

**\$239**



**NEW KIT**

**Jaycar ELECTRONICS**

## IN-CIRCUIT TRANSISTOR TESTER

- Ref: EA September 1983

When built this simple kit will enable you to TEST IN-CIRCUIT transistors, SCR's and diodes without the need to desolder!

Cat. KA-1119 **ONLY \$15.00 GREAT VALUE**

**LCD THERMOMETER** - Ref: EA Feb 82  
1.5mm high 3 1/2 digit readout unit that can measure from around 100 degrees C to below freezing. Very accurate - supplied with 2 sensors.  
Cat. KA-1404

**NORMALLY \$74.50  
A FEW LEFT AT ONLY \$64.50**

## LCD HEARTRATE MONITOR

If you are concerned about the condition of your heart then this is the unit for you. Large liquid crystal readout and all readings are taken by optical sensors - great value to those who exercise!  
Cat. KA-1466

**TREMENDOUS VALUE AT \$69**

## ETI 1515 MOTOR SPEED CONTROLLER

- This kit enables you to control the speed of electric motors such as found in drills, saws, grinders, blenders etc. Reasonably constant speed over varying loads.  
Cat. KE-4031

**NORMALLY \$19.95 NOW \$14.95**

**NEW**

NOW OPEN BURANDA QUEENSLAND

## STEAM SOUND SIMULATOR

Ref: EA December 1984

Features infra-red optical switch to synchronise "chuffs" with wheel rotation.

Cat. KA-1562 **\$15.95**

## DIESEL SOUND SIMULATOR WITH LIGHTING CIRCUIT FOR RAILMASTER

REF: EA NOVEMBER 1984

You will be amazed how authentic this kit sounds. Kit includes PCB and all parts for sound effects as well as all the components for the lighting circuit.

Cat. KA-1561 **\$19.95**

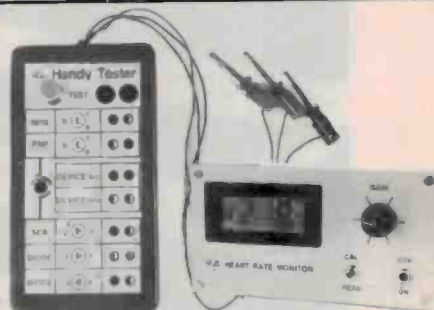

## OUT THEY GO!! SUBWOOFER AMP SPEAKER CABINET

- Ref: EA July 1982

We have a few left of these quality speaker box cabinet kits. The kit is finished in an attractive black vinyl with a modern speaker cloth cover, factory mounted on a frame. The specially made port tube is provided along with speaker connector etc.

**NORMALLY \$79 SAVE \$30  
THIS MONTH \$49**

(Please allow \$8 for post & packing as they are fairly heavy).  
Cat. KA-1454 (Subwoofer speaker extra)  
Subwoofer speaker to suit Cat. CW-2119 \$89.50



SEE OUR OTHER ADS ON PAGE 7 FOR ADDRESS PANEL AND OTHER INFORMATION

# RIGHT PRICE. RIGHT SIZE. RIGHT SPEED.

## That's Riteman!



RITEMAN II

RITEMAN 15

RITEMAN PLUS  
(Tractor feed and cover optional)

RITEMAN BLUE PLUS

If you're looking for an Epson\* or IBM\*\* compatible dot matrix impact printer that's lower in price, smaller, durable, and fast enough to keep pace with your work flow . . . we'd like to show you a Riteman!

Four great new printers. All priced well against comparable Epson models. All substantially smaller. Yet solid as a rock. With print speeds up to 50% faster than the competitors.

The Riteman Plus, Riteman II, Riteman 15, and Riteman Blue Plus with IBM graphics. All are backed by a full one-year warranty. And, as you can see, they're great-looking, too!

For further information contact your local Riteman dealer, or Warburton Franki

\* Epson is a registered trademark of Epson America, Inc.

\*\* IBM is a registered trademark of International Business Machines Corp.

## RITEMAN:

Distributed exclusively in Australia by:-



# Warburton Franki

A DIVISION OF THE ANI CORPORATION LTD (INCORPORATED IN N.S.W.)

- ADELAIDE (08) 356-7333
- BRISBANE (07) 277-0222
- HOBART (002) 28-0321
- MELBOURNE (03) 795-9011
- PERTH (09) 277-7000
- SYDNEY (02) 648-1711
- AUCKLAND N.Z. (09) 50-4458
- WELLINGTON N.Z. (04) 69-3016



# No more pictures, it's the words next time . . .



**T**he traditional oscilloscope will soon be little more than a museum curio, according to Hewlett Packard, for the traditional analogue oscilloscope technology and the newer logic analyser technologies are beginning to merge.

Oscilloscope users need more and more information from their instruments, more than the 'pictures' and knobs can provide. (Hence the parody on the Negro spiritual, "God gave Moses the rainbow sign, no more water, it's the fire next time".)

These days, the trend in electronic engineering design is based on a movement from a position of correct by design through *test on prototype* hardware, to correct by design *before* constructing hardware, through software simulation of designs.

Hence, once hardware is constructed, proof of design and performance characterisation requires instrumentation with 'answer' capabilities, where the parameters of the test and the instrumentation setup are 'written' on the screen and/or transferred to a printout.

Hewlett Packard expects to provide both a catalyst and direction in this design trend. Shorter product life predicated shorter design cycles, creating a demand for 'getting it right first time'. Hence, increased productivity in design is required.

Hewlett Packard's recent release of the HP 54100 digitising oscilloscope is the first step in a new series of instruments catering to this perceived trend. It is aimed at engineers who need to solve problems in high speed logic design.

The 54100 is a fully programmable, 1 GHz bandwidth digitising oscilloscope with *completely digital architecture*. It features 100 picosecond timebase accuracy and provides two vertical channels and one trigger input, plus extensive logic triggering capabilities.

The HP 54100A model has three configurable inputs — two vertical channels and one trigger input. The HP 54100D model provides an additional trigger input. Unlike most oscilloscopes, the HP 54100A/D's inputs are configured with removable pods chosen by the user according to the application. There are currently three probe pods that can be installed in any of the inputs on the unit's front panel.

At the press of a front-panel button, the HP 54100A/D automatically measures frequency, period, pulse width, transition times, peak-to-peak amplitude, top and base voltage levels, pre-shoot and overshoot.

In addition, the HP 54100A/D provides:

- measurement performance for high-speed logic design;
- digital storage;
- infinite persistence displays;
- pre-trigger viewing;
- a clutter-free, easy to use front panel; and
- a variety of setup aids that simplify time-domain measurements for digital design.

The instrument owes a lot in its design to the company's 1630 analyser, in both hardware and software.

By combining an HP 9000 Series 200 computer with the HP 54100A/D, the user can let the computer analyse and compare measurement data. The HP 54100A/D's English-like mnemonics, uncomplicated syntax and command hierarchy simplify software development, enabling the user to program complex measurement sequences easily.

Hewlett Packard Australia is planning to introduce the extensive measurement capabilities of the new HP 54000 series digitising oscilloscopes with a program of digital design seminars.

Further details from Hewlett Packard Aust. Pty Ltd, 31-41 Joseph St, Blackburn, Vic 3130. (03)895-2895.



## Echo sounder

**T**he new SMR SL-1600 echo sounder has been released by Imark. The SL-1600 is a 480 m 4" straight line recorder with a wide viewing screen and a corrosion resistant cabinet. The SL-1600 features microcomputer electronics and is useful for offshore fishing and leisure boats.

Twelve depth ranges are provided from 0-3 m to 288-480 m. The Sea Surface Adjustment can be used to expand the bottom trace in the deeper ranges. The SEA LAB SL400 has the ability to display depths as shallow as 1 m sharply and accurately.

Furthermore, the ranges overlap to avoid having to switch ranges constantly, thus avoiding having the bottom displayed in sections on both the bottom and the top of the chart paper and instead, displays the sea bottom in a continuous manner.

The SL-1600 has controls for paper speed, white line, STC, sea surface adjustment, and on-off gain control and switches for the six depth ranges, power reduction, density control, marker and paper light.

A 50 kHz bronze thru-hull transducer is supplied and the power output is 400 watts RMS.

Dimensions are 300 mm(W) x 204 mm(H) x 76 mm(D) including mounting bracket and knobs. Weight is only 3 kgs. The SL-1600 is supplied complete with dc cable, transducer and cable, operators manual and one roll of paper.

Further details are available from the importers Imark Pty Ltd, 167 Roden Street, West Melbourne, Vic 3003. (03)329-5433.

# A complete workstation for the price of a home computer.

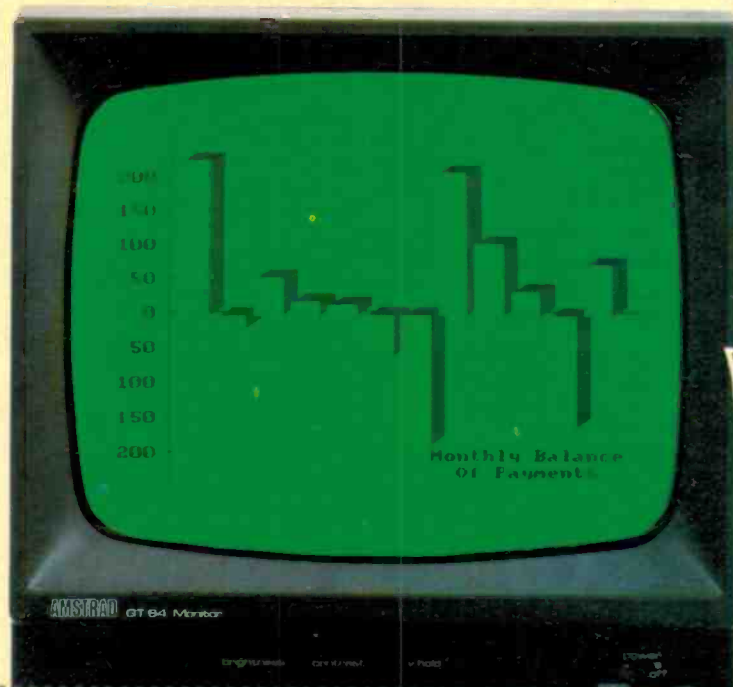

**CPC 464**  
complete  
with  
monitor  
and  
datacorder



It's mouthwatering.  
64K of RAM, 32K of ROM, a high resolution green screen VDU, integral cassette data recorder, typewriter style keyboard, numeric keypad and a very fast extended BASIC.

The CPC464 is also available with a



CPC464 colour monitor (CTM640)

colour monitor instead of the green screen VDU.

You'd be hard pressed to find a comparable computer for the money let alone the monitor and recorder.

And the CPC464 comes complete and ready-to-go. Just plug it in.

### 64K RAM (42K available).

The low cost but powerful CPC464 is equally at home in business and educational applications as it is running the household budget or playing games.

With 42K RAM available to BASIC, the opportunities for sophisticated and complex programming are considerable.

### 80 column text display.

The green screen VDU is purpose designed with a bright, crisp, 80 column text display that compares favourably with systems costing several times as much.

You can program up to 8 text windows and there's a graphics window, too.

The CPC464 has a typewriter style keyboard, large ENTRY key, sensibly positioned cursor keys, numeric keypad for fast data entry and a full 8-bit character set.

If you think that sounds impressive, wait until you hear the 3-voice, 7-octave stereo output through a hi-fi amplifier and speakers.

### Amsoft. High quality software.

A wide range of programs is already available and we're expanding it rapidly. The software takes full advantage



of the CPC464's high specification and speedloading capability. Which means even complex programs can be loaded quickly.

Business applications, educational programs and arcade games are all designed to make maximum use of CPC464's impressive graphics, stereo sound and processing abilities.

### Amstrad. User Information Service.

Whether you're interested in serious commercial applications or you're a games fanatic you'll want to receive the latest information about your AMSTRAD Computer. Upon request you will be advised about the latest software and its application, special information concerning your CPC464, available peripherals and software reviews. There will also be programs and exercises to try.

In addition to the User Information Service you will be given details

of where you may contact your nearest independent user club.

### CPC464. Unlimited scope for expansion.

We've thought of everything you're likely to need in the future. That's why there's a built-in parallel printer interface. A low cost optional disk drive system including CP/M\* (with the option to access 3000 programs) and LOGO. Joystick port. And the virtually unlimited potential of the Z80 data bus with sideways ROM support.

Finally, a power supply and modulator (MP-1) allows you to connect your CPC464 green screen VDU system to a colour TV.



Optional disk drive DDI-1 including interface CP/M\* and LOGO



Optional 80 column dot matrix printer DMP-1 operates at up to 50 characters per second. Combined with the CPC464, it offers a high performance text processing system.

Distributed and guaranteed throughout Australia by:

**AWA-THORN AMSTRAD**

\* Trade mark Digital Research

I'd like to know more about the incredible CPC464 complete computer system and where to see one.

Please send literature right away.

NAME

ADDRESS

POSTCODE

To: AWA-THORN Consumer Products Pty. Ltd.,  
348 Victoria Road, Rydalmere, N.S.W. 2116.



CODE NO: TPB 184

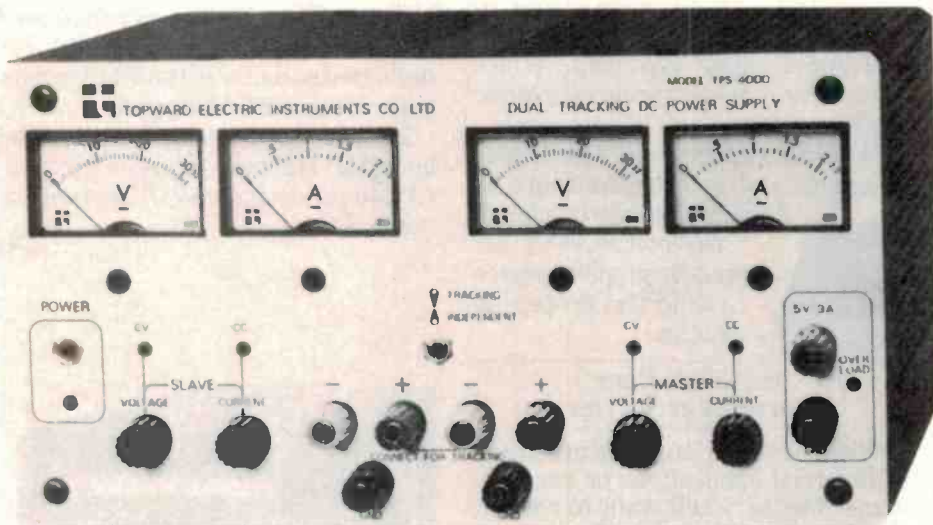

## Topward power supply

Pacific Electronics has announced the Australian release of the Topward TPS-4000 series dual tracking power supplies.

These power supplies offer voltage ranges of  $\pm 30$  to  $\pm 60$  V, current ranges of 2 A to 5 A, and a fixed 5/3 A output on specified models.

All models offer analogue voltage and current indication on both outputs with CV, CC and overload indication by LED. Line and load regulation is 0.02% with tracking error of 0.1%.

For further information contact Pacific electronics, GPO Box 1899R, Melbourne 3001. (03)534-3601.

## David Hall Electronics

Phone:

**(07) 208-8808**

For Queensland's widest range in projects come along and see us.

Books —  
Components — etc.



Shop 5  
376 Kingston Road,  
Slacks Creek Qld 4127  
**(07) 208-8808**

IAN J. TRUSCOTTS

## Electronic World

Kits, tools, components books etc.

Products from  
Dick Smith  
&  
Altronics

Everything for the  
electronic hobbyist

Now open till 9pm  
Friday evenings.

## Electronic World

Cnr. Lacey St. and  
Windsor Rd.  
Croydon, 3136, Vic.  
Phone: (03) 723 3094

### VZ200-VZ200-VZ200-VZ200 MONITOR/DEBUGGER

The ideal tool for M/L programs.

- Saves/loads M/L tapes
- HEX dumps onto printer
- Step through program from breakpoint to breakpoint
- Set registers/flags

and more \$14.95 only

### MERGE/RENUMBER BASIC PROGRAMS

Renumbers with given start/  
increment merges as often as  
you wish  
\$12.50 only

(Note, 16K-RAM needed for both  
tapes)

Send money/check order to:  
W. Obrist  
P.O. Box 56, St. Kilda 3182  
Victoria

VZ200-VZ200-VZ200-VZ200



**TDK VIDEO TAPES AT BARGAIN PRICES!**  
**VHS:** E60 \$12.50  
 E120 \$12.50  
 E180 \$11.80  
 E240 \$22.40  
**BETA:** L250 \$13.50  
 L500 \$14.40  
 L750 \$17.50



**VIDEO PROCESSING CENTRE**  
 Combination stabilizer, enhancer, distribution amplifier, RF converter, designed to enhance all recording needs. Will handle 3 VCR's simultaneously with virtually zero signal loss. Built in RF converter permits in-line connection between VCR and TV for improving recording whilst viewing.

**Specifications:**  
 Power Requirements: 12 V DC 300 mA  
 Inputs: Video, Audio  
 Outputs: 3 video, 3 audio  
 RF UHF: Channel 36  
 Output Level: + - 0.3 dB  
 Output Isolation: More than 40 dB  
 Audio Outputs: Unity gain  
 Input/Output: 75 ohms  
 \* PP300 recommended power source  
 Cat. A13012 **\$129.00**

**VIDEO CABLES AND CONNECTORS**  
 PA-24 5 Pin 180 degree dubbing adaptor - Reverse pins for video use.  
 Cat. \$6.95

**VC-14 8 Pin square plug to 8 pin square plug. Cable length 2 metres.**  
 Cat. \$29.95

**VC-15 6 pin DIN plug to 6 pin DIN plug. Cable length 1.5m.**  
 Cat. \$4.95

**VC-1 BNC plug to BNC plug. Impedance-75Ohm. Cable length 1.5m.**  
 Cat. \$6.50

**VC-2 BNC plug to PL259 plug. Impedance-75Ohm. Cable length 1.5m.**  
 Cat. \$6.75

**VC-3 PL259 plug to PL259 plug. Impedance-75Ohm. Cable length 1.5m.**  
 Cat. \$4.95

**VC-4 PL259 plus to RCA plug. Impedance-75Ohm. Cable length 1.5m.**  
 Cat. \$4.95

**VC-5 RCA plug to RCA plug. Impedance-75Ohm. Cable length 1.5m.**  
 Cat. \$5.95

**VC-6 BNC plug to RCA plug. Impedance-75Ohm. Cable length 1.5m.**  
 Cat. \$5.95

**VP-8 8 pin square video connector plug.**  
 Cat. \$7.50

**VS-8 8 pin square video connector inline socket.**  
 Cat. \$7.50

**VP-10 10 pin male video plug. Used in JVC, Panasonic, Sharp and other VHS machines.**  
 Cat. \$11.50

**BS-10 10 pin female inline socket. Used in JVC, Panasonic, Sharp and other VHS machines.**  
 Cat. \$11.50

**VP-14 14 pin male video plug. Used in Sony, Sanyo, Toshiba and other Beta machines.**  
 Cat. \$16.50

**VS-14 14 pin female inline socket. Used in Sony, Sanyo and Toshiba and other Beta machines.**  
 Cat. \$16.50



**VIDEO CASSETTE STORAGE CASES**  
 VHS and Beta library type storage cases made of durable plastic with identification card pouch.  
 1 - 9 **10+**  
 VHS Cat. A15036 **\$2.95**  
 Beta Cat. A15035 **\$2.25**



**VCR HEAD CLEANERS**  
 VHS and Beta available. A professional head cleaner, employs 'double slied' cleaning action. Just Insert the cassette 'play' for 30 seconds and the job's done!  
 VHS CAT. A11456 **\$17.50**  
 Beta Cat. A11457 **\$17.50**

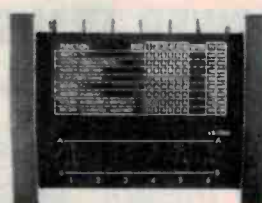

**VIDEO SWITCHING BOX**  
 Low loss RF. switching - allows inputs for: VCR, video disc, antenna, cable TV, home computer and video games.  
 Cat. A13015 **\$39.50**



**VDK1 VIDEO DUBBING KIT**  
 For European and Japanese machines.  
 Contains:  
 Audio/Video: 6 pin DIN plug to 6 pin DIN plus 1.5 metres.  
 Audio/Video: 6 pin DIN socket to (a) Video: RCA plus (b) Audio: 5 pin DIN plug (Both 16cm in length.)  
 Video: 1 each plug adaptor (PA21) RCA socket to PL259 plug (PA23) RCA socket to BNC plug.  
 Audio: 5 pin DIN socket to 2 RCA plugs 16cm length 2 plug adaptors (PA60) RCA socket to 3.5mm phone plug.  
 Cat. VDK1 **\$16.95**

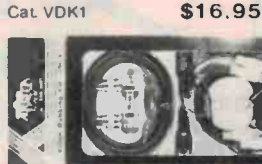

**VDK2 VIDEO DUBBING KIT**  
 Contains:  
 Video: RCA plug to RCA plug - 1.5m - 75 ohm. 2 plug adaptors (PA23) RCA socket to BNC plug.  
 2 plug adaptors (PA21) RCA socket to PL259 plug.  
 Audio: RCA plug to RCA plug - 1.5m-shielded cable. 2 pcs 5 pin DIN plug to 2 RCA sockets, (in/out) - 16cm. 2 plug adaptors (PA60) RCA socket to 3.5mm phone plug.  
 Cat. VDK2 **\$19.95**

# PRINTERS GALORE



**Juki printer**  
 Professional daisy wheel printer 18 CPS full incremental mode Diablo 630 emulation Large range of daisy wheels 8K internal buffer available.  
**Was \$950 Now \$790**



**Star Gemini 10**  
 120 CPS logic seeking Italics, graphics and down-loadable characters sets Friction and tractor 9 x 9 matrix. Hi res graphics Low cost typewriter ribbon  
**Was \$499 Now \$430**



**Star Gemini 15**  
 120 CPS logic seeking Italics, graphics and down-loadable characters sets. Friction and tractor 9 x 9 matrix. Hi res graphics Low cost typewriter ribbon  
**Was \$899 Now \$729**



**Star Radix 15**  
 Excellent fast printer 200 CPS eats up the pages With an amazing 16K internal buffer you won't waste any time.  
 Has near letter quality mode, graphics, and font variation.  
**\$1,395**



**CPA80**  
 The next generation of '80' type printers. 100 CPS, internal buffer expandable to 4K. Greek as well as italics. Dip switches accessible at the top. The print quality is the same as its forerunner Square pins and film ribbon make it unbeatable.  
**Was \$475 Now \$395**

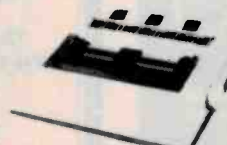

**ENP1091**  
 The latest addition to our range. Has a near letter quality mode. 120 CPS. Down loadable character set. Graphics, Italics, emphasized etc.  
**Was \$500 Now \$420**

# MONITOR MADNESS

## RITRON 1



**SAVE UP TO \$60!!**  
 Our most popular model in a steel cabinet to minimise R.F.I. interference. Prices include tax. Make sure you get in early.  
 1-4 5-9 **10+**  
 Cat. X14500 (Green) **\$139 \$135 \$129**  
 Cat. X14500 (Amber) **\$139 \$135 \$129**

## RITRON II



Swivel base monitor in stylish case.  
 1-9 **10+**  
 Cat. X14506 Green **\$169 \$159**  
 Cat. X14508 Amber **\$169 \$159**

## RITRON III



Great resolution, swivel base Amber only. Prices include tax. Buy now for Xmas.  
 1-4 5-9  
 Cat. X14510 **\$169 \$159**

# COLOUR IS HERE IN A BIG WAY!!

**PHOENIX IV**  
 Suits IBM R.G.B. input  
 \* R.G.B. TTL  
 \* High Resolution  
 \* 13" CRT Dot Pitch 0.31mm  
 \* Horiz. Resolution 720 dots  
 \* Vert. Resol 240 TV Lines  
 \* Display Characters 2000 Ch. (80 x 25)  
 \* Display Colours 8 Colours and Intensity  
 \* Green Text Display  
 Cat. X14520 **\$690**



**PHOENIX V**  
 Pal Suits Apple, Commodore even your V.C.R!  
 \* Pal and R.G.B  
 \* Normal Res.  
 \* 13" CRT Dot Pitch 0.65mm  
 \* Horiz. Resol. 320 TV Lines  
 \* Vert. Resol. 560 TV Lines  
 \* Display Characters 1000 Ch. (40 x 25)  
 \* 16 Colours (Pal)  
 \* Green Text Display  
 Cat. X14522 ~~\$449~~ **\$399**

Errors and Omissions Excepted



Rod Irving Electronics

425 HIGH STREET, NORTHCOTE VICTORIA.  
 Ph:(03)489 8866 489 8131  
 48-50 A'BECKETT STREET, MELBOURNE VICTORIA.  
 PH:(03)347 9251  
 Mail Order and correspondence:  
 P.O. Box 235 NORTHCOTE 3070

**YOU WON'T GET BORED OVER THE HOLIDAYS WITH THESE GREAT SPECIALS!! GREAT 'IN STORE' BARGAINS TOO!**  
 Call in at either 2 of our conveniently located stores:  
**48-50 A'Beckett St., Melbourne 425 High St., Northcote.**  
 Or take advantage of our Mail Order Department.  
 Write to:



or phone ...  
**MAIL ORDER HOT LINE**



481 1436



**POSTAGE RATES**  
 \$1-\$9.99 ..... \$1.50  
 \$10-\$24.99 ..... \$2.00  
 \$25-\$49.99 ..... \$3.00  
 \$50-\$99.99 ..... \$3.50  
 \$100-\$199 ..... \$5.00  
 \$200-\$499 ..... \$7.50  
 \$500 plus ..... \$10.00

# PROFESSIONAL QUALITY ELECTRONIC COMPONENTS



KT1808/MKT1817/MKT1826  
Series Polyester and  
Metalized Polyester Film  
Capacitors 5 mm PCM  
220pF-1μF.



Commander.  
Fully enclosed  
ASC11 keyboards  
serial or  
parallel output.

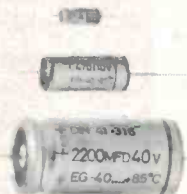

EL/EB/EG. Radial, long  
life low leakage  
electrolytic capacitors.  
Temperature range  
-40°C — +85°C.



D Sub-min.  
9-50 pin D  
Connectors, gold  
contacts, solder  
cup or PCB mount.



ETPW.  
Tantalum bead  
capacitor. Very low  
leakage, flame  
retardant and  
temperature rating of  
-55°C — +125°C.



## MAYER KRIEG & CO.

248 ANGAS-ST, ADELAIDE, S.A. 5000.

For further information and data sheets contact your local distributor.

NSW: Mayer Krieg (02) 684 1900;

M. Ruffy (02) 476 4066.

NEWCASTLE: DGE Systems (049) 69 1625.

QLD: E.C.Q. Electronics (07) 376 5677;

Fred Hoe (07) 277 4311.

SA: Anelco Electronics (08) 294 2600.

VIC: Mayer Krieg (03) 579 5722.

WA: Pro-Spec Distributors

(09) 362 5011.

NZ: Channelmaster (9) 59 9003.

## PCB TRANSFORMERS

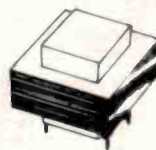

2.5/3VA

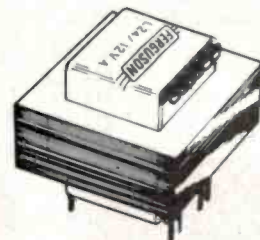

12/15VA

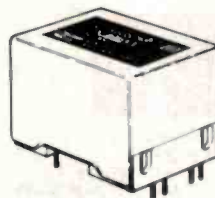

5/7 & 7.5/10VA

- Manufactured to AS3126 and Telecom approved
- Suit standard PCB grids and simplify construction

## POWER TRANSFORMERS

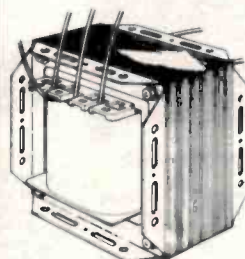

Conventional

Low Profile.

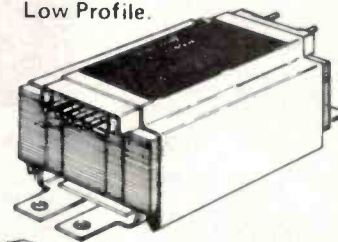

Plug Pack  
Adaptor



- Wide range of secondary voltages from 1.5V to 115V
- Stock range has ratings up to 1000VA
- Special types for microprocessors, 115V etc

## AUDIO TRANSFORMERS

PCB mounted  
phone patch

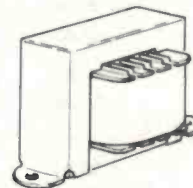
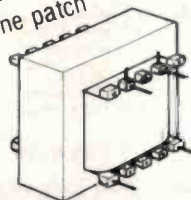

75 ohm to 300  
or 600ohm matching transformer

- Line and Matching transformers up to 150W
  - Power transformers for high power amplifiers
  - Transistor drivers
  - Special 'C' core transformers
- Ask for MAL VK2BMS  
or DOUG VK2BPX

TALK TO FERGUSON - THE AUSTRALIAN COMPANY  
WITH NEARLY 50 YEARS EXPERIENCE OF MANUFACTURING  
IN AUSTRALIA FOR AUSTRALIAN CONDITIONS

Ferguson Transformers Pty. Ltd.

331 High Street, Chatswood 2067. Tel: (02) 407-0261.

Telex: AA25728. Melbourne: (03) 561-6699.

# FERGUSON

## Cutting the cost of chip design

Custom-designed technology to solve individual problems in the workplace will become a key element in the production of goods and service in the future, according to a thesis of Alvin Toffler's in his book *Previews and Premises*.

Custom chip design is moving out of the realm of corporate R&D teams and down to the individual engineer level (see *Silicon Compilers*, Oct. '84 ETI, page 14) per the medium of sophisticated computer-aided design (CAD) software.

Minicomputer software for this job can cost \$50 000 or more but Texas Instruments has brought out a CAD system for the IBM pc costing US\$500, aimed at small engineering firms which want to design semi-custom chips on their own premises.

Texas Instruments reckon that, by 1990, close to a third of all logic chips bought in Europe will be of the semi-custom type. Companies that use semiconductors in their products are making increasing use of semi-custom chips rather than the standard mass-produced devices or completely customised versions.

Semi-custom chips comprise a selection of 'components', some fixed by the maker and some which are made to a customer's specifications. There are two forms: logic arrays and standard cells. Both require the customer to do some design work.

Until now, firms or individuals who wanted to use a CAD system to do this work either had to invest in a minicomputer or rely on the chip company's own CAD facilities. Designing a custom chip is not a 'trivial exercise', according to TI. It requires

computer simulation which few companies could afford.

TI's 'Professional Computer Transportable Design Utility' (PCTDU) is said to be almost identical to the programs the company has produced for mainframe use. The main difference is that the programs for use on a PC run more slowly and there is a limit to the size of the model that can be simulated.

How could they do it so cheaply? Well, one reason is that the software contains a database of the diffusion and metallisation processes used in fabricating TI's semi-custom chips. But this makes it useful only to people buying Texas chips.

The value of providing customers with a cheap design system package has not escaped other firms in the business of providing semi-custom chips. The British-based Ferranti, currently the world's biggest producer of semi-custom chips is said to be reviewing its position in light of this development from TI.

Just for the record, TI's PCTDU package needs a 16-bit micro (presumably a processor featuring 16-bit operation internally — Ed.), half a meg of main memory and a 10M Winchester hard disk, guaranteeing you have to be a rich engineer or a well-to-do small business, at present.

— Roger Harrison

## George Brown shows his wares

The Sydney based company George Brown, has recently released details of new stock.

For instance, the programmable, dual-port, low-power Z80L PIO which provides a TTL-compatible interface between a wide range of peripheral devices and the Z80L CPU, requiring no other external logic.

Another is the Z8671 microcomputer BASIC/debug interpreter (MCU). It is a complete microcomputer preprogrammed with a BASIC/debug interpreter. It is ideal for industrial control applications that require fast hardware tests, bit manipulation and logical operations.

The Z8681 is also available. This MCU is the "ROMless" version of the powerful Z8601 single-chip microcomputer. With it you can design a powerful microprocessor system incorporating a minimum number of support devices.

The Z80 family of microcomputers is also available. This includes the Z8611 single-chip microcomputer with 4K ROM, the Z8612 development device with memory interface and the Z8613 prototyping device with EPROM interface.

The Z8611 microcomputer has all the Z8601's sophisticated capabilities, but with larger internal memory capacity.

The Z8601 introduces a new level of sophistication to single-chip architecture. Amid its advantages over earlier single-chip offerings are faster execution with no accumulator bottleneck; more efficient use of memory; more computation capabilities; no sophisticated interrupt; input/output and bit manipulation capabilities; and easier system expansion.

Finally, the Z80L central processing unit (CPU) extends the range of Z80 applications to low power products such as hand-held and battery backup devices. You get all the functions and efficiency of the Z80 CPU, plus a dramatic saving in power.

The Z8300 CPU is supported by the full range of Z80 peripheral devices, with all the features of the Z8400 peripherals, but with lower power consumption.

For more information contact The George Brown Electronics Group, 174 Parramatta Road, Camperdown 2050. (02) 519-5855.

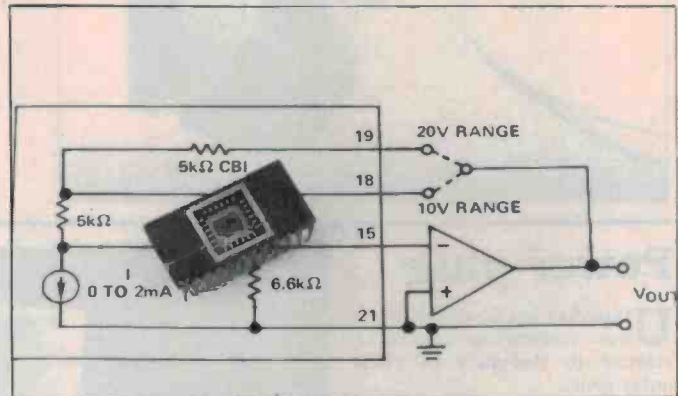

Other key features of the DAC include fast 300 ns settling to  $\pm 0.01\%$  of full scale, guaranteed monotonicity over a 0 to +70°C temperature range, and the widest compliance voltage range of any comparable DAC, -2.5 V to +10 V. In addition, the internal buried-zener reference can supply 2.5 mA maxi-

mum for use elsewhere in the application.

Available in a 24-pin hermetically-sealed ceramic DIP the DAC801 provides complementary binary input coding.

For further information contact Parameters, 41 Herbert St, Artarmon NSW 2064. (02) 439-3288.

## New DAC80

A new monolithic current-output version of the industry-standard DAC80 is specified at  $\pm 2\%$  maximum gain error  $\pm 1/2$  LSB linearity error. Introduced by Analog Devices, the

DAC801 12-bit digital-to-analog converter (DAC) offers the lowest maximum power dissipation of any current-output DAC80 or equivalent; 450 mW.

Unlike many DAC80s and equivalents, the DAC801 operates without a +5 V logic supply.

## Angstrom resistors

**P**romark Electronics of Crows Nest NSW, and Nunawading Vic, has recently been appointed Australian agents for Angstrom Precision of Maryland, USA, who manufacture a broad range of resistive products.

Angstrom has wire-wound power rheostats from 12.5 to 300 W, precision fixed resistors in Tempcos to 5 ppm and values to 7.5M and a range of precision metal film resistors for military applications which conform to MIL-R-55182 in hermetic, conformal and moulded packages.

A wide variety of power wire-wound fixed resistors are also offered for miniature pc board types to large shunts for current measurement.

For more information contact Promark Electronics in either Sydney or Melbourne.

## Precision Sensors

**D**eveloped for four-terminal current sensing and printed circuit board mounting, the 4LPC series of wirewound fixed resistors offers resistance values from 0.01-1 ohm with tolerances from  $\pm 5\%$  to  $\pm 1\%$ . Power dissipation is 3 W.

The 4LPC is designed for circuits where accurate sensing is required. It can be used in such applications as power supply regulation, motor controls, RF sampling, feedback control loops, and overload sensors.

4LPC resistors are encased in a steatite ceramic case using inorganic fill material, making them flameproof. Typical dimensions include a length of 23.5 mm, excluding terminals, a height of 10.5 mm excluding leads, and a width of 9 mm.

For further information contact Total Electronics, 9 Harker St, Burwood Vic 3125. (03)288-4044.



## Low energy inverters

**S**electronics has just released two new inverters for low energy fluorescent fittings operating from 12 and 24 volt supplies.

Standard models are available from 8 to 40 watts, but the

makers will accept special orders for 6-110 V operation.

For further information write to Ken Scott, Selectronic Components, 25 Holloway Drive, Bayswater Vic. (03)762-4822.

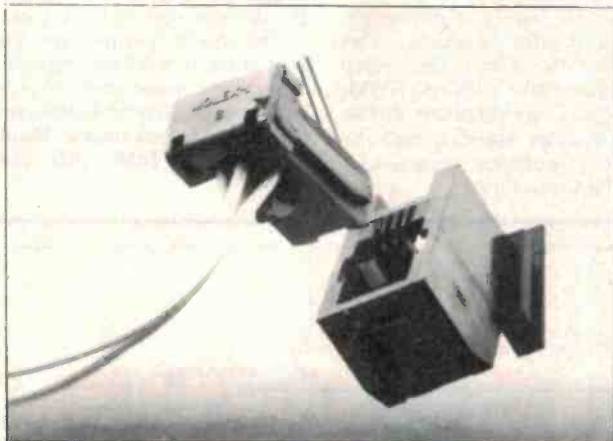

## Molex phone plug

**M**olex has released a range of new FCC-68 modular jack retainers and a receptacle housing for use with an FCC-68 telephone plug.

As well as its primary function for use in telephone connections, the module can, in fact, be used for a wide variety of applications. An insulation displacement termination version for 26 AWG top-coated stranded wires is available.

The jack retainer can be fitted to a variety of housings such as a

custom designed housing, a cavity moulded into customer telephone equipment or the Molex 90079 receptacle housing.

The 90079 accepts the 4- and 6-way Molex FCC-68 jack retainer and the modular telephone plug. Its front face can be custom designed and colours, other than the standard black, can be supplied to match the telephone shell. Like the jack, the receptacle is moulded of 94 V-VO polyester.

For more information contact Utilux, 14 Commercial Rd, Kingsgrove NSW 2208. (02)50-0155.

## Power plug

**U**tilux has begun marketing a new connection system of interest to designers of computer gear.

The Molex four-way pc board mounted power plug has been specifically designed to suit computer disk drive units.

It comes with phosphor bronze terminals, pre-plated with electro tin over copper, and has a friction lock to aid retention of the mating connector.

For more information contact Utilux, 14 Commercial Rd, Kingsgrove NSW 2208. (02)50-0155.

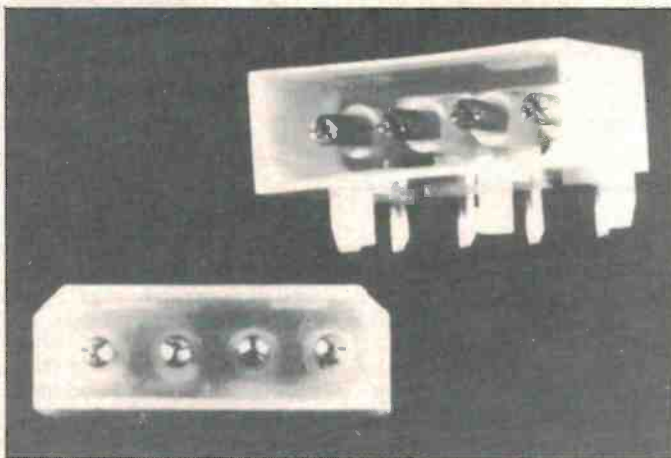

## IR LEDs

**P**romark Electronics has been appointed the distributor of the SFH 484 infrared LEDs from Siemens.

Peak output is at 880 nm, where it will deliver 900 mW/SR at one amp.

The device is housed in the standard 5 mm package with a half angle of about eight degrees.

Contact Promark Electronics, PO Box 381, Crows Nest NSW 2065.





# ACTIVE ELECTRONICS

289 LATROBE STREET, MELBOURNE 3000 PH. 602 3499

9am-5.30pm MON-THURS 9am-8.30pm FRIDAYS 9am-12noon SATURDAY

## NEW YEAR SPECIALS!

ALL YOU HAVE EVER WANTED IN AN ELECTRONIC STORE - AND MORE!

### MAIL ORDER HOTLINE. (03) 67 1312

### VERBATIM VEREX

12 MONTH WARRANTY  
5 1/4 SOFT SECTORED

**\$22.50/10**

SINGLE SIDED

DOUBLE DENSITY



### TOP DISKETTE PRICES

VERBATUM DATALIFE  
SINGLE SIDE

525-01 **\$26.50**

DOUBLE SIDE

550-01 **\$36.50**

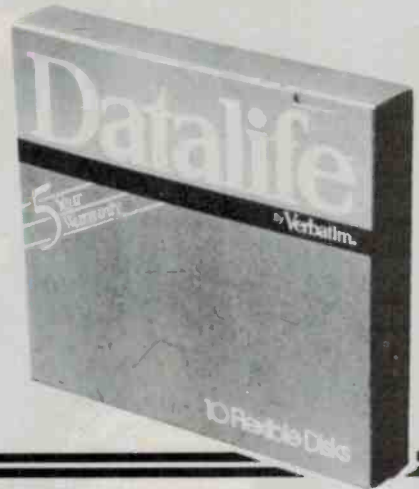

### MITSUBISHI DISK DRIVES

Mitsubishi 5 1/4 drives

M4851 500K 40 track D.D	only <b>\$215</b>
M4853 1M 80 track D.D	only <b>\$255</b>
M4854 1.6M 77 track D.D	only <b>\$339</b>
M4855 2 meg	only <b>\$384</b>

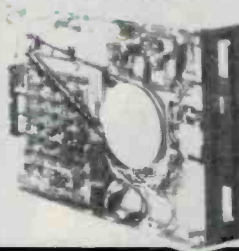

Mitsubishi 8" drives

M2896 Slimline	<b>\$570</b>
M2894 Standard	<b>\$545</b>

### 10 PACK SPECIALS



10 x 74LS00

**\$2.50**

10 x 4011B

**\$2.90**

10 x 2N3055

**\$6.50**

10 x 2732

**\$55.00**

10 x LM 555 TIMERS **\$3.50**

10 LM 741 OP AMPS **\$3.50**

10 x 4164 15ONS

**\$59.50**

10 x LM324

**\$4.00**

ALL PRICES INCLUDE SALES TAX

**\* NOW YOU CAN BUY YOURSELF COMPONENTS AT PRICES WELL BELOW THE NORMAL RETAIL PRICES. SO SAVE YOURSELF MONEY. SEND YOUR ORDER TODAY. ALL COMPONENTS ARE FULL SPEC BY LEADING MANUFACTURERS.**

PRICES CORRECT AT TIME OF PUBLICATION BUT SUBJECT TO CHANGE WITHOUT NOTICE:



BANKCARD VIA YOUR PHONE



### DATA BOOK

**\$5.00**

incl. post & packed to anywhere in Australia.

POST & PACKING FOR GOODS SENT BY STANDARD

MAIL IN AUSTRALIA ONLY		
Order Value		P & H
\$5	\$9.99	\$1.50
\$10	\$24.99	\$3.60
\$25	\$49.99	\$4.00
\$50	\$99.99	\$5.50
\$100 or more		\$7.50

MAIL ORDER

MAIL ORDER

MAIL ORDER

MAIL ORDER

MAIL ORDER

MAIL ORDER

MAIL ORDER

MAIL ORDER

MAIL ORDER

MAIL ORDER

MAIL ORDER

# What would you do,



# if:

IF you had to win the support and respect of thirty men and women whom you'd never met before?

IF you had to lead a platoon into unknown country for several weeks with their welfare your responsibility?

IF you had to act as a United Nations Truce Supervisor?

IF you had to handle the logistics for moving five hundred soldiers and their equipment across the continent?

IF you had to assist in directing the evacuation of a civilian population during a major civil disaster?

If you're undaunted by this kind of challenge, then you have the potential to become a professional Army Officer. It's a career in which you're regularly faced with new situations, new problems to solve and new challenges that test you both physically and mentally. But if you're equal to the task, you can achieve, at an early age, a level of executive management that few ever achieve in civilian life.

If you're a man or woman aged between 18½ and 23 on entry (or up to 25 with a degree or diploma), have your HSC or equivalent and the challenge of leadership appeals to you, contact Army Recruiting Centre or fill in this coupon.

**The 18 month  
Officer Training  
Course commences  
each July and  
January. See your  
Army Careers  
Adviser for  
closing dates of  
application.**

For more information post coupon to GPO Box XYZ,  
in your Capital city.

Sydney 2195555, Newcastle 263011, Wollongong 28 1855,  
Albury 552248, Lismore 21 6111, Canberra 822333,  
Melbourne 6979755, Geelong 21 1588, Bendigo 438008,  
Ballarat 31 1240, Brisbane 2262626, Townsville 724566,  
Adelaide 212 1455, Perth 3256222, Hobart 34 7077,  
Launceston 31 1005.

Name \_\_\_\_\_

Address \_\_\_\_\_

Postcode \_\_\_\_\_

Phone \_\_\_\_\_

Birthdate \_\_\_\_\_

Educ. Std. \_\_\_\_\_

**Army Officer. A leading profession.**

All enquiries treated in confidence

OCS 18. DPS 1184



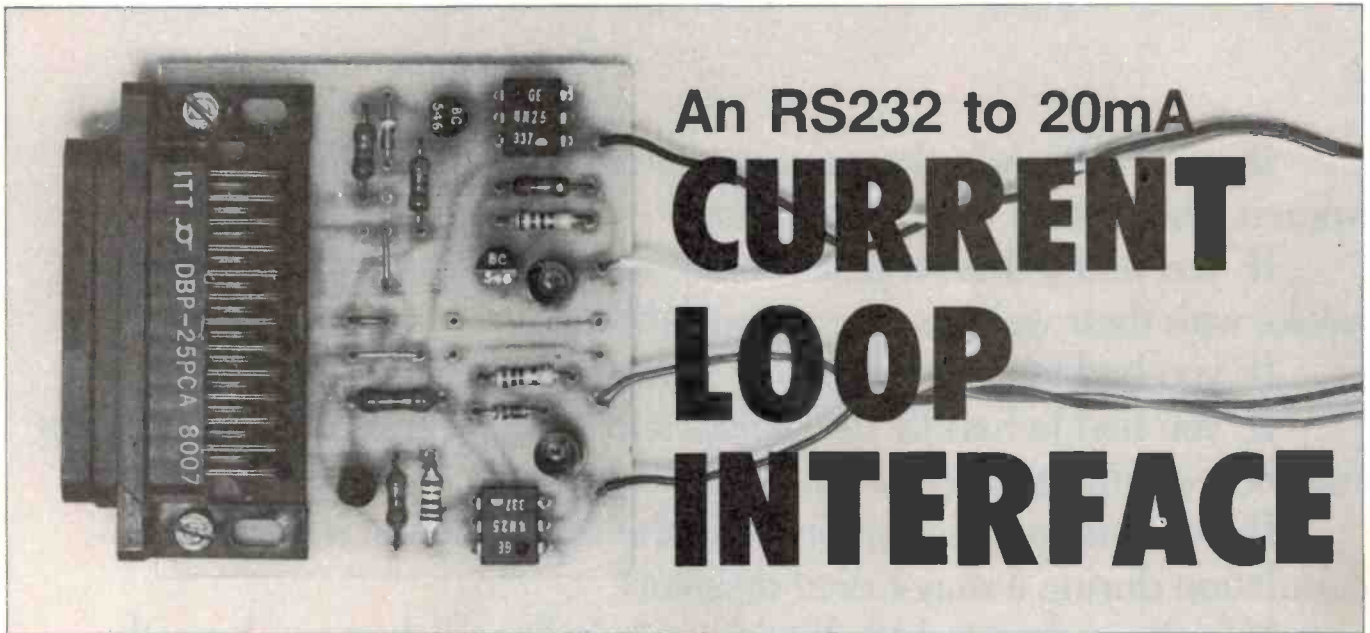

This project enables your computer to communicate with 'current loop' devices from its serial port.

Geoff Nicholls

MANY COMPUTER HACKERS built the early computer projects such as the ETI-632 VDU or (dare I say it) the EA 2650 computer series. These early projects used 20 mA current loops for their serial interfaces, and most are probably stuck away somewhere becoming dust encrusted. Why don't you dig the old beast out and see if it still works? You can run a Microbee remotely via the input/output redirection commands, or you can turn it into a terminal with the Net ROM or Telcom programs.

The interface uses opto-couplers to isolate the two transmission systems to the tune of 500 V. This allows complete flexibility in interconnecting the devices. Power is only required for the voltage-oriented RS-

232 side of the interface.

On the Microbee the power is taken from pin 9 of the RS-232 connector as 12 V is available there (on Series II and later 'Bees'). Other computers probably won't have this facility so the pc board has a link to select pin 9 or an external supply.

A 'proper' RS-232 receiver requires a negative voltage for logical one signals. Many modern computers will work with a 'one' that only goes to zero volts (the Microbee for example). To allow either option to be used, another link selects between the RS-232 signal ground and an external negative supply for the RS-232 driver.

The current loop side is purely passive and requires the device on the other end of

the current loop to provide the loop power supply.

There is one more link on the pc board to select the sex of the RS-232 interface. When RS-232 was first proposed it was intended to connect terminal devices to communications equipment such as modems. To enable a straight through cable to be used, two different pin standards were defined (hence the 'sex').

This was fine until people started using RS-232 connectors with equipment that was not either a terminal or a modem. These days a computer might be wired as either sex, so a pair of links has been provided to configure the RS-232 part of the interface as either sex. Note that R8 is actually the RS-

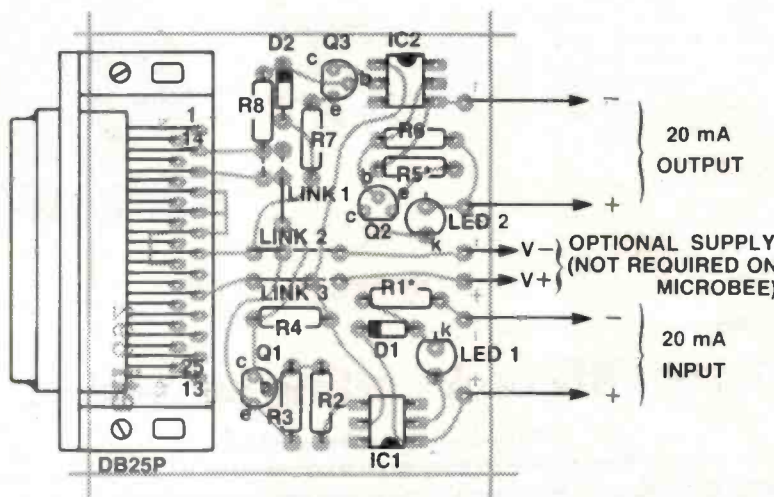

PARTS LIST — ETI-692

Resistors.....all 1/4 W, 5%

- R1, R5 ..... see text
- R2 ..... 10k
- R3, R7 ..... 1k
- R4 ..... 560R
- R6 ..... 27k
- R8 ..... 5k6

Semiconductors

- D1, D2 ..... 1N914
- LED1, LED2 ..... Red LED
- Q1, Q2, Q3 ..... BC547
- IC1, IC2 ..... 4N28

Miscellaneous

ETI-692 pc board; optional DB25P right angle pc mount plug.

Estimated price: \$14-\$16

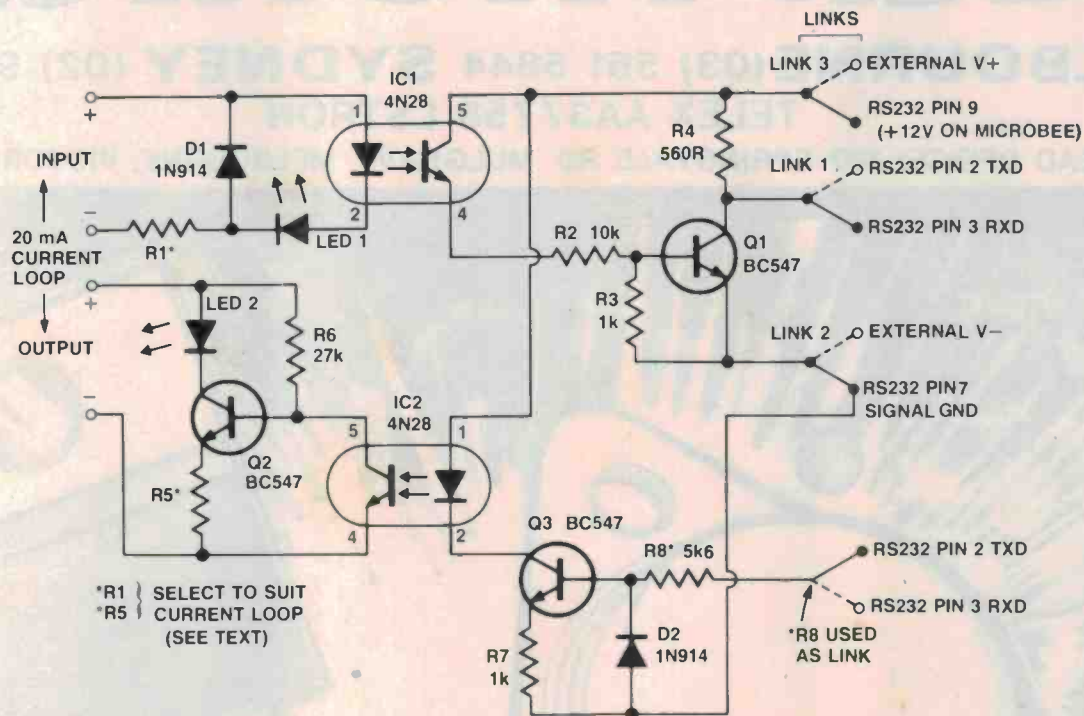

232 receiver link. [The logical solution to the 'sex' problem is to make all devices as Data Terminal Equipment (DTE), i.e.: pin 2 is always an output, and use cross-coupled cables exclusively].

### Setting up the links

Firstly, decide how to configure the links on the pc board. If your computer (or other RS-232 device) is set up as DTE then pin 2 of the connector will be an output and pin 3 an input. This is the case for the Microbee or a terminal. For a DTE device, R8 goes to the closest hole and link 1 also goes to the closest hole. The overlay shows the DTE connection as the solid lines.

To configure as DCE (Data Communications Equipment, such as a modem) then R8 and link 1 should go to the far holes.

If your RS-232 receiver can do without a negative voltage for logical 'one' then connect link 2 to pin 7 of the connector. This is shown on the overlay as the solid link. If an external negative voltage is required then put link 2 in the dotted position and connect the negative supply to the pad near the edge of the board. (The supply should be negative with respect to pin 7 of the RS-232. Any device needing the negative-going input will have a suitable supply rail with a common ground.)

The positive supply is already provided on Microbees at pin 9 (Series II and later), and in this case link 3 should be as shown on the overlay. Other computers or terminals may have a positive supply on some other pin that can be connected with a short wire. Once again, the supply should have a common ground in pin 7.

### Construction

Once the links have been sorted out the remaining components can be soldered in. If you are using a right-angle DB25P connector you should drill its mounting holes and bolt it down before soldering, to reduce any stress on the pins.

The only components to watch are the two ICs (the notches face away, toward the board edges), the 1N914 diodes and the LEDs, which should have the flats toward one another. The transistors' leads should go in without much bending.

The values of R1 and R5 have not been specified since they depend on the way the rest of the loop is wired. If you don't have data on the loop wiring then try around 180R for both to start with.

### Testing

Make up a temporary loop supply by connecting a 1k resistor in series with a 20 V dc power supply.

Connect the supply to the 20 mA output, observing the polarity. Plug into the computer and try setting and resetting the RS-232 output. I have provided a short program for the Microbee to test both input and output sections. LED2 should be on when the

### HOW IT WORKS — ETI-692

The equivalence of the various signal standards is shown in Table 1. When the RS-232 output line is positive Q3 will be on and about 10 mA will flow through the LED in optocoupler IC2. The transistor in IC2 will be on, thus pulling the base of Q2 down, turning it off. Under these conditions the loop current will be set by R6, and will be under 1 mA, or essentially zero.

When the RS-232 line is 0 V or negative the optocoupler transistor will be off, and R6 will bias Q2 on, passing the 20 mA or so loop current through LED2.

The input loop current flows through the LED in IC1 and also LED1. Diode D1 prevents reverse breakdown of either LED from reversed loop polarity. If the loop current is flowing then the transistor in IC2 will pass base current for Q1 thus dropping the RS-232 driver output down to the negative rail, as selected by link 2.

When no loop current is flowing R3 will keep Q1 turned off and the RS-232 output will be pulled positive by R4.

The handshaking lines RTS, CTS, DSR and DTR on pins 4, 5, 6 and 20 respectively are tied together to ensure the RS-232 port is always active. It was beyond the scope of the project to convert these to X-ON, X-OFF protocol!

LOGIC LEVEL	TTL	RS-232C	20 mA
'ZERO'	0 to 0.8 V	5 to 15 V	0 mA
'ONE'	2.4 to 5 V	-5 to -15 V	20 mA

TABLE 1. Transmission standards

# ELLISTRONICS

PTY.  
LTD.

MELBOURNE (03) 561 5844 SYDNEY (02) 922 3220

TELEX AA37758 LSTRON

HEAD OFFICE: 797 SPRINGVALE RD. MULGRAVE, MELBOURNE, VICTORIA 3170

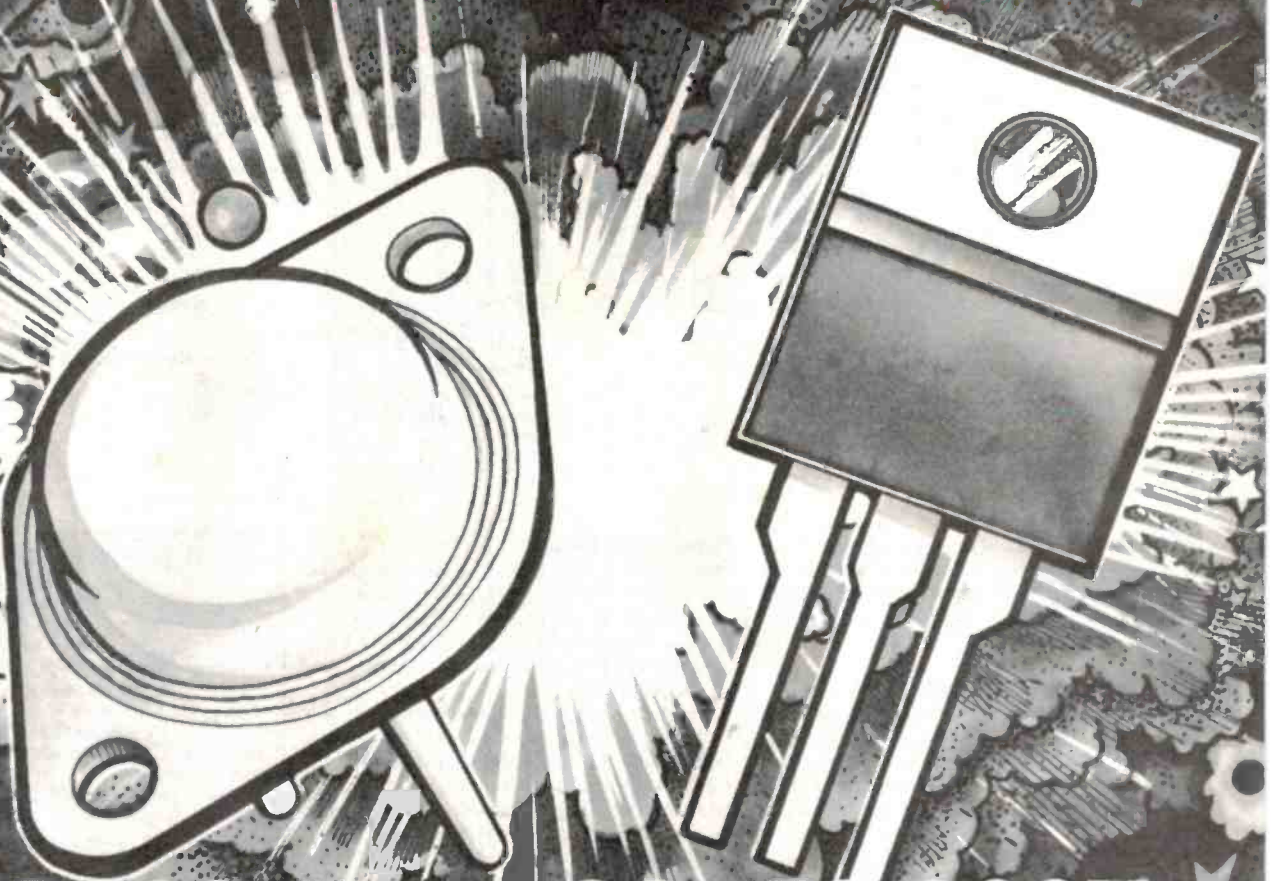

## FRP800 Series 8A, 50-200V

- Ultrafast 35 ns Recovery Time
- Soft Recovery ( $S > 0.5$ )
- Low  $I_{R(REC)}$
- 150°C Operating Junction Temperature
- Popular DO-220 Package

PRICES PLUS SALES TAX  
IF APPLICABLE

# FRP805 - \$1.24

min. quantity 100+

ELLISTRONICS NOW IN SYDNEY - 922 3220

# ELLISTRONICS PTY. LTD.

MELBOURNE (03) 561 5844 SYDNEY (02) 922 3220  
TELEX AA37758 LSTRON

HEAD OFFICE: 797 SPRINGVALE RD. MULGRAVE, MELBOURNE, VICTORIA 3170

## POWER

### FRP800 Series 8A, 50-200V

- Ultrafast 35 ns Recovery Time
- Soft Recovery ( $S > 0.5$ )
- Low  $I_{R(REC)}$
- 150° C Operating Junction Temperature
- Popular DO-220 Package

FRP805 - \$1.24  
FRP810 - \$1.44  
FRP815 - \$1.54  
FRP820 - \$1.75

### FRM/FRP1600 Series 16A, 50-200V

- Ultrafast 35 ns Reverse Recovery Time
- Soft Recovery ( $S > 0.5$ )
- Low  $I_{R(REC)}$
- 150° C Operating Junction Temperature
- Popular TO-3 and TO-220 Package

FRM1605 - \$4.14  
FRM1610 - \$4.60  
FRM1615 - \$4.87  
FRM1620 - \$5.08

### FRP1600CC Series 16A, 50-200V

- Ultrafast 35 ns Reverse Recovery Time
- Soft Recovery ( $S > 0.5$ )
- Low  $I_{R(REC)}$
- 150° C Operating Junction Temperature
- Popular TO-220 Package

FRP1605 - \$1.75  
FRP1610 - \$2.07  
FRP1615 - \$2.17  
FRP1620 - \$2.49

### FRM3200CC Series 32A, 50-200V

- Ultrafast 35 ns Reverse Recovery Time
- Soft Recovery ( $S > 0.5$ )
- Low  $I_{R(REC)}$
- 150° C Operating Junction Temperature
- Popular TO-3 Package

FRP1605CC - \$2.07  
FRP1610CC - \$2.32  
FRP1615CC - \$2.53  
FRP1620CC - \$2.79

FRM3205CC - \$4.60  
FRM3210CC - \$4.77  
FRM3215CC - \$5.19  
FRM3220CC - \$6.01

Prices shown are for minimum quantities of 100+ each device - Larger quantities : prices on application. All prices correct at publication date.

PRICES PLUS SALES TAX  
IF APPLICABLE

**FAIRCHILD**

A Schlumberger Company

# Project 692

RS-232 output is 0 V (or negative) and off when the output is positive.

Connect the temporary loop supply to the 20 mA input through a switch and read the RS-232 port (or run the Input Test Microbee program). Toggling the switch should flash LED1 and change the RS-232 input's state.

Once the unit passes these tests it's ready to use!

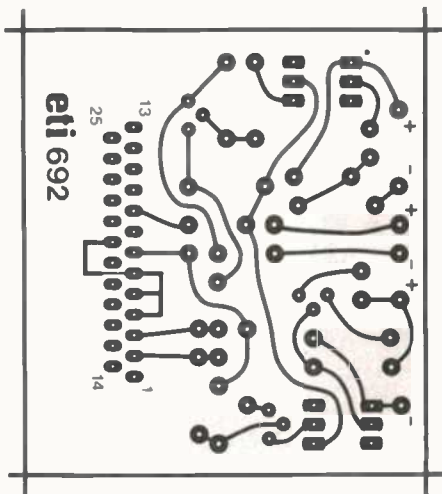

## PROGRAM LISTING FOR MICROBEE

Connect a 1k resistor in series with a 20 Vdc power supply to power the input and output 20 mA loops. Type in and run this test program. Note that the input test is slow to respond to changes due to the code required to isolate the RS-232 bit from the other bits in the Z-80 PIO port. This is done by the code from line 240 to line 270.

```

00100 REM *** Test Program ETI-692 ***
00110 REM Written in Microworld Basic
00120 REM By Geoff Nicholls, ETI
00130 PRINT "Output Test"
00140 PRINT "Press ESC then RETURN to run Input Test"
00150 PRINT " Just press RETURN to toggle output."
00160 CURS 960:PRINT"LED 2"
00170 CURS 966:OUT 2,32:INPUT" on";A00;
00180 IF A00=CHR0(27) THEN 210
00190 CURS 966:OUT 2,0:INPUT"off";A00;
00200 IF A00(<)CHR0(27) THEN 170
00210 PRINT\\"Input Test"
00220 CURS 960:PRINT"LED1";
00230 A=IN(2)
00240 FOR N=7 TO 5 STEP-1
00250 B=INT(2^FLT(N));A=A-B
00260 IF A<0 THEN LET A=A+B
00270 NEXT N
00280 IF A>15 THEN LET L00="off" ELSE LET L00=" on"
00290 CURS 966:PRINT L00;CHR(13);
00300 GOTO 230
00310 END
    
```

# MAIL-ORDER Madness! FREE PACK POST THIS MONTH ONLY!

**TV ANTENNA AMPLIFIERS**  
You don't have to have lousy TV reception; our all band signal booster may fix your problem. 2 types avail for UHF/VHF/FM bands, newly designed for Aust channels.

**MASTHEAD MODEL** mounts onto the antenna bracket, 75/300 ohms input, 75 ohms output, inbuilt VHF/UHF mixer, 24dB gain on VHF, only...\$59.00

**INDOOR AMPLIFIER/SPLITTER**  
6dB gain, 75 ohms input, 2x 75 ohms outputs, ideal for TV or FM, home, caravan or boat, 12VDC & 240VAC \$24.50

**TV ANTENNA SWITCH-BOX**  
Lots of applications for this changeover switch in a metal box with input/output 75 ohm connectors e.g. interchange 2 aerials, or 2 TV sets or VCR or video game or home computer etc...\$4.95

**VOX CONTROL UNIT \$19.50**  
Voice activated remote control unit starts/stops most cassette recorders which have a microphone on/off switch, adjustable sensitivity, battery operated.

**TELEPHONE VOX UNIT \$9.50**  
Ideal for phone line monitoring, starts/stops cassette recorders which have a mike switch; record phone conversations easily (not approved for Telecom lines).

**NEW PROFESSIONAL**



**ALARM CONTROL UNIT**

Similar alarm boxes sell for upto \$199. Built for Aust. home, office, factory!  
● Heavy duty steel cabinet (lockable).  
● Sophisticated & versatile circuitry.  
● Adj. entry, exit & adj. reset delay  
● N.O./N.C. instant, N.C. delay ops.  
● Inbuilt siren, add horn speaker(s).  
● 6x LED status indicators, all modes  
● Inbuilt 24hr panic or fire circuit.  
Lots more features, send for brochure

**CAR ALARM INDICATOR \$7**  
Twin high-brightness LEDs, alternately F-L-A-S-H-I-N-G will probably scare off any burglar, even if you don't actually have an alarm. The black metal box is easily inst'd under dash, 12V...\$7

**STEREO SIMULATOR...\$30**  
For TV, VCR etc, active electronic circuit (not passive R's and C's), simulates stereo from any mono source. It's actually, very hard to distinguish from the real thing! Adds a new dimension to your TV sound; 240V AC; Was \$59.95, now...\$29.95

**24HR TIME SWITCH \$19.95**  
There are many timers avail but the Arista one is fully programmable and offers any combination of half-hourly ON/OFF periods daily and switches 10 Amps; SEC app'd

**SCOOP BUY! HALF PRICE ALARM CONTROL BOX - JUST \$99 Built/tested.**

Similar alarm boxes sell for upto \$199. Built for Aust. home, office, factory!  
● Heavy duty steel cabinet (lockable).  
● Sophisticated & versatile circuitry.  
● Adj. entry, exit & adj. reset delay  
● N.O./N.C. instant, N.C. delay ops.  
● Inbuilt siren, add horn speaker(s).  
● 6x LED status indicators, all modes  
● Inbuilt 24hr panic or fire circuit.  
Lots more features, send for brochure

**"HANDS-FREE" INTERCOM**  
An FM Wireless Intercom not just new, but it works so well! Voice-controlled 3 CH master stations; connect as many as you wish for multi-user operation. Also touch-pad manual control, 400 mts range, 240V AC. Pair \$79.00

**VIDEO CAMERA CABLE**  
We have it in stock now! A high grade, flexible cable, grey PVC covered, 2x 75 ohm video, 2x shielded microphone, 6 other colored wires, suit Beta or VHS...\$3.95/m 10 pin VHS plug or skt \$14. 14 pin Beta plug or skt \$19.

**CENTRONICS PLUGS \$8.75**  
Many dealers sell Taiwanese plugs, but we have genuine U.S.A. Amphenol plugs with 36 gold-plated contacts at just \$8.75 ea. (usually \$12 to \$15 in other stores).

**12V PCB MINI-DRILL \$10**  
If you don't have your own PCB drill, now's the time to buy! Powerful 6000 RPM for precision drilling with 1.0mm drill incl. 12V DC 1A power supply to suit.\$19.95

**SOLDER SCOOP BUY!**  
We've just bought a large quantity of best quality, resin-cored solder at cheap prices, which we pass on to you. Choose 1.0mm or 0.7mm Per metre.....50¢ or Bulk pack 200gms.....\$4.95

**FLOPPY DISK CLEANERS**  
Are you losing data due to dirty heads? Clean disk drives regularly (weekly or monthly), with these Arista non-abrasive "wet" disk pad kits; for single or double sided drives, takes 20 secs 5 1/4" set, 6 discs now \$19.50 8" set, 6 discs now \$24.95

**NEW DE-SOLDER PUMP**  
Non-conductive, specially designed to combat static damage to ICs when desoldering; a must for digital designers and servicemen. Long life ceramic tip \$14.50

**HEATSHRINK PACK...\$4.50**  
For kit-builders, hobbyists etc, various colours and diam, 14 pcs totaling 1.4m of high grade PVC spaghetti which shrinks upto 50% diam when heated. Fully imported

**FULL AUTO CAR AERIALS**  
Wouldn't it be a good idea if your motorised antenna only went up or down when you turned your radio on or off? Well, we have them in stock. An in-built detector suits all types of radios, easily fitted, 12V. Now \$39

**AM/FM AERIAL BOOSTERS**  
For car radio, boat, etc. 2 new models just in, amplify the signal picked up by the antenna; actually doubles the signal strength, clear noise-free reception, 12VDC AERIAL + BOOSTER...\$12.50 IN-LINE BOOSTER only...\$8.00

**PIEZO TWEETER...\$12.50**  
100 Watt rating super-horn, rectangular, flared, needs no crossover, 3KHz-30KHz, 8 ohms, wide dispersion. New!

**SPEAKER X'OVER NETWORKS**  
A new shipment of these popular crossovers just landed! All suit 8 ohm system  
2 way 60W 3500Hz 6dB \$3.95  
3 way 60W 800Hz, 5KHz \$7.95  
3 way 100W 800Hz, 5KHz \$19.50

**ATTENUATORS DISCOUNTED!**  
Genuine L-Pads for constant impedance, high quality.  
LA-1 Mid-Range 180rms \$4.30  
LA-2 Tweeter, 180rms \$7.95  
LA-3 G.P. use, 100W \$10.65  
LA-4 G.P. 2-gang 100W \$17.75  
LA-5 Mid-range/Tweeter with 5x LEDs 180rms \$13.45

**PRE-PAK electronics p/1**

**1a WEST ST, LEWISHAM, NSW**

**569-9797**  
24 HR PHONE ORDER SERVICE

**Phone or mail order BANKCARD accepted**



**Special  
Reader  
Offer!**

# GET YOUR COMPUTER TALKING!

**ONLY \$75!** ready-built and operating board. Just attach your own speaker and a connector to suit your computer and it's ready to rave!

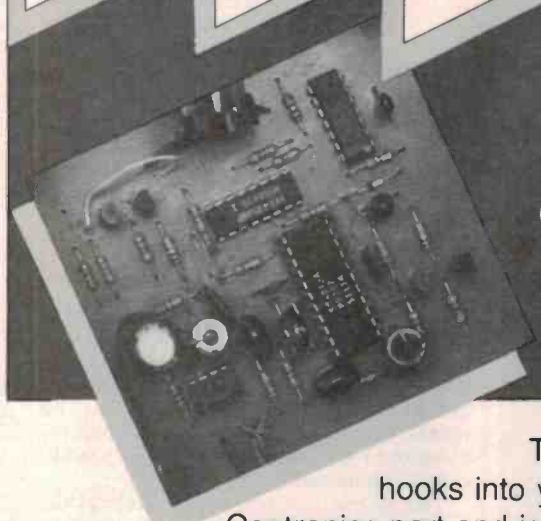

The **CHATTERBOX** just hooks into your computer's parallel or Centronics port and is programmed quite simply as explained in Tom Moffat's article. Never before has true voice synthesis been offered so cheaply. Here's an unbeatable opportunity to get into this fascinating facet of computing. And the best part is — you don't have the potential hassles and anxiety of building it up — **the project arrives ready-built!**

All that's left for you is to add a speaker and connector to suit your computer's port (as these vary from model to model, we have to leave it to you). You might need to arrange a suitable power supply (a plugpack's great!) unless you can tap into your computer's supply rails.

**The ETI-677 CHATTERBOX Voice Synthesiser Project**

was developed by Tom Moffat, well-known to ETI readers, who is Development Engineer for Flexible Systems, makers of the Tasman Turtle and Turtle Tot educational robots, which they export to Europe and the US. The project was designed around the Votrax SC-01 voice synthesiser chip. But that presented a problem — there was no Australian distributor for it when the project was first mooted. After some considerable footwork on the part of Flexible Systems, they managed to obtain an agreement with the Federal Screw Works (true!), manufacturers of the SC-01 chip. With supply assured the project was ready to roll. But in the past, voice synthesiser projects proved not terribly popular. They were relatively expensive; some gave limited realism, others had limited vocabulary. Perhaps the concept was 'too early'. So, to 'sweeten the deal' and to encourage the inveterate 'hacker' into the ground floor of a computing field that is rapidly burgeoning, **Electronics Today** and **Flexible Systems** devised this special offer, **exclusive to ETI readers**. Flexible Systems would normally sell this product for \$90, but for **the next three months** they will offer it to readers for the fabulous price of **just \$75!**

**Sweet enough?  
Don't delay  
— send the coupon today!**

Offer closes last post 31 March 1985

**FEDERAL MARKETING ORDER FORM**

*Yes! I don't want to miss this opportunity! Please rush me ..... ETI-677 Chatterbox Voice Synthesisers at the great price of \$75 plus \$2.50 post and handling.*

Name .....

Address .....

Postcode .....

Signature .....

(Unsigned orders cannot be accepted.)

American Express  Bankcard  Cheque\*

\* Please make cheques payable to the Federal Publishing Company Pty Ltd.

Credit Card No: .....

Card Expiry Date: .....

Send completed coupon to:

Federal Marketing, PO Box 227, Waterloo NSW 2017.

# THE CHATTERBOX

Computer voice synthesiser

Tom Moffat

39 Pillinger Drive, Fern Tree, Tas.



Until the Chatterbox, voice synthesis for the inveterate computer hacker involved either economically out-of-reach hardware or an unsatisfactory software fudge. This project solves all that. And if you want to get into it at the rock-bottom price, a kit is available on special offer.

THE MIGHTY MICROBEE can do just about anything else, so you may as well teach it to talk. Imagine the thing jabbering away through some space game, warning you of impending perils; or announcing the results of calculations, instead of just displaying them on the screen. All these things are possible with the device to be described, nick-named the "Chatterbox". As well as the Microbee, the unit should be useful with other computers that use a "Centronics" printer port.

Just another speech synthesizer? Not really, it goes a bit deeper than that. There's synthesizers, and then there's synthesizers. Perhaps an explanation is in order. Anyone wanting a full-scale discussion of the subject should read the article on the Turtle Talk speech synthesizer by Allan Branch in September 1982 ETI. This gave a complete run-down on the theory of getting human speech into and out of a computer.

## Synthesis techniques

Speech synthesizers come in three basic types. There's *waveform digitization*, used in National's 'Digitalker' chip set (not to be confused with a Microbee program called "Digitalker"). National's system was used in Flexible Systems' Turtle Talk speech board. Another method is *Linear Predictive Coding*, used in the Texas Instruments "Speak and Spell". The third method is *Phoneme Reconstruction*, used in the Votrax SC-01 synthesizer chip, the basis of the ETI-677 Chatterbox.

The Digitalker system is generally recognized as providing the very best speech quality, but at a price . . . the vocabulary has to be stored in advance, in read only memory, so it's limited to a few hundred common words at the most. Unless you can incorporate (and afford) heaps of ROMs.

Linear Predictive Coding is much the

same. The words that are stored were originally spoken by humans, and then squashed down to fit in the ROMs. So any words are possible, in any language, even those African languages that have decidedly non-English (!Kung) sounds. But any non-standard word list must be manufactured by the thousands to be economically worthwhile.

## Electronic vocal tract

The Votrax system, on the other hand, generates human-like sounds in an electronic model of the human vocal tract. The programmer has available a list of sounds which are strung together to make words. This means just about any word is possible by using the right combination of the sounds, called "phonemes".

The Votrax is a true synthesizer, as the words it speaks and the phonemes it generates have never been spoken by humans . . . they're cooked up, on the spot, strictly by electronic means. The quality of speech generated by the Votrax isn't quite up to that of the "stored speech" systems. It sounds exactly like you'd expect a computer to sound, speaking in a mechanical monotone (although the Chatterbox design overcomes this somewhat by using "inflection" inputs). People who hear the Chatterbox for the first time say it sounds like it's got a bad cold. But it's the only system that can say those well known television robot phrases like "EXTERMINATE!" (Dr. Who) and "Hello Sexy Bum, Boogie-Boogie" (Metal Mickey). Any serious computer hacker will realize that the ability to say these phrases (and certain others) is quite valuable.

## How it works

The phonemes are generated in the Chatterbox by sending it 8-bit words through the computer's parallel port. Bits 0 through 5 tell the Votrax chip which phoneme is required. This remarkable chip strings the phonemes together and adds a kind of "automatic inflection" to the resulting phrase. Bits 6 and 7 of the control word can be used to force an inflection. The two bits allow four levels of inflection to be expressed. In the BASIC version of the Chatterbox software, bit 6 is set high and 7 is set low, producing inflection at the second level. With some fiddling, bit 7 can be set high as well, making the Chatterbox bellow with a strong sense of urgency (EXTERMINATE!). Or you can set bit 6 low in the second phoneme of a phrase like "Oh'oh", making it inflect downwards.

The synthesis process is triggered off by a strobe pulse from the computer, and the Chatterbox sends back a busy signal to the

computer while it's speaking. This "hand-shaking" system is put to a useful purpose in the machine code version of the software.

The Votrax chip contains its own clock circuit, with the clock speed being controlled around a nominal 720 kHz by RV1. Changing the control raises or lowers the pitch, and the speed, of the speech. You set it to your preference. The other control, RV2, is the volume control to the LM386 audio amplifier, IC4.

Two sections of IC2, a 4001 NOR gate, invert the "inflection" signals, which are inverted again in the two transistors that change the logic levels to those required by that part of the SC-01. The other two sections of IC2 are used to change a positive-going strobe signal from the computer into a trigger pulse of about three microseconds for the SC-01. The Microbee holds the RDY line high for the duration of the phoneme; Centronics ports pulse the line low, so the SC-01 begins speaking on the end of this pulse.

The SC-01 sends its A/R line low for the duration of each phoneme. This means the chip is in total control of speech timing if the computer monitors the state of A/R and sends the next phoneme to the SC-01 when the line goes high. In the Microbee a low-to-high transition on BSY triggers an interrupt, a feature that is put to good use in the machine code version of the software. Centronics ports want BSY the other way around. The logical levels from the SC-01 chip are once again wrong, so two more transistors are used to "invert and convert". You use both transistors for the Microbee, but take the signal out after the first one for Centronics ports.

IC3 is simply a buffer to make sure no part of the SC-01 is exposed to the nasty influences of the outside world. P0 through P5 on the SC-01 could have been fed directly since they will respond to +5/0 volt logic levels. But considering the high cost of an SC-01 chip, a 4050 was considered cheap insurance.

The SC-01 power supply can be anything between 7 and 14 volts, so power can be pinched directly from the computer. This voltage is regulated down to 5.6 volts by a simple zener diode arrangement to supply the "logic level" circuits. Being CMOS or simple transistors their current drain is next to nothing.

To use the Chatterbox on a Microbee, you'll need to see that 12 V is available on pin 9 of the parallel port. Check with a multimeter. Series II and III 'Bees have it, but not Series I. If you have the early model, make the following modification.

Under the 'Bee's main circuit board, run a wire from pin 9 of the parallel port connector to the 'Bee's (nominal) +12 volt line. You'll probably find it closer to nine or 10 volts with a fair bit of ac ripple on it (which is why there's so much filtering in the Chatterbox). A good place to tap off the voltage is directly from the filter capacitor. If you don't want to attack your 'Bee in this way

you can power the Chatterbox from a small 9 volt plugpack.

Many computers, such as the Apple, have a 12 volt supply brought out to a slot or expansion interface connector. Some, such as the Commodore 64, provide a 9 volt ac supply that can be rectified to power the Chatterbox.

Well, so much for the hardware. Let's get into the good stuff, making the thing talk.

### Blah-blah-blah

Early attempts at using the SC-01 were fraught with frustration. I wrote a BASIC program to send a short series of phonemes out the parallel port. The Microbee promptly locked up because it wasn't getting its strobe signal back from the SC-01. Eventually the project progressed to the stage where the SC-01 would say such things as "SSSSS" and "AHRRR" and "OOGLE-OOGLE" as "Syntax error" popped up.

Then one night it said "Whiskey"!

That was a real shock. It was as if my dog had looked up at me and said "Whiskey". You know what the chip's meant to do but it's still a real thrill when the thing actually talks for the first time. The wonders of modern technology!

Soon the Chatterbox, haywired together on proto-board, was rattling off the names of everyone in the family, including the dog, but it wasn't very good. It seems that programming the Chatterbox is like playing the saxophone. Your early attempts might produce something recognizable, but they sound bloody awful. Practice, practice, and more practice will soon bring your efforts up to standard.

To make the programming task easier, we now present the CHATTERBOX PHRASE COMPOSER program; for the Microbee it's Listing 1, for the Apple, it's Listing 2.

Let's take the Microbee first. When the program is first run, the Chatterbox should say "testing". Hit and key except <ESC> and <P>, and the Chatterbox will repeat "testing" and the phonemes responsible for it will appear on the screen. Hit <P> and the phonemes, and an ASCII string, will be sent to a 1200 baud printer and shown on the screen as well.

The ASCII string is the finished product of the composer program. Every character in it can be generated by the Microbee's keyboard ("—" is shift/delete). When you want the phrase you've just composed to be

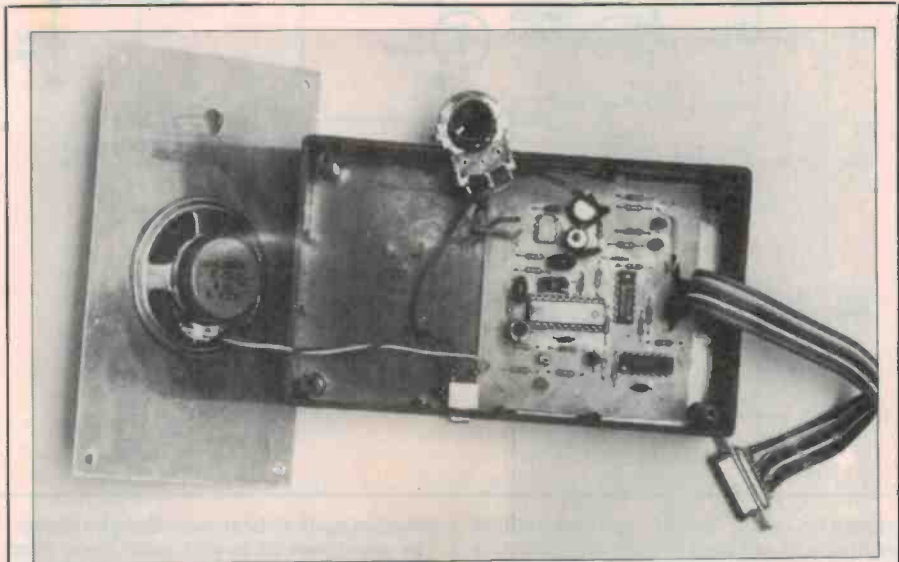

**Bunged in a box!** This project is different. You get your pre-built board from Flexible Systems (see Special Offer), hookup a speaker, the volume control and computer interface connector, bung it all in a box — and start talking! ETI's prototype was housed in a standard zippy box measuring 158 x 95 x 53 mm. The front panel was dressed up with a Scotchcal label. Audio output is a few hundred milliwatts so volume from the 50 mm speaker is quite low. It works much better into a larger, more efficient speaker in a proper enclosure. A test on the ETI-1422 4-speaker PA brought most of the staff crowding into the ETI lab!

To house the unit as shown, drill several large holes about the centre of the panel, where the 50 mm speaker is to mount. Also drill a hole for the volume control — using the front panel artwork as a guide. Drill a hole in the side of the case for the external speaker socket and mount it. Apply the Scotchcal over the panel and cut out the *volume pot hole only*. The sound from the speaker goes pretty well straight through the Scotchcal. Complete the wiring up, file a slot in the box to let the ribbon cable pass through, and screw it all together. The box we used, from Altronics, has "press-fit" things on the walls so the board need not be bolted in place. Just push it in!

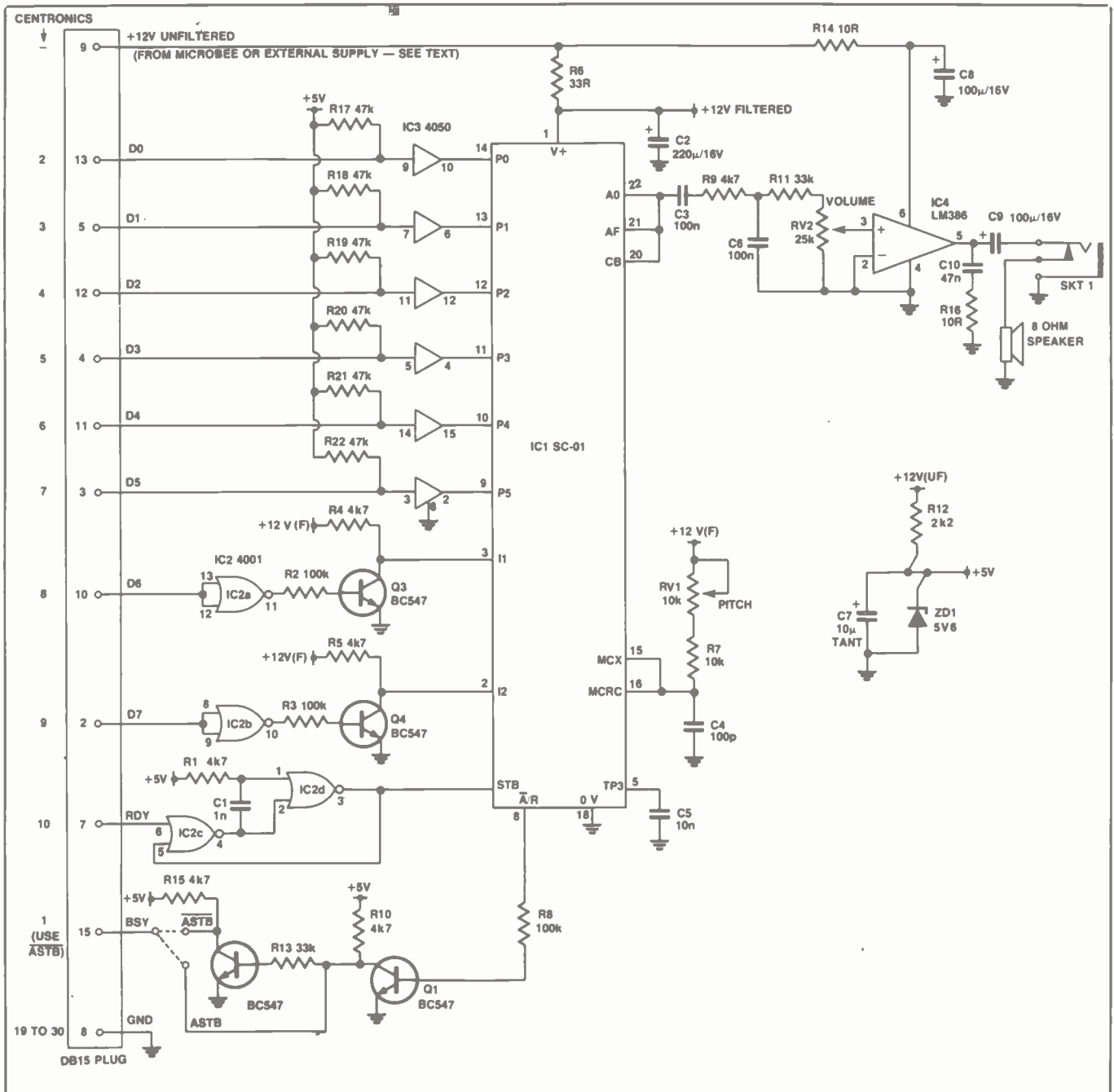

spoken in some BASIC program you're writing, you initialize the parallel port near the start of the program with "OUT#1" and then LPRINT the ASCII string every time the phrase is to be spoken. What could be easier? The ASCII character that represents each phoneme is shown in the second column of the phoneme list (see accompany panel).

The Phrase Composer looks up the ASCII characters for you (using a binary search) and then lets you hear the phrase. Now here comes the good bit: If you press <ESC> the screen will display:

```
00150 A0$="T EH S T I NG"
```

The Microbee is now in the EDIT mode and you can chop and change your phrase, as A0\$, to your heart's content. You RUN the

program again to hear your changed phrase. The phonemes of course must come from the list, and they must be separated by one space. If you mess something up in this area the Chatterbox will tell you all about it!

You'll notice that the ASCII string coming out of the program has a tilde (~) at the start and finish of the phrase. This is a pause, and it's necessary for proper operation of the synthesizer. If you leave it off you'll notice the speech sounds clipped. You should also turn off the the synthesizer with the *shut-up* code (3F) when finished. Also, terminate all the BASIC "LPRINT" lines with a ";". This suppresses the RETURN signal which would otherwise turn the Chatterbox back on with an "AHHH" sound.

Listing 2 is a Chatterbox phrase composer program for the Apple II. This pro-

duces a similar result to the Microbee phrase composer, although the details of operation have had to be changed somewhat to work within the syntax of Applesoft BASIC. In this case the Chatterbox is driven via a serial card and a "serial to Centronics" converter (see ETI, January '84, Project 675, pages 52-55).

The Apple program uses the normal Apple edit keys, <CONTROL> I, J, K, and M to edit the phoneme string. You print the results (on the screen only) with <CONTROL> P <RETURN>, and bail out of the program with <CONTROL> C <RETURN>.

Now, just to see how all this works, let's arm ourselves with the phoneme list and compose a phrase. Assume that our new BASIC program is to issue an appropriate verbal insult, possibly as a result of an "ON

ERROR GOTO 1000" statement. We will now work out what line 1000 is to be.

Let's start by entering the phrase in proper English spelling, with the phonemes separated by spaces and the words separated by pauses. Run the program, and replace "T E H S T I N G" with:

**B I T E P A I Y O U R P A I B U M**

Now RUN, and the Chatterbox will respond with "BITTEY, YEWER, BOOM". That's not right at all. Let's butcher the phrase a bit, and enter it more like it sounds:

**B A Y T P A I Y E R P A I B U H M**

That comes out as "BITT, YER, BUM". Pretty close, but the first word is still wrong. We know (have learned from experience) that the "AY" as in "tie" can be produced with a combination of two phonemes. Lets try it:

**B A H I I 2 T P A I Y E R P A I B U H M**

That's pretty good, but the Chatterbox is still saying the phrase as three unrelated words. We want "BITEYERBUM" so lets take the pauses out:

**B A H I I 2 T Y E R B U H M**

Spot on! The sweet sound of success. Now we hit the <P> key, and we get on the printer, and the screen:

PHONEMES:  
B A H I I 2 T Y E R B U H M

ASCII:  
NUJjizNsL

So line 1000 in our new program will look like this:

01000 LPRINT " NUJjizNsL ?";

And of course, near the start of the program we use an "OUTL#1" to initialize the parallel port.

To further demonstrate the capabilities of the Chatterbox, we present in Listings 4 and 5, "Sayings of the Daleks", in both Apple and Microbee versions. If you are a young keen computerist, this program will *drive your parents mad!* If you are a bit older you will drive *yourself mad.*

The program makes the Chatterbox rattle off some of the more familiar (and silly) utterances from those nasty little creatures of the Dr Who television series. All of the data in this program were collected from one episode of Dr Who. It was a particularly good night for Daleks and I spent the whole time scribbling "quotes" as fast as I could into my trusty reporter's notebook.

"Sayings of the Daleks" are spoken without external inflection because, well, that's the way Daleks speak! Both programs print the text onto the screen as the Chatterbox speaks. The Microbee program uses ASCII strings to store the phoneme data; these can be seen in the program listing directly below the text of each sentence to be spoken. The

**NOTE:** The printed circuit board artwork is copyright to Flexible Systems and is thus not reproduced here. The project is available, in kit form only (as a ready-built board), from Flexible Systems, 217 Liverpool St, Hobart, Tas. 7000. (See Special Offer, this issue.)

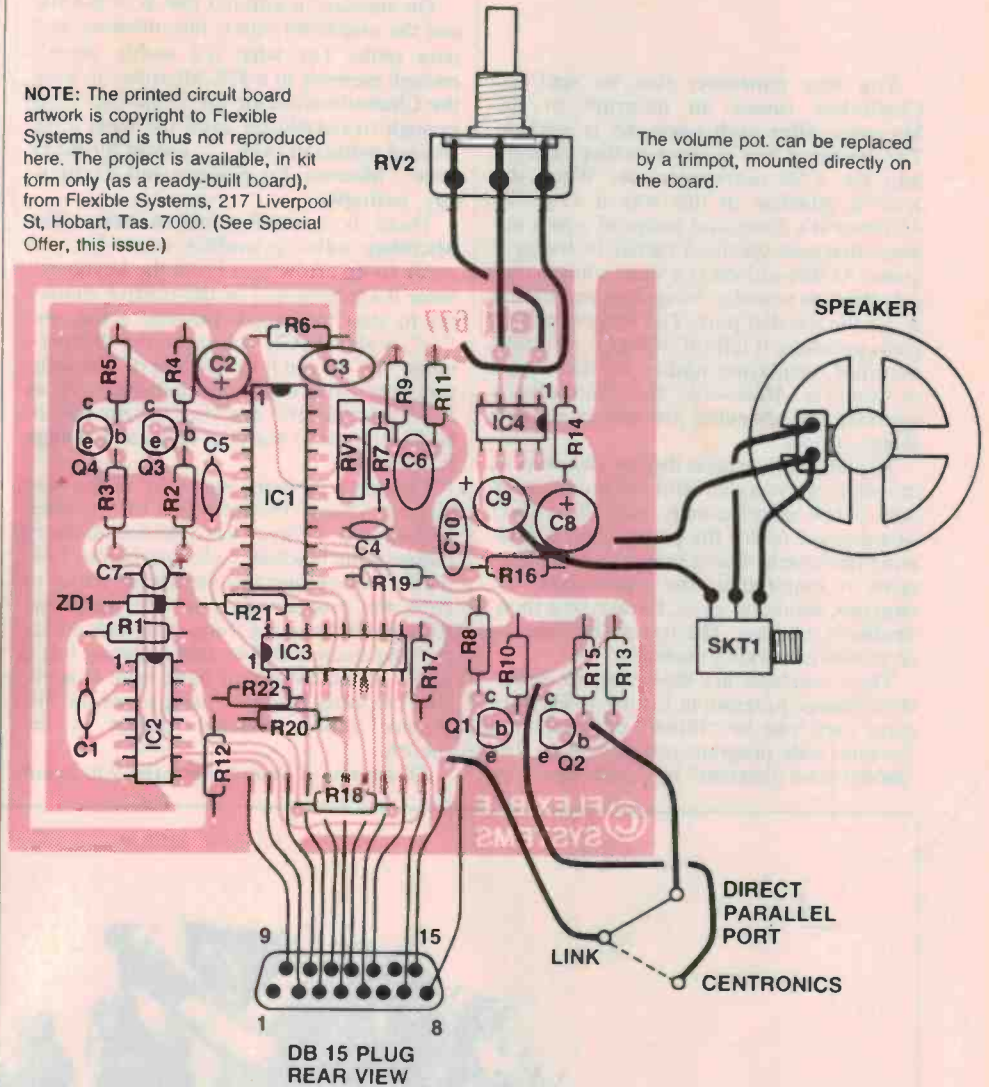

Apple program uses phoneme numbers in DATA statements to generate the speech.

If you use the BASIC editing program for long, you'll notice you seem to be spending an awful lot of time waiting for something to happen. You will also notice that it's not possible to use the Chatterbox inflection inputs when making it speak unmodified ASCII strings. However, there is a solution in the form of a flashy real-time fully interactive phoneme editor/composer program for the Microbee, written in machine code. (Did you like all those buzz-words?)

You can type in your phonemes using a full screen editor (just like in Wordbee) and when you want to hear your sentence spoken you hit RETURN. The Chatterbox speaks instantly, without affecting the position of your edit cursor or anything else. You can edit-in inflection levels by adding a number between 1 and 4 to the front of the phoneme.

The finished sentence (which can occupy the whole page if necessary) can then be printed as the string of phonemes, followed

by their equivalent numbers (with inflection included), both in hexadecimal and decimal format.

The source code alone for this monster runs to seven pages, so we won't be publishing it here. But, if you'd like a ready-to-run cassette of the machine code editor program, \$13.50 to the author will speed one on its way, postpaid.

### Machine code magic

Making a BASIC program talk is quite easy, but what about one of those high speed machine code arcade style games, like Asteroids Plus? Wouldn't it be good, as space objects converge on you from all directions, for the Chatterbox to bellow, "DANGER! DANGER! PUT UP YOUR SHIELDS!"?

This involves doing two things at once. After all, you can't stop the screen action while the Chatterbox talks. So we'll use a technique called "interrupt processing" to give the appearance of doing two things at once.

# Project 677

You may remember that we said the Chatterbox causes an interrupt in the Microbee after each phoneme is spoken. The interrupt has its own hotline straight into the Z-80 microprocessor. When the Z-80 is attacked in this way it suspends whatever it's doing and jumps to a new address that was specified earlier in the program. At this address is a short routine that gets the next sound to be spoken and squirts it out the parallel port. The processor then picks up where it left off when the interrupt occurred, displaying nasties on the screen or whatever. *Meanwhile*, the Chatterbox is speaking the phoneme just sent to it. Two things at once.

Actually, the screen display did stop as the phoneme was sent. But the routine took only a few microseconds, and the viewer would never notice the pause. And considering the length of time before another phoneme is required by the Chatterbox, the interrupt condition exists for maybe a thousandth of the time. The rest of the time the processor is working normally.

These concepts are shown in the assembly language program in Listing 1. The program parts can be "lifted" and used in a machine code program you're writing. The "model main program" isn't quite up to As-

teroids standard. All it does is print the alphabet on the screen as the Chatterbox delivers a message. But it clearly shows the concept of "two things at once".

The message is entered just as in BASIC and the assembler lays it into memory as a data table. For what it's worth, there's enough memory in a 32K Microbee to keep the Chatterbox talking for 55 minutes; long enough to out-bluster even the most long-winded politician (well . . . except for Barry Jones, Minister for Science and Technology, perhaps).

There is a small problem here. The Microbee editor/assembler won't let you enter an up arrow (^) From the keyboard, since it's interpreted as the control character to step backwards through a file. The "^" is the ASCII character for the phoneme "D" so you'll be needing it. The solution is to enter a dummy character such as "-" (shift/delete) and then use the Microbee's monitor to search it down and change it manually.

Changing memory manually is the way you can change the inflection of a phrase. Listing 2 is a direct hexadecimal memory dump of the machine code program of Listing 3. You can use this memory printout to enter the program in your own computer. Listing 3 is the same thing, although inflection has been added by manipulating bits 6 and 7 of the bytes that have been shaded. You can enter this new listing to see the difference added inflection makes to the speech.

Of course, if you're using the you-beaut

Microbee machine code editor program mentioned earlier, the inflection is provided automatically within the phoneme numbers. You can forget about ASCII strings and enter the numbers directly as "DEFB" or "DEFW" statements with an assembler, or record them directly as a data table with a monitor.

## Getting your chatterbox

Now, after reading all this, you must have decided that life won't be worth living any longer without your very own Chatterbox. Well, this must be your lucky day. Electronics Today, in conjunction with Hobart manufacturer Flexible Systems, is offering the Chatterbox as a board-level computer peripheral, for a miserly \$75.

You get a ready-built pc board (not a kit), ready to take an edge connector or D plug to interface to your computer. However, you must supply your own power supply arrangements, box, and speaker. See the special reader offer elsewhere in this issue.

As a grand finale, here is the last word from Chatterbox:

"Llanfairpwllgwyngyllgogerychwyrndrob-wylllantysiliogogoch".

It's a small Welsh town with the biggest name in the world. If you want to know how to pronounce it, feed this ASCII string to your Chatterbox:

```
"-sLNUlieWOYmKMKQCrX\zKY  
[YmUM^kceckQoM-I-IXlu^Y^Y^  
Y~".
```

eti 677



VOLUME



CHATTERBOX  
VOICE SYNTHESISER

# CHATTERBOX SOFTWARE LISTINGS

## LISTING 1

```

00100 REM CHATTERBOX PHRASE COMPOSER
00110 REM by Tom Moffat, 24/7/84
00120 REM
00130 OUTL#1: DIM T0(63),T(63): STRS (512): ON ERROR GOTO 350
00140 FOR I=0 TO 63: READ T0$(I),T(I): NEXT I: LPRINT "?";
00150 A0$="T E H S T I N G"
00160 A=1: B=0: A0$=A0$+" ": C0$=""
00170 C=B: B=SEARCH(A0$," ",A)
00180 IF B=0 THEN 250
00190 A=A+1: B0$=A0$(C+1,B-1)
00200 K=32: N=0: FOR I=1 TO 6
00210 IF B0$=T0$(N) THEN NEXT I 240
00220 IF B0$>T0$(N) THEN LET N=N+K ELSE LET N=N-K
00230 K=K/2: NEXT I
00240 C0$=C0$+CHR$(T(N)): GOTO 170
00250 V0$=""+"C0$+"
00260 PRINT A0$: LPRINT V0$: LPRINT "?";
00270 K0$=KEY$: IF K0$="" THEN 270
00280 IF K0$=CHR$(27) THEN EDIT 150
00290 IF K0$="P" OR K0$="p" THEN 310
00300 GOTO 260
00310 CLS: OUT#5 ON
00320 PRINT "PHONEMES:": PRINT A0$: PRINT
00330 PRINT "ASCII:": PRINT V0$: PRINT
00340 PRINT: PRINT: PRINT: OUT#5 OFF: GOTO 270
00350 LPRINT ""Bz5+>>P{YCXUJHmrMJJK}>?": EDIT 150
01000 DATA "A",96,"A1",70,"A2",69,"AE",110,"AE1",111
01010 DATA "AH",100,"AH1",85,"AH2",72,"AW",125,"AW1",83
01020 DATA "AW2",112,"AY",97,"B",78,"CH",80,"D",94
01030 DATA "DT",68,"E",108,"E1",124,"EH",123,"EH1",66
01040 DATA "EH2",65,"EH3",64,"ER",122,"F",93,"G",92
01050 DATA "H",91,"I",103,"I1",75,"I2",74,"I3",73
01060 DATA "IU",118,"J",90,"K",89,"L",88,"M",76
01070 DATA "N",77,"NG",84,"O",102,"O1",117,"O2",116
01080 DATA "OO",87,"OO1",86,"P",101,"PA0",67,"PA1",126
01090 DATA "R",107,"S",95,"SH",81,"T",106,"TH",121
01100 DATA "THV",120,"U",104,"U1",119,"UH",115,"UH1",114
01110 DATA "UH2",113,"UH3",99,"V",79,"W",109,"Y",105
01120 DATA "Y1",98,"Z",82,"ZH",71,"ZZZ",0

```

## LISTING 2

```

100 REM
110 REM CHATTERBOX SPEECH EDITOR -
120 REM
130 REM BY CRAIG FORD-ING -
140 REM
150 REM 19-10-84 -
160 REM
170 REM
180 REM SERIAL CARD DRIVER
190 REM
200 POKE 768,169: POKE 769,161: POKE 770,44: POKE 771,161
210 POKE 772,192: POKE 773,240: POKE 774,251: POKE 775,96
220 REM
230 REM INITIALIZE SERIAL CARD
240 REM
250 W = -16224: POKE W + 3,152: POKE W + 2,11
260 DIM A$(255),B$(255)
270 HOME
280 REM
290 REM SAY 'TESTING' WHEN INITIALIZED
300 REM
310 A$="T E H S T I N G": GOTO 330
320 INPUT A$
330 IF A$="" THEN 770
340 IF A$=CHR$(16) THEN 850
350 W=0:LC=1
360 FOR I=1 TO 255:A$(I)=""
370 IF MID$(A$,LEN(A$),1)="" THEN 390
380 A$=A$+A$
390 LA=LEN(A$)
400 REM
410 REM FIND NUMBER OF PHONEMES
420 REM
430 FOR I=1 TO LA
440 IF MID$(A$,I,1)="" THEN W=W+1
450 NEXT I
460 REM
470 REM SEPARATE THE PHONEMES FROM THE STRING
480 REM
490 FOR I=1 TO W
500 A$(I)=A$(I)+MID$(A$,LC,1)
510 LC=LC+1
520 IF MID$(A$,LC,1)="" THEN 500
530 LC=LC+1
540 NEXT I
550 HOME
560 REM
570 REM SEARCH FOR PHONEME IN DATA
580 REM AND GIVE IT A VALUE
590 REM

```

## LISTING 3 PHONEME CODE LIST

PHONEME	ASCII	EXAMPLE	HEX	DEC	DURATION
A		tAme	60	96	185
A1	F	pAil	46	78	103
A2	E	mAke	45	69	71
AE	n	dAd	6E	110	185
AE1	o	AfTer	6F	111	103
AH	d	mOp	64	100	250
AH1	U	fAther	55	85	146
AH2	H	hOnest	48	72	71
AW	)	cAlI	7D	125	250
AW1	S	lAwful	53	83	146
AW2	p	sAlty	70	112	90
AY	a	JAdE	61	97	65
B	N	BaG	4E	78	71
CH	P	CHip	50	80	71
D	^	paId	5E	94	55
DT	D	buTTer	44	68	47
E	l	mEEt	6C	108	185
E1	!	bE	7C	124	121
EH	(	rEAdy	7B	123	185
EH1	B	hEAvy	42	66	121
EH2	A	EnlIst	41	65	71
EH3	@	JackEt	40	64	59
ER	z	biRd	7A	122	146
F	J	Fast	5D	93	103
G	\	Get	5C	92	71
H	[	Hello	5B	91	71
I	g	pIn	67	103	185
I1	K	inhibit	4B	75	121
I2	J	Inhibit	4A	74	80
I3	I	inhibit	49	73	55
IU	v	yOU	76	118	59
J	Z	JudGe	5A	90	47
K	Y	trIck	59	89	80
L	X	Land	58	88	103
M	L	Mat	4C	76	103
N	M	suN	4D	77	80
NG	T	thING	54	84	121
O	f	cOlD	66	102	185
01	u	abOUrd	75	117	121
02	t	bOlD	74	116	80
00	W	bOOk	57	87	185
001	U	lOOkIng	56	86	103
P	e	Past	65	101	103
R	k	Red	68	107	90
S	-	paSS	5F	95	90
SH	Q	SHop	51	81	121
T	J	Tap	6A	106	71
TH	y	THin	79	121	71
THV	x	THe	78	120	80
U	h	mOve	68	104	185
U1	w	jUne	77	119	90
UH	s	cUp	73	115	185
UH1	r	Uncle	72	114	103
UH2	q	About	71	113	71
UH3	c	Under	63	99	47
V	O	Van	4F	79	71
W	m	Win	6D	109	80
Y	i	anY	69	105	103
Y1	b	Yard	62	98	80
Z	R	haZe	52	82	71
ZH	G	aZure	47	71	90
PA0	C	(sIl)	43	67	47
PA1	~	(sIl)	7E	126	185
STOP	?	----	3F	63	47

# CHATTERBOX SOFTWARE LISTINGS

## LISTING 4

```

00100 REM *** SAYINGS OF THE DALEKS ***
00110 REM
00120 REM --- Tom Moffat, October 18, 1984
00130 REM
00140 OUTLW1: REM Establish parallel "list" data output
00150 X=INT(RND*16): REM Random number between 0 and 15
00160 X=1000*(X*10): REM Index to data statements at line 1000
00170 RESTORE X: READ A1$: PRINT A1$
00180 READ A1$: LPRINT CHR(126); A1$: CHR(126);
00190 FOR T=1 TO 500: NEXT T: REM Pause between sayings
00200 GOTO 150
00210 REM
00220 REM TEXT AND VOTRAX DATA INDEXED TO LINE 1000
00230 REM
01000 DATA "The hostiles must be exterminated."
01005 DATA "ysD_jJxX_Lr_njN:BY_jzLJMAa,jr^"
01010 DATA "The Daleks must be obeyed."
01015 DATA "ys^dXBY_Lr_njNfN(a^"
01020 DATA "You must obey."
01025 DATA "ihLr_jCfN(a^"
01030 DATA "Take the patient to the examination centre."
01035 DATA "jBaYyre^GrM_Cjny;B\RoLkM BaQqM_BQqM^z"
01040 DATA "You must cooperate. You must lie down."
01045 DATA "ivwLr_jytmUacKAaj^bvwlr_jU^UwM^"
01050 DATA "You will remain silent."
01055 DATA "bvwmqXkL'aM_UaXAM,j"
01060 DATA "The Daleks are the superior being."
01065 DATA "yrC^dXBY_Ukyr_vegkzNlKT"
01070 DATA "We do not need assistance."
01075 DATA "mi^vwMUJMi^h_K_HM_."
01080 DATA "You will assassinate the members of the High Council."
01085 DATA "ivwmKXh_nJM_jyrLBNzRrOyrLU@yUcM_BX"
01090 DATA "We have been sent by the Supreme Dalek."
01095 DATA "mlCoON:M_BMjNUbxr_ivweKL^UXBY"
01100 DATA "We obey Davros. He is our leader."
01105 DATA "mlfNBiC^oHOKU_~^lG_UzX^z"
01110 DATA "The prisoner is secured."
01115 DATA "yrekL_rM_QzgrC_@Yivz^"
01120 DATA "EMERGENCY! EMERGENCY! The enemy must be destroyed!"
01125 DATA "Lz^ZrM_L^Lz^ZrM_L^yLMqLLr_njNl^@_kfi^"
01130 DATA "Nothing will interfere with the destiny of the Daleks."
01135 DATA "MqyJTMIX@jzlgzmJxyr^A_jQMirOyr^UXBY_"
01140 DATA "The collapse of Earth society will soon occur."
01145 DATA "ysYUXne_rOzky_..UaBjmJX_vhMuYz^"
01150 DATA "You have not won, Doctor. Join me and I will make you the ruler of the world."
01155 DATA "ivwCoOMUjmsM^SYjz^ZuKMLICn^UlImJXLEaYcivwyskhXzsOynmzX^"

```

## LISTING 5

```

100 REM SAYINGS OF THE DALEKS
110 REM
120 REM BY CHRIS FORD-ING
130 REM
140 REM 18 10 84
150 REM
160 REM
170 REM - SERIAL CARD DRIVER -
180 REM
190 REM
200 POKE 768:169: POKE 769:169: POKE 770:441: POKE 771:1611: POKE 772:192: POKE 77
3,240: POKE 774:251: POKE 775:96
210 TEXT : HOME : VTB# 10: HT#6 13: PFIHT "LOADING ARRAY"
220 REM
230 REM - INITIALIZE SERIAL CARD -
240 REM
250 M = -162241: POKE M + 3:152: POKE M + 2:11
270 DIM H(130):A(20):H(13):A(4):A(36):A(20):A(7):A(7):A(39):A(33):A(28)
280 REM
290 REM -READ DATA INTO ARRAYS-
300 REM
310 READ H(1):H(2):H(3):H(4):H(5):H(6):H(7):H(8):H(9):H(10):H(11):H(12):H(13)
320 READ A(1):A(2):A(3):A(4):A(5):A(6):A(7):A(8):A(9):A(10):A(11):A(12):A(13)
330 READ H(14):H(15):H(16):H(17):H(18):H(19):H(20):H(21):H(22):H(23):H(24):H(25):H(26)
340 READ H(27):H(28):H(29):H(30):H(31):H(32):H(33):H(34):H(35):H(36):H(37):H(38):H(39)
350 READ H(40):H(41):H(42):H(43):H(44):H(45):H(46):H(47):H(48):H(49):H(50):H(51):H(52)
360 READ H(53):H(54):H(55):H(56):H(57):H(58):H(59):H(60):H(61):H(62):H(63):H(64):H(65)
370 READ H(66):H(67):H(68):H(69):H(70):H(71):H(72):H(73):H(74):H(75):H(76):H(77):H(78)
380 READ H(79):H(80):H(81):H(82):H(83):H(84):H(85):H(86):H(87):H(88):H(89):H(90):H(91)
390 READ H(92):H(93):H(94):H(95):H(96):H(97):H(98):H(99):H(100):H(101):H(102):H(103)
400 READ H(104):H(105):H(106):H(107):H(108):H(109):H(110):H(111):H(112):H(113):H(114):H(115)
410 READ H(116):H(117):H(118):H(119):H(120):H(121):H(122):H(123):H(124):H(125):H(126):H(127)
420 READ H(128):H(129):H(130):H(131):H(132):H(133):H(134):H(135):H(136):H(137):H(138):H(139)
430 READ H(140):H(141):H(142):H(143):H(144):H(145):H(146):H(147):H(148):H(149):H(150):H(151)
440 READ H(152):H(153):H(154):H(155):H(156):H(157):H(158):H(159):H(160):H(161):H(162):H(163)
450 READ H(164):H(165):H(166):H(167):H(168):H(169):H(170):H(171):H(172):H(173):H(174):H(175)
460 READ H(176):H(177):H(178):H(179):H(180):H(181):H(182):H(183):H(184):H(185):H(186):H(187)
470 READ H(188):H(189):H(190):H(191):H(192):H(193):H(194):H(195):H(196):H(197):H(198):H(199)
480 READ H(200):H(201):H(202):H(203):H(204):H(205):H(206):H(207):H(208):H(209):H(210):H(211)
490 READ H(212):H(213):H(214):H(215):H(216):H(217):H(218):H(219):H(220):H(221):H(222):H(223)
500 READ H(224):H(225):H(226):H(227):H(228):H(229):H(230):H(231):H(232):H(233):H(234):H(235)
510 HOME
520 REM
530 REM - PICK A NUMBER 1 TO 10 -
540 REM
550 X = INT ( PIR ( 1 ) * 10 ) + 1
560 ON X GOSUB 580,600,620,640,660,680,700,720,740,760
564 REM
565 REM - PAUSE BETWEEN SAYINGS -
566 REM
570 FOR T = 1 TO 500: NEXT T: GOTO 550
580 HOME : VTB# 10: PFIHT "The Hostiles Must Be Exterminated"
590 FOR C = 1 TO H(10): POKE M+H(C): CALL 768: NEXT C: RETURN
600 HOME : VTB# 10: HT#6 13: PFIHT "The Daleks Must Be Obeyed"
610 FOR C = 1 TO H(10): POKE M+H(C): CALL 768: NEXT C: RETURN
620 HOME : VTB# 10: HT#6 13: PFIHT "You Must Obey"
630 FOR C = 1 TO H(10): POKE M+H(C): CALL 768: NEXT C: RETURN
640 HOME : VTB# 10: PFIHT "Take The Patient To The Examination": VTB# 12: HT#
6 13: PFIHT "Centre, Proceed"
650 FOR C = 1 TO H(10): POKE M+H(C): CALL 768: NEXT C: RETURN
660 HOME : VTB# 10: PFIHT "You Must Co-operate, You Must Lie Down"
670 FOR C = 1 TO H(10): POKE M+H(C): CALL 768: NEXT C: RETURN
680 HOME : VTB# 10: HT#6 13: PFIHT "You Will Remain Silent"
690 FOR C = 1 TO H(10): POKE M+H(C): CALL 768: NEXT C: RETURN
700 HOME : VTB# 10: PFIHT "The Daleks Are The Superior Being": VTB# 12: HT#
6 13: PFIHT "We Do Not Need Assistance."
710 FOR C = 1 TO H(10): POKE M+H(C): CALL 768: NEXT C: RETURN
720 HOME : VTB# 10: PFIHT "You Will Assassinate The Members Of The": VTB# 12: HT#
6 13: PFIHT "High Council"
730 FOR C = 1 TO H(10): POKE M+H(C): CALL 768: NEXT C: RETURN
740 HOME : VTB# 10: PFIHT "We Have Been Sent By The Supreme Dalek"
750 FOR C = 1 TO H(10): POKE M+H(C): CALL 768: NEXT C: RETURN
760 HOME : VTB# 10: PFIHT "We Obey Davros, He Is Our Leader"
770 FOR C = 1 TO H(10): POKE M+H(C): CALL 768: NEXT C: RETURN
780 REM
790 REM AND NOW THE VOTRAX DATA...
800 REM
810 DATA 29,121,115,91,125,95,106,85,97,88,95,76,114,95,106,78,124,66,89,95,10
6,122,76,74,77,65,97,106,114,94
820 DATA 19,121,115,94,100,88,66,89,95,76,114,95,106,78,124,102,78,123,97,94
830 DATA 12,105,104,76,114,95,106,67,102,78,123,97,67
840 DATA 45,106,66,97,89,121,114,101,96,81,114,77,106,67,106,104,121,124,65,92
,82,111,64,76,75,77,66,97,81,113,77,95,66,64,77,106,122,126,126,101,107,117,95,1
24,105,94
850 DATA 34,98,118,119,76,114,95,106,89,116,109,35,101,99,107,65,97,106,126,12
6,98,118,119,76,114,95,106,88,85,99,94,85,119,77,67
860 DATA 19,98,118,119,109,103,88,107,124,76,96,97,77,95,85,97,88,65,77,106
870 DATA 46,121,72,67,94,100,88,66,89,95,100,107,121,72,95,118,101,103,107,98
,122,78,108,75,84,126,126,109,124,94,118,118,77,100,106,77,124,94,72,95,103,95,1
06,72,77,95,67
880 DATA 35,105,118,118,109,103,88,72,95,110,95,74,77,96,106,121,66,76,66,76,7
8,122,95,100,79,121,85,91,85,64,105,89,85,99,77,95,66,88,67
890 DATA 32,109,108,91,111,79,98,124,77,95,66,77,106,72,72,64,105,121,64,95,10
5,118,119,101,107,108,76,94,85,88,66,89,67
900 DATA 27,109,108,102,78,66,105,67,94,111,79,107,85,95,126,126,91,108,103,95
,85,99,122,88,108,94,122,67
600 PRINT "SEARCHING FOR : "
610 FOR I = 1 TO WC
620 PRINT A(I): " "
630 E = 0
640 FOR J = 1 TO 63
650 READ B(J)
660 IF B(J) = H(I) THEN E I = J : F I = 1 : J = 63
670 NEXT J
680 IF E < > 1 THEN PRINT : PFIHT : PRINT "ILLEGAL PHONEME": GOSUB 520: PRINT
: E = 0 : I = WC : X = 1 : PFIHT
690 RESTORE
700 NEXT I
710 IF X = 1 THEN X = 0: GOTO 600
720 PRINT
730 REM
740 REM ADD PAUSES TO FRONT W/IC END
750 REM THEN SAY IT!
760 REM
770 B(0) = 126181(WC + 1) + 1:6
780 FOR I = 0 TO WC + 1
790 POKE M,B(I): CALL 768
800 NEXT I
810 POKE M,63: GOTO 870
820 REM
830 REM PRINT OUT ASCII EQUIVALENT
840 REM
850 PRINT : PRINT "ASCII "
860 FOR I = 0 TO WC + 1: PFIHT CHR( I ) : I = I + 1 : NE T I
870 PRINT : PRINT "-----" : PFIHT
880 GOTO 320
890 REM
900 REM SAY ERROR MESSAGE
910 REM
920 E$ = "YOU COULD NOT READ THE MESSAGE"
930 FOR I = 1 TO LEN E$
940 POKE M,ASC ( MID ( E$,I,1 ) )
950 CALL 768: NEXT I: RETURN
960 REM
970 REM CODES FOR PHONEMS
980 REM
990 DATA "A",96,"H",70,"C",63,"E",110,"I",111
1000 DATA "M",100,"N",85,"O",72,"U",125,"W",83
1010 DATA "X",112,"Y",97,"Z",78,"_",80,"_",94
1020 DATA "!",68,"@",88,"#",124,"$",123,"%",106
1030 DATA "&",91,"*",103,"+",76,"-",127,"_",13,"_",73
1040 DATA "!",118,"!",90,"!",89,"!",88,"!",76
1060 DATA "!",77,"!",84,"!",10,"!",117,"!",116
1070 DATA "0",87,"1",95,"2",101,"3",96,"4",114
1080 DATA "5",107,"6",95,"7",113,"8",114,"9",111
1090 DATA "!",10,"!",104,"!",114,"!",115,"!",114
1100 DATA "U",113,"U",94,"_",104,"_",106
1110 DATA "V",98,"_",12,"_",24,"_"

```



# CHATTERBOX SOFTWARE LISTINGS

## LISTING 6

```

ADDR  CODE  LINE  LABEL  MNEM  OPERAND
00100  ;SPEECH SYNTHESIZER MACHINE CODE DRIVER ROUTINES
00110  ;
00120  ; - Tom Moffat, 16/7/83
0400    00130  DEFR  16
010E    00140  PNT   EQU  010EH ;PHONEME POINTER
0400    00150  ORG   0400
00160
00170 ;Initialize PIO and interrupt vector for speech.
00180
0400 3E0F 00190 LD    A,0FH ;MAKE PIO OUTPUT
0402 D301 00200 OUT  (1),A
0404 3E80 00210 LD    A,B0 ;GET VECTOR FROM 0080
0406 D301 00220 OUT  (1),A
0408 214404 00230 LD    HL,PHON ;SET INTERRUPT VECTOR TO "PHON"
040B 220000 00240 LD    (B0),HL
040E AF 00250 XOR  A ;CLEAR BUSY FLAG
040F 320901 00260 LD    (109),A
00270
00280 ;Model main program, prints the alphabet.
00290
0412 215F04 00300 LD    HL,BLURB;POINT TO PHRASE
0415 220E01 00310 LD    (PNT),HL
0418 CD3904 00320 CALL SPEAK ;START SPEAKING
041B 3E41 00330 LD    A,41 ;START AT "A"
041D 061A 00340 LD    B,1AH ;DO 26 LETTERS
041F CD4200 00350 LOOP CALL B042 ;REDIRECTED OUT TO UDU
0422 F5 00360 PUSH AF
0423 110000 00370 LD    DE,B000 ;TIME DELAY
0424 1B 00380 DELAY DEC  DE
0427 7A 00390 LD    E,DE
042B 03 00400 OR   E
0429 20FB 00410 JR   NZ,DELAY
042B F1 00420 POP  AF
042C 3C 00430 INC  A
042D 18F0 00440 DJNZ LOOP ;GET NEXT LETTER
042F 210805 00450 LD    HL,0B00 ;JUMP ADDR FOR BASIC I.S.R.
0432 220000 00460 LD    (B0),HL ;RESTORE I.S.R. TO NORMAL
0435 2AA200 00470 LD    HL,(0A2)
0438 E9 00480 JP   (HL) ;CLEAR OUT OF PROGRAM
00490
00500 ;Speak-a-phrase subroutine.
00510
0439 3A0901 00520 SPEAK LD  A,(109) ;GET BUSY FLAG
043C B7 00530 OR   A ;TEST FOR BUSY
043D 20FA 00540 JR   NZ,SPEAK
043F 3EFF 00550 LD  A,0FFH ;SET BUSY FLAG
0441 320901 00560 LD  (109),A
00570
00580 ;Interrupt routine, sends one phoneme to synthesizer
00590
0444 F5 00600 PHON  PUSH AF
0445 E5 00610 PUSH  HL
0446 2A0E01 00620 LD    HL,(PNT)
0449 7E 00630 LD    A,(HL) ;GET A PHONEME
044A D300 00640 OUT  (0),A ;SEND IT TO SYNTHESIZER
044C 23 00650 INC  HL
044D 220E01 00660 LD    (PNT),HL
044E FB 00670 EI
0451 2F 00680 CPL  ;INVERT IT
0452 E63F 00690 AND  3FH ;TEST FOR SHUTUP CODE
0454 2005 00700 JR   NZ,CONT
0456 AF 00710 XOR  A
0457 320901 00720 LD    (109),A ;CLEAR BUSY FLAG
045A F3 00730 DI
045B E1 00740 CONT POP  HL
045C F1 00750 POP  AF
045D ED4D 00760 RETI
00770
00780 ;ASCII data to generate synthesized message.
00790
045F 7E 00800 BLURB DEFM 'I(XfwCyBk~~yq_KRr'
0471 4C 00810 DEFM 'Lq01MYf^LB_J^21krLC'
0484 6A 00820 DEFM 'J)I(LCL5)qJRDak1YXB0ck'
0498 4C 00830 DEFM 'LH1aYk^N1YrLe1uJck~~~~'
04AF 42 00840 DEFM 'B^YC_LjckLAMBaj~?'
00850
00860 END
00000 Total errors
CONT 045B DELAY 0426 LOOP 041F SPEAK 0439
BLURB 045F PHON 0444 PNT 010E

```

## LISTING 7

```

0400 3E 0F D3 01 3E 00 D3 01 21 44 04 22 00 00 AF 32
0410 09 01 21 5F 04 22 0E 01 CD 39 04 3E 41 06 1A CD
0420 42 00 F5 11 00 00 1B 7A 03 20 FB F1 3C 10 F0 21
0430 00 B6 22 00 00 2A A2 00 E9 3A 09 01 07 20 FA 3E
0440 FF 32 09 01 F5 E5 2A 0E 01 7E D3 00 23 22 0E 01
0450 FB 2F E6 3F 20 05 AF 32 09 01 F3 E1 F1 ED 4D 7E
0460 5B 78 58 66 77 43 79 42 68 7E 7E 79 67 5F 4B 52
0470 73 4C 71 51 6C 4D 59 66 5E 4C 42 5F 4A 5E 5A 5D
0480 68 72 4C 43 6A 7D 4C 43 4C 53 5D 71 6A 52 4F 41
0490 68 6C 59 58 42 4F 63 68 4C 48 49 61 59 68 66 4E
04A0 6C 59 72 4C 65 7C 76 6A 63 68 7E 7E 7E 7E 7E 42
04B0 48 59 43 5F 6A 63 68 4C 41 4D 42 61 6A 7E 3F 00

```

## LISTING 8

```

0400 3E 0F D3 01 3E 00 D3 01 21 44 04 22 00 00 AF 32
0410 09 01 21 5F 04 22 0E 01 CD 39 04 3E 41 06 1A CD
0420 42 00 F5 11 00 00 1B 7A 03 20 FB F1 3C 10 F0 21
0430 00 B6 22 00 00 2A A2 00 E9 3A 09 01 07 20 FA 3E
0440 FF 32 09 01 F5 E5 2A 0E 01 7E D3 00 23 22 0E 01
0450 FB 2F E6 3F 20 05 AF 32 09 01 F3 E1 F1 ED 4D 7E
0460 5B 78 58 66 77 43 79 42 68 7E 7E 79 67 5F 4B 52
0470 73 4C 71 51 6C 4D 59 66 5E 4C 42 5F 4A 5E 5A 5D
0480 68 72 4C 43 6A 7D 4C 43 4C 53 5D 71 6A 52 4F 41
0490 68 6C 59 58 42 4F 63 68 4C 48 49 61 59 68 66 4E
04A0 6C 59 72 4C 65 7C 76 6A 63 68 7E 7E 7E 7E 7E 42
04B0 00 D3 DF EA E3 EB CC C1 CD C7 E1 EA FE 3F 00

```

Australia's Top  
Motorcycle Monthly

# TwoWheels

ON SALE AT YOUR NEWSAGENT EVERY MONTH

# KITS specially picked for the school holidays, from Rod Irving Electronics — the kit specialists!

## ★★ RECENT RELEASES★★



### ELECTRONIC MOUSETRAP

This clever electronic mousetrap disposes of mice instantly and mercifully, without fall, and resets itself automatically. They'll never get away with the cheese again! (ETI Aug '84).

Cat. ETI 1524 **\$29.95**



### SOUND SIMULATOR FOR MODEL TRAINS

Fancy a diesel sound simulator for your model train layout? This circuit mounts inside the train for added realism and even varies its 'speed' according to the throttle setting (EA Nov. '84).

**\$18.00**



### 1 W AUDIO AMPLIFIER

A low-cost, general-purpose, 1 watt audio amplifier, suitable for increasing your computers' audio level, etc. (EA Nov. '84).

**\$9.95**



### RAILMASTER PULSE POWER TRAIN CONTROLLER

Here's an up-to-the-minute train controller offering all the most desirable features including inertia, full overload protection, walk-around throttle and excellent low-speed running characteristics. Probably the best controller available, regardless of the cost! (EA Sept. '84, 841c9)

Cat. K84091 **\$79.50**



### COMPUTER DRIVEN RADIO-TELETYPE TRANSCIVER

Here's what you've all been asking for — a full transmit-receive system for a computer-driven radio teletype station. The software provides all the latest "whizz-bangs" like split-screen operation, automatically repeating test message, printer output and more. The hardware uses tried and proven techniques. While designed to team with the popular Microbee, tips are available on Inter-facing the unit to other computers. (ETI Nov. '84, ETI-755)

Cat. K47550 **\$119.00**



### DRUM SYNTH. MODULE

A simple, low-cost Module that will generate a wide variety of drum-like sounds from a pulse input provided from a sound pick up or electronically.

(ETI Oct. '84), **\$24.95**



### SOLAR POWERED HOUSE NUMBER

Searching for a house at night in an unfamiliar street can be a frustrating business. This illuminated house-number switches itself on at dusk and switches off six hours later. (EA Sept. '84, 84M8B)

Cat. K84092

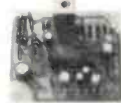

### EA AM STEREO DECODER

AM stereo is now broadcast in Australia on an experimental basis. This add-on decoder works with the Motorola C-QUAM system. (EA Oct. '84, 84MS10)

Cat. K84101 **\$24.95**



### READY-SET-GO LIGHTS

A simple project for starting slot car races, etc. It provides the traditional Red/Amber/Green lights with a random delay between the amber and green. (ETI Oct. '84).

ETI-277 **\$24.95**



### 150 W BASS AMP

This guitar amp for impeccable bass players features many facilities found on expensive 'commercial' ones. It delivers 150 watts into 4 ohms, has a t-band graphic, limiter, line out and bi-amp facilities. (ETI Aug. '84, ETI-1410)

Cat. K54100 **\$299.00**



### DIRECTIONAL DOOR MINDER

Most electronic door minders function by having a beam of light shining across a doorway. Interrupted, but are incapable of detecting whether the light beam is broken by a person entering or leaving the room. This project overcomes that problem with the aid of digital logic. (ETI Nov. '84, ETI 278).

Cat. K42780 **\$29.95**



### EFFECTS UNIT

An "effects unit" that can create phasing, flanging, echo, reverb and vibrato effects. (EA June '83).

83GA6 **\$65.00**



### INVERTER

This 12 240V inverter can be used to power mains appliances rated up to 40W, or to vary the speed of a turntable. As a bonus, it will also work backwards as a trickle charger to top up the battery when the power is on.

(EA May '82) **\$49.50**



### CUDLIPP CRICKET

A fascinating Electronic Cricket with just two ICs. The Cudlipp can be used to bug your home, office etc. Great fun! (EA Feb. '82).

Cat. 82EG2 **\$12.00**



### ELECTRONIC WATT METER

This unit will measure the power consumption of any mains appliance with a rating up to 3 kilowatts. It makes use of a special op amp called an "output transconductance amplifier" or OTA, for short. (EA Sept. '83).

Cat. 83WMB **\$79.50**



### PH METER KIT

Build this pH meter for the swimming pool season is here again! From swimming pools to fish tanks to gardening, this pH meter has many applications around the home. This unit features a large 3 1/2 digit liquid crystal display and resolution to .01pH units, making it suitable for use in the laboratory as well. (EA Dec. '82).

Cat. 82PH12 **\$139.00**



### 12-230V DC-AC INVERTER

#### INCLUDING TRANSFORMER 300 WATTS

This EA Inverter is capable of driving mains appliances rated up to 300VA and features voltage regulation and full over load protection. (EA June '87).

Nominal Supply Voltage	12V DC
Output Voltage	see table
Frequency	50Hz ± 0.05%
Regulation	see table
Maximum Load	300VA
Current Limiting	30A (primary)
Efficiency	see table

P & P \$10.00. Anywhere in Australia. **\$195.00**

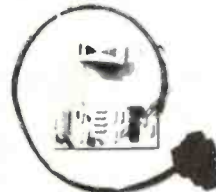

### RADIOTELETYPE CONVERTER FOR THE MICROBEE

Have your computer print the latest news from the international shortwave news service. Just hook up this project between your shortwave receiver's audio output and the MicroBee parallel port. A simple bit of software does the decoding. Can be hooked up to other computers too.

(ETI Apr. '83) **\$20.00**



### 50 W AMPLIFIER MODULE

Cat. K44800 **\$24.50**

### 100 W AMPLIFIER MODULE

Cat. K44801 **\$27.50**

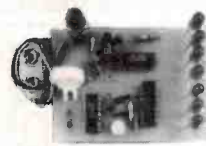

### HUMIDITY METER

This project can be built to give a readout of relative humidity either on a LED dot-mode display or a conventional meter. In addition it can be used with another project as a controller to turn on and off a water mist spray in a hothouse, for example. (ETI May '81).

(Includes humidity sensor. \$19.50).

Cat. K42560 ETI256 **\$29.50**



### TEMP PROBE

Can measure temperature from -50° to +150°C. It simply plugs into your multimeter — great for digital multimeters. Accuracy of 0.1°C resolution of 0.1°C. (ETI June '83).

ETI-153 **\$22.50**

### VIDEO ENHANCER 100's SOLD

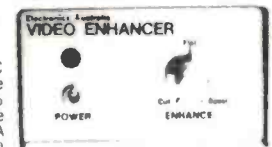

Like tone controls in a hi-fi amplifier, touch up the signal with this Video Enhancer. (EA Oct. '83).

83VE10 **\$35.00**



### LOW OHMS METER

How many times have you cursed your Multimeter when you had to measure a low-value resistance? Well with the "Low Ohms Meter" you can solve those old problems and in fact measure resistance from 100 Ohms down to 0.005 Ohms. (ETI Nov. '81).

ETI-158 **\$34.50**

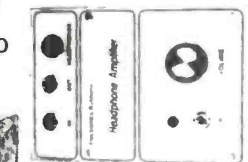

### HEADPHONE AMPLIFIER

PRACTISE WITHOUT ANNOYING THE FAMILY! If you play any type of electronic instrument, this headphone amplifier will surely interest you. It will let you practise for hours without upsetting the household, or you can use it to monitor your own instrument in the midst of a rowdy jam session. (EA Feb. '84).

83MA11 **\$28.00**

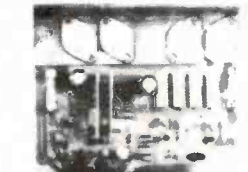

### MOSFET POWER AMPLIFIER

Employing Hitachi Mosfets, this power amplifier features a "no compromise" design, and is rated to deliver 150% W RMS maximum and features extremely low harmonic, transient and Intermodulation distortion. (ETI Jan. '81).

Cat. ETI 477 **\$63.00**



### PARABOLIC MICROPHONE

Build a low cost parabola, along with a high gain headphone amplifier to help when listening to those natural activities such as babbling brooks, singing birds of perhaps even more sinister noises. The current cost of components for this project is around \$15 including sales tax, but not the cost of batteries or headphones. (EA Nov. '83)

83MA11 \$15.00



### MODEL ENGINE IGNITION SYSTEM

Get sure starts every time and no more glow plug burnouts on your model engines. (ETI June '83)

ETI-1516 \$41.50



### CAR IGNITION KILLER

Most car burglar alarms are easily circumvented, but not this cunning "Ignition Killer". This sneaky anti-theft device uses a 555 timer to place an intermittent short circuit across the points. Until disabled by its hidden switch the circuit effectively makes the car undrivable — a sure deterrent to thieves! (EA Feb. '84)

84AU1 \$16.95  
(Our kit includes the box!)

### EA SUPER SIREN



Ever wanted to build an ear-splitting alarm which would be compact and not draw much current? This is just the circuit for you. It uses a piezo electric tweeter in a pulsed mode to form an arresting and very efficient alarm. (EA Nov. '82)

82AL17 \$21.00  
(battery extra)

### VIDEO AMPLIFIER



Bothered by smeary colours, signal beats and RF interference on your computer display? Throw away that cheap and nasty RF modulator and use a direct video connection instead, it's much better! The Video Amplifier features adjustable gain and provides both normal and inverted outputs. Power is derived from a 12V DC plugback supply. (EA Aug. '83)

83VA8 \$15.00



### ELECTRIC FENCE

Mains or battery powered, this electric fence controller is both inexpensive and versatile. Based on an automotive ignition coil, it should prove an adequate deterrent to all manner of livestock. Additionally, its operation conforms to the relevant clauses of Australian Standard 3129. (EA Sept. '82)

82EF9 \$19.50



### MOTORCYCLE INTERCOM OVER 500 SOLD!

Motorcycling is fun, but the conversation between rider and passenger is usually just not possible. But build this intercom and you can converse with your passenger at any time while you are on the move. There are no "push-to-talk" buttons, adjustable volume and it's easy to build! (EA Feb. '84)

84CM5 \$45.00



### TRANSISTOR TESTER 1000's SOLD

Have you ever desoldered a suspect transistor, only to find that it checks OK? Trouble-shooting exercises are often hindered by this type of false alarm, but many of them could be avoided with an "in-circuit" component tester, such as the EA Handy Tester. (EA Sept. '83)

83TT8 \$15.00

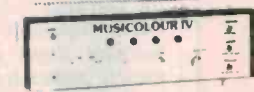

### MUSICOLOR IV

Add excitement to parties, card nights and discos with EAs Musicolor IV light show. This is the latest in the famous line of musicolors and it offers features such as four channel "color organ" plus four channel light chaser, front panel LED display, internal microphone, single sensitivity control plus opto-coupled switching for increased safety. (EA Aug. '81)

81MC8 \$84.00



### FUNCTION GENERATOR

This Function Generator with digital readout produces Sine, Triangle and Square waves over a frequency range from below 20Hz to above 160Hz with low distortion and good envelope stability. It has an inbuilt four-digit frequency counter for ease and accuracy of frequency setting. (EA April '82)

82AO3A/B \$79.50

# THE BRILLIANT SERIES 5000

## STILL GOING STRONG INDIVIDUAL COMPONENTS TO MAKE UP A SUPERB HI-FI SYSTEM.

By directly importing and a more technically orientated organisation, ROD IRVING ELECTRONICS can bring you these products at lower prices than their competitors. Enjoy the many other advantages of RIE Series 5000 kits such as "Super Finish" front panels at no extra cost, top quality components supplied throughout. Over 1,000 Sold.

For those who haven't that time and want a quality hi-fi, we also sell the Series 5000 kits Assembled and Tested.



### POWER AMPLIFIER WHY YOU SHOULD BUY A "ROD IRVING ELECTRONICS" SERIES 5000 POWER AMPLIFIER.

- ★ 1% Metal Film resistors are used where possible.
  - ★ Aluminium case as per the original article.
  - ★ All components are top quality.
  - ★ Over 1000 of these kits now sold.
  - ★ Super Finish front panel supplied at no extra cost.
- Please note that the "Superb Quality" Heatsink for the Power Amplifier was designed and developed by ROD IRVING ELECTRONICS and is being supplied to other kit suppliers.

**SPECIFICATIONS:** 150 W RMS into 4 ohms  
**POWER OUTPUT:** 100 W RMS into 8 ohms (±5 V SUPPLY)  
**FREQUENCY RESPONSE:** 8 Hz to 20 KHz, ±0.4 dB 2.8 Hz to 65 KHz, ±0.3 dB NOTE: These figures are determined solely by passive filters.  
**INPUT SENSITIVITY:** 1 V RMS for 100 W output  
**HUM:** 100 dB below full output (flat)  
**NOISE:** 116 dB below full output (flat, 20 KHz bandwidth)  
**2nd HARMONIC DISTORTION:** <0.001% at 1 KHz to 1000 Hz on Prototypes at 100 W output using a ±5 V SUPPLY, rated at 5A continuous <0.003% at 10 KHz and 100 W  
**3rd HARMONIC DISTORTION:** <0.0003% for all frequencies less than 10 KHz and all powers below clipping  
**TOTAL HARMONIC DISTORTION:** Determined by 2nd Harmonic Distortion (see above)  
**INTERMODULATION DISTORTION:** 0.003% at 100 W (50 Hz and 7 KHz mixed 4:1)  
**STABILITY:** Unconditional

Cat. K44771 Normally \$319, \$299 packing and post \$10



### PREAMPLIFIER THE ADVANTAGES OF BUYING A "ROD IRVING ELECTRONICS" SERIES 5000 PREAMPLIFIER KIT ARE:

- ★ 1% Metal Film Resistors are supplied.
  - ★ 14 Metres of Low Capacitance Shielded Cable are supplied (a bit extra in case of mistakes).
  - ★ English "Lorlin" switches are supplied (no substitutes here).
  - ★ Specially imported black anodised aluminium knobs.
- Available Assembled and Tested. (We believe that dollar for dollar there is not a commercial unit available that sounds as good.)

**SPECIFICATIONS:**  
**FREQUENCY RESPONSE:** High level input: 15 Hz-130 KHz, ±0 -1 dB Low Level input - conforms to RIAA equalisation ±0.2 dB  
**DISTORTION:** 1 kHz <0.003% on all inputs (mini of resolution on measuring equipment due to noise limitation)  
**S/N NOISE:** High Level input, master full with respect to 300 mV input signal at full output (1.2V) >92 dB (flat) >100 dB A-weighted MM input, master full, with respect to full output (1.2V) at 5 mV input 50 ohms source resistance connected >85 dB (flat) >92 dB A-weighted MC input, master full with respect to full output (1.2V) and 200 uV input signal >74 dB (flat) >75 dB A-weighted

Cat. K44791 Normally \$289, \$259 PACKING AND POSTAGE \$10



### THIRD OCTAVE GRAPHIC EQUALIZER SPECIFICATIONS:

**BANDS:** 28 Bands from 31.5 Hz to 16 KHz.  
**NOISE:** <0.008 mV, sliders at 0, gain at 0 (-102 dB0).  
**20 KHz BANDWIDTH DISTORTION:** 0.007% at 300 mV signal, sliders at 0, gain at 0; maximum 0.01%, sliders at minimum.  
**FREQUENCY RESPONSE:** 12 Hz-105 KHz, ±0, -1 dB, all controls flat.  
**BOOST AND CUT:** 14 dB.

Cat. K44590 1 Unit...\$199 2 Units...\$379 PACKING AND POSTAGE \$10

## SERIES 4000 SPEAKERS

- 8 Speakers On ..... \$295
- 8 Speakers with Crossovers ..... \$499
- Speaker Boxes (assembled with grill and speaker cutout) ..... \$299
- Crossover Kits ..... \$199
- Complete kit of parts (speakers, crossovers, screws, innerband boxes) ..... \$799
- Assembled, tested and ready to hook up to your system ..... \$849

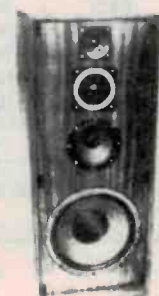

Errors and Omissions Excepted



Rod Irving Electronics

425 HIGH STREET,  
 NORTHCOTE VICTORIA.  
 PH:(03)489 8866 489 8131  
 48-50 A'BECKETT STREET,  
 MELBOURNE VICTORIA.  
 PH:(03)347 9251  
 Mail Order and  
 correspondence:  
 P.O. Box 235  
 NORTHCOTE 3070

**YOU WON'T GET BORED OVER THE HOLIDAYS WITH THESE GREAT SPECIALS!! GREAT 'IN STORE' BARGAINS TOO!**

Call in at either 2 of our conveniently located stores:  
 48-50 A'Beckett St., Melbourne  
 425 High St., Northcote.  
 Or take advantage of our Mail Order Department.  
 Write to:



or phone ...

MAIL ORDER HOT LINE



481 1436



**POSTAGE RATES**

\$1-\$9.99	\$1.50
\$10-\$24.99	\$2.00
\$25-\$49.99	\$3.00
\$50-\$99.99	\$3.50
\$100-\$199	\$5.00
\$200-\$499	\$7.50
\$500 plus	\$10.00

High quality 10-channel

Part 2

# RADIO MICROPHONE

This article goes into the alignment and suggests a method of encasing the unit to 'look like a bought one'. There's no reason you can't fashion a professional-looking unit for yourself with a little ingenuity and elbow grease.

Ian Thomas

NOW WE GET DOWN to the nitty gritty of putting the unit on-air and making a suitable housing for it. What I describe here is simply how I housed the unit for myself. You can make a 'Chinese copy' or simply use what I've done as a guide. Then again, you might like to do something completely different! Enough. On with it.

**Alignment**

Tack a piece of wire on to the antenna lead point but at this stage it need only be 100 mm or so long. The next thing you have to decide is what part of the 88 to 108 MHz band you want to use. Tune your FM receiver across the band and find what seems to be a comparatively unoccu-

pied region (they're getting a bit hard to find in Sydney) and note where you want to use the radio microphone. Then, using Table 1 cut the appropriate tracks to pins 9 to 13 on the board to select that band of frequencies in the synthesiser. Set the rotary switch to channel 4, connect a power supply to the appropriate terminals on the board and stoke the beast up. Monitor the node of R9, R11 and C6 with a 10M input impedance DVM or the like and slowly screw the ferrite adjusting slug into L1.

Before you start adjusting L1 the voltage on the DVM should be very close to ground but as the slug is part way in the voltage should start to rise. It may help if the cup core is loosely placed over the coil but it shouldn't be necessary. A word of warning about adjusting the ferrite slug: they're rather fragile and if the slug's right in the former and breaks it's nigh on impossible to get the pieces out. Before you start, get or make a brass or copper adjusting tool that fits nicely (it's kind of dumb to use iron!).

Adjust the slug until the DVM reads about two and a half volts give or take a volt. Tune your FM receiver across the band watching the signal strength meter. Around the frequency you expect to be radiating the receiver should go quiet. You should see a massive signal with no modulation. If there's a station on the frequency you're using, the radio microphone will probably swamp it out but if you want you can change channels to a vacant frequency (that's why you spent the money). When you do change channels the control voltage should go up or down by about 0.25 volts per channel.

**Trouble shooting**

If all this is happening OK then you're definitely cooking with gas and the whole

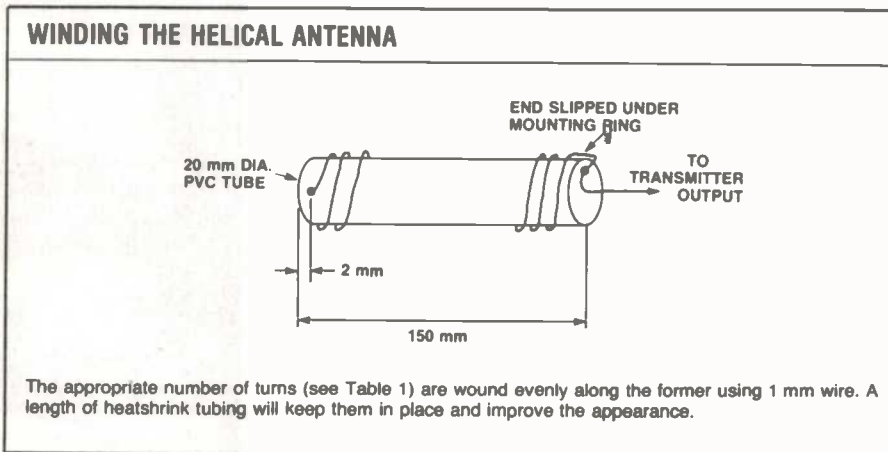

MC145112 DIN					CH0	CH9	ANTENNA TURNS
9	10	11	12	13			
	X			X	88.0	90.25	23.0
	X				92.0	94.25	22.0
		X	X	X	96.0	98.25	21.125
		X	X		100.0	102.25	20.25
		X		X	104.0	106.25	19.5
		X			108.0	110.25	18.75

Table 1: Cut the tracks to the PLL's pins as indicated (by the 'X') to get the desired synthesiser range. The antenna turns for each range are also given.

## FREQUENCY SYNTHESISERS

With today's demands on the frequency spectrum it is essential that the frequency of all radio transmissions be precisely controlled to avoid interference between adjacent channels. In the past this was done by having each transmission frequency set by separate quartz crystals. If many frequencies were wanted in the one unit this meant that a considerable part of the unit cost was taken up by crystals and their associated circuitry. It also meant that an upper limit was placed on the number of available channels in a unit by space requirements even if cost alone was ignored. Clearly a better way of setting transmission frequency was needed.

It was inevitable that digital techniques would provide the answer in the form of the digital phase-locked loop (PLL) frequency synthesiser. This circuit enables an arbitrary number of frequencies to be generated which are all controlled by the one quartz crystal and which have the same stability (at least in the long term) as the crystal. Years ago the digital circuitry needed was far bulkier than multiple crystals and used far more power. Recent developments in high speed CMOS have reduced package count and power to the point that the frequency synthesiser is a good alternative to the multiple crystal transceiver.

The basic circuit for a PLL frequency synthesiser is shown in the diagram and may be divided up into seven separate blocks. The first is the **reference oscillator** which is usually controlled by a quartz crystal and gives out a frequency which we will call  $f_r$ . This frequency is divided down digitally by a **reference divider**, whose division ratio is normally fixed, to give out a much lower frequency which we will call  $f_c$  or the comparison frequency.

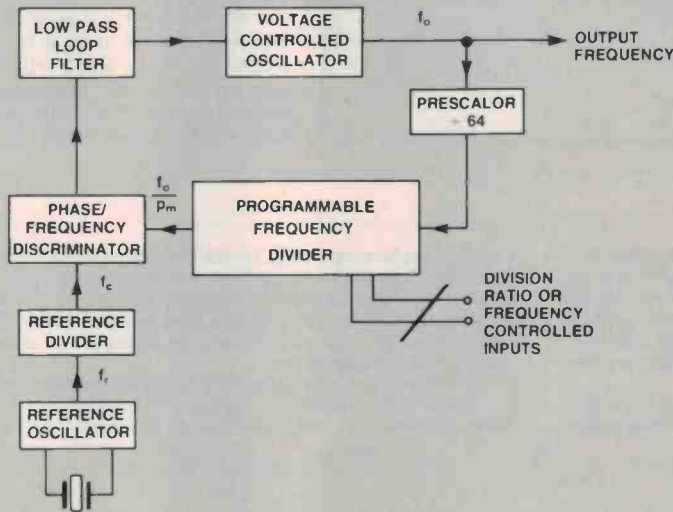

Figure A.

The next block, which is the heart of the synthesiser, is the **voltage controlled oscillator**. This is an oscillator whose frequency is set by an input control voltage and must be designed to cover the complete range of frequencies to be generated by the synthesiser. It must also have very good short term frequency stability as the PLL cannot correct short term frequency variations.

The voltage controlled oscillator output is fed to the next block of the synthesiser (as well as the rest of the transceiver) which is usually a high speed frequency divider called a **prescaler**. As the output frequency of the synthesiser may be many hundreds of megahertz (in our case about 100 MHz) it must be reduced to the order of kilohertz before it can be handled by the next block which is the **programmable divider** which actually determines the final output frequency.

The programmable divider takes the signal from the prescaler and further divides its frequency by a ratio which is digitally determined by digital control lines used to set the frequency. The output of the programmable divider output frequency is, say, too high then the discriminator output will go lower, and

This block, at least in the steady, locked state produces an output dc voltage which is proportional to the phase difference between its two input frequencies. The discriminator dc output is fed to a loop filter to remove any ac components then connected to the control input of the voltage controlled oscillator. If the programmable divider output frequency is, say, too high then the discriminator output will go lower and lower the voltage controlled oscillator frequency which, in turn, lowers the programmable divider output until the two frequencies are exactly the same.

To describe this in more detail we have already said that the reference oscillator frequency is  $f_r$ . If we say the reference divider divides by  $n$  then the comparison frequency is  $f_c = f_r/n$ . Similarly the voltage controlled oscillator is  $f_o$  (it's also the output frequency) and is divided first by the prescaler ratio  $p$  then by the programmable divider ratio  $m$ . Therefore the output frequency from the programmable divider is  $f_o/pm$ . The phase/frequency discriminator ensures that these two frequencies are exactly the same so we can write

$$\frac{f_r}{n} = \frac{f_o}{pm}$$

system has come up fine. If, however, you can't get anything at all and the control voltage seems to be stuck to the positive rail then the oscillator probably isn't running. Check all the dc potentials around

the circuit starting with the 1.2 volts at the top of the reference IC4. The emitters of Q2 and Q3 should be at 0.6 to 0.7 volts and the emitter of Q1 should be at about 2.5 volts.

or rearranging things

$$f_o = \frac{pmf_r}{n}$$

or, putting things in words, the output frequency is exactly equal to the reference frequency multiplied by a fixed constant,  $f_r$ , and also multiplied by a digitally controlled variable number,  $m$ . As  $m$  is always an integral number (that is  $m$  never has fractions — that's the way digital dividers work) then the output frequency of the synthesiser can be stepped in frequency increments of  $pf_r/n$  and this is the channel spacing of the synthesiser.

To illustrate this more clearly take the example of the radio microphone. The reference frequency is 4,000 MHz and the fixed reference divider ratio used is 1024 so the comparison frequency is

$$\frac{4\,000\,000}{1024} \text{ or } 3906.25 \text{ Hz.}$$

The prescaler used has a division ratio of 64 (it's always easier i.e. cheaper to divide by  $2^n$  where  $n$  is integral) so if we want an output frequency of 108,000 MHz then the programmable divider ratio must be set to 432. This gives a programmable divider output frequency of

$$\frac{108\,000\,000}{64 \times 432} = 3906.25 \text{ which is what is expected.}$$

If the division ratio of the programmable divider were to be changed to 431 then the phase discriminator would adjust the voltage controlled oscillator so the output frequency divided by 64 x 431 = 3906.25 Hz of  $f_o = 3906.25 \times 64 \times 431 = 107.750$  MHz.

This shows that the channel spacing for the microphone synthesiser is 250 kHz which is the answer given from the formula.

Check that the crystal reference oscillator's running at 4 MHz by monitoring pin 4 of IC2 as pin 3 is a high impedance point and doesn't take kindly to load. If all this is correct then it's a pretty good bet the polarity of the inductor L1 is wrong and you'll have to reverse the secondary terminations. This should get things going but if you still have trouble check that the ends of the bypass capacitors C3, C17 and C23 are a good solid connection to the ground plane. The same applies to the tuning capacitor C13; if it's open circuit the oscillator will be a mile off frequency.

### Final set-up

Once things are running OK you can paint the oscillator coil windings with lacquer. This should be done reasonably generously; if the coil windings can move around, the radio microphone will be microphonic in ways you don't want. If it's knocked the coil geometry will change slightly and change oscillator frequency. Use superglue ▶

# Project 741

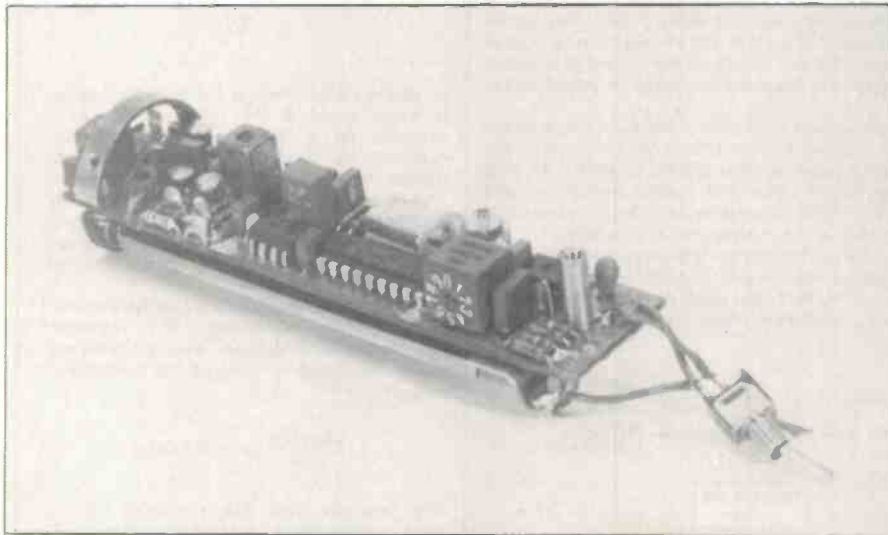

to stick down the cup core over the lacquered coil and solder that can cover the lot. Realign L1 so the control voltage is 2.5 volts for channel 4 and try putting some tone on the audio input. It should take about -46 dBm or 4 mV to give full modulation which will be clearly audible on your receiver. On the prototype I found that the total harmonic distortion going through the microphone and a good (well — sort of) receiver was -47 dB or 0.45%. It was interesting to note that the THD got worse rapidly as I wound the deviation over the  $\pm 75$  kHz, presumably as the receiver started cutting off sidebands. This type of modulator will quite happily give MHz of deviation so I assumed the bad things were happening in the receiver.

## Mechanical

The board as assembled and tested so far can be mounted virtually anywhere and if you want to put it in a box of your own contriving that's fine. I didn't put a volume control in the microphone itself as it seemed better to do all the gain controlling at the receive end rather than risk

## PHASE-LOCKED LOOPS

The phase-locked loop is only one of a whole class of control systems all of which have an essential requirement. That is that the sum of all the gains in the loop *must* be less than 0 dB when the sum of all the phase shifts reaches  $360^\circ$ . How much the loop gain is less than 0 dB when the loop phase shift reaches  $360^\circ$  is called the gain margin and how much the total phase shift is less than  $360^\circ$  when the total loop gain reaches 0 dB is called the phase margin.

When a phase-locked loop is designed the loop gain and phase are always plotted on a Bode plot, named after the bloke who really got control loop design

on a sound engineering footing. Before Bode came along fudge factors were high art. The Bode plot for the synthesiser is shown in Figure B. The first thing you will notice is that the loop with no filtering at all shows a 20 dB per decade rolloff. This is because the control voltage from the discriminator controls oscillator frequency but error signals out of the phase discriminator are proportional to oscillator phase.

To understand how this causes the 20 dB rolloff suppose the audio signal that modulated the oscillator in our radio microphone had a frequency of 100 Hz. Suppose also that we've opened the control loop and magically

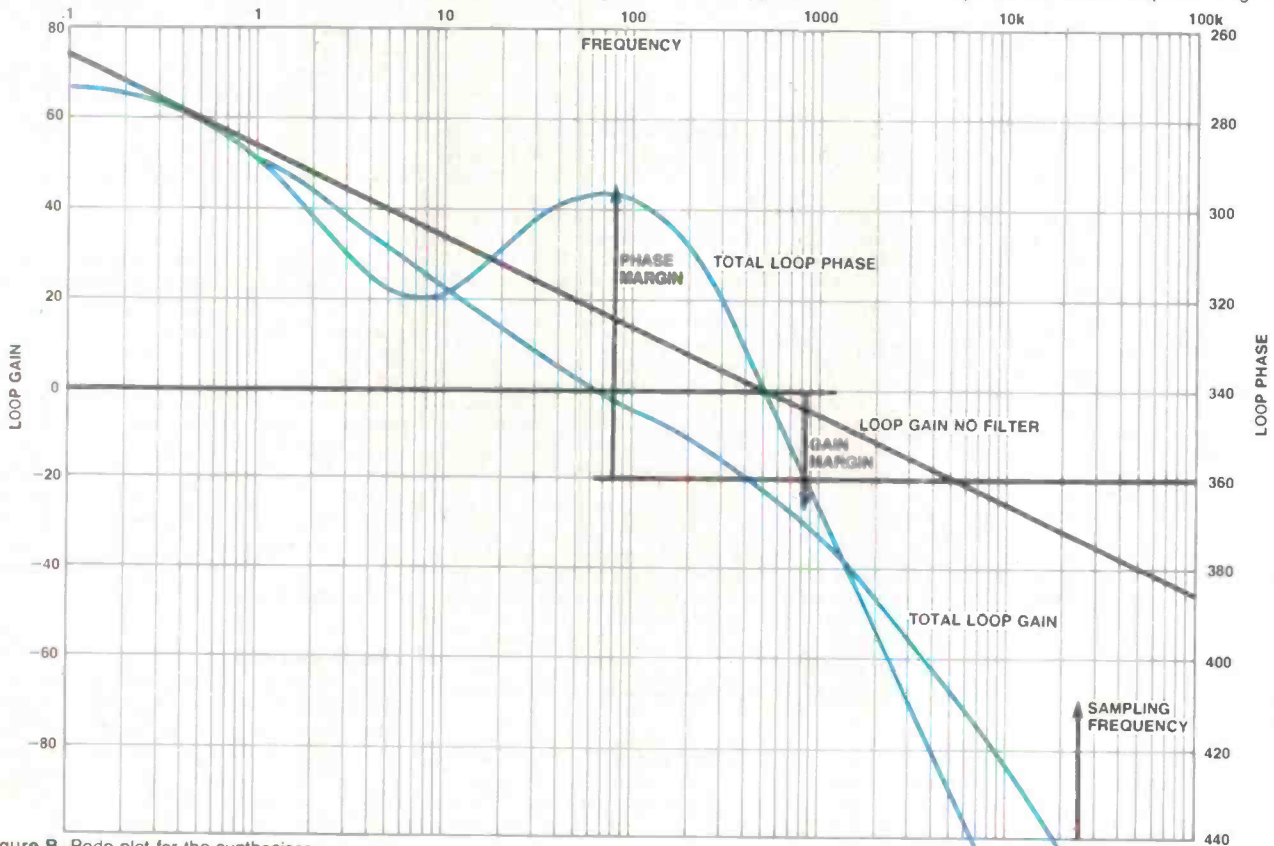

Figure B. Bode plot for the synthesiser.

having someone wind the modulation up to  $\pm 500$  kHz and wonder why it sounds poorly. This makes it necessary to find out what sort of level comes out of the microphone you intend to use and adjust R1 and R2 to suit. If you do mount the transmitter in a box and want a gain control then R8 could be replaced with a pot to give some variation but it should be 1k or less to avoid causing the audio response to roll off too soon.

Since I'm a sucker for trouble I decided to mount the board in a tubular case so it could be used as the handle of a microphone. This meant that everything finished up absolutely jammed in but made for a nice neat unit. I'll describe how I did it but *be warned*: mounting the transmitter this way takes a fair bit of sheet metal work and you'll need some basic tools to do the job right. The very basic essentials are a good bench vice, drill press and selection of drills to go with it, assorted files, a 2.5 mm x 0.45 mm thread cutting tap, a multiple size hole saw and lots of patience.

The first thing to do is make the mounting bracket to mount the board in the

tube. Cut and clean a strip of the sheet brass 5 mm wide and 50 mm long then bend it around a mandrel (see Figure 3) so it will fit exactly inside the copper tube. Next bend in the two mounting tabs so the distance from the outside of the mounting tabs to the bottom of the curve is exactly 14 mm (see Figure 4). Cut the two mounting tabs off and file them down so there is enough material to hold the mounting screws but not so much that the bracket fouls any components. Hold the bracket where it's finally to go on the board and mark where the mounting holes on the board go. Drill and tap the two mounting tabs with the 2.5 mm tap. The spacer that goes on the audio end of the board is also about 5 mm diameter and exactly 14 mm long drilled and tapped 2.5 mm.

Temporarily attach the bracket and spacer and try the assembly for fit in the copper tube. The first thing you'll see is that the channel select switch fouls the tube wall but this is correct — don't worry. To mount the board start by trimming one end of the tube off clean and square to become the antenna end of the final unit. Next mark a point on the tube

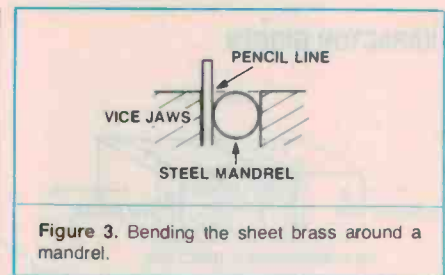

Figure 3. Bending the sheet brass around a mandrel.

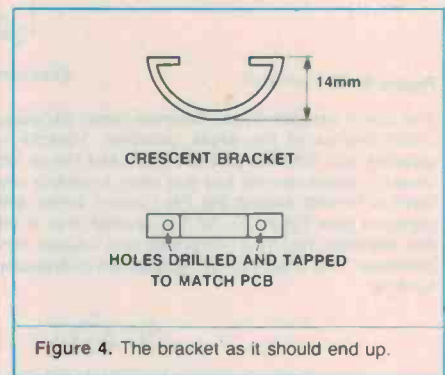

Figure 4. The bracket as it should end up.

arranged that the correct dc voltage is applied to the dc control input of the voltage controlled oscillator so it doesn't drift. The resultant output from the oscillator has 100 Hz frequency modulation with deviation of, say,  $\pm 1$  kHz. The frequency deviation peaks will correspond exactly to the peaks in the modulating signal. The phase error as seen by the phase discriminator is not so straightforward however.

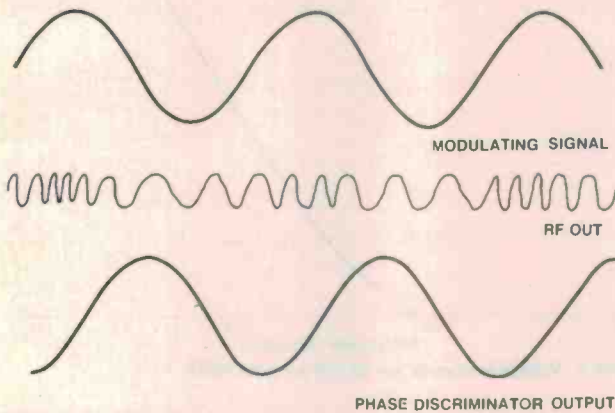

Figure C. The frequency deviation peaks correspond with the peaks in the modulating signal.

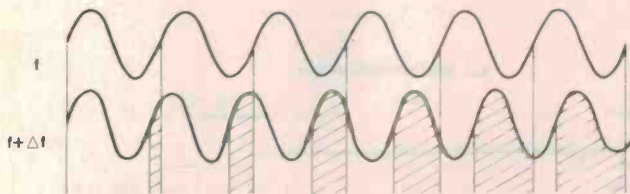

Figure D. Showing how two slightly different frequencies have a phase difference that increases linearly with time.

Herein lies the nub of the peculiar behaviour. If two signals have frequencies that differ slightly by an exact fixed amount the phase difference between them increases linearly with time. This effect is shown in Figure D where two sine waves with fractionally different frequencies are drawn. The phase error is given by:

$$\phi = \int f dt$$

in our example, with a signal modulated by a 100 Hz tone, the phase error is zero when the modulating signal passes through zero but for all the time that the modulating signal is positive the phase error is adding up and causes the output of the phase discriminator to continue going positive. This means that when the modulating tone passes through zero going negative the phase discriminator output is at its peak positive point. So the value of the discriminator swing is proportional to the area under the positive swing of the modulating signal. This causes two effects. The first is that the peaks of the phase discriminator output correspond to the zero crossings. This corresponds to an inherent  $90^\circ$  phase shift between the input phase error signal and the phase discriminator output.

The second effect is shown by considering what happens if the modulating signal frequency is increased to 200 Hz without altering its amplitude. As the discriminator output is proportional to the area under the excursions of the input error signal, the peak output will be only half the peak for 100 Hz.

All this rather complicated description says is that the phase discriminator output is  $90^\circ$  phase shifted and shows a 20 dB per decade rolloff with frequency — just what is shown on the Bode plot! It may seem rather baffling but if you don't allow for it in the design your circuit won't work!

The final upshot of this discussion is that at zero frequency a phase-locked loop has infinite gain (really!). But at high frequencies the loop gain naturally rolls off and in many cases no loop filter is necessary for stability. This is such a case. I used a loop filter, but only to remove the crud from the discriminator output.

We must now look at the problem of phase shifts around the loop. The first phase shift must be  $180^\circ$  because we want any disturbance in the loop to be corrected by a signal in the opposite direction. The next inherent phase shift in the loop is the frequency-to-phase  $90^\circ$  shift I just described.

One of the basic rules of this game is any filter whose frequency response falls with rising frequency shows a phase shift the wrong way for our case (Murphy again) so if we want to include a loop filter it must roll off very slowly with frequency so as not to give too much phase shift (the faster the rolloff the larger the phase shift during the rolloff).

Hence the loop filter has only one simple RC stage at low frequencies with a second resistor (R10) in series with the capacitor to ensure that the phase shift in the loop never gets too near  $90^\circ$ . As the loop gain nears the critical 0 dB point most of the roll-off is removed to give plenty of phase margin. As soon as the loop gain is comfortably below 0 dB we can do anything we want to the phase so C8 is placed across R10 and a second stage, R11 and C5, is added to attenuate the discriminator nasties. Both the total loop gain and loop phase shift are shown on the Bode plot to show how they are optimised.

The crystal reference is a normal parallel mode 4.000 MHz device. The crystal is packaged in a small can to keep things compact. As it has to resonate with a parallel 30 pF capacitance both sides really need 60 pF to ground but you can vary this a bit as it isn't absolutely necessary to have the reference right on 4.000 000 MHz. The main thing the crystal provides in this case is a dead stable reference frequency with temperature and voltage changes having no effect (almost). The trimmer is provided as a nicety as I like to see the output frequency come up on the counter as say 105.750 000 MHz.

## VARACTOR DIODES

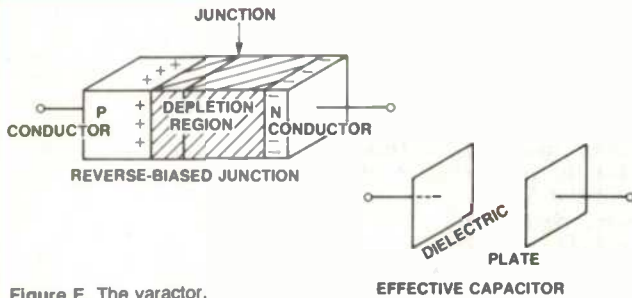

Figure E. The varactor.

The use of varactor diodes deserves some discussion as this device sets the characteristics of the whole oscillator. Varactor diodes come in several varieties with different junction types and hence different characteristics. All varactor diodes use the fact that when a diode is reverse biased a depletion layer is formed around the PN junction which acts as the dielectric for a capacitor (see Figure E). As the reverse bias is increased the thickness of this depletion region is increased and causes the junction capacitance to decrease. This effect can be represented mathematically in a rather simplified form by

$$C_d = \frac{C_0}{(V + \phi)^\gamma}$$

where  $\phi$  is normally about 0.7 V at room temperature,  $C_0$  is a function of the diode geometry and assorted other parameters. It's constant for any diode.  $\gamma$  is dependent on the dopant profile in the diode.  $\gamma$  is really the most important parameter in designing voltage controlled oscillators as it determines the way the diode capacitance changes with voltage and hence the way the oscillator frequency changes with voltage.

By far the easiest type of diode to make is the abrupt junction diode where  $\gamma$  is equal to about 0.5. Most of the varactors you can buy are of this sort. However for some applications a diode with a tuning range greater than that given by a  $\gamma$  of 0.5 is needed and for this special diodes are used called hyperabrupt junction diodes (now there's a really impressive term — try laying that one on your non-technical friends!). The diodes are fabricated using special epitaxial growth or ion implantation techniques and show the peculiar property that the dopant concentration increases the nearer you are to the actual junction. In this way diodes with  $\gamma$  of 1 or 2 can be made.

"So what!" did I hear you say? Well all this has a point. The frequency of oscillation of a tuned circuit is given by the recipe:

$$f_o = \frac{1}{2\pi\sqrt{LC}}$$

Now if we could find a varactor whose capacitance is proportional to  $1/V^2$  then the resonant frequency of a tuned circuit using such a diode would be given by

$$C \propto \frac{1}{V^2}$$

and therefore

$$f_o \propto \frac{V}{\sqrt{L}}$$

or the frequency is directly proportional to the varactor bias voltage — a very nice thing to have. Usually the  $\gamma$  of a diode will not be exactly 2 but in general the higher the  $\gamma$  of the varactor diode the more linear the voltage-frequency characteristics of a tuned circuit using it. This means that oscillators using such a varactor as the tuning control element will have a gain that's constant (more or less) with bias voltage (the gain of a voltage controlled oscillator is the change in frequency divided by the change in voltage required to produce the frequency change or

$$A_{vco} = \frac{\Delta f}{\Delta V}$$

and for our case is given in MHz/V). If an abrupt junction varactor was used in a voltage controlled oscillator then the frequency would change very fast with voltage for low biases. But as the bias increased the rate of change would slow. We could probably live with this and design the phase-locked loop to allow for the gain variations, but the major stumbling block would be that the same modulating voltage is being applied to the varactor to give frequency modulation no matter what dc bias is being applied to it. This means the radio microphone would have different modulation deviation as the channel was changed. Using a hyperabrupt junction diode avoids both problems and gives nearer constant gain and modulation. You do lose a little in circuit Q with hyperabrupt junction diodes but the advantages far outweigh the problems.

Diodes are made just to suit operation in the 88-108 MHz band by Motorola and I chose one of these to use in the oscillator. It has a  $\gamma$  of about 1 so the voltage/frequency law of the final oscillator isn't perfectly linear but is quite good enough (see Figure F). As the oscillator doesn't have to span the full 88 to 108 MHz but only about 4 MHz the actual varactor diode is padded out with a series capacitor C12 and a parallel capacitor C13. This reduces the total frequency range but increases the tuned circuit Q.

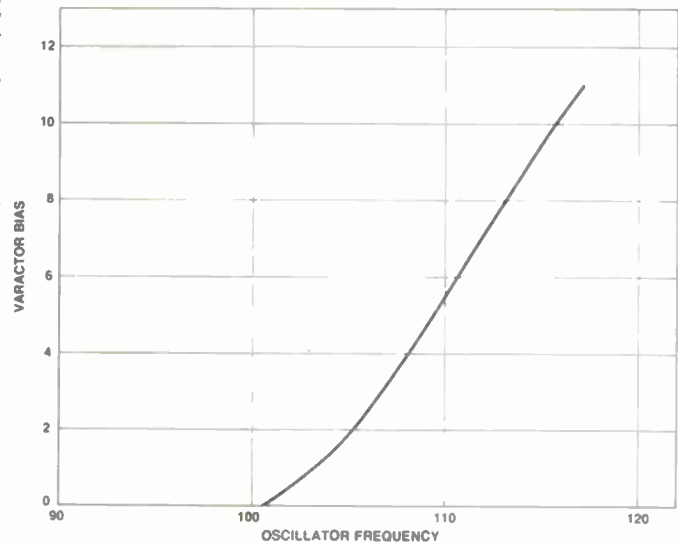

Figure F. Voltage/frequency law of the project's VCO.

where the spacer should go so that if the board is mounted from this screw the transmitter end of the board will be 7 mm from the end of the tube. Drill a hole to clear a 2.5 mm screw and countersink it as deep as possible. Don't cut right through the tube though. Next hold the board against the outside of the tube and mark off where the channel select switch will go.

When you're satisfied with the switch hole, screw a 2.5 mm diameter x 5 mm long countersink head screw into the spacer to hold the board in place in the tube. With a thin piece of rod of some sort measure exactly the distance from the antenna end of the tube to the crescent bracket with the board mounted in the tube. With the board still mounted in the tube drill two holes through both the tube and the mounting bracket. When drilling

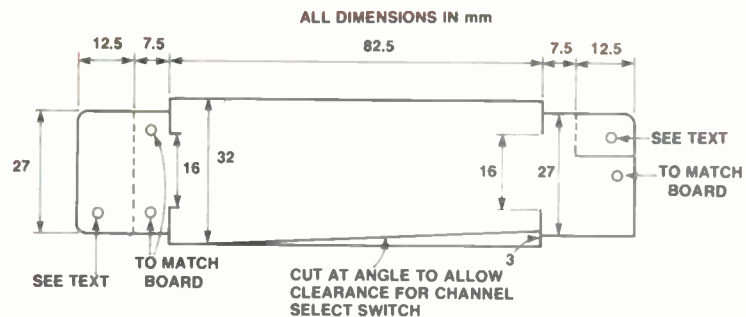

Figure 5. Battery holder.



through the bracket it's necessary to hold it hard up against the wall of the tube. Remove the board from the tube, tap the two holes in the bracket, open out the holes in the tube to 2.5 mm and countersink them as before and the board mounting in the tube is complete.

### Battery holder

The battery holder is the next part to be made and is kind of fiddly so I hope you've got lots of patience. The batteries used are AAA cells that fit (just) in the free space beside the board in the tube. The terminals and contact springs can be salvaged from the cheap plastic AA cell holders you can buy from most electronics suppliers. Using the same sheet brass as before or perhaps a little thinner cut out the shape shown in Figure 5. Using the board as a template mark and drill the three mounting holes to clear 2.5 mm screws and make sure it will fit OK. Bend up the end with the two holes where the sketch shows a dotted line *sharply at right angle*. To get a nice sharp bend hold the sheet in a vice so the point to be bent lies exactly on the edge of the vice jaw and clamp it *hard*. Hammer the bit that protrudes down against the vice jaw and you get a good clean bend! Next bend up half of the other end the same way and the two battery terminal mountings are done.

To stop the batteries rattling around in the final unit I bent up a piece of mild steel around the mandrel in a nice even curve. Try placing four AAA batteries in the channel you've made and if it's right they should fit snugly with almost no free movement at all. If they won't lie down flat against the bottom of the channel the sides have been bent up too sharply and you can fix it by opening the sides out a bit. If they are very loose the battery holder may not fit in the tube and it's necessary to repeat the bending process with the mandrel moved down a bit.

The next thing to be done is to attach spacers to the bottom of the battery holder so it clears the cut off leads on the board. First work all over the board cutting *all* the leads off as short as possible. Next find three small brass nuts no thicker than 2 mm and no wider than 5 mm in any dimension. Align these nuts over the three holes in the battery holder on the back of the holder and solder them in place. The nuts must be exactly in line with the holes already drilled in the sheet brass or when everything's assembled the nuts may short out tracks. Finally dress down the surfaces of the nuts that touch the board with a file so the thickness of the nuts *plus* the sheet brass is 2.5 mm. Any more and there's a risk the batteries won't fit. When all this is done try mounting the completed metalwork on the board with 2.5 mm diameter x 8 mm long countersink head screws and try the assembly for size in the tube.

The channel select switch needs to be

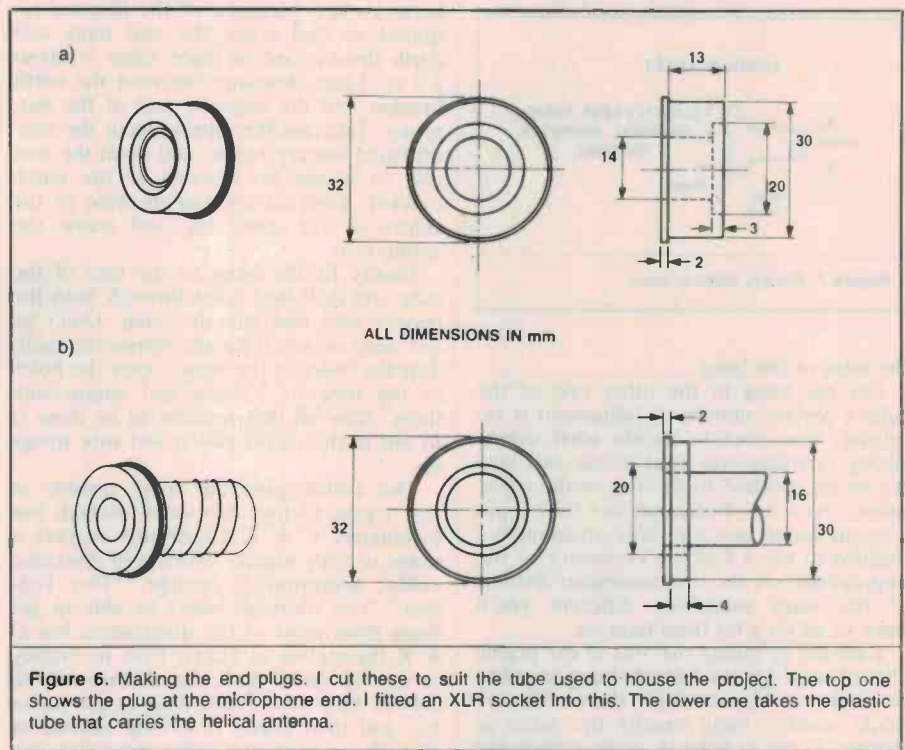

**Figure 6.** Making the end plugs. I cut these to suit the tube used to house the project. The top one shows the plug at the microphone end. I fitted an XLR socket into this. The lower one takes the plastic tube that carries the helical antenna.

eased into place and to give room to do this the side of the battery holder is deliberately slightly cut away. If the terminal ends of the battery holder foul the tube they should be trimmed away until they fit but don't get carried away — take off small bits and try again until it's right.

### Battery terminals

The battery terminals are made up from 3 mm pan head screws for the positive terminals and springs salvaged from the commercial holder for the negative terminals. Mount the 3 mm screws in one end of the battery holder using a plastic insulating washer from a T0220 transistor mounting kit. A solder tag should be placed under the nut to allow connection.

The other end of the battery holder needs a piece of printed circuit board to act as a spacer. Cut out a piece so it fits exactly over the end of the whole bent up end and just clears the two mounting screws. The board should be singled sided copper laminate with the copper side away from the brass. Make a positive terminal diagonally opposite the positive terminal you've just made. Then take one of the springs that will act as negative terminal and bend the bottom end until it forms a neat loop to go under the screw. The spring should line up with the end of the battery.

### Antennas

The two ends of the case are made from sheets of 6.4 mm thick plastic. Make up the antenna end of the microphone first

by cutting out a disc of sheet plastic with a one and one half inch hole saw. Don't cut too fast or you'll melt the plastic and mess it up. Cut and file until you have a disc the same diameter as the outside of the tube. Then, leaving a 1 mm wide rim, cut away the rest of the edge of the disc until it just fits into the tube. This gives you a neat bung that closes off the end of the tube (see Figure 6).

Next cut a 22 mm diameter hole in the centre of the disc. This hole should be an interference fit with a 22 mm conduit (that is it shouldn't be a sloppy fit but rather you should have to push *hard* to get it in). Using Araldite, glue in a piece of conduit exactly 150 mm long so when the bung is in the end of the tube the conduit sticks out 144 mm to form the antenna.

To make the actual antenna you'll need about 1.5 m of 1 mm diameter copper wire. Drill holes at either end of the conduit. These two holes are to terminate the antenna wire. The antenna needs 19.5 turns to operate correctly at 106 MHz. If you've decided to use a different part of the 88 to 108 MHz band refer to Table 1 to see the correct number of turns.

Once the wire helix is tight and even with 19½ turns (count them again!) slip a piece of heat shrink tubing over it and gently heat it over a gas torch or stove. Be patient here as if you try to rush it you'll burn the tubing and have to try again. Finally trim off the wire at the outer end of the helix and the antenna's finished. To fit it to the body of the microphone fit it to the end of the copper tube and drill three holes through both the copper tube and

# Project 741

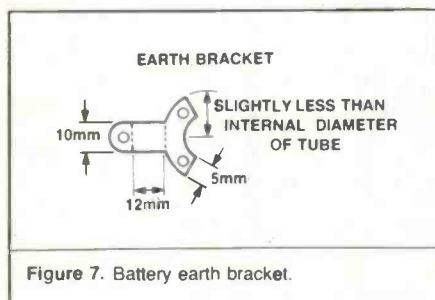

Figure 7. Battery earth bracket.

the edge of the bung.

For the bung in the other end of the tube a certain amount of judgement is required. You have to decide what microphone cartridge you want to use and how it's to be attached to the top of the transmitter. As a lot of microphones have 3 pin Cannon connectors for cable attachment I decided to use a Cannon connector of the appropriate sex for the transmitter fixture. If you want something different you'll have to ad lib a bit from here on.

I started by gluing two bits of the plastic sheet I used for the bottom bung together to make a 12 mm thick sheet. Then I made another bung exactly the same as before. I cut a hole in it to accept the outer shell of the connector. The shell was cut off so that when the cut end was flush with the inner end of the bung the screw that holds the connector in the shell was just free of the bung. The cut off shell was then Araldite in place. The much thicker bung ensured that the connector would hold the heaviest microphone. Testing was done with an AKG D330BT microphone which is a great lump of a thing and plenty of strength seemed a good idea.

## Earth clamp

The final part to be made is the earth clamp and connection for the battery holder. Cut out a piece of sheet brass according to the drawing given (Figure 7) and bend it sharply at right angles where the dotted lines show. Drill and tap 2.5 mm threads in the inner end of the top end bung so that when the bung is inserted the bent over tag is next to the earth end of

the batteries. Before the bung is fitted to the tube the tube must be trimmed off to the correct length. With all the works in the tube and the four AAA cells in place carefully measure where the end of the batteries lies. Measure off the distance required so that when the end bung and earth bracket are in place there is about 2.5 to 3 mm clearance between the earth bracket and the negative end of the batteries. Take another spring from the cannibalised battery holder and bend the free end so it can be screwed to the earth bracket. Drill an appropriate hole in the centre of the earth tag and screw the spring to it.

Finally fit the bung to the end of the tube and drill four holes through both the copper tube and into the bung. Don't go too deep or you'll hit the connector shell. Tap the holes in the bung, open the holes in the tube to 2.5 mm and countersink them. Now all that remains to be done is to put in the on/off switch and wire things up.

The switch gave me some trouble at first trying to find one small enough but fortunately C & K Electronics market a range of truly minute switches in Australia called, appropriately enough, "Tiny Toggles". You probably won't be able to get them from most of the distributors but C & K themselves at Harris Park in Sydney or any of the C & K distributors will be able to help you. I was able to get just a few and their policy is to help anyone at all with no minimum order size (nice one C & K!). Even though the switch is small I still had to trim off the terminals before it would fit. The switch mounts in a 4.8 mm (3/16") hole so to mount it all that's necessary is to drill a hole through the copper tube next to the battery positive terminal and screw in the switch. After the switch is in, attach insulated wires to the mic input pads, the positive and negative pads and the antenna pad on the board and also a lead to the positive terminal on the battery holder. Screw it in place in the tube and trim and connect the positive lead from the battery holder to the centre terminal of the switch. Do the same for the positive lead from the board to the upper terminal of the switch. The antenna lead can be cut short and soldered to the tinned end of the antenna and the whole antenna screwed into position. Connect the earth pin of the microphone socket to the earth bracket and the

earth bracket to the earth lead from the board using as short a wire as you can. Trim off the two mic leads and solder them to the connector pins. Finally insert the four batteries and screw on the top bung with four screws and the radio microphone's ready to test.

## Testing

I found that there's a free space in Sydney that corresponds to channel 8 or 9 on the microphone at about 106 to 106.5 MHz. Tune your FM receiver to this space or, if it isn't free where you live, find a free space and tune to it and adjust the transmitter to that frequency. Turn on the project with a microphone plugged in and you should see the signal strength meter or tuning indicator slam over against the stops. You're only transmitting 25 to 30 mW but you're a hell of a lot closer than the FM stations. In fact, if you inadvertently tune to the same frequency as an FM station you'll completely swamp it out but DON'T DO IT DELIBERATELY; you'll annoy the hell out of the neighbours. Just talk into the mic and listen to see if it sounds OK.

To test for range, arrange for someone to listen to the radio and walk down the street turning the transmitter on and trying it occasionally. The person listening can wave to you if they can hear you. I found that I could get about 400 metres range before the signal got too weak. If you want you can drill a hole in the transmitter over L2 and adjust the inductor to optimise transmitter power but I found it hard to do as the transmitter always gave out heaps of power and swamped the receiver.

Once everything seems to be going as desired you may like to embellish the transmitter by having the copper body plated either with nickel or chrome (or if you want a *really* class job, gold!) and it's all finished. Just a final warning though: don't ever use the transmitter on the same frequency as a commercial or community station. You've got a choice of 10 frequencies while they have but one. Do the right thing and find a free channel — that way you don't bother them and they probably won't bother you. If you do interfere with broadcasting the Department of Communications MUST act to find you and at the very least confiscate the results of all your labours! If you use it wisely nobody will be bothered.

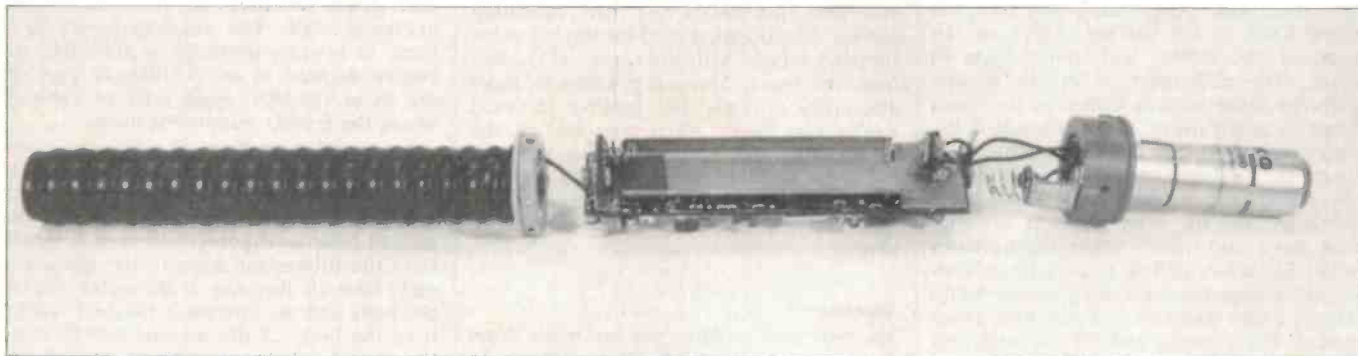

Ready to house. The project showing battery holder and mounting bracket and pillar, ready to slip in the tube used to house it.

# A simple DARKROOM EXPOSURE METER

Peter Ihnat

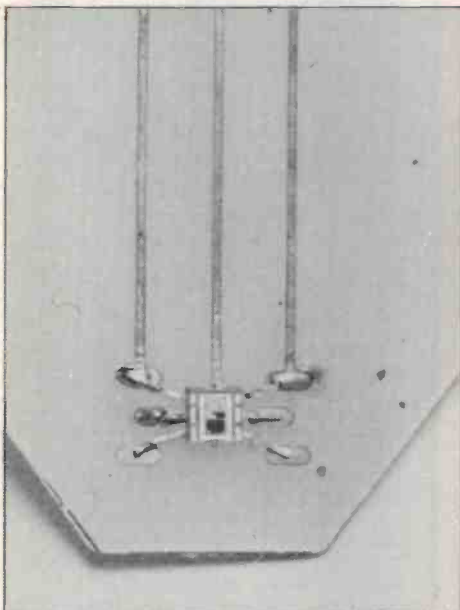

For those into a lot of darkroom work (photographic, of course!) the following project will speed up print making. It is a low cost, compact exposure meter which features battery operation, three LEDs to indicate under, over or correct exposure and a new photodiode/op-amp IC as the sensor.

MOST ETI PROJECTS come about for one of two reasons — either there isn't a commercial gadget available to perform a certain function or if it is, it's expensive to buy. The latter is the reason for the current project. Several types of darkroom exposure meters are available commercially. These vary from simple "comparator" types (dear) to sophisticated units with digital readout (very dear). A very accurate digital exposure meter was described in the March 1984 issue of ETI and featured digital readout in seconds, a calibration control, remote sensor and a linear response from one to about 300 seconds. It is quite reasonably priced for its performance but as with all things, there is always a demand for smaller, lower cost units.

The current project is an exposure meter which uses the comparative technique for determining exposure rather than having a direct readout in seconds. By "comparative" I mean that a reading for a certain type of photographic paper is taken after some test negative has been correctly printed. Then any other negative can be printed on this paper if the aperture of the enlarger lens is adjusted to give the same reading on the meter.

The reason for this technique working relies on the fact that when a print is made, the exposure time multiplied by the amount of light striking the paper equals a constant. (This also explains why halving the amount of light hitting the paper requires the exposure time to be doubled to produce the same print — it's to keep the constant constant. Simple!) So if the same exposure time is used for all prints, only the lens aperture (f-stop) needs to be varied to cater for differences between negatives or size of enlargements. The meter indicates when the

The sensor as mentioned in the main text is a combination photodiode/op-amp with an open collector transistor output. It sinks a current in direct proportion to illuminance. However, a voltage either directly or inversely proportional to illuminance would be preferred. Ohm's law provides the solution — if the current is passed through a resistor then an equivalent voltage will be produced. This is the function of R1. The voltage produced across it will be

$$V_r = I_r \times R_1 \\ = 5 \times R_1 \mu\text{V/lux}$$

since the sensor has a sensitivity of about 5  $\mu\text{A/lux}$ .

The voltage fed to the next stage is actually the supply voltage (9 V) minus the voltage given above. If necessary, R1 can be adjusted to change the range of illumination covered by the unit. For high light levels, R1 can be decreased; for much lower light levels, R1 can be increased. The value selected for this project results in good sensitivity for dark-room light levels.

The voltage produced by the sensor will have an ac and a dc component since the enlarger light source is usually ac-powered (i.e. from the mains). Only the dc component is required and so IC2a is set up as a first-order filter which cuts off frequencies above about 10 Hz.

A variable voltage is fed to the other input of IC2a and is used as an offset adjustment. In fact, this is the 'calibration' control on the front panel, and when adjusted causes the signal to be dc level-shifted up or down. This voltage is compared with a fixed voltage (not really a single voltage as we will see shortly)

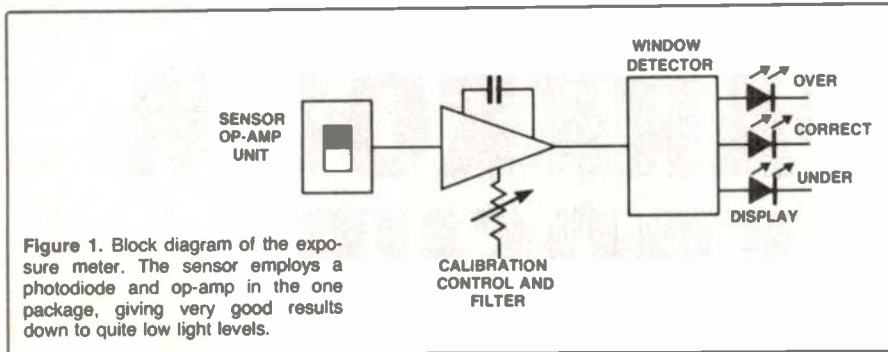

Figure 1. Block diagram of the exposure meter. The sensor employs a photodiode and op-amp in the one package, giving very good results down to quite low light levels.

aperture adjustment is correct by illuminating one of three LEDs. More details of exposure determination are given in the section 'Using It'.

A block diagram of the exposure meter is given in Figure 1. The sensor I have used is a fairly new device which combines a photodiode and op-amp in the one package. Known as the TFA1001W it features high sensitivity (typically 5  $\mu\text{A/lux}$ ), wide illuminance range (0 to 5000 lux), high output

current linearity (see Figure 2) and low current consumption. Impressive, eh? It also provides a stabilized voltage of 1.35 volts (typical) as a reference on one of its pins. Its output is an open-collector transistor which sinks a current in direct proportion to the illumination. Figure 2 gives more details on the device.

### Construction

The circuit can be assembled in a variety of ways. For compactness and ease of construction the recommended pc board should be used. Whether you make your own or buy a commercial board, check for broken tracks or shorts and see that the mounting holes are correctly drilled. If all is OK, construction may begin. The first thing you may notice is that the board is tapered at one end. If your board isn't then cut it to shape

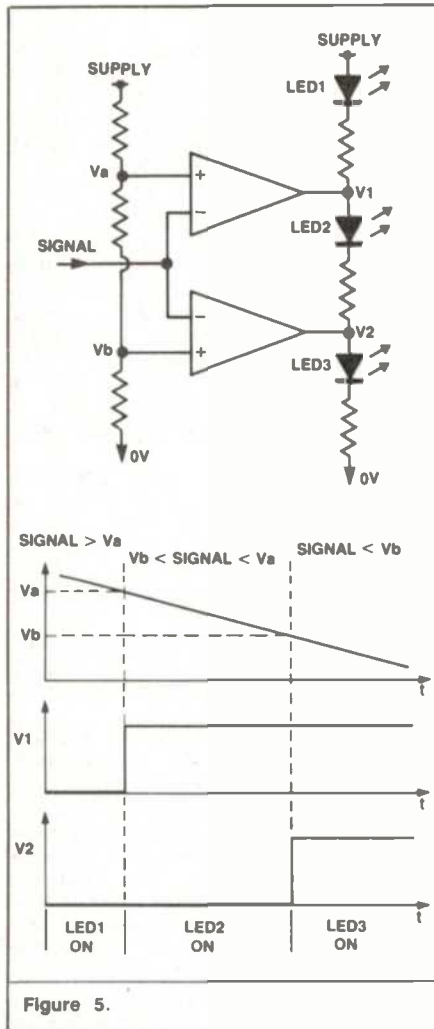

Figure 5.

### TFA1001W photodiode with amplifier.

The bipolar IC TFA1001W contains a photodiode and an amplifier. At its output (open collector) the TFA1001W supplies a current directly proportional to the illuminance. At another pin, a stabilised voltage of 1.35 volts is available as a reference.

Figure 2.

#### TFA 1001 W

##### Maximum ratings

Supply voltage  $V_S$   
Output current  $I_O$   
Power dissipation  $P_{tot}$   
Storage temperature  $T_{stg}$   
Junction temperature  $T_j$

Thermal resistance, system-ambient air  $R_{thSA}$

Characteristics at  $T_{amb} = 25^\circ\text{C}$ , supply voltage applied to pin 5

Supply voltage  $V_S$   
Current consumption at  $E_v = 0 \text{ lx}$   $I_S$   
Ambient temperature (during operation)  $T_{amb}$   
Illuminance  $E_v$   
Sensitivity in range  $S$   
Output current at  $I_O$   
 $E_v = 0.05 \text{ lx}$   
 $E_v = 1 \text{ lx}$   
 $E_v = 1000 \text{ lx}$   
 $E_v = 5000 \text{ lx}$   
Stabilized voltage at pin 6  $V_{stab}$   
Supply voltage dependence of stabilized voltage  $\Delta V_{stab}/\Delta V_S$   
Temperature dependence of stabilized voltage  $\Delta V_{stab}/\Delta T_{amb}$

	Lower limit B	Upper limit A	
$V_S$		15	V
$I_O$		50	mA
$P_{tot}$		200	mW
$T_{stg}$	-40	85	$^\circ\text{C}$
$T_j$		100	$^\circ\text{C}$
$R_{thSA}$		250	K/W
	Lower limit B	typ.	Upper limit A
$V_S$	2.5		15
$I_S$			1
$T_{amb}$	-10		70
$E_v$	0		5000
$S$	2.5	5	7.5
$I_O$		0.25	
$I_O$	2.5	5	7.5
$I_O$	2.5	5	7.5
$I_O$		25	
$V_{stab}$	1.2	1.35	1.5
$\Delta V_{stab}/\Delta V_S$		2	
$\Delta V_{stab}/\Delta T_{amb}$		-0.3	

to provide indication of 'over', 'under' or 'correct' exposure.

The final stage of the circuit is the comparator and display part. In older meters using a similar principle of operation, the filtered and offset voltage was compared to a single fixed voltage by two comparators. Each comparator controlled a single light (or LED) to indicate 'over' or 'under' exposure. Correct exposure was indicated by having both lights glow equally in brightness (as the calibration control was turned, one light would increase in brightness and the other would decrease). The problem was that it required a fair amount of fiddling for correct adjustment.

In this project, two comparators are set up to operate as a window detector (see Figure 5). This has two fixed voltages with which the signal is compared. At any time, the circuit will be in one of three conditions —

- 1) signal is higher than  $V_a$ ;
- 2) signal is between  $V_a$  and  $V_b$ ; or
- 3) signal is lower than  $V_b$ .

Figure 5 shows the three possibilities. By placing an LED between supply and  $V_1$ , one between  $V_1$  and  $V_2$  and one between  $V_2$  and zero volts, only one LED will have a potential difference across it any time. In other words, only one LED can be on at a time depending on which of the three conditions above is true. In this project, the difference between  $V_a$  and  $V_b$  is quite small allowing the correct exposure to be accurately and easily determined.

Circuit. It's pretty simple.

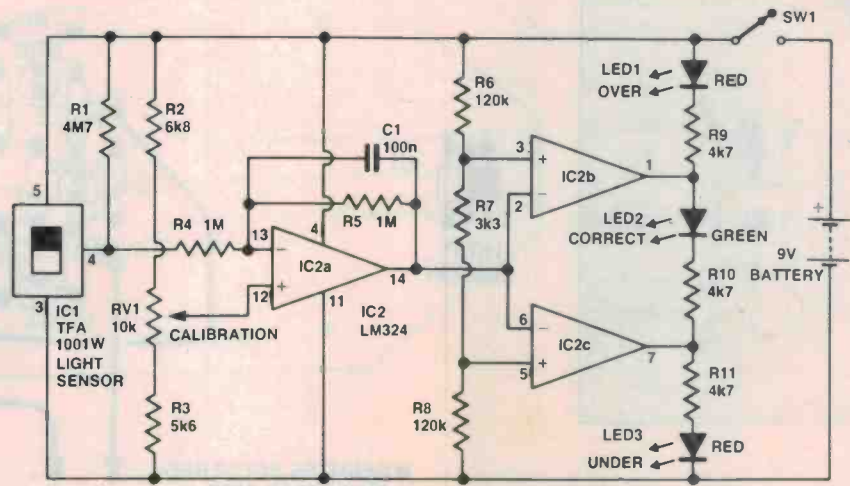

### Remarkable features

- high sensitivity
- high output current linearity
- good spectral sensitivity
- low current consumption
- wide modulation range
- large operating voltage range

### Pin configuration

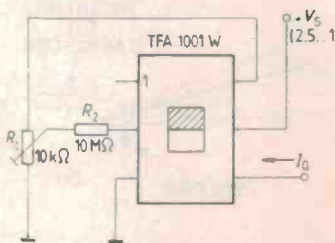
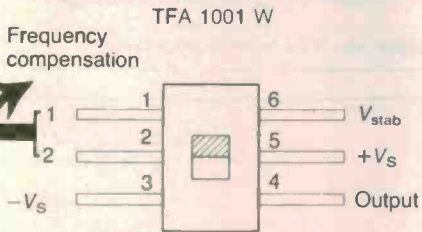

For very low illuminance (down to 0.1 lux) the output current may not be precisely linear as shown in the graph. The circuit here can be implemented to adjust the linearity. Note that this is not required for project ETI-279.

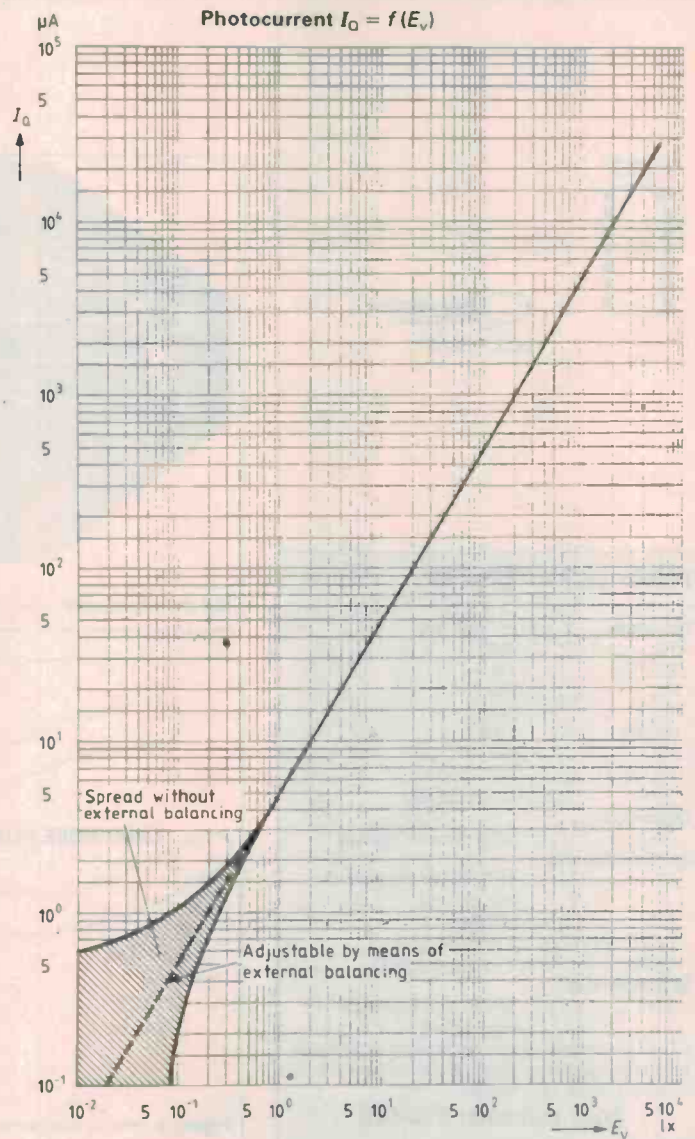

# Project 279

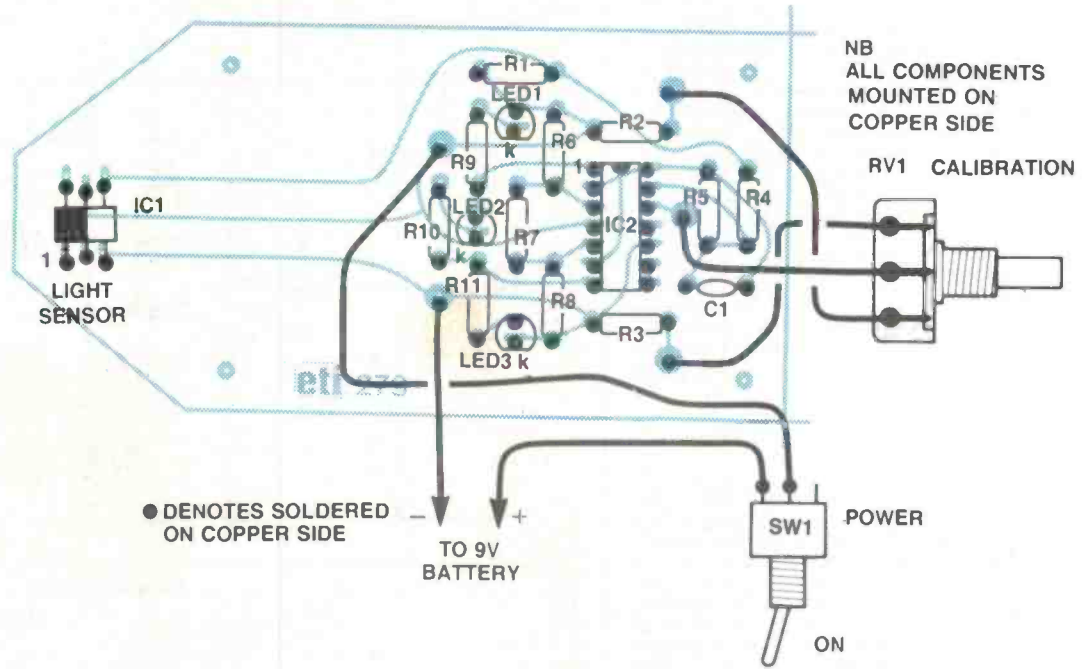
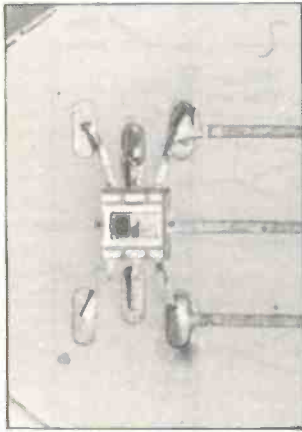

NOTCH OR SPOT  
AT THIS END

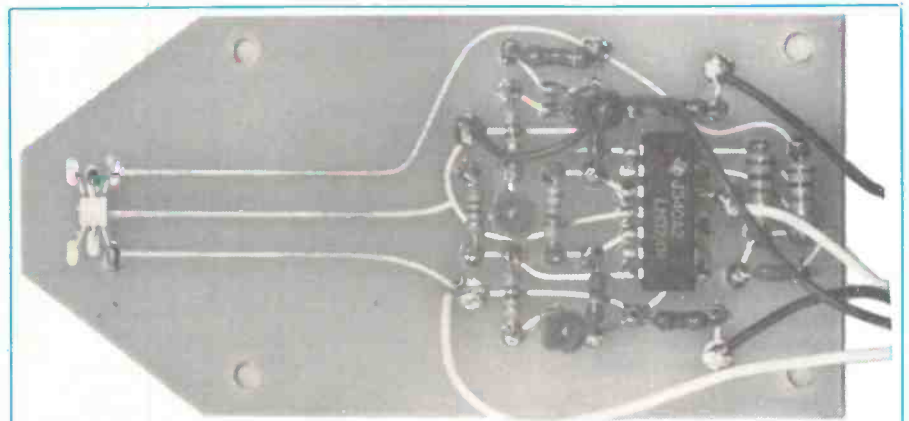

Not the wrong side. The components mount on the copper side of the board in this project.

## PARTS LIST — ETI-279

**Resistors**.....all 1/4W, 5%  
 R1.....4M7  
 R4, R5.....1M  
 R2.....6k8  
 R3.....5k6  
 R6, R8.....120k  
 R7.....3k3  
 R9, 10, 11.....4k7  
 RV1.....10k/B log. pot.

**Capacitors**  
 C1.....100n ceramic bypass

**Semiconductors**  
 IC1.....TFA1001W photodiode  
 with op-amp  
 IC2.....LM324  
 LED1, LED3.....5 mm red LED  
 LED2.....5 mm green LED

**Miscellaneous**  
 SW1.....DPDT ultra-miniature  
 toggle switch

ETI-279 pc board; Scotchcal front panel; 84 x 54  
 x 28 mm zippy box; knob; 9 volt battery clip (if  
 required); three LED bezels.

**Price estimate: \$18-\$20**

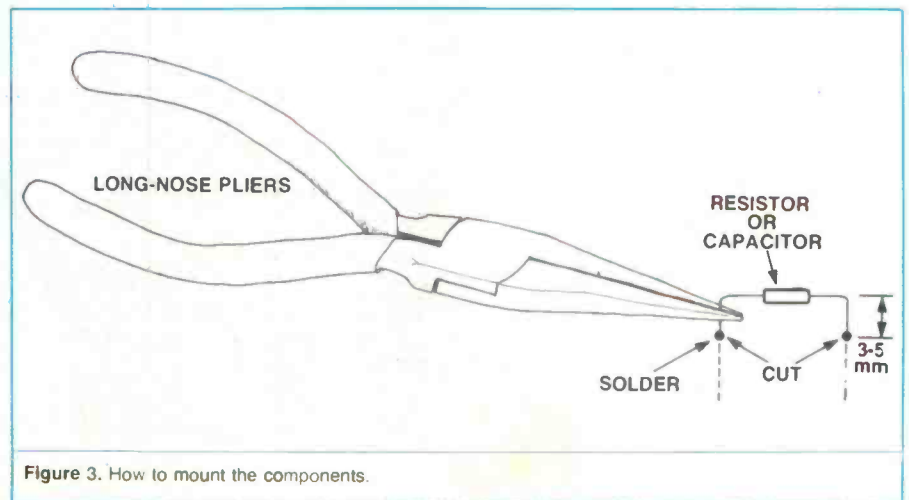

Figure 3. How to mount the components.

## exposure meter



Insides out. The switch mounts on the side of the box and the battery slips in cross-wise. The pc board becomes the bottom, replacing the box's original lid.

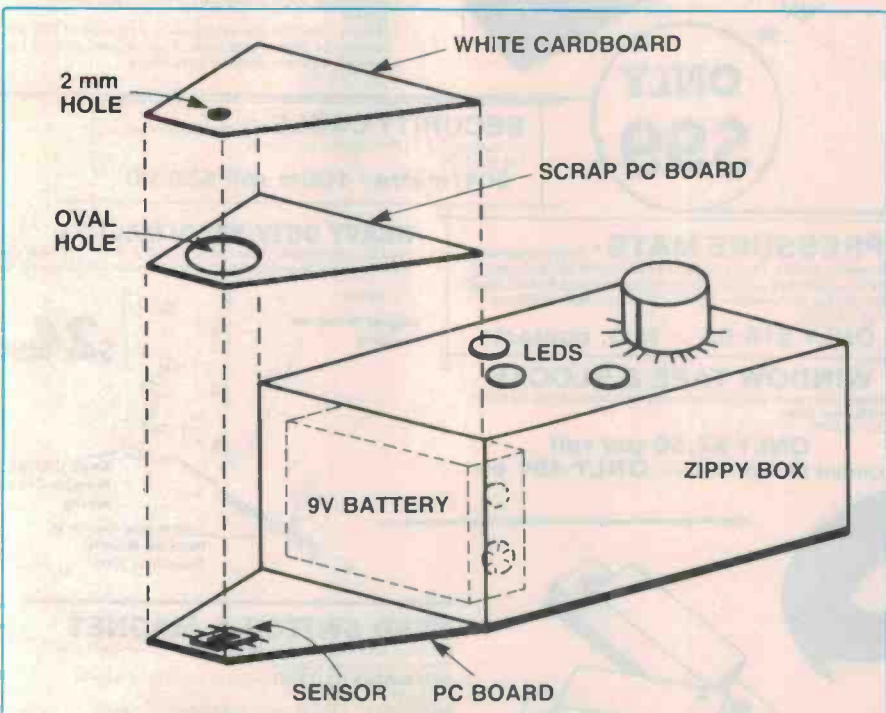
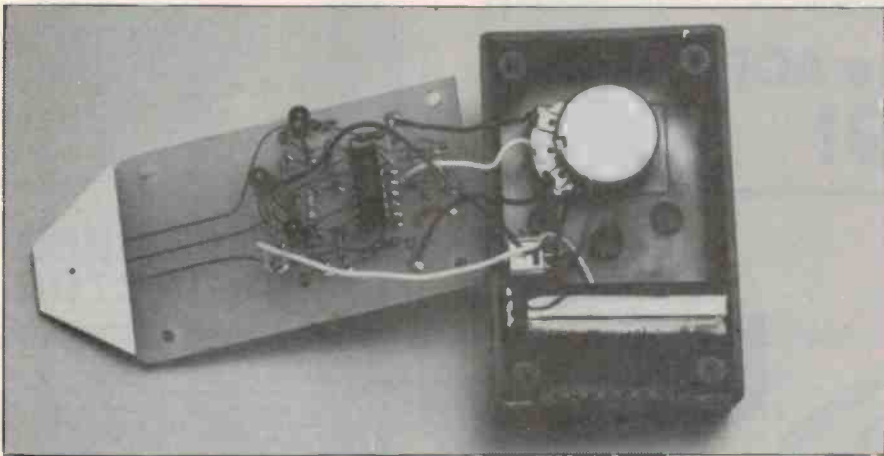

Figure 4. How I constructed and assembled a cover for the light sensor, which allows more accurate positioning.

very carefully with a fine hacksaw blade. Curve all sharp corners with a file so that the completed unit won't scratch fingers, the enlarger baseboard or anything else it comes into contact with.

The next oddity you may notice from glancing at the photos of the prototype is the way the components are mounted — they sit on the *copper side* of the board and the whole assembly becomes the bottom of the zippy box (instead of the aluminium lid). Because of this, no component mounting holes need be drilled in the board. Only four 3 mm holes are required to hold the board to the zippy box.

Mounting components is a bit tricky so work slowly and carefully. Each component must be held in position while being soldered. Start with IC2. Squeeze the two rows of pins slightly inwards so that they sit at 90° to the body. Sit the IC in its correct position on the pc board and, with a fine-tipped iron, carefully solder each pin to its pad. Next, the resistors and capacitor. Prepare each component by bending and cutting the leads as shown in Figure 3. Tin the end of one lead and tin one of the pc board pads for each component. To mount a component, hold its untinned leg with a pair of long-nose pliers, position it correctly so that the tinned lead sits on the tinned pad and heat both with your iron. When the joint cools, simply solder the other lead as normal.

The LEDs mount similarly. First, trim the longer lead so that it's the same length as the other and then mount and solder as previously described. Ensure that you check the orientation before mounting. Finally mount IC1, the sensor op-amp device. Once again check orientation, but be careful — the pin spacing is only 1.27 mm which is *half* that of a normal IC. Spread the pins slightly and shorten pins 2 and 5 to match the pc board pads before mounting.

To house the prototype, I used an 84 x 54 x 28 mm zippy box. This produces a very compact unit but any other type of case can be used if you prefer. Remember though that with the prototype, the pc board is used as the bottom (actually the lid) of the case. If you build a larger unit, you may have to increase the size of the board or use some other method of mounting it.

If you use the recommended case, first check to see if the 9 V battery fits at one end. Some zippy boxes have internal ribs which can be used to hold small circuit boards. This feature is not needed for the current project and, in actual fact, hinders construction slightly by limiting the amount of room available for the battery. An *unribbed* zippy box is preferred for use in this project but if you happen to get the other, don't despair. Just use a sharp knife and remove the ribs which get in the way but don't lose any fingers in the process! If you find that the battery and its clip still fit very tightly in your case, leave out the clip and solder the wires directly onto the battery terminals instead.

Five holes should be drilled in the case to hold the LEDs, power switch and calibra-

# START YOUR OWN BUSINESS!

Many people will come back from their X'mas holidays to find their house has been burgled. They do not know that they can have electronic burglar alarm protection at a modest cost. Modern burglar alarm components from Jaycar enable you to easily make domestic premises more secure. So why not use your technical skills to install alarms in your neighbourhood in your spare time. You will make money and provide a community service as well.

## ★ ★ ★ PRODUCT OF THE MONTH ★ ★ ★

### ACP-2 LOW COST STEEL ALARM CONTROL PANEL

This is the first low-cost but professionally made steel encased unit that we have seen. It has most of the main features of professional control boxes including:

- ★ Lockable baked enamel steel box. Tamper switch can be fitted.
  - ★ Space in box for back-up rechargeable batteries.
  - ★ Facility to connect remote key switch. (Alarm will latch if remote key wiring is cut, whether alarm is "on" or "off").
  - ★ Built in siren driver.
  - ★ Relay output control provides 12V DC for sirens, bells etc.
  - ★ N.O. instant and N.C. delay alarm loops for perimeter protection.
  - ★ Will operate as fire alarm as well. (Has fire/smoke sensor inputs)
  - ★ Different siren tone for fire/burglary
  - ★ Diagnostic audible and visual alarm circuit status indicators
  - ★ Simple one-key operation. Ideal for non-technical people to operate once installed.
  - ★ Built in PANIC button
  - ★ Separate timing and latching relay outputs with high current contact ratings
  - ★ (The above could be used to operate automatic telephone dialler etc.)
  - ★ Dimensions 230(H) x 170(W) x 70(D)mm
  - ★ Weight 1.5kg without standby batteries.
- This unit would normally cost at least \$200 elsewhere (even WITHOUT steel box). Jaycar has secured this product for you at a fantastic breakthrough price.  
Cat. LA-5165



**DON'T PAY  
\$199  
NEW**

## Believe it or not the ACP-2 is only

Power supply with facilities to recharge Gel battery.  
Cat. MP-3018  
**\$34.90**

**\$119!**

Get battery to suit  
Cat. SB-2480  
**\$24.50**

## PASSIVE INFRA-RED DETECTOR

Jaycar breaks the \$100 price barrier. Bulk buying by Jaycar has enabled us to pass on large savings on popular Passive Infra-Red detectors. PIR's (as they are known in the trade) are the most popular method of detecting movement in open areas. They are very reliable and being passive (i.e. they are not transmitters like microwave or ultrasonic sensors) they false trigger a lot less. For a technical description see page 21 of our 1984 Catalogue. The only drawback in the past was their fairly high cost. Now you have no excuse to install one (or two) as part of your alarm system.  
(Please note that the illustration is indicative of PIR. We reserve the right to ship units of similar performance but possibly different physical appearance).  
Cat. LA-5015

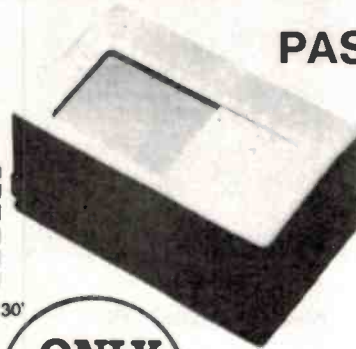

**ONLY  
\$99**

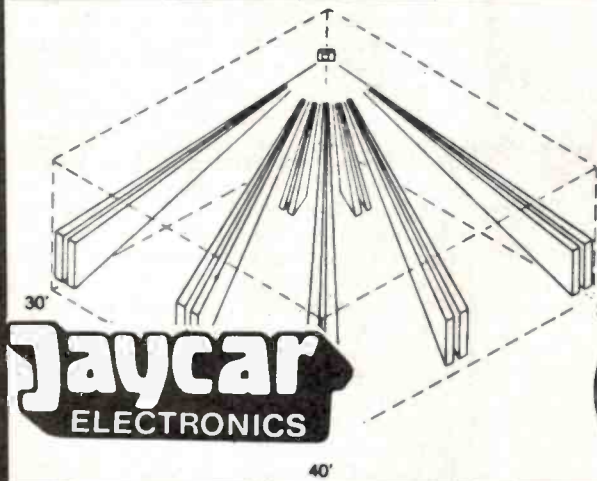

**Jaycar  
ELECTRONICS**

**SECURITY CABLE** - 4 core, flexible stranded conductors (7 x 0.18) in tough outer sheath.  
Cat. WB-1590  
**60¢/metre - 100m roll \$38.00**

### EXTERNAL SIREN COVER

Louvered painted steel. Size for 5" horns or sirens. Special tamper switch on bracket.  
(Included)

Cat. LA-5110

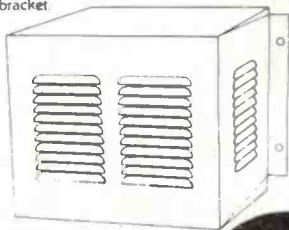

**\$23.50**



**ALARM STICKER** - A durable self adhesive sticker that clearly tells a would be thief that an alarm is fitted. Does not refer to a particular type of alarm - creates more doubt in the thieves mind.  
Cat. LA-5100

**95¢ each or 85¢ for 10 or more**

### PRESSURE MATS

- A very underrated & reliable sensor. Once installed (we admit that lifting carpet can be a hassle) they can usually be forgotten about forever. Ideal for placing at vulnerable window locations. 800 x 520mm.  
Cat. LA-5002

**ONLY \$16.95 - N.O. contacts**

### WINDOW TAPE & BLOCKS

Simply stick tape in place and terminate with circuit blocks. 32 metre roll 6.4mm wide.  
Cat. LA-5050

**ONLY \$7.50 per roll  
Circuit Blocks Cat. LA-5060 ONLY 45¢ ea**

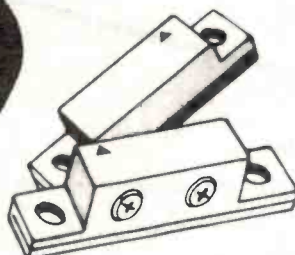
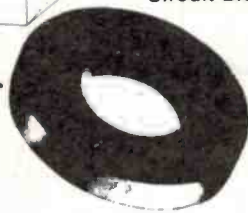

### HEAVY DUTY REED/MAGNET

Used for roller-shutter doors, tilting garage doors or any wide-gap application. Supplied with strong magnet, flexible conduit connector etc.  
Cat. LA-5073

Magnet Protected Housing

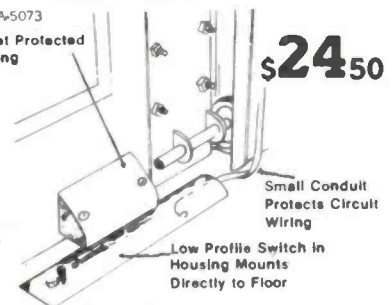

**\$24.50**

### REED SWITCH & MAGNET

Complete assembly of a reed switch and powerful magnet. Can be screw mount or self-adhesive.

**NORMALLY CLOSED** (when in proximity of magnet)

Cat. LA-5070

**NORMALLY OPEN** (when in proximity of magnet)

Cat. LA-5071

**BOTH TYPES SAME PRICE**

**\$2.95 ea or \$2.50 ea for 10 or more**



## SOUNDERS

**SIREN** - the ever popular mechanical siren. 12V operation with a sound level pressure of 116dB. Comes with mounting bracket. Cat. LA5265

**ONLY \$29.95**

### WEATHERPROOF SIREN HORN

12V DC operation with deafening wail. Current drain 500mA approximately. Attractive off-white PVC finish. Cat. LA-5700

**VALUE AT \$22.50**

**THIS MONTH ONLY \$19.50**

**5 WATT 8 OHM HORN** - Fully weatherproof and with unique voice coil construction for dependability on full drive. Cat. AS-3180

**ONLY \$9.95** Has plastic flare

### 116dB of "TWEETIE PIE"

This incredible little piezo screamer (measuring 57L x 33H) emits a 116dB wail. It sounds like a very loud canary. The sound at close range is almost unbearable. If you mount it inside your car and your alarm fires, a thief would probably be scared half out of his wits! Ideal for any component high noise alarm application. Simply connects to 12V DC. Cat. LA-5255

**ONLY \$24.95**

NOW OPEN BURANDA QUEENSLAND



**KEYSWITCH** - This is the standard solid barrel type with 19.5mm mounting hole required. SPST action. Two keys supplied. Cat. SM-0130

**ONLY \$6.95**



### AUTOMOTIVE KEYSWITCH

This special automotive unit features a rugged neoprene rubber boot that clips over the weather-exposed part of the switch - even the keys are special tube types. Size of hole required only 12mm. Cat. SM-1032

**ONLY \$4.95**

### 'THE RED FLASHER'

Is your car safe? Well why not make sure by installing the Red Flasher. Thieves stay away from cars with flashing lights and this unit looks so good they're bound to think you have an alarm fitted, whether you have or not!

We supply a quality Swiss pushbutton illuminated square switch and electronics to make it flash plus 2 deterrent stickers.

Cat. KJ-7000

**ONLY \$20.95**

### AT LAST! LOW COST TELEPHONE EXTENSION CORDS!

### QUALITY PROBE CASES

We have secured a small quantity of probe cases. They can be used for digital (i.e. logic probes, pulsers etc) or for analog purposes (signal injectors etc).

**PROBE CASE 1:** Measures 155(L)x25(D)mm. It has a chrome metal body tube. A stout insulated probe is fitted at one end with a grommet/cap on the other. Weight 88 grams.

**PROBE CASE 2:** Identical to the above except that the body is a clear acrylic tube. Overall length 135(L)x25(D)mm. Weight 25 grams.

Probe 1 Cat. HB-6310 **\$8.95**

Probe 2 Cat. HB-6311 **ONLY \$6.95**



### 30V 1 AMP POWER SUPPLY KIT

Brand new design with two ranges of current limit in special plastic case.

Cat. KA-1574 Ref: EA January 1985

**\$64.50** Ref: EA Jan 1985

**NEW**



**Jaycar**  
ELECTRONICS

NOW OPEN BURANDA QUEENSLAND

### LOW COST STEREO HEADPHONES

Ideal replacement for walkie stereo units. Hi Fi sound. Cat. AA-2015

**ONLY \$6.95**

**NEW**

### LOW COST

### QUALITY MICROPHONE

Looks like the \$70 plus units but at a staggering price! Unbelievable sound quality. Low impedance.

★ Supplied with 2.9 metre of cord and ¼" phone plug

★ Attractive silver colour

Cat. AM-4090

**GRAB THIS! \$19.95**

### VCR STEREO ADAPTOR

**NEW**

★ Converts mono sound of standard VCR's or TV's. AM radio etc to pseudo-stereo signal.

★ 1 x RCAS socket input. 2 x RCA socket output

★ NOT A KIT, built, tested and guaranteed

★ Complete with plug-pack

★ Dimensions: 110 x 130 x 32mm

Cat. AV-6506

**ONLY \$37.50**

### THE ULTIMATE AMPLIFIER?

The staff of "Electronics Australia" have been working for over 12 months now on an ambitious project. The project? An integrated amp with input facilities for wide dynamic range sources such as compact discs and the new stereo Hi Fi VCR's.

Apart from this the amp has incredible features. Among them:

- ★ Toroidal power transformer for very low hum radiation
- ★ Virtually ZERO screened wiring (almost no other wiring as well)
- ★ Massive heatsinks
- ★ Electronic input switching
- ★ Almost all parts mounted on one giant PCB so assembly is enormously simplified
- ★ Over 100 watts per channel genuine

Here is what EA (a conservative bunch usually) say about their new amp -

"The best integrated amplifier design ever published".

"A no compromise design. . ."

"Here is a stereo amplifier that will equal or better any commercial amplifier design regardless of price".

(Quotes from EA December 1984 Page 95)

Right now Jaycar is tooling up for this project. We will have a full kit available in MARCH. As you have come to expect from Jaycar our kit will reflect the "no compromise" philosophy. You will not be disappointed.

**Jaycar**  
ELECTRONICS

Incorporating ELECTRONIC AGENCIES  
**NUMBER 1 FOR KITS**

MAIL ORDER VIA  
YOUR PHONE

VISA



MasterCard



Cards Welcome

NSW: SYDNEY 117 York St Tel: (02) 267 1614

CARLINGFORD Cnr Carlingford & Pennant Hills Rd. Tel: (02) 872 4444

CONCORD 115/117 Parramatta Rd. Tel: (02) 745 3077

HURSTVILLE 121 Forest Rd. Tel: (02) 570 7000

QLD: BURANDA 144 Logan Rd. Tel: (07) 393 0777

MAIL ORDERS: P.O. Box 460, AUBURN NSW 2144. Tel: (02) 643 2000

For all other information (i.e. P&P, shop hours etc) see other ads.

# Project 279

tion pot. Use the front panel artwork as a template and mark the hole centres. Note that the power switch can be mounted on either side of the unit but ensure that it doesn't foul with any components when the unit is assembled. After drilling, de-burr all holes and stick the Scotchcal label into place. Mount the switch and pot, connect the battery and finally, bolt the unit together. With the prototype I countersunk the screw heads into the pc board to allow it to sit flat when being used.

The final part of construction is optional but allows the meter to be positioned more accurately when in use and cuts down on any stray light affecting the exposure reading. This is to cover the sensor with white cardboard which has a 2 mm diameter hole cut in it to allow light to fall onto the sensitive area (the dark part of the sensor/op-amp device). First cut a small piece of scrap pc board to the same size as the tapered end of the exposure meter and cut an oval hole in it so that it fits round the sensor (see Figure 4). Glue it copper side up into place. Next, measure the distance from the end of the zippy box to the centre of the sensor and mark this on a suitable piece of white cardboard. Cut the hole with a scalpel and then glue the cardboard into place. Trim to size if necessary.

## Using it

To check if the unit is operating correctly, place it on the baseboard of your enlarger but don't place a negative in the carrier. Switch the lights off and turn both the enlarger and meter on. Note that when making any measurements of exposure in the darkroom, ensure that all safelights are off. To your eyes it may seem that the red or yellow-green light is quite faint but in many cases your meter will see it as much brighter than the part of the image you are trying to get a reading from (especially if you're making a large print). You should now be able to adjust the calibration control so that the green LED comes on. Try this at a few different f-stop settings just to make

sure all is OK. If it doesn't work, check the orientation of components and your soldering.

One more point to check, switch the unit on under normal room lights. The "over" LED should come on. Don't worry if you can't adjust the calibration control to make the green LED come on since the meter isn't meant to cope with this much light.

With some op-amps however, (referring to IC2, the LM324) a latch-up condition may occur when the calibration control is set at zero and the unit is switched on under normal room illumination. If this occurs with your unit, simply put a 1M ohm resistor in series with the middle terminal of Rv1 (i.e: cut the lead to this terminal and put the resistor in series). This aids in balancing the op-amp's offset current.

As mentioned previously, this exposure meter operates by comparing the amount of light coming through some part of a negative or slide with the amount that came through a similar area of a test neg. (or slide) which you have already correctly printed.

The first step then is to work out a setting for the calibration control for the photographic paper you will be using. Select a negative which has a good tonal range and make the best print possible using the test strip method. Then, without changing any enlarger settings, place the meter on the baseboard to read the light level of the brightest area of the projected image. Adjust the calibration control until the green LED lights. This reading represents the setting required to produce a good print on this paper when the same exposure time is used. Write down the calibration control setting and the exposure time on the packet of photographic paper just used. Keep in the back of your mind however, that the calibration control reading is just a number. It doesn't represent seconds or f-stop directly.

That's the end of the adjustment procedure. Note that it only needs to be performed once for each type of paper you use. From now on, each time you want to produce a print from any negative, set t

exposure meter to the value determined previously for the paper you want to use. Place the meter on the baseboard to monitor the brightest area and adjust the lens f-stop until the green LED comes on. (Don't worry if it lands between two fixed f-stops.) If the same exposure is now used as your original test print on this paper then you should end up with an excellent print or one very close to it. With the saving in time and amount of wasted prints the meter should pay for itself very quickly.

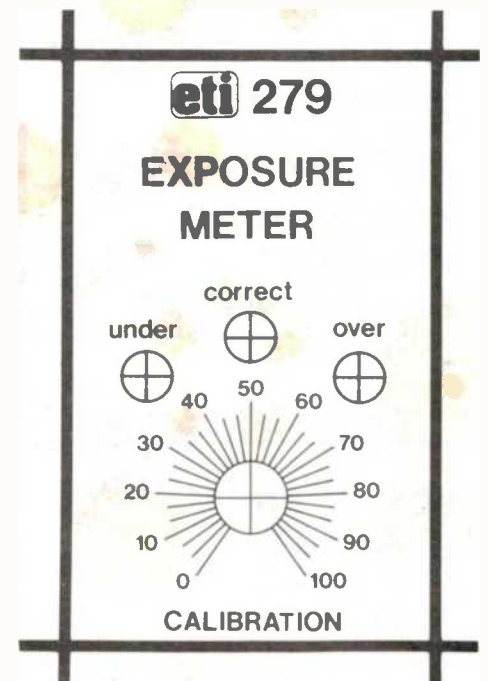
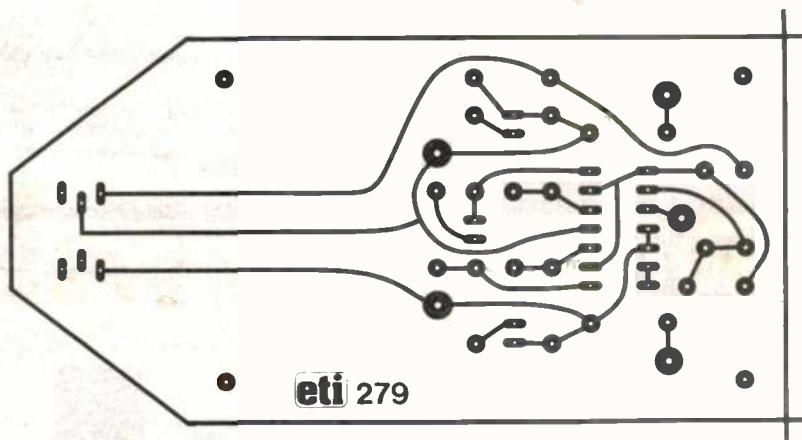
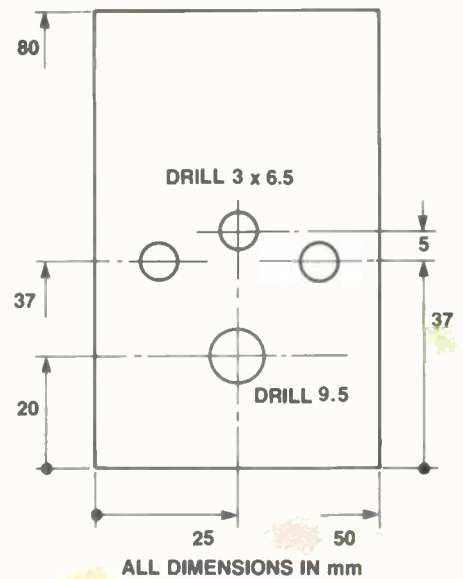

# Electronics Today

BOOK SALES

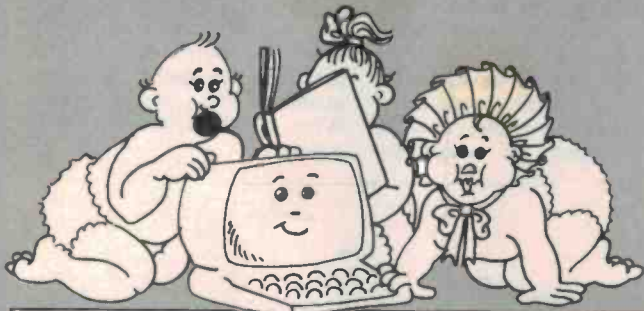

## Beginners Computing

Just starting? Choose one of these great titles. They make computing seem like child's play!

### PROGRAMMING FOR REAL BEGINNERS: BOOK 1

**H0344A** \$7.95  
Written for complete beginners, this book assumes no previous knowledge of computing at all, and guides you gently through the initial stages of building up simple programs. The text is written to be non-machine-specific, and so can be used with any micro that is programmable in BASIC.

### PROGRAMMING FOR REAL BEGINNERS: BOOK 2

**H0387A** \$11.50  
This book introduces you to the stages involved in planning a program, including the use of flowcharts, and explores the wider range of facilities the computer has to offer. You'll also learn how to plan your screen displays attractively to make your programs really user friendly.

### YOUR FIRST COMPUTER

**H0271A** \$15.25  
An easy-to-understand beginner's book to small computers. Understanding them, buying them and using them for personal and business applications.

### KIDS AND THE APPLE

**H0300P** \$25.75  
How to write programs for the Apple computer, including action games, board games and word games.

### BEGINNER'S GUIDE TO MICROPROCESSORS AND COMPUTING

**H0143B** \$6.95  
Introduction to basic theory and concepts of binary arithmetic, microprocessor operation and machine language programming. Only prior knowledge assumed is very basic arithmetic and an understanding of indices.

### A MICROPROCESSOR PRIMER

**H0144B** \$5.95  
Learning about microprocessors is easy with this book, written in a style that is easy to follow. The shortcomings of this basic machine are discussed and the reader is shown how these are overcome by changes to the instruction set. Relative addressing, index registers follow as logical progressions.



## Basic Electronics

Books that tackle electronics right from the beginning — what better place to start?

### INTRODUCTION TO AUTOMOTIVE SOLID-STATE ELECTRONICS

**A0015P** \$14.95  
For the professional as well as the home mechanic — explains the functions of most on-board automotive black boxes and logic systems, including anti-skid braking, electronic spark control and diagnostic systems.

### BASIC ELECTRICITY/ELECTRONICS — VOL 2

**A0009P** \$15.95  
Builds on the basic information in Volume 1 by giving detailed information on AC and DC circuits — covering series and parallel circuits, electro-magnetism, resistance, capacitors and inductance plus associated calculations.

### BASIC ELECTRICITY/ELECTRONICS — VOL 3

**A0010P** \$15.95  
Valves and transistors, from an introduction to vacuum tube — through multi-element tubes, semiconductor devices, power supplies, amplifiers, oscillators, pulse circuits — to special semiconductor devices.

### BASIC ELECTRICITY/ELECTRONICS — VOL 4

**A0011P** \$15.95  
Construction, operation and usage of electronic test instruments. Included are analogue and digital multimeters, vacuum-tube voltmeters, oscilloscopes, tube testers, bridge instruments and signal generators.

### ELEMENTS OF ELECTRONICS — BOOK 1

**A0003B** \$9.95  
This five-book series is an introduction to modern electronics. All the maths is taught as the reader progresses. The course concentrates on the understanding of concepts central to electronics, rather than digressing over the whole field. The author anticipates where difficulties lie and guides the reader. Book 1 covers all fundamental theory necessary to full understanding of simple electronic circuits and components.

### ELEMENTS OF ELECTRONICS — BOOK 2

**A0004B** \$9.95  
Alternating current theory — see Book 1.

### ELEMENTS OF ELECTRONICS — BOOK 3

**A0005B** \$9.95  
Semiconductors technology leading to transistors and ICs — see Book 1.

### ELEMENTS OF ELECTRONICS — BOOK 4

**A0006B** \$9.95  
Microprocessing systems — see Book 1.

### ELEMENTS OF ELECTRONICS — BOOK 5

**A0007B** \$9.95  
Communications — see Book 1.



Prices subject to change without notice



Simply fill out the reply-paid card insert and send to:

**ETI Book Sales,**  
140 Joynton Ave, Waterloo NSW 2017

All phone enquiries: (02) 663-9999, ext 242

## IDEAS FOR EXPERIMENTERS

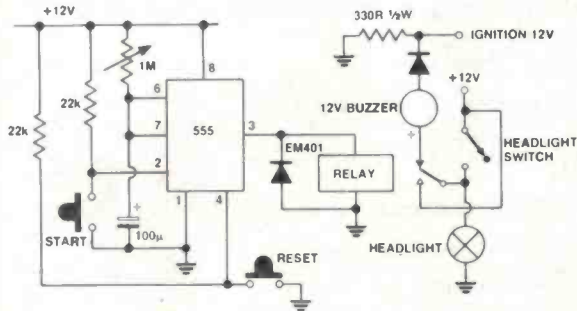

### Headlight delay and reminder

This circuit from P. Howarth of Gunnedah NSW 2380 is very simple to build and operate.

The 555 timer is wired as a one-shot multivibrator. When the momentary start button is pressed the relay will stay operated for between 1 and 120 s dependant upon the adjustment of the 1M pot. If the reset button is pressed the relay will drop-out, removing 12 volts

from the headlights. The buzzer is disconnected whenever the headlight delay is operated.

The reminder works on the principle that if there is 12 V across the headlight and the ignition is turned off the buzzer will operate because there is also 12 V across it. This reminds the driver that he has left the headlights on after parking.

The buzzer will not operate while actually driving at night because there is 12 V on both terminals of the buzzer.

### Home computer control of model trains

This simple modification from C. McKilligan of Hobart, Tas, allows most commonly available analogue transistor train controllers to be modified for control by a home computer.

Most train controllers vary the train's speed by controlling

the base on a driver transistor.

By inserting an inertia capacitor and using one bit to turn on an additional control transistor, trains may be made to accelerate and decelerate to and from a preset speed (set by the normal speed control). When the output line is low, the train will speed up to and maintain the preset speed. When it is high, it will slow to a stop.

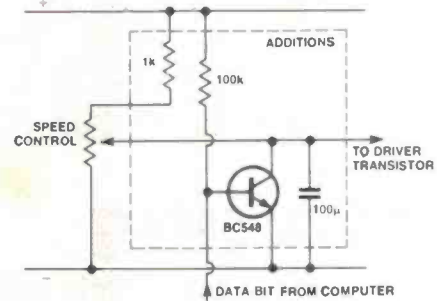

Any 12 V SPDT relay can be used so long as the contacts can handle the current drawn by the

headlights, and also that the relay coil draws no more than 200 mA of current.

## 'IDEA OF THE MONTH' CONTEST

### COUPON

Cut and send to: Scope/ETI 'Idea of the Month' Contest, ETI Magazine, P.O. Box 227, Waterloo NSW 2017.

"I agree to the above terms and grant *Electronics Today International* all rights to publish my idea in ETI Magazine or other publications produced by it. I declare that the attached idea is my own original material, that it has not previously been published and that its publication does not violate any other copyright."

\* Breach of copyright is now a criminal offence.

Title of Idea .....

Signature .....

Name .....

Date .....

Address .....

Postcode .....

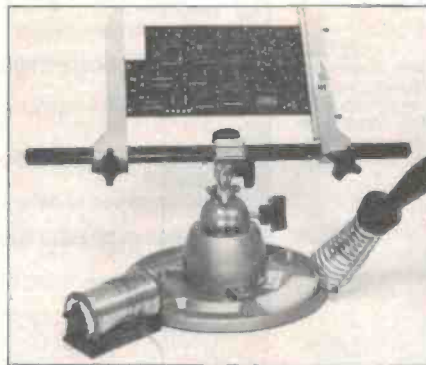

Scope pc board Work Centre

Scope Laboratories, which manufactures and distributes soldering irons and accessory tools, is sponsoring this contest with a prize given away every month for the best item submitted for publication in the 'Ideas for Experimenters' column — one of the most consistently popular features in ETI Magazine. Each month we will be giving away a pc board Work Centre consisting of the Model 315 adjustable pc board holder with capacity to accept 300 mm boards, Model 300 180° swivel and lock base which can be attached to the Model 312 tray base with wet sponge receptacle, Model 371 solder spool holder and Model STS 3 soldering iron safety stand. Please note prize does not include solder or scope TC60 temperature controlled iron shown above. The prize is worth \$123!

Selections will be made at the sole discretion of the editorial staff of ETI Magazine. Apart from the prize, each winner will be paid \$10 for the item published. You must submit original ideas of circuits which have not previously been published. You may send as many entries as you wish.

PRIZE WORTH \$123!

### RULES

This contest is open to all persons normally resident in Australia, with the exception of members of the staff of Scope Laboratories, The Federal Publishing Company Pty Limited, ESN, The Litho Centre and/or associated companies.

Closing date for each issue is the last day of the month. Entries received within seven days of that date will be accepted if postmarked prior to and including the date of

the last day of the month.

The winning entry will be judged by the Editor of ETI Magazine, whose decision will be final. No correspondence can be entered into regarding the decision.

The winner will be advised by telegram the same day the result is declared. The name of the winner, together with the winning idea, will be published in the next possible issue of ETI Magazine.

Contestants must enter their names and addresses where indicated on each entry form. Photostats or clearly

written copies will be accepted but if sending copies you must cut out and include with each entry the month and page number from the bottom of the page of the contest. In other words, you can send in multiple entries but you will need extra copies of the magazine so that you send an original page number with each entry.

This contest is invalid in states where local laws prohibit entries. Entrants must sign the declaration on the coupon that they have read the above rules and agree to abide by their conditions.



# WIRELESS INSTITUTE OF AUSTRALIA

FOUNDED 1910

The W.I.A. represents the Radio Amateur at Local, National and International level and offers following services:



- ★ Monthly "AMATEUR RADIO" Magazine, included in membership fee.
- ★ Most REPEATERS have their licence, power and site cost paid by the institute.
- ★ World wide QSL-service.
- ★ Assistance to members in legal problems arising out of the pursuit of their hobby.
- ★ A Weekly Sunday Broadcast to Amateurs and Short Wave Listeners.
- ★ Assistance in dealing with Interference Problems (TVI-RFI etc.)
- ★ Novice and full call courses.
- ★ Trial Novice and AOC P theory exam papers.
- ★ Advice on Radio Mast approvals
- ★ The ONLY representation of the RADIO AMATEUR in legislative matters.



Join the 8,600 Amateur members in the W.I.A. by forwarding this coupon to:  
W.I.A. P.O. BOX 300,

CAULFIELD SOUTH, VIC. 3162

Please forward a membership application form and further details to:

Mr, Mrs, Miss, Ms .....

Address .....

Callsign .....

Postcode .....

**PROGRAMMABLE  
POCKET  
SCANNER**

**—MICROCOMM—  
SX-150**

**PROFESSIONAL  
POCKET SCANNER  
WITH OVER 45,000  
CHANNELS & 160  
MEMORIES**

**26  
to  
32,  
68  
to  
88,  
138  
to  
176  
and  
380  
to  
514  
MHz**



The Microcomm SX-150 represents the latest developments in State-of-the-art LSI CMOS technology as applied to scanning monitor receivers. It incorporates many features, a lot of which are not even found in today's larger base scanners.

For example the SX-150 has 160 memory channels which can be programmed in either of two modes. The first allows you to manually program the entire 160 channels. The second mode provides for manual programming of the first 40 channels with the top 120 reserved for use by the SX-150 while in its SEARCH mode. It uses these channels to automatically store frequencies on which it has found signals during the search phase.

The SX-150 also features a Priority Channel (for that important frequency). An LCD display providing readout of all receiver functions including an accurate crystal controlled 24 hour clock.

Supplied complete with rechargeable Nicad batteries, charger, and rubber duck antenna, the SX-150 is a must for anybody with an interest in monitoring.

**PRICE \$499  
+ \$12 P&P**

AUSTRALIAN DISTRIBUTOR

**GFS ELECTRONIC IMPORTS**  
Division of GD & JA WHITER PTY. LTD.

17 McKeon Road, Mitcham, Vic. 3132  
PO Box 97, Mitcham, Vic. 3132

Telex: AA 38053 GFS  
Phone: (03) 873 3777 3 Lines

**Just for  
Listening!!!**



**SAIKO  
SC7000**

Computerized Programmable  
Scanning Receiver



**AMAZING  
FUNCTIONS . .**

- 70 Memory channels.
- Scans the Aircraft Band, the UHF Band and the VHF (High and Low) Band
- 2.5 KHz channel steps on VHF and Aircraft Bands
- 240 volt and 12 volt operation.
- Tape Recording Connections.

You may want to listen for many reasons whatever the reason, the SAIKO SC7000 offers a truly "state of the art" receiver with micro-processor technology and far more features than competitive receivers.

**I M A R K**  
PROPRIETARY LIMITED

167 RODEN STREET, WEST MELBOURNE,  
VIC. 3003, AUSTRALIA.  
PHONE: (03) 329 5433. TELEX: AA37753 IMARKO

## New monitoring and surveillance equipment for DOC

The Department of Communications has been authorised to buy radio frequency spectrum monitoring and surveillance equipment to support its planning, licensing and regulatory activities, the Minister for Communications, Mr Michael Duffy, announced late in August.

Mr Duffy said \$790 000 had been provided in the Federal Budget for 1984-85 to begin the upgrading process.

Increasing congestion in the HF bands has led to a situation where it was almost impossible to assign new HF allocations to potential users. The introduction of satellite communications services in Australia, scheduled to start in late 1985, had created the need for satellite monitoring facilities.

The provision covered four elements:

- purchase of automated, remotely controllable receivers to replace obsolete, manually operated equipment which has reached the end of its life and is no longer suitable for monitoring new generation radiocommunications services;
- a forward commitment for the implementation of a major re-equipment program to upgrade the Department's HF direction finding capability in Perth, Brisbane and Hobart.
- purchase of portable direction-finding facilities for use by field officers when conducting interference and regulatory investigations;
- provision of satellite monitoring facilities in Sydney, Perth, Adelaide and Brisbane to support the Department's regulatory activities associated with the operation of the AUSSAT satellite system, scheduled for launch in the second half of 1985.

# Sound & TV stations list, 1984, published

The Department of Communications has published a book listing data about all the national and commercial sound (AM and FM) and television broadcasting stations, translators and repeaters licensed to operate in Australia and territories as at June 30, 1984.

The 146-page book, titled "Sound and television broadcasting stations 1984" has the data divided into 18 sections and four appendices.

The first five sections cover the medium frequency AM broadcast band, listing national, commercial and Special Broadcasting Service (SBS) stations and translators.

Section 6 lists Australian offshore islands/territories stations, and the seventh lists HF (short-wave) stations. Data on frequency, power, aerial and location are given.

The VHF (FM) sound broadcasting stations, national, commercial and public, are listed in sections 8, 9 and 10. Data given

includes frequency, radiated power and polarisation.

The TV stations, national, commercial and SBS, are listed in sections 11, 12 and 13, with translators and repeaters following in chapters 14 and 15. Data given includes channel, service area, vision carrier frequency, radiated power and polarisation.

Sections 16 and 17 list all the stations in frequency order, while section 18 lists the TV stations, translators and repeaters in channel order.

The appendices give details on Australian TV technical standards, TV channel numbers and frequency limits plus notes relating to the various sections.

Copies should be available

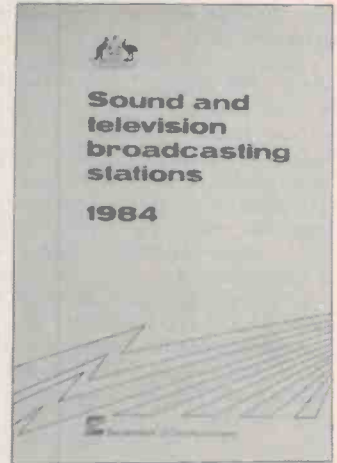

through Australian Government Publishing Service offices or perhaps Department of Communications offices. The book is listed as 'DOC 503', reference no. ISSN 0812-2016.

## Two new mobile signalling units

Sepac Industries has introduced two low cost mobile radio signalling units which provide an economical mobile-to-mobile radio selective calling network.

The S331 provides a mobile operator with the facility to selectively call up to 10 stations by the setting of a slider switch. Full facilities are provided such as the use of the vehicle horn as an external alarm, flashing LED

and audible beep to alert the called driver, individual addressing of mobile units and auto acknowledge.

The S360 is an advanced version of the S331, which in effect allows any vehicle to operate like a base station. Features such as mobile-to-mobile selective calling of up to 1000 outstations, individual addressing of called mobile units, auto acknowledge of receipt of

addressing calls, external horn alarm and many more are provided.

These two units directly interface with most brands of mobile radio and are compatible with all of the Sepac range of Selcal console and mobile units.

For further information contact Sepac Industries, 134 Beach Street, Frankston, 3199. (03)781-3144.



◁ The S360:

The S331: ▷

## HP digital sig gen

The new HP 8656B is a programmable signal generator. It provides frequency coverage from 100 kHz to 900 kHz, an output range of +13 to -127 dBm, with 0.1 dB resolution, flexible AM and FM and output of 50 W.

It has several new capabilities which, HP believe, will make the unit more acceptable. These include faster switching speed, higher reliability, single-sideband (SSB) radio testing, low-rate digital tone testing, voltage-controlled oscillator simulation and phase-sensitive device characterization.

To compensate for system or cable losses, the HP 8656B offers amplitude-offset capability. This feature lets the user put an offset on the display to show the level actually delivered to the device under test. In addition, the new RF on/off switch disables the output quickly, without changing the attenuator setting. SSB radio testing can be done

with less than 7 Hz RMS residual FM and improved phase noise. Providing 10 Hz resolution over its entire frequency range, the HP 8656B simplifies SSB receiver testing, sets narrow channel spacings, and pinpoints RF characteristics of filters.

With its dc-FM stability and accuracy, it can be used as a stable VCO in phase-lock loop applications. One such application is phase-locking a network analyzer to increase its stability and resolution when characterizing narrow-band devices.

Phase sensitive devices, such as phase detectors, can be characterized using the HP 8656B's phase increment or decrement feature. This feature also permits precise control of timing delays if the HP 8656B is used as a digital clock.

For more information contact Hewlett Packard, 31 Joseph St, Blackburn Vic 3130. (03)895-2895.

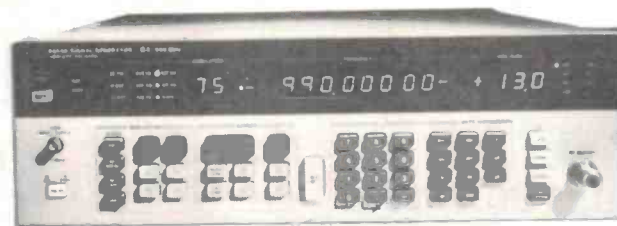

## Pocket scanner

The Microcomm model SX-150 HF/VHF/UHF programmable pocket scanning receiver is now available.

This new version features many improvements over its earlier predecessor. Some examples of these improvements include a UHF sensitivity of better than 0.45  $\mu$ V as well as a new BNC antenna socket in place of the earlier screw type. Additionally the SX-150's duck antenna has been redesigned to improve its performance.

Most of the SX-150's other unique features remain unchanged. These include its

frequency coverage of 26-32 MHz, 68-88 MHz and 380-514 MHz incorporating 5 and 12.5 kHz channel spacing. Its 160 memory channels may be programmed manually or used for automatic storage of active frequencies found by the receiver while in its search mode.

Microcomm's SX-150 is priced at \$499 including sales tax plus \$12 p & p.

For further information contact the distributors, GFS Electronic Imports, P.O. Box 97, Mitcham, Vic 3132. (03)873-3777.

# WHERE THE ACTION IS!

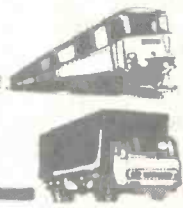

There's a whole other world of communications beyond 'the shortwaves'. Thousands of big businesses, small businesses, government and community services, amateurs and universities use the communications channels scattered from 30 MHz upwards.

*How do you get amongst all this 'action'?  
With a VHF/UHF scanner!*

But you need to know a little more than how to hand over your money, take one home and plug it in.

Australian SCANNER'S WORLD is the book that will introduce you to that other world beyond the shortwaves. It contains an introduction to scanning and scanners, an article on scanner antennas including how to build two types for yourself along with how to erect antennas. The major part of the book is the "Listener's Guide", computer-sorted listings of services throughout Australia and NZ, with their frequencies listed in both frequency order and alphabetical order by service. Beacons are listed also, along with relevant overseas ones. A roundup of scanners, antennas and accessories is also included.

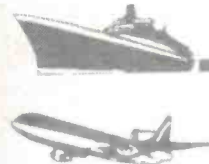
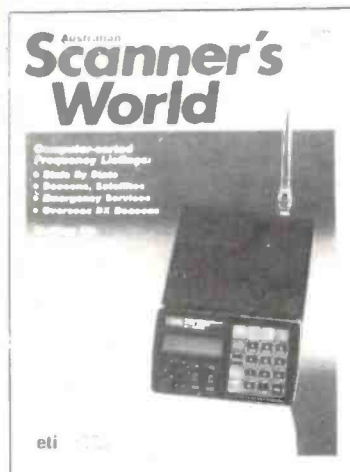

**GET AMONGST THE ACTION!**  
**Australian SCANNER'S WORLD**

at your newsagent  
**\$5.95**



# ICOM'S STAR PERFORMER



Icom's latest general coverage shortwave receiver caused a little consternation in the Harrison household.

**Roger Harrison VK2ZTB**



THE PROBLEM with this job is that, when a truly *great* piece of equipment comes in for review, amongst all the fine gear one gets to see regularly, the *technological lust* that creeps insidiously over you can be hard to resist. Who was it who said "... that's life"?

Such was the case with Icom's 'flagship' communications receiver, the IC-R71A. While of conventional appearance for a modern communications receiver, it incorporates a few innovative features clearly designed to appeal to the operator who has diverse interests, demands top performance and convenient operation.

## Features

The IC-R71A covers 100 kHz to 30 MHz continuously. It can be manually tuned or frequencies may be 'punched up' on its numeric keypad. A 32-channel memory is incorporated along with scanning facilities for searching across a band of frequencies (put in the 'start' and 'stop' frequencies) or amongst the memory channels.

It can be controlled from a handheld infrared control unit (RV-11) and/or remotely controlled via a computer interface/

terminal unit (CT-10). This latter option gives you the ability to operate the receiver at a remote site, close to a conveniently located antenna sited in a noise and interference-free area.

The IC-R71A is equipped to resolve all the currently popular transmission modes — CW/AM/SSB/RTTY. An optional FM detector can be fitted. Three IF filters are provided for optimum selectivity on the various modes.

The digital frequency readout provides a six-digit display to 100 Hz. The frequency control is a CPU-based, 10 Hz step digital PLL synthesiser that includes a dual VFO system.

Sensitivity is quoted as less than 0.15  $\mu$ V for 10 dB S+N/N ratio above 1.6 MHz on SSB/CW/RTTY, less than 0.5  $\mu$ V on AM.

Frequency stability is quoted as less than 200 Hz drift after switch-on — one minute to one hour, less than 30 Hz thereafter.

Drift over the temperature range 10°C to 50°C is quoted as less than 500 Hz. A high-stability crystal option (CR-64) can reduce those figures substantially.

The unit measures 111 mm high by 286 mm wide by 276 mm deep and weighs ▶

## REVIEW

7.5 kg. It can be operated from 235 Vac (50-60 Hz) or from 12 Vdc with the CK-70 optional dc cable kit.

### Just feel it . . .

The R71A is a delight to operate. Dial action is positive and smooth. You get a 'three-speed dial'. Hit the 'band' button, spin the knob and you change in MHz steps. Hit the 'TS' button and you tune in rapid 1 kHz steps. Ordinarily, you tune in 100 Hz steps.

The sensitivity figures, so far as I could determine, are easily reached. On any band, this receiver will sort out 'the men from the boys', with ease. Stability and resettability — no problem, I could set it up on the VNG time/frequency transmission on either 7500 kHz or 12.500 MHz and expect it to come up *spot-on* every day! No matter if it were turned off for 10 hours or more, turn it on and there was VNG!

I must say, after years of getting used to rotary selector switches et al, the pushbuttons (or key switches) on the R71A are far more preferable. (Your Editor came up in the 'old school' of AR88s, Collins 75S1s and Racal RA17s.) It's just a matter of look at what you want and hit the appropriate button. Sigh . . . (lust, lust). Not only that, but the digital readout shows what reception mode you're in. Very handy.

The memory channels also come in handy, particularly if you wish to regularly monitor a variety of fixed frequencies of the HF region.

The rear panel of the R71A has a few surprises that Icom don't tell you about, but which quite a few dedicated HF users would like to know. Firstly, there's a 'scope output. That's self explanatory to those who know. But it's very handy for looking at the modulation characteristics of signals etc — which just about every serious user gets into at one time or another. There's a remote recorder output for taping received signals; that's self-explanatory. The main antenna connector is an SO-239 socket. The low-band antenna connector is a spring-clip type and the receiver ground is a Fahnstock-type connector. An external speaker is also included.

I tried an external speaker on the unit. In fact, I used an up-coming ETI 'Communications Speaker' project — to great effect. The internal speaker does a good job, providing you can leave the top of the R71A's cabinet free to let the sound radiate. But such is not always the case. Then, an external speaker is a better bet — particularly if it has a 'tailored' response like our speaker project. 'Intelligibility' is the name of the game and if you can get that with an

external speaker, go for it.

The remote control facility speaks for itself. No real need to explain the advantages of that.

Overall, the Icom IC-R71A is a 'professional' receiver at a 'hobbyist' price. At \$850 dollars recommended retail, I couldn't resist it . . . but my bank manager could. Ah well, let technological lust take its course . . . that's life. But at least I convinced Icom I should have it a few more weeks on review . . .

Want to convince yourself? Talk to Icom, 7 Duke St, Windsor Vic 3128. (03)51-2284.

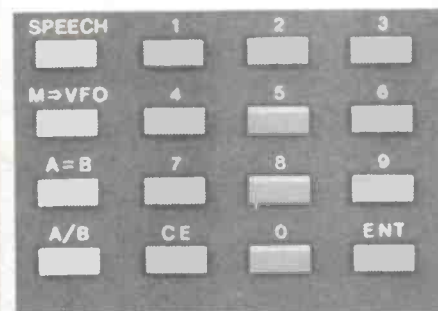

QUALITY FROM ENGLAND

# CLIFF

AUSTRALIAN DISTRIBUTOR

## DELSOUND PTY. LTD.

1 WICKHAM TERRACE, BRISBANE 4000.

PH: (07) 229-6155

YOUR ONE-STOP ELECTRONICS SUPPLIER

**K9** 19 x 20 mm  
**K10** 18.5 x 17 mm  
**K11** 20 x 19.7 mm  
**K12** 19.2 x 25.3 mm



K9-10-11-12 matt black finish available in push-on or screw-fix. Push on caps, available colours red, black, white, blue, yellow, orange, grey or green.



### I.C. TEST CLIP

3 sizes — 14-16, 26-28 and 40 way



### QUICKTEST

Ideal for w/shops and test depts. Plugless leads rapidly connected to mains.

### S2 SERIES

S2 range 6.5 mm nylon mono and stereo sockets. High quality brass and nickel contacts. Colours available.



### P2 SERIES

6.5 mm plugs. Nylon and metal covers. Mono and stereo. Colours available.

# THE SHORTWAVE BABEL — listening to language broadcasts on shortwave.

Want to learn a language or listen to your 'home' country?  
Shortwave radio broadcasts are the answer.

Arthur Cushen

COUNTRIES LARGE and small the world over broadcast on the shortwave bands between 3 MHz and 30 MHz. Their transmissions can be received here at various times on a wide variety of frequencies. Here is a guide to various 'language' broadcasts from countries all round the world; you can choose from those that teach languages (including English) to those that broadcast languages commonly spoken by ethnic groups in Australia and New Zealand.

### Learning languages

There are many listeners who find shortwave radio an excellent teacher of foreign languages and this is particularly so of those students who are learning French. The writer receives many requests for times and frequencies of broadcasts in French which can be received in Australia, so that the student can listen to the language and get an excellent example of how it is spoken.

There is now a much wider field of in-

struction via shortwave and many countries are promoting their own languages with lessons for the English speaking listener. Learning a language right in your own home by shortwave radio is now a standard means of education. The language lessons are not only received on shortwave, but most international broadcasters back up this service by supplying free text books to those listeners who follow the course.

Radio Australia is possibly the best ►



The Foreign language staff of Radio Japan who are responsible for broadcasts in 21 languages.

## COMMUNICATIONS TODAY

known teacher of English in Indonesia, and some years ago it was reported that several hundred thousand text books were in use throughout Indonesia with listeners tuned to Radio Australia for this unique means of education. Radio Australia's lessons in English for the Indonesian listener are heard at 2230 UTC on 11 970 kHz.

Radio Nederland plans to introduce a new series of 'Dutch by Radio' this month, which would be carried in the service to Australia 1030-1120 UTC on 9650 kHz, while Deutsche Welle presents different levels of courses in German.

### Text books

Free text books are available for the language courses from Radio Japan; Voice of Free China; Deutsche Welle, Cologne, West Germany; Radio Beijing, China; and Radio Moscow World Service, while Radio Finland lessons are available from book stores in Finland.

The BBC 'English by Radio' courses are available to listeners at a charge. The Spanish Foreign Radio, Madrid and Radio South Africa Johannesburg do not have text books available for their broadcasts in Spanish and Afrikaans. In the past, Radio Nederland has provided text books, but the position concerning their new course is not known.

Here is a selection of language lessons broadcast on shortwave:

**AFRIKAANS:** Radio South Africa, Johannesburg, Saturday 2130 UTC 9585, 11 900 and 15 155 kHz.

**CHINESE:** Radio Beijing, China, Monday 0900 UTC, Wednesday 0900 UTC repeated at 1000 UTC on the same days, on 9860 kHz.

**ENGLISH:** BBC, London, 'English by Radio' daily 0930-1000 UTC on 9725, 11 955, 15 360 kHz.

**ESPERANTO:** Vatican Radio, Thursday 0500 UTC on 6250, 11 715, 15 120; Sunday 1900 UTC on 6190, 6250, 9645 kHz.

**ESPERANTO:** R. Polonia, Warsaw, daily 0530-0600 UTC on 6135, 7270 kHz; daily 1930-2000 UTC on 5995, 6135 and 7270 kHz.

**FINNISH:** Radio Finland, Helsinki, Monday and Tuesday 0830 UTC on 21 465 kHz.

**GERMAN:** Deutsche Welle, Cologne, West Germany 'German by Radio' Sunday 2140-2150 UTC on 7130, 9765 kHz; Saturday 1010-1020 UTC on 9650, 15 275 and 17 780 kHz.

**ITALIAN:** Rome Radio, Tuesday and Thursday 1945-1955 UTC on 7275, 9710 and 11 800 kHz.

**JAPANESE:** Radio Japan, Tokyo, Tuesday and Wednesday 0920 UTC on 11 875 and 15 235 kHz.

**KOREAN:** Radio Korea, Seoul, Monday 1010 UTC on 5975 kHz.

**RUSSIAN:** Radio Moscow World Service, Sunday 0830 UTC on 11 770, 15 220 and 17 830 kHz.

**SPANISH:** Spanish Foreign Radio, Madrid, Tuesday 0550 UTC on 9630 and 11 880 kHz.

### 'Special English'

On 1 October 1959 the Voice of America (VOA) introduced news in 'Special English', now a service widely heard from VOA transmissions. Special English is ideal for those learning the English language. It is based on a vocabulary of about 1500 of our most useful and common words, written and broadcast in short direct sentences. Programmes are read over the air at 90 words per minute, or about two-thirds the speed of standard English programmes.

News in Special English is heard in Australia at 2230 UTC and again an hour later from VOA on 11 760, 15 185 and 17 740 kHz. The programmes were originally broadcast only to Europe and the Middle East, but the reaction from those who heard them was so enthusiastic that Special English news programmes were soon being broadcast to other areas. Eventually, several series of features were also added.

This year, the 25th anniversary of Special English, millions of people world wide eagerly await each of these VOA programmes. Now almost everyone can hear at least one 10 minute Special English news programme every day of the week.

The slower speed at which the scripts are read presents special problems to the writers and announcers. Special English announcers must, of course, perfect the art of pronouncing each word clearly, but they must also practice reading the scripts at the slower pace, while avoiding any monotonous tones and speech rhythms. Since fewer words are read per minute, the writers must keep the scripts shorter than normal.

There are hundreds of thousands of words in the English language and although professional speakers do use more complex sentences, all linguists know that most people use only several thousand basic words in everyday life.

Because of the wide acceptance and popularity of the Special English programmes, VOA publishes the Special English word book for its overseas listeners. This 180-page illustrated booklet lists and explains approximately 1500 words used in the broadcast. The book has been reprinted several times and is available in Japan, China, Korea and other countries where their learning material has been based on the Voice of America textbooks.

### Listening to home

Many immigrants wish to tune to their homeland to hear news in their local tongue and the preceding selection of broadcasts

covers only a few of the languages received in Australia. It will also provide students who are learning these languages typical examples of how it is spoken and enable them to follow the broadcast in a more practical form.

This list is by no means complete, as languages on shortwave from local broadcasting organisations are heard in almost every spoken tongue throughout the world. These range from broadcasts in Eskimo through to Uzbek.

The list below highlights broadcasts which should be heard in Australia, taking into account the frequencies and time of reception which, at the present period, is better during the hours of darkness.

### DUTCH:

**Radio Nederland:** 0630-0725 UTC on 9715 and 11 880 kHz; then 0830-0925 UTC on 9770 kHz.

**Belgium Radio:** 0715-0800 UTC Saturday and Sunday on 9880 and 21 810 kHz.

### FRENCH:

**Radio Australia:** 0000-0100 UTC on 15 140 and 17 750 kHz; then 0100-0200 UTC on 15 160, 15 320 and 17 795 kHz; followed at 0400-0500 UTC on 15 320 and 17 795 kHz.

**Radio Canada:** 0600-0615, 0630-0645 UTC Monday-Friday on 9760, 11 775 and 11 825 kHz; then 0300-0359 UTC on 5960 and 9755 kHz.

**Radio France International:** from 0500 UTC on 7135, 9790, 11 705 and 15 155 kHz; then 2000-2200 UTC on 9790, 11 705, 15 300 and 15 435 kHz.

**Swiss Radio International:** 0800-0830 UTC on 9560 and 15 305 kHz.

### GERMAN:

**Deutsche Welle, Cologne:** 0600-1000 UTC on 9690, 9735 and 11 795 kHz; 2000-2200 UTC on 9585 and 11 955 kHz.

**Swiss Radio, Berne:** 0830-0900 UTC on 9560 and 15 305 kHz.

### ITALIAN:

**Rome Radio:** 0830-0930 UTC on 9585, 11 810 and 15 330 kHz; then 2050-2130 UTC on 9710 and 11 800 kHz.

**Swiss Radio, Berne:** 0730-0800 UTC on 9560 and 15 305 kHz.

### PORTUGUESE:

**BBC London:** 2200-2315 UTC on 9515, 11 820 and 15 390 kHz.

**Voice of America:** 1000-1100 UTC on 11 715, 15 195 and 17 830 kHz.

### SPANISH:

**Spanish Foreign Radio:** 0200-0500 UTC on 9630 and 11 880 kHz.

**BBC, London:** 0215-0415 UTC on 9765 and 11 820 kHz to 0300 UTC.

**Deutsche Welle Cologne:** 0200-0330 UTC on 9640, 11 810 and 11 865 kHz.

### RUSSIAN:

**Moscow:** 0600-0615 UTC News UTC on 11 870, 12 020 and 12 070 kHz; plus 0700-0715 UTC Press Review on 11 705, 15 150 and 15 175 kHz.

**BBC London:** 0445-0500 UTC on 9750 kHz; and later 1900-1930 UTC on 9770 and 11 845 kHz.

**Deutsche Welle, Cologne:** 0345-0450 UTC on 9650, 9690 and 11 905 kHz. ●

# How To FISH The ESTUARIES

The first in  
MODERN FISHING'S  
four-part series  
on angling in  
Australian waters

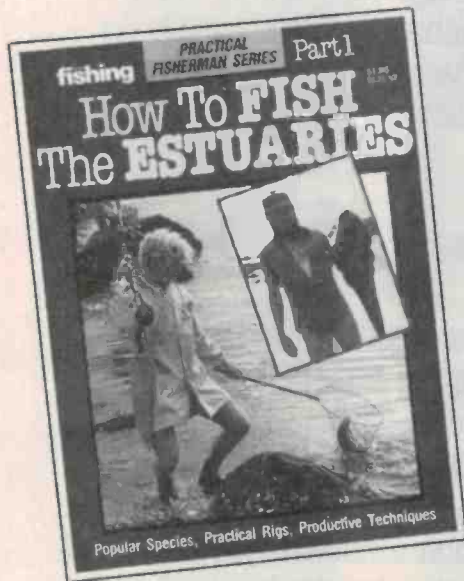

Top fishing writers  
will guide you:

- ★ to the right places  
at the right time,
- ★ in the selection of  
tackle and rigs,
- ★ choice of baits  
and lures,
- ★ correct (and successful)  
techniques.

*All common estuary species covered,  
PLUS advice on accessories and knots.*

ONLY \$1.95 AT  
YOUR NEWSAGENT NOW!

# AR2001 WORLD'S FIRST

- CONTINUOUS COVERAGE
- THREE MODE SCANNER
- COMMUNICATIONS RECEIVER



NOW ONLY \$499  
INCL. TAX

#### FEATURES:

- 25-550 MHz continuous
- NBFM — for communication
- WBFM — for BC & TV monitoring
- AM — for Air band monitoring
- 20 CH memory
- Priority Channel
- Clock

WRITE FOR FULL SPECIFICATIONS

## NEW Personal 2-way radio here at last! "EMTRON ACE"

A QUALITY 40-CH HIGH POWER UHF CB HAND-HELD  
TRANSCIVER ● DESIGNED FOR AUSTRALIA  
DOC APPROVED

#### FEATURES:

- 40 CHANNEL OPERATION
- HIGH (2.5W)-LOW (0.5W) RF OUTPUT
- OFFSET FOR REPEATER OPERATION
- NICA0 RECHARGEABLE BATTERIES
- ILLUMINATED DIAL FOR NIGHT OPERATION
- SMALL IN SIZE — BIG IN PERFORMANCE

#### APPLICATIONS:

- FARMING
- FISHING, BOATING, HUNTING, BUSHWALKING
- BUSH FIRE CONTROL
- AG SHOWS
- SECURITY
- CONSTRUCTION SITES
- CAR RALLIES
- CROWD CONTROL AND MANY OTHERS

DEALER INQUIRIES WELCOME



# EMTRONICS

Retail Division of EMONA ELECTRONICS P/L

All Mail to: PO Box K21, Haymarket, NSW 2000  
Ph: (02) 211 0531 Ph: (02) 211 0988  
94 Wentworth Ave, Sydney, 2000.

# at the leading edge

## WANGTEK TAPE DRIVE'S GOT IBM'S BACK-UP

Designed as an add-on for **IBM PC**,<sup>®</sup> **XT**<sup>®</sup> and **AT**<sup>®</sup> the **Wangtek PC-36** board and **5000E** Series half-height 5.25" **cartridge tape drive** provide **20, 45 or 60 MByte** of **hard disk back-up** in minutes. Mirror image or selective file backup/restore require minimal operator intervention. Software utilities supplied with the controller allow for easy integration and operation.

## PTD PUTS MEGAVALT 212 MBYTE HARD DISK IN FAST LANE

The super fast **MVP212 PTD** (Parallel Transfer Disk) offers 212 MBytes of storage in a compact **8" format**. A modified **SMD** interface yields a per channel transfer rate of **9.67 MHz**. When used in its **4 channel** concurrent mode the rate increases to **38.6 MHz** or **4.8 MBytes** per second. Units may be daisy-chained for up to **1.696 Gigabytes** of storage. CAD/CAM, satellite data collection, high resolution animated graphics and digital video data dumps will find ready application for the MVP212 PTD.

## AUSSIE INTERFACE FOR JUMBO LCD GRAPHICS DISPLAYS

Originally targetted at the **Sharp** range of large scale dot matrix graphics displays the **LCD-01** will also find application with other brands using similar driving techniques. ASCII data is entered via a **Centronics** port or, equally, graphics information may be directly loaded into an on-board memory via an 8 bit bidirectional bus. The interface effectively allows an **LCD** to be used as an **alternative** to the **VDU** especially where its **5V** operation would make it a **safer** choice.

daneva australia Pty Ltd

66 Bay Rd, Sandringham, Vic. 3191  
P.O. Box 114, Sandringham, Vic. 3191  
Telephone 598-5622. Telex: AA34439

Sydney: E&M Electronics (02) 51-5880  
Adelaide: DC Electronics (08) 223-6946  
Brisbane: Baltec (07) 369-5900



daneva

## New micro for big things

Warburton Franki has announced details of the Zenith Z100 microcomputer. The manufacturer Zenith Data Products has just won a contract with US military.

The contract is believed to be the largest of its kind and was won in competition with more than 50 other suppliers.

The Z-100 comes in two basic configurations: the Low Profile unit and the All-in-One. The All-in-One features a built-in monochrome CRT (cathode-ray tube). The Low Profile unit lacks a display, but it's only seven inches high and designed to serve as a base for an external monitor. Both units provide signals for an external RGB (red, green, blue) or monochrome video monitor.

The Z-100 is enclosed in a "durable earthtone-colour cabinet", that has proved quite resistant to smudges and fingermarks. The optional 8-inch floppy-disk system comes in a cabinet of the same colour.

The Z-100 will run with CP/M or ZDOS operating systems and can be used with languages such as Z BASIC, BASIC-80, C-BASIC, FORTRAN-80, COBOL-80 and MACRO-80.

Business application software includes Multiplan, Supercalc, Condor and the various Peachtree accounting packages. For word processing, the Z-100 offers Wordstar, Spellstar, Magic Wand, Magic Spell, Mailmerge, Datastar, Supersort.

"Perhaps the most exciting news in relation to the Z-100," commented a Warburton Franki spokesman, "is the recent availability of the LOTUS 1-2-3 integrated software package. This software combines the largest electronic worksheet currently available with state-of-the-art graphics and a complete information management capacity. It is the first that can truly take full advantage of both the 16-bit and graphics capabilities of the Z-100".

For further information contact your local Warburton Franki Office or the head office at Warburton Franki, 9 Birnie Avenue, Lidcombe NSW 2141. (02)647-2266.

# Data General's cat amongst the portable pigeons



**What one looks for in a portable computer is of course, portability balanced against comprehensibility. So designers strive for more and better features with less bulk and weight. It seems Data General's new portable, just released in the US, has done just that.**

The new Data General/One Portable has achieved the integration of a full size flip-up LCD screen displaying 25 lines of 80 characters, a standard full size low profile QWERTY keyboard, a 3½-inch floppy disk drive (with room for an additional built-in drive), a maximum of 720K bytes of storage per disk, into a unit 10 pounds (or 4.5 kilos) in weight.

The LCD display screen is as large as a standard IBM monitor and bigger than usual portable displays. It is composed of two glass sheets separated by a conductive liquid material requiring 256 by 640 pixels. This large number of pixels demands a formidable frequency of electrical pulses to retain an image. To overcome this a panel has been

inserted which is divided electrically into smaller ones all driven simultaneously.

The QWERTY keyboard is compatible with IBM-PC as well as with other Data General products. It features 10 function keys on the top of the keyboard and four cursor-control keys at the bottom right. The shift and return keys are situated in the usual typewriter locations.

Most IBM-PC software can be run on it by means of an external 5¼-inch drive or by transfer to 3½-inch disks. Some software is built into its ROM for printing and configuration functions.

Other features of the computer are its use of the 80C88 CMOS microprocessor which uses less power than the 8088 but is slower operating; 128K bytes

of RAM on a main printed circuit board, of which 80K is user available and 48K for screen graphics; 32K bytes of ROM for BIOS, diagnostics and built-in software; and a 128K byte memory expansion card that can be added to give up to 512K bytes with 464K bytes for user programs.

Input/output and power supply components are on a separate card. Disk-controller hardware is on top of the disk drives.

An optional 300 baud modem card can be installed internally and a buss expansion connector and two RS-232C serial ports are located on the back, one of which also acts as an RS-422 port.

The Data General/One can be used from a wall outlet by means of an ac adapter, or alternatively by a pack of nickel-cadmium batteries. A recharger is also supplied. The suggested price is \$US2895.

# More bytes

First shipment sold out in days . . .  
So popular we've had to air-  
freight new stocks in . . .  
The greatest value you'll ever  
see . . .

That's the new Bondwell 14  
Portable computer:  
**EXCLUSIVE to Dick Smith  
Electronics**

Simply brilliant! That's the all-new Bondwell 14 portable personal computer. Small wonder it has become one of America's top-selling computers in just a few short months - and now the same thing is happening here in Australia.

It's everything you've ever wanted in a computer and much, much more besides: small enough to go anywhere with you, yet large enough to do virtually any computing job.

This incredibly powerful personal portable operates from the world-standard CP/M system: which means there will always be an incredibly large range of software available for it. For virtually any purpose.

That's if you ever ever need any other software: the Bondwell 14 comes with over \$1200 worth of top quality business software (including Wordstar word processing!).

## Look at what else you get:

- Twin double density, double sided disk drives inbuilt (360K capacity each)
  - 9in amber screen inbuilt - for minimum glare and fatigue
  - Standard parallel and twin RS-232C interfaces inbuilt
  - 16 user definable keys for incredibly easy use
  - CP/M version 3.0 including a host of utility software - even a SPEECH synthesiser (it can read to you in English!)
  - Ergonomically designed keyboard & durable cabinet for complete portability
  - PLUS over all this famous Micropro bundled software: Wordstar, Calcstar, Mailmerge, Datastar, Reportstar - worth over \$1200.00!
- Cat X-9000

**OVER \$1200 WORTH OF  
SOFTWARE FREE!**

All this  
for **\$2295**  
only

\*Or from \$233 deposit and \$18.23 per week over 48 months to approved applicants. Commercial Leasing also available!



*Dick Smith Electronics Pty Ltd*

**COMPUTERSTOP**





# for your bucks!

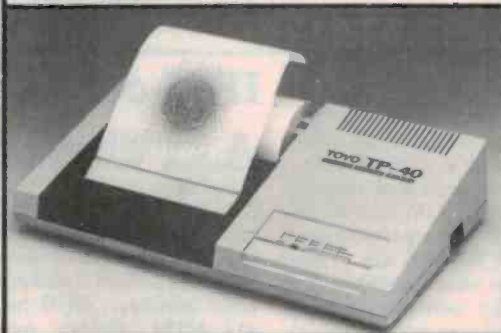
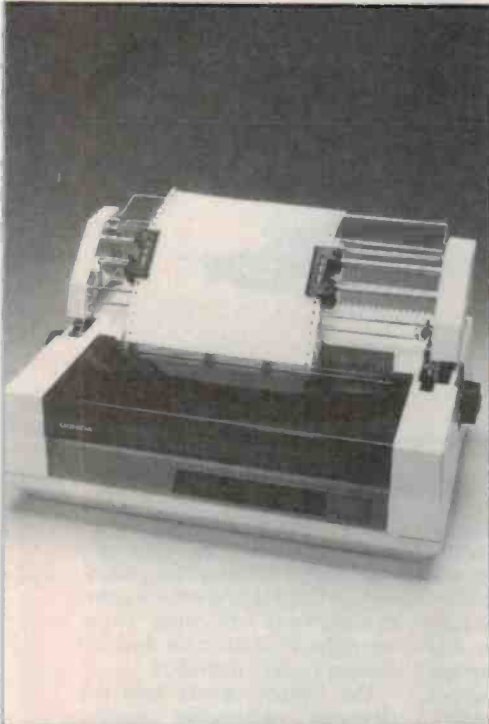

## Uchida Daisywheel Printer

Top quality printing at a budget price. Prints at 18 cps and offers a choice of 3 pitches plus proportional. Standard Centronics type interface. Cat X-3270

Save \$120  
Now only **\$575**

Tractor feed shown is optional (Cat-3273 or \$99.50).

## Quality Japanese Hi-Res Monitors

Green: X-1222  
Amber: X-1227 **\$249** each

## TP-40 Four Colour Printer Plotter

Incredible performance at a bargain price. Centronics type interface. Cat X-3245

LAST YEARS PRICE \$229  
Now only **\$99**

## Apple II software compatible CAT!

Australia's best value 64K Computer. That's the CAT. It's the best of both worlds: the very latest and most powerful hardware, plus the ability to run a very broad range of tried-and-proven software. If you want a machine which is software compatible with thousands of popular programs and which is supported by a reputable dealer, our CAT with emulator is good value. Check the CAT out at your nearest Dick Smith Electronics Computerstop. It purrs.

### Save \$232 on CAT system!

	Cat. No.	Normally
Basic CAT Computer	X-7500	\$ 699.00
Disk Drive	X-7505/6	\$ 349.00
Disk Controller	X-7510	\$ 149.00
RF Modulator	X-7550	\$ 34.90
		<b>\$1231.90</b>

SPECIAL OFFER!  
VALUE AT ONLY **\$999**

\*Or \$81 deposit and \$8.31 per week over 48 months to approved applicants.



Dick Smith Electronics Pty Ltd

# COMPUTERSTOP



nearest Dick Smith Electronics Centre.

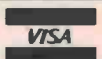
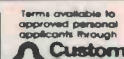
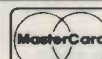

## More from Labtam

Labtam has released a new desktop computer to compliment their currently impressive range of 8-, 16- and 32-bit Computers.

The new model, nicknamed "Baby" is said to offer some impressive features not even found on computers costing much more than the \$8500 for the fully configured Labtam.

For example, the new Labtam Baby comes standard with an 8- and 16-bit computer, 512K of RAM memory, concurrent CP/M high-resolution graphics monitor, word processing and spread sheet with network available.

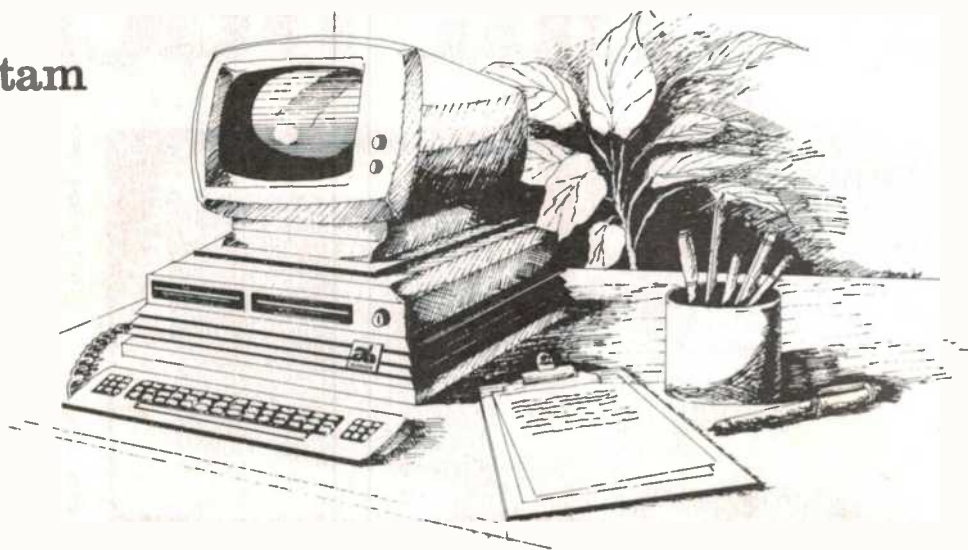

## IBM LAN

The growing need in office applications to network pc's has brought about the development of the low cost Trans-Net Local Area Network. This LAN allows data sharing, peripheral sharing and inter-computer communications.

The system is designed for the IBM-PC and compatibles and is simply an interface card which plugs into one of the pc expansion slots.

The Trans-Net system uses RS-422 twisted pair wires as the cabling system and transmits

data at the rate of 1 Megabit/sec. The system uses its own fully self contained data communication sub-system which incorporates a dedicated control processor, 8K ROM and 8K of static RAM. The operating parameters of the unit are established by the user's setting of the on-board dip switches. A network system can be supported over a maximum distance of 1200 metres and can handle up to a maximum of 255 addressable users.

For more information contact: Emona Computers, 661 George Street, Sydney, NSW 2000. (02) 212-3463.

## Dewhirst-LAN

The Dewhirst Corporation has announced that the company has received a grant from the Department of Science and Technology for the purpose of developing an Australian computer local area network (LAN). The project is estimated to cost some \$500 000, half of which will be funded by the Department.

The project has 18 months to run and is on schedule. Already 8-bit nodes have been released and 32 have been sold.

The significant aspect of the project, as far as the Department and Dewhirst are concerned, is the special data base management system for the network. This will permit the 8-bit, 16-bit or the 32-bit nodes now under development to access the same data base from anywhere on the network.

Copies of the Dewhirst technical plan overview and other details are available on request from The Dewhirst Corporation, 428 St Kilda Road, Melbourne, Vic 3004. (03) 267-5877.

## CLUB CALL

Bruce McGregor is the organiser of the Wellington based NEC Computer users group (NZ). The group specialises in the NEC PC8000, PC8800 and PC8200. If you're in the area contact Bruce at PO Box 3820, Wellington, New Zealand.

The BBC Acorn computer club of NZ is alive and well at PO Box 9592 Wellington. (Why are they all in Wellington?) The club is thriving and publishes a monthly magazine. The editor is called Bruce Willis. The secretary is Anton Erasmus.

## IBM colour graphics card

A new colour graphics adapter which makes a powerful video display interface for the IBM-PC and PC compatibles has just been released. The card can be used with medium and high resolution monochrome video monitors, RGB monitors and NTSC Colour monitors. There are two primary operation modes, text or alphanumeric and graphics mode.

The Text/Alphanumeric mode has a high resolution 80 x 25 display and a low resolution display of 40 x 25. Colours supported are 16 foreground and 8 background and video attributes such as reverse video, blinking, highlighting and non-display are also included. There are 256 characters and symbols in the ROM

based character generator, which includes 96 character ASCII set, characters for games, foreign language, scientific notation and word processing. There are eight 40 column or four 80 column buffers provided.

The Graphic mode uses the all-points addressable method and has a low resolution of 320 x 200 pixel four colour display and a high resolution of 640 x 200 pixel black and white display.

In addition to the RGB, monochrome and NTSC interfaces a light pen interface is also provided on the card.

For more information contact Emona Computers, 661 George Street, Sydney, NSW 2000. (02) 212-3463

Tell them you read it in ETI

## Plotters get cheaper

The very technical and production processes which are giving us more power and versatile computers, are doing the same for peripherals which allow the computer to express the results of its internal work.

A good example of this is the new professional-grade X-Y Plotter produced by Hioki.

The model 8401 makes extensive use of microcircuits to reduce both size and price.

It has cassette-type interfaces, for easy interchangeability between 8-bit parallel (Centronics), RS-232-C, and GP-IB operation. You order the inter-

face to suit your computer.

There are 74 plotting commands built-in, which makes the development of software easier and quicker, and the option of expansion RAMs in one-touch mountable cartridges with memory expandable to 7K will prove most valuable. The high volume data storage capability will free your computer for performing other tasks.

The Hioki 8401 X-Y Hi Plotter retails at about \$1900, and is distributed throughout Australia by Nilsen Rowe Australia, 200 Berkley St, Carlton Vic 3053 (03)347-9166.

# Microbee HACKER'S HANDBOOK

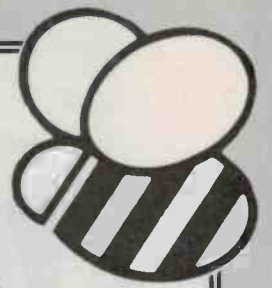

The Microbee Hackers Handbook will tell you how to:

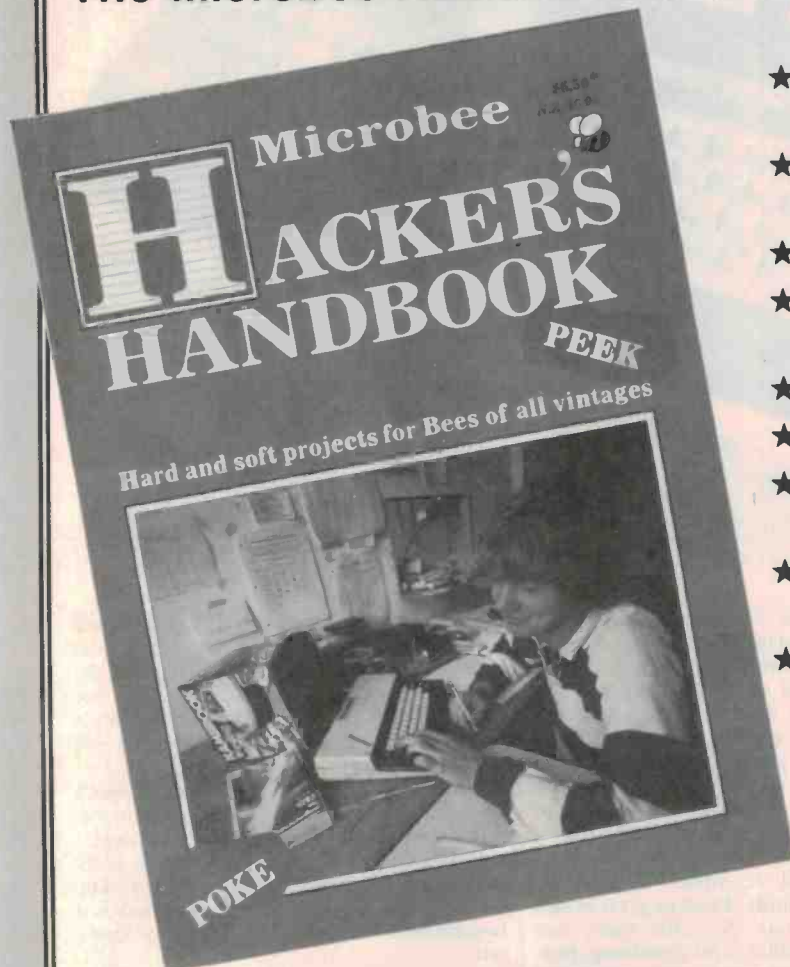

- ★ get more from the Bee's graphics capabilities,
- ★ set up for telecommunications on the Bee,
- ★ play music on the Bee,
- ★ build a joystick and a light pen for the Bee,
- ★ get hard copy — cheaply,
- ★ expand your 16K Bee to 32K,
- ★ make the Bee a better games machine,
- ★ turn your Bee into a facsimile decoder,
- ★ solve equations on the Bee  
... and much more!



From the publishers of 'ETI' and 'Your Computer' magazines.

We've also included listings of the Bee's BASIC scratch area and machine language locations — to make the Hacker's pursuits easier.

For sociable Hackers there are the contact addresses and phone numbers of all known Microbee user groups.

**\$6.50 Aust. (\$6.95 NZ) at your local newsagent.**

# KEYBOARD UPGRADE

— for the Microbee

If you've been dreaming of the time when you could upgrade the keyboard on your Microbee, then this article could well be what you've been waiting for.

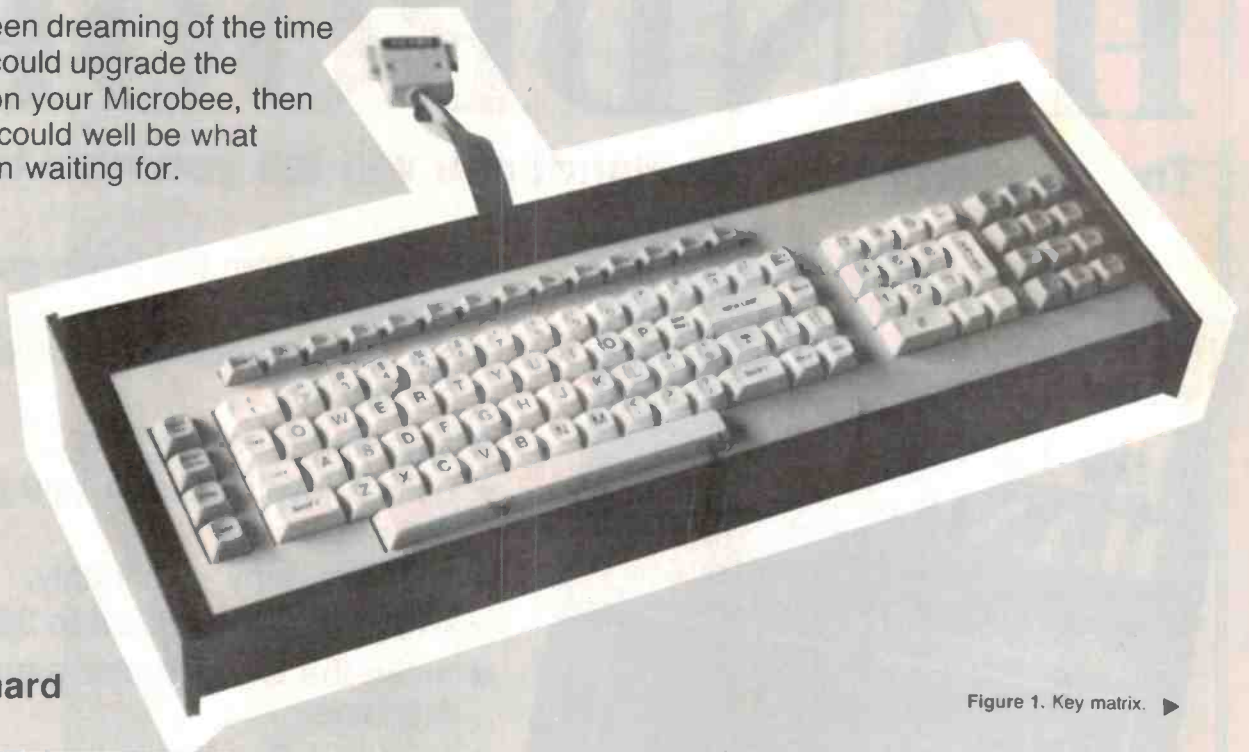

Figure 1. Key matrix. ►

J. Blanchard

FOR SOME TIME I've been experiencing trouble with the keys on my Microbee. Some keys felt spongy no matter what corrective action I took, while others consistently malfunctioned despite loving maintenance. Add these problems to the fact that there are no numeric pad or function key facilities and you can see how easy it was to build up a substantial case to convince my wife that a new keyboard was an investment and not an expenditure. Well, that's my story anyhow.

My next task was to find a keyboard that, on the one hand, matched my ego and imagination, while on the other hand wasn't going to murder my meagre bank account. And so I went, from electronics store to electronics store in search of my dream board.

The search ended the day I wandered into the newly opened Dick Smith store here in Ballarat. Amongst the opening specials I found a 'Cherry' brand keyboard that was the answer to my quest. Enough keys to work imagination overtime, an aesthetic appearance to satisfy my ego and a price tag that was friendly to my budget. This keyboard features a standard QWERTY section, a numeric pad, eight

function keys plus 21 other assorted keys thrown in for good measure, and is still currently available from Dick Smith outlets.

Having decided that this keyboard was the answer to my dream, I purchased one and took it home, thinking to myself what a simple task it was going to be to remove the old keyboard and wire in the new one. That such things could come to pass so easily in electronics! The simple task turned into a major project.

Having extolled the virtues of this new keyboard to my family, I had to get it in and working to save face. So, after many late nights, much mumbling and grumbling, programming, erasing and reprogramming EPROMs I came up with the necessary hardware and software modifications to bring my dream to fruition. If you follow these modifications with a small change here or there to suit your own needs, then you too can have a new keyboard to enhance your Microbee.

The changes will depend on how you lay out your key matrix and the type of pcb termination used on the keyboard you buy. According to Dick Smith ads there are four styles available. So far I have seen two: one, like mine, which has two 22-pin sockets

mounted on the rear edge of the pcb, and the other which has one 22-pin socket instead. Some keyboards do not have all the keytops labelled; mine has, as you can see from the photo. If you have a different style of board then some of the comments will not apply.

The task of upgrading your Microbee's keyboard with a 'Cherry' board, will involve four stages: namely, hardware changes, software changes, constructing a new scanner board and housing the keyboard. The physical size of the 'Cherry' board makes it impossible to fit in where the old keys come out.

## Hardware changes

The first task to undertake is to work out the pin connections on the termination socket/s. I used a three volt buzzer and jumper leads to do this and noted down the commons for each row of keys. From this information you can draw up a matrix layout of the keyboard. Unfortunately my matrix only coincided with the original keyboard matrix at three points: the ESCAPE, SPACE-BAR and RETURN keys were in the same position. You might be luckier with your matrix layout.

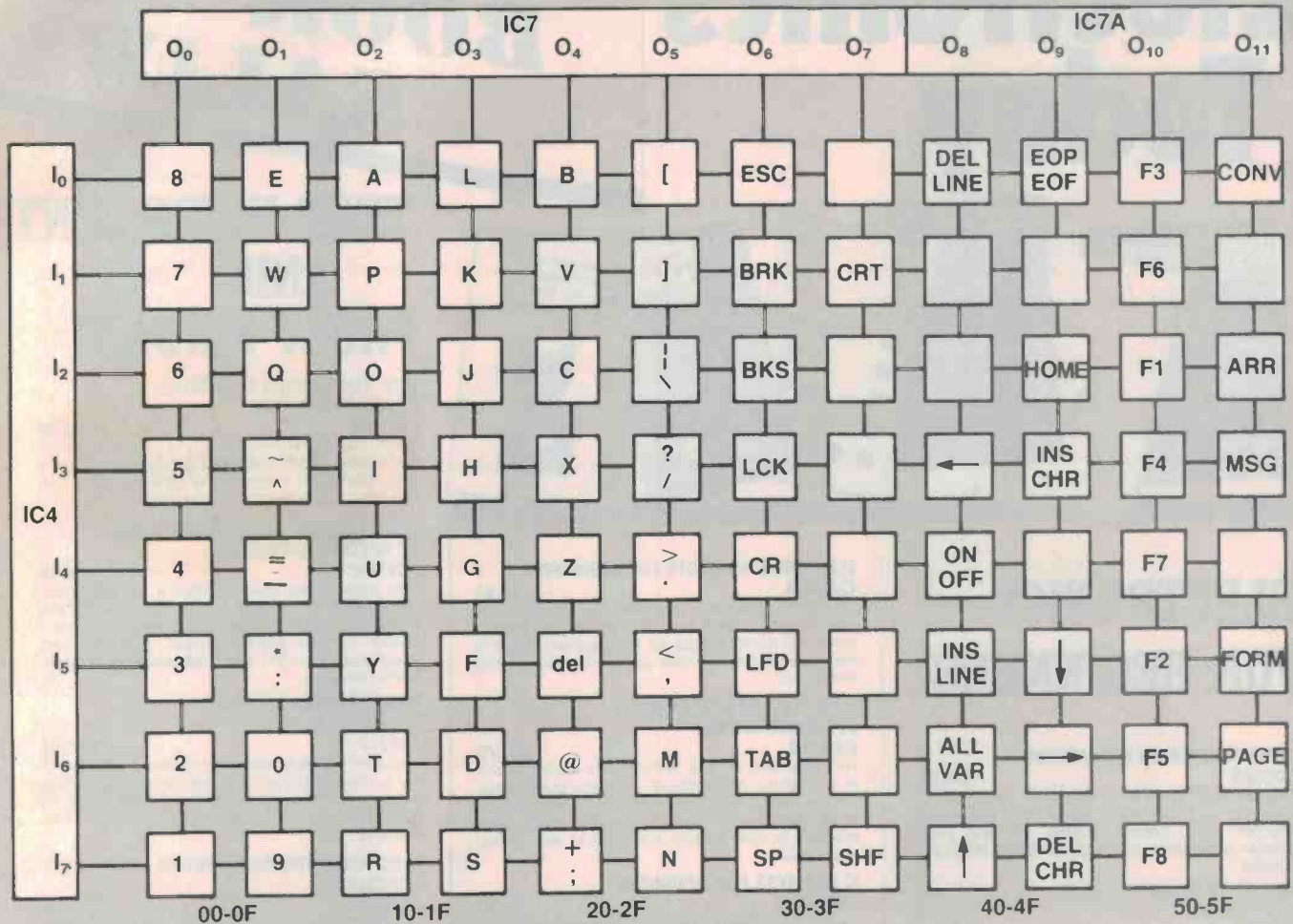

Next you will have to decide which column on your matrix you are going to designate as number one. It doesn't matter which one you choose as the software can be altered to suit. I used the numerals column because this also suited the physical layout of my scanner board which I will cover later.

When you have your matrix worked out, the next step is to reduce the number of columns to 12. Here's how I did it. The numeric pad numeral keys were paralleled with the numeral keys in the QWERTY section, the ENTER key was paralleled with the NEW LINE key, the two COMMA keys were paralleled and the FULL STOP key on the numeric pad was paralleled with the SPACEBAR to give that function from the numeric pad when entering DATA lists etc. These changes involve a fair amount of track-cutting and jumper wiring as the numeric pad shares a few commons with the 12-key pad at the right-hand end of the board.

The next cut-and-solder job is on the bank of 14 small keys above the QWERTY section. I relocated the RESET key to position 1 (left-hand end), cut the tracks and brought them out to two unused pins on

the termination socket. Then I followed through from left to right with the F1 to F8 keys, ATTR, FORM, CONV, MSG, and PAGE. You can leave these keys in their original order if you wish but the RESET key does not wire into the matrix and must have independent lines to RST and GND. A few jumpers may be required to bring the commons in to tie in with the QWERTY section commons.

With regard to the 4-key pad at the left-hand end of the board, if you are going to use these keys then you can slot them into the matrix wherever you wish, provided it's above 40H. The CONTROL key should, however, be wired into position 39H on the matrix, so some more track-cutting and soldering will be necessary here. As I had other uses planned for the three keys on the left-hand pad they do not appear on my matrix layout.

Two changes are needed on the QWERTY section; the first being to parallel the LOCAL key with the LOCK key to give two position Alpha-locking and the second is to locate the SHIFT key into position 3FH on the matrix. Just a word here about the SHIFT and CONTROL keys. It is not absolutely necessary to locate these two

keys into the exact same matrix position as in the original because a software change can be made to suit a new matrix value. However, it is necessary to have these two keys on a column of their own to avoid software complications when keyscan routines are handled for dual-key operations.

Looking now at the 12-key pad on the right-hand end; only a few jumpers should be necessary here to bring these keys into the matrix layout.

With the laborious task of the above changes completed your matrix layout should look something like mine (Figure 1). If it doesn't match mine, don't cry or panic, the software changes to come can be manipulated to suit.

### Scanning circuit

You will have realised by now that four extra columns have been added to the original number of eight. Obviously some additional circuitry is going to be needed to scan these extra columns, and that's just what is next up for discussion.

If you have a circuit diagram of your Microbee then get it out. Now concentrate your attention on the keyscan circuit and matrix.

# Electronics Today

# BOOK SALES

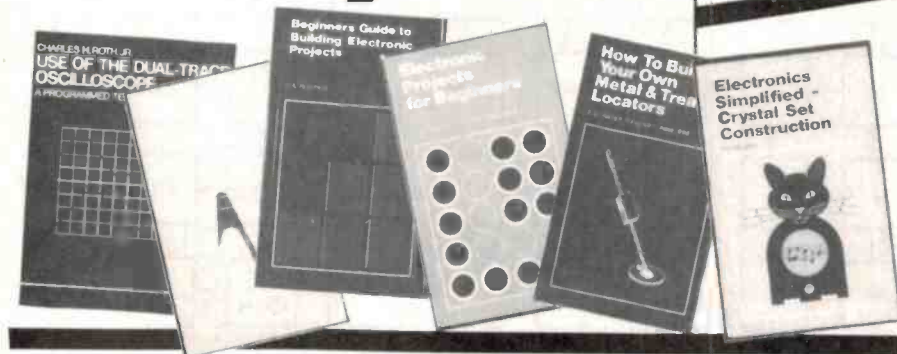

## TEST EQUIPMENT AND FAULT-FINDING

### HOW TO GET YOUR ELECTRONIC PROJECTS WORKING

**F0114B** \$6.95  
Helps you to overcome the problems of a circuit that doesn't work by indicating how and where to start looking for many of the common faults that can occur when building up a project.

### PRACTICAL REPAIR AND RENOVATION OF COLOUR TELEVISIONS

**F0116B** \$6.55  
This book shows how to obtain a working colour television for very little outlay by repairing and renovating a set that has been 'written off' by a dealer. Includes practical details of how to construct your own CRT tester/rejuvenator and cross-hatch generator.

### TROUBLE SHOOTING WITH THE OSCILLOSCOPE

**F0121P** \$16.95  
Excellent for the professional service technician or the serious hobbyist, as it combines step-by-step procedures for using the scope with the specific nuts and bolts of television receiver troubleshooting.

### ELECTRONIC TROUBLESHOOTING HANDBOOK

**F0257P** \$11.50  
This workbench guide shows you how to pinpoint transistor troubles in minutes, how to test almost everything electronic and how to get the most out of low-cost test equipment.

### USE OF THE QUAL-TRACE OSCILLOSCOPE

**F0259P** \$33.25  
This programmed text breaks down the process of operating a scope into a series of logical steps, starting with the deflection of the electron beam and continuing through proper use of the triggering controls to measure the phase difference between two waveforms.

### HOW TO BUILD YOUR OWN SOLID-STATE OSCILLOSCOPE

**F0282B** \$6.95  
This book comprises a project divided into sections for builder to individually construct and test — then assemble into complete instrument. Includes short section on scope usage.

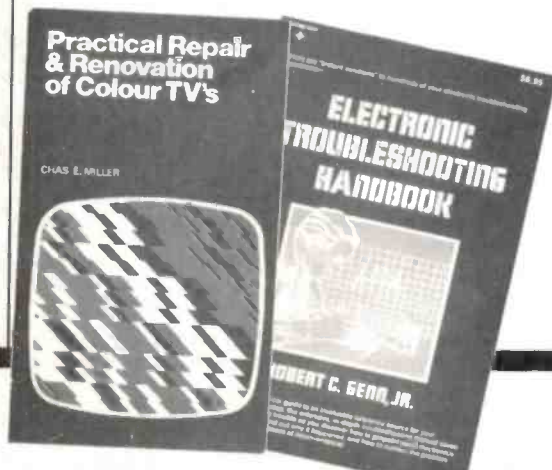

## ELECTRONICS FOR BEGINNERS

### HI-FI LOUDSPEAKER ENCLOSURES

**C0028B** \$4.95  
Data for building corner reflex, bass reflex, exponential horn, folded horn, tuned port, Klipschorn labyrinth, tuned column, loaded port and multi speaker panoramics. Clear dimensioned diagrams included.

### BEGINNER'S GUIDE TO DIGITAL ELECTRONICS

**C0029B** \$4.95  
Covers all essential areas including number systems, codes, constructional and sequential logic, analogue/digital/analogue conversion.

### BEGINNER'S GUIDE TO BUILDING ELECTRONIC PROJECTS

**C0030B** \$6.95  
Enables total beginners to tackle electronic projects. Includes component identification, tools, soldering, building methods, cases, legends, etc, etc. Practical basic projects are included.

### RADIO CONTROL FOR BEGINNERS

**C0034B** \$5.95  
How complete systems work with constructional details of solid-state transmitters and receivers. Also included — antennas, field strength meter, crystal controlled superhet, electro-mechanical controls. Section dealing with licensing, etc, is not applicable to Australia.

### HOW TO BUILD YOUR OWN METAL AND TREASURE LOCATORS

**C0036B** \$6.95  
Electronic and practical details on the simple and inexpensive construction of heterodyne metal locators.

### ELECTRONIC PROJECTS FOR BEGINNERS

**C0038B** \$6.95  
This book gives the newcomer to electronics a wide range of easily built projects. Actual components and wiring layouts aid the beginner. Some of the projects may be built without using soldering techniques.

### EASY ELECTRONICS: CRYSTAL SET CONSTRUCTION

**C0041B** \$6.75  
For those who wish to participate in the intricacies of electronics more through practical construction than by theoretical study. The circuits are based on those from earlier publications but have been modified to use modern components and home-wound coils.

### IC PROJECTS FOR BEGINNERS

**C0042B** \$6.75  
Especially written for the less experienced hobbyist, and offers a range of fairly simple projects based around a number of popular and inexpensive linear and digital ICs. Complete layout and point-to-point wiring diagrams.

### SOLID-STATE SHORTWAVE RECEIVERS FOR BEGINNERS

**C0044B** \$5.95  
Design and construction of several solid-state shortwave receivers giving high level of performance yet utilising few components.

### SIMPLE PROJECTS — VOL 2

**C0256E** \$2.95  
Contains easy projects plus chapters on construction techniques and useful information on components.

### ETI PROJECT ELECTRONICS

**C0269E** \$4.95  
Twenty-six projects for beginners, including battery saver, electronic siren, Morse practice set, FM antenna, etc, etc. Fifth edition.

### SIMPLE PROJECTS — VOL 3

**C0416E** \$5.95  
Popular projects for cars, music, around the home and special hobby affects. A valuable addition to the library of all those interested in electronics.

Prices subject to change without notice.

Simply fill out the reply-paid card insert and send to:

**ETI BOOK SALES,  
140 Joynton Ave., Waterloo NSW 2017**

All phone enquiries:  
(02) 663-9999

# BOOK SALES

## ELECTRONIC MUSIC AND AUDIO/VIDEO

### MOBILE DISCOTHEQUE HANDBOOK G0093B

\$4.95

Most people who start mobile discos know little about equipment or what to buy. This book assumes no preliminary knowledge and gives enough info to enable you to have a reasonable understanding of disco gear.

### AN INTRODUCTION TO VIDEO G0124B

\$6.95

This book is written in layman's language and is for anyone who is thinking about buying or renting or who has just bought or rented a video recorder and wants to get the best out of the machine.

### MODERN RECORDING TECHNIQUES G0128P

\$21.95

Explains the equipment controls and techniques found in a modern recording studio and how to use them creatively and correctly to produce a desired result. Numerous photographs, diagrams and charts.

### SOUND-SYSTEM ENGINEERING G0129P

\$35.50

Dealing with audio systems as a whole, it includes installing and equalising the sound system and interfacing the electrical and acoustic systems, instrumentation, the acoustic environment and designing for acoustic gain.

### TUBE SUBSTITUTION HANDBOOK G0130P

\$8.75

Complete, accurate, up-to-date guide to direct substitutes for receiving and picture tubes. Contains more than 6000 receiving tube substitutes, 4000 monochrome and colour picture tube substitutes, and 600 communications substitutes. Also includes pinouts for quick operational checks.

### HOW TO BUILD SPEAKER ENCLOSURES G0131P

\$9.50

A guide to the 'whys' and 'hows' of constructing top-performance loudspeaker enclosures.

### Electronic Music Projects

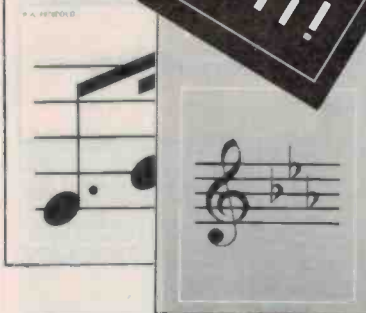

### ELECTRONIC MUSIC PROJECTS

G0135B \$5.95

Provides constructors with practical circuits for the less complex music equipment including fuzz box, waa-waa pedal, sustain unit, reverb and phaser, tremolo generator, etc. Text covers guitar effects, general effects, sound generators, accessories.

### ELECTRONIC MUSIC AND CREATIVE TAPE-RECORDING

G0136B \$6.95

Shows how electronic music can be made at home with the simplest and most inexpensive of equipment. Describes how the sounds are generated and how these may be recorded to build up the final composition.

# Electronics Today



### SINGLE-CAMERA VIDEO PRODUCTION G0379P

\$25.75

Step-by-step diagrams and illustrations show you how to produce low-budget, high-quality video programs. Chapters on audio, lighting, shooting, editing, graphics and set design.

## COMPUTING SOFTWARE

### USING THE UNIX SYSTEM K0185P

\$24.95

This book by Richard Gauthier, of RGL, has been written for people with some knowledge of computers, but with no specific knowledge of Unix. It is also of value to current Unix users.

### PROGRAMMING IN BASIC FOR PERSONAL COMPUTERS

K0186P \$18.95

Simple instructions show how to give BASIC commands and statements a wide range of applications, from programming video games to developing business or scientific programs.

### BASIC FOR EVERYONE K0187P

\$22.40

Some 350 pages of BASIC information for all purposes.

### APPLE FILES K0190P

\$21.95

This book is for people who know some BASIC and would like to expand and apply this knowledge by using the capabilities of the Apple. Includes programs for the stock market, inventories, grades and medical records.

### COMPUTER PROGRAMS IN BASIC

K0192P \$18.25

Fully indexed guide to more than 1600 BASIC computer programs published in personal computer magazines for microcomputers, mini-computers and mainframe computers. Compiled by Paul Friedmann, first published in 1981.

### 32 BASIC PROGRAMS FOR THE APPLE COMPUTER

K0218A \$29.50

Full of programs with practical applications, educational uses, games and graphics.

### PROGRAMMING THE 6502

K0227A \$22.95

Principles of assembly-language programming for the 6502 microprocessor are taught in this introductory text. Includes a discussion of trade-offs between hardware and software and detailed explanations of the 6502's internal registers and bus operation. Third edition.

### 6502 GAMES

K0229A \$21.95

You learn how to play 10 sophisticated games and also learn assembly language programming. Also learn the techniques of algorithm design and data structures.

Prices subject to change without notice.

Simply fill out the reply-paid card insert and send to:

**ETI BOOK SALES,**  
140 Joynton Ave., Waterloo NSW 2017

All phone enquiries:  
(02) 663-9999



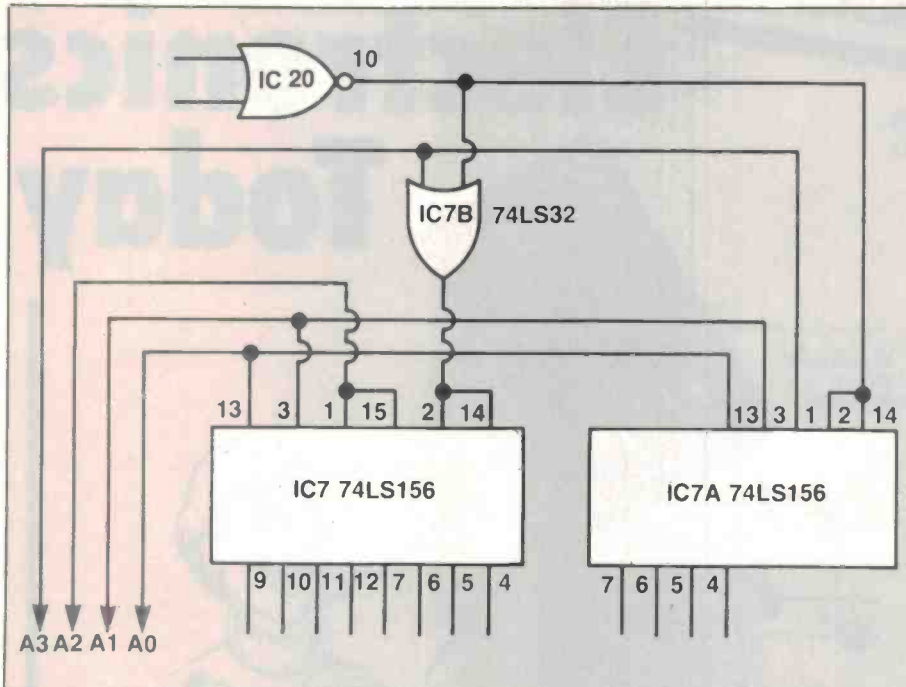

Figure 2. Keyscan circuit.

At first appearance the task looks easy; just replace IC7 with a 1-of-16 decoder such as a 74LS154. A nice thought, but as open-collector outputs are needed for dual-key operations such as SHIFT and CONTROL, the '154 is out. Looking at Figure 2, you see that I solved the problem by simply adding another '156 decoder, to handle the extra column, an OR-gate to select or deselect IC7 and a new address line, A3, from IC9.

Following the circuit through, address lines A0 and A1 are paralleled from IC7 to IC7A, as these provide a count from zero to seven for the outputs of either IC7 or IC7A. Address line A2 remains as in the original circuit and is used to select which half of IC7 is enabled. When A2 is low, decoder 'b' of IC7 is enabled and pins 9 through 12 will be active according to A0/A1. When A2 is high, decoder 'a' is enabled and pins 4

through 7 will be active. IC7 is therefore doing exactly the same job as in the original circuit except that an OR-gate, IC7B, has been inserted in the enable line from pin 10, IC20. This OR-gate will enable or disable IC7 according to the outputs of IC20 and the new address line A3. Coming from pin 14 on IC9, A3 is MA10, the next memory refresh address line to be active after MA9 (A2). A3, therefore, selects one of the two decoder chips to provide the outputs for the keyscan.

When A3 is low, IC7 will provide outputs for columns 1 to 8 or  $O_0$  to  $O_7$ . When A3 goes high, IC7A will be enabled and provide outputs for columns 9 to 12 or  $O_8$  to  $O_{11}$ . Thus the extra columns in the new matrix are scanned in sequence after the original eight columns. Their respective matrix values range from 40H to 5FH

Adding four columns instead of four rows was more suited to the software and hardware design of the Microbee.

### Scanner board

The problem of where to mount the extra ICs was my next task. After some thought and mumbling I finally settled on the idea of mounting the four IC's used in the scanning circuit onto a piece of matrix board which then plugs into the termination socket/s on the keyboard as in Figure 3. If your keyboard has two 22-pin sockets like mine then you may elect to use my method. Again, if your board has different termination arrangements then you will have to adapt as necessary.

IC7, 7A, 7B and IC4 will need to be hard-wired on matrix board (Figure 4). You need to solder two banks of header pins to align with the sockets on the keyboard. As you can see the left-hand bank of pins is 16 in number: the first eight being the row commons and the next eight being the commons for columns 1 to 8. The right-hand bank is 10 pins in number with pins 1 and 2 for the RESET key, pins 3 to 6 not connected but used for support, and pins 7 to 10 for the commons to columns 9 to 12. The two 22-pin sockets will need to be desoldered, removed and soldered back in on the underneath side of the pcb. The connection cable is run from the other end of the scanner board.

From Figure 5 you can see only 12 lines are required to interface the scanner board to the computer. A DB15 plug and socket would be adequate here to connect your keyboard to your Microbee. I used a 25-way DB plug and socket for two reasons. Firstly, to avoid any possible confusion with the DB15 socket used for the parallel port and secondly because I planned to add LED indicators for ROM bank selection status and CTC status.

With regard to the 12 lines required by the scanner board, you may use any method you like to pick up these lines from the motherboard. This is how I did it. The RESET line I took from the original RESET key position on the motherboard; this retains the delay feature on the RESET

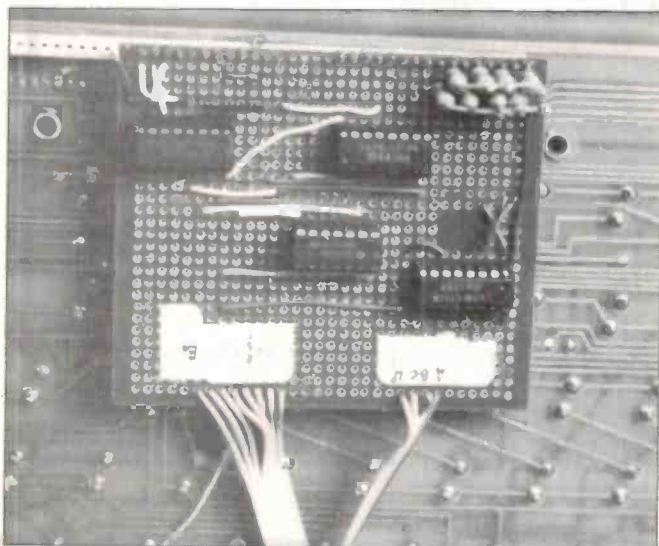

Figure 3: Scanner board underneath motherboard.

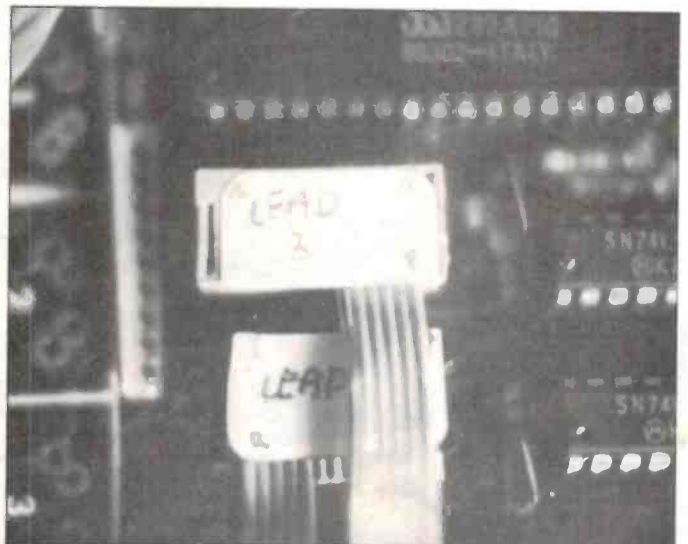

Figure 4: Headers plugged into IC4 and IC7 sockets on motherboard.



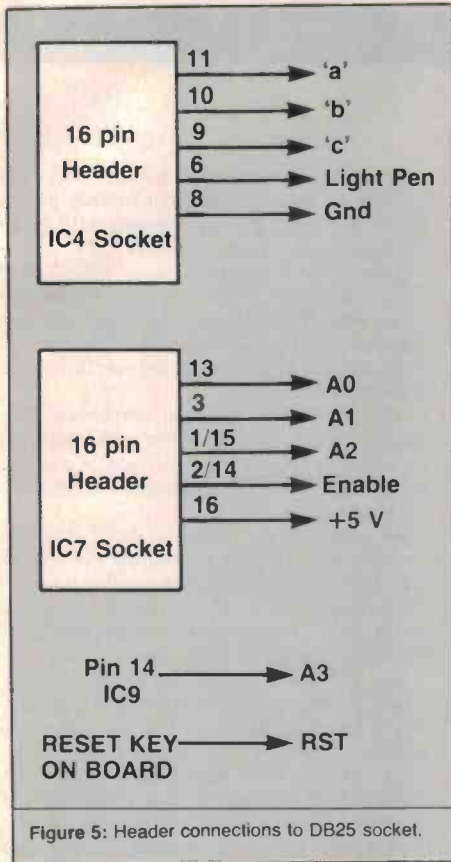

Figure 5: Header connections to DB25 socket.

key. A3 was wired from underneath the pcb from pin-14 on IC9. Two 16-pin IDC headers were then used to pick-up the remaining lines. Header one plugs in where IC4 was and picks up lines 'a', 'b', 'c', light pen, and GND. Header 2 plugs in where IC7 was and picks up A0, A1, A2, +5 V and the enable line. This method leaves the motherboard virtually untouched and easy for restoration if ever desired. I also took the opportunity to increase the key matrix pull-up resistors from 3k3 to 33k. I used seven discreet resistors mounted on the left-hand corner of the scanner board.

At this stage you may wish to plug in your new keyboard and see how things are progressing. Only those keys that coincide with the original matrix position will work correctly, the others will produce different characters on the screen. RESET S and RESET M functions will be different and the ROM test will also fail. But don't despair, the necessary software is at hand to restore all to proper working order.

**Software**

The next obstacle I faced was to find a place within the existing ROM space to fit the new software. After a little searching I found a long, boring message hiding at location B85CH. This message was the cold-start message that pops up when you do a RESET/ESC or your battery back-up has failed. Here was something I could have well done without. Tracing the routine through I found at 8550H a command to load HL pair with location B85CH. Once I found this I worked out a new cold-start message, my conversion program and the accompanying look-up table. The new cold-

start message now reads: "Welcome to Microworld Basic 5.2". Enough to tell the story.

Now, if you cast one eye on Figure 6, I'll go through the changes.

**Change 1:** The instruction 21 5C B8 simply loads HL pair with the starting location of the cold-start message. This should now be 21 9E B8, the start of the new message.

**Change 2:** At A461H the program loads reg A, containing the matrix value of the key you pressed, into location 0102H. Changing this to CD 5C B8 re-directs the program to where the conversion subroutine is hiding.

**Change 3:** The keyscan routine, beginning at A50AH, takes the matrix value of a key, loaded into reg A, and checks to see if that key has been pressed. The zero flag will be set if the key has been pressed and reset if not. At location A516H to A517H is the instruction E6 03. This instruction logically ANDs reg A with 03H and has the effect of limiting to 3FH the value that can be loaded into reg A. Changing this to E6 07 allows key matrix values up to 7FH to be loaded into reg A and accepted by the software. If you follow this routine through you will see that the value arrived at, after instruction E6 07, is loaded into reg 18 of IC9, the 6545. This reg holds the high byte of the Update Address and drives lines MA8 to MA13. As we are now using MA10 to IC7A, we must be able to toggle this line. Hence the reason for ANDing reg A with 07H instead of 03H.

**Change 4:** This is where you will insert the conversion program. This subroutine simple loads reg A into 0102H, loads HL pair with the top of the look-up table, adds reg A and reg L to arrive at the low-byte location in the look-up table and returns to the main program with reg A containing the matrix value corresponding to the old location.

**Change 5:** Here is where the look-up

table lives. You must alter this table if your matrix layout differs from mine.

**Change 6:** At location B89EH the new cold-start message begins. You can alter the wording if you wish but the first six bytes must stay and OD must be at the end, otherwise you'll have problems.

**Change 7:** At this location is the value loaded into reg A for a RESET S scan. As this function and RESET M do not use the normal GETKEY routine at 8009H this value must be altered to match the value of 'S' in your new matrix.

**Change 8:** Same as 7, but value is for 'M' (RESET M function).

**Change 9:** Optional. The look-up table for the RESET S keyboard check sequence resides at BF44H. This table must be changed if you wish to have the keycheck return a tick. Unfortunately there is only room for 59 bytes so only the QWERTY section can be checked.

**Change 10:** Optional. The 'ROM a' check byte for a RESET S ROM test is at location BFF0H. Change this to 2FH only if your ROM changes match mine.

**Change 11:** Optional. The 'ROM b' check byte is at BFF1H. Change this to D0.

Just a short note here about changes 10 and 11. If you wish the RESET S ROM test to return a tick and you have made different changes to the ROMs, then here's what to do. To arrive at the correct check byte, each byte is added to the next then rotated to the left using an RLCA instruction. ROM test 'a' covers from 8000H to 9FFFH, while ROM test 'b' covers from A000H to BFF0H.

Different matrix locations for SHIFT or CONTROL keys are handled from locations A501H and A507H respectively. By changing the value at A501H you can match this to the matrix location of your SHIFT key and similarly with location A507H for the CONTROL key.

LOCATION	OLD BYTE/S	NEW BYTE/S TO BE INSERTED
B550	21 5C B8	21 9E B8
A461	32 02 01	CD 5C B8
A517	03	07
B85C	Start of cold-start message	Conversion program
B866	"	32 02 01 21 66 B8 85 6F 7E C9 look-up table for new keyboard
B876	"	28 27 26 25 24 23 22 21 05 17 11 1E 2D 2A 20 29
B886	"	01 10 0F 09 15 19 14 12 0C 0B 0A 08 07 06 04 13
B896	"	02 16 03 18 1A 1F 00 2B 1B 1D 1C 2F 2E 2C 0D 0E
B89E	"	30 36 31 35 34 33 32 37 New cold-start message
BD58	13	0C 07 20 20 20 20 57 65 6C 63 6F 6D 65 20
BDFE	0D	74 6F 20 4D 69 63 72 6F 77 6F 72 6C 64 20
BF44	Start of look-up table for RESET S keyboard check	42 61 73 69 63 20 35 2E 32 0D (end B8C3) 1F (RESET S) 2E (RESET M) 07 06 05 04 03 02 01 00 0F 0E 0D 0C 0B 2A 32 36 0A 09 08 17 16 15 14 13 12 11 35 34 31 33 10 1F 1E 1D 1C 1B 1A 19 18 27 26 25 28 29 3F 24 23 22 21 20 2F 2E 2D 2C 2B 3F 33 30 37 (end BF7E) 2F (ROM a check byte) D0 (ROM b check byte)
BFF0	7E	
BFF1	93	

Figure 6: Table of software changes.



**Rockwell**

## MEDIUM AND HIGH SPEED MODEMS

If you are in the market for Modems, don't look any further!

Rockwell have a range of plug-compatible modems from \$256.00 to \$900.00 in single quantities -

Much better prices for large quantities!



73 ERIC ST, GOODNA.  
P.O. BOX 6502, GOODNA.  
4300, AUSTRALIA.

TELEPHONE: (07) 288-2757.  
TELEX: AA43778 ENECON.

## JAZZ UP YOUR '80 BASIC

For only \$49.95 CUSTOM BASIC will add over 45 routines to your TRS-80 Model I/III or SYSTEM 80 16K, 32K or 48K computer. Listed below are some of the routines provided:

- Spooler • Improved Screen Graphic commands • Improved INPUT routine
  - Lower case drivers • Flashing Cursor
  - Repeating Keys • Single Key entry
  - Keep variables while editing programs • Move, Copy and Renumbr program lines • Move and Swap blocks of memory • Improved MID\$, LSET, RESET and INSTR commands • A fast string sort • Dump screen to printer.
- Also provides the tape or ESF user with most DOS enhancements • Comes with 86 page manual. Specify Disk or cassette when ordering from:

**W. S. & D. S. Sands**  
363 Slade Point Rd,  
Slade Point, Qld 4740.  
Phone: (079) 55-3091

For more details send a SSAE or see review in ETI OCT '84 page 129.

## COMPUTING TODAY

That completes all the software changes; the only task remaining is to program three new EPROMs to replace the outdated ones. The ROMs to replace are ROM A, 8000H to 8FFFH; ROM C, A000H to AFFFH; ROM D, B000H to BFFFH. I tackled the programming by moving the respective 4K block from its ROM location to RAM location 1000H to 1FFFH. Then, under monitor, I changed the necessary byte/s using either 'M' or 'A' command. Just to double check before programming I did a 'C' (compare) between the original ROM and the altered RAM location in case a mistake had crept in. Once satisfied that all was well I 'burned in' the new EPROMs using my ETI programmer.

With the software changes complete, I inserted the new EPROMs, plugged in the keyboard and switched on. No smoke, sparks or other nasties; only a 'bleep' from the speaker and my new cold-start message graced the screen. What was even more encouraging was that all the keys functioned as they should, including the additional ones. All was well.

Just by way of an idea: I have three utility programs, DEBUG, EPROM programmer and Character Generator, residing on ROM at E000H to EFFFH, the network ROM space, which I call using F1, F2 or F3 key.

### The case

Now here's your chance to let your creative flair take over. Because of the physical size of the keyboard I decided to make it a stand-alone unit. This involved two stages; one to build a case to mount the keyboard in and two, relocating the Microbee mother and coreboards into a new home.

The new home consists of a square chassis arrangement with a wrap-over lid on

which sits my monitor. This chassis is big enough to take the original boards plus a regulated two amp power supply with room for expansion boards to follow.

The original parallel port, RS232 and S-50 sockets remained as they were and are located on the lefthand end of the chassis. The keyboard socket, on/off switch and battery standby switch are mounted on the front of the chassis.

The keyboard case is simply an aluminium sheet bent to form the base and front with two side panels made of acrylic. A second piece of aluminium forms the back panel.

As you can see from Figure 7 the side panels have a piece of sliding glass track glued to the inside edge. A similar piece of track is glued to the inside edge of the front of the case. These tracks act as guides for the keyboard top to slide into.

The keyboard top is also made of black acrylic, 6 mm thick. I mounted it to the keyboard by using off-cuts as spacers through which I drilled a 5/32 countersunk hole. These spacers were then positioned, with a metal thread and nut, over existing holes in the metal frame and the keyboard cover was then glued onto the spacers. Using this method means I can slide the keyboard out of its case, remove six nuts from under the pcb and lift off the top for access to the keys.

I covered the keyboard top with a light tan coloured Contact and the rest of the case with a leather-look Contact.

The accompanying photos should give you some idea of the finished article — however, it's your keyboard so let your imagination take over and do your own thing.

Happy Computing.



Figure 7: Keyboard sliding on tracks.

# Don't ignore these High-performance, Low-cost Peripherals!

- Dot matrix
- 100 C.P.S.
- 80 columns
- Interfaces standard Centronics or optional RS232

\$325 inc. s/tax (Centronics)



CPA80

- N.L.Q.
- Draft 120 C.P.S.
- N.L.Q. 22 C.P.S.
- 80 columns
- 132, IBM-PC characters
- Friction and sprocket feed

\$435 inc. s/tax (Centronics)



P1091

- Dot matrix
- 180 C.P.S.
- Full graphics
- 7 colours
- 132 columns
- Centronics interface

\$920 inc. s/tax (Centronics)



CP1018

- Daisywheel
- 20 C.P.S.
- QUME compatible
- Friction feed
- Optional single sheet feeder or tractor feed
- Interfaces standard Centronics or optional RS232

\$450 inc. s/tax (Centronics)



DWX-305

Available from:

**Electrical Equipment Limited**

Measurement & Control Division  
192 Princes Highway, Arncliffe,  
NSW 2205. Phone: (02) 597-1155.  
Telex: 22692.

169 Burnley St., Richmond, Victoria 3121.  
Melbourne: (03) 429-1122,  
Adelaide: (08) 277-5299,  
Brisbane: (07) 44-4801,  
Perth: (09) 381-2866.

WITH **TANDON** DRIVES YOUR COSTS

GO **DOWN**



- ★ Genuine world leading Tandon drives — not cheap copies
- ★ Fully warranted and serviced by sole Australian agents, adaptive electronics
- ★ Plug 'em in and run! Models to suit TRS-80, Apple II, IBM PC & XT, CAT, Challenger, & S100 systems. New models are being added regularly.

- ★ Floppies from \$232 (10+) or \$258 (Singles)
- ★ Winchester from \$1443 (10+) or \$1725 (Singles)

PRICES EX S.T., DLY. B'CARD, VISA & AMEX WELCOME. ALL DRIVES SUPPLIED COMPLETE WITH CASE, CABLES & POWER SUPPLY AS REQUIRED.

CALL MICRO GENERAL (02) 398 8601  
FOR THESE SPECIAL DEALS NOW!

TELEX AA135042 "ATTN MICANGEN"  
TRADE ENQUIRIES WELCOME

## READ OVER 130 CP/M DISK FORMATS ON YOUR MICROBEE STARTING FROM \$350

PERIPHERALS FOR YOUR MICROBEE, BBC & IBM COMPATIBLE

MICROBEE:		IBM:	
Dreamdisk Controller	\$350	64K print spooler	\$270
Single drive system	\$799	Clock calendar	\$95
Dual drive system	\$1050	Prototype board	\$25
Single 80 track system	\$880	10MB Winchester	\$1995
Dual 80 track system	\$1200	512K RAM board	POA
Add on 40 track drive	\$270	<b>HITACHI MBE 16000</b>	<b>\$2200</b>
Add on 80 track drive	\$320	(IBM compatible, 8086 CPU, 128K colour and dual drives)	
		Hitachi colour monitor	\$750
<b>BBC™:</b>		Daisy wheel typewriter	\$580
Eprom Board	\$70	(centronics interface)	
Disk Controller	\$160	Star Gemini printer	\$450
(single and double density)		(with cables)	
Single 40 track drive	\$290	Mitsubishi Hi-res monitor	\$180
(in case)			
Dual 80 track drive	\$750	<b>EPROM ERASERS</b>	
(in case)		MEET: 12 in 20 minutes	\$145
		LEET: 40 in 10 minutes	\$170
		GEET: 150 in 10 minutes	\$320

**DREAMDISK PTY. LTD.**  
171 Moray St.,  
South Melbourne,  
3205.  
(03) 690 8283

**AUSTRAL BEE**  
265 Springvale Rd.,  
Glen Waverley, 3150  
(03) 233 9665



# CICADA 300 Baud DATA MODEMS



- CICADA 300
- CICADA 300T with telephone
- CICADA 300c for use with Commodore 64 and Vic 20 computers



P.O. Box 184 Brookvale N.S.W.  
Telephone (02) 451-5555

## commodore 64 VIC-20 sinclair SPECTRUM



can

TALK

with our Speech Synthesizers from Currah. No software needs to be loaded, just plug the synthesiser onto your computer and it's ready to talk, using the sound on your TV.

An infinite vocabulary is achieved through use of allophones or sound syllables. These look just like they sound and are very easy to enter into your programmes. The Microspeech and Speech 64 have "speechware" available — synthesiser compatible software from commercial suppliers. Full instructions are provided for endless fun and education.

Speech 64 for Commodore 64 **\$69.00**  
Chatterbox for Vic 20 **\$66.50**  
Microspeech for Sinclair Spectrum **\$62.00**

Phone or send sae for FREE brochure — specify computer type.



Australian distributor:

dolphin computers

99 Reserve Road, Telephone: (02) 438-4933  
ARTARMON, NSW. 2064. Telex: AA20677

At discerning computer shops or mail order from Dolphin. Airmail software \$1.00. Post and parcel \$2.50. Online course \$6.00. Enclose cheque, money order, bank card details. All prices include sales tax. All products guaranteed.

**\*\*Dealer enquiries welcome\*\***

## COMMODORE COLUMN

```

10 REM *COMMODORE 64 COMPLETE CALENDAR*
20 REM BY ALAN A COPE
30 REM JULY 1984
40 REM FOR STAR *GEMINI-10X* PRINTER
50 REM CODE *CALENDAR*
100 ES$=CHR$(27)
110 OUS$=CHR$(24)
120 T$="CHINESE YEAR OF THE "
150 DIM A(84,5)
200 PRINT CHR$(147)
210 PRINT CHR$(18):"      COMMODORE COMPLETE CALENDAR"
220 PRINT
230 INPUT "   ENTER YEAR REQUIRED :";Y$
240 IF LEN(Y$) 4 OR LEN("Y") 4 THEN 270
250 IF VAL(Y$)\1900 OF VAL(Y$) 2099 THEN 270
260 GOTO 320
270 PRINT
280 PRINT "YEAR SELECTED MUST FALL"
290 PRINT
300 PRINT " BETWEEN 1900 AND 2099"
310 GOTO 220
320 PRINT
330 INPUT "           HOW MANY COPIES:":CO
340 IF CO=0 THEN 320
350 IF CO>1 THEN 410
360 PRINT
370 PRINT "      ":OUS$:"S":OUS$:" FOR SHORT FORM"
380 PRINT
390 PRINT OUS$:"RET":N":OUS$:" FOR CONTINUOUS":
400 INPUT SH$
410 PRINT:PRINT:PRINT:PRINT
420 PRINT "           PLEASE WAIT CALCULATING"
430 Y=VAL(RIGHT$(Y$,2))
440 IF INT(Y/4)=Y/4 THEN 480
450 K=2
460 IF VAL(Y$)>1999 THEN K=8
470 GOTO 500
480 K=1
490 IF VAL(Y$)>1999 THEN K=7
500 X=Y+K+INT(Y/4)
510 H=X-INT(X/7)*7
520 IF H=0 THEN H=7
530 IF K=7 OR K=8 THEN Y=Y+100
540 Y0=Y-INT(Y/12)*12
600 FOR L=1 TO 6
610 DA=31
620 IF L>4 THEN DA=30
630 C=0
640 FOR L1=H TO H-1+DA
650 C=C+1
660 A(L1,L)=C
670 NEXT L1
680 H=43-(H+DA)
690 IF H>7 THEN H=H-7
700 H=8-H
710 DA=30
720 IF L=1 THEN DA=28
730 IF L=1 AND K=1 THEN DA=29
740 IF L=1 AND K=7 THEN DA=29
750 IF L>3 THEN DA=31
760 C=0
770 FOR L1=H+42 TO H+41+DA
780 C=C+1
790 A(L1,L)=C
800 NEXT L1
810 H=43-(H+DA)
820 IF H>7 THEN H=H-7
830 H=8-H
840 NEXT L
850 PRINT CHR$(145):"           PLEASE WAIT PRINTING "
860 OPEN 1,4:CMD1:IF SH$<>"S" THEN PRINT ES$:CHR$(97):CHR$(3)
870 IF SH$="S" THEN PRINT ES$: "B":
880 FOR L=1 TO CO
890 IF L>1 THEN PRINT ES$:CHR$(97):CHR$(3)
900 PRINT ES$: "E":ES$: "G"
910 IF Y0=0 THEN Y0$="RAT"
920 IF Y0=1 THEN Y0$="OX"
930 IF Y0=2 THEN Y0$="TIGER"
940 IF Y0=3 THEN Y0$="RABBIT"
950 IF Y0=4 THEN Y0$="DRAGON"
960 IF Y0=5 THEN Y0$="SNAKE"
970 IF Y0=6 THEN Y0$="HORSE"
980 IF Y0=7 THEN Y0$="GOAT"
990 IF Y0=8 THEN Y0$="MONKEY"
1000 IF Y0=9 THEN Y0$="ROOSTER"
1010 IF Y0=10 THEN Y0$="DOG"
1020 IF Y0=11 THEN Y0$="PIG"
1030 LE=LEN(Y0$+" "+T$+Y0$+" "+Y$)+12
1040 TA=INT((80-LE)/2)
1050 PRINT TAB(TA):CHR$(14):Y$: "      ":CHR$(20):
1060 PRINT ES$: "4":T$:Y0$:ES$: "5":
1070 PRINT CHR$(14):"      ":Y$
1080 PRINT:PRINT
1090 GOSUB 2000
1100 PRINT
    
```

1984							
CHINESE YEAR OF THE RAT							
THE RAT							
1900							
1912							
1924							
1936	JANUARY						
1948	SUN	MON	TUE	WED	THU	FRI	SAT
1960	1	2	3	4	5	6	7
1972	8	9	10	11	12	13	14
1984	15	16	17	18	19	20	21
	22	23	24	25	26	27	28
	29	30	31				
THE OX							
1901							
1913							
1925							
1937	FEBRUARY						
1949	SUN	MON	TUE	WED	THU	FRI	SAT
1961	1	2	3	4	5	6	7
1973	8	9	10	11	12	13	14
1985	15	16	17	18	19	20	21
	22	23	24	25	26	27	28
	29	30	31				
THE TIGER							
1902							
1914							
1926							
1938	MARCH						
1950	SUN	MON	TUE	WED	THU	FRI	SAT
1962	1	2	3	4	5	6	7
1974	8	9	10	11	12	13	14
	15	16	17	18	19	20	21
	22	23	24	25	26	27	28
	29	30	31				

```

1110 FOR L1=1 TO 6
1120 GOSUB 2100
1130 PRINT
1140 GOSUB 2200
1150 C1=0
1160 C2=42
1170 LN=0
1180 FOR L2=1 TO 6
1190 PRINT TAB(7);
1200 FOR L3=1 TO 7
1210 C1=C1+1
1220 T=1
1230 IF A(C1,L1)>9 THEN T=0
1240 IF A(C1,L1)=0 THEN 1270
1250 PRINT TAB(T);A(C1,L1);
1260 GOTO 1280
1270 PRINT TAB(4);
1280 IF A(36,L1)>0 THEN LN=1
1290 NEXT L3
1300 PRINT TAB(11);
1310 FOR L4=1 TO 7
1320 C2=C2+1
1330 T=1
1340 IF A(C2,L1)>9 THEN T=0
1350 IF A(C2,L1)=0 THEN 1380
1360 PRINT TAB(T);A(C2,L1);
1370 GOTO 1390
1380 PRINT TAB(4);
1390 IF A(78,L1)>0 THEN LN=1
1400 NEXT L4
1410 PRINT
1420 NEXT L2
1430 IF LN=1 THEN PRINT
1440 NEXT L1
1450 PRINT
1460 GOSUB 2000
1470 PRINT ES$;"F";CHR$(15);
1480 PRINT "      THE RAT  THE OX  THE TIGER  THE RABBIT  THE DRAGON";
1490 PRINT "  THE SNAKE  THE HORSE  THE GOAT  THE MONKEY  THE ROOSTER";
1500 PRINT "  THE DOG  THE PIG"
1510 C3=0
1520 FOR L5=1900 TO VAL(Y$)
1530 C3=C3+1
1540 IF C3=1 THEN T=6
1550 IF C3=2 THEN T=3
1560 IF C3=3 THEN T=3
1570 IF C3=4 THEN T=6
1580 IF C3=5 THEN T=6
1590 IF C3=6 THEN T=5
1600 IF C3=7 THEN T=5
1610 IF C3=8 THEN T=5
1620 IF C3=9 THEN T=5
1630 IF C3=10 THEN T=6
1640 IF C3=11 THEN T=5
1650 IF C3=12 THEN T=3
1660 PRINT TAB(T);L5;
1670 IF C3=12 THEN PRINT
1680 IF C3=12 THEN C3=0
1690 NEXT L5
1700 IF C3<>0 THEN PRINT
1710 PRINT ES$;"B";CHR$(1);ES$;"E";
1720 GOSUB 2000
1730 PRINT ES$;"F";CHR$(15);
1740 PRINT ES$;"S";CHR$(0);
1750 PRINT "COMMODORE COMPUTER CALENDAR ";CHR$(203);" 1984"
1760 PRINT ES$;"T";ES$;"H";ES$;"B";CHR$(1);
1770 IF SH$<>"S" THEN PRINT CHR$(12);CHR$(241);
1780 NEXT L
1790 IF SH$="S" THEN PRINT ES$;"9";
1800 PRINT CHR$(7);
1810 PRINT#1:CLOSE#1
1820 IF CO=1 THEN PRINT CHR$(145);"      FINISHED PRINTING 1 COPY"
1830 IF CO>1 THEN PRINT CHR$(145);"
1840 IF CO>1 THEN PRINT CHR$(145);"      FINISHED PRINTING";CO;" COPIES"
1999 END
2000 FOR L9=1 TO 80
2010 PRINT CHR$(241);
2020 NEXT L9
2030 PRINT
2040 RETURN
2100 IF L1=1 THEN PRINT TAB(17);"JANUARY";TAB(32);"FEBRUARY"
2110 IF L1=2 THEN PRINT TAB(18);"MARCH";TAB(34);"APRIL"
2120 IF L1=3 THEN PRINT TAB(19);"MAY";TAB(36);"JUNE"
2130 IF L1=4 THEN PRINT TAB(19);"JULY";TAB(34);"AUGUST"
2140 IF L1=5 THEN PRINT TAB(16);"SEPTEMBER";TAB(31);"OCTOBER"
2150 IF L1=6 THEN PRINT TAB(17);"NOVEMBER";TAB(31);"DECEMBER"
2160 RETURN
2200 PRINT TAB(7);"SUN MON TUE WED THU FRI SAT";
2210 PRINT TAB(12);"SUN MON TUE WED THU FRI SAT"
2220 RETURN

```

READY.

## COMPUTER CALENDAR

Alan Cope, Paradise SA 5075

This program was originally written to run on the Dick Smith Wizzard for which a listing is still available. However, a re-write became necessary to take advantage of the Commodore 64 capabilities.

Due to incompatibility of the graphics on the Star printer, all print codes are expressed as CHR numbers.

The Escape code ESS; CHR\$(97); CHR\$(3) is a 3 line feed.

The heart of the program is between line 430 and 840 where all the calculating and storing is done. The first part sets up the screen and the rest handles the printout.

Lines 1110 to 1450 (including subroutines 2100 and 2200), do the month and day headings. They also format the dates in six rows of two months.

**C64**

## Z80 SILICON DISC SYSTEM

The R&DC Silicon Disc System is a single card computer, oriented towards CPM, which incorporates the following major components:

Single card 16 x 9 inches.

4 MHz Z80A CPU, CTC.

Z80A DMA Controller, for disc data transfers, with access to the trigger available at the external bus connector.

64K bytes of main CPU memory, with parity protection.

512K bytes of dynamic RAM, parity protected, interfaced as the Silicon Disc. All the appropriate handlers and tables are provided in the BIOS to enable this memory array to act as a very fast pseudo-disc drive for CPM.

Z80A SIO, giving 2 RS232 ports with modem controls. External clocking facility is provided on the 'A' port for synchronous communications systems, with a software select mechanism on the 'B' port allowing the CTC device to generate non standard bit rates for unusual applications.

Z80A PIO, interfaced as a 'Centronics' printer port.

Flexible disc interface, (8") single/double sides/density software selectable. Data transfers via DMAC.

Internal calendar clock with battery backup. Gives current time/date and interrupts down to 1 mS intervals.

Buffered external CPU bus connector allowing external interfacing if required. (ST506 interface card under development.)

A PROM resident BIOS for CPM 2.2 (60K), featuring fully buffered, interrupt driven I.O., allowing fast and smooth operation of all peripherals. At least 1 line of buffering is provided on each device, which also permits adequate 'type-ahead' at the keyboard.

Utility programmes to format blank discs, set drive characteristics, etc.

Source code of the BIOS and all the utility routines to enable in-house support of the system if required.

The Silicon Disc System offers speed improvements in excess of 25 times over 5" single density systems, and around 5 times over 8 inch double density systems. Access times and disc errors eliminated. Only one disc drive is required. The system is available as follows, excluding CPM.

1. As minimum kits, i.e. unloaded printed circuit board, PROM, schematic, software and hardware write-up, and flexible disc containing software sources, \$250.00.
2. As a completely assembled and tested card, excluding cables and connectors, \$1500.00.
3. As a kit of all parts to build the card, \$995.00.
4. Where the purchaser takes option 1, we are able to supply any individual components which may be more difficult to purchase through normal retail outlets.

All prices are less sales tax, add 20% if applicable.

R and D Carbuhn  
3 Viscount Way  
Forest Hill  
Victoria 3131.  
Tel. 03 233 3595.

**STOP  
PRESS!  
PRICE  
REDUCTION**

## THE AUSSIE BYTE SINGLE BOARD COMPUTER

### AUSSIE BYTE FEATURES

- ★ A fully tested and proven SBC with a 4 MHz Z80A CPU running CP/M Plus (3.0) with 256K of fast dynamic RAM, 4K Monitor BIOS EPROM and DMA capability.
- ★ On-board disk controllers for up to eight 5¼ or 8 inch floppy drives, two hard disk drives, video display and keyboard controller, Hi-res 640 x 608 graphics, four serial RS232C interfaces and one parallel Centronics port.
- ★ Access to BIOS source and operating system software at no charge to any designer. The ultimate in flexibility.
- ★ Optional MP/M supporting up to four users, voice synthesis, S100 or STD bus expansion, future 16 bit support.
- ★ All this on one 30 x 42 cm board minimising cost, complexity and risks.

### SPECIFICATIONS

The Aussie Byte board is a complete computer requiring only a power supply, disk drives, keyboard, monitor and cables. No other circuitry is needed to form a complete Z80 based computer.

The Aussie Byte measures 297 by 420 mm. Along its back

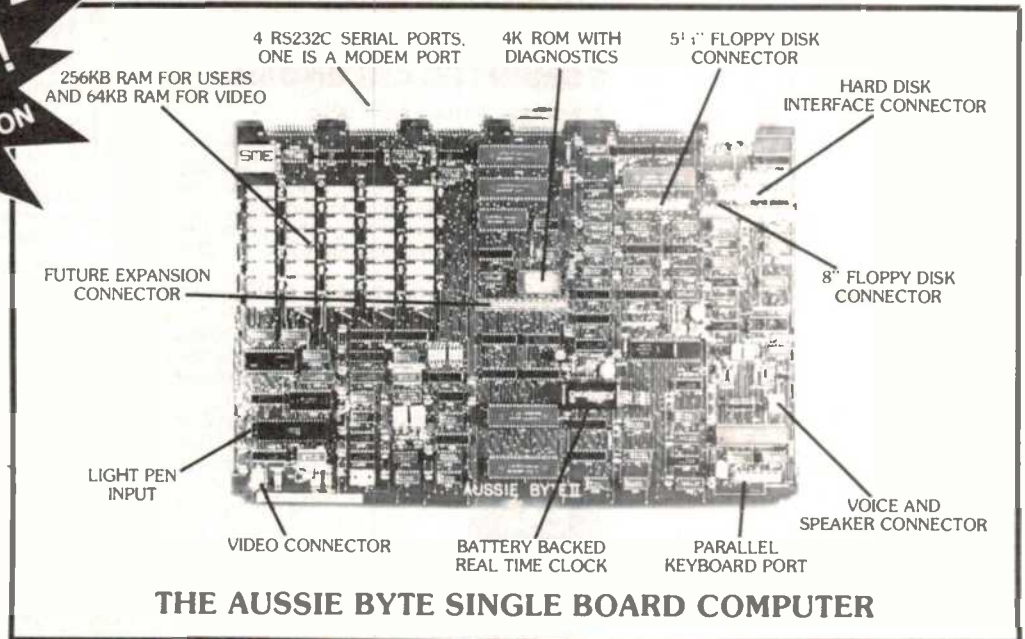

edge, four 26 way RS232C male connectors are mounted for the serial I/O and a 37 way male connector is provided for connection to a standard Centronics printer. Standard 0.1 by 0.1 pitch upright connectors are provided to connect to 8 and 5¼ inch floppy drives, to a hard disk controller, and for the bus expansion to an S100 or STD bus.

The Aussie Byte directly interfaces to both 8 and 5 inch disk drives connected via flat ribbon cables. Winchester hard disk drives are also supported with the inclusion of a WD-1002 controller and an interface cable. Both floppy and hard disk drives are supported in the CP/M implementation. For graphics applications, the graphics display controller can be placed in the 630 by 608 pixel high resolution mode. This allows quality graphics to be generated.

Expansion is catered for by the use of a "bus expansion header" connector that provides all the basic Z80 signals. This connector also provides access to the DMA controller, system clock and baud rate generators.

Other features of the Aussie Byte include a programmable tone generator, four serial channels including a modem port, parallel keyboard interface, speech synthesizer, battery backed real time clock. Power is supplied by means of an 8 way connector. Video information suitable for connection into a monochrome monitor is also available on an external connector. Power requirements are 5V at 3 amps, 12V at 1 amp and -12V at .25 amps.

When power and the required drives, monitor and keyboard are connected, the Aussie Byte will display a message to the screen indicating that it is operating. At this stage the user can press a key to enter the monitor or if left for a few seconds, the internal program will automatically load an operating system from disk. This makes the Aussie Byte particularly easy to start, requiring only switch-on and an operating system disk to be inserted in a disk drive.

The Aussie Byte Z80 CPU has a 4K EPROM monitor program which is used for system

diagnostics and for initiating disk based operating systems. The Z80 also has 256K of dynamic RAM which is accessible through bank switching for operating systems that require large address spaces or extra RAM for buffering or cache.

The Aussie Byte has been designed for the greatest possible throughput by the use a full complement of fully interrupt driven Z80 peripheral chips. Another powerful feature is its DMA multiplexer that enables any of the I/O devices to automatically send data to or from memory via the Z80 DMA device by using the ready lines from a selected device to control the DMA channel. This enables data and port transfer to be done in a background mode without processor intervention. Video display is handled by a 6545 display chip and an 8002 attribute controller. These have their own separate 64K of RAM as well as a 2K CMOS RAM. ASCII characters are generated from an internal lookup table in the attribute controller.

The Aussie Byte is an advanced single board computer with many features, it is easy to implement in dedicated systems and extremely cost-effective.

**SME**  
SYSTEMS  
THE PROBLEM SOLVERS



SME SYSTEMS PTY. LTD.  
Incorporated in Victoria  
22 QUEEN STREET, MITCHAM,  
VICTORIA, AUSTRALIA 3132  
PHONE (03) 874 3666 TELEX AA 37213

	EXEMPT	TAX
AUSSIE BYTE II ASS. & TESTED	995.00	139.30
CP/M PLUS Ver. 3.00 SOFTWARE	375.00	52.50
5 1/4 DSDD 1 Meg DISK DRIVE	295.00	41.30
75 W SWITCH MODE SUPPLY	125.00	17.50
KNIGHT SYSTEM METALWORK	225.00	31.50
MONITOR 12" GREEN SCREEN	225.00	31.50
KEYBOARD—SERIAL IBM STYLE	195.00	27.30
SERIAL KEYBOARD PCB ADAPTOR	45.00	6.30



**Altronics**

105 Stirling St, Perth W.A.  
(Box 8280, Stirling St, Perth 6000 W.A.)

FOR YEARS, Dick Smith 'thumped the tub' about getting rich, just like him. He freely told all and sundry what he'd done to turn his little electronics business into a giant, multi-million dollar enterprise. For some reason, would-be millionaires ignored his advice in droves. "If only they'd listen to me," Dick would wail on occasion.

Well, somebody did take his advice — one Jack O'Donnell, a resident of that winning city of the west, Perth.

Jack opened his present Stirling Street shop in 1976, starting out as Dick Smith reseller. He stocked the familiar range of goodies beloved of hobbyists. Being the closest electronics store at hand — in fact, the only one — in that vast half of this great continent west of West Wyalong then. Altronics copped a few tentative mail order enquiries from outback enthusiasts (ah, they breed 'em tough and resourceful in the west). Encouraging them with a taste of good service and resourcefulness on his own part, the mail orders turned into not a little deluge.

In 1980, Jack took Dick Smith's advice (as mentioned above) and 'went it alone'. Taking advantage of the two-hour time difference between east and west (to the west's advantage), three hours during the summer months (except for Queensland, but they have to wait for Joh to get up, anyway). Jack O'Donnell tackled what is termed in the trade "the mail order market". He had another bonus to cash in on, too. Freight rates from west to east are cheaper than the other way around. What's more, an order placed from the east one evening can be delivered on your doorstep next morning. ETI can vouch for that — we've tried it on numerous occasions (more often than you knew, Jack . . .).

But, it was clear after running this service



Hard to miss! (Top left) The Altronics store at 105 Stirling St, Perth. Motto on the sign reads, "we won't be beaten on price, service, expertise". Note the prosperous customer. The honest Irishman. (Top right) Jack O'Donnell — knows good advice when he hears it. Case for de fence! (Above) Kits, cases, coil wire . . . corr!

for a while that there was some reluctance to call STD to Perth from eastern states buyers, even after 6 pm eastern time when STD's cheaper. "I'll fix that," said Jack. So he installed an INWATTS line. For the cost of a local call you can "phone your order in, quote your backcard number and order what your little heart desires — having first found out stock availability. No mucking around. And if you're champing at the bit to get that new project off the ground — you can have delivery the following day for a nominal fee. Great stuff. It's a unique service.

To keep his product line up to date and interesting, Jack makes at least one pilgrimage a year to the east. No, I don't mean Sydney — I mean Asia! Realising it's cheaper to import direct from Asia to Perth — rather than through Sydney, Jack O'Donnell maintains a buyer in Hong Kong. This person has learned the inscrutable tastes of Australian electronics enthusiasts first hand — early in his career he worked for a large Australian electronics outfit.

Walk into Altronics' Stirling Street store in Perth and you're immediately in familiar ▶

## OVER THE COUNTER



'One from here, two from there, um.' The Sublaco kit packing department.

surroundings. Funny? It's just like lots of other electronics stores you've walked into (good advice, that . . .). Everything's set out on racks and shelves so you can browse at your leisure. One thing that caught our eye was the extensive range of boxes and cabinets — from the familiar jiffy box (two styles — with the common metal front panel and with a plastic moulded lid) to 19" rack cases in a range of colours. Well, black or

silver really. The latter, Jack has made and packaged overseas. There's an extensive section devoted to reference and data books, magazines and project books. File copies of magazines are kept on-hand for customers' reference. Very handy.

As the store is located diagonally opposite the Perth mail exchange, Jack's mail order department is here. All incoming calls are assiduously logged and orders written out

on the spot. It's a tightly run facility which gets pretty busy at times, but they seem to manage very well.

Altronics' head office and warehouse is located in a modern building in nearby Subiaco, a charming old inner city suburb. All non-mail freight despatching is done from here. The kits are packaged here in a well set up and efficiently organised area. Your Editor has never seen so many Series 5000 amplifier kits at one time. Whew! Naturally, the whole Altronics operation is computerised.

Jack has a pretty strict requirement with regard to both shop and mail order staff. To work at Altronics, you *have* to be an *electronics enthusiast* with a pretty thorough knowledge of the basics and familiarity with components. Plenty of customers seek technical advice and it's no good talking to a person who doesn't know his beans, according to Jack. "Unless you have technically inclined and experienced staff," he says, "you just get the blind leading the blind". So, if you have a problem with your Altronics kit, or you're looking for a substitute device in an obscure circuit, don't be afraid to ask Altronics staff. They mightn't be able to help every time, but you'll get assistance where they can provide it.

As a highly successful electronics importing, wholesaling and retailing business, Altronics is obviously set to go places. Luck of the Irish? I asked Jack O'Donnell. "Not really," Jack answered modestly, "I just took some good advice as a young man".

## MINI MART

### COMPUTERS

VIP-III development board, ASR-33 keyboard printer, UART breadboard interface, and all documentation. Ideal to get hang of micro hardware and programming. \$175. Clive (03)699-9584.

RESEARCH MACHINES 380Z computer, 48K RAM, three RS232 ports, four 8In. DS/SD BASF floppy drives, Okidata 110 printer, two cassette drives with controller. Votrax speech synthesiser, Dataphone 300 baud direct modem, extensive CP/M software. Cost \$10,000+, sell for \$4000. Frank, (051)55-9232.

VZ200 SOFTWARE. Cash book ledger, assembler, utilities, hardware Tips etc. Send SAE to Mr J. C. E. D'Alton, 39 Agnes St, Toowong. Qld 4066.

MICROBEE 32k model II with Editor Assembler roms, \$150 worth of game software, many books and manuals. The lot just, \$499. Be prompt, contact David on (043)41-4558.

FOR SALE: IBM books two Visicalc, one graphics microcomputer power series, \$10 each. D. Lewis, 4 Albert St, East Malvern 3145. (03)211-1934.

FOR SALE: MPT INTERRUPT clock with 089 Driver, \$60. DS 68 6809 CPU with mother board and serial port, \$150. MDI SS30 FDC, \$50. R. Steedman, RMB 9010, Omeo Hwy, Lucknow 3875. (051)56-8291.

FOR SALE: MICROBEE 32+ with 4 MHz mod., EDASM Kaga Denshi green monitor, joystick, chess, \$550, K. Lau. (02)498-7270.

WANTED: MICROBEE — any condition, also dot matrix printer, monitor, cassette player. pay cash. Phone Craig: (053)52-1472 a.h.

FOR SALE: SUPER 80 disassembler, cassette \$9. Teleprinter \$40. Vintage valves, receiving and transmitting incl. 6L6, 809, 4060. Send SAE for price list. R. Vowels, 93 Park Drive, Parkville 3052.

### AUDIO

FOR SALE: CARTRIDGE DECK 6 audio carts rec-play, broadcast quality, ex CH10 TV, new motors, excel. cond. Several features incl. auto recue, cue out, composite or discreet outputs. Worth much more. \$500 ono. (02)651-1166 or (02)260-1630.

FOR SALE: PART ASSEMBLED new amplifiers 4 x 300 watt ETI-466 amps with transformer \$28 each. 4 x 100 watt ETI-480 amps with transformer \$58 each. Metal work plus extras to suit, available cheap. (02)651-1166 or (02)260-1630.

FOR SALE: SOUND MIXER Yamaha PM700 12 inputs 2+2 outputs sep. channel EQ effects send pre and post, switched atten., pan, solo, and much more. Complete in road case. \$1500 ono. (02)651-1166 or (02)260-1630.

PREAMPLIFIER PS audio latest IVH version custom built, HI current power supply, sulzer low impedance regulator \$580. G. Page, 17 Elm St, Unley Park SA 5061. (08)271-9191.

### MISCELLANEOUS

FOR SALE: LANGUAGE LABORATORY Sony. Sult 2 x 30 students or 1 x 60 new, in boxes \$600 many features. (02)651-1166 or (02)260-1630.

SPARE TIME servicing and a solid 3 bedroom home \$46 850. Sult retiring technician. Beautiful climate, Atherton Tablelands. Write T. C. Maden, 16 Moore St, Ravenshoe 4872.



# COMPUTER BOARDS



**NEW PRODUCT!**

## EXCALIBUR

**EXCALIBUR IS ALIVE AND WELL, KITS NOW AVAILABLE!**

This stunning design with excellent colour, basic in ROM and a host of features is now available as a Kit

### FEATURES:

- Z80-A CPU, 3.5 MHz, 64K RAM, 16K ROM.
- Direct video output, RF output and RGB.
- QWERTY Keyboard.
- Cassette Interface built in.
- Serial RS232C, Parallel 8 bit Centronics.
- Colour 16 foreground and 8 background colours.
- 24 lines by 80 characters 7 x 12 dot matrix (monitor required)

Cat. **\$595**

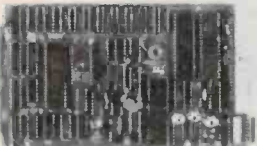

## THE AMPRO LITTLE BOARD

**★ ASSEMBLED AND TESTED ★**

### FEATURING:

- ★ 4 MHz Z80 CPU!
- ★ 64K Dynamic RAM!
- ★ Double Density (5 1/4 inch) Floppy controller.
- ★ Centronics style parallel printer port.
- ★ Uses +5V DC at 75mA and +12V DC at 50mA.
- ★ Two RS232 serial ports.
- ★ Same size as a mini floppy (only 5 1/4 x 7 1/2 inches).
- ★ 2732 Boot Eprom.
- ★ 110 Page Manual.

\*\*\* FREE CP/M 2.2 !!! (\$195 VALUE) \*\*\*

A FREE 5 1/4 inch CP/M 2.2 Diskette is included with each Kit.

ASSEMBLED AND TESTED ONLY Including tax **\$516**

Cat. **18x exmpd \$430**



## BIG BOARD II OVER 1,000 SOLD!

Jim Ferguson, designer of the "Big Board" distributed by Digital Research Computers, produced this stunning computer "Big Board II"

### FEATURES ...

- **4 MHz Z80 CPU AND PERIPHERAL CHIPS:** The Ferguson computer runs at 4MHz. Its monitor code is lean, uses Mode 2 Interrupts, and makes good use of the Z80-A DMA chip.
- **64K RAM + 4K STATIC CRT RAM - 24K (EPROM OR STATIC RAM):** "Big Board II" has the third memory bank; the first memory bank has 64K RAM that provides 60K of user space and 4K of monitor space. The second memory bank has two 2K and 8 SRAMs for the memory mapped CRT display and space for six 2732s or 2K x 8 static RAMs, or pin-compatible (EPROMs). The third memory bank is for RAM or ROM added to the board via the STD bus. Whether bought as a bare board, a full Kit, or assembled and tested, it comes with a 450NS2732A EPROM containing the monitor.
- **MULTIPLE DENSITY CONTROLLER FOR 5 1/4" FLOPPY DISKS:** The "Big Board II" computer has a multiple density disk controller; it can use 1793 or 8877 controller chips. The board has two connectors for disk signals with 34 pins for 5 1/4" drives, the other with 50 pins for 8" drives.
- **VASTLY IMPROVED CRT DISPLAY:** The "Big Board II" computer uses a 68455 CRT controller and 8002 Video Attributes controller to produce a display that will rival the display of quality terminals. Characters are formed by a 5 x 7 dot matrix on 15.75 KHz monitors and 8 7 x 9 dot matrix on 15.75 KHz monitors. The display is user programmable with the default display 24 lines of 80 characters.
- **STD BUS CONNECTOR:** "Big Board II" brings its bus signals to a convenient place on the PC board where users can solder a STD socket, bus cards can be plugged directly into it, and it can also be connected by bus cable to industry standard card cages.
- **A Z80 A 510/0 - TWO ASYNCHRONOUS/SYNCHRONOUS SERIAL PORTS.**
- **TWO Z80A CTCs = EIGHT PROGRAMMABLE COUNTERS/TIMERS:** The "Big Board II" has two Z80-A CTCs. One is used to clock data into and out of the Z80-A CTCs. One is used to clock data into and out of the Z80-A 510/0, while the other is for systems and application use.
- **PROM PROGRAMMING CIRCUITRY AND SOFTWARE:** The "Big Board" computer has circuitry and drivers for programming 2716s, 2732As, or pin-compatible (EPROMs) (Software \$25 extra).
- **CP/M CAPABILITY:** CP/M with Russel Smith's CBIOS for the "Big Board II" is available (plus tax) \$230. The CBIOS 5" or 8" is avail. separately (plus tax) \$85.

Cat. K41015 **NOW \$595**

(plus tax)

Assembled and Tested **\$849**

(plus tax)

Less 10% for 3 or more



## THE LITTLE BIG BOARD

### FEATURES:

- Z80-A CPU (4 MHz)
- 5536 bytes of RAM
- Two RS232C I/O ports
- Battery back up realtime clock and calendar.
- Up to four, 8 inch or 3 1/2 inch double sided, double density or single density floppy disk drives
- Full STD Bus
- Designed for CP/M, MP/M and CP/NET systems

Cat. (including tax) **\$459**



## 6809 "UNIBOARD" NEW SINGLE BOARD COMPUTER KIT!

Many software professionals feel that the 6809 features probably the most powerful instruction set available today on ANY 8 bit micro. Now, at last, all of that immense computing power is available at a truly unbelievably low price!

### CHECK THE FEATURES!!!

- 64K RAM using 4116 RAMs.
- 6809E Motorola CPU.
- Double Density Floppy Disk Controller for either 5 1/4 or 8 inch drives. Uses WD 1793.
- On board 80 x 24 video for a low cost console. Uses 2716 Char. Gen. Programmable Format. Uses 6845 CRT Controller.
- ASCII Keyboard parallel input interface. (6522)
- Serial I/O (6551) for RS232C or 20 MA loop.
- Centronics compatible parallel printer interface. (6522)
- Bus expansion interface with DMA Channel (6844).
- Dual timer for real clock application.
- Powerful on board system monitor (2732). Features commands such as Go To, Alter, Fill, Move, Display, or Test Memory. Also Read and Write Sectors, Boot Normal, Unknown, and General Flag.
- PC board is double sided, plated through solder masked, 11 x 11 1/2 inch.
- Includes the powerful 3rd generation Motorola 6809 Processor. Ideal for colleges, O.E.M.'s, industrial and scientific uses!

**BLACK PC BOARD WITH PAL'S AND TWO EPROMS..... \$199**

5 1/4 OR 8 INCH SOURCE DISKETTE ADD ..... \$25

plus tax

**COMPLETE KIT, FULLY SOCKETED, ALL OPTIONS ARE STANDARD, NO EXTRAS TO BUY ..... \$599**

including tax

Cat. Please allow 4 weeks for delivery.

**YOUR CHOICE OF POPULAR DISK OPERATING SYSTEMS:**

FLEX Im from TSC Cat. **\$259**

OS9 Im from Microwave Cat. **\$349**

(Please specify 5 1/4 or 8 inch)



## THE ORIGINAL BIG BOARD 1 COMPUTER KIT!

### FEATURING:

- **64K RAM:** Uses industry standard 4116 RAMs. All 64K is available to the user, our VIDEO and EPROM sections do not make holes in system RAM. Very special care was taken in the RAM array PC layout to eliminate potential noise and glitches.
- **Z80 CPU:** Running at 2.5 MHz. Handles all 4116 RAM refresh and supports Mode 2 INTERRUPTS. Fully buffered and runs 8080 software.
- **BASIC I/O:** Consists of separate parallel port (Z80 P10) for use with an ASCII encoded Keyboard for input. Output would be on the 80 x 24 Video Display.
- **24 x 80 CHARACTER VIDEO:** With a crisp, flicker-free display that looks extremely sharp even on small monitors. Hardware scroll and full cursor control. Composite video or split video and sync. Character set is supplied on a 2716 static ROM, making customized fonts easy. Sync pulses can be any desired length or polarity. Video may be inverted or true. 5 x 7 Matrix, upper and lower case.
- **FLOPPY DISK CONTROLLER:** Uses WD 1771 controller chip with a TTL Data Separator for enhanced reliability. IBM 3740 compatible. Supports up to four 8 inch disk drives. Directly compatible with standard Shugart drives such as the S8800 or S8801. Drives can be configured for remote AC off/on. Runs CP/M 2.2.
- **PFM 3.3 2K SYSTEM MONITOR:** The real power of the Big Board lies in its PFM 3.3 on board monitor. PFM commands include: Dump Memory, Boot CP/M, Copy Exam, Fill Memory, Test Memory, Go To, Read and Write I/O ports, Disk Read (Drive Track, Sector), and Search PFM occupies one of the four 2716 EPROM locations provided.
- **FULLY SOCKETED.**

Ideal for OEM, Industrial Business, Scientific, Colleges etc

Cat. K41001 including tax, **\$379**

### OPTIONS AVAILABLE:

- CP/M 2.2 FOR BIG BOARD **\$269**
- TWO PORT PARALLEL I/O **\$19**
- SERIAL I/O **\$35**
- REAL TIME CLOCK **\$15**
- DOUBLE DENSITY ADAPTOR BOARD **\$225**
- BIOS DISK **\$25**

Errors and Omissions Excepted



## MITSUBISHI DISK DRIVES

### M2896-63

Slimline 8" Disk Drive Double sided Density No AC Power required. 3ms track to track. 1.6 Mbytes unformatted, 77 track side 10<sup>10</sup> bit soft error rate.

Cat. C11916 **\$630**

Case & Power Supply to Suit

Cat. X11022 **\$109**

### M2894

Standard size 8" drive. Double Sided, Double Density, 3ms track to track access, 1.6 Mbytes unformatted, 77 track/side. 10<sup>10</sup> bit soft error rate.

Cat. C11914 **\$630**

Case & Power Supply to Suit

Cat. X11011 **\$79**

### M4854

Slimline 5 1/4" disk drive. Double sided, double density, 96 track/inch, 9621 bit/inch, 1.6 Mbyte unformatted, 3ms track to track access, 77 track/side.

Cat. 11904 **\$350**

Case & Power Supply to suit.

Cat. X11011 **\$79**

### M4853

Slimline 5 1/4" disk drive. Double sided, double density, 1 Mbyte unformatted, 3ms track to track, 80 track/side, 5923 bits/inch. Steel band drive system.

Cat. C11903 **\$260**

### M4851

Slimline 5 1/4" disk drive. Double sided, double density 500K unformatted, 40 track/side. Steel band drive system.

Cat. C11901 **\$225**

Case & Power Supply to suit.

Cat. X11011 **\$79**

### M4855

Slimline 5 1/4" disk drive, double sided, double density, 96 track/inch. 2.0 Mbytes unformatted, 3ms track to track access, 77 track/side.

Cat. C11905 **\$385**

### MF353

3 1/2" Standard size disk drive, Double sided, double density, 1 Mbyte unformatted.

Cat. C11923 **\$265**

### MF351

3 1/2" Standard size disk drive Single sided, double density, 500K unformatted.

Cat. C11921 **\$225**



## AVTEK MULTI MODEM

Down the street or across the world, MultiModem speaks the language.

- 300 baud full duplex, 1200 baud half duplex or 600 baud half duplex, answer or originate
- CCITT and Bell standards
- Plugs straight in (hardwired phone)
- Superior VLSI chip performance works reliably with -4dBm signal with S/N ratio of 6dB Error rate on this level is 10<sup>-5</sup>
- Telecom Approval C84/37/1135

Inc. phone, only **\$399**

★ ★ ★ ★ ★ ★ ★ ★  
We stock a full range of computer connectors!  
★ ★ ★ ★ ★ ★ ★ ★

Errors and Omissions Excepted

# rie

Rod Irving Electronics

425 HIGH STREET, NORTHCOTE VICTORIA. Ph: (03) 489 8866 489 8131  
48-50 A'BECKETT STREET, MELBOURNE VICTORIA. PH: (03) 347 9251  
Mail Order and correspondence: P.O. Box 235 NORTHCOTE 3070

**YOU WON'T GET BORED OVER THE HOLIDAYS WITH THESE GREAT SPECIALS!! GREAT 'IN STORE' BARGAINS TOO!**

Call in at either 2 of our conveniently located stores: **48-50 A'Beckett St., Melbourne Northcote.** Or take advantage of our Mail Order Department. Write to:



or phone ...

**MAIL ORDER HOT LINE**

**481 1436**



**POSTAGE RATES**

\$1-\$9.99	\$1.50
\$10-\$24.99	\$2.00
\$25-\$49.99	\$3.00
\$50-\$99.99	\$3.50
\$100-\$199	\$5.00
\$200-\$499	\$7.50
\$500 plus	\$10.00

# DREGS

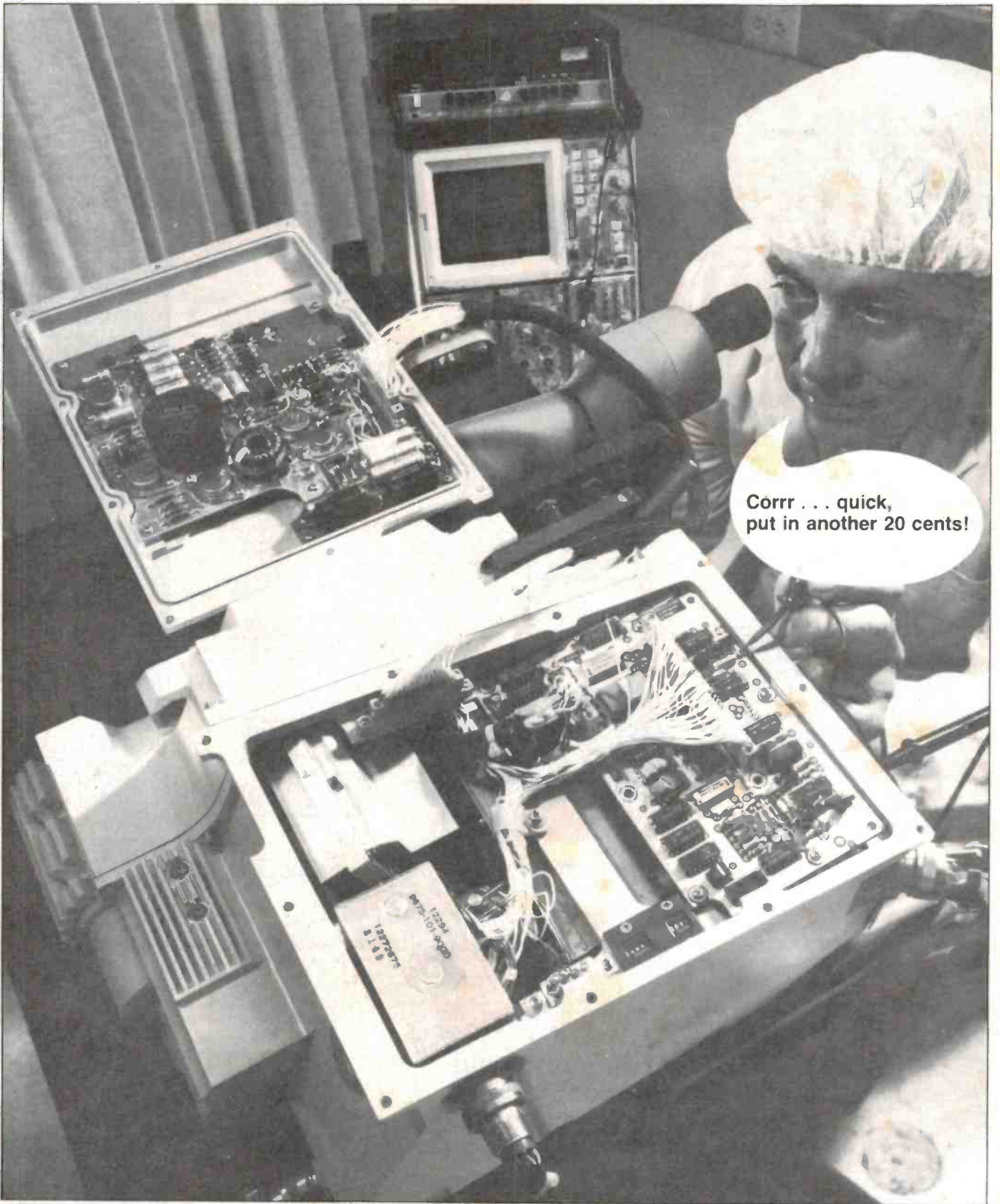

(Yes — the hacks who write dregs have taken a holiday . . .)

SONY

# DIGITAL DAWN.



The world is waking up to the ultimate sound experience that only digital perfection can deliver.

And Sony's ES Series are the top of the range digital components.

The CDP-501ES Compact Disc Player with multi-function cordless remote control, featuring volume control.

**SONY DIGITAL AUDIO DEALERS:**  
**BRISBANE,**  
Reg Mills Stereo 391 5606;  
**MACKAY,**  
Mackay Stereo Sales 57 7512;

The TA-F444ES integrated amplifier gives you the outstanding dynamic range of over 120dB and the channel separation of over 100dB (at 1KHZ) that digital audio demands.

The ST-S444ES FM stereo/AM tuner, the original direct comparator quartz frequency synthesis tuning for striking

**SYDNEY,**  
Bery's Radio 969 3830,  
Chatswood Colour TV 411 2090,  
Sydney Hi-Fi Centre 29 1082;  
**CANBERRA,**  
Kent Hi-Fi 82 2874;

S/N ratio of 88dB (stereo).

The TC-K555ES-MkII cassette deck, with three head laseramorphous record and playback heads plus closed loop dual capstan tape transport, assure the wide dynamic range and reduced modulation noise.

The SEQ-555ES programme equaliser automatically customises music to suit the

**MELBOURNE,**  
Beta Audio Video 509 6846,  
Encel Electronics 428 3761,  
Intercape Video Centre 63 3086;  
**ADELAIDE,**  
Grenfell Plaza Hi-Fi 51 5017;

room and the full function wireless remote commander adds convenience.

APM-55W speakers, (from the APM range), with flat square diaphragms for clean, powerful sound.

For the best in sound it has to be digital and it has to be the Sony ES series.

**PERTH,**  
Audio Equip 330 3397,  
Vince Ross Audio 321 2644.

ES

APM

COMPACT  
DISC  
DIGITAL AUDIO

It's a Sony

# The range of Hi-Fi equipment you thought was beyond your means is now within your grasp.

RECEIVERS

SEPARATE AMPS

CASSETTE DECKS

INTEGRATED AMPS  
TUNERS  
CASSETTE DECKS  
TURNTABLES  
RECEIVERS  
SEPARATE AMPS  
SPEAKERS  
CARTRIDGES  
HEADPHONES  
SYSTEM COMPONENTS

A Hundred Years of Musical Experience

YAMAHA  
HI-FI



Please send me the latest Yamaha Hi-Fi catalogue.

Name \_\_\_\_\_

Address \_\_\_\_\_

Postcode \_\_\_\_\_



Yamaha Hi-Fi Division, Rose Music Pty. Ltd.,  
17-33 Market St., South Melbourne, Victoria. 3205.

MCR/AM 3861 E/R