

COMPUTER COLUMNS: MicroBee, VIC-20, ZX.

Stereo
for AM radio?
\$2.35* NZ \$2.75



JUNE 1983

ELECTRONICS TODAY INTERNATIONAL

'SURE START'
*Ignition system for
model engines*

**NEW
SCANNERS' WORLD
COLUMN**



**Temperature adaptor
for your multimeter
Part 2,
40V/5 A Lab. supply**

**Using optocouplers
Programmer for
bipolar PROMs**

IF YOU'RE SWITCHED ON, THIS IS PARADISE.

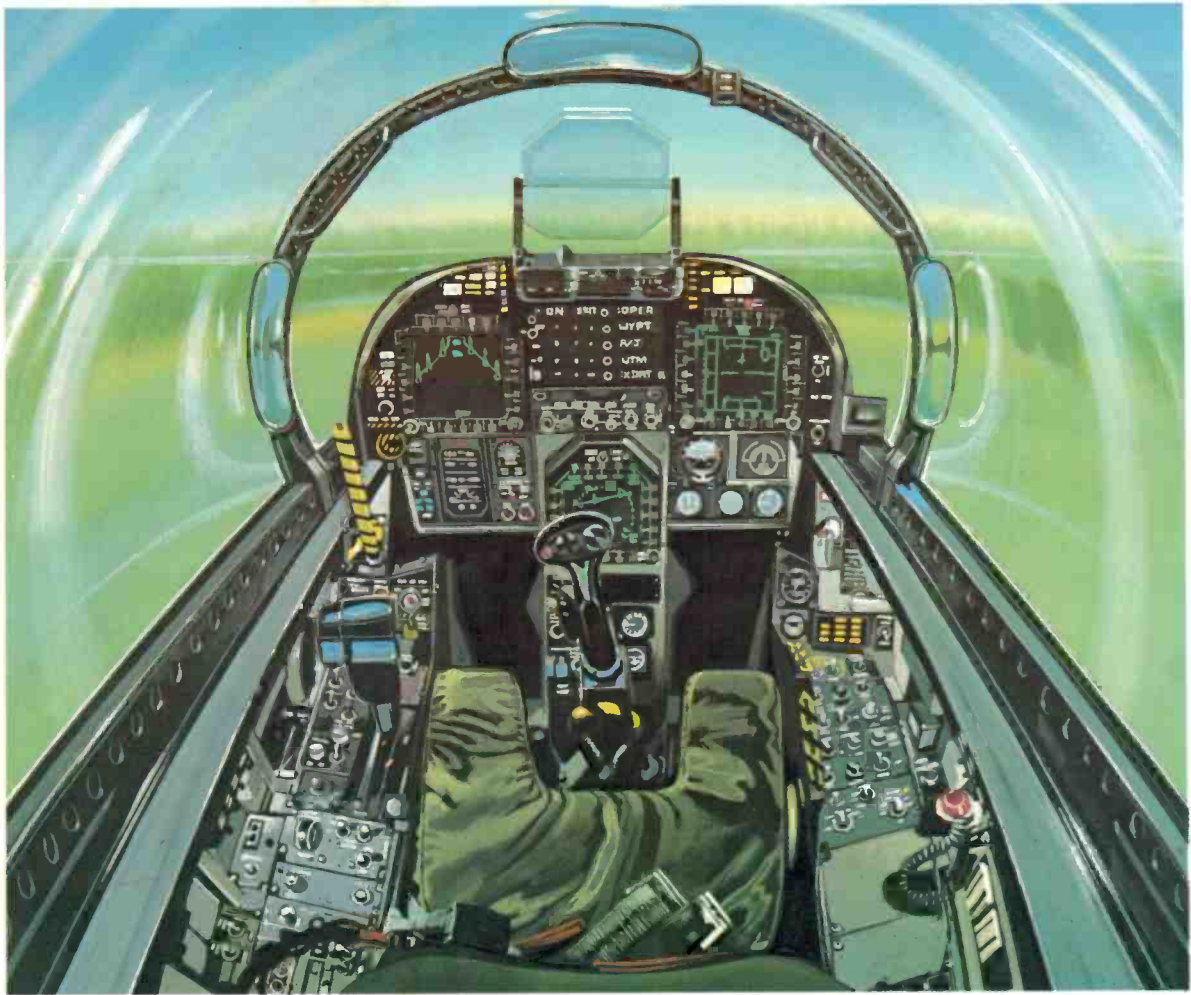

Australia's Hornet. The cockpit contains the latest in the world. Enough electronics to keep any switched on enthusiast happy for years. The Hornet will form the backbone of Australia's Air Force. You can form the backbone of the people who will keep it in the air. Simply phone your Air Force Careers Adviser on Sydney 212 1011, Newcastle 25476, Wollongong 286492, Parramatta 635 1511, Canberra 82 2333, Melbourne 61 3731, Geelong 21 1588, Brisbane 226 2626, Townsville 72 4566, Adelaide 212 1455, Perth 3256222, Hobart 34 7077, Launceston 31 1005.



RG14.FPC.92

JOIN AUSTRALIA'S AIR FORCE.

Authorised by Director General Recruiting Dept. Defence.



advertisers

Australia Government . . . IFC	
Applied Technology 18,	19,26,27
Ampec 33	
Altronics 68,76,77,90	91,100,101
All Electronic Components 83	
AED 50	
Audio Engineers 16	
Bertas 25	
Bright Star Crystals 41	
Continental Distillers 28	
Dick Smith 60,61	
Danish Hi-Fi 17	
Electronic Agencies 50	
Emona 38	
Emac 49	
George Brown 70,71	
Imark 110	
Jaycar 6,7,42,43,66,67,	99,105,106,107
K-Nar 55	
Lamron 52	
Microtrix 38	
Micro80 41	
Minitools 98	
Maurice Chapman 13	
McWilliams 34	
Nilsen Rowe 10,11	
Philips 96	
Pre-Pak 45	
Rose Music IBC	
RIFA 85	
Rod Irving 4,39,44,53	56,59,102,109
Software Source 29,31	
Scientific Devices 63	
Sony OBC	

features

- 12 **AM Radio to go Stereo?** It could happen quite quickly
- 92 **Using Optocoupler Devices** These handy devices have many uses
- 111 **Scanners' World** New column starts this month

projects and technical

- 46 **688: Programmer for Fusible-link Bipolar PROMs** Aah, blow it!
- 69 **1516: 'Sure Start' Model Engine Ignition System** Sure does!
- 78 **163: 40 V/5 A Laboratory Supply, Part 2** Construction and setup
- 86 **153: Temperature Adaptor for Multimeters** -55°C to +150°C
- 92 **Lab Notes: Using Optocoupler Devices** When isolation is necessary
- 103 **Ideas For Experimenters** Touch switches, CMOS safety, logic probe
- 112 **Shoparound** Where to buy kits, components, pc boards & panels for projects

computing today

- 23 **Personal Computer of the Year** It was NEC and DEC at the finish
- 35 **Graphics Driver for the ETI-640/685, Part 1** How to get 'real' graphics
- 46 **688: Bipolar PROM Programmer** Blow your own programmable logic array
- 51 **MicroBee Column** Name calling, ATAN below 0.1, character generator
- 54 **VIC-20 Column** Machine language graphics
- 57 **'660 Software** Block move editing, tank battle
- 58 **ZX Column** How to save memory writing programs for the 1K ZX81

sight & sound

- 12 **Stereo for AM Radio?** Rapid introduction is possible
- 20 **Tannoy 'Little Red' Monitors Reviewed** Intriguing two-way

news

- 8 **News Digest**
- 14 **Sight & Sound News**
- 24 **Printout**
- 62 **Equipment News**
- 64 **Component News**
- 108 **Communications News**
- 111 **Scanners' World**

contests and special offers

- 104 **Idea of the Month Contest**
Easy to enter — \$90 prize to win

general

- 110 **Subscriptions, Back Issues — order form**
- 121 **Mini-Mart**
- 113 **Mail Order Books**
- 122 **Dregs**

COMPUTER COLUMNS: MicroBee, VIC 20, ZX81

et*i* ELECTRONICS TODAY INTERNATIONAL

'SURE START'
Ignition system for model engines

NEW SCANNERS' WORLD COLUMN



Temperature adaptor for your multimeter Part 2. 40V/5A Lab. supply

Using optocouplers Programmer for bipolar PROMs

Get that old model 'plane out of the cupboard and fire it up with our 'Sure Start' model engine ignition system project. No more flick-flick-sputter, the motor just bursts into life!

Aeroplane model by Bob Taylor
Cover Design by Ali White

Cover design by Ali White.

eti

Editor

Roger Harrison VK2ZTB

Technical Editor

David Tilbrook VK2YMI

Assistant Editor

Jennifer Whyte B. App. Sc.

Editorial Staff

Geoff Nicholls B.Sc./B.E.

Jonathan Scott

B.Sc./B.E. (Hons) VK2YBN

Jan Vernon B.A.

Draughting

David Currie

Advertising Production

John Gerrie

Advertising Sales

Bob Taylor (Group Manager)

John Whalen (National)

Art Staff

Alli White B.A.

Bill Crump

Githa Pilbrow

Typesetting

Julie Hewlett

Reader Services

Jane Nicholls

Managing Editor

Collyn Rivers

Acoustical Consultants

Louis Challis & Associates

Editorial and Sales Office

140 Joynton Ave, Waterloo NSW 2017

Ph: (02)663-9999; Tlx FEDPUB AA74488

Melbourne: Virginia Salmon and Mel Godfrey,

150 Lonsdale St, Melbourne Vic. 3000.

Ph: 662-1222; Tlx AA34340.

Adelaide: Admedia Group, 24 Kensington Rd,

Rose Park SA 5067. Ph: 332-8144;

Tlx AA82182.

Brisbane: Geoff Home Agencies, 16 Bellbowrie

Centre, Bellbowrie Qld 4070. Ph: 202-6813.

Perth: C. Thomas, Adrep Advertising

WA 6000. Ph: 325-6395; Tlx ADREP PERTH.

New Zealand: Steve Edgar, Circulation

Marketing Manager, c/- Collector Publications,

Box 7118, Auckland. Ph: 546-380; Tlx Archcol

NZ 21217.

United Kingdom: Australian Consolidated

Press, Ludgate House, 107 Fleet St, London

EC4A 2AL. Ph: 353-1040; Tlx: 267163.

Japan: Genzo Uchida, Bancho Media

Services, 15 Sanyocho, Shinjuku-Ku, Tokyo

160. Ph: 359-8866; Cable: Elbanchorito;

Tlx: BMSINC J25472 Tokyo.

USA: Australian Consolidated Press, 21 East

40th Street, (Floor 23), New York NY 10016.

Phone: (212)685-9570.

Electronics Today International is published

by The Federal Publishing Company Proprietary

Limited, 140 Joynton Avenue, Waterloo NSW

2017. (02)663-9999. Telex AA74488

'FEDPUB'. This issue was printed by ESN,

The Litho Centre of 140 Joynton Avenue,

Waterloo NSW 2017. (02)662-8888. Distributed

by Network Distribution Company.

* Recommended retail price only

comment



ARTWORK

The announcement last month that film positives or negatives will be available led some readers to conclude that we were no longer going to publish artwork for the projects. This is *only an additional service*. I'd like to make it *perfectly clear* that printed circuit board artwork will be published with the projects in the magazine, except where space restrictions or the size of a board won't allow it.

In such cases, a print will *always* be available, free of charge, simply by requesting it. It was unfortunate that, last month, space restrictions prevented us from publishing the artwork, except for the ETI-734 Phony Patch, where copyright has been retained by Dick Smith Electronics but pc boards are readily available from that organisation.

So, as you can see from this issue, we will continue to publish printed circuit, front panel and meter scale artwork where possible. Where artwork has not been published, prints will *always* be available on request and film positives or negatives will also be available for a nominal sum for those that require them.



Roger Harrison
Roger Harrison
Editor

services

Technical enquiries: We can only answer readers' technical enquiries by telephone after 4.30 pm Mondays to Thursdays. The technical enquiry number is (02)662-4267. Technical enquiries by mail must be accompanied by a stamped, self-addressed envelope. There is no charge. We can only answer queries relating to projects and articles as published. We cannot advise on modifications, other than errata or addenda. We try to answer letters as soon as possible. Difficult questions may take some time to answer.

General enquiries: For enquiries about back issues, photostats of articles, artwork or submitting articles, call (02)663-9999 or write to the address on this page.

The publisher accepts no responsibility for unsolicited manuscripts, illustrations or photographic material.

COPYRIGHT: The contents of Electronics Today International and associated publications is fully protected by the Commonwealth Copyright Act (1968).

Copyright extends to all written material, photographs, drawings, circuit diagrams and printed circuit boards. Although any form of reproduction is a breach of copyright, we are not concerned about individuals constructing projects for their own private use, nor by pop groups (for example) constructing one or more items for use in connection with their performances.

Commercial organisations should note that no project or part project described in Electronics Today International or associated publications may be offered for sale, or sold in substantially or fully assembled form, unless a licence has been specifically obtained so to do from the publishers, The Federal Publishing Company, or from the copyright holders.

LIABILITY: Comments and test results on equipment reviewed refer to the particular item submitted for review and may not necessarily pertain to other units of the same make or model number. Whilst every effort has been made to ensure that all constructional projects referred to in this edition will operate as indicated efficiently and properly and that all necessary components to manufacture the same will be available no responsibility is accepted in respect of the failure for any reason at all of the project to operate effectively or at all whether due to any fault in design or otherwise and no responsibility is accepted for the failure to obtain any components parts in respect of any such project. Further, no responsibility is accepted in respect of any injury or damage caused by any fault in the design of any such project as aforesaid. The Publisher accepts no responsibility for unsolicited manuscripts, illustrations or photographic material.

next month

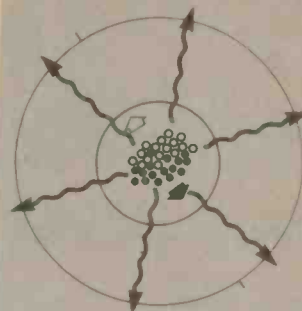

MAGNETIC MONOPOLES MYSTERY

Single north and south magnetic monopoles are predicted to exist, but haven't yet been found. Could this be because of their expected properties: massive, slow-moving and rare? Jennifer Whyte discusses these fascinating objects and the hunt to find them.

GENERAL PURPOSE IC AUDIO AMP. MODULE

A dead-simple, low cost, build-in-one-hour audio amplifier module capable of 4 W output. It can run off any supply from 3 V to 18 Vdc. It employs the popular uA380/LM380 audio power amp IC and can be used for an intercom, a 'baby minder', crystal set amplifier — in fact, a whole host of audio applications.

LOUDHAILER

A perfect application for the above project! Now you can make yourself heard at the Sunday School picnic, family barbecue, political rally, or whatever! Make yourself heard at 100 metres without shouting.

1 HZ to 1 MHZ FUNCTION AND PULSE GENERATOR

The ETI-163 was the first in a series of 'laboratory standard' test equipment we're developing here at ETI. This function-pulse generator is next in line. Featuring a coverage from 1 Hz to 1 MHz in overlapping decade ranges, it has outputs of sine/square/triangle/sawtooth/pulse and includes sweep capability and digital frequency readout. A companion sweep generator is to follow. The pulse output features adjustable on and off periods.

DANISH JAMO CBR 1703 SPEAKERS REVIEWED

These intriguing loudspeakers from Danish manufacturer, Jamo, have only recently been introduced to the Australian hi-fi market. Louis Challis says they are generally well-designed and offer performance "... bordering on the superlative". They are not afraid to handle power levels which would quickly destroy lesser speakers, so seem well suited to the rapidly encroaching 'digital age'.

Although these articles are in an advanced state of preparation, circumstances may affect the final content. However, we will make every attempt to include all features mentioned here.

LOW COST EQUIPMENT

low cost hi fi

3-WAY SYSTEM
\$24.95 a set
2 SETS (6 SPKR)
FOR STEREO
ONLY \$39.95



That's right a 3-WAY HI FI speaker kit from only \$19.98!! Each kit contains a massive 10" (250mm) woofer, cone midrange and DOME tweeter!! You also get, at no extra charge, the special cross-over capacitors!
The system is rated at approximately 20 watts RMS so it is ideal as an economical but reasonably powerful main HI FI unit or as a second system for another room or outdoors.
Each 3-way kit comes with a recommended enclosure design which you can build yourself easily!
You would normally pay well over \$60 for the equivalent from major kit speaker suppliers so this is an outstanding bargain. Sensitivity of system 93dB/1m/1 watt. Cat. AK3700
HURRY LIMITED STOCKS and they are made in JAPAN!!

Woofer not to same scale as other components

FROM ONLY
\$19.98

28 PIN IC SOCKETS FROM ONLY 15 CENTS!!
SAVE A FORTUNE

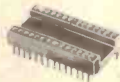

YOU MUST BUY THESE FROM US!! WE DARE YOU TO FIND THEM FOR LESS!! Buy in bulk and save!! NORMALLY 60c & 55c 10+ NOW 30cents each 10 up 20cents each 100 quantities!! 15cents each 1000 up Quality US-made Robinson-Nugent Cat. PI6507 All prices include sales tax!!

1N914 DIODES - INCREDIBLE SAVINGS

The 1N914 (or 1N4148 if you like) is probably the most popular diode in the history of electronics. We probably use over 1,000,000 a year ourselves!! We have made a bulk scoop purchase and for JUNE ONLY we can pass them on at great savings!

Because they are so low in price anyway, we must sell in minimum lots of 500.

Cat. No.	Description*	500	1,000	10,000
ZR1100	1N914/1N4148	0.035	0.028	0.02

Prices INCLUDE sales tax!!

* The glass envelope is really too small to have markings, however some are branded. We reserve the right to supply units that are the same size as the 1N914/1N4148 but are electrically superior.



Fully Guaranteed **\$12.50**
INTRIGUING ~~\$36.50~~

For years and years 240V mains powered strobes have been selling for between \$30 and \$40. Even kits are around \$36. So why is it that Jaycar can sell a 240V strobe - guaranteed - for \$12.50? We can tell you for a start that we're not selling them below cost. Even at \$12.50 we're doing OK.

Why so cheap? Well they were made for a well known electronics chain. Their Q.C. (Quality Control) Department rejected them on the grounds that around 5% of them were faulty. That was an unacceptable figure considering the very good name that the chain has in this country. All goods were rejected (even the 95% good ones) and sent back to the importer.

The importer came to us with his problem. We said that we would sell them PROVIDED we could offer a 90 day guarantee on the item. Whilst all stock has been checked and the duds weeded out we STILL feel that even at \$12.50 you deserve a comeback if we sell you faulty goods. So that's it. You get a 240V strobe that is perfectly OK for \$12.50. Compare THAT with the \$36.50 that you will pay elsewhere. It's almost too good to be true except for one thing. It's true. FULL 90 DAY WARRANTY - Cat. XM7005

NEW CODEMASTER*



~~\$9.95!~~ ONLY ~~\$12.50~~

Many of you know the clever parlour game that uses coloured tokens to stretch the brain to work out a hidden code in a minimum number of moves.

The people that came up with the game used a descriptive name which no-one else can use. It is a popular game and is well known under this name. Our game is similar to this game but - naturally - its electronic!! And, what's more, you can play against the machine - alone. Each XM7015 Codemaster measures 140(l)x85(w)x25(d) looks similar to a pocket calculator and runs off a standard 9V cell. Provision is made for a mains adaptor as well.

The Codemaster once sold for \$29.50 but Jaycar has made a huge scoop purchase. You save a fortune!

Grab one now for only \$12.50!! ~~\$9.95~~
* (For a further clue to the origin of this game read this page carefully)



ONLY \$3.95

THE catalogue of Motorola Semiconductor's products.

Over 330 pages of specifications, drawings, data and other information on:

- MOS devices, including CMOS, Memory and CPU.
- Bipolar, including Linear, Memory, Logic (SSI) etc.
- Power, including Rectifiers, SCR's, Triacs & power transistors.
- RF, small signal & Opto.
- Solar power systems.

This valuable reference book also contains a comprehensive index at the back! At \$9.95 this book would be great value. But not it's yours for only \$3.95!! Book measures 210x280x15 (336 pages) Cat. BM4250

JAYCAR FOR VALUE!

NEW! MICRO CHARTS

Instant Data on the Most Popular Computer and Microprocessor Parts

- Fully decoded data — no need to unscramble numbers
- Instant Access
- Compact 8 1/2" x 11" size
- Durable credit card plastic — lasts a lifetime
- Perfect for programmers and engineers — two-sided and totally comprehensive
- Clear and concise tables for full instruction set, dis assembly, ASCII, base conversion, effect of flags, com pare vs jump, interrupt structure, prout, cycle times, diagrams, bug notes, and much more

Cat. BM8500 Z80 CPU
Cat. BM8501 8080A/8085A
Cat. BM8502 6502(65XX)

NOW ONLY \$9.95 SAVE \$3.00!!

B R I L L I A N T New range of Super-Bright LEDs! Due to the incredible demand for our 200mCd super-bright LED, we have increased the range available. Now you can get super-bright in green & yellow as well as a new massively powerful 500mCd red! This new red LED will give you 500mCd @ 20mA or -wait for it- ONE CANDELA of light at 40mA! Remember, a typical 15 cent 5mm red LED gives only 1.8mCd at 20mA, the difference is staggering!

Cat No.	Description	1-9	10+
ZD1790	200mCd SB Red LED	\$.69	\$.62
ZD1792	500mCd SB Red LED	\$2.95	\$2.50
ZD1794	80mCd SB Green LED	\$.95	\$.85
ZD1795	160mCd SB Yellow LED	\$.95	\$.85



LIQUID CRYSTAL DISPLAY

AMAZING LOW PRICE!

ONLY \$2.95 each
\$2.50 each 10+

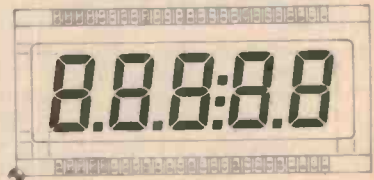

We have done it again! Once again Jaycar has secured a quantity of valuable LCD displays. Once again we are passing them on to you at prices that will make our competition green with envy!

Basically we have a 5 digit x 18mm high (that's BIG) LCD display. But there is a snag, and here is where you save. Normally this display would sell for around \$20 — if it had the connecting pins bonded to the glass substrate. But this display just has the metalization on the glass substrate. Too hard to connect you say? No, not at all!!!

We have discovered that a humble Molex pin is JUST PERFECT as a connector! You slip the Molex pin on to the edge and superglue it in place. You then have a permanent connection, a great LCD display and have saved a fortune to boot! (Instructions for fitting the Molex pins as well as FULL DATA and connection diagrams on the LCD are supplied).

And what do you pay for this LCD display? ONLY \$2.95 each or \$2.50 each 10 up. Staggering value. Cat. ZM9015
Pack of 50 Molex pins (only 42 required) Cat. PI6540 Only \$1.00

★ AM/FM STEREO CAR CASSETTE ★

Unbelievably low price! (Pre Budget tax) That's right! An AM/FM Stereo Radio and Cassette!

- Features:
- * 2 x 7 watts * One lever operation (fast forward and eject) * Tape run indicator * FM Stereo indicator * Auto stop * Adjustable pitch controls * Mounting hardware included.



STAGGERING VALUE ONLY **\$69.50**

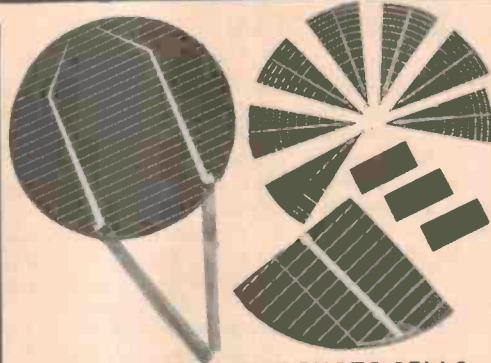

LOW COST SILICON PHOTO CELLS

We now stock a COMPLETE range of high efficiency Silicon Solar Cells. All cells give 0.45V under rated load and they can be stacked in series or in parallel for higher current.

Cat. No	Description	1-9	10+
ZM9002	Rect. 10x20mm 45mA	\$2.95	\$2.45
ZM9003	3" diameter 1 amp	\$29.50	\$26.50
ZM9004	3" diameter x 30° segment 78mA	\$3.50	\$3.25
ZM9005	4" diameter x 1/4 segment 450mA	\$12.95	\$12.45

Are the "rabbit ear" antennas on the back of your portable TV broken? You know those ones that are telescopic and have ball-swivel joints.

We have genuine 'HMV' factory spares that will fit other TV's. Apparently they are almost industry-standard components. Each unit comes with a short length of lug-terminated 300 ohm ribbon.

We have a small job lot available at only \$7.95 each.

ONLY 220 SETS AVAILABLE.

Cat. AA2005

\$7.95

WHAT'S UP DOC?

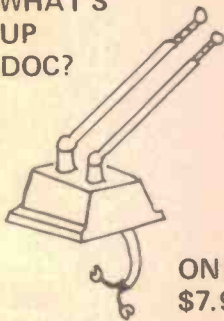

ONLY \$7.95

COMPUTER TRANSFORMER

ONLY \$24.50
SAVE \$5.00
WAS \$29.50

We have secured a quantity of a power transformer at a never-to-be repeated price. This transformer is ideal as the basis of an S-100 power supply, but can be used for many other computer or general power supplies.

SPECS: Primary 240V AC — Secondary 1: 15VAC 2 amp — Secondary 2: 15VAC 2 amp — Secondary 3: 8VAC 8 amp.

A typical DC supply could be ±15VDC @ 1.5A & 5VDC @ 8A or ±12VDC @ 2A & 5VDC @ 8A.

This transformer would normally sell for around \$50

Brand new stock.

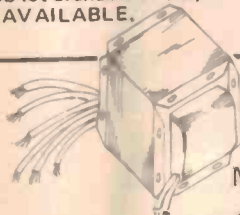

Clue

M-S T-RM-N-D

TRANSISTOR BARGAIN

3 AMP HIGH SPEED TO-5 POWER TRANSISTOR
TYPE 2SC 799
NORMALLY \$1.95 each
NOW 75 cents each OR \$5 for 10!

Has exclusive slide-on flange to convert to chassis mount for greater power dissipation!

SPECS: NPN Silicon — Vce 40V — Vcb 80V — Veb 5V — Ic 3A — hFE 50-90 — Ft 150MHz. Cat. ZT2600



Jaycar NUMBER 1 FOR KITS

SYDNEY SHOWROOM

125 YORK STREET PHONE: (02) 264 6688
TELEX: 72293

CARLINGFORD SHOWROOM

Cnr. CARLINGFORD & PENNANT HILLS ROAD
PHONE: (02) 872 4444

MAIL ORDERS & CORRESPONDENCE

BOX K 39 HAYMARKET, SYDNEY 2000

POST AND PACKING CHARGES

\$5 — \$9.99 (\$1.50) \$10 — \$24.99 (\$3.70)

\$25 — \$49.99 (\$4.50) \$50 — \$99.99 (\$6.50)

\$100 or more (\$8.00)

SHOP HOURS CARLINGFORD

Mon — Fri 9am — 5.30pm; Sat 9am — 12pm; Thurs night 8.30pm

SHOP HOURS SYDNEY

Mon — Fri 8.30am — 5.30pm; Sat — 8.30am — 12pm; Thurs night 8.30pm



Mail Order By

BANKCARD

Via Your Phone

New Government policies for communications and electronics industries

The new Federal Labor Government's policy on communications, electronics and high technology promises to benefit the industry in the short term, through the maintenance of tariff assistance, and in the long term through higher research and development grants, says the Australian Electronics Industry Association (AEIA).

The ALP policy platform, as outlined by the Prime Minister, Mr Hawke, specifically states that the Government "will continue as a major supporter of the Australian electronics industry" and that "Telecom's Buy Australian policy will be maintained".

The Government said it will rebuild Australia's manufacturing base with no reduction of existing protection levels until the current economic crisis is overcome.

However, the AEIA is not completely satisfied with the ALP policy of no general reductions in tariff protection during the current period of high unemployment. It believes that it would be more encouraging if the Government ruled that tariff reviews be abolished for the next 12 months.

The AEIA has asked the Federal Government to postpone an inquiry into the review of tariffs until the economic recovery is complete.

The Government has also promised to immediately review the need for additional short term aid to selected industries until steady growth is restored.

Funding for the Australian Research Grants Scheme will increase significantly, said Mr Barry Jones, the new Minister for Science and Technology. This funding would be increased by 10% more than the rate of inflation, for the next three years.

In an effort to 'catch up' with other industrialised countries, the Hawke Government will select and support the establishment of new intermediate and high technology industries in which Australia has special skills and opportunities.

These pledges have been welcomed by the AEIA which

represents major manufacturers of telecommunications and electronics equipment. Some sections of these industries have recently been under increasing pressure from challenges of low-priced imported products.

The Government plans to give specific support to 16 key areas of high technology and will also provide much-needed venture capital.

'Sunrise' industries so far singled out by Mr Jones for special attention are: communications, biotechnology (in nine areas), scientific instrumentation, solar energy, fusion energy, personal computers, computer software, custom-made chips, lasers, medical technology, hydrogen generation, intermediate technology products, industrial ceramics and biomass.

The AEIA stated that it hopes the Minister's description of so-called 'sunrise' industries includes the well established sectors of high technology in electronics and communications.

Mr Ed Hodgkinson, executive director of AEIA, said, "We already have a strong and rapidly-accelerating manufacturing sector in the communications and electronics industry".

In 1982 the Australian Communications and Electronics Industry represented a \$660 million investment in assets and a \$1030 million sales turnover.

"Support for this industry," said Mr Hodgkinson, "is just as important as for new emerging industries."

Research is currently being conducted into developing manufacturing techniques for ultra-sophisticated semiconducting devices for the Australian electronics industry.

This research will be further boosted by CSIRO scientists as

the CSIRO Division of Mineral Physics is installing a Heavy Ion Analytical Facility (HIAF) at its laboratories in North Ryde NSW. This is for research into mineral, energy and geological-related investigations and is scheduled for commissioning this September.

This facility is based on a \$1.2 million Tandetron accelerator, imported from the US, and will be particularly useful for the electronics industry in the research stage and in trouble-shooting.

The 2.25 MV electrostatic tandem accelerator can deliver

virtually all species of ion beams at relatively high currents and at millions of electron volts, making it useful as a manufacturing tool as well as a diagnostic or analytical instrument.

This research is important because if Australia wants to develop its high-technology industry it will need to keep abreast of the fast-moving field of semiconductor technology.

In the next decade, the expertise provided by HIAF is expected to flow on to the manufacturing sector.

Wrist-watch radio

The Ferranti ZN414 device was widely used in miniature trf radio receivers in its circular metal encapsulation, but is now available in the cheaper TO-92 plastic package.

One of the first applications of

the device in this new package is a wrist-watch radio. The device is used with only six external components to form a medium waveband AM tuner operating from a single cell with low power consumption.

The plastic packaged version is designated as the ZN414Z device.

B. Dance



Philips post graduate scholarships 1984

Applications are now invited for places in a Masters Degree of Electronic Engineering from Philips International Institute.

Since its foundation in 1957 the Institute has offered facilities for study and practical training to promising young graduate engineers and scientists.

Most of the 30 available places annually are reserved for nationals of developing countries, but a few are awarded each year to students from more industrialised countries and a number of Australian students have been successful in the past.

The Netherlands Universities Foundation for International Co-operation accepts responsibility for awarding Masters Degrees to PII students who successfully complete a three semester degree programme (17 months). A Philips International Institute Diploma is awarded to each student who satisfactorily completes the normal study period of one year.

Qualifications needed by applicants include a university degree in a field of study related to electronics and its engineering

principles indicating a high level of academic achievement. A good working knowledge of spoken and written English, which is the teaching language, is necessary. Both men and women are eligible, and most awards are made to candidates under 30.

Financial support, including air fares and living allowance, is paid and other assistance is provided.

Completed applications for the 1984 year must be evaluated before the middle of August 1983. Application before July 8 is necessary and lodgement before August 1 so that interviews can be completed before August 13. Application forms and full information can be obtained by writing to Mr Ian Anstey, Philips Industries Holdings Ltd, PO Box 1138, North Sydney NSW 2060.



The talking book

Books for children which actually talk as the child scans a bar code with a hand-held probe, have been introduced by Texas Instruments.

The books are hailed as learning aids which help children to read by actually talking to them as they themselves read the story from the letters printed above

the same part of the bar code.

The bar code reader is coupled to speech synthesis microchips which produce the signals fed to the loudspeaker. Questions are asked and answered by the bar code system. Sound effects and even simple tunes are incorporated in the bar codes of these colourful books.

Other features of the books are puzzles with multiple choice answers, simple spelling tests and games.

B. Dance

Solder sucking sponges

C & K Electronics has been appointed Australian distributor for Elvo Electronics of Switzerland.

Elvo manufactures a soldering iron tip cleaning instrument under the name 'Clean-O-Point'. This unit uses motor driven sponge viscose rollers to provide

perfect tip cleaning every time, claim C & K Electronics.

They also state that the unit cleans tips in one second, collects the excess solder which can be recycled and increases the tip life.

For more detail contact C & K Electronics (Aust) Pty Ltd, 15 Cowper St, Parramatta NSW 2150. (02)635-0799.

April 29, 1983

The Editor,
Electronics Today International.

Re: Power Supply Project — ETI-163

Dear Sir,

Over the years, I have noticed that you use many 'brand' name transformers in your projects and, in particular, I note the use of the 'Ferguson' transformer type number PF4673 for the above kit.

This transformer was designed to the relevant clauses of AS3126, 'Approval and Test Specifications for Extra Low Voltage Transformers'.

I realise that many of the kit sets on the market today include wound components made by the small 'one man band' manufacturers.

While such transformers may be well made, these organisations rarely, if ever, submit products to statutory authorities for approval nor do they have the professional backing of the larger, recognised organisations. The cost of submissions are generally in excess of \$500.00, which is beyond the financial limits of the small company.

It is my considered opinion that the interests of your readers would be best served by ensuring that the kit sets they purchase include the components listed by you and not low cost substitutes.

This particularly applies to the transformer which is the component that isolates the rather lethal 240 volt mains from the rest of the circuitry. Obviously, the transformer is not the only factor in determining the safety of the finished project, but its significance should not be overlooked for the saving of a few dollars.

Yours faithfully,
FERGUSON TRANSFORMERS PTY LTD

JOHN RICHARDS,
Chief Engineer.



NOTES & ERRATA

Project 653, 16 Channel computer output driver, November '82: The address line inputs are connected to CMOS gates. This means that the address lines from the computer should be buffered with CMOS drivers to ensure that the high level voltage is above the switching threshold.

However, if a TTL driver is used, such as a 74LS374 etc, pull-up resistors should be used to raise V_{OH} to the CMOS specification. A pull-up of about 220 ohms is sufficient.

The resistors may be conveniently mounted between IC4 and the DIL input socket on the component side of the pc board. There are five feed-through links in a diagonal pattern between IC4 and the input socket. Remove these and install the five resistors, bending them towards the copper area at the bottom of the board. Solder the resistors leads through the feedthrough link holes on both sides of the board and solder the other ends to the copper area (+5 V rail). Murphy — go suck eggs!

The price

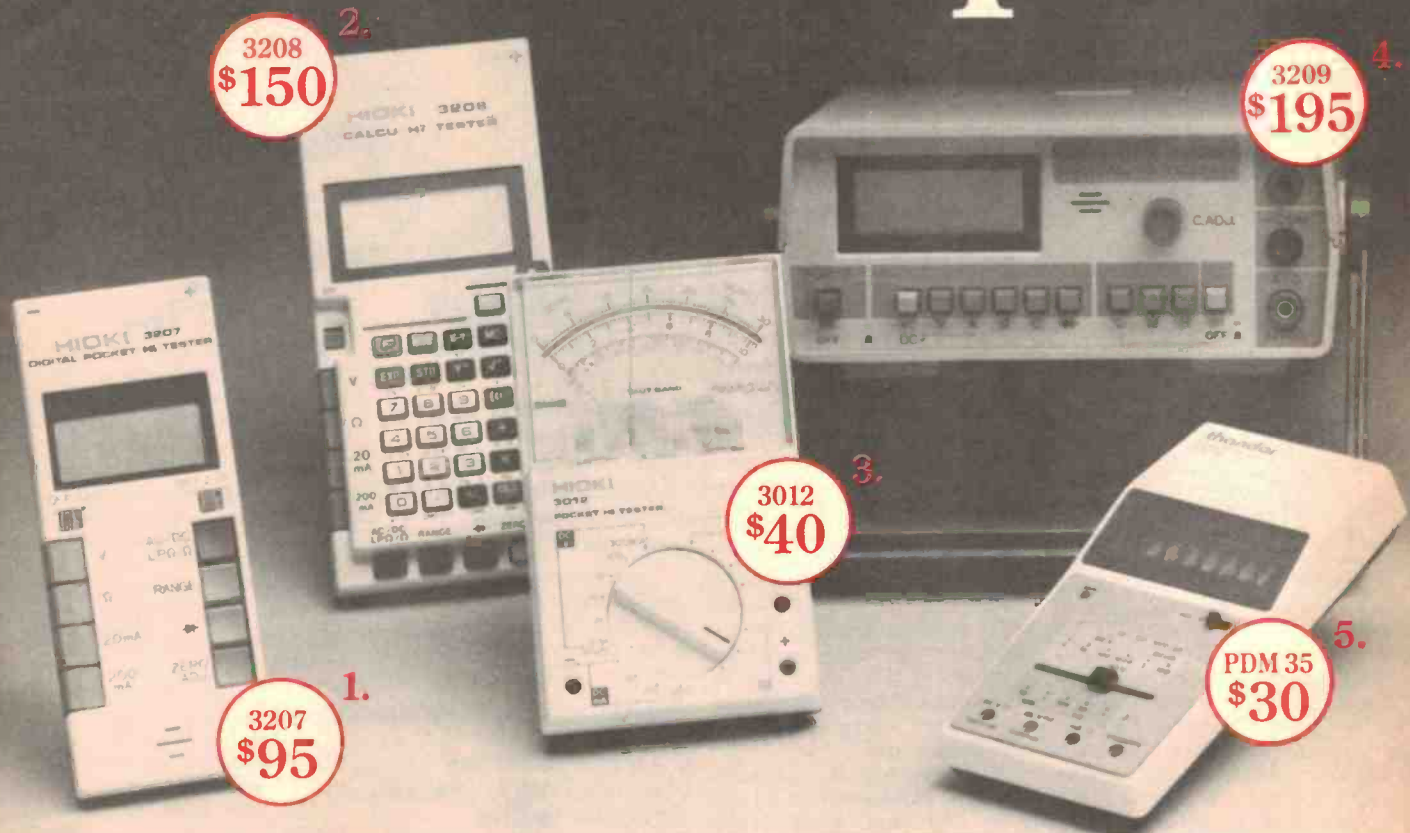

3208
\$150

3209
\$195

3012
\$40

3207
\$95

PDM 35
\$30

- 1 HIOKI: 3207: Light, ultra-thin, full auto-ranging.** Slim as a pocket book with enormous capacity and accuracy.
- 3½ DIGITS L.C.D. (1999).
 - Input impedance AC/DC 10MΩ with 100μV sensitivity on 200mV range.
 - Low power ohms for in-circuit resistance measurement.
 - Continuity test alarm.
 - Diode check facility.
 - DC V: 200mV to 1000V.
 - AC-DC A: 20mA to 200mA.
 - Low power ohms: 0.2KΩ to 2000KΩ.
 - Battery included.
- 2 HIOKI: 3208: Combination scientific function Calculator/Digital Multimeter.**

- One handed one key operation to give fast accurate answers. D.M.M. and Calculator have separate displays.
- Full scientific calculator with Separate Entry/ Function keys.
- 3½ DIGITS L.C.D. (1999) D.M.M.
- D.M.M. readings can be transferred to calculator by single key touch.
- Alarm indicates over range and incorrect function selection.
- Ranges as multimeter 3207.
- Battery included.

- 3 HIOKI: 3012: Slim pocket-sized Drop-Proof Multimeter.** Accurate, rugged multimeter with very simple, easy to read scale.
- Only 22mm thick.
 - Up to 20KΩ/V Sensitivity.

- DC V: 0.3-3-10-30-100-300-1000V.
- AC V: 10-30-100-300-1000V.
- DC A: (50μA)-1mA-3mA-30mA-300mA.
- OHMS: 10K-100K-1MΩ (mid scale 100Ω).
- Dry battery included.

- 4 HIOKI: 3209: Lightweight, portable, digital Hi-Tester.** Has advanced features that save time, ensure accuracy.
- 3½ DIGITS L.C.D. (1999).
 - Superior accuracy.
 - Measures capacitance 0.001nF-20μF.
 - Input impedance: 1000MΩ (200/2000mV DC) & 10MΩ 20/1000V DC.
 - B.C.D. Output allows use with a digital printer.
 - Checks continuity.

- Wide range of accessories.
- DC V: 10mV to 1000V.
- AC V: 200 mV to 1000V.
- OHMS: 200 ohms to 20 Megohms. Full scale.
- DC A: 200μA to 2A.
- AC A: 200μA to 2A.
- Capacitance: 2nf to 20μF.
- Dry batteries included.

- 5 THANDAR: PDM 35: Neatly packaged D.M.M. in rugged pocket-size case.** This accurate hand held digital multimeter compares in cost to an analog meter but without interpretation and parallax errors - and delicate movements.
- 3½ digit resolution.
 - Automatic polarity selection.
 - Resolution of 1mV and 0.1mA.
 - Resistance measurement to 20MΩ.

Nilsen Rowe is having a sale!

The Multimeter sale includes famous makes and models at prices you won't find again. Prices that range from \$10-\$195. And they'll stay that way until stock runs out.

This is a once only offer from Nilsen Rowe. Use the handy order coupon for convenient shopping by mail, or come to your nearest Nilsen Rowe Office. Payment via Bankcard, Cheque or Postal Note.

As a customer you can use the mail order coupon using Bankcard or personal cheque.

There couldn't be a better time to buy. The products are great and the price is right.

N.S.W.: 18 Newton St., Alexandria. 2015. P.O. Box 139, Alexandria. 2015. Phone: (02) 519 1422, Telex: AA20433. Qld: 8 Allison St., Mayne. 4006. P.O. Box 682, & Allen Sts., South Townsville. 4810. Phone: (077) 71 3448. Telex: AA41592. S.A.: 100 Regency Rd., Ferryden Park. 5010. P.O. Box 111, Kilkenny. 5009.

is right.

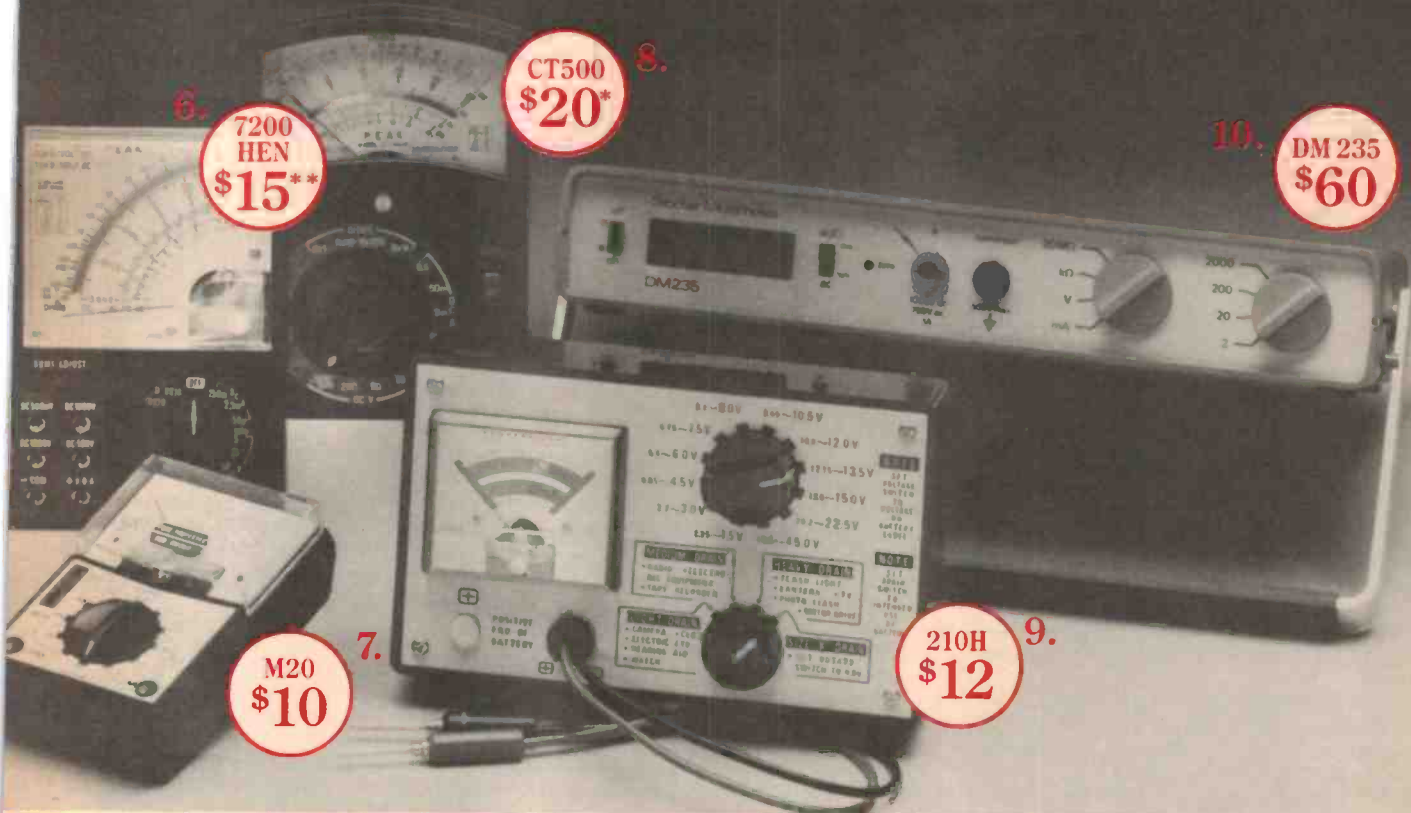

6. **7200 HEN**
\$15**

8. **CT500**
\$20*

10. **DM 235**
\$60

7. **M20**
\$10

9. **210H**
\$12

- 1% of reading accuracy.
- Can operate from standard AC to 9V adaptor.
- Made in England by Sinclair Electronics Ltd.
- Price includes dry battery (9V).

6 PEAK: 7200HEN: Modern quadrant scale Multimeter combines compact size with wide ranges. High sensitivity, well designed multimeter has robust, diode protected, movement with mirror scale.

- DC V: 0.5-5-25-125-250-500-1000V.
- AC V: 10-50-250-500-1000V.
- DC A: 50 μ A-2.5mA-250mA.
- Resistance: 6K-600K-6M Ω .
- Decibel: -20 to +22db.
- Carry case available.
- Dry battery included.

****\$18 with case.**

7 PEAK: M20: Small rugged Multimeter ideal for hobbyist. Features fuse protected ohms circuit, colour coded meter scale and front panel.

- AC V: 10-50-250-500V.
- DC V: 10-50-250-500V.
- DC A: 250mA.
- Resistance: 5K-50K-500K Ω .
- Dry battery included.

8 PEAK: CT500: Of intermediate size, this popular Multimeter combines high accuracy with 24 range versatility. Has mirror scale for accurate reading, diode protected movement; and 20K Ω /V sensitivity on DC.

- DC V: 2.5-10-50-250-500-5000V.
- AC V: 10-50-250-500-1000V.
- DC A: 50 μ A-5mA-50mA-500mA.

- Resistance: 12K-120K-1.2M-12M Ω .
 - Decibel: -20 to +62db.
 - Carry case available.
 - Dry battery included.
- *\$26 with case.**

9 PEAK: 210H: Versatile general purpose battery tester. All purpose professional battery tester for work bench and store use. Provides four-drain switch - LIGHT, MEDIUM, HEAVY and SIZE K, in addition to 12 Cell voltage ranges.

- | | |
|--------------|-----------------|
| 1 1.35-1.5V. | 7 9.45-10.5V. |
| 2 2.70-3.0V. | 8 10.80-12.0V. |
| 3 4.05-4.5V. | 9 12.15-13.5V. |
| 4 5.40-6.0V. | 10 13.50-15.0V. |
| 5 6.75-7.5V. | 11 20.20-22.5V. |
| 6 8.10-9.0V. | 12 40.50-45.0V. |

10 THANDAR: DM 235: Bench type D.M.M. provides full facilities for field servicing, testing and laboratory work.

- High accuracy, resolution and input impedance are combined with a large wide-angle display to provide quick clear unambiguous readings where-ever you use it.
- 3½ Digit resolution.
 - Automatic polarity selection.
 - 10M Ω Input impedance.
 - 0.5% of reading basic accuracy.
 - Full multimeter facilities including AC Current.
 - Selection of all functions from a single input terminal pair.
 - Made in England by Sinclair Electronics Ltd.
 - Price includes two size C dry cells.

Cut off and mail to: Nilsen Rowe Australia Pty. Ltd., P.O. Box 349, North Melbourne, VIC. 3051
Please supply the following to:

Name _____

Address _____

Postcode _____

My cheque/postal note herewith, or please debit my Bankcard Account Number bankcard _____

Card Holder's Signature _____

Card Expiry Date _____

Model No.	Quantity	Price	Sales Tax if Applic. at 20%	TOTAL
Plus Postage & Handling Charges				\$2.50
TOTAL				

NILSEN ROWE Registered Office
AUSTRALIA PTY. LTD. 200 Berkeley St.,
Carlton, Vic. 3053.

AM radio stations to go stereo

Stereo broadcasting on the AM band could shortly be introduced here. To date, a number of standards for encoding the stereo channels on transmissions have been proposed. However, 'multistandard' receivers could allow stations to use different encoding systems so that a single standard need not be chosen. AM stereo may not be too far off!

Jennie Whyte

STEREO BROADCASTING is usually associated with FM, probably because that's the way it's been transmitted up to now.

But it's perfectly feasible to transmit a stereo programme using modified AM transmitters and receivers.

In fact, in the US stereo broadcasts on the AM band began in July 1982 and there are now about 80 AM stereo stations broadcasting there.

But Australia is not far behind. The Engineering Committee of the Federation of Australian Radio Broadcasters is currently working with the Department of Communications in laboratory and field tests of the various AM stereo systems.

When the Department approves the systems it is planned to have a common launch date for AM stereo which, hopefully, will be in another three or four months time.

AM stereo has been bogged down for a long time, in the US and in Australia, because of arguments about the different systems and which was the best choice.

Originally five systems were considered: Magnavox, Kahn, Belar, Harris and Motorola. The FCC in the US finally approved four systems; Belar missed out.

Until recently some of the AM stereo stations in the US were broadcasting on the Harris system and some on the Kahn.

Listeners would have been able to pick up only one of the systems on their radios and would, therefore, have been restricted in their choice of stations. So obviously there had to be agreement on which system was to be chosen by the radio industry.

However, things changed when the Japanese solved the problem by designing an integrated circuit which formed the basis of a multi-mode receiver. This multi-system receiver automatically senses which system is being broadcast and so it changes the receiver accordingly.

So if you are listening to 2CH broadcasting on the Kahn system and you want to tune to 2SM using the Harris system, your receiver will simply adjust automatically. Japanese technology has effectively removed the main obstacle holding up AM stereo in the major countries of the world.

Australia has stricter broadcasting standards than the US which is why the Department of Communications is presently conducting its own tests on the Kahn, Magnavox, Harris and Motorola systems. Irrespective of US approval, these systems must be approved in Australia.

The arrival of AM stereo in Australia was inevitable; it was just a matter of sorting out a few problems and now that the Japanese have done most of that for us, it's all systems go.

Several radio stations in NSW already have their studios and transmitters set up for AM stereo broadcasting. 2CH and 2UW have the Kahn system, 2SM has the Harris system, 2WS has the Magnavox and the Motorola systems and 2UE has the Magnavox system.

Many of the stations have been preparing for years, gradually changing from mono to stereo as the equipment needed replacing. Most of the studio equipment, such as recording systems, cassette players and turntables, is already stereo.

So the major cost for an AM radio station would be, at the most, \$300 000 to modify its existing AM transmitter to stereo operation with the broadcasting system of its choice.

If one system does eventually prove itself to be superior it would then be a relatively simple matter for the broadcaster to change over. It would only cost about \$50 000 to change the encoder to the preferred system.

And the listener wouldn't suffer as the new radio receivers are capable of decoding AM stereo channels in any of the four possible modes.

Many of the AM stereo stations in the US and in Australia use the Kahn system of modulation. Here the carrier is phase-modulated with the L-R signal and then amplitude modulated with the L+R signal. Sophisticated circuitry produces the broadcast signal which has the left channel on one sideband and the right channel on the other.

When an ordinary mono AM receiver is tuned onto the carrier it receives the normal AM envelope which is the L+R signal. The listener is unaware that the station is transmitting a stereo signal.

Stereo reception requires the receiver to

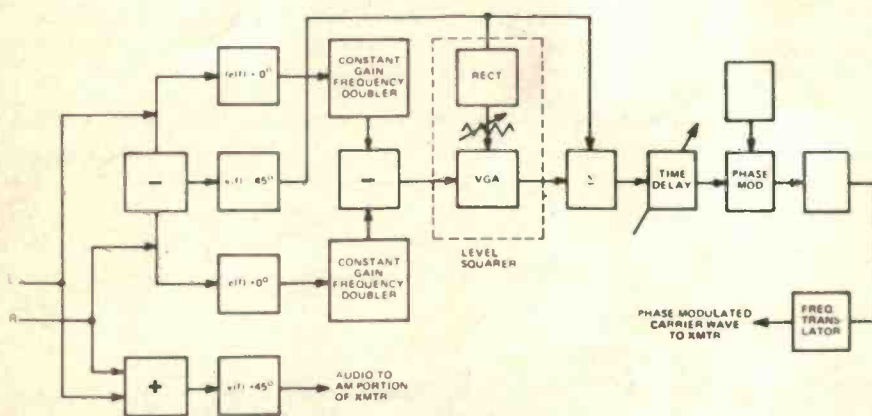

Kahn transmitter. The L-R signal phase modulates RF from a crystal oscillator. The L and R signals are carried by separate sidebands and are picked up on a receiver equipped for phase detection.

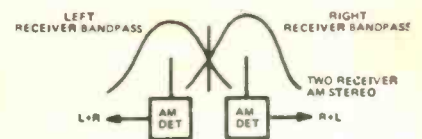

Stereo signal from the Kahn transmitter. It can be picked up by two mono receivers, one tuned a little high, the other a little low.

Klinger marries in final MASH episode

In the final episode of MASH, 'Goodbye, Farewell and Amen', soon to be released by CBS/FOX Video on prerecorded videocassette, Klinger falls in love with a Korean girl and they are married by Father Mulcahy.

The usual MASH comedy is overshadowed by the strong emotional ties that are about to dissolve with the end of the Korean War and the discharge of the men and women of the 4077th Mobile Army Surgical Hospital.

The show begins with peace just a few days away and Hawkeye is in a mental ward. At first he refuses to talk seriously about his problems, resorting to his usual wisecracks. But the truth eventually comes out in a confusion of chickens and dead babies hiding from an enemy patrol. What? Of course, Hawkeye leaves the mental ward.

In the last furious rage of the war Father Mulcahy is knocked down by a blast and is wounded

in the ear, leaving him nearly deaf.

The truce finally happens and the long-awaited cease-fire takes effect. The MASH team talk about their future plans, Hot Lips revealing that she will work in a US hospital. Klinger and his wife decide to remain in Korea and Colonel Potter says that he'll become a country doctor.

Hot Lips and Hawkeye, who have had many arguments with each other, fall into a passionate farewell embrace. BJ refuses to say goodbye but ends up doing it in his own way in the final dramatic scene.

'Goodbye, Farewell and Amen' has a VCR running time of 114 minutes and scoops the TV final episode.



Easy to use Akai VCR

The new Akai VS-4 features Akai's exclusive Interactive Monitor System that spells out operating instructions on the TV screen itself.

It also offers a variety of recording and playback times with its two-speed system. The standard play mode gives you 240 minutes of recording and playback with an E-240 video cassette tape. For long TV programs which you want to record on a single cassette the long play mode extends the time to eight hours on the same tape.

The Interactive Monitor System tells you which buttons to push for the function you want to use, confirms your commands and memorises them, so you don't have to refer to the owner's

manual all the time.

The VS-4 has VHS standard format and allows you to record four separate programmes over a four-week period, using any combination of the eight preset stations.

The RC-V404 infrared-ray remote control permits you to operate most of the functions from your chair.

You can find out more about Akai products by contacting Akai Marketing Services Australia Pty Ltd, Unit 11, 31 Waterloo Rd, North Ryde NSW 2113. (02)887-2311.



Marantz compact disc player

If you've had the opportunity of listening to the performance of the Marantz CD-73 compact disc players, which are now on the market, you'll understand why digital audio is being heralded as the greatest advance in audio reproduction since stereo emerged.

The compact disc player can be connected to any current hi-fi system without modifying the other components. However, for optimum reproduction of the digitally recorded sound Marantz will be integrating the CD-73 into complete systems incorporating tuner, amplifier, cassette deck, turntable and speakers.

The CD-73 has a slimline design, weighs 8 kg and in true Marantz style is finished in gold and black with a body shell made of metal rather than the commonly used high-impact plastic.

With the disc in position in its compartment, pressing the 'next program-play' button will cause the disc to be played from selection one through to the end, then automatically switched off. Pressing the 'next program-play' button at any time during this cycle means that it will immedi-

ately cease playing the current track and move on to the next selection on the disc or in the program.

The CD-73 features reverse, fast forward, pause and repeat. Random Access Programming allows the user to nominate up to 15 tracks for play in any order.

The specifications for the Marantz CD player are: a frequency range of 20 Hz to 20 kHz, dynamic range, signal/noise ratio and channel separation are all better than 90 dB, THD is less than 0.005%, wow and flutter are immeasurable, audio output level is 2 VRMS and power consumption is 40 W.

The suggested retail price of the CD-73 is \$999. More details can be obtained from Marantz (Australia) Pty Ltd, 19 Chard St, Brookvale NSW 2100. (02) 939-1900.

Real time analysers

Gold Line (USA), manufacturers of highly specialised audio spectrum analysers, have introduced four new products.

For professional sound applications there is the model '30' which has microprocessor technology, making it very accurate and stable, switched filtering and options such as non volatile memory, disc and CRT interfaces etc.

The ASA 10C is a complete analysis system designed for rack use featuring an internal pink noise generator and a calibrated microphone.

Two handheld models are also available, featuring separate pink noise boxes, for use in the home and in sound reinforcement. Prices range from \$500 to \$4000 depending on options.

For more information contact Rose Music Pty Ltd, 17-33 Market St, South Melbourne Vic. 3205. (03)699-2388.



Quad 34 audio control unit

Quad Electroacoustics, the British manufacturers of the famous electrostatic loudspeakers, have introduced a new audio control unit.

The Quad 34 is an advancement of the original Quad 44 control unit and has quickly followed the new Quad FM4 radio tuner unit with which it is designed to be used.

This control unit has been designed to provide everything that the serious domestic music listener requires in order to obtain maximum enjoyment from radio, analogue record, compact digital disc and tape.

Inputs are selected by push-button controlled solid state switches which are all fully isolated from each other.

The unit provides correct matching of load and sensitivity for both moving coil and moving magnet pickup cartridges by means of disc input modules. A range of modules is available to match pickup cartridges not covered by the two standard modules.

The 'auxiliary' input is intended for use with a compact disc player, but can also be used as a second tape record/replay socket.

The filters provide four characteristic curves to remove some of the distortions inherent in the

record playing system and leave more of the music.

The 'Tilt' control produces a gradual change in balance across the frequency range. The 'Bass' control boosts the bass and in the 'Step' mode the control acts as a step filter.

The maximum distortion introduced by the Quad 34 with any input is 0.05%. Frequency response is flat to ± 0.3 dB, except for disc input when it is matched to the RIAA curve to within ± 0.5 dB. Residual noise with volume at a minimum is quoted as -105 dB.

The new Quad FM4 tuner is deceptively simple in appearance and easy to operate but is designed as an adjunct to a high quality music system.

The only controls on the FM4 are an off/on switch, tuning knob and eight pushbuttons which are used to store and recall stations in the tuner's memory.

For more information on Quad Electroacoustic products contact **AudioSon International Pty Ltd, 64 Winbourne Rd, Brookvale NSW 2100. (02)938-1186.**

Sansui sound while you drive

Sansui's car hi-fi components include amplifiers, cassette decks, tuners, speaker systems, remote control units and graphic equalisers.

The integrated amplifiers, SA-7, SA-5 and SA-3, all have a connector for adding the graphic equaliser. The SA-7 and SA-5 both have a remote control unit. Maximum output power for the SA-7 is 16 WRMS into four channels, at 1 kHz, 1% THD.

Audio cable tester

The new Cable-Q from InterFax Electronics is a no-fuss service tool that simplifies troubleshooting all types of audio cables.

Cable-Q features eight receptacles that mate with the variety of standard connectors. Two switches and five lights automatically report the exact information, in less than five seconds.

With the cable connected between mating receptacles on opposite sides of the enclosure, Cable-Q tells you which conductors have continuity, are broken, shorted, or connected to the outer shell of XLR type connectors and which cable is cross-wired or phase reversed.

Since there are no pushbuttons or test leads to fumble with, both hands are free to stress the cable to check for intermittent defects.

Further information is avail-

able from **BWD Instruments Pty Ltd, Miles Street, Mulgrave Vic. 3170. (03)561-2888.**



Movies at home with Sanyo

Sanyo has released its latest model Betacord Video Cassette Recorder, selling for around \$699.

The model VTC 5000-II is equipped with an eight-day programmable timer which allows you to record any programme on any day, up to eight days in advance. It also allows you to see, with the picture search at seven times normal speed in forward or

reverse, the programme on the screen.

With the cord Remote Pause Control the unwanted material can be edited by a touch of a button without even moving from your seat.

The digital timer doubles as a 12-hour (am/pm) clock.

Sanyo also offers an L-830 cassette which gives you a full 215 minutes recording.

For further information contact **Sanyo Australia, 225 Miller St, North Sydney NSW 2060. (02)436-1122.**



RMS power for the SA5 and SA-3 is 16 W into two channels.

The SX-7 and SX-5 cassette decks feature auto reverse, metal tape compatibility, automatic music search and an optional remote control unit.

If space is a premium you can

choose the SY-7, a combination of tape deck and amplifier in one unit.

More information about Sansui car hi-fi can be obtained by contacting **Vanfi (Aust) Pty Ltd, 283 Alfred St, Nth Sydney NSW 2061. (02)929-0293.**

Fisher products in Australia

According to Sanyo, Fisher has become a well established second brand for the company since the Fisher Corporation of the USA was acquired by Sanyo Japan in 1977.

The Fisher portable tape recorder, Model PH 480K, has a four broadcast band radio (AM/SW1/SW2/FM), tape deck and speakers. Output power is 13 watts maximum per channel and it has a recommended retail price of \$582.

Other Fisher tape recorders are the PH 420K with 5 W output per channel, PH 460K with 9 W per channel and the top of the line PH 492K with a huge range of features, including 20 W output per channel and a graphic equaliser.

On the video scene, Fisher's FVH-P530 features a 15-function infra-red remote control. Recording and playing time on a VHS E-240 cassette is four hours and the programme timer lets you select programmes up to 14 days in advance with as many as five programmes selected in that time subject to the length of the

tape used. The recommended retail price is \$1428.

Model FVH-P520 video cassette recorder features an eleven function, cord remote control and a timer for recording one programme per day for up to seven days. It is available at a recommended retail price of \$1071.

For more information on Fisher products contact Sanyo Australia Pty Ltd, 225 Miller St, Nth Sydney NSW 2060. (02) 436-1122.



PDMagnetics tapes

The range of PDMagnetics tape cassettes covers the full spectrum of sound and vision requirements for every major audio and video reproduction system.

An ambitious claim for a 'newcomer' to the market, but it is backed up by a partnership of DuPont and Philips.

PDMagnetics Video 2000 format cassettes feature the 'high grade' chromium dioxide tape coating, plus the Philips 'flip-over' facility which enables up to eight hours playing. Four versions are available: VCC120, VCC240, VCC360 and VCC480.

Three VHS cassettes are available, the E60, E120 and E180, and the long-playing E240 will be out soon.

The L250, L500 and L750 Beta system cassettes are available now and the L830 will be introduced soon.

PDMagnetics claim that the ACQ audio cassettes have a special system which virtually eliminates tape jamming or looping.

Available in the audio range are the 1100 Metal which has an



output of at least 3 dB (10 dB at 16 kHz), 500 Crolyn with an output of 2 dB up to 17 kHz and the Tri-oxide Ferro.

More information on PDMagnetics cassettes can be obtained from Marantz (Australia) Pty Ltd, 19 Chard Rd, Brookvale NSW 2100. (02) 939-1900.

AUDIO CRITICS RAVE ABOUT THE V15 TYPE V:

"Our tests show that the Shure V15 Type V not only lives up to the claims made for it, but in virtually every respect OUTPERFORMS the best cartridges we have previously tested . . . It is hard to imagine how the V15 Type V could be improved significantly. It offers the MOST PERFORMANCE in the most areas, plus the most convenience and safety in installation and operation." - **Julian Hirsch, Stereo Review, June, 1982.**

"... (The V15 Type V) is definitely the FINEST pickup Shure has ever made, which makes it one of the finest ever made, period." - **High Fidelity, July, 1982.**

"... In a world of audiophile discs with demanding tracking requirements, the Shure V15 Type V

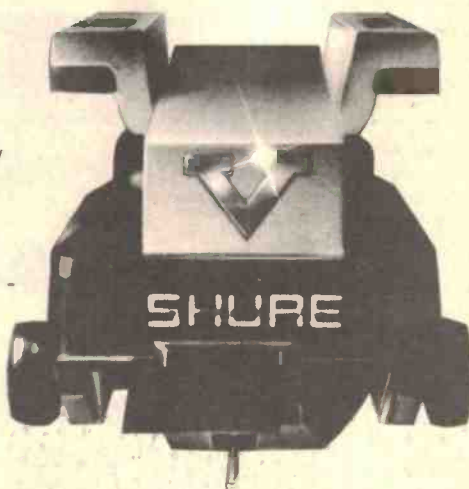

KEEPS AHEAD of the times." - **Rich Warren, Chicago Sun-Times, June 4, 1982.**

"(The V15 Type V) REDEFINES its maker as a pioneer in cartridge design not only from the beginnings of microgroove technology but well into the future of the LP disc." - **FM Guide (Canada), June, 1982.**

"... It may be safe to say that this cartridge's excellent tracking ability is NUMBER ONE in the world. Provides exquisite and elaborate sound." **Swing Journal (Japan), May, 1982.**

SHURE

AUDIO ENGINEERS P/L
342 Kent Street
Sydney NSW 2000
(02)29 6731

NOMIS ELECTRONICS (S.A.)
(08)293 4896

AUDIO ENGINEERS (Qld)
(07)369 9670

AUDIO ENGINEERS (Vic)
(03)44 3295

MARKETEC Pty Ltd
(09) 335 8275

Best bass yet from a kit!

As featured in Electronics Australia Projects June and July 1981.

Now Peerless introduces another major advance to kit-set loudspeaker technology. A bass speaker with a rigid polypropylene cone that clearly outperforms traditional paper composite cone speakers to provide:

- Cleaner, tighter bass sound reproduction
- Low colouration and distortion
- High efficiency, suiting 25W to 100W amplifiers
- Consistent rigid panel, low mass speaker cones.

Other outstanding features of Danish-built Peerless speaker kit-sets are:

- Sealed back mid-range with excellent linearity and low distortion
- Latest Peerless 1" soft-dome tweeter
- State-of-the-art crossover networks
- Exceptionally flat response extending to 25,000 Hz.

Choose from these EA/Peerless speaker projects:

- PAS 100 12" 3-way 100W (100L)
- PAS 60 10" 3-way 90W (60L)
- PAS 25 8 1/4" 2-way 60W (25L)

includes drivers, crossover, wiring and instructions.

Sole Australian Importer, G.R.D. GROUP PTY. LTD.

698 Burke Road, Camberwell, Vic. 3124. Trade enquiries welcome.

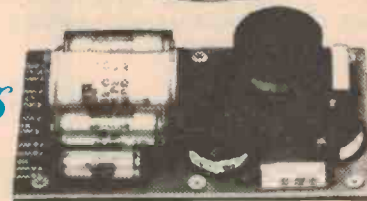
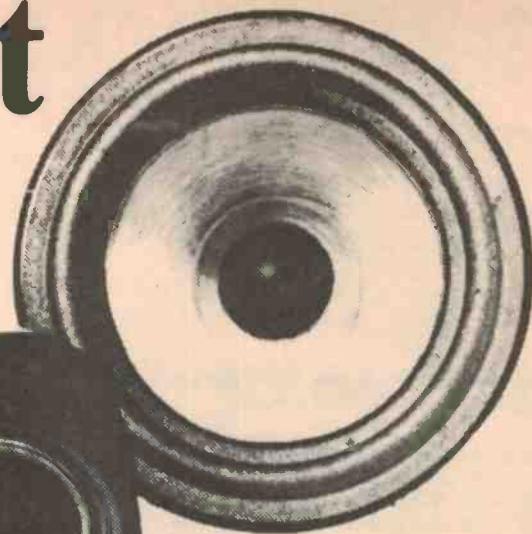

N.S.W.

Bondi Junction
Danish Hi-Fi Aust. Pty. Ltd. Ph: (02) 387 5878

Concord
Electronic Agencies Ph: (02) 745 3077

Crows Nest
Deeva Hi-Fi Ph: (02) 439 3999

Dee Why
David Ryall Electronics Ph: (02) 982 7500

Sydney
Electronic Agencies Ph: (02) 29 2098

Wagga Wagga
Car Radio & Hi-Fi Centre Ph: (069) 21 4618

VIC.

Ballarat
Turner Audio Ph: (053) 32 2042

Camberwell
Danish Hi-Fi (Aust) Pty. Ltd. Ph: (03) 82 7348

Cheltenham
Beland Electronics Ph: (03) 550 2279

Geelong
Steve Bennett Audio Ph: (052) 21 6011

Hawthorn
Tivoli Hi-Fi Ph: (03) 818 8637

Warrnambool
Bruce Henderson Audio World Ph: (055) 62 5147

S.A.

Adelaide
Hi-Fi Acoustic Ph: (08) 223 6774

Adelaide
Danish Hi-Fi Aust. Pty. Ltd. Ph: (08) 51 2124

Goodwood
The Acoustic Foundry Ph: (08) 271 0276

Hawthorn
Sound Craftsmen Ph: (08) 272 0341

St. Peters
Miltronix Ph: (08) 42 3781

W.A.

Nedlands
Danish Hi-Fi Aust. Pty. Ltd. Ph: (09) 386 8564

QLD.

Brisbane
Brisbane Agencies Audio Centre Ph: (07) 221 9944

Barunda
G. Mills Stereo Ph: (07) 391 5606

Redcliff
Hi-Fi Sales Ph: (07) 284 2495

CONCORD/6480

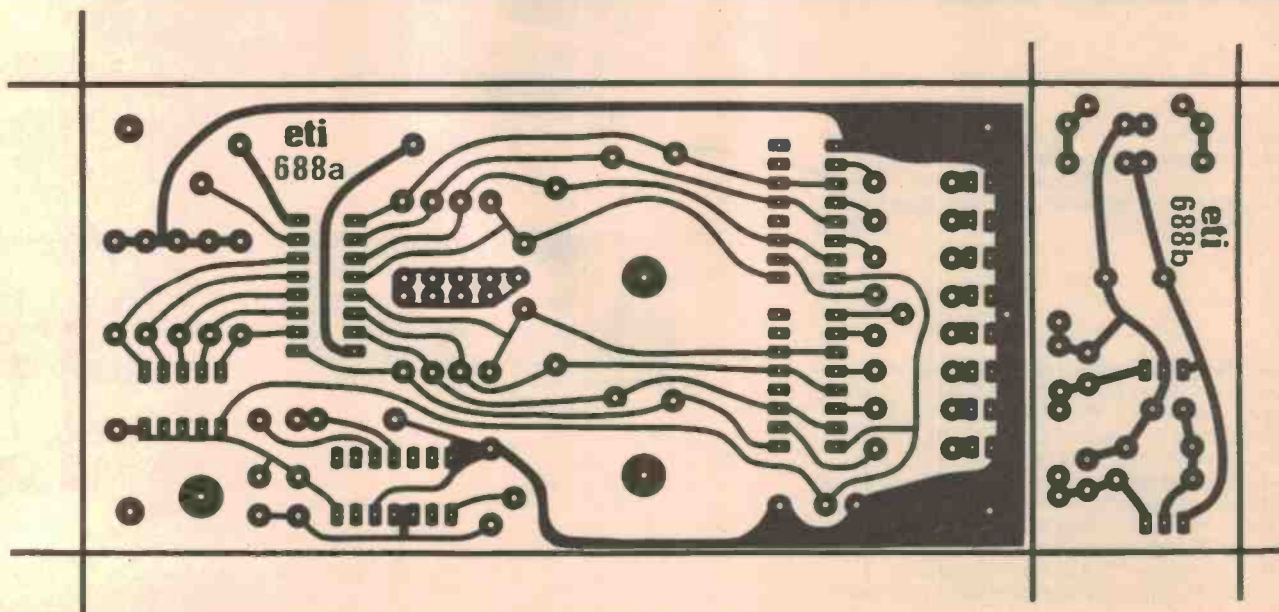

microbee®

*"You won't find a better computer
NOW here's a range"*

High Resolution KAGA Monitor — Ideal for professional applications this monitor will produce crisp clean graphics and text when operating with any MicroBee. Display is green with P31 phosphor. **\$299**

To take advantage of the new ColourBee you'll need a converted colour TV or RGB monitor.

Colour Conversion — Any MicroBee can now be converted to run in brilliant colour, (as featured in the March edition of *Your Computer*), with 26 background plus 26 foreground colours and up to 80 characters per line on a converted colour TV or RGB monitor. MicroBee colour is fully software compatible with black and white MicroBee programmes. Conversion also includes the new Microworld colour BASIC and high speed operation at 3.375 MHz and 80 x 24 display option for any 16K or 32K MicroBee. Please note that because of the high resolution achieved, colour encoders and modulators are not recommended. The ColourBee must be operated with a specially converted colour TV or any RGB monitor.
Colour Option

\$169

Professional quality Daisy Wheel Printer (40 CPS) will turn your MicroBee with WordBee into a top quality word processor capable of producing print to match that from systems costing many times as much. Please check with your local MicroBee dealer for recommendations of the models available.

High Speed Dot Matrix Printer — MicroBee operates well with any printer such as Epson. Please check with your local MicroBee dealer for suggestions.

Any low cost cassette recorder can be used to load and save MicroBee programmes. These units have been extensively tested in our engineering department and found to be ideal for operation at 300 and 1200 baud.
Data Cassette Recorder

\$39.50

The cost effective MicroBee 16K Plus is supplied with Microword BASIC in ROM with room for additional ROM firmware such as WordBee or EDASM. User area is 16K or battery backed CMOS RAM which retains programme even after switching off. I/O is an 8 BIT programme port, RS232 serial port 300 and 1200 baud, direct video cassette interface 300 and 1200 baud. Screen is 16 lines of 64 characters upper and lower case with low resolution 128 x 48 and PCG high resolution 512 x 256 graphics. Fully expandable to colour, 32K or even 64K as your needs grow.

MicroBee 16K Plus

\$449

The clever MicroBee 32K Plus has BASIC in ROM with room for additional ROM based software such as WordBee or EDASM. Has full 32K of CMOS battery backed user RAM as well as 4K screen and graphics RAM. Operates in 64 character x 16 line format as well as high resolution 512 x 256 PCG graphics. A powerful machine equally useful in the classroom, home or almost anywhere. Fully expandable to colour and 64K operation.
MicroBee 32K Plus

\$549



*etter performance personal computer for the price
e of peripherals to increase your performance."*

New Release — The MicroBee monitor also includes a built-in power supply for your MicroBee. Display is high resolution on a green screen. **\$199**



For economy use a black and white converted TV monitor — Ready to use for **\$149**

Direct Connect Modem — Soon to be released. This advanced design modem incorporates auto answer and auto dialling and operates a 300, 600 and 1200 baud.

XY Plotter — Digiplot is the intelligent plotter for the MicroBee. Ideal for line drawings, geometric designs, computer art, bar charts and contour plotting. Automatic selection of up to six different coloured pens.

MicroBee Disk Drives — Connects directly to any 64K MicroBee and operates under CP/M world standard disk operating system for 8 BIT micro processors. Massive 380K formatted storage on each double sided double density drive. Supplied with comprehensive software including Microworld disk BASIC, EDASM, WordBee and a full library of utility programmes. Also accepts Osborne and other popular disks. Single drive unit complete with disk controller and power supply. **\$799**
Add on disk drives **\$399**

Wide range of support software on disk, cassette and ROM. Educational, business, games and support programmes now available. Call your local MicroBee dealer for more details.

The mighty MicroBee 64K Plus can be used as a free standing personal computer or coupled with disk drives to produce a top performance system capable of running any of the world class software running under CP/M. Has programmable 80 x 24 and 64 x 16 screen format and can be fitted with optional colour to produce probably the lowest cost CP/M colour computer on the Australian market today.

MicroBee 64K Plus **\$699**



Tannoy's 'Little Red' monitors

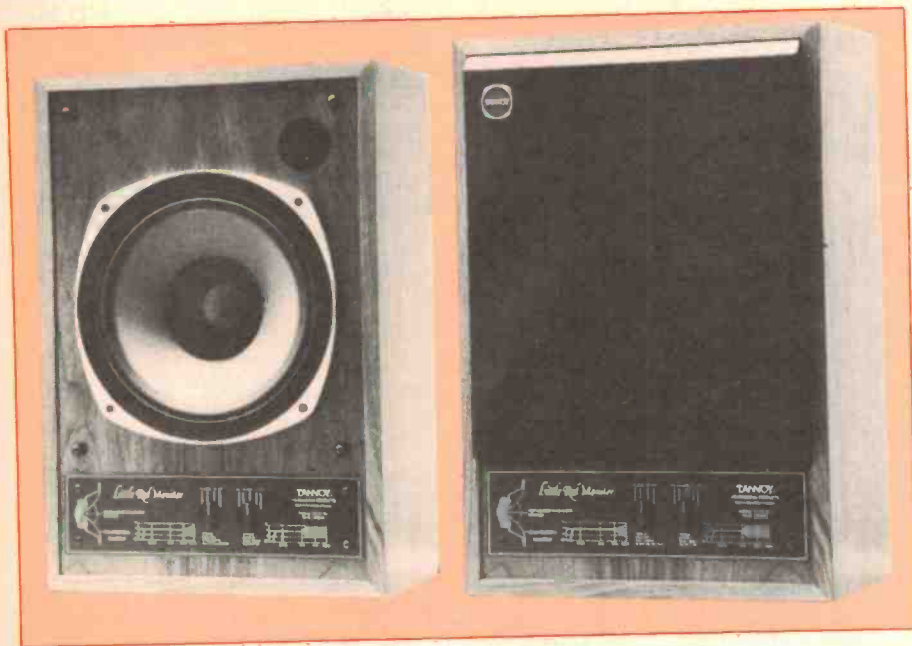

Louis Challis

TANNOY'S 'LITTLE RED' MONITORS

Dimensions: Height 590 mm; width 400 mm; depth 290 mm
Weight: 16.3 kg
Price: Rrp \$1899 per pair
Manufactured: By Tannoy in Strathclyde, Scotland
Distributor: John Barry Group, 105 Reserve Rd, Artarmon NSW 2064. (02)439-6955.

Tannoy have enjoyed a much-envied reputation over many years for the quality and performance of their loudspeaker drivers, in particular their dual-concentric models. This loudspeaker differs a little from their more familiar designs. A dual-concentric driver is housed in a small bass reflex box and while a generally good performer, there's room for improvement.

TANNOY HAS LONG BEEN one of the most respected names in England in the field of manufacturing loudspeakers. Until quite recently most English broadcasting and recording studios favoured Tannoy monitors over all other brands.

Tannoy built their reputation on the basis of their dual concentric loudspeakers and their 15 inch (380 mm) diameter woofers for serious studio use.

The 'Little Red' monitor is probably the first small Tannoy monitor speaker to be imported into this country and follows a slightly different design philosophy to previous Tannoy speakers which we have seen. It is designed for either wall mounting or shelf mounting. The design of the cabinet is based on a simple and straightforward philosophy which achieves a rugged and neat appearance.

The dual concentric speaker has a nominal diameter of 305 mm and an externally accessible crossover system. This speaker is a little unusual as the outer element incorporates a plastic loaded, cloth edged surround while the inner element is a horn loaded compression high frequency driver. This incorporates an aluminium horn and has an integral preformed, semicircular nylon mesh

protector at the central region of the direct radiating woofer diaphragm. The single speaker assembly is front mounted onto the ported base reflex enclosure which is veneered in dark English oak.

The grill protecting the speaker is in the form of a particle board taper-edged frame which is covered by open weave, dark brown terylene cloth. This is intended to match with the oak veneer of the enclosure but the colour balance is not good. The protection frame is retained by four plastic compression clips at each of the four corners.

Below the cover is an anodised fascia plate providing information about the speaker. This shows the schematic cross-section of the dual concentric loudspeaker system. It also provides two equalisation controls for the treble and mid-range respectively, with settings of flat, ± 1.5 and -3 for the treble and ± 3 , ± 1.5 and flat for the midrange.

The response curves for these controls, shown schematically on the front panel, are very close to how they actually perform. The curves presented by us vary because the measured results provided by the speakers are non linear.

The rear of the cabinet features two sets of sockets for bi-amping when it is required.

Alternatively the speakers may be driven with a single amplifier by using the outer terminal of each pair to drive the speaker. The terminals are colour coded universal terminals to assist the user in making the correct phase connections.

Many two-way and three-way speakers experience problems of poor phase response. The advantages of dual concentric loudspeakers are that, in theory, these problems are obviated by the concentric configuration. I was keen to evaluate the phase response characteristic as I have used at least one dual concentric loudspeaker for some of the more esoteric psycho-acoustic research work in our laboratory. I have never actually measured the phase response although I have measured the other parameters with which I was concerned.

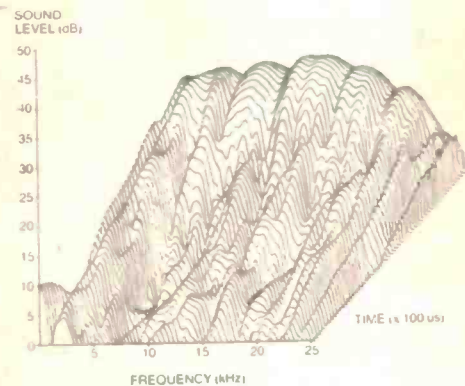

Get the picture. The decay response spectra for the 'Little Red' monitors measured at one metre.

Objective testing

Tannoy claim an eight ohm impedance for this speaker and, as the measurements show clearly, this statement is very accurate as the lowest impedance measured was 7.8 ohms. Although the speaker exhibits the normal low frequency ported resonance at 15 Hz, the main speaker resonance occurs at 70 Hz. There are a couple of other normal peaks and bumps but generally the impedance curve is smooth, as would be expected for a speaker of this size and configuration.

The frequency response was measured on axis in the anechoic room and proved that, with a single amplifier drive and 'flat' settings, the treble is brighter than the bottom end of the speaker. The speaker also exhibits a significant number of obvious peaks and bumps lying within a nominal 10 dB excursion over the frequency region of 1 kHz to 20 kHz. The resonance at 1.7 kHz, in particular, is fairly sharp, well pronounced and the most significant of all of those exhibited.

The low frequency response droops from 150 Hz down to 30 Hz because of the small size of the enclosure. But if the speaker is mounted so that it is clear of the wall, whether it is on the floor or on a bookshelf, this may partially compensate for the low frequency response and achieve a better bottom end response. The off-axis response (30° to the main axis) is particularly smooth and the difference between on-axis and off-axis response is a credit to the dual concentric speaker concept.

While the treble is still a little bright compared with the mid-range it is nonetheless clear that the frequency response of the speaker extends to beyond 17 kHz. In general terms the frequency response is broad enough to satisfy the majority of users.

The measured performance of the attenuators, which I have presented separately for both the mid-range and tweeter controls, provides sufficient adjustment to reduce the overbright performance. This response is not indicated on the front panel of the speaker. It is clear that the designer's aims for these two equalisers have been achieved even if the measured performance of the speaker does not match the indicated frequency response.

I was pleased to find that the phase response is exceptionally smooth and one of the best I have measured from any speaker to date. This response lies within a range of

MEASURED PERFORMANCE OF: Tannoy SRM 12B

FREQUENCY RESPONSE: 50Hz - 20kHz

CROSSOVER FREQUENCIES: 1 kHz

SENSITIVITY: 7.0 VRMS
(for 90dB average at 2m)

HARMONIC DISTORTION:
(for 96dB at 1m)

	100Hz	1kHz	6.3kHz	
2nd	-42.8	-32.6	-40.4	dB
3rd	-44.4	-33.9	-46.2	dB
4th	-	-57.3	-	dB
5th	-55.1	-56.9	-	dB
THD	0.96%	3.1%	1.1%	

INPUT IMPEDANCE

100Hz	8.0 Ω
1kHz	10.9 Ω
6.3kHz	8.6 Ω
Minimum at 140 Hz	7.8 Ω

Absolute copyright in this review and accompanying measurements is owned by Electronics Today International. Under no circumstances may any review or part thereof be reprinted or incorporated in any reprint or used in any advertising or promotion without the express written agreement of the Managing Editor.

Tone burst response of the Tannoy 'Little Red' monitors (SRM 12B). For 90 dB steady state sound pressure level at two metres on axis.

Upper trace is electrical input. Lower trace is the loudspeaker output.

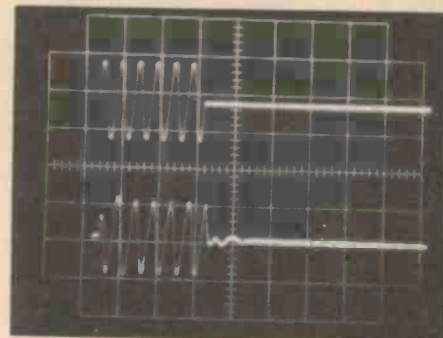

Output at 100 Hz (20 ms/div).

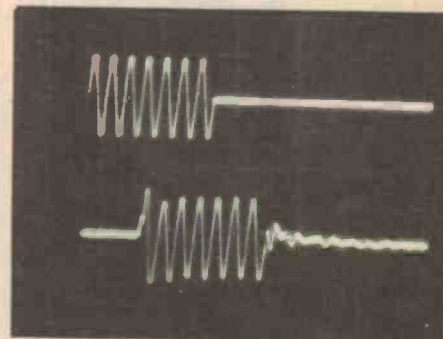

Output at 1 kHz (2 ms/div).

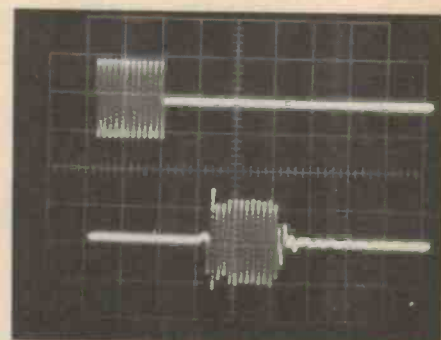

Output at 6.3 kHz (1 ms/div).

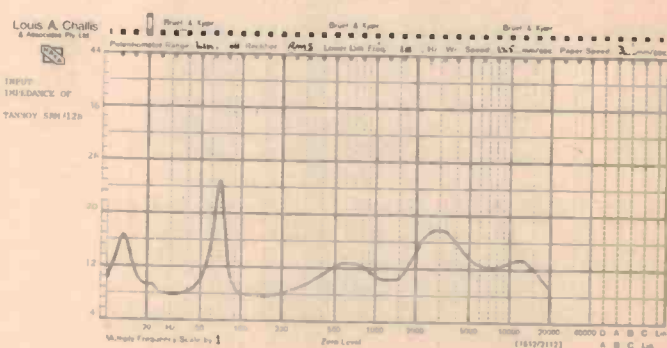
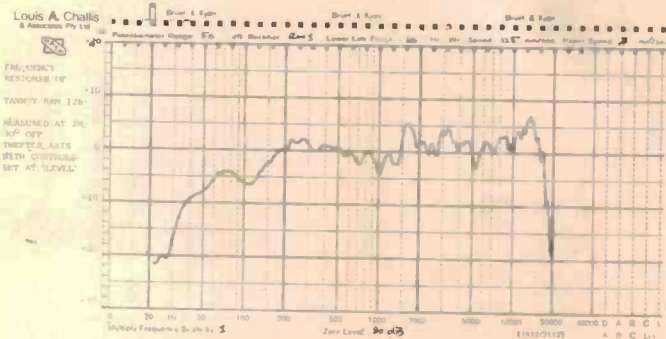

better than $\pm 45^\circ$ from approximately 3 kHz to 20 kHz. It would be difficult for most other speaker manufacturers to match this phase response. The tone burst testing displays an unusual range of characteristics with a very stable response at 100 Hz, a significant carry over in non-linearity in the 1 kHz region and a nondescript performance at the 6.3 kHz region. This performance is, of course, closely matched and confirmed by the time decay response spectra.

The time decay response spectra very clearly show the well pronounced resonance at 1.7 kHz, another slightly less significant resonance at about 3.5 kHz and a further series of less pronounced resonances in the 13 kHz region and some others lying in the region of 18-22 kHz. It was clear to me from the decay response spectra that these components would be audible and this proved to be the case in the subsequent subjective assessment.

By contrast, the distortion figures of the speaker with 96 dB at one meter (or 90 dB at two meters) are moderately low for the bottom end and the top end of the spectrum, but in the 1 kHz region are somewhat higher than normal at 3.1%. This is very much a function of the speaker resonance at 1.7 kHz. Consequently the signals fed in at 1 kHz are likely to be significantly distorted at the second harmonic which proved to be the case in this particular situation.

It is interesting that the polar response of this speaker is particularly uniform and at frequencies of up to approximately 6 kHz it is substantially better than that which we have come to expect from other wide range or two-way speaker systems.

Subjectively

The subjective assessment of the speakers can be performed as a bi-amped configuration or with a single channel amplifier feeding each speaker. I chose to use a Yamaha B4 stereo amplifier with one half of the amplifier feeding each speaker.

With the mid-range control set at the maximum attenuation of three decibels, the mid-range and treble still appeared to be unusually bright. Subsequent powering of the system by a Sansui Z9000 stereo receiver with integral graphic equaliser revealed that a further 2 dB of attenuation over the frequency range of one to four kilohertz is required to produce a spectral balance that sound natural and pleasing to most ears. From this I deduced that this amplifier really ought to be used in a bi-amp configuration, or with graphic equalisers in the amplifier circuitry, if the correct tonal balance is required.

The standard listening tests with a pre-recorded voice, using Robin Archer's 'A Star is Torn' and Kerry Biddell's 'Compared to What' (EMI SS301), revealed that these monitors perform very well on speech. They produce a natural quality and spatial stereo imaging which is truly excellent and comparable with other speakers costing at least twice the price.

By contrast, the performance on the 'Sheffield Track Record' (Lab 20) revealed that at low frequencies the drum sequences lacked the punch I would expect from a monitor speaker system. It left me concerned as to whether the designers had made a mistake in trying to put a 305 mm diameter

speaker into such a small enclosure (61 litres). The problem with such a small enclosure is that you run the risk of a drooping low frequency response which the porting system can never quite correct.

The speakers perform well on tympany, clarinet, organ and violins but it is easy to detect added components and presence that were not part of the original recordings. I would not have expected this characteristic from speakers which are marketed as monitor speakers.

The designers claim that the speakers have a 100 watt power rating capacity and I confirmed that for short periods they are capable of handling 250 watt peaks without any ill effects whatsoever. Admittedly, at the 110 dB levels involved the distortion was appreciable, but it would most probably have been just as apparent with other speakers.

The Tannoy 'Little Red' monitor speakers form an interesting and, in general terms, well designed loudspeaker system. The title 'Little Red' does nothing for the image of the speakers.

After listening to them for a weekend I feel the designers would be well advised to consider a few carefully selected changes in the design to optimise the potential that the speaker system already has.

My first recommendation would be to consider using a larger volume than the 61 litres provided in this unit. Secondly, the designers should try to overcome the pronounced resonance at 1700 Hz as this is the only other factor limiting the speakers' ability to correctly achieve the accolade of 'monitor' speakers. ●

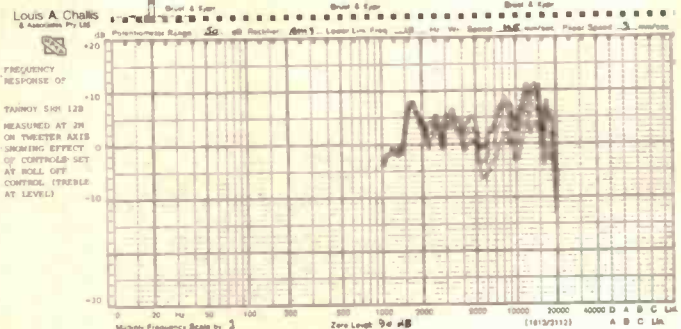
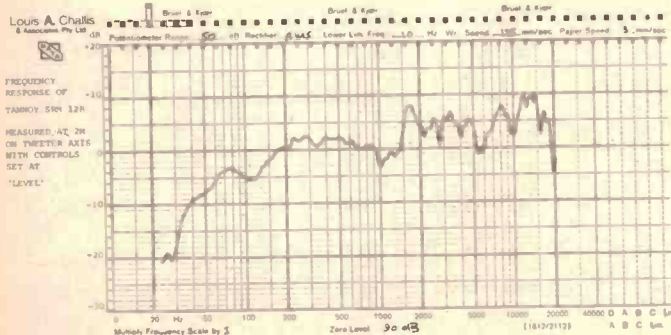
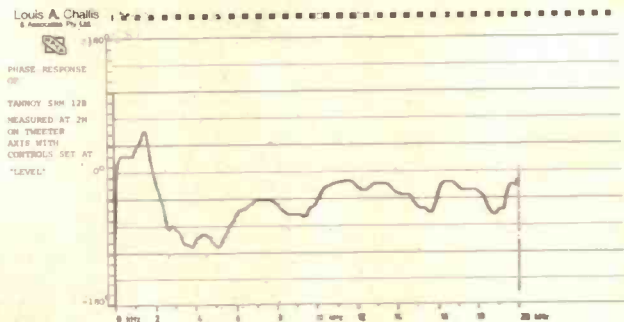
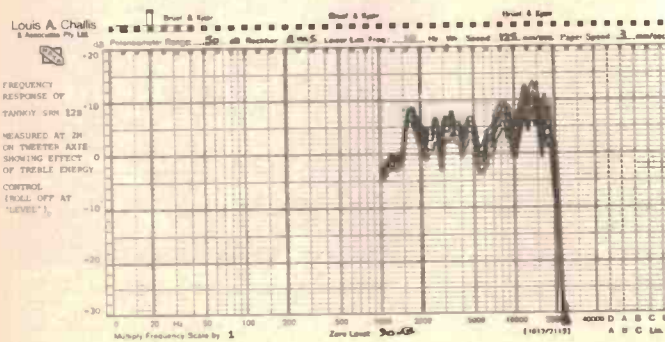

COMPUTING TODAY

NEC wins 'Personal Computer of the Year' award



In a surprise outcome, a Japanese machine has topped the front-running US contenders for the world's first Personal Computer of the Year award.

The award, from ETI's associate, Your Computer, went to the NEC Advanced Personal Computer from NEC Information Systems Australia, out-performing rivals from Digital Equipment Corporation, IBM and other companies.

The decision is the first sign of Japanese penetration into the US-dominated field. It is significant that NEC's US division is responsible for the machine's software support.

A panel of academics and business people deliberated over the dozens of machines released in the Australian marketplace in the past 12 months.

Technical excellence and advance were the crux of the award. Other criteria included value for money, performance, user support, documentation and training and 'user friendliness'.

"As the personal computer revolution reaches the average man in the street, he needs ammunition to fight his way through the flood of new machines

hitting the market," said Your Computer Editor, Les Bell.

"The Personal Computer of the Year award provides that ammunition, in the form of detailed information.

"This award does not laud the 'best' personal computer. There's no such machine. Every buyer has his own requirements, and there is usually a machine which fits his particular bill. Instead, we have sought the greatest advance in several areas," Mr Bell said.

The finalists shortlisted for the award were: Commodore 64, BBC Microcomputer, Otrona Attache, Toshiba T100, IBM-PC, Columbia MPC, NEC Advanced Personal Computer, Sirius and the DEC Rainbow.

In the final analysis it was neck-and-neck between NEC and DEC! The NEC won out by 3.9 points over a total weighted score of 69.1 for the DEC. The spread of scores was not very large, from 50.6 for the Toshiba to 73 for the NEC.

Every home should have its own robot

The RB5X Intelligent Robot will not hang out the washing, cook the dinner or do the shopping, but it does learn by experience.

It is designed for home experimenters and is manufactured by RB Robot Corporation of Colorado.

With tactile sensors the robot detects and responds to objects in its path. Once a successful random response is achieved, the RB5X remembers its actions and repeats the correct response when confronted again with the same situation.

The RB5X is an ideal starter system for experimentation in robotics. Its RS232 interface makes it compatible with the Apple, TRS-80, IBM PC and other popular microcomputers. Its

memory can be transferred to a personal computer to enable the user to study memory patterns generated and alter RB programs accordingly.

It can even sense when its batteries are low and will then seek out its battery charger and fully charge itself.

The basic RB5X unit sells for US\$1195. A special option package with additional memory, the Polaroid Rangefinder sonar sensor and a pulsating light option is also available for US\$295.

High speed DOS for the Apple II

Pnakotic Software has released 'HDOS', a high-speed disk operating system enhancement for the Apple II computer.

It is compatible with almost all software designed to run under DOS 3.3 and has a greater level of compatibility with software

packages than other fast DOS programs currently available, it is claimed.

The package includes a utility to place HDOS onto a DOS 3.3 disk. HDOS is unprotected for easy backup and costs only \$29.95.

Anyone who is interested should contact Pnakotic Software, P.O. Box 159, Campbelltown, Adelaide SA 5073. (08)337-8575.

10 000 MicroBees and more to come

The 10 000th MicroBee computer was completed on Applied Technology's assembly line on 14th April and handed over to the NSW Minister for Education at a factory-opening ceremony the same day.

Applied Technology's new factory at Gosford, north of Sydney, is already producing 1000 computers a month and plans to increase this to 2000 units per month before the year is out.

To meet increasing demand for the MicroBee and associated products, land has been purchased adjacent to the new factory and plans are under way to expand production facilities even further.

The NSW Minister for Education, The Rt. Hon. R.J. Mullock, officiated at the factory-opening

ceremony. Owen Hill of Applied Technology presented him with the 10 000th MicroBee which will become a prize in a State schools competition.

The MicroBee has been officially approved for use in Schools in NSW and WA; Queensland and other states are also considering it. Applied Technology say that South Africa, the Phillipines and Malaysia are considering the MicroBee at senior government levels in education as a viable alternative for an educational computer.

32-bit mainframe processor

The NCR 9300 is a full 32-bit VLSI mainframe computer for general business applications.

NCR claim that the 9300 processor represents the next generation of business data processing systems.

The 9300 can be packaged in three different styles: as a floor standing unit, as a desk top unit and as a unit which can be hung on a wall.

The processor cabinet is the size of a small suitcase and houses the processor board, one memory board (second is optional) and the communications board.

The processor board contains the processor memory bus, memory interface, cache, instruction storage unit buffer and external registers. The instruction storage unit is a separate board attached to the processor board and uses 126K of ROM with 2K of patch PROM.

The memory interface has a 32-bit data path plus seven bits for correction codes and is capable of addressing up to 16M of main storage. It transfers data as four-byte words.

Peripheral data is transferred at 16Mb/s and communications data at 1Mb/s.

One memory circuit board provides up to 2M of memory and a second board permits a total of 4M. Using an NCR patented process called 'memory scrubbing', the probability of double-bit errors is virtually eliminated. Each word in memory is automatically accessed for scrubbing during the memory refresh cycle. The entire 4M memory is scrubbed and refreshed every 16 seconds.

The communications subsystem appears to the host software as a communications multiplexer with asynchronous and syn-



chronous adapters. A total of 42 RS-232C communications lines can be provided.

The chip set consists of four 32-bit VLSI chips: the central processor chip, address translation chip and two systems interface chips.

The central processor chip (CPC) is externally programmable and, because of its flexible design, can be used to emulate existing computer instruction sets. The CPC operates with a clock frequency divided into two

non-overlapping clock phases to form a system cycle period of 150 nanoseconds.

The address translation chip provides the interface between the central processor and the main storage unit (MSU). It features 128M MSU address virtual capability and provides eight different protection levels when accessing memory. Address translation is performed using a 16-entry associative memory.

The two systems interface chips operate under control of the

central processing chip. They provide support for the I/O subsystems and have direct access to the MSU through the processor memory bus.

The 9300 can be configured as a complete standalone system or can support a cluster controller environment in a large-scale SNA communications network.

More information about the 9300 can be obtained from NCR Australia Pty Ltd, 8 Napier St, North Sydney NSW 2060. (02)922-0161.

Club Call

Beebnet is the Australian BBC and Econet Users Group which is based in South Australia.

The group intends to produce a newsletter on a monthly basis with hints, software evaluation and other items of interest to BBC owners. New members are needed to expand the range of experience in the group. It is also interested in any software producers or distributors who would be interested in serving the group's market requirements.

All correspondence should be sent to Beebnet, P.O. Box 262, Kingswood SA 5062.

The Motorola Users Group Society (MUGS) — is this how the members see themselves?) is interested in 6800/02/09 based computers, particularly if running Flex although this is not a prerequisite to join. The group has monthly meetings and usually has a guest speaker at each meeting.

If anyone is interested and would like more information on the club

they can contact Clive Allan, 11 Haros Avenue, Nunawading Vic. 3131. (03)878-1298.

The Ballarat Computer Users Group has meetings on the first Wednesday of each month at 7.30pm. The location varies so to find out where the meeting will be held contact the publicity officer, John Preston, on (053)31-4363.

The club caters for all tastes and normally every meeting is devoted to a special topic, usually a specific personal computer which will be demonstrated either by an owner or by a retailer.

Meetings of **The Microcomputer Society** are held on the second Friday of each month in the Old Town Hall, cnr Vulture and Graham Streets, South Brisbane. Meetings start at 7.30pm and if the main gate is closed use the back stairway.

For more information contact The Secretary, The Microcomputer Society, P.O. Box 580, Fortitude Valley Qld 4006.

COLOUR GENIE

HERE TODAY? GONE TODAY!!

Bertas International Pty. Ltd. would like to make an apology to the people who enquired about the Colour Genie Home Computer.

Due to numerous complications and delays with the manufacturer, we have decided not to pursue further, the importing of the Colour Genie Computer. However, we may consider the new upgraded Colour Genie due to be released around the end of this year!

Bertas International Pty. Ltd. is currently sourcing the Japanese market for a computer that will meet the requirements of the Australian market.

Bert Tassoni
Managing Director
Bertas International Pty. Ltd.

ROBOT MAN — You must move about the maze eating up the power food. Watch out for the Robot Men as they are programmed to destroy you before you complete your mission! **\$14.95**

MICROBEE CHASE PLUS — A menu driven collection of 6 BASIC programs featuring excellent use of PCG graphics. **BANNER** — Allows large character displays on the screen.

LEARNING CAN BE FUN — This set of 3 cassettes combines graphics with text to produce highly motivated teaching games. Uses variations of well known arcade games to enhance the learning process. **Volume 1A: GRILLA** — Answer questions to avoid the barrels Kong is rolling.

Love my
Microbee
Don't you

CHESS — Match your skills against the MicroBee chess master. You can select from 1 to 16 ply and also analyse any position. A built-in 'Help' feature enables the computer to play your current move for you. **\$9.95**

LEARNING CAN BE FUN — Volume 2A
A — C This is a maths revision program, based around a well known little Alien Creature. All questions, including the opening selection, are answered by moving the hand of the alien to point to the required answer. Correct answers score points and also cause a plant to grow on the screen.

Incredible software support.

The MicroBee is supported by a wide range of software running in colour and black and white. High resolution, low resolution graphics and text freely mixed.

MICROSPACE INVADERS — Yes the arcade favourite! This fast moving version was written especially for MicroBee by Tim Morris-Yates and has become one of the most popular programs yet released. **\$14.95**

MATHS ADVENTURE — Wander into the fascinating world of the Wizard of Aus. Test your mathematic skills and have fun at the same time. A highly recommended graphics adventure game. Fun for high school maths students and teachers. **\$14.95**

TURTLE GRAPHICS — A very clever program allows the student to use the MicroBee to draw using high resolution turtle graphics. A booklet of procedures is available from the N.S.W. Department of Education. This is a very powerful graphics program which uses the PCG facility of the Microbee to its full extent. **\$14.95**

WORK-A-BEE — A new release. Work-A-Bee is a program which can actually write educational programs almost automatically! Any teacher with little or almost no knowledge of BASIC can insert details as to question and answer, number of tries, marks per question and other controls. Any CAI program can be saved and reused and subroutines have been included to enable the student to go back over his work, printing answers, a void error traps etc. **\$14.95**

CONCENTRATION — A real family favourite for 1 to 4 players to test your memory skills. If you call one player Merlin, the computer will play that turn so watch out! **\$9.95**

BUSY-CALC — Yes, an electronic spread sheet running under microworld BASIC. Accepts text and numbers with easy cursor

control. Commands include:— Average; Sum; Compute; Format; Recalculate; Load and Save. Ideal for cash flow projections, bill of materials and even classroom data. **\$14.99**

PRINTER PACK — Biorhythm Calendar Maker, Banner Print Maze Maker. Ideal for parties or carnivals. Requires a serial printer. You can print biorhythms for anyone. Also prints calendars for any year A.D. and B.C. **\$9.95**

Z TREK — Captain! The warp drives are disabled, the Klingons are closing in on us, what will we do? In Z Trek you are the captain of the starship Enterprise, your five year mission to search out the Klingons and destroy them. There are ten levels of difficulty (0 - 9). Beware of this game — it is strangely addictive. **\$9.95**

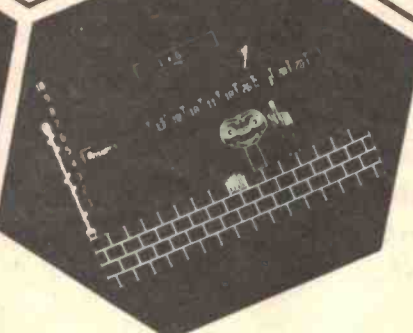
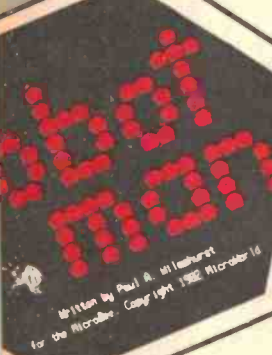

SEARCH AND DESTROY WUMPUS — Have you ever played the game Wumpus? If you liked it then you'll like this! The object is the same as the earlier version except that it's a lot harder. To say any more would spoil the fun. Good Hunting! **\$14.95**

ESC KEY — This is a program for all of the two fingered typists in the world. The program allows you to enter BASIC key words in an abbreviated form. For instance, instead of typing 'list' the user would press the "ESC" key and then "1". The computer then types out the rest of the word for you. Suitable for 16K and 32K machines. **Only. \$14.95**

GRAPHIC GAMES PACK — This cassette contains five programs, 'Poker', 'Slots', 'Dodgem', 'Picture', 'Richochet'. 'Poker' is the main program on the cassette. In this game the computer is the bank and you have to beat it at Draw Poker. Warning — the computer plays a cunning game and is quite prepared to bluff! 'Slots' is a one armed bandit and for 20c a go you can try your luck. In 'Dodgem' the player must guide his car through a forest to the bottom of the screen — this game allows you to drive a car without the random breath tester getting you!! 'Picture' is an excellent game for the children. The final program on the cassette is 'Richochet', where the player has to decide where to fire a bullet through a hole in the wall. If you hit the wall you're dead. **\$14.95**

PCG TUTORIAL — The PCG Sampler cassette has eight programs on it. These programs show you how the graphics work and demonstrates their capabilities by way of games etc. The cassette is excellent for both beginners and experts. It allows you to design your characters on the screen, so you can see exactly what you are creating. Suitable for all MicroBees. **\$9.95**

STARSHOOT/HANGMAN — Starshoot is perhaps one of the most deceptive games available on computer. It appears to be very easy: it isn't. Hangman is based on the popular school game that everybody knows. **\$9.95**

ELIZA — Want someone to talk to? Eliza is possibly the person for you. (If you can get her to shut-up). Eliza is a program that demonstrates artificial intelligence. Eliza is prepared to talk about life, the universe and everything. **\$9.95**

BUSY BEE CAI SYSTEM — Easy to use computer aided instructions similar to the very popular Work-A-Bee, a two sided program with students and teachers versions. **\$14.95**

TYPING DRILL/SOLITAIRE — Want to become a touch typist? Typing Drill enables you to learn touch typing without paying an exorbitant fee to learn. Solitaire is a game in which the object is to remove all of the "pegs" from the board, leaving one peg in the centre of the board. Sounds simple, but, it requires skill to master it. **\$9.95**

TARGET — Target is a game of hit and miss. Your task is to aim the cannon at the bottom of the screen and shoot down the U.F.O.'s (ET watch out). There are nine levels of play to this entertaining game thus making it suitable for any player. Suitable for all Microbees. **\$9.95**

LEARNING CAN BE FUN — This set of 3 cassettes combines graphics with text to produce highly motivated teaching games. Uses variations of well known arcade games to enhance the learning process.
Volume 1A: GRILLA — Answer questions to avoid the barrels Kong is rolling.
FRACE — A game to teach fractions.
Volume 1B: MUNCH — Tests your knowledge by eating the right answer.
TNT — Answer before the dynamite fuse burns down.
Volume 1C: ADSTAR — Avoid the invaders. Shoot the space ship with the right answer.
SQUARE — The Enterprise can save the Galaxy. You arm the laser cannons. **\$9.95 each or \$24.95 for the set of three.**

PILOT — Pilot is a very easy programming language to learn, and ideal for preparing CAI (computer-aided-instruction). Microbee Pilot supports several enhancements including full integer arithmetic. **\$14.95**

BOGGLER — The popular family word game. **\$14.95**

ESCAPE FROM COLDITZ — An exciting adventure game. Beat the Hun and escape to freedom. **\$14.95**

SEADOG GRAPHICS GAME — A Swashbuckling adventure at sea in days of old. Engage the enemy, fire cannons and launch boarding parties. Call in at port for supplies — but watch out for the natives! **\$9.95**

MATCAL — An educational program for calculating with matrices. **\$14.95**

MICROBEE BASIC TUTORIAL — Teaches familiarity with Keyboard Self Pace Learning of Microworld Basic. Ideal for real beginners. **\$9.95**

INVENTORY SYSTEM — Personal business software. **\$14.95**

MICROBEE USERS GROUP SOFTWARE: Vol 1 — Assorted programs. **\$14.95**

GRAPH PLOTTER — An excellent learning tool — Specify the function and your Microbee plots the graph. **\$14.95**

PERSONAL FINANCIAL DIARY — Keeps track of your own personal debit/credit situation. Reconciles bank statements etc. **\$14.95**

DATBAS — Database demonstration illustrates the concepts of database management. **\$14.95**

SUPER DISSASSEMBLER — Utility software for technical boffins. **\$19.95**

MONKEY MATHS — A fun learning game. Answer the questions before the monkey climbs the palm tree. **\$14.95**

UNDERWORLD OF KIN — A 32K adventure game with graphics. You are transported to the massive twisted underworld and must escape by destroying the evil wizard.

LEARNING CAN BE FUN — Volume 2A: A · C — This is a maths revision program, based around a well known little Alien Creature. All questions, including the opening selection, are answered by moving the hand of the alien to point to the required answer. Correct answers score points and also cause a plant to grow on the screen.
M-RACER — Similar to A · C but without the graphics. The main variation is that a pre set time limit is placed on answering each question. **\$9.95**

MICROBEE CHASE PLUS — CHPLUS — A menu driven collection of 6 BASIC programs featuring excellent use of PCG graphics. The first 3 items on the menu are pattern drawing programs. The **TIMEHOLES** program can produce a superb display. **BANNER** allows large character displays on the screen. **KNOCKOUT** is a variation of single player Ping Pong. **CHASED** is a game where you attempt to avoid robots which are chasing you around an enclosure with electrified fence. **\$14.95**

APPLIED TECHNOLOGY PTY LTD

Head Office/

Showroom: 1 Pattison Avenue, Waitara 2077 N.S.W.
Telephone: (02) 487 2711

Factory: 1 Debenham Road, West Gosford 2256 N.S.W.
Telephone: (043) 24 2711 Telex: AA72767

For direct enquiries or the name of your nearest dealer, Phone: (02) 487 2711.



microbee
Personal computers for schools, homes and you.
CEAT 2641



Chatelle Brandy.
The French masterpiece you can afford.

The Original Chatelle Napoléon 100% French Brandy.
Imported from France by Continental Distillers.

Printout

CEMOS 16K x 1 static RAMs outperform NMOS

The new low-power IDT6167 16K x 1 bit CMOS Static RAM is said to be the fastest memory device in its class for both commercial and military applications.

The commercial version of the IDT6167 specifies equal address access, chip-select access and read-cycle time options of 45, 55, 70 and 85 ns.

The military part, screened to MIL-STD-883B, offers three of these speed options 55, 70 and 85 ns. This is more than 20% faster than access times possible with NMOS devices, the makers claim.

Typical active power consumption for the IDT6167 is 150 mW and typically consumes only 10 uW in standby mode. This means you don't need special power-down circuitry, like that required for n-channel memories.

The IDT6167 includes a data retention mode not offered with typical NMOS devices. In this mode the supply voltage can be as low as 2 V. At this point the current decreases significantly and power consumption is typically less than 1 uW.

IDT6167 devices meet JEDEC pinouts and are available in space-saving 20-pin DIPS and 20-pin LCCs. They are ready for immediate shipment. For additional technical and ordering information on this device or on the IDT6116 2K x 8 static RAM, contact George Brown & Co., Sydney, Melbourne, Canberra & Newcastle or Protronics P/L, Adelaide & Perth.

New universal peripheral interface chip

A high-speed, eight-bit programmable interface chip with expanded memory for control of a wide range of peripheral devices has been announced by Intel.

The 8042 is a general-purpose universal peripheral interface (UPI) chip which can be easily customized by the user.

The single-chip microcomputer contains two kilobytes of ROM program memory, 128 bytes of RAM, 18 I/O lines and a 12 MHz clock.

For OEMs this chip is available in an ultraviolet, EPROM version, the Intel 8742.

The 8042/8742 chips enable current users of Intel's 8041A

interface chip (with 1K ROM and 64-byte RAM) to double both memory size and throughput rate. The 40-pin configuration of the 8042/8742 is fully compatible with the UPI-41A.

Intel's UPIs are designed to reduce master CPU overhead and simplify software design.

For further information contact Total Electronics, 9 Harker St, Burwood Vic. 3125. (03) 288-4044.

Apple Computer Australia to assume local distribution

Effective 1 May, 1983, Apple Computer Australia will take over responsibility for the distribution of all Apple products in Australia from the current sole distributors, Electronic Concepts.

According to David Strong, general manager of Apple Computer Australia, this move is in line with the plans announced in July, 1982 when Apple established a local subsidiary to gradually assume local importation, distribution and dealer support.

"This is the logical extension of Apple's activities here", said Mr Strong.

"Apple recognised the need to

have a direct presence and responsibility here, to meet the increasing sophistication of the personal computer market and especially the emphasis on personal office system products."

It is anticipated that Electronic Concepts will continue to market Apple products in Australia, as well as providing on-going support to dealers with added value products.

You've just erased a vital CP/M file! What can you do?

Before you do anything drastic - there is an easy solution to this common disaster. In the situation mentioned above, the file is still on the disk. The powerful DIRECTORY SORT utility will allow you (amongst other things) to retrieve accidentally erased files. Other powerful facilities include:

- Reordering of the file directory in alphabetical order. No more searching through file directories for the file you want. New files are identified.
- Reporting of disk free space.
- Customizable password security.
- Extensive CP/M and file information.

Programmers, business users or anyone who has a lot of files to keep organized will find DIRECTORY SORT an invaluable and time saving piece of software, as well as providing a safeguard against the inevitable disaster.

DIRECTORY SORT runs on any Z80 based computer running CP/M 2.0 or later.

Memory requirement is 32K

minimum. It operates with any brand of fixed or floppy disk drive.

**Software
Source Pty Ltd**
Showroom: 344-348 Oxford Street Bondi Junction, New South Wales
Postal Address: PO Box 364, Edgecliff, NSW 2027. Ph: (02) 389 6388
Please send me further information on
DIRECTORY SORT
Name
Address
Postcode

LIGHT PENS

VIC 20 * COMMODORE 64

LIGHT PEN DOCUMENTATION & DEMO TAPE **ONLY \$39.95**

EXPANSION UNIT

FOR VIC '20 COMPUTERS

* 3 switch selectable slots
* on board reset
* Australian made **\$59.95**

POWER UP



A MUST FOR YOUR COMPUTER OR HI FI SYSTEM

e.g. Plug your computer into the single controller socket. When you turn your computer on, special sensing circuitry applies power to all other sockets AUTOMATICALLY turning on your monitor, printer, discs, tape, etc. **KIT \$39.95 BUILT & TESTED \$59.95**

MICRO BEE SOFTWARE

BS-01 TEXT EDITING WORD PROCESSOR.....	\$24.95
an easy to use new text editor with documentation	
BS-02 LISTER/DECODER	\$21.95
this program prints what LIST won't: all machine code sequences, hidden coding and self modifying code.	
BS-03 FINANCIAL MANAGER.....	\$19.95
provides accurate and formatted records for personal or business.	
BS-04 FILE INDEX SYSTEM	\$19.95
store and retrieve name/address oriented records with your own relevant information.	
BS-05 CARD INDEX SYSTEM.....	\$19.95
simulated card index system (date) for personal or business indexing or diary	
BS-06 STOCKTAKE.....	\$22.95
stock on hand, value, mark up, etc.	

WRITE OR CALL FOR MORE INFORMATION AND LIST OF PROGRAMS. DEALER ENQUIRIES WELCOME FOR BS SOFTWARE.

COMPUTERS

VIC 20.....?	SPECIAL 30 cm MICRON 12 GREEN PHOSPHOR MONITOR GUARANTEED! \$179 * 12V/240V * RCA INPUT * 10Hz-20MHz * HIGH DEFINITOR
ATARI.....?	
KAYPRO.....?	
PERIPHERALS...?	
CALL US NOW!	

COMMODORE 64 WRITE OR CALL FOR SPECIAL PRICE.	TAX PAID — PRICES SUBJECT TO CHANGE
---	-------------------------------------

P&P Software \$1.50 Under 5 kg \$4.50 Over 5 kg \$7.50

PH (02) 588 6293
A K

computer technics

Kogarah NSW 2217 Suite 2, 1A Montgomery St.,

FAST DISCOUNT
MAIL ORDER
P.O. BOX 25
KOGARAH
2217 NSW
MAIL ORDER ONLY

Printout



Dick Smith colour computer

The Dick Smith VZ-200 personal computer features colour graphics, sound, Microsoft BASIC and both RF and video output.

Priced at only \$199, the VZ-200 has been specially designed for the computer beginner. It has 8K of RAM which can be easily expanded to 24K with the addition of the 16K memory expansion module.

The VZ-200 is a fully functional computer, so there's no extra equipment to buy. A comprehensive step-by-step instruction manual is included to teach you how to program in BASIC.

The keys on the typewriter-style movable-key keyboard have been specially designed so

that it's difficult to make a mistake. The number of switches and controls have been kept to a minimum.

The VZ-200 has the facility to attach cassette recorders in order to store programs on standard audio tape. The interface module, priced at \$49.50, allows the connection of a printer to the computer.

The VZ-200 is now available from any of the 37 Dick Smith Electronics stores Australia-wide.

The NewBrain is a brain wave

The NewBrain is a handheld computer measuring 280 mm x 150 mm x 50 mm into which it packs 32K of RAM and 29K of ROM.

This standard basic memory store can be expanded by plug-in modules to give a total of 2M.

There are dual 1200 baud cassette ports for connection to audio tape recorders, a CCITT compatible video output and a UHF channel output, as well as V24 compatible software-driven bi-directional and printer ports.

The battery safeguards the memory in the event of mains failure and allows the computer to be used as a portable instrument for 1 1/4 hours.

The NewBrain is manufactured by Grundy Business Systems Ltd, Cambridge Science Park, Milton Rd, Cambridge England.





My hero, the robot

The Heath Company, which claims to be the world's largest manufacturer of do-it-yourself electronic kits, has entered the robotics field with the introduction of a computerised multi-function robot and a comprehensive robotics education course.

The Heath robot, named Hero 1, is claimed to be the most advanced and versatile product for teaching robotics available on the market today. It is an intelligent, mobile robot and completely self-contained.

It is controlled by its own on-board programmable computer and carries electronic sensors to detect light, sound, motion and obstructions in its path.

It can be programmed to pick up small objects with its arm, speak complete sentences with its voice synthesiser, travel over predetermined courses and repeat specific functions on a predetermined schedule.

It carries its own rechargeable power supply and can function totally free of any external control.

Designed as a robotics and industrial electronics trainer, Hero 1 permits easy access to all interior boards and components. The robot and course provide practical experience in many disciplines that have broad applications to the modern industrial setting.

For further details of this robot contact Warburton Franki Ltd, 372 Eastern Valley Way, Chatswood NSW 2067. (02) 407-3261.

CLASSIFIED

15¢ per character

Minimum of 32 characters

CHARGES: Cash with order only

GUIDE to Oscar Operating \$3.75
UOSAT Handbook \$9.75 posted.
C. C. Co, P.O. Box 5451, Cairns, Qld.

FERGUSON TRANSFORMERS
200W, 240/100V, 10/23A at \$280
each as new, used for computer
power supply. Contact R. Ballie on
597 1911.

Cicada data modem

The Cicada 300 is a compact answer-and-originate unit designed for direct connection to the phone line and for computer interface using either an RS-232C or V24/V28 system.

The Cicada 30 is aimed at the home and small business computer market users of local, STD or ISD facilities and has Telecom approval.

Further information is available from Centre Industries, 187 Allambie Rd, Allambie Heights NSW 2100.

Hewlett Packard chose Spellbinder over all other CP/M wordprocessors.

Why?

Hewlett Packard conducted exhaustive research before selecting a CP/M wordprocessor program to run on their HP125 business computer. The result? Spellbinder was judged superior in all key areas. Here are some of the reasons:

Spellbinder is fully customizable. Function keys and cursor keys really work on Spellbinder! This means faster training and more efficient use.

The most useful and workable mailing list capabilities. Sort by post code then merge any individual information from a mailing list into text.

Powerful sorting facilities. Sort clients by income and then print out a list in order of income with telephone numbers. Sort alphabetically or numerically. Eg. Print up mailing labels for only NSW customers from an all states list and have them sorted by post code.

Note: These facilities are built in. They are not expensive add-ons.

Boilerplating. The user can create entire documents by specifying the numbers of pertinent paragraphs on a master 'boiler plate' file and printing them in any order.

Advanced printing features. Includes the ability to print in two columns and to print multiple documents.

Forms generation facilities. Create a template that 'looks like' your invoice. Spellbinder will show you where to fill in the blanks - then print just the information on your pre-printed stationery.

Ease of use. The three interactive levels of help are fully customizable so they are right for YOUR system. You can even view other documents on your disk without disturbing your current text.

Arithmetical facilities are built in. Total your invoices, prices or statements automatically. Full 16 digit precision with up to 15 decimal places.

Full support. Software Source is dedicated to the support of this powerful package. A growing library of applications programs is available, from mail list entry to invoice generators.

Contact Software Source for further details and the name of your nearest dealer. Come and find out what real wordprocessing is all about.

Exclusive Australasian distributor.

Spellbinder

Software Source Pty Ltd

344-348 Oxford Street Bondi Junction.
PO Box 364 Edgecliff NSW 2027 Phone (02) 389 6388.
Please send me further information on Spellbinder

Name

Address

Glover & Assoc. SS/2

Acoustic couplers

Electro-Med, an Australian company, has a new range of options available for the Sendata 700 series of acoustic couplers.

This will make them compatible with many of the new personal computers, including the IBM PC.

Acoustic couplers provide personal computers with the facility to access the data base of large information systems.

The new models of Sendata acoustic couplers will still be known as the 700 series 300 BPS,

but will be fitted with the answer/originate function and a 23-way flat ribbon interface cable, terminated by both a male and female connector, as standard features.

The new 700 series answer/originate model is now available for only \$249 (plus tax, if applicable) which is a saving of around \$100 over previous models, according to Electro-Med.

For further information contact **Electro-Medical Engineering Pty Ltd, 69 Sutherland Rd, Armadale Vic. 3143. (03) 509-5844.**

More Sinclair ZX add-ons

The Sinclair ZX80 and ZX81 are claimed to be the world's largest selling computers.

Vendale has been part of this Sinclair ZX growth by supplying hardware to the market and has now released a series of new products designed to further upgrade the ZXs.

The 16K RAM pack has been designed to overcome the 'wobbling' problem associated with many other packs and has expansion pins for the attachment of the X-ROM card. It has a 200 ns access time and is priced at \$69.50.

The X-ROM card has several built-in features such as autostart ROM, printer interface and

EPROM burner and is priced at \$69.95.

With the ZON X-81 sound generator you can create some amazing effects with the Sinclair ZX80 and ZX81. It is a completely self-contained sound unit and just plugs into the computer. Standard 16K ROM packs and printers can be plugged into the ZON X-81 without affecting normal operation. It is priced at \$69.50.

All these products are available from **Vendale Pty Ltd, P.O. Box 456, Glen Waverley Vic. 3150.**

Computer access to information

Paris Radio Electronics is now providing a Dial-up Information Service for users of 6800, 6809 and 68000 computer systems.

This service can be accessed by a 300 baud modem link between 5.30 pm and 9.30 am week days, 24 hours on weekends and public holidays.

Initially, the service will include a complete listing of hardware

and software available, with a bulletin board in the works.

The service is running on an SWTPC 6809 multi-user system running a Uniflex operating system.

To log on to the service dial (02)344-9111 and type 'infocentre'.

Paris Radio Electronics is situated at 161 Bunnerong Rd, Kingsford NSW 2032. (02)344-9111.

Light pen for Vic-20

A light pen for the Vic-20 computer has now been released by Ozi Soft.

The light pen comes complete with operating instructions and a demonstration cassette, retailing for \$39.95.

An expansion board, also available from Ozi Soft, has three switch selectable slots allowing the user to switch between extra memory, utilities and games.

The switch can be on or off in any combination and there is an on-board reset switch so the new cartridge can be initialised without switching the computer off

then on again.

The board is double sided, plated through and sprayed with a protective resin. High quality connectors and switches are used.

Designed and manufactured in Australia, it is distributed by Ozi Soft through **The Computer Spot, Shop C4 MLC Centre, Martin Place, Sydney NSW. (02)235-2971.** It is also available through your local Vic-20 dealer for \$59.95.



Columbia and Kaypro computers

Columbia claim to have the largest repertoire of compatible off-the-shelf 16-bit hardware and software add-ons available.

They currently list in excess of 120 readily available packages produced by the top names in the software business.

The minimum package includes 2 x 320K drives, a 128K RAM expandable to one megabyte, eight expansion slots, a colour graphics board, a 16-colour high resolution monitor, DMA controller, tone generator and hard disk interface.

The standard software includes an MPS DOS operating system, a CPM 86 operating system, BASIC language, asynchronous communications, Columbia tutor, fast graph, space commanders, diagnosis, dumb terminal, Perfect Writer (w/p package) and Perfect Calc (electronic spreadsheet). The software alone is valued at over \$3000.

The Columbia can be expanded up to 20M and with MPM it can support up to eight terminals.

The Kaypro 11 microcomputer is for the small business user. It comes with a robust, portable carrying case and large standard 24 x 80 screen.

New packages that have joined the Kaypro 11 standard issue of CP/M, SBASIC and Profitplan are: Perfect Writer, a powerful word processor; Perfect Calc, the most sophisticated spreadsheet available; Perfect Speller, a fast 50 000 word dictionary; Perfect Filer, a small data base that links up with Perfect Calc and Perfect Writer.

The Australian distributor for the Columbia and the Kaypro is the President Computer Group, an Australian group of companies that have been in business equipment for over a decade. The President Group supports over 140 dealers and can be contacted at 100 George St, Hornsby NSW 2077. (02)476-2700.





Medfly can tax your mind, mind your tax, and let you play in space.

The Medfly home computer is compatible with the largest library of software available today. What this opens up to you and your family is simply amazing.

For your children — education packages on Algebra, Spelling, Mathematics, Vocabulary — making your Medfly virtually a home coach or tutor.

For personal and business use — you get access to Time Management, Business Systems, Accounting Packages and Financial Broadsheets.

For family entertainment — you'll be able to share the fun of Action Games, Strategy

Games and Adventure Games, which you can plug straight in to your home TV screen.

Medfly is a thinking machine to expand young minds; a working machine for home or business accounting; a games machine for family fun. And above all, Medfly is a value machine, with quality electronics by Siemens and with more features, capabilities and add-on potential than many costlier microcomputers.

The basic Medfly microcomputer system — alpha/numeric keyboard and processor — is available now for just \$1,995 including sales tax.

MEDFLY

putting the value buzz into home computing

VICTORIA:

Medfly Basis (Vic.) Pty. Ltd. 43 Atherton Rd. OAKLEIGH, VIC. 3166 PH: 569 0169.

ALL OTHER STATES

DATA UNIVERSE

2/190 George Street, PARRAMATTA. PH: (02) 689 2599

Not all great Clarets come from Bordeaux.



Claret is the name which the English gave to the elegant, delicate reds of Bordeaux. These clarets were the product of the sun, the earth, Merlot, Cabernet Sauvignon and Malbec grape varieties and French wine making skill.

We took the same sun, earth and grapes, plus Australian wine making skill and produced an indescribably delicate and complex Claret which we think is just as worthy of the name.

Indeed the only real difference between McWilliam's Claret and a comparable French Bordeaux is the price. Vive la différence. **McWILLIAM'S**

Machine language graphic driver for the ETI-640/ETI-685

Developing this software may have caused the authors to tear out their hair in frustration but it means that now you can do something really useful with your computer. This graphic package is designed to make interfacing as easy as possible, be extendable, fast and give you all the features of the current popular computers and more.

G.H. Secomb J.F. Adamthwaite

BEING 2650 OWNER/DRIVER enthusiasts — a strange group who, if not locked up, dwell in caves and mumble strange incantations such as "Z80, BAH, HUMBUG" — we have often looked longingly through the doors of Tandy stores (provided nobody is looking) thinking "... if only I could draw some pictures ...". Go on, admit it, you have, haven't you.

We were amazed that Tandy, after all their big-buck market research, put a Z80 in the Model I, guaranteeing that it would die, as history shows it did.

(The views of the contributor are not necessarily those of the magazine.) Actually, this is a back-handed way of saying that Tandy had their act together before anybody else knew what an act was.

This is the story of our mental meanderings while attempting to improve on the opposition.

The first part is a summary of how it could have been done, closely followed by the only way we could manage to do it. The details of software interfacing, source listing and a sample driver program hang on the end.

Pseudo high-level language representations of the functions are provided as food for thought for owners of 'other' CPUs.

There are no real secrets here; it just seems that those who know aren't telling, and those who are telling, don't know. (Beware, this could include the authors.)

The noteworthy thing about this package is that it has most of the popular features collected together to form one program with an integrated, extendable, hierarchical, executive core. (We are deeply into buzz-words.)

Hardware review

A survey of hardware display techniques showed two distinct approaches to be in common use.

● **Vector scan** which uses direct display beam deflection, rather like that of a normal cathode ray oscilloscope, to create the picture on the screen. This method can be seen in arcade games such as 'Tank Battle Commander'.

● **Raster scan** where the entire picture content is written once into a memory buffer, after which the buffer is sequentially scanned by simple hardware to display the contents.

A feasibility study into vector scanning showed that it made very high resolution and smooth angled lines possible. However it required a lot of very fast, dedicated hardware to achieve this and the display had to be capable of running itself with only minimal CPU support, usually DMA.

Raster scanning seemed to hold more promise for microcomputers as the simpler display hardware takes care of itself, leaving the CPU free to calculate the required updates for the next scene. If anybody can, raster scan. Rah-don. Smoker scoff.

Raster scan

Raster scan can be subdivided into two main categories:

1. **Character cell type** where the successive bytes of screen memory are subjected to an encoding process such as a character generator ROM, or a programmable character generator RAM block as found in the ETI-681 PCG VDU or the MicroBee.

2. **Bit-mapped type** where each bit of each byte of screen memory corresponds to a fixed screen pixel location. If a given bit in memory is set to a logic 1 the associated screen pixel is turned on, or lit.

The PCG RAM method has the advantage of higher image detail, or resolution, for a given screen memory size. This reduces the amount 'stolen' from the CPU addressing range. However, you don't get something for nothing.

This method requires complicated software to manage the PCG RAM resources. You must be prepared to manipulate shape tables and return currently unused PCG space to a 'free-list' etc.

A common error message on the MicroBee seems to be 'PCG overflow'. Dreary.

The bit-mapped approach has the advantage of increased generality and simplicity. A new shape to be drawn is directly plotted in the screen RAM without any concern for PCG translation or space allocation.

The main disadvantage of a bit-mapped VDU is the square-law relationship of screen resolution to memory requirements.

This limitation has been overcome by the new IEEE-696 S100 standard, although very few manufacturers have as yet taken advantage of the extended addressing capability in the design of new system boards. (Applied Technology seem to be the only local exception.)

It seems that if you want high display resolution you must be prepared to pay for it in the form of memory space, software complexity, money (in the form of a separate display processor) or all three.

When the current system was being put together memory mapped VDU boards were not common. The availability of the ETI-640 board with its relatively low price determined the choice of the hardware. We were broke.

Compared to the standard of the day, the TRS-80 Model 1, the ETI-640 was superior in text character formation, vertical graphic coordinate addressing range and 'squareness' of the chunky graphic block shape. Did you ever notice how tall and skinny things look on a TRS-80?

The early version of the ETI-640 did require a little 'massaging' to get it to stand still but these problems have been overcome, resulting in a sturdy little work-horse VDU.

In the future we predict that LSI-based VDUs, such as the MW6545 or the Technitron 'Provida', will give it some competition.

The advent of Ron Koenig's excellent ETI-685 2650 CPU board, with extended addressing and capable of running at 2 MHz, was the last item we needed to get us going.

Let's face it, how many of you have really done something useful with your computer? Not many I'll bet! Everyone starts out thinking that they might control the garage door first, closely followed by controlling the rest of the world. Most of us can count the number of such successfully completed projects on the fingers of our left foot.

Anyway, computer tinkering is still just bashing your head against a wall, with the latest boards forming a pretty veneer that merely looks soft. ▶

Software review

Having decided on raster scan, in the form of the ETI-640, several approaches to software implementation were investigated.

1. **Character oriented graphics** sequentially sends the elements of the scene to the normal character outputting routine as bytes to be stored in consecutive screen locations.

2. **Sprite graphics** is a development of the above. A group of bytes (sprite), which make up a pre-defined image object, are 'block moved' to the desired screen location. An example is to be found in the new Texas Instruments personal computer.

3. **Line and point oriented graphics** where all image items are constructed of points, lines and arcs.

Character oriented graphics, using the same outputting routine as the text driver, were found to be slow for normal text and complicated. This is due to the necessity of testing several 'mode' flags before actually writing the character to the screen. They also lack flexibility in screen positioning as movement is only possible by whole character cell positions, using cursor control codes. Their main use is for writing large text characters on the screen. An example is the PET Commodore computer.

Sprites seem to be the most commonly used method, making up the bulk of arcade games such as Space Invaders or Galaxian, where one 'master sprite' image can be copied to the screen at many locations, simplifying the CPU's task considerably. Sprites have the advantage of speed (important on a micro-computer) but do require pre-definition of each sprite image, making smooth size or orientation changes tricky.

Note — the master image is the final image of the object. The only manipulation possible without special hardware (such as the new TI or NEC LSI devices) or a lot of brain-strain, is vertical or horizontal movement (coordinate translation). This amounts to moving cardboard cut-outs around, when you think about it.

The lack of colour or grey-scale (variable intensity) attributes on the ETI-640 seemed to make sprite methods suitable for only the most trivial applications, as it would be hard to separate foreground and background images, a feature performed well by the TI device.

Note, a sprite can be made up of lines but, as the diagram below shows, it is tricky to draw a straight line with sprites.

This leaves us with line-oriented techniques as being the most easily implemented on the ETI-640, while still being useful for more than just basic tasks.

CAD/CAM graphics package

The application we were most interested in when this project was started was computer-aided design and manufacturing (CAD/CAM) (we big-note a lot), and we saw the current task as being good trainer wheels for the real thing.

Most technical or business use involves display of graphs or representation of real-world objects, which must be viewable at will from any angle or distance.

To achieve spontaneity in size, orientation, distance and perspective, the image must be 'computed' from a set of coordinates which represent the object, rather than selecting the 'nearest fit' pre-defined image already in memory.

Note — the master info is *not* the image, but a set of parameters from which the current screen image is derived by mathematical (mostly trigonometric) manipulation.

An 'all-singing, all-dancing' graphics package suitable for CAD/CAM work, or producing something like 'Tron', requires many different program functions, the *least* complex of which is the final drawing of the image. It would run something like this —

First, the master object parameters such as dimensions, material, colour and reflectivity (e.g. glossy chrome) are fed into the computer. This is generally done by hand from a keyboard, joystick or light-pen. This 'front-end' data acquisition program must be able to save these parameters to disc for later recovery, as any but the simplest objects take a long time to define. More complex shapes must be definable as groups of the simpler shapes, in order to save finger-work.

The current viewing position must also be fed in, as the final image is obviously dependant on the position the computer thinks you are viewing the objects from.

The viewing position coordinates and object parameters are then manipulated by a 3D transformation program module to determine the apparent position and size of the objects.

The manipulations performed are typically rotation, scaling and translation. Perspective, if desired, can be done as well. The numeric results, if plotted at this stage, would result in a 'wire-frame' image, much like the intro to the ABC show, 'Towards 2000'.

The results of the 3D transformation are then examined for hidden lines, and surfaces are shaded according to material 'colour' and the computer 'light source' position. This process gives the image a 'solid' look. The image is now in the form of two dimensional coordinates and pixel intensities.

As most of us only have eyes in the front of our heads, (politicians excepted, apparently) we can only see that portion of a scene which

happens to be in front of us. Similarly, only those objects within a certain computed viewing angle should be represented on the screen. Objects 'in front' of the screen, either side of it or more than a certain distance away should not be plotted or realism will be lost.

The image coordinates are examined to determine whether they lie outside the current 'viewing window'. If so, they are 'clipped', rather like cropping a photograph with a pair of scissors, the process being done mathematically in this case. Note that the viewing window does not have to be the same size as the screen. Quite often it is smaller, to allow space to be reserved on the screen for text or other picture segments.

The clipped 2D results, still in coordinate form, are then converted to whatever form is needed by the final display hardware such as a VDU or plotter.

The full CAD/CAM package as shown involves several man-years of hardware and software development and is unfortunately out of our range as part-time tinkerers. Besides, if we had done all that, we would be out there selling it, wouldn't we? Certainly not telling you lot how to do it.

Another constraint is that not everybody wants a CAD/CAM package, and it would be too slow on a microcomputer (all that trigonometry) for real-time applications such as games and animation.

This program

The software package presented here is intended to provide the user with the graphic functions available on most of the currently popular personal computers, plus a few functions we have not yet seen on other devices.

A coordinate system with the origin ($X=0$, $Y=0$) at the bottom-left corner was chosen because our brain seems to work better that way. Don't you just hate upside-down coordinates?

A strict CAD style implementation would limit the functions allowable to points and lines only, with no pre-defined shapes allowed. In practice however, some common shapes, such as squares and circles, need to be drawn quite often, so these tricks were included for user convenience and speed.

A feature not commonly found, but commonly desired, is to be able to invert the state of a screen pixel directly, without the need to test it first, then conditionally set or clear it; a slow and cumbersome process if done in BASIC.

This feature allows an object to be drawn and erased by two identical inversion processes without destroying the background, allowing cross-hairs and the like to be moved quite simply, regardless of prior screen content.

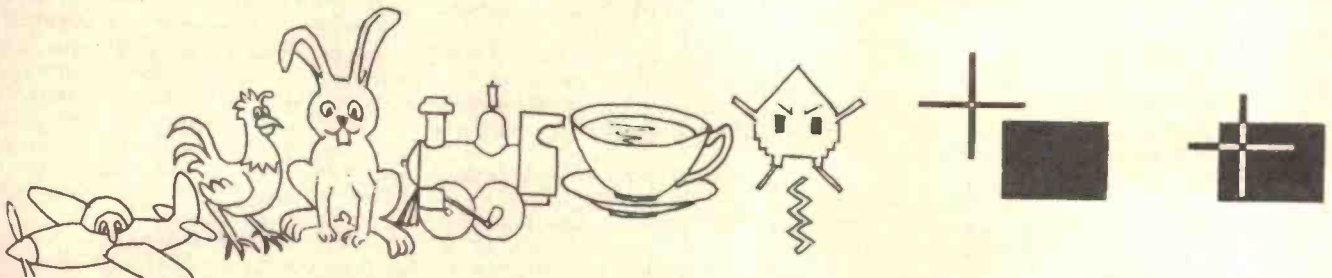

This would normally wipe out everything in the moving object's path, requiring a re-draw of the background to restore it.

In this implementation there are four operations that can be performed on a pixel:

1. SET Turn it on.
2. CLEAR Turn it off.
3. INVERT Make it whatever it wasn't.
4. TEST Test the pixel's current state, returning a zero result if the pixel is clear, or a non-zero result if it is set.

It was felt that for the package to be easy to use, its instruction set must be regular and consistent (buzz-word is orthogonal). It must allow all possible pixel modes to be employed for any of the higher-order functions. The only exception to this is the TEST operation, which does not have a simple parallel in the higher order functions. As suitable variants of the TEST function are dreamed up, they could be included in the package fairly painlessly.

The functions are grouped in fours, starting at zero, to reduce the need to keep a reference sheet handy while programming.

Features provided

● General screen operations

00. SET WINDOW
Flood a rectangular area with 1s.
01. CLEAR WINDOW
Clear a rectangular area with 0s.
02. INVERT WINDOW
Reverse the state of all pixels in the area.
03. PROTECT SCREEN
Protect from scrolling and clear entire screen.

● Single pixel operations

04. SET POINT
Turn it on.
05. CLEAR POINT
Turn it off.
06. INVERT POINT
Go on, take a guess.
07. TEST POINT
Test pixel state and set a flag accordingly.

● Line operations

08. SET LINE
Draw a line between two end-points.
09. CLEAR LINE
Erase the line.
10. INVERT LINE
Reverse every pixel encountered on the line.
11. —
Not used.

● Rectangle operations

12. SET RECTANGLE
Draw a rectangle.
13. CLR. RECTANGLE
Erase it.
14. INV. RECTANGLE
Reverse every pixel around the perimeter.
15. —
Not used.

● Ellipse operations

16. SET ELLIPSE
Draw an ellipse of variable height and width.
17. CLEAR ELLIPSE
Erase it.

18. INVERT ELLIPSE
Reverse every pixel on the circumference.
19. —
Not used.

HOW THEY WORK

Window function

The purpose of operations 0, 1 and 2 are to allow large or small areas of the screen to be manipulated quickly. They can initialise windows amongst text for subsequent scribbling in, such as a chess-board background, or be used to draw simple shapes. The algorithm employed is quite simple, as follows:

```
* WINDOW FUNCTION
* Input parameters required are (X1,Y1)
  and (X2,Y2)
IF X2 > X1 THEN XINCREMENT = +1.
IF X2 = X1 THEN XINCREMENT = 0.
IF X2 < X1 THEN XINCREMENT = -1.

IF Y2 > Y1 THEN YINCREMENT = +1.
IF Y2 = Y1 THEN YINCREMENT = 0.
IF Y2 < Y1 THEN YINCREMENT = -1.

FOR X = X1 TO X2 STEP XINCREMENT
  FOR Y = Y1 TO Y2 STEP YINCREMENT
    PLOT(X,Y)
  NEXT Y
NEXT X

END.
```

Note that the input arguments (X1,Y1) and (X2,Y2) are used to specify the diagonally opposite corners of the area to be manipulated. They can be specified in any order, with the same results; it just draws in a different direction.

e.g. (X1,Y1)(X2,Y2)
(X1,Y2)(X2,Y1)
(X2,Y1)(X1,Y2)
(X2,Y2)(X1,Y1) are all equivalent.

The term PLOT in the algorithm refers to any of the three pixel operations: SET, CLEAR, INVERT.

Function 3 was initially intended only to reserve a number of screen lines for graphic use, by protecting them from scrolling. However, a lot of text drivers for the ETI-640 do not include a text mode FORM FEED function, so this feature was included for speed, as it is faster than the CLEAR

WINDOW function or the printing of multiple line-feeds. It can be easily removed if desired.

The only parameter passed to this function is the number of lines to be protected. The number should be in the range of 0 to 15 (decimal) if you are using a BINBUG monitor or something similar.

Single point functions

Functions 4, 5, 6 and 7 are the single pixel operations. As previously outlined, any screen point can be SET, CLEARed, INVERTed or TESTed. The TEST function returns a value of HEX'FF' (decimal 255) if the point was on, or a value of 00 if the point was off.

Any coordinates can be specified in the range of 0 to 255 with complete safety, when calling these functions. Any points outside the screen addressing range (i.e. if X is greater than 127 or if Y is greater than 63) will give a null result. The points are simply not plotted. The pixel TEST function will return a value of 0 in such a case.

These single point operations form the foundation of all the higher order functions, being called as necessary to plot lines, circles etc.

The single point functions share a common subroutine 'CONVRT' which converts the single-byte horizontal (X) and vertical (Y) screen coordinates into a VDU memory address pointer and a 'bit within byte' mask value.

The CONVRT subroutine is essentially the 'bit-twiddling' operation which dedicates the program to the ETI-640. Assuming similar screen resolution, any memory mapped VDU could be driven by this program merely by changing this subroutine to match the coordinate addressing scheme of your VDU.

One very important feature included in CONVRT is a test to determine whether the current screen byte about to be plotted is currently storing an ASCII character. If this is the case the screen byte is cleared to a 00 value and the byte's graphic attribute bit is set ON. This is necessary to avoid having the remaining bits of the original ASCII character showing up as gibberish when the new point is plotted. See the diagram below for the bit translation details of the ETI-640.

The CONVRT subroutine is ideally suited to hardware implementation, with the potential for useful (spelled H-U-G-E) speed improvements. ▶

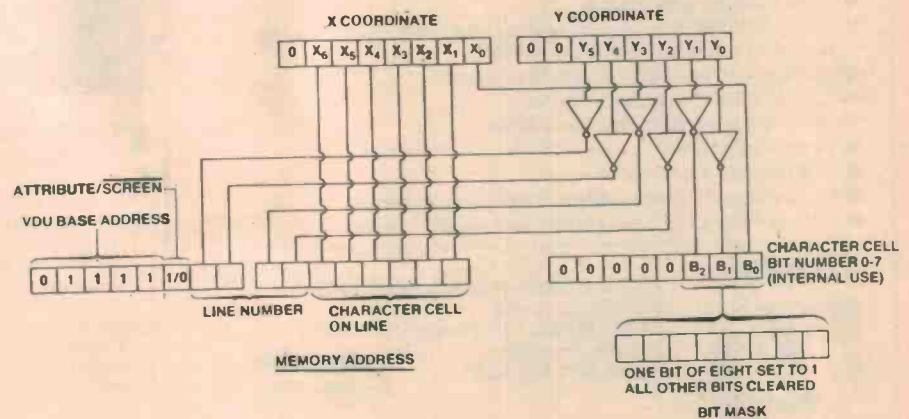

Bit translation details of the ETI-640.

WORLD'S MOST POPULAR SCANNER!

NEW J.I.L.SX-200



Now with optional 32 memories!

SPECIFICATIONS

- Type: FM & AM
- Frequency Range:
 - a) 26-57.995 MHz Space 5 kHz
 - b) 58-88 MHz Space 12.5 kHz
 - c) 108-180 MHz Space 5 kHz
 - d) 380-514 MHz Space 12.5 kHz
- Sensitivity:
 - FM a) 26-180 MHz 0.4µV S/N 12 dB
 - b) 380-514 MHz 1.0µV S/N 12 dB
 - AM a) 26-180 MHz 1.0µV S/N 12 dB
 - b) 380-514 MHz 2.0µV S/N 12 dB
- Selectivity:
 - FM More than 60 dB at -25 kHz
 - AM More than 60 dB at -25 kHz
- Dimensions: 210 (W) x 75 (H) x 235 (D) mm
8½ (W) x 3¼ (H) x 9¼ (D) in.
- Weight: 2.8 kg
- Clock Error: Within 10 sec./month
- Memory Channel: 16 Channels
- Scan Rate: Fast, 8 Channels/sec.; Slow, 4 Channels/sec.
- Seek Rate: Fast, 10 Channels/sec.; Slow, 5 Channels/sec.
- Scan Delay Time: 0 or 4 sec.
- Audio Output: 2 Watts
- Ant Impedance: 50-75 ohms Whip or External Antenna with LO/DX Control (20 dB ATT.)
- Freq. Stability: 26-180 MHz within 300 Hz, 380-514 MHz within 1 KHz

Also: NIRECOME FS-10 SERIES 10CH POCKET SCANNER

Crystal controlled the FS-10 is available in both VHF high and VHF low band versions. Using a unique dual transistor low noise cascade RF amplifier Nirecom have provided the FS-10 with an amazingly high sensitivity. Rechargeable batteries and charger are supplied as standard and a range of accessories is available.



EMTRONICS

Retail Division of FMONA ELECTRONICS P/L

649 George Street, Sydney, NSW 2000 Phone: (02) 211 0531

CORRESPONDENCE & MAIL ORDERS:

Box K21, Haymarket, NSW 2000

WRITE, PHONE OR CALL IN

Introducing the first complete single board computer for the S100 bus ...

SBC100 MASTER PROCESSOR

Provides all resources necessary for stand-alone CP/M operation, yet allows expansion into multi-processor and hard disk systems.

Features:

- Z-80A 4MHz
- Two serial ports (Z-80 DART—SIO optional)
- Two parallel ports (Z-80A PIO)
- NEC 765 floppy disc controller supports 4, 203 mm drives double sided, double density.
- 64K RAM (no wait states)
- 2732 4K EPROM supplied with system executive, may be switched out under software control.
- Intelligent Winchester interface (optional).
- IEEE 696 S100 standard interface.
- Software programmable baud rates.
- Time-of-day clock.
- Will operate stand-alone.
- Expandable into multi-user and hard disk systems.
- 4-layer PCB, all IC's socketted, high quality construction.

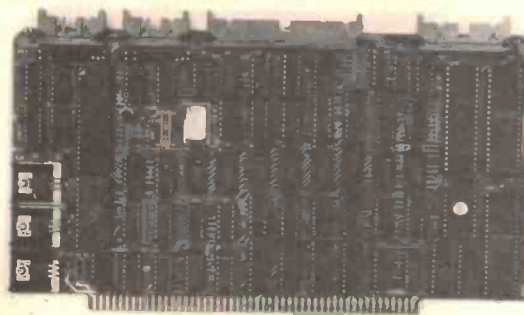

**N
E
W**

NOW AVAILABLE:

- System 1000 professional single user system and
- System 8000 multi-user, multi-processing system operating under TURBODOS; both based on the SBC100

We also stock VDUs, printers, and a large range of CP/M software.

We can provide individual boards, metalwork, single user systems, or complete multi-processor machines. Write for a full catalogue (enclose \$1) and be put on our mailing list. Mail orders are welcome. Prices and specifications subject to change without notice.



75 Grand Boulevard, Montmorency, 3094,
Victoria, Australia.
Postal: PO Box 158, Hurstbridge, 3099,
Victoria, Australia.
Phone: (03) 439 5257





S100 PRODUCTS

Australian Designed and Manufactured

What's New!

S100 Floppy Disc Controller

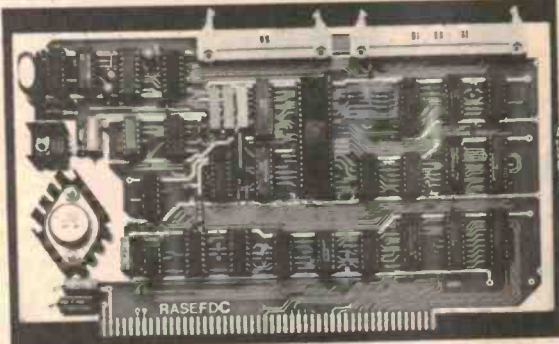

HIGH TECHNOLOGY PRODUCTS AND EXPERIENCE

GENERAL DESCRIPTION:

The extensive capabilities of the rasefdc are to a large part due to the presence of the Western Digital WD1795 double density controller chip. This device will perform the majority of the timing and control functions as required by floppy disk drives when carrying out the following operations:

1. Head loading and unloading.
2. Track seeking.
3. Address reading and writing.
4. Data conversion during read and write.
5. IBM3740 soft sector compatibility.
6. CRC error code inspection/generation.
7. Double density write precompensation.

The board uses the phase locked loop technique when recovering data from disk, the vco of the phase locked loop is under the control of the WD1691 circuit to ensure very reliable data recovery during double density operations. To ensure synchronism between the CPU and the controller card during disk read and write operations the rasefdc will insert wait states until the WD1795 is ready to pass or receive the next byte of data.

When used with rase80 CPU card the rasefdc card is available with full software support in the form of an eprom that is designed to interface with the rase80 monitor for console message passing. As well as the double density raw bios on the eprom there is a full disk diagnostic routine that permits the following operations to be carried out:

1. Head seek testing.
2. Sequential sector write/read testing with random data.
3. Read testing for CRC and seek errors.
4. Random sector write/read testing with random data.
5. Multi drive random write/read testing.
6. Disk formatting (any type of disk).

During implementation of the above tests, any errors that may occur are fully reported back to the console for operator action.

When using either CP/M or MP/M the rasefdc and rase80 CPU card are fully supported with boot, bios and xbios routines that will ensure a very smooth transition into the use of the above systems. Under normal circumstances the board operates within a polled environment, however when using interrupt based disk operating systems there are provisions for jumping the necessary interrupt onto the S100 bus.

Bare Board \$150.00 & tax

Kit Price \$345.00 & tax

Assembled & tested \$372.00 & tax

Manual Available Separately for \$12 inc. Postage

The Mitsubishi range of disc drives

M2896-63
Slimline 8" Disk Drive, Double Sided, Double Density, No AC power required, 3ms track to track, 1.6 mbytes unformatted, 77 track/side, 10⁹ bit soft error rate.
\$495 + tax. Box & Power supply to suit \$95 + tax

M2894
Standard size 8" drive, Double sides, double density, 3ms track to track access. 77 track/side. 10⁹ bit soft error rate.
\$495 + tax. Box & power supply \$95 + tax

M4854
Slimline 5 1/4" disk drive, Double sides, double density, 96 track/inch, 9621 bits/inch, 1.6 mbytes unformatted, 3ms track to track access, 77 track/side.
\$395 + tax. Box & power supply \$65 + tax

M4853
Slimline 5 1/4" disk drive, Double sides, double density, 1 mybyte unformatted, 3ms track to track, 80 track/side, 5922 bits/inch, steel band drive system.
\$375 + tax. Box & power supply \$65 + tax

S100 CPU Card

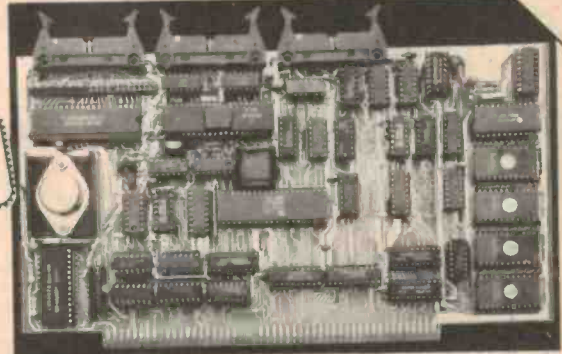

GENERAL DESCRIPTION:

- * Z80A CPU running at a full 4 Mhz
- * Battery backed real time clock and calendar
- * 2K of CMOS ram as standard
- * 2716/2732 Eprom from 2K to 16K
- * Z80A CTC with all 4 channels available to user
- * 2-RS232 serial ports available
- * Software controlled baud rates one each channel
- * 16-baud rates from 50-192200 baud available
- * 3-8 bit parallel ports via an 8255A
- * Centronics compatible printer port via 8255A
- * DMA operations supported
- * Power on jump to any 4K boundary in memory
- * On board memory enable/disable for full 64K operation
- * Vectored interrupt chain via Z80 CTC
- * Daisy chain interrupts through system full supported
- * Comprehensive 2K monitor available
- * Complemented by Disk, Memory and Input/output cards
- * Local software and hardware support available
- * A QUALITY AUSTRALIAN PRODUCT

What's Coming

- * 256K Dynamic Ram Card (\$100)
- * Intelligent Video Card (\$100)
- * Versatile I/O Card (\$100)
- * Hard Disc Controller

"Magnetic Media Experts"

We stock a very comprehensive range of diskettes

Verbatim Discs

- 5 1/4" SOFT SECTORED
- S- side double density \$30.00/10
- D- side double density \$47.50/10

- 8" SOFT SECTORED
- S- side single density \$32.00/10
- D- side double density \$49.00/10

Please write or call for full floppy disc price list.

Well Known Brand

12 month data guarantee

5 1/4 SS.DD.
for only \$29.00 for 10
plus tax

HI-TECHNOLOGY PRODUCTS

errors & omissions excepted

Available from:

Ritronics Wholesale Pty. Ltd.

48-50 A'Beckett St. Melbourne 3000 (03) 347 9251
425 High St. Northcote Vic. (03) 489 7099
Mail orders to P.O. Box 235 Northcote 3070 Vic.



Bankcard mail orders
ORDER FORM
Please Debit my Bankcard

No. _____
Expiry Date _____
Name _____
Signature _____



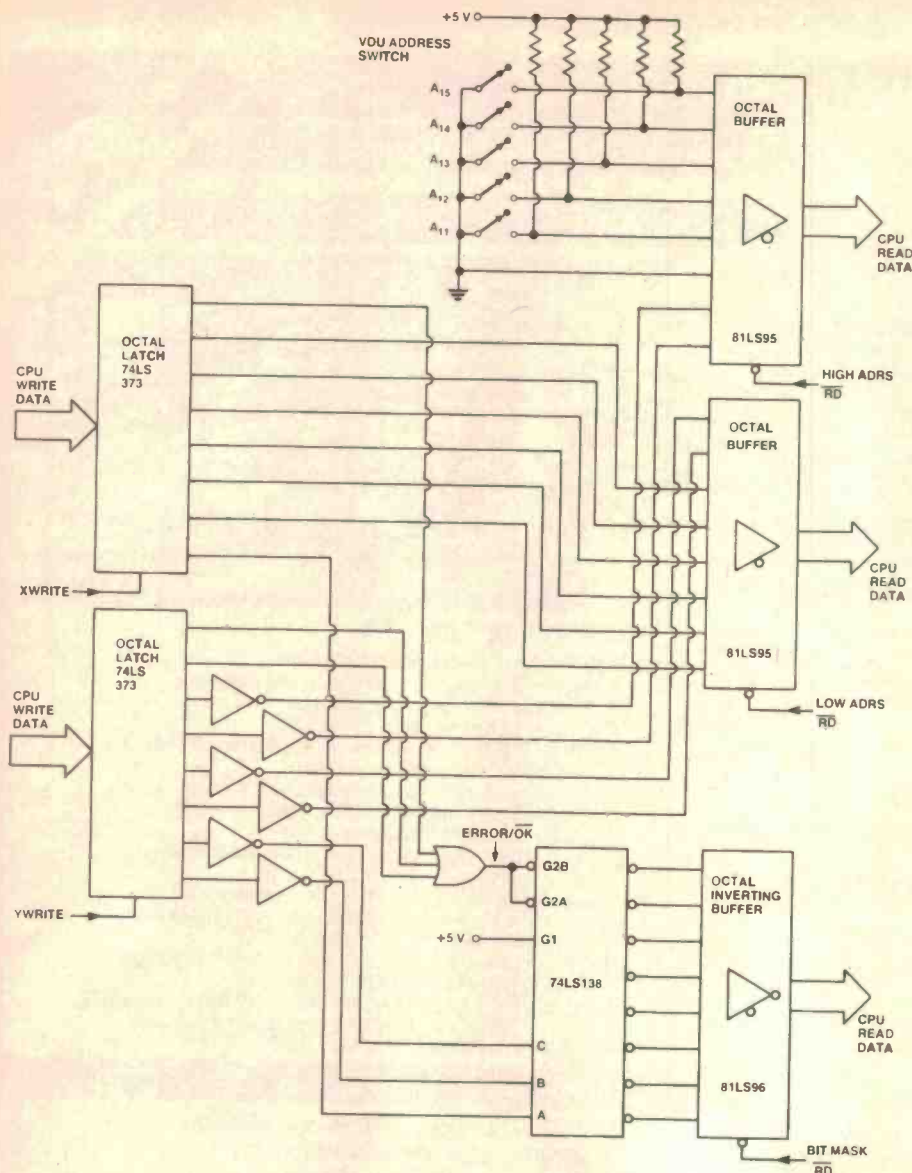

For anyone serious (silly?) enough about fast plotting, the diagram above shows one way this might be done. Note the use of the 'OR' gate to check for out-of-range coordinates and produce a 'safe' bit mask value in case of error.

The obvious extension to this idea is to directly manipulate the VDU memory with the hardware, via DMA. (Die-hard's Madness Accelerator).

Line operations

Developing this function caused a considerable amount of hair to reach escape velocity. The requirements it had to fulfill were fairly stringent if it was to be usable with the rest of the package.

1. No point in a line could be plotted more than once, or disruption of the INVERT LINE function would result, as two inversions of a pixel would leave it unchanged.
2. The steps in a gently sloping line must be evenly spaced, with equal distances to the first step points from each end of the line (see diagram).

If this requirement is met, the true line will pass through the middle of each line segment.

3. The points plotted on a line must always be adjacent, with no gaps, regardless of the slope of the line. This required the use of two separate loops, one for plotting lines equal to or less than 45 degrees, the other for lines steeper than 45 degrees.

Perusal of computer literature turned up the book 'Principles of Interactive Computer Graphics', a very informative little tome, even though it is written in High-Browsian. The authors are William M. Newman and Robert F. Sproull, if you are interested. Recommended reading.

In this book, chapter 2, page 25, the outline of a line drawing routine devised by J.E. Bresenham is given, written in the Pascal language.

This method has the advantage, for our purposes, of being able to work in integer quantities and does not require multiplication or division, making it very fast indeed. The Bresenham algorithm always steps one or both of the coordinates by an increment of plus or minus one, thereby solving our INVERT LINE function problem.

Much hair pulling at the keyboard later, we spotted an explanation of how it worked. This was indeed fortunate, as we didn't have a clue. The answer was in an article titled 'The Variable Duty-Cycle Algorithm' in Byte magazine, October 1981, page 311. The article described a new general class of algorithm with the highest fog index of anything we have ever seen. It seemed that the Bresenham algorithm was just one variant of this class. It took many re-reads before a faint glimmer of understanding dawned.

The VDC algorithm is a loop structure which conditionally performs an event once per loop cycle, depending on the ratio (duty cycle) of the control parameters. In our case, the condition-dependent event is a single step up or sideways, and the control parameters are the horizontal and vertical components of the line length, DELTA X and DELTA Y. The relative magnitude of these two values determine the ratio of steps-up to steps-sideways.

More effort later (you see, we really aren't all that smart) the VDC algorithm was bashed into its final shape as shown opposite.

The first statement in each line loop plots the intermediate point; the second statement tests to see if the end of the line has been reached yet. If so, the line is finished and the loop is exited.

The third statement of each line loop unconditionally steps the independent coordinate on by plus or minus one, then the value of RUNCOUNT is updated and tested to see if the dependant coordinate needs to be stepped. If not, a branch is taken back to the start of the loop to plot the next point at the same level.

If stepping is required, the dependant coordinate is incremented by plus or minus one, depending on the direction of line slope. The value of RUNCOUNT is updated to reflect the fact that a step was taken, followed by a branch back to the start of the loop to plot the next point at the new level.

The function of the ENDLINE portion of the algorithm is to swap the end coordinates (X2,Y2) of the now completed line into the start coordinate variables to create the 'Microsoft-ish' end-to-end line plotting feature of:

DRAW TO (NEWX2,NEWY2)

This nearly doubles the speed of line drawing when being driven from a BASIC program. The feature can be over-riden by simply specifying new starting coordinates if the lines are not to have joining end-points.

This routine was written using 8-bit arithmetic which limits the maximum specifiable coordinate values for any X or Y to 127. This choice was made in the interests of speed, a decision which has paid off. Line plotting is very fast. If a VDU with a greater coordinate addressing range than the ETI-640 is used then the use of 16-bit arithmetic will become mandatory. Otherwise the line plotting algorithm is extendable to any desired coordinate system.

* VARIABLE DUTY-CYCLE LINE PLOTTING ALGORITHM
 * Input parameters are- (X1,Y1) Line start coords
 * (X2,Y2) Line end coords

```

LINE  LET RUNCOUNT = 0.
      DELTAX = ABS(X2-X1)

      IF X2 > X1 THEN XINCREMENT = +1.
      IF X2 = X1 THEN XINCREMENT = 0.
      IF X2 < X1 THEN XINCREMENT = -1.

      DELTAY = ABS(Y2-Y1)

      IF Y2 > Y1 THEN YINCREMENT = +1.
      IF Y2 = Y1 THEN YINCREMENT = 0.
      IF Y2 < Y1 THEN YINCREMENT = -1.

      LET XPLOT = X1
      LET YPLOT = Y1

      IF DELTAY > DELTAX THEN DO LOOP2
      ELSE DO LOOP1
  
```

* Line loop 1 is used for lines equal to or less than 45 deg.
 LOOP1 PLOT(XPLOT,YPLOT)
 IF XPLOT = X2 THEN GOTO ENDLIN

```

XPLOT = XPLOT + XINCREMENT
RUNCOUNT = RUNCOUNT + DELTAY
  
```

IF RUNCOUNT < DELTAX - RUNCOUNT THEN GOTO LOOP1

```

YPLOT = YPLOT + YINCREMENT
LET RUNCOUNT = RUNCOUNT - DELTAX
GOTO LOOP1
  
```

* Line loop 1 is used for lines steeper than 45 degrees.
 LOOP2 PLOT(XPLOT,YPLOT)
 IF YPLOT = Y2 THEN GOTO ENDLIN

```

YPLOT = YPLOT + YINCREMENT
RUNCOUNT = RUNCOUNT + DELTAX
  
```

IF RUNCOUNT < DELTAY - RUNCOUNT THEN GOTO LOOP2

```

XPLOT = XPLOT + XINCREMENT
RUNCOUNT = RUNCOUNT - DELTAY
GOTO LOOP2
  
```

* End of line, swap end coords into start variables
 * to create "DRAW TO (X2,Y2)" function.

```

ENDLIN LET X1 = X2
      LET Y1 = Y2
      RETURN
  
```

to be concluded next month. ●

Bright Star Crystals Pty Ltd

PO Box 42, Springvale.
 Ph (03) 546-5076 Telex AA36004

Manufacturers of

PIEZO ELECTRIC CRYSTALS

Contractors to Federal and State
 Government Departments.

REPRESENTATIVES:

NSW: Master Communications,
 27 Woodville Rd., Granville N.S.W.
 (02) 682 5044.

SA: R.W. Electronics, 51 Woodville Ave.,
 Riddleton S.A. (08) 464 571.

36 years in the business

AND STILL ON TOP

QLD: Fred Hoe & Sons P/L, 246 Evans
 Rd., Salisbury North, Brisbane.
 (07) 277 4311.



CRYSTAL UNITS

- Decade Counting Units to 1 Hz.
- Wide Band Amplifier for your counter, 1MV sensitivity, band width 1-250 MHz.

Send SAE for new catalogue or quote for your requirements.

For System 80™, TRS-80™ Model I/III and Colour Computer owners:

ONE BIG ISSUE OF MICRO-80 MAGAZINE FREE!

If you own one of these computers, you should be reading MICRO-80 magazine, the magazine not only written by enthusiasts, but actual owners and operators of the same computers you use.

MICRO-80 understands your needs, is vital reading from cover to cover and features six new programs in each issue with full operating instructions.

An analysis of each program's structure and operation is included to help you improve your own programming capabilities.

Instructional articles on programming techniques, hardware improvements and answers to readers' problems are also published each month.

ANOTHER MICRO-80 PLUS

Readers can purchase a wide range of software and hardware for their systems at keen prices.

DON'T DELAY, ACT TODAY

Either telephone your order on (08) 211 7244 (4 lines) or send in the coupon today.

TRS-80 is a trademark of the Tandy Corporation. System 80 is a trademark of Dick Smith Electronics.

Please send me your free issue of MICRO-80

My computer is a: System 80 Model I Model III Colour

Name _____ Address _____ P/code _____

Bankcard No. _____ Exp. End _____ Signature _____

(a) Please debit my Bankcard
 (b) I enclose a cheque for \$26.00

To: Micro-80
 P.O. Box 213,
 Goodwood,
 S.A. 5034

ETI

GREAT NEW PRODU

You may have wondered why Jaycar did not (until now) sell home computers. We had many reasons but our main one was that we were not entirely "happy" with any of the units currently on the market. The closest we came to what we thought was a pretty good computer was the Apple. We thought that it was, quite frankly expensive. However it was sold and serviced throughout Australia by a reputable sales network — so there was no need for Jaycar!

That's why we got so excited when we saw the "Micro Professor MkII". It is the closest thing that we have seen to be software compatible with the Apple. Yes, we know what you're thinking. It's NOT one of those cheap Taiwanese "Apple" copies which infringe Apples' copyright. The Micro Professor MkII is a completely new and unique design in its own right. It just so happens that most of the widely distributed Apple software will run on this machine. O.K. But why so excited? LOOK AT THE PRICE! Check out the STANDARD FEATURES of this unit. Sit down. Think about it and COMPARE what you get with the Micro Professor MkII as STANDARD that are options on other machines!

6 Colours



COMPUTER Only \$658 SENSATION!

MICRO-PROFESSOR II OUTSTANDING!
Low cost colour computer with APPLE compatibility*



Cat. YC1300

*Most Apple Soft II BASIC programs will run on the MPF II.

SPECIFICATIONS	
CPU	8050Z
RAM	8K Bytes
BASIC	64K Bytes
Interface	More than 90 instructions stronger than those for Apple II
Video Display	Memory mapped into system RAM
Type	Text, low resolution graphics, high resolution graphics (3 modes are mixed)
Screen Format	950 characters (24 lines, 40 columns)
Character Set	Upper case ASCII, full character
Character Type	8 x 7 dot matrix
Graphics Capacity	1920 lines (low resolution) in 40 x 48 array, 33760 dots (high resolution) in 280 x 182 array
Number of Colors	6 colors
Keyboard	48 alphanumeric and function keys
Case	Use various cassette tape and cartridge as disk storage units
Software	Connect to printers with Centronics I/F
Printer	Connect to color TV or video display
Display	Unit for protection & error treatment
Dimensions	8 ohm, 58mm, 0.25W
Speaker	A switching power supply is provided to convert AC power to required power
Power	24.1 x 175 x 30mm

PRO-GRADE SOLDER SUCKER

SEE REVIEW EA DECEMBER 1982
Our claim. The best solder sucker for its price in Australia!

- Unique double diaphragm design
- O-ring seal
- Spare O-rings supplied
- Teflon tip
- Self-cleaning plunger
- One hand operation
- Non slip body
- Pro-grade for heavy usage.
- 225(l) x 28(d)mm
- Spare Teflon tip \$1.95

ONLY \$11.95



Cat. TH1820

COOLING FANS 240VAC



Quality Bell Race construction, now you pay no more for quieter, much longer lasting and more efficient ball bearing fans from Jaycar!

TWO POPULAR SIZES:	
12 WATTS - 80x80x42(d)	\$24.95 Cat. YR2510
13.8 WATTS - 110x110x29(d)	\$27.50 Cat. YR2514

MORE GREAT KITS

Cat. No.	DESCRIPTION OF KIT	Ref.	PRICE
KA1300	FUZZ BOX COMPLETE	EA 1/81	\$ 19.50
KA1320	LE GONG	EA 3/81	\$ 13.95
KA1346	PC BIRDSIES SHORT FORM	EA 5/81	\$ 14.95
KA1370	PHOTON TORPEDO	EA 9/81	\$ 29.50
KA1400	METRONOME	EA 1/82	\$ 16.95
KA1402	EPROM PROGRAMMER	EA 1/82	\$ 59.00
KA1406	CUDLIPP CRICKET SHORT FORM	EA 2/82	\$ 12.50
KA1408	DIGITAL STORAGE CRO ADAPTOR	EA 2/82	\$110.00
KA1430	VOCAL CANCELLER	EA 4/82	\$ 19.50
KA1432	VOX RELAY SHORT FORM	EA 4/82	\$ 14.50
KA1450	GUITAR BOOSTER	EA 6/82	\$ 14.50
KA1452	SUBWOOFER MOSFET AMP	EA 7/82	\$ 79.00
KA1454	SUBWOOFER ENCLOSURE	EA 8/82	\$ 79.00
KA1476	STEREO SYNTHESISER SHORT FORM	EA 9/82	\$ 38.50
KA1478	STEREO SYNTHESISER COMPLETE	EA 9/82	\$ 49.50
KA1482	POWER UP KIT COMPLETE	EA 11/82	\$ 39.50
KA1484	SUPPER SIREN SHORT FORM	EA 11/82	\$ 5.00
KA1490	BOGGLE GOGGLES	EA 12/82	\$ 9.50
KA1492	PH METER LCD	EA 12/82	\$ 69.00
KA1494	PROBE FOR PH METER WITH BUFFER		\$ 69.00
KA1498	AM WIDEBAND TUNER	EA 12/82	\$249.00
KA1500	LED HEAD SHORT FORM	EA 1/83	\$ 9.95
KA1510	STEREO SYNTHESISER SHORT FORM	EA 4/83	\$ 11.95
KA1515	ALIGNMENT KIT AM TUNER	EA 3/83	\$ 7.95
KE4050	50 WATT AMP MODULE	ETI 480	\$ 23.00
KE4052	100 WATT AMP MODULE	ETI 480	\$ 27.00
KE4064	PREAMPLIFIER MODULE	ETI 480	\$ 30.00
KE4090	GENERAL PURPOSE PREAMPLIFIER	ETI 445	\$ 7.99
KE4092	AUDIO LIMITER	ETI 446	\$ 12.00
KE4094	BALANCED MICROPHONE PREAMPLIFIER	ETI 449	\$ 5.50
KE4105	CAR ALARM	ETI 330	\$ 29.50
KE4205	LED LEVEL METER	ETI 458	\$ 59.00
KE4206	MC MOVING COIL PREAMPLIFIER	ETI 478	\$ 26.50
KE4207	MM MOVING MAGNET PREAMPLIFIER	ETI 478	\$ 19.50
KE4210	MOSFET AMPLIFIER	ETI 477	\$ 58.00
KE4220	150 WATT MOSFET AMPLIFIER	ETI 499	\$ 79.50
KE4222	150 WATT MOSFET PREAMPLIFIER	ETI 498	\$ 39.50
KE4225	BRIDGING ADAPTOR	ETI 479	\$ 9.95
KE4405	+/- 15 VOLT POWER SUPPLY	ETI 581	\$ 17.50
KE4410	POWER SUPPLY 13.8 VOLT/10 AMP	ETI 160	\$ 79.50
KE4505	SOUNDBENDER SHORT FORM	ETI 492	\$ 24.50
KE4552	UHF CONVERTOR	ETI 735	\$ 32.50
KE4554	VIDEO MODULATOR	ETI 760	\$ 12.99
KE4560	LOW OHMS METER	ETI 158	\$ 29.50
KE4570	POWER SUPPLY 0 - 30 VOLTS 1 AMP	ETI 162	\$ 49.50
KE4600	MODEM SHORT FORM	ETI 644	\$169.00
KE4602	MODEM COMPLETE	ETI 644	\$169.00
KJ6502	SYNTOX DRUM SYNTHESISER KIT		\$ 36.50
KJ6508	CHORUS GENERATOR KIT		\$ 69.95
KJ6510	SHORT FORM IONISER KIT		\$ 14.50
KJ6511	FULL IONISER KIT		\$ 29.50

TRANSISTOR ASSISTED IGNITION - OPTO OPTION

We now have the breakerless OPTO Ignition kit for the popular TAI

This kit uses the genuine MIL-SPEC 5401 IC as well as the hermetically sealed Texas photodiode/transistor pair.

GRAB A KIT FOR ONLY \$14.50
Cat. KA1507



MAGAZINE BINDER

Keep your precious (and expensive) magazines in order for easy reference. Smart blue colour with gold lettering. Heavy gauge and richly chromed metal fittings.
LOW IMPORT PRICE
ONLY \$4.95
4 up \$4.50 each



2SC2545. The low noise transistor for pre-amps (See EA April 1983)
Jaycar has them!
Only \$1.95
Cat. ZT2400



'T - REX'

Our wirestripper, nicknamed 'Tyranosaurus-Rex' is far from extinct! It's a great way to strip all sorts of cable without damaging the conductors. It's also a price breakthrough!!
— Automatically adjusts to insulation diameter.
— One hand operation.
— New low price for an automatic wirestripper

Cat. TH1824

ONLY \$9.95

CITS - FROM JAYCAR



VIDEO SENSATION AT LAST
A Video Enhancer/
Distribution Amplifier
designed
EXCLUSIVELY
for AUSTRALIA

Jaycar has had designed a high quality, high performance Video Enhancer which is specifically for the Australian 625 line 50 frame PAL-D system.

As far as we know it is the **ONLY** Australian-designed, Australian-built unit available!!

But, guess what? The Jaycar AV6501 Enhancer is **CHEAPER** than its inferior imported Asian counterparts!!

This unit is professionally designed and University tested! It works and it works well.

SPECIFICATIONS

- 01 Maximum enhancement, not less than +8.3dB @ 2MHz
- 02 Enhance disabled (Bypass) response, DC to 5MHz, -0.5-1.0dB, 0.5dB, all settings.
- 03 Colour Subcarrier 0dB notch frequency, tunable to 4.43 MHz, -12.95
- 04 Amplifier group delay, less than 0.075µs
- 05 Signal handling capability not less than 1.35 volts p.p. (Sync. is clipped first).
- 06 Power 12V AC @ 100mA
- 07 Controls, ON/OFF, ENHANCE, ENHANCE/BYPASS SWITCH, CORE/GAMMA CONTROL
- 08 Input connector, RCA socket
- 09 Output connector, RCA socket x 3

DESIGN FEATURES

- 01 A unity gain notch at the colour subcarrier frequency, whose purpose is to prevent chrominance to luminance errors at high enhance levels.
- 02 A closed loop configuration with lead lag compensation to achieve stable, well defined gain.
- 03 DC coupling, eliminating large capacitors in series with the video signal and achieving DC response for applications requiring it.
- 04 Low output impedance prior to termination resistors, enabling up to three outputs to exist and be used or left unterminated.
- 05 A level dependent closed loop response or Gamma control (Cors)
- 06 Clip on negative going signals at -67 volts into 75 ohms to prevent sync errors owing to overshoot.

200V POWER ADAPTER \$12.95

VALUE \$49.50

Cat. AV6501

NOT A KIT BUILT, TESTED AND GUARANTEED KIT VERSION ONLY \$39.50

We are proud to announce a great new range of **DIRECT IMPORT** all - ABS plastic cases for the discerning electronics enthusiasts. Quite frankly we are sick and tired of those black flimsy styrene boxes with their Aluminium lids. They split, they shatter and they look plain **ORDINARY**. Shown below is a range of boxes that is going to revolutionise your small projects. Each box has a precision fitting **MOULDED** lid (in the same colour as the box) with moulded-in brushes to take metal-thread countersunk screws. True quality. Naturally each box has slots formed in the sides to take PCB's etc. Most are available in 4 beautiful colours - Black is one of them!! Shown also are 2 new sizes of die cast box. Note the sizes.

CONSOLE BOXES

- EACH UNIT HAS AN ALUMINIUM FRONT PANEL**
- SIZE - 461(W) x 96(D) x 39(HF) x 57(HR)mm
Cat. HB6200 - ORANGE Cat. HB6201 - GREY Cat. HB6202 - BLUE Cat. HB6203 - BLACK
PRICE 1 - 9 UNITS ONLY \$6.95 EACH; 10 OR MORE \$6.45 EACH
- SIZE - 215(W) x 130(D) x 47(HF) x 73(HR)mm
Cat. HB6210 - ORANGE Cat. HB6211 - GREY Cat. HB6212 - BLUE Cat. HB6213 - BLACK
PRICE 1 - 9 UNITS ONLY \$12.95 EACH; 10 OR MORE \$11.95 EACH
- SIZE - 105(W) x 143(D) x 32(HF) x 56(HR)mm
Cat. HB6220 - GREY Cat. HB6221 - BLUE Cat. HB6222 - BLACK
PRICE 1 - 9 UNITS ONLY \$7.95 EACH; 10 OR MORE \$7.45 EACH
- SIZE - 170(W) x 143(D) x 32(HF) x 56(HR)mm
Cat. HB6230 - GREY Cat. HB6231 - BLUE Cat. HB6232 - BLACK
PRICE 1 - 9 UNITS ONLY \$9.95 EACH; 10 OR MORE \$9.45 EACH
- SIZE - 170(W) x 214(D) x 32(HF) x 82(HR)mm
Cat. HB6240 - GREY Cat. HB6241 - BLUE Cat. HB6242 - BLACK
PRICE 1 - 9 UNITS ONLY \$12.95 EACH; 10 OR MORE \$11.95 EACH

RECTANGULAR BOXES

- SIZE - 100(L) x 50(W) x 25(D)mm
Cat. HB6120 - ORANGE Cat. HB6121 - GREY Cat. HB6122 - BLUE Cat. HB6123 - BLACK
PRICE 1 - 9 UNITS ONLY \$3.95 EACH; 10 OR MORE \$3.45 EACH
- SIZE - 112(L) x 62(W) x 31(D)mm
Cat. HB6130 - ORANGE Cat. HB6131 - GREY Cat. HB6132 - BLUE Cat. HB6133 - BLACK
PRICE 1 - 9 UNITS ONLY \$4.75 EACH; 10 OR MORE \$4.25 EACH
- SIZE - 120(L) x 65(W) x 40(D)mm
Cat. HB6140 - ORANGE Cat. HB6141 - GREY Cat. HB6142 - BLUE Cat. HB6143 - BLACK
PRICE 1 - 9 UNITS ONLY \$4.95 EACH; 10 OR MORE \$4.45 EACH
- SIZE - 150(L) x 80(W) x 50(D)mm
Cat. HB6150 - ORANGE Cat. HB6151 - GREY Cat. HB6152 - BLUE Cat. HB6153 - BLACK
PRICE 1 - 9 UNITS ONLY \$5.45 EACH; 10 OR MORE \$4.95 EACH
- SIZE - 190(L) x 110(W) x 60(D)mm
Cat. HB6160 - ORANGE Cat. HB6161 - GREY Cat. HB6162 - BLUE Cat. HB6163 - BLACK
PRICE 1 - 9 UNITS ONLY \$9.95 EACH; 10 OR MORE \$9.25 EACH

DIE CAST BOXES

- NATURAL GREY FINISH**
SIZE: 50 x 50 x 31mm Cat. HB5010 1-9 \$3.95 each; 10 or more \$3.45 each
SIZE: 190 x 110 x 60mm Cat. HB5016 1-9 \$12.95 each; 10 or more \$11.95 each.

JAYCAR

SEE THE OTHER JAYCAR ADS IN THIS MAGAZINE FOR OUR STORE ADDRESSES AND PHONE NUMBERS. . .

Video Enhancer

NOT A KIT BUILT AND TESTED. . .

Cat. AV6500

\$89



Unbelievable but true. This unit enables you to actually **IMPROVE** a copy of a recorded video tape. How? By amplifying the top end of the video signal by a small amount. This sharpens up the detail of the picture. Dubs can actually look better than the original. Works as a video distribution amplifier as well. Will drive up to 3 VCR's from one VCR input.

VIDEO STABILISER Cat. AV6502

As many of you know, many video tapes, - especially from the USA have the sync pulses suppressed to prevent unauthorised copying of the original dub. This process is fine because it hinders unauthorised re-recording (dubbing) of material. It is annoying though when you hire the original and find that the "Copyguard" is causing problems with your TV. The AV6502 re-inserts the sync pulses automatically and restores stability.

WARNING! The AV6502 is intended solely for the use above. Whilst the AV6502 will virtually remove copyguard on a tape copy (and hence restore the picture) it is against the law to unlawfully copy copyright material.

The AV6502 looks almost identical to the AV6500 **ONLY \$79.95**

NEW Touch Sensitive Light Dimmer



Ref: EA April 1983

Complete kit including quality HPM wall plate with attractive brushed metal insert. The Jaycar kit is absolutely complete including a small dial spring which can be used to connect the PCB to the wall plate. (Beware of other kits that do not include this). In addition to the above, we supply the High Voltage Resistors **ALREADY SOLDERED** in as a foolproof safety feature! Buy the complete kit for this exciting project for only Cat. KA-1508

only \$19.95



ETI 160 POWER SUPPLY

Ref: ETI July 1982

13.8V DC 7.5 amps continuous 10 amps intermittent

Great for powering your mobile rig at home! This regulated, short circuit proof unit is perfect.

Cat. KE4410

ONLY \$79.50

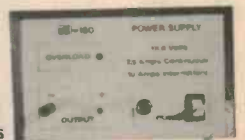

BOXES MULTI PURPOSE

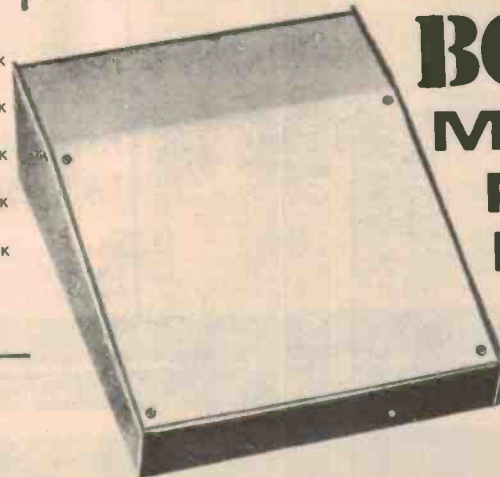



RITRONICS WHOLESALE PTY. LTD.

DISCOUNT CITY STORE

48-50 A'Beckett Street, Melbourne 3000, Ph.: (03) 347 9251
Mail orders to P.O. Box 235, Northcote 3070

You Will Never Have to Pay Full Price for Components Again!

The Mitsubishi range of disc drives

M2896-63
Slimline 8" Disk Drive, Double Sided, Double Density, No AC power required, 3ms track to track, 1.6 mbytes unformatted, 77 track/side, 10^9 bit soft error rate.

\$515 + tax. Box & Power supply to suit \$95 + tax

M2894

Standard size 8" drive, Double sides, double density, 3ms track to track access, 77 track/side, 10^9 bit soft error rate.

\$515 + tax. Box & power supply \$95 + tax

M4854

Slimline 5 1/4" disk drive, Double sides, double density, 96 track/inch, 9621 bits/inch, 1.6 mbytes unformatted, 3ms track to track access, 77 track/side.

\$385 + tax. Box & power supply \$65 + tax

M4853

Slimline 5 1/4" disk drive, Double sides, double density, 1 mybyte unformatted, 3ms track to track, 80 track/side, 5922 bits/inch, steel band drive system.

\$385 + tax. Box & power supply \$65 + tax

HI TECHNOLOGY PRODUCTS AND EXPERIENCE

CPM SYSTEMS

Twin 8"
4 MHz Double Density
Big Board (2) \$2950.00 + tax
Twin 5" Drives
4 MHz Double Density
Big Board \$2250.00 + tax

Ring for Details

HARD DISC DRIVES ARE HERE!

5 megabyte \$900 + tax
10 megabyte \$1250 + tax
Controller to suit \$495 + tax
Box and Power Supply \$225 + tax

CENTRONICS CONNECTORS

Solder type
Male \$9.50 + tax
Female \$9.50 + tax

BIG BOARD (1) NEWS

Double density add on
\$195 + tax (incl. software and hardware)
Hard disc interface \$195 + tax

MPI DISC DRIVES

to suit Tandy and System 80 Computers) with box and power supplies)

1 DRIVE 2 DRIVES
B51 \$295 + tax \$550 + tax
B52 \$375 + tax \$750 + tax
B91 \$460 + tax P.O.A.
B92 \$550 + tax P.O.A.



Table with columns for product names (e.g., LINEAR REGULATORS, HYBRID REGULATORS, TRANSISTORS) and prices.

SCOTCHCAL RANGE OF PHOTSENSITIVE PRODUCTS.

Table listing Scotchcal products (e.g., 8001 Red on Aluminium) with dimensions, per sheet, and per box prices.

All prices plus Sales Tax. Dealer and Trade Inquiries welcome. Please note full range of products are available on order. Please contact Tim Bray on (03) 489-7099 for further information.

RITRONICS WHOLESALE FOR FAIRCHILD DISTRIBUTION

All prices plus 20% tax
Transistors plus 32.5% tax
Post \$2 Heavy items extra



Bankcard mail orders welcome
ORDER FORM
Please Debit my Bankcard

No. Expiry Date Name Signature

RITRONICS WHOLESALE PTY. LTD.

48-50 A'Beckett St., Melb. 3001. Telephone: (03) 347 9251



Errors and omissions excepted.

ADVERTISING PROMOTION OFFER!

JUNE ETI

SEND THIS ADVERT. OR A COPY, WITH YOUR ORDER TO THE VALUE OF \$20 OR MORE, AND WE'LL GIVE YOU A FREE PAIR OF QUALITY STEREO HEADPHONES (NORMAL RRP- \$14.95) Your response will enable us to assess the value of advertising in this issue.



Dynamic stereo headphones • ADJUSTABLE HEAD-BAND • SOFT FOAM EAR CUSHIONS • 250 ONLY AVAILABLE

Free Gift Offer!

Super Savers

Save on Hi-Fi SPEAKERS

8 INCH 25 WATT 3 WAY RMS PAIR ONLY

\$89

DON'T PAY UP TO \$159 OR MORE FOR 8 INCH 3 WAY SPEAKERS! THESE FACTORY-MADE SPEAKERS ARE IN BEAUTIFUL WALNUT WITH BLACK CLOTH. 8 OHMS

Z80 SINGLE BOARD \$100 COMPUTER SBC 2/4

SALE! LAST 2 DAYS! \$239

\$199 NO S/TAX KIT PRICE. BUILT & TESTED. \$249 no Tax BARE BOARD \$79.20 PLUS MANUAL. \$66 no Tax ADD FREIGHT: \$4.00 ONLY

TAKE YOUR PICK!

LUCKY-DIP PACKS \$2 EA

- 500 1/4WATT RESISTORS
- 200 1/4WATT RESISTORS
- 50 1/2 HI-STAB RESISTORS
- 20 MIXED POTENTIOMETERS
- 25 PRESET POTS ASST.
- 30 POLY. GREENCAPS
- 100 CERAMIC CAPACITORS
- 45 ELECTROLYTIC CAPS
- 12 VARIOUS SWITCHES
- 40 RADIO/TV KNOBS
- 50 ASST TAGSTRIPS

\$2 EACH PACK

THE MODERN PHONE DIALER

• EASY INSTAL IN MINS

• ONLY 3 WIRES

• IVORY COLOUR

• FULLY G'TEED

• LED INDICATOR

• LAST NUMBER MEMORY REDIAL

if called number is engaged NOW ONLY **\$20 EA**

Direct replacement for rotary dial. Not approved by Telecom currently. BUY 5+ \$19 EA.

ex-computer ELECTROS

FULLY GUARANTEED. TESTED!

21,000uF .75V	\$2.50
20,000uF .10V	\$3.50
90,000uF .10V	\$6.00
4,600uF .15V	\$2.00
15,000uF .15V	\$4.00
120,000uF .15V	\$9.00
7,200uF .20V	\$4.00
10,000uF .20V	\$5.00
46,000uF .20V	\$7.50
58,000uF .20V	\$8.00
8,200uF .25V	\$4.00
12,000uF .25V	\$4.50
19,000uF .25V	\$6.00
22,000uF .25V	\$6.50
50,000uF .25V	\$8.00
71,000uF .25V	\$9.00
2,000uF .30V	\$1.50
16,000uF .30V	\$5.00
26,000uF .30V	\$6.50
37,000uF .30V	\$7.50
40,000uF .30V	\$8.00
8,300uF .40V	\$4.00
5,500uF .45V	\$4.00
20,000uF .45V	\$7.00
8,000uF .50V	\$7.50
15,000uF .63V	\$9.00
6,300uF .75V	\$4.00
22,000uF .75V	\$11.00
14,500uF .100V	\$12.00
1,700uF .150V	\$4.00
3,100uF .150V	\$6.00

This is a sample of our huge range, please ask for others

PACK & POST

\$2.00 PLUS 5% OF ORDER VALUE

12V 120mA LAMP

10c ea.

12V DC ROTARY SOLENOID STEPPING SWITCH

\$12.99

12 POSITION, SINGLE POLE, SHORTING.

64K \$100 STATIC RAMBOARD

BARE BOARD..... \$105
KIT (NO RAM)..... \$165
ASSEMBLED 64K.... \$430

Plus Sales Tax 20% If applic.

- 150ns RAMs standard fitting.
- Board access time under 200nanosec.
- Uses popular 2716 pinout type static rams.
- ATI data, status and address lines fully buffered.
- Top BK may be switch disabled and/or interchangeable with 2716 type Eproms.
- Extremely low power dissipation (500mA typical).

256K \$100 DYNAMIC MEMORY BOARD

BARE BOARD.. \$215
ASSEMBLED... \$1,095

PLUS SALES TAX 20% EXTRA

- 16K to 256K bytes; uses 4116 or 4516 or 4164 memory devices.
- Guaranteed to operate at 4MHz with Z80, 8080, 8085 micros.
- Adjustable timing allows operation with Z80, 8080, 8085 micros.
- Can be divided into max. 16 banks, each variable in 4K add-ons.
- Each 4K segment can be individually enabled or disabled easily.
- Each bank can be located on any 4K boundary.

PARTY STROBE

\$12.50

NORMAL PRICE \$29.95
SAVE NEARLY 17.50

"Freeze" the action at your next party or theatrical show! Mains operated with a continually variable flash rate, housed in an attractive black vinyl box 150mm

REWORKED WARRANTY STOCK

DC MOTORS

6-12V

LARGE SIZE! IDEAL FOR TOYS, MODEL BOATS, CARS, HOBBY ETC.

OPERATES FROM 4.5V TO 12V, POWERFUL AND RUGGED. SIZE 47MM DIAM X 60MM

\$3.00 10 for \$25

YOUR HOME OF BARGAINS!

PAKS OF ASSORTED POTS

20 MIXED VALUES Linear, 10c our choice! **\$3**

100 MIXED VALUES Dual, switched, all new **\$10**

250 MIXED VALUES Bonus bulk package! **\$20**

SEMIS

NPN UNMARKED TO-5 TRANSISTORS
40V 500MA SILICON

20 for \$1.10	for \$4.1K	\$30
BC547	10 for	90c
BC558	10 for	\$1
BC559	10 for	\$1
BC228	10 for	90c
BC204 (BC557)	10 for	50c
BD237 80V 2A 25 WATT	2 for	\$1
1T800	2 for	\$1
1T801	2 for	\$1
2SC1307	2 for	\$6

RECTIFIERS, DIODES ETC.

0A91	5 for	70c
1N914/1N4148	10 for	60c
1N4002	10 for	60c
100P1V 5AMP	6 for	\$2
400P1V 5AMP	4 for	\$3
1N5626 600V1V JAMP	5 for	\$2

BRIDGE RECTIFIERS

W02 200V 1.5A 5 for \$2.65

400VOLT 5AMP 2 for \$3.95

KBPC25-10 1000VOLT 25AMPS 2 for \$8.95

SCR TS-1218... 4 for \$2
TO-66 200 VOLT 10 AMPS

SCR TS-1232... 3 for \$1
TO-5 100 VOLT 1 AMP

ALL NEW! ELECTROS

220uF 25v pcb	10 for	\$2
220uF 25v ax	12 for	\$2
330uF 63v ax	5 for	\$2
400uF 40v ax	6 for	\$2
470uF 25v pcb	8 for	\$2
470uF 25v ax	10 for	\$2
470uF 63v ax	4 for	\$2
640uF 16v pcb	9 for	\$2
1000uF 16v ax	6 for	\$2
1000uF 25v pcb	5 for	\$2
2200uF 16v pcb	4 for	\$2
2500uF 25v ax	2 for	\$2
3300uF 6.3v ax	4 for	\$2
2000uF 64v can	2 for	\$8
5500uF 25v can	2 for	\$8
15000uF 75v can	1 ea	\$12

CAPACITORS

100pF ceramic	15 for	\$1.00
0.001uF ceramic	15 for	\$1.00
0.01uF 50v cer	15 for	\$1.00
0.01uF 500v cer	8 for	\$1.00
0.047uF ceramic	12 for	\$1.00
0.1uF ceramic	12 for	\$1.00
0.001uF 630v poly	8 for	\$1.00
0.001uF 1kv styro	5 for	\$1.00
0.0068uF 600v styro	6 for	\$1.00
0.01uF 400v poly	10 for	\$1.00
0.015uF 200v poly	12 for	\$1.00
0.022uF 250v poly	9 for	\$1.00
0.047uF 200v poly	8 for	\$1.00
0.056uF 1kv poly	2 for	\$1.00
0.068uF 100v poly	7 for	\$1.00
0.068uF 400v poly	5 for	\$1.00
0.1uF 100v poly	5 for	\$1.00
0.1uF 630v GC poly	3 for	\$1.00
0.15uF 100v poly	6 for	\$1.00
0.15uF 250v poly	5 for	\$1.00
0.22uF 100v poly	5 for	\$1.00
0.22uF 250v poly	5 for	\$1.00
0.27uF 250v GC poly	5 for	\$1.00
0.33uF 100v poly	4 for	\$1.00
0.33uF 250v poly	4 for	\$1.00

GREENCAPS 100V POLYESTER

0.001uF, 0.0022uF, 0.0033uF, 0.0047uF, 0.0068uF, .25 for \$2.00

0.01uF, 0.022uF, .20 for \$2.00

0.033uF, 0.047uF, .14 for \$2.00

0.056uF, 0.068uF, .13 for \$2.00

0.082uF, .15 for \$2.00

0.1uF, .10 for \$2.00

0.22uF, .9 for \$2.00

0.39uF, .8 for \$2.00

0.47uF, .6 for \$2.00

LEDs

3mm Round
RED... 10c
GREEN... 15c
YELLOW... 15c

5mm Round
RED... 10c
GREEN... 15c
YELLOW... 15c

5x2mm Rect
RED... 20c
GREEN... 25c

FLASHING LED
5mm RED ONLY... 35c
SUPER-BRIGHT LED
5mm GREEN... 59c
5mm YELLOW... 59c
DUAL-COLORED LED
5mm RED/GREEN... 90c

FANS

MUFFIN, ROTRON, ETC. FULLY TESTED

Ex-computer
5 inch 115v \$8
220v \$10

MINI RELAYS

240V AC coil HEAVY DUTY 10A CONTACTS 4 CHANGE OVER

Great value, worth over \$5 **\$2.50** huge purchase enables us to sell for less than HALF! Buy 10+, \$2.25

SPDT 8 to 15V DC, 225 OHMS, PCB MOUNTING

DPDT 24V, 700 OHMS, 5A CONTACT

Take your pick, great value, limited quantities avail.

RESISTORS

1/4 WATT 5% TOLERANCE ALL E12 VALUES, 10HM TO 10MEG.

PAKS OF 10 EACH VALUE... 25c

PAKS OF 100 EACH VALUE... \$1.25

PAKS OF 1000 EA. VALUE... \$10

PRE-PAK electronics p/l

1a WEST ST, LEWISHAM, NSW

569-9797 24 HR PHONE ORDER SERVICE

SEE THE HUGE RANGE IN-STORE! IF YOU THINK WE PACK A LOT INTO OUR ADS, YOU SHOULD SEE WHAT'S IN OUR SHOP!

Programmer for fusible-link bipolar PROMs

The problem: How do I configure an array of memory chips of differing capacities without resorting to multiple decoders and a rat's nest of jumpering? Or, how would I get a 7-segment display to show more than the usual 0-9 digit information?

The solution: A bipolar PROM! They're fast. They're cheap. They're easy to program. They're cheap. They don't take up a lot of expensive pc board real estate. And they're cheap!

HAVE YOU EVER been designing a project and wished you had a custom decoder or simple PLA (programmable logic array) to reduce the chip count and make the circuit less complex? How about using a seven-segment LED display to show more than the usual zero-to-nine digit information? All these applications and many more can be addressed by one versatile integrated circuit called the *Schottky Bipolar Programmable Read Only Memory*.

They are produced by many manufacturers in pin-compatible forms and are widely available through normal sources. Although they range in sizes up to 4K x 8 (ten inputs, eight outputs), for our purposes we will be discussing only the smallest one, the 32 x 8 (five inputs, eight outputs), known under the generic number of 74LS188/288. Table 1 gives a cross reference of the more popular, pin-compatible parts. All have similar or identical specifications.

The bipolar PROM programmer described in this article is a by-product of a micro-controller design to be presented in later issues of ETI.

Bipolar PROMs — a lot more than just a memory chip

Pin-out and logic diagram are given in Figure 1. Some suggested uses are shown in Figure 2. Figure 2(a) illustrates the original application of a memory decoder. With the appropriate program in PROM, the memory banks can be any size from 2048 to 32K bytes, in any mixture, and may be located on any 2K boundary.

Figure 2(b) shows the PROM used as a LED segment driver. With 32 different characters, these PROMs can be cascaded to produce custom 14 and 16-segment 'starburst' display drivers.

The device is used as a liquid crystal display driver in Figure 2(c) with address line four and the LCD's backplane being driven from a low frequency oscillator. The lower half of the PROM is programmed with 'positive' segment data while the upper half is 'negative'. The result is a 180° phase relationship between the backplane and the decoded segment information.

As in Figure 2(d), any eight different

functions, based upon any 32 input conditions, or the states of five inputs, can be realised with these chips. Keep in mind the 25-35 ns propagation delay time when designing your circuits and calculate this into any timing equations.

These Schottky PROM memories are organised as 32 words by eight bits. An enable input is provided to control the output states. When the enable input is in the low state, the outputs present the contents of the selected word. If the enable input is raised to the high level, it causes all eight outputs to go to the 'off' or high impedance state.

Since these devices are of a Schottky-clamped type, they have very fast access times, in the range of 25-35 ns maximum.

They are available in both open-collector (74LS188) and totem-pole versions (74LS288). PROMs are shipped from the distributor with *lows* in all locations. A high may be programmed into any selected location by using the following programming instructions. (NOTE: Once programmed, it is impossible to go back to a low state.)

In order to generate a high level on the outputs, the PROMs must be programmed in the following manner:

1. Address/Inputs and chip-enable pins must be driven from normal TTL logic levels during both programming and verification.
2. Programming will occur at a selected address when V_{cc} is held at 10.5 V, the appropriate output is held at 10.5 V, and the chip is enabled. To achieve these conditions and the appropriate sequence, the following procedure must be followed:

(a) Select the desired word by applying a high or low level to the address/inputs. Disable the chip by taking the enable input to a high level.

(b) Increase V_{cc} to 10.5 V. Since V_{cc} supplies the current to program the fuse as well as the Icc of the device at programming voltage, it must be capable of supplying 750 mA at 11.0 V.

Chuck Simmers

Field Application Engineer, Intel Corp., NSW

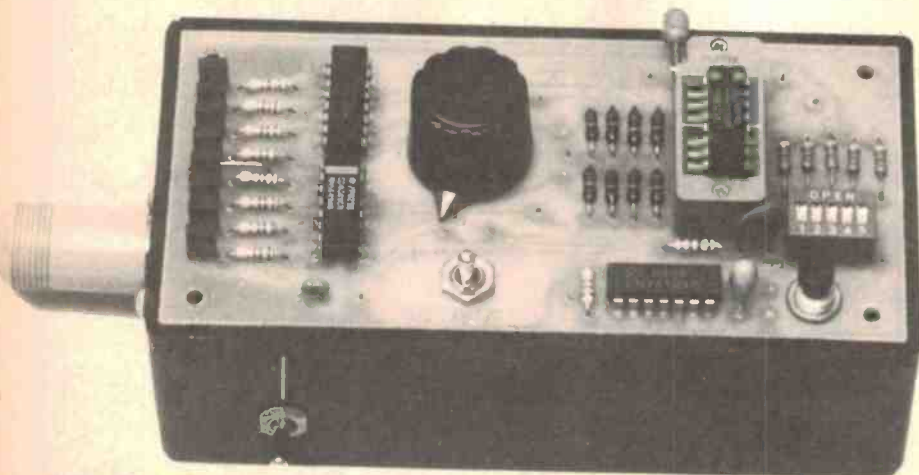

Plain and simple. No, it doesn't come in a spray can, but you'll find it very useful, nonetheless! The pc board for the programmer simply replaces the lid on a small jiffy box.

(c) Select the output where a high level is desired by raising that output pin to 10.5 V. It is critical that only one output at a time be programmed since the internal circuitry can only supply programming current to one bit at a time. Outputs not being programmed must be left floating or tied to a high impedance source of at least 20k Ohm.

(d) Enable the device by taking the chip enable to a low level for a duration of 10 us.

(e) Verify that the bit is programmed by first removing the programming voltage of 10.5 V and returning Vcc to 5 V. The chip must be enabled to sense the states of the outputs. Steps (b), (c) and (d) are repeated about ten times or until the output is verified.

(f) Following verification, apply about five more programming pulses to the bit to ensure that the fuse is completely blown.

(g) Repeat steps (a) through (f) for each bit to be programmed to a high level. After all selected bits are programmed, verification of the entire contents of the memory should be performed.

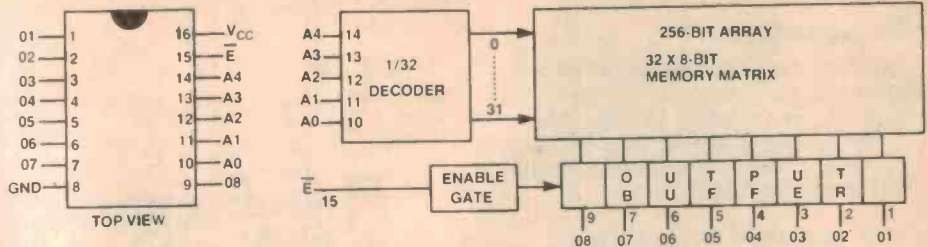

Figure 1. Standard pinout (left) and logic diagram (right) for the range of pin-compatible bipolar PROMs listed in Table 1.

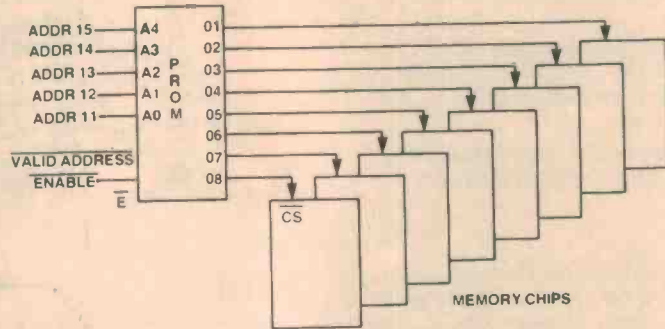

Figure 2(a). This project was designed so that I could blow a PROM for the application illustrated here — a memory address decoder.

TABLE 1.

Pin-compatible fusible-link bipolar PROM types

Type No.	Speed	Manufacturer
74S188	22 ns	National Semiconductor
74S288	22 ns	National Semiconductor
77S188	12 ns	National Semiconductor
77S288	12 ns	National Semiconductor
27S18		A.M.D.
27S19		A.M.D.
6330-1		M.M.I.
6331-1		M.M.I.
82S23		Signetics
82S123		Signetics

The circuit

Two voltage regulators provide the appropriate programming and verifying voltages needed. The ground of one of the regulators is 'lifted' about 5 V above ground to obtain the 10 V for programming. SW1 is a 4PDT type and is used to switch between programming and verifying modes. PB1, a momentary-action normally-open pushbutton, enables the one-shot 74121 to enable the chip for about 10 us when in 'PROG' mode.

A 9-position rotary switch (SW3), is used to select the output that is to be set high. Replacing this switch with a bank of single-pole switches is not recommended because of the possibility, or temptation, to blow more than one fuse at a time.

SW4 through SW8 are the address/input

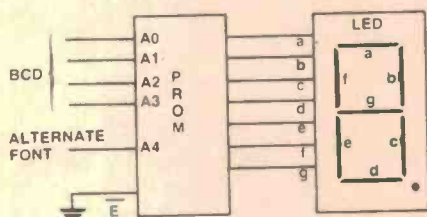

Figure 2(b). A 7-segment LED display driver. You can get more than just 0-9 you know!

select switches. The two CMOS 4949 hex buffers were chosen for output drivers for their ability to tolerate input voltages up to 15 V with a 5 V Vcc supply.

Lastly, the LEDs are used for visual display and verification of the PROM

contents after programming. Simple, right?

The circuit could easily be expanded to accommodate larger PROMs, but I think I would be inclined to explore a more automatic approach by adding ports and driving transistors to a microprocessor-based system.

A4	A3	A2	A1	A0	a 07	b 06	c 05	d 04	e 03	f 02	g 01	DISPLAY
0	0	0	0	0	1	1	1	1	1	1	0	0
0	0	0	0	1	0	1	1	0	0	0	0	1
0	0	0	1	0	1	1	0	1	1	0	1	2
0	0	0	1	1	1	1	1	1	0	0	1	3
0	0	1	0	0	0	1	1	0	0	1	1	4
0	0	1	0	1	1	0	1	1	0	1	1	5
0	0	1	1	0	1	1	1	1	1	1	1	6
0	0	1	1	1	1	1	1	0	0	0	0	7
0	1	0	0	0	1	1	1	1	1	1	1	8
0	1	0	0	1	1	1	1	1	0	1	1	9
0	1	0	1	0	1	1	1	0	1	1	1	A
0	1	0	1	1	0	0	1	1	1	1	1	B
0	1	1	0	0	1	0	0	1	1	1	0	C
0	1	1	0	1	0	1	1	1	1	0	1	d
0	1	1	1	0	1	0	0	1	1	1	1	E
0	1	1	1	1	1	0	0	0	1	1	1	F
1	0	0	0	0	0	0	0	0	0	0	0	—
1	0	0	0	1	1	0	0	1	1	1	1	

TABLE 2. Logic table for the application illustrated in Figure 2(c). Note that, beyond address 10000, the display complement is generated.

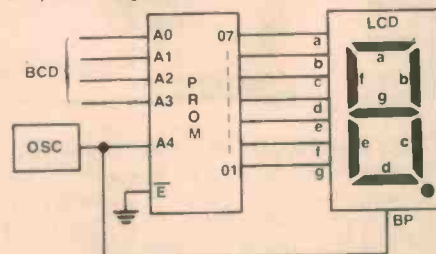

Figure 2(c). A liquid crystal 7-segment display driver. The logic operation can be determined from Table 2.

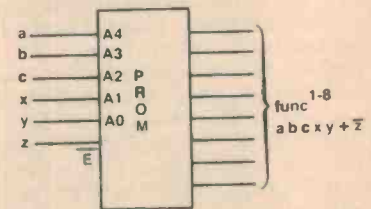

Figure 2(d). Any eight different functions can be realised, based on any 32 different input conditions or the states of five inputs.

Construction

The programmer is built on two pc boards. The larger one replaces the lid of a medium-sized jiffy box (41 x 68 x 130 mm), while the smaller board (comprising the power supply), fits inside. Before commencing assembly of the boards, check that:

- (i) the small board fits into the box vertically;
- (ii) the larger board fits in place of the box's lid;
- (iii) the screws used to secure the lid pass through the corresponding holes in the pc board and align with the pillars in the box; and
- (iv) the rotary switch, the PROG/VERIFY switch and the 5-way DIL switch all fit correctly.

Also run your eye over the tracks on the pc board looking for small cracks or possible shorting 'bridges' between tracks. Check also that the component holes are all drilled and the correct size.

Build the smaller board first. There are two alternatives to choose from here, depending on whether you have an ac or a dc plugpack. I used a 12 Vdc/1 A plugpack and did not install the four rectifier diodes. As the plugpack I used powers the office MicroBee, which has a 5-pin DIN plug output, I installed a 5-pin DIN socket on the end of the programmer's case and wired pin 1 via a small toggle switch to the diode cathode pad nearest the 2200 uF filter capacitor (C2). This switch was mounted on the side of the jiffy box, about 10 mm up from the bottom and 20 mm in from the end with the DIN socket.

If you are using an ac plugpack or an externally-mounted transformer, you should install the four diodes and wire the ac input via a switch, as shown in the overlay and wiring diagram.

The components can be assembled on the power supply board in any order, just take care that they are correctly oriented.

When you've completed it, apply power and check that the +5 V and +10 V rails are present (measured with respect to the 0 V rail).

The large pc board can be tackled next. Start by installing the link between the positions of R20 and R21. Install all the resistors and capacitors next (make sure you get C1 the right way round).

Follow by soldering the eight rectangular LEDs in place. The anode lead of each is the longer one and this is inserted in the hole closest to the edge of the pc board.

The 5-way DIL switch may now be soldered in place with the 'open' side facing the row of resistors R2-R6. Next install IC3 and the 16-pin socket for the PROMs. I used a 'Textool' 'zero insertion force' (ZIF) socket, but you could cut more than \$10 off the price of the project by using an ordinary 16-pin IC socket. It's perfectly adequate where the programmer is not in everyday or every-week use.

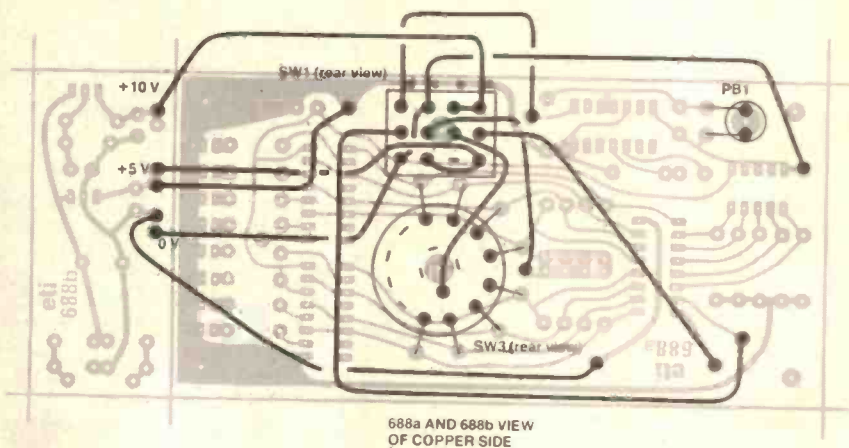
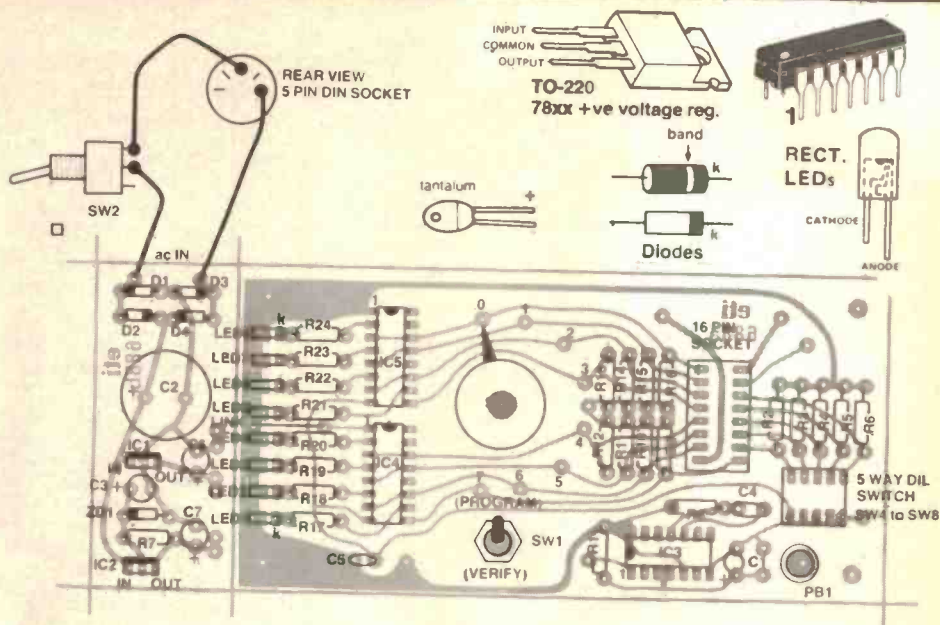

PARTS LIST — ETI-688

Resistors	all 1/4 W, 5%	IC1, IC2	uA7805, LM7805
R1	47k	IC3	74121
R2-6	4k7	IC4, IC5	4049
R7	1k	LED1-8	rectangular red LEDs
R8	10k	ZD1	5V1/1 W zener
R9-16	22k		
R17-24	220R		
Capacitors		Miscellaneous	
C1	10u/25 V RB electro.	PB1	miniature momentary action pushbutton
C2	2200u/25 V RB electro.	SW1	three-pole, two position min. toggle switch
C3, 6, 7	4u7/10 V tant.	SW2	DPDT min. toggle switch
C4	1n5 greencap	SW3	single pole, 12-position C&K 'Lorlin' rotary switch, set for 8-pos. operation.
C5	100n ceramic of greencap		
Semiconductors			
D1-D4	1N4001, 1N4002, EM401, EM402 etc		

ETI-688 pc board; zippy box 48 x 68 x 130 mm; 16-pin ZIF socket; ac plugpack to suit (see text) etc.

Price estimate \$38 — \$42

The rotary switch, SW3 can now be screwed to the pc board. I used a C&K 'Lorlin' 12-position switch here with the index pin set to stop the action at nine positions. Orient the switch so that pin 1 is adjacent to the pad which has a track leading to pins 3 and 14 of IC5. Using eight short lengths of 22 gauge

tinned copper wire, wire each of the contacts, one to eight, to the respective pads on the pc board, as per the underside wiring diagram.

Now install the pushbutton, PB1 and wire its contacts to the board with tinned copper wire too.

Install the PROG/VERIFY switch, SW1,

bipolar prom prog.

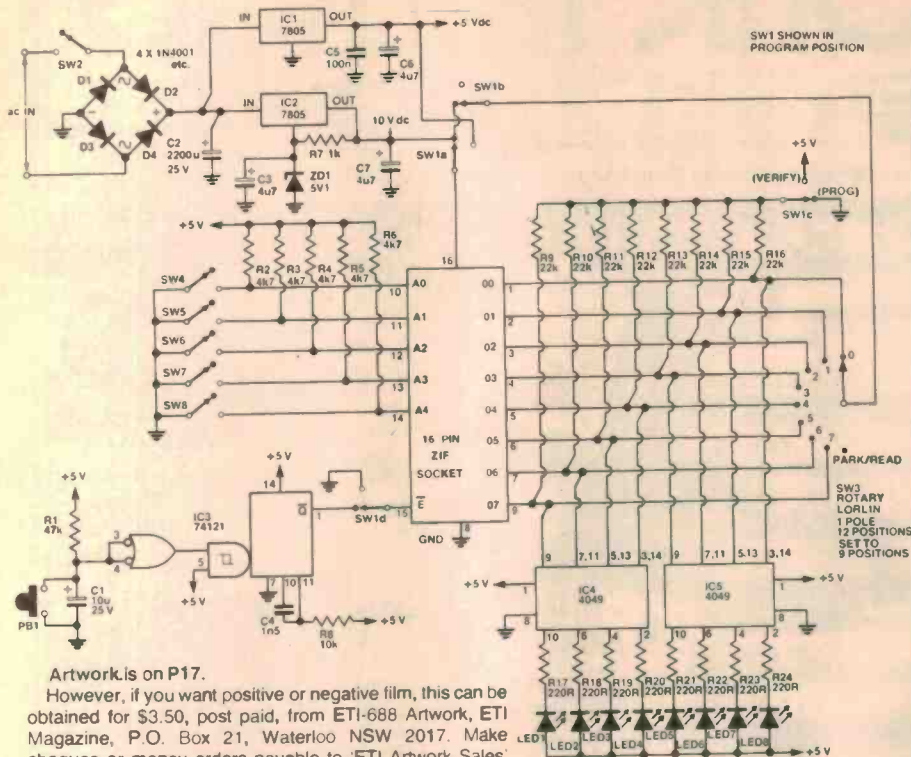

Artworks on P17.

However, if you want positive or negative film, this can be obtained for \$3.50, post paid, from ETI-688 Artwork, ETI Magazine, P.O. Box 21, Waterloo NSW 2017. Make cheques or money orders payable to 'ETI Artwork Sales' and ensure that you ask for a positive or negative, as required.

HOW IT WORKS — ETI-688

There's not much to it, just power supply, programming pulser and simple readout.

Two supply rails are necessary: +5 Vdc and +10 Vdc. The 5 V rail is provided by a 7805 (IC1) three-terminal regulator from the capacitor-input bridge rectifier (D1-D4, C2). The 10 V supply is provided by 'jacking-up' the reference terminal of another 7805 (IC2) by 5 V using a zener (ZD1).

The programming pulse is provided by triggering a 74121 one-shot multivibrator, IC3. When PB1 is pressed, the NOR gate inputs of IC3 (connected as an inverter), pins 3 and 4, are pulled low and the inverter triggers the following Schmitt trigger, which sets off a 10 microsecond pulse from the Q-bar output of the 74121.

and tighten it in place. The remaining wiring, to this switch and the power supply board, should be done with plastic insulated, light hookup wire (10 x 0.2 mm). The underside wiring diagram shows the details. Do this wiring carefully and check it when you've finished.

Lastly, install the two CMOS ICs, IC4 and IC5. Don't handle their pins, either use an appropriate IC insertion tool or only handle the devices with your thumb and forefinger grasping the ends of the package. Solder pins 1 and 8 first. Digital CMOS ICs are pretty robust in general and it's unlikely you'll damage them. If you prefer, IC sockets can be used.

Well, all that's left is to do a 'trial run' to see if it works and to get familiar with the procedure.

A typical programming session

A) With all power off, insert a PROM into the programming socket.

When SW1 is in the PROGRAM position, SW1d couples this pulse to the enable pin of the PROM in the 16-pin PROM socket. Capacitor C1 debounces PB1.

Switches SW4-SW8 pull the address pins of the PROM socket low when closed, resistors R2-R6 pull the address pins high when the switches are open.

Resistors R9-R16 provide pull-ups or pull-downs on the output pins according to how the PROG/VERIFY switch, SW1, is set. The rotary switch, SW3 selects the output line to be programmed. Two 4049 CMOS buffers drive the indicator LEDs which let you know what's happening.

Capacitors C5, C6 and C7 bypass the supply rails and ensure the regulators remain stable.

B) Set SW1 to the VERIFY position and turn the main power on. At this time all the LEDs should be on, indicating all fuses intact.

C) Set switches SW4 to SW8 to conform to the appropriate input condition.

D) Set switch SW3 to the output to be programmed.

E) Throw SW1 to the PROG position.

F) Touch PB1 a few times to burn the bit. A bit cannot be over-programmed.

G) Put SW1 back into the VERIFY position to check that the bit is in fact programmed, which the LEDs will indicate.

H) Repeat steps C through G until done.

This is rather tedious and boring, and it would become a rather large pain if you were doing more than two or three chips at a time, or if the PROMs being used were of a larger variety. But, I've found 32 bytes isn't too bad. Just get a cup of coffee, find a comfortable chair, and take your time.



NORTRONICS

AUDIO & DIGITAL TAPE HEADS



for long life extended response

- Replacement heads for cassette decks, reel to reel decks, cartridges and cassette recorders. Also professional recorders and duplicators.
- Will fit AMPEX, SCULLY, TEAC, ATC, GATES, PENTAGON and many more.
- Specification sheet of all Nortronics heads available on request.
- Complete range of Alignment tapes for cassette, reel to reel and cartridge decks.
- REGULAR MAINTENANCE ENSURES CONTINUED OPTIMUM PERFORMANCE. Nortronics manufacturers a full range of audio care products.

TAPE HEAD CLEANER



ALIGNMENT TAPES



SPlicing BLOCKS



SPlicing TABS



ZENITH/HEIGHT GAUGES

- NORTRONICS audio care products are designed to care for and maintain your valuable recording equipment.
- SEND TWO 27c STAMPS FOR OUR FREE BROCHURE ON THE COMPLETE NORTRONICS ACCESSORIES RANGE.

E.I. EMAC INDUSTRIES Pty. Ltd.

2 Bengal Crescent, Mount Waverley, Vic. 3149. Ph: (03) 277-9989.

ELECTRONIC AGENCIES

115-117 Parramatta Rd. Concord 2137
 (Corner Parramatta Rd & Lloyd George Ave)
 Telephone (02) 745 3077 (two lines)
 117 York St. Sydney Phone 29 2098

Mall Orders: NSW & ACT ONLY VIC. SA. QLD. TAS. WA. NT
 PO Box 185 \$1 — \$ 9.99 \$1.50 \$1 — \$ 9.99 \$2.50
 Concord \$25 — \$24.99 \$3.50 \$25 — \$24.99 \$4.00
 2137 \$50 — \$49.99 \$4.50 \$50 — \$49.99 \$5.00
 \$100 or more \$5.50 \$100 or more \$7.50



TRADING HOURS
 BOTH STORES
 Mon-Fri 9 am-5:30 pm
 York St Thursday 8 pm
 Saturday 9 am-12 pm

All heavy or bulky items (over 20 kg) sent Comet Road Freight \$12.00 anywhere in Australia.

NEW MICROBEE SOFTWARE

- XE6760 FILEX** \$14.95
 This program provides a multi purpose, multi function means of storing a wide range of name/address orientated records for subsequent retrieval and manipulation.
- XE6780 BACUP** \$9.95
 This machine language program will copy ANY program regardless of protection.
- XE6785 PIANO BEE** \$14.95
 You can compose music and replay it. The program will print the notes as they are played back. You can compose four different songs, save a song at 300 or 1200 bps and load a song back.
- XE6790 ARTILLERY** \$11.95
 — angles, parabolas and the effect of wind speed changes on the trajectory of a shell.
 — three modes of operation — tutorial, game, competition for 2-6 players.
- XE6795 CLOZE** \$11.95
 Designed to develop reading skills. Looking ahead and guessing are encouraged. Contains 3 stories at approx the same reading difficulty. Suitable for senior primary/junior secondary.
- XE6800 ESCAPE** \$11.95
 Mathematics — full graphics and sound in a game situation to develop understanding of the order of operations and to develop skill in writing and solving simple equations.
- XE6805 TANK BATTLE** \$11.95
 A game for two players whose tactics is an important factor.
- XE6810 TOWNS & CITIES — NSW** \$11.95
 Deals with maps and the location of various towns and cities throughout Australia. This one is on towns in NSW.
- XE6815 TOWNS & CITIES — AUSTRALIA** \$11.95
 This program is similar to the above except that it deals with 40 major cities and towns in Australia.
- XE6820 NUMBER FACTS** \$11.95
 — Drill and practice of tables and number facts
 — Options cover all operations plus mixed parameters for addition and subtraction may be set.
 — Speed is selectable, suitable for individual or a small group.
- XE6825 SECRET NUMBER** \$11.95
 A comprehensive program in a challenging format which develops a child's understanding of the properties of a number, eg prime, composite, multiple square, fibonacci, random etc.
- XE6830 BATTLESHIP** \$11.95
 The old game where the Battleships have to be bombed and they are at certain places on the grid.

MICROBEE MONITORS

- XE1186 12" Micron Green Monitor \$199.50
- XE1188 12" Kaga Denshi Orange \$325.00
- XE1190 12" Kaga Denshi Green \$325.00
- XE1192 12" B&W Monitor \$129.50

MICROBEE

- XE5000 Microbee 16K Plus \$449.00
- XE5100 Microbee 32K Plus \$549.00
- XE5200 Microbee 64K Plus \$699.00
- XE6505 Editor Assembler \$59.50
- XE6605 Wordbee \$59.50

New Lower Price \$59.50 Save \$30.00

MICROBEE ACCESSORIES

- XE8000 Editor Assembler Manual \$6.50
- XE8001 Wordbee Manual \$11.50
- XE8005 Microbee Basic Manual \$12.50
- XE8020 16K Decal \$3.50
- XE8021 32K Decal \$3.50
- XE8022 64K Decal \$3.50
- XE5410 Microbee Plug pack \$17.50
- XE5400 Microbee Cassette Recorder \$49.50
- XE3530 C10 Blank Cassette \$1.10
- XE3540 C20 Blank Cassette \$1.20
- XE3545 C30 Blank Cassette \$1.40

DISKS FOR YOUR DGOS

(From the official Applied Technology S100 support company)

APPLIED TECHNOLOGY S100 CARD OWNERS, NOW THERE IS A STANDARD IBM 8 INCH DISK SYSTEM FOR YOUR COMPUTER.

SINGLE SIDED VERSION 1 x 600K DRIVE	FROM: \$1370 + SALES TAX
--	-----------------------------

SINGLE SIDED VERSION 2 x 600K DRIVE	FROM: \$2340 + SALES TAX
--	-----------------------------

DOUBLE SIDED VERSION 1 x 1.2 MEG DRIVE	FROM: \$1804 + SALES TAX
---	-----------------------------

DOUBLE SIDED VERSION 2 x 1.2 MEG DRIVE	FROM: \$2504 + SALES TAX
---	-----------------------------

SYSTEMS INCLUDE CASE, SUPPLY, CABLES, MANUAL, CONTROLLER, DRIVES CP/M 2.2
 MICROSOFT BASIC-80 TOTAL SOFTWARE VALUE NEAR \$600.00 FREE!
 CONTROLLER AVAILABLE SEPARATE

ALSO A BROAD RANGE OF OTHER S100 CARDS TO SUIT YOUR SYSTEM.

USERS GROUP!

If you own an Applied Tech System or Cards then contact AED about users group activity (Help us, Help you!).



MICROCOMPUTER PRODUCTS

ACOUSTIC ELECTRONIC DEVELOPMENTS PTY., LTD. INC. IN N.S.W.

9-5
 6 DAYS/WEEK
 PHONE: 681-4966
 TELEX: AA70664



OFFICIAL SYSTEM SUPPORT ORGANISATION FOR APPLIED TECH. S100 SYSTEMS

Advance Australia

MICROBEE COLUMN

CHARACTER GENERATOR

Miroslav Kostecki, Elizabeth Park SA

After encoding many PCG characters by hand, I finally decided to write a program to do the encoding for me. This small program encodes up to 120 programmable characters in a 6 x 20 PCG block.

An enlarged 'working' character is displayed on the left of the screen with a grey cursor to mark the dot to be changed. Pressing the space bar places a black dot and pressing any letter leaves a white dot. These changes cause the encoded decimal value to be updated on left of the line of dots. The cursor may be moved to the next line of dots by simply pressing the slash (/) key.

All changes on the enlarged character simultaneously modifies the coordinate character living on the lower right of the screen. These consist of a 6 x 20 PCG character block with a scale on each axis. Any one of these may be chosen as a working character by keying the appropriate coordinates. This specified character is then enlarged to the left of the screen and all lines are encoded.

Thus, blocks of up to 6 x 20 characters may be programmed and corrected with the finished product displayed instantly. If you couldn't quite follow all this then don't worry, just run the program, push a few buttons and it all should make sense.

You can now use the decimal coding on the left to produce PCG characters, like monsters for games, special mathematical symbols or 3D pictures. This is done by poking generated values into the PCG RAM space (decimal 63488 — 65535) and then using the CHR function or the PCG command. This is how the grey cursor and white blocks were produced.

I hope you find this little program useful.

CHARACTER GENERATOR

```

00100 REM      *** Character Generator ***
00110 REM      by Miroslav Kostecki ; 30.3.83
00120 CLS: HIRES: Q=65519: ZONE 16
00130 PRINT, " CHARACTER GENERATOR"+"1A:", [A21 126];
00140 D=96: E=256: FOR A=1 TO 20
00150 IF A<7 THEN CURS 30,10+A: PRINT A;"|";
00160 IF A<17 THEN POKE Q+A,255: POKE Q+A-16,85
00170 CURS 32+A,10: PRINT CHR(64+A);: NEXT A
00180 CURS 32,3:PRINT "Press 'space' bar for no dot,"
00190 ZONE 15: PRINT, " any letter to place a dot,"
00200 PRINT, " '/' to move the cursor down,"
00210 PRINT, " and the coordinates to change"
00220 PRINT, " the character position."
00230 PRINT, " es:'1B'"
00240 REM      # Active section follows #
00250 FOR A=1 TO 16: Q=D-A: IF M=1 THEN 320
00260 FOR B=0 TO 7: X=10+B*2
00270 CURS X,A: PRINT [A2 254];: CURS X,A
00280 A1$=KEY$: IF A1$="" THEN 280
00290 IF A1$="0" AND A1$<"7" THEN NEXT*B 370
00300 IF A1$="/" THEN LET M=2: NEXT*B 320
00310 IF A1$="" THEN RESET B+E,Q ELSE SET B+E,Q
00320 S=0: T=128: CURS 10,A: FOR C=0 TO 7
00330 IF POINT(C+E,Q) THEN PRINT[A2 255];:
      S=S+T ELSE PRINT " ";
00340 T=T/2: NEXT C: CURS 5,A: PRINT [I4 S];
00350 IF M=0 THEN NEXT B
00360 M=M-M/2*2: NEXT A: M=0: GOTO 250
00370 CURS 64: PRINT A1$: D=112-INT(VAL(A1$))*16
00380 A1$=KEY: IF A1$("<A" OR A1$)"T" THEN 380
00390 PRINT A1$: E=ASC(A1$)*8-264: M=1:NEXT*A 250
00400 END
    
```

DIGITAL MULTIMETERS

that measure capacitance

various models to suit your requirements

MODEL	7601	7605	7901	7905
Test/measure	transistor	transistor	capacitance	capacitance
DC Voltage	100uV to 1000V	100uV to 1000V	100uV to 1000V	100uV to 1000V
Basic Accuracy	0.1%	0.5%	0.1%	0.5%
AC Voltage	100uV to 750V	100uV to 750V	100uV to 750V	100uV to 750V
Basic Accuracy	0.5%	1.0%	0.5%	1.0%
DC Current	1uA to 10A	1uA to 10A	1uA to 10A	1uA to 10A
Basic Accuracy	0.1%	0.5%	0.1%	0.5%
AC Current	1uA to 10A	1uA to 10A	1uA to 10A	1uA to 10A
Basic Accuracy	0.1%	0.5%	0.1%	0.5%
Resistance	0.1 to 20Meg	0.1 to 20Meg	0.1 to 20Meg	0.1 to 20Meg
Basic Accuracy	0.2%	0.5%	0.2%	0.5%
Hfe @ 10uA 2.8V	0 to 1000	0 to 1000	###	###
Capacitance	###	###	1PF to 20uF	1PF to 20uF
Basic Accuracy	###	###	0.5%	1.5%
Diode Test	1mA	1mA	1mA	1mA
PRICE	\$110.50	\$87.50	\$123.50	\$98.90

All complete with test leads, carry case and instruction manual.

- Low battery voltage automatically detected and displayed.
- Dual slope integration measurement technique to ensure noise-free measurements.
- Each range has full auto-polarity operation and over-range indication.

LAMRON PTY. LTD.

20 Stamford Ave., Ermington, NSW 2115 Phone: (02) 85 2599 85 6228
Cables: 'LAMRON' Sydney Telex: AA71551 LAMRON

SORRY NO SHOP SALES MAIL ORDER ONLY to P.O. Box 438, Ryde, NSW 2112
Please send order or S.A.E. for further information. Bankcard Mail Orders welcome.

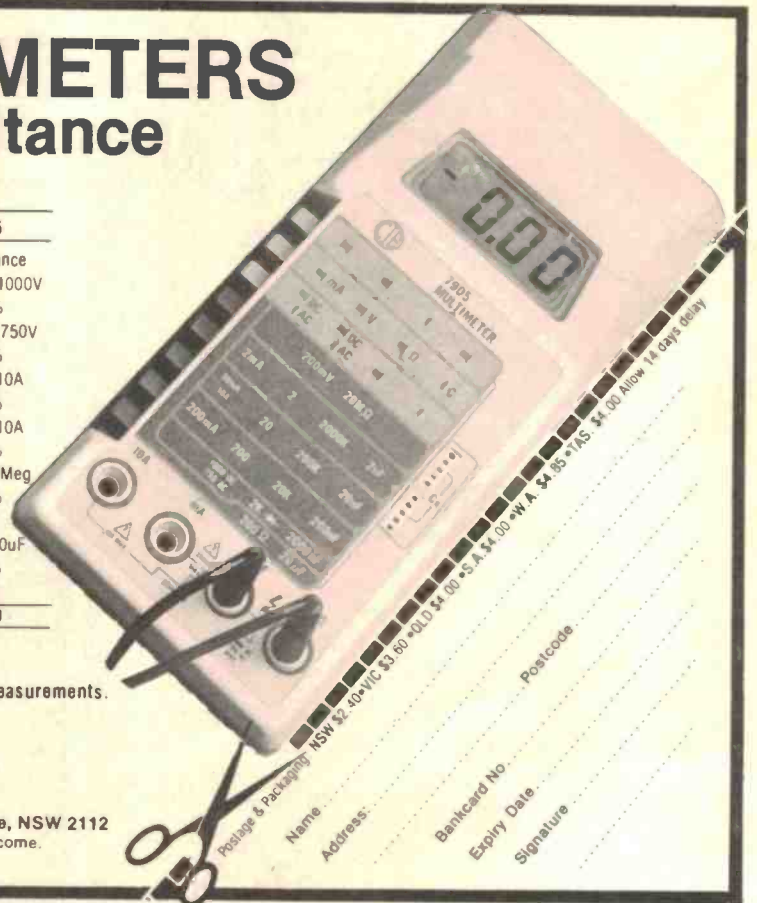

Postage & Packaging NSW \$2.40 VIC \$3.60 QLD \$4.00 S.A. \$4.00 W.A. \$4.85 TAS \$4.00 Allow 14 days delay

Name _____

Address _____

Postcode _____

Bankcard No. _____

Expiry Date _____

Signature _____



No. 1 for Video accessories

Built and tested

Video Switching box

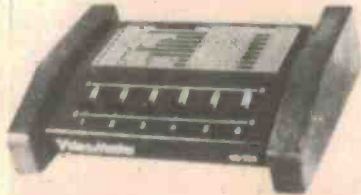

\$47.50

Low loss R.F. switching—allows inputs for:- VCR, video disc, antenna, cable TV, home computer and video games.

WE HAVE A GREAT RANGE OF VIDEO CONNECTORS AND CABLES FOR VIDEO TO VIDEO DUBBING.

Cables

- PA-25**
5 pin 180 degree dubbing adaptor—Reverse pins for video use \$6.95
- VC-14**
8 pin square plug to 8 pin square plug. Cable length 2 metres \$29.95
- VC-15**
6 pin DIN plug to 6 pin DIN plug. Cable length 1.5m \$4.95
- VC-1**
BNC plug to BNC plug. Impedance-75Ohm. Cable length 1.5m \$6.50
- VC-2**
BNC plug to PL259 plug. Impedance-75Ohm. Cable length 1.5m \$6.75
- VC-3**
PL 259 plug to PL 259 plug. Impedance-75Ohm. Cable length 1.5 \$4.95
- VC-4**
PL 259 plug to RCA plug. Impedance-75Ohm. Cable length 1.5m \$4.95
- VC-5**
RCA plug to RCA plug. Impedance-75Ohm. Cable length 1.5m \$5.95
- VC-6**
BNC plug to RCA plug. Impedance-75Ohm. Cable length 1.5m \$5.95

Video Connectors

- VP-8**
8 pin square video connector plug \$7.50
 - VS-8**
8 pin square video connector inline socket \$7.50
- 
- VP-10**
10 pin male video plug. Used in J.V.C., Panasonic, Sharp and other VHS machines \$11.50
 - VS-10**
10 pin female inline socket. Used in J.V.C., Panasonic, Sharp and other VHS machines \$11.50
 - VP-14**
14 pin male video plug. Used in Sony, Sanyo, Toshiba and other Beta machines \$16.50
 - VS-14**
14 pin female inline socket. Used in Sony, Sanyo, Toshiba and other Beta machines. \$16.50

Built and tested

Video Enhancer

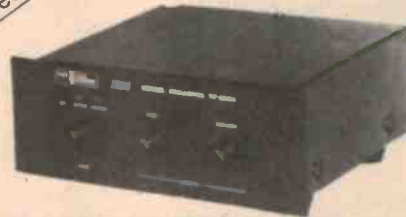

Detail Enhancer VP5030 is another important contribution to the world of video accessories. The lightweight Detail Enhancer has been particularly designed to rectify loss in detail derived from VCR tapes and picture impairments. With simple adjustments for more or moderate detailing, the detail enhancer can also overcome such picture impairments as loss of detail and disappearance of verticle lines.

Specifications:

1. Power requirement: 12V DC 110mA
2. Input: 1 Video (RCA connector)
3. Outputs: 3 Videos (RCA connectors)
4. Output level: Video outputs: 1.0Vp-p, 75 Ohm unbalanced below 1Vp-p out.
5. Enhance: Enhance 9dB (Referenced/1.0Vp-p)
6. Signal-to-noise ratio: Greater than 50dB below 1Vp-p out.

Bargain Price
\$87.50

TDK E180 VHS VIDEOTAPES
10 for \$148.00
Unbelievable Value!!

T.V. and F.M. Splitters

Model	F Range (MHz)	Impedance (Ohms)		Output	Band	Splitting loss	Isolation	V S W R
		IN	OUT					
DDF-332 U/V	50-890	300	300	2	VHF	3.5	25	1.5
					UHF			20
DDF-772 U/V	50-890	75	75	2	VHF	3.5	25	1.5
					UHF			20
DDF-774 U/V	50-890	75	75	4	VHF	6.7	30	1.4
					UHV			7.6

DDF-332 \$3.95, DDF-772 \$4.95, DDF-774 \$6.95

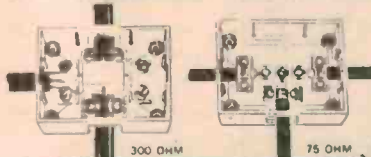

Errors and omissions excepted.

VIDEO HEAD CLEANERS

- HC-1 V.H.S. Video head cleaner
- HC-2 Beta Video head cleaner

A professional head cleaner—employs new "double sided" cleaning action—no need to "operate" on your machine. Just insert the cassette, play for 30 seconds and the job's done. Effective for 100 operations.



HC-1 \$17.50 HC-2 \$17.50

ROD IRVING ELECTRONICS

2 BRANCHES:

425 High St. Northcote, Ph.: (03) 489 8131
48-50 A'Beckett St. Melb. Ph.: (03) 347 9251

Mail orders: P.O. Box 235 Northcote, Vic. 3070

min p&p \$3.00



Bankcard mail orders welcome
ORDER FORM
Please Debit my Bankcard

No.....
Expiry Date.....
Name.....
Signature.....



THE VIC-20 COLUMN

☆ ENCOURAGEMENT ☆

RESPONSE to our first couple of columns has been encouraging and to encourage you a little more, Ozi-Soft has generously offered to donate a prize each month for the best item submitted. Details are in the accompanying panel.

What we are looking for is original programs and utilities. The Editor will judge the best submitted each month and the winner will receive the prize and get paid for the contribution into the bargain! We'll also consider useful modifications to other programs (but please name the original source).

MACHINE-LANGUAGE GRAPHICS

J. Ennis, East Malvern Vic.

The recommended way to create high-res graphics on the VIC is to bit-map as much of the screen as you have memory for. But even with memory expansion cartridges, the maximum size is about 160 by 160 pixels because character memory cannot be located in the expansion cartridge.

The following program does not try to bit-map the entire screen, so it avoids this limitation. When plotting graphs and the like, only a small portion of the screen is actually used.

To turn on a single pixel, the program PEEKs into screen memory at the place the pixel will appear when it is plotted. If the character there is a space, it POKEs another character in its place and then POKEs into character memory to turn on a single dot within that character.

Thus, when a graph is plotted, most of the screen is filled with spaces and the remainder with other characters.

Within the program the plotting of points on the screen is achieved by two machine-language routines which must be POKEd into memory before running. The first of these clear out the character memory in RAM, sets the character memory pointer to 5120 (decimal), clears the screen and sets the 8116 character size.

Ozi-Soft, in conjunction with Computer Technics, is offering to donate a VIC-20 expansion board for the best software item submitted to this column every month.

The board is Australian designed and manufactured and simply plugs into the VIC-20's expansion slot. It features three sockets that can be independently switch-selected, plus an on-board reset switch. With it you can plug in up to three separate expansion units to your VIC-20 and avoid the hassle of plugging things in and out and turning the computer on and off each time. It is distributed by Computer Technics, P.O. Box 75, Kogarah NSW 2217 and costs \$59.95.

All submissions must be accompanied by a signed letter from you stating that it's your original work. The winning submission will be judged by the Editor and no correspondence will be entered into. All published submissions will be paid for.

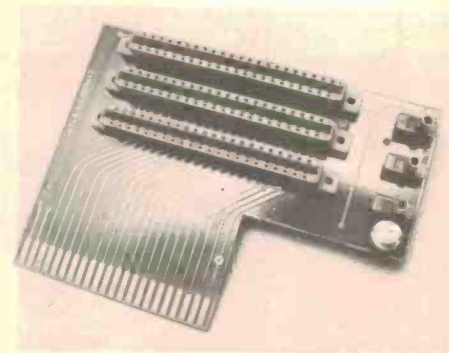

.Send entries to: The Editor, VIC-20 Column, ETI Magazine, P.O. Box 21, Waterloo NSW 2017.

The second routine plots a point whose x and y coordinates are stores in locations 0 and 1 respectively. Both routines are relocatable but only work on the unexpanded VIC, although they could be modified.

Type in Program 1 and save it immediately, taking special care with the data statements; a mistake there may well crash the program later. Erase the first program, then type in Program 2 and save it on tape immediately after Program 1.

To use it, load and run Program 1, which POKEs the machine language into memory; unless there is a mistake, it will then automatically load and run the second program on the tape, the one that does the plotting.

When run as above, the second program will plot the graph, in Cartesian coordinates, of a function defined in line 5. To do this, it will ask for the domain of the function of the function, i.e.: the range of values on the x-axis for which values of the function are to be plotted.

It will then ask for the plotting density, i.e.: how close

together it will plot the points, where 1 gives the highest density and 4 the lowest.

Once plotted, the graph will remain on the screen until the user presses the CTRL key and then the space bar.

Both parts of the program should be typed in without any spaces between words as this saves using too much memory space.

HEART STOPPER

Neil Duncan, Heathmont Vic.

This program catches a few hearts. To play it, simply press the two cursor buttons which will move the capturing position on the screen.

The game is over when the score reaches 20. On ending, the time taken is printed out.

The small type in lines 60 and 160 refer to VIC-20 buttons and should not be typed as text (no commas either).

```

MACHINE-LANGUAGE GRAPHICS      Program 1
10 REM LOADS MACHINE-LANGUAGE
20 CH=0:FOR I=5892 TO 6119:READA:POKE I,A:CH=CH+A:NEXT:IPCH<>33481
  THEN PRINT "ERROR":END
30 FOR I=5892 TO 6119:POKE I-1000,PEEK(I):NEXT:POKE 631,131:POKE
  198,1:END
40 DATA 177,3,144,9,1,141,3,144,169,8,141,15,144,169,253,141,5,
  144,169,147,32,210,255
50 DATA 169,0,133,251,169,30,133,252,169,150,160,0,145,251,200,
  192,0,208,249,230,252,165
60 DATA 252,201,32,208,237,169,20,133,252,169,0,133,251,160,0,
  145,251,200,192,0,208,249
70 DATA 230,252,165,252,201,30,208,235,96,169,0,133,251,133,252,
  133,253,133,254,165,0
80 DATA 24,105,248,230,251,176,249,198,251,165,1,24,105,240,230,
  252,176,249,198,252,166
90 DATA 252,169,0,24,105,22,202,224,0,208,248,24,101,251,133,253,
  164,253,185,0,30,201
100 DATA 150,208,9,173,255,29,153,0,30,238,255,29,133,253,165,1,
  166,252,56,233,16,202
110 DATA 208,250,133,254,169,20,133,3,165,254,166,253,24,105,
  16,144,2,230,3,202,224,0
120 DATA 208,244,133,2,165,0,166,251,56,233,8,202,224,0,208,248,
  133,252,169,7,56,229
130 DATA 252,170,169,1,24,133,251,101,251,202,224,0,208,246,133,
  252,201,0,208,2,230,252
140 DATA 160,0,177,2,5,252,145,2,96

      Program 2
5 DEFN A(X)=SIN(X)
10 POKE 36878,9:PRINT CHR$(147)SPC(48)"VIC GRAPHICS":PRINT SPC(90)
  :INPUT "DOMAIN(A,B)":A,B
20 IFA=B THEN PRINT SPC(50)"ERROR":POKE 36876,200:FOR I=0 TO 1500:NEXT
  :POKE 36876,0:GOTO 10
30 PRINT SPC(45):INPUT "PLOT DENSITY(1-4)":G:IF C<10 OR C>4 THEN C=4
40 SYS 4892:POKE 7679,1:D=C*(B-A)/175:U=0:L=0:FOR I=ATOBSTEPD:C=
  PNA(I):IF C<L THEN L=C
50 IF C>U THEN U=C
60 NEXT:R=175/(ABS(L)+U):W=175/(B-A):IF B<0 OR A>0 THEN B=0
70 POKE 0,-A*W:FOR I=0 TO 175:POKE I,I:SYS 4968:NEXT
80 POKE 1,175-ABS(L)*R:FOR I=0 TO 175:POKE I,I:SYS 4968:NEXT
90 FOR I=ATOBSTEPD:C=PNA(I):X=(I-A)*W:Y=175-(ABS(L)+C)*R:POKE
  0,X:POKE 1,Y:SYS 4968:NEXT
95 POKE 36875,180:FOR T=0 TO 600:NEXT:POKE 36875,0:WAIT 653,4:WAIT
  197,32
100 POKE 36879,27:POKE 36869,240:POKE 36867,PEEK(36867)AND 254:POKE
  198,0:GOTO 10
  
```

HEART STOPPER

```

10 V=36878:S2=36875:H=83:X9=22
20 T1=7680:C1=38400:X1=10:S3=38884:T2=8164
30 POKE S2,200
40 IF W=20 THEN PRINT "TIME=";MIDS(TIS,4,1);
  "-";MIDS(TIS,5,2);" PRESS RETURN";:INPUT AS
50 TIS="000000":W=0
60 PRINT "clear,home,21 times down cursor"
70 IF RND(1)<.1 THEN R=22*RND(1):POKE T2+R,H:
  POKE S3+R,0
80 PRINT
90 POKE (T1+X1),X9:POKE (C1+X1),0
100 POKE V,0:GET AS:IF LEN(AS)>1 THEN 150
110 IF ASC(AS)=17 THEN X1=X1-1:GOTO 130
120 IF ASC(AS)=29 THEN X1=X1+1
130 IF X1>21 THEN X1=21:GOTO 150
140 IF X1<0 THEN X1=0
150 GOSUB 500
160 IF W=20 THEN PRINT "clear,home,FINISHED":
  FOR I=100 TO 200:POKE S2,I:POKE V,15:NEXT I:
  POKE V,0:GOTO 10
170 POKE (T1+X1),X9:POKE (C1+X1),0
180 GOTO 70
500 W1=0:POKE V,0
510 IF PEEK(22+T1+X1)=H THEN W1=1
520 IF W1=1 THEN POKE V,15:W=W+1
530 IF W<10 THEN POKE T1,W+48:POKE C1,0
540 IF W>9 THEN Z=INT(W/10):POKE T1,48+Z:
  POKE T1+1,W-10*Z+48:POKE C1,0:POKE C1+1,0
550 RETURN
  
```

K-NAR COMPUTER CARDS

S100 Z80 System Card Specialists

CP/M3



CP/M3 USERS

DRC-II. The board for multi-user installations. 256K dynamic RAM card, bank select, fast 4 Mhz operation, on-board memory prom, dip-switch selectable boundaries, bank mode allows up to 2 boards on bus, hidden refresh, phantom disable. List Price \$995.

\$795 OUR PRICE

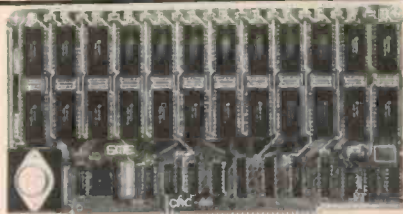

CRC-64. Fool-proof memory system. State-of-the-art 64K CMOS memory card with memory protection, on board battery back-up, compatible with DRC-II, write protection enable/disable. List Price \$675.

\$565 OUR PRICE



FDC-II. Enhanced floppy disk controller, IBM 3740 compatible, operates 5" & 8" and single/d. density drives, handles up to 4 drives, runs multi-density CP/M2.2 & MP/M 2. Vectored Interrupt operation optional. List Price \$465.

\$370 OUR PRICE



VDC-8024. The low cost alternative to stand-alone terminal. Flexible 80x24 memory mapped video display board with full ASCII, semi graphics, Inverse & half intensity video, flicker free screen updating. Battery backed option offers diagnosis of system shut downs. List Price \$325.

\$230 OUR PRICE

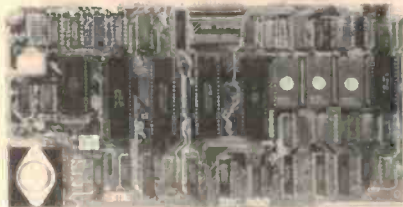

SBC-800. 4 Mhz Z-80 CPU, two serial RS232 ports, software programmable Baud rate gen., Centronics parallel port, 22 prog. I/O lines, real time clock (battery backed), 2K CMOS RAM, power on reset/power fail detect, battery backed as standard, etc. List Price \$495.

\$395 OUR PRICE



SPC-29. High performance dual serial & 9 parallel port I/O CARD, with full I/O address decoding. Switch selectable baud rates. Link patch area, programmable modes for strobed/latched I/O. List Price \$295.

\$235 OUR PRICE

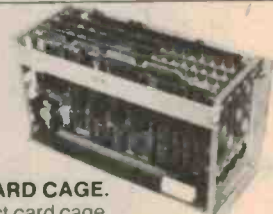

MINI CARD CAGE.

Compact card cage frame with 5-slot motherboard plated through hole. Five edge connectors. Was \$150.

\$125 OUR PRICE



S-100 WIRE WRAP CARD. Gold-plated edge connectors, through hole plating, provisions for four regulators, distributed power rails. I/O connector provision on top of card.

\$33 OUR PRICE

DIGITAL PANEL METER

Analogue Devices 4 1/2 digit LED Panel Meters. Brand new in original boxes. Originally \$300.

\$75 OUR PRICE

(Limited Stocks)

Please send me product data sheets.
(I enclose 4 stamps).

I wish to order

My cheque/order form for .. is enclosed

Please debit my Bankcard No.

Name

Address

Signature

Please include me on your new product mailing list. I am mainly interest in systems for Hobby, Industrial use, Education, Business, Process control, Other.

KN/469

K-NAR

COMPUTER CARDS

PO Box 412, Dandenong 3175, Phone (03) 795 5858.
Authorised distributor of SME Systems products.

* Prices subject to change without notice. All prices excluding tax. For retail prices add 20%.
All boards fully assembled and tested and backed by 90-day guarantee.

RITRONICS WHOLESALE PTY LTD

425 HIGH STREET NORTHCOTE 3070 MELBOURNE (03) 489-8131
48-50 A'BECKETT STREET MELBOURNE (03) 347-9251

"BIG BOARD II"

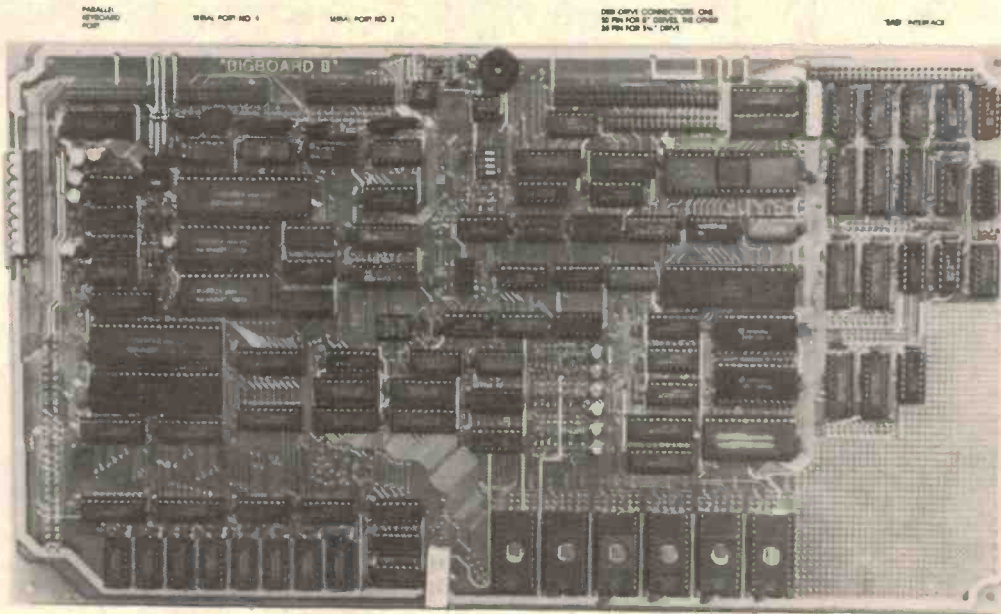

STD
Bus
Connector

EPROMs
shown only
for clarity.

Prototyping
Area

Jim Ferguson, the designer of the "Big Board" distributed by Digital Research: Computers, has produced a stunning new computer that we will begin shipping in November called "Big Board II", it has the following features:

4 MHz Z80 — CPU AND PERIPHERAL CHIPS

The Ferguson computer runs at 4 MHz. Its monitor code is lean, uses Mode 2 Interrupts, and makes good use of the Z80-A DMA chip.

64K DYNAMIC RAM + 4K STATIC CRT RAM + 24K E(P)ROM OR STATIC RAM

"Big Board II" has the three memory banks. The first memory bank has eight 4164 RAMs that provide 60K of user space and 4K of monitor space. The second memory bank has two 2Kx8 SRAMs for the memory-mapped CRT display and space for six 2732 As, 2Kx8 static RAMs, or pin-compatible E(E)PROMs. The third memory bank is for RAM or ROM added to the board via the STD bus. Whether bought as a bare board, a full kit, or assembled and tested, it comes with a 350 nS2732 EPROM containing the monitor.

MULTIPLE-DENSITY CONTROLLER FOR SS/DS FLOPPY DISKS

The new Ferguson single-board computer has a multiple-density disk controller. It can use 1793, 1797, or 8877 controller chips since it generated the signal with TTL parts. The board has two connectors for disk signal with 34 pins for 5.25" drives, the other with 50 pins 8" drives.

VASTLY IMPROVED CRT DISPLAY

The new Ferguson SBC uses a 6845 CRT controller and 8002 Video Attributed controller to produce a display that will rival the display of quality terminals. Characters are formed by a 5x7 dot matrix on 15.75 KHz monitors and 7x9 dot matrix on 18.60 KHz monitors. The display is user programmable with the default display 24 lines of 80 characters. 8002a chip supplied for 18 to 60 kHz monitors.

STD BUS CONNECTOR

The Ferguson computer brings its bus signals to a convenient place on the PC board where users can solder an DSTD, bus cards can be plugged directly into it, and it can as well be connected by bus cable to industry-standard card cages.

DMA

The new Ferguson computer has a Z80-A DMA chip that will allow byte-wise data transfers at 500K bytes per second and bit serial transfers via the Z80-A S10 at 880K bytes per second with serial processor overhead, though the monitor for the new computer uses the DMA chip mainly for transferring data to and from disk, the chip can readily be used for other things since its "wait/ready" pin can be connected under software control to some half a dozen signal lines. When a hard-disk subsystem is connected to the "Big Board II" via its "SASI" interface, the DMA chip makes breathtaking disk performance possible.

"SASI" INTERFACE FOR WINCHESTER DISKS

The "Big Board II" implements the Host portion of the "Shugart Associates Systems Interface". Adding a Winchester disk drive is no harder than attaching a floppy disk drive. A user simply 1: Runs a 50-conductor ribbon cable from a header on the board to any of several inexpensive controller cards for Winchester drives that implement the controller portion of the SASI interface. 2: Cables the controller to an appropriate drive, and 3: Provides power for the controller-card and drive. Since our CBIOS contains code for communication with hard-disk, that's all a user has to do to add a Winchester to a system!

A Z80-A S10/0 = TWO ASYNCHRONOUS/SYNCHRONOUS SERIAL PORTS

A PARALLEL KEYBOARD PORT = FOUR OTHER PARALLEL PORTS USER I/O

The new Ferguson single-board computer has one parallel port for an ASCII keyboard and four others for user-defined I/O. When the computer is powered-up or reset, the monitor looks for a carriage-return at the keyboard and serial ports. If the first carriage-return the monitor gets comes from the parallel keyboard, the monitor uses the board's video display circuitry to communicate with the user via a CRT. If the first carriage-return is typed at an ASCII terminal attached to a serial port, the monitor dutabauds and makes the terminal the system console.

TWO Z80-A CTCs = EIGHT PROGRAMMABLE COUNTERS/TIMERS

The new Ferguson computer has two Z80-A CTCs. One is used to clock data into and out of the Z80-A S10/0, while the other is for systems and application use.

PROM PROGRAMMING CIRCUITRY AND SOFTWARE

The new Ferguson SBC has circuitry and drivers for programming 2716s, 2732(A)s, or pin-compatible (E)EPROMs. Software \$25 extra.

CP/M

CP/M with Russell Smith's CBIOS for the new Ferguson computer is available for \$220. The CBIOS is available separately for \$65.

Actual board size: 39.6cm x 22.2cm. 5 inch BIOS being developed. Approx price \$95.

Pricing and Availability:

Availability: 2 weeks delivery.

In single quantities, full kits cost \$775.00 + tax, and A&T'd computers cost \$895. There are attractive discounts that range to 35% for OEM's and dealers. For details about them please call Rod Irving on (03) 489 7099. ie: 3 Ferguson II "Big Board" are less 20% off the one-off price, hard disks disk controllers, boxes and power supply to suit both 8" & 5 1/4" systems will be available.

Bare board with main chips now available (Includes PCB, Manual, PALS, Monitor ROM, SMC chips). You have to add rest of components at \$495 + tax

Errors and omissions excepted

HERE are a couple of useful utilities and a new game. We now have such a stack of software — this column being the most popular computer column in ETI — that we'll have to run a 'potpourri' again very soon!

For those who have enquired, or thinking of enquiring, we haven't forgotten about the spare I/O port or expansion projects. Be patient, we're gathering our resources and working on it.

In the meantime, keep those programs, hints, tips, and modifications coming; there are plenty of '660 owners out there who want to be kept busy.

The first program this month is an editing utility. Correcting wrongly entered instructions is OK, but if you have ever missed a few early on in a big program, then you'll know what frustration means! Now you can 'insert' those missing bytes.

BLOCK MOVE

Tzu-Pei Chen, Mulgrave Vic.

Have you ever entered a 500 byte program only to discover that you had left out one byte right up the front? 'Block Move' allows you to salvage this situation by letting you insert that missing line of code without retyping the rest of the program. What the program does is move chunks of memory around. For instance; say you wanted to enter this program:

```
0600 16 B6 3D 7D 16 55 00 00
But you entered this;
0600 16 B6 16 55 00 00
```

You would proceed thus;
 0700 06 06 ; 606 is the byte after the chunk of memory to be moved.
 0702 06 02 ; 602 is the beginning of the chunk of memory to be moved.
 0704 07 30 ; 730 is somewhere convenient to put it for the meantime.
 Then you type RESET 0 0706 RESET 6 (execute machine code at 706). The 660's memory will now look like this;

```
0600 16 B6 16 55 00 00
0730 16 55 00 00
Then you enter;
0700 07 34 ; 734 is the byte after the chunk of memory to be moved back.
0702 07 30 ; 730 is the start of the chunk of memory to be moved back.
0704 06 04 ; 604 is where to replace the code leaving two bytes for the missing code.
```

Then you again type RESET 0 0706 RESET 6. The 660's memory should now be;

```
0600 16 B6 16 55 16 55 00 00
Then you just enter the missing code and there it is,
0600 16 B6 3D 7D 16 55 00 00
This was a silly example but imagine if it had been 500 bytes long ...
```

NOTE:
 If you use Block Move to move memory up, i.e:

```
NEWPOS (eeff) > START (ccdd)
then you must make sure that
NEWPOS (eeff) >= FINISH (aabb)
otherwise Block Move will not work correctly.
```

TANK BATTLE

J.R. Hyde, Christchurch NZ

This game has been adapted from a game originally written for the Cosmac VIP. You are a 'tank commander' and the object is to annihilate targets. It's a variation on a familiar theme, but this one has a few twists and it's not as easy as it appears.

A target will appear at random on the screen and may disappear at times. By manoeuvring your tank, you try to shoot the target and score a hit using the fire button (key F — what else!). Your score (00 to start with) is shown on the left of the screen and the number of shots left is shown on the right. For each hit you score 10 points. Each time the target hits you, however, five shots are deducted from those remaining!

To manoeuvre the tank, use the keys as follows:

Key 1	UP
4	LEFT
6	RIGHT
9	DOWN
F	FIRE

By changing the data at 07b8 to 4428 and 07cc to 442F, the tank can be made to move and fire in the bottom part of the screen if required.

BLOCK MOVE

```
>
>          0700          NAM BLKMVE
0700 0000 FINISH RMB 2 *aabb End of block.
0702 0000 START RMB 2 *ccdd Start of block.
0704 0000 NEWPOS RMB 2 *eeff Where block is to
0706 F8 07 MOVE LDI 07 be placed.
0708 B5 PHI R5
0709 B7 PHI R7
070A F8 00 LDI 00
070C A5 PLO R5
070D F8 01 LDI 01
070F A7 PLO R7
0710 F8 07 LDI 07
0712 B8 PHI R8
0713 F8 02 LDI 02
0715 A8 PLO R8
0716 48 LDA R8
0717 B9 PHI R9
0718 48 LDA R8
0719 A9 PLO R9
071A 48 LDA R8
071B B6 PHI R6
071C 48 LDA R8
071D A6 PLO R6
071E 49 LOOP LDA R9
071F 56 STR R6
0720 16 INC R6
0721 B9 GLO R9
0722 E7 SEX R7
0723 F5 SD
0724 CA 071E LBNZ LOOP
0727 99 GHI R9
0728 E5 SEX R5
0729 F5 SD
072A CA 071E LBNZ LOOP
072D C0 0000 LBR MONITOR
>          072F          END
*
```

-> BLKMVE LISTING 2

```
700 aa bb cc dd ee ff F8 07
708 B5 B7 F8 00 A5 F8 01 A7
710 F8 07 B8 F8 02 A8 48 B9
718 48 A9 48 B6 48 A6 49 56
720 16 89 E7 F5 CA 07 1E 99
728 E5 F5 CA 07 1E C0 00 00
```

TANK BATTLE

```
0600 - 1630 76fb 6020 8065 4f00 6600 1784 00ff
- DATA FILES
0630 - 6e00 6da0 6a01 6906 6804 6709 6619 6410
0640 - 630c 6200 6106 a612 fa55 27d4 6040 f015
0650 - f007 3000 1650 27d4 270a 2762 a612 f565
0660 - 26ae 26c6 26ec 3f01 2714 3f01 26ec 3f01
0670 - 26ec 3f01 267c 4f01 1766 1662 a612 f565
0680 - 4600 3500 1688 178c e7a1 6209 e8a1 6204
0690 - e9a1 6206 eaa1 6201 4200 00ee 26ae 8120
06a0 - 279a 27ac 6c01 6200 6f00 a612 f555 a7ff
06b0 - 4101 6000 4104 6013 4106 600d 4109 6006
06c0 - f01e d347 00ee 600f e09e 00ee 450f 00ee
06d0 - 650f 76ff a612 f555 7403 7303 279a 279a
06e0 - 279a a623 f555 a819 d341 00ee a623 f565
06f0 - 4500 00ee a819 d341 279a 6c02 27be 4bbb
0700 - 170a d341 a623 f555 00ee 6500 6000 a617
0710 - f055 1704 a61d f565 350f 1744 a81a d345
0720 - 3200 1732 c103 a619 f11e f065 8100 c20f
0730 - 7201 279a a81a 6c03 72ff 6f00 d345 a61d
0740 - f555 00ee c407 a81f f41e f065 8300 a827
0750 - f41e f065 8400 a81a d345 6020 f018 650f
0760 - 173e 6500 173e 4c01 1602 4c02 1782 a623
0770 - f565 4500 1602 a819 d341 6f00 d341 3f01
0780 - 1602 7e0a 6040 f018 00e0 164a 00e0 27d4
0790 - 6060 f018 1794 6e00 1784 4101 74ff 4104
07a0 - 73ff 4106 7301 4109 7401 00ee 4400 7401
07b0 - 4300 7301 4338 73ff 4418 74ff 00ee 6b00
07c0 - 4400 17ce 4300 17ce 433f 17ce 441f 6bbb
07d0 - 6f00 00ee 6308 6408 a629 fe33 f265 27ec
07e0 - 6328 a629 f633 f265 27f2 00ee f029 d345
07f0 - 7306 f129 d345 7306 f229 d345 00ee 0110
0800 - 547c 6c7c 7c44 7c7c 6e7c 5410 00fc 786e
0810 - 78fc 003f 1e76 1e3f 0080 a870 f870 a80b
0820 - 1b28 3830 2010 0000 0000 081b 1b1b 1804
```

ZX COLUMN

WELL, It seems ZX enthusiasts have come out of the woodwork in response to our call in the April issue column!

One such was David Vernon, Secretary of the Australian ZX Users Association, who promises regular contributions. His first effort heads up the column this issue.

Keep those contributions coming. We'd especially welcome contributions for the ZX Spectrum. All submissions must be your original work or describe a useful modification to published software.

SAVING MEMORY

David Vernon, Campbell, ACT

I have received a number of comments from AZUA (Australian ZX User's Association) members who have bought an unexpanded ZX81 and don't seem to be able to fit a workable program into only 1K of RAM. However, don't despair, for there are many ways that you can fit more into 1K. Look at the following:

1. Use only single letter variables. Instead of this:
10 LET SCORE=0

use:

```
10 let S=0
```

2. The Sinclair instruction manual suggests using REM statements at the start of subroutines and throughout the program. This is fine if you own a 16K RAM pack. If not, cut out all REM statements.

3. Use Sinclair keywords within PRINT statements. For example:

```
10 PRINT "PRESS S TO STOP AND  
R TO RUN AGAIN."
```

By using the Sinclair keywords for STOP, AND and TO, you save 14 bytes.

These words are shifted words printed in red on the keyboard. This is not all, you can replace the word RUN also with a keyword. This is not as simple as it may seem.

To get RUN, you must use the Sinclair keyword for THEN and then type RUN (on the R key) straight after it. Backspace and delete the THEN. By doing this you save a total of 17 bytes in that one sentence!

4. Replace the numbers 1 and 0 with the following expressions: 0 can be replaced by SGN PI, SIN PI, INT RND or TAN PI. NOT PI is the fastest command. 1 is replaced with SGN PI, and of course 3 can be replaced with INT PI.

The use of these techniques in your program will slow the running time down, but will save you 4 bytes everytime they are used.

5. All numbers which are larger than three or less than zero can be placed within strings. For example:

```
120 GOSUB VAL "30"
```

or

```
10 PRINT AT VAL "6", VAL "10"; "AZUA"
```

Believe it or not each time this is used you save three bytes.

6. You can save four bytes each time with regard to numbers in the range of 0-255, excluding 67-127. This is because each of these numbers is a ZX character or keyword.

The function CODE can be used to return the numerical value of the corresponding character. For example: 105 GOTO 60 can be replaced by 105 GOTO CODE "W". Within a program it certainly looks weird, but it works.

7. Don't use the INKEY\$ function like this:

```
50 IF INKEY$="8" THEN LET A=A+1  
60 IF INKEY$="5" THEN LET A=A-1
```

if you are using it for moving things around on the screen.

Use this instead:

```
50 LET A=A+(INKEY$="8")-(INKEY$="5")
```

8. If you are using PRINT AT a number of times together like:

```
10 PRINT AT Y,X;"H"  
20 PRINT AT Q,R;"V"  
30 PRINT AT A,B;"$"
```

use this instead:

```
10 PRINT AT Y,X;"H"; AT Q,R;"V"; AT A,B;"$"
```

This method saves lots of memory and typing!

9. If you give two variables the same value, e.g:

```
5 LET A=20  
10 LET N=20
```

use this instead:

```
5 LET A=20  
10 LET N=A
```

It saves memory and is also faster than the other way.

10. Use undefined variables to stop the program. So, replace

```
60 IF M=0 THEN PRINT "GAME OVER"  
70 IF M=0 THEN STOP
```

with:

```
60 IF M=0 THEN PRINT "GAME OVER";X  
where X hasn't been defined previously.
```

The program will stop with an error code 2 instead of an error code 9.

11. Don't use the whole screen for your display. The program example here, "Oesophagus", gives a good example of this. I used only the first 12 lines of the screen. The reason for this is that the display file and the RAM for your program are all in the same 1K and the more memory you use, the less display you get.

12. Use scientific notation where possible. Instead of:

```
10 LET G=VAL "10000"  
use
```

```
10 LET G=VAL "1E4"
```

Use the following subroutine to see how much memory you have used up in your program:

```
9999 PRINT PEEK 16400+PEEK 16401*256-16587  
use GOTO 9999 to use it. The number of bytes it shows doesn't include the routine itself.
```

The 16K version is:

```
9999 PRINT PEEK 16400+PEEK 16401*256-16587  
and for those who own the ZX80 with 4K ROM the routine is:
```

```
9999 PRINT PEEK (16392)+PEEK  
(16393)*256-16461
```

and those lucky enough to have a ZX Spectrum can use:

```
9999 PRINT PEEK 23720+256 PEEK 23731-PEEK  
23653-256*PEEK 23654
```

Finally, you can try this program which uses the memory saving devices outlined above to make it fit into 1K.

OESOPHAGUS

Use the N and M keys to manoeuvre your globule of food down an evil oesophagus. You must prevent your globule from being absorbed into the sides. If you don't like the idea of globules of food, perhaps you can change it to a car and call the program "Grand Prix" ●

OESOPHAGUS

```
5 LET R=NOT PI
```

```
10 LET A=VAL "12"
```

```
20 LET B=VAL "6"
```

```
30 LET F=A
```

```
40 LET G=VAL "10"
```

```
50 LET S=NOT PI
```

```
100 LET X=INT (RND*INT PI)-SGN PI
```

```
110 LET I=INT (RND*INT PI)+VAL "2"
```

```
120 FOR L=SGN PI TO I
```

```
130 LET B=B+X
```

```
135 IF B>VAL "10" THEN LET B=B-SGN PI
```

```
140 LET G=G+(INKEY$="M")-(INKEY$="N")
```

```
150 PRINT AT A,B;" graphics T,
```

```
6*graphics space, graphics Y ";
```

```
AT F,G;" graphics H "
```

```
160 IF G<=B OR G>=B+VAL "7" THEN GOTO VAL "300"
```

```
170 SCROLL
```

```
175 LET S=S+SGN PI
```

```
180 NEXT L
```

```
190 GOTO VAL "100"
```

```
300 PRINT "SLURP"
```

```
310 PRINT "SCORE";S
```

```
320 IF S>R THEN GOTO VAL "400"
```

```
325 GOTO VAL "420"
```

```
400 PRINT "NAME?"
```

```
410 INPUT B$
```

```
415 LET R=S
```

```
420 PRINT "TOP SCORE";B$;" ";R
```

```
430 PAUSE VAL "200"
```

```
440 CLS
```

```
450 GOTO VAL "10"
```



ROD IRVING ELECTRONICS

BMC VIDEO MONITORS



- Green Phosphor
- 12MHz B/W
- Used by Telecom
- Great Value

**NOT \$299
ONLY \$279**

2 BRANCHES:

425 High St. Northcote, Ph.: (03) 489 8131
 48-50 A'Beckett St. Melb. Ph.: (03) 347 9251
 Mail orders: P.O. Box 235
 Northcote, Vic. 3070
 min p&p \$3.00

TERMINAL WITH DETACHED KEYBOARD

Incredible Quality
Unbeatable Value
\$1099 inc. tax



BEAT MAINS INTERFERENCE WITH OUR LINE FILTERS



Easily mounted inside equipment with flying heads. Stop the glitches that destroy valuable data. Manufacturer enquiries welcome. Another High Tech Direct Import by Rod
\$12.25

INGERSOLL GREEN PHOSPHOR MONITORS

Update now, and add a touch of class to your computer.

- Features:
- 18 MHz B/W
 - Green Phosphor
 - Concealed Controls
 - 1 Year Warranty



\$199.50 Orange Phosphor

DISC DRIVES

MP1 51 \$265 + 20% ST
 MP1 52 \$385 + 20% ST
 MP1 91 \$415 + 20% ST
 MP1 92 \$515 + 20% ST

MITSUBISHI DRIVES

8" Standard \$618
 8" Slimline \$618

**If you want two or more
"GIVE US A YELL!"**

We have the full range of Mitsubishi drives and won't be beaten on price

2 x 8" Slimline Case with power supply (can also take 1 standard 8" drive) Put your S.B.C. in bottom.



Power supply delivers
 +5V @ 5A
 ±12V @ 1A
 +24V @ 2A
\$350.00 inc. fan

**2 x 8" Standard Drive Case
Bare Case \$120.15**

5" Drive Cases with power supplies

For 1 drive **\$69.00**
 For 2 drives **\$119.00**



KEYBOARDS
 Clare C70 \$169.00 Case with cutout \$85.00
 RCA \$139.00



Unbeatable 5 1/4" FLOPPY DISC PRICES S.S.D.D.

1-9 10-99 100+
 \$3.00 \$2.85 \$2.60
 Well known brand
 Plus 20% sales tax
 12 month guarantee

SPEECH SYNTHESISER

Our Price
 DT 1050 National Digitalker and Romset **\$75.00**
 DT 1057 National Digitalker Second Romset **\$59.00**
 Data Sheets included in chip sets

PRINTERS

		Tax ex.
8510P	\$895	\$795
8510S	\$1075	\$990
1550P	\$1195	\$1095
1550S	\$1295	\$1195

ETI 640 VDU

Bare Board	\$59.00
Kit Price	\$129.00
A + T	\$149.00
A & T	\$149.00

\$100 EXTENDER CARD

Plug into your S100 system and be able to check your board voltage lines are all fused.
\$49.50

WHAT ABOUT A STAND FOR YOUR PRINTER

Adjustable and sturdy. Makes life a "hell of a lot easier"
\$249.00



WE HAVE UNBEATABLE PRICES ON SYSTEMS



Give Rod a ring and discuss what you need



Bankcard mail orders welcome
ORDER FORM
 Please Debit my Bankcard

No. _____
 Expiry Date _____
 Name _____
 Signature _____

BIG SAVINGS ON CASIO CALCULATORS

Casio FX-3600P Scientific/Programmable

Wow! Check out the Casio FX-3600P, programmable up to 38 steps - and it's an ideal calculator for engineers, uni, tech and advanced high school students, technicians etc. Ask about our tax free price for students. Cat. Q-3105



WAS ~~\$59.95~~ **SAVE \$10**
ONLY **\$49.50**

Casio FX-602P Advanced Programmable

Advanced programmable:
88 memories... 512 steps... full memory retention. An amazing 33 sub-parenthetical levels, up to 9 sub-routines and nestings... Sounds more like a computer than a calculator? You're right!
Cat. Q-3110



WAS ~~\$199~~ **SAVE \$30**
ONLY **\$169**

NOW IN STOCK

The Dick Smith AUSTRALIAN SEMICONDUCTOR HANDBOOK



Application data for the nine to five engineer... and the weekend professional. The book you've always needed, a 'one source' reference for the common devices often used. It contains data on hundreds of semi-conductor devices - discrete, linear, TTL, CMOS, etc the types of components used extensively in Australia, particularly by the Australian Electronics magazines. Cat. B-4200

\$7.95

EVERY OHM NEEDS ONE!

RECALL NOTICE

Cat. T-1300 240V Soldering Iron PURCHASED SINCE DECEMBER 1ST, 1982

A possible manufacturing fault in some of the last batch of T-1300 Soldering Irons could cause faulty operation and, in some rare circumstances, make them potentially dangerous.

For maximum safety we are recalling the iron and offering a refund or exchange with different model.

If you have purchased one of these irons please return it to any Dick Smith Store or re-seller for your exchange or refund.

This recall applies ONLY to irons purchased since December 1st, 1982.

DICK SMITH ELECTRONICS

A Colour Computer \$200!

for under

DICK SMITH
VZ-200

Here it is at last - the personal computer you've been waiting for! With all the right features: colour graphics, sound, standard Microsoft BASIC, both RF and video output, and lots more. Yet thanks to modern technology and Dick Smith's massive buying power, it will cost you only \$199 - far less than any comparable machine! Because of this dramatic breakthrough in terms of value for money, our new VZ-200 provides you and your children with the ideal opportunity to learn about computers and programming.



Cat. X-7200

SOME OF ITS AMAZING FEATURES

- 8K bytes of RAM memory Inbuilt
- Powerful Microsoft BASIC in ROM - so your VZ-200 understands easy-to-follow BASIC commands as soon as it's turned on.
- Full colour graphics capability: 8 colours
- 128 x 64 high resolution graphics mode or 64 x 32 - (mixed graphics & text mode)
- Built in sound/music facility: plays any note in a 2-1/2 octave range.
- Large 45-key keyboard, typewriter layout, Auto-repeating keys, too.
- RF output (channel 1) or direct Video output for colour TV monitor.
- Easily expandable using optional 16K memory expansion module, Centronics printer interface module (availability shortly).

**AMAZING
VALUE**

\$199

A PROFESSIONAL SOLDER STATION - HOBBYIST'S PRICE!

The Exclusive Dick Smith SOLDERING STATION

Here's our brilliant temperature controlled solder station, offering you the very best quality at an unbelievably low price. Compare our Solder Station to others.

FEATURES INCLUDE:

- Variable temperature control from around 200 to over 500 degrees Celsius.
- Large temperature meter
- Fully approved by the Energy Authority
- Complete with lightweight iron, holder, cleaning sponge and users manual!

ONLY \$65



HUGE SAVINGS!

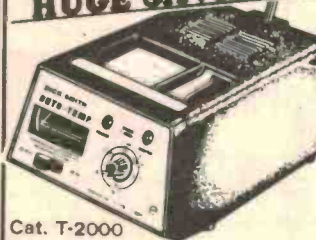

Cat. T-2000

AMAZING! SOLDERING SET AID

For the person working with PC boards this is an essential aid. Kit contains: guide fork tool, scribe, heatsink clip and stainless steel bristle brush. Can also be used for restringing dials! Cat. T-2610

**AMAZING \$5.50
VALUE**

High Impedance Multimeter 10 MEG FET INPUT

For the professional who wants the lowest circuit loading... you want the highest input impedance. The FET input multimeter gives you a huge 10M input impedance on DC voltage, and a highly respectable 1M on AC voltage. Batteries, test leads & instructions supplied. Cat. Q-1200



LIMITED STORE STOCK
SAVE \$13
WAS \$72.00
ONLY \$59

BUY IN BULK AND SAVE!! SOLDER

Top quality corrosion free multicore solder. 1.25mm (18g) 200 grams
Cat. N-1619

ONLY \$4.95

0.71mm (22g) 200 grams
Cat. N-1623

ONLY \$4.95

FAMOUS ADCOLA 12 Watt Soldering Iron \$30

Reliable iron for general service or production area and ideal for the hobbyist. High impact plastic handle, complete with Triclad 3mm long life tip. Cat. T-1820
Tips to suit Cat. T-1854 **\$2.60**

WAS \$27 **NOW \$15.95**
ONLY

FAMOUS SHURE CARTRIDGES

WOOPS! We forgot to put them in our Catalogue (slap wrists) but we DEFINITELY still stock Shure Cartridges.

M70B (Spherical) Cat. C-5511 **\$22.50ea**

M91ED (Elliptical) Cat. C-5515 **\$49ea**

Styl to suit

N70B (Spherical) C-5032 **\$17.60**

N70EJ (Elliptical) Cat. C-5034 **\$19.95**

N91ED (Elliptical) Cat. C-5036 **\$21.95**

DICK SMITH

NEW 'PHONY PATCH'

Landline Interface

As seen in the May issue of Electronics Today. Get ready for Phone Patching when it's made legal - this great little kit is ideal for connecting a four wire (eg transmitter/receiver) system to a two wire (eg phone lines or intercoms, etc). You could even set your transmitter up for complete remote operation using VOX.

UNIQUE IN AUSTRALIA!

Cat K-3054

\$59⁵⁰

HURRY!

ATARI CARTRIDGES
AT LOW PRICES
- YOUR LAST
CHANCE

STORE
STOCK
ONLY



EXPERIMENTERS TRANSCEIVER

Here's one for all the amateurs, servicemen, technicians etc. Famous National brand 9 channel 27MHz CB, ideal for conversion to 10 meters, use as spare parts, experiment with etc. We over-bought on this model and we MUST reduce stocks - our loss is your gain. Take advantage of our mistake and save a fortune! Cat. D-2500

HURRY!

STRICTLY LIMITED STOCK

Now sacrificed
at only

\$49⁹⁵

~~WAS \$169~~

Bargain Grab Bag

Wow! Up to \$30 worth - and more. Mainly components from end of runs in our kit department; also includes things like 40 channel CB switches, various pcb's, rubber feet, etc etc. Fantastic bits'n'pieces for the hobbyist's junk box.

LIMITED STOCK
Cat R-7101
\$4⁹⁵



SAVE \$20
WAS \$29.50
Cat. Y-1607
Storage Cassette Unit

Suit Y-1600 WIZZARD
Comes complete with fantastic demo-cassette. **\$69⁵⁰**

HORN SPEAKER

A miniature rugged weatherproof horn with an impedance of 8ohms and a power rating of 5 watts. Ideal for PA work, burglar alarms etc. It has a mounting bracket for easy installation and comes complete with lead. Cat. C-2705



SAVE \$2.00
WAS \$10.25
NOW ONLY **\$8²⁵**

The last Great Aviation Adventure

A special souvenir edition of Dick Smith's solo round-the-world helicopter flight, with pictures, maps, flight details etc. of this historic & record-breaking flight. Cat. B-9100



Dick Smith Flight Cap
\$3⁵⁰
Cat. Y-1000

ONLY **\$1⁵⁰**

Transmitting Valves

Replacements for when yours stop working. 6146B...Cat. D-7202

\$19⁹⁵

6SJ6C Cat. D-7204

\$14⁹⁵



Quality Stainless Steel Tools Dick Smith Prices!

Resists rust, spring load return, insulated, easy grasp hand grips.

Transistor Nipper
Ideal for PCB work, long life, cutting edge. Cat. T-3205

Mini Flat Nose Plier
Great for those small nuts. Cat. T-3325

Mini Needle Nose Plier
Ideal for small components, and confined spaces. Cat. T-3570

Mini Long Nose Plier
Long reach in a small plier. Cat. T-3565

DIRECT IMPORT YOU REAP THE BENEFIT!

ALL ONE PRICE
TOP QUALITY

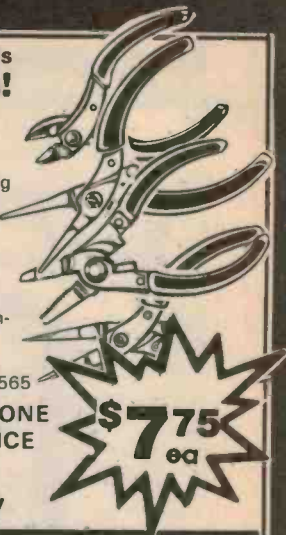

\$77⁵⁰

JOYSTICK INTERFACE KIT

Calling all System 80 owners: isn't it a pain in the neck using the arrow keys to play games? Wouldn't you rather use a Joystick control?

Here's your chance! This kit allows you to add a joystick to your System 80 via the printer port - and here's the good news: This month only we're GIVING A FREE 'QUICKSHOT' JOYSTICK with each Interface kit! That's right, save an amazing \$24.95 - this month only!

OVER \$62.00 WORTH FOR JUST \$37⁵⁰

QUICK SHOT JOYSTICK

It must be the ultimate joystick... Features: Contour grip, rubber suction cups to hold it down during those tight movements. It's just like the real one in a helicopter. Suit VIC and Atari, or System 80 (see above). Cat. Y-1495

Normally \$24.95 or FREE with the above Interface Kit.



AMAZING VALUE

NOISE PROBLEM? BEAT IT WITH THESE SUPPRESSORS

Inline Distributor Suppressor
Connect anywhere in lead to eliminate or reduce distributor noise. Cat. A-7904 **55¢**

Spark Plug Noise Suppressor
A spark plug cap with inbuilt 50K resistor. Cat. A-7908 **\$1.00**

Generator Noise Suppressor
Heavy duty 0.5uF-100 volt capacitor. Cat. A-7902 **80¢**

Alternator Noise Suppressor
A capacitor type suppressor with three leads. Reduces or eliminates the whine. Cat. A-7924 **\$2.80**

Delux Alternator Suppressor
A coil type filter wound on a high density ferrite core. Cat. A-7926 **\$11.95**

Coax Alternator Suppressor
Heavy duty 0.5uF 50 volt coaxial capacitor for extreme cases of alternator whine. Will handle 60 amps. Cat. A-7928 **\$5.50**

UNBEATABLE VALUE & QUALITY

DICK SMITH DIRECT IMPORTS



NSW AUBURN 848 0558	VIC COBURG 383 4455
BANKST. SQ. 707 4888	FRANKSTON 783 9144
BLAKEHURST 546 7744	GEELONG 78 6766
BONDI JCT 387 1444	VIC MELBOURNE 67 9834
BROADWAY 211 3777	RICHMOND 428 1614
BROOKVALE 93 0441	QLD SPRINGVALE 547 0522
CHULLORA 642 8922	BRISBANE 229 9377
GORE HILL 439 5311	BURANDA 391 6233
GOSFORD 25 0235	CHEERMSIDE 59 6255
LIVERPOOL 600 9888	TOOWOOMBA 38 4300
NORTH RYDE 88 3855	SA TOWNSVILLE 72 5722
PARRAMATTA 689 2188	ADELAIDE 212 1962
SYDNEY 27 5051	DARLINGTON 298 8977
SYDNEY 290 3377	ENFIELD 260 6088
TAMWORTH 66 1961	WA CANNINGTON 451 8666
TIGHE HILL 61 1896	PERTH 328 6944
WOLLONGONG 28 3800	PERTH 321 4357
ACT Fyshwick 80 4944	TAS HOBART 31 0800

HEAD OFFICE AND MAIL ORDER CENTRE:
PO Box 321, NORTH RYDE, NSW 2113. TEL (02) 888 3200.

ELECTRONICS



50 MHz oscilloscope goes mini

Vu-Data is an American company which has established itself in portable oscilloscopes and has now introduced what it has billed as 'the world's first 50 MHz miniscope'.

The new model, the PS950A, weighs only 6.4 kg but carries the sophistication associated with larger 50 MHz bandwidth oscilloscopes.

Apart from being small and light-weight, it also provides self-contained battery operation.

The quality design and rugged construction contribute to making this miniscope the ideal tool for field service, in-plant main-

tenance, mobile test applications or laboratory use.

It claims to have superior trigger features and a bright display with the optional extra of a model 975B digital multimeter-counter.

Full specifications and details of other products in the Vu-Data range are available from Vicom International Pty Ltd, 57 City Rd, South Melbourne Vic. 3205. (03)62-6931.

Heavy duty power supplies

Imark now has available two models of Alinco heavy duty power supplies which are imported from Japan.

The EPS-300 and EPS-30M power supplies provide 25 amps continuous (30 A maximum) current at 16 Vdc. The output voltage on both models is adjustable from 9 — 16 Vdc.

The EPS-300 is internally adjustable while the EPS-30M can be adjusted by the control on the front panel.

All models feature automatic overload protection as well as short circuit shut down circuitry.

Further details are available from Imark Pty Ltd, 167 Roden St, West Melbourne Vic. 3003. (03)329-5433.



State-of-the-art designs from Tech-Sales

New components for analysis and assessing the performance of systems are a frequency response analyser, dual channel FFT analyser, data logger and digital voltmeter.

Tech-Sales claim that the Solartron 1250, the frequency response analyser, provides precise measurement of gain and phase between any points in a

dynamic system.

The 1250 features two fully floating matched channels to provide two channel simultaneous measurements and an

in-built sine/square generator programmable from 10 uHz to 65 kHz, at 10 mV to one volt. Integration times from 10 us to 10⁴ seconds allows resolution of 0.1 dB and 0.01 degrees.

The Solartron 1200 provides a self contained FFT analysis for dynamic, acoustic and vibration monitoring from dc to 30 kHz. This dual channel spectrum analyser uses an array processor to calculate 840 point Fourier transform. The 16-bit control microprocessor matches the efficiency of the algorithm with a calculation time of 300 ns for a complex multiplication.

The results can be displayed on the 9" CRT or output via the IEEE-488 interface or analogue plotter interface.

The Solartron 'Orion' data logger measures voltage and current (ac/dc), resistance, PRT, thermocouples, strain gauges, flow meters, status,

events, binary and BCD data.

A maximum of 600 channels and scan speeds of up to 500 points per second can be configured with up to eight tasks. Tasks may be triggered from real time or measured events. The Orion can be used as a stand alone or in a computer controlled operation.

The Solartron 7060 digital voltmeter provides 250 readings per second with five digit resolution. The basic dc accuracy is 0.002% for 24 hours with long term stability exceeding 0.009%.

A choice of models enables the measurement of dc only or dc, ac (RMS or mean) current and resistance.

For more information on these products contact Nigel Gamblin, Applications Engineer, Tech-Sales Pty Ltd, 83 Wellington St, Windsor, Vic. 3181. (03) 51-1306.



Power supply prices cut

The Managing Director of Scientific Electronics, Peter Lloyd, is well known in the electronics industry for his forthright and aggressive approach to marketing.

He has recently announced price cuts of up to 15% in his company's range of open frame switch mode power supplies.

He stated that some imported power supplies were coming in at very competitive prices and his company was fully prepared to meet them head on. He has also initiated enquiries to determine if dumping is occurring.

For further information contact Scientific Electronics, 6 Holloway Drive, Bayswater Vic. 3153. (03)762-5777.



Dick Smith capacitance multimeter

Dick Smith Electronics has an LCD multimeter that measures capacitance.

This multimeter features the normal ranges found on ordinary

digital units and also has five ranges of capacitance checking, two ranges of conductance, a diode check position and hi-lo resistance settings for in-circuit semiconductor checks.

With an accuracy of less than 0.25% on dc volts and a high impedance of 10M, this instrument is ideally suited for the designer's test bench.

Priced at \$129 it features overload protection, automatic polarity, 12.5 mm LCD digits, measurement to 1 A ac and dc and single range selection. There's no need to push numerous buttons to switch from one range to another.

This multimeter comes complete with test leads, carry case and full instruction manual.

Designated as catalogue number Q-1460 this capacitance digital multimeter is available at any of the 36 Dick Smith Electronics stores Australia-wide.



Special prices for test instruments

Nilsen Rowe, an importer/distributor of electrical testing instruments with offices in all states, is offering some of its most popular models of various famous brand multimeters (analogue and digital) directly to the trade and hobbyists at not-to-be-repeated prices.

Several of the HIOKI range of multimeters are included in this offer.

All instruments carry a 90 day warranty and are backed by spares and service facilities readily available from Nilsen Rowe.

The offer is only available while stocks last so customers are advised to send in their orders right away to avoid disappointment.

More information can be obtained from Nilsen Rowe, 200 Berkeley St, Carlton Vic. 3053. (03)347-9166.



National

A NEW WAVE IS ON THE HORIZON

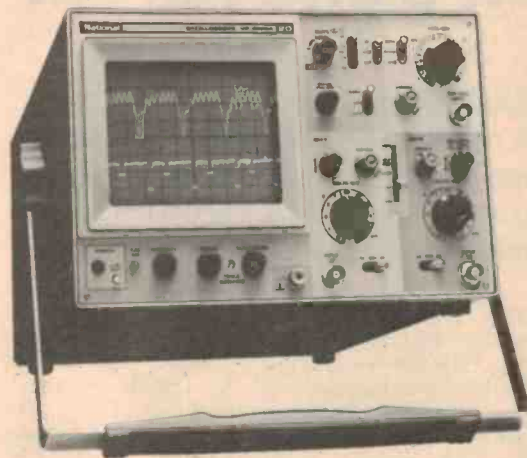

Available in four models these low cost oscilloscopes feature:

- 15-20-30 MHZ.
- 1mV/Div sensitivity
- Stable automatic trigger 'AUTO FIX'
- Full range of triggering mode
- Bright and sharp CRT with Auto Fix
- TV(V) and TV(H) sync separator circuit
- Rectangular tube, illuminated internal graticule (VP-5220A and VP-5231A)
- Built-in delay line for observation of pulse transient (VP-5231A only)
- High reliability—MTBF 15,000 hours

National have a wide range of scopes—to 300 MHz. Please call or write for further information

Probes supplied as standard accessory



SCIENTIFIC DEVICES AUSTRALIA PTY. LTD.

2 JACKS ROAD, SOUTH OAKLEIGH, VICTORIA, 3167.

TELEPHONE: 579 3622

P.O. BOX 63, SOUTH OAKLEIGH, VICTORIA, 3167. TELEX: AA32742

CABLES: DEVICES MELBOURNE

31 HALSEY ROAD, ELIZABETH EAST, S.A., 5112.

TELEPHONE: (08) 255 6575

35-37 HUME STREET, CROWS NEST, N.S.W., 2065.

TELEPHONE: (02) 43 5015

Far out — it's one Farad!

High value 'super capacitors' have been developed to provide back-up or standby power for volatile memory banks and similar applications in computing and digital processing equipment.

Soanar Electronics has released the NEC Supercap, a one Farad (1.0 F!) 5 V capacitor designed for just this purpose. It's a compact beast, measuring just 44.5 mm diameter by 18.5 mm high.

Until now, standby power has been achieved either by the use of primary cells, such as lithium, or by rechargeable batteries, such as nickel-cadmium.

Unfortunately, both of these systems have some basic disadvantages. Primary cells can be risky as there is no way of telling whether the amount of charge available will be enough to handle power cuts of unknown duration.

NiCads require controlled charging rates and may exhibit

'discharge memory'. They must also be replaced periodically.

These problems led to the development of super capacitors as a new standby power source, capable of providing up to 30 days back-up voltage and current to CMOS RAMs during power failures.

The high capacitance and low leakage current of the NEC supercapacitor makes it an efficient, reliable and cost-effective storage device, Soanar claim.

It has the following advantages:

- It never needs replacing or maintenance
- Unlike NiCads, it does not exhibit discharge memory
- Lack of polarity enables it to be wired either way
- It can be soldered onto pc boards with

other components • It can be charged or discharged at high and low current rates, i.e. microamps to amps • Completely safe. It will not explode under extremes of temperature, nor will it leak.

For further information on the

NEC Supercap No. FA0H1052, contact the Soanar branch in your State or write to Soanar Electronics Pty Ltd, 30 Lexton Road, Box Hill Vic. 3128. (03)840-1222.

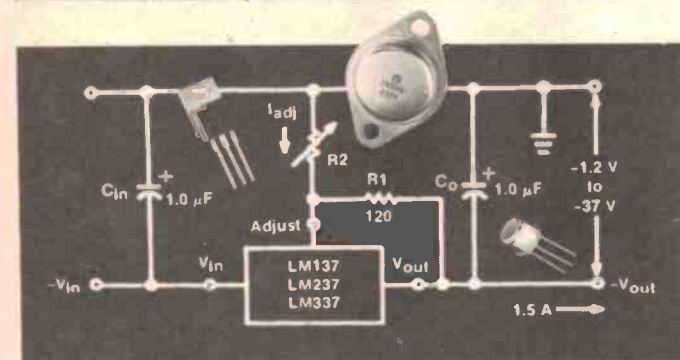

Motorola's voltage regulators

Motorola's series of three-terminal negative voltage regulators are capable of supplying in excess of 1.5 A over an output voltage range adjustable from -1.2 V to -37 V.

These voltage regulators, the LM137/237/337, require only two external resistors to set the desired output voltage and are

offered in three temperature ranges.

Features such as internal current limiting, thermal shutdown and safe area compensation make these devices exceptionally resistant to failure over all load conditions, claim Motorola.

For more information contact Motorola Semiconductor Products, 250 Pacific Hwy, Crows Nest NSW 2065. (02)438-1955.

Molex DIP switch

The Molex 10040 DIP switch accomplishes mechanical switching for solid state circuitry and is available from Utilux.

It is a SPST low profile switch, with long or short actuators, which is designed for soldering to a pc board in a standard 2.54 mm x 7.62 mm IC hole pattern. The height of the 10040 with the long actuator is 11.7 mm and with the short actuator it is 8.89 mm.

Utilux can now provide a total connector service to all aspects of the Australian electronics industry.

Utilux has been appointed the representative for the Hypertac range of MIL-SPEC and BS approved connectors. Utilux also represents the G & H Technology range of Breech-Lok circular connectors and the Trompeter range

of RF and data buss connectors.

More information on these connectors can be obtained from Utilux Pty Ltd, 14 Commercial Rd, Kingsgrove NSW 2208. (02)50-0155.

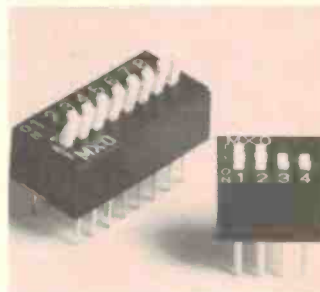

NEW COMPONENT SUPPLIER

Phil Gleeson, a familiar face to patrons of the various electronics suppliers in Sydney, especially a certain store in York St, has started his own company, named Avtek Electronics.

It opens this month at... guess where?... 119 York St, Sydney, directly above Charlie Brown's Wine Bar — which should be familiar to many Sydney hobbyists!

Phil worked for Dick Smith Electronics for over six years, later joining Applied Technology where he became involved in the 'MicroBee Project'. Until recently, he was the General Manager for Jaycar, but left to 'go it alone'.

Phil believes that the growing interest in electronics has created a need for the kind of products he will be selling. The aim of Avtek, he says, will be to carry the largest range of over-the-counter semiconductors available to the hobbyist in Australia. In addition, Avtek will be carrying a large range of chassis and printed circuit hardware and will be Sydney's largest outlet for the Perth-based Altronics Distributors.

Avtek will be open from 9 am to 5.30 pm Mondays to Fridays, to 7:30 pm on Thursdays and 9 am to 12 noon on Saturdays. Drop in and check him out; Avtek, 119 York St, Sydney. (02)29-8777.

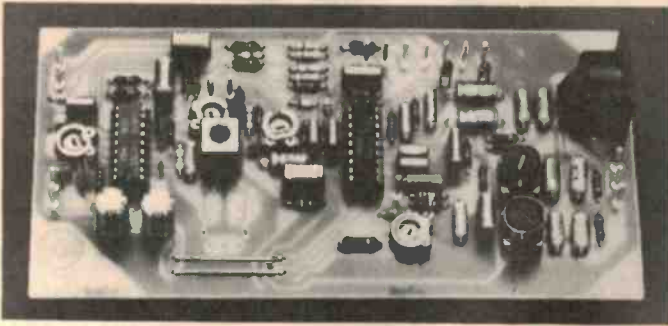

ICs for hi-fi and auto radio

The TDA1576 is an FM/IF amplifier/quadrature demodulator which has 22 μ V sensitivity for 3 dB limiting and a S/N ratio of 75 dB for a 1 mV input voltage.

AM suppression is 50 dB over most of the input signal range.

A four-stage symmetrical limiting IF amplifier in the TDA1576 is followed by a fast-acting noise-muting circuit and a quadrature demodulator. This muting circuit simulates the performance of a ratio detector and provides a symmetrical AFC output voltage.

A signal-strength output drives an S-meter. The TDA1576 is able to compensate for any offset due to the noise from high-gain tuners.

An additional feature is a built-in detune detector which can also be used as a dynamic noise detector.

The TDA1578A is a multiplex PLL stereo decoder designed for optimum performance with a minimum of peripheral components. The total gain of the stereo decoder will be constant ± 1 dB over the whole supply voltage and temperature range. The internal signal path consists

of an input operational amplifier, an AF muting circuit, the MUX decoder and an output op-amp.

When the muting system in the TDA1578A is active, an indicator driver can control a LED which indicates the correct tuning point. The dc-controlled muting can be controlled by any combination of the field strength voltage and the detuning voltage of the TDA1576, with adjustable muting slope and level up to -60 dB.

When the TDA1576 and TDA1578A are used together the detune circuits in the TDA1576 drive a muting or dc-controlled mono/stereo blend circuit in the TDA1578A.

The TDA1576 and TDA1578A are each encapsulated in an 18-pin plastic DIL.

For further information contact Philips Electronic Materials & Components, 67 Mars Road, Lane Cove NSW 2066. (02) 427-0888.

I-Scan design development set

The I-Scan design development set is being offered by Fairchild as a tool with which to gain understanding of the principles of charge-coupled devices.

The set includes a Fairchild CCD111 and a 256-element line scan sensor, mounted on a pc board which contains all the necessary CCD111 operating electronics.

I-Scan is intended for use as a construction aid for experimental systems using CCD line scan sensors or it can be incorporated directly into systems requiring 256 elements of resolution.

I-Scan comes fully assembled and tested and requires only the input supply voltage and an oscilloscope to display the video information corresponding to the

image placed in front of the sensor.

The I-Scan pc board includes a variable frequency clock generator that can be overridden by an external input, logic circuitry for timing the drive signals, drivers to interface and TTL logic to CCD levels and video buffer circuits.

Detailed schematics, a parts layout and timing diagrams are included with I-Scan.

For more information contact Fairchild Australia Pty Ltd, 366 Whitehorse Rd, Nunawading Vic. 3131. (03)877-5444.

Zero voltage crossing triac drivers

Two new series of optically coupled zero voltage crossing triac drivers are intended to be used for low power dc controlling of power triacs in 120 Vac and 220 Vac lines controlling resistive, inductive and capacitive loads.

The OPI3030, OPI3031, OPI3032 and OPI3033 series are designed for 120 Vac operation and the OPI3040, OPI3041, OPI3042 series are designed for 220 Vac operation. Each series has ratings of 30 mA, 15 mA, 10 mA and 5 mA respectively (LED drive current necessary to trigger the output).

Zero voltage crossing ensures that the devices will not turn on at voltages in excess of 15 V (typ) for the OPI3030 series and 25 V

(typ) for the OPI3040 series. Advantages include longer load life and reduced amplitude of line peaks since full line voltage will not appear across the load when the power triac turns on.

These devices can also be used as low level triacs for driving small ac loads, warning lamps, display alarms, etc.

For further information contact Total Electronics, 9 Harker St, Burwood Vic. 3125. (03) 288-4044.

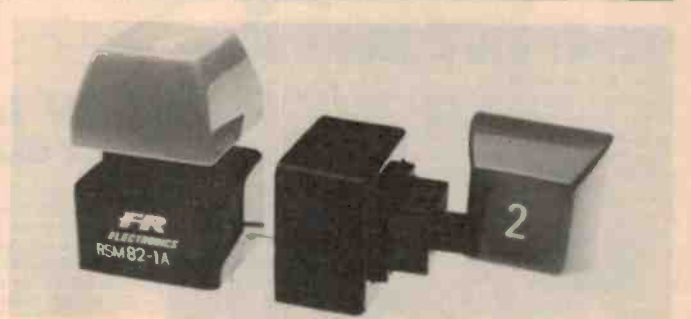

Keypad and keyboard range

FR Electronics manufacture a range of keyswitch products which use the RSM62 and RSM82 reed switch type keyboard switches.

It is claimed that the reed switches offer long electrical life and high reliability with a maximum of flexibility. The anti-rotational four-bearing plunger design is used to minimise

sideplay and give smooth action.

Illuminated and non-illuminated versions are available with single pole or double pole normally open functions. A full range of coloured keytops is available and alternative characters can be supplied on request.

More information is available from C & K Electronics (Aust) Pty Ltd, 15 Cowper St, Parramatta NSW 2150. (02)635-0799.

How SIOVs broke the drought

SIOVs (Siemens metaloxide varistors) can be used to break down the damaging effects of high voltage spikes which are often at their worst in dry atmospheric conditions.

Siemens claim that SIOVs provide protection, for delicate components, against deliberate or accidental voltage transients. e.g: SIOV S10 K20 has a diameter of 13.5 mm and a thickness of 4 mm and can absorb transients over 20 VRMS (26 Vdc) of 500 A or 1.6 joule (single-shot 20 us rating; lower ratings for repeated SIOV operations).

Thicker metaloxide discs have higher operating voltages, while larger diameter discs have higher

current ratings. More material bulk from either thickness or diameter gives higher energy absorption ratings.

The local stock range now covers the most popular current and voltage ratings for Australian and New Zealand conditions. These products can be obtained from any Siemens Electronic Components' outlet. In Sydney they're at 383 Pacific Hwy, Artarmon NSW 2064. (02) 436-8730.

KITS-- KITS-- KITS--

500MHz Digital Frequency Period Meter

Ref: EA Dec '81 - Feb '82
Jaycar has by far the best kit version of this project in Australia. We now supply 2 x GOLD plated BNC input connectors at no extra cost!
Cat. KA1390 \$119 (50MHz Version)
Cat. KA1392 \$26 (500MHz option)
(Beware of kits that don't conform to the original design).



ONLY \$119

HEART RATE MONITOR

Ref: EA July '82
Brilliant kit which enables you to measure your heartbeat instantly. One of our most popular kits ever. The Jaycar kit comes in a beautiful ABS splashproof case with professional silk-screened panel.
Cat. KA1466



\$79

DIGITAL CAPACITANCE METER

\$74.50



Ref: EA March '82
Accurately measure capacitance from 1pF - 19.99uF. A must for the serious enthusiast.
Cat. KA1420 \$74.50

Digital Thermometer

Ref: EA Feb '82
0 - 100 degrees C with 0.1 degree resolution. Bright, easy to read display. Kit includes two temperature sensors.
Cat. KA1404 \$74.50

magnificent!
\$74.50

TRANSISTOR ASSISTED IGNITION

Ref: EA Jan '83. Latest version of this popular kit. The Jaycar kit has a genuine die cast box as used in the EA prototype. Beware of others that use flimsy sheet metal.
Cat. KA1506 \$35



MAGIDICE

The best electronic dice ever made! Firstly, this is not a kit. It is completely built and tested. Basically the MAGIDICE is a glistening black cube measuring 75mm on all sides. It has 6 LED's set into the top of the cube under a red filter (the filter LOOKS black as well). When the switch in the base is turned on, a wave of the hand over the top of the cube causes the circuit to operate. The cube beeps and gives you a guaranteed random dice "throw" in the form of illuminated LED's. There are no buttons to press and you don't even have to touch the cube!
The last number will remain until you note or wave your hand over the unit to "throw" another number. This (patented) product makes an absolutely unique gift and comes attractively presented.
Cat. XC-2006

Please note that a 9V battery snap (supplied) must be fitted to use on local 9V standard cell.

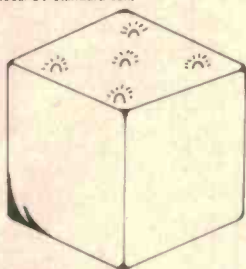

GREAT GIFT

\$5 OFF
JUNE ONLY
NOW ONLY \$14.95

BRILLIANT FUN

0-30V 1amp power supply

Ref: ET1
December 1982

- Fully protected
 - Output variable from 0-30V DC
 - Selectable current limit
 - Both voltage and current metering
 - After a multimeter & soldering iron an absolute must for the enthusiast.
- You will never own a more useful piece of gear.

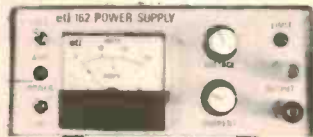

Function Generator

Ref: EA April 1982

\$99

"Pigeon Pair" companion to the new 500MHz DFM. Low distortion generator of sine, square and triangular waveforms. From below 20Hz to over 160kHz. Inbuilt 4 digit frequency counter in de-luxe Pac-Tec case.

JAYCAR EXCLUSIVE - 1% 50ppm metal film resistors used for stability

5000 SERIES GRAPHIC EQUALISERS



SPECIFICATIONS:
Signal to Noise - 100dB with respect to 1 volt Frequency Response: 20Hz - 100kHz to -1dB Bandwidth: 16dB (20dB) (100Hz)
Distortion: 100Hz - 0.01% THD @ 0.001% 100Hz - 0.005% THD @ 0.001% (resistively inductive or out of band)
Current consumption (DC): approx 100mA @ 12V (Requires 30V AC CT)
Output short circuit proof

AUSTRALIAN (NOT HONG KONG) MADE - SPECIAL BUILT RACK CABINET - QUALITY!!!!

\$199

BUY 2 AND SAVE \$10 - ONLY \$389

ALL IC SOCKETS PROVIDED



- FUNCTIONS
- MOVING COIL INPUT
 - MOVING MAGNET (DYNAMIC CART)
 - INPUTS (2 OFF)
 - TUNER INPUT
 - AUX INPUTS (2 OFF)
 - TAPE INPUTS (2 OFF)
 - INPUT LEVEL CONTROL
 - TAPE OUTPUTS (2 OFF)
 - 400Hz CALIBRATION OSCILLATOR
 - LED AVERAGE (VU) & PEAK
 - LEVEL METERS - 48dB TO +9dB

- MODE SWITCH, STEREO BALANCE CONTROL
- LINE OUT, MONITOR OUT, MONITOR VOLUME CONTROL

- FEATURES
- EXTREMELY CLOSE TRACKING TO RIAA PHONO EQ.
 - GOLD PLATED CONNECTORS ON ALL INPUTS
 - ENGLISH 'LORLIN' LOW NOISE SELECTOR SWITCHES

- LOW NOISE 1% 50ppm METAL FILM RESISTORS USED
- FINED FIBRE GLASS PCB'S
- LOW CAPACITANCE SCREENED CABLE USED THROUGHOUT
- QUALITY I.C. SOCKETS
- SPECIAL REAR PANEL
- MULTICOLOURED RECTANGULAR LED'S USED

STEREO STEREO STEREO STEREO Synthesiser

Creates a very realistic stereo sound from mono sources i.e. AM tuners, TV or video units
Very easy to build and comes complete.

Ref: EA
September 1982

Cat. KA1478



Short Form Version Only Cat. KA1478 \$39.50

EA dual tracking P/S



Ref: EA March '82
Cat. KA1410

Extremely versatile power supply: Will give plus & minus 1.3V to 22V at up to 2 amps PLUS A FIXED +5V@0.9A. The supply is completely protected against short circuits, overloads and thermal runaway. A large meter with voltage calibration is supplied as well as IC sockets. A quality kit.

\$89.50



FREE! TILTING BAIL WORTH \$4.95 included

NEW MAGNUM 200

NEW! - LOW COST 5000 SERIES AMP

ONLY \$299

Black Monolith \$319

"BLUEPRINT"

ONLY \$299

Ref: ET1
JAN/MARCH 1981

Cat. KE4200

\$199

BUY 2 AND SAVE \$10 - ONLY \$389

ALL IC SOCKETS PROVIDED



- FUNCTIONS
- MOVING COIL INPUT
 - MOVING MAGNET (DYNAMIC CART)
 - INPUTS (2 OFF)
 - TUNER INPUT
 - AUX INPUTS (2 OFF)
 - TAPE INPUTS (2 OFF)
 - INPUT LEVEL CONTROL
 - TAPE OUTPUTS (2 OFF)
 - 400Hz CALIBRATION OSCILLATOR
 - LED AVERAGE (VU) & PEAK
 - LEVEL METERS - 48dB TO +9dB

- MODE SWITCH, STEREO BALANCE CONTROL
- LINE OUT, MONITOR OUT, MONITOR VOLUME CONTROL

- FEATURES
- EXTREMELY CLOSE TRACKING TO RIAA PHONO EQ.
 - GOLD PLATED CONNECTORS ON ALL INPUTS
 - ENGLISH 'LORLIN' LOW NOISE SELECTOR SWITCHES

- LOW NOISE 1% 50ppm METAL FILM RESISTORS USED
- FINED FIBRE GLASS PCB'S
- LOW CAPACITANCE SCREENED CABLE USED THROUGHOUT
- QUALITY I.C. SOCKETS
- SPECIAL REAR PANEL
- MULTICOLOURED RECTANGULAR LED'S USED

KITS-- KITS-- KITS--

LOW COST DIGITAL MULTIMETER KIT

BY POPULAR DEMAND

Ref: EA March 1983 (This month)
Almost every day we are asked for a multimeter kit. Up until now we thought that it was just not worth it considering the fine low-cost built-up units available. The DP2010 changed all that.
This kit, fully imported from the UK uses the famous DP2010 custom LCD/Volmeter to achieve phenomenal accuracy at very modest cost!
All parts are included to complete the meter including an attractive and colourful front panel.
(A 9V battery is required)

Set of test probes to suit \$2.95
Probe to suit Cat. WT5312 ONLY \$2.50
Eveready 216 (red) 9V Battery Cat. SB2370 ONLY \$1.40



ONLY \$45

AC VOLTAGE AND CURRENT RANGES
When S3c selects S4, functions the output from either the voltage attenuator or current shunt is fed through C1 to remove any d.c. component.

SPECIFICATIONS

Function (d.s.)	f.s.d.	Resolution	Accuracy	Protection	Current (d.s.)	f.s.d.	Resolution	Accuracy	Protection
Voltage	2V	1mV	1%±1 digit	500V for 1c.m.	Current	2mA	10A	1%±1 digit	1A/250V
	20V	10mV	1%±1 digit	100mV		200mA	1mA	1%±1 digit	250V
	200V	100mV	1%±1 digit	500V		1V	1%±1 digit	1A/250V	
Current	2mA	10A	1%±1 digit	1A/250V	Resistance	2K	1	1%±1 digit	260V
	20mA	100A	1%±1 digit	200mA		20K	10	1%±1 digit	r.m.s.
	200mA	1000A	1%±1 digit	2000A		200K	100	1%±1 digit	
Volts (a.c.)	2V	1mV	2%±5 digit	500V for one minute	Diode Test	2V	1mV	1%±1 digit	260V r.m.s.
	20V	10mV	2%±5 digit	one minute					
	200V	100mV	2%±5 digit						

Sparkrite

The Brandleaders in Auto Electronics

the ultimate in electronic ignition

Each kit is complete down to the last nut & bolt. All fittings included! SX-2000. UK's largest selling electronic ignition! "Reactive Discharge" system - NOT CDI - with great reliability. Cat. KJ-6650

Sparkrite SX2000

- A Reactive Discharge System combines all features of the SX500 plus
- Reactive Discharge electronics combining all the advantages of both Inductive and Capacitive Discharge for maximum spark performance.
- Gives the most thorough combustion of air/fuel ratios especially current lean mixture emission controlled engines.
- Voted "Accessory of the Year" and the best as tested by Popular Motoring Magazine.
- Patented clip-to-coil fitting.
- Systems Function Light as well as Static Timing Light.
- The ultimate brand leading contact-breaker triggered system.

NEW Value
\$49
SAVE
\$10
\$39



TX-2002. Breakerless ignition! Full fitting kit to convert 90% of all cars! All contactless hardware supplied. No drilling or tapping. You can easily convert - and even use your points to work the TX-2002! Cat. KJ-6652

Sparkrite TX2002

- A Reactive Discharge System - with unique auxiliary circuit. Combines all features of the TX1002 plus
- Reactive Discharge electronics combining all the advantages of Inductive and Capacitive Discharge for maximum spark performance
- Gives the most thorough combustion of air/fuel ratios especially current lean mixture emission controlled engines.
- Unique 3-way change-over switch incorporating an auxiliary back up circuit. "ELECTRONIC/OFF/AUXILIARY"
- Robust die-cast case, fully resistant to moisture and heat.
- The ultimate system - REACTIVE DISCHARGE - CONTACTLESS OR CONTACT TRIGGERED - AUXILIARY BACK UP CIRCUIT - CLIP-TO-COIL FITTING - FOUR CONNECTIONS ONLY. ALL PARTS IN ONE BOX TO FIT OVER 500 APPLICATIONS.

\$99
SAVE
\$16
\$115

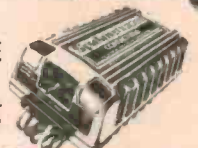

TX-1002. Slightly lower powered version of the TX-2002. Ideal for most 4 cylinder cars. All fitting pieces included! Cat. KJ-6651

Sparkrite TX1002

- An Inductive Discharge System
- Can be operated utilising "Hall Effect" inductive or existing contact-breakers
- Extended dwell Inductive Discharge for maximum spark efficiency
- Three position switch.
- Static Timing Light
- Systems Function Light
- Patented clip-to-coil fitting
- Robust die-cast case.
- Fully waterproof
- Protected from the hostile environment of the engine compartment

THE BRAND LEADER
TX APPLICATIONS
No separate fitting kit required. All parts in one box, to fit more than 500 vehicles.

Sparkrite AT-80

Brightest Computer Programmable Car Security System
This kit, the famous British Sparkrite AT-80 is absolutely unique. It uses a self-sensitive sensor pad that attaches to the inside of your glass windscreen. You have a special key fob (2 are supplied) and you program YOUR SPECIAL CODE in from the OUTSIDE OF THE CAR to get back in.
The windscreen pad is a REAL deterrent sticker! Cat. KJ-6660

ONLY \$89
\$99



SAVE \$10 **\$79** \$69

ROBOTICS

JAYCAR - FIRST IN AUSTRALIA WITH THE VERY LATEST IN THE FIELD OF ROBOTICS

Jaycar is the first major electronics company in Australia to stock useful robots in kit and built-up form.

MICRO GRASP



ONLY \$499

The Micro Grasp is the first low-cost true robot. Basically the unit has an articulated arm jointed at the shoulder, elbow and wrist positions. The entire arm rotates on its base and has a motor driven gripper on the end of the arm. Each of the arm movements is SERVO CONTROLLED i.e. there are position sensors feeding back information to the interface board where it is compared with the programmed in standard position. Any positional error is automatically and continuously corrected. This servo action is independent of the computer, simplifying programming the software to drive the robot. All programming is carried out with a small number of common BASIC commands. The interface board is memory mapped using only 64 bytes at any of the 1024 memory locations.
Control of the Micro Grasp as a computer peripheral is accomplished thru the parallel expansion port of most small computers. To keep the cost to an absolute minimum and to increase the learning factor the Micro Grasp is supplied as a self-assembled kit. All components down to the last nut and bolt are included, as is the power supply.

MICRO GRASP KIT INCLUDING POWER SUPPLY Cat. XR1000 - SPECIAL INTRODUCTORY PRICE \$499.00
UNIVERSAL COMPUTER INTERFACE BOARD (in kit form) Cat. XR1010 ONLY \$179.00 (not required for Sinclair ZX81 computer) \$2 - 23 way strip connector at \$9.95. ZX-81 peripheral/BIAS pack splitter board \$10.95
CALL IN TO OUR YORK STREET SHOWROOM AND SEE WORKING!!!

AS DESCRIBED ETI MAG. APRIL/MAY 1983

EPROM programmer for the MicroBee

Ref: ETI Feb '83

Fantastic little accessory for the popular "MicroBee" computer. The Jaycar kit contains all components including the following SPECIAL features:

- 28 pin IC socket included!
 - 3 x 16 pin "PERSONALITY PLUG" HEADERS
 - 15 pin PARALLEL CONNECTOR
 - IC sockets for all logic devices including personality socket.
- ALL THIS FOR ONLY \$39.95!**
Cat. KE4650
24 pin ZIF socket to suit only \$12.95 Cat. P16522



Jaycar NUMBER 1 FOR KITS

SYDNEY SHOWROOM
125 YORK STREET PHONE: (02) 264 6688
TELEX: 72293

CARLINGFORD SHOWROOM
Cnr. CARLINGFORD & PENNANT HILLS ROAD
PHONE: (02) 872 4444

MAIL ORDERS & CORRESPONDENCE
BOX K 39 HAYMARKET, SYDNEY 2000
POST AND PACKING CHARGES
S5 \$9.99 (\$1.50) S10 \$24.99 (\$3.20)
S25 \$49.99 (\$4.50) S50 \$99.99 (\$6.50)
S100 or more (\$8.00)

SHOP HOURS CARLINGFORD
Mon - Fri 9am - 5.30pm; Sat - 9am - 12pm; Thurs night 8.30pm
SHOP HOURS SYDNEY
Mon - Fri 8.30am - 5.30pm; Sat - 8.30am - 12pm; Thurs night 8.30pm

Mail Order By **BANKCARD**
Via Your Phone



ALTRONICS KITS COST MORE

**Around
\$1
more**

REASONS ★ PREMIUM COMPONENTS USED eg. MOTOROLA, FAIRCHILD etc. ★ QUALITY INSTRUMENT CASES SUPPLIED WHERE INDICATED ★ EVERY LAST NUT AND BOLT SUPPLIED, EVEN SOLDER ★ IC SOCKETS SUPPLIED WHERE INDICATED.

Your finished product will look so good your friends won't believe you built it.

ALTRONICS • BANKCARD JETSERVICE DELIVERY NEXT DAY • ALTRONICS

ALTRONICS • BANKCARD JETSERVICE DELIVERY NEXT DAY • ALTRONICS

OUR BEST SELLING POWER SUPPLY KIT EVER

3-32 volt output at 1 amp UNDER \$40
THE ALTRONICS POWER SUPPLY
Based on EA LM 317K Project
Every workshop, school and hobbyist should get one now !!!



- Fully protected from thermal runaway and short circuits.
- Voltage and current metering.
- T₀-3 regulator plus powerfin heatsink.
- Fully documented, every last part included.

K3200..... \$42.50

ETI 162 BENCH SUPPLY

1.3-30V @ 1 Amp
With voltage and current limiting

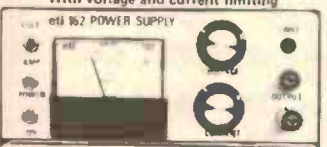

- Overload and short circuit protected.
- Voltage and current metering.
- Regulation - better than 0.2% zero to full load
- Hum and noise on output - less than 1mV at full load.
- LED indication of current limit.

Exclusive - fully S.E.C. Certified Mains Transformer supplied.
If you're considering buying this kit from your local supplier or one of our competitors - first ring and ask them if the mains transformer is S.E.C. certified to ASC126 - chances are that it won't be.

K3205..... \$49.50

DUAL TRACKING POWER SUPPLY

1.3 to 22V @ 2 AMPS : +5V @ 0.9 AMPS



The ideal power supply for the audiophile experimenting with linear OP amp designs in which split supply operation ensures improved distortion and noise figures.

- Fully protected against short circuits, overloads and thermal runaway.
- LED indicator for regulator dropout.
- Floating ground.
- Uses 0.25% linearity 10 turn pot - tracks within 1mV.
- Voltage adjustable to within 10mV.

K3220. (EA MARCH 1982) . \$86.00

13.8V HIGH CURRENT SUPPLY

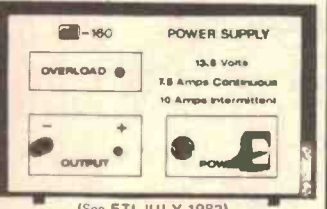

(See ETI JULY 1982)
Output voltage - 13.8 Vdc.
Output current - 7.5A continuous
10A Intermittent

- Regulation - 0 to 7.5A : 50mV

Save the expense of a mains powered rig. Kit complete in every way.

K3250..... \$84.00

DIGITAL FREQUENCY METER

7 Digit Resolution, measures period and frequencies to • 500 KHz
Professional unit - cost a fraction of similar built-up units.



This project is "so easy to construct", virtually all components mount on one single PCB, ensuring success even for the "not so experienced" constructor.

Use of the latest LSI circuitry ensures impeccable performance from the completed unit. This is further ensured by our use of top grade components.

NOTE: (Altronics use only the specified Interil LSI - beware of inferior kits that do not conform to the original design.)

Frequency measurement to 500MHz (with optional Prescaler) in 3 ranges - 0-10MHz, 0-50MHz, 10-500MHz • 4 gating times - 0.01, 0.1, 1, 10 seconds.

Period measurement for accurate low frequency counts, 4 ranges - 1, 10, 100, 1000 input cycles • resolution 0.1us.

High Input Sensitivity - 10mV to 30MHz, 100mV at 50MHz @ 1MOHM input impedance, 200mV @ 500MHz @ 75 OHMS input impedance.

Accuracy - typically better than 0.005% uncalibrated.

Exclusive Altronic Kit Features

- IC sockets provided throughout
- low aging 10,000 MHz XTAL.
- Genuine Fairchild High Brightness FND 507 display's.
- Quality ABS plastic case - deluxe front panel.
- Complete kit as specified by EA includes instructions, all cables and every last nut, bolt and washer.

K2500..... \$119.50

DECIMAL POINT FOR K2500

READ FREQUENCY DIRECTLY IN MHz and PERIOD IN US.

K2502..... \$7.50

PRESCALER FOR K2500

ALLOWS FREQUENCY MEASUREMENT TO 500MHz

K2501. . . (essential option) . . . \$26.00

TRANSISTOR TESTER



Electronics Australia Project, Tests Bipolar Transistors, Diodes, Fets, SCR's and PUT's. Excellent service aid for the hobbyist and serviceman. Complete kit and instructions.

K 2525..... \$19.75

FUNCTION GENERATOR

(with digital display)
Sine, triangle and squarewaves :
15Hz - 250KHz.

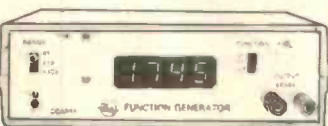

The most essential piece of test gear (second only to a good multimeter) on any hobbyist's bench is some kind of audio signal generator. This design utilizes the latest circuit techniques to produce a stable, low distortion waveforms.

A truly versatile unit at a bargain price.

- 4 digit frequency readout (eliminates tiresome dial calibration) - typical accuracy ± 2%.
- 3 overlapping ranges x1, x10, x100.
- 600 OHM Nominal Output - continuously variable 3mV-2.5V P-P.
- Distortion - sinewave : less than 0.7% @ 1KHz.
- Linearity - triangle wave : better than 1% @ 1KHz.
- Squarewave rise time - 6V/uz maximum output.
- Amplitude stability - better than 0.1dB on all ranges.

With the exception of the display all components mount on a single PCB making this kit suitable for all constructors.

K2505..... \$85.00

DIGITAL LED CAPACITANCE METER

K 2521 . ONLY \$55.00



with Deluxe Instrument Case

EXPANDED SCALE LED VOLTMETER

HAS MANY APPLICATIONS



ETI design suitable for lead-acid wet cells, lead acid gel electrolyte, vented nickel cadmium types and so on and so on.

Unit covers range of 10.5v to 15v.
Determine battery condition instantly
Easy to Build!

K 4326..... \$9.50

ANALOG / DIGITAL STORAGE CRO ADAPTER

(See EA Nov 1980 and March 1981).



Unit enables indefinite storage of non-replicative waveforms at a fraction of the cost of conventional storage CRO's. National semi-conductors A-D/D-A conversion techniques allow analog signals up to 100KHz to be stored • two channels while in digital mode • positive and negative edge triggering • AC/DC/HF and LF rejection • timebase tracer for accurate frequency measurement • accurate down to 1.9Hz Analog mode - 1us Digital Mode • delayed trigger 10us-1s • sensitivity - 160mV P-P @ 1 MEG (Analog) • standard TTL and CMOS levels 3-15 volt supply (Digital).

The features of this unit are to numerous to list, yet is simple to operate.

Be assured of quality with an Altronics Kit.

1. Genuine National A-D conversion chips not second sourced dropouts.
2. All IC sockets provided (27 total - you pay no more)
3. Low capacitance coax and a full metre of rainbow cable.
4. Full instructions and every last nut, bolt and washer.
5. Deluxe mini rack cabinet.

K2600..... \$189.00

NEW DELUXE FINISH

We are pleased to announce the release of the Digital Capacitance Kit housed in our Deluxe M 0480 ABS Instrument Case.

This superb Test Instrument Kit now complements our top selling Digital Frequency Counter and Function Generator Project Kit. Electronics Australia Project. Measures capacitance of both polarized and non-polarized capacitors from 1 picofarad to 99.99 microfarads in 3 ranges.

Check values of unmarked capacitors, especially those little trimmers that are never coded.

Select precise values for filters and timing networks within ease.

• • • EXCLUSIVE TO ALTRONICS • • •

Each kit includes precision measured capacitors for accurate calibration of each range.

STANDARD VERSION K 2520
(In metal case) Same Specifications. . \$49.50

MICROWAVE OVEN LEAK DETECTOR



ETI PROJECT
Completely passive project receives microwaves via an antenna which develops a voltage across a detector diode driving the meter.

Monitor your microwave oven with this easy to build kit. All components mount on single PCB, including the meter.

Genuine Hewlett Packard Hot Carrier Diode supplied.

K1724..... (still only) \$14.50

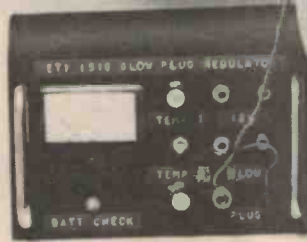

The 'sure start' model engine ignition system

No more flick-flick-sputter, flick-flick-sputter. This 'glow plug regulator' ensures a lively start for that model petrol engine in your favourite model aeroplane, boat or whatever.

Jonathan Scott

HOW MANY OF YOU have one of those infernal model petrol engines lying around the garage or store room somewhere? And why exactly are these things so often left unapproached and undisturbed in these dark crannies — because they are noisy? No. It is usually because they are *so difficult to start* that you have decided that they are not worth the trouble or the cost.

I recall spending ages as a kid with model aeroplanes trying in vain to get them going, wearing my fingers to the bone — flick, flick, flick ... and no start. Often they would appear to kick over, encouraging the soul, only to remain in that half-starting phase turn after turn.

I gave up then — anyone with any sense and/or no money does. Yet, with the development of the 'magical' ETI-1516, friends and relatives have been volunteering their discarded models for testing, encouraged by the effortless instant starts which can be produced on demand. (The author had already bought several engines and wasn't interested in any more, thank you.)

So this project should provide the incentive to resurrect that long-stored model with the promise of quick ignition which, we hope, will encourage you to give it another go. After all, for under \$40 plus fuel you can buy a complete aeroplane kit including the engine and all the accessories to have the thing flying on a control line almost instantly.

Ah, but the experts (read fanatics if you like) seem to be able to get their models to go promptly, so you might think that the complexity of the ETI-1516 is rather unnecessary. What do the regular modellers use to get the same end?

Firstly there is experience. They have probably been just where we have but they didn't give up, the blockheads. However, the endless tinkering and fiddling has payed off; they have tried all the possibilities and learnt to tell quickly what is the problem. Too much fuel or a flat-ish battery are dead giveaways when you have been at it for life. Misadjusted mixture takes thirty seconds to spot with enough experience, while a major failure may be the only problem not

eliminated after two minutes.

All this is fine, but useless if you don't have a pet modeller on hand. Next, there are the current commercial inroads made by electronics which are available at the model shops. For around \$30 you can buy what is termed a 'power board'.

This thing connects to a car battery and allows you to deliver 0 to 5 A to the plug while giving a rough indication of current by means of a meter. It is basically a single transistor or Darlington and a few resistors, and not surprisingly delivers a lot of heat to the atmosphere and the unwary modeller's fingers! Also, of course, it takes the same current from the main 12 V battery as it delivers to the plug, necessitating the use of a car-sized battery rather than a small set of sealed cells.

Again, with experience, but less this time, you can adjust it neatly so as to allow starting without regular incineration of the glow plug.

But for a similar outlay, our new unit is significantly superior in its operation. Firstly, it regulates not the current (bad) or ►

The George Brown

PROTRONICS
SOUTH AUSTRALIA

Ph. (08) 212 3111 Telex AA88261

George Brown & Co.

VICTORIA

Ph. (03) 419 3355 Telex AA35886

George Brown & Co.

SYDNEY

Ph. (02) 519 5855 Telex AA21732

4000 CMOS



FAIRCHILD
A Schlumberger Company

40014BPC	0.59	40175BPC	0.90	4044BPC	0.65	4510BPC	0.84
40018PC	0.30	40178PC	0.67	40478BPC	0.79	4511BPC	0.79
40028BPC	0.30	40193BPC	0.90	40498BPC	0.38	4512BPC	0.68
40068BPC	0.73	40198BPC	0.51	4050BPC	0.368	4516BPC	0.74
4007UBPC	0.30	40208BPC	0.74	40518BPC	0.82	4518BPC	0.79
40085BPC	0.81	40218BPC	0.59	4052BPC	1.82	45208BPC	0.90
40088BPC	0.73	40228BPC	0.90	4053BPC	1.82	45288BPC	0.87
400978BPC	0.71	40238BPC	0.30	40668BPC	0.53	45398BPC	0.67
400988BPC	0.74	40248BPC	0.67	40678BPC	7.03	45558BPC	0.59
40118BPC	0.30	40258BPC	0.30	4069UBPC	0.29	45568BPC	0.59
40128BPC	0.30	40278BPC	0.42	4070BPC	0.37	47028BPC	9.28
40138BPC	0.34	40288BPC	0.71	4071BPC	0.30	47038BPC	15.12
40148BPC	0.82	40298BPC	1.07	40768BPC	0.73	47208BPC	7.27
40158BPC	0.82	40308BPC	0.45	40818BPC	0.30	47238BPC	1.49
401618BPC	1.07	40358BPC	0.87	40868BPC	0.34	47248BPC	1.32
40168BPC	0.398	40408BPC	0.99	40938BPC	0.53	47258BPC	7.27
401748BPC	0.82	40428BPC	0.704	41048BPC	2.64	47318BPC	8.26

MINIMUM
ORDER \$20

PRICES WHILST STOCKS LAST
PRICES SUBJECT TO CHANGE WITHOUT NOTICE
PRICES + SALES TAX IF APPLICABLE - RATE 20%

LOW POWER SCHOTTKY

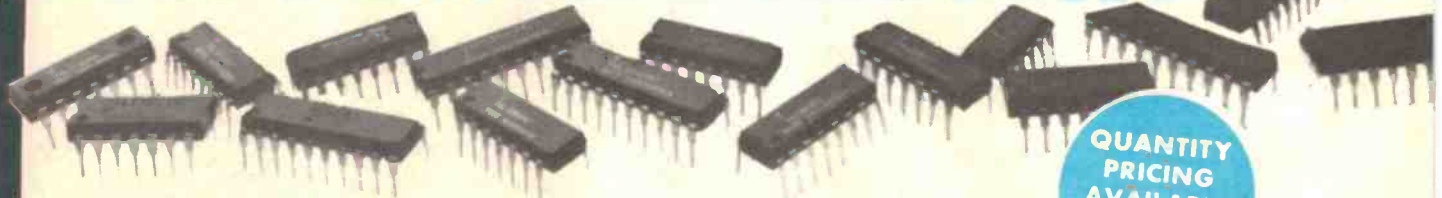

FAIRCHILD
A Schlumberger Company

QUANTITY
PRICING
AVAILABLE
CONTACT YOUR
NEAREST
OFFICE

74LS00PC	0.30	74LS139PC	0.50	74LS170PC	0.97	74LS244PC	0.89	74LS293PC	0.63	74LS377PC	1.03	74LS503PC	5.90
74LS02PC	0.30	74LS13PC	0.30	74LS173PC	0.67	74LS245PC	1.15	74LS295PC	0.83	74LS378PC	0.63	74LS51PC	0.34
74LS03PC	0.35	74LS14PC	0.36	74LS174PC	0.50	74LS247PC	1.29	74LS298PC	0.67	74LS379PC	0.65	74LS533PC	1.04
74LS04PC	0.30	74LS151PC	0.50	74LS175PC	0.50	74LS251PC	0.52	74LS299PC	2.30	74LS379PC	0.65	74LS534PC	1.01
74LS05PC	0.35	74LS153PC	0.50	74LS181PC	2.46	74LS253PC	0.53	74LS30PC	0.30	74LS379PC	0.65	74LS540PC	1.16
74LS08PC	0.30	74LS155PC	0.58	74LS190PC	0.78	74LS256PC	1.05	74LS323PC	3.30	74LS379PC	0.65	74LS544PC	0.35
74LS09PC	0.33	74LS156PC	0.72	74LS191PC	0.79	74LS257PC	0.54	74LS32PC	0.30	74LS379PC	0.65	74LS554PC	0.33
74LS109PC	0.43	74LS157PC	0.50	74LS192PC	0.57	74LS258PC	0.52	74LS33PC	0.41	74LS38PC	0.37	74LS555PC	0.33
74LS10PC	0.30	74LS158PC	0.49	74LS193PC	0.73	74LS259PC	0.71	74LS332PC	0.68	74LS38PC	0.37	74LS574PC	0.98
74LS112PC	0.46	74LS15PC	0.36	74LS194APC	0.68	74LS260PC	0.46	74LS353PC	0.95	74LS390PC	0.65	74LS570PC	1.12
74LS113PC	0.55	74LS160PC	0.73	74LS194PC	0.68	74LS266PC	0.39	74LS365PC	0.58	74LS393PC	0.79	74LS74PC	0.38
74LS11PC	0.30	74LS161PC	0.60	74LS195APC	0.61	74LS26PC	0.38	74LS365PC	0.58	74LS395PC	1.13	74LS83APC	0.71
74LS125APC	0.43	74LS162PC	0.76	74LS196PC	0.92	74LS273PC	0.88	74LS366APC	0.57	74LS40PC	0.44	74LS85PC	0.46
74LS126PC	0.52	74LS163PC	0.81	74LS197PC	0.67	74LS279PC	0.48	74LS367APC	0.50	74LS42PC	0.51	74LS86PC	0.38
74LS132PC	0.50	74LS164PC	0.60	74LS20PC	0.30	74LS27PC	1.28	74LS368APC	0.50	74LS47PC	0.80	74LS90PC	0.52
74LS133PC	0.38	74LS165PC	0.66	74LS21PC	0.35	74LS283PC	0.61	74LS374PC	0.88	74LS48PC	0.59	74LS93PC	0.54
74LS136PC	0.37	74LS168PC	0.97	74LS240PC	0.88	74LS28PC	0.43	74LS374PC	0.88	74LS49PC	0.95	74LS958PC	0.55
74LS138PC	0.53	74LS169PC	1.24	74LS241PC	1.06	74LS290PC	0.72	74LS375PC	0.61	74LS502PC	5.19		

E. & O. E.

174-180 Wright St. Adelaide. S.A. 5000

93 Sackville St. Collingwood. Vic. 3066.

174 Parramatta Rd. Camperdown.
N.S.W. 2050.

Electronics Group.

PROTRONICS
WESTERN AUSTRALIA

Ph. (09) 362 1044 Telex AA93883

George Brown & Co.
NEWCASTLE.

Ph. (049) 69 6399 Telex AA28461

George Brown & Co.
A.C.T.

Ph. (062) 80 4355 Telex AA62128

ZILOG

Z8001PS	16 BIT C.P.U. 2.5 MHZ	57.20
Z8001APS	16 BIT C.P.U. 4 MHZ	70.51
Z8002PS	NON SEG C.P.U. 4 MHZ	51.15
Z8010APS	ZMMU 6 MHZ	60.17
Z8030PS	Z-SCC 2.5 MHZ	45.98
Z8030APS	Z-SCC4 MHZ	57.48
Z8036PS	ZC10 4 MHZ	30.80
Z8036APS	ZC10 6MHZ	56.10
Z8038PS	ZF10 INTERFACE UNT16 MHZ	56.43
Z8400BPS	Z80 8 BIT C.P.U. 6 MHZ	14.15
Z8400APS	Z80 8 BIT C.P.U. 4 MHZ	3.87
Z8410APS	Z80 DMA 2 PORT PLASTIC 4 MHZ	18.82
Z8410PS	Z80 DMA 2 PORT PLASTIC 2.5 MHZ	13.29
Z8420APS	PIO 2 PORT PLASTIC 4 MHZ	3.75
Z8420PS	PIO 2 PORT PLASTIC 2.5 MHZ	4.79
Z8430APS	Z80 CTC 4 CHAN CTR/TIMER 4 MHZ	5.14
Z8430BPS	Z80 CTC 4 CHAN CTR/TIMER 6 MHZ	10.27
Z8430PS	Z80 CTC 4 CHAN CTR/TIMER 2.5 MHZ	4.79
Z8440APS	Z80 SIO2 CHAN IO 4 MHZ	19.07
Z8440PS	Z80 SIO 2 CHAN IO 2.5 MHZ	13.29
Z8441APS	Z80 SIO / 12 CHAN IO 4 MHZ	19.07
Z8442APS	Z80 SIO 2 CHAN IO 4 MHZ	19.07
Z8442PS	Z80 SIO 2 CHAN IO 2.5 MHZ	13.29

Z8470APS	Z80 DART 4 MHZ	13.29
Z8470PS	Z80 DART 2.5 MHZ	9.08
Z8530PS	Z80 SCC 2.5 MHZ	45.98
Z8563PS	Z80 CIO 4 MHZ	30.80
Z8602QS	Z8 2K XROM 64 PIN 8 MHZ	62.20
Z8603RS	2 K XROM 8 MHZ	121.00
Z8671PS	BASIC DEBUG 8 MHZ	31.10
Z8681PS	Z8 ROMLESS 8 MHZ	17.82

AND ANY MANY MORE ZILOG CHIPS ARE AVAILABLE!



NO SALES TAX APPLICABLE

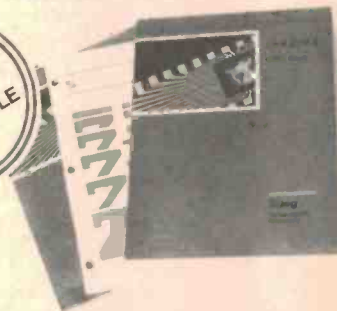

ZILOG BOOKS

GOOD RANGE OF ZILOG SUPPORT LITERATURE AVAILABLE

00-2034-A0	ZILOG GENERAL DATA BOOK	\$ 8.70
00-2013-A0	Z80 DATA TECHNICAL MANUAL	\$ 9.00
03-0002-01	Z80 ASSEMBLY LANGUAGE PROG. MANUAL	\$18.37
03-0012-02	Z80 CPU PROGRAMMING REF. CARD	\$ 1.80
03-0029-01	Z80 CPU TECHNICAL MANUAL	\$ 9.16
03-3047-02	Z8 TECHNICAL MANUAL	\$18.37
03-3055-02	Z8000 PLZ/ASM ASSY. LANG. PROG. MANUAL	\$18.37

QUANTITY PRICING AVAILABLE CONTACT YOUR NEAREST OFFICE

PRICES WHILST STOCKS LAST
PRICES SUBJECT TO CHANGE WITHOUT NOTICE
PRICES + SALES TAX IF APPLICABLE - RATE 20%

LINEAR

UA301ATC	G.P. OP AMP D.I.P	0.59
UA771ATC	FET OP AMP D.I.P	3.10
UA771BTC	FET OP AMP D.I.P	0.96
UA772TC	BI-FET OP AMP D.I.P	1.70
UA772BTC	BI-FET OP AMP D.I.P	2.55
UA774LPC	QUAD-FET OP AMP D.I.P	1.85
UA776TC	PROGRAMMABLE MULTI OP AMP D.I.P	1.05
UA1488PC	QUAD LINE DRIVER RS232C D.I.P	0.90
UA1489PC	QUAD LINE RECEIVER RS232C D.I.P	0.90
UA2240PC	PROGRAMMABLE TIMER/COUNTER D.I.P	1.80
UA494PC	DUAL OUTPUT SWITCHING REG. P.W.M. D.I.P	4.46
UA7854PC	SINGLE OUTPUT SWITCHING REG. D.I.P	2.70
UA555TC	TIMER D.I.P	0.38
UA7805UC	FIXED POSITIVE REG. 5V TO220	0.83
UA7905UA	FIXED NEGATIVE REG. 5V TO220	0.83
UA7812UC	FIXED POSITIVE REG. 12V TO220	0.83
UA7912UC	FIXED NEGATIVE REG. 12V TO220	0.83
UA7915UC	FIXED NEGATIVE REG. 15V TO220	0.83

MINIMUM ORDER \$20

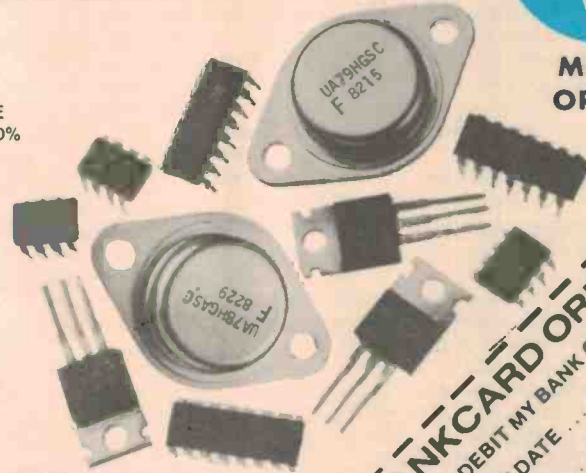

FAIRCHILD
A Schumberger Company

"E. & O.E."

BANKCARD ORDER FORM
PLEASE DEBIT MY BANK CARD NO. _____
EXPIRY DATE _____
NAME _____
SIGNATURE _____

24 Teddington St. Victoria Park. W.A. 6100

3 Elizabeth St. Tighes Hill. Newcastle.
N.S.W. 2300

23 Whyalla St. Fyshwick. A.C.T. 2609

Project 1516

the voltage (better) but the actual resistance of the glow coil, and hence the temperature of the plug (best).

Secondly, it employs a switchmode supply, which means that it dissipates only a modicum of power, typically five watts, rather than something over 50 watts.

What is more, it draws only a small fraction of the current that it delivers to the load, typically 20 to 25%! Result: less of a heat problem and smaller batteries for the same performance (penlite NiCads are fine) or even longer, lighter wires, running to your car cigarette lighter or whatever.

In addition to these features, it has a few more. It is cleanly and sharply current limited, which makes it infinitely harder to ruin a glow plug. We have equipped it with a button to allow the current meter to act as a battery check meter.

It has two potentiometers which are alternately selected by another switch: these can be preset to provide the correct starting temperature for two different engines or two different grades of glow plug for the one competition engine.

In case you thought that 'glow plugs was glow plugs' then it is about time that you took another wander through a model and hobby shop and saw the range of glow plugs which are available for tuning your engine. There are even several devious speciality twists you can get for improving some aspect of the running performance.

These features put the ETI-1516 ahead of anything commercially available, and coupled with its relatively simple construction and lack of critical or rare components, we feel it is the best option both for those not heavily involved in modelling and as a replacement piece of equipment for the serious model enthusiast.

Construction

The commercial power boards I saw sold at hobby shops are constructed on a small flat plate of aluminium with the components mounted by bolts or silicone glue, to the back of the plate. The user is presumably free to mount this plate in a box or use it as is.

Out of a desire to conform to the expected structural format, I built one prototype on such a small plate, but it is the front panel of a jiffy box, so that you have a ready-made enclosure if you want.

If you are not concerned with the compactness or the appearance but rather the robustness, I recommend using a tent-shaped panel quickly bent up from 14 or 16 gauge aluminium sheet or similar.

This structure provides its own heatsink/mount for the power transistor (Q7), as well as allowing access to the innards at short notice (very handy with the situations you find cropping up on the runway when you're miles from home). I built another unit like this. If your metalworking facilities do not stretch to this, the jiffy box is easier to prepare.

Also provided as a convenience, because commercial units often have it, is a second pair of banana sockets for the 12 volt supply so that more than one device running on the same source can be accommodated simultaneously without piggyback plugs. This can be deleted if you prefer.



Jiffy box model. This one I constructed on the metal lid of a suitably-sized jiffy box. Note that the layout is laterally reversed to the model pictured on the front cover.

Perhaps the first stage to construction is the winding of the coil, L1. I wound about 50 turns of 1.45 mm (15 B&S) enamelled copper wire on the former of an FX2243 45 mm diameter potcore assembly. This produces 20 mH inductance and is easy to buy and wind. In fact, any value of inductance from a minimum of about 5 mH up to 50 mH will do, but remember that it must be wound of wire sufficient to handle five amps. I suggest that you use 1.45 mm diameter wire, but at the very least 1 mm wire might do as the unit will not be used continuously. This inductor is the bulkiest component, so choose the box you wish to use with an eye to the size of this as well as the meter, M1. The next stage is to drill and prepare the front panel. My advice here is not to go overboard on the cosmetic side as the working environment and chemicals will make a mockery of any efforts at glamorous packaging.

While indelible pen is probably the most cost effective method of marking the front panel, I sprayed it with aerosol paint and marked the controls with labels on one prototype which were later covered with some clear lacquer. The result is clear and durable. *Scotchcal is a bad investment!*

If you have the panel area, the pc board can be mounted on it. I have made provision for mounting holes on the board.

Next mount all the panel components. I used pots with the short ribbed spindles and screwdriver slots, intended as 'chassis presets'. I recommended them as you do not want to alter the settings often and knobs make it likely that there will be some potentially hazardous (to the glow plug) twiddling by well-meaning or curious persons.

For the pushbutton, SW2, I used one of the small positive action momentary switches which cost a little more but are crisp in their action and fairly robust.

Now comes the assembly of the pc board. Two factors are worth noting. Firstly, if there is no chance of the incoming polarity being reversed, forget D3, the supply protection diode. Otherwise fit it either as I did, between the pc board V+ connection and the lead going to the terminal, or at the incoming terminal junction.

You could even fit it in such a fashion as to protect components further down the chain by placing it between the first and second positive input banana sockets.

I used the banana sockets as these are what the commercial units are normally equipped

with, but a polarised-type plug would be preferable as D2 can be dropped and then you can run to a lower input voltage before the electronics gives up.

As the voltage coming in to the box must run the op-amp, it is desirable to keep the input as high as possible. My prototype ran down to 9 V (after D2) comfortably.

Warning: polarity reversal will be quite lethal, so use D2 if you are not otherwise guarded.

The second factor concerns the heatsink on Q1. If you will not be running the unit for more than one or two minutes at most (the usual case), about 3 cm x 3 cm of heatsink is quite adequate, but a 6 cm x 4 cm heatsink at least must be used if you wish complete protection from burnout in continuous operation.

The consideration of operation duration also effects the choice of D1, the freewheel diode. It should actually be rated for about four amps continuous forward current but a three amp diode will be quite safe if you are only running it for a minute or two at a spell. Five amp diodes are more costly and harder to get, and our unit ran quite well using a three amp type. Higher current diodes tend not to be pigtail types too, which complicates mounting. ▶

HOW IT WORKS — ETI-1516

The block diagram of this unit is shown in Figure 1. There are three main parts to it: the resistance 'bridge' and the bridge amplifier, the pulse generator and the switching regulator.

The pulse generator provides constant-width pulses at regular intervals to the switching regulator. This provides current to the bridge, most of which (I_L) flows down through the glow plug (R_L) and a low value resistor (R_S). The ratio of $R_A:R_B$ is compared to $R_L:R_S$ by the bridge amp. If the ratios are different, then a voltage will appear across the op-amp inputs. If the glow plug (R_L) is cold, its resistance will be low. The ratio of $R_A:R_B$ is set such that, when the glow plug is cold, $R_A:R_B$ is greater than $R_L:R_S$.

Under these circumstances, the output of the bridge amp will cause the pulse generator to speed up, increasing the output of the switching regulator which then drives more current through the glow plug. The glow plug's resistance then increases and the ratio of $R_L:R_S$ decreases. This causes the bridge amp to slow up the pulse generator until $R_L:R_S$ equals $R_A:R_B$, i.e. the bridge is 'balanced'. The pulse generator then provides pulses at such a rate to the switching regulator so as to maintain the resistance, and thus the temperature, of the glow plug as desired. Varying the value of R_A thus sets the temperature of the glow plug.

Note that the majority of current supplied by the switching regulator passes down the $R_L:R_S$ 'leg' of the bridge, only a small amount passing down the $R_A:R_B$ side. The load current (I_L) thus flows through R_S and the voltage across R_S is used to drive the current-limit circuitry.

Looking at the circuit, the bridge consists of RV1/RV2-R14 (R_A), R13 (R_B), R15 (R_S) and the glow plug (R_L). The bridge amplifier comprises IC2 and associated components. The pulse generator is provided by IC1 and associated components while the switching regulator comprises Q1, Q2, L1 and D1. The voltage drop across R15, through which the glow plug current

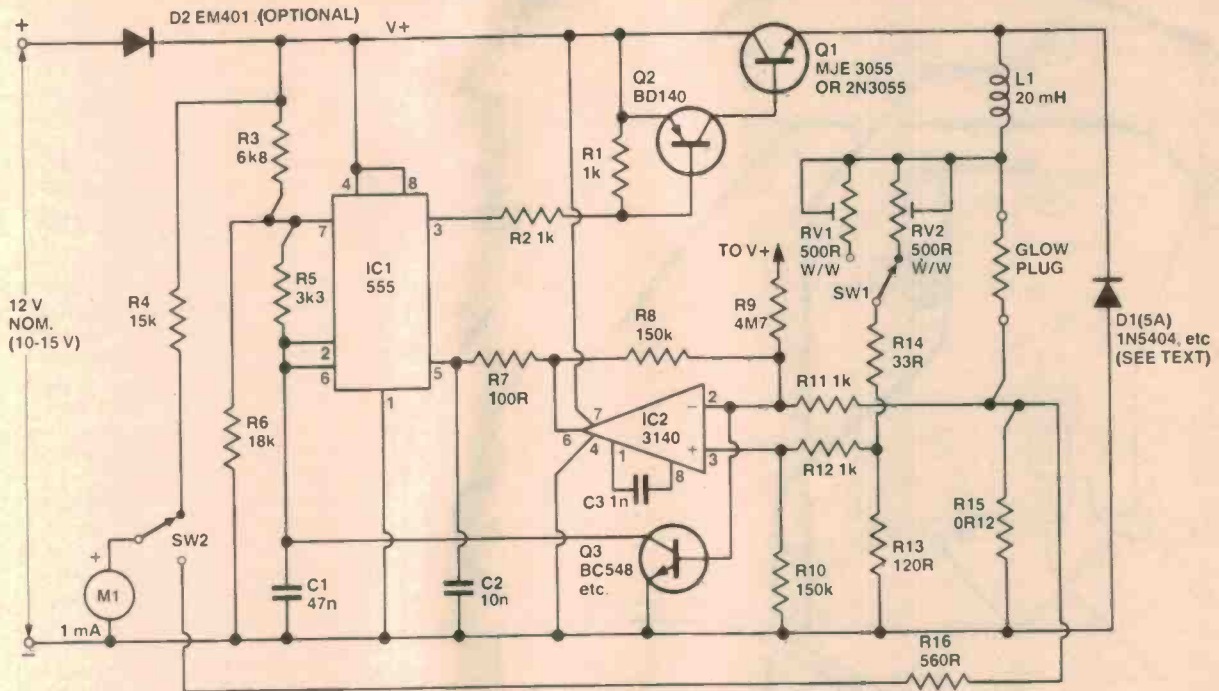

(I_L) flows, is sensed by Q3 which provides current-limiting.

Initially, C1 will be discharged and the output of IC1 will be high (i.e. at +12 V). Thus Q2, and therefore Q1, will be biased off. C1 will begin to charge via R3 and R5. Now, the inverting input of IC2 has a small positive bias applied to it via R9 and thus IC2's output is low (0 V), pulling pin 5 of IC1 (the control pin) low. This allows the 555 to trigger its output to the low state after C1 has charged only a little way.

When pin 3 (the output) of IC1 goes low, Q2 will be biased on, turning Q1 on. This applies 12 V to L1 and current will commence to flow through L1, the glow plug and R15 (also a little through RV1/RV2-R14 and R13). Because of the inductance of L1, the load current (via the glow plug, etc) will rise slowly. As the glow plug is cold to start with, the ratio of the glow plug resistance to R15 will be much less than the ratio of RV1/RV2+R14 to R13. Thus, the voltage at the inverting input of IC2 will be greater than that at the non-inverting input and the output of IC2 will continue to hold pin 5 of IC1 low. Thus, Q2 and Q1 will remain on, allowing the current through L1 and the glow plug to continue building up.

When IC1 first triggers, pin 7 goes low and C1 will begin to discharge via R5. The output of

IC1 will remain low for as long as it takes C1 to discharge to half the level it was previously charged to, at which point pin 3 of IC1 goes high again and Q2-Q1 turn off.

The magnetic field built up in L1, having nothing to sustain it now, will begin to collapse, the voltage across L1 will reverse and forward bias D1. Thus, the current generated by the collapsing magnetic field in L1 will continue to flow through the glow plug and R15, but now via D1.

The current now supplied by L1 will fall as the coil's energy is dissipated by the glow plug and R15. As the glow plug is still relatively cold, the inverting input of IC2 will be higher than the non-inverting input as the voltage drop across the glow plug will be less than the voltage drop across RV1/RV2+R14. Thus, IC2's output will hold pin 5 of IC1 low, allowing C1 to charge again.

When pin 3 of IC1 went high, pin 7 also went high, thus allowing C1 to charge again. When the voltage across C1 reaches the trigger point of IC1, pin 3 again goes low, turning Q2-Q1 on again.

Once again, current is applied to the glow plug, which continues to heat up. As the glow plug heats up, the voltage on the inverting input of IC2 will eventually reach that on the

non-inverting input and the output of IC2 will then switch to the high state. This drives pin 5 of IC1 high and pin 3 low once C1 has completed its current discharge cycle.

The time taken for C1 to discharge will remain constant irrespective of the level on pin 5 of IC1. Thus, the pulses produced by IC1 will be of constant length, but the level on pin 5 will affect the pulse rate. If the glow plug is 'cool', the pulse rate will be high. As the glow plug heats up and its resistance increases, the pulse rate will decrease.

With IC1 operating at a high pulse rate, Q2-Q1 turn on more frequently, delivering a lot of power to the glow plug. When IC1 operates at a slow pulse rate, less power is delivered to the glow plug.

Switch SW1 selects either of the two preset pots, RV1 or RV2. As the setting of these determines the ratio of R_A to R_B , they will determine the ultimate temperature of the glow plug.

If the current through the glow plug exceeds that necessary to develop a voltage drop across R15 of about 0.6 V (about 5 A), then Q3 will be biased into conduction. The collector-emitter junction of Q3 then shorts C1, preventing IC1 from firing, turning Q2-Q1 off until the current through R15 drops below the limit. Thus, the current through the glow plug is limited to a safe value, preventing burnouts.

A 1 mA meter is used to monitor the supply voltage and the glow plug current. Resistor R4 provides the meter with 1 mA of current at a supply of 15 V. Resistor R16 provides 1 mA of current through the meter when 5 A flows through R15. Switch SW2 allows switching the meter so that it reads supply voltage and glow plug current as you wish.

Capacitor C2 protects IC1 against 'spikes' present on pin 5 of IC1. Capacitor C3 compensates IC2.

A diode, D2, may be added to prevent damage to the unit should the supply be connected in reverse polarity.

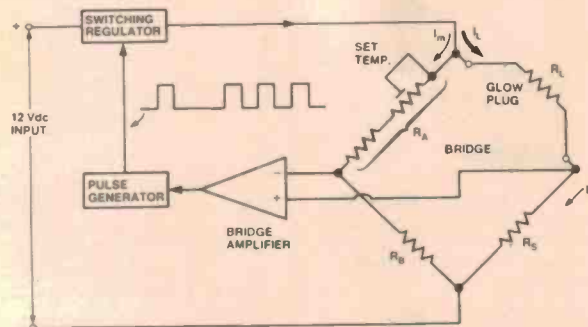
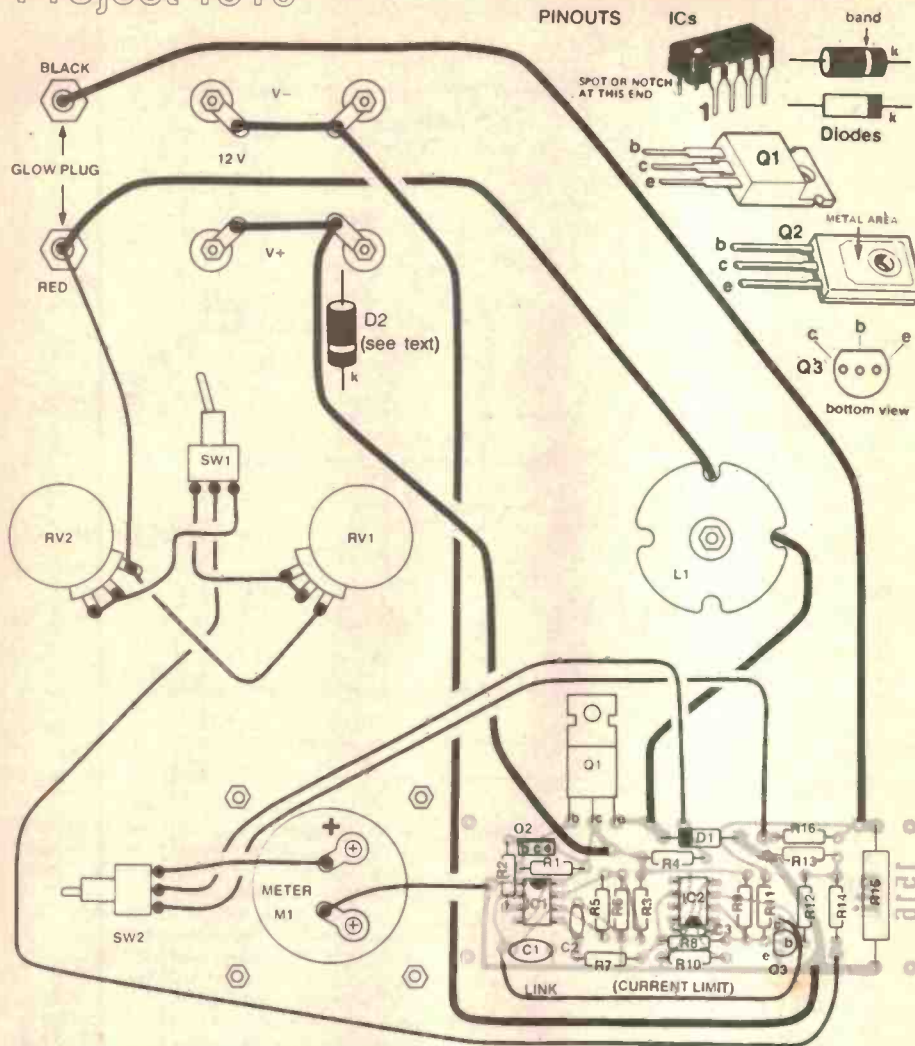

Figure 1.

Project 1516



Component overlay and wiring diagram.
General wiring diagram and pc board assembly. Note that SW2 is a pushbutton switch. Push in to read voltage.

Components & Kits

Suppliers of components and kits for this project are listed in the 'Shoparound' page in this issue. ETI does not sell kits or components for projects.

PARTS LIST — ETI-1516

Resistors	all ½ W, 5% unless noted
R1, 2, 11, 12	1k
R3	6k8
R4	15k
R5	3k3
R6	18k
R7	100R
R8, R10	150k
R9	4M7
R13	120R
R14	33R
R15	0R12, 5 W
R16	18k
RV1, RV2	500R preset or panel mount type pots
Capacitors	
C1	47n greencap
C2	10n greencap
C3	1n greencap
Semiconductors	
D1	3 A or 5 A, 100 PIV (e.g. 1N5405 or 1N5408)
D2	EM401, EM402, 1N4001, 1N4002
IC1	µA555, NE555, LM555 etc
IC2	CA3140

Q1	MJE3055, TIP3055, 2N3055
Q2	BD140
Q3	BC548, BC108, DS548 etc
Miscellaneous	
L1	20 mH inductor, wound on FX2243 potcore assembly with 1.5 mm enamelled copper wire, 40 mm 4 BA bolt, nut and fibre washers
M1	1 mA meter movement; e.g. University TD48 or Minipa MU45
SW1	SPDT or DPDT miniature toggle switch; e.g. D.S.E. S-1245 or similar.
SW2	SPDT or DPDT momentary action pushbutton; e.g. D.S.E. S-1220 or similar.

ETI-1516 pc board; banana sockets or polarised plug/socket; metalwork (see text); heavy duty hookup wire (24 x 0.2 mm or heavier); meter scale; terminals for plug cable termination; standoff pillars, nuts, bolts, wire, solder etc.

Price estimate \$35 — \$40

So, having settled for the option you wish, assemble the pc board components with particular attention to the IC polarity. Note that the two ICs are oriented oppositely to simplify the pc board pattern. There are no electrolytic (polarity conscious) capacitors specified. If you are far away from the battery you may find you need a 10 µf/16 V tantalum capacitor across the supply terminals, but my prototype was quite happy without one. Check the board when you've finished it.

The last stage of assembly is to fit the pc board and run the interconnecting wires. Be sure to use heavy gauge hookup or automotive wire for the connections to L1, the supply, D1 and the glow plug current loop. Fit Q1 to its heatsink using some thermal compound. Use an insulating washer if you are fitting it to the panel as a heatsink. Be sure to remove any burrs from the mounting holes which might prevent close mating of the transistor and heatsink, or puncture the washer if used.

My prototypes used the least reliable option in each of the above cases, to prove that the unit could work that way: small heatsink on Q1, 3 A diode for D1, a diode in place for D2, no capacitor on the supply and the whole thing inside a jiffy box.

After five minutes of heavy work (at 3 A) I had to turn it off to prevent Q1 failing, but all else worked.

If you are not skimping we think that you should use a large heatsink on Q1 and perhaps a capacitor on the supply terminals if you are not sure what leads will be used in the field. The other construction suggestions will all aid reliability also.

The second unit tested used the tent-shaped metalwork and Q1 was bolted to the rear panel. This will run indefinitely without sign of failure.

Once construction is completed, check it over thoroughly. When you're satisfied all's well, apply power and listen carefully before connecting up the glow plug. The inductor is almost certain to emit a 'singing' noise as the switcher idles along. Short the output and the current meter will respond with about 4½ amps and the singing note will change. This indicates normal operation.

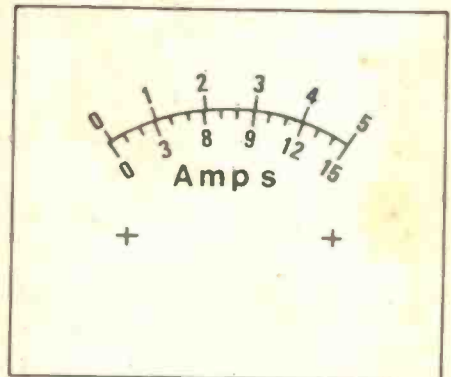

Meter scale. Full size reproduction of the meter scale. For those who want to make their own from Scotchcal, a same-size negative or positive transparency can be had for \$1 post paid from: ETI-1516 Artwork, ETI Magazine, P.O. Box 21, Waterloo NSW 2017. Make cheque or money order payable to 'ETI Artwork Sales'. Ensure you ask for a positive or negative according to your requirements.

Using it

In practice, nothing could be simpler than this device to use. Ideally, you should set the temperature control while viewing the glow plug removed from the head of the engine.

Connect a 12 V battery to the input of the unit. Remove the glow plug from the engine head. Reduce the selected temperature pot. to minimum resistance and connect the glow plug to the output terminals. Slowly bring the temperature up by adjusting the pot. away from the minimum resistance end of its travel (rotate clockwise). The plug coil will begin to glow.

Clearly, if you bring the temperature up too far you will burn the plug out, so be careful. A glow just beyond red is best, just tending to orange. If you are in doubt, it is best to try a lower setting and go up later.

You can set one pot. for red-orange plug coil and the other for orange-white, using this higher setting by flipping the temperature select switch if the lower setting will not effect motor starting.

Once you have seen the level which causes no starting problems it is simple to set up all further plugs in a like manner.

Once the plug is reinstalled in the head you should proceed to start the engine in the usual manner as recommended by the manufacturer. Because of the temperature regulating action of the controller you will find it much more difficult to foul the plug or flood the engine.

Any foreign matter in the glow plug fitting tends to cool the element and so elicit an increase in the power delivered, burning the extraneous stuff off quickly. The current limit mechanism prevents plug failures due to one part of the coil cooling and producing higher currents while another part of the coil is uncooled and overstressed.

You will also notice certain other effects. When coming close to starting by firing on the first compression stroke, but not further ones, the current needle will be seen to dip momentarily. This is on account of the heat produced by the single ignition, which heats the plug somewhat, reducing in turn the need for the controller to supply heat to keep the coil up to the commanded temperature.

On the other hand, too rich a fuel mixture or tendency to flood will be evidenced as the reverse; momentary rises in the current delivered to the plug indicate that the coil has been splashed or otherwise cooled, necessitating a moment of boost. (You may feel free to consider at these moments how another system would be labouring to boil off the contaminant).

Again, when the engine has started there will be a significant fall in current, simply because the repeated combustion explosions in the head are doing most of the heating of the glow plug.

Other non-temperature sensitive systems would tend to overload the glow plug at this point, a fact that was only brought to our attention by the observation of the power drop upon starting.

One final note: The ETI-1516 may seem like overkill to some, realising that there would be significant feedback action if the glow plug were merely connected to a sound voltage regulated output, (preferably with



Tent model. This is the tent-shaped model I built. The wiring diagram on the previous page shows the physical layout of the rear panel of this unit.

remote sensing to eliminate the constant resistances of wires and so forth) by virtue of the sharply non-linear nature of the temperature/resistance characteristic.

This is indeed true, but the complexity of a current-limited switchmode voltage supply falls short of the complexity of the system here by only such a small margin that it turns out not to really be worth it.

One could save the odd few resistors and a diode or so, but it would require all the major semiconducting elements with which we have managed to achieve temperature regulation merely to provide a sharp low impedance source, so why not go the whole hog, so to speak?

May your starts be many, now that they're virtually all 'sure starts'!

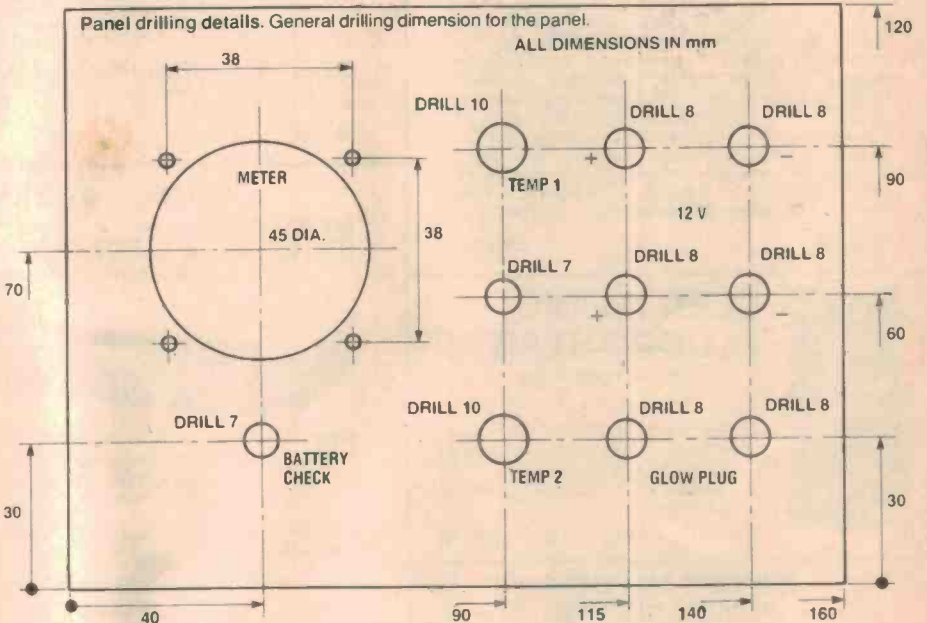

Printed circuit artwork. Full-size layout of the pc board, copper side. A same-size positive or negative transparency can be had for \$1 post paid from: ETI-1516 Artwork, ETI Magazine, P.O. Box 21, Waterloo NSW 2017. Make cheque or money order payable to 'ETI Artwork Sales'. Ensure you ask for a positive or negative as you require.

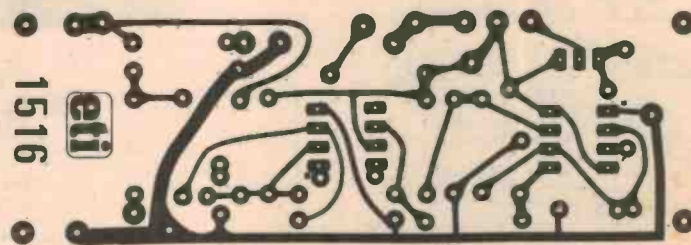

TRANSISTOR ASSISTED IGNITION WITH DWELL EXTENSION

127 SOLD LAST MONTH

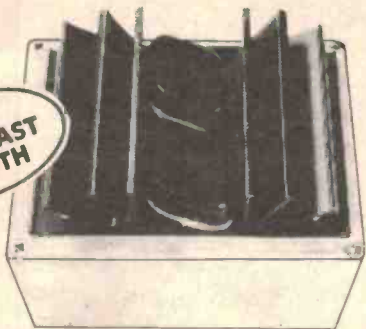

The Altronics Kit includes all components for the modifications, detailed by Electronics Australia Feb. 1983.

Yes, it's bad enough paying \$2.00 a gallon for petrol without wasting a fortune on an out of tune engine. Fit this transistor assisted ignition kit in minutes and start saving money from the very next petrol stop. Easy to build!

K 4010 \$35.00

THE EVER POPULAR MUSICOLOUR IV EA PROJECT



Combination Colour Organ and Light Chaser. Four channel colour organ. Internal microphone or connect to speakers for colour organ operation. (The lights connected to each channel pulse in beat to the music proportional to portion of frequency spectrum concerned.) Four chaser modes forward and reverse. Output lamp load capacity a massive 2400 watts — that's 100 party globes. Full instructions and every last nut and bolt included. Great for parties, shop signs, display windows etc.

K5800 \$89.50

ELECTRONIC FLUORO STARTER

(SEE EA OCT. 1982)



Save a fortune on Fluoro Tubes.

- * Extends the life of your fluoro tubes by 1,000's of hours.
- * Instant "ON" — no more flickering at switch on.

K6300 \$4.95

MICROCOMPUTER POWER SUPPLY



- + 5 Volts @ 3 Amps,
- + 12 Volts @ 2 Amps,
- 12 Volts @ 200 mA.

This universal computer power supply is based upon an EA design. (Our version is updated).

- + 5 Volts for memory, CPU all Micro's.
- + 12 Volts for RS232 interfaces etc.
- 12 Volts handy for additional hardware using OP Amps.

- * Uses TO-3 Regulators + 5 V and + 12 V.
 - * Heavy Duty Fan Type Heatsink.
 - * Complete Boxed Kit with Delux Front Panel.
- NOTE: This unit has enough grunt to power most small disk drives.

K 3350 \$59.50

**THE INCREDIBLE SERIES 5000 FROM ETI
SERIES 5000 1/3 OCTAVE GRAPHIC EQUALIZER**

Another brilliant DAVID TILBROOK no compromise design



SPECIFICATIONS:

Noise — at zero gain and 20 KHZ Bandwidth — 102 db. Distortion 1 KHZ — typically .007%. Bandwidth — 12HZ — 105 KHZ + 0 — 1 db. Boost/Cut + and — 14 db.

ALTRONICS EXCLUSIVES:

- * All 1C sockets provided
 - * Quality series Racking Case supplied
 - * Genuine Philips Sygnetics Low Noise 5534 1C op amps supplied
 - * Specially imported high accuracy linear slide potentiometers employed for precision control adjustment.
- (NOTE: Not compromise "Null Centre" types that some suppliers offer.)

K 5025 See ETI Magazine November 1982 \$199.50

**STUDIO FORMAT
ETI 5000 STEREO CONTROL PREAMPLIFIER**

There have been countless accolades exclaiming this brilliant design by Australia's top audio design engineer David Tilbrook — and with good reason!

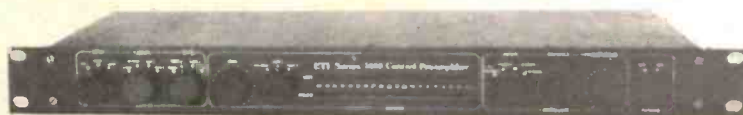

As a demonstration of our faith in this classic designed preamplifier we proudly release the **STUDIO FORMAT 5000 PREAMP** which includes some very worthwhile refinements as detailed here:—

- * Gold plated RCA Jacks on all phono inputs
- * 1 x pair gold plated RCA Line Plugs, supplied
- * Military spec. National Semiconductor LM 394's employed
- * Low capacitance screened cable, supplied; 1C sockets provided throughout;
- * Multicoloured led display
- * Metal film 1% resistors used throughout all audio circuitry
- * Pretinned PCB's
- * Satin Black brush finished, aluminium control knobs

DELUXE STUDIO FORMAT 5000 PREAMP KIT

Complete kit includes all ETI specified parts plus the Studio Format Package. Full instruction booklet included. SEE ETI MAG. JULY '81—OCT. '81 FOR FULL DETAILS.

K 5001 \$275.00

ETI 5000 STEREO MOSFET AMPLIFIER

See ETI magazine Jan. '81—April '81. New generation mosfet power semis facilitate David Tilbrook's classic power amplifier. Listening tests prove it surpasses even the best in conventional amplifiers in low fatigue, high definition audio. Completely uncoloured crisp sound purity.



EVEN BETTER: This beautifully engineered amp design is based principally on two identical printed circuit boards with a minimum of other wiring, thus enabling even a relative "beginner" to accomplish

building this project as long as the step by step instructions are followed.

The **ALTRONICS Kit** includes the **DELUXE FINISH FRONT PANEL HEATSINK**

- * Original specified chassis bar design case
- * All metal work finished satin black
- * Flux shorting strap transformers used to minimise hum
- * Low leakage power supply electrolytics

SPECIFICATIONS: Power Output: 100 watts into 8 ohms x 2. Frequency Response: 8 HZ - 20 KHZ + 0 db — .4 db. Noise: 116 db below full output. Input sensitivity: 1V RMS for 100 W output. Distortion: Less than .001% at 1 KHZ and full output. Stability: Unconditional stable.

COMPLETE MOSFET AMP KIT K 5005 \$299.00

LOUDSPEAKER PROTECTION KIT



Protect your valuable loudspeaker system with this easy to build, professional appearance kit. This easy to construct kit, based on the latest ETI design (Oct. '82), provides both DC and overpower protection for your valuable HI-FI speakers. Self-powered unit disconnects the speakers within 1/10th of a second of a fault occurring yet in no way effects the sound quality.

The **ALTRONICS Kit** comes in a superb 1 unit rack box including quality silk screened front panel.

- EXCLUSIVES:** * LED Monitoring of channel cutout
- * Fujitsu 10 amp relays
- * **ALTRONICS Kit**, stereo unit complete to last nut bolt and washer
- * Input/Output speaker cable terminals supplied.

Install it in minutes — no AC or DC connections required — simply connects into the left and right channel speaker lines.

K 5050 Stereo Rack Version \$79.50

OF THE MONTH
KIT

**EA'S BRILLIANT
LABORATORY POWER SUPPLY**

See EA May and June 1983

**2-50V
DC at a
massive
175W**



Over the last 2 or 3 years we have had literally dozens of requests for a universal 5 amp Bench Power Supply Kit. Naturally we passed this on to the design team at Electronics Australia and at last it is now a reality. Just look at the design concept! A fully mains transformer isolated supply with a very clever "Switch Mode" low voltage circuit.

Most importantly it's dead easy to build (ours worked first time!).

Specifications
Input 240V 50Hz
Output Variable 2 - 50V at up to 5 amps

Cat K3300 \$139.50

Why pay over \$250 for an inferior commercial unit?

NEW



TOUCH LAMP DIMMER

HALF THE COST OF COMMERCIAL UNITS

Great new kit from EA. (April '83). Based on new Selmens IC S576A Light Dimmer IC. Instantly turn lamps on and off with just a light touch on a wall panel, or provide mood lighting by touching the panel for a few seconds. The Altronics Kit is complete in every way, including satin silver touch plates for that prestigious look.

K6320 \$19.50

REMOTE CONTROL FOR K6320

This kit enables extra dimmer/switches to be installed in conjunction with the Dimmer Kit. Includes satin silver touch plate.

K6321 ONLY \$9.00

NEW



**RADIOTELETYPE-
COMPUTER DECODER
DESIGNED FOR
THE MICROBEE**

(SEE ETI APRIL '83)

Display RTTY encoded messages on your VIDEO Monitor.

Simple circuit uses PLL TECHNIQUES, most components mount on a single PLB simplifying construction. Complete Kit includes D15 Plug for connection to Microbee IN/OUT PORT.

K9733 \$19.50

'MICROBEE' EPROM PROGRAMMER

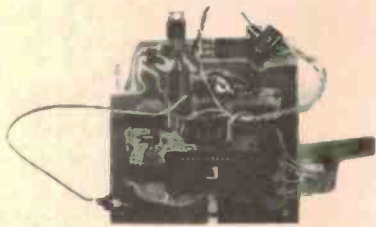

VERSATILE. LOW COST & EASY TO BUILD

Great new project from ETI (Jan. 1983). All components mount on a single printed circuit board. Unit simply plugs into the Microbee I/O port. Suitable for 2716, 2732, 2532, 2732A and 2764's. Burn your games programmes and eliminate cassette loading times
★ Zero insertion force IC socket for eproms
★ Sockets for all other IC ★ 1 x 2716 supplied — get started straight away. ★ Kit supplied in deluxe jiffy box, all mounting hardware included

K9668 \$48.50

VIDEO RF MODULATOR

(SEE ETI OCT 1981)



If you cannot afford a Video Monitor for your computer this is the kit for you. Super stable oscillator design and very low modulation distortion ★ Works with both B & W and Colour TV sets ★ Suitable for computers, TV games, TV pattern generators or what have you. Deluxe kit featuring heavy duty diecast box for RF shielding ★ Input and output sockets

K9760 \$17.50

**POWER
UP**

See EA November, 1982

**A MUST
FOR YOUR
COMPUTER
SYSTEM**



This great new Project from EA is the answer to a Maiden's Prayer.

What Does it Do?

A single 240v mains plug and lead feeds one unswitched-master 240v outlet plus 4 switched 240v outlets. With say a hi-fi system, plug your main equipment item (e.g. Amp) into the master outlet and whenever you "switch on" your amp — presto — mains power is applied to the other 4 outlets i.e. simply "turning on" your amp turns on your tape cassette, tuner, turntable, graphic equaliser without mains spikes, plops etc.

Just the shot for your Computer System. The Altronics Kit includes case and all outlets.

Cat K6000 \$39.50



IC Sockets Provided

K6700 \$55.00

300 WATT

Fully regulated and overload protected XTAL locked frequency.

★ ★ ★ ★ ★

**NOW USING HIGH EFFICIENCY
TRANSFORMER**

★ ★ ★ ★ ★

Use to power hi-fi, TV sets and for emergency lighting.



★ Gold plating on both PCB edge and edge connector.
★ Low age rate parallel resonant XTAL used.
★ Sockets for all IC's.

K6750 \$199.50

**\$10 DELIVERY ANYWHERE
IN AUSTRALIA!**

For despatch P + P charges and Altronics address details please refer to our advert on Pg 91.

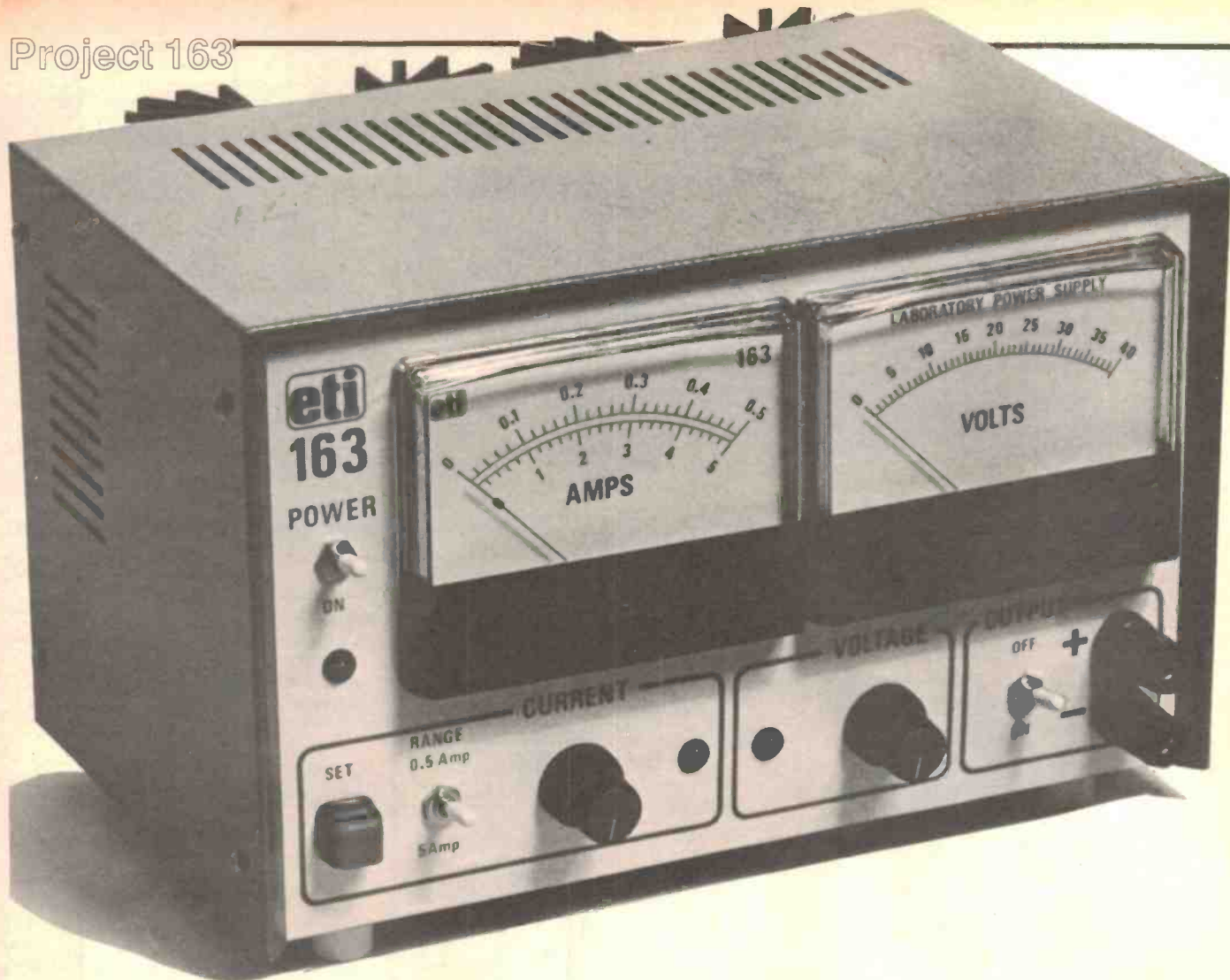

0-40 V/5 A laboratory power supply

Part 2.

Having introduced the project and the design technique chosen in Part 1, this part describes the construction and setting up.

David Tilbrook

Construction

This project is not recommended for beginners or inexperienced constructors. However, anyone with a modicum of electronics construction experience should be able to assemble this project with little difficulty.

First off, no matter whether you've bought the components individually or purchased a kit, lay out all the parts and see that you have everything you need — including things like thermal compound, the right size nuts and bolts etc. Two basic grades of hookup wire are used to wire up the supply: ordinary 'light duty' (10 x 0.12 mm) hookup wire and 'heavy duty' (24 x 0.2 mm) or 'ultra heavy duty' (32 x 0.2 mm) wire. Those parts of the circuit carrying high currents are wired up

with the heavy duty wire, as indicated in the wiring diagram.

The case we used is from K&W of Ballarat, Victoria, model C1066, supplied to us courtesy of Rod Irving Electronics. It is a popular and widely available case. Overall, it measures 255 x 165 x 155 mm and has a U-shaped aluminium chassis and hammertone blue steel lid with ventilation slots. It is supplied with four screw-on feet.

The chassis will need to be marked out and all holes drilled or cut out before any assembly can be commenced. Mark out the front panel according to the accompanying diagram. Centre punch all holes before drilling. Do a trial assembly of each component to see that they all fit and make any necessary adjustments.

No drilling diagrams have been given for the chassis bottom and rear panels as these will depend on the physical dimensions of the exact components used. Tackle the rear panel first. Place the two heatsinks side by side (see rear photograph), leaving room at the right for the mains fuse and power cord inlet. The two heatsinks we used were 150 mm lengths of black anodised radial fin type, manufactured and marketed by Rod Irving, No. HS3. There are similar types available. Any heatsink with suitable dimensions and rated dissipation of 1-1.3°C/watt will be perfectly adequate.

Holes will need to be drilled in the rear panel to accommodate the transistor mounting hardware, the transistor leads and bolts for securing the heatsinks. Having organised

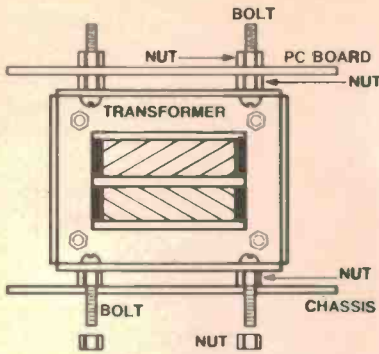

Transformer and board mounting. How the power tranny, T1, and the pc board are mounted.

that, then locate the holes for the mains fuse holder and the power cord grommet — which should be a clamp type.

Mark out the case bottom next. Locate the mains transformer centrally between the sides and towards the rear, leaving no less than 15 mm clearance from the rear panel to the transformer bobbin. Four bolts are used to secure the transformer. Then locate and mark out the two filter capacitors, the bridge rectifier, the mains terminal block and earth bolt and the auxilliary 12 V (2851) transformer (if used). Make sure you don't foul the four case feet. Do a trial assembly to see it all fits correctly.

Remove burrs from all holes, then check that you've drilled all the required holes. Now stick masking tape across the rear (inside) of the front panel and spray paint the outside of it white. At the same time, remove the scale panels from the two meters, turn them over and spray paint them white, too. This ensures that the background for the Scotchcal labels is neutral as white Scotchcal is slightly translucent. Remove the masking tape from the chassis after the paint has dried.

Now the Scotchcal labels can be attached. Tackle the meter scales first. Peel off the backing along one edge for a little way then carefully align it on the edge of the scale panel and rub it down. Then peel off the backing further, rubbing down the Scotchcal carefully as you go. Take care not to get any, or many, bubbles under the Scotchcal label.

Transistor mounting. How to mount the two power transistors, Q3 and Q4.

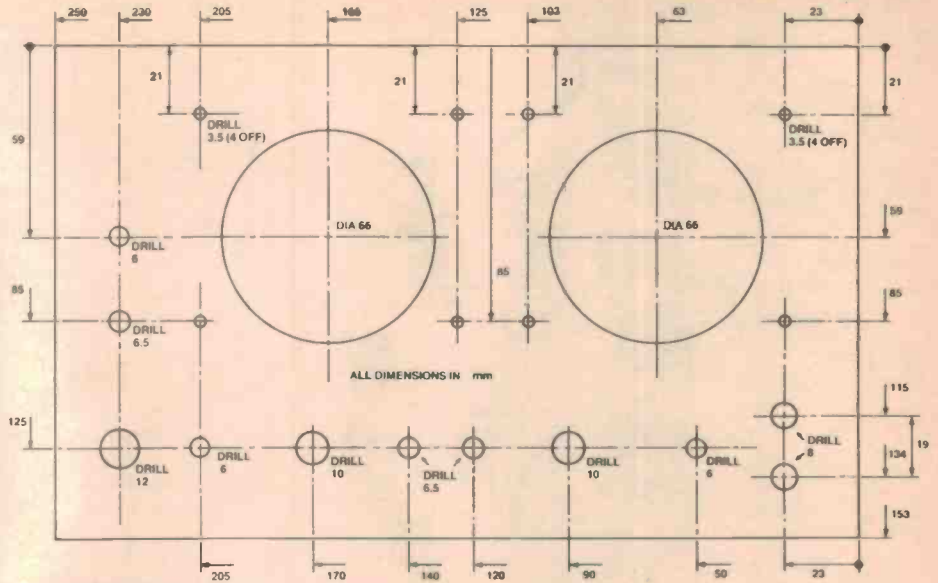
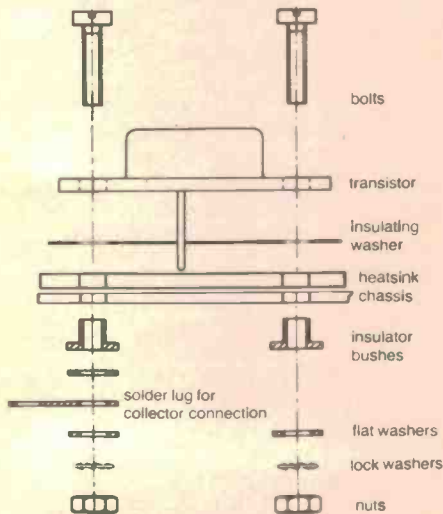

Get the drill! Drilling details for the front panel.

If you do get some, they can be removed by rubbing them away towards the nearest edge. Work from the centre of the panel outwards.

Follow by applying the other meter scale Scotchcal and then the front panel. When the labels have been applied, cut out the holes using a modeller's scalpel or the like. Remember, a little patience prevents accidents. Re-assemble the meters.

Now, you can mount all the front panel components — the meters, switches, output terminals, etc. Attach wires of appropriate length to them, as shown in the panel wiring diagram. Take care to use light duty and heavy duty hook-up wire where indicated. Note that the lead from the voltage control potentiometer (RV4) to the pc board is a shielded cable. The shield braid is soldered only to the pot lug which connects to the 0 V output terminal and is left unconnected at the pc board.

Mount the rear panel components, but leave the mains cord off for the moment. Assemble the transistors to the heatsinks and chassis as indicated in the accompanying diagram. Attach wires to the transistors as per the wiring diagram.

Mount the bridge rectifier and attach heavy duty leads of appropriate length to the lugs. Then mount the mains terminal block and the 2851 auxilliary transformer, if used. Wire the mains switch, mains fuse and mains terminal block. Sleeve the exposed fuse and switch connections. Mount the power transformer as per the diagram here, followed by the filter capacitors.

Assembly of the pc board can be tackled next. First, examine the tracks, looking for any breaks or hairline copper bridges between tracks. Check that all the holes are drilled and that they're of the correct size, particularly where the relays mount. ▶

Rear view. Showing the components mounted on the rear panel. Note that the lip on the chassis lid needs to be cut away around the heatsinks and fuseholder.

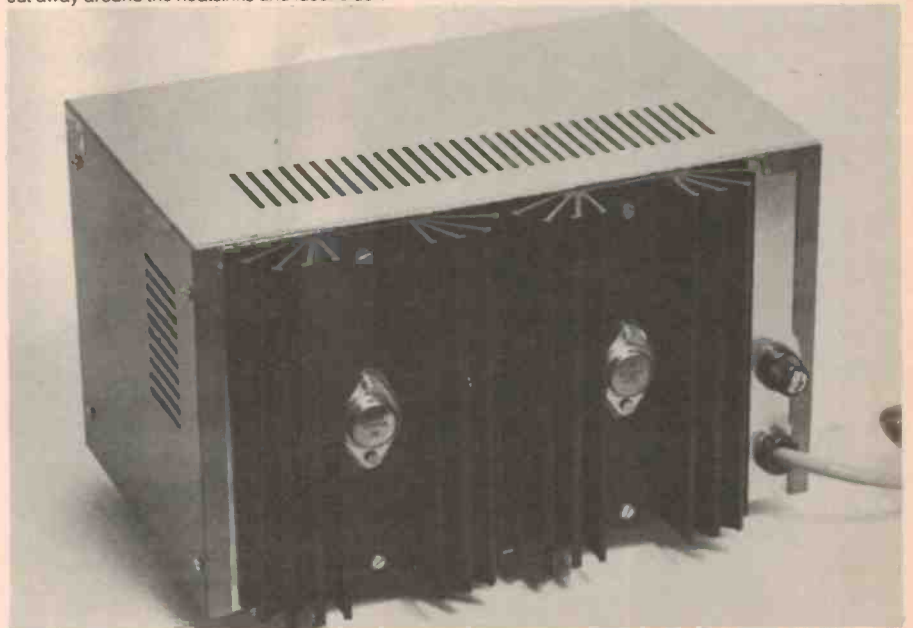

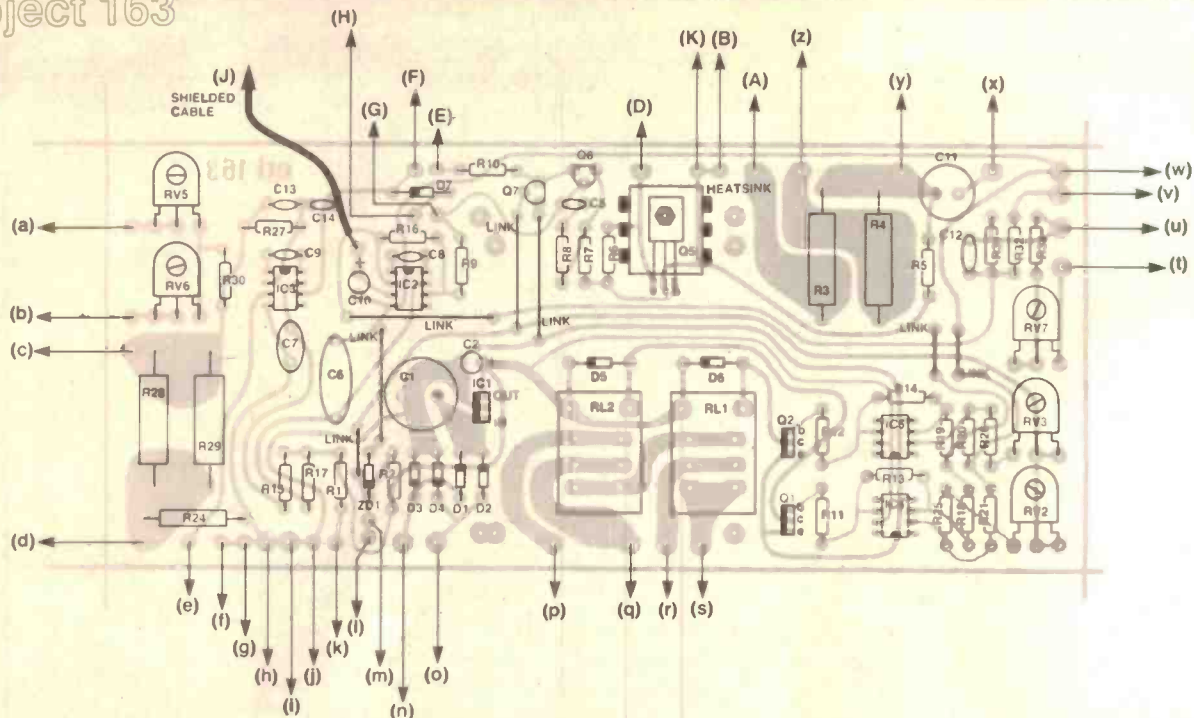

If, or when, all's well with the board, commence assembly by soldering all the resistors and capacitors in place. Make sure you place the electrolytics and tantalums the right way round. The trim pots, note, are all laid flat on the board. Solder the pins in first, then carefully bend them so that the body lays flat.

The semiconductors may be soldered in place next. Check that each is correctly oriented before you solder it in place. If you wish, IC sockets may be used. Note that Q5,

the BD140, requires a small heatsink. I used a Thermalloy No. 6073B, but any similar type that physically fits will do. Smear a little thermal compound on the metal face of the transistor before assembling it. No insulating washer is necessary.

The two relays can be mounted and soldered in place next, followed by all the pc stakes for terminating the leads to the components on the chassis.

The pc board bolts on top of the transformer. Note that provision has been made on the pc

board for mounting holes to suit either the Permatran or the Ferguson transformer, whichever is used. It mounts on top of the transformer, as per previous diagram.

Referring to the wiring diagram, wire up the pc board. Route all the wires carefully. Check it thoroughly when you've finished. Last of all, wire in the mains cable. Make sure the earth (yellow/green) lead is the longest so that, should the cable be accidentally pulled out, the earth lead is the last to break.

PARTS LIST — ETI-163

Resistors	
R1, 2, 6, 7, 9, 10	1k
R3, 4, 28, 29	0R22, 5W
R5	47R
R8	3k9
R11, R12	2k2
R13, R14	1M
R15, R30	100R
R16	220k
R17	100R
R18, 19, 22, 27	10k
R20	15k
R21	33k
R23	1k8
R24	1R, 1W
R25	12k
R26	27k
R31	39k, 1%
R32	5k6, 1%
R33	33k
RV1, RV4	10k/A panel mount pot.
RV2, RV3	10k/A min. vert. trim pots
RV5, RV6	500 R min. vert. trim pots
RV7	25k min. vert. trim pot
Capacitors	
C1	1000u/25 V single ended electro.
C2, C10	10u/16 V tantalum
C3, C4	8000u/75 V can electro.
C5	5n6 greencap
C6	470n greencap
C7	100n greencap
C8, C9	220p ceramic
C11	100u/63 V single ended electro.
C12	47p ceramic

C13	1n ceramic
C14	150p ceramic
Semiconductors	
BR1	PB40, MDA2504, MDA3504 etc bridge rectifier
D1, 2, 3, 4	1N4001, 1N4002 etc
D5, 6, 7	1N914, 1N4148
Q1, Q2	BD139
Q3, Q4	MJ15003, MJ15024 etc
Q5	BD140
Q6	BC547, BC107 etc
Q7	BC559, BC159 etc
IQ1	uA7812, LM7812 etc
IC2, 3, 4, 5	CA3130
LED1	TIL220R red LED
LED2	TIL220Y yellow LED
LED3	TIL220G green LED
ZD1	5V1
Miscellaneous	
F1	2.5 A or 3 A fuse, type 3AG, and bayonet holder (e.g. D.S.E. cat. S-4206 or similar).
M1, M2	Minipa MU65 1 mA meter movements, or similar.
PB1	SP momentary action pushbutton, 125 Vac/6 A contacts, D.S.E. No. S-1199 or similar.
RL1, RL2	DPCO heavy duty relays, 125 Vac/10 A contacts, 12 V coil (160 ohm), Fujitsu FRL-264D012/02CK (D.S.E. No. S-7140 or similar).

SW1	DPST miniature toggle switch, 240 Vac/1.5 A contacts or greater, D.S.E. No. S-1174 or S-1168, or similar.
SW2, SW3	DPDT miniature toggle switches, 240 Vac/5 A contacts, D.S.E. No. S-1168 or similar.
T1	transformer, 240 V primary, 250 VA rating, main secondary to deliver 36 V at 5 A or better, tapped at 12 and 24 V, with auxiliary secondary of 15 V at 200 mA (or additional 2851 12 V/150 mA transformer if 15 V secondary not available).

ETI-163 pc board; K&W case No. C1066; two heatsinks — Rod Irving No. HS3 150 mm long single-sided radial fin type black anodised, or similar (1°C/watt); one Thermalloy TO-220 heatsink 6073B or similar (for Q5); two heavy duty captive-head binding posts (one red, one black); one two-way terminal block; TO3 insulating components — two sets; one clamp grommet; mains cord and plug; Scotchcal labels for meter scales and front panel; short length of shielded cable; three LED mounts; hookup wire — light (10 x 0.12 mm) and heavy (24 x 0.2 mm or 32 x 0.2 mm); 6 BA and 4 BA bolts and nuts, solder lugs etc.

Price estimate \$165 — \$170

COMPONENT PINOUTS

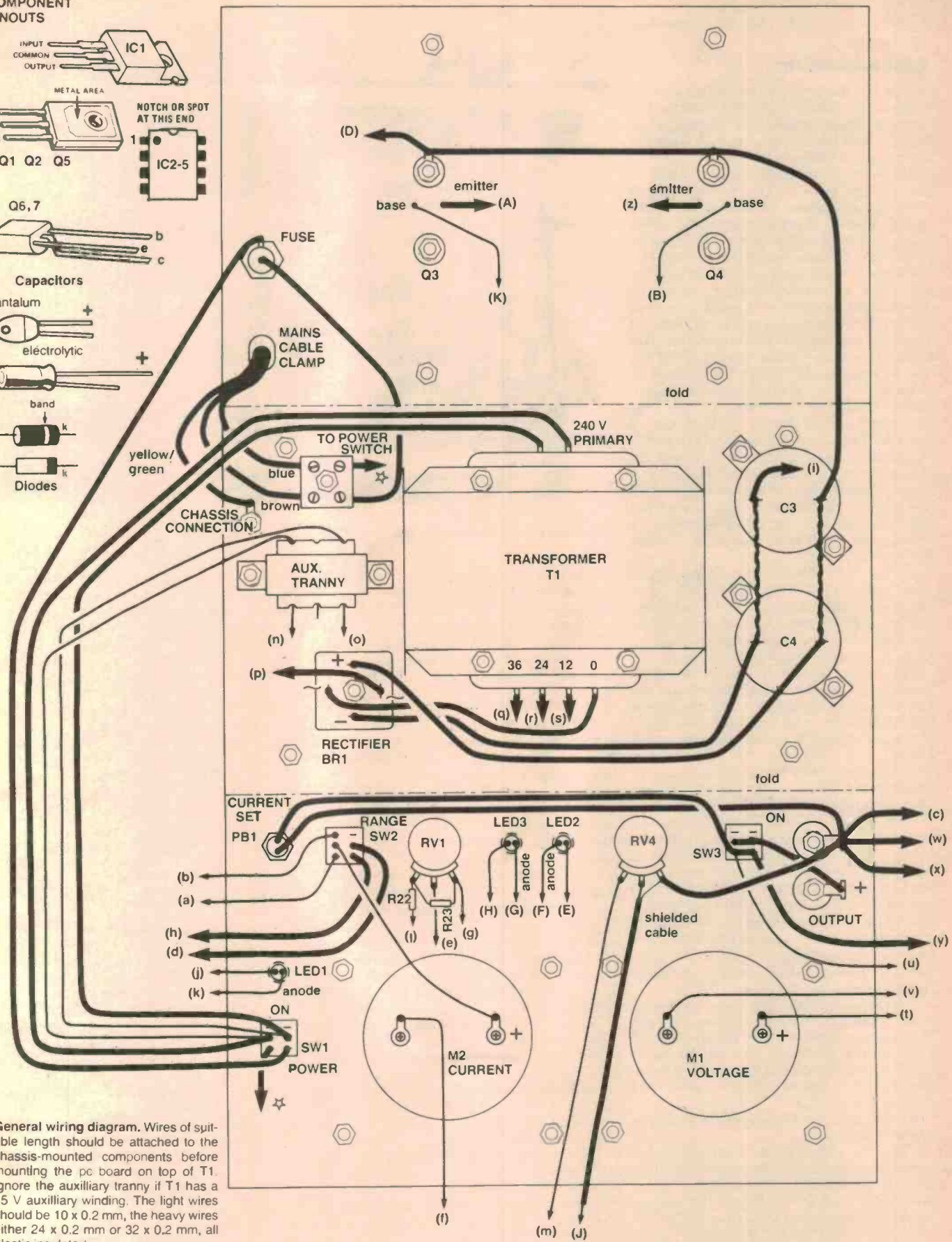
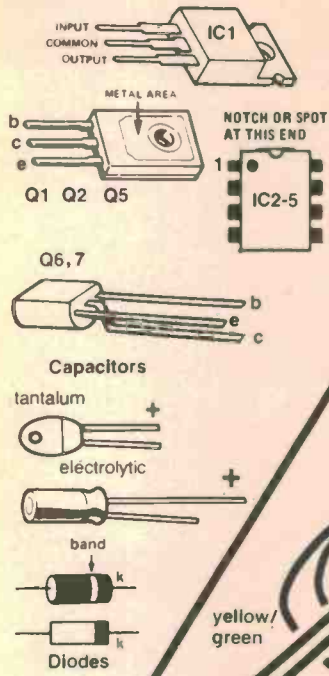

General wiring diagram. Wires of suitable length should be attached to the chassis-mounted components before mounting the pc board on top of T1. Ignore the auxiliary tranny if T1 has a 15 V auxiliary winding. The light wires should be 10 x 0.2 mm, the heavy wires either 24 x 0.2 mm or 32 x 0.2 mm, all plastic insulated.

Project 163

Now you're ready for the traditional 'smoke test'.

Test and set-up

Set all the trimpots to mid-position and the current and voltage controls a quarter-turn from minimum. Set the current range switch to 0.5 A and the output switch on. Plug the mains cord in and switch it all on.

The mains LED should come on, along with the voltage mode LED. The volts meter should read forwards, somewhere on the low end of the scale. If you don't get these indications, switch off and check for a wiring error (make sure you've a fuse in the fuseholder!).

Using a multimeter, check the voltage across the main filter capacitors (C3-C4). It should read around 17.5 V (with respect to the supply's negative output terminal — all readings are quoted with respect to this point). Check the voltage at pin 1 (in) of IC1 (i.e. at cathodes of D2-D4). This should be around 17.5 V if you're using the 12 V auxiliary transformer, or around 21 V if your main transformer has a 15 V auxiliary winding. Then check the output of IC1 (pin 3). It should be very close to 12 V. Check the voltage on the cathode of ZD1. It should be very close to 5.1 volts. No other voltages will tell you very much at this stage. If you don't get the correct readings switch off and check wiring and component placement. Correct any errors.

If all's well, advance the voltage control until you hear RL1 'click' on. The voltage on the positive terminals of C3-C4 should then be around 36 V. Advance it further until RL2 clicks on and the voltage on the positives of C3-C4 should rise to about 54 V or so.

Now check the voltage across the output terminals. Vary the voltage control over the full range and ensure that you can vary it right from zero volts to a little over 40 V. We'll get around to calibrating the meter later.

The current-limit operation can now be checked. Set the output switch off. Connect your multimeter directly across the output terminals. Set it to the 5 A or 10 A range. Ensure the supply's current range switch is set to 0.5 A. Set the voltage control back to about a quarter-turn from minimum. Throw the output switch on. The voltage mode LED should go off and the current mode LED should go on. (This should also occur when the voltage control is set at minimum.) See that the multimeter reads a low current. If it doesn't, you've got the current range switch upside down.

Set the multimeter to a convenient scale (1 A or 2 A). Turn the current control around to maximum and see that the multimeter reads around 0.6-0.7 A. Now set the multimeter to the 10 A scale and the current range switch to 5 A. The multimeter should read between 6 A and 7 A.

If all's well, the two meters can now be calibrated.

First, the volts meter. With the multimeter still connected to the output terminals, set it to a convenient scale so that you can accurately read 20 V. Adjust the voltage control to obtain 20.0 V on the multimeter. Now adjust RV7 so that the volts meter on

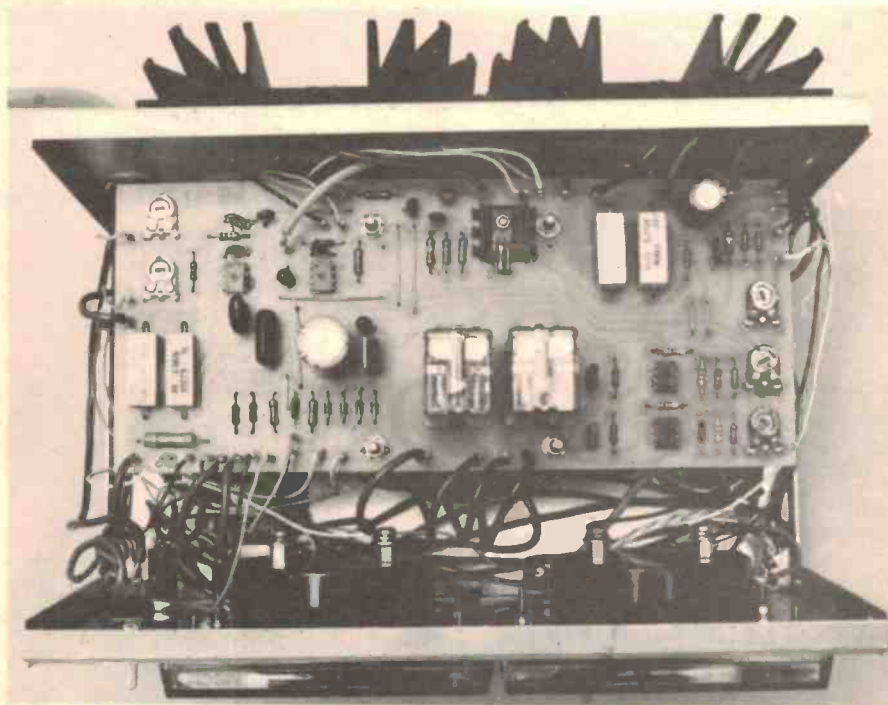

Top down view. Inside the lab. supply, showing board mounting and wiring.

the project also reads precisely 20 V. Then set the voltage to read 5 V on the meter and check that the output's within ± 0.25 V.

I have done this because many devices, TTL ICs and op-amps in particular, require accurate supply voltages and most are driven from supplies of less than 20 V. With TTL ICs a supply in excess of 5.5 V can destroy the device. Calibrating the meter at 20 V ensures that the meter accuracy at the low end is sufficient to obviate problems. If it's a volt or two out on the 20-40 V end of the scale, it doesn't matter so much.

To calibrate the current meter, first set the supply's output switch off. Set the current range switch to 0.5 A and set both the voltage and current controls about a quarter-turn off minimum.

Switch on the supply output and adjust the current control to obtain a reading of 500 mA on the multimeter. Then adjust RV6 so that the current meter reads full scale. Set the multimeter to the 5 A or 10 A scale and the current range switch to 5 A. Set the current control so that the multimeter reads 5.00 A and adjust RV5 so that the current meter reads full scale.

The current control has to be re-adjusted when switching from 0.5 A to 5 A as the current sensing resistor for the 5 A range is not exactly 0.1 ohms, being made up from two 0R22/5 W resistors in parallel which are the only ones generally available. Some tolerance in values will account for a difference in any case.

Now the relay 'trip' points can be set. Turn RV2 and RV3 fully anticlockwise. Set the output voltage to something less than 10 V. You can do this adjustment using either the project's volts meter or your multimeter connected across the output terminals.

Slowly advance the voltage control until the output is 12.5 V or thereabouts. Then rotate RV3 clockwise until RL1 just clicks in. This trimpot gives a trip point range of about 3 V from about 11 V to about 14 V. You may notice the output actually drop a few hundred millivolts when RL1 pulls in, but this is of no consequence.

Having done that, slowly advance the voltage control until the output voltage reaches about 25.5 V. Then rotate RV2 clockwise until RL2 clicks in. The output will drop a few hundred millivolts when you do this, but as before, it's unimportant. This trimpot has a trip point range of about 6 V, from roughly 24 V to about 30 V.

That's it! Now you can screw the lid down and put your ETI laboratory supply proudly on the workshop shelf.

Tips on using it

Always set up the power supply with the output switch off. Set the output voltage to what is required by the circuit you're working on. Then set the current limit range switch to the appropriate range, press the current set button and adjust the current control so that the current meter reads a little above what you expect the circuit to draw. Don't forget to allow for relay turn-on currents, lamps, indicators and etc in the circuit.

With straight CMOS circuits, even those with a dozen or more ICs, a current limit of 100-150 mA is a good safe limit.

Beware of circuits which may draw peak currents several times the average current and set the current limit to take this into account (i.e. audio amplifiers, pulse circuits).

With a little experimentation and experience, you'll soon learn how to set up and effectively use the ETI-163 Lab. Supply. ●

ALL ELECTRONIC COMPONENTS

118 LONSDALE STREET, MELBOURNE, VIC. 3000. TEL 662 3506.

MAJOR STOCKISTS OF ALL GENERAL RADIO AND ELECTRONIC COMPONENTS

KIT SET SPECIALIST

JOIN THE GOLDRUSH

ETI 1500 KITSET

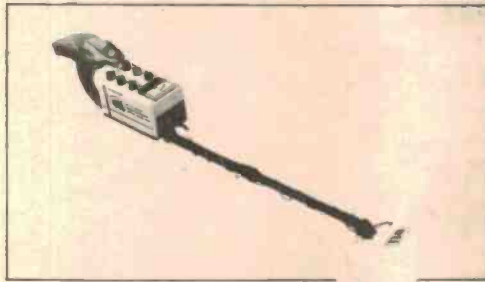

Superb unit featuring:

- Tune and discriminate.
- 4 modes of operation.
- VLF/TR design.
- Ground balance.
- Auto balance push buttons.
- Pre-wound search heads.
- Very professional unit.
- Approximately 1/3 price of many similar commercial built up locators.
- Audio and meter indication. Lets you know when to rejoice.

PRICE: \$193.50 including pre-drilled and punched case, or \$179.99 including blank case. Plus \$10.50 p&p reg. post.

Stac Timer

ETI 650

\$135.00

incl. tax

Plus \$6.00 p&p



This unit has four different programmable outputs, clock controlled switch-ons/switch-off times. Selected days from the seven or eight day cycle can be "skipped". Ideal for operating air conditioning, fish tanks, hi-fi systems, tape recorders, slide & movie projectors, laboratory control, video equipment, etc.

TRANSISTOR ASSISTED IGNITIONS

ETI 316

\$33.30 plus \$5 p&p

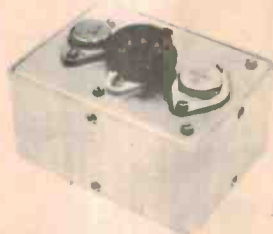

ETI 316

\$33.50 plus \$5 p&p

Features include:

Built in dwell extension.

Improved performance and economy.

Simple to install.

As per EA feb. '83.

\$34.14 plus \$5 p&p

Features include:

Built in dwell extension.

Add-on opto-electronic trigger option (\$17.38 plus \$3.00 p&p)

Maintains coil current and therefore spark energy at very high engine speeds.

Includes die-cast case and heat sink.



'PRO' BENCH POWER SUPPLY

ETI 142

0-30 VOLTS;

0-15 AMPS!

\$272.64 plus \$10.50 pack & reg. post.



A phenomenal supply with professional finish and professional performance. It features 20 mV regulation from zero to full load, 10 mV ripple and noise, voltage and current metering on separate meters, overload protection and adjustable current limiting. Sturdy metal cabinet with silk-screened aluminium front panel supplied.

ETI speaker systems

ETI 496—4000/14 way
100 watt \$541.32
not incl. boxes.

ETI 497—4000/23 way
100 watt \$383.14
not incl. boxes.

Post & packing for speakers—
allow 5% of order value.

**We stock the largest range of ETI and EA
Kits in Australia.**

**Call in and see our comprehensive
catalogue.**

Artwork. Here is full-size artwork for the pc board and the two meter scales. Unfortunately, the artwork for the front panel is too large to reproduce here. A photostat can be obtained by sending us a stamped-addressed A4-sized envelope. Scotchcal and pc board suppliers were listed on page 80 of the May issue.

You can obtain 1:1 positive or negative film of all the artwork for this project for \$15 post paid from ETI-163 Artwork, ETI Magazine, P.O. Box 21, Waterloo NSW 2017. Make cheques or money orders payable to 'ETI Artwork Sales' and ensure you ask for positive or negative film, as you require.

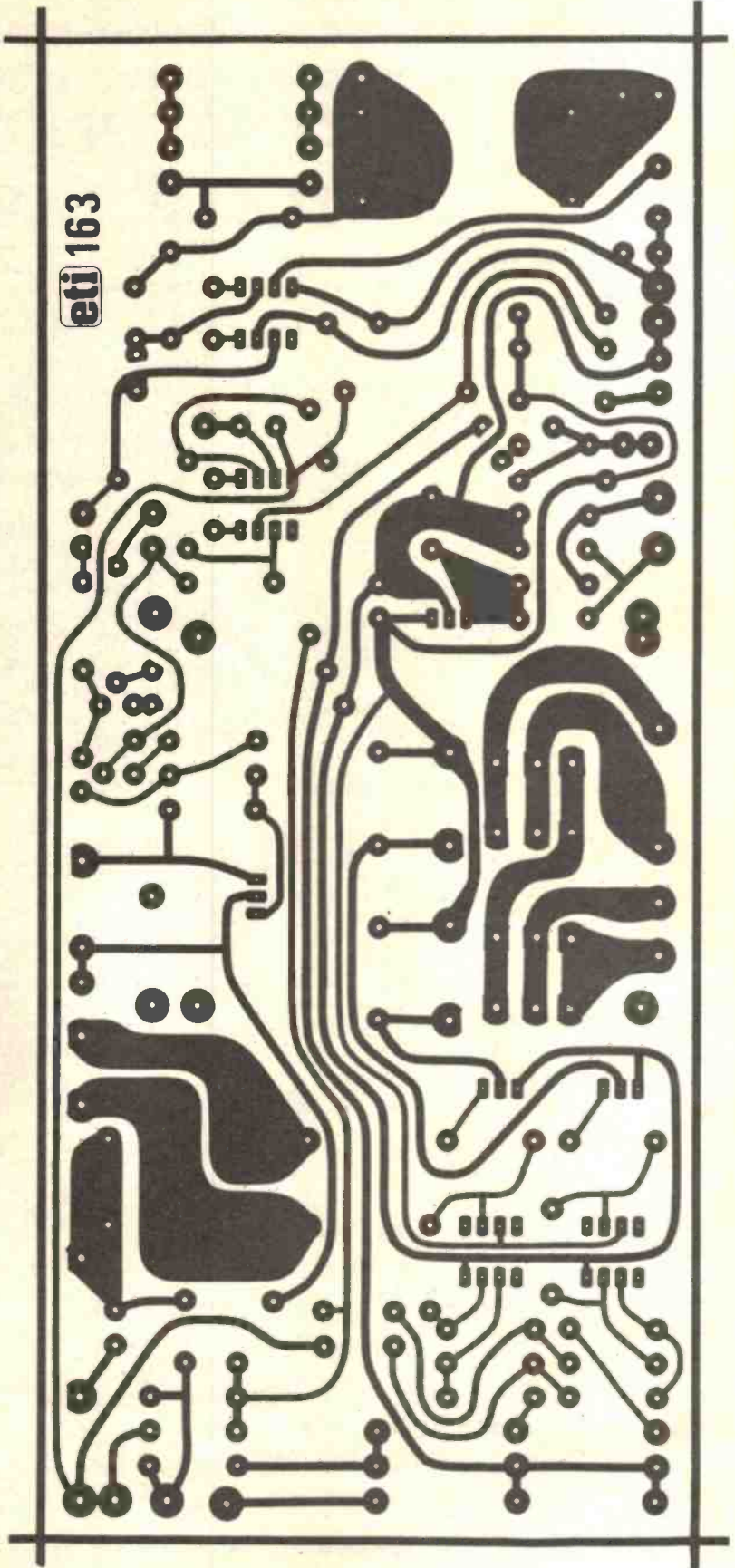
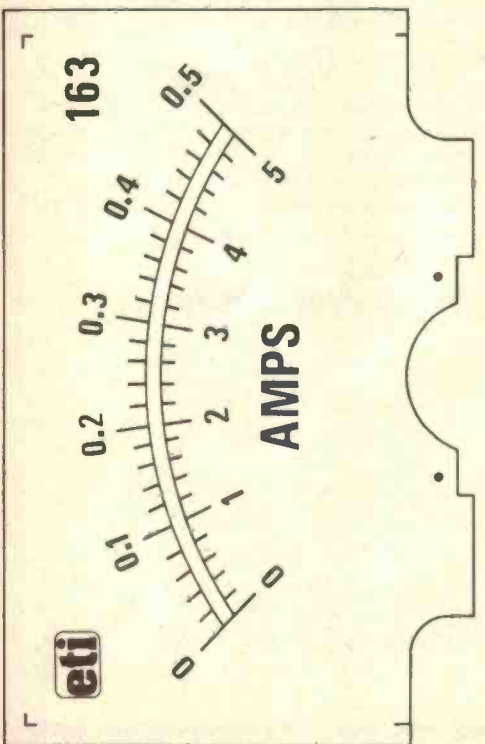
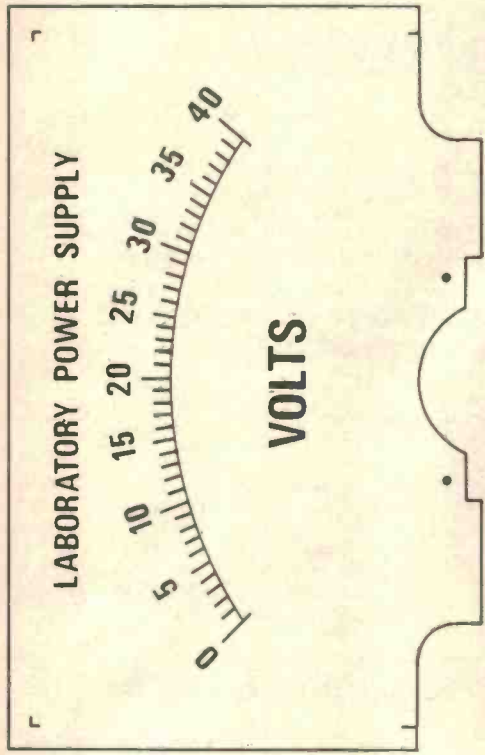



Check Our Super Special Prices!

LITHIUM MEMORY SUPPORT BATTERIES

MEMOGUARD LM & LF Series. Horizontal or Vertical mounting. The ideal power source for memory back up! Nickel Cadmium versions available also.



LITHIUM MEMORY SUPPORT BATTERIES SERIES LH & LF

Construction: Case is of the Dual-in-line type with standard spacing for direct insertion to a printed circuit board. Markings are engraved and non-erasable and clearly indicate polarity. Pins are plated to facilitate wave soldering. Insulated stand-offs ensure good access for solvent cleaning. Reliability: Excellent capacity retention and voltage stability, excellent performance under thermal variations, shocks and vibrations with a life expectancy of ten years at room temperature.

ELECTRICAL CHARACTERISTICS		
Open Circuit Voltage	V	3.5
Average Voltage	V	3.0
Capacity	mAh	200
Operating Temp		
Normal	°C	60
Intermittent	°C	70
Self discharge at 20°C	%/yr	2 to 3%
Energy Density	Wh/dm ³	400-500

R.R. \$4.64 + 20%

SCOPE COMMODORE MODEL PH20 370°C

Now a Production Quality 20W Iron that air cools your fingers. . . * 240VAC

- Designed for continuous production line use
- for students
- serious hobbyists.

A professional quality non-temperature-controlled soldering tool. Earthed tip and barrel for component safety.

*Idling temperature subject to variations in line voltage and ambient conditions.

\$16.95+TAX



BECKMAN HD100 MULTIMETRES

FULL 1 YEAR WARRANTY

\$235 + 20% TAX

80 SERIES CHIPS

8085 \$ 4.00	8226 \$ 1.21
8086 \$ 17.51	8228 \$ 2.39
8155 \$ 3.77	8243 \$ 2.01
8156 \$ 3.69	8251 \$ 3.32
8212 \$ 1.21	8255 \$ 2.20
8216 \$ 1.21	
8224 \$ 1.35	

EX STOCK

8253 \$ 3.69
8257 \$ 3.43
8259 \$ 3.43
8279 \$ 2.77

+ 20% Tax

MEMORY BARGAINS

HM6116P-3	\$5.99	250ns
MB2716	\$2.95	450ns 16K EPROM
MB2764-30	\$10.96	300ns 64K EPROM
MB8118	\$3.95	120ns 16384 X 1 RAM
MM2708Q	\$2.80	450ns 8K EPROM
MB8114 NLC	\$4.00	300ns CERAMIC
HN462532G	\$7.00	450ns 32K EPROM
S6834	\$13.30	512 x 8 EPROM
S6810	\$4.70	128 x 10 RAM 450NS
MC68000-LB	\$99.95	8MHZ C.P.U.

+20% TAX

Great Value!

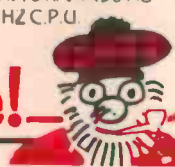

FUJITSU RELAYS DUAL IN LINE

BR211 DO12V	3.64	DP.DT
BR221 DO06V	3.64	
BR221 DO24V	3.64	SP.DT

BR211 DO06V	2.54	+20%
BR211 DO12V	2.54	TAX
BR211 DO24V	2.54	

DIP SWITCHES

4 WAY SLIDE	1.40
8 WAY SLIDE	1.60
10 WAY SLIDE	2.00

+ 20% TAX

DATA ACQUISITION CHIPS FOR ETI
— 654 APPLE II INTERFACE CARD
AD570 — 8 BIT ADC \$34.32 + 20%
AD7524 — 8 BIT DAC \$8.40 + 20%

INSTRUMENT CASE. MODEL IC-1

KIT COMPRISING

- 2 blank styrene panels \$5.25
- 4 bump on rubber feet +20% TAX
- all screws required for PCB mounting



13x12-5x3-8mm

CAMBION I/C SOLDER SOCKETS

8 PIN	18c
14 PIN	25c
16 PIN	29c
24 PIN	41c
28 PIN	50c
40 PIN	66c

+20% TAX

CRYSTALS

1 MEG	6.00
2 MEG	4.00
3.579 MHZ	1.50
4 MEG	4.00
4.194 MHZ	3.00
8 MHZ	4.00
10 MHZ	4.00

+20% TAX

MULTI-COMBI ELECTRONIC METAL AND CABLE SEARCHING TOOL + VOLTAGE TESTER.

- Finds: Hidden cables and metals
- Finds: Voltage cables
- Checks: 240 Volt
- Protects: from accidents and damages

ONLY AT MAGRATH'S

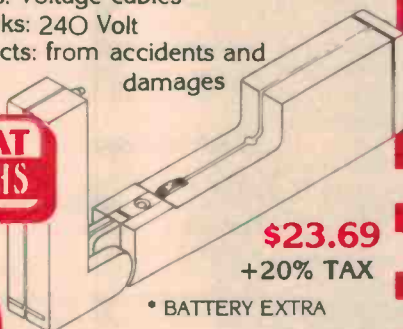

\$23.69

+20% TAX

* BATTERY EXTRA

On and off switch operates automatically when opening and closing. Regulator adjusts the sensitivity of both searching functions. Indicator control lamp red — for voltage cables yellow — for metal.

HARD TO GET CHIPS!

27C16	10.00
CDP1802 ACE	9.82
6850P	4.00
ISP 8F-025A	17.00
2716-50	2.75
INS 8060N	7.22
RC 4136	.60
TL 074	1.80
TL 084	1.50
NE 571N	3.00
IIC90	12.75
MC10116P	1.00
TIP 31C	.50
TIP 32C	.50

DIB 04 1A 400V
DUAL, IN LINE
BRIDGE RECT. .50
+ TAX

SUPER BARGAINS AT MAGRATH'S

Phone or Mail.



bankcard welcome here

MAGRATH'S ELECTRONICS
55 A'BECKETT STREET, MELBOURNE, 3000
Tele (03) 347 1122, Telex AA31001
Prices subject to change without notice.

— Mail or phone orders add \$2.00 up to 1kg pack post
Special rates for heavy items on request

Temperature adaptor for your multimeter

This simple add-on project extends the functions of your multimeter to the measurement of temperature. It is particularly suited to digital multimeters. It can be used to measure temperature over the range from -55°C to $+150^{\circ}\text{C}$ with an accuracy of 0.5°C or better.

Geoff Nicholls

IT IS SURPRISING how useful an 'electronic thermometer' can be in an electronics workshop or laboratory. Temperature measurement is a rarely-included function on modern multimeters, however. Measuring temperature in a chemistry or physics lab is commonplace, and the same should be so in an electronics lab, but rarely is.

Component temperature rise, or the actual operating temperature of a device, can be an important parameter in a circuit — no matter whether the component's a resistor or a transistor. The performance of heatsinks can be assessed using temperature measurements.

When fault-finding or servicing equipment, thermal problems can be quickly sought out and identified by temperature measurement. And that's just a few applications!

Sensors

There are a number of ways to measure temperature electrically or electronically. Thermocouples, which consist of two dissimilar metal wires bonded together, have long been used. The junction of the metals generates a small voltage that is proportional to the junction temperature. The voltage output is non-linear with changing temperature. Thermocouples are generally used for temperature measurement at high temperatures and over extremely wide ranges.

The resistance of semiconductor material varies considerably with temperature and this is exploited in 'thermistors'. The variation is non-linear, but thermistors have been used for temperature measurement where accuracy and linearity are not important.

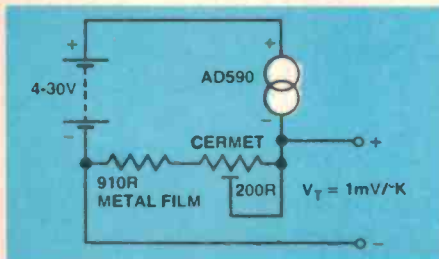

Figure 1. Simple thermometer with $\pm 2^{\circ}\text{C}$ accuracy.

Any semiconductor junction will exhibit temperature dependence of the forward conduction voltage. For silicon junctions, which have a forward conduction voltage of around 600 mV, the junction voltage will vary by typically $-2.2\text{ mV}/^{\circ}\text{C}$ at a forward current of around 250 μA , and this is generally linear over quite a wide range.

Silicon diodes and the base-emitter junction of silicon transistors are often used in temperature sensing and control applications. Accuracy and repeatability are generally very good. We described a digital temperature meter which employed a silicon diode sensor (ETI-589) back in the December 1977 issue.

However, a number of specially-constructed ICs are available which have been designed to provide a highly accurate and linear temperature-to-current or temperature-to-voltage output over a wide temperature range. Such devices are unrivalled for accuracy, linearity and speed of response.

I chose the Analog Devices' AD590 which is available in two package styles — a TO-52 'can' and a tiny ceramic flat pack — and several accuracy grades. It is distributed by Parameters Pty Ltd, 41 Herbert St, Artarmon NSW 2064. (02)439-3288.

The AD590

The AD590 is a two-terminal integrated circuit temperature transducer which produces an output current proportional to absolute temperature. For supply voltages between $+4\text{ V}$ and $+30\text{ V}$ the device acts as a high impedance, constant current regulator passing $1\text{ }\mu\text{A}/^{\circ}\text{K}$. Laser trimming of the chip's thin film resistors is used to calibrate the device to $298.2\text{ }\mu\text{A}$ output at 298.2°K ($+25^{\circ}\text{C}$).

The device is particularly useful in remote sensing applications. The device is insensitive to voltage drops over long lines due to its high impedance current output. Any well-insulated twisted pair is sufficient for operation hundreds of feet from the receiving circuitry.

Superior interference rejection results from the output being a current rather than a

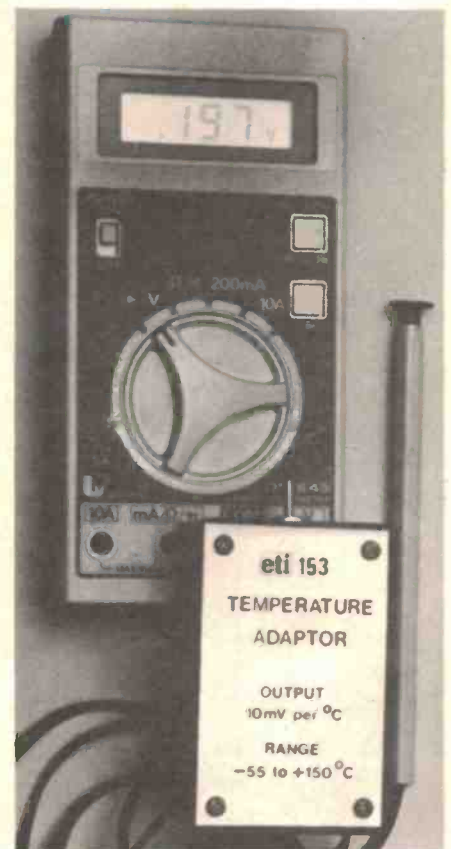

And it's 19.7°C ! Our adaptor plugged into one of the lab. multimeters.

voltage. In addition, power requirements are low (1.5 mW s @ 5 V @ $+25^{\circ}\text{C}$), making the AD590 easy to apply as a remote sensor. The high output impedance ($>10\text{M}$) provides excellent rejection of supply voltage drift and ripple.

It is electrically durable, withstanding a forward voltage up to 44 V and a reverse voltage of 20 V . Hence, supply irregularities or pin reversal will not damage the device.

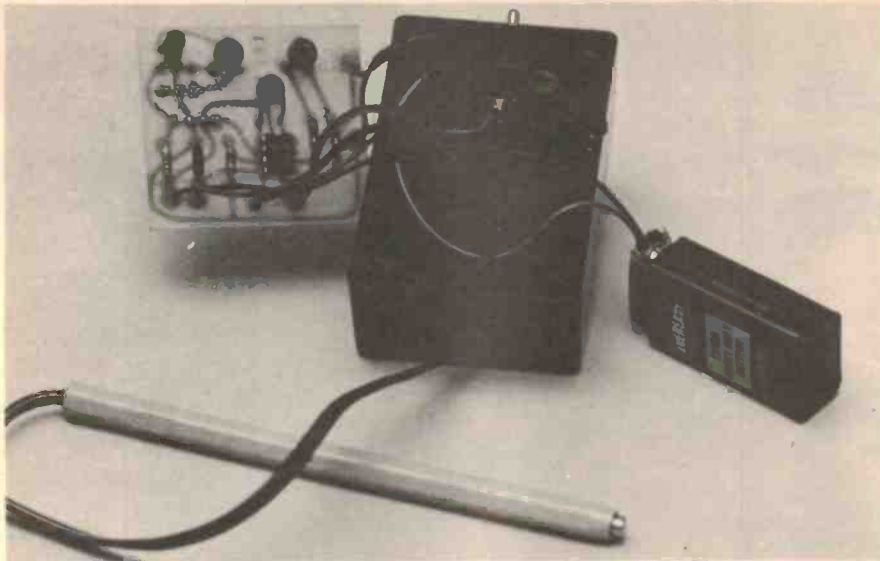

Simplicity. Construction is quite simple and all the electronics fits neatly in a small jiffy box. The tops of the banana plugs can just be seen. These are spaced at 19 mm ('GR' spacing) or to suit your multimeter input sockets spacing.

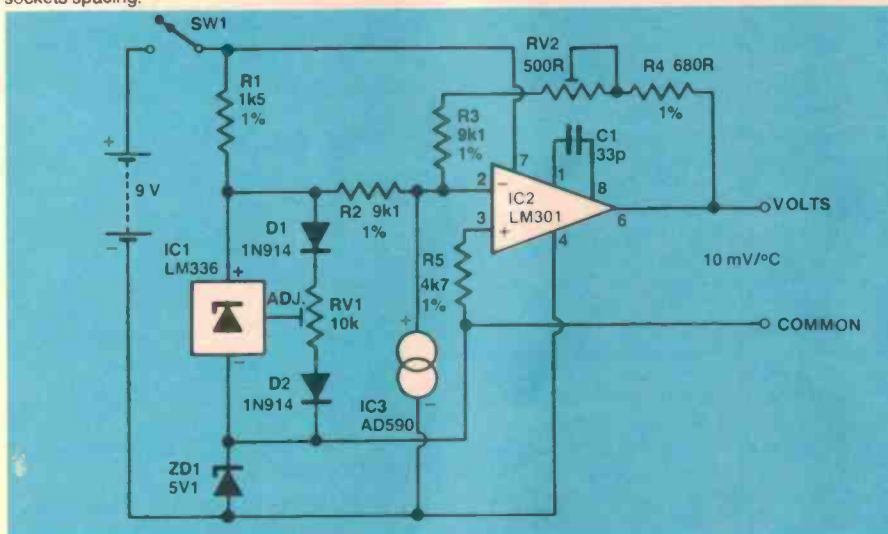

HOW IT WORKS — ETI-153

The AD590 temperature transducer, IC3, requires a voltage to be applied across it, developing a current that is directly proportional to absolute temperature with a precision sensitivity of 1 $\mu\text{A}/^\circ\text{K}$. This is amplified by an op-amp, employed here as a current-to-voltage converter that provides an output of 10 $\text{mV}/^\circ\text{C}$. As zero Kelvin is 273 degrees below zero Celsius, an 'offset' has to be provided for the output to be proportional to the Celsius scale. This is achieved by running the op-amp input at 'virtual ground' and supplying the AD590 sensor from a negative supply rail. Thus, at 0°C, the output will 0 V.

IC1 is a precision voltage reference (LM336) that maintains 2.49 V between its +ve and -ve pins. Two silicon diodes, D1 and D2, and a cermet (high stability) trimpot, RV1, allow the reference voltage to be 'trimmed'. This is normally done to minimise the temperature coefficient of the LM336, however, I have used it to provide trimming of the offset of Celsius zero from absolute zero.

Zener diode D3 provides a negative supply rail for the AD590 temperature transducer (IC3). The voltage obtained is around -4.5 V as the 5V1 zener is operated at a current of about

1 mA, set by the value of R1. The zener in the prototype was rated at 400 mW. If a 1 W type is used, R1 should be reduced to 1k.

IC2 is used in 'virtual ground' mode as a current-to-voltage converter. Its operation can be understood by remembering that IC2 is an op-amp and to a good approximation has infinite gain and infinite input impedance. A negative feedback path, formed by R3-R4-RV2, acts to maintain the inverting input (pin 2) at the same potential as the non-inverting input (pin 3). i.e. at 0 volts. Although very little current flows into pin 2 of IC2, it is kept at 0 V by the feedback action.

The AD590 connects to pin 2 of IC2 (inverting input) and acts as a current sink, passing 1 $\mu\text{A}/^\circ\text{K}$. The reference, IC1, supplies a current of 273 μA through R2, which can be trimmed by RV1. Thus, the current through the feedback resistors is equal to the absolute temperature minus 273, in microamps, and results in an output voltage of 10 $\text{mV}/^\circ\text{C}$ when RV2 is set to provide the 'scale factor' required.

To ensure the appropriate accuracy, high stability 1% metal film resistors and cermet trimpots are used. Capacitor C1 provides compensation for the op-amp, to ensure stability.

The AD590 is available in a number of accuracy grades. The 'M grade' device will give better than $\pm 0.05^\circ$ accuracy from 0° to 100° Celsius. It costs around \$60, however. For about \$5, you can purchase the 'J grade' AD590 which will give an accuracy of $\pm 0.3^\circ$ from 0° to 100°C. The accuracy you get depends on a number of factors (discussed later) and the type of circuit.

The simplest circuit you could use is shown in Figure 1. This will give temperature directly in the Kelvin scale with a voltage/temperature relationship of 1 $\text{mV}/^\circ\text{K}$. Thus at a typical ambient temperature of +25°C (298°K), the output will be 0.298 V. The output can be 'trimmed' to the correct temperature (calibrated) at one temperature point by the 200 ohm cermet trimpot. This is a 'one trim' circuit. With the AD590J, accuracy will be $\pm 2^\circ$ over the range from 0° to 100°C.

A circuit which provides for two trim, or calibration, points results in much better accuracy. Also, a more convenient voltage/temperature relationship is useful, which requires the output of the sensor to be scaled. An op-amp can be used for this to provide a stable gain. A figure of 10 $\text{mV}/^\circ\text{C}$ (or $^\circ\text{K}$) is suitable, and that's what I chose.

The accompanying photograph shows the two package styles compared to a match head. The TO-52 can (H package) is for general use. It has a longer time constant — the time taken to stabilise after changing the package's temperature — than the ceramic flat pack (F package). Typically, the H package will take four minutes to stabilise in still air, but the F package will only take about half that time. When applied to an aluminium block (e.g. a heatsink), the H package will typically take four seconds to stabilise, while the F package will take around half a second.

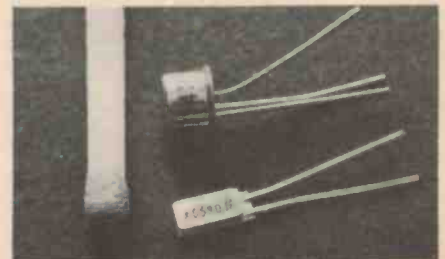

Tiny, what? The two versions of the AD590 packaging, compared to a match head. Above is the H package (TO-52); below is the ceramic F package.

Construction

The project was designed to fit inside a small jiffy box with a metal lid having overall dimensions of 30 x 50 x 80 mm. They're common and low in cost.

All the electronics, except the AD590 sensor, are mounted on a small pc board. This can be assembled first. Just check your pc board before assembling the components, ensuring there are no broken tracks or shorts between tracks and that all holes are correctly drilled.

The components can be assembled to the pc board in any order, just watch that you put the two ICs, the two diodes and the zener the right way round. Don't take too long to solder the resistors as they are high stability types, but ensure that each joint is properly made. ▶

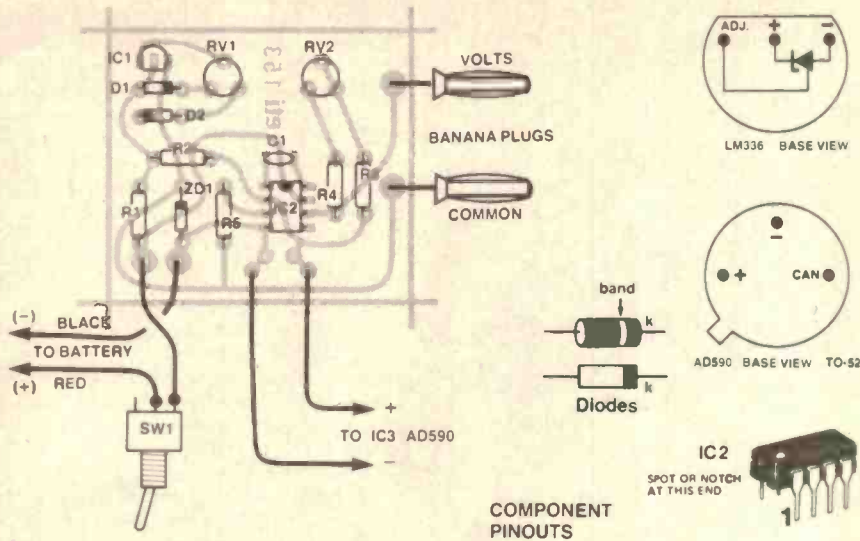

I mounted the banana plugs in the box between the plastic pillars at one end so that the whole unit plugged straight into a normal multimeter. To do this, the plugs must be spaced $\frac{3}{4}$ " (19 mm) which is known as 'GR' spacing. To make this easier, I have laid out the pc board with the output pads spaced exactly at 'GR' spacing. The board can be used as a template when drilling the holes for the banana plugs.

Remove the plastic body of each plug and solder about 10 cm of insulated hook-up wire to each. Using the pc board, drill pilot holes of about 1 mm diameter through the box near one end and enlarge them until the banana plugs will fit through the box.

Cut the plastic body of each plug in half and install the plugs, tightening the body from the inside for each plug.

Drill a hole for the switch, between the plugs, in the end of the box making sure that the switch will not foul the plugs.

If the switch you have will not mount as mine did then you may fit it into the lid of the box, but keep it near the end where the plugs are.

Also drill a hole, in the end of the box opposite the switch, for the cable from the sensor.

Wire up the battery connector, switch and plugs, following the overlay. Don't connect the AD590 yet. Plug the unit into your multimeter, set RV2 to the mid-position and set your multimeter to the 20 V range. Switch on and adjust RV1 to obtain a reading of -2.73 V.

The probe

I made the probe from the barrel of a BIC 'finepoint' pen. Discard the innards and cut back the pointed end by about 2 mm. Use a 7/32" drill bit to carefully enlarge the hole at the pointed end to a depth of 2 mm.

Cut the -ve lead of the AD590 back about 6-7 mm. This identifies the two leads. Now snip the tab off the AD590 and file the tab stump back to allow the device to slip into the pointed end of the modified pen barrel.

The lead between the sensor and the electronics is a convenient length of small figure-8 flex with one marked lead (i.e. 'light speaker wire'). I used a length about one metre long. Slip one end through the pen

barrel and trim back the unmarked lead by about 6 mm. Solder the marked lead to the AD590 +ve lead, the unmarked (cut back) lead to the AD590 -ve lead.

It is important to keep moisture away from any exposed conductors, since only one microamp of leakage will cause a one degree error. Consequently, after soldering I coated all exposed conductors and the base of the AD590 with two coats of nail polish*, allowing drying time between coats.

Now seal the AD590 into the end of the pen barrel. I used a silicone sealant ('Silastic'), poking some down the pen barrel, in the pointed end first, then putting a blob on the base of the AD590 before pushing it in place. Wipe away any excess. Put a blob down the other end of the barrel, too.

Take the free end of the cable, strip and tin the two wires. Pass this end through the hole you drilled in the box for it and knot the cable on the inside leaving about 60 mm to the end. Solder the two wires to the pc board as per the overlay. Remember, the marked lead is from the +ve of the AD590.

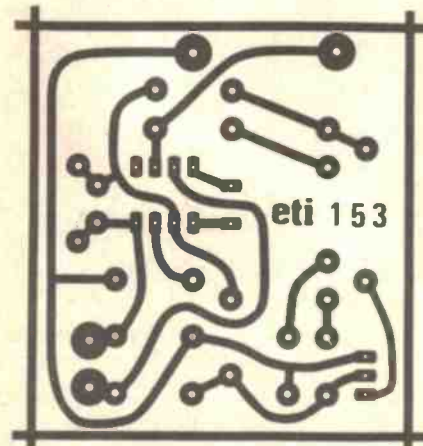

Artwork. Full size artwork for the pc board and front panel. You can obtain a 1:1 negative or positive, for making your own pc board and/or Scotchcal, for \$1.00 each, post paid, (\$2.00 the pair) from ETI-153 Artwork, ETI Magazine, P.O. Box 21, Waterloo NSW 2017. Make your cheque or money order out to 'ETI Artwork Sales'. Ensure you ask for a positive or negative, as you require.

Resistors	all 1% metal film, unless noted
R1	1k5
R2, R3	9k1
R4	680R
R5	4k7
RV1	10k cermet, horizontal pc mount trimpot
RV2	500R cermet, horizontal pc mount trimpot
Capacitor	
C1	33p ceramic
Semiconductors	
IC1	LM336 precision voltage reference
IC2	uA301, LM301 gen. purp. op-amp
IC3	AD590J precision temp. sensor (see text)
D1, D2	1N914 or 1N4148
ZD1	5V1, 400 mW zener (see note).

Miscellaneous
ETI-153 pc board; UB5 zippy box (28 x 54 x 83 mm); two banana plugs; hook-up wire, cable, probe etc.

NOTE: A 5V6/1 W zener may be used but, if so, change R1 to 1k.

Price estimate \$18 — \$20

Switch the unit on and set the multimeter to the 2 Vdc range (unless it's an auto-ranging meter). You should get a reading of around 0.200-0.250 or so, depending on the ambient temperature. If not, reverse the leads from the AD590 and try again. If you still get no result, there's a fault which you'll have to track down and correct.

If all's well, you can now calibrate the unit for maximum accuracy.

Calibration

There are three main methods of calibration; I shall describe them in order of increasing

+

eti 153

TEMPERATURE ADAPTOR

OUTPUT
10mV per °C

RANGE
-55 to +150 °C

+

accuracy.

The simplest way is to leave RV2 set in the mid-position and adjust RV1 to read a known temperature. This requires a thermometer to be placed in the same thermal environment as the AD590 sensor. This method will result in accurate readings over a range of 10 to 20 degrees, depending on the resolution of the reference thermometer.

The second calibration technique involves adjusting RV1 to obtain a reading at 0°C with the sensor immersed in melting ice, then placing the sensor in steam and adjusting RV2 for a reading at 100°C.

For this method, a good ice bath is a tall glass (but a vacuum 'Thermos' flask is better) filled with pure crushed ice which is then allowed to melt until the liquid level about two-thirds fills the glass.

Place the sensor about 20 mm below the water surface, wait for the multimeter reading to stabilise, then adjust RV1 to obtain a reading of 0.000 V.

Next, surreptitiously borrow a small

saucepan from the kitchen and half an hour of kitchen time. Boil up a litre or two of water so that it's boiling rapidly with plenty of steam emitting. Place the sensor in the steam cloud, allow a few seconds for the reading to stabilise, then adjust RV2 for a reading of 1.000 V. Note that the boiling point of water depends on altitude so this method is strictly only accurate at or near sea level, unless you can borrow a reference thermometer of sufficient accuracy.

The most accurate calibration is obtained by using a laboratory grade thermometer and immersing it and the AD590 in a stirred liquid bath — first one bath at a temperature low in the desired range, then in another at a temperature high in the range. For best accuracy, you need to repeat the procedure several times, adjusting RV1 at the lower temperature and RV2 at the higher temperature, until the desired accuracy is reached.

With the calibration completed, you can complete the assembly. Cut a rectangle of thin cardboard the same size as the box lid,

then cut off the corners. The pc board goes in the box with the components facing down, the battery going in first. The cardboard goes between the copper side of the pc board and the lid, preventing shorts.

I dressed up the box lid with a Scotchcal label. If you want to do the same, apply the Scotchcal to the lid before screwing it to the box. Peel off the backing at one end and carefully align it against the edge of the panel. Smooth it down and then continue peeling off the backing, smoothing the label in place as you go. Any air bubbles can be removed by rubbing them towards the nearest edge.

That's it!

For improved thermal coupling under some circumstance, a small heatsink can be slipped over the AD590. I used a Thermalloy No. 2224B. Note that this slows down the thermal response. When measuring the temperature of solid objects, particular metal objects (transistor cases, heatsinks, resistor bodies, etc), use a little thermal paste to improve thermal coupling.

ACCURACY

The overall accuracy of the ETI-153 is determined by three main factors: (i) calibration error and overall accuracy of the AD590 sensor; (ii) the thermal environment in which it is used, and (iii) drift in the electronics due to changes in the ambient temperature.

1. Calibration error and non-linearity of the AD590. This factor is easily calculated by referring to the table from the Analogue Devices applications note (Table 1), reproduced here. The 'Number of Trims' column refers to the type of circuit used with the AD590J. For the ETI-153, use the 'Two Trims' data. For the simple Kelvin circuit (Figure 1) use the 'One Trim' data.

To obtain the error after calibrating at 0°C and 100°C, look down the row where the temperature span is 100°C until you find the column under 0°C, which is the lowest temperature in the span. The error is found to be ±0.3°C. If you calibrate the instrument at 0°C and 50°C, the error is ±0.1°C. These figures exclude any trim errors due to the calibration technique, of course.

2. Thermal environment. The AD590 dissipates a tiny amount of power owing to the voltage across it and the current flowing through it. This power causes self-heating of the sensor and must be allowed for so as to obtain maximum accuracy.

The rise in sensor temperature due to self-heating is given by:

$$T_J - T_A = P (\theta_{JC} + \theta_{CA})$$

Where T_J is the junction temperature of the AD590.

T_A is the ambient temperature

P is the power dissipated

θ_{JC} is the chip-to-case thermal resistance

θ_{CA} is the case-to-medium thermal resistance

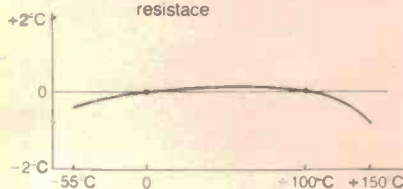

Typical two-trim accuracy.

J GRADE Number Of Trims	Temperature Span (°C)	Lowest Temperature In Span (°C)							
		-55	-25	0	+25	+50	+75	+100	+125
None	10	4.2	4.6	5.0	5.4	5.8	6.2	6.6	7.2
None	25	5.0	5.2	5.5	5.9	6.0	6.9	7.5	8.0
None	50	6.5	6.5	6.4	6.9	7.3	8.2	9.0	—
None	100	7.7	8.0	8.3	8.7	9.4	—	—	—
None	150	9.2	9.5	9.6	—	—	—	—	—
None	205	10.0	—	—	—	—	—	—	—
One	10	0.3	0.2	0.2	0.2	0.2	0.2	0.2	0.3
One	25	0.9	0.6	0.5	0.5	0.5	0.6	0.8	0.9
One	50	1.9	1.5	1.0	1.0	1.0	1.5	1.9	—
One	100	2.3	2.2	2.0	2.0	2.3	—	—	—
One	150	2.5	2.4	2.5	—	—	—	—	—
One	205	3.0	—	—	—	—	—	—	—
Two	10	0.1	*	*	*	*	*	*	0.1
Two	25	0.2	0.1	*	*	*	*	0.1	0.2
Two	50	0.4	0.2	0.1	*	*	0.1	0.2	*
Two	100	0.7	0.5	0.3	0.7	1.0	—	—	—
Two	150	1.0	0.7	1.2	—	—	—	—	—
Two	205	1.5	—	—	—	—	—	—	—

*Below 0.05°C

Typical values of $\theta_{JC} + \theta_{CA}$ are given in Table 2.

Using this information, the temperature rise at 25°C (= 298°K) due to a power dissipation of approximately 298 uA by 4.5 V = 1.3 mW (in still air, without a heatsink), is given by:

$$T_J - T_A = 1.3 \times 10^{-3} \times 480 = 0.62^\circ\text{C}$$

Note however, that $T_J - T_A$ is directly proportional to the absolute temperature and hence, if the ETI-153 is calibrated with the AD590 in the same medium as it will be used, then the adjustment of the scale factor, with RV2, will compensate for the self-heating effect. In any case, the error is reduced by better thermal coupling to the medium.

The other main environmental effect is the thermal time constant, or the speed of response of the sensor to temperature changes. The column, τ , in Table 2 gives the time required to reach 63.2% of a step temperature change. The response is given by:

$$T(t) = T_{\text{initial}} + (T_{\text{final}} - T_{\text{initial}}) (1 - e^{-t/\tau})$$

3. Drift in the electronics due to ambient temperature changes. There are three error terms here. Thermocouple errors are introduced by dissimilar metal junctions being at different temperatures. This can only be seen in the AD590 end of the circuit, since all the electronics in the jiffy box can be assumed to be at the same temperature.

Since the AD590 has a power supply rejection

Table 1.

of 0.5 uA/V and the maximum possible thermocouple voltage is far less than 20 mV, the effect on the output is negligible.

The electronics in the jiffy box operates at ambient temperature which introduces errors when it varies from what it was during calibration of the instrument.

The major contribution to this error comes from the two ICs. Using the worst-case figures for temperature changes over a 0° — 70°C ambient range results in a maximum error of less than 1°C in the output. In practise, the drift from this cause should be much less.

I subjected the prototype to a blast from a hair dryer for about one minute which resulted in a temperature change of 0.1°C. Few multimeters would have better stability than the ETI-153 under these conditions.

Over normal ambient temperature changes ranging from about +15° to +35°, the output change caused by drift in the electronics should not degrade the accuracy of the AD590.

MEDIUM	$\theta_{JC} + \theta_{CA}$ (C/watt)		τ (sec)	
	H	F	H	F
Aluminium block	30	10	0.6	0.1
Stirred oil	42	60	1.4	0.6
Moving air				
with heatsink	45	—	5.0	—
without heatsink	115	190	13.5	10.0
Still air				
with heatsink	191	—	108	—
without heatsink	480	650	60	30

Table 2

ALTRONICS ... ALTRONICS ... ALTRONICS ... ALTRONICS ... ALTRONICS ... ALTRONICS ... ALTRONICS ... ALTRONICS ... ALTRONICS ... ALTRONICS ...

**Powerful New
6000 RPM
Mini Drill
for PC
Work**



Tons of Torque.
Just the shot for
PCB work.
12V DC
operated
from external
Power Pack
1.2mm
chuck
capacity.
Supplied c/w
1mm drill bit.

T2302	\$12.95
Drill Bits:		
T2320 (0.8mm)	\$1.25
T2325 (1.0mm)	\$1.25

**WILL
YOUR BUDGET PROBABLY WON'T STRETCH TO AFFORD OUR
PROFESSIONAL SERIES ALL ALUMINIUM RACK CABINETS**

NOW YOUR PREAMPS, AMPS, CONTROL MODULES MONITOR PANELS ETC. CAN LOOK EVERY BIT AS GOOD AS TECHNICS, NAKAMICHI AND OTHER TOP MANUFACTURERS

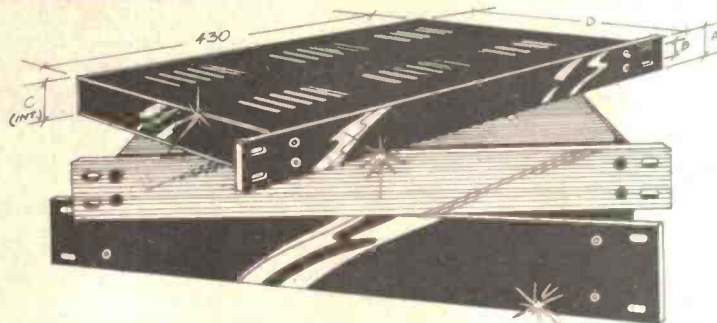

* These beautifully crafted rack cabinet boxes will give your equipment a real 1st class appearance. * All aluminium construction. * REMOVABLE TOP AND BOTTOM PANELS. * All dimensioning conforms to the International Standard. * Natural or Black finish. * Ventilated lid. * Deluxe

brushed finish anodised front panel. * Individually cartoned. * Supplied in Flat Pack Form - Easily assembled in minutes.

Side Elevation:
D = 254mm C (Internal Chassis Height)
B (Mounting Bolt Centres)

Cat. No.	Finish	A	B	C	ea.	5 +
H 0401	Natural	44	34	38	\$42.50	\$39.95
H 0402	Natural	88	57	82	49.95	47.50
H 0403	Natural	132	89	126	55.00	49.95
H 0411	Black	44	34	38	42.50	39.95
H 0412	Black	88	57	82	49.95	47.50
H 0413	Black	132	89	126	55.00	49.95

Beware of other rack boxes that do not conform to International Rack Sizing.

**DIRECT IMPORT ELECTRONIC HARDWARE
FANTASTIC SAVINGS ON BULK 'TRADE' PACKS**

**TO3
INSULATING
KIT**

Mica washers and bushes for 4 TO3 semi conductors



H 158075

TO3 Trade Pack

100 mica washers + 200 bushes
H 1582\$12.50

**TO220
INSULATING
KIT**

Mica washers and bushes for 4 TO220 or other flat Pack Semis.



H 158595

TO220 Trade Pack

100 mica washers + 100 bushes
H 1587\$9.80

RUBBER FEET

With 3mm Mounting Hole

Standard

Stickon Type

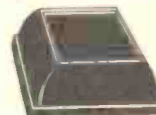

	Size (diam.)	Pack Qty.	Price
H 0914	13mm	8	\$.85
H 0913	13mm	100	7.50
H 0917	16mm	8	.95
H 0916	16mm	100	8.00
H 0940	12mm Stickon	4	.80
H 0942	12mm Stickon	100	9.60
H 0950	20mm Stickon	4	.95
H 0952	20mm Stickon	100	11.50

1/8th inch WHITWORTH

STEEL NUTS AND BOLTS
ROUND HEAD ZINC PLATED

	Length	Pack Qty.	Price
H 1000	3mm	25	\$.85
H 1002	9mm	500	4.50
H 1005	12mm	25	.85
H 1007	12mm	500	4.95
H 1009	25mm	25	.95
H 1011	25mm	500	6.95
H 1020	Hex Nut	30	.75
H 1022	Hex Nut	500	5.95
H 1030	S/Proof Washer	50	.95
H 1032	S/Proof Washer	500	6.95
H 1040	Flat Washer	50	.95
H 1042	Flat Washer	500	6.95

Huge Savings with Trade Packs (Contents: 500)

BA NUTS AND BOLTS

Bolts Cheesehead Steel, Nuts Brass

		Pack	Price
H 1045	4BA x 6mm	25	\$.95
H 1047	4BA x 6mm	500	5.95
H 1050	4BA x 12mm	25	.95
H 1052	4BA x 12mm	500	6.95
H 1060	6BA x 12mm	25	.95
H 1062	6BA x 12mm	500	7.50
H 1070	Nut Hex 4BA	25	1.00
H 1072	Nut Hex 4BA	500	12.50
H 1080	Nut Hex 6BA	25	1.00
H 1082	Nut Hex 6BA	500	12.50
H 1090	4BA S/Proof Washer	50	.95
H 1092	4BA S/Proof Washer	500	5.95
H 1095	4BA Flat Washer	50	.95
H 1097	4BA Flat Washer	500	6.95

SELF TAPPING SCREWS

Nickel Plated Steel



		Pack	Price
H 1100	No. 4 x 6mm	25	\$.75
H 1102	No. 4 x 6mm	500	4.50
H 1110	No. 4 x 12mm	25	.95
H 1112	No. 4 x 12mm	500	5.50
H 1120	No. 8 x 12mm	25	.95
H 1122	No. 8 x 12mm	500	6.95

From less than
1c each

SPACERS (STANDOFFS) SUPERB NICKEL PLATED BRASS

UNTAPPED 4 BA or 1/8" CLEARANCE

TAPPED 4 BA

Cat.	Length	Pack Qty.	Price	Cat.	Length	Pack Qty.	Price
H 1305	6mm	8	\$.95	H 1379	9mm	8	\$1.00
H 1359	6mm	100	8.50	H 1380	9mm	100	9.50
H 1362	9mm	8	.95	H 1383	12mm	8	1.20
H 1365	9mm	100	9.50	H 1384	12mm	100	12.50
H 1372	12mm	6	.95	H 1387	25mm	4	1.00
H 1373	12mm	100	11.00	H 1388	25mm	100	17.50
H 1375	25mm	4	.95				
H 1376	25mm	100	15.00				

NEW

DELUXE ABS INSTRUMENT CASE



Case color
light grey
front-rear
panels black

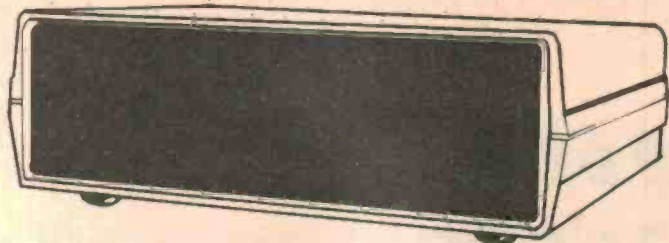

Our superb new instrument case will give your projects the professional appearance they deserve.

- ★ Internal mounting posts enable a wide combination of PCB's, Transformers, etc. to be accommodated (screws supplied).
- ★ PCB guide rails provided internally allow vertical PCB positioning to several locations.
- ★ Removable front and rear panels. Attractive textured finish one side and plain the reverse side. (Enables direct engraving, silk screen printing etc. to plain side.)
- ★ Great for test instruments and other high grade projects.

Overall Size: 200W x 160D x 70mmH

H 0480 ONLY \$13.50 10 up \$11.50

OEM'S - Manufacturers - Bulk Users: Your product will look like it's straight out of "Hewlett Packard's" factory with this brilliant low cost case. Contact our Wholesale Department for Bulk Prices.

HIGH RESOLUTION MONITOR NOW WITH SCREEN INVERT FUNCTION AT NO EXTRA COST

One of the hassles of sitting there for countless hours operating your computer is *eye strain* (anyone who has just spent 10 hours solid will agree!!) Well our fantastic new MICRON 12 High Resolution Green Phosphor Monitor has a 'reverse' or invert screen function where by simply rotating the contrast control anti-clockwise the screen information and background are reversed. This is especially valuable in poor lighting conditions.

NO MORE HEADACHES AND BLURRED VISION

MICRON 12

Green Phosphor Monitor
Features 12" screen
Front controls, on/off, contrast reverse, brightness. Power 240V 50Hz or 12V DC. Input: RCA type. DC Output Jack 12V 1.1 Amp - power your Micro direct without a power pack. Bandwidth 10Hz to 20MHz the resultant definition is truly amazing for a low cost monitor

Guaranteed by ALTRONICS!
Incredible Value.

D 1112 \$199.50



Adjustable Azimuth DATA CASSETTE

At last a Data Cassette Recorder/Player you can afford. The Micron D 1120 is fully adjustable azimuth (absolutely essential in our opinion) and incorporates tailored audio frequency response audio stage together with low distortion. Now you can save and load software in your Micro with confidence.

Micron D 1120
Data Cassette
ONLY \$49.50

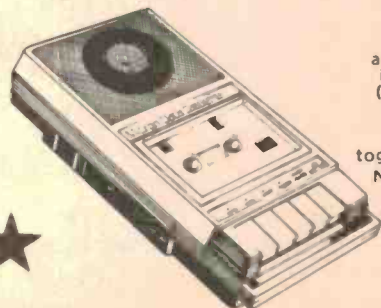

ALTRONICS RESELLERS

Please note that resellers may not have all the items advertised in stock, and as resellers have to bear the cost of freight, prices may be slightly higher than advertised. ALTRONICS reseller prices should however represent a considerable saving over our competitors' prices.

SOUTH AUSTRALIA		QUEENSLAND	
CITY		CITY	
ADN Electronics	212 5505	Diamond P/L	229 6155
Prinjones	212 3111	SUBURBAN	
SUBURBAN		SALISBURY	
PROSPECT		Colourview Wholesale	275 3188
Jenny Electronics	269 4744	FORTITUDE VALLEY	
ELIZABETH GROVE		St Lucia Electronics	92 3547
A.E. Cooling	255 7240	BIRKDALE	
CHRISTIE BEACH		Wholesale Sound Accessories	207 2502
Force Electronics	382 3366	COUNTRY	
KEWICK		CAIRNS	
Freeway Electric Wholesalers	207 2033	Thompson Instrument Services	51 2404
VICTORIA		TOWNSVILLE	
CITY		Solex	72 2015
All Electronic Components	662 3506	ROCKHAMPTON	
Electronics	602 3499	Purely Electronics	21058
SUBURBAN		GLADSTONE	
FOOTSCRAY		Purely Electronics	72 4321
Acron Electronics	680 1911	GYMPIE	
CHELTENHAM		TV and Appliance Services	281 1671
Talking Electronics	550 2386	IPSWICH	
HUNTINGDALE		P & P Electronics	281 8001
Simwell Electronics	543 3733	TODOWOMBA	
SOUTH CROYDON		Home Electronics	32 9677
Truscott Electronics	723 3860	Diary's Radio and TV	32 1044
COUNTRY		NAMBOUR	
SHEPPARTON		Nambour Electronics	41 1604
CV Electronics	21 8866	NT	
MILDURA		DARWIN	
Electronic and Digital Services	23 3380	Radio Parts Darwin	81 8508
NEW SOUTH WALES		Ken's Electronics	81 4749
CITY		Syntronics	81 3491
Radio Dispatch	211 0191	ALICE SPRINGS	
Electronic Agencies	29 2098	Farmer Electronics	52 2967
Jayan	264 6688	Ascot Electronics	52 1713
SUBURBAN		TASMANIA	
LEWISHAM		HOBART	
Pro-Pak Electronics	569 9770	Beta Electronics	34 8232
CONCORD		KINGSTON	
Electronic Agencies	745 3077	Kingston Electronics	29 6802
DEEWY		AVOCA	
David Pyall Electronics	982 7500	Fremmans TV	84 2166
WAITARA		WEST AUSTRALIA	
Applied Technology	487 2711	ALBANY	
MATRAVILLE		EP Electronics	41 2681
Creative Electronics	666 4000	GERALDTON	
COUNTRY		General TV and Radio	21 2777
BROKEN HILL		WYALKATCHEM	
Crystal TV	4803	D & J Price	81 1132
COFFS HARBOUR		MANDURAM	
Coffs Harbour Electronics	52 5684	Kentronics	35 3227
PENRITH		KALGOORLIE	
Acron Electronics	21 2409	Tollax Electronics	215 2372
NEWCASTLE		ACT	
D.G.E. Systems	69 1625	Scientronics	54 8334
WINDANG		Electronic Components	80 4654
Malpas Electronics	96 5066		
GOSFORD			
Tomlinson Electronics	24 7246		
KURRI KURRI			
Kurri Electronics	37 2141		

RESELLERS WANTED IN ALL AREAS (including WA)

Phone: STEVE WROBLEWSKI (09) 381 7233
for details

NEW 24 HOUR 7 DAYS P/WEEK PHONE ORDER SERVICE FOR BANKCARD HOLDERS

Take advantage of "off peak" low STD phone rates and phone your order to our new recorded 24 hour order service. Give your name, address with postcode, phone number, bankcard number and expiry date then your order—and presto your order will be processed and back to you in a flash—Please nominate Jetservice if you want overnight delivery.

\$2.50 DELIVERY AUSTRALIA WIDE We process your order the day received and despatch via Australia Post. Allow approx. 7 days from day you post order to when you receive goods. Weight limited 10kgs.

\$4.50 DELIVERY AUSTRALIA WIDE We process your order day received and despatch via Jetservice for delivery next day.

BANKCARD HOLDERS CAN PHONE ORDER UP TO 8PM (EST) FOR NEXT DAY DELIVERY - SOUNDS INCREDIBLE DOESN'T IT? Alright you cynics just try us! Weight limit 3.3kgs. Jetservice cannot deliver to P.O. box numbers (Australia Post would have a fit).

\$10.00 HEAVY HEAVY SERVICE - AUSTRALIA-WIDE All orders over 10kgs must travel on the heavy service, that is - road express. Delivery time 7 days average.

ALTRONICS

105 STIRLING ST., PERTH
FOR INSTANT SERVICE
(09) 328 1599

All Mail Orders:
Box 8280 Stirling St.,
Perth WA 6000

Optocoupler devices and their applications

Ever wanted to control one circuit with another without having any intermediate electrical connection? Devices that provide coupling via a beam of infra-red light are called 'optocouplers' and they're just perfect for the job. Here's a run down on a host of popular optocouplers and how to use them in practical circuits.

Brian Dance

THE ELECTRONIC circuit designer is often faced with the problem of providing a high degree of isolation between two circuits which must nevertheless be able to pass alternating signals from one part of the circuit to the other.

For example, one may wish to have one part of the circuit completely isolated from the mains, yet use signals from this part of the circuit to control the flow of the mains current through a load. Another example occurs in patient monitoring equipment where the small voltages developed by the beating of a heart can be coupled into mains powered equipment without any danger of the equipment causing a current to flow through the heart.

Optocouplers

Optocouplers use a beam of infra-red radiation (or occasionally, visible light) to convey the signal from one part of the circuit to the other without any electrical connection whatsoever between the two parts. They are sometimes known as photon-coupled devices or as optoisolators. They may be employed to replace conventional relays when a fast response is required or when sparking at relay contacts must be avoided in an explosive atmosphere.

An optocoupling device consists of an infra-red emitting device or other lamp on its input side and some form of detector for the radiation on the output side, both the emitter and detector being in a light-tight enclosure. The silicon detector itself may be a phototransistor, a photo-Darlington device, an opto-triggered triac or even a field effect phototransistor.

No matter which of these device types is employed, the silicon detector has its maximum sensitivity at a wavelength quite near to that at which the gallium arsenide device emits with its maximum intensity. In other words, the devices are spectrally well matched so that a small emitter device current can produce a reasonably large response in the detecting device.

Types

A very large number of types of optocoupler have been marketed with the electrical characteristics of both the emitter and the detector having to be specified in every type. Rather than involve readers with a mass of type numbers, this article will concentrate on a limited number of readily-available devices.

The 4N26, 4N28 and MCT2 devices are examples of those using a phototransistor as a detector, the 4N33 has a Darlington output stage, the 6N139 (equivalent to the MCC671) has a 'split-Darlington' fast output device, the MCT6 is a dual device and the MOC-3020 has a triac output for 240 V mains supplies.

Dual-in-line

Although some optocoupled devices are fabricated in circular metal packages, the most common types, including those listed above, are produced in dual-in-line (DIL) packages with a typical construction like that shown in Figure 1. The emitter and detector

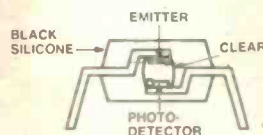

Figure 1. Cross-section through an optocoupler.

are placed fairly close together with a clear insulating material between them. The black silicon body of the device prevents stray radiation from falling on the detector. A circuit symbol is shown in Figure 2.

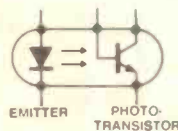

Figure 2. Symbol for an optocoupler having a transistor output stage.

In most DIL devices the radiating emitter is connected to pins on one side of the device, while the detector is connected to pins on the other side. This arrangement provides the maximum possible electrical isolation between the input and output circuits. Many of the simpler optocoupled devices differ from most other dual-in-line devices in that they have a total of only six connecting pins.

The basic internal circuitry of the devices under discussion is shown in Figures 3 to 7 inclusive. The three devices 4N26, 4N28 and MCT2 with a single phototransistor output all have the connections shown in Figure 3. The dual device type MCT6 is housed in the 8-pin package of Figure 4 so that the additional pins required are available.

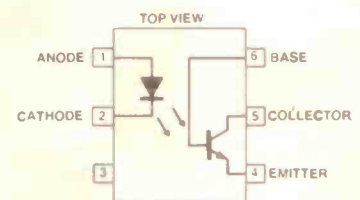

Figure 3. Pinout for the 4N26, 4N28 and MCT2 devices.

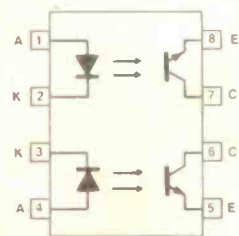

Figure 4. Pinout of the MCT6 dual optocoupler device.

DEVICE TYPE	4N26	4N28	MCT2	MCT6 (dual)	4N33	6N139	MOC-3020
Output device	← Phototransistor(s) →				← Darlington →		Triac
CTR (%) Min.	20	10	—	5	—	400	—
Typ.	50	30	—	50	500	—	—
Isolation (kV) (min.)	1.5	0.5	1.5	1.5 (0.5 between channels)	1.5	3	7.5 (max 5 sec)
Isolation resistance (Typical ohms)	10 ¹¹	10 ¹¹	10 ¹²	10 ¹²	10 ¹¹	10 ¹²	—
Isolation capacitance at 1 MHz (pF)	1.3	1.3	0.5	0.5	0.8	0.6	—
Maximum emitter current (mA)	80	80	60	60 per emitter	80	20	50
Typical emitter voltage at 50 mA	1.2	1.2	—	—	1.2	1.5 (at 1.6 mA)	—
Maximum reverse input voltage (V)	3	3	3	3	5	5	3
Input capacitance (pF)	150	150	250	—	150	—	—
Maximum power Total (mW)	250	250	250	400	250	—	300
Input	150	150	200	100	150	35	—
Output	150	150	200	150	150	100	—
Output transistor:							
BV _{CEO} (min.)	30	30	85	85	30	—	—
BV _{CBO} (min.)	70	70	165	—	50	—	—
BV _{EBO} (min.)	7	7	14	13	5	—	—
h _{FE} (typ.)	250	250	60	—	5000	—	—
I _{CEO} (nA typ.)	50	100	50	50	100	1000	—
V _{CE(SAT)} (typ.)	0.2	0.2	0.24	0.24	1.0	—	—
Typical I _C for I _F = 10 mA	5	3	—	—	—	—	—
Typical bandwidth (kHz)	300	300	150	150	30	—	—
Package	Figure 3	Figure 3	Figure 3	Figure 4	Figure 5	Figure 6	Figure 7

V_{DRM} = V_{RRM} = 400 V
 Trigger current 5 mA (typ.), 20 mA (max.)
 Holding current 100 µA (typ.) at V_{AK} = 3 V
 Maximum output current 100 mA RMS

TABLE 1. Basic data on the types of optocouplers discussed.

The 4N33 with its high-gain photo-Darlington output device is encapsulated in a 6-pin package with the same type of connections as the phototransistor output types of Figure 3; except for the performance differences, these devices are pin-for-pin replaceable.

The 6N139 'split-Darlington' output device has its output transistor base brought out to a separate pin, so the 8-pin dual-in-line package of Figure 6 is employed; this enables the input diode connections to be kept on the opposite side to all of the output connections.

Finally, the MOC-3020 with its triac output stage, is housed in a 6-pin dual-in-line package with the connections shown in Figure 7.

The basic parameters of these devices are listed in Table 1, but it cannot be over-emphasised that some of these values apply only under certain operating conditions stated on the data sheet which cannot all be shown in a table of a reasonable size.

It can be seen that most of the specifications required for the MOC-3020 differ from those of the other devices in their nature owing to the fact that the output triac must be specified in a different way to transistors and Darlington's.

Which type?

If one wishes to use an input signal to control alternating current from the mains in a load, the MOC-3020 will generally be the best device from those under discussion. This optocoupler will be discussed separately from the others.

If one has to design a circuit which requires two separate control coupling systems, this can be done using the dual MCT6 device provided that phototransistor outputs are suitable for the particular application concerned. Indeed, two of these MCT6 devices

can be inserted into a 16-pin dual-in-line IC socket so that one has a quadruple coupling system. (Quad devices in a single package are manufactured, but are not so common as the types under discussion.)

This leaves us with a choice, in the case of single devices, of those using a phototransistor or those employing a photo-Darlington output stage. The types using a phototransistor are most commonly employed, since they provide a fast response and can usually handle input signals with frequencies of over 100 kHz (see Table 1).

Photo-Darlington output devices provide a higher gain, but the bandwidth (or maximum usable signal frequency) is about an order of magnitude less than devices which use a simple phototransistor output; in addition, devices using a photo-Darlington output stage may be priced some 50% higher than those employing a phototransistor output, although this is not always the case.

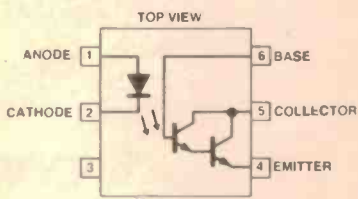

Figure 5. Pinout of the 4N33, an optocoupler having a photo-Darlington output stage.

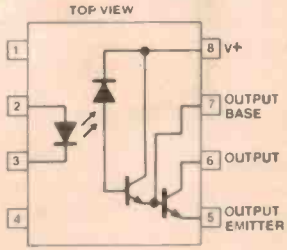

Figure 6. Pinout for the 6N139 (or MCC671) device which has a separate photodiode for maximum speed and a Darlington output for high gain.

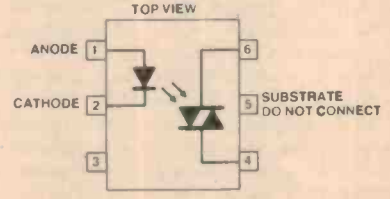

Figure 7. Pinout of the MOC-3020, which has a triac output stage.

The single devices of Figures 3 and 5 (but not the dual device of Figure 4) have the transistor base connected to a separate pin so that suitable circuitry may be used to trade-off gain in order to obtain a better high frequency response. The maximum usable frequency will be obtained when the output phototransistor is connected as a photodiode using only the base and collector connections of Figure 3, but a relatively large input current will then be needed to produce a small output current; the CTR value may be under 0.1%.

Apart from the more limited response speed of a device with a photo-Darlington output stage, it can be seen from Table 1 that the saturation voltage (under high input conditions) is much greater for the photo-Darlington device than for a simple phototransistor. Both the speed of response and the saturation differences are inherent properties of photo-Darlington devices and are not limited to optocouplers.

CTR

In order to understand some of the figures quoted in Table 1, we must first examine the ways in which certain device parameters are specified. The user need not consider any of the internal optical design points, since the manufacturer takes care of such considerations when he is designing the devices concerned.

Optocouplers are supplied as sealed units, although opto-interrupter modules are also manufactured in which there is a slot between the emitting diode and the detector so that a metal vane passing through the slot can interrupt the beam; such opto-interrupters can, for example, be used in car ignition timing systems.

One of the most important parameters of an optocoupled device is its *current transfer ratio* (CTR) which is the ratio of the output current to the input current under certain conditions specified by the manufacturer; it is usually expressed as a percentage and, broadly speaking, may be considered as the 'gain' of the device. It may be noted that devices with a triac or a thyristor output do not have a CTR value.

It can be seen from Table 1 that typical values of the CTR in the case of devices which have a simple phototransistor output stage is of the order of 50% — which means the collector current in the output phototransistor will be about half that to the input diode emitter.

The minimum value in a device of any specified type may be considerably less than that of the typical value. However, in the case of devices with photo-Darlington outputs, a CTR value of 500% is more common — which means the output current is five times the input current.

In some special devices a short light pipe is used to carry the radiation from the emitter to the detector, inevitably with some loss, so the CTR value may be reduced in such devices which may be able to withstand a much higher voltage between their input and output sides.

Unfortunately, the CTR does not have a constant value but varies widely with the diode input current and with the device temperature. Figure 8 shows the typical variation of the CTR value of the MCT2 device (which has a simple phototransistor output stage) with the forward input current passed through the emitter diode.

Each curve is for a different MCT2 device, the wide spread being due to variations in the phototransistor gain, the emitter efficiency and the coupling efficiency between the two internal components. The percentage values quoted on each curve are those for a 10 mA input current.

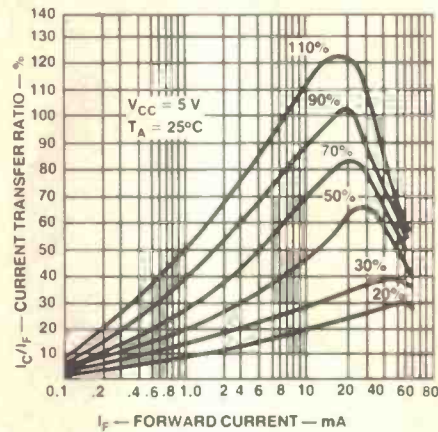

Figure 8. Variation of the current transfer ratio (CTR) with forward current in typical MCT2 devices.

The CTR value of a 4N26 or 4N28 can vary by a factor of about 2.5 between high temperatures (where it is relatively low) and very low temperatures, while devices with Darlington outputs may show variations of double this factor between temperature extremes. Rather smaller variations are more commonly found.

Isolation

Manufacturers of optocoupled device specify a maximum voltage which may be safely applied between the input and output sides of the device. In most devices this is in the range 500 to 8000 V, depending on the device type, but special types can be obtained for higher voltage isolation.

The resistance between the input and output sides of a typical device is often around 10^{11} to 10^{12} ohm. Although this seems very high, if a potential of a few kilovolts is applied across the device, a current of somewhat under 100 nA can flow. This is comparable with the current through the output of a high gain device when the input current through the emitter is under 1 mA.

If an optocoupler fails under a high applied voltage between its input and output sides, a short circuit will normally develop as a track is formed between the emitting and detecting

devices. The problem can be reduced by the use of suitable current limiting resistors or protective devices in either the input or output circuit.

The stray capacitance between the input and output circuit of an optocoupler is typically of the order of 1 pF (Table 1). It can provide some unwanted coupling in circuits designed to be able to operate at high speeds, especially when inductive loads are being switched.

The emitter

The emitting diode will have a maximum continuous current rating, normally some tens of milliamps as indicated in Table 1. In some devices, pulsed currents above the maximum continuous current are permissible.

A maximum voltage is also imposed on the reverse voltage which may appear across the emitter diode. The application of a higher reverse voltage can cause it to breakdown and perhaps pass a destructive current; however, this problem is easily avoided by connecting an external diode across the emitter diode as shown in Figure 9.

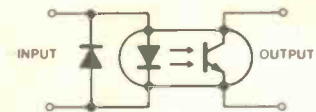

Figure 9. If a reverse voltage is likely to appear across the optocoupler emitter an external diode can be used to 'clip' it.

Although gallium arsenide diodes have been the main type used in optocouplers, there is an increasing trend to employ gallium-aluminium-arsenide types, since the latter not only emit photons more efficiently, but also provide a slightly better spectral match to the silicon detector. Thus an appreciable increase in the CTR value can be obtained.

In many optocouplers one must be careful to observe not only the total power dissipated in the complete package, but also the power dissipated in the separate input and output devices, as indicated in Table 1.

The detector

As with any other phototransistor or photo-Darlington, there is a certain value quoted for the maximum voltage which may be applied between the collector and the emitter with the base unconnected without risk of the device undergoing breakdown; this is BV_{CEO} . Similarly, values may be quoted for BV_{CBO} and BV_{ECO} .

A maximum collector current may also be quoted together with a maximum collector leakage current with base unconnected, I_{CEO} , under specified conditions.

The characteristics of the detector determine the speed of response and the bandwidth, since the emitting diodes are fast. The response time can be reduced by the use of a smaller value of load resistor, but many

manufacturers quote rise and fall times and bandwidths with load resistors which are so small that the circuit would have an inadequate gain for most applications.

The response speed of an optocoupler can be improved by using the circuit of Figure 10 in which the collector load is effectively reduced to a very low value by the virtual earth input impedance of the operational amplifier.

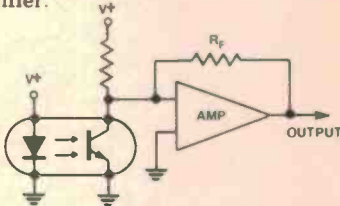

Figure 10. Response speed may be increased by the use of the virtual earth input of an op-amp.

An even simpler way of obtaining a faster response at the expense of a reduced value of the CTR involves connecting a resistor between the base and emitter of the output transistor. As the value of this resistor is reduced, the response becomes faster until in the limit, when the resistor is a short circuit, one is using the detector as a photodiode.

If one expects to be working with a very small input current, one might expect the use of a high gain device with a photo-Darlington output would be ideal. This is not necessarily true, since the overall efficiency can fall at such currents to the point where a device with a phototransistor would be better.

APPLICATIONS

Optocoupling devices can be employed to replace relays and pulse transformers in a wide variety of applications in which high isolation may be desirable or essential. They provide fast signal transfer with excellent noise immunity. They are suitable for interfacing with TTL and CMOS circuits and can also be used for analogue signal coupling.

Circuits designed for use with single phototransistor output optocoupled devices can generally employ the 4N26, 4N28 or MCT2, but note should be made of the individual differences listed in Table 1.

For example, the 4N28 is limited to applications in which the voltage across the device does not exceed 500 V, while when the other devices are selected, it may be as great as 1.5 kV.

The phototransistors in the MCT2 and in the dual MCT6 outputs are much higher voltage devices than those used in the 4N26 and 4N28.

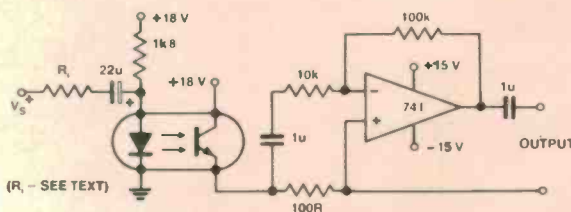

Figure 12. An isolation circuit covering the whole audio range.

The bandwidth of the 4N26 and 4N28 is typically greater than that of the other two types, but so is the isolation capacitance between the input and output. However, these points are not likely to be of any great importance in most applications.

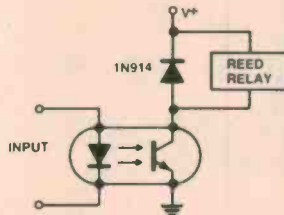

Figure 11. Using an optocoupler to isolate a reed relay.

Relay control

The simple circuit of Figure 11 shows how a small input current may be employed to control a reed relay. The inductive back-emf from the relay coil formed when the current ceases to flow through it is by-passed by the 1N914 diode so that this relatively high voltage pulse cannot damage the output transistor of the optocoupler.

The supply voltage used, V^+ , should have a value about equal to the voltage required by the relay, but should not exceed the V_{CEO} value of Table 1 for the optocoupler used.

Although the use of a reed relay is suggested so that the output current of the optocoupling device is kept quite small, other types of small relay can be controlled with careful circuit design. Obviously this type of circuit provides better isolation than many types of relay.

The circuit can easily be modified so that the relay does not close until the input has been applied for a short time. One merely connects a capacitor across the input diode and feeds this diode through a series resistor. The delay time before the relay closes will be dependent on the time taken for the capacitor to charge through the series resistor.

Isolated audio

The circuit of Figure 12 shows how an audio output completely isolated from the audio input signal may be obtained. A positive bias is applied to the input signal, V^+ , so that the emitter diode polarity is satisfied.

The value of the input resistor R_1 should be chosen so as to limit the modulating input current to a maximum of 5 mA. The 100 ohm load resistor of the phototransistor results in rather a low gain, but the 741 stage provides a gain of about ten so that a reasonably large output voltage is obtained.

The low value of the collector load resistor enables an upper frequency up to 20 kHz to be obtained, while the lower frequency response is determined by the values of the coupling capacitors employed — about 25 Hz in the case of the values shown.

Two separate +18 V supplies are required if complete isolation between the two parts of the circuit is needed. The input resistor R_1 may consist of a variable resistor in series with a fixed resistor if it is required to alter the output signal voltage without any danger of receiving an electrical shock from the output circuit when the latter is at a relatively high voltage.

TTL interface

Optocouplers are widely used in interface logic circuits where the logic signal must be transferred from a circuit at either a high or a low voltage level to a circuit at a very different voltage level.

The circuit of Figure 13 shows how an optocoupling device employing a simple output transistor may be employed to couple the output of a TTL gate to one of the inputs of a TTL 7413 device at a very different voltage level. The 7413 Schmitt circuit provides switching.

A Fairchild report suggests that the base of the output phototransistor of the optocoupling device should be connected to the emitter through a resistor of about 200 kilohm to prevent false triggering of the outputs.

Another logic circuit for coupling an input to a 7413 device is shown in Figure 14, but in this case the 4N33 with its photo-Darlington output device is used.

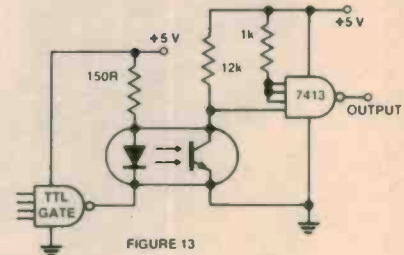

FIGURE 13

Figure 13. Isolating TTL circuits with an optocoupler.

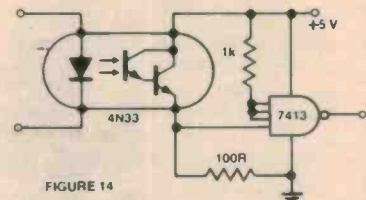

FIGURE 14

Figure 14. Control of a TTL Schmitt trigger circuit from a 4N33 photo-Darlington device.

It may be noted that in Figure 13 the load resistor (12 kilohm) is much higher than in Figure 14 (100 ohm), but the use of the higher gain of the 4N33 makes up for the lower value of load resistor.

Make the Switch to GTO + Power MOS

Philips Powerful Partners

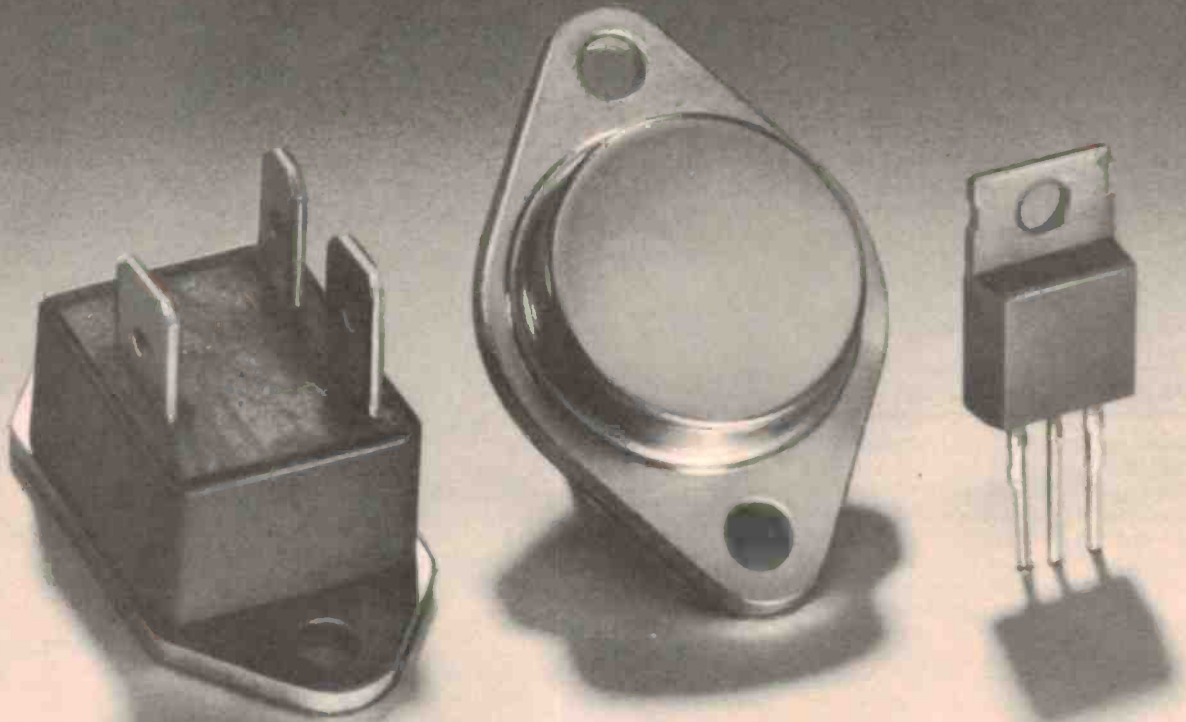

Now the choice in power semi-conductors for switching applications is easy with Philips complementary range of GTOs (gate turn off switches) and MOS FETS known as Power MOS. Together they cover the complete spectrum of power switching applications up to 1500 Volts and 50 Amps.

GTOs will be used mainly for higher voltage applications. Like the thyristor, GTOs can be turned on by positive gate drive and like high

voltage transistors, can be turned off by negative gate drive...the best of both worlds.

The new Power MOS transistors are electrically and thermally very rugged, while their construction intrinsically means very fast turn-on and turn-off times...typically 100ns.

Other Power MOS features include:

- Direct drive from TTL/LSI plus μ C output ports.
- Optimum reliability via outstanding

SOAR characteristics.

- Easy parallel operation.
- High power amplification.

We can help you make the perfect switch. Simply contact your local Philips Components office for further detailed information on GTOs and Power MOS.

Call Sydney 427 0888,
Melbourne 542 3333,
Brisbane 44 0191,
Adelaide 243 0155,
Perth 277 4199.



Electronic
Components
and Materials

PHILIPS

Simple latch

The very simple latching circuit of Figure 15 can employ a pair of 4N33 photo-Darlington output devices. Initially, S1 is open and no current flows through either 4N33. If S1 is then closed, a current flows from the positive supply through the diode emitter in the upper 4N33 and through the emitter in the lower 4N33, the output of the upper device being shorted out by S1 during this time.

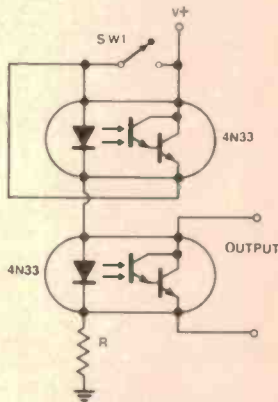

Figure 15. A latching circuit using two 4N33 devices.

When S1 opens, the short is removed from its output circuit, but the response time of the latter is longer than that of the emitter. The current therefore flows through the output of the upper 4N33, through the diode emitter of this same device to maintain the output in its conducting state and through the emitter of the lower 4N33. Thus the output of the lower device remains in its conducting state after S1 has re-opened.

The voltage across the two forward-biased emitting diodes is around 3.5 V and it is convenient to operate these diodes at about 5 mA. Thus, a suitable value for the resistor R is $(V^+ - 3.5)/0.005$ or about 3.9 kilohm with a 24 V supply.

Bidirectional control

The output current of an optocoupler using a phototransistor or a photo-Darlington device must flow only in one direction, so such a device cannot control alternating current.

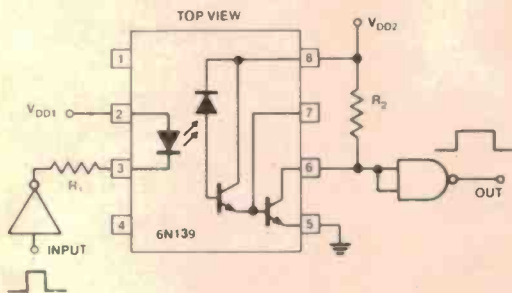

Figure 18. A fast TTL interfacing and isolating circuit using the 6N139.

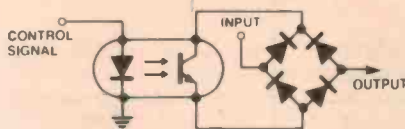

Figure 16. Controlling a bi-directional current using an optocoupler.

This problem can easily be overcome by the use of the circuit of Figure 16, in which the input-to-output current is rectified by a diode bridge circuit before being fed to the output stage of the optocoupled device.

The output signal which switches the output on and off must be unidirectional.

Power supply

Optocoupling devices can be used to isolate the control voltage of a regulated high voltage power supply from this supply line. The basic circuit which may be used is shown in Figure 17.

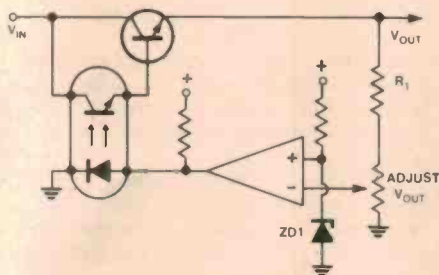

Figure 17. Using an optocoupler in a high voltage series-pass regulator.

A current flows from the stabilised output supply through the high value resistor R1 so that the variable resistor taps off a voltage proportional to the output voltage. This is compared with that across the zener diode D1 using the operational amplifier.

The output signal from this amplifier is fed to the emitter of the optocoupled device which is used to control the series pass transistor and hence to keep the output voltage constant. Thus, the amplifier device output is isolated from the high voltage supply.

A photo-Darlington device may be used in this type of circuit for higher feedback loop gain, but an external pass transistor is

always required, since the output devices incorporated into optocouplers can handle only very limited power.

Fast interface

The 6N139 with its 'split photo-Darlington' output device enables the high speed of the separate photodiode to be combined with the high gain of the Darlington connected internal transistors. Although the CTR has a minimum value of 400% at a 500 mA input current, the device output can switch in a few microseconds.

A fast non-inverting logic interface circuit using this device is shown in Figure 18. The maximum switching speed depends on the load resistor, R2, and the input resistor, R1. If R1 has a value of 180 ohm a current of about 17 mA will flow to the output of the TTL input device from the internal emitter diode and the use of a 100 ohm load resistor for R2 will then enable data rates of about 300 kbit/s to be obtained. On the other hand, R1 may be increased to 1k8 for a 1.7 mA diode current with R2 2k2 for a maximum data rate of nearly 50 kHz.

Electrocardiograph amplifier

The use of an optocoupled device to provide complete isolation of a patient from electrocardiography equipment is shown in Figure 19. The electrodes from the patient are connected to the programmable 4250 preamplifier stage which operates from ± 3 V battery supplies, nulling facilities being provided by the variable resistor connected between pins 1 and 5.

The same +3 V battery supply provides the bias for the high gain BC109 transistor which drives the diode emitter of the optocoupling device.

The output phototransistor of the optocoupler receives a base bias so that some current is always passing through its collector circuit. This enables the positive and negative parts of the signal waveform to be obtained at the output.

This is a particularly important application of optocoupled devices, since without the isolation provided by such a device, small currents could be fed into the patient which in certain circumstances could produce death.

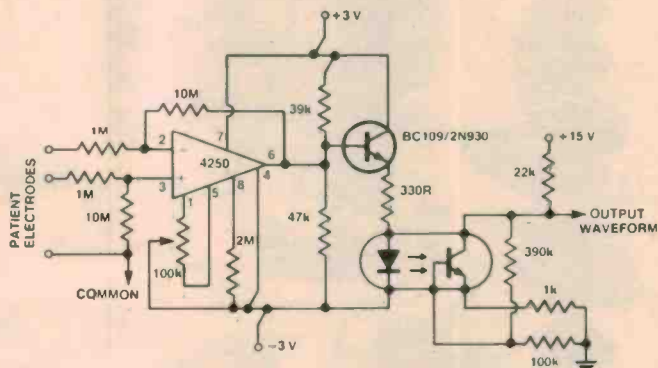

Figure 19. An electrocardiograph preamplifier circuit providing isolation of the patient from the equipment. (Litronix.)

Lab Notes

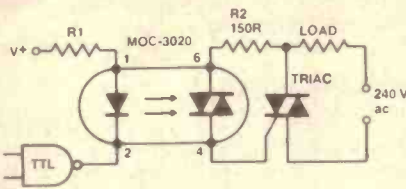

Figure 20. Control of ac power where there is a resistive load, using the MOC-3020.

The MOC-3020.

The small triac in the MOC-3020 output can provide a current of up to 100 mA. This is too small for controlling the mains current passing through the load in almost all applications, but is adequate to trigger an additional external triac.

A circuit of this type is shown in Figure 20 in which the output of the TTL gate, controls the emitter current of the MOC-3020 which triggers the internal triac, the latter triggering the external triac.

The latter device should be selected so that it can hold-off the applied mains voltage and also pass whatever current is required by the particular load being used.

Figure 21 shows the use of the MOC-3020 to switch the ac current through a lamp fed from the 240 V mains when the lamp current is less than 100 mA. As the filament of the lamp has a much lower resistance when it is cold, care must be taken to ensure that the initial peak current is not excessive (about 1 A for a very short time is permissible).

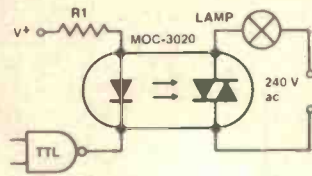

Figure 21. Controlling a lamp on the ac mains using a MOC-3020 (but watch the power rating).

In the circuits of Figures 20 and 21, the load is resistive and conduction of the internal triac ceases when the mains voltage passes through zero during the course of the mains cycle.

In the case of an inductive load (such as an electric motor), however, large back-emf pulses can be generated when the current ceases to flow through the load and this could

cause the internal triac of the optocoupler to operate in an improper way.

This problem can be avoided through the use of the type of circuit shown in Figure 22, the values of the components of the 'snubber network' connected across the external triac being dependent on the load inductance and resistance.

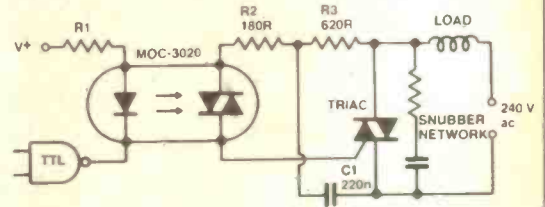

Figure 22. Control of ac power where the load is inductive (i.e. a motor), using the MOC-3020. Note the use of a 'snubber' network. Typical values for the RC network would be R=180 ohms, C=220n.

Conclusion

Simple optocoupler devices can be employed in a wide range of circuits from the simplest types to quite complex ones. At prices ranging from under one dollar up to a few dollars, they are excellent value!

CRAFTY POWER
STOCK-TAKING SALE!!

Offer expires 30/6/83
all prices include Sales Tax
unless otherwise marked.



TOYO - \$538.00 \$520.00 + S/Tax
MINI-LATHE
Standard as shown.
Centre Height - 50mm.
Swing (Carriage) - 50mm.
Cast Iron Bed. Options - Taper Turning, Screw Cut, etc.



MD-1H - 2 SPEED
8000 - 12000 R.P.M.

240 V AC.
SECV Appr.
\$198.00 \$195.00
incl. Vice & Chuck.

MD-1 - 6 SPEED
850 - 3100 R.P.M.

WORKSHOP KIT \$209.00 \$185.00

000.62.90X - Carry case.
Power supply, Pistol drill,
Drill stand, Orbital sander,
Jigsaw, flexible Shaft unit,
spare Blades, Table clamp,
Platform table.



DRILL STAND
000.62.493 \$39.00 \$32.00
Accepts Pistol Drill & Angle
Grinder.

PISTOL DRILL
000.62.402
7,000 R.P.M.
\$39.00 \$37.00
0 to 6.5mm.

ANGLE GRINDER
IN DRILL STAND

Circ.
Sawblades
for Wood &
Metal available.

ORBITAL SANDER
000.62.206
5000 R.P.M.
\$39.00 \$31.00

JIG SAW 000.62.108
10mm CUT
5,000 R.P.M.
\$39.00 \$35.00

Gravilo
Self contained hand engraver
18000 R.P.M 12V DC \$39.00
Engraving points for glass, metal,
ceramic & plastics available also
Optional Tip. \$28.00

Platform Table
inc. in Kit. Extra
as individual
item.

000.62.251
2 Speed PISTOL DRILL.
TORQUE + \$47.00

POWER SUPPLY
240V
000.62.608 12V.1A.
\$12.00 \$16.00

FLEXIBLE SHAFT & GRIND STICK
000.62.204
7,000 R.P.M.
\$47.00 \$43.00

ANGLE GRINDER
000.62.605
10mm Diameter
7,000 R.P.M.
\$47.00 \$43.00

Jigsaw Workbench
000.62.153 \$47.00 \$4.00

NEW!!

NEW!!

MODULE CASES

80mm H. x 50mm Sq.
With 8 Pin (Octal) Base \$4.55
With 11 Pin Base - \$4.65
Power Supply G.P. P.C.B. \$3.20
General Purpose P.C.B. - \$3.20
240V-24V AC 1VA Trans. \$5.87
Relay - 10A 240V Contacts
24V DC Coil C/0 - \$6.30

CIGAR LIGHTER ADAPTOR AVAILABLE: 000-62-073 \$6.00

Send Self Addressed Envelope for full price and accessory list.
Accessories include points, buffer plates, items, tooling, stones, etc.

miniloo
AUSTRALIA PTY. LTD.

134A AYR STREET,
DONCASTER, VIC. 3108
Tel. 550 9887

NAME
ADDRESS
BANKCARD NO.
OR CHEQUE
EXPIRY DATE VALUE SIGNED



POST &
PACK
To \$25
+ \$2.50
To \$100
+ \$4.00
To \$150
+ \$6.00
To \$400
+ \$8.00
Over
\$400
+ \$12.00

"HIGH TECHNOLOGY ~ LOW COST"

8 CHANNEL MIXER KIT

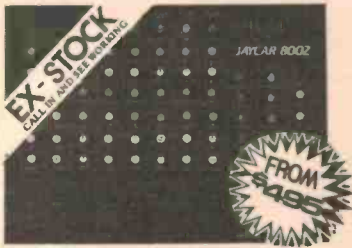

Ref: EA March/April 1983
 This great 8 channel 'live' mixer is perfect for bands, churches, theatre groups, home recording, disco etc.
 Each input channel accepts either microphone (balanced) or line (1V) levels. Powerful equalisation foldback effects facilities are provided. The left and right master channels can drive balanced or unbalanced lines with 5 band "graphic" equalisation. Separate foldback and "effects" are provided.
 The unit can be rack mounted or housed in a console chassis (which accommodates the power supply). Attractive wooden end-pieces finish the console to form a professional looking unit.
Complete 8 channel mixer (19" rack mount) Cat. KJ6504 \$495.00
Console mount chassis, power supply and wooden end pieces Cat. KJ6505 \$98.00
You end up with a \$1500+ unit for under \$600

50V/5A laboratory power supply



By far the most exciting high power supply we have seen! Using the latest switchmode principle, very little energy is wasted with high dissipation in the regulators — a cause of considerable heat dissipation and high hardware costs.

The Jaycar kit comes with every originally specified component down to the last nut and bolt. Also included are special Scotchcal meter scales. Beware of inferior kits that do not supply such components. (Not for sale as a separate item).
 Cat. KE1520

GRAB ONE NOW — \$149.00

HEAVY EQUIPMENT HANDLES

No, they are NOT toilet roll holders! They are UK-made quality "REAN" brand speaker cabinet/equipment cabinet handles — as used in the famous "Marshall" PA gear. They flush-fit with the side of the cabinet and use minimal internal space.
 Cat. HS8010 \$7.95

Quality at low prices!



IR 20 Passive Infra-Red Detector

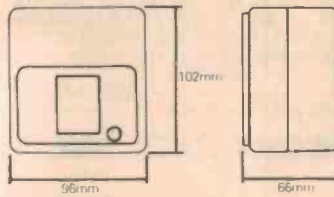

A truly extraordinary device. The passive IR detector is the classic adaption of military hardware for commercial use. This device is basically a box measuring 96(W) x 102(H) x 66(D)mm. On the front face is a "window" with a deep red IR filter across it. Directly behind the window is a high gain IR "antenna" or "lens" (choose which word you prefer). At the focal point of the antenna is a super-duper IR photodiode.

The heat radiated from a human body can be detected up to 20 metres away! The unit will operate reliably over a very wide temperature range and is not nearly as subject to the annoying "false triggering" found so often in microwave or ultrasonic surveillance systems. The microchip electronics in the unit ensures further reliable operation with a "memory latch" system. A LED on the panel indicates that the unit has been triggered.
 Cat. LA5010

Specification

Range: 20 metres 90° field of view using 9 short range and 9 long range zones
 Size: 96mm x 102mm x 66mm
 Sensor: Dual element pyro-electric detector
 Temperature Range: -10°C to 40°C
 Alarm Memory: LED alarm stored in armed state displayed in disarm state
 Track Test: LED operates in disarm state
 Relay Output: SPCO 1A 30V
 Current Consumption: 25 mA typical at 12V DC
 Supply Voltage: 12V DC (10-16V DC)
 Weight: 200 g

Will directly interface with 90% of existing alarm systems...

ONLY \$149.50

video monitor



Cat. YM2000

Green Screen

MICON DATA CASSETTE
 Cat. YD1950 ONLY \$49.50

ALCOHOL BREATH CHECKER

Ref: EA May 1983
 Don't get caught by the random breath units. Use this handy checker to determine your relative degree of inebriation. Complete kit all parts supplied, Cat. KA1522

ONLY \$29.95



Sub-Woofer Sensation

Ref: EA July/Aug '82
 Special system price for JUNE ONLY!
 Buy the complete system and save a fortune!

Subwoofer Speaker
 Normally \$79.00 THIS MONTH \$69.00
Subwoofer Amplifier Module
 Normally \$79.00 THIS MONTH \$69.00
PF4361/1 Transformer
 THIS MONTH \$39.50
Cabinet (Pre-cut Kit)
 Normally \$79.00 THIS MONTH \$69.00

SAVE \$30
 The Cabinet can be purchased SEPARATELY for \$69.00 — But not the others (Note that we no longer supply the metal cabinet for the subwoofer amp. A suitable equivalent cabinet is available for \$47.50 Cat. HB5412)

Cat. AS3250



SAVE



Cat. KA1454



(Transformer)
 Cat. MM2015

Cat. KA1452

BBD EFFECTS BOX Ref: EA June 1983

Fantastic low-cost instrument using the versatile MN3001 Bucket-Brigade Delay line to achieve brilliant sonic effects.

Now you can emulate the commercial rock groups with Phasing, Flanging, Reverb and Echo. The Jaycar kit includes all components INCLUDING IC sockets and the TU-04 box. (Not cut down but this is easily done). Jaycar has a specially built cabinet for this kit with all holes pre-punched etc., at only \$10 extra but only if you buy the original kit from us. Available as a separate item for \$29.50.

COMPLETE KIT Cat. KE1522 \$79.00
Special cabinet to suit Cat. HB6445 \$10



YOU CAN NOW PURCHASE ITEMS FROM JAYCAR THROUGH

ALL REPAYMENTS INCLUDE INSURANCE



Customers must satisfy the requirements of HFC to purchase. All repayments are monthly

Micrograsp Robot Kit
 \$12.01 per week over 12 months
Series 5000 Power Amp
 \$7.39 per week over 12 months
Series 5000 Pre-amp
 \$6.93 per week over 12 months

JAYCAR

SEE THE OTHER JAYCAR ADS IN THIS MAGAZINE FOR OUR STORE ADDRESSES AND PHONE NUMBERS...



FERGUSON TRANSFORMERS

PRINTED CIRCUIT BOARD MOUNTING TRANSFORMERS

PL9/5VA	\$7.95	PL24/5VA	\$7.95	PL18/12VA	\$10.50
PL12/5VA	\$7.95	PL30/5VA	\$7.95	PL24/12VA	\$10.50
PL15/5VA	\$7.95	PL40/5VA	\$7.95	PL30/12VA	\$10.50
PL18/5VA	\$7.95	PL161/5VA	\$10.50		

LOW PROFILE CHASSIS MOUNTING TRANSFORMERS

PL12/20VA	\$14.75	PL12/60VA	\$19.50	PL24/40VA	\$16.50
PL15/20VA	\$14.75	PL15/60VA	\$19.50	PL30/40VA	\$16.50
PL18/20VA	\$14.75	PL18/60VA	\$21.50	PL40/40VA	\$16.50
PL24/20VA	\$14.75	PL24/60VA	\$21.50	PL30-9/40VA	\$23.50
PL30/20VA	\$14.75	PL12/40VA	\$16.50		
PL40/20VA	\$14.75	PL15/40VA	\$16.50	PL30/60VA	\$21.50
PL1.5-18/20VA	\$23.50	PL18/40VA	\$16.50	PL30-9/60VA	\$25.50

CONVENTIONAL CHASSIS MOUNTING TRANSFORMERS

PF3577	\$33.90	PF3993	\$23.90	PF4362	\$57.90
PF3783	\$79.50	PF4244	\$46.50	PF4363	\$57.90
PF3787	\$21.50	PF4354	\$49.50	PF4405	\$44.50
PF3788	\$43.50	PF4361/1	\$49.50		

BELL TRANSFORMERS

PPB4/1000	\$15.50	PPB8/1000	\$15.50	PPB12/500	\$15.50
-----------	---------	-----------	---------	-----------	---------

AUDIO TRANSFORMERS

MT552	\$28.50	OP590	\$46.50	OP592	\$36.90
-------	---------	-------	---------	-------	---------

D.C. POWER SUPPLIES

PPA30C	\$12.90	PPA60C	\$12.90	PPA90C	\$12.90
PPA45C	\$12.90	PPA75C	\$12.90		

BUILD YOUR OWN SPEAKERS WITH PHILIPS

Part No.	Price
ADO 1610 T8	\$16.95
ADO 2160 SQ8	\$49.50
AD70601 W8/620	\$28.50
AD 12250 W8	\$83.00

P.C. EDGE CONNECTORS



S100 gold plated wire wrap	\$8.50
S100 solder tail	\$7.90
D2 Motorola bus	
43 86 solder tail	\$8.50
43 86 gold plated wire wrap	\$11.50

10 TURN POTENTIOMETERS

Stock resistance values

50R 100R 200R	
500R 1K 2K 5K	
10K 20K 50K	
100k	

Spectrol model 534 1/2 shaft	\$12.50
Price 1 g	
10 + values may be mixed	\$11.50

DIP PLUGS

Ideal for use with flat ribbon cable or to mount components on

14 pin	\$1.50	24 pin	\$2.90
16 pin	\$1.90	40 pins	\$5

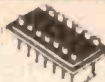

POWER TRANSFORMERS

SPECIALLY DESIGNED FOR MICROCOMPUTERS

- Good regulation electrostatic shield
- RI 810 8V @ 10A x 15V @ 1A **\$36.50**
- RI R20 8V @ 20A 15V @ 1A 15V @ 3A **\$43.50**

20 TURN CERMET TRIM POT



SPECTROL 43P ACTUAL SIZE

STOCK RESISTANCE VALUES

10R 20R 50R 100R 200R 500R 1K	
2K 5K 10K 20K 50K 100K 200K	
500K 1M 2M	
1 g	\$1.80
10 99	\$1.60
100	\$1.30

Values may be mixed

Hexadecimal Keypad

\$42.50



19 key pad includes 1 10 keys ABCDEF and 2 optional keys and a shift key

Ideal for dream project

MULTIDIALS



Dials to suit 10 T Pots	
Model 21 1 8 dia	\$24.50
Model 16 9 dia	\$19.50
Model 18 1 x 1 75 dia	\$27.50

RS232 & "D" TYPE CONNECTORS

PART NO	DESCRIPTION	1 9	10 25	25+
DE 9P	9 PIN MALE	\$3.50	\$3.50	\$3.10
DE 9S	9 PIN F MALE	4.50	4.20	3.90
DF 9C	9 PIN COVER	2.20	2.10	1.90
DA 15P	15 PIN MALE	4.50	4.20	3.90
DA 15S	15 PIN F MALE	5.10	4.90	4.70
DA 15C	15 PIN COVER	2.30	2.10	2.00
DB 25P	25 PIN MALE	5.90	5.60	5.10
DB 25S	25 PIN F MALE	6.90	6.60	6.10
DB 25C	1 in Grey Hood	2.40	2.20	2.00
DB 25C2B	2 in Black Hood	2.80	2.70	2.50
DB 25C2G	2 in Grey Hood	2.70	2.50	2.40
DC 37P	37 PIN MALE	7.90	7.50	7.10
DC 37S	37 PIN F MALE	10.90	9.90	9.10
DC 37C	37 PIN COVER	4.90	4.50	4.10
DH S	Hardware set (2 Pairs)	2.10	1.90	1.80

VERBATIM DISCS

5 YEAR DATALIFE GUARANTEE

		Per Box of 10
MD525-01	Single Sided, Double Density	43.00
MD525-10	SSDD 10 Sectors 40 Tracks	43.00
MD525-16	SSDD 16 Sectors 40 Tracks	43.00
MD550-01	Double Sided, Double Density	51.00
MD550-10	DSDD 10 Sectors 40 Tracks	51.00
MD550-16	DSDD 16 Sectors 40 Tracks	51.00
MD577-01	SSDD Soft Sect 80 Tracks	51.00
MD577-10	SSDD 10 Sectors 80 Tracks	57.00
MD577-16	SSDD 16 Sectors 80 Tracks	57.00
MD557-01	DSDD Soft Sect 80 Tracks	63.00
MD557-16	DSDD 16 Sectors 80 Tracks	63.00

8" VERBATIM

FD32-1000	Single Sided, Single Density	43.00
FD32-8000	Single Sided, Double Density	54.00
FD32-9000	SSDD Critically Certified	53.00
FD34-1000	Single Sided, Single Density	43.00
FD34-8000	Single Sided, Double Density	51.00
FD10-4008	Double Sided, Single Density	59.00
FD10-4015	Double Sided, Single Density	59.00
FD10-4026	Double Sided, Single Density	59.00
FF32-2000	SD FLIPPY FLOPPY	62.00
FF34-2000	SD FLIPPY FLOPPY	62.00
DD32-4000	Double Sided, Double Density	53.00
DD34-4001	Double Sided, Double Density	53.00
DD34-4008	Double Sided, Double Density	53.00
DD34-4015	Double Sided, Double Density	55.00
DD34-4026	Double Sided, Double Density	55.00



16 Pin Zip* Dip 11	\$11.50
24 Pin Zip* Dip 11	12.50
40 Pin Zip* Dip 11	17.50

*Zero Insertion Pressure

DIP SWITCHES SPST

P N	No of Switches	Price
SD3	3	\$1.60
SD4	4	1.70
SD5	5	1.90
SD6	6	2.30
SD7	7	2.40
SD8	8	2.50
SD9	9	2.70
SD10	10	3.00

DIP SWITCHES SPST

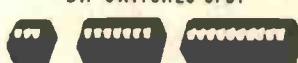

cermet single TURN TRIM POT

Spectrol model 63P ACTUAL SIZE

STOCK VALUES
10R 20R 50R 100R 200R 500R 1K
2K 5K 10K 20K 50K 200K 500K
1M 2M

1 9	\$1.20
10 99	\$1.00
100	\$0.90

Values may be mixed.

HEATSINKS

High Thermal Capacity Black Anodised

	1-4	5-9	10-49	50-99	100-499	500 plus
	\$	\$	\$	\$	\$	\$
HS1 - 38mm	1.85	1.75	1.50	1.35	1.00	0.90
HS2 - 75mm	3.00	2.90	2.50	2.00	2.00	1.50
HS3 - 150mm	5.80	5.40	4.90	3.80	2.90	2.70
HS4 - 225mm	8.10	7.60	7.10	5.90	4.50	4.30
HS5 - 300mm	8.90	8.40	7.90	6.50	4.90	4.60

Unanodised

HS11 - 38mm	1.40	1.20	1.00	0.90	0.80	0.70
HS12 - 75mm	2.50	2.20	1.90	1.60	1.25	1.20
HS13 - 150mm	4.90	4.50	4.00	3.20	2.45	2.40

BLANK CASSETTES T.D.K.

TDK ADC60	1 for \$3.60	10 for \$26.00
TDK DC60	1 for \$2.10	10 for \$18.00
TDK ODC60	1 for \$3.50	10 for \$31.00
TDK SAC60	1 for \$3.50	10 for \$31.00
TDK SAXC60	1 for \$5.70	10 for \$46.00
TDK DC90	1 for \$2.40	10 for \$21.00
TDK ADC 90	1 for \$3.50	10 for \$30.00
TDK SAC 90	1 for \$4.20	10 for \$39.00
TDK ODC90	1 for \$4.70	10 for \$45.00
TDK SAXC90	1 for \$5.50	10 for \$49.00
TDK DC120	1 for \$4.50	10 for \$37.00
TDK ADC120	1 for \$5.40	10 for \$46.50

Bankcard Mail Orders Welcome
Please debit my Bankcard.
Bankcard No.
Expiry Date
Name
Signature

Post & Pack \$2.50 small kits, heavier kits add extra postage.
Prices subject to change without notice. Send 60c and SAE for free price list and inclusion on all future mailing lists.

MAIL ORDERS: PO Box 235, Northcote, Vic 3070. Min P & P \$1.00.
Ph: (03) 489 8131. ERRORS AND OMISSIONS EXCEPTED

ROD IRVING ELECTRONICS

425 HIGH STREET, NORTHCOTE 3070, MELBOURNE, VICTORIA. Ph (03) 489 8131 Telex No. 38897
48-50 A BECKETT STREET, MELBOURNE (03) 347-9251

Making touch switches

One of the most difficult aspects of using touch switches in projects is the mechanical construction of the switch. This touch switch was designed by Tim Wooler of Wahroonga NSW to be used with the circuit found in the September 1981 ETI, page 51 Figure 5 (reproduced below). It is a method which is quick, easy and uses readily available parts.

The amount of water required should be put in a plastic container then the Sodium Hydroxide added to make the solution. After the piece is sprayed with varnish lettering may be put on the front and another coat of varnish applied to hold it in place.

The next item required is a piece of blank pc board of the same size as the piece of

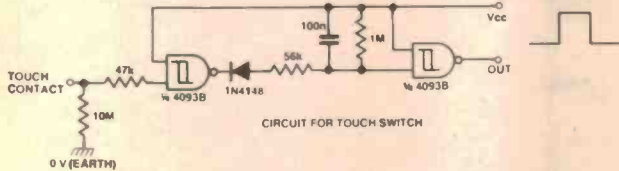

The touch plate is constructed of aluminium sheet. A piece of aluminium is cut out to the size required, then in the centre back a small indent is made by drilling with a 1/4" bit half way through the aluminium, as shown.

aluminium. A 1/16" hole is drilled in the centre of the pc board. The wire for the switch is passed from the non-copper side through the hole and soldered. The joint is then filed down to make it as small as possible.



If a matt finish is required the front of the aluminium may be sanded with successively finer grades of wet and dry paper. Then the aluminium is placed in Sodium Hydroxide solution for a few minutes to etch the surface. It is then washed clean, dried and sprayed with a coat of clear matt varnish. Drains, used for cleaning drains, is about 60% Sodium Hydroxide, and is ideal for etching the aluminium. Great care should be taken with the Sodium Hydroxide solution to keep it off the skin and clothes.

Now the switch is almost complete. All that remains is to glue the aluminium piece to the pc board, the hole in the back of the aluminium covering the solder joint on the copper side of the pc board. Tarzans Grip worked well here. The switch is now complete. To mount the switch on a panel a hole is drilled for the wire and the pc board is glued to the panel, as shown.

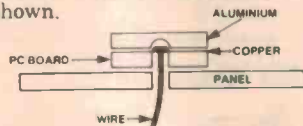

Aid to safe soldering of CMOS chips

In articles describing an electronics project which uses CMOS chips there's usually a warning about the soldering of these devices. These warnings usually contain advice about heatsinking and earthing the barrel of the soldering iron etc.

Keith Jeeves of Kirrawee NSW describes a simple device which he uses for working with CMOS chips and he says this method has never let him down.

An IC test clip is a device with (usually) 16 pins arranged in a 'clothes peg' type clamp. It is intended to extend each of these pins of an IC to a tester, usually via a length of ribbon cable.

However, if all the tags at the top of the clip are connected together with short lengths of wire and a length of flexible lead is soldered to the arrangement with a crocodile clip attached to the free end, a foolproof soldering aid is the result.

In use, the crocodile clip is attached to the barrel of the soldering iron, the earth rail of the circuit board or any good earth.

The test clip is clamped over the IC while the chip is in its protective foam and used to transport the IC to the circuit board (use 1 — a handling device).

The clip is left in place during soldering and will shunt heat away from the chip (use 2 — a heatsink).

The clip will ensure that all the pins of the IC are at earth potential during soldering (use 3 — a static eliminator).

Automatic car aerial correction

In ETI January '83, we published the 'Automatic car aerial' circuit, designed by Steve Gagen of North Balwyn, Victoria.

Steve received several letters and phone calls from people who had built the circuit but couldn't get it to work. So he checked his circuit again and found that he had made a couple of errors when copying his circuit to send to us. So all you experimenters can relax now as this amended circuit is guaranteed to work.

The most important error was that diodes D2 and D3 were reversed, so that positive, rather than negative, pulses were sent to the 555 and it would not trigger.

The wiring of the relays was also mixed up, confusing the wiring of a DPST relay with the correct wiring for a SPDT relay. The correct wiring for the SPDT relays is shown below.

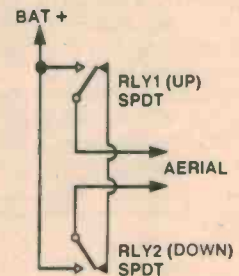

Rapid step through of '660 memory

Operating the '660 by repeated pressing of the step key, or changing the contents of the address window, is a tedious way of stepping through memory.

So Michael Samerski of Loftus NSW devised a circuit which uses a 555 in the astable mode to pulse pin 21 of the CPU at a determined frequency, the modified step key is used. This causes the '660 to step through memory.

One of the step keys can be disconnected for normal use and come to operate as a 'step repeat' Or a separate pushbutton key can be installed.

A word of warning — never

hold down both 'step' and 'step repeat' keys simultaneously as a supply short results.

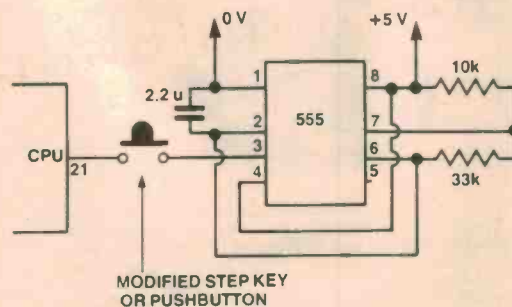

A piece of Vero board was used for the circuit and glued on to the main board between IC5 and IC24.

'Traffic lights' circuit correction

Charles Symes of Flynn ACT designed a circuit, 'Traffic lights', which appeared in ETI November '82 on page 56. There were two mistakes in the circuit, both referring to the pre-setting of the six JK flip flops.

IC1b should be reset therefore the wire from pin 8 to pin 7 should be removed.

IC3b should be set (i.e. Q high). The reset line from R5C6 to pin 3 of IC3a should be connected to pin 7 of IC3b.

In order to drive more than one LED off each flip flop will require a transistor driver stage for each output.

IDEA OF THE MONTH

These pages are intended primarily as a source of ideas. As far as reasonably possible all material has been checked for feasibility, component availability etc, but the circuits have not necessarily been built and tested in our laboratory. Because of the nature of the information in this section we cannot enter into any correspondence about any of the circuits, nor can we produce constructional details.



IDEA OF THE MONTH

C. Proctor, Hobart, Tasmania

Logic probe/injector

This digital logic probe uses a 7-segment LED display turned on its side to show a 1 or a 0 according to the state of the input, and to light the decimal point if the input is floating.

An LM339 quad comparator (IC1) is used to provide all functions. The display is a MAN74A, or similar. IC1a compares the input voltage with a reference voltage of half the supply voltage. If the input is a logic 0, then segments a-b-f-g of the display light, showing a zero on the right. If the input is a logic 1, then IC1c drives segment d of the display on, showing a 1 on the left.

With a floating input, a negative pulse will be stretched by IC1d, flashing the decimal point.

For an injector, IC1b is con-

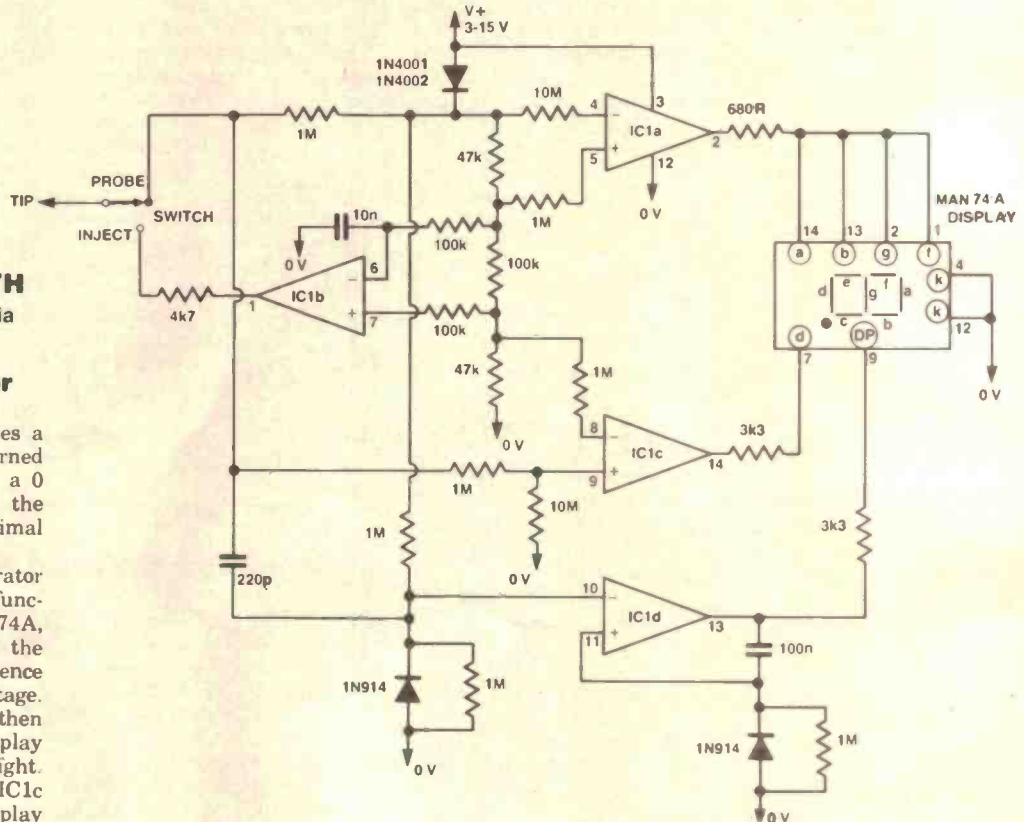

nected as an oscillator, producing square waves at its output. It oscillates at around 1 kHz. Rise and fall times of its output are around 100 ns. The switch is used

to select the probe or injector function.

The supply voltage can range from 3 V to 15 V. Probe input current is around 2 uA, sink cur-

rent from the injector is around 16 mA and thus the unit can be used with both CMOS and TTL circuitry. It could be built for less than \$10.

'IDEA OF THE MONTH' CONTEST

PRIZE! WORTH \$90!

COUPON

Cut out and send to: Scope/ETI 'Idea of the Month' Contest, ETI Magazine, 140 Joynton Ave, Waterloo NSW 2017.

"I agree to the above terms and grant Electronics Today International all rights to publish my idea in ETI Magazine or other publications produced by them. I declare that the attached idea is my own original material, that it has not previously been published and that its publication does not violate any other copyright"

* Breach of copyright is now a criminal offence.

Title of Idea

Signature

Name

Date

Address

Postcode

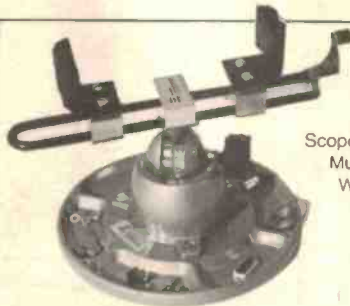

Scope Panavise Multi-purpose Work Centre.

Scope Laboratories, who manufacture and distribute soldering irons and accessory tools, have offered to sponsor a contest with a prize to be given away every month for the best item submitted for publication in the 'Ideas for Experimenters' column — one of the most consistently popular features in ETI. Each month we will be giving away a Scope Panavise Multi-purpose Work Centre, Model 376/300/312, comprising a self-centering head (376), standard base (300) and tray base mount (312), all worth about \$90! Selections will be made at the sole discretion of the editorial staff of ETI Magazine. Apart from the prize, each winner will be paid \$10 for the item published. You must submit original ideas of circuits which have not previously been published. You may send as many entries as you wish.

RULES

This contest is open to all persons normally resident in Australia with the exception of members of the staff of Scope Laboratories, Federal Publishing Company Propriety Limited, ESN, The Litho Centre and/or associated companies.

Closing date for each issue is the last day of the month. Entries received within seven days of that date will be accepted if postmarked prior to and including the date of the last day of the month.

The winning entry will be judged by the Editor of ETI, whose decision will be final. No correspondence can be entered into regarding the decision.

Winner will be advised by telegram the same day the results are declared. The name of the winner, together with the winning idea, will be published in the next possible issue of ETI.

Contestants must enter their names and address indicated on each entry form. Photostats or clearly legible copies will be accepted but if sending copies you must enclose with each entry the month and page number from the bottom of the page of the contest. In other words you send in multiple entries but you will need extra copies in magazine so that you send an original page number with each entry.

This contest is invalid in states where local laws prohibit entries.

Entrants must sign the declaration on the coupon that have read the above rules and agree to abide by the conditions.

GREAT NEW BOOKS

FROM JAYCAR THE ELECTRONIC BOOK SPECIALIST.....



COMPUTERS

CP/M PRIMER

If you are a first-time microcomputer user wanting to increase your technical knowledge or a veteran who wants to explore switching to the CP/M operating system, this book can help you find the answers. It's the only complete one-stop source available on CP/M — the very popular operating system for 8080, 8085, and Z80 based microcomputers. Includes a complete list of CP/M compatible software. 100 pages, 5 1/2 x 8 1/2, soft. Cat. BS0564

ONLY \$24.95



THE S-100 AND OTHER MICRO BUSES

2nd EDITION

The key to successful computer system expansion is a complete understanding of the bus system through which the computer communicates with peripherals. This book provides you that key, a general discussion of bus systems and an examination of each of the 21 most popular buses. Additional information is given which will help you interface one type of bus to another. 208 pages, 5 1/2 x 8 1/2, soft. Cat. BS0566

GREAT VALUE \$15.95



APPLE INTERFACING

Apple Interfacing helps you to understand the important task of successfully interfacing your Apple computer to a variety of electronic devices. Using this book, you will be able to perform useful experiments which will provide a much clearer understanding of the fundamentals of computer interfacing and computer electronics. You will be better able to understand interactions between computer hardware and software so that you can effectively communicate with your Apple computer. 208 pages, 5 1/2 x 8 1/2, soft. Cat. BS0568

A BARGAIN AT \$15.95

EXPERIMENTS IN ARTIFICIAL INTELLIGENCE FOR SMALL COMPUTERS

Conducts interesting and exciting experiments in artificial intelligence with this book, a small computer with extended BASIC, and some knowledge of the BASIC language. The author first introduces you to artificial intelligence — the capability of a device to perform functions normally associated with human intelligence, such as game playing, problem solving, reasoning, creativity, and verbal communications. Then game-playing programs, with a checkers-playing game as the main topic are explained. 112 pages, 5 1/2 x 8 1/2, soft. Cat. BS0512

ONLY \$12.95

TRS-80 INTERFACING BOOK 1

Written for users who have a fairly good understanding of Level II BASIC. Author John Titus introduces you to the various I/O signals used by the TRS-80 and explains how these signals can be used in a number of interesting and practical circuits. Numerous hands-on experiments are included. 192 pages, 5 1/2 x 8 1/2, soft. Cat. BS0572

BOOK 1 \$15.95

TRS-80 INTERFACING BOOK 2

Provides you with a number of practical and useful ways to utilize your knowledge from Book 1. Applications include how to generate voltage and current signals used in a variety of control applications, how to measure unknown voltages how to drive high current and high voltage loads, and many more. Complete software programs are included. 256 pages, 5 1/2 x 8 1/2, soft. Cat. BS0574

BOOK 2 \$16.95

COMPUTERS

PET INTERFACING

Demonstrates how you can build numerous interfacing devices for your PET hardware. BASIC language programs are used throughout the book, so you should be familiar with this powerful programming language. The Commodore PET microcomputer has several special purpose interface connectors that ease the job of interfacing the computer to "real-world" hardware. Also includes a discussion of the microprocessor's internal architecture and general software/hardware interfacing. 264 pages, 5 1/2 x 8 1/2, soft. Cat. BS0576

INTERFACE FOR \$25.95

PROGRAMMING AND INTERFACING THE 6502 WITH EXPERIMENTS

Excellent starting point for 6502 based microcomputer novices and veterans alike who may not have much assembly language and programming or chip level interfacing experience. Includes experiments and examples of simple I/O techniques, instructions, and chip level interfacing that can be reinforced with a low cost ROM, SVM, or AIM system. Helps you understand all 6502 based computer systems 416 pages, 5 1/2 x 8 1/2, soft. Cat. BS0580

Also available: 6502 SOFTWARE DESIGN Cat. BS0578 \$17.95

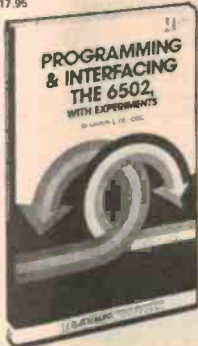

We have dozens of other books — Call in and browse



16-BIT MICROPROCESSORS

Carefully steps you through the complex processes of programming and designing with the new and powerful 16-bit microprocessors. The major advantages and disadvantages of these state-of-the-art devices are discussed and numerous benchmarks are provided to help you in your comparison of the chips. The book begins with a simple, straightforward review of the basics of microprocessor design and construction, and then takes an in-depth look at each of the most popular 16-bit microprocessors on the market today, including the 68000, 8086, Z8001/2, 9900 and NS16000. 352 pages, 5 1/2 x 8 1/2, soft. Cat. BS0588

16-BITS FOR \$24.95

USING THE 6800 MICROPROCESSOR

No special background in digital electronics is needed to use this book, which steps you through the conception, configuration, writing, and running of a variety of programs that demonstrate the practical application of the powerful 6800 microprocessor. The unit's straightforward internal architecture, efficient instruction set, and sophisticated support circuits are covered. 176 pages, 5 1/2 x 8 1/2, soft. Cat. BS0584

GREAT VALUE \$14.95



COMPUTERS

8085A COOKBOOK



A design-it-yourself guide to developing a number of completely operational, low cost microcomputers around the 8085A microprocessor. Includes a discussion of all support hardware and 8085A family compatible chips. A tremendous amount of software is already available for use on these systems. Almost anyone can learn to design an 8085A based microcomputer with the 8085A Cookbook. 352 pages, 5 1/2 x 8 1/2, soft. Cat. BS0592

\$24.95

ONLY \$24.95

Z-80 MICROCOMPUTER HANDBOOK

Designed to acquaint you with the hardware of the Z-80 and to discuss the impressive software aspects of this "computer on a chip". A number of chapters are devoted to the use of machine and assembly language. Also included is a discussion of many different microcomputers built around the Z-80, including the popular TRS-80. 304 pages, 5 1/2 x 8 1/2, soft. Cat. BS0594

\$16.95

Also available: Z-80 MICROCOMPUTER DESIGN PROJECTS. 208 pages. Cat. BS0596

\$23.95

GENERAL SON OF CHEAP VIDEO

This sequel to The Cheap Video Cookbook provides a complete video display system which you can build for as little as \$7. Likewise, transparency display can be created for under \$1 by using a video circuit called "The Snuffler" which is completely described in chapter 2. This book makes cheap video even cheaper. 224 pages, 5 1/2 x 8 1/2, soft. Cat. BS0604

\$15.95

Son Of Cheap Video

By Don Lancaster



CHEAP AT ONLY \$15.95



THE CHEAP VIDEO COOKBOOK

Complete discussion of a new, low cost way to get words, pictures, and opcode out of your computer and onto any ordinary TV set. Don Lancaster outlines an easy-to-build seven IC circuit which you can build for less than \$20. This circuit can be software-controlled to provide any alphanumeric or graphics format including high resolution (256 x 256) and a four colour mode. 256 pages, 5 1/2 x 8 1/2, soft. Cat. BS0510

\$11.95



A practical, easy-to-read discussion of the many types and uses of active filters. Learn how to construct filters of all types including high-pass, low-pass, and band-pass having Bessel, Chebyshev or Butterworth response characteristics. Easy to understand — no advanced math or obscure theory is used. Active Filter Cookbook can be used as an introduction to active filter circuits or as a reference book for analysis and synthesis techniques for active filter specialists. 240 pages, 5 1/2 x 8 1/2, soft. Cat. BS0519

\$21.00

REGULATED POWER SUPPLIES

(3rd Edition)

The newest, most comprehensive discussion of internal architecture and operation of the latest solid state regulators. Thoroughly explains when regulated supplies are needed and how to incorporate them into your design projects. Discusses modern, practical circuitry including linear and switching circuits and late ICs. A valuable asset for any technician or engineer involved in servicing or design. 424 pages, 5 1/2 x 8 1/2, soft. Cat. BS0526

\$27.95

GREAT VALUE \$27.95



RF CIRCUIT DESIGN

A user-oriented text with a practical approach to the design of RF amplifiers, impedance matching networks, and filters. Can be used in cookbook fashion as a catalogue of useful circuits with component values. Utilizes a minimum of complex math. A valuable bridge between the classroom and "real world" application, and an excellent reference manual. 352 pages, 5 1/2 x 8 1/2, soft. Cat. BS0530

\$27.95

DESIGN OF PHASE-LOCKED LOOP CIRCUITS WITH EXPERIMENTS

An excellent introduction to the theory, design and implementation of phase-locked loop circuits using various TTL and CMOS devices. Useful self-study course for the experimenter and for inclusion in college courses on control systems or linear ICs. Includes manufacturers data sheets and describes the use of breadboarding aids in the wide range of laboratory type experiments. 256 pages, 5 1/2 x 8 1/2, soft. Cat. BS0534

\$15.95

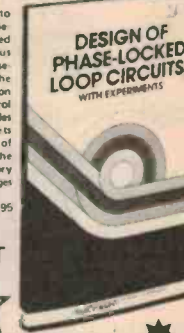

VALUE AT \$15.95



ELECTRONIC MUSIC CIRCUITS

Written for computer and electronics hobbyists with an interest in music, as well as musicians and studio engineers. The author describes how to build a custom electronic music synthesizer, outlines numerous other circuit designs and then shows you how to modify them to achieve particular responses. Many of the circuits can be used as special effects boxes for guitars and other musical instruments. Approximately 288 pages, 5 1/2 x 8 1/2, soft. Cat. BS0578

\$25.95

OTHER BOOKS

Cat. No	Description/Title	Pages	Price
BS0516	Solar cells & photo cells	96	\$8.95
BS0518	CMOS cookbook	416	\$18.95
BS0520	IC OP amp cookbook	480	\$22.95
BS0522	555 timer sourcebook	160	\$10.95
BS0524	Design of OP amp circuits/exp.	224	\$15.95
BS0532	Design of active filters/w. exp.	240	\$15.95
BS0538	How to read electronic cts. dia.	192	\$10.95
BS0540	Modern dictionary of electronics	832	\$29.95
BS0542	TV ant & signal dist. systems	256	\$13.95
BS0546	Modern recording techniques	368	\$18.95
BS0548	73 dipole & longwire antennas	160	\$10.95
BS0550	Handbook elect. tables/formulas	288	\$17.95
BS0556	IC timer cookbook	288	\$15.95
BS0558	Digital counter handbook	264	\$15.95
BS0560	Cable TV	392	\$21.00
BS0562	Sound system engineering	296	\$29.95
BS0578	6502 software design	272	\$17.95
BS0582	How to prog./interface 6800	416	\$24.95
BS0586	68000: principles & programming	240	\$24.95
BS0590	8080/8085 software design	336	\$17.95
BS0596	Z-80 micro. design projects	208	\$23.95
BS0598	Microcomputer-analogous conv. software/hardware interfacing	200	\$10.95
BS0600	Mostly basic app. for Apple II	160	\$17.95
BS0602	Micros for business applications	256	\$15.95
BS0606	Audio IC OP amp applications	208	\$14.95
BS0608	Interfacing & scientific data communication experiments	160	\$11.95
BS0614	Electronic telephone projects	168	\$10.95

Jaycar

SEE OUR OTHER ADS IN THIS MAGAZINE FOR STORE ADDRESSES AND PHONE NUMBERS.

GREAT NEW PROD

BALANCED MIC TRANSFORMER **\$18.95**



A true Mu-metal shielded unit for balanced applications.
 Primary - 200 - 600 ohm CT (Balanced)
 Secondary - 10 - 50K Unbalanced
 (Can be operated either way round)
 9mm bushing mount with flexible wire leads
 Frequency response 30 - 15kHz at mic level
STAGGERING VALUE
ONLY \$18.95

Cat. MT4710

We also have a 10K:10K line isolating transformer (Identical in appearance to above) at **ONLY \$17.95**

Cat. MT4720

SENNHEISER MUFFS

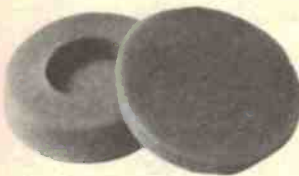

\$5.95

PAIR

Genuine factory made spare foam earpads for the famous HD-414. We now have plenty of stock.

Cat. AA2011

\$5.95 pair

HIGH SPEED LOGIC PROBE



QT2210

- DTL/TTL/HTL/CMOS/MOS compatible
- Pulse memory
- 10MHz input frequency (tested to 12MHz)
- ± 50V input overload
- Complete with leads.

ONLY \$29.95

IEC 320 240V APPLIANCE CONNECTOR

Some day all mains equipment will be fitted with these!

- CHASSIS PLUG - Front or rear mount
- Accepts RH, LH, or straight IEC 320 standard line skt.
 - Simplifies 240V wiring
 - Quick connect/solder terminals

Cat. PP2302

LINE CORD/SOCKET

- 3 wire cord (A,N,E)
- Moulded line socket
- Strain relief grommet
- other end unterminated

ONLY \$2.95

Cat. PS4302

\$4.95

\$4.95

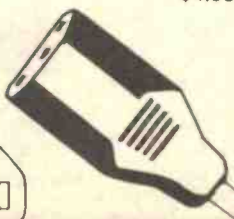

NEW

HEAVY DUTY MAINS FILTER

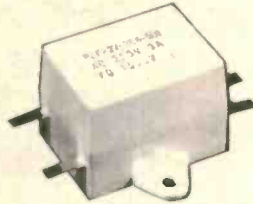

There are an enormous number of Desktop micros now having problems with mains borne interference.

Our MS4002 filter has been invaluable where mains interference is only marginal problem. This unit (illustrated) costs only \$14.50 and is supplied with full data.

For much more serious problems, or when a free standing unit (not illustrated) is required the MS4004 is ideal. It will pass 2 amps (conservative) at 240V AC. This unit is a grey painted metal case that plugs into a standard mains socket. On one end of the case is an unswitched 240V outlet. Virtually the only thing that comes out of this socket is mains. All frequencies above 50 Hz are very heavily attenuated. Ideal for problem areas.

Cat. MS4002

\$14.50

Cat. MS4004

\$99.00

NEW 28 PIN ZIF SOCKET



It's hard to keep up with demand for the popular 24 pin zero insertion force socket however, we have had many requests for a 28 pin version.

24 PIN ZIF SOCKET

Cat. PI6522

\$12.95

28 PIN ZIF SOCKET

Cat. PI6523

\$17.95



FUEL FLOW SENSOR
 NEW
 LOW
 PRICE



As used in the EA Fuel Consumption Meter. (Ref: EA March 1983)

The original, accurate fuel flow meter. Delivers a TTL compatible pulse in linear proportion to fuel flow. Will measure flow of many low-viscosity liquids apart from fuel.

Cat. XC2020

\$45.00

NORMALLY \$59.50 SAVE \$14.50

SPEEDO CABLE SENSOR
 BACK IN STOCK

Amazing \$29.50



Great for precision electric speedos, car computers etc. Provides TTL compatible pulse directly proportional to speed of vehicle. Simple fitting with instructions provided.

Cat. XC2025

\$29.50

JAYCAR'S DIRECT IMPORT PRICES

9 VOLT BATTERY HOLDER/
 CONNECTOR

ONLY **\$2.95**

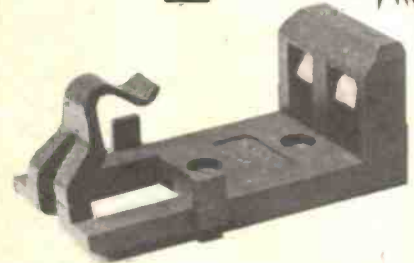

The 216 cell 9V battery is a common source of power for many projects. The problem is, however that they are difficult to mount. You usually end up letting the battery bounce around the box tethered to its battery snap. This great unit (pictured) enables you to secure the 9V cell as well as connect to it. Great for any portable equipment!

Cat. PH9232

ONLY \$2.95

INSULATION DISPLACEMENT CONNECTORS & RIBBON CABLE

I.D. Insulation displacement. The quick and reliable way of making multiple connections to computer peripheral connectors. Great for Disk Drives, Printers etc. Crimp them yourself and save a fortune.

PI6550	16 pin DIP header	\$1.99
PI6555	24 pin DIP header	\$2.50
PI6560	PC edge connector 34 way (Suits 5 1/4" Disk Drives)	\$8.50
PI6575	25 pin Cannon 'D' male	\$8.95
PI6576	25 pin Cannon 'D' female	\$8.95
WM4502	16 way cable	\$1.50/metre
WM4504	25 way (for DB25's & 24 way DIP)	\$2.50/metre
WM4506	34 way for Disk Drives	\$3.45/m

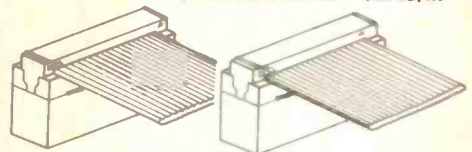

EXPERIMENTER BREADBOARDS



from
\$3.45
 VALUE!



Cat. PB8810	WBDN 100 holes	\$3.45
Cat. PB8812	WBTN 640 holes	\$10.95
Cat. PB8814	WB2N 840 holes	\$16.95
Cat. PB8816	WB4N 1680 holes	\$29.50
Cat. PB8818	WB6N 2420 holes	\$45.00

UCTS- LOW PRICES

MEAN YOU SAVE A BUNDLE!!

NEW



\$42⁹⁵

FAR CHEAPER THAN DPM SEPARATELY

Function	F.S.D.	Resolution	Accuracy
Voltage (d.c.)	20V	10mV	0.5% - 1 digit
	200V	100mV	0.5% - 1 digit
Resistance	2000	100mΩ	0.5% - 1 digit
	20kΩ	100	0.5% - 1 digit
R.P.M.	20,000 r.p.m.	10 r.p.m.	1% - 3 digits
Dwell	90	0.1	2% - 3 digits

minitune

Following the spectacular success of the DP2010 Digital Multimeter kit, we now have an ENGINE ANALYSER KIT! But the spectacular thing is the price! It is ACTUALLY CHEAPER than the DPM-05 Display and Case!! The Minitune will measure voltage, resistance (down to a very low range), RPM and Dwell Angle.
Cat. KJ7012

MINITUNE KIT \$42.95
TEST LEADS TO SUIT ONLY \$2.95

PCB MOUNT SCREW TERMINALS

NEW

\$1²⁵

FROM

We now stock two (2) types of 4 way and 8 way. Great for the rugged connection of 240V or other heavy duty wiring to PCB's when solderless disconnection may be required at a later date.

4 way Cat. HM3207
8 way Cat. HM3208

PRICE \$1.25
PRICE \$1.95

EXPERIMENTER'S MAGNET KIT

NEW

ONLY \$4⁹⁵



Magnets never cease to amaze - yet most of us know very little about them.

With this in mind Jaycar has had a special "Magnet Kit" produced. The kit contains: 2 very powerful Ceramic magnets, flux concentrator, pole pieces and a short manual written by experts in magnetism. Magnet experiments are also shown as well as a technique to actually make your magnets stronger!!
Cat. KJ6512

\$4.95



Digital Delay Line KIT
400ms VERSION **\$449** COMPLETE

WE DARE YOU TO COMPARE WITH DEARER UNITS!!

The Digital Delay Line is designed to produce a huge variety of electronic effects. It works very well but the amazing thing is the low, low price!

The effects depend on the time delay selected and some of those included are: Phasing, Flanging, Chorus, ADT (Automatic Double Tracking), Echo, and Vibrato. The delay time can be varied from 0.32ms to 1.6 seconds! Because the signal is stored in digital form there is, unlike analog systems, no degeneration of the signal with time and unlimited repetition is provided by use of the Freeze control.

All the controls mount directly upon PCB's to eliminate wiring and to further simplify construction the main board is 'plated-through' i.e. there are no wire links or link-through pins. The whole of the memory whether for the basic 400ms machine or the fully expanded 1.6 second model all fits on the main board. The cabinet, which is free standing but also suitable for 19" rack mounting, is fully finished to a very high standard. The panel is deep blue whilst the cover is sprayed with a durable black enamel. The kit is available right now from Jaycar at only \$449 - compare that with inferior units that can cost over \$2,000!!
Cat. KJ6621 \$449

Jaycar NUMBER 1 FOR KITS

SYDNEY SHOWROOM
125 YORK STREET PHONE: (02) 264 6688
TELEX: 72293

CARLINGFORD SHOWROOM
Cnr. CARLINGFORD & PENNANT HILLS ROAD
PHONE: (02) 872 4444

MAIL ORDERS & CORRESPONDENCE
BOX K 39 HAYMARKET, SYDNEY 2000
POST AND PACKING CHARGES
\$5 - \$9.99 (\$1.50) \$10 - \$24.99 (\$3.20)
\$25 - \$49.99 (\$4.50) \$50 - \$99.99 (\$6.50)
\$100 or more (\$8.00)

SHOP HOURS CARLINGFORD
Mon - Fri 9am - 5.30pm; Sat 9am - 12pm; Thurs night 8.30pm
SHOP HOURS SYDNEY
Mon - Fri 8.30am - 5.30pm; Sat - 8.30am - 12pm; Thurs night 8.30pm



Mail Order By
BANKCARD
Via Your Phone

History of the RAAF Wireless Reserve

The RAAF Wireless Reserve was created about 1931 by Howard Love (then VK3BM), President of the WIA Victorian Division and the Air Board of the RAAF.

It was realised that the radio amateurs of Australia represented a great potential of emergency communications to the RAAF in providing a group of trained signals operators.

At the outbreak of the 1939/45 war some 200 operators were called up for full-time active services from all states.

The Air Force appointed Bob Cunningham VK3ML, with the rank of Pilot Officer, to command and organise this reserve. Bob now wishes to write a history of the RAAF Wireless Reserve.

Unfortunately there are many missing gaps in the 1931-1939 years where records of members and their activities are unavailable. He would therefore be grateful if former members of the Reserve would provide him with known lists of members and any items of interesting activities worth recording in the proposed history.

Please forward any such information to VK3ML at 384 Glenferrie Road, Malvern Vic. 3144.

Traeger get Butternut

Traeger Distributors (NSW) Pty Ltd has been appointed as sole Australian agents for Butternut Electronics Co of San Marcos, Texas USA.

Butternut are the manufacturers of the famous HSV-6 vertical all band — no relays amateur antenna (featured in CQ Feb. '82).

In addition to their range of amateur antennas, Traeger will also be handling their 35 ft (10.65 m) commercial antennas to the basic HSV-6 design for base/in-field use.

These commercial antennas will cover the frequency range of 2-18 MHz and are specifically

built for clients' frequencies.

Further information can be obtained from Traeger on amateur and commercial models in the Butternut range.

Traeger Distributors are better known as state agents and distributors for Tracker Communications Pty Ltd, South Australia HF SSB products.

You can contact Traeger at P.O. Box 348, Moree NSW 2400. (067)52-1627.

Vicom releases handheld transceivers

Vicom has recently released a new series of handheld transceivers in UHF and VHF. This series of FM transceivers offers high quality, ease of operation and an economical price, Vicom claim.

The transceivers, which have been approved by the Department of Communications, include an SEC-approved battery charger and feature rugged construction.

They can be supplied to operate in a choice of bands and with a choice of output. For example, the UHF models cover the bands 450-470 MHz and 470-500 MHz. One version has an output of one watt only. The other version has outputs of either one watt or three watts, in the same unit. These are called the SU101 series.

The VHF models cover 148-174 MHz and provide a choice of output of either one watt or five watts in the same unit. These are called the SV1000 series.

Vicom provides a 12 month warranty on the transceivers. Full specifications and details of option are available from Vicom,

57 City Rd, South Melbourne Vic. 3205. (03)62-6931. They have offices in Sydney, NSW and Lower Hutt, N.Z.

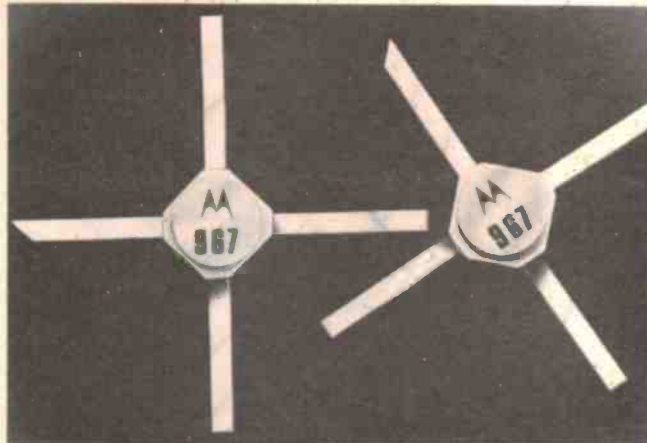
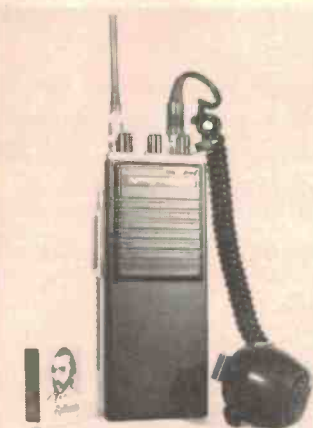

Motorola offer 1 GHz GaAs FETs

Motorola, which has been sampling the industry with state-of-the-art UHF GaAs FETs, is going into full scale production and is prepared to deliver these in quantity.

The new Motorola FETs offer 1 GHz performance with a typical 18 dB gain and 1.2 dB noise level. The devices represent the first US high-volume, low-cost GaAs FETs to compete directly with parts that, until now, have been manufactured exclusively in Japan.

Available from warehouse

stock, according to Motorola, the transistors are being introduced under the part numbers MRF966 for plastic packaged devices and MRF967 for ceramic package components.

"We expect to compete aggressively with all competitors in this field — both in performance and in price," says Doug Fowler, Motorola product planner for RF Products, "And we're working toward developing higher frequency GaAs FETs which we expect to introduce later this year."

New WA antenna manufacturer

The Western Antenna Company is pleased to announce the commencement of local manufacture at their Osborne Park, Perth, factory.

A large range of frequency conscious base station and directional antennas, specifically designed for operation in the West Australian environment, are now available direct from a genuine local producer.

Western Antenna to offer the complete service to the WA radio communication market.

The company is located at Unit 2, 9 Collingwood St, Osborne Park WA 6017. (09) 446-4448.

Employing the latest designs and up to date test equipment, Western Antenna has the capacity to manufacture antennae up to 1.5 GHz and welcomes the opportunity to satisfy any specific requirements.

With nearly twenty years combined experience in the field of radio communication Western Antenna offers advice on all types of antenna applications, both mobile and base station.

Also offered is an overnight service on all emergency requirements, thus keeping system off-air time to a minimum.

These services, together with the large range of stock mobile antennae, accessories, coaxial connectors, cable (multicore and coaxial) and speakers enables

New low-loss foam coax

Kabelmetal of West Germany now have in production 40 mm (1½") low-loss foam dielectric coaxial cable.

The distributors, Antenna Engineering Australia Pty Ltd, say this new cable is ideal for long runs at 2.5 GHz and below where pressurisation is not desirable.

Attenuation per 100 m is quoted as: 1000 MHz 2.9 dB, 1700 MHz 4.25 dB, and 1900 MHz 4.6 dB.

For further information contact Antenna Engineering Australia Pty Ltd, P.O. Box 191, Croydon Vic. 3136. (03)728-1777.

ROD IRVING ELECTRONICS

425 HIGH STREET, NORTHCOTE 3070, MELB, VIC PH (03) 4898131 TELEX-38897

RACK MOUNTING BOXES

19 X 5 1/2 X 12"	\$45.00
19 X 6 X 10"	\$39.95
19 X 5 1/2 X 12"	\$55.00
19 X 7 1/2 X 12"	\$79.00
19 X 10 X 12"	\$89.00
SERIES 5000	\$55.00

CABINET OF 16 DRAWERS

PUT ALL YOUR BITS & PIECES AWAY IN THESE INCREDIBLY CHEAP CABINET OF DRAWERS.



14.50

JIFFY BOXES

UB1 - 150 X 90 X 50	\$1.80
UB2 - 196 X 113 X 60	\$2.75
UB3 - 130 X 68 X 41	\$1.50
UB5 - 83 X 54 X 28	\$.90



ROD CUTS PRICES ON CANNON CONNECTORS



Line socket	1-9	10 up
Panel plug	\$3.70	\$3.60
Line plug	\$2.70	\$2.50
Panel socket	\$2.60	\$2.50
	\$3.90	\$3.80

HORN SPEAKERS

NOW ONLY **6/75**



PANEL METERS

MMS	0-30V	\$10.00	\$9.00
MMS	0-20V	\$10.00	\$9.00
MMS	0-100uA	\$10.00	\$9.00
MMS	0-10A	\$10.00	\$9.00
MMS	0-1A	\$10.00	\$9.00
MMS	0-100uA	\$ 8.50	\$5.50
MMS	0-100uA	\$ 8.50	\$5.50
MMS	0-100uA	\$ 8.50	\$5.50
MMS	0-20V	\$ 8.50	\$5.50
MMS	0-1A	\$ 8.50	\$5.50
MMS	0-10A	\$ 8.50	\$5.50
MMS	0-10A	\$ 8.50	\$5.50

CONNECTORS DB 25

DB25P - PLUG -
DB25S - SOCKET -
DB25C - COVER -

1-9	10 +
\$3.90	\$3.50
\$4.90	\$4.50
\$2.20	\$1.80

SAVE

SOLDERING IRON STAND

5/50



TRANSFORMERS

2156	1-9	10-19	20+
2851	\$7.95	\$6.95	\$5.95
2155	\$8.95	\$3.00	\$2.50
6672	\$5.90	\$4.50	\$3.90
	\$7.90	\$6.50	\$6.00



HOOK UP WIRE

4/75 a roll



WELLER SOLDERING STATION

67.50



DIGITAL MULTIMETERS

GREAT NEW AUTO RANGING MULTIMETERS AS ADVERTISED RECENTLY

\$49.95 ME-533

\$89.95 ME-531

MULTITESTERS

YF 370 **28/50**

YF 303 **17/50**

34/50

21/50

YF 10

COMPONENT SPECIALS

BF469	\$.90	BD 139	45c
BF470	\$.90	10 FOR \$4.00	
2114	\$1.95	10 FOR \$4.00	
4116	\$1.95	BD 140	45c
2708	\$4.50	10 FOR \$4.00	
2716	\$5.50	4MHZ XTAL	\$2.00
2732	\$9.50		
TAP50	\$1.10		

BATTERY SNAPS A STEAL AT 10c EACH

3AG FUSE HOLDER 50c
2AG FUSE HOLDER 50c

1-9	10-99	100-999	1000
1N4148	.06c	.05c	.04c
1N4001	.06c	.05c	.05c
1N4002	.06c	.05c	.05c
1N4003	.06c	.05c	.05c
1N4004	.07c	.06c	.05c
1N4005	.09c	.08c	.06c
1N4006	.10c	.09c	.06c
1N4007	.12c	.09c	.07c

2.2 MF POLY 400V CAPS	.90c
BC547	100 For \$ 9.00
BC558	100 For \$10.00
BC559	100 For \$10.00
BC548	100 For \$ 9.00

CAPACITORS

	CAPACITY (uF)	VOLTAGE (DCV)	
33000	16V	\$21.70	2900 40V \$ 5.90
68000	16V	\$19.50	6800 16V \$ 5.75
100000	10V	\$19.50	10000 25V \$ 9.00
			10000 40V \$11.50
			15000 25V \$10.30
			22000 25V \$12.00
			22000 40V \$20.50
			27000 35V \$21.70

COMPUTERS OF THE DECADE

Sorcerer Mk II - Dick Smith System 80
? 'Ask Rod for a price' ?



COMPUTER COOLING FANS

18.90

115V 240V 4%

RELAYS

6 AMP CONTACTS PCB MOUNTING

12V SP	\$4.50
12V DP	\$5.50
24V SP	\$4.90
24V DP	\$5.90

We have the cheapest price on Philips speakers

Please debit my Bankcard ETI 12/82/3

Bankcard No. _____

Expiry Date _____

Name _____

Signature _____

MAIL ORDERS: P.O. BOX 235 NORTHCOTE, VIC. 3070
Min. P&P \$2.00. Mail Order Enquiries (03) 481 1436.

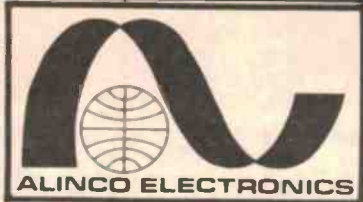

EPS 20M

EPS 30M



EPS 200

EPS 300

Commercial DC Power Supplies

IDEAL FOR - Ham Shacks, Technical Schools, Universities, Research Laboratories, Repair Workshops, Assembly Lines, etc.

Specifications	EPS-200	EPS-20M (With Meter)	EPS-300	EPS-30M (With Meter)
Input Voltage	240V 50Hz	240V 50Hz	240V 50Hz	240V 50Hz
Output Voltage	13.8 Volts DC \pm 0.3V	10 - 16 Volts DC	13.8 Volts DC \pm 0.3V	10 - 16 Volts DC
Output Current	20 AMPS DC (MAX)	20 AMPS DC (MAX)	30 AMPS DC (MAX)	30 AMPS DC (MAX)
Ripple Voltage	30mV P-P (Rated)	30m V P-P (Rated)	30mV P-P (Rated)	30mV P-P (Rated)
Automatic Protection Circuit @	20 AMPS	20 AMPS	30 AMPS	30 AMPS

I M A R K

PTY LTD, 167 RODEN ST, WEST MELBOURNE 3003
PHONE (03) 329 5433 TELEX AA 37753

SUBSCRIPTIONS BACK ISSUES BINDERS PHOTOCOPIES BINDERS

ORDER FORM

I enclose \$ for (tick appropriate box/es). All prices include postage.
Send orders to: ETI, Federal Publishing, 140 Joynton Ave, Waterloo NSW 2017.

Subscriptions \$28.20 per year within Australia \$
\$39.00 overseas (surface mail) \$
Airmail rates on application

Back issues \$2.50, available from November 1978.

or photocopies \$2.50 per article per issue
Project No. Month Year \$
Project No. Month Year \$
Project No. Month Year \$
Project No. Month Year \$

Please attach a list if more than four required.

Binders No. @ \$6.10 in NSW \$
No. @ \$7.50 in other states \$

NAME (Please print)

ADDRESS

Please debit my Bankcard
 American Express Card

Name

Number

Expiry Date

Signature

WELCOME

Welcome to 'Scanners' World'. If you're interested in the exciting new hobby of scanning, then this column is for you.

Got anything interesting to report? — then we'd like to hear from you. Heard any interesting DX (long distance reception)? Tell others about it — date, time, frequency, location, etc. Found a new and interesting channel? — other scanners would like to know.

Importers/distributors/retailers — readers would like to know about your products. Everything the scanning enthusiast needs — from the scanners themselves to antennas, mod. kits, rotators, whatever.

Send all information to: The Editor, 'Scanners' World', ETI Magazine, P.O. Box 21, Waterloo NSW 2017.

New accessories for SX-200 scanner

GFS Electronics recently announced the release of our new accessories to suit their JIL SX-200 Scanning receiver.

The first, known as the Model CVR-1B Scanverter, allows the SX-200 to cover 216 to 380 MHz. It simply plugs in series with the external antenna lead and gives the SX-200 full frequency coverage from 26 MHz to 514 MHz with no gaps except for the 88 to 108 MHz FM Broadcast band.



The range 216 to 380 MHz encompasses frequencies used by the Space Shuttle crew for direct communication to tracking stations.

The Model CVR-2 Globscan shortwave converter turns the SX-200 into a broadcast and shortwave receiver. It provides coverage from 550 kHz to 26 MHz enabling the user to receive all normal broadcast stations as well as thousands of overseas signals from shortwave stations.

Like the CVR-1B it simply plugs in series with the external antenna lead of the SX-200.

Priced at \$199 and \$189 respectively the CVR-1B and CVR-2 turn the SX-200 into a full coverage programmable receiver from 550 kHz through to 514 MHz with the exception of 88 to 108 MHz.

Also available, and designed to increase the JIL SX-200's facilities, are two user-assembled and installed kits.

The A4-AM kit allows the SX-200 to automatically select the AM mode whenever it receives an Airband or 27 MHz Marine/CB frequency. The facility is also manually overrideable so that the FM mode can be used in either of these bands, if required.

The EXP-32 memory expander kit provides the SX-200 with an additional 16 memory channels. With this kit installed a total of 32 memories are available and may be selected in two separate banks of 16 or the entire 32.

Prices are \$32 and \$53 for the A4-AM and EXP-32 respectively. For full details of all four products contact GFS Electronic Imports, 15 McKeon Road, Mitcham Vic. 3132. (03)873-3939.

Mobile scanner by Kraco

The Kraco Pro 20 MKii scanner is different from most in that it is specifically designed to be mounted in a vehicle for mobile use. It operates on the vehicle 12 Vdc supply and is compact enough to be conveniently mounted in almost any vehicle.



While a telescopic antenna is supplied the receiver is fitted with a Motorola-type connector on the rear to accept the normal car-type antenna lead.

The unit features a programmable PLL-type double conversion FM receiver which covers both the VHF Hi and Lo bands, from 70.010 MHz to 84.410 MHz and 156.010 MHz to 170.410 MHz, in



Low cost, 10 channel desk-top scanner from Dick Smith

Dick Smith Electronics has released an inexpensive desk-top scanner. The Bearcat 150FB is a 10 channel crystal-less programmable scanner covering a large part of the UHF and VHF spectrum.

The frequency ranges covered are: • UHF from 406-490 MHz (includes the full amateur 70 centimetre band) • 66-98 MHz (includes Australian VHF low band allocation) • 144-174 MHz (includes amateur two metre band and VHF high band).

With the Bearcat 150FB you don't need crystals. You can program the frequencies into it and change them anytime and program different frequencies, as you prefer.

Features include a smooth, touch-sensitive keyboard (no knobs and switches), 8-digit fluorescent display to show the

frequency programmed for each channel and special scan function and command confirmation.

The receiver sensitivity is specified as 0.5 uV on VHF, 0.8 uV on UHF. It will scan the programmed channels at 16 channels/second and it has a two second selective delay. The unit is powered from 240 Vac and is supplied with a telescopic antenna. An external antenna socket is provided.

The Bearcat 150FB is listed in Dick's catalogue as No. D-2800 and costs only \$275 from any Dick Smith Electronics store.

15 kHz steps. Any twenty frequencies of the 1920 frequencies within these ranges can be programmed without the need to purchase even one crystal.

The receiver is solid state for low battery consumption and uses one crystal filter and two ceramic filters to ensure excellent sensitivity and selectivity. Backup batteries are included to provide memory 'keep alive' of the programmed frequencies even if the dc power is removed.

Programming of the required frequencies is easy and can be performed simply 'in situ' by

setting the programme switches according to the frequency selection chart supplied.

Manual channel change and automatic scanning function as well as a channel bypass feature are standard equipment. A green LED display, which is more visible in bright sunlight, is used for channel number indication. Other features include adjustable squelch control and scanning delay function.

Further details are available from Imark Pty Ltd, 167 Roden Street, West Melbourne Vic. 3003. (03)329-5433.

SHOPAROUND

This page is to assist readers in the continual search for components, kits, printed circuit boards and other parts for ETI projects and circuits. If you are looking for a particular item or project and it is not mentioned here, check with our advertisers.

ETI-163 Lab. supply

Most of the information on parts and kit suppliers for this project was covered in last month's Shoparound, so we'll just re-iterate the kit suppliers: Altronics in Perth, Rod Irving in Melbourne and Dick Smith Electronics (stores in all states). Don't forget to try All Electronic Components in Melbourne while you're shopping around, too.

Ferguson Transformers has advised us that they will be making a transformer suitable for this project, part No. PF4673. This, they advise, is constructed to the relevant clauses of Australian Standard 3126. It includes the 15 V/250 mA auxiliary winding. Check with your local supplier(s) to see if it's in stock, or can be obtained. Recommended retail price is \$39.90.

ETI-1516 'Sure Start' ignition for model engines

Most components for this project should be readily available from almost any electronic components supplier. If you're after a kit, try Rod Irving Electronics and All Electronic Components in Melbourne.

If you're shopping around for individual components, then

you'll find the FX2243 potcore is not a common item. However, Electronic Agencies in Sydney have indicated they'll be stocking it and you'll find Radio Despatch Service (also in Sydney) plus All Electronic Components in Melbourne keep this component in stock. Don't forget to ask for two cup cores and a bobbin.

The potentiometers with slotted shafts were obtained from Dick Smiths but you can make your own by cutting a pot shaft very short and then cutting a slit across the shaft end with the hacksaw.

You can obtain negatives or positives of the meter scale and pc board artwork from ETI Artwork Sales, as mentioned in the article.

Ready-made printed circuit boards can be obtained from any of the suppliers listed in Shoparound on page 80 of the May issue.

ETI-688 Bipolar PROM programmer

This useful little gadget should be found on the shelf of every digital enthusiast's workshop. Most of the components can be obtained off-the-shelf from almost any electronic components retailer. The exception would perhaps be the 16-pin ZIF socket.

However, plenty of suppliers stock these. Try: Radio Despatch Service in Sydney; Data Parts in Shepparton, Victoria; Rod Irving Electronics, Magraths and Ellistronics in Melbourne, or Active Electronics (mail order only, 4 King St, Sandringham Vic.).

Rod Irving Electronics has indicated they'll be carrying a kit for this project. Printed circuit artwork is obtainable through our artwork sales (see the article). Ready-made pc boards can be obtained from the suppliers listed on page 80 of last month's issue.

ETI-153 Temp. probe

Another of our popular add-on projects for your multimeter. Kits should be obtainable from Electronic Agencies in Sydney plus Rod Irving Electronics and All Electronic Components, both in Melbourne.

If you're assembling the components yourself, not building a kit, then you'll have to do a bit of shopping around to find the AD590 temperature sensor IC. There are several versions (refer to the article). The device is made by Analog Devices, distributed here by Parameters Pty Ltd, who can be contacted at (02)439-3288 in Sydney or (03)580-7444 in Melbourne.

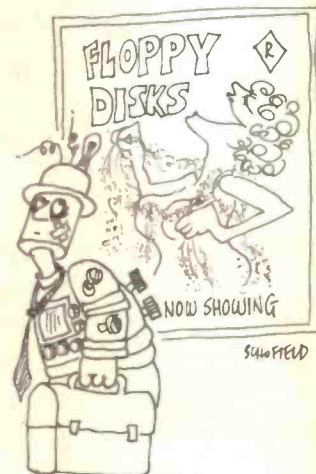

The LM336 precision voltage reference made by National Semiconductor is stocked by Jaycar and Radio Despatch Service in Sydney. Also try Rod Irving Electronics and All Electronic Components in Melbourne. Note that there are several versions, the one used in this project is the 2.5 V type. We obtained ours from National Semiconductor distributor, Semtech Pty Ltd, Suite 6/1 Johnston Lane, Lane Cove West NSW 2066. (02)428-4111.

Artwork for the pc board and front panel is obtainable from our Artwork Sales Dept., or ready-made pc boards and Scotchcals can be obtained from the suppliers listed on page 80 of last month's issue.



Look out Joh, here comes Dick Smith! Queensland 'country members' can now source their electronic requirements from stores in the country centres of Townsville and Toowoomba.

Townsville, erstwhile capital of 'the deep north', now sports a fully equipped Dick Smith store at the corner of Ingham Rd and Cowley St (077)72-5722. "Store manager Syd McKittrick (pictured left) and his specially trained staff are looking forward to serving you".



Toowoomba, commercial and social hub of the Darling Downs area, also sports its own fully equipped Dick Smith store, too. It's located at the corner of Ruthven and Bowen Sts (076)38-4300. "Store manager Brian Marney (pictured right) and his specially trained staff are looking forward to serving you".

If you picked up a Dick Smith catalogue from our April issue, now you know where to get those goodies. If you haven't a catalogue, drop in to your nearest store and get one.

ETI BOOK SALES

Save time and trouble with mail order. Just fill out the coupon on page 120.

electronics textbooks

ELECTRONICS — IT'S EASY VOL. 1 \$5.95
Meters, resistance, capacitance and inductance, emitter followers, op amps, power supplies and electronic filters.

ELECTRONICS — IT'S EASY VOL. 1 \$12.95
Same content in a hard-cover form.

ELECTRONICS — IT'S EASY VOL. 2 \$5.95
Digital sub-systems counters and shift registers, A-D and D-A conversion, digital instruments and test equipment, computers, transmission links and oscilloscopes.

ELECTRONICS — IT'S EASY VOL. 2 \$12.95
Same content in a hard-cover form.

ELEMENTS OF ELECTRONICS

This series is an introduction to modern electronics. All the maths is taught as the reader progresses. The course concentrates on the understanding of concepts central to electronics, rather than digressing over the whole field. The author anticipates where difficulties lie and guides the reader through them.

BOOK 1
BP62 \$7.52
All fundamental theory necessary to full understanding of simple electronic circuits and components.

BOOK 2
BP63 \$7.52
Alternating current theory.

BOOK 3
BP64 \$7.52
Semiconductors technology leading to transistors and ICs.

BOOK 4
BP77 \$9.76
Microprocessing systems and circuits.

BOOK 5
BP89 \$9.76
Communications.

BASIC ELECTRICITY/ELECTRONICS VOL 1
21501P \$13.25
First volume of five volume set provides thorough theoretical and practical background to the overall subject of electricity and electronics.

BASIC ELECTRICITY/ELECTRONICS VOL 2
21502P \$14.95
Volume 2 in this series builds on the basic information in Volume 1 by giving detailed information on AC and DC circuits — covering series and parallel circuits, electro-magnetism, resistance, capacitors and inductance plus associated calculations.

BASIC ELECTRICITY/ELECTRONICS VOL 3
21503P \$14.95
This, the third volume in this series, introduces valves and transistors — from an introduction to vacuum tube through multi-element tubes, semiconductor devices, power supplies, amplifiers, oscillators, pulse circuits — to special semiconductor devices.

BASIC ELECTRICITY/ELECTRONICS VOL 4
21504P \$14.75
Volume 4 covers construction, operation and usage of electronic test instruments. Included are analogue and digital multimeters, vacuum-tube voltmeters, oscilloscopes, tube and transistor testers, bridge instruments and signal generators.

BASIC ELECTRICITY/ELECTRONICS VOL 5
21505P \$9.95
The last volume in this series explains the principles of motors and generators. Devices covered include AC and DC motors and generators, three-phase systems and power converters. The final chapter covers servo control systems.

ESSENTIAL THEORY FOR THE ELECTRONICS HOBBYIST
228B \$4.32
This book supplies the electronics hobbyist with the background knowledge which will exactly suit their specific requirements. Minimum maths.

BEGINNER'S GUIDE TO DIGITAL ELECTRONICS
BP61 \$3.36
Covers all essential areas including number systems, codes, constructional and sequential logic, analogue/digital/analogue conversion.

A MICROPROCESSOR PRIMER
BP72 \$5.92
Learning about microprocessors is easy with this book, written in a style that is easy to follow. The shortcomings of this basic machine are discussed and the reader is shown how these are overcome by changes to the instruction set. Relative addressing, index registers follow as logical progressions.

reference and data handbooks

AUDIO CYCLOPEDIA
20675P \$66.00
A complete, in-depth look at the art of audio — from the basic principles of sound to solid-state and integrated circuits. Over 3000 entries and hundreds of illustrations and circuit diagrams cover acoustics, amplifiers, recording, reproduction, test equipment, audio measurements, and much more.

REFERENCE DATA FOR RADIO ENGINEERS
21218P \$54.50
The largest and most comprehensive collection of equations, graphs, tables, and other reference data needed in general radio engineering and design. Contains hundreds of charts, monographs, diagrams, curves, tables and illustrations.

TUBE SUBSTITUTION HANDBOOK
21746P \$8.75
Complete, accurate, up-to-date guide to direct substitutes for receiving and picture tubes. Contains over 6000 receiving tube substitutes, over 4000 monochrome and colour picture tube substitutes, and 600 communications substitutes. Also includes pinouts for quick operational checks.

CONTEMPORARY MATHEMATICS FOR ELECTRONICS
70274P \$29.75
This book is split into three sections. Direct current maths introduces the student to the calculator, fractions and dimensional analysis. Alternating current maths covers p-nosors, quadratics and RMS in both sine and digital waveforms. Active device maths introduces number systems and boolean.

HANDBOOK OF RADIO, TV, INDUSTRIAL & TRANSMITTING TUBE & VALVE EQUIVALENTS
BP2 \$2.25
Equivalents book for amateurs and servicemen. More than 18 000 old and new valves from UK, USA, Europe, Japan et al. CV (military) listings with commercial equivalents included.

RADIO AND ELECTRONIC COLOUR CODES AND DATA CHART
BP7 \$1.60
This large wall chart covers all colour codes in use throughout the world. For all radio and electronic components made in UK, USA, Europe and Japan.

THE CP/M HANDBOOK WITH MP/M
88048A \$19.95
Shows you how to use CP/M (control program for microprocessors) and its resources. No prior knowledge of computers is assumed. CP/M is available on nearly all computers using the 8080, 8085 or Z80 microprocessors.

FIRST BOOK OF TRANSISTOR EQUIVALENTS AND SUBSTITUTES
BP1 \$3.36
This guide covers many thousands of transistors showing possible alternatives and equivalents. Covers transistors made in UK, Japan, USA, Germany, France, Europe, Hong Kong and includes types produced by more than 120 different manufacturers.

SECOND BOOK OF TRANSISTOR EQUIVALENTS AND SUBSTITUTES
BP14 \$5.92
Interchangeability data covers semiconductor manufacturers all over the world. Immediate equivalents are shown and possible substitutes are included.

GIANT CHART — RADIO, ELECTRONICS, SEMI-CONDUCTORS & LOGIC SYMBOLS
BP27 \$1.92
Identify those symbols at a glance. A must for beginners and advanced enthusiasts alike. Professionals can always hide it in their desks!

RESISTOR SELECTION HANDBOOK
BP28 \$2.24
Shows how to combine two preferred values of resistor to obtain virtually any required value of resistance. Includes information about fixed resistors, standard ranges, colour codes and markings, power ratings and resistor calculations.

ELECTRONIC CALCULATOR USERS' HANDBOOK
BP33 \$5.12
Presents formulae, data, methods of calculation, conversion factors, etc, for use with the simplest or most sophisticated calculators. Includes the way to calculate using only a simple four-function calculator: trigonometric functions, hyperbolic functions, logarithms, square roots and powers.

AUSTRALIAN MICROCOMPUTER HANDBOOK
72505 NOW \$15.00
Normally \$25.00. A detailed buyer's guide to micro-computer systems and application packages in commercial, industrial, scientific, educational and home/hobby areas.

TRANSISTOR SUBSTITUTION HANDBOOK
21515P \$8.75
17th edition — Accurate transistor substitution in a matter of seconds with this replacement listing of over 19 000 American and foreign bipolar transistors.

Practical Electronic Calculations & Formulae

BP53 \$9.76
For the practical person's workbench. Bridges gap between technical theory and cut-and-dried methods which work but leave the experimenter unfulfilled. There's a strong practical bias. Tedious and higher maths avoided where possible.

International Transistor Equivalents Guide

BP85 \$9.76
Companion to BP1 and BP14 equivalents books, but contains a huge amount of information on modern transistors produced by over 100 manufacturers. Wherever possible, equivalents are subdivided into European, American and Japanese types. Also shown are the material type, polarity, manufacturer and indication of use or application.

How to Identify Unmarked ICs

BP101 \$2.46
This chart shows the reader how, with just a test-meter, to go about recording the particular 'signature' of an unmarked IC which should enable the IC to be identified with reference to manufacturers or other data.

electronics for beginners

Beginners Handbook of IC Projects

74286P \$19.25
The novice is guided in mastering the fundamentals of building, troubleshooting and testing electronic projects. In addition to many elementary projects, more advanced ones are included concerning bipolar integrated circuits and medium and large-scale integrated circuits.

Hi-Fi Loudspeaker Enclosures

205B \$3.36
Data for building corner reflex, bass reflex, exponential horn, folded horn, tuned port, Klipschorn labyrinth, tuned column, loaded port and multi speaker panoramics. Clear dimensioned diagrams included.

Solid State Novelty Projects

219B \$3.04
A number of novelty projects using modern ICs and transistors. Includes 'Optomin' — a musical instrument played by reflecting a light beam with your hand, water warbler for pot plants, music tone generator, LEDs and ladders game, touch switch, electronic roulette wheel, etc.

Solid State Shortwave Receivers for Beginners

222B \$4.32
Design and construction of several solid-state shortwave receivers giving high level of performance yet utilising relatively few inexpensive components.

Beginners' Guide to Building Electronic Projects

227B \$5.12
Enables total beginners to tackle electronic projects. Includes component identification, tools, soldering, building methods, cases, legends, etc. Practical basic projects are included.

Essential Theory for the Electronics Hobbyist

228B \$4.32
This book supplies the electronics hobbyist with the background knowledge which will exactly suit their specific requirements. Minimum maths.

Radio and Electronic Colour Codes and Data Chart

BP7 \$1.60
This large wall chart covers all colour codes in use throughout the world. For all radio and electronic components made in UK, USA, Europe and Japan.

First Book of Practical Electronic Projects

BP23 \$2.72
Full constructional data, circuits, components lists for many practical projects including audio distortion meter, superFET receiver, guitar amp, metronome, etc.

Resistor Selection Handbook

BP28 \$2.24
Shows how to combine two preferred values of resistor to obtain virtually any required value of resistance. Includes information about fixed resistors, standard ranges, colour codes and markings, power ratings and resistor calculations.

How to Build Your Own Metal and Treasure Locators

BP32 \$5.92
Electronic and practical details on the simple and inexpensive construction of heterodyne metal locators.

Electronic Projects for Beginners

BP48 \$4.64
This book gives the newcomer to electronics a wide range of easily built projects. Actual components and wiring layouts aid the beginner. Some of the projects may be built without using soldering techniques.

Popular Electronic Projects

BP49 \$4.96
A collection of the most popular types of circuits and projects to interest most electronics constructors. The projects cover a wide range and are divided into four basic types: radio, audio, household and test equipment.

Beginners Guide to Digital Electronics

BP61 \$3.36
Covers all essential areas including number systems, codes, constructional and sequential logic, analogue/digital/analogue conversion.

Electronic Games

BP69 \$5.92
How to build many interesting electronic games using modern ICs. Covers both simple and complex circuits for beginner and advanced builder alike.

Radio Control for Beginners

BP79 \$5.92
How complete systems work with constructional details of solid state transmitters and receivers. Also included — antennas, field strength meter, crystal controlled superhet, electro-mechanical controls. Section dealing with licensing etc. not applicable to Australia.

Easy Electronics-Crystal Set Construction

BP92 \$6.56
For those who wish to participate in the intricacies of electronics more through practical construction than by theoretical study. The circuits are based on those from earlier publications but have been modified to use modern inexpensive components and home wound coils.

IC Projects for Beginners

BP97 \$6.56
Especially written for the less experienced hobbyist, and offers a range of fairly simple projects based around a number of popular and inexpensive linear and digital ICs. Complete layout and point-to-point wiring diagrams included.

Electronics — It's Easy Vol. 1

Meters, resistance, capacitance and inductance, emitter followers, op amps, power supplies and electronic filters.

Electronics — It's Easy Vol. 1

Same content in a hard-cover form.

Electronics — It's Easy Vol. 2

Digital sub-systems counters and shift registers, A-D and D-A conversion, digital instruments and test equipment, computers, transmission links and oscilloscopes.

Electronics — It's Easy Vol. 2

Same content in a hard-cover form.

Hobby Electronics Project Book

Fifty projects ranging from very simple ones for complete beginners to more elaborate ones for those with more experience. There's a complete guide to soldering and instructions on how to make your own pc boards.

How to Build Electronic Games

Alien invaders, electronic die, sound effects, two slot car controllers, electronic poker machine, the family ferry and lots more.

How to Build Gold and Treasure Detectors

Tells you how metal detectors work and how to construct the different types of detectors: discriminating, BFO, induction balance and a professional deep-seeking unit. How to build a geiger counter.

constructional projects general

Design of Transistor Circuits, with Experiments

21626P \$20.75
A self-teaching course in transistor circuits — seven chapters explore the fundamentals of active semiconductor and their operating principles and procedures. Experiments in design and semiconductor testing provide hands-on experience.

Build Your Own Hi-Fi & Audio Accessories

220B \$3.04
Essential for keen hi-fi and audio enthusiasts. Projects include stereo decoder, three-channel mixer, FET preamp for ceramic pick-ups, mic preamp with adj. bass, stereo dynamic noise limiter, loudspeaker protector, voice-operated relay, etc.

28 Tested Transistor Projects

221B \$4.32
Some circuits are new, others are familiar designs. Projects can be split and/or combined for specialised needs.

50 CMOS Projects

224B \$4.64
Many interesting and useful projects — multivibrators, amplifiers and oscillators; trigger devices; special devices.

Major Solid State Audio Hi-Fi Projects

BP29 \$3.04
Three projects for the more experienced constructor: 12.5 W/ch stereo amplifier, eight input stereo/mono mixer and 4x14 W quadraphonic amplifier. Full constructional details provided.

How to Build Your Own Metal and Treasure Locators

BP32 \$5.92
Electronic and practical details on the simple and inexpensive construction of heterodyne metal locators.

How to Make Walkie-Talkies

BP43 \$5.12
This treatise on low power transmitter-receivers (walkie-talkies) covers many aspects from licensing requirements and bands, through practical circuitry and construction to the various types of aerials that may be used.

Projects in Opto-Electronics

BP45 \$5.92
Included are simple circuits using ordinary LEDs as well as more sophisticated designs such as infra red transmitters and detectors, modulated light transmission and also photographic projects etc.

Popular Electronic Projects

BP49 \$4.96
Includes a collection of the most popular types of circuits and projects which cover radio, audio, household projects and test equipment.

Single IC Projects

BP65 \$5.12
Simple to build projects based on a single IC. A few projects use one or two transistors as well. A strip board layout is given for each project plus special constructional and setting up info. Contents include low level audio circuits, audio power amps, timers, op-amps and miscellaneous circuits.

Electronic Games

BP69 \$5.92
A number of interesting electronic games projects using ICs for both the beginner and advanced enthusiast.

Electronic Household Projects

BP71 \$5.92
Most useful and popular projects for use around the home. Includes two-tone buzzer, intercom, smoke and gas detectors, baby alarm, freezer alarm etc. etc.

Remote Control Projects

BP73 \$6.56
Covers radio, infra-red, visible light, ultrasonic controls. Full explanations are provided so that the reader can adapt the projects for domestic and industrial as well as model use.

Power Supply Projects

BP76 \$5.92
This book gives a number of power supply designs, including simple unregulated types, fixed voltage regulated types and variable voltage stabilised designs. The designs are all low voltage types for semiconductor circuits.

Popular Electronic Circuits — Book 1

BP80 \$6.56
Yet more circuits from Mr. Penfold! Includes audio, radio, test gear, music projects, household projects and many more. An extremely useful book for all hobbyists, offering remarkable value for the designs it contains.

Electronic Projects Using Solar Cells

BP82 \$6.56
Includes a number of projects that benefit from solar power and obviate the problems encountered with batteries, such as weight and bulk, frequency of replacement, and failure when batteries are exhausted.

Digital IC Projects

BP84 \$6.56
Companion to No. 225 Practical Introduction to Digital ICs and BP61 Beginner's Guide to Digital Electronics. The projects included in this book range from simple to more advanced projects — some board layouts and wiring diagrams are included.

Audio Projects

BP90 \$6.56
Covers a wide range of audio projects including pre-amplifiers and mixers, power amplifiers, tone controls and matching etc. A number of board layouts and wiring diagrams are included.

LOOK! More books!

mail order coupon on page 120

ELECTRONIC TIMER PROJECTS

BP93 \$6.56
These may have a high degree of accuracy with quartz control or they may be quite simple designs, using only a few components. A number of specialist timer projects are car windscreen wiper delay unit, darkroom timer, metronome etc.

ELECTRONIC PROJECTS FOR CARS AND BOATS

BP94 \$6.56
Fifteen fairly simple projects designed for use with 12 V electrical systems but in some cases can also be employed with 6 V and/or positive earth systems as well.

MODEL RAILWAY PROJECTS

BP95 \$6.56
Projects include such things as controllers, signals and sound effects units. Construction stripboard layouts are provided for each project.

CB PROJECTS

BP96 \$6.56
A number of useful designs include a speech processor, interference filters and a simple CB radio receiver. Stripboard layouts, wiring diagrams and notes on construction are provided.

POPULAR ELECTRONICS CIRCUITS — BOOK 2

BP98 \$7.52
A companion for BP80, this book provides a wide range of designs for electronics enthusiasts who are capable of producing working projects from just a circuit diagram without the aid of detailed constructional information.

MINI-MATRIX BOARD PROJECTS

BP99 \$6.56
This book provides a selection of 20 useful circuits which can all be built on a mini-matrix board which is just 24 holes by 10 copper strips in size. Simple and easy for those with not much experience in electronics.

MULTI-CIRCUIT BOARD PROJECTS

BP103 \$6.56
All circuits are based on one specially designed pc board. Recommended to the less experienced hobbyist.

AERIAL PROJECTS

BP105 \$6.56
Practical aerial designs including active, loop and ferrite which are relatively simple and inexpensive to build. The complex theory and mathematics of aerial design have been avoided.

MODERN OP-AMP CIRCUITS

BP106 \$6.56
A collection of widely varying circuits and projects based on the op-amp ICs.

HOW TO GET YOUR ELECTRONIC PROJECTS WORKING

BP110 \$6.56
Helps you to overcome the problems of a circuit that doesn't work by indicating how and where to start looking for many of the common faults that can occur when building up a project.

circuit techniques and design

TTL COOKBOOK

21035P \$17.50
A complete look at TTL logic circuits — what TTL is, how it works, and how to use it. Many kinds of practical TTL are included, such as digital counters, electronic stopwatches, digital voltmeters, etc.

ACTIVE-FILTER COOKBOOK

21168P \$21.95
Learn how to construct filters of all kinds — highpass, lowpass, bandpass. The book is easy to understand — no advanced maths or obscure theory is used.

UNDERSTANDING IC OPERATIONAL AMPLIFIERS

21511P \$10.25
Latest edition of this book covers theoretical and practical aspects of operational amplifiers and associated circuits. This edition includes material on BIFET and BIMOS and CMOS op-amps.

CMOS COOKBOOK

21398P \$19.25
This book explains CMOS technology and its application to 'real world' circuitry. A mini-catalogue is included, which lists over 100 devices, giving their pinouts and application notes.

IC TIMER COOKBOOK

21416P \$15.95
Gives you a look at the hundreds of ways IC timers are used in electronic instrumentation.

IC CONVERTER COOKBOOK

21527P \$20.75
Written for the practising engineer, technician, hobbyist or student, this book will be an invaluable working guide to the understanding and use of IC analogue/digital and digital/analogue converters.

DESIGN OF OP-AMP CIRCUITS, WITH EXPERIMENTS

21537P \$16.50
The design of the fundamental circuits that are the basic building blocks of more sophisticated systems. A series of 35 experiments illustrates the design and operation of linear amps, differentiators and integrators, voltage and current converters, active filters, and lots more.

555 TIMER APPLICATIONS SOURCE BOOK, WITH EXPERIMENTS

21538P \$11.25
This book describes the construction of the 555 timer and gives numerous practical examples of its applications in all areas of electrical and computer engineering, including 17 simple experiments.

DESIGN OF ACTIVE FILTERS WITH EXPERIMENTS

21539P \$15.95
Introduction to the theory, implementation and design of active filters using the 741 op-amp.

Z80 MICROCOMPUTER DESIGN PROJECTS

21582P \$20.75
This book provides a complete look at the internal architecture of the Z80, the heart of many microcomputers, and even shows how to build a microcomputer, the EX80, using this powerful chip.

DESIGN OF PHASE-LOCKED LOOP CIRCUITS, WITH EXPERIMENTS

21545P \$15.95
An excellent introduction to the theory, design and implementation of phase-locked loop circuits using various TTL and CMOS devices. Includes manufacturers' data sheets and describes the use of breadboarding aids in the wide range of laboratory-type experiments.

AUDIO IC OP-AMP APPLICATIONS

21558P \$13.25
This book discusses IC op-amps and their application in audio systems, and describes the numerous advantages of using op-amps, including small spatial needs, low power consumption, reliable performance and low cost. Assumes a basic understanding of op-amp theory.

UNDERSTANDING CMOS INTEGRATED CIRCUITS

21598P \$9.95
This book tells you what CMOS ICs are, how they work, and how they can be used in electronic circuit designs. Many practical circuits, complete with parts values, are included.

DESIGN OF TRANSISTOR CIRCUITS WITH EXPERIMENTS

21626P \$20.75
A self-teaching course to provide the background and explanations necessary to teach the reader the art of designing transistor circuits.

GUIDE TO CMOS BASICS, CIRCUITS, AND EXPERIMENTS

21654P \$14.95
If you are already familiar with TTL devices and are ready to examine the benefits of CMOS, this book is your complete source. It tells you what CMOS devices are, their characteristics and design rules. 22 experiments demonstrate the concepts discussed.

PRACTICAL TRANSFORMER DESIGN HANDBOOK

21657P \$35.50
An easy to understand, illustration-filled guide to designing and constructing transformers. Reviews the fundamentals of electricity, magnetism and algebra needed to understand transformer theory, and covers general design considerations, transformer types, power losses and transformer use in converters and inverters.

DESIGN OF VMOS CIRCUITS, WITH EXPERIMENTS

21686P \$17.50
The authors look at the technology which makes dramatic advancements possible with VMOS, and show how these components can easily and effectively be integrated into common circuit designs to enhance their responses.

IC OP-AMP COOKBOOK

21695P \$23.75
Basic op-amp theory in detail, with 200 practical, illustrated circuit applications: JFET and MOSFET units are featured, plus manufacturers' data sheets and company addresses.

EXPERIMENTS IN ARTIFICIAL INTELLIGENCE FOR SMALL COMPUTERS

21785P \$13.25
Artificial intelligence is the capability of a device to perform functions normally associated with human intelligence. With this book, a small computer with extended BASIC and some knowledge of BASIC language, you can conduct interesting and exciting experiments in artificial intelligence.

PRACTICAL SOLID-STATE CIRCUIT DESIGN

21787P \$14.95
An introductory course in practical solid-state circuit design for the experimenter, designer or technician who is interested in constructing tailor-made circuits.

SCRS AND RELATED THYRISTOR DEVICES

21806P \$19.25
Written for experimenters, technicians and engineers, this book is a practical and comprehensive guide to theory, operation, specifications and applications of silicon-controlled rectifiers (SCRs) and related thyristor devices.

REGULATED POWER SUPPLIES

21808P \$29.75
Comprehensive discussion of the internal architecture and operation of the latest solid-state regulators. Explains when regulated supplies are needed and how to incorporate them in your projects, and discusses modern circuitry including linear and switching circuits and late ICs.

ANALOG INSTRUMENTATION FUNDAMENTALS

21835P \$29.75
Numerous practical, hands-on lab experiments and solved problems are included, plus discussions of movements, dc ammeters, voltmeters, ohmmeters, bridges, filters and attenuators. No calculus is required.

RF CIRCUIT DESIGN

21868P \$33.95
A practical approach to the design of RF amplifiers, impedance-matching networks and filters. Uses a minimum of complex maths.

SOLAR CELLS

22270P \$37.95
In-depth description of the basic operating principles and design of solar cells. It also covers the techniques currently used to produce solar cells and reviews system applications.

ELECTRONIC DESIGN WITH OFF-THE-SHELF ICs

50274P \$14.70
It contains virtually all the information you need to design and build electronic circuits, systems and subsystems with readily available ICs. Shows how to interface them into highly complex systems.

MODERN FILTER DESIGN

94663P \$49.95
This book details the advances in active RC filters, both from a practical standpoint and from a state-of-the-art point of view. It is the first book that gives detailed analysis and design procedures for switched capacitor filters.

50 PROJECTS USING CA3130 ICs

223B \$4.32
The CA3130 is an advanced operational amplifier capable of higher performance than many others: circuits often need fewer ancillary components. Audio projects. RF projects. Test equipment. Household projects. Misc. projects.

PRACTICAL INTRO TO DIGITAL ICs

225B \$4.32
Introduction to digital ICs (mainly TTL 7400). Besides simple projects, includes logic test set to identify and test digital ICs. Also includes digital counter-timer.

50 CIRCUITS USING GERMANIUM, SILICON AND ZENER DIODES

BP36 \$3.36
50 interesting and useful circuits and applications using the germanium and silicon signal diodes, silicon rectifier diodes and zener diodes etc.

50 PROJECTS USING RELAYS, SCRS AND TRIACS
BP37 \$5.92
Practical working circuits using silicon controlled rectifiers, relays and bi-directional triodes. With a minimum of difficulty you can use them in motor control, dimming and heating control, timing and light sensitive circuits, warning devices and many others.

50 FET PROJECTS
BP39 \$5.92
Projects include amplifiers and converters, test equipment, tuners, receivers and receiver aids, mixers and tone controls etc etc. The FET used is not critical. This book is of interest and value to SW listeners, radio amateurs, hi-fi enthusiasts and general experimenters.

50 SIMPLE LED CIRCUITS
BP42 \$3.36
50 interesting and useful circuits and applications using the LED. Also includes circuits for the 707 Common Anode Display for the beginner and advanced enthusiast.

IC555 PROJECTS
BP44 \$6.56
One wonders how life went on before the 555! Included are basic and general circuits, motor car and model railway circuits, alarms and noise makers plus section on subsequent 556, 558 and 559s.

PROJECTS IN OPTO-ELECTRONICS
BP45 \$5.92
Included are simple circuits using ordinary LEDs as well as more sophisticated designs such as infra-red transmitters and detectors, modulated light transmission and also photographic projects etc.

LM 3900 IC PROJECTS
BP50 \$4.64
Unlike conventional op-amps, the LM 3900 can be used for all the usual applications as well as many new ones. It's one of the most versatile, freely obtainable and inexpensive devices around. This book provides the groundwork for simple and advanced uses — it's much more than a collection of projects. Very thoroughly recommended.

50 CIRCUITS USING 7400 SERIES ICs
BP58 \$5.12
50 interesting and useful circuits and applications using these inexpensive and versatile devices.

50 CMOS IC PROJECTS
224B \$4.64
Projects include multivibrators, amplifiers and oscillators, trigger devices and other special devices.

SECOND BOOK OF CMOS IC PROJECTS
BP59 \$5.12
Leading on from book number 224 '50 CMOS IC PROJECTS', this second book provides a further selection of useful circuits mainly of a fairly simple nature. Contents have been selected to ensure minimum overlap between the two books.

COUNTER DRIVER AND NUMERAL DISPLAY PROJECTS
BP67 \$5.92
Well-known author F.G. Rayer features applications and projects using various types of numeral displays, popular counter and driver ICs, etc.

VMOS PROJECTS
BP83 \$6.56
Though primarily concerned with VMOS power FETs and their applications, power MOSFETs are dealt with too, in a chapter on audio circuits. Projects include audio circuits, sound generator circuits, dc control circuits and signal circuits.

DIGITAL IC PROJECTS
BP84 \$6.56
Helps the reader to develop a knowledge of the workings of digital circuits. Board layouts and wiring diagrams are included.

HOW TO USE OP-AMPS
BP88 \$7.52
Design notes and applications on many topics including basic theory, amplifiers, power supplies, audio circuits, oscillators, filters, computers and control engineering. It's written around the 741 IC but includes design notes for most of the common op-amps.

ELECTRONIC TIMER PROJECTS
BP93 \$6.56
These may have a high degree of accuracy with quartz control or they may be quite simple designs, using only a few components. A number of specialist timer projects are car windscreen wiper delay unit, darkroom timer, metronome etc.

ETI CIRCUITS BOOKS 1/2/3 \$2.95 ea
Many of these circuits have been published in the 'Ideas for Experimenters' section in ETI.

ETI CIRCUIT TECHNIQUES VOLS 1/2 \$4.75 ea
The how, what, which, where, why and how much anthology of electronic components, circuits and techniques.

ETI CIRCUIT TECHNIQUES VOL 3 \$4.95

test equipment and fault finding

AUTOMOTIVE TUNE-UP AND EMISSION CONTROL SERVICE
21712P \$20.75
Car owners who wish to save money and maintain their cars at peak performance will learn from this book how to adjust, repair and maintain the systems that ensure best operation.

TROUBLESHOOTING WITH THE OSCILLOSCOPE
21738P \$15.95
Excellent for the professional service technician or the serious hobbyist, as it combines step-by-step procedures for using the scope with the specific nuts and bolts of TV receiver troubleshooting.

MICROCOMPUTER DESIGN AND TROUBLESHOOTING
21819P \$26.75
Tells you how to design microcomputer systems and make them work without an expensive commercial development system or the need for costly test instrumentation. The author also provides a complete description of two popular microprocessors — the 8085 and the 6502.

PRACTICAL REPAIR AND RENOVATION OF COLOUR TVS
BP34 \$4.32
This book shows how to obtain a working colour TV for very little outlay by repairing and renovating a set that has been 'written off' by a dealer. Includes practical details of how to construct your own CRT tester/rejuvenator and cross hatch generator.

TRANSISTOR RADIO FAULT-FINDING CHART
BP70 \$1.92
Used properly, this chart should enable the reader to trace most common faults quickly. Across the top of the chart are four rectangles containing brief descriptions of the faults. Selecting the appropriate fault, the reader simply follows the arrows and carries out the suggested checks in sequence until the fault is cleared.

ELECTRONIC TEST EQUIPMENT CONSTRUCTION
BP75 \$5.92
Describes construction of wide range of test gear including FET amplified voltmeter, resistance bridge, field strength indicator, heterodyne frequency meter etc.

POWER SUPPLY PROJECTS
BP76 \$5.92
Includes simple unregulated types, fixed voltage regulator types and variable voltage stabilised designs. The designs are all low voltage types for semiconductor circuits.

HOW TO GET YOUR ELECTRONIC PROJECTS WORKING
BP110 \$6.56
Helps you to overcome the problems of a circuit that doesn't work by indicating how and where to start looking for many of the common faults that can occur when building up a project.

USE OF THE OSCILLOSCOPE
39389P \$27.95
Programmed Instruction course for use in a basic electrical engineering laboratory course. Author assumes basic knowledge of DC and AC circuits but none of oscilloscopes. This is an essentially practical course — thoroughly recommended.

TEST GEAR — METERING AND POWER SUPPLY PROJECTS \$3.00
Includes many types of meters, audio noise and signal generators, simple CMOS tester, oscilloscope calibrator etc.

TEST GEAR — VOL. 2 \$3.95
Projects include audio oscillator, transistor tester, true RMS voltmeter, RF signal generator, versatile logic test probe, microwave oven leak detector etc.

ELECTRONIC PROJECTS FOR YOUNG SCIENTISTS \$3.95
PH meter, gelger counter, helium-neon laser, sound level meter, solar cells, negative ion generator and much more.

electronic music/audio/video

CHEAP VIDEO COOKBOOK
21524P \$11.75
Complete discussion of a new, low-cost way to get words, pictures and opcode out of your computer and onto any ordinary TV screen, using a seven-IC easy-to-build circuit which you can build for less than \$20.

AN INTRODUCTION TO VIDEO
BP100 \$6.56
This book is written in layman's language and is for anyone who is thinking about buying or renting or who has just bought or rented a video recorder and wants to get the best out of the machine.

MOBILE DISCO HANDBOOK
BP47 \$4.64
Most people who start mobile discos know little about equipment or what to buy. This book assumes no preliminary knowledge and gives enough info to enable you to have a reasonable understanding of disco gear.

AUDIO CYCLOPEDIA
20675P \$66.00
A complete in-depth look at the art of audio — from the basic principles of sound to solid-state and integrated circuits. Over 3000 entries and hundreds of illustrations and circuit diagrams cover acoustics, amplifiers, recording, reproduction, test equipment, audio measurements, and much more.

ELECTRONIC MUSIC CIRCUITS
21833P \$24.95
How to build a custom electronic music synthesiser, outlines numerous other circuit designs and then shows you how to modify them to achieve particular responses. Many of the circuits can be used as special-effects boxes for guitars and other musical instruments.

INTRODUCTION TO ELECTRO-ACOUSTIC MUSIC
81515P \$15.95
This book assumes no previous technical knowledge. It discusses the relationship between the technology and the composition of electro-acoustic music.

MODERN RECORDING TECHNIQUES
21037P \$19.25
Explains the equipment controls and techniques found in a modern recording studio and how to use them creatively and correctly to produce a desired result. Numerous photographs, diagrams and charts.

SOUND SYSTEM ENGINEERING
21156P \$32.50
Dealing with audio systems as a whole, it includes installing and equalising the sound system and interfacing the electrical and acoustic systems. Instrumentation, the acoustic environment and designing for acoustic gain are covered.

TUBE SUBSTITUTION HANDBOOK
21746P \$8.75
Complete, accurate, up-to-date guide to direct substitutes for receiving and picture tubes. Contains over 6000 receiving tube substitutes, over 4000 monochrome and colour picture tube substitutes, and 600 communications substitutes. Also includes pinouts for quick operational checks.

HOW TO BUILD SPEAKER ENCLOSURES
20520P \$8.75
A practical guide to the 'whys' and 'hows' of constructing high-quality top-performance loudspeaker enclosures.

ACTIVE-FILTER COOKBOOK
21168P \$21.95
Learn how to construct filters of all kinds — highpass, lowpass, bandpass. The book is easy to understand — no advanced maths or obscure theory is used.

DESIGN OF ACTIVE FILTERS WITH EXPERIMENTS
21539P \$15.95
Introduction to the theory, implementation and design of active filters using the 741 op-amp.

AUDIO IC OP-AMP APPLICATIONS
21558P \$13.25
This book discusses IC op-amps and their application in audio systems, and describes the numerous advantages of using op-amps, including small spatial needs, low power consumption, reliable performance and low cost. Assumes a basic understanding of op-amp theory.

VIDEO TAPE RECORDERS
21521P \$17.50
In this completely revised second edition, the author tells in simple language how helical VTRs work and how to operate and service them. Includes numerous examples of circuits and mechanical systems.

OOPS! More books!

mail order coupon on page 120

ELECTRONIC MUSIC AND CREATIVE TAPE RECORDING
BP51 \$5.92
Shows how electronic music can be made at home with the simplest and most inexpensive of equipment. Describes how the sounds are generated and how these may be recorded to build up the final composition.

PRACTICAL CONSTRUCTION OF PREAMPS, TONE CONTROLS, FILTERS, ATTENUATORS
BP60 \$4.96
This book shows the enthusiast how to construct a variety of magnetic tape recording, microphone and disc preamplifiers, and also a number of tone control circuits, rumble and scratch filters, attenuators and pads.

ELECTRONIC SYNTHESIZER PROJECTS
BP81 \$5.92
For the electronic music enthusiast, an invaluable reference. This book is full of circuits and information on how to build analogue delay lines, sequencers, VCOs, envelope shapers, etc. etc. The author takes a clear and logical approach to the subject that should enable the average enthusiast to understand and build up what appears to be a quite complex instrument.

AUDIO PROJECTS
BP90 \$6.56
Covers a wide range of audio projects including preamplifiers and mixers, power amplifiers, tone controls and matching etc. A number of board layouts and wiring diagrams are included.

ELECTRONIC MUSIC PROJECTS
BP74 \$5.92
Provides constructors with practical circuits for the less complex music equipment including fuzz box, waa-waa pedal, sustain unit, reverb and phaser, tremolo generator etc. Text covers guitar effects, general effects, sound generators, accessories.

SONICS 1982 YEARBOOK \$5.35
An interview with Kraftwerk, how to cope with recording, lighting, rock acoustics, guitars, equipment reviews and more.

SONICS MAGAZINE \$2.35 ea
The Australian music magazine dedicated to the art and craft of sound. Published April, July, October, Yearbook in December. \$15 for one year subscription. Please indicate starting issue.

computers for beginners

COBOL FOR BEGINNERS
39378P \$21.95
It is a solid text for introductory programming courses in Cobol, using a format that is easy to understand, yet comprehensive enough to make supplementary readings unnecessary.

THE PET PERSONAL COMPUTER FOR BEGINNERS
61827P \$20.95
This handy guide is written for use with all varieties of PET computer, from the original 2001 to the new 8032 Super PET. It is suited to novices with no practical experience and provides advice and practical examples.

BIG THINGS FROM LITTLE COMPUTERS
77859P \$19.25
A layperson's guide to personal computing with all the basic information and lots of examples of how personal computers can be used.

BEGINNER'S GUIDE TO DIGITAL ELECTRONICS
BP61 \$3.36
Covers all essential areas including number systems, codes, constructional and sequential logic, analogue/digital/analogue conversion.

BEGINNER'S GUIDE TO MICROPROCESSORS & COMPUTING
BP66 \$5.92
Introduction to basic theory and concepts of binary arithmetic, microprocessor operation and machine language programming. Only prior knowledge assumed is very basic arithmetic and an understanding of indices.

A MICROPROCESSOR PRIMER
BP72 \$5.92
Learning about microprocessors is easy with this book, written in a style that is easy to follow. The shortcomings of this basic machine are discussed and the reader is shown how these are overcome by changes to the instruction set. Relative addressing, index registers follow as logical progressions.

AN INTRO TO BASIC PROGRAMMING TECHNIQUES
BP86 \$6.56
Ideal for beginners seeking to understand and program in BASIC. Book includes program library for biorhythms, graphing Y against X, standard deviations, regressions, generating musical note sequences, and a card game.

BEGINNING BASIC
39806A \$19.95
Intended for beginners with no computing experience, one should be able to intelligently program in BASIC in a short time.

BEGINNING FORTRAN
46011A \$19.95
Starts with simple elementary examples and proceeds to intermediate level programs. Also includes references, tutorials, flow charts, deck set-ups and matrix algebra.

UNDERSTANDING COMPUTERS
39815A \$17.95
This book describes how computers work. For people who use small computers, it starts with the most elementary gates and works up to the complete computer. Gives an understanding of languages and how they operate in the computer.

NAILING JELLY TO A TREE
39842A \$24.95
This guide to software teaches you about machine language, assembly language programming and BASIC. The emphasis is not on learning to write programs but on learning to use the thousands of available programs that have already been written.

PEANUT BUTTER AND JELLY GUIDE TO COMPUTERS
39813A \$14.95
A simple, easy-to-digest source of information on personal computing for the potential buyer who is less than an expert in the field.

INTRODUCTION TO WORD PROCESSING
88076A \$17.95
Written for the non-technical reader, this book tells about the concepts common to all word processing systems, then analyses all features in detail.

YOUR FIRST COMPUTER
88045A \$12.50
An easy-to-understand beginner's book to small computers. Understanding them, buying them and using them for personal and business applications.

FROM CHIPS TO SYSTEMS: AN INTRODUCTION TO MICROPROCESSORS
88063A \$19.95
Explains exactly what a microcomputer system is and how it works. Introduces fundamental concepts and covers all aspects of microprocessors and related components: internal operation, memories, interfacing and system development etc.

COMPUTERS FOR EVERYBODY
39849A \$8.95
In this easy-to-understand book it is explained how a computer can be used at home, in the office or at school. Includes a consumer's guide to computer equipment that will help the reader decide what to buy and who to buy it from.

computers hardware & techniques

IAPX 88 BOOK
93016P \$20.25
This book from Intel itself describes the unique Intel 8088 microprocessor in total detail. Absolutely invaluable for all involved with the 8088.

USING THE 6800 MICROPROCESSOR
21512P \$13.25
This will guide the reader through the conception, configuration, writing and running of a variety of programs that demonstrate practical use of a 6800 system.

Z80 MICROCOMPUTER DESIGN PROJECTS
21682P \$20.75
This book provides a complete look at the internal architecture of the Z80, the heart of many microcomputers, and even shows how to build a microcomputer, the EX80, using this powerful chip.

MICROPROCESSOR CIRCUITS VOL. 1
21877P \$14.75
Presents basic microprocessor concepts in simple language for beginners and teaches you to construct a useful microcontroller system. Offers 30 demo circuits which take you through assembly, operation and programming of a microcontroller.

INTERFACE PROJECTS FOR THE APPLE II
69387P \$15.95
A series of interface projects that are easily built and enable the user to realise the computer's potential through project construction. Projects are primarily hardware-oriented, with some software supporting the hardware.

PET INTERFACING
21795P \$25.25
Demonstrates how to build numerous interfacing devices for PET hardware. BASIC language programs are used throughout, and the book includes a discussion of the microprocessor's internal architecture and general hardware/software interfacing.

6809 MICROCOMPUTER PROGRAMMING AND INTERFACING, WITH EXPERIMENTS
21798P \$21.95
Gives a solid understanding of how to program and interface the high-performance 6809 microprocessor. The author completely explores internal structure, addressing modes, data movement instructions, registers, arithmetic logic and test instructions for the 6809.

Z80 MICROCOMPUTER HANDBOOK
21500P \$17.50
This thorough handbook covers hardware, software and microcomputers built around the Z80.

THE \$100 AND OTHER MICRO BUSES
21810P \$13.25
The key to successful computer expansion is a complete understanding of the bus system, through which the computer communicates with peripherals. This book will give you that understanding.

MICROCOMPUTER DESIGN AND TROUBLESHOOTING
21819P \$26.75
Tells you how to design microcomputer systems and make them work without an expensive commercial development system or the need for costly test instrumentation. The author also provides a complete description of two popular microprocessors — the 8085 and the 6502.

COOK LANCASTER'S MICRO COOKBOOK, VOLUME 1
21828P \$20.75
This 'cookbook' starts with the very fundamentals of microprocessors and microcomputers and takes you through number systems, codes, memory, etc, until you can work intelligently with micros.

MICROPROCESSOR CIRCUITS VOL. 1
21877P \$14.75
Presents basic microprocessor concepts in straightforward language for beginners. Teaches you to construct a useful microcontroller system through progressive demonstration circuits.

8080 MICROCOMPUTER EXPERIMENTS
39808A \$29.50
This 'hands on' book includes 105 experiments presenting programs and diagrams as required for clarification.

A STEP-BY-STEP INTRODUCTION TO 8080 MICROPROCESSOR SYSTEMS
39804A \$16.95
Doesn't require any electronics or computer background. This book describes the 8080 architecture and instruction set through simple examples. Some basic software is introduced.

DIGITAL CIRCUITS WITH MICROPROCESSOR APPLICATIONS
46032A \$39.50
An introductory text, this book provides readers with the basic ideas and tools needed to analyse and design digital circuits and computer systems. Discusses microprocessor computer organisation, machine language number systems and gate circuits.

MICROPROCESSOR INTERFACING TECHNIQUES
88029A \$24.95
Teaches you how to interconnect a complete microprocessor system and interface it to the usual peripherals. The hardware and software skills needed to effectively interface peripheral devices are covered along with various buss standards and A/D conversion.

PRACTICAL INTRO TO DIGITAL ICs

225B \$4.32
Introduction to digital ICs (mainly TTL 7400). Besides simple projects, includes logic test set to identify and test digital ICs. Also includes digital counter-timer.

BEGINNER'S GUIDE TO MICROPROCESSORS & COMPUTING

BP66 \$5.92
Introduction to basic theory and concepts of binary arithmetic, microprocessor operation and machine language programming. Only prior knowledge assumed is very basic arithmetic and an understanding of indices.

A MICROPROCESSOR PRIMER

BP72 \$5.92
Learning about microprocessors is easy with this book, written in a style that is easy to follow. The shortcomings of this basic machine are discussed and the reader is shown how these are overcome by changes to the instruction set. Relative addressing, index registers follow as logical progressions.

PRACTICAL COMPUTER EXPERIMENTS

BP78 \$5.92
How to build typical computer circuits using discrete logic. This book is a useful intro to devices such as adders and storers as well as a general source book of logic circuits.

THE 6809 COMPANION

BP102 \$6.56
It is not a beginners introduction to microprocessors in general but a discussion of the features of the 6809 and a reference work for the 6809 programmer in particular.

COMPUTERS & COMPUTING

YEARBOOK 1982 \$4.95
Includes disks, CP/M and your computer, learners microcomputer, programming in CHIP-8, alphasort, fast plotter, PET talk, the System 80 etc.

computing software

HOW TO WRITE AN APPLE PROGRAM

92990P \$23.25
Very much a 'how-to' book. Author assumes only a minimal familiarity with computer and BASIC. The book covers every aspect of simple program writing from initial concepts to final debugging — wittily illustrated too!

HOW TO WRITE A TRS-80 PROGRAM

92992P \$23.25
This book is virtually identical to 'How to Write an Apple Program' (92990P) described above. Changes have been made to allow for differences in the two machines and variations in BASIC. Also wittily illustrated!

HOW TO WRITE AN IBM PC PROGRAM

92991P \$23.25
See above.

USING THE UNIX SYSTEM

98162P \$24.95
This book by Richard Gauthier of RGL has been written for people with some knowledge of computers, but with no specific knowledge of Unix. It is however also of value to current Unix users.

APPLE FILES

90191P \$23.25
This book is for people who know some BASIC and would like to expand and apply this knowledge by using file capabilities of the Apple. Includes programs for the stock market, mailing lists, inventories, grades and medical records.

CP/M PRIMER

21791P \$21.95
A complete one-stop course on CP/M, the very popular operating system for 8080, 8085 and Z80-based microcomputers. Complete terminology, hardware and software concepts, startup of a CP/M system, and a complete list of CP/M-compatible software.

THE CP/M HANDBOOK (WITH MP/M)

88048A \$19.95
Contains a step-by-step description of all the CP/M command features. Designed for the beginner, the book progresses to detailed explanations of the file transfer program, the debugging program and CP/M's text editing program.

HOW TO GET STARTED WITH CP/M

39832A \$19.95
This practical book eases the reader into the essentials of the system, giving an overview of the operating system, an idea of what it will be like to use and what it can do for the reader.

AUSTRALIAN MICROCOMPUTER HANDBOOK

72505 NOW \$15.00
Normally \$25.00. A detailed buyer's guide to microcomputer systems and application packages in commercial, industrial, scientific, educational and home/hobby areas.

THE 68000: PRINCIPLES AND PROGRAMMING

21853P \$19.95
An easy-to-read, systematic approach to the 68000 advanced 16-bit microprocessor. The book guides you through the complex architecture, instruction set, pinouts and interfacing techniques. Written for design engineers, programmers and students.

PROGRAMMING IN BASIC FOR PERSONAL COMPUTERS

30739P \$14.75
Simple Instructions show how to give BASIC commands and statements a wide range of applications, from programming video games to developing business or scientific programs.

PROGRAMMABLE CALCULATORS

46008A \$24.95
This book suggests which calculators to buy, their possibilities and limitations, and the how-tos of programming them.

TAKE A CHANCE WITH YOUR CALCULATOR

39807A \$14.95
An introduction to modern mathematics, this book deals with programming of programmable calculators and includes probability problems.

AN INTRO TO BASIC PROGRAMMING TECHNIQUES

BP86 \$6.56
Ideal for beginners seeking to understand and program in BASIC. Book includes program library for biorhythms, graphing Y against X, standard deviations, regressions, generating musical note sequences, and a card game.

BASIC FOR EVERYONE

61481P \$19.75
349 pages of BASIC information for all purposes.

BEGINNING BASIC

39806A \$19.95
Intended for beginners, this book discusses how a programmer and a basic computer interact with the computer. Problems likely to be met by the beginner, the need for and uses of documentation etc.

FIFTY BASIC EXERCISES

88056A \$17.95
Designed to teach BASIC through actual practice, this book contains graduated exercises in math, business, operations research, games and statistics. The programs were designed to run directly on a TRS-80 and will run with minor or no changes on any system with Microsoft BASIC.

INSIDE BASIC GAMES

88055A \$19.95
The medium of games teaches readers how to design error-free, interactive BASIC programs. Rules, algorithms and coding differences for the PET, APPLE II and TRS-80 are also included.

MICROSOFT BASIC

39823A \$19.95
Includes branching and loops, arithmetic in BASIC, strings, editing, arrays and files, the disk and a description of the Radio Shack Level II BASIC.

INTRODUCTION TO FORTH

21842P \$14.95
The most complete book available on the MMS FORTH version of FORTH, but also a fundamental approach to programming in all versions of FORTH. Many programming examples are provided, with direct comparisons to the Microsoft Level II BASIC version of these programs.

STARTING FORTH

42922P \$23.75
A clear and complete guide to FORTH, this book covers fundamental principles and then a full set of high-level FORTH commands. It concludes with advanced techniques and style.

A FORTRAN PRIMER

80454P \$6.95
Assumes no previous knowledge of program writing. It covers the fundamentals of the FORTRAN language, enables extensive program writing and concentrates on programming style.

INTRODUCTION TO STRUCTURED FORTRAN

46007A \$19.95
Written for the beginner, the text incorporates the new FORTRAN 77 with a discussion of structural programming. Includes a discussion of time-sharing, pseudo language programming and WATFIV statements.

CP/M ASSEMBLY LANGUAGE PROGRAMMING

88250P \$20.25
This valuable guide provides the beginning computer user with a 'hands-on' method of learning assembly language programming. Very little prior knowledge is assumed either of CP/M or assembly language programming.

BEGINNING FORTRAN

46011A \$19.95
Introduces readers to FORTRAN. Included are references for further study, brief tutorials on key punching, flow charting, deck set-ups and matrix algebra.

QWIKTRAN

39824A \$19.95
Quick FORTRAN for Micros, Minis and Main Frames. Starts with the basic concepts of computing and Qwiktran, a fundamental subset of FORTRAN IV. Lots of examples to increase the reader's proficiency.

THE UCSD PASCAL HANDBOOK

35536P \$23.75
Language descriptions organised in a quick and easy reference are given in this book for readers with no prior experience of Pascal programming.

INTRODUCTION TO PASCAL

91522P \$19.95
The second edition of this popular book has been updated to conform to the new international standard of Pascal. The contents illustrate the design and construction of Pascal programs, involving a wide range of basic computer algorithms in a practical context.

PASCAL

46028A \$19.95
For people with little or no programming experience, this book gives lots of examples that clearly explain proper usage of language features. Discusses top-down programming, debugging, self-documentation etc.

THE PASCAL HANDBOOK

88053A \$23.50
This book summarises the entire Pascal vocabulary, including the variations introduced by different commercial versions of Pascal. All in dictionary format.

PASCAL PROGRAMS FOR SCIENTISTS AND ENGINEERS

88058A \$23.50
Over 60 of the most frequently used scientific algorithms, along with their program implementation in Pascal, are in this book.

TRS-80 COLOUR COMPUTER GRAPHICS

97864P \$21.95
Explore the creative and imaginative blending of computers and colour. Shows how to create dynamic and interesting graphics to enhance your own computer programs.

STARSHIP SIMULATION

39810A \$11.95
This book offers both a specific simulation which can be implemented, modified and played, and a complete look at how to put together a simulation on almost any subject.

BASIC PROGRAMS FOR SCIENTISTS AND ENGINEERS

88073A \$19.95
This book contains scientific and engineering application programs written in BASIC.

COMPUTER GRAPHICS PRIMER

21650P \$21.95
Almost every page has a colour drawing, photograph, picture or a schematic to help you learn computer graphics quickly and easily. Programming concepts apply to all microcomputers, and examples are given in BASIC for the Apple II.

INTRODUCTION TO TRS-80 GRAPHICS

39818A \$17.95
It begins with the basic concepts of line drawing and leads the reader on to geometric shapes, moving figure animation and other more advanced topics.

CIRCUIT DESIGN PROGRAMS FOR THE TRS-80

21741P \$21.75
A number of programs written to aid you in using your TRS-80 and Level II BASIC for the design and analysis of many electronic circuits. The programs analyse information on ms values, periodic waveforms, integrated circuit timers and bipolar transistor circuits.

MOSTLY BASIC: APPLICATIONS FOR YOUR TRS-80

— BOOK 1 21788P \$19.25
28 ready-to-use BASIC programs which have been completely tested and debugged. Programs include a telephone dialler, digital stop-watch, spelling test, house buying guide, gas mileage calculator, and others. Complete with explanations of each program, sample runs, and complete program listing.

MOSTLY BASIC: APPLICATIONS FOR YOUR TRS-80

— BOOK 2 21865P \$19.25
32 ready-to-run BASIC programs, including two to test your ability in history and maths, a Dungeon of Danger that's strictly for fun, eleven household programs, seven on money and investment, two to test your ESP level, and more. Complete with explanations, sample run and listing for each program.

INTERMEDIATE PROGRAMMING FOR THE TRS-80

MODEL I 21809P \$14.95
Step-by-step instructions for the TRS-80 user who wants to progress from BASIC to machine and assembly language programming with the TRS-80 Model I system. A complete how-to guide with numerous examples.

... and for good measure...

computing for business

TRS-80 — MORE THAN BASIC

21813P \$15.95
Learn to program in Z80 mnemonics by using the book's error-tolerant interactive monitor program. Over 26 commands available, with total documentation that helps you change the commands to meet specific applications.

TRS-80 ASSEMBLY LANGUAGE MADE SIMPLE

21851P \$19.25
If you have an understanding of BASIC programming, this book will help you learn to plan, write and hand-assemble your own assembly language programs in memory, using the T-bug and Level II BASIC ROM subroutines.

PROGRAMMING THE TRS-80 POCKET COMPUTER

30531P \$13.25
This book explains all aspects of problem-solving in BASIC, and covers cassette machine interfacing and how to make the best use of the system's keyboard and display.

TRS-80 ASSEMBLY LANGUAGE SUBROUTINES

31188P \$19.25
A wide spectrum of applications is discussed in this book, which provides easy-to-use routines that can be used as they stand or modified.

32 BASIC PROGRAMS FOR THE TRS-80 COMPUTER

39827A \$29.50
Programs for the TRS-80 Level II or Model III BASIC (with 16K or more user memory).

APPLE BASIC

39099P \$19.25
This book gives the beginner a thorough introduction to BASIC programming on an Apple computer, and covers all areas of programming, including graphics, games, mathematical programs, and a great deal more.

CIRCUIT DESIGN PROGRAMS FOR THE APPLE II

21863P \$23.75
A series of ready-to-run Apple II programs ideal for electronics design engineers and others faced with solving problems related to plotting and verification of experimental data. The programs may be used as sub-routines in larger programs, and many can be translated to run on other microcomputer systems.

APPLESOFT LANGUAGE

21811P \$13.95
Written for Apple II micros that use the Microsoft language, this introduction covers each aspect of programming in non-technical language, from elementary concepts to advanced techniques.

APPLE MACHINE LANGUAGE

90230P \$21.95
This straightforward book teaches machine language programming through BASIC, the transition being made step-by-step. Many sketches of video displays are provided, as well as exercises with answers.

APPLE PASCAL GAMES

88074A \$19.95
Explore all the essential elements of UCSD Pascal and learn the important Apple Pascal extensions.

PASCAL PROGRAMMING FOR THE APPLE

95454P \$18.95
This book teaches UCSD Pascal on the Apple II. Many examples, programs for financial applications, graphics, file structures and sound reproduction are supplied.

32 BASIC PROGRAMS FOR THE APPLE COMPUTER

38834A \$29.50
Full of programs with practical applications, educational uses, games and graphics.

PET/CBM BASIC

61751P \$19.25
This book provides a thorough introduction to BASIC programming on a PET computer, explaining programming concepts for graphics, including three-dimensional letters, bar graphs and the use of sound effects in PET programs.

THE PET PERSONAL COMPUTER FOR BEGINNERS

61827P \$20.95
This handy guide is written for use with all varieties of PET computer, from the original 2001 to the new 8032 Super PET. It is suited to novices with no practical experience and provides advice and practical examples.

PET BASIC 1

95524P \$19.25
For users of the PET computer, this book covers such topics as creative graphics, humour and interesting small programs.

PET GAMES AND RECREATIONS

95529P \$18.85
Presenting an interesting mixture of diversions guaranteed to entertain and educate. Ideal for beginners, yet also challenging to computer veterans, the book features progressive levels of difficulty and five different types of games.

32 BASIC PROGRAMS FOR THE PET COMPUTER

39825A \$29.50
Each chapter fully documents a different bug-free program. If readers have a good working knowledge of BASIC, they can devise and implement their own program changes.

THE ATARI ASSEMBLER

90236P \$19.25
This practical book gives detailed instructions for using the Atari Assembler cartridge for novices with some knowledge of BASIC programming. Fundamental information programming in assembly language is given.

ATARI GAMES AND RECREATIONS

90242P \$19.25
Beginners and advanced users can use the pre-programmed games in this book to improve their skill. Charts, flash cards, an error dictionary and graph paper designs are among the features.

EXPLORE COMPUTING WITH THE TRS-80 (AND COMMON SENSE)

96137P \$17.95
This introduction to microcomputers and the BASIC language is suitable for novices and users of the TRS-80. Among the topics covered are creating tables, arts and graphics, games and simulation.

32 BASIC GAMES FOR THE EXIDY SORCERER

39835A \$29.50
Full of programs with practical applications, educational uses, games and graphics. Each chapter documents a different bug-free program.

THE ART OF PROGRAMMING THE 1K ZX81

BP109 \$6.56
This book explains how to use the features of the ZX81 including its random number generator, graphics and timer. PEEK and POKE are explained and you should learn enough to develop programs of your own.

PROGRAMMING THE 6502

88046A \$18.95
Principles of assembly language programming for the 6502 microprocessor are taught in this introductory text. Includes a discussion of trade-offs between hardware and software and detailed explanations of the 6502's internal registers and bus operation.

6502 APPLICATIONS BOOK

88015A \$17.95
Use this book and a few low-cost components to build a complete home alarm system, an electric piano, a motor speed-regulator, a time-of-day clock, a simulated traffic control system and a Morse code generator, etc.

6502 GAMES

88023A \$17.95
You learn how to play ten sophisticated games and also learn assembly language programming. Also learn the techniques of algorithm design and data structures.

8080 MACHINE LANGUAGE PROGRAMMING FOR BEGINNERS

39814A \$12.95
The book will take the reader step-by-step through the most common 8080 op codes and it will do so at a level anyone can understand.

PROGRAMMING THE Z80

88047A \$19.95
This book will enable every reader to write complete application programs for Z80-based computer systems. Includes exercises to measure progress and comprehension at each level of programming.

PROGRAMMING THE Z8000

88072A \$19.95
A complete introduction to programming concepts and techniques for use with the 16-bit, Z8000 microprocessor. Presents detailed descriptions of the architecture and functions of this 'super chip'.

START WITH BASIC ON THE COMMODORE VIC 20

97070P \$14.75
Helpful exercises and step-by-step instructions show you how to program in BASIC utilising all the graphic functions on the Vic 20.

BASIC FOR ACCOUNTANTS

80098P \$9.95
Shows accountancy students and accountants how to use a computer to perform the repetitive tasks associated with record keeping, calculating and report writing. Using the BASIC language attention is concentrated on debtors, inventory and general ledger systems.

COMPUTER BASED BUSINESS SYSTEMS

80192P \$10.95
A short introduction to the sorts of systems used by a typical business to handle its typical activities. The book aims at providing a general understanding and therefore avoids technological detail.

THE COMPUTER SOLUTION

80195P \$13.50
It should be of interest to business people contemplating, implementing or already using computer data processing or to any non-technical person curious to know why and how computers are used in Australian businesses and organisations.

SMALL BUSINESS COMPUTERS: A GUIDE TO EVALUATION AND SELECTION

81134P \$14.95
Ideal for the inexperienced user, this text emphasises management considerations in determining the feasibility, economics, evaluation, selection, contracts and practicality of installing a computer.

SMALL BUSINESS COMPUTER SYSTEMS

81136P \$14.95
This book provides a bridge between the accountant and the DP professional by explaining every step of the trading and reporting process in DP terms. It is especially useful to people engaged in the specification process or in auditing DP accounting systems.

THE VISICALC BOOK — APPLE EDITION

98397P \$22.25
If you are using Visicalc on your Apple II and want to learn more about its expanded uses then this book will show you how to build a model, enter your data and solve problems about profit/loss projections, pricing/costing estimates etc.

THE CP/M HANDBOOK (WITH MP/M)

88048A \$19.95
Containing a step-by-step description of all the CP/M command features, the book progresses to detailed explanations of the file transfer program, the debugging program and CP/M's text editing program.

YOUR FIRST COMPUTER

88045A \$12.50
A beginner's guide to small computers, understanding them, buying them and using them for personal and business applications. Includes peripherals, languages and application packages.

DON'T (OR HOW TO CARE FOR YOUR COMPUTER)

88065A \$16.95
A guide to computer and peripheral preservation. Specific advice for the computer, floppy disks, hard disks, the CRT terminal, the printer, tape units, the computer room, software and documentation are included.

INTRODUCTION TO WORD PROCESSING

88076A \$17.95
Written for the non-technical reader, this book tells about concepts common to all word processing systems, then analyses all features in detail, from screens to scrolling and formatting.

SMALL COMPUTERS FOR THE SMALL BUSINESSMAN

39831A \$24.95
The book tells readers how and where to shop for a computer successfully: what to expect their computer to do for them; how to select software; whether or not to use a consultant; how to introduce the computer to the staff and how much computer is necessary.

INVENTORY MANAGEMENT FOR SMALL COMPUTERS

39848A \$24.95
Owners of retail businesses and their employees need this book. The program provides an inventory control system so that you know what stock is on hand, where it is located, what price was paid for it and the selling price.

BASIC FOR BUSINESS FOR THE TRS-80

90352P \$22.25
This book covers the application of BASIC language to business uses on the TRS-80 models II and III.

FROM THE COUNTER TO THE BOTTOM LINE

39811A \$24.95
A demystifying guide to basic accounting needs and computer use. Includes inventory and purchasing, billing, accounts receivable, accounts payable and general ledger.

THE OFFICE AUTOMATION PRIMER

077P \$15.50
 Guides the user step by step through all aspects of planning, evaluating and installing stages. Lively vignettes illustrate how automation increases productivity in word and data processing, photocomposition, electronic mail, telecommunications, scheduling and message switching. Probably the most comprehensive guide of its kind for every manager seeking to maximise productivity and profitability.

**amateur radio, DX,
 communications**

TUBE SUBSTITUTION HANDBOOK

21746P \$8.75
 Complete, accurate, up-to-date guide to direct substitutes for receiving and picture tubes. Contains over 6000 receiving tube substitutes, over 4000 monochrome and colour picture tube substitutes, and 600 communications substitutes. Also includes pinouts for quick operational checks.

RF CIRCUIT DESIGN

21868P \$33.95
 A practical approach to the design of RF amplifiers, impedance-matching networks and filters. Uses a minimum of complex maths.

COMPUTERS AND THE RADIO AMATEUR

66306P \$28.00
 For the radio operator who wants to know how computers function and how they can be used with other equipment.

SOLID STATE SHORT WAVE RECEIVERS FOR BEGINNERS

222B \$4.32
 Design and construction of several solid-state shortwave receivers giving high level of performance yet utilising relatively few inexpensive components. See also 226.

LONG DISTANCE TV RECEPTION (TV-DX)

BP52 \$6.56
 Written by UK authority, the book includes many units and devices made by active enthusiasts. A practical and authoritative intro to this unusual aspect of electronics.

HANDBOOK OF RADIO, TV, INDUSTRIAL & TRANSMITTING TUBE & VALVE EQUIVALENTS

BP2 \$2.25
 Equivalents book for amateurs and servicemen. More than 18 000 old and new valves from UK, USA, Europe, Japan et al. CV (military) listings with commercial equivalents included.

RADIO STATIONS GUIDE

BP55 \$5.92
 This is an aid for all those who have a radio receiver. Shows the station site, country, frequency and/or wavelength, as well as Effective Radiation Power of the transmitter and in some cases, the station's call sign as well.

AN INTRODUCTION TO RADIO OXING

BP91 \$6.56
 One section is devoted to amateur band reception and the other section covers broadcast band reception, with advice on suitable equipment and the techniques employed when using that equipment. The construction of a number of useful accessories is described.

AERIAL PROJECTS

BP105 \$6.56
 Practical aerial designs including active, loop and ferrite which are relatively simple and inexpensive to build. The complex theory and mathematics of aerial design have been avoided.

general

TELEMATIC SOCIETY

02460P \$17.50
 An extensive update of 'The Wired Society', this book demonstrates how developments in telecommunications will affect the way we live.

INTRODUCTION TO AUTOMOTIVE SOLID-STATE ELECTRONICS

21825P \$14.95
 For the professional as well as the home mechanic — explains the functions of most on-board automotive brake boxes and logic systems, including anti-skid braking, electronic spark control, diagnostic systems and trip computers.

EXPERIMENTS IN ARTIFICIAL INTELLIGENCE FOR SMALL COMPUTERS

21785P \$13.25
 Artificial intelligence is the capability of a device to perform functions normally associated with human intelligence. With this book, a small computer with extended BASIC and some knowledge of BASIC language, you can conduct interesting and exciting experiments in artificial intelligence.

ELECTRONIC SECURITY DEVICES

BP56 \$9.92
 Besides including both simple and more sophisticated burglar alarm circuits using light, infrared and ultra-sonics, this book also gives circuits for gas and smoke detectors, flood alarms, fire alarms, doorphones, baby alarms, etc.

ELECTRONIC CALCULATOR USERS' HANDBOOK

BP33 \$5.12
 Presents formulae, data, methods of calculation, conversion factors, etc. for use with the simplest or most sophisticated calculators. Includes the way to calculate using only a simple four-function calculator: trigonometric functions; hyperbolic functions; logarithms; square roots and powers.

YOUR ELECTRONIC CALCULATOR AND YOUR MONEY

BP54 \$4.64
 Starts with a basic revision of percentages and decimals, then deals with mortgages, cars, insurance, fuel, shopping, tax etc. There's a section on investment and the last section deals with the calculator in a small business.

ORDER FORM

Send to ETI Book Sales, 140 Joynton Ave, Waterloo NSW 2017.

Allow 4-5 weeks for delivery. Post & Handling \$1 per book. Effective until June 30, 1983

Please supply:

BOOK TITLE	BOOK NO.	QTY	TOTAL PRICE
.....
.....
.....
.....
.....
.....
.....
.....
.....
.....

Post and handling

I enclose TOTAL \$

Name: Please debit my Bankcard American Express Card Expiry Date

Address: Number

Postcode Signature

MINI-MART

Where readers can advertise —
For Sale/Wanted/Swap/Join

● We'll publish up to 24 words (maximum) totally free of charge for you, your club or your association. Copy must be with us by the 1st of the month preceding the month of issue. Please — please — print or type adverts clearly, otherwise it may not turn out as you intended! Every effort will be made to publish all adverts received; however, no responsibility for so doing is accepted or implied. Private adverts only will be accepted. We reserve the right to refuse adverts considered unsuitable.

● Conditions: Name and address plus phone number (if required) must be included within the 24 words. Reasonable abbreviations, such as 25 W RMS or 240 Vac, count as one word. Adverts must relate to electronics, audio, communications, computing etc — general adverts cannot be accepted. Send your advert to:

ETI Mini-Mart,
140 Joynton Ave, Waterloo NSW 2017.

AUDIO

FOR SALE: AMPLIFIER, SANSUI AU-D9, super feedforward dc amp, moving coil input, 90 WRMS/ch, 20 Hz to 20 kHz, THD 0.005%, IMD 0.007%. Brand new sacrifice \$640 ono. (02)896-2975.

FOR SALE: PAIR 100 litre speaker boxes, high density particle board, uncut front baffle, suitable any 100 litre speaker kit. T. Hunter, (08)356-4111 (9 am — 4 pm).

FOR SALE: STEREO ACTIVE crossover, (2-4 way) adjustable frequencies, 24 dB Butterworth filters using NE5534AN. One third octave equaliser less than 100 Hz to correct bass speaker roll off. Separate power, \$550. (03)439-9138.

FOR SALE: MERIDIAN 101 pre-amp with moving coil module. Mint condition, only \$360. Adelaide (08)276-4691.

AUDIO SPECTRUM ANALYSER: stereo, 20 Hz to 200 kHz, Merguro-Mat 140. Ideal for testing performance of amplifiers, pre-amps etc. New price \$3600, sacrifice at \$890 ono. (02)896-2975.

ETI SYNTHESISER: Black anodised metalwork, 8 VCO, 4 VCF, 6 channel mixer, 5 VCA, 6 ENV, 2 trans, noise, numeric k/b pad, 20 x 40 patch board, exclusive bass pedals, 61 note k/b, extra 2 VCO, 10 VCA, PSU. \$2200. (03)531-3207.

RODGERS HG 88 valve amplifier: Phono/aux/tuner/tape input. 17 W/ch complete with circuit diagram and spare tubes. \$80 ono. (02)896-2975.

COMMUNICATIONS

FOR SALE: DRAKE TR7 transceiver 12 months old. Used for receive only. Fitted with AUX-7 and three band change modules. Covers 0-30 MHz, \$1550 ono. (09)457-3869.

MISCELLANEOUS

WANTED TO BUY: DK40 electron valve, new or used. Price etc. P.O. Box 2, Blaxland NSW 2774. (047)39-2464 any time.

SELL: PAST ISSUES of Electronics Today International and other 'electronic' magazines. Con Engel, P.O. Box 132, Enfield NSW. (02)73-1060 ah or (02)230-6812 bh.

FOR SALE: TAPE punch and tape reader. Offers. G. Cornwell, Ainslie Village, c/- Bag Service, Canberra City ACT. 2601.

SWITCHING POWER SUPPLY: good condition. Input 90-130 V. Output +5 V/30 A, +15 V/11 A, -12 V/4 A. Replacement value \$670, sell \$90. R. Barrie, P.O. Box 363, Dee Why NSW 2094. (02)938-1634.

SELL: OSCILLOSCOPE, Trio CS-1560A/II, dc — 15 MHz, 10 mV/div. Add/subtract, X-Y single and dual trace modes. One probe, very good condition, \$450. Brisbane (07)391-8145 ah.

FOR SALE: ELECTRONIC data manuals and reference books. Cheap. (02)73-2461.

FOR SALE: TRAIN SET Hornby/Lima, two engines, five carriages, 20 metres track, nine points, clipper transformer. \$95 ono (new \$240). R. Kermod, (051)47-1389 5-6 pm.

SWAP: COLOUR TV, stereo, computer with printer for any old government surplus gear. Will separate. Wayne (02)668-9616 after 4pm weekdays.

WANTED: TEST equipment, parts etc, suitable for TV repair shop. P. Domaschen, 181 Long St, Hervey Bay Qld 4655. (071)28-1531.

FOR SALE: OSCILLOSCOPE, small size, excellent condition, single beam, no further use to owner, \$80. (02)637-4741.

COMPUTERS

MICROBEE SOFTWARE, inventory, games pack, Robot attack. All \$10.50 including tape and postage. Write Tim Buchalka, 1 Arbor St, Mt Gambier SA 5290. (087)25-4196.

FOR SALE: FLOPPY disk controller board, suit up to three Schugart SA400 drives. Brand new, with manual \$120 ono. (02)357-6783 ah.

SORCERER OWNERS: COGNIVOX voice recognition unit. As new with manual, cost \$200, sell \$140. (02)357-6783 ah.

SELL: FOUR DEC RK05 disk cartridges, \$50 each. Good condition. (02)357-6783 ah.

PRINTERS: CENTRONICS 737 needs repair, \$300. Teletype KSR33, 110 V, \$100. Microline 82A, \$100. Votrax type 'n' talk speech synthesiser, \$500. Theo (02)807-3961.

FOR SALE: A LIMITED number of a very difficult-to-get chip, AY-5-2376 keyboard encoder plus data sheet. \$10 + \$2 p+p. (02)78-6249 ah.

FOR SALE: ZX 80/81 printer c/w instruction manual plus full roll metalised paper. New \$150, sell \$100 ono. P. Gray, 19 Wallace St, Kotara NSW 2288. (049)57-3354.

SIGNETIC 2650 microprocessor, 8K RAM, 1K PIPBUG ROM, pc board for further expansion available. Price includes VDU terminal and cassette interface plus software. \$190 ono. Ken George (03)878-7574.

MICROBEE 16K PLUS, B&W monitor and tape recorder, as new. \$530. Mathew (02)663-0651 ext 53.

\$100 MICROCOMPUTER: Has DG680 CPU, DG640 VDU, PCG, 8K RAM, programs, calculators, cassette player. Complete working unit in calculator style case. \$495 ono. Steve (08)225-6833 bh.

MICROBEE 16K with Kaga hi-res green monitor. Near new, excellent condition. Sell both for \$650. (02)798-7141 after 4 pm.

LUNAR LANDER \$8. Solar System model \$15, including Lander. ZX assembler for ZX81, 16K \$15. P. Connor, P.O. Box 1, Kuranda Qld 4872.

ATTENTION, SORCERER MK2 48K with quad disk drive. CP/M 2.2, great word processor, green screen and heaps of software. Cost \$5500, sell \$2200. Warranty. (02)449-3647.

FOR SALE: ONE ADom terminal, 75-9600 baud, RS232C. Dual printer interface, 80 x 16 display, good condition, \$200. John Baird (02)871-6277 ah.

SELL: SS50 CPU, SWTP 6800, MIKBUG ROM, factory assembled, fully gold socketed with complete documentation, baud rates to 9600. \$95 (posted). (051)56-8291.

\$100 BOARDS: TCT RAM card with 64K fitted, \$295. TCT PROM card takes 2708 through to 2532/2732 up to 64K, \$80. Phone (02)888-7624.

FOR SALE: TANDY plotter/printer, brand new. Two rolls of paper, dust covers, service manual, \$1000. Paul Fuller, 24 Penman St, New Lambton NSW 2305. (049)57-2409 weekends.

FOR SALE: OSBORNE hard disk, Winchester technology, 12 Mb storage. (058)62-1407 ah.

MICROBEE USERS GROUP: Frenchs Forest area, Sydney. Anyone interested in forming a group contact David (02)452-3156.

SELL: TWO ETI-660, both 6K RAM, in cases, one colour, one B/W, neither working. \$90 and \$80 respectively. Phone (frustrated) Barry (03)557-5945 ah.

FOR SALE: \$100, DG680 CPU, DG640 VDU, 2 x 16K RAM cards, 12K ROM BASIC, cassette interface, power supply, keyboard, fully operational, manuals incl. \$800. (02)599-4195 bh.

FOR SALE: MICROACE, 2K RAM, normal-inverse video switch, manual, leads, tapes, joystick. \$160. (03)277-6987.

SELL: 24K MEMORY and expansion unit for VIC-20 computer. Bargain at \$180. (03)221-7191.

FOR SALE: APPLE HARDWARE with documentation. Language card \$200. Zev. 80 x 24 video card \$250. Communication card \$100. Disk interface card \$150. RS-232 card model 7710 A \$150. Graphics tablet interface card \$150. Sell individually or as whole package for \$850. (050)23-5144 bh or (050)25-3258 ah.

FOR SALE: MICROBEE 16K Trek. Warp, impulse engines, multiple torpedoes, shields. Aggressive enemy etc. \$6. Glenn Self, 27 Borden St, Maddington WA 6109.

FOR SALE: SYSTEM 80 with sound, manuals, games, books, bandwidth monitor. Everything \$550. 119 Edwardes St, Deniliquin NSW. (058) 81-1485 after 6 pm.

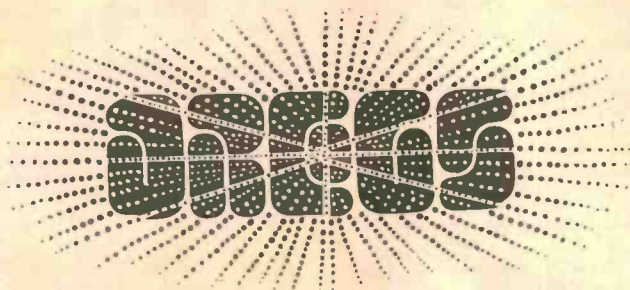

IF YOU HAVE WORKED, or are now working, in any aspect of research and development — be it electronics, physics or whatever — then no doubt you have suffered the frustrations of administrative cutbacks and frugality over the past half dozen years.

From the research worker's point of view, a certain amount of administrative 'impedance' is always expected and encountered. But recently the value of 'Z' has risen, eh?

It seems that Gerhard Herzberg of Canada's National Research Council has found a way to quantify administrative impedance. He claims that, irrespective of a researcher's brightness, his current output is inversely proportional to the administrative impedance placed in his path. Sounds familiar? Let's write that as an equation.

$$I_{\text{output}} = \frac{\text{Potential}}{\Sigma Z_{\text{admin.}}}$$

(Σ = 'sum')

Looks remarkably like Ohm's law, doesn't it? Herzberg says that $\Sigma Z_{\text{admin.}}$, the 'bureaucracy factor', reduces I_{output} by as much as 50 per cent, which is diametrically opposed to what one would want in an ideal world.

What can be done to reduce the effects of administrative impedance? How about applying a bit of ac theory — remember what it says about increasing admittance as the frequency reduces? If you think of the administration as applying 'interference' at a certain frequency, then think about means of reducing the frequency . . .

The laws of nature

One of the first laws of nature one learns, whether one is a science student or not, is **Murphy's Law**, which states that if anything can go wrong, it will (. . . see!). However, there are a number of concomitant laws, which, although they affect our everyday existence, are not so well observed or publicised. For the edification of all then, here they are:

Mrs Murphy's Law: "Murphy was always the optimist".

Jenkinson's Law: "It will never work".

Sattinger's Law: "It works better if you plug it in".

The Harvard Law: "Under rigorously controlled conditions the device will do what it damn well pleases".

Pudder's Law: "What begins well, ends badly", and the corollary: "What begins badly ends badly".

Smith's Law: "The man who smiles when things go badly . . . has thought of someone to put the blame on".

(Thanks to 'Radio Communications', journal of the RSGB, Break-In, journal of the NZART, and a series of anonymous authors for the wisdom of that lot.)

This remarkable amplifier was developed over 95 years from a primitive reed organ.

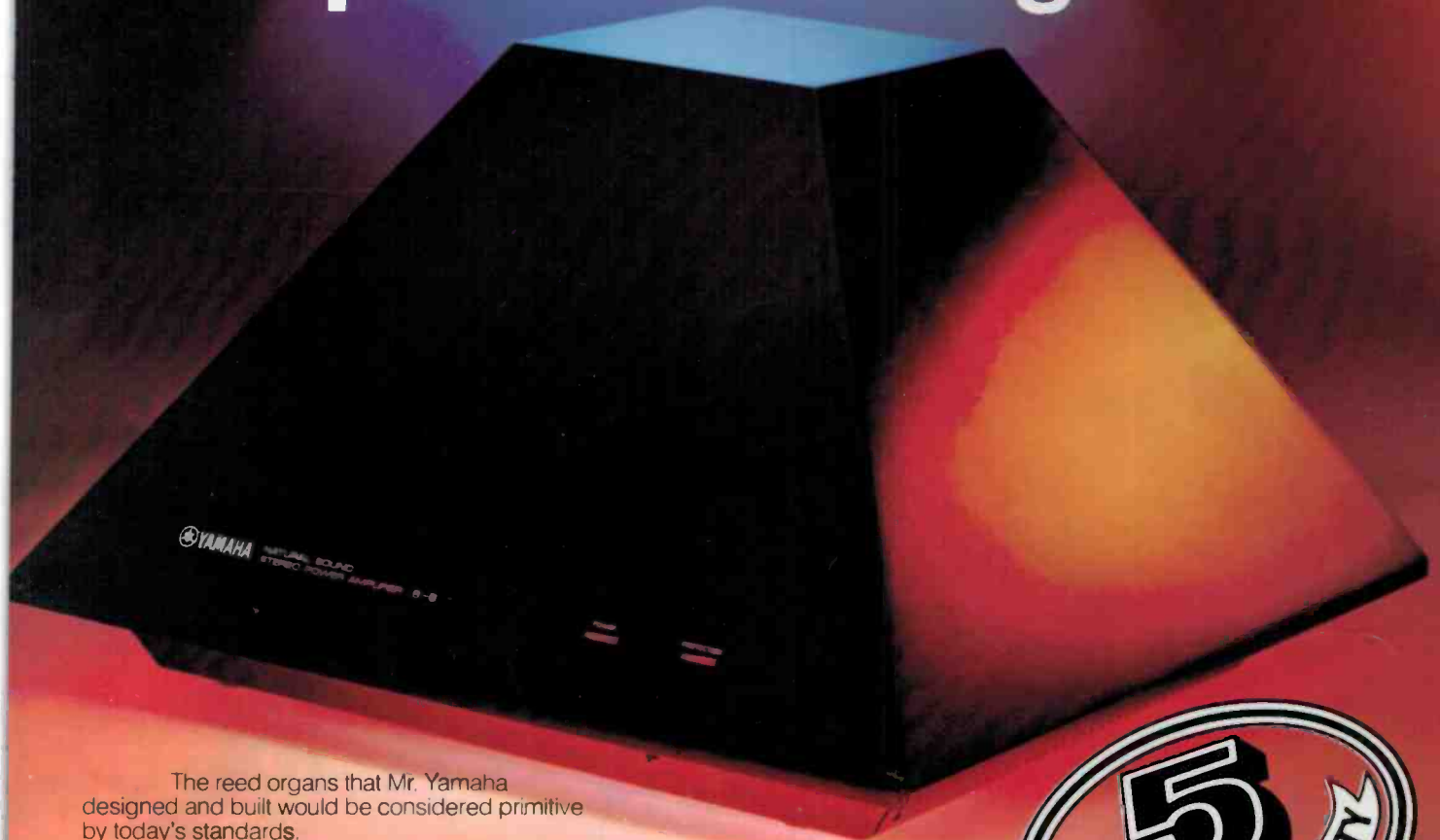

The reed organs that Mr. Yamaha designed and built would be considered primitive by today's standards.

But in 1887 they were hailed as the world's finest.

Since then, Yamaha has become the world's largest maker of high quality musical instruments; from flutes to flügel horns, from clarinets to concert grands.

But our audio equipment is perhaps our proudest achievement.

The pyramid-shaped B-6 amplifier illustrated above for instance, is just as much 'state-of-the-art' now as Mr. Yamaha's reed organs were 95 years ago. And though technology has changed, the Yamaha principle hasn't.

All of our audio equipment, just like our fine musical instruments, is designed, crafted and ruthlessly tested by musicians. Just like our reed organs almost a century ago.

Indeed, the trained ear rather than a computer will always be the final arbiter of perfection.

And naturally the perfection that our musicians require and that our heritage demands, cannot be achieved by cutting corners or trimming costs.

Which may explain Yamaha's premium pricing and the full five year warranty we give all our audio equipment.

Simply, Yamaha precision audio equipment will reward those whose passion for perfection matches their means with a lifetime of the finest, most natural sound reproduction.

Please send me the latest Yamaha Hi-Fi Catalogue

Name

Address

Send to: Yamaha Hi-Fi Catalogue,
Rose Music Pty. Ltd., 17-33 Market Street,
South Melbourne Vic. 3205



SONY
THE ONE AND ONLY

The Sony CDP101

The magic of digital audio becomes a magnificent reality.

Digital Audio is a revolution. The greatest advance in home music reproduction since the gramophone record. As you'd expect, Sony is the leader of this revolution with its magnificent CDP-101 player that offers you original studio master quality at home.



For the technically minded, the specifications read more convincingly than any superlatives

- flat frequency response over the entire audible range
- dynamic range and signal to noise ratio over 90dB
- perfect channel separation
- immeasurable wow and flutter
- negligible distortion.

Sony's CDP-101 uses an optical laser pick-up (incorporating three micro processors), it is easier to use than a conventional turntable and connects easily to your existing system.

Other features include

- fully automatic linear skate front disc loading

- automatic music sensor
- dual function digital readout of playtime
- audible fast forward and reverse
- 10 function wireless remote control.

Compact Discs Last Forever

Just 12 cms in diameter, the Compact Disc plays up to 60 minutes of music. It's protected from scratches, dust and finger prints by a plastic coating; and because the pick-up is a laser beam, deterioration is non-existent. Reproduction remains perfect virtually forever.

Hundreds of titles will be available with many more to follow from major companies such as CBS.

CDP-101 Specifications

Frequency Range	5Hz-20kHz \pm 0.5dB
Dynamic Range	more than 90dB
S/N	more than 90dB
Channel Separation	more than 90dB (at 1kHz)
Harmonic Distortion	less than 0.004% (at 1kHz)
Wow and Flutter	immeasurable



Contact Sony for the name of your nearest dealer.

Sydney (02) 266 0655, Adelaide and N.T. (08) 212 2877, Brisbane (07) 44 6554, Perth (09) 323 8686, Melbourne (03) 419 3133, Launceston (003) 44 3078, Wollongong (042) 715777.

AUD0378