

JUNE 1982



**ELECTRONICS TODAY INTERNATIONAL**

\$2.15\* NZ \$2.50

**150W Public  
Address Amp  
Project**

# *Ghost Writers in the Sky!*

**Getting the Turtle  
Robot Going**

**CHIP 8 Programs  
for ETI-660 & VIP**

**ZX Printer Reviewed**

**DBX-Challenge to Digital**

**Sequencer for Our Percussion Synth**

**Making Things Move *Very Fast!***



## The Sansui XR-Q7 with the Silent Synchronotor System—a direct-drive turntable that doesn't sound like one.

Today's finest direct-drive turntables are marvelous pieces of engineering, providing uncanny speed accuracy, high reliability and great specs. But even the best of them is plagued by cabinet vibration, a phenomenon brought about by the action-reaction torque generated by the motor's servo system. Cabinet vibration, when passed onto the tonearm, lends an unpleasant muddiness to overall sound quality, and also affects stereo imaging. Many spare-no-expense audiophiles are aware of this problem and often opt for belt-drive systems, accepting a little higher wow and flutter in exchange for better overall

sound quality.

Sansui has a solution to this problem. It's called the Silent Synchronotor System. And it's found only in the new XR-Q7 turntable. What it does is cancel vibration right at the source by means of a counter-rotating "synchronotor" located directly under the drive motor. Vibration never has a chance to reach the tonearm and affect sound quality.

If you demand exceptionally low wow and flutter (the XR-Q7 is rated at 0.009%) and the smoothest, clearest sound around, the new fully automatic XR-Q7 from Sansui is your *only* choice.



SANSUI ELECTRIC CO., LTD. 14-1 Izumi 2-chome, Suginami-ku, Tokyo 168 Japan  
VANFI (AUST.) PTY. LTD. 297 City Road, South Melbourne, Victoria 3205, Australia Tel: 690-6200  
283 Alfred Street, North Sydney, N.S.W. 2060, Australia Tel: 929-0293

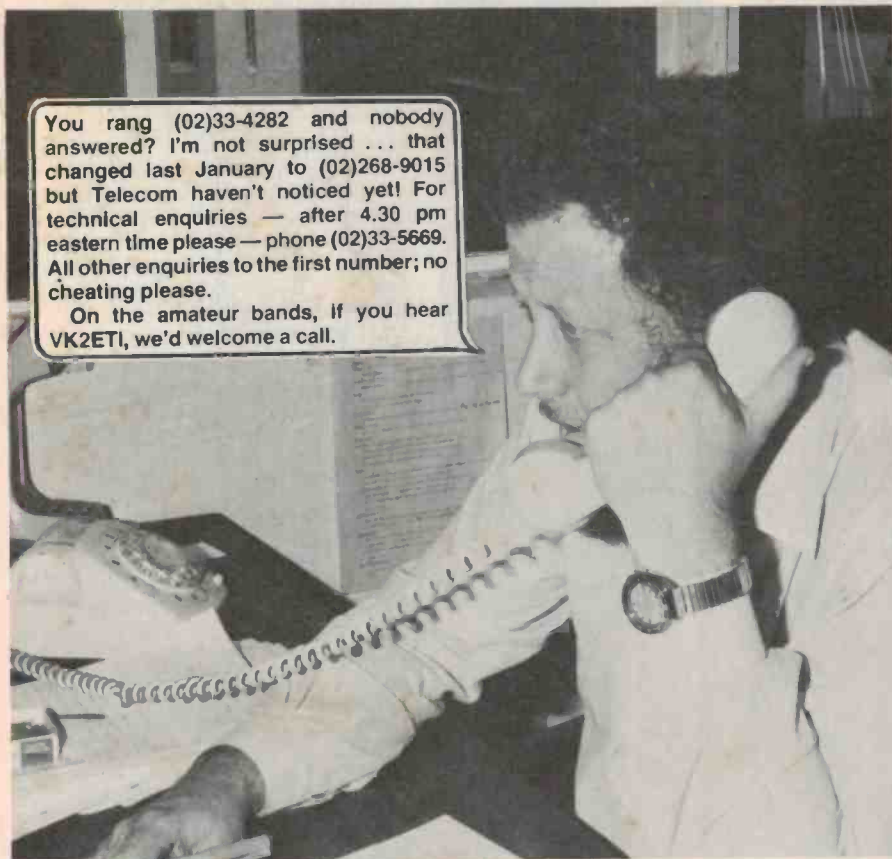

You rang (02)33-4282 and nobody answered? I'm not surprised ... that changed last January to (02)268-9015 but Telecom haven't noticed yet! For technical enquiries — after 4.30 pm eastern time please — phone (02)33-5669. All other enquiries to the first number; no cheating please.

On the amateur bands, if you hear VK2ETI, we'd welcome a call.

Roger Harrison  
Editor

## QUICK INDEX

### FEATURES

- 6 Ghost Writers in the Sky
- 20 How to Make Things Move Very Fast
- 30 Light & Power from dc Supplies
- 47 Tasman Turtle Robot Kit Offer
- 49 Turtle Demonstrations — details
- 79 'Idea of the Month' Contest
- 154 Dregs

### PROJECTS & TECHNICAL

- 42 645: Tasman Turtle Robot
- 54 498: Public Address Amp.
- 67 496B: Sequencer for Percussion Synth.
- 38 Lab Notes: The Exclusive-OR Gate
- 74 Ideas For Experimenters
- 84 Short Ccts: Centre Zero LED Meter
- 81 Shoparound

### COMPUTING TODAY

- 87 System 80 Contest Winner
- 89 Printout — News & Views
- 92 CHIP-8 Column
- 98 Alternative Pocket Computer Printer
- 103 Apple Graphics Guide
- 110 '660 Software
- 116 Ohio & UK101 Graphic Details
- 121 Hard Copy for your Sinclair

### SIGHT & SOUND

- 127 Stereo TV Sound Proposals
- 132 Sight & Sound News
- 134 dbx — Challenge to Digital?
- 142 Pioneer A-8 Amp Review

### GENERAL

- 6 News Digest
- 49 Turtle Robot Demonstrations
- 62 Babani Books — mail order
- 83 Communication News
- 96 Mini-Mart — Readers' Adverts
- 152 ETI Credits & Services

# advertisers

Abacus	88
Australian Government	37,138,139
Applied Technology	90,91,112,113
Altronics	60-61
Adaptive Electronics	88
All Electronic Components	36
AED	120
A & R Soanar	18
Bishop Graphics	41
Bright Star Crystals	84
Communications Power Inc	126
Consolidated Marketing	29
Commodore	86
Computer City	97
Computailor	96
Computer Country	102,108
Circuit Techniques	148
CP/M Data Book	25
Convoy	128,129,132,133,136
Dick Smith	8,9,10,11,26,27,34, 50,52,53,70,71,76,84,97, 118,119,123,140
Danish Hi-Fi	148
Electronic Agencies	73
Erona	72
Energy Control	97
Electromedical	93
Electrocraft	128
Emac	128
Electronic Developments	81
Flexible Systems	51
G.F.S.	72
Hitachi	141
Imark	73
Jaycar	16,17,66
John F. Rose	OBC
Kalex Electronics	73
Microgear	95
Magnetic Media	94
Magraths	33
Marantz	130
Maurice Chapman	131
Mini Tools	124,125
McWilliams	153
National Panasonic	150-151
Peterson	145
Philtronics	97
Philips	75,78
Powerchip Software	97
Q.T. Computers	114
Rod Irving	19,64,80,109,115
Radio Despatch	75
Radio Parts	82
Scientific Devices	93
Sansul	IFC
S.I. Microcomputers	120
Software Source	111
Sheridan	28
SME Electronics	82
Sanyo	146,147
Sony	155
Truscotts	82
Top Projects Vol. 7	85
United Sound	141
Warburton Frankl	13



# ELECTRONICS TODAY INTERNATIONAL

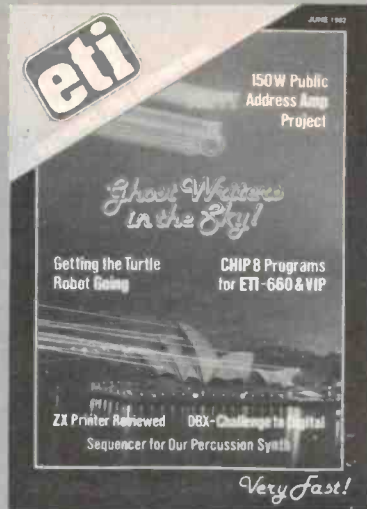

Sydney's 50th Anniversary of the Harbour Bridge opening celebrations saw probably the most spectacular outdoor laser light show yet staged in Australia. It was devised and staged by a new company, Laservision Pty Ltd, using quite sophisticated equipment — read all about it on page 6.

Photography by ON COLOR Pty Ltd, courtesy of Laservision. Cover design by All White.

\*Recommended retail price only

## news

### NEWS DIGEST 6

Ghostwriters in the sky — laser display; Infrared airborne observatory; Electronics Yellow Pages; Pioneer 10 — a space odyssey; and much more.

### COMMUNICATIONS NEWS 83

VK2ETI on the air; Spurious sidebands; Shuttle communications; etc.

### PRINTOUT 89

Four million pixels on hi-res CRT; Club call; 16-bit bits; Software Guide — book review; TRS-80C software update; etc.

### SIGHT AND SOUND NEWS 127

Stereo TV sound; Pioneer car sound; Noise reduction developments; and more.

## features

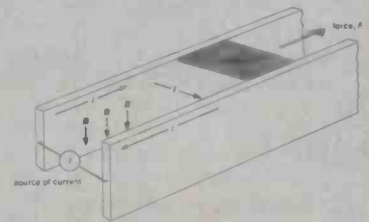

### HOW TO MAKE THINGS MOVE VERY FAST 20

The macron accelerator may eventually make energy available for use in a wide range of applications, including controlled thermonuclear fusion.

### LIGHT AND POWER FROM DC SUPPLIES 30

Generating mains-independent light and power from batteries is fraught with many unrealised problems. Whether you want dc back-up for when the mains goes 'off the air' or a wholly independent supply, you should know the problems up front.

## projects

### 645: TURTLE ROBOT PART 3 42

This month's article talks about testing the robot, notes on driving it and its motors, and some programming and interfacing hints.

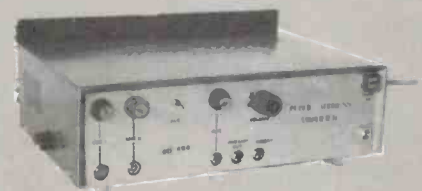

### 498: PA AMPLIFIER 54

This PA amplifier teams with ETI-499, the 150 W general purpose MOSFET power amp (March '82), and offers several facilities to deal with overcoming extraneous noise, increasing intelligibility, speech filtering, and so on.

### 469B: SYNTHESISER SEQUENCER 67

This sequencer enables you to program a rhythm sequence of up to eight steps on the percussion synthesiser (ETI April '82), for automatic accompaniment.

## computing

### COMPUTING TODAY 87

System 80 contest winner; Sorcerer 'Beginning'; Chromasette for TRS-80C; etc.

### CHIP-8 COLUMN 92

Commencing a new column for programmers using this learner's language — for ETI-660 and COSMAC VP-111 microcomputer owners.

### ALTERNATIVE POCKET COMPUTER PRINTER 98

For the thin-of-pocket or frugal-minded, here's how to employ a cheap 'surplus' teleprinter as a printer for your Sharp or Tandy pocket computer.

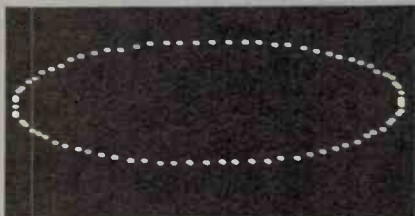

### APPLE GRAPHICS GUIDE 103

The Apple II still has much to offer — apart from colour, it features three display modes, including hi-res and lo-res graphics. This article gives a guide to beginners.

### '660 SOFTWARE — SPACE DOGFIGHT 110

Luke Skywalker rides again! Shoot the evil X-wing fighter and see it disintegrate before your very eyes! There are also lots of ways to modify the game.

### GRAPHIC DETAILS 116

This month a giant 'detail' for UK101 and Super-board II owners, revealing their systems' subtleties.

### HARD COPY FROM YOUR SINCLAIR 121

The ZX printer was produced to complement the ZX81 and ZX80 with 8K BASIC ROM. It does so not only in style, but at a very competitive price.

## sight & sound

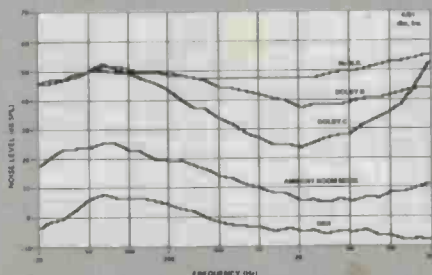

### dbx — CHALLENGE TO DIGITAL? 134

The dbx system of compansion claims to be able to achieve 90 dB dynamic range, better than the very best discs and open-reel tape decks at present. Brian Dance takes a look at the system.

### PIONEER A-8 AMPLIFIER 142

Words like 'superlative'... 'exemplary' don't come often from Louis Challis, but after reviewing the Pioneer A-8 stereo amp he was using them quite a few times!

## general

### TURTLE KIT OFFER 47

### ELECTRONIC BOOKS FROM ETI 62

Beginners' books, data books, circuit books, etc.

### SHORT CIRCUITS

Centre-zero bar/dot LED display 84

### IDEAS FOR EXPERIMENTERS 74

Sub-octave oscillator for ETI synthesiser; Turntable speed controller; Idea of the Month winner; etc.

### SHOPAROUND 81

### MINI-MART 96

### ETI SERVICES 152

### DREGS 154

## next month

### 13.8 V/10 AMP POWER SUPPLY

"When your battery acts up ornery...", as a certain advertisement puts it, this power supply would make an acceptable substitute for many applications! We've received so many requests from readers for a decent supply to power 12 Vdc (nominal) operated equipment we just had to do something...

### 12 V FLUORESCENT LIGHT INVERTER

"I hate to see that evenin' sun go down", wrote Will Handy in his famous song, St. Louis Blues. If he'd had our fluorescent light inverter he might not have said that! This project is just the thing for an 'emergency' light at home, for camping trips, etc. It is low-cost and simple to build, uses commonly available parts and will power up to two 20 W tubes from a 12 V battery — silently.

### GRAND HI-FI CONTEST!

Over \$7000 in prizes, two complete systems to win! PLUS dozens of consolation prizes. First prize is a complete system of top class equipment from such famous names as Shure, SME, Pioneer, Rega, Marantz, Technics, Sansui, Audio-Technica and KEF, plus accessories from Convoy, TDK and Allsop. Second prize is a system from Sharp. Consolation prizes include headphones, tapes, and record and tape deck cleaners. You've got to be in it to win it — our grandest contest for years!

### SYSTEM 80/TRS-80 GRAPHICS GUIDE

An 'overview' of programming the graphics on these two popular micros. Learn how to SET your screen, PRINT @ and NAME things. PEEKing and POKEing will never be the same after this!

### '660 COLOUR PATTERNMAKER

The Patternmaker program (February issue), hailed as one of the most fascinating we've published for the ETI-660 Learner's Microcomputer, can now be run in colour — thanks to a contribution from reader (and ETI-660 owner) Noel Plummer.

Although these articles are in an advanced state of preparation, circumstances may affect the final content. However, we will make every attempt to include all features mentioned here.



## 'Ghostwriters' in the sky!

The 50th anniversary of the opening of Sydney's world-famous harbour bridge, the 'old coathanger', was the occasion for a spectacular laser light show devised and staged by Laservision Pty Ltd.

**Our front cover picture and the picture here show two views of the show, staged several times each evening over three evenings of the event last March.**

The Laservision show was financed by the New South Wales Department of Main Roads, who maintain the bridge. A single 20 W argon gas laser was used, which generates predominantly green light. An X-Y deflection system of mirrors under the control of a computer system was employed to move the laser beam under program control.

The Z80-based multiprocessor computer system, designed by Laservision, can drive up to three X-Y mirror deflection scanning systems,

enabling patterns, such as that on the front cover, to be 'written' against a background. The system enables the operator to switch programs at the push of a button, thus effecting a change in the display.

Smoke canisters were used for the display so that scattering from the smoke particles would make the beams visible. Rain on one of the nights made for a very effective backdrop, according to Gary Levenberg, even enabling 'writing on the clouds'.

Laservision Pty Ltd, headed by Gary Levenberg, has been formed in association with Soleil-Laser (Australia) to pursue the newly established field of laser productions. Geoffrey Rose of Soleil (Australia) and a team of artists/physicists have

staged a number of laser light shows and demonstrations around Australia recently and are currently touring with the Space Light show, a laser and holography 'spectacular' (presently ensconced in the Melbourne Town Hall — a 'not to be missed' event).

Gary Levenberg, an American, has been associated with the US Soleil Company since 1975. They have staged laser spectacles to as many as four million people, as well as doing light

shows at symphony orchestra concerts and rock shows.

Recent work of Soleil-Laser (Australia) includes large outdoor displays such as the opening of the Sydney Tower at Centrepont, and displays emanating from transmitting towers outside Brisbane and Adelaide for 4MMM-FM and 5AD, in conjunction with Channel 7. They have also done promotional work for Coca-Cola, De Beers Diamonds, BMW, Datsun and many others.

### ETI DISTRIBUTION

During the past few years we have received a number of complaints to the effect that ETI has been very late on sale in several areas outside NSW.

While aware of the problem, we have until now been powerless to correct it. However, our parent company (Australian Consolidated Press) has expanded and updated its own distribution system, and as from our June issue we shall be switching over to this system.

On-sale dates in NSW will remain much as they are now, but interstate on-sale dates will be brought forward very substantially.

Please let us know if you experience any difficulties — we will fix the problems immediately.

## Infrared airborne observatory

NASA has equipped a Lockheed 300 cargo plane with a 36-inch infrared telescope and computer systems for the detection of infrared radiation from astronomical objects and from inter-stellar space. This is an effective and efficient way to get the telescope above the infrared absorbing water vapour in the atmosphere.

The Lockheed 300 (a commercial version of the C-141 Starlifter) can fly at altitudes of between 41 000 and 45 000 feet, where the telescope is above some 99% of the atmospheric water vapour, so it can provide clearer and more sensitive measurements of the radiation from the planets and stars than are possible from ground-based observatories. It is much more economical than the use of instruments on board space vehicles (such as the Voyager and Pioneer craft), although a special earth-orbiting telescope is scheduled for launching in 1983.

Known as the Kuiper Airborne Observatory (after Gerald P. Kuiper, a pioneer planetary astronomer), the aircraft has

taken part in key scientific discoveries, including that of the rings around the planet Uranus. It is considered to be complementary to both the planned infrared space telescope and to the infrared cameras on spacecraft, since its flights are measured in hours rather than years and this provides for much greater flexibility in mission planning. Unlike spacecraft cameras, it is easy to make changes in the equipment of the Kuiper Observatory.

NASA states that the airborne observatory is expected to play a key role in recording the passage of Halley's Comet in 1986 — a passage which is expected to be the least brilliant to the lay public of any passage during the past thousand years, since



the comet's approach will be from the other side of the sun. Its approach can only be seen from a spacecraft and, while the space telescope will be in use, only the aircraft observatory will be able to operate in the infrared.

The Kuiper Observatory usually carries a crew of six together with a scientific team of two to

five persons. Recently it has been used to detect the presence of carbon monoxide gases in the regions of inter-stellar space where stars are being formed, while it was previously used to identify the water molecular lines in the radiation from the Orion nebula.

Brian Dance

## Electronics Yellow Pages

The Electronic Industry Telephone Directory (EITD) lists nearly 19 000 manufacturers, representatives, and distributors worldwide.

The directory contains two sections: the alphabetical section, which lists electronics firms alphabetically by company name, and the purchasing section, which lists companies under 3500 different product categories. Every listing in EITD's alphabetic section provides the company name, its complete address, including state, and the US direct-dial telephone number.

Because each listing is individually verified each year, EITD is 99% accurate. It has a distribution of 101 000 copies to buyers and engineering specifiers in all phases of the electronics industry in the USA. Due to its intensive distribution to the electronics market and its success in the industry for over 20 years, the USA's largest corporations use EITD to advertise their products and

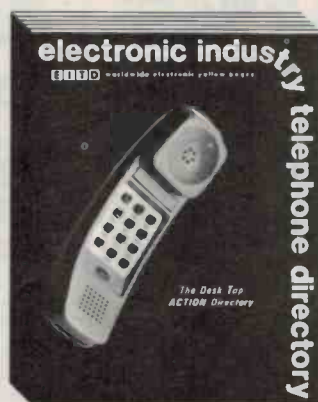

services to the most influential electronic buyers. It costs just \$40 per copy, including air freight.

For free brochures and information write to S.D. Chamberlin, Export Manager, Harris Publishing Co, 2057-2 Aurora Rd, Twinsburg, OH 44087, USA.

## Versatile, low-cost multimeters

If you're looking for a low-cost, highly portable analogue multimeter then Altronics' models Q1001 and Q1002 should attract your attention.

The Q1001 is a 'pocket' multimeter featuring 2000 ohms/volt sensitivity, a mirror-backed scale and overload protection. On dc and ac it covers 10 V, 50 V, 250 V and 1000 V, and it has a 100 mA current scale plus x10 and x100 ohms scales. You get a dB scale too (ac range). It measures just 90 x 60 x 30 mm! Cost? — \$12.50! You can obtain a pvc carrying case, with probe pocket, for \$2.50, too.

The Q1002 is a portable instrument featuring a 60 mm wide mirror-backed scale and 23 ranges. Sensitivity is quoted as 20 000 ohms/volt on dc, 10 000 ohms/volt ac. It is overload protected and comes with a 'unique' carry handle that

doubles as a bench stand.

On dc it measures 250 mV to 1 kV in eight ranges and 50 uA to 500 mA in five ranges. A dB scale is included, spanning -20 to +22 dB. On ac it measures 10 V to 1 kV in five ranges. Four resistance ranges are included: x1, x10, x100 and x1k — all for a mere \$22.50! A 'leather look' carrying case costs \$3.50, but readers mentioning this item when purchasing the Q1002 — or Q1001 — will have a carry case thrown in free of charge (if ordered during June).

Amble out to Altronics or airmail if you're unable to go there personally — they're at 105 Stirling St, Perth or behind P.O. Box 8280, Perth WA 6000.

# MEET A MAN WHO KEEPS 74,961 CUSTOMERS HAPPY!

He's got to get that adrenalin flowing — so it's off for a quick jog around the park before work. This is David Broome, our Mail Order Manager. He'll probably never meet our 75,000 mail order customers: but to David, this makes looking after them even more important!



A quick shower, shave and bowl of Kellogs — and David's ready to start another day. First job is to check the computer for overnight orders received via the Electronic Shopping System.



Then it's onto the mail — enough to gladden the heart of even Santa Claus. Up to 10 staff are on hand to open and process each batch of mail.

## The good news

// These top quality products are all available by Mail Order at direct import prices. //

**1%  
TOLERANCE  
RESISTORS**

**WHY SETTLE  
FOR LESS?**

**WHY METAL FILM?**  
High stability — Very low temperature coefficient — High reliability — Ruggedly made — Professional quality

**SAVE OVER \$5.00  
BARGAIN PACK**

Cat. R-7015 **\$12<sup>90</sup>**

300 precision 1% 1/4W metal film resistors, \$18.00 value!

Cat. A-1000



**AVAILABLE LATE JUNE**

**NOW MINIATURE HI FI  
THAT DOESN'T  
COST A  
FORTUNE!**

**DON'T  
PAY \$500  
OR MORE!**

**ONLY  
\$249**

This 3-in-one system offers big performance. It's the ideal system for flats, bedrooms, etc. It features: AM/FM stereo tuner — Integral cassette deck with noise reduction and chrome facilities — 10 watt amplifier with LED VU meters, full switching and 2 phono preamps — Separate 2-way Hi Fi speakers. Small in size, big in sound!

**FOUR WAY RADIO  
CONTROL**

**4 CHANNEL DIGITAL  
HERE AT LAST!** A 4 channel radio control for bringing life to your model boats, tanks, cars, etc. This fantastic unit will make every boy the envy of fellow modellers.

**\$149<sup>50</sup>**

**DON'T PAY  
FANCY MODEL  
SHOP PRICES!**



**FREE POWER!**

**SOLAR CELL SECTOR**  
22nd Century technology! Connect these in series or parallel to power your projects. 450mV @ 125mA  
Cat. Z-4835

**\$2<sup>95</sup>**

**CHEAP RESISTANCE!**

**Resistance Substitution Wheel**  
Convenient size with large, easy to read value selections from 5 ohms to 1 M ohm in 36 steps. Complete with leads and crocodile clips.  
Cat. Q-1410

**\$7<sup>95</sup>**

**DIGITAL  
MULTIMETERS UNDER \$50**

Cat. Q-1446

**AUTORANGING DIGITAL**

At last — a fantastic full autoranging budget priced multimeter! This LCD Digital is a portable 3 1/2 digit, compact-sized tester ideally suited for field, lab, shop and home applications. Just look at these features: Overload protection — Battery operated — Low cost — 0.8%, 1.35% DC V reading error. All these features for only \$49.50!  
Cat. Q-1446

**ONLY \$49<sup>50</sup>**



**TOP QUALITY TEXAS  
CALCULATOR UNDER \$20!**

**That's the Slimline T130**

This calculator is great for any student and well within their reach at this low Dick Smith price! Just look at these features:

- Easy-to-read Liquid Crystal Display
- AOS Algebraic operating system allows you to enter mathematical sequences in the same order that they are algebraically stated.
- Constant memory feature holds numbers in a user memory even while the calculator is turned off.

**ONLY \$19<sup>95</sup>**

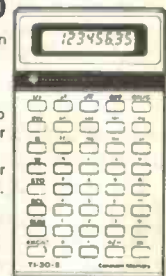

Cat. Q-3737

**18c  
m  
VALUE!**

**LIGHT DUTY  
SPEAKER CABLE**

Ideal cable for use with Hi Fi systems for speaker connections or with intercoms. Twin plastic insulated conductors, insulation marked with a trace to keep speakers correctly polarised.  
Cat. W-2010  
Bulk price 100m or more — 15c/m





As soon as the mail orders are entered in the customer record system (just in case good old Aust. Post send an order to Upper Cumbuckta West instead of lower Woop Woop) they're rushed through to the assembly section, where a staff of eager enthusiasts is ready to pounce on every order in record time.



It's like a mini Dick Smith store — but the customers are missing. Instead, our mail order assemblers rush your order around, choosing the items you've ordered. David has made sure the most popular items are closest to the front — minimising delays in getting your order on its way.

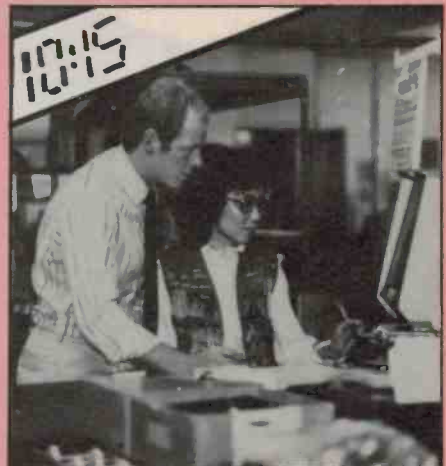

Once assembled, your order is double checked to make sure everything is there, then the pricing is checked. You'd be surprised how often we find that customers are overcharging themselves — mainly because they don't know the items on 'special', etc.

# and . . . the good news

// You don't have to buy by Mail Order, we have 30 stores around Australia, all offering the same value and service. //



## Here's why you should insist on quality DICK SMITH SEMI'S

- ★ All top quality recognised brand names
- ★ Up to 1/2 the price of other suppliers. Save up to 66%.
- ★ Guaranteed Quality
- ★ No need to buy 10 when you only want one
- ★ Quantity discounts
- ★ No job lots, end of run or below spec. devices
- ★ When you buy semiconductors from DS you buy with confidence

### TOP SELLERS

Cat. No.	Description	1-9	10 up
Z-1300	DS547	.14	.12
Z-1308	DS548	.14	.12
Z-1319	DS549	.14	.12
Z-1329	DS549c	.34	.30
Z-1340	DS557	.17	.15
Z-1348	DS558	.17	.15
Z-1359	BC159	.55	.50
Z-1443	BD139	.55	.50
Z-1444	BD140	1.00	.95
Z-2145	2N3055	.20	.17
Z-2242	BC328	.35	.30
Z-2242	BC338	.35	.30
Z-2252	DSOA91	.20	.15
Z-3042	IN9141	.08	.06
Z-3120	IN4002	.10	.08
Z-3202	IN4004	.15	.13
Z-3204	IN4004	.20	.15
Z-3207	IN4004	.45	.35
Z-3222	IN5404	.45	.35
Z-3531	6V8 Zener diode	.40	.30
Z-3547	15V Zener diode	.40	.30
Z-3228	IN5408	.50	.45
Z-4000	Flashing LED	.45	.40
Z-4010	Sml Red LED	.20	.18
Z-4020	green LED	.28	.25
Z-4030	Lge red LED	.20	.10
Z-4032	green LED	.30	.25
Z-4034	Yellow LED	.55	.45
Z-4040	Rect. red LED	.45	.35
Z-4042	green LED	1.35	1.20
Z-4150	FND500	1.50	1.25
Z-4510	Triac SC141D	.80	.70
Z-4802	Double LDR	.40	.35
Z-5601	4001 Norgate	1.20	1.10
Z-5617	4017 Dec. counter	2.00	1.80
Z-6105	UA4136 quad amps	.40	.35
Z-6145	DS555 timer	.40	.35
Z-6382	LM741 op. amp.	1.20	1.00
Z-6545	7805	1.20	1.00
Z-6552	7812	3.95	3.50
Z-9310	4116 RAM		

### AMAZING VALUE ON AMAZING FLASHING LED

Cat. Z-4000  
All you need to make these amazing LEDs work, is your own voltage. Dozens of uses!

NOW 45¢



SAVE 70%

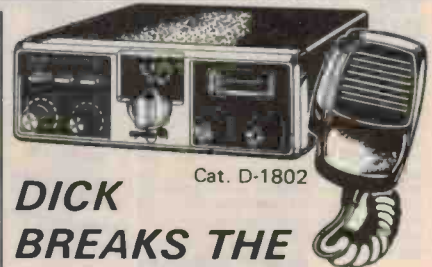

Cat. D-1802

## DICK BREAKS THE PRICE BARRIER FOR 40ch UHF CB!

Full 40 channel operation with delayed action squelch for flutter free reception. The RF gain control lets you increase faint signals and decrease strong local signals. A truly amazing radio for the cost conscious person!

## APOLLO 40ch UHF

ONLY \$280

### IC TIMER HANDBOOK

This new book is packed with projects and experiments as well as exploring the world of IC timers. Cat. B-1610

\$8.95

### NEW COMPUTING TITLES

COMPUTER GRAPHICS 29 ready-to-run programs to develop your graphic skills. Entertaining and enlightening book. Cat. B-2350

\$8.95

Available Mid June  
TRS-80 DISK, and OTHER MYSTERIES 130 pages of actual memory maps and samples  
Cat. B-2347

\$29.95



# DICK SMITH Electronics

SEE PAGE 34 FOR ADDRESS DETAILS



Down the conveyor belt to the packing section (sometimes with a pricer hanging on — they're so keen, they sometimes forget to let go: David's working on that one . . .) And your order is carefully packed to make sure you don't receive double the number of pieces you ordered!

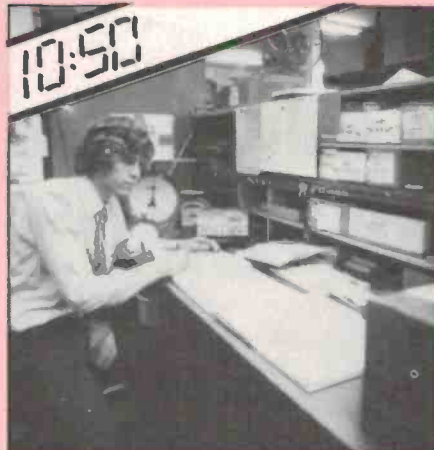

Your order is weighed, stamped and entered into a despatch ledger (once again, just in case . . .) And within an hour, it's on its way to the Post Office — one of 5 batches of orders to leave every day! By the end of the day the label lickens have almost run out of lick!



"What do I do about this, David?" Carefully avoiding getting Vegemite on the paperwork (he's not really that tidy — just doesn't want to lose his Vegemite) David answers another query. They don't stop just because it's lunch-time!

**\$10 CHEAPER THAN WELLER!**

**The DICK SMITH Solder Station**

If you are serious about soldering, there's only one way to do it - with a temperature controlled soldering iron. Dick Smith brings you this brand new temperature controlled station, offering you the best quality at an unbelievably low price. AND it's fully approved by the Energy Authority. The station comes complete with lightweight iron, iron holder and cleaning sponge, with a comprehensive instruction manual with full servicing information. Cat T-2000



**PRO QUALITY AT A HOBBYISTS PRICE**

now **\$59<sup>50</sup>**

**AVAILABLE MID JUNE**

**Look at Dick's price for quality! Belt Drive Turntable**

Here's top value; a semi automatic belt-drive turntable, with all the 'mod cons' such as variable speed, strobes, anti-skate, auto return etc, etc... mounted in a deluxe shock-damped plinth with perspex hinged lid. Cat A-3080

**only \$169<sup>00</sup>** (Inc. Cartridge)

**HITACHI QUALITY - DICK SMITH PRICE!**

**HITACHI 15MHz Dual Trace Cro**

**Model V-152B**

For the service bench, technical college, university or school - or even the serious hobbyist or amateur who simply wants a top-of-the-line CRO without breaking the bank, we have the outstanding Hitachi V-152B 15MHz Dual Trace Oscilloscope. It costs no more than our previous CRO's which didn't have anywhere near the number of features of the Hitachi V-152B. Features like ★Extra high sensitivity ★TV Sync-separator circuit for rapid video measurement ★5 display modes ★Trace rotation via front panel control ★One touch wave-form shifting ★One touch 10x sweep magnifier AND LOTS MORE! Cat Q-1242

**SPECIFICATIONS**

Vertical sensitivity: 5mV/div-5V/div

Bandwidth: DC-15MHz, -3dB

Rise time: 24ns

Non-dist. max amplitude: More than 4 div @ 15MHz

Input R and C: Direct 1M ohm, approx. 30pF

Maximum input voltage: 600V P-P (300V AC + DC peak)

Display modes: CH1, CH2, DUAL, ADD, DIFF

Sweep time: 0.2us-0.2s/div; 19 calibrated steps

Power requirements: 120-240V, 40W

**great value \$655**

**100MHz x 1 x 10 PRO CRO**

This versatile probe set gives you features you would pay \$55 more for and will suit virtually any CRO. You get a Basic probe with built in x1/x10 switch, 1.5 metres of cable with co-ax type CRO connector and wandering earth lead with alligator clip, IC adaptor tip, spring clip, insulating shroud, BNC adaptor, trimming tool, and a plastic wallet for safe keeping. Cat Q-1245



**only \$32<sup>50</sup>**

Compares with \$70 Probe Sets!

**HUGE SCOOP PURCHASE!**

**Looking for a good BASE STATION?**

A fantastic base station CB that lets you communicate to others from the comfort of your own home! Has 18 channels available and comes ready to connect to your antenna. Features include a quality loudspeaker with headphone socket, large easy to read power/signal meter, delta tune for receiving stations slightly off frequency, built in power supply - just plugs into mains\*, finished in attractive wood grain. Cat D-1432 \*Requires 240V to 110V external stepdown transformer.

**value \$169 at**

**DICK SMITH LOW COST SOLDERING IRON**

A general purpose iron that can be plugged into the 240V AC mains and will give 25 watts of heat very quickly. That is more than enough for most jobs around the home or workshop. It has a stainless steel barrel and comes with a copper tip. Complete and ready to use with mains plug and cord attached. Cat T-1300

**10,000 Sold!**

**only \$9<sup>75</sup>**

**SAVE \$8**

**MINI CASSETTE RECORDER**

This palm sized recorder is ideal for recording anything that would be ordinarily very difficult with standard sized recorders, such as lectures, interviews and conferences etc. Uses standard cassette tape, has thumb operated controls, and built-in microphone. Can be connected to external power source and has earphone jack. AND it features a review button allowing automatic playing after rewinding a cassette. Cat A-4050.

**only \$39<sup>50</sup>**

**YOU REAP THE BENEFIT!**

**Latest micro technology makes you a musician with The amazing VL TONE**

Small enough to fit into the palm of your hand but gives you performance and flexibility that would have been thought impossible a couple of years ago. It gives you ten different background rhythms, records the melody you've just played, 5 different instrument sounds PLUS the ability to create millions of sounds of it's own. You'll be playing tunes in a couple of minutes. And...

**IT DOUBLES AS A CALCULATOR!**

Cat Y-1156

**only \$89<sup>95</sup>**

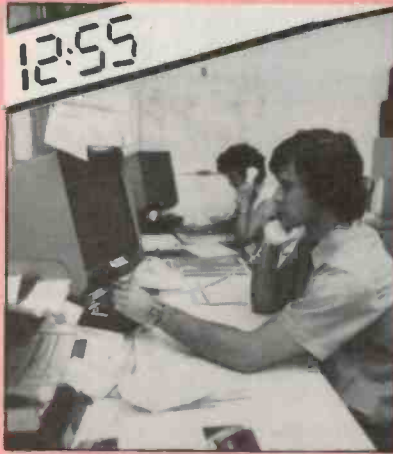

Calls may come in from Perth to Papua — checking about products, querying orders — or even ordering by 'phone. Our 'phone-in Bankcard ordering system has proven really popular. It is one way to get your order on the way very quickly.

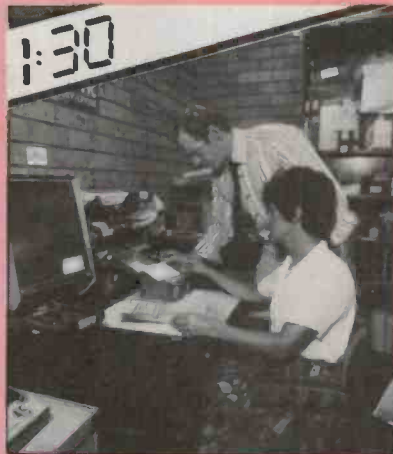

And any goods not in stock (shame!) are 'back-ordered' and sent later at our expense. As soon as we receive it, you'll get it — David and Dorothy make sure of that!

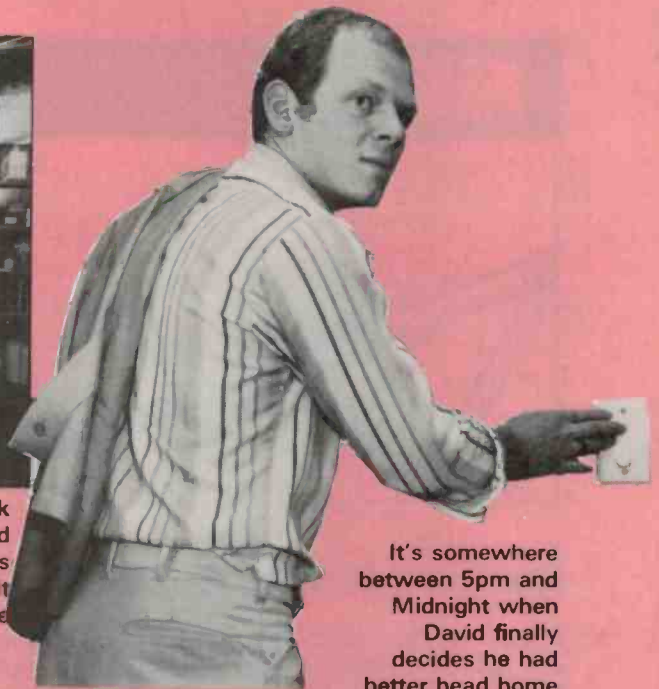

It's somewhere between 5pm and Midnight when David finally decides he had better head home (he's only been married a few months and Penny starts getting anxious after about 8 o'clock). One last check — and he's off. Don't forget the light on the way out, David!

## SAVE ON TEAC HI-FI!

Dick Smith offers you this superb TEAC Hi-Fi system at an unbelievable low price.

**System Comprises**  
**35 watt RMS amplifier BX-330B**  
 Features LED power meters, low distortion, dual speaker outputs and a frequency response of 10Hz - 100kHz.

Cat A-1301 **\$249**

**AM/FM tuner TX-550B**  
 Unbelievable performance - not just on FM but on AM too!

Cat A-1501 **\$199**

**Metal tape deck V-30**  
 For those with a discerning eye for style and quality. Has Dolby NR switch, peak level display, tape (Bias/EQ) switch, pause key and much much more.

Cat A-3505 **\$169**

**Turntable P-50**  
 Semi-automatic belt driven turntable in modern silver and black finish and with tinted vinyl dust cover. Superb performance.

Cat A-3079 **\$169**

**Two litre speakers**  
 Designed as bookshelf speakers but can be used on the floor also. Each contains a 200mm woofer and a tweeter for top end sound.

Cat A-2460 **\$95 pr.**

**Superb Hi-Fi stand**  
 Store all your Hi-Fi equipment on this quality stand. Separate compartments for amp, cassette deck, tuner and turntable. Great little space saver!

Cat A-0105 **\$72**



## The Affordable CRO!



**DICK SMITH**  
**6.5MHz 75mm**  
**Laboratory CRO**

This oscilloscope is ideal for the laboratory, the classroom, in field service, in bench service in assembly centres and, of course, in hobby applications. Solid state electronics (apart from the tube!) ensures extremely low drift and fast warm up. Features include retrace blanking for a clearer display; fibreglass PCB; lower threshold triggering; sharper focus; and colour coded input terminals.

Cat Q-1280  
**OVER 2000 SOLD!**  
 only **\$199**

## CRO BNC ADAPTOR

This smart little adaptor plugs into the input terminals on the Dick Smith laboratory oscilloscope, converting the banana socket terminals to a BNC type, as used on more expensive oscilloscopes. Cat Q-1281



**\$9<sup>90</sup>**

## WANT A DISK BASED COMPUTER SYSTEM?



**The SYSTEM 80 Mk II**  
**saves you \$750**  
**straight away!!**

When cassette operation is too slow for business usage, this System 80 is the answer. The normal inbuilt cassette mechanism has been removed (even though we've still allowed for external cassette connection) to allow for connection to a disk drive. Features of this superb computer are flashing cursor; numeric keypad; 12K microsoft BASIC; screen print facility; FULL upper and lower case display plus provision for full expansion to 48K of memory. Cat X-4100

**WAS \$1495**  
**SAVE \$745!**  
**NEW LOW PRICE ONLY \$750**

**YOU REAP THE BENEFIT!**



## NO BOAT IS TOO SMALL

**DICK SMITH**  
**5 watt**  
**6 ch**  
**Hand Held**



Now a transceiver offering the maximum legal power on the 27MHz marine band (5 watts) and a choice of up to 6 channels. Operates from 12 volts. A real workhorse. Cat D-1123

DOC Approval No 242M161

# DICK SMITH Electronics



SEE PAGE 34 FOR ADDRESS DETAILS

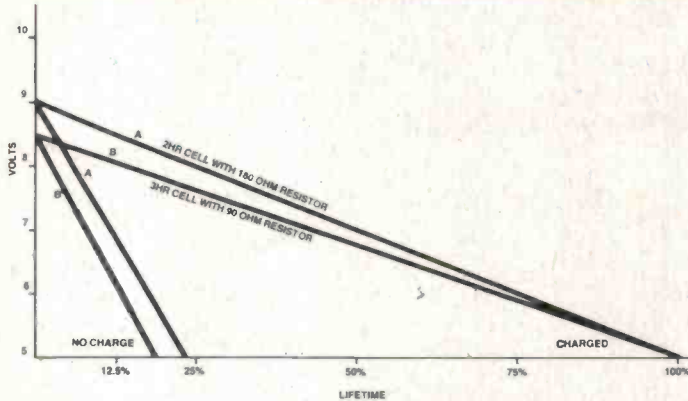

## Radio recharges its own batteries

A radio receiver which recharges its own ordinary type of zinc-carbon batteries was recently introduced in Britain by Fidelity Radio Ltd. These batteries are not the expensive nickel-cadmium types, but the ordinary batteries used in radio receivers, which are normally discarded when they are exhausted.

When the 'Battery Saver' receiver is connected to the mains — no matter whether it is operating at the time or not — a mixture of alternating and direct current is passed through the battery so that the zinc is reformed in a polished form on the negative electrode. Unfortunately there is a limit to the extent to which this process can be satisfactorily carried out, but the manufacturers state that the life of a battery can be extended by a factor of at least four times.

Eventually the zinc no longer adheres in an even film to the electrode and the electrolyte becomes devoid of hydroxyl ions. It is important that the batteries are not overcharged, since this can cause loss of the electrolyte,

but the circuit incorporated in the Battery Saver receiver is designed to automatically prevent overcharging when the battery reaches its preset voltage of 8.5 V.

It is important that the charging should be quite slow at a low current or the build-up of gases in the cells of the battery can cause a build-up of pressure which may be dangerous.

A red LED provides an indication as to when the battery requires recharging. The receiver should be left connected to the mains supply until this indicator lamp has become completely extinguished, showing that the battery has reached its optimum voltage.

Brian Dance

## Prestel retracts

British Telecom have decided to close down 14 of the 20 Prestel computers so as to provide an estimated saving of some £1 million per year.

It appears that the original computer network was based on an assumption that by late 1981 some hundreds of thousands of domestic computers would be using the Prestel service in their homes; however, this has not taken place and neither is there any sign that it will occur.

Prestel customers are almost entirely business users. The total number of Prestel installa-

tions in Britain is now about 15 000, and is increasing at about 500 per month.

Currently 200 000 pages of information are available and new services are being introduced, including 'Gateway' to provide access to third-party computers and 'Mailbox' to provide an electronic message facility.

Telecom announced the development of Prestel for the

## British telewriting trial for 1983

Telewriting, in which handwritten material (including sketches) is produced at one location and sent over an ordinary telephone line so that it can be reproduced on a visual display unit screen elsewhere, is part of a proposed visual services trial planned by British Telecom for 1983 in the London area.

Research work in the Government's laboratories has resulted in the development of various forms of experimental telewriting equipment. However, the Government has now decided to sponsor a STG£85 000 two-year trial of a 'Cyclops' telewriting system invented by the Open University. Cyclops is a two-way system for both images and speech signals, the two types of data being sent over separate telephone links.

Light pens are employed at both ends of the telephone link to produce written messages and drawings, and the receiving station can use its pen to alter or erase any of the information.

Video material which has been stored on an ordinary audio cassette can also be transmitted, including computer-generated graphic diagrams, charts, tables and black and white pictures.

Brian Dance

## Soanar agent for Curtis RFI filters

Soanar Electronics Pty Ltd have been appointed sole Australian Agent for the range of RFI power line filters manufactured by Curtis Industries, USA.

The recent proliferation of computers, peripherals, industrial controls, test equipment and many other devices utilising digital techniques, including electronic games, has highlighted a major suppression problem.

For years, manufacturers and users of interconnected digital devices have recognised the need for RFI power line filters in their equipment. Interference created in one module could adversely affect others, causing them to malfunction unless proper RFI filtering had been incorporated in the system.

Curtis Industries' unique filter design, together with their modern assembly and testing methods, can now provide manufacturers with line filters of extremely high quality which are capable of meeting and surpassing government regulations on noise emission.

The Soanar branch in your state will be pleased to provide you with additional information and literature on Curtis RFI Filters, or contact Soanar Electronics Pty Ltd, 30 Lexton Road, Box Hill Vic. 3128. (03)840-1222.

blind and for the deaf in October 1981. The first Braille reader for use with Prestel was shown in that month, in which the television screen was replaced by a flat box about the size of a small case. Production models of the prototype demonstrated are expected to become available in 1982.

A telephone communication terminal for the deaf has also been demonstrated, in which a small typewriter and a moving strip display are used with an ordinary telephone fitted with an

acoustic coupler. Calls are set up by dialling in the usual way, but coloured flashing lights indicate whether the connection has been established and users communicate by typing the words shown on the display.

This same terminal can be used with Prestel installations, while deaf persons can use it to communicate with hearing people who have Prestel installations and an alphanumeric keyboard.

Brian Dance

# Sanwa's new versatile auto-ranging family!



## LD-520H

In addition to the functions of the LD-510, the LD-520H also has built-in hFE ranges of 200 and 2000. Measuring ranges are the same as the LD-510. Accuracies: OCV:  $\pm(0.5\%rdg + 0.2\%fs)$  ACV:  $\pm(0.8\%rdg + 0.25\%fs)$   $\Omega$ :  $\pm(0.5\%rdg + 0.2\%fs)$  LO- $\Omega$ :  $\pm(0.8\%rdg + 0.5\%fs)$  DCmA:  $\pm(0.9\%rdg + 0.2\%fs)$  ACmA:  $\pm(1.2\%rdg + 0.25\%fs)$ .

## LD-510

Automatic range selection for DCV, ACV and OHM. Manual selection and range holding devices provided. In addition to the basic measuring ranges, optional adaptor units add the functions of hFE, capacity, temperature and circuit check. Supplied with safety test leads which have vanishing pins and protected test tip.  
DCV: 200m, 2, 20, 200, 1000. ACV: 2, 20, 200, 750.  $\Omega$ : 200, 2k, 20k, 200k, 2000k. LO- $\Omega$ : 2k, 20k, 200k, 2000k. OCA: 200m, 12. ACA: 200m, 12. Indication: 3.5 digits, max 1999. LCD, first figure "1" flashes when an overload occurs with the piezo electric buzzer sounding simultaneously. Automatic polarity selector provided. Cells: 1.5V (UM-3 or RG) x 2. Dimensions & weight: 168 x 90 x 46.5mm & 400g.

## LD-530F

The LD-530F also has built-in capacitance ranges of 2n, 20n, 200n 2 $\mu$ , 20 $\mu$ F. Measuring ranges and accuracies are the same as the LD-520H except the hFE ranges. Other specifications are the same as the LD-510/LD-520H.

Optional adaptor units: MU-1F (capacity), MU-2H (hFE value), MU-3T (temperature), MU-6B (circuit check).

**sanwa**

# WARBURTON FRANKI

• ADELAIDE (08) 356-7333 • BRISBANE (07) 52-7255 • HOBART (002) 28-0321 • MELBOURNE (03) 699-4999  
• PERTH (09) 277-7000 • SYDNEY (02) 648-1711 • AUCKLAND N.Z. (09) 50-4458 • WELLINGTON N.Z. (04) 69-3016



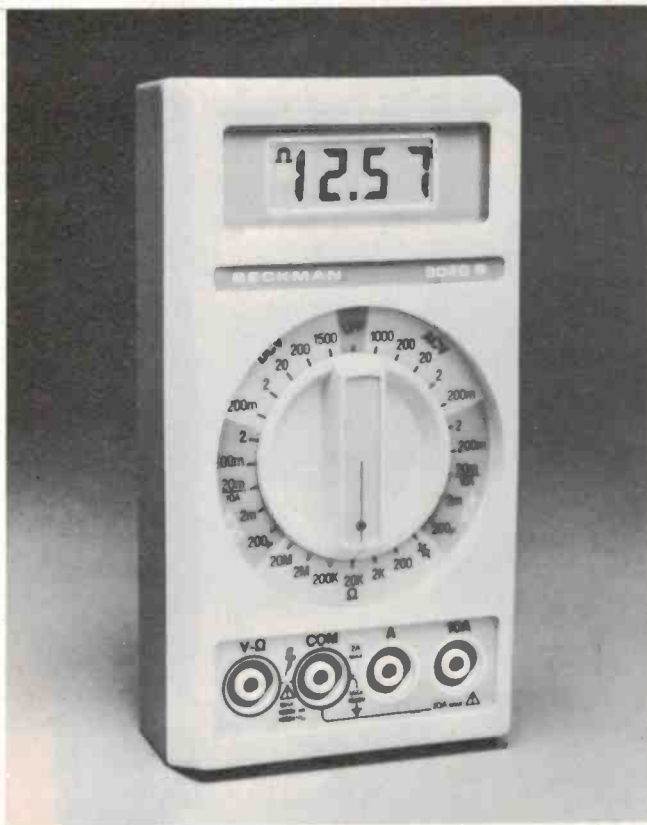

## Beckman DMM goes beep

**Beckman Instruments Inc has expanded its line of digital multimeters for engineers, technicians and service representatives to include a new portable that gets your attention by sound when continuity is detected.**

The attention-getting DMM is called the 3020B, and has both audible and visual continuity indication. When it's not possible to see the large-area LCD, the meter will alert the user when continuity is detected by a single loud 'beep' tone. Continuity is also visually signalled (in less than 1/10 of a second after detection) by the appearance of an ohms sign in the upper left corner of the LCD.

Like other Beckman portable DMMs the 3020B features an easy to use single centre selector switch, 0.1% basic Vdc accuracy, has 10 ampere ac/dc current ranges, 2000 hour battery life from a standard 9 volt battery, semiconductor test function and overload protection on all ranges.

Like all Beckman DMMs the 3020B's 27 ranges are protected against overload conditions that result from the measure-

ment of unknown signals or from operator error. Voltage ranges are protected to 1500 volts dc or 1000 volts RMS ac. All resistance ranges are protected by 500 V RMS and current ranges are rated up to 20 amps for 30 seconds.

Resistance ranges are low-power, allowing accurate measurement of in-circuit resistance, without turning 'on' diodes and semiconductors which would affect the measurement. When testing diodes and semiconductors, a separate semiconductor test function provides a 0-2 V, 2 mA constant test current — enough to verify the operation of semiconductor junctions while in circuit with as little as 350 ohms shunt resistance.

For more information and complete specifications, contact your local Warburton Franki office.

## 'Phone competition

**The British Government has announced that Britain is to have an independent telephone network for business users only which will operate in competition with British Telecom.**

A consortium (comprising Cable and Wireless Ltd, BP and Barclay's Merchant Bank) has been granted a 25-year licence to operate the competitive network, to be known as Project Mercury. No other networks will be licensed within the foreseeable future.

Mercury intends to undercut British Telecom's rates, using optical fibre cables laid alongside British Rail's tracks. It plans to link its first customers in London by the start of 1983, and the first main trunk route between London and Birmingham should be available early in the same year.

An all-digital system will be employed, capable of carrying telephone, data signals and video-conference images. Seven major centres will be linked initially, but British Telecom has agreed in principle that Mercury will be able to interconnect with its own network. Thus a company outside the seven main centres will be able to dial into the Mercury system using Telecom lines.

The consortium has yet to reach a full agreement with Telecom on the interconnection, both as regards the technical requirements and on the financial aspects. It is hoped that the parties will come to a suitable agreement within the next few months. Mercury will be required to pay a royalty to the Government (either directly or possibly through Telecom.)

Telecom will remain the sole international carrier, since there is currently no method available

for negotiation between more than one international carrier in any one country and the authorities in other countries. However, Mercury will be able to lease and offer private international circuits by linking directly to international communications satellites from its own independent Earth station, which will be constructed with a large dish antenna in the UK.

The Mercury consortium has struggled for the right to interconnect with the public switched international circuits now used by business and domestic users, but it has not yet been able to obtain any such rights.

British Telecom is currently spending large sums on its international connections, and these connections bring in a large part of its profit; Telecom claim it could therefore suffer considerably if the consortium were allowed to become fully independent in the international communications field.

Britain has had a state monopoly in the telecommunications field for the past 60 years (with the exception of the town of Hull). The consortium's plans to lay 1000 km of optical fibre cable with four cores (each able to carry a 140 Mbit/s data rate signal or 2000 simultaneous telephone calls) will soon change this position for the large industrial companies, but the private telephone user will still have no alternative to the use of Telecom's lines with higher charge rates.

**Brian Dance**

## Pioneer 10 — a space odyssey

**A decade in space for Pioneer 10! — The first spacecraft (to our knowledge) to closely approach Jupiter completed a decade in space on March 7.**

Launched in 1972, Pioneer 10 is now travelling through the space between the orbits of Uranus and Neptune, about 4 billion km from the sun.

Its next major history-making event will be when it enters inter-

stellar space after passing the orbit of Pluto. In fact, Pioneer 10 will be the first (known) spacecraft to leave our solar system — about 1986. (Thanks to Westlink Report).

## No-burn tube provides high light output

A specially-developed, burn-resistant, secondary emission insulator in the storage tube of Philips PM 3219 oscilloscope enables this instrument to provide maximum light output in storage and non-storage operation. Previously, such instruments had to reduce light output by up to 40% in storage operation to avoid damage to the storage layer.

The key to the improvement is the substitution of a magnesium oxide-based layer for more conventional magnesium flouride on the storage mesh. Whilst magnesium flouride provides slightly higher initial writing speeds, it ages rapidly and is liable to irreversible damage or 'burn-in' marking if a high intensity beam stays on too long. The magnesium oxide layer is harder chemically and lasts longer. The after image may persist for a short time but after 24 hours or so it will fade away, leaving an unmarked screen.

Other features of the tube — developed in-house by Philips Electronics Components Division — include a quick start ensured by fast-heating cathodes in writing and flood guns. Warm-up takes around five seconds.

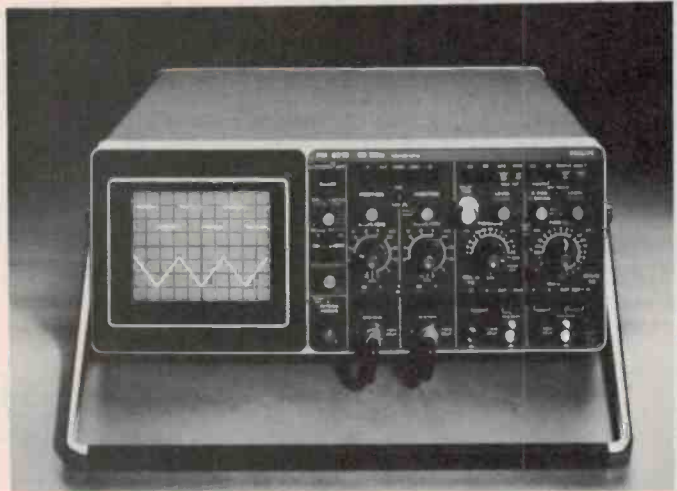
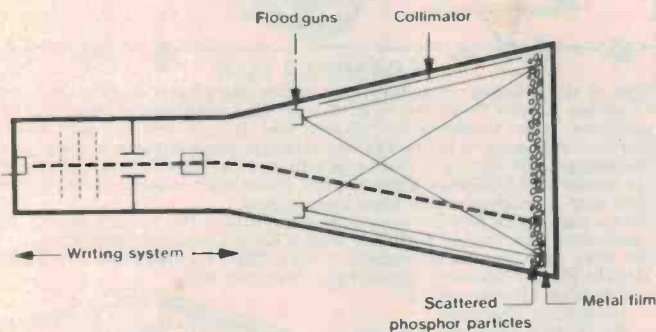

An improved collimation system ensures a full display over the whole screen with no diminution of light output at the edges.

A wide range of electronic and non-electronic applications are simplified by the PM 3219, varying from testing of loudspeakers to the analysis of mechanical operations at very low frequencies using the auto-erase facility.

Whether it is single-shot

applications, where a storage scope is the only answer, or a more complex trend-tracking use, such as comparing response curves during sweep measurements, the sophisticated facilities of Philips latest 50 MHz instrument can simplify storage operations.

For further information contact Philips Scientific & Industrial Equipment, 25-27 Paul St, North Ryde NSW 2113. (02) 888-8222.

## Silicon Glen

The United Kingdom contains one of the largest manufacturing microelectronics industries in Europe, situated in the

lowland region of Scotland between Edinburgh and Glasgow.

Known as 'Silicon Glen', it has the densest concentration of semiconductor manufacturers anywhere in Western Europe. Some 36% of the UK's production of semiconductors comes from this region, but new investments of some STG£150 million by foreign manufacturers in the region will result in half of Britain's semiconductor products coming from this area within the next two years. The annual output of the glen is some STG£100 million, and it accounts for some 7% of the Scottish manufacturing labour force.

The development of this industry during the past four years has been due to the investments

of large US and Japanese manufacturers (aided by large grants from the British Government) rather than to the efforts of British manufacturers. A large fraction of the devices produced is exported.

General Instrument commenced work in Scotland some 13 years ago, whilst National Semiconductor, Hughes and Motorola quickly followed. Nippon Electric (NEC) have recently announced a STG£40 million development project in the area.

Other British semiconductor manufacturers are widely distributed throughout the country, and include Ferranti, Plessey and the British General Electric

Company. The National Enterprise Board's Inmos Company has a new plant in Colorado producing chips and another under construction at Newport in South Wales; it is the only British company exclusively manufacturing microelectronic devices and no other products.

Why should such a large proportion of Britain's semiconductor industry be collected in a small region of Scotland? Large government grants of the order of STG£2000 million per year for the development of the area is one important reason, but an adequate supply of trained graduates, good communications and a relatively cheap cost of living in this area

all played their part.

Most of the research and development work of these Scottish manufacturers is still carried out by their parent companies in the USA or elsewhere, but there is now an increasing tendency for the companies to carry out design work locally. In particular, General Instrument and National Semiconductor have design facilities in Scotland.

Scotland is now especially keen to encourage private sector interests in the region and has announced a scheme to help manufacturers to learn about the applications of microelectronics.

Brian Dance

# MORE SPECIALS

## HANIMEX PRINTING CALCULATOR - MASSIVE PRICE BREAKTHROUGH

- Quality Hanimex Brand Model MC 1500P
- 12 Digits, (12 Digit Print Plus D.P. Comma & Two Symbols)
- Seiko Printer
- Uses Standard Plain Paper Rolls (not expensive and hard to get Aluminium coated paper)
- Floating or Fixed Decimal Point
- Selectable % Mode, & most of the usual features found in machines costing well over \$100!!
- A Real Accountant's Special
- Weighs over 3Kg!!
- Roll of Paper Supplied - available virtually everywhere.

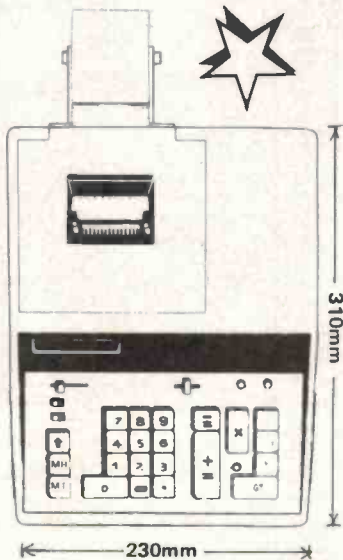

WE ONLY HAVE A SMALL QUANTITY OF THESE UNITS. STRICTLY ONE PER CUSTOMER

*Staggering Value* **\$5950**

## \* FAMOUS \* GENERAL ELECTRIC

**BURGLAR ALARM SLASHED!!!**  
**HUGE SCOOP PURCHASE - ONCE SOLD FOR OVER \$100**

*Slashed to*  
**\$29.50**

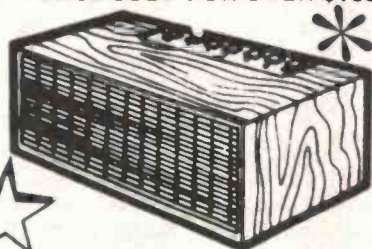

Amazingly low price for a full-feature ultrasonic proximity/burglar alarm. + Completely self contained + 12 month manufacturer guarantee + Instant or delayed alarm + Handsome imitation woodgrain + Cabinet measures 180Wx85Hx100D + Programmable multi-code disable switch + Single 9V Alkaline battery\* lasts one year + Unit beeps when battery gets low + Contains two receiver elements for greater sensitivity without false triggering + Uses State-of-the-art LSI circuitry + Worth the money for parts alone + Comprehensive 24 page manual included + Comes complete with 4 window deterrant stickers + Absolutely no installation needed. \* Battery extra

**SAVE A FORTUNE - COMPARES WITH UNITS OVER \$100**  
Below cost distress stock - Factory orders to sell.

### PCB EDGE CONNECTORS - Lowest in Australia

- Tell us if we're wrong!!!!

#### 0.1" DOUBLE SIDED SPECIALS

2x18 WAY GOLD SOLDER	1-9 \$2.50	10+ \$1.95
2x36 WAY GOLD WIRE WRAP	1-9 \$3.25	10+ \$2.50
1x39 WAY GOLD WIRE WRAP	1-9 \$2.00	10+ \$1.50
2x85 WAY GOLD WIRE WRAP PCB MOUNT		

\* CAN BE CUT TO ANY LENGTH METAL END CLIPS 30c ea.  
THIS IS PART OF OUR HUGE BULK PURCHASE. WE ALSO HAVE 0.125" AND OTHER SIZES - CALL IN!!

S-100 0.156" solder tail gold plated pins QUALITY  
1-9 \$4.95 10+ \$4.50

S-44 0.156" solder tail 22 way gold plated QUALITY

1-9 \$2.95 10+ \$2.60

## PLESSEY-FOSTER MORE SLASHINGS!!

We have purchased most of the remaining stock of these high quality units. Grab them now at not-to-be repeated prices.

12" 50WRMS C300K05

Normally \$69.50  
This month \$39.50

Unbelievable!! Ten pcs or more \$29.50  
SAVE UP TO 57%!!

15" 240WRMS C380K50

Normally \$245  
April Price \$175  
May \$145

THIS MONTH JUNE \$140

IS THIS WHAT THEY CALL A DUTCH AUCTION??  
HI FI

12" 20WRMS C300L05

Normally \$29.95  
This month \$19.95  
SAVE \$10.00

Where else would you get a 12" Hi Fi speaker for this price???

8" 20W C200L19

Normally \$15.00  
This month \$7.95  
SAVE \$7.05

5 1/4" 30W Midrange C130M06

Normally \$11.50  
This month \$9.50  
SAVE \$2.00

4" 50W Midrange C120K04

Normally \$5.00  
This month \$2.95  
SAVE \$2.05

6" 10W Widerange C160K03

Normally \$12.95  
This month \$6.95  
SAVE \$6.00



## CONSUMER FLOP

One of the greatest consumer flops of the last decade was the Ionization Chamber Smoke Detector. Even though it is a brilliant product (reliable compact, easy installation, fail-safe etc) it just did not sell. Human nature being what it is finds safety-oriented products just not worth the investment. We all know that accidents and fires never happen to US!! As smoke is the greatest killer in a fire, the market research gurus thought that such a product would have wide appeal. When they were \$49.50 no-one wanted them. The price fell to a very reasonable \$29.50 and still they stayed on the suppliers shelves. We have now been instructed to clear them for less than 1/2 of \$29.50 At \$14.50 this device is worth it for the parts alone.

- Contains Americium 241 Ionization Chamber
- 9V Mallory Duracell included
- Contains very loud solid state buzzer and other useful electronic components.
- 12 month factory warranty



## GENERAL ELECTRIC

*Grab One NOW* **\$14.50**

## LOGIC PROBES

We have purchased the entire stock of a very well-known supplier. We have probes and pulsers (injectors) made in both the USA & Far East.

MF504 LOGIC PROBE

- TTL/CMOS Minimum Pulse Width 20ns
- Input imp. 100K
- Max Freq 30MHz
- Multi-LED readout
- Stainless Steel Probe Tip

Normally \$49.50  
This month \$24.50  
SAVE \$25.00

MF520 SIGNAL GATE

Used to extend the operation range of probes. Will open "time window" to let logic probe signal state in that window . . . . .

Normally \$29.50  
This month \$12.50  
SAVE \$17.00

LOGIC PULSER MF512

- TTL/CMOS Will Generate Pulses (10% High 90% High) at 0.5pps or 400 pps
- Output protected

Normally \$59.50  
This month \$29.50  
SAVE \$30.00

SAVE OVER 50%!!!





# READ & REAP

## AUTORANGING DIGITAL MULTIMETER SENSATIONAL NEW PRICE!!

This fantastic meter is apparently exclusive to Dick Smith! Well we have been selling a meter that is identical to his Q-1446 except that ours weighs only 250 grams whereas (if you believe his new catalogue) the Q-1446 weighs 250kg. Perhaps that's why his is exclusive!! It certainly is not as portable as ours!!

We have made a bulk buy of these units as well as the model with the buzzer that gives GO/NO GO short circuit checks.

GRAB ONE NOW WHILE STOCKS LAST  
- 2 MODELS -

ME533 (Similar to D.S. Q-1446 except that it does not weigh in at 250kg)

**ONLY \$45 SAVE \$4.95**

CLUBS CAN BUY IN LOTS OF 10 (FOR CASH) FOR ONLY \$42.50

ME532 with low ohms buzzer **ONLY \$54 SAVE \$5.95**

CLUBS CAN BUY IN LOTS OF 10 (MIXED WITH ME533 IF YOU LIKE)  
FOR \$52.50 (CASH)

(SAVINGS ARE SHOWN OFF OUR NORMAL PRICES)



**SOAR  
BRAND**

- FEATURES: - 3 1/2 DIGITS LCD  
- AUTO RANGING  
- AUTO POLARITY  
- SAMPLING RATE: 2/sec  
- 0-1KV DC +/-1.35% worst case  
- 0-600VAC +/-2.3% worst case  
- 0-2Mohm  
- 0-200mA  
- POWER CONSUMPTION 5mW  
ME532 ONLY - RANGE CHANGE INDICATION BY ELECTRONIC BEEPER  
- SHORT CIRCUIT GO/NO GO BEEPER

\* PLUG-IN  
1% CURRENT  
SHUNT (TO 30 AMPS)  
TO SUIT BOTH  
METERS ONLY  
\$8.50 \*

*From Only*  
**\$42.50**

### AT LAST! REALLY HIGH POWER CAR SPEAKERS AT A LOW PRICE

SCOOP PURCHASE 3-WAY 6x9" 35WRMS 100WIHF MUSIC POWER We have snapped up a smallish quantity of a South-American made "NOVIK" speakers.

They feature a MASSIVE magnet assembly, (we mean it) weighing 570g, 1 1/4" diameter voice coil.

These speakers are ideal for high power car installations or Hi Fi. Available Individually. (Note: Due to their size they may not fit into car door panels - 100mm deep).

THESE UNITS ARE 4 OHMS IMPEDANCE

6x9" Professional grilles to suit \$4.50 each.

**ONLY \$29.50 ea**  
(\$59)/pair



### "INTERSI" LCD PANEL METER EVALUATION KIT

BARGAIN OF THE CENTURY!!! ICL7106EV

This kit has featured in numerous construction projects. Until the Jaycar DPM-200 it was the lowest cost LCD DPM around. It normally sells for around \$45.00

GRAB ONE NOW FOR ONLY \$29.50  
SAVE 35%!!

#### KIT INCLUDES:

- High Contrast 3 1/2 digit LCD module
- Intersil 7106 LSI
- PCB and all passives

#### FEATURES

- +/-1 count over +/-2000 counts
- Guaranteed zero reading for 0 volts
- Differential input

**\$29.50**

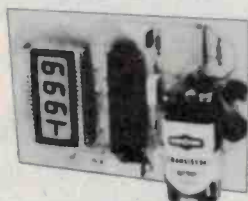

### EXPERIMENTER BREADBOARDS

We stock a great range of experimenter breadboards.

WB-TH - total 200 holes	\$8.95
WB-2N - total 840 holes	\$12.95
WB-4N - total 1680 holes	\$24.50
WB-6N - total 2420 holes	\$39.50



### 470 OHM THERMISTORS (NTC) DISC TYPE

A MUST IN EVERY JUNK BOX

**5 for \$1.00**

### NEED A NEW MUFF??

We keep spare earmuffs for the "Industry Standard" Sennheiser HD-414 Headphones. Maybe you have never seen a blue muff before but ours are and they come in pairs.

**\$3.95 set**

**Jaycar**

125 YORK ST SYDNEY 2000

Ph. 2646688 Telex 72293

Mail Orders To:

Box K-39 Haymarket 2000

Post and Packing charges



#### SHOP HOURS

Mon-Fri 9 to 5.30

Sat 9 to 2

Thurs night to 8pm

\$5-\$9.99 (\$1.20) \$10-\$24.99 (\$2.40)

\$25-\$49.99 (\$3.50) \$50-\$99.99 (\$4.60)

\$100 up (\$6.20)



# CURTIS RFI POWER LINE FILTERS

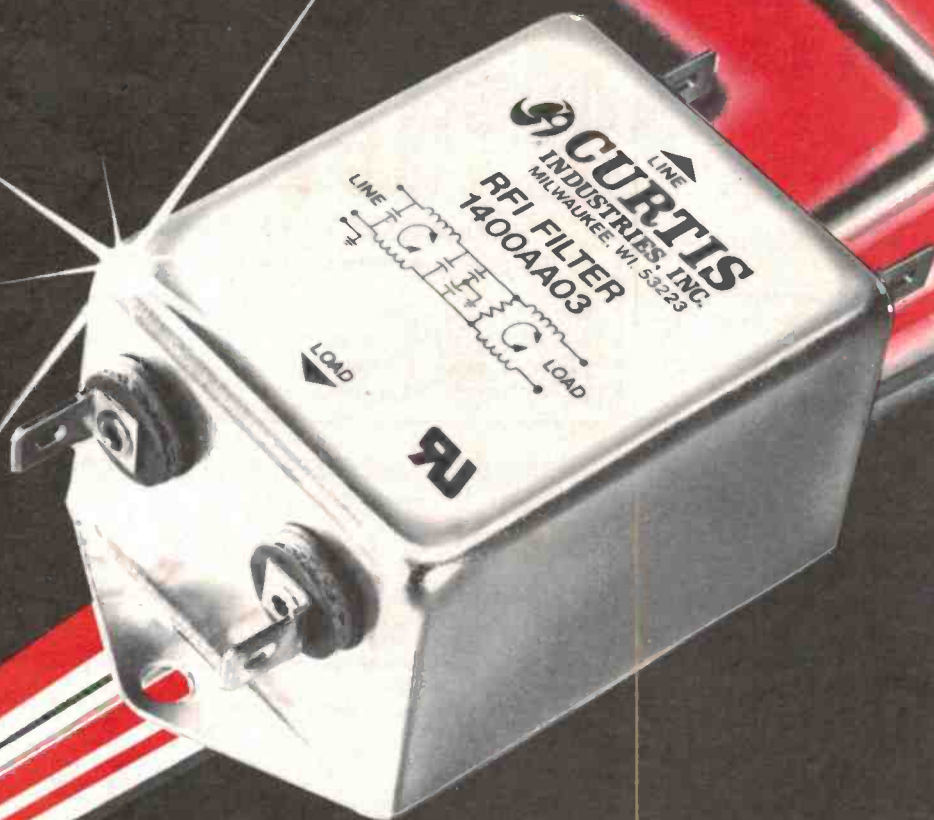

## SOANAR

Soanar Electronics Pty Ltd

30-32 Lexton Road, Box Hill, Vic., 3128, Australia.

VICTORIA: 840 1222

QUEENSLAND: 52 1131

N.S.W. 789 6733

WEST. AUST. 381 9522

STH. AUST: 42 8918

TASMANIA: 31 6533

Technical information available on request.

# ROD IRVING ELECTRONICS

425 HIGH STREET, NORTHCOE 3070. MELBOURNE. (03) 489-8131.

**ELECTRONIC COMPONENT SUPPLIERS, DESIGNERS & MANUFACTURERS.**  
**RITRONICS WHOLESALE (03) 489-7099. MAIL ORDERS (03) 481-1436.**

TELEX: AA38897

For heavier items add additional postage. Extra heavy items sent Comet freight on. Prices subject to change without notice. Send 60c and SAE for free catalogues. Minimum pack and post \$1.00. Bankcard Mail Orders welcome.

SUPER SPECIALS				BU326		\$1.90	
2708		\$ 4.50		2708S10		\$18.00	
2716		\$ 4.90		1771		\$18.00	
2732		\$ 8.00		1791		\$59.00	
6800		\$ 7.90		1795		\$59.00	
6802		\$11.00		4116		\$ 1.95	
6809		\$19.00		2114		\$ 1.95	
8085		\$ 9.00		TA7205		\$ 3.30	
8080		\$ 7.00		100 Red Leds		\$ 9.00	
6821		\$ 3.50		BUX80		\$ 3.90	
280P10		\$ 5.00		BU126		\$ 1.90	

CMOS	74C04	40	LF356-AN	1.50	UA4558TC	1.40	7494	.90
4000	74C08	40	LF357	1.50	MM5837	2.50	7495	.45
4001A	74C10	40	LM358	.70	LM7555	1.80	7496	.80
4001B	74C14	90	LM373	4.10	Mc10116L	.95	7497	2.50
4002	74C20	40	LM374	5.40	LF13741	.60	74107	.80
4006	74C30	40	LM376	.70	LF1374-1H	.70	74109	.60
4006	74C32	40	LM377	2.90	DS75452	.60	74116	2.20
4008	74C42	1.10	LM379s	6.70	76477	4.90	74121	.45
4009	74C48	.80	LM308 8PIN	1.30	75451	.60	74122	.65
4010	74C73	1.55	14PIN	1.50	75491	1.40	74123	.60
4011	74C74	.70	LM318A-N	2.40	75492	1.40	74125	.55
4012	74C83	1.40	LM318N	1.80	74500	.80	74132	.80
4013	74C85	1.20	LM382N	2.00	74502	.80	74141	1.10
4014	74C86	.80	LM383	2.70	74504	.80	74145	.85
4016	74C90	1.40	LM384	2.40	74510	.75	74147	2.00
4017	74C93	1.40	LM386	1.00	74511	.75	74148	1.40
4018	74C95	.95	LM387	1.30	74532	.75	74150	1.20
4019	74C107	.70	LM391	1.80	75551	.75	74151	.60
4020	74C150	3.40	LM393	.80	74574	1.20	74152	4.90
4021	74C151	1.00	LM398	5.00	74586	1.40	74153	.70
4022	74C160	.90	NE530	1.10	745112	1.20	74154	1.20
4023	74C192	1.00	OM350	9.90	745135	2.20	74155	.90
4024	74C164	1.10	555	.40	745138	3.20	8T28	3.00
4025	74C173	1.00	556	.80	745157	2.95	8310	.65
4026	74C174	.80	LM565	1.00	745158	2.95	8311	1.00
4027	74C175	1.00	LM565CH	2.00	745187	3.30	8312	1.35
4028	74C192	1.20	NE566	2.50	7400	.40	74156	1.50
4029	74C195	1.00	LM567	1.50	7401	.40	74157	.60
4030	74C221	1.90	NE571	4.50	7402	.40	74161	1.00
4031	74C373	1.80	LM709 14PIN	.70	7403	.40	74162	1.00
4034	74C374	2.00	UA710CA	.60	7404	.40	74163	.85
4035	74C901	90	LM710-CH	.90	7405	.50	74164	.60
4039	74C905	11.20	711	.80	7406	.50	74165	.60
4040	74C906	.90	UA711-H	.85	7407	.50	74166	.85
4041	74C907	.80	UA716HC	6.25	7408	.40	74167	1.10
4042	74C915	1.50	723	1.90	7409	.40	74177	1.10
4043	74C922	3.80	LM723CH	1.50	7410	.40	74180	.90
4044	74C923	5.00	LM725	3.90	7411	.40	74181	2.20
4046	74C925	7.50	LM733	1.20	7412	.40	74182	.90
4048	74C926	7.50	UA739	2.00	7413	.50	74184	3.75
4049	74C927	5.90	741	.40	7414	.70	74185	1.20
4050	74C932	5.50	LM741-H	1.20	7416	.50	74190	1.00
4051	1.00		UA747	1.50	7417	.60	74191	1.20
4052	.80		UA747HC	2.20	7420	.40	74192	1.20
4053	.80		UA748	.50	7421	.40	74193	.80
4060	2.00		UA748HC	1.25	7423	.50	74194	1.10
4066	.80		UA753	1.80	7425	.45	74195	.65
4068	.60		UA760HC	1.40	7426	.40	74196	.85
4069	.70		UA777	2.40	7427	.40	74197	1.10
4070	.50		UA777HC	2.65	7430	.40	74198	1.10
4071	.60		9334	1.70	7432	.40	74199	1.30
4072	.50		UA743	1.80	7437	.40	74221	.90
4073	.60		UA760HC	4.10	7438	.50	74290	.90
4075	.60		UA796HC	1.70	7440	.50	73293	.90
4076	1.20		LM802	1.10	7441	1.00	74365	.80
4077	.50		LM1310N	2.40	7442	.50	74366	.80
4078	.60		1408	4.90	7443	1.40	74367	1.00
4081	.60		LM1458	.60	7444	1.20	74368	1.00
4082	.60		UA1488	1.50	7445	1.10	8T96	1.80
4089	1.00		UA1489	1.50	7446	1.00	9314	1.30
4093	.80		MC1495	7.30	7447	1.00	9368	2.50
4503	.60		MC1496L	11.40	7448	1.00	9370	2.00
4510	1.50		LM1558	1.50	7450	.50	74LS00	.40
4511	1.40		LM1596	1.40	7451	.50	74LS01	.40
4512	1.10		LM1380	3.10	7453	.40	74LS02	.40
4514	2.50		LM2902	1.40	8126	2.20	74LS03	.40
4516	1.40		LM2917	3.90	9300	.60	74LS04	.40
4518	1.50		8PIN	2.80	9307	1.80	74LS05	.40
4519	.55		LM310-N	1.20	9308	1.20	74LS08	.40
4520	1.60		CA3028	1.80	7454	.60	74LS09	.40
4522	1.25		LM3039	.90	7472	.60	74LS10	.40
4527	1.20		CA3046	1.70	7473	.60	74LS11	.40
4528	1.25		LM311-H	1.20	3065	.45	74LS13	.50
4529	1.60		LM318	2.80	7475	.60	74LS14	.90
4539	1.60		LM322	3.90	7476	.60	74LS15	.40
4541	1.60		LM324	1.10	7480	.65	74LS20	.40
4543	2.00		LM325	3.20	7482	1.80	74LS21	.40
4553	5.50		LM329-DZ	1.40	7483	.80	74LS22	.40
4555	1.00		LM334-Z	1.30	7485	.80	74LS26	.40
40097	.95		LM335	12.40	3611	1.10	74LS28	.40
40098	.95		LM336-Z	3.20	LM3900	.90	74LS30	.40
40175	1.00		LM339	.90	LM3909	1.00	74LS32	.40
74C SERIES			LM348	1.30	LM3914N	3.90	74LS33	.40
74C 00	.40		LM349	1.80	4136	1.40	74LS37	.50
74C02	.40		LF351-N	.70	MA250	1.75	74LS38	.50

DIP SWITCHES SPST			
P/N	No. Switches	Price	
SD4	4	1.70	
SD5	5	1.90	
SD6	6	2.30	
SD7	7	2.40	
SD8	8	2.50	
SD9	9	2.70	
SD10	10	3.00	

WIRE WRAP 3-LEVEL			
	1-9	10-25	
8 Pin	1.00	.90	
14 Pin	1.10	1.00	
16 Pin	1.20	1.10	

COMPUTER GRADE ELECTRO.			
2900uf	40V	6.50	
6800uf	16V	6.40	
10,000uf	16V	9.00	
10,000uf	25V	9.50	
10,000uf	40V	11.90	
15,000uf	40V	12.00	

MULTISTRANO RIBBON CABLE			
		Price per metre	
		1-9	10+
10 Way	1.00	.90	
12 Way	1.20	1.10	
16 Way	1.60	1.40	
20 Way	2.00	1.80	
40 Way	4.00	3.50	

TRANSISTORS			
81LS97	2.10	2N5874	1.40
2N5961	.30	TIP32C	1.00
2N5963	1.10	TIP33A	1.10
2N6027	.60	TIP34A	1.20
3N201	1.50	TIP42B	1.50
AC127	1.00	TIP42B	1.10
AC128	1.00	TIP110	1.30
AC187	1.00	TIP120	.90
AC188	1.00	TIP2955	1.90
AD149	3.10	TIP3055	1.90
AD162	2.00	VN88AF	3.90
BC318	.30	MICRO CMPS	
BC319	.18	ADCO 800	15.00
BC327	.15	DACO 080	3.90
BC328	.30	2102 650 NS	1.40
BC337	.30	2513	14.50
BC338	.30	2516	55.00
BC547	.45	2532	12.00
BC548	.15	2650	23.00
BC549	.15	MCT2	1.00
BC559C	.40	MCT5	3.30
BC557	.16	MCT6	3.30
BC559	.16	MCT7	1.00
BC637	.60	MCC671	3.00
BC638	.60	4N28	.85
BC639	.40	4N33	1.20
BC640	.40	4N36	1.20
BCY70	.85	4N37	1.20
BCY71	.85	4N38	1.20
BD115	1.50	4N39	1.20
BD135	.70	4N40	1.20
BD136	.70	4N41	1.20
BD137	.70	4N42	1.20
BD138	.70	4N43	1.20
BD139	.70	4N44	1.20
BD140	.70	4N45	1.20
BD235	.65	4N46	1.20
BD234	.50	4N47	1.20
BD237	.50	4N48	1.20
BD262	1.20	4N49	1.20
BD301	.75	4N50	1.20
BD302	.75	4N51	1.20
BD263	1.25	4N52	1.20
BD435	.75	4N53	1.20
BD646	1.70	4N54	1.

# How to make things move very fast

Michael N. Kreisler

The macron accelerator may eventually make energy available for use in a wide range of applications, including controlled thermonuclear fusion.

MANY OF US have been fascinated by the challenge of making objects reach extremely high speeds. That fascination is evident in the glamour of high-performance racing cars and in the continuing popularity of the hero who is 'faster than a speeding bullet'. I would like to review here a growing field in which new techniques are being applied to that enticing challenge and to indicate why such efforts are worthwhile<sup>(1)</sup>.

The problem is not simply one of obtaining high speeds — elementary particle accelerators routinely produce electrons or protons with velocities extremely close to the speed of light. Rather the challenge is to achieve high velocities with macrons — macroscopic bits of matter of the order of a fraction of a gram. The name 'macron accelerator' is used to describe any device designed for that purpose.

The attempt to apply technological advances to this type of problem is not new. The catapult of the ancient Romans could be considered a prototype macron accelerator, and as such it demonstrates that although there are many other uses for such devices (some of which are explained below), there is usually an obvious military application.

The level of technology involved is both high and costly, and a legitimate question is why this particular type of research is worth pursuing. Some very interesting problems can be explored with macron accelerators, among them the study of the physical properties of matter. In collisions of stationary targets with matter travelling at very high speeds, it is possible to produce very high-density, high-temperature material momentarily. We can then determine the equation of state of such material to obtain information important to our understanding of material properties, as, for example, in the study of stellar interiors.

Michael N. Kreisler is Professor of Physics at the University of Massachusetts at Amherst. He received his Ph.D. in high-energy physics particle research from Stanford University in 1966 and was on the faculty at Princeton University before going to the University of Massachusetts in 1972. He has done research on a variety of topics ranging from the rare decays of elementary particles to the study of the hadronic production of interesting objects to the hunt for the fastest particles of all — tachyons (*American Scientist*, March 1973). He has recently been involved with colleagues at both Lawrence Livermore National Laboratory (LLNL) and Los Alamos Scientific Laboratory (LASL) in some of the research leading to this paper. Address: Department of Physics and Astronomy, GRC-Tower C, University of Massachusetts, Amherst, MA 01003, USA.

Another incentive is the desire to simulate the effect of micrometeoroids on space vehicles. Although the most probable velocity for a micrometeoroid is about 20 km/sec, the velocity distribution extends upward to several times that speed<sup>(2)</sup>. Being able to study in the laboratory the effects of collisions of such objects with space vehicles would clearly aid design procedures.

There is also the hope that macron accelerators will prove useful in the production of energy<sup>(1,3)</sup>. A projectile with a mass of 0.5 g travelling with a speed of 200 km/sec has a kinetic energy of  $10^7$  J, or roughly 200 eV, per nucleon. If the projectile is small, of the order of a millimetre, the collision time with a stationary target is approximately  $10^{-8}$  sec. The power in that collision is huge —  $\sim 10^{15}$  W — and is sufficient, if the projectile and target are properly designed, to initiate a controlled fusion reaction. Once an accelerator capable of producing speeds necessary to initiate such a reaction can be constructed, we will be within sight of power plants using macron accelerators. It is intriguing to realise that in such power plants the machines responsible for the high-velocity projectile could be removed by some reasonable distance from the furnace in which the thermo-

nuclear reaction would occur. Obviously, the energy produced per reaction would have to exceed that necessary to accelerate the macron.

Figure 1 shows the energies involved in the collisions of high-speed particles with stationary targets as the speed is varied from 1 to 1000 km/sec and beyond. In this range, the average energy per nucleon increases from a small fraction of an electron volt to energies approaching a million electron volts. At the high end of this scale, we would not only be able to produce new, exotic forms of matter as well as energy with controlled thermonuclear reactions, but we would also be able to conduct some tests of special relativity.

Thus there are many reasons to strive for high-velocity macrons. This article will concentrate mainly on the status of attempts to produce a macron accelerator. We set as our goal a device that would allow us to enter the region on the right hand side of Figure 1 — by accelerating a macron of at least a fraction of a gram to a velocity between 100 and 1000 km/sec. In addition, we would like a device which is capable of repeated use and which yields a solid projectile. For these reasons, we will not consider the many interesting results produced with shaped charges and with assorted liquid jets<sup>(4)</sup>.

Accelerating macrons to such velocities is quite difficult. To demonstrate the problem in a naive fashion, consider the case of a simple rocket. The well-known relation for the final velocity,  $v_f$ , given a rocket with a constant thrust, is expressed in the formula:

$$v_f = v_{\text{exhaust}} \ln \frac{m_i}{m_f}$$

where  $v_{\text{exhaust}}$  is the velocity of the exhaust, and  $m_i$  and  $m_f$  are the initial

and final masses of the rocket-fuel system. It therefore appears that we can achieve any final velocity, given a large enough mass ratio. Some numbers may be unconstructive. If we assume that  $v_{\text{exhaust}}$  is 3 km/sec (approximately 10 times the speed of sound), the logarithm of the mass ratio must be 300 in order to have a final velocity of 1000 km/sec. This implies that to have a final projectile of 1 g:

$$m_i = e^{300} \text{ g}$$

But  $e^{300}$  is a huge number — approximately  $2 \times 10^{130}$ ! Since the mass of the earth is only  $6 \times 10^{27}$  g, another approach is clearly necessary. In what follows we consider other techniques — some of which might succeed.

### Some acceleration techniques

A technique that has been investigated at some length and that still holds the possibility of attaining the goal of extremely high speeds involves the use of an electrostatic field. In the simplest case, one takes a macron, places as large a charge on it as possible, and then allows it to fall through a large potential difference. The expressions for the acceleration  $a$  and the final velocity  $v_f$  are

$$a = \frac{QE}{M} \text{ and } v_f^2 = 2L \frac{QE}{M}$$

where  $Q/M$  is the charge-to-mass ratio for the macron,  $E$  is the magnitude of the

electric field, and  $L$  is the length of the accelerator.

Several problems have limited the success of this technique. The first is a natural limit to the magnitude of  $Q/M$ . If  $Q$  is negative, the magnitude is limited by the onset of field emission. If  $Q$  is positive, the limits are set by the tensile strength of the material, which experiences electrostatic forces trying to tear the projectile apart.

Another problem arises from factors such as interactions with residual gas in a long accelerator, which might cause the  $Q/M$  of a projectile to vary during the acceleration cycle. A variation of this sort would play havoc with any acceleration scheme using a travelling wave.

Third, the length of the accelerator needed to obtain high velocities seems to be prohibitively long. One calculation indicates that in a travelling-wave accelerator with  $E = 10^4$  V/cm, velocities of 1000 km/sec could be obtained for small particles (having radii of  $10^{-4}$  cm) with a 10 km accelerator (3). Such prodigious lengths have tended to discourage further investigation. However, with current technology we realise that 10 km is big but not outrageous. Indeed, several elementary-particle accelerators now rival that dimension. For example, the Stanford Linear Accelerator is 3.2 km long, the accelerators at the Fermi National Accelerator Laboratory and at the European Centre for Elementary Particle Research (CERN) are approximately 8 km in circumference, and the proposed large electron-positron facility in Europe (LEP) will be 30 km in circumference. Certainly the dimensions of a macron accelerator should not be an

overwhelming argument to discourage active effort.

Among other schemes which have been proposed is a very interesting suggestion, first made by Winterberg (5), which uses a travelling magnetic wave to accelerate a magnetic dipole. Although this technique works, the eddy currents set up in the projectile yield Joule heating ( $I^2R$ ) sufficient to vaporize the projectile. In order to eliminate this annoying side effect, the projectile is made superconducting. As the superconducting projectile approaches a section of the accelerator, energy stored in large capacitor banks is converted into a magnetic field that accelerates the projectile.

In various forms, this proposed technique has received a reasonable amount of attention. Garwin and co-workers have done detailed analyses of the feasibility of such accelerators (6), and Kolm has constructed similar devices concentrating on large masses (7). At the Lawrence Livermore Laboratory, a brief engineering study of this technique was made (8). That study concluded that if in the operation of this device no unusual problems with materials properties arose, an accelerator capable of producing a 0.1 g projectile travelling at 150 km/sec could be built for roughly \$60 million. That accelerator would be 3.2 km long. Once again there seems to be no fundamental reason why such a device could not be constructed.

An obvious naive choice for a device to accelerate a projectile is a gun. Unfortunately, even so-called 'high-speed bullets' are barely moving compared with the velocities under discussion here. The limitation on the velocity of

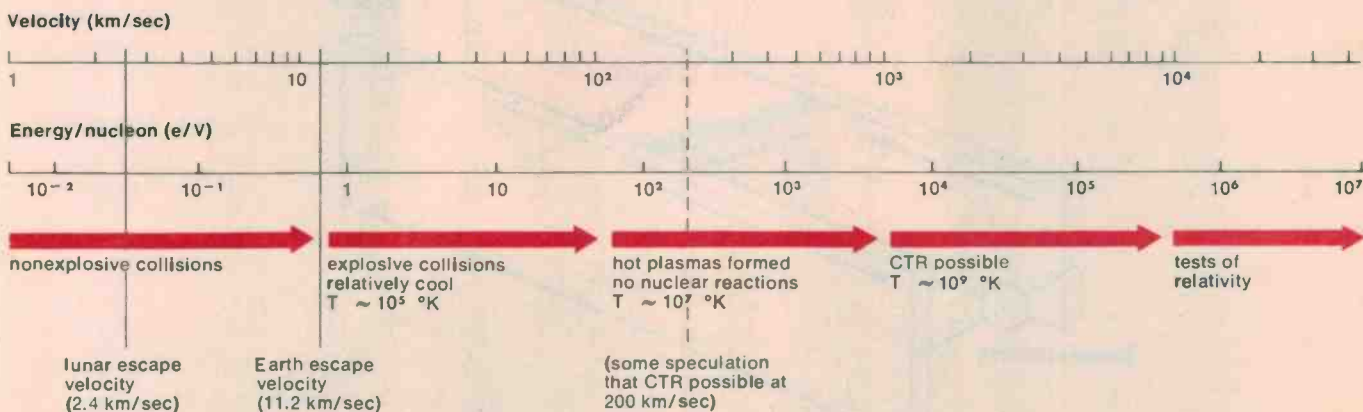

Figure 1. Energies involved in collisions of high-speed particles with stationary targets are shown diagrammatically. As the speed of the projectile increases from 1 to 1000 km/sec and beyond (indicated on the top line), the average energy per nucleon increases from a small fraction of an electron volt to energies approaching a million electron volts (indicated on the second line).

Both scales are logarithmic. The phenomena associated with these collision energies and some of the proposed applications are suggested in the descriptions of the collisions at the bottom of the scale. Among possibilities at the high end of the scale are controlled thermonuclear reactions and tests of the theory of special relativity.

such bullets can be understood from a simple analysis<sup>(9)</sup>. In order to get high-velocity projectiles, a very high pressure must be maintained on the projectile for as long a time as possible. The magnitude of the pressure is limited by the strength of the gun barrel itself. The time during which the pressure acts is limited also, regardless of the length of the barrel. As the projectile moves, the driving gas expands to fill the space behind it. This expansion is, of course, limited by the local speed of sound in the gas. When the velocity of the projectile exceeds the local sound velocity, the driving pressure drops rapidly, and any further increases in projectile velocity are very small.

There are many ways to indicate the parameters of this phenomenon, one of the simplest being the following:

$$p/p_0 = e^{-\gamma v/s}$$

where  $p$  is the driving pressure,  $p_0$  is the initial pressure,  $\gamma$  is the ratio of specific heats for the driving gas,  $v$  is the projectile velocity, and  $s$  is the sound velocity. For the case of an ideal gas:

$$s \approx \left( \frac{kT}{m} \gamma \right)^{1/2}$$

where  $k$  is the Boltzmann constant,  $T$  is the temperature of the gas, and  $m$  is the mass of the gas. Therefore, in order to get the local speed of sound high, it is desirable to go to gases with high temperatures and low atomic numbers. This approach has led to a device known as the two-stage light gas gun.

In the two-stage gun, a first-stage is used to compress and heat a gas in the second stage. This high temperature allows the final velocity of the projectile to reach several times the sonic velocity of the ambient gas. In fact, velocities approaching 5 km/sec have been obtained regularly, allowing accurate equation-of-state measurements<sup>(10)</sup>. Proposals to improve the performance of these guns include the use of shaped charges to superheat the driving gas and the acceleration of the entire second stage, in addition to the heating and compression. There have even been attempts to modify guns so that additional driving gas is injected at points along the trajectory<sup>(4)</sup>. Unfortunately, it does not appear that any of these modifications holds the promise of significant increases in projectile velocities. Above 5 km/sec, we have to search for a new method.

The acceleration of small particles using high-power lasers seems to hold great promise. The idea, of course, is quite simple. The end of a target projectile is hit with a high-power laser pulse. A large amount of material is ablated off at supersonic velocities and the remaining mass is accelerated to high velocities.

In order to calculate the velocity, the simple rocket equation suffices (with some problems to be mentioned below). The advantage of this method is that the ablated material is ejected supersonically. Recently, McCann and Degroot performed a calculation that showed the possibility of achieving very high velocities<sup>(11)</sup>. In their computer simulation, a laser was directed onto a 1 g target. Ninety per cent of the target was

ablated in  $10^{-3}$  sec, leaving a projectile of 0.1 g with a kinetic energy of  $10^6$  J and a velocity of 140 km/sec.

Depending on the power of the incident laser, there are several different types of acceleration mechanisms. These range from simple blasts detonated in the gas above the surface of the projectile to the ablation of the surface to the complete ionisation of the projectile<sup>(12)</sup>. The laser power required is, of course, quite large (typical efficiencies of conversion of laser power to kinetic energy are about 10%). Great strides have been made in the development of large laser facilities, but limits are set by the material properties of the projectile, primarily the yield strength of its constituent solids.

There is, however, a more serious problem with this technique: the cloud of ablated materials gets in the way of the incident laser light<sup>(3,11)</sup>. Since we want a target material that will absorb a large fraction of the incident laser energy, it is entirely reasonable that the cloud will absorb the energy as well. At an extreme limit, the incident energy is entirely absorbed by the cloud, and the target vaporises, acquiring little or no velocity in the process.

Two possible solutions suggest themselves. One is to create a pulse along the trajectory. If the laser pulses are directed onto the projectile at widely spaced intervals along its path, the particle can outrun the cloud. Of course, this requires very careful monitoring of the particle position. Such systems should, however, be rather simple to develop.

Multi-layered targets are another possibility. Although the technique is

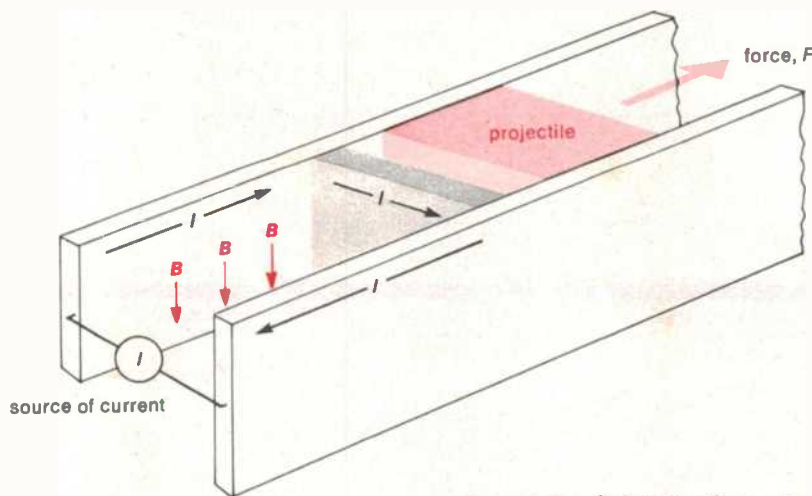

Figure 2. The electromagnetic launcher, or rail gun, is a device which uses electric current to drive a projectile. In the diagram, the current,  $I$ , creates a magnetic field,  $B$ , that in turn acts on the current with an outward force,  $F$ . The current flows down one of the rails, across a fuselike material on the back of the projectile, and back through the other rail. The large currents are supplied from homopolar generators, capacitor banks, or explosively driven current generators.

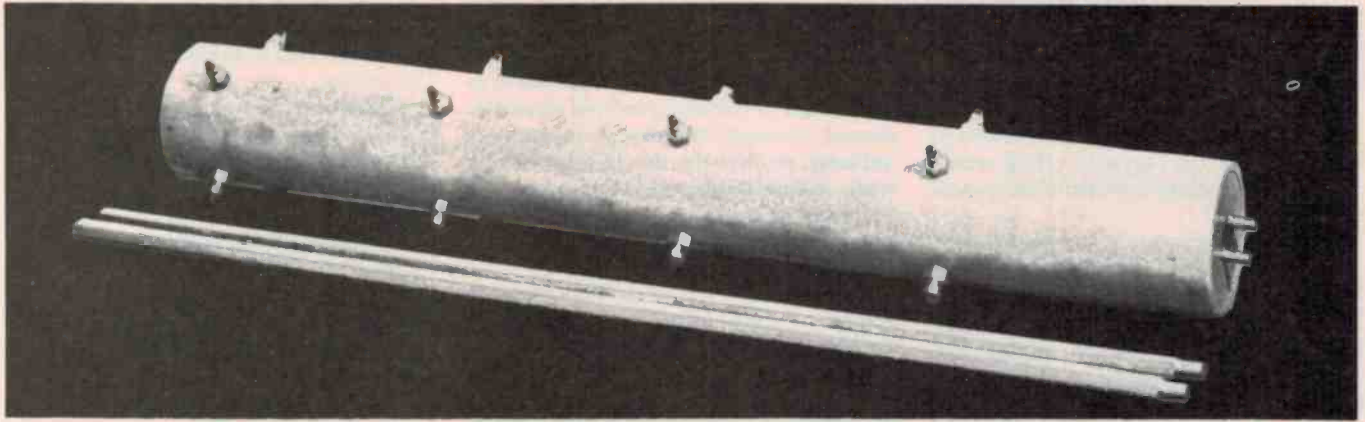

Figure 3. A team of scientists from Lawrence Livermore Laboratory and Los Alamos Scientific Laboratory devised a rail gun with copper rails embedded in a strong casing to reduce the effects of the powerful currents acting on the rails. Input connections to the rails emerge from the right face; alignment and diagnostic ports are visible along the cylinder; rails are shown in the foreground. (Photo courtesy of C.M. Fowler, LASL.)

still speculative, it may prove convenient to use targets constructed of layers of different materials, with driving lasers at different wavelengths. It might be possible for the ablated cloud from the outer layer of the target to be somewhat transparent to the light from the second laser. Obviously, such a scheme is merely a variation on the pulsing technique mentioned above.

Laser ablation acceleration appears promising and is worth a reasonable effort, but it is not easy to obtain time with the large laser facilities. The fact that this method is rather messy makes the situation more difficult, as does the strong competition for the use of high-power lasers, which are in demand for laser implosion studies.

## The rail gun

We turn now to an ingenious device — the electromagnetic launcher, or rail gun. This acceleration technique uses the Lorentz force to push a current-carrying element. As can be seen in the diagram in Figure 2, the current,  $I$ , that flows in the circuit produces a magnetic field, which in turn acts on the current with an outward force. Since the accelerating force is proportional to the square of the current, obtaining high speeds depends on being able to generate and maintain very large currents. This type of acceleration has been under investigation, with varying degrees of enthusiasm, since 1938<sup>(4)</sup>. Interest became quite intense when, in 1978, Rashleigh and Marshall were able to shoot 12.7 mm cubes of LEXAN, a plastic, to velocities of 6 km/sec<sup>(13)</sup>. The source of energy for their high currents (typically a few hundred thousand amperes) is a homopolar generator, a standard device to convert the

mechanical energy of a rotating flywheel into large currents. When the section containing the rails and the projectile is switched into the circuit, the current flows down one of the rails, across a fuse-like material on the back of the projectile, and back through the other rail.

The simplicity of this technique has encouraged a great deal of experimental effort, most notably by a team of scientists from the Lawrence Livermore Laboratory and the Los Alamos Scientific Laboratory<sup>(14)</sup>. This team has been exploring various aspects of rail-gun technology, ranging from methods of providing high-current pulses to rail manufacture and materials. One of their rail guns is shown in Figure 3. The copper rails are embedded in a strong dielectric container to prevent separation of the rails under the extremely large forces involved.

In the tests done so far, an initial current, provided by a large capacitor bank, yields an initial magnetic field. The region containing the magnetic field is then compressed explosively. In accordance with Lenz's law, this compression causes the current to increase rapidly, thereby greatly increasing the force on the projectile<sup>(15)</sup>. (An alternative way to understand the operation of this device is to consider it analogous to a gas gun in which the driving gas is the magnetic field. As such, the 'speed of sound' of the driving gas is the speed of light.) In one recent experiment, the rail gun was 1.8 m long, the peak current was nearly  $10^6$  A, and the peak acceleration was  $5 \times 10^6$  times the acceleration due to gravity. The LEXAN projectile has a velocity of almost 10 km/sec.

To be sure, this technique, too, is not without difficulties. Problems relating

to resistive losses in the rails, rail damage, stresses on the rails, and so forth must be solved before major increases in projectile speed can be obtained. But the technique looks very promising and should certainly provide velocities high enough for new equation-of-state measurements. It may even prove to be a convenient method for launching very small payloads into space. Some people have suggested looking into this technique as the ultimate solution to garbage-disposal problems<sup>(19)</sup>.

## New approaches

Several more speculative suggestions have recently been proposed. Before examining them in detail, we mention, in passing, two other techniques. One is acceleration with a charged-particle beam. The projectile is charged, and the beam transfers energy to the projectile. Velocities above 10 km/sec might be possible. The second proposal calls for velocity multiplication. In an elastic collision, a stationary object recoils with a velocity which is the speed of the incident object times an appropriate ratio of masses. This technique is limited by problems related to the strength of materials and the speed of sonic shock waves.

Among the new, speculative approaches which we want to look at in more detail is that involving orbital collisions. Consider an object orbiting Earth in a near-Earth orbit. Elementary physics indicates that the velocity,  $v$ , is:

$$v^2 = \frac{GM}{R^2}$$

where  $G$  is the gravitational constant, ►

$M$  is the mass of Earth, and  $R$  is the radius of the orbit measured from the centre of Earth — in this case, the radius of Earth. This corresponds to a velocity of 7.9 km/sec. Head-on collisions of two objects in opposite orbits would thus yield a relative velocity on impact of 16 km/sec.

Since the velocity is proportional to  $M^{1/2}$ , it is appropriate, when trying to improve this technique, to search for larger masses. The obvious choice is the sun. The dependence on radius also indicates that we want to conduct our experiment close to the sun. At the radius of Mercury, we find that the orbital velocity is 47 km/sec, yielding head-on collisions with relative impact velocities of approximately 100 km/sec. In order to get 1000 km/sec, it is necessary to reduce the radius to  $1/100 R_{\text{Mercury}}$ , which, unfortunately, is inside the sun. Undaunted, we propose finding and using black holes — leaving the problem of finding them to others. But if a black hole with a mass approximately equal to the mass of the sun were discovered, very interesting orbital velocities would exist at radii of  $10^6$  km. (To be sure, other interesting phenomena would exist as well.)

Tidman and Goldstein have recently suggested a very clever use for imploding plasmas <sup>(16)</sup>. It is well known that when a hollow annular discharge is initiated, the plasma collapses, or pinches, toward the axis of the discharge. Residual gas is swept ahead of the discharge. If a suitably shaped projectile is squeezed in a succession of such imploding plasmas, there could be a very large acceleration, which is often referred to under the enticing label of 'watermelon pit' acceleration. The effect is similar to the way in which watermelon seeds squirt from wet fingers squeezed together at picnics. Many aspects of this technique would need to be explored, including stability of the projectile, materials and their interaction with the plasmas, and so on. So far, this novel idea looks very promising.

Recently we have been re-examining the use of electrostatic fields as accelerators. It is quite simple to accelerate charged objects. One of the major problems is that the constancy of  $Q/M$  is hard to guarantee, and consequently the use of travelling waves may prove difficult. Matching the speed of the travelling wave with that of the particle also presents difficulties, but some of these become less important when we consider the acceleration of the dielectrics. When a dielectric is placed in an electric field, a dipole moment is induced. The particle then feels a force proportional to the square of the magnitude of the electric field.

At first glance, this particular scheme seems very promising, because, for one thing, the acceleration is proportional to the square of the electric-field strength; second, because the dipole moment is induced, so that the use of a travelling wave is facilitated; and, third, because the accelerating force is always pulling the object, so that questions of phase stability are reduced.

However, a few calculations make it apparent that very high fields are necessary to get velocities approaching 1000 km/sec. If the electric field is roughly  $\phi/\lambda$ , where  $\lambda$  sets the scale of the gradient of the electric field, and  $\phi$  is the electric field, we find that obtaining the required velocities in a 10 km long accelerator implies that  $\phi$  is about  $10^7$  volts! This approach therefore seems rather hopeless as a way of achieving the maximum velocities.

Some thought is being given to attempts to use the acceleration of dielectrics to obtain intermediate velocities. In such schemes, travelling electric waves provide the acceleration. Even at reduced velocities, serious obstacles remain to be hurdled, including frequency and temperature-dependent dielectric properties.

Finally, Harrison has recently considered the acceleration of needlelike projectiles in strong electric fields <sup>(17)</sup>. He finds that field emission by the needle provides a self-charging, charge-regulating mechanism. In addition, the charge-to-mass ratio (and therefore the acceleration) is significantly higher than for a spherical projectile. Long projectiles would be ideal test probes when velocities high enough to test special relativity are reached.

## Applications

Although I have not presented all the suggestions for macron accelerators, it is clear that meeting the challenge of high speeds is not limited by the availability of ideas. Given the variety of methods being proposed to produce projectiles moving with extremely high speeds, it is appropriate to review some of the possible uses of these devices.

Obviously, any scheme which allows repeated firing of massive objects at very high velocities is of immediate interest to the military. In fact, the rail-gun principle, or electromagnetic launcher, was used during World War II <sup>(4)</sup>. Both the Japanese and the Germans are known to have constructed relatively successful electromagnetic weapons. The Japanese device, built to defend a harbour installation in Japan, was reportedly destroyed by the incoming occupation troops. The German weapon, powered by a bank of storage batteries,

was capable of firing projectiles weighing about half a kilogram to speeds of 100 m/sec.

The interest by the military in these devices continues today. As the acceleration techniques improve and as the parameters of the system (mass and velocity of projectile, refire rate, ease and accuracy of aiming) surpass those of more conventional weaponry, such interest will, of course, intensify. It should be obvious that extremely high-speed bullets will penetrate almost any shield.

Another possible application is as space launchers. When the projectile speed approaches Earth escape velocity (see Figure 1), it is natural to contemplate using the accelerator to launch objects into orbit or into space. Such thoughts have formed the basis of many science fiction tales, the best known being the Earth-Moon travels described by Jules Verne. Clearly, the ability to launch massive payloads into space without the use of rocketry would benefit the space program. Some macron accelerator workers are concentrating on increasing the size of projectiles once speeds near the escape velocity are reached.

The potential use of such devices as launchers has played an important role in the plans for space colonisation originally put forth by O'Neill <sup>(18)</sup>. He has proposed using a modification of the travelling magnetic-wave accelerator developed by Kolm <sup>(7)</sup>. Such devices could be transported to and assembled on celestial bodies such as the Moon or asteroids and used to send huge quantities of rocks and other raw materials to space habitats.

An intriguing, albeit controversial, suggestion involves the use of macron accelerators located near power plants to launch small payloads of radioactive waste into space as a solution to the waste-disposal problem confronting the nuclear power industry. Conventional rocketry is not practical for the purpose, because economic considerations demand a large payload, and a large cargo of radioactive material would present a severe problem in the event of an aborted launch <sup>(19)</sup>.

Meteoroid simulation arouses interest, because there is a need for the artificial generation of particles moving at speeds similar to those of meteoroids. Although the most probable meteoroid velocity is about 20 km/sec, speeds as high as 70 km/sec have been observed <sup>(20)</sup>. On the basis of this and the mass distribution of meteoroids, researchers are interested in objects up to 1 g in mass with velocities up to 70 km/sec. The availability of such projectiles would allow a better understanding of crater-



ing theories for high-velocity impacts, permit accurate calibration of satellite and rocket-borne cosmic dust detectors, and result in better evaluations of the hazards to manned vehicles in a micrometeoroid environment. (21).

Another extremely useful application involves equation-of-state measurements. When a fast-moving object hits a stationary one, a shock wave, accompanied by very high pressures and temperatures, is generated. Although these conditions exist for only a short time, they are similar to those found in the centres of stars. For example, the collision of two flat plates constructed from tantalum at a relative velocity at impact of 8 km/sec results in a pressure roughly five million times normal atmospheric pressure. Except for underground nuclear explosions, the only hope for studying the behaviour of materials at these pressures in order to learn about stellar interiors is through the use of macron accelerators. Scientists working in this field are anxiously awaiting new developments in high-velocity projectiles. Interest in such high pressures is not limited to the study of material properties. Chemists, for example, want to study reactions and reaction rates at ultra-high pressures.

For many years, various techniques for producing controlled thermonuclear fusion have been suggested and attempted because of the tantalising prospect of an abundant energy source. The process is quite simple. Very small amounts of deuterium and tritium would be fused in a thermonuclear reaction, producing vast quantities of electrical power. It is currently believed that to initiate such a reaction it is necessary to deliver in the order of  $10^7$  J of energy into a volume of less than  $1 \text{ cm}^3$  in a time interval of  $10^{-8}$  sec<sup>(8)</sup>. In the attempt to produce such conditions, lasers, electron beams, and ion beams have been suggested.

One of the most exciting aspects of macron accelerators is that they provide an alternative approach to this problem. High-velocity projectiles have the requisite energy concentrated into a small volume. If the dimensions of the projectile are kept sufficiently small, the impact with a stationary target implies an extremely rapid energy delivery rate. Current accelerators are still about a factor of ten away from the velocities needed to produce thermonuclear reactions. However, that prospect is extremely inviting and has led to serious consideration of all aspects of impact fusion — the name given to this subfield<sup>(1)</sup>.

Even short of velocities high enough to initiate thermonuclear reactions,

macron accelerators might be used as fuel injectors for other fusion devices, such as Tokamaks<sup>(9)</sup>. Not only could the injector deliver fuel particles at a high rate, but with the proper choice of accelerator, the fuel would not be heated by the injection process.

Clearly the ideas for accelerators are many, and the applications cover just as wide a range. It is an extremely exciting field.

*This paper was originally published in 'American Scientist', Volume 70, Jan. — Feb. 1982. Reproduced by kind permission of the author.*

## References

1. A. T. Peaslee, Jr., ed. 1979. *Proc. Impact Fusion Workshop*, National Security and Resources Study Centre, LASL. LA8000C. See M.N. Kreisler, p. 321. See also M.N. Kreisler. In press. *Macron acceleration. Proc. Second Internat. Conf. on Energy Storage, Compression, and Switching*, Venice, 1978, ed. H. Sahlin and V. Nardi.
2. E.B. Igenbergs, D.W. Jex, and E.L. Shriver. 1975. New two-stage accelerator for hypervelocity impact simulation. *J. AIAA* 13:1024.
3. E.R. Harrison. 1963. Alternative approach to the problem of producing controlled thermonuclear power. *Phys. Rev. Lett.* 11:535. 1967. The problem of producing energetic macrons. *Plasma Phys.* 9:183.
4. C.D. Hendricks. 1958. *Macroscopic-Particle Accelerators*. Ramo-Woolridge Corp. Tech. Note ERL-LM-151 and pers. comm.
5. F. Winterberg. 1966. Magnetic acceleration of a super-conduction solenoid to hypervelocities. *Plasma Phys.* 8:541.
6. F. Winterberg. 1964. On the attainability of fusion temperatures under high densities by impact shock waves of small solid particles accelerated to hypervelocities. *Z. Naturforsch.* 19a:231.
7. R.L. Garwin, R.A. Mullen, and B. Richter. 1978. *Magnetic Gun Ignition for Controlled Thermonuclear Fusion*. SRI International, JSN-77-20.
8. H.H. Kolm. 1979. Electromagnetic accelerator concepts. In (1), p. 206.
9. J.N. Brittingham and R.S. Hawke. 1979. *Devices for Launching 0.1 g Projectiles to 150 km/s or More to Initiate Fusion*. UCRL-52778.
10. A.E. Seigel. 1965. *Theory of High Speed Guns*. AGARDograph #91.
11. J. Shaner. 1977. *Device for Injection of Neutral Fuel into Tokamak Device*. Internal Livermore Technical Note.
12. See, for example, J. Shaner et al. 1977. UCRL-79586.
13. T.E. McCann and J.S. DeGroot. 1977. *Acceleration of Solid Macroparticles by Laser Produced Ablation*. UCRL-79732.
14. F.S. Felber. 1979. Models of laser ablative acceleration for impact fusion. In (1), p. 250.
15. S.C. Rashleigh and R.A. Marshall. 1978. Electromagnetic acceleration of macroparticles to high velocities. *J. Appl. Phys.* 49:2540.
16. R.S. Hawke and A.L. Brooks, LLNL; C.M. Fowler and D.R. Peterson, LASL.
17. See, for example, 1980. Hypervelocity railgun experiments. In *Energy and Technology Review*, Lawrence Livermore National Laboratory, UCRL-52000-80-6.
18. D.A. Tidman and S.A. Goldstein. 1979. *Mass Accelerator for Producing Hypervelocity Projectiles Using a Series of Imploded Annular Discharges*. JAYCOR Tech Note 350-79-004; and (1), p. 285.
19. E.R. Harrison. 1981. Impact fusion and the field emission projectile. *Nature* 291:472.
20. G.K. O'Neill. 1974. The colonisation of space. *Phys. Today* 27:9.
21. G. Chapline, R. Hawke, and J. Scudder. LLNL, pers. comm.
22. E.B. Igenbergs, E.L. Shriver, and D.W. Jex. 1974. Recent developments in micro-meteoroid simulation. *Acta Astronautica* 1:1337.
23. J.F. Vedder. 1963. Charging and acceleration of micro-particles. *Rev. Sci. Instr.* 34:1175.

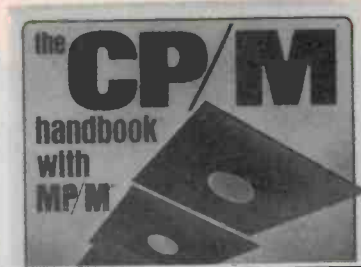

# CP/M finally explained!

Rodney Zaks



Anyone interested in computers will have heard the expression CP/M, but many may still be unclear as to what it is and what it does. Rodney Zaks' book *The CP/M Handbook with MP/M* will answer any questions you may have about using a computer equipped with CP/M.

CP/M stands for Control Program for Microprocessors, and is the industry standard in operating systems for small computers. It is available on nearly all computers using the 8080, 8085 or Z80 microprocessors, as well as some using the 6502 microprocessor.

The CP/M Handbook is a simple, clear and practical introduction to the use of CP/M-equipped computers, and a reference text. For beginners this book offers step-by-step instructions for using CP/M without fear — turning the system on, inserting a diskette, correct user discipline, remedial action for a problem situation — and everything is explained in a clear, concise and easy-to-read format.

For experienced programmers the book includes a comprehensive description of all CP/M facilities and resources, plus a complete discussion of all versions of CP/M, up to and including 2.2, MP/M and CDOS. Fifteen appendices feature complete summaries of all commands and facilities.

#### Contents include:

- An introduction to CP/M
- CP/M and MP/M facilities
- Handling files with PIP
- Using the editor
- Inside CP/M and MP/M
- Reference guide to CP/M and MP/M commands and programs
- Practical hints
- The future

The CP/M Handbook with MP/M is available from ETI Book Sales, 4th Floor, 15 Boundary St, Rushcutters Bay NSW 2011 for \$16.95 plus \$2 postage and packing.

Please send me . . . copies of The CP/M Handbook with MP/M at \$16.95 + \$2 p&p per copy

Total .....

Name .....

Address .....

Postcode .....

Signature .....

# BIG SAVINGS for NZ hobbyists

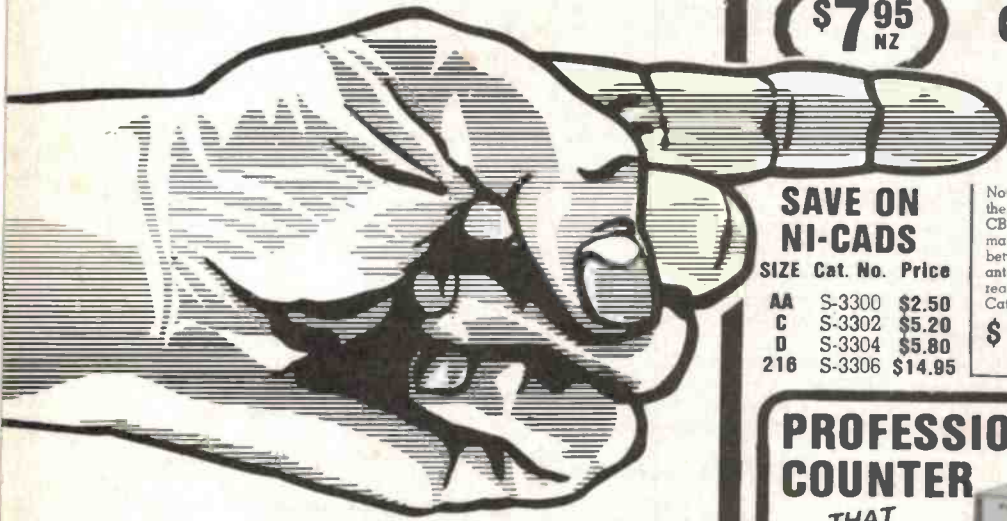

For the convenience of our thousands of New Zealand customers, Dick Smith Electronics now has a retail centre open in Auckland. With a large range of quality Dick Smith products (as much as we're allowed to bring into New Zealand), this store is open to both retail and wholesale customers. It offers prices up to 50% less — and more — than the prices you've been forced to pay in the past — and since we've opened, we've found many of our competitors' prices have dropped — which is good for all hobbyists, whether they're Dick Smith customers or not. We also have a large number of authorised re-sellers throughout New Zealand, so you're never far away from quality, value & service.

## HEY KIDS (& elders!) LEARN ELECTRONICS THE FUN WAY



**FUN WAY VOL 1**  
4th PRINTING! 72 pages packed with 20 exciting projects to build ranging from an electronic siren to a beer powered radio! No soldering required. Safe and ideal for all ages. Cat. B-2600 P&P \$1.00

**\$5.95 NZ**

**FUNWAY VOL 2**  
3rd PRINTING! 130 pages. Once you've mastered Vol 1 projects, this book will take you step by step through 20 projects while teaching you basic electronic laws, component codes etc. Make a home intercom, mosquito repeller, LED counter & other exciting projects. Cat. B-2605 P&P \$1.00



**GREAT RANGE OF KITS AVAILABLE!**

**\$7.95 NZ**

**SAVE ON NI-CADS**

SIZE	Cat. No.	Price
AA	S-3300	\$2.50
C	S-3302	\$5.20
D	S-3304	\$5.80
216	S-3306	\$14.95

### POWER/SWR METER

Now you can measure the output power of a CB transmitter and the matching conditions between transmitter and antenna. Large easy to read measurements. Cat. Q-1350



**\$19.95 NZ**

### PROFESSIONAL FREQUENCY COUNTER

Cat. K-3439

**THAT YOU BUILD YOURSELF!!!**



- Accuracy better than .005%
- Huge bright efficient 7 segment display.
- 3 ranges - 0-10MHz, 0-50MHz, 10-500MHz (with optional prescaler)
- 4 gating times - 0.1, .1, 1, 10 seconds.
- 4 period measuring ranges - 1, 10, 100 & 1000 input cycles.
- PLUS MUCH MORE!

**\$139.50 NZ**

Optional Instrument Case: **ONLY \$31.50 (H-2505)**  
Optional Prescaler 500MHz: **ONLY \$45.00 (K-3432)**

**ULTRASONIC TRANSDUCERS \$7.95 NZ EA**

Hundreds of applications: alarms, TV remote control etc etc. Transmitter (L-7050), receiver (L-7052)



**"Why pay more when you can build your own computer & save \$\$\$!"**

# THE DICK SMITH SUPER 80

**No. 1 for quality & value!**

Imagine telling your friends that you actually built your own computer! Now you can with this superb kit. Not only do you end up with a powerful computer, you learn so much about computer technology while you are building it.

**LOOK AT THESE GREAT FEATURES:**

- Full size professional keyboard
- Cassette interface on board
- Budget tape 'BASIC' or optional 'EPROM BASIC'
- Supplied on board memory of 16K, expansion to 48K RAM
- On board video modulator - works on any TV
- All components on board except transformer
- S-100 expansion system for add-ons
- PLUS MUCH MUCH MORE!!!

**ACCESSORIES TO SUIT:**

Cassette BASIC to suit Super 80	Cat. K-3602	.....	\$29.90
IC Socket Kit (recommended)	Cat. K-3603	.....	\$18.50
ROM BASIC for Super 80	Cat. K-3604	.....	\$120.00
S100 Expansion System for Super 80	Cat. K-3606	.....	\$39.75
Super 80 Character Generator	Cat. K-3607	.....	\$109.50



**ONLY \$545 NZ**  
Cat. K-3600 P&P \$5.50

**DATA SHEETS that save you time AND Money!**



- How to Install your own Burglar Alarm B-6000 ..... \$1.95 NZ
- How to Install your own TV or FM antenna B-6010 ..... 75c NZ
- A Guide to Printed Circuit Board Making B-6005 ..... 75c NZ

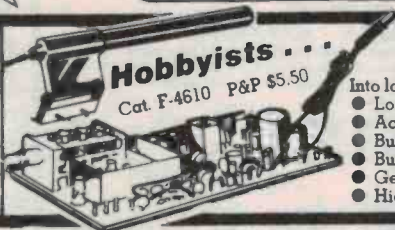

**AM/FM TUNER MODULE**

Into low cost cost quality hi-fi? Then here's the one for your money!

- Loop stick antenna fitted for AM stage
- Accepts 12V-16V DC & has overload protection
- Built in FM muting, tuning & signal meter circuits
- Built in 19kHz & 38kHz notch filters for MPX stage
- Geared 5 gang variable capacitor
- High image rejection over 50 decibels.

**NZ \$139**

**COMPARE OUR PRICES SOLD ELSEWHERE FOR \$7.00!!!**

**57mm MINI SPEAKER**

This 57mm mini speaker has performance - in fact we found that it offered more performance than speakers up to 75mm in diameter! Nominal impedance of 8 ohms make it ideal for many purposes.



WHY PAY MORE THOUSANDS OF USES **\$2.95 NZ**

**DEMAGNETIZE IT!**

Demagnetizes tape recorder heads, removing excessive noise levels & saving your tapes from possible loss of quality.



**\$14.95 NZ** Cat. C-7222 P&P \$2.00

**COMPUTER VERIFIED CASSETTE TAPE** Cat. X-3502

Famous 'Microsette' C10 cassette gives 5 minutes per side - over 40K capacity per side!

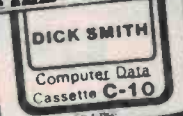

**\$3.95 NZ** Cat. X-3502  
**One unnamed company sells a similar tape for \$18.00!!!**

**LOW COST SIGNAL INJECTOR**

Check out both audio and RF circuits (harmonics extend to many MHz) simply and easily. Self contained, battery operated with probe and earth clips.

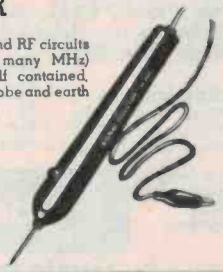

AND ONLY **\$11.50 NZ**

**INTERCOM PICK-UP**

Place suction cap to your phone or intercom etc. With lead & plug to connect to your amp or tape recorder.



**\$4.50**

**FREE 2nd Edition NZ CATALOGUE!**

Packed with lots of goodies for Kiwi enthusiasts, hi-fi buffs, amateur & CB freaks, computer nuts etc etc etc.

If someone pinched yours from this magazine, don't worry. Just send \$1.05 to our address below. We'll take care of the rest!!!

DSE A269NZ

**DICK SMITH Electronics**

98 Carlton Gore Rd. Newmarket Auckland. Tel: (649) 50 4409

Mail Orders: PO Box 9452, Newmarket NZ

**WHY PAY MORE?**

Store Hours: Mon - Fri 8.30am to 5pm.



# SHERIDAN ELECTRONICS

"Top brands and prime spec too"

## 2114 RAMs FROM \$1

Excess Stock must be cleared so we're selling at less than half our normal low price. You benefit!!

2114-3 (300nS) 1Kx4 RAMs.  
1 to 9 \$1.50  
10up \$1.20  
100up \$1.00

STOCKS MUST BE SOLD

## 50 WAY COMPUTER RIBBON

Top quality multicoloured computer ribbon at a down to earth price. For computer components at the best prices, shop at Sheridan's.



only \$5 per metre



## 12 way Terminal Block

Don't go paying \$1.30 for terminal blocks. These are top quality nylon. And look at the price.



75c each 10 for \$6.50

NEW DESIGN 'D' CONNECTOR

## 9 PIN QUICK RELEASE

New design 9 pin 'D' connector from AMP has quick release socket. Chassis socket can be flat or PC mounted. Plastic body. Gold plated pins.



\$10 the set

## A PUSHBUTTON PHONE COMPLETE

Once only scoop purchase. Pushbutton dialling and memory function are yours for less than Telecom's installation cost. The Instaphone dialler is top quality from PYE/TMC U.K. You get pushbutton dialling with 'try again facility plus 10 memories. Comes complete with Telecom plug and installation manual. Perfect for that extra phone or extension.



only \$59 while stocks last

Not Telecom Approved

## ZIF Socket

These superb 24 pin Textool zero insertion force sockets are ideal for ROM burners etc. The best quality doesn't cost a fortune at Sheridan's.

only \$12.00

LOOK

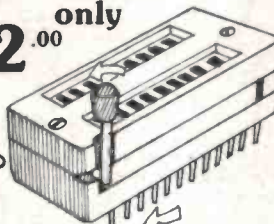

## 10 Way Submini PCB Connector

This fantastic subminiature plug and socket set is 0.1" pitch so it is ideal for PCB connections to computer boards etc. The price per set only

\$1.00



## 'D' Connectors for Half Price

Top quality American TRW 'D' connectors at under half price. All gold plated contacts. Only sold as plug and socket pairs.

Prices are for a pair

50 way \$12.00  
37 way \$10.00  
9 way \$4.50  
9 way wirewrap \$6

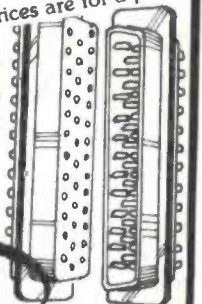

QUALITY

## µA78HG Adjustable 5A Regulators Below Cost

We have managed to make a bulk purchase of these incredibly useful adjustable regulators. And we're passing the savings on to you. Our price is below normal wholesale cost. The µA78HG is a positive voltage regulator in a T03 case. Maximum output current is over 5A. Voltage is adjustable from 5 to 24 volts. Only two external resistors are needed to set the output voltage. Major features:-

- 5.0A Output Current
- Internal current and thermal limiting
- Internal short circuit current limit
- Low dropout voltage (2.3V@5.0A)
- 50W Power dissipation
- Electrically neutral case
- Max. input voltage 40V
- Max. differential voltage 35V

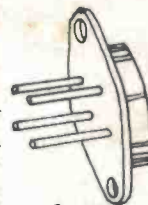

only \$5.20 includes data sheet

## SHERIDAN ELECTRONICS

164-166 Redfern St., Redfern St., Redfern NSW 2016.  
Phone (02)699 5922, (02)699 6912  
Mail Orders to:- Dept ET PO Box 229 Redfern NSW 2016

Trading Hours:-  
Mon-Fri... 9am-5.30pm  
Thursday... 9am-7pm  
Saturday... 9am-12noon

Mail Charges:-  
\$5.00-\$9.99... \$2.50  
\$10.00-\$24.99... \$3.00  
\$25.00-\$49.99... \$5.00  
\$50.00-\$99.99... \$6.00  
\$100.00 or more... \$7.00

Heavy or bulky items sent freight forward by 'Overnighters'





The ZX PRINTER  
— designed for use  
with ZX81 and ZX80  
with 8K BASIC ROM.  
Alpha-numeric! Graphics!

**\$190**  
incl. Sales Tax



**\$199**  
COMPLETE

# sinclair ZX81 PERSONAL COMPUTER

\* excluding mains adaptor

## sinclair COMPLETE WITH BASIC MANUAL, LEADS, ONLY \$199

**16K-BYTE  
RAM PACK \$150**

Higher specification,  
lower price — how's it done?

Quite simply, by design. The ZX80 reduced the chips in a working computer from 40 or so, to 21. The ZX81 reduces the 21 to 4!

The secret lies in a totally new master chip. Designed by Sinclair and custom-built in Britain, this unique chip replaces 18 chips from the ZX80!

The ZX81 comes complete with all leads to connect to your TV (colour or black and white) and cassette recorder.

### New, improved specification

- Z80 a microprocessor — new faster version of the famous Z80 chip, widely recognised as the best ever made.
- Unique 'one-touch' key word entry: the ZX81 eliminates a great deal of tiresome typing. Key words (RUN, LIST, PRINT, etc.) have their own single-key entry.
- Unique syntax-check and report codes identify programming errors immediately.
- Full range of mathematical and scientific functions accurate to eight decimal places.

- Graph-drawing and animated-display facilities.
- Multi-dimensional string and numerical arrays.
- Up to 26 FOR/NEXT loops.
- Randomise function — useful for games as well as serious applications.
- Cassette LOAD and SAVE with named programs.
- 1K-byte RAM expandable to 16K bytes with Sinclair RAM pack.

- Able to drive the new Sinclair printer (not available yet — but coming soon!)
- Advanced 4-chip design, microprocessor, ROM, RAM, plus master chip — unique, custom-built chip replacing 18 ZX80 chips.

### ZX Software Cassettes

Send for free catalogue of Games, Business, Educational, Junior Education. Encl. S.A.E.

**FREE New Basic ZX81 Manual**

### ORDER FORM: SINCLAIR EQUIPMENT (A'SIA) P/L

86-88 Nicholson St., Abbotsford, Vic. 3067. Ph. (03) 419 3033.

QUANTITY	ITEM	ITEM PRICE	TOTAL
	Ready assembled ZX81 Sinclair Personal Computer including leads, BASIC manual, excluding mains adaptor.	\$199	
	16K-BYTE RAM pack (optional extra)	\$150	
	1.2 Amp Adaptor	\$ 17.50	
	ZX Printer	\$190	

I enclose cheque/Bankcard/Diners Club/Amex

Name \_\_\_\_\_ P'code \_\_\_\_\_

Address \_\_\_\_\_

Signature \_\_\_\_\_

ETI

**QUEENSLAND:** Myer (all branches); Bundaberg — Datacom; Taringa — Software 80; Rockhampton — Purely Electronics Pty. Ltd.; Townsville — Scott's Audio-Optical.  
**ACT:** Fyshwick — Steve's Communication Centre. **TASMANIA:** Hobart — J. Walsh and Sons Pty. Ltd.; Launceston — Birchalls; Hobart — Quantum Computers,  
**VICTORIA:** Myer; Prahran — The Logic Shop; West Melbourne — Radio Parts Group; Northcote — Rod Irving Electronics; Bendigo — Minit Computer Service; Mildura — C. & G. Computers Pty. Ltd.;  
South Melbourne — B.B.J. Computer Shop Pty. Ltd.; Croydon — Mindbenders of Croydon; Melbourne — Strachan Office Supplies; Melbourne — Computerland.  
**WESTERN AUSTRALIA:** Perth — Microbase. **SOUTH AUSTRALIA:** Myer (Adelaide store); Adelaide — Acuis Australasia Pty. Ltd.; Mt. Gambier — Omni Computing.  
**NORTHERN TERRITORY:** Alice Springs — Ascorm Electronics; Wulagi — Eyles Computer Services.  
**NEW SOUTH WALES:** Albury — Minit Computer Service; Crows Nest — B.B.J. Computer Shop Pty. Ltd.; Sydney — David Reid Electronics Pty. Ltd.; Sydney — Computer Wave Pty. Ltd.;  
Parramatta — Trinity Computing; Sydney — CISA Microcomputers Pty. Ltd.; Hurstville — Direct Computer Sales; Dick Smith Electronics (all stores); North Sydney — Computer Gallerie;  
Gullford — A.E.D. Microcomputer Products; Neutral Bay — Computers Galore; Broken Hill — Paul Derez Radio TV Services; Wollongong — L. & B. Television Service Pty. Ltd.;  
Armidale — Micla Sales & Service; Chatswood — Computerland Chatswood; Tamworth — L.S.T. Electronics; Penrith — Acorn Electronics.

# Light and power from dc supplies

Generating mains-independent light and power from batteries is fraught with many unrealised difficulties. Whether you want dc back-up to operate equipment when the mains goes 'off the air' or a wholly independent 240 Vac supply, you should know the problems up front.

**Roger Harrison**

THAT'S THE TROUBLE with Electricity Commissions — they've insidiously crept into our lives and made us quite dependent on them. For those occasions when we cannot avail ourselves of their 'services', we have to rely on other sources to provide light and power. The old kerosene pressure lamp has its advantages — and disadvantages — but how on earth do you keep a disk drive running when the ac mains 'browns out'? As storage batteries are ubiquitous, the 12 V car battery in particular, it's natural that we turn to them to provide back-up and mains-independent supplies.

## Back-up supplies

For equipment designed to be powered directly from a nominal 12 Vdc source or from either 12 Vdc or 240 Vac, back-up supplies are employed to maintain continuity of supply, the battery being kept charged from the mains, but the battery acts to maintain power supply to the equipment in the event of mains failure. This sort of system is commonly installed with burglar alarms, amateur radio repeaters and geophysical mon-

itoring equipment, for example.

The 'power budget' of such systems is carefully considered to provide maximum service period from the battery supply when mains is unavailable. Hence a single 12 V storage battery — generally a low maintenance type — is employed. Let's learn a bit about lead-acid batteries first.

The fully-charged, no-load terminal voltage of a lead-acid cell is between 2.3-2.4 volts. This drops under load to about 2.0-2.2 volts. When discharged, the cell voltage is typically 1.85 volts. The amp-hour capacity is determined from a 10-hour discharge rate. The current required to discharge the battery to its end-point voltage of 1.85 V/cell is multiplied by this time; e.g. a 40 Ah battery will provide four amps for 10 hours before requiring recharge. Note however that the amp-hour capacity varies with the discharge current. The same battery discharged at a rate of 10 amps will not last four hours; on the other hand if it is discharged at 1 amp it will last somewhat longer than 40 hours. The typical discharge characteristics of a (nominal) 12 V battery are shown in Figure 1.

The ideal initial charging current for the fully discharged battery (cell voltage under 2.0 V) should be about 20 amps per 100 amp-hours of capacity (i.e. 8 amps for a 40 Ah battery). Once the electrolyte begins to gas rapidly, the terminal voltage will be around 13.8 volts and rising rapidly. At this point, the charging current should be reduced to somewhere between 4-8 amps per 100 Ah until charging is complete.

At the end of charging, terminal voltage may rise to about 15.6 volts or more, but this decreases slowly after the charger is removed, the terminal voltage then usually reading around 14.0 to 14.4 volts (see Figure 2).

Back-up supplies are generally of the 'trickle-charge' type or the 'battery condition' sensing type. Two good examples are ETI projects 597 — Emergency Lighting Unit (December 1980) — and 1503 — Intelligent Battery Charger (August 1981). The ETI-597 trickle charges a 12 V battery when the mains is on and provides automatic switchover when the power drops out. It's cheap and simple, but needs to be used for the batteries to stay in condition so that they deliver their rated capacity when

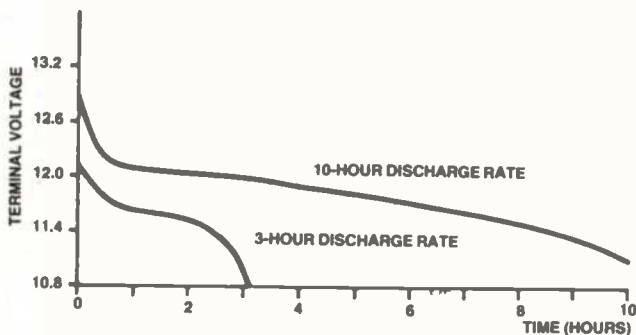

Figure 1. Typical discharge characteristics of a 12 V (nominal) lead-acid battery.

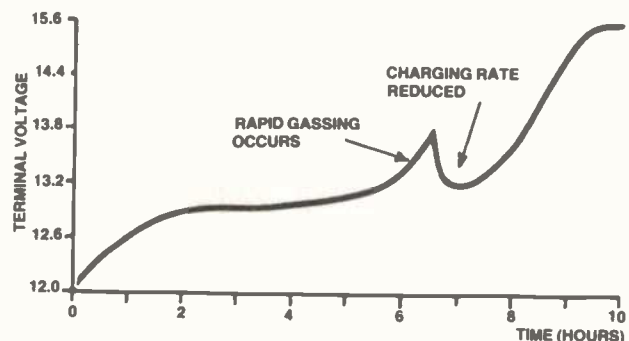

Figure 2. Charging characteristics of a 12 V (nominal) lead-acid battery. The 'kink' in the curve near six hours is explained in the text.

needed. Back-up supplies of this sort are only practical where the load on the supply is not too heavy — generally 20 W or so.

To drive a heavier load, upwards of 50 W for example, it's best to power the equipment from the battery *all the time* and have a charger which senses the battery terminal voltage, charging the battery when the terminal voltage falls to a preset level and turning off when the terminal voltage rises to the desired operating level again. This is what the ETI-1503 does. There is a slight element of luck involved as to how charged the battery will be at any one time, but the lower limit is usually set so that the equipment will operate for a specified period. The ETI-1503 can be used with batteries with a capacity up to 100 Ah. Such a battery can drive a 10 A load at the 10-hour discharge rate — which effectively means it's a good back-up supply for equipment with a power budget of up to 120 W mean consumption. This means that actual consumption can be greater than that from time to time provided that consumption falls below the mean level for an equivalent period. An amateur VHF or UHF repeater is a good example. Whilst 'listening' only — no stations active on the input channel — consumption is quite low. When 'activated' by a station or stations, the repeater spends most of its time transmitting, and consumption can be four to ten times that during inactive periods, depending on the power output of the transmitter employed in the repeater.

As stated earlier, the major consideration with back-up supplies is the power budget of the equipment being supplied. If you anticipate the necessity of operating the equipment for periods exceed-

ing, say, eight hours, then a battery of adequate ampere-hour capacity needs to be used. It is always prudent to choose a battery with 20-50% more capacity than strictly necessary.

### dc-ac inverters

Like storage batteries, 240 Vac mains-operated equipment is ubiquitous! The huge variety of products have been designed to be *convenient*, thus making themselves *necessary*. Or so it seems. Why on earth anyone would want to take an electric razor on a camping expedition and expect to power it from an ersatz 240 Vac supply is beyond this writer — but then I haven't had a shave in more than 15 years except when my appendix was removed and then they didn't shave my face!

There are two common approaches to providing 50 Hz ac power for mains operated appliances: provide square wave drive of the appropriate amplitude, or derive a sinewave (or pseudo sinewave) supply of appropriate amplitude. Both are fraught with hidden difficult-

ies. If you want any substantial amount of power output — like 200 W — you're in hot water — and probably unable to boil a billy, to boot!

A square wave dc-ac inverter has the advantage of simplicity and efficiency — depending somewhat on the design. Inverters generally take two forms: *self-excited*, usually employing a feedback winding on the transformer, and *driven*, where an oscillator drives a switching circuit, generally with transformer output. Where the precise frequency of the ac output is unimportant, self-excited inverters are employed. Where a stable 50 Hz output is required, a driven inverter is necessary.

Lighting is one area where self-excited dc-ac inverters find application. The common tungsten filament incandescent light globe is a poor choice for lighting where a dc supply is employed. They have an efficiency of less than a fifth of that of a fluorescent light of the same power rating — viz: around 12 lumens/watt for the tungsten filament lamp versus better than 60 lumens/watt for a fluorescent tube. A 20 W fluorescent tube would provide as much light output as a 100 W incandescent globe! Those figures are based on 50 Hz ac supply. Fluorescent tubes *actually improve in efficiency* when driven from a higher frequency supply. Figure 3 shows how the light output of a fluorescent tube increases with increasing supply frequency. Driving the tube from a supply frequency of 10 kHz or more will result in a 20% increase in light output.

The circuit of a self-excited inverter driving a fluorescent tube is shown in Figure 4. This is taken from Project ETI-516 of November 1972. It ran at around 2 kHz and employed a ferrite-cored transformer. Consumption was 2.5 amps. An incandescent globe to pro-

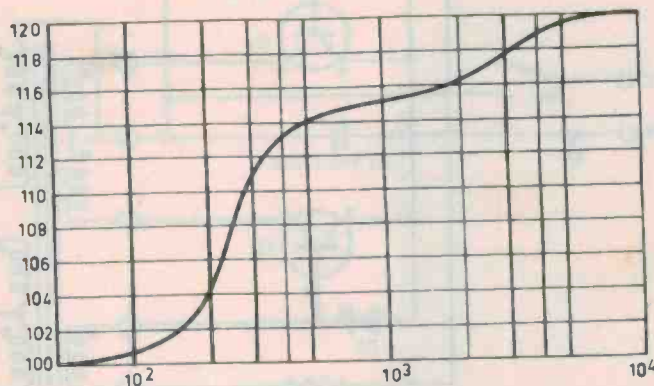
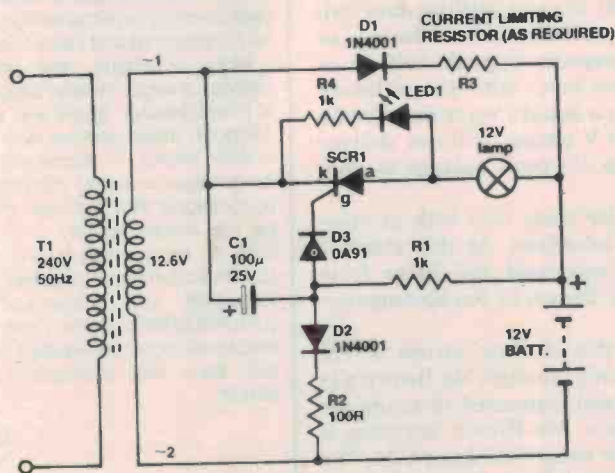

Figure 3. The light output of a fluorescent tube increases with increasing supply frequency in the manner shown in this graph. The property is exploited in dc-ac square wave inverters for lighting.



Circuit of the ETI-597 'Emergency Lighting Unit', a simple back-up supply that can be used for other than lighting applications.

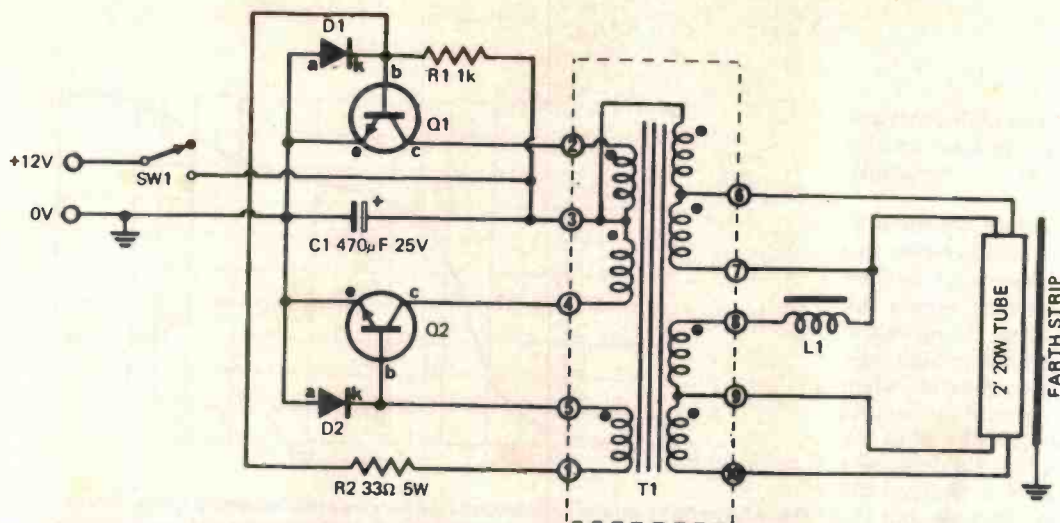

Figure 4. ETI project 516 (Nov. '72) employed a self-excited dc-ac square wave inverter operating at 2 kHz to drive a 20 W fluorescent tube — an efficient solution to providing light from a dc supply.

vide a similar light output would draw around 10 amps! Such inverters have one drawback — the transformer core 'sings' owing to the magnetostrictive forces on the core pieces (which generally come in two pieces). That can be solved in two ways — put the inverter in a 'soundproof' box or operate the inverter at a frequency above audibility. The first solution was employed with the ETI-516 inverter, but is inevitably only partially successful (though often acceptable). The second solution will be described next month in Project ETI-1505.

When it comes to powering 240 Vac-operated equipment or appliances a number of considerations have to be looked at. First, will the equipment operate from a square wave supply? Many appliances employing an ac or ac/dc motor will operate quite happily from a square wave supply. One of ETI's correspondents employed battery backup for his computer's disk drives, supplying these with 240 V, 50 Hz square wave ac from a driven inverter. The general arrangement is shown in Figure 5. A 100 Hz oscillator drives a flip-flop, which drives a pair of HEXFETs connected in push-pull across the secondary of a toroidal transformer. Battery supply was 24 V. The transformer is operated 'back-to-front' here, where input is applied to the secondary and the load connected across the primary. Toroidal transformers perform much better in this application than conventional types as core losses are lower and primary-to-secondary coupling is generally better. Some losses are involved, the saturation voltage of the HEXFETs generally being the greatest source. Hence the use of a 20-0-20 V winding and not a 24-0-24 V winding.

The saturation voltage loss in switch-

ing devices driving a transformer is an important consideration. One or two volts lost from a 24 V supply represents only about 4% to 8% loss, but at 12 V it's twice that! Any further losses only magnify the problem.

A square wave ac supply is inherently rich in harmonics. These can play havoc with audio and digital equipment and it's often difficult to suppress interference generated by the supply. Then again, some equipment — particularly anything containing a transformer and rectifier, will produce entirely different performance from when it's operated from a sine wave supply. The problem arises because the peak and RMS values of a square wave are the same, whereas the peak/RMS ratio for a sine wave is 1.414. To deliver the same *work value* as a sine wave supply, the peak output voltage of a square wave dc-ac inverter is generally set at 240 V. When driving a motor or resistive load, the square wave supply will deliver the same amount of power as a sine wave supply; i.e. the same amount of *work* will be done (all else being equal). But, where the load or equipment expects a peak voltage of 340 V (as we have with the ordinary mains), then a square wave supply of a nominal 240 V output will not 'deliver the goods' as its peak voltage is only 240 V.

So much for that; let's look at sine-wave dc-ac inverters. At this stage, I recommend you read the letter from reader Barry Brown in the accompanying panel.

Requests of a similar nature arrive quite commonly, though Mr Brown's is a little unusual compared to many we receive. Where Mr Brown suggests a dc-ac inverter to operate from a 24 V or 32 V supply, many readers ask for a

Dear Sir,

Despite the financial burden of component costs for an ever-expanding range of new projects, please find enclosed my cheque for subscription renewal. Would you consider a three-to-six-month moratorium on new projects to enable those of us who are more enthusiastic about starting the new than finishing the old to clear some of the backlog?

No?

Well, to an area with possibly more appeal — that of small domestic power supplies. With most homesteads using 32 Vdc power for lighting and almost all travellers using 24 or 12 Vdc power, a stable inverter producing 240 Vac at 50 Hz in the 500 W-1 kW range could be of enormous benefit to many people. With an increasing range of domestic electronic equipment becoming available, the only way for many people to enjoy these products is to crank over the, if available, 240 V diesel generator. This is great stuff during the day, especially with auto-start, but can be a bit distressing when you discover that your evening music selection is really a duo for harpsichord and Lister Diesel.

More ambitious, and probably a lot heavier: a larger inverter capable of starting a fridge/freezer would win many friends. Although these devices may have considerable losses in conversion, there are advantages in using converters for many applications. Not the least of these would be the lifetime supply of European carp likely to be donated by the Darling River United Naturalists Kangaroo Appreciation, Research and Development Society (DRUNKARDS). Such a society, although unformed, could be initiated at the drop of a cold tinny after publication of a suitable circuit.

Barry Brown,  
Young NSW.





**Fantastic new Panel Meter 0-1mA DC.**  
Easy to fit,  
No cut-out needed.

Remember the last time you fitted an 0-1mA panel meter — hard cutting out the hole wasn't it?  
Try our new flush mounting meter. Mounts easily with 2 screws or double sided adhesive pads — all supplied.

**\$8.46**



**MINITOOL ELECTRONICS TOOLS**

These tools have to be seen to be believed. Perfect for electronic work, modelling, carving — any job that requires a fine, detailed, professional finish.

- Jig Saw
  - Orbital Sander
  - Pistol Drill
  - Drill Stand
  - Power Supply
  - Angle Grinder
  - Flexible Shaft & Grindstick
- All **\$37.00 each** Tax exempt  
 \$47.00 each Tax exempt  
 All accessories available

**MM2708 EPROM**  
Only **\$2.50 ea.**



**"Eddystone" Diecast Boxes**

10% Off List All popular sizes

	Dimensions MM	Now
6357P Diecast	187.7x119.5x77.8	<b>8.61</b>
6827P Diecast	187.7x119.5x52.4	7.16
6908P Diecast	119.1x 93.6x52.4	4.50
7970P Diecast	187.3x187.3x63.5	<b>18.18</b>
7134P Diecast	111.1x 60.3x27.0	2.88
7969P Diecast	92.1x 38.1x27.0	1.52
9732P Diecast W/Prf	125.0x 80.0x45.0	<b>12.83</b>
9920P Diecast W/Prf	220.0x120.0x66.0	<b>32.53</b>
9902M Plastic	119.0x 93.7x52.3	2.92
9901M Plastic	111.1x 60.3x27.0	2.52

**MAGRATH'S 6-PACK SPECIALS**

6 for the price of 5

**DIGITAL & LINEAR**

6x4016B	\$1.50
6x4066B	\$2.40
6x4511B	\$3.45
6x74LS00	\$1.00
6x74LS14	\$2.00
6x74LS90	\$2.10
6xLM324	\$2.10
6xLM340KC-12	\$6.00
6xLM340T-5	\$2.55
6x74C04	\$1.00
6x74C02	\$1.00

**TANTALUM CAPACITORS**  
QUALITY KEMET RESIN  
DIPPED ALL 20% TOLERANCE

	NORMAL PRICE EACH	SPECIAL PRICE PER PACK OF 6
0.33 uFD 35V	6c	30c
0.47 uFD 35V	11c	55c
1.5 uFD 35V	12c	60c
3.3 uFD 35V	12c	60c
6.8 uFD 35V	25c	\$1.25
10 uFD 35V	29c	\$1.45
22 uFD 25V	81c	\$4.05
4.7 uFD 20V	15c	75c
10 uFD 16V	16c	80c

**BOURNS MODEL 3006P CERMET TRIMPOTS**  
15 TURN 1.25 WATT  
ALL POPULAR VALUES

Pack No. 1	Pack No. 2
One of each value 200 ohms	One of each value 500 ohms
1K	2K
5K	10K
20K	50K
100K	200K
500K	1 MEG
Price per pack <b>\$5.16</b>	Price per pack <b>\$5.16</b>

**Hurry — while stocks last**

**TRIO TEST INSTRUMENTS OSCILLOSCOPES**

15MHz, 130mm Dual-Trace  
Triggered Sweep  
CS-1560A11  
**\$610.00 inc. probes.**

10MHz, 130mm Dual-Trace  
Triggered Sweep  
CS-1562A  
**\$580.00 inc. probes.**

15MHz, 75mm Dual-Trace  
Triggered Sweep, Portable  
CS-1352  
**\$699.00 inc. probes.**  
Battery extra.



**DIGITAL MULTIMETER**

DL703  
**\$250.00**

**E SERIES**

RF Signal Generator,  
100kHz — 30MHz  
SG-402  
**\$112.00**

CR Oscillator, 20Hz —  
200kHz  
AQ202A  
**\$149.00**

Other TRIO Test Instruments plus all accessories available.

**Logic Designer in a pencil box.**

All you'll ever need to design and experiment with logic circuitry is found in this small battery powered Instrument.  
● Solderless breadboarding.  
● 8 LED's  
● 8 Logic Level Switches.  
● 2 Debounced Pushbuttons.  
● Variable Clock.  
● Attractive Carrying Case.  
Kit **\$102.00**  
Assembled **\$134.00**

**HILLS TV ANTENNAE**

Designed to provide the best possible reception in your area. Built to highest electrical standards, simple, lightweight, strong and easy to install.

**VHF**

Gold Anodised elements and booms. Impedance matched to better than 2:1 (USWR). Frequency response over wanted channel  $\pm 0.5$ dB.  
E.F.C.2 **\$35.41**  
E.F.C.3 **\$57.63**

**UHF TRICOLOR SERIES**

Designed to cover all proposed or feasible UHF Channels.  
TC10 **\$20.70**  
TC18 **\$26.07**

**MAGRATHS MONEY SAVERS**

**DIGITAL & LINEAR**

See 6-Pack Specials for super prices on asterisked products.

4011B	.19c
*4016B	.30c
4023B	.19c
4028B	.55c
*4066B	.44c
*4511B	.69c
4520B	.74c
7406	.20c
7414	.33c
74164	.48c
74365	.37c
*74LS00	.20c
*74LS14	.40c
74LS47	.72c
*74LS90	.42c
74LS161	.53c
81LS95	.87c
81LS98	.88c
LM301A DIP	.35c
LM308 DIP	.49c
*LM324	.42c
LM339 DIP	.42c
*LM340KC-12	<b>\$1.20</b>
*LM340T-15	.51c
LM386N	.60c
LM555	.25c
LM741N DIP	.23c
LM741 DIP	.36c
*74C04	.20c
*74C02	.20c
74C89	<b>\$1.50</b>
IN4002	.05c
IN4148	.04c

**LORLIN ROTARY SWITCHES**

CK 1024	1 Pole 12 Way Non Shorting	<b>\$1.70</b>
CK 1025	2 Pole 6 Way Non Shorting	<b>\$1.70</b>
CK 1026	3 Pole 4 Way Non Shorting	<b>\$1.70</b>
CK 1027	4 Pole 3 Way Non Shorting	<b>\$1.85</b>

**C&K SWITCHES**

The best in the business.

Model Number	PUSH BUTTON	
8121	SPDT	Snap-acting <b>\$2.10</b>
8221	DPDT	Snap-acting <b>\$3.05</b>
8161	SPDT	Alternate action 6A <b>\$1.80</b>
8531	Mom.N.O.	Subminiature <b>\$1.12</b>
8533	Mom.N.O.	Subminiature <b>\$1.12</b>
8631	Mom.N.O.	Microminiature <b>\$1.20</b>

**TOGGLE SWITCHES**

7101 SPDT	<b>\$0.90</b>
7103 SPDT	<b>\$1.35</b>
7105 SPDT	<b>\$1.52</b>
7107 SPDT	<b>\$1.62</b>
7108 SPDT	<b>\$1.35</b>
7201 DPDT	<b>\$1.40</b>
7203 DPDT	<b>\$1.90</b>
7205 DPDT	<b>\$2.35</b>
7207 DPDT	<b>\$1.87</b>
7208 DPDT	<b>\$1.85</b>
7211 DPDT	<b>\$2.80</b>
7301 SPDT	<b>\$3.10</b>

J.H. MAGRATH & Co. ETI-2  
208 Little Lonsdale Street,  
Melbourne, Vic., 3000.  
Telephone: (03) 663 3731

Add Sales Tax if applicable  
Prices valid until stock sold.  
Prices subject to alteration



**MORE OPPORTUNITIES TO SAVE!**

# DICK SMITH OPENS 2 NEW STORES

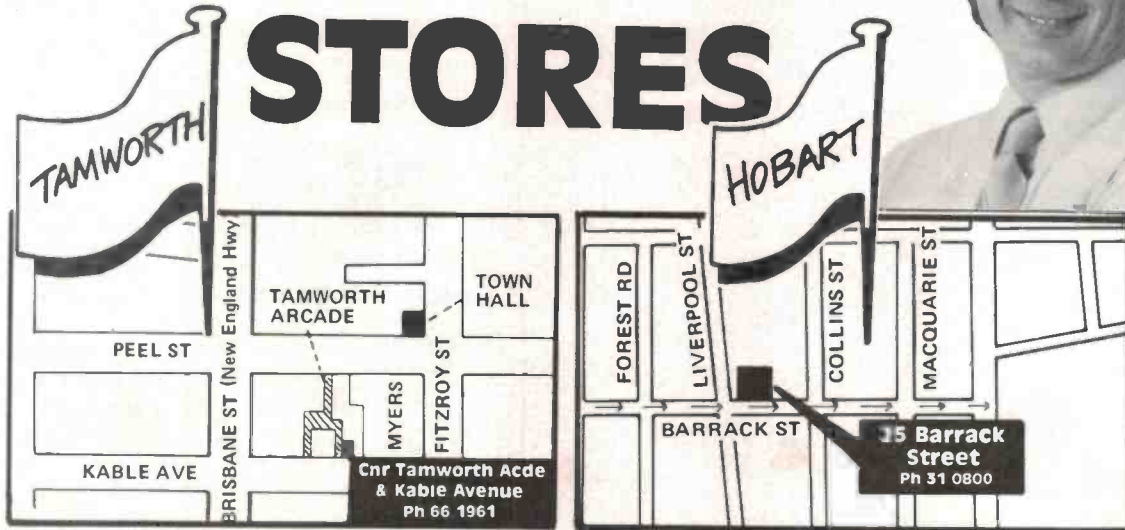

## DICK SMITH ELECTRONICS



### MAJOR DICK SMITH RESELLERS

**ATHERTON, QLD:** Joe Sue's Radio Service  
55 Main Street Phone 91 1208

**BENDIGO, VIC:** Sumner Electronics  
7 Edward St. Bendigo Phc 43 1977

**BALLINA, NSW:** A. Cummings & Co.  
91-93 River Street, Phone 86 2285

**BROKEN HILL, NSW:** Crystal TV Rentals  
166 Argent Street, Phone 6897

**CAIRNS, QLD:** Thompson Instrument Services  
79-81 McLeod Street, Phone 51 2404

**COFFS HARBOUR, NSW:** Coffs Hbr Electronics  
3 Coffs Plaza, Park Ave Phone 52 5684

**DARWIN, NT:** Kant Electronics  
42 Stuart Hwy, Phone: 81 4749

**DARWIN, NT:** Ventronics  
24-26 Cavanagh Street

**EAST MAITLAND, NSW:** East Maitland Elect.  
Cnr Lays & High Streets, Phone 33 7327

**GERALDTON, WA:** KB Electronics & Marine  
361 Main Terrace, Phone: 21 2176

**GOSFORD, NSW:** Tomorrow's Electronics  
68 William Street, Phone: 24 7246

**KINGSTON, TAS.:** Kingston Electronics  
Channel Court, Phone: 29 6802

**LAUNCESTON, TAS.:** Advanced Electronics  
5a The Quadrant, Phone 31 7075

**USMORE, NSW:** Decro Electric  
Magellan St. & Brunner Hwy, Phone: 21 4137

**MACKAY, QLD:** Stevens Electronics  
42 Victoria Street, Phone: 51 1723

**MARYBOROUGH, QLD:** Keller Electronics  
218 Adelaide Street, Phone 21 4559

**MT GAMBIER, SA:** Hutchesson's Comm.  
5 Elizabeth Street, Phone: 25 6404

**MILDURA, NSW:** McWilliams Electronics  
40 Lemon Avenue, Phone: 23 6410

**NAMBOUR, QLD:** Nambour Electronic Shop  
Shop 4 Lowan House Ann Street, Phone: 41 1604

**NEWCASTLE, NSW:** Elektron 2000  
Shop 18, Hunter Shopping Village, Phone: 26 2644

**ORANGE, NSW:** M & W Electronics  
173 Summer Street, Phone: 82 6491

**PENRITH, NSW:** Acorn Electronics  
Shop 12 541 High St, Phone: 36 1466

**PORT MACQUARIE, NSW:** Nail of Electronics  
113 Horton Street, Phone: 83 5486

**ROCKHAMPTON, QLD:** Purely Electronics  
15 East Street, Phone: 21 058

**SOUTHPORT, QLD:** Amateur's Paradise  
121 Nerang Street, Phone: 32 2644

**TAMWORTH, NSW:** Sound Components  
111 Bridge Street, Phone: 32 9677

**TOOWOOMBA, QLD:** Hunts Electronics  
18 Neil Street, Phone: 32 9677

**TOWNSVILLE, QLD:** Tropical TV  
49 Fulham Road, Vincent Village, Phone: 79 1421

**TRARALGON, VIC:** Power'n'Sound  
147 Argyle Street, Phone: 74 3638

**WAGGA, NSW:** Wagga Wholesale Electronics  
82 Forsyth Street

**WOODONGA, VIC:** A & M Electronics  
78a High Street, Phone: 24 4588

**WYALLA, SA:** Mellor Enterprises  
Shop 2, Forsyth Street, Phone: 45 4784

These are our major dealers, however we cannot guarantee they will have all these items in stock and at the prices advertised.

### DICK SMITH STORE LOCATIONS

NSW 145 Parramatta Rd AUBURN 648 0558 • T55 Terrace Level BANKSTOWN SQUARE 707 4888 • 613 Prince Hwy BLAKEHURST 546 7744 • 552 Oxford St BONDI JUNCTION 387 1444 • 818 George St BROADWAY 211 3777 • 531 Pittwater Rd BROOKVALE 93 0441 • 147 Pacific Hwy GORE HILL 439 5311 • 396 Lane Cove Rd NORTH RYDE 888 3200 • 30 Grose St PARRAMATTA 683 1133 • 125 York St SYDNEY 290 3377 • Cnr Kable Ave & Tamworth Acde TAMWORTH 66 1961 • 173 Maitland Rd TIGHES HILL (Newcastle) 61 1896 • 263 Kelra St WOLLONGONG 28 3800 VIC 399 Lonsdale St MELBOURNE 67 9834 • 280 Sydney Rd COBURG 383 4455 • 656 Bridge Rd GEELONG 78 6363 • Cnr Ross Smith Ave & Nepean Hwy FRANKSTON 783 9144 ACT 196 Gladstone Rd Fyshwick 80 4944 QLD 166 Logan Rd BURANDA 391 6233 • 842 Gympie Rd CHERMSIDE 59 6255 TAS 25 Barrack St HOBART 31 0800 SA 60 Wright St ADELAIDE 212 1962 • 435 main North Rd ENFIELD 260 6088 • Cnr Main South & Flagstaff Rds DARLINGTON 298 8977 WA Cnr Wharf St & Albany Hwy CANNINGTON 451 8866 • 414 William St PERTH 328 6944 Mail Order Centre PO Box 321 North Ryde 2113, Phone (02) 888 3200

#### Dear Customer,

Quite often, the products we advertise are so popular they run out within a few days. Or, unforeseen circumstances might hold up goods so that advertised lines are not in the store by the time the advert appears. Please don't blame the store manager or staff; they cannot solve a dock strike on the other side of the world, or even locate a shipment that has gone astray. What we are trying to say is that, if you are about to drive across town to pick up a particular line at a Dick Smith store, why not give the store a ring first... just in case! Thanks.

Dick Smith and Staff.



Please send  copies of the 1982 Dick Smith Electronics Wholesale Catalogue. I enclose  cheque,  money order for \$ (\$1.25 each catalogue).

NAME .....

ADDRESS .....

POSTCODE .....

Please add my name to your mailing list to receive regular monthly specials  
SEND TO: PO BOX 321 NORTH RYDE NSW 2113

**SHOPS OPEN 9am to 5.30pm (Saturday: 9am till 12 noon) BRISBANE: Half hour earlier. ANY TERMS OFFERED ARE TO APPROVED APPLICANTS ONLY**

#### POST & PACKING CHARGES

ORDER VALUE	CHARGES
\$5.00-\$9.99	\$1.40
\$10.00-\$24.99	\$2.40
\$25.00-\$49.99	\$3.50
\$50.00-\$99.99	\$4.60
\$100.00 or more	\$6.20

Charges for goods sent by post in Australia only — not airmail, overseas or road freight.

MAIL ORDERS SEND TO:  
DICK SMITH ELECTRONICS PTY. LTD. P.O. BOX 321,  
NORTH RYDE N.S.W. 2113 AUSTRALIA

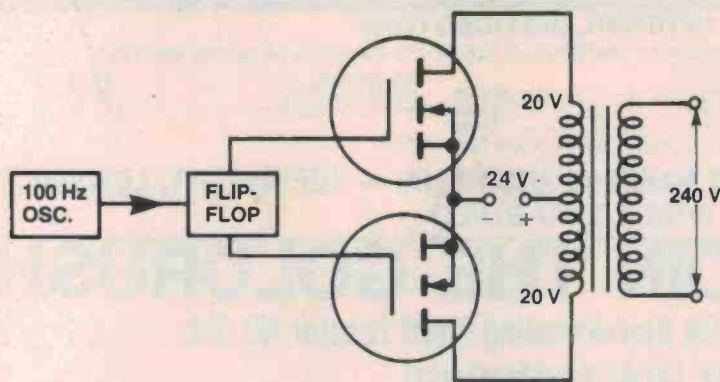

Figure 5. Example of a 'driven' dc-ac square wave inverter with nominal 240 Vac output. This technique has been employed by one of our correspondents as a computer back-up supply.

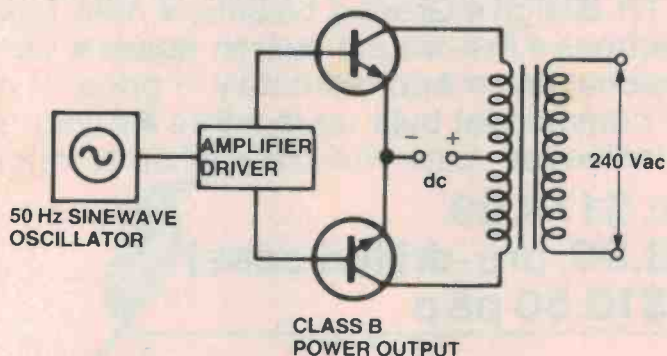

Figure 6. Class B driven sinewave inverter technique for providing 240 Vac from a dc supply.

1 kW or similarly rated inverter to run from a 12 V battery. The latter is impractical, for the following reasons.

Consider this: a sinewave dc-ac inverter needs to be of the driven type. Hence it generally consists of an oscillator driving a class B power amplifier — usually a push-pull type. The theoretical maximum efficiency obtainable with a class B power amplifier is 78%. With losses and power consumption of drive circuitry taken into account the dc power input to ac power output efficiency of an inverter of this type is generally around 65-70%. Thus a 1 kW dc-ac inverter to run from a 12 V battery would draw in excess of 120 amps at full load! Few batteries available would supply that sort of current for long. With currents of that magnitude, special arrangements have to be made for primary circuit conductors. A resistance of 5 milliohms (0.005 ohms) will result in a power loss of more than 70 watts. Then again, special consideration has to be given to heat dissipation in the power output stage. The devices used would dissipate something over 400 W at peak load. No load dissipation would probably be in the vicinity of 40-50 W, which is no mean amount to

get rid of.

Apart from the weight of a heatsink, consider the weight of a 1 kVA (or 1000 W) transformer (assuming a single transformer is used). We'll leave the expense to your imagination.

The problems are reduced somewhat when a much higher dc supply voltage is available. However, in the latter case other techniques of dc to ac conversion present themselves — but that should be the subject of another article as it's a whole new ballgame.

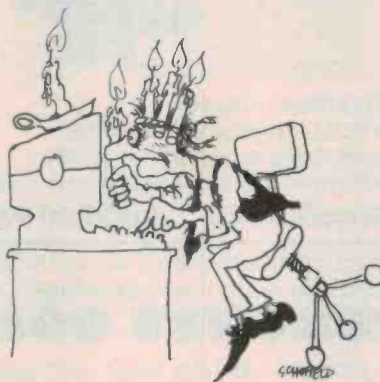

Where a 12 V battery supply only is available, there is a practical limit to the maximum power of a dc-ac inverter, and that's probably around 300 W output. At typical efficiencies, the dc input power is around 450 W, or close to 35-40 amps current from the battery.

As you would already appreciate, this brings its own special problems. A battery to supply that sort of power for any appreciable or worthwhile period would need to have a considerable ampere-hour capacity. Your typical 40-60 Ah car battery would barely deliver an hour's worth of power. If the inverter is installed within the vehicle, or close by, and you are willing to keep the engine running during operation, then the battery will deliver the goods for quite a period, provided you can 'set' the throttle to suit so that battery charge is maintained. At this stage, I might point out that an alternator coupled to the motor would provide a more efficient energy conversion.

To gain, say, four to six hours of operation for a 300 W inverter, you would need a battery system of more than 200 Ah capacity.

A more practicable power level for a sinewave dc-ac inverter would be around 120 W. Such an inverter would pull 12 to 15 amps from the battery, a much more manageable figure.

Having seen the primary side of the problem, let's consider the secondary side — the load. How many appliances do you have rated at less than 300 watts? Very few. The humble electric kettle is rated from 1 kW to 2.4 kW. Monochrome TV sets, particularly portables, may only consume 100 W, but a colour TV may draw three times that or more. A 'low power' (say, 30 W/ch.) domestic hi-fi will draw around 100 W, depending on how much equipment is in use and how loud you like it. Anything more ambitious has a proportionately larger consumption. A 300 W dc-ac inverter is best considered where the full output is only required intermittently.

## Conclusion

As can be seen, many factors have to be taken into account when considering obtaining light and power from a battery supply — whether it be in a back-up application, for lighting or 240 Vac substitution. The ubiquitous 12 V battery is not up to the job in some instances — in which case higher voltage dc systems are better considered. ●

# ALL ELECTRONIC COMPONENTS

*That's our name . . . that's our game!!!*

**MAJOR STOCKISTS OF ALL GENERAL RADIO AND ELECTRONIC COMPONENTS**

**"WE ARE NOW OFFICIAL INTERSIL DISTRIBUTORS"**

Check our low prices on these fabulous products by "INTERMIL". O.E.M.'s & Resellers enquiries welcome.

ICM 7211 .....	\$11.84	ICM 7215EV/Kit .....		ICL 8038 CC .....	\$6.70
ICM 7226B .....	\$35.25	(Stopwatch Kit) .....	\$36.56	ICL 8069 CC SQ .....	\$3.45
ICM 7556 IPD .....	\$ 2.20	ICL 7650 CPD .....	\$5.85	Product & Data Book etc. etc. ....	\$14.10
ICM 7555 IPA .....	\$1.70	ICL 7660 CPA .....	\$4.28		

Prices include Sales Tax. Allow \$2.00 Pack and Certified Post.

**ETI AND EA KITSET SPECIALISTS (LARGEST RANGE IN AUSTRALIA) — TOP QUALITY, LOW PRICES  
LEARN WHILE YOU BUILD**

## BASIC ETI 660 COMPUTER only \$99. Plus \$5 P/P



Complete with colour option, keyboard, power supply, programmed EPROM, R.F. modulator, case etc.

**\$207 plus  
\$10.50 p&p**

Refer ETI October 1981

## JOIN THE GOLDRUSH

**ETI 1500 Discriminating Metal Locator Kit Set.**

**Super Unit featuring!**

- Tune and discriminate • 4 modes of operation
- VLF/TR design • Ground balance • Auto balance
- push buttons • Pre-wound search heads • Very professional unit
- Approximately 1/3 price of many similar commercial built up locators
- Audio and meter indication. Lets you know when to rejoice

**Price: \$179.99**

**(\$193.50, pre-drilled case)**

**Plus \$10.50 p&p**



All AEC KITSETS contain only top quality prime specifications' components by recognised manufacturers. Don't be misled by other so called "KITS" which do not meet ETI and EA standards.

***Give yourself and your Kitset every chance of success.***

**ALL PARTS COVERED BY MANUFACTURERS WARRANTY**

## ETI 549 Metal Detector KITSET



Features include:

- Induction balance • Volume and level control • Phone jack
- Dual sensitivity • Audio and meter indication

**Price \$53.40 \* plus \$7.00 P&P**

## ETI 561 KITSET Metal Locator Kit Set



Features include:

- B.F.O. principle • Crystal controlled • Good sensitivity
- Simple construction • Low cost

**Price \$30.45 \* plus \$7.00 P&P**

## Stac Timer

ETI 650



This unit has four different programmable outputs, clock controlled switch-ons/switch-off times selected days from the seven or eight day cycle can be "skipped". Ideal for operating air conditioning, fish tanks, hi-fi systems, tape recorders, slide and movie projectors and laboratory control etc.

**Price: \$135.00 plus \$9.00 P&P**

For our free comprehensive kit list with discount prices, send stamped self-addressed envelope to:

**ALL ELECTRONIC COMPONENTS**

118 LONSDALE STREET, MELBOURNE, VIC. 3000. TEL: 662-3506.

The F18 Hornet. The world's latest technology and know how wrapped up in a twin engine fighter /interceptor.

The Hornet is forming the backbone of Australia's Air Force. Right now we are looking for apprentices to become the backbone of the people who will keep it in the air.

Young men to join us in Trade or

Technologist Apprenticeships. To undertake up to three years of extensive classroom and practical training.

Trade Apprentices need to be between the ages of 15-17½ on January 1 with good Year 10 results in English, Maths and Science (with a Physics content).



Technologist apprentices need to be between 16-21 with good results in English, Maths and Physics at Year 11 or Year 12.

For more details contact your Air Force Careers Adviser on Sydney 212 1011, Newcastle 25476, Wollongong 286492, Parramatta 635 1511, Canberra 822333, Melbourne 61 3731, Geelong 21 1588, Brisbane 226 2626,

Townsville 72 4566, Adelaide 212 1455,

Perth 3256222, Hobart 347077, Launceston 31 1005, or send the coupon below.

# GET THE GROUNDING TO KEEP THIS IN THE AIR.

Forward this coupon to Air Force Careers Adviser,  
G.P.O. Box XYZ in your nearest capital city.  
**Applications close August 16, 1982.**

Name: \_\_\_\_\_

Address: \_\_\_\_\_

State: \_\_\_\_\_ Postcode: \_\_\_\_\_

Education Level Reached: \_\_\_\_\_

Date of birth: \_\_\_\_\_

Authorised by Director General Recruiting Dept. Defence  
AFAP 3.FP42



**JOIN AUSTRALIA'S AIR FORCE.**



# Lab Notes

## "For members only . . ." — the exclusive OR gate

The 4070B quad EX-OR gate is one of the least known but most useful members of the commonly available family of CMOS quad two-input gate ICs. The device's gates can readily be used as programmable (inverting or non-inverting) pulse amplifiers, phase comparators, free-running or gated astables, or multi-bit magnitude checkers, etc. Pretty good for a cheap chip!

Ray Marston

THE OUTLINE and pin notations of the 4070B are shown in Figure 1, together with the truth table for each of the EX-OR gates in the package. The most important point to note here is that the output goes high only (EXclusively) if a logic 1 is applied to only one of the inputs (A OR B). The output takes a

logic 0 state if identical inputs are applied to both inputs.

Figure 2 shows how individual gates can be used as programmable pulse amplifiers. With the connections shown in Figure 2a, the circuit functions as an inverting amplifier. In Figure 2b the amplifier acts in the non-inverting

mode, while the Figure 2c circuit shows the connections for making a switch-programmable amplifier.

The EX-OR programmable amplifier can be used as the basis of a so-called scrambler system of the type used on security telephones, etc., by using the basic circuit shown in Figure 3. Here, in

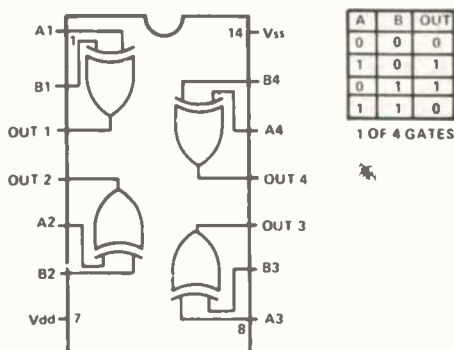

Figure 1. Pin notations, outline and truth table of the 4070B quad two-input EX-OR gate.

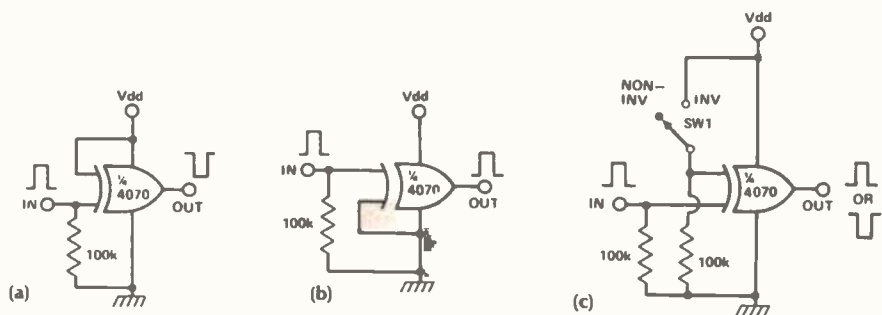

Figure 2. The EX-OR gate can be used as an a) inverting, b) non-inverting, or c) switch programmable pulse amplifier.

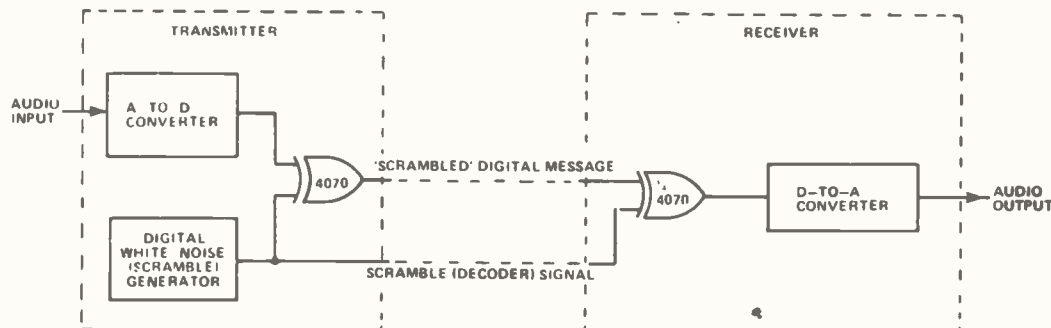

Figure 3. Basic circuit of an audio (telephone, etc.) scrambler system.

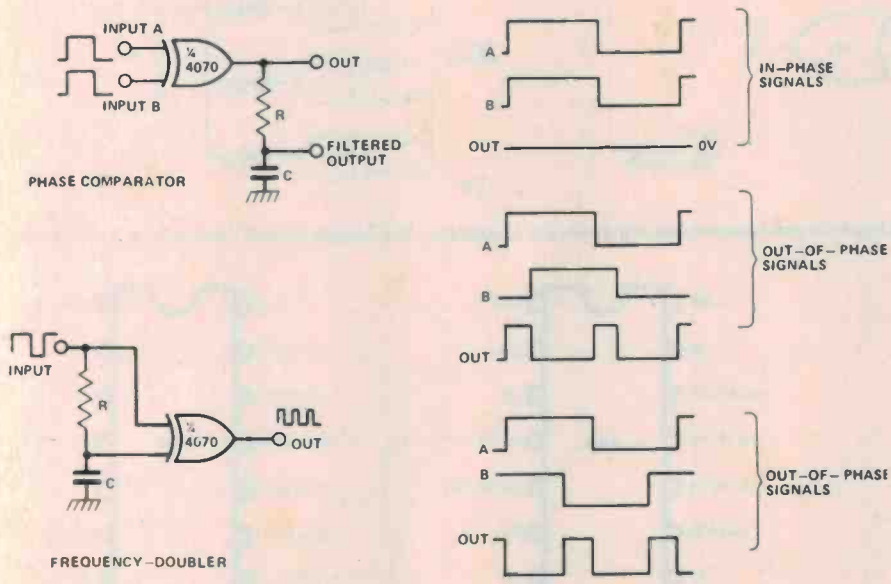

Figure 4. An EX-OR gate can be used as both a phase comparator and a frequency doubler. Typical waveforms for the phase comparator circuit are shown on the right.

the transmitter, the audio signal is converted to digital form by an A-to-D converter and fed to one input of the EX-OR gate, while the other input is fed from a digital white noise or 'scramble' signal. The output of the EX-OR gate is thus inverted or non-inverted in a random manner and cannot readily be deciphered.

Both the scrambled message and the scramble signal are sent out (on separate lines) from the transmitter. At the receiver, the two signals are picked up and fed to the two inputs of a second EX-OR gate, where the digital analogue signal is restored (unscrambled) to its original form (the simple principle here is that if both gates are either inverted or non-inverted, the net effect will be an overall non-inversion of the signal). The restored digital signal is then converted back to analogue form by a D-to-A converter. Neat.

**More circuits**

Figure 4 shows ways of using an EX-OR gate as a digital phase comparator and as a frequency doubler. The two circuits use the same basic principle of operation, so let's look at the phase comparator first. The comparator is meant to be fed with digital (ideally,

square wave) signals that are identical in form and frequency but which may differ in relative phase. A digital signal is available directly at the output of the gate, or a dc signal may be available from an R-C low-pass output filter.

From the circuit waveforms, you can see that if both input signals are precisely in phase the two inputs will always be identical and the output will be zero. If, on the other hand, the two signals are not in phase, the output switches high at those points in the waveform where the two inputs are in opposite logic states. This situation occurs twice in each input cycle, so the output signal is frequency doubled. The pulse width of the output signal and thus the mean dc output levels of both the gate and the low-pass filter are directly proportional to the magnitude of the phase difference between the two input signals. The level is low with a small phase difference, rises to a maximum at 180° difference and then reduces again as the phase difference is shifted from 180° towards 360°.

From the above, it is easy to see how the Figure 4 frequency doubling circuit works. The digital input signal is fed directly to the 'A' input terminal of the EX-OR gate but is fed to the 'B' terminal

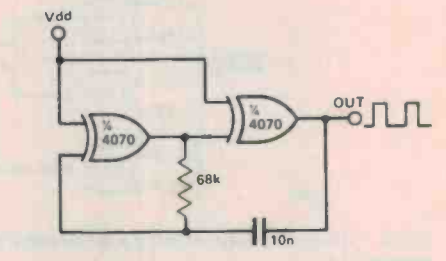

Figure 5. A 1kHz EX-OR astable.

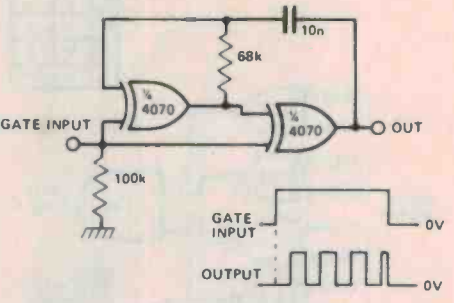

Figure 6. A gated 1 kHz EX-OR astable.

through the phase-shifting network formed by R-C; the resulting phase-shift implements the frequency doubler action.

Figure 5 shows how a pair of EX-OR gates can be used to make a 1 kHz astable multivibrator or square wave generator. The circuit operates as a standard CMOS astable, the two gates being made to function as pulse inverters by taking one of their two inputs high.

Figure 6 shows how to modify the above circuit so that it functions as a gated 1 kHz astable circuit. Useful features of this design are that it uses a logic 1 (high) gate signal and its output goes to the logic 0 (zero) state when the astable is gated off.

**Magnitude comparators**

We've already seen that the output of an EX-OR gate goes low if its two inputs are identical, or high if the inputs differ. The device can thus be used to compare a pair of digital bits, or a number of gates can be used to compare the magnitudes of a pair of multi-bit digital words. Figure 7 shows how a 4070B can be used to compare two four-bit words and give a high output if the two words are not identical. In Figure 7a, the ▶

# Lab Notes

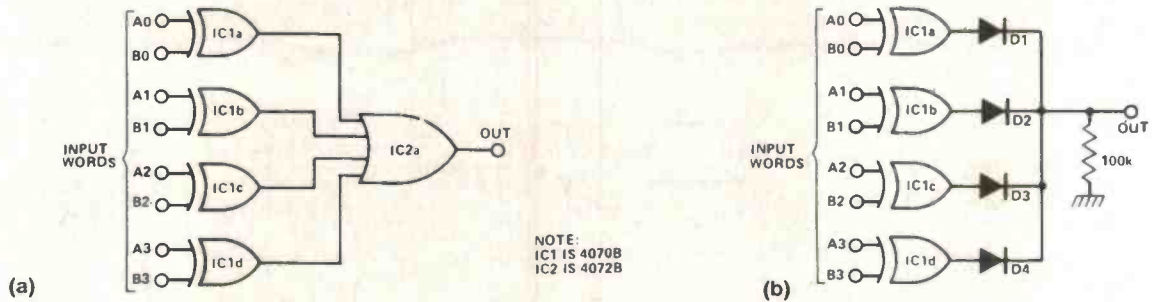

Figure 7. Alternative ways of using a 4070B and a four-input OR gate to make a four-bit two-word comparator. The outputs go high if the two input words are not identical.

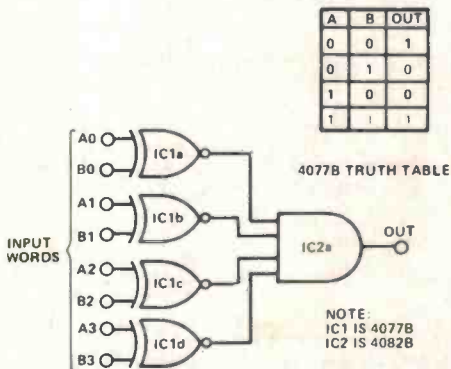

Figure 8. Method of using 4077B EX-NOR gates to make a four-bit two-word comparator that gives a high output if the two input words are identical.

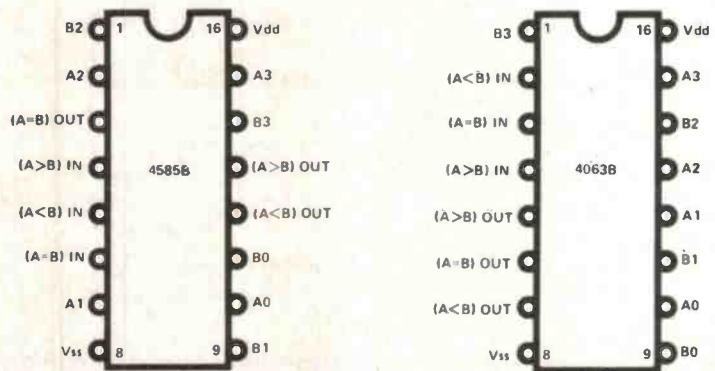

Figure 9. The 4585B and the 4063B are four-bit magnitude comparator ICs.

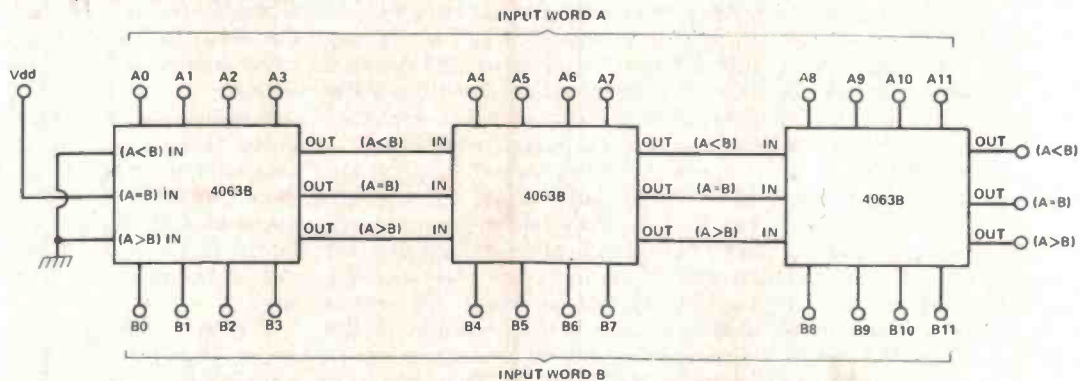

Figure 10. Method of cascading three 4063Bs to make a 12-bit two-word comparator.

outputs of the four EX-OR gates are ORed by one half of a 4072 dual four-input OR gate. In the Figure 7b circuit the outputs are ORed by a four-input diode gate.

An opposite action, in which the output goes high if the two words are identical, can be obtained by replacing the 4070B with a 4077B EX-NOR IC and ANDing the outputs by one half of 4082B, as shown in Figure 8. The 4077B has the same outline and pin notations as the 4070B.

The two magnitude comparator cir-

uits described above are quite inexpensive and, clearly, are not particularly sophisticated. If a more sophisticated magnitude comparator performance is required, special chips such as the 4063B or 4585B four-bit magnitude comparators can be used. Figure 9 shows the outlines and pin notations of these two CMOS devices. Note that these chips have three outputs, one going high if the two words are identical, one if the 'A' word is greater than the 'B' word, and the remaining output going high if the 'A' word is less than the 'B' word. Obviously, only the

one output can be high at any given time.

A useful feature of the 4063B and 4585B comparators is that they can readily be cascaded to compare words of any desired 'bit' length. Figure 10, for example, shows the basic connections for making a 12-bit comparator, using three cascaded ICs. When using these comparators, either singly or in cascade, note that the cascading inputs of the least significant comparator are connected as follows: (A<B) and (A>B) are biased low, and (A=B) is biased high.



# Now Available!

## NEWLY REVISED, EXPANDED AND UPDATED EDITION!

### An Invaluable "HOW-TO" Source of PC Design and Drafting Information.

Beginner or expert... if you're designing, drafting or producing printed circuits, the newly revised, expanded & updated edition of *The Design & Drafting of Printed Circuits* is a must! Nearly twice as large as the original, *The Design & Drafting of Printed Circuits* is the most complete, informative and authoritative book of its kind available today. Jam-packed with 400 pages of state-of-the-art technical information, *The Design & Drafting of Printed Circuits* will become a permanent source of "how-to" information you will refer to again & again.

Included in this one-of-a-kind reference manual by author Darryl Lindsey, founder of The Masters PC Design School and veteran of over two decades as a PC designer and drafter are...

#### All New Chapters On...

- CADD (computer aided design and drafting)
- "How-To" shield electronics against EMI (electro-magnetic interference)
- "How-To" deal with flexible circuits
- PC Board design considerations

#### Plus Expanded & Updated Chapters On...

- Schematics
- Multi-Layer PC Boards
- Master Artwork tape-ups
- Printed Circuit manufacturing processes and product considerations

#### And...

- An informative design reference guide
- Over 200 understandable "how-to" photos, charts & illustrations
- More than 20 chapters in all

When the question is about PC design, drafting or production, the answer is in *The Design & Drafting of Printed Circuits*... your "how-to" source for PC design & drafting information. Get your copy today!



The Innovators

## Bishop Graphics, Inc.

5388 Sterling Center Drive, Westlake Village, CA 91359-5007 U.S.A. • (213) 991-2600 • Telex:66-2400

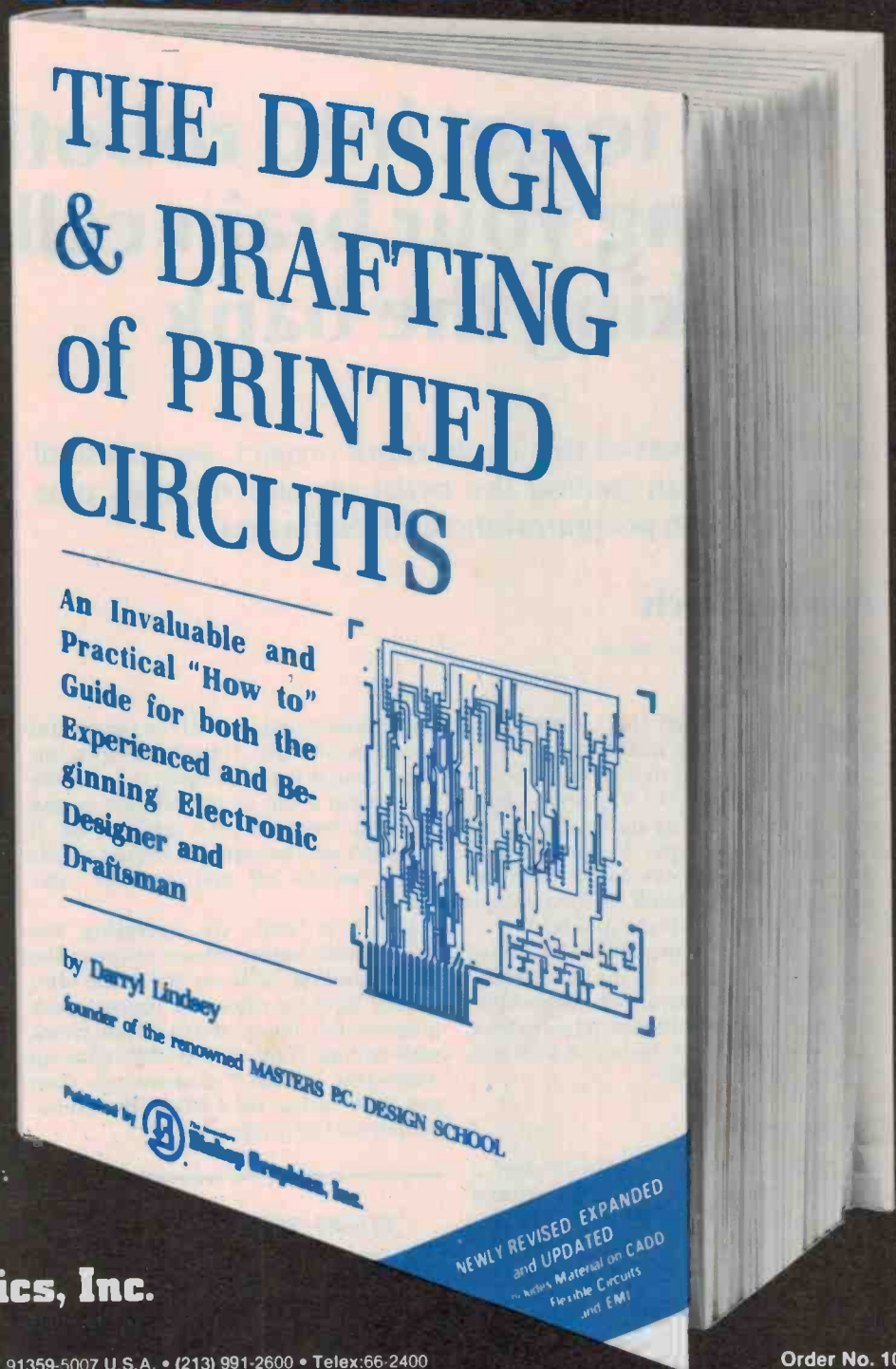

Order No. 10001

For complete information on the design and drafting of printed circuits, contact your local Bishop Graphics dealer today!

#### VICTORIA

STEWART ELECTRONIC  
COMPONENTS PTY. LTD.  
44 Stafford Street  
Huntingdale, 3166  
Tel: 5433733  
Telex: AA36908

#### SOUTH AUSTRALIA

GRAPHIC ELECTRONIC  
INDUSTRIES PTY LTD.  
41A Rundle Street  
Kent Town  
Tel: 426655

#### WESTERN AUSTRALIA

RESERVE ELECTRONICS  
PTY. LTD.  
5 Vockhan Street  
Morley 6062  
Tel: 2752377  
Telex: 92686

#### SYDNEY

CIRCUIT COMPONENTS  
(A/Asia) PTY. LTD.  
Post Office Box 70  
383 Forest Road  
Bexley, N.S.W. 2207  
Tel: 596550 593720  
Telex: CIRCOM AA27197

#### BRISBANE

L.E. BOUGHEN  
& CO.  
Corner of Baroona  
& Milton Rds.  
Milton,  
Queensland 4064  
Tel: 361722  
Telex: 41500 AA

#### CANBERRA

GEORGE BROWN  
& CO. PTY. LTD.  
23 Whyalla St.  
Fyshwick  
A.C.T. 2609  
Tel: 804355  
Telex: 62128 AA

## How to get into robotics without boiling your brain cells or breaking the bank

In this third part of the Turtle robot project, we give final instructions on getting the beast up and running, plus some hints on programming and interfacing.

**Allan Branch**

Flexible Systems, Hobart, Tasmania

**Part 3**

HAVING completed the construction, you're ready for an initial test. At this stage you will need to buy, beg, borrow or build a suitable 12 V power supply capable of delivering up to about 2 A. The panel on page 48 describes a power supply you can build. Many of the parts can be found in the average hobbyist's or workshop's 'junkbox'.

If you don't wish to go to the trouble of building a supply, a mains CB rig supply makes an excellent alternative. The vast majority of these deliver about 12.5 V or 13.8 V at up to 2 A and cost between \$40 and \$50.

### Turtle test

For this initial test you will need a 25-pin socket, the above-mentioned power supply, a length of figure-eight flex with one lead marked, a 'jumper' lead and a multimeter. Solder one end of the figure-eight flex to the 25-pin socket — the marked lead designates the 0 V line and it should be soldered to pins 12-13 of the 25-pin socket; the other lead is the +12 V line — solder it to pins 1-2 of the 25-pin socket. Having done that, plug the 25-pin socket into the plug on the dome of the Turtle and connect the free end of the figure-eight flex to the power supply — watch the polarity: *marked lead to 0 V, unmarked lead to positive.*

Hold your breath . . . and switch on. The pen solenoid should operate

immediately and the LED on the control board should light. If the LED lights but the solenoid does not operate, give the pen clamp a tap as the plunger in the solenoid may be a little stiff at first. If you don't get the expected results at this stage, switch off and go over your wiring.

If all is well, try operating the microswitch bump sensors in turn. The corresponding LED on the inner disc should light up when you operate each microswitch. If not, switch off and check your wiring. If the wrong LED lights up when you actuate a microswitch, then you have either the LED or the micro-switch wiring incorrect.

Next, take a jumper lead. Connect one end to +12 V and touch the other end on pin 18. This is the LAMP INPUT and the two green lamps should light. If they don't, a wiring check is necessary. If, or when, all is OK, next connect the free end of the jumper lead to pin 19, the PEN INPUT. The solenoid should release immediately and retract when you take the jumper off the pin. When the solenoid is operated, the current drawn from the supply should be about 1.4 A, dropping to about 0.8 A when it is not operated. OK? Next connect the free end of the jumper lead to pin 20. This will turn on the HORN. Bridge pins 20 and 21 with the free end of the jumper

---

### ETI-645 SPECIFICATIONS TASMAN TURTLE ROBOT (minimum version)

---

Dimensions	385 mm diameter 180 mm height	Input functions	Left motor direction Left motor toggle (drive) Right motor direction Right motor toggle (drive) Lamps (on/off) Pen (draw/not draw) Horn (on/off) Horn (low pitch/high pitch)
Weight	2.5 kg		
Drive	Left and right stepper motors		
Power requirement	12 Vdc (nominal) 1.5 A (max.)		
Load capacity	4.5 kg	Output functions	Left bump sensor Right bump sensor Front bump sensor Rear bump sensor
Pulling force	500 grams (max.)		
Negotiable Incline	15°		

---

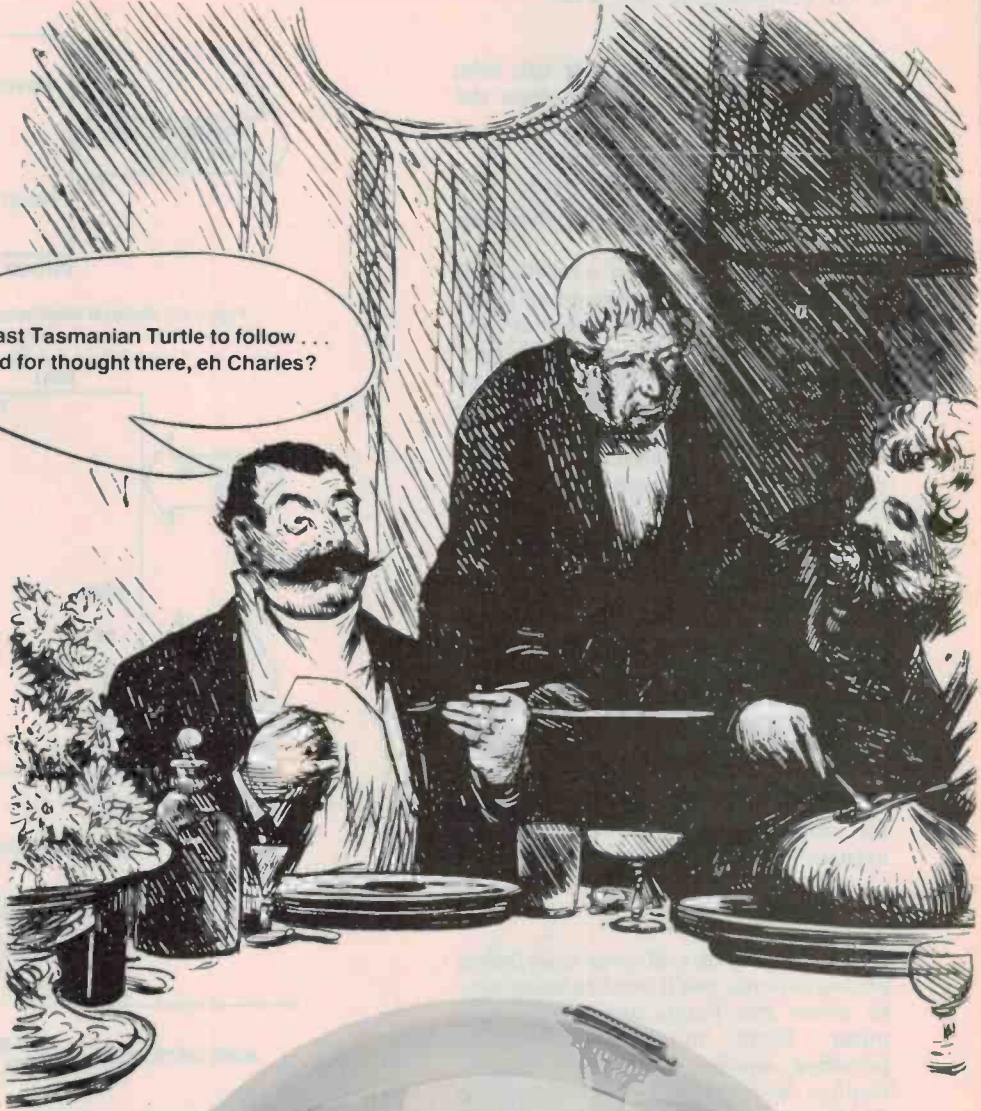

Roast Tasmanian Turtle to follow . . .  
food for thought there, eh Charles?

lead and the horn pitch should go up in frequency.

You can test the motor drives by momentarily touching the free end of the jumper lead first to pin 14, when the left motor should 'jump', then to pin 16, when the right motor should jump.

Last of all, you can check the **SENSOR** outputs. Using your multimeter switched to a convenient range to read 12 V, connect the negative lead to 0 V and the positive lead to each sensor output pin on the 25-pin socket in turn. You should read 12 V on each pin. Operate the appropriate microswitch and the voltage should drop to zero. Make sure the appropriate microswitch corresponds with each of the sensor pins tested. If not, or if you don't obtain the required indications, check your wiring.

That's about all you can do for an initial test; the final performance comes when you have interfaced the Turtle to your computer and get some software up and running.

## INTERFACING — general details

As computers vary widely in the manner they can be arranged to communicate with 'the outside world', we can only give general interfacing information at this stage and we will have to leave you to sort out the individual details of how you interface your Turtle to your particular computer. ▶

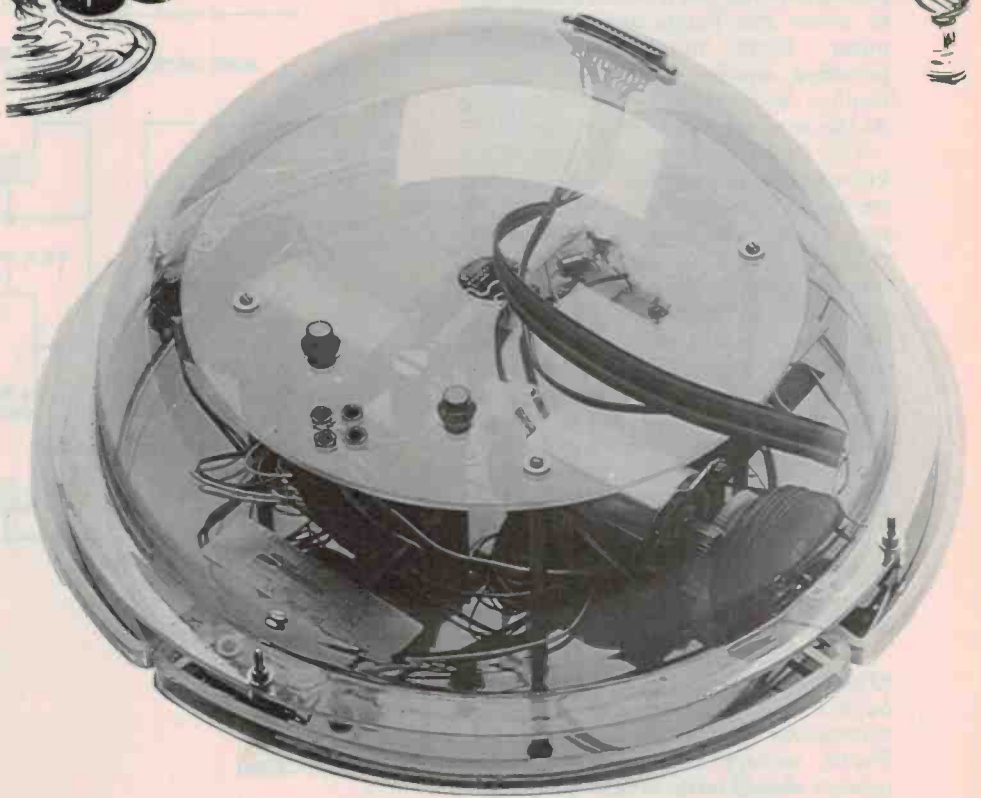

# Project 645

An input/output controller can take on many forms, but it *must* have the following two characteristics:

- (a) the output must be latched;
- (b) the input must be tri-stated.

The general arrangement is shown in Figure 24.

There are a number of methods that can be employed to implement an interface and there are quite a few devices available to assist. One of the better-known devices is the 6821 peripheral interface adaptor. This has two completely separate 8-bit I/O ports — PA and PB — and four control lines, two per port. Figure 25 shows general details of how a 6821 could be employed as an interface between a computer and the Turtle.

Another method is to employ a pair of tri-state buffers, as illustrated in Figure 26. This employs a 74LS367 hex buffer/driver for the four Turtle output bits and a 74LS244 octal buffer for the eight Turtle input bits, plus a little extra logic for address and read/write decoding.

We'll get down to some specific circuits for particular computers in follow-up articles\*.

## Drivers' manual

Having taken care of your interfacing arrangements, you'll need to know how to 'drive' the Turtle using your computer. Eight input functions are provided, and four output functions — that's a lot more than the average car! At the moment, you're at a standstill.

The first thing that is important to know is how to move the Turtle. This is very easy to accomplish, even for beginners in programming, and surprisingly requires very little memory space. In conventional programming the largest part of the software is more often than not dedicated to producing the screen display. Making graphics uses lots of RAM. With the Turtle none of this is needed because there is now a real-world or physical representation of what you need. There is no point setting up a simulated robot on the screen and a complex obstacle course when you have a Tasman Turtle and a kitchen (office/garage/workshop). Very interesting programs will use only about 20 lines of BASIC.

\*Flexible Systems can provide ready-built interface boards and details on interfacing to particular computers. Turtle owners and potential Turtle owners should write to them for further details — Ed.

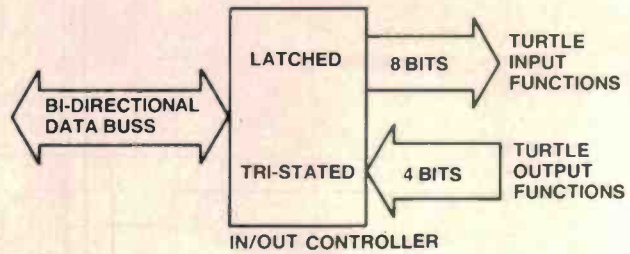

Figure 24. General Interfacing arrangements for the Turtle.

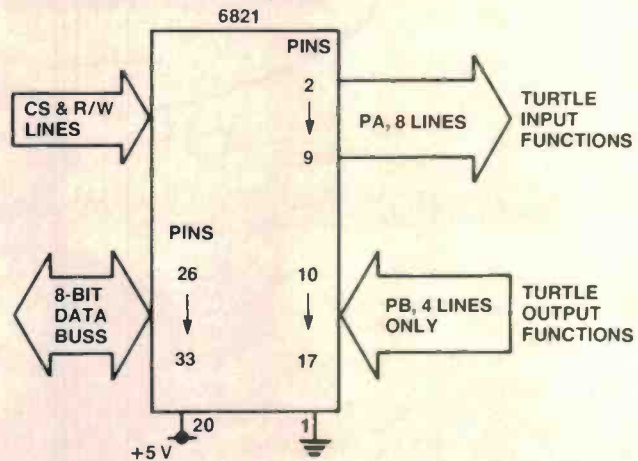

Figure 25. Interfacing via a 6821 PIA.

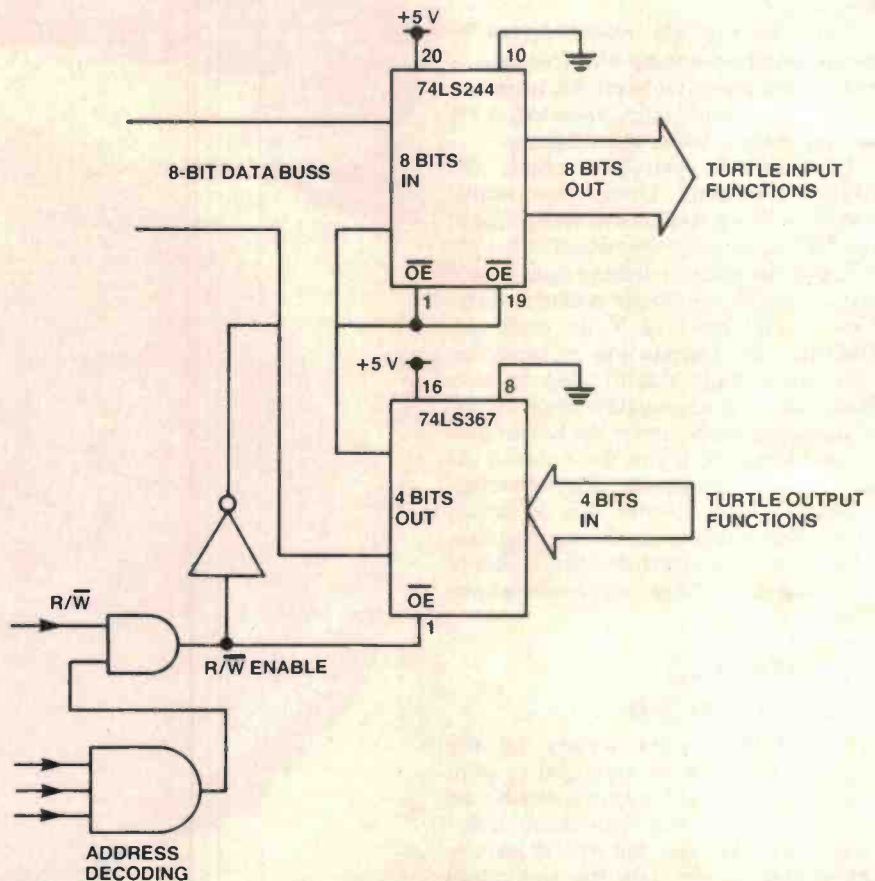

Figure 26. Interfacing using buffer/drivers.

Understanding how to control the Turtle requires an understanding of the robot's 'control line'—that is, its control cable from the computer. If the minimum Turtle is thought of as the skeleton and the muscles or body, and the computer as the brain, then it is easy to see that the pair become an exceedingly powerful combination, limited only by your imagination.

The Turtle's control cable has eight separate control functions, or 'nerves' if the anthropomorphism is maintained. These are dedicated to the following uses:

Table 1

1	} Motors
2	
3	
4	
5	Lamp
6	Pen
7	Horn
8	Tone

We will discuss the motors soon, but the last four functions are the easiest to start with. The eight Turtle functions are each controlled by one of the eight data buss lines.

Table 2

Function	Name	Data Line	Binary Value
1	LMT	D0	1
2	LMS	D1	2
3	RMT	D2	4
4	RMS	D3	8
5	LAMP	D4	16
6	PEN	D5	32
7	HORN	D6	64
8	TONE	D7	128

Suppose your Turtle occupies part of the computer memory space at address W. More will be discussed about this when we get to specifics on interfacing, but it is sufficient to say here that W will have a value between 0 and 65 536. On some computers W may be negative numbers in the same range.

To operate the Lamp simply requires that the binary value for the Lamp function, which is 16, be sent to the Turtle (at address W). This will be either POKE W, 16 or OUT W, 16, depending on the type of computer. For those of you lucky enough to have the language LOGO, the instruction to turn on the lamp is simply 'LAMP ON'.

Similarly, the Pen or Horn can be turned on by:

POKE W, 32 or POKE W, 64  
respectively.

To turn them off again simply requires:  
POKE W, 0

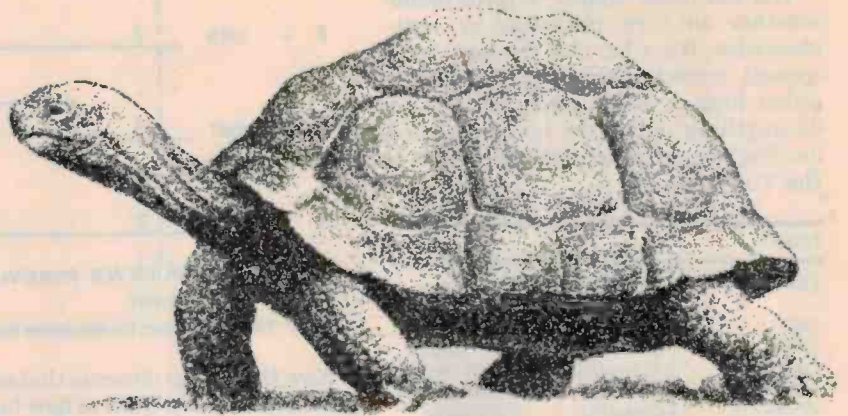

The Horn Tone control is operated by:  
POKE W, 192

This is not a mistake, as the tables below show.

Table 3

Function No.	Name	Action
7	HORN	ON/OFF
8	TONE	HIGH/LOW

Table 3a

TRUTH TABLE			
7	8	Result	Binary
Off	Off	Nil	0
Off	On	Nil	128
On	Off	Low	64
On	On	High	192 (128+64)

The Horn function simply turns the horn on or off. Whether it is high or low in pitch when it is turned on depends on the value of the Tone function *at the same time*. That is, the horn has to be turned on (binary value 64) and at the same time, if you want the pitch to be high, the Tone function must be turned on (binary value 128), hence:

POKE W, 192 puts the horn on high pitch, and  
POKE W, 64 puts the horn on low pitch.

Some of you will have already seen what to do if, for instance, the Lamp and the Pen were required to be on together. The instruction would be POKE W, 48, since the value for the PEN is 32 and the value for the LAMP is 16. In fact for any combination of functions, the instruction must use the sum of the binary values for each function.

## Motor control

The motors used in the Tasman Turtle are stepper motors. This gives the robot great precision, but requires that certain programming requirements are taken into account before the robot can be made to move.

Stepper motors require pulses to be sent to them. In the Turtle these pulses are generated by software for two special reasons:

1. The speed can be controlled;
2. The program can do other tasks between pulses, such as sense the microswitches.

Luckily, all the difficult tasks, such as phasing and rotating the pulses, are done by electronics in the Turtle, so the programmer has a relatively simple job left to do.

If the list of motor functions is looked at again it will be seen that there are four motor commands:

LMT, LMS, RMT, RMS.

Table 4

Function No.	Command	Meaning
1	LMT	Left Motor Toggle (pulses)
2	LMS	Left Motor Set (direction)
3	RMT	Right Motor Toggle
4	RMS	Right Motor Set.

Those of you familiar with information theory will see that with four bits of the data line, there should be 16 ( $2^4 = 16$ ) possible combinations of motor movements. In fact there are only nine. There are two motors and each motor can have three conditions ( $3^2 = 9$ ). This is perhaps a waste of bits! Where are the other combinations? We shall see shortly. ▶

# Project 645

The 'Set Input' simply tells the motor whether to turn clockwise or anti-clockwise. It's a bit like the horn tone control, since the horn tone can be set either high or low in pitch, but doesn't do anything unless the horn is turned on. The thing that turns the motors on is the 'Toggle Input'.

Table 5

Left motor	Right motor	Action
OFF	OFF	OFF
OFF	FORWARD	LEFT WHEEL
OFF	BACKWARD	RIGHT WHEEL
FORWARD	OFF	RIGHT WHEEL
FORWARD	FORWARD	FORWARD
FORWARD	BACKWARD	RIGHT
BACKWARD	OFF	LEFT WHEEL
BACKWARD	FORWARD	LEFT

The next thing to consider before actually seeing the programming is the effect of each motor. For the Turtle to move forward (for example), it can be seen from looking at the beast that the right motor must move clockwise and the left motor must move anti-clockwise. If both motors turn in the same direction, say *clockwise*, then the Turtle will turn *left*.

Now, to generate pulses from the software for the stepper motors is quite simple. For the left motor we determine LMS to be high or low for whatever direction we want the motor to turn in and we then set up a loop where LMT is made alternatively high then low:

```
10 POKE W, 1    10 POKE W, 3
20 POKE W, 0   or 20 POKE W, 2
30 GOTO 10     30 GOTO 10
```

To move the right motor:

```
POKE W, 4    POKE W, 12
POKE W, C    or POKE W, 8
```

To move both motors:

```
POKE W, 5
POKE W, 0    etc.
```

To see what is happening, let us look at a timing diagram of the first four data lines (Figure 27). The list below shows what combinations of numbers give what directions of movement.

Table 6

MOTION	A	B
FORWARD	8	13
BACK	2	7
LEFT	10	15
RIGHT	0	5
RIGHT WHEEL	0	1
or	0	4
LEFT WHEEL	2	3
or	8	12

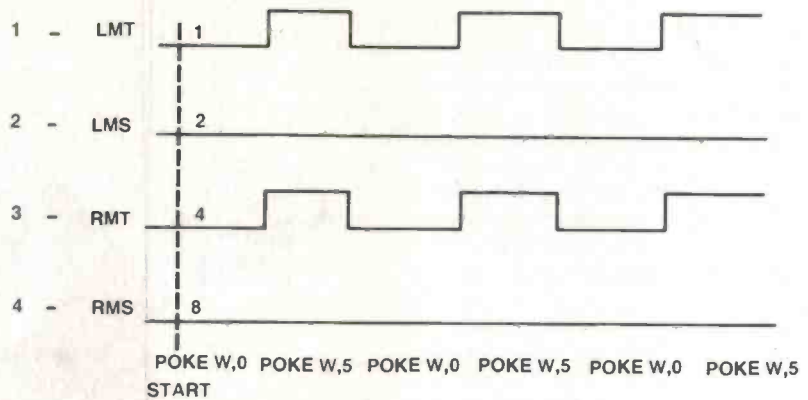
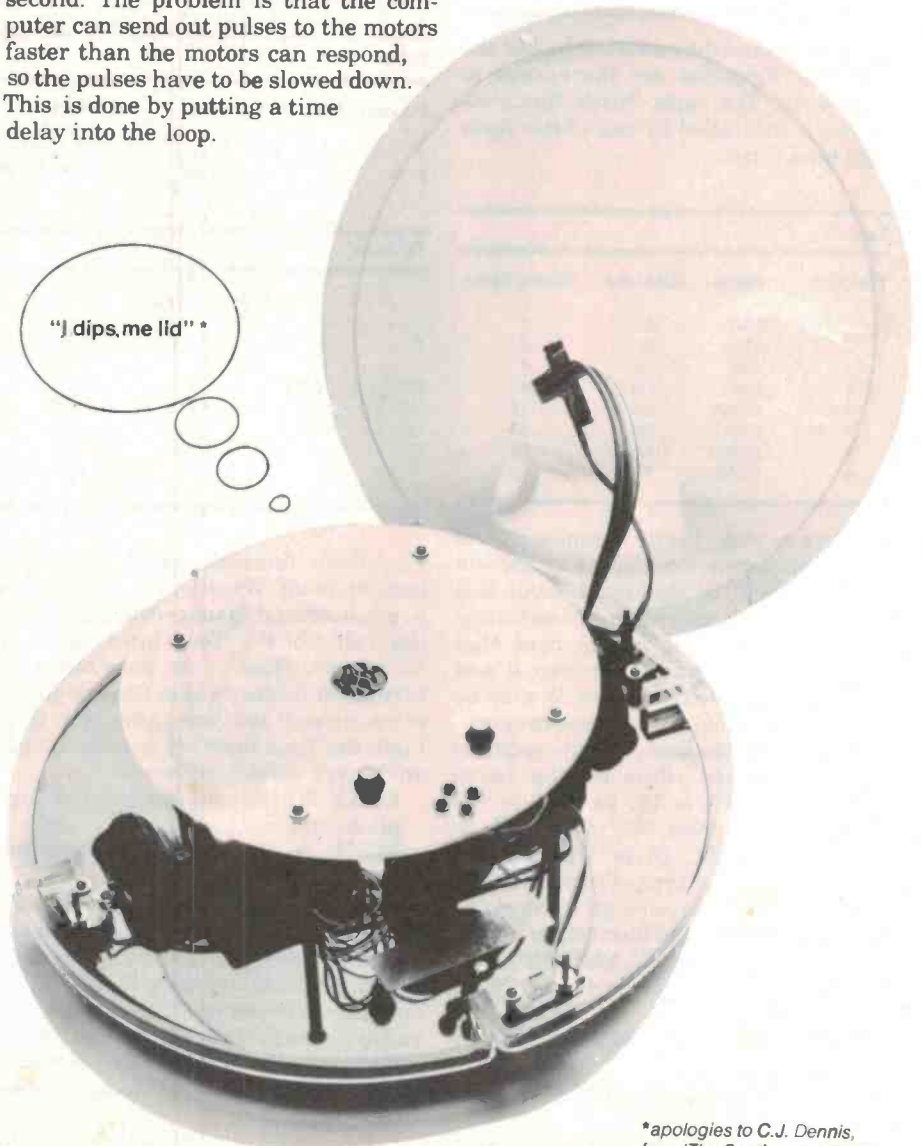

Figure 27. Timing diagram for the motor lines.

Now the next problem is that all stepper motors have a limit to how fast they can rotate, which is much less than for ordinary dc motors. For the Tasman Turtle it is about 100 pulses per second. Since the motors have a step angle of 7.5° (48 steps per revolution) this amounts to about two revolutions per second. The problem is that the computer can send out pulses to the motors faster than the motors can respond, so the pulses have to be slowed down. This is done by putting a time delay into the loop.

```
10 POKE W, A
20 GOSUB 100
30 POKE W, B
40 GOSUB 100
50 GOTO 10
100 FOR T = 1 TO TT
110 NEXT T
120 RETURN ▶
```



\*apologies to C.J. Dennis, from 'The Sentimental Bloke'.

**SPECIAL OFFER**

# TASMAN TURTLE ROBOT KIT

## EXCLUSIVE TO ETI READERS

Special Offer Price:

**\$349.00**

**(tax exempt: \$297.00)**

plus \$6 post and handling  
(inc. registration).

This product has never previously been offered as a kit and would normally retail for around \$600.



### OFFER CLOSSES 30 JULY 1982

Here is a not-to-be-missed opportunity to get started in robotics. For minimum cost this kit will provide you with the basic equipment to construct a robot which can be driven by remote control, electronic hand control or under computer control. Called the 'Minimum Turtle Kit', it has been put together by Flexible Systems of Hobart, Tasmania, manufacturers of the Tasman Turtle (see Printout, page 82, February ETI). Using this kit as a start you can develop a sophisticated robot capable of a huge variety of tasks.

The complete Minimum Turtle Kit comes ready for assembly according to the construction description published in ETI, packed in a box which has been designed so that the Turtle may be housed or stored in it after assembly.

#### HOW TO PURCHASE A MINIMUM TURTLE KIT

Fill out the coupon here and include a cheque or money order for a total of \$355. Make out the cheque or money order to 'Flexible Systems, Turtle Kit Offer', and post it, together with the coupon, to:

ETI/Turtle Robot Kit Offer  
ETI Magazine  
15 Boundary St  
Rushcutters Bay NSW 2011

The orders will be processed by ETI and, on clearance of the cheque or money order by Flexible Systems, the kit will be despatched directly to you by ETI via registered post.

Alternatively: You may call in to ETI's Sydney or Melbourne offices at the addresses given below and purchase a Minimum Turtle Kit for \$349. A demonstration kit and/or model will be available for inspection during this offer.

Sydney: ETI, 4th Floor  
15 Boundary St  
Rushcutters Bay

Melbourne: Murray Publishers, 22nd Floor  
150 Lonsdale St  
Melbourne

Tax exemption: For schools, TAFEs, etc. this kit can be purchased at the tax exempt price only if the coupon is accompanied by a signed order and a tax exemption declaration.

NOTE: This offer is made by Flexible Systems in co-operation with ETI Magazine. ETI is acting as a clearing and despatch agent for orders. All mail orders will be despatched by registered post. Please allow four to six weeks for delivery.

Note that the offer expires 30 July 1982.

#### DEMONSTRATIONS: see the Turtle — live!

Sydney: at ETI's office, 4:30 — 6:00 pm, Monday to Thursday.

Apple II computer supplied for demonstrations courtesy Imagineering Pty Ltd.

Melbourne: at city office, by appointment.

Apple II computer supplied for demonstrations courtesy Computer Country Pty Ltd.

#### WHAT YOU CAN DO WITH IT

You can use your Minimum Turtle to experiment with many aspects of robotics by interfacing it with a computer: draw figures under program command, solve mazes, make measurements, identify objects, etc. It can be driven via a cable or a remote control. The Minimum Turtle has been designed so that a wide variety of add-on projects may be included to increase the sophistication as you desire.

#### THE MINIMUM TURTLE KIT CONTAINS:

- All hardware (base, nuts and bolts, perspex dome, 'touch' ring, pen solenoid, speaker, etc)
- All mechanical parts (wheels, gears, axles, two stepper motors, etc)
- 'Standard Turtle' electronic control pc board and components
- All wire and cable for internal wiring
- A 25-pin plug for bidirectional data buss, control lines and power supply connections
- Comprehensive instruction manual

\*Tasman Turtle is a registered trademark of Flexible Systems.

#### COUPON

Please supply . . . . . Minimum Turtle Kit(s)

I enclose \$ . . . . . plus \$6 each postage (inc. registration).

TOTAL \$ . . . . .

Name . . . . .

Address . . . . .

Postcode . . . . .

Cheque or Money Order No . . . . .

Signature . . . . .

(please allow four to six weeks for delivery)

# Project 645

By varying the value of TT, the speed can be controlled.

To move a certain number of steps (each step is about a millimetre), a FOR-NEXT loop is used. N determines the distance the Turtle will move:

```
For I = 1 to N
POKE W, A
GOSUB 100
POKE W, B
GOSUB 100
NEXT I
```

If any other function is required while the Turtle is moving, simply add its value to A and B.

## Output (sensor) functions

The Turtle sends back information from its touch sensors when the PEEK statement is used (on INP). If the Turtle is not touching something then PEEK (R) = 255, where R is the Turtle's address for reading. Otherwise, PEEK (R) will have one of the following values:

Table 7

	L	R	F	B
L	254			
R	252	253		
F	250	249	251	
B	246	245	243	247

```
LFB — 242
RFB — 241
LFR — 248
LBR — 244
LBFR — 240
```

It is easy to make the Turtle decide which direction to move using IF-THEN statements, e.g:

```
If PEEK (R) = 255 then RETURN
If PEEK (R) = 254 then A = 5 : B = 0
etc.
```

Note that the time delays required for the stepper motor pulses can be achieved by using PEEK instructions, e.g:

```
10 FOR I = 1 TO N
20 POKE W, A
30 IF PEEK (R) < 255 THEN GOTO 100
40 POKE W, B
50 IF PEEK (R) < 255 THEN GOTO 100
60 NEXT I
100 S = PEEK (R)
110 IF S = 254 THEN A = :
    B = : RETURN
```

```
120 IF S = 253 THEN A = :
    B = : RETURN
130 IF S = 251 THEN A = :
    B = : RETURN
140 IF S = 247 THEN A = :
    B = : RETURN
150 RETURN
```

Don't forget the PRINT statement:  
**If PEEK (R) = 254 THEN PRINT "BACKSWITCH"**  
 Also, A can equal B:  
**If PEEK (R) < 255 THEN A = 192: B = 192: RETURN** ▶

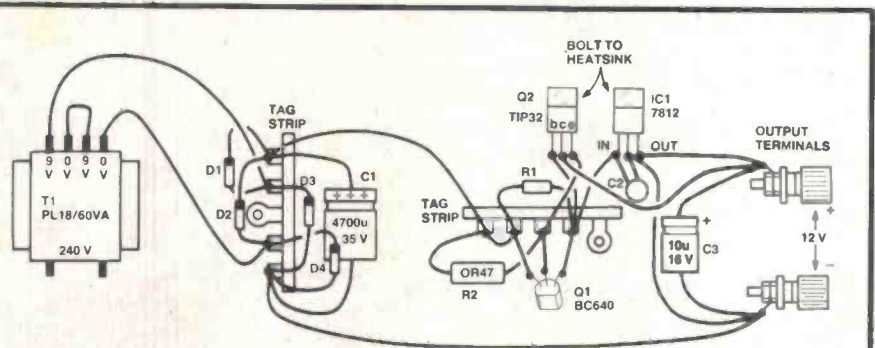

## POWER FOR THE TURTLE

The Tasman Turtle requires a supply of nominally 12 V at up to 2 A, which leaves plenty of current 'headroom' for later additions, as the 'minimum' Turtle only draws about 1.2 A.

### PROTECTED SUPPLY

If you're a dyed-in-the-wool experimenter and plan to attach accessories of your own to the minimum Turtle, then this supply will provide over-current protection in the event you do something foolish during installation or in the course of an experiment.

The diagrams show the circuit and suggested construction. A capacitor-input bridge rectifier is used, delivering about 25 V across C1. Output at the terminals is regulated 12 V. IC1 provides up to 1 A of the output current, and the series-pass transistor, Q2, provides a further 1 A or so of the output current. Fold-back over-current protection is provided by means of Q1. When the load current exceeds about 2.3 A, the voltage drop across R2 rises to about 0.6 V, turning Q1 on. The collector of Q1 then 'robs' Q2 of base current, turning Q2 off, and as IC1 cannot supply any further current it drops the output voltage. The output drops to near zero at a load current of about 2.5 A. Thus if you get a short circuit in the Turtle or some

circuit attempts to draw too much current, your supply protects the wiring and circuitry from possible damage.

It is suggested the supply be built in a sturdy plastic case such as the Arlec PC1. The rear panel of this case is metal, which allows IC1 and Q2 to be mounted to it, providing some heatsinking. A suitable heatsink should be secured to the panel rear. Both devices should be insulated from the panel by suitable insulating washers. Smear the washers both sides with heatsink compound before installation. Don't forget to insulate the bolts securing the tags of IC1 and Q2.

### PROTECTED SUPPLY — PARTS LIST

T1 — PL18/60VA  
 D1-D4 — 1N5404, 1N5408, 1N5625, A14P or similar  
 C1 — 4700u/35 V electrolytic  
 C2 — 220n ceramic  
 C3 — 10u/16 V electrolytic  
 R1 — 1R, 1W  
 R2 — 0R47, 5W wirewound  
 IC1 — 7812  
 Q1 — BC640  
 Q2 — TIP32

Two terminals (one red, one black); 240 Vac rated toggle switch; mains cable and clamp grommet; sturdy case (e.g. Arlec PC1); two tagstrips; wire etc. Estimated cost — \$38 — \$42

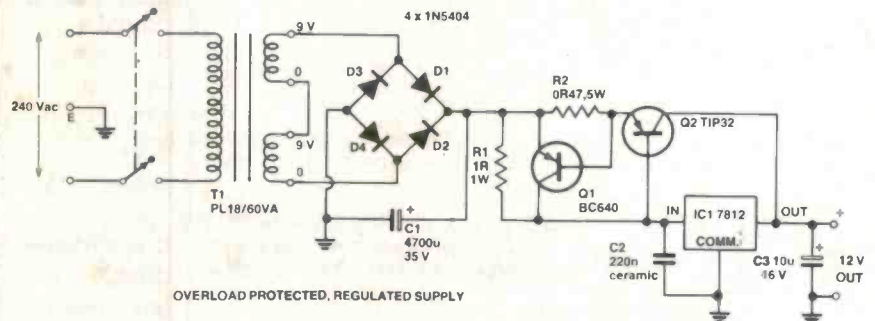

OVERLOAD PROTECTED, REGULATED SUPPLY



# DEMONSTRATIONS!

## See the Turtle strut its stuff!

Yes folks, it's an amazing sight. A Tasman Turtle toddling along, beeping, bumping and flashing, obeying the every whim of a devious computer program.

You can see the Turtle in live action at our Sydney and Melbourne offices — a not-to-be-repeated exhibition. If you're interested in purchasing a Turtle kit (or kits) and would like to *caveat emptor* (roughly translated: 'don't go into a cave unless it's empty'), then we'd only be too happy to show the beast in action. You can purchase kits on the spot if you wish.

The demonstrations have been arranged with the kind co-operation of Imagineering in Sydney and Computer Country in Melbourne, who have supplied Apple II computers, and Machine Dynamics of Victoria, who supplied interface cards.

## HOW, WHO, WHERE?

**In Sydney:** ETI, 4th Floor, 15 Boundary St,  
Rushcutters Bay. (02)268-9015.  
Monday to Thursday each week, 4:30 to 6:00 pm

Apple II computer used for demonstration kindly supplied by Imagineering Pty Ltd, 22 Sir John Young Crescent, Woolloomooloo.

**In Melbourne:** Murray Publishers, 22nd Floor,  
150 Lonsdale St,  
Melbourne.

**By appointment, phone Virginia Salmon  
(02)662-1222.**

Apple II computer used for demonstration kindly supplied by Computer Country Pty Ltd, 338 Queen St, Melbourne.

Interface cards for Apple computers supplied by Machine Dynamics, Mitcham, Vic.

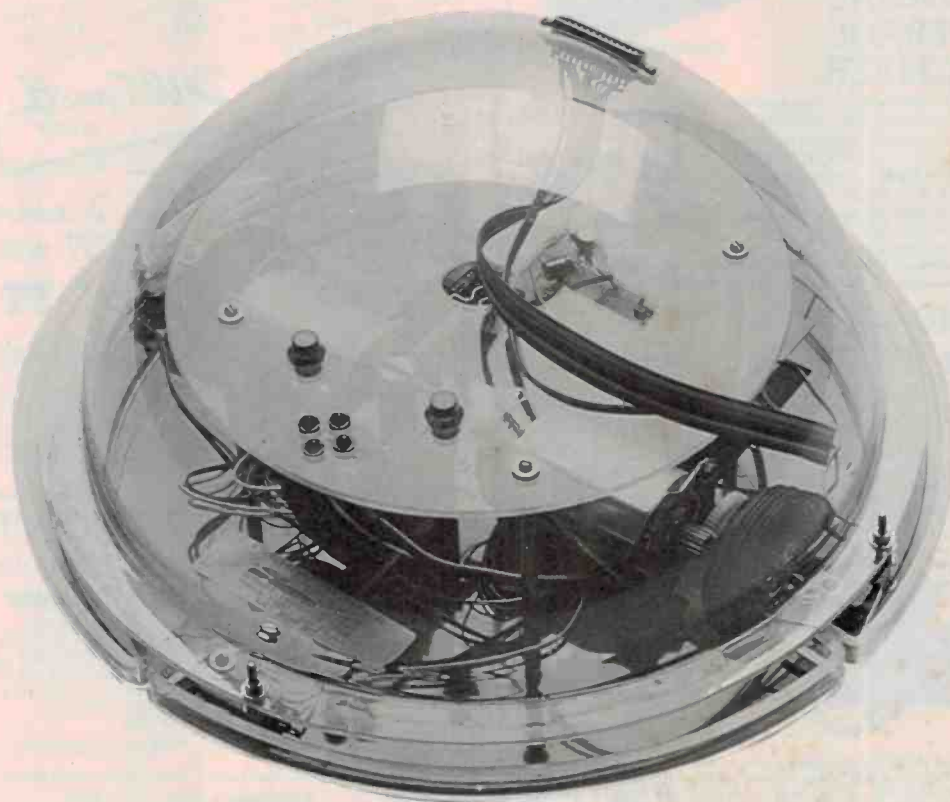

# AMATEURS read this, avoid an expensive mistake

**NOW IN STOCK**

## THE FANTASTIC FT-ONE GENERAL COVERAGE TRANSCEIVER



SELLING IN  
USA FOR  
\$2995!

Cat D-2852

An  
unbelievably  
low  
**\$1795**

\*FM board optional  
extra

Now Dick Smith and Yaesu bring you this superb general coverage transceiver with outstanding features for such a low, low price. Just look at some of the features: ★ All mode - even FM★; ★ All band - receives from 150kHz to 30MHz continuous, with resolution down to 10Hz; ★ Transmitter includes all the WARC bands; ★ All microprocessor controlled ★ Runs from 100-120 or 200-240V AC or 13.5 DC, and much more! And the price?



## HAND HELD FM The FT 208R

2.5W/.25W

The FT 208R transceiver brings a new flexibility to today's active 2M operator. An easy to read LCD display is coupled with a 4-bit microprocessor, bringing 10 memories and a scanning function. Only with Yaesu can you get these features at such an economical price. Cat D-2889

Complete with  
battery & charger

ONLY  
**\$368**



## FM 2 metre FT 230R

and it's only

**\$375**

It's here! The brand new Yaesu FT 230R with features you'd pay \$555 more for. 3W/25W output, full 144-148MHz band coverage, fully synthesised, 12V operation. Plus two VFO's, LCD readout, 10 memories, scanning, hi/lo power switch, and much, much more. Check it out now!  
Cat D-2893

**SUPER COMPACT!**



## SUPERB MOBILE/BASE FT 707

100 WATT

ONLY  
**\$795**

What a performer packed into such a tiny package! It's a full power all HF band (including WARC) multi-mode transceiver not much bigger than the average 2 metre mobile! And you get digital display as well. LED S/power meter, push button operation etc, etc. Team it up with and FT-707 supply and you have a superb base station too! What more could you ask for?  
Cat D-2869

Dear Amateur,  
Consider these two recent reports of amateurs who purchased Yaesu equipment from 'backyard' importers: both these cases were told by the purchasers to our store staff in trying to get some help.

Case History No. 1;  
Mr X from Adelaide bought a transceiver by mail order. After waiting some time for delivery, the unit arrived but shortly after the digital display failed. Mr X rang the supplier to be told the repair would take 6 to 8 weeks, and he would have to pay freight charges both ways. Mr X ended up having the unit repaired in Adelaide at his own cost.

Case History No. 2  
Mr Y from Sydney bought a 'new' transceiver from the same source. On opening the carton, Mr Y strongly suspected the unit was not new, but had been 'refurbished'. It failed to operate at all - the PA stage was inoperative. Mr Y rang the supplier to be told that parts were unavailable and the repair would take at least three months. As it was supposed to be a brand new unit, Mr Y asked for a replacement. This was refused.

Other problems:  
We have often heard of transceivers supplied without instruction manuals, or with Japanese language instruction manuals... Obviously these units were intended for the Japanese domestic market, and never intended to be exported. The warranty is not valid in Australia on these units.  
Many 'backyard' importers do not have any service facilities whatsoever - let alone spare parts. They are not authorised by Yaesu, (or usually anyone else) and often have little expertise.

Is it worth the risk?  
\*Dick Smith is the only authorised Yaesu dealer offering full 12 month warranty!

Dick Smith  
VK2ZJP



## 2 metre SSB-FM- CW with scanning FT 290R

ALL-MODE

only  
**\$395**

The brilliant Yaesu FT 290R. For the person who can't quite decide whether they want a portable or a mobile set. This one is both! And what's more, it's fully microprocessor controlled offering up to 10 memory channels, scanning, LCD display, high or low power operation, all modes plus full 144-148MHz band coverage. All this in a transceiver which can be operated both portable (from internal batteries and whip antenna) or mobile (ext. antenna and power sockets fitted). Complete with carry strap, scanning microphone and whip antenna. Cat D-2885.

## DEMO CLOSEOUT SALE

Ex-demo and store stock, some slightly marked.

Full 12 month warranty

FT 207R	2 mt hand held with charger SAVE \$60!	(D-2888)	\$235.00
PA 2	Mobile charger supply for FT 207H SAVE \$10!	(D-2894)	\$19.95
<b>SPECIAL PACKAGE - BOTH UNITS FOR \$246.50!!</b>			
FT 107M	Solid state HF transceiver (power supply built-in)	(D-2863)	\$850.00
FT 7B	Solid state portable HF transceiver SAVE \$50!	(D-2868)	\$549.00
FT 901D	Transceiver 160 - 10 mtrs (built-in power supply) SAVE OVER \$70!	(D-2854)	\$999.00
FT 901/902	Memory unit for 901/902 series SAVE \$40!	(D-2858)	\$99.00
FT 901/902 DC-DC	DC power supply for 901/902 series SAVE \$20!	(D-2856)	\$49.00
FT 720RVH	2 mt mobile transceiver SAVE \$80!!	(D-2890)	\$369.95
FT 101ZD	101 digital HF transceiver with WARC bands (built-in power supply) SAVE \$60!!	(D-2859)	\$850.00
FT 227RB	2 mt FM mobile with scanning SAVE \$60!!	(D-2891)	\$319.00
FV 707DM	Digital VFO for FT 707 SAVE OVER \$30!	(D-2896)	\$265.00
MMB2	Mounting bracket for FT 707 SAVE \$9!	(D-2897)	\$25.95
	Galbraith paddle morse key SAVE \$2.55!	(D-7103)	\$14.95
YM-34	Desk Mic for FT 707 SAVE \$14.55!	(C-1114)	\$29.95

Some stores have limited or no stock available. Ring Jim Powell at Head Office (02) 888 3200 for details on where to find these bargains.

# DICK SMITH Electronics



See Page 34 for address details

DSE/A240/PA1

For a real life example of all the foregoing, one of ETI's correspondents, Phil Cohen, has written a 'Random Walk' program for the Minimum Turtle interfaced to an Apple II via a PIA card which plugs into Slot 2. For this interface, the Turtle input functions 'reside' at address -16224, and the Turtle output functions at address -16222. The program effectively 'exercises' all the Turtle's functions, both input and output. The randomness of its 'walk' comes from the function at line 200 — you never know how far the Turtle's going to turn after it meets an obstacle and backs off!

The Turtle commences moving forward, and if it doesn't meet an obstacle after a short period it will execute a turn and continue in another direction, etc. If it meets an obstacle (other than running out of 'umbilical cord') it will flash its lamps, sound its horn, back off and continue in another direction. It's a fascination to watch!

## Conclusion

Well, it's not a conclusion, really — more like 'until next time'. Now you have your Turtle 'up and running' — even if you haven't organised interfacing to a/your computer, the limits are bounded by physics and your imagination (the Turtle won't transport you around, but the family's new kitten might enjoy a ride!). At present, we're working on a number of accessories, e.g: a manual controller (drive it yourself); a line follower (draw a line and the Turtle will follow you anywhere); interfacing to popular micro/personal computers, etc. We hope to present these in forthcoming issues, very soon. In the meantime, ETI would appreciate feedback from Turtle owners/constructors with their own ideas/hints/tips/circuits/programs.

## RANDOM TURTLE WALK

```

10 DIM ARR(8)
20 W = - 16224
30 R = - 16222
40 POKE W + 1,0
50 POKE W,255
60 POKE W + 1,52
70 POKE R + 1,0
80 POKE R,0
90 POKE R + 1,60
100 POKE W,0
110 ARR(1) = 0
120 ARR(3) = 1
130 A = 4: GOSUB 230
140 ARR(7) = 0:A = 6: GOSUB 230
150 A = 10: GOSUB 390
160 ARR(7) = 1:A = 6: GOSUB 230
170 ARR(1) = 1:ARR(3) = 0:A = .5:
    GOSUB 390
180 ARR(1) = 0:ARR(3) = 0
190 IF RND (1) > .5 THEN ARR(1)
    = 1:ARR(3) = 1
200 A = ABS ( RND (1) * 3) + 1
210 GOSUB 390
220 GOTO 110
230 REM ***** FLASH BIT A

240 ARR(A) = 1
250 GOSUB 320
260 POKE W,OUT
270 FOR I = 1 TO 100: NEXT I
280 ARR(A) = 0
290 GOSUB 320
300 POKE W,OUT
310 RETURN
    
```

```

320 REM ***** GENERATE
    OUT
330 ARR(0) = 0:ARR(2) = 0: REM M
    AKE SURE MOTORS ARE OFF
340 OUT = 0
350 FOR I = 1 TO 8
360 OUT = OUT + (2 ^ I) * ARR(I)
370 NEXT I
380 RETURN
390 REM ***** TURN MOT
    ORS FOR A SECS UNTIL STOPPED
    AFTER 1/2 SEC
400 GOSUB 320
410 OS = OUT + 5
420 POKE W,OUT
430 FOR I = 1 TO 50
440 POKE W,OUT
450 FOR T = 1 TO 3: NEXT T
460 POKE W,OS
470 NEXT I
480 IF ARR(1) < > ARR(3) THEN
    GOTO 550
490 FOR I = 1 TO A * 110
500 POKE W,OUT
510 FOR T = 1 TO 3: NEXT T
520 POKE W,OS
530 NEXT I
540 RETURN
550 FOR I = 1 TO A * 110
560 IF PEEK (R) < > 15 THEN
    RETURN
570 POKE W,OUT
580 POKE W,OS
590 NEXT I
600 RETURN
    
```

## CORRECTIONS

In the May issue, Figure 11 on page 25 — the pc board component overlay — shows the LAMP INPUT going to the track joining the collectors of Q5 and Q6. This is incorrect, as the circuit (and common sense) shows. The LAMP INPUT goes to the free end of R10, and the LAMPS connect between the pad joined to the collectors of Q5 and Q6 and the +12 V line, where one lead of R13

protrudes through the top side of the board (as per original). In other words, swap the two leads going to the pads over Q6 and R10.

The printers failed to effect a number of alterations to Figure 13 on page 28. The principal problem is with the length of the leads to the lamps and MSW2 (right). The leads to the lamps should be 260 mm long, the leads to MSW2, 500 mm long.

# TURTLE TALK™ \$240.00 + Tax

## Speech Generation at an incredibly low price

For Plugging into the Tasman Turtle™ to give the world's first talking robot for general use, or as a stand alone board for special projects, talking keyboards, aids for disabled or linguistic experiments.

### FEATURES

- Vocabulary expansion by simply plugging in more ROMS • Standard 143 word vocabulary all the letters of the alphabet and all numbers • Expandable to approx. 600 words • Unlimited combinations of words to form phrases, sentences, etc.

### THESE FEATURES ALLOW PHONEME RECONSTRUCTION METHODS

- Interrupt facility to use the start of words • Mute facility to allow use of the internal parts of words • Command facility allows words to be cut short • Prefix and suffix words for combinations

All circuitry on board for interfacing, ROM expansion, power supplies and audio amp.

### EDUCATIONAL

ROM's with French, German, Italian and other languages can plug in also. Have many languages on the one board! Both American and European

English available. Spelling is determined by the programmer. Comprehensive Manual with applications included.

### INTERFACING CIRCUITING ON BOARD

Two interfacing methods can be used with many variations for each:

- Data Control Interfacing uses multiplexed data bus.
- Direct Control Interfacing uses parallel port control pins.

Can be used with all popular micro-computers including System 80, TRS 80, Apple II, Superboard II, etc.

Can even be used as stand alone board with discrete circuitry or switches. Have your message spoken to visitors at the door while you are away. Have the radio tell you what station it is on.

### INDUSTRY

Suitable for process control and alarm warnings.

### PROGRAMMING

Uses simple POKE and PEEK Instructions. One line of programming for any word.

Available from: **FLEXIBLE SYSTEMS** 219 Liverpool Street, HOBART, Tasmania. 7000. Australia. Ph (002) 34 3064



TASMAN TURTLE & TURTLE TALK ARE TRADE MARKS OF FLEXIBLE SYSTEMS

# Electronics Australia/ DICK SMITH SUPER 80 Computer Kit



Production costs have now been absorbed due to fantastic response — YOU REAP THE BENEFIT!!

**NEW SUPER LOW PRICES**

was \$289.50  
NOW  
**\$239.50**  
save \$50

Yes, this makes the full 16K computer, with 9K BASIC on tape, transformer and IC sockets — only

**\$289.50**

- SHORT FORM KIT:** Designed for computer applications where 'BASIC' programming is not required. Kit supplied with EPROM monitor and 16K RAM. (Cat. K-3600)  
 WAS \$289.50 — SAVE \$50.00 ..... **\$239.50**  
 Transformer to suit (Cat. M-2325) ..... **\$23.00**  
 IC Socket Set (Cat. K-3603) ..... **\$12.50**  
 BASIC program (interpreter) on cassette (Cat. K-3602)  
 WAS \$24.50 — SAVE \$12.00 ..... **\$12.50**
- OTHER OPTIONS:**  
 Case to suit (Cat. H-3200) ..... **\$39.50**  
 BASIC program in EPROM (Set of 3 IC's) (Cat. K-3604)  
 WAS \$89.50 — SAVE \$40.00 ..... **\$49.50**  
 S-100 Expansion (Cat. K-3606) ..... **\$19.50**  
 Character Generator (upper/lower case) (Cat. K-3607)  
 WAS \$69.00 — SAVE \$20.00 ..... **\$49.00**  
 Detailed construction manual (Cat. B-3600)  
 WAS \$12.50 — SAVE \$3.00 ..... **\$9.50**  
 BASIC manual (Cat. B-3602)  
 WAS \$14.50 — SAVE \$5.00 ..... **\$9.50**  
 RAM expansion to 48K (2 sets 16K RAM IC's) (Cat. X-1186 x 2) ..... **\$59.90**

Photo shows the basic board with the following options: S-100 expansion, IC sockets and a full 48K of memory.

# EX-STOCK Available NOW! OVER 2000 SOLD!

The SUPER 80 is the proven computer kit with over 2000 sold and it is available ex-stock! Why wait for others — check out our prices with the competition and whilst you are doing that, check out the features too! Dick Smith Electronics have reduced the price of the SUPER 80 as the enormous design costs have now been absorbed by the superb sales of this superlative kit computer — read on . . .

Check the Super 80 against all others

	SUPER	OTHER
* IS IT S-100 EXPANDABLE	<input checked="" type="checkbox"/>	<input type="checkbox"/>
* DOES IT EXPAND TO 48K ON BOARD	<input checked="" type="checkbox"/>	<input type="checkbox"/>
* DOES IT HAVE RF OUTPUT FOR TV CONNECTION	<input checked="" type="checkbox"/>	<input type="checkbox"/>
* WAS IT FEATURED IN ELECTRONICS AUSTRALIA — AUSTRALIA'S LEADING ELECTRONICS MAGAZINE	<input checked="" type="checkbox"/>	<input type="checkbox"/>
* IS IT AVAILABLE EX-STOCK	<input checked="" type="checkbox"/>	<input type="checkbox"/>
* HAS IT SOLD OVER 2000 AND BEEN PROVEN AGAINST TEETHING TROUBLES	<input checked="" type="checkbox"/>	<input type="checkbox"/>

**CHECK OUT THESE FEATURES:** \* Relay operates cassette unit automatically \* 2K Monitor program supplied \* Character generator giving full 64 characters, 32 characters x 14 line screen \* Spare IC positions for prototyping and user customising \* RF modulator inbuilt, connects to your TV set \* Optional S-100 provision \* Keyboard can be remotely mounted if required \* 12MHz quartz crystal \* Optional 9K SUPER BASIC in ROM plug in facility \* Full size professional 60 key keyboard \* Inbuilt power supply \* 16K RAM on board plus provision for on board expansion to 48K \* Inbuilt cassette interface

## 'Sorry Dick, It Doesn't Work'

This service is specifically intended for constructors who have completed their Super 80 kit, but have difficulty in getting it to work correctly. We will not complete half-built kits, then get them to work; your kit must be complete before taking advantage of this service.

Your kit must have been constructed using IC sockets.

Our Service Centre will check and repair your Super 80 for the cost of \$100. This fee includes necessary replacement of components, etc.

## 7 Day Satisfaction Guarantee

Another exclusive Dick Smith offer: purchase this kit and inspect it for up to 7 days. If, for some reason, you do not wish to go ahead and construct the kit, simply return it to us in original condition and packing (ie. before construction has commenced) and with all instructions, cards, etc. and we will refund your money in full. What have you got to lose?



*This is what Reg Hespe, Technical Officer of Gladesville had to say about 'Super 80' "I enjoyed building the Super 80 project and felt it worthwhile, of immense educational value and quite easy to construct. It worked as soon as I turned it on and has provided many hours of enjoyment".*



**SEE PAGE 34 FOR ADDRESS DETAILS**

Very Advanced design — but works with any TV set!

The 'Super 80' offers a specification that we believe just cannot be bettered at the price. It uses the popular Z80 Microprocessor IC, a professional keyboard and has direct RF output so that you can use the computer with any TV set (you don't need to purchase a special video monitor).

Easy to build

Even though we would not recommend this kit to the raw beginner, it is very easy to build. Any person who can use a small soldering iron and can solder neatly should have no difficulty in construction. This is because of the unique double-sided board design which means there is virtually no other wiring. The board is covered with professional 'solder mask', this makes soldering much easier without the problems of bridges, etc. Once the components are soldered onto the board in their marked positions over 98% of the construction is completed. Even if you cannot get the completed kit to work, we have a special "Sorry Dick it doesn't work" repair service to assist you.

NEW lower price, higher specification - how is it done?

Most computers sold in Australia are manufactured in the U.S.A. where extremely high labour rates prevail - and you pay dearly for this on built up units. With this computer kit, you provide the labour and therefore save a fortune. And remember, this computer does not have a small toy-like calculator keyboard but a full size professional typewriter keyboard.

Advanced programming capability

The Super 80 Computer gives you a huge 9K of BASIC — comparable in fact, with the BASIC on our very popular Sorcerer computer (over 2000 sold) — and this machine sells for over \$1,000. Many other computers currently available do not offer as much BASIC programming capability as the SUPER 80 — it is obvious that by building it yourself you are saving real money!

Electronics Australia/Dick Smith design

This is not a half baked design with no back up. The resources of Electronics Australia, Australia's most popular electronics magazine, and Dick Smith Electronics have combined to design and bring you this kit in the interests of computer enthusiasts actually building and not just buying. The design is fully Australian.

Imagine how much you will learn!

Most computer enthusiasts can program a computer but would have absolutely no idea of how to build one. By building this kit you will learn both the technical side of construction, how it works and then how to program. What a fantastic background for the future. . . . .

Sectional construction

We have designed this kit not only for the serious computer user but also for first time users like the student or hobbyist. This is why we have a short form kit which may be added to as you build (and as you have the money!). For example, you may build the computer originally and operate it with 'BASIC on tape' and then add 'BASIC in ROM', add the S-100 and provide other parts at a later stage.

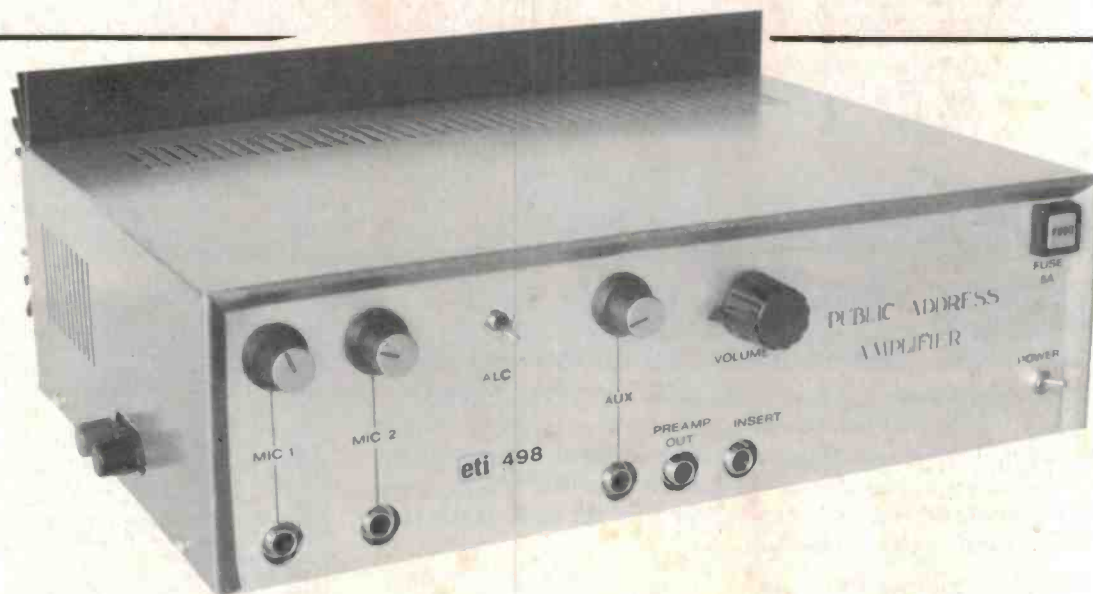

# Versatile public address amplifier

Featuring 'speech filtering' and ALC on the mic inputs to improve intelligibility, an 'insert' input and a power MOSFET output stage delivering 150 W RMS maximum output to 100 V, 70 V or low impedance lines, this PA amplifier has much to offer.

THIS PROJECT has been designed specifically for use in large open areas where ambient noise levels are often high, such as outdoor sporting events. It features two microphone inputs, which can be configured for high or low impedance microphones, as desired, when the project is constructed. The microphone signal path incorporates speech filtering to increase the intelligibility of the voice signal under 'difficult' conditions where other noises compete for the audience's attention. Automatic level control (ALC) is included to

decrease the variation in voice level between different commentators using the PA and, again, improve 'penetration' where extraneous noise is present. This feature may be switched in or out, as desired.

An auxiliary input is provided, which can be used to connect a line level signal or a speaker output from a radio, etc. A preamp output enables several power amplifiers to be 'slaved' from the one preamp, and provides a high-level signal for output to a tape recorder, for example.

**Geoff Nicholls**

The insert socket allows further signal processing devices to be 'inserted' in series with the signal path from the output of the preamp to the input of the power amp.

The completed amplifier has actually been used at a large, noisy outdoor venue driving eight horn speakers. It gave an excellent account of itself, especially when compared directly against a system using two of our old ETI-480 100 W modules (circa 1976) driven by an ETI-419 preamp (circa 1973!).

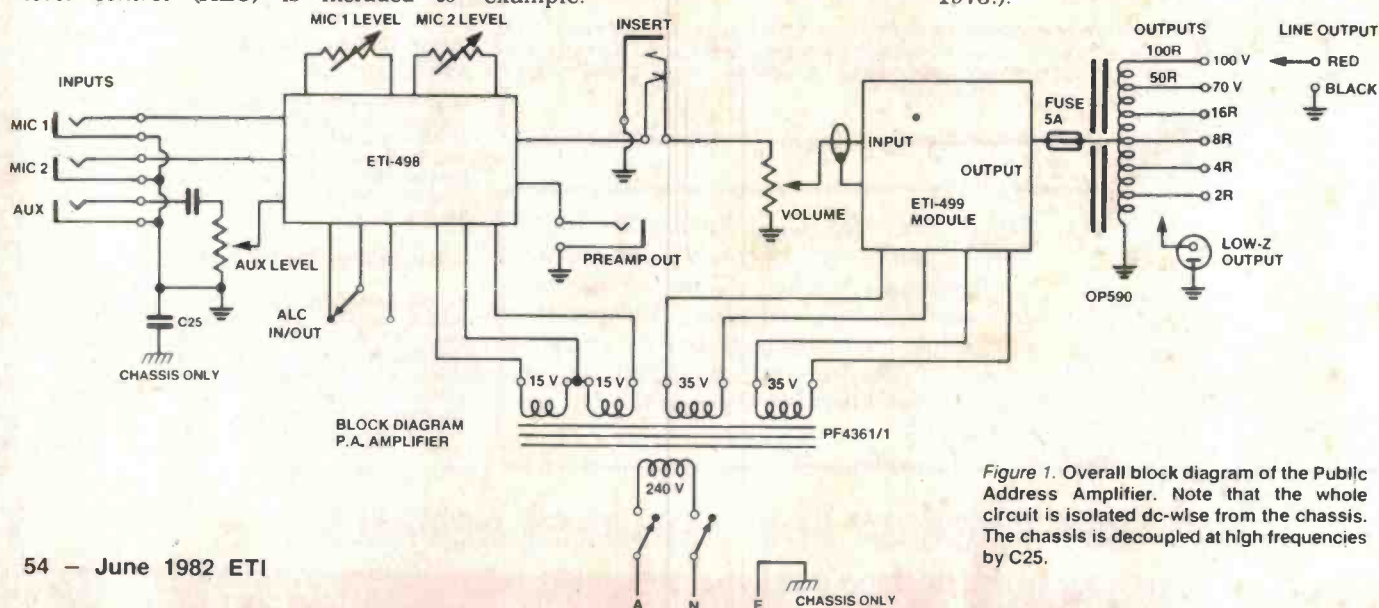

Figure 1. Overall block diagram of the Public Address Amplifier. Note that the whole circuit is isolated dc-wise from the chassis. The chassis is decoupled at high frequencies by C25.

## Design notes

Most public address set-ups, for all but the largest outdoor events, generally use a single announcer or commentator, occasionally two. Thus as more than two microphones are rarely required, only two microphone inputs have been provided. This allows the constructor either to provide two low impedance inputs, two high impedance inputs or one of each. In a pinch, a low impedance input could be used with a high impedance, high output mic, provided the level control is near minimum. The auxiliary input is shunted by a low value resistor to provide loading for the earphone or external speaker output of radios, cassette decks, etc. It also terminates a line level output correctly.

The signal 'earth' is isolated at low frequencies from the chassis and mains earth to eliminate the possibility of hum loops brought about by connecting external mains powered equipment to the amplifier. The chassis is ac-coupled to the signal earth to higher frequencies as the impedance of capacitor C25 (which couples the chassis to the signal earth) decreases.

The frequency response of the microphone preamps is rolled off rapidly below 150 Hz. This allows the output transformer to deliver more useful power than would be the case if a flat frequency response were employed. The distortion is also reduced by rolling off the low frequencies. Distortion and frequency response curves for the OP590 are illustrated in the accompanying graphs (courtesy Ferguson Transformers).

Automatic Level control (ALC) is included, the purpose of which is to maintain a nearly constant output level with large excursions in signal level. For a signal input level range of greater than 20 dB, the output level will only vary by 3 dB or less for typical microphone input levels. This greatly improves intelligibility and 'punch' of the sound produced, particularly where all sorts of extraneous sounds are about, interfering with the audience's ability to hear the PA.

To provide ALC, I have used half of an NE570/571 audio compressor chip. The basic circuit employed is shown in Figure 2. Inside the NE570/571 are a precision rectifier (the block shown with the diode inside), a variable gain cell ( $\Delta G$ ) and an op-amp. Resistors R1, R2 and R3 are inside the chip. The rectifier and variable gain cell operate in the feedback circuit of the op-amp, the gain of which is varied with signal level. At high input levels, the op-amp gain is reduced, at low input levels the gain is

increased. Resistor  $R_x$  is used to set the maximum gain. The gain of this circuit is given by:

$$K = \frac{R1 R2 I_B}{2R3 V_{IN (avg)}}$$

where  $I_B = 140 \mu A$

$$\text{and } \frac{V_{IN}}{V_{IN (avg)}} = \frac{\pi}{2\sqrt{2}}$$

for sine waves

The maximum gain is limited (by  $R_x$ ) to prevent high output levels occurring at low input levels (such as background noise).

The maximum gain is given by:

$$\frac{R1 + R_x}{1.8} \cdot \frac{R2 \cdot I_B}{2R3}$$

The output voltage is determined by:

$$V_{out} = \frac{R1 R2 I_B}{2R3} \cdot \frac{V_{IN}}{V_{IN (avg)}}$$

The time constant is important as the circuit needs to react quickly to positive sounds, yet 'hang on' following peaks. The ALC time constant is determined by:

$$\tau = R1 \cdot C_{RECT}$$

The value of  $C_{RECT}$  affects the distortion, so its choice is a compromise between providing an effective time constant and keeping the distortion within bounds. Reducing  $C_{RECT}$  improves the time constant but increases the distortion; increasing it reduces the distortion but reduces the ALC effectiveness. Distortion is determined by:

$$\text{Distortion} = \frac{100n}{C_{RECT}} \cdot \frac{1 \text{ kHz}}{\text{freq.}} \cdot 2 (\%)$$

The frequency response of the mic signal path is 'tailored' to improve speech intelligibility. There is much redundant energy in the spectrum produced by the voice. Reducing those components below 300 Hz and rapidly attenuating components above 3 kHz removes the redundancy and subjectively provides improved intelligibility for the listener — particularly where extraneous noise is present. Speech 'weighting' filters are used to great effect in communications equipment. In the preamp, the response below 330 Hz is rolled off at 12 dB per octave down to 150 Hz, where an extra filter section provides 18 dB/octave roll-off down to 125 Hz, where the roll-off is further increased to 24 dB/octave. Between 330 Hz and about 2 kHz, the preamp has a response rising gently at 6 dB/octave. Between 2 kHz and 3 kHz, the response is es-

entially flat. At 3 kHz the response rolls off steeply at 18 dB/octave.

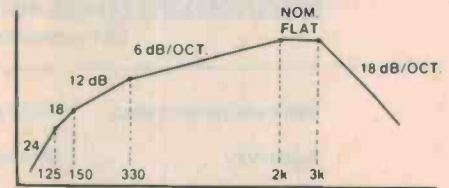

Generalised shape of the preamp mic signal path response showing the rolloff frequencies and attenuation rates. This response provides an effective 'speech weighting' filter to improve 'punch' under noisy conditions.

The steep roll-off below 150 Hz reduces distortion contributed by the output transformer at low frequencies, as mentioned earlier.

The combination of ALC and speech filtering has an additional advantage in that it permits greater sound levels to be achieved before howl-round feedback becomes a problem.

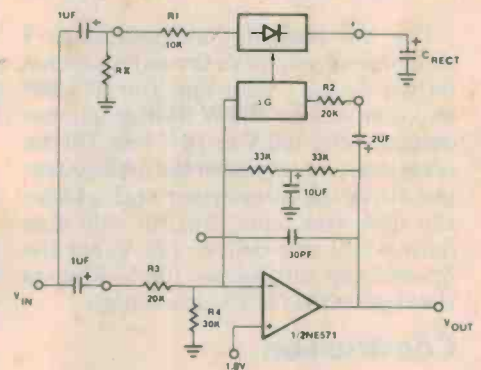
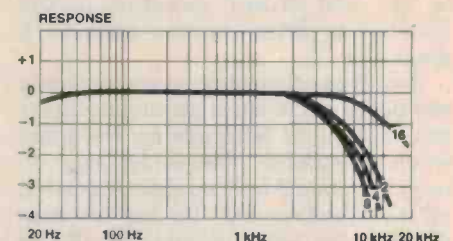
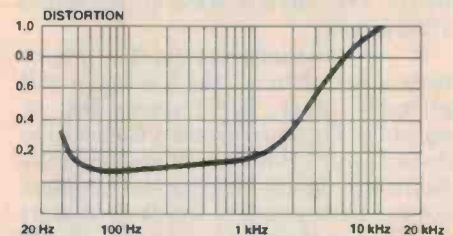

Figure 2. General circuit of the NE570/571 audio compressor chip connected as an automatic level control (ALC). Note that R1, R2, R3 and R4 are inside the chip.



Distortion and frequency response characteristics of the Ferguson OP590 line output autotransformer (courtesy Ferguson Transformers).

# Project 498/499

## SPECIFICATIONS ETI-498/499 PUBLIC ADDRESS AMPLIFIER (as measured on prototype)

Maximum power output	150 W RMS (at onset of clipping)	
Sensitivity	(RMS input for full output)	
	1 kHz	2 kHz
MIC 1	50 mV	15 mV (level at min.)
	1 mV	0.3 mV (level at max.)
MIC 2	100 mV	35 mV (level at min.)
	30 mV	10 mV (level at max.)
AUX.	60 mV	60 mV (level at max.)
Signal/noise ratios		
(level controls set to provide rated output for the quoted input levels at 2 kHz — ALC off)	MIC 1	-71 dB re 1 mV
	MIC 2	-73 dB re 50 mV
	AUX.	-74 dB re 100 mV
Outputs	2 ohms, 4 ohms, 8 ohms, 16 ohms	
(selectable)	50 ohms (70 V nom.), 100 ohms (100 V nom.)	

For the majority of applications I recommend you drive the output transformer at the 8 ohm tap. The ETI-499 will then deliver 100 W RMS maximum output to the 100 V or 70 V line. On the occasions you may need the greater output, drive the transformer at the 4 ohm tap. However, note that the 100 ohm output will now deliver 123 V, but the 50 ohm tap will deliver 108 V. Change the taps on the OP590 accordingly.

### Construction

This article covers construction of the ETI-498 preamp board and assembly of the preamp and ETI-499 power amp module into the case. For details on constructing the ETI-499 150 W MOSFET power amp module refer to the March 1982 issue.

If you are constructing this project from a kit, then all the hardware will probably have been pre-drilled or punched. This can certainly save a lot of dreary work. However, if you have the facilities and are tackling the complete construction yourself, the place to start is with the hardware. The case should be cut and drilled according to the dimensions given in our metalwork diagrams.

Note that all the potentiometer shafts should be cut to leave about 12 mm for the knobs to fit flush against the panel when assembled. The solder lugs on each pot should be modified by cutting off the eyelets so that the lug can pass through the holes provided in the pc board for soldering directly to the relevant pad. Pads for the pot lugs should be drilled with a 2 mm diameter hole.

56 - June 1982 ETI

When cutting the eyelets from the lugs, make sure you leave as much of the stem of the lug as you can, otherwise they may not reach through the pc board. Note that the volume control pot, RV4, has only one lug soldered to the pc board — check the photo of the assembled pc board and only modify the relevant lug. The auxiliary level pot, RV3, has only two lugs modified.

Bend the modified lugs down *toward the pot shaft* and install each pot on the pc board. Pass the pots through the board from the *non-copper* side and secure them with *one nut* on the copper side.

Next mount the jack sockets. Orientate them so that their lugs are adjacent to the relevant holes in the pc board, and tighten the nuts firmly.

The completed preamp board (but I hadn't put C25 on yet . . .).

Mount R1, R6 and R15 between the switch and tip lugs on the two MIC jacks and AUX jack, respectively. Extend the switch lug end of the resistor pigtailed to the sleeve lug in each case, as shown in the accompanying drawing.

General assembly of the pc board-mounted components follows. Note that *all soldered joints on the copper side of the board should be 'clinched' or cut short* as the board is mounted close behind the front panel of the case.

Mount R21 and R22 between the pc board and the lugs of the PREAMP OUT and INSERT jack sockets, as shown on the component overlay.

Probably the easiest order of construction is to first install all the resistors, then the ICs and diodes, followed by the capacitors. Watch the orientation of the ICs, the four diodes and the tantalum and electrolytic capacitors. The component overlay shows the appropriate orientation of all these components. Note there are a number of links on the board. Use insulated hookup wire for these.

Having finished the assembly of the components to the board, check it carefully to see that you have everything in its correct place and that there are no suspect joints, missed joints or solder bridges on the copper side of the board.

Now solder the two 15 V windings of the PF4361/1 power transformer to the preamp board (make sure they're correctly phased) and attach about 100 mm of twisted-pair hookup wire from the preamp output. Use hookup wire at least as big as 24 x 0.2 mm for this twisted-pair lead.

Mount two countersunk 8 BA x 12 mm screws in the appropriate front panel holes and secure them with *one nut and*

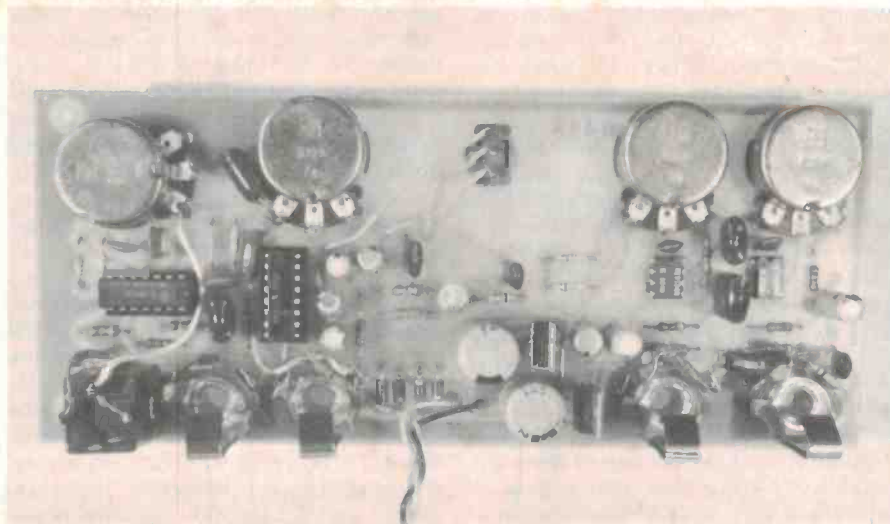



# public address amp

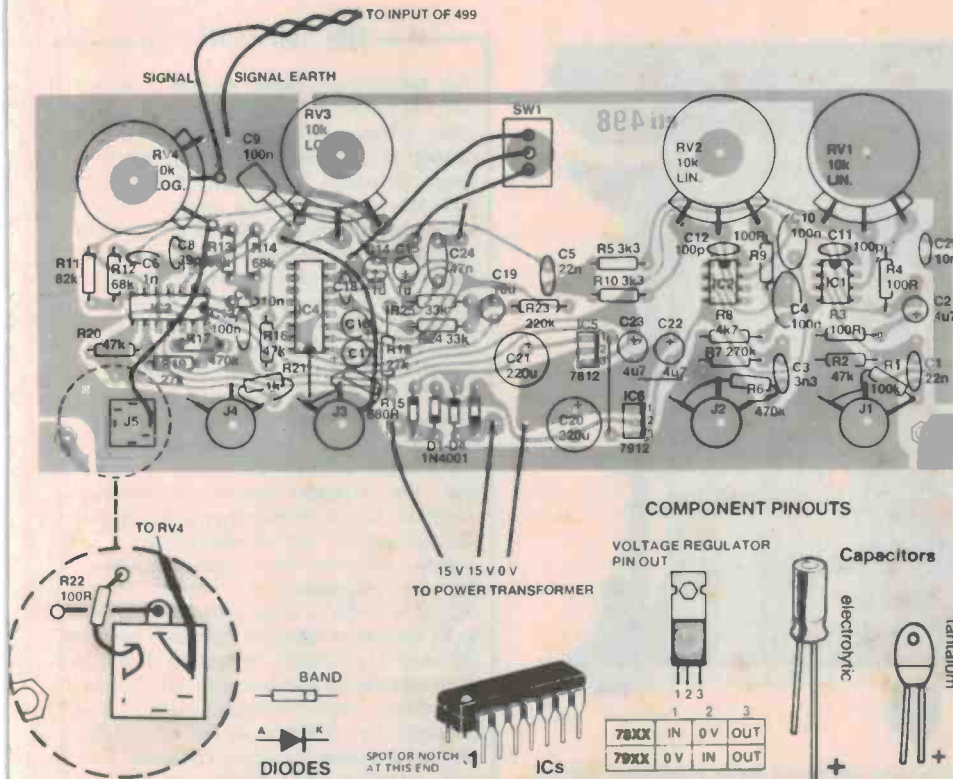

## PARTS LIST — ETI 498

Resistors all 1/2W, 5% unless noted

R1	100k
R2, 16, 20	47k
R3, 4, 9, 22	100R
R5, R10	3k3
R6, R17	470k
R7	270k
R8	4k7
R11	82k
R12, 13, 14	68k
R18, R19	27k
R21	1k
R23	220k
R24, R25	33k

Potentiometers

RV1, RV2	10k lin.
RV3, RV4	10k log.

Capacitors

C1, C5	22n greencap
C2, 22, 23	4u7/50 V RBLL
C3	3n3 greencap
C4, 9, 10, 13	100n greencap
C6	1n greencap
C7, C25	10n greencap
C8	39p ceramic
C11, C12	100p ceramic
C14, C15	1u/25 V electro.
C16	2u2/25 V electro.
C17	470n/20 V tant.
C18	33p ceramic
C19	10u/25 V electro.
C20, C21	220u/35 V electro.
C24	47n greencap

Semiconductors

IC1, IC2	NE5534, NE5534A
IC3	TL074, uA774
IC4	NE570, NE571
IC5	7812
IC6	7912

Miscellaneous

ETI-498 pc board; 4 x 6.5 mm mono phono jack sockets — shorting type; 1 x 6.5 mm stereo phono jack socket with switch (closed when empty); SW1 — SPDT miniature toggle switch; etc.

Other components to complete PA amplifier

ETI-499 150 W MOSFET Module (March ETI); 1 x PF4361/1 Ferguson power transformer; 1 x OP590 Ferguson line output transformer; 1 x DIN-type polarised speaker connector; 1 x front-loading fuse holder and 5 A fuse; spring terminal type speaker connector strip; K&W case, model C1284; Scotchcal or silk-screened front panel to suit; heatsink — e.g. Rod Irving type HS5 300 mm length black anodised flat-sided, fan-finned type or similar; 4 x 6.5 mm long stand-off pillars; four knobs to suit; mains cable, cable clamp and plug; hookup wire, nuts, bolts & etc.

Price Estimate \$230 — \$240 inclusive

two flat washers each. Cut a piece of thin cardboard to fit between the rear of the pc board and the rear of the case front panel. Cut out clearance holes for the pot shafts and jack sockets. Mount the assembled preamp board to the front panel, not forgetting the cardboard cut-out, which prevents any possibility of shorts between the rear of the pc board and the front panel. Sit the power transformer inside the case as you do this. Check that all sockets clear the case. Use a shakeproof washer (8 BA) and nut on the component side of the pc board when securing it to the two screws previously mounted to the case front panel. We used a metal Scotchcal label to 'dress up' the front panel and indicate what controls and sockets were what. This should be attached next. Take care aligning it and smoothing it in place. When you've got it right, install a nut on each pot shaft and all will be secured. Put insulation tape on the case bottom beneath each jack socket to preclude the possibility of the jack contacts touching the bottom of the case.

Next, install the low-Z output socket on the rear of the case. This is a polarised DIN-type socket and installs from the outside. Secure it with two 8 BA x 12 mm screws — nuts on the inside of the case. Install a grommet in the rear panel of the case for the mains cord. We used a Heyco nylon insulated bushing type A2030.

Now for the heatsink, which I pre-

sume has already been drilled to take the power amp mounting bracket. There are six other holes in the heatsink: four for the mounting bolts, one to allow access to the low-Z output socket and one for the mains cord. Another grommet should be installed in the latter. Then feed the mains cord through this and through the mains-entry grommet in the rear of the chassis. Just let the mains cable 'hang loose' for the moment.

Mount the heatsink using 6 BA x 20 mm long screws and 6 mm long brass spacers to hold off the rear panel.

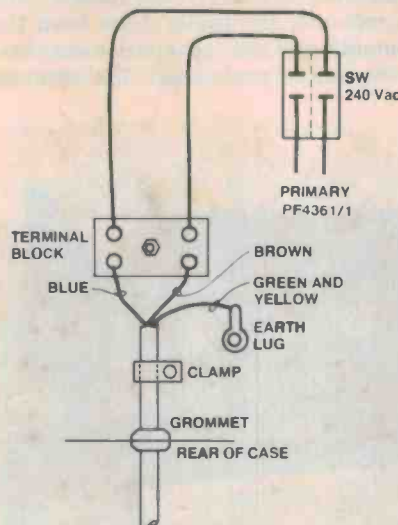

Mains cable wiring. Be sure to sleeve all exposed connections for your own protection.

Use lock washers and nuts on the inside of the case, passing the screws through the heatsink and spacers.

Now you can mount the mains terminal block; expose the three wires at the end of the cable inside the case, remove about 20 mm of the mains cable outer sheath and clamp the cable securely to the bottom of the case with a cable clamp. Make sure the mains wires can

# Project 498/499

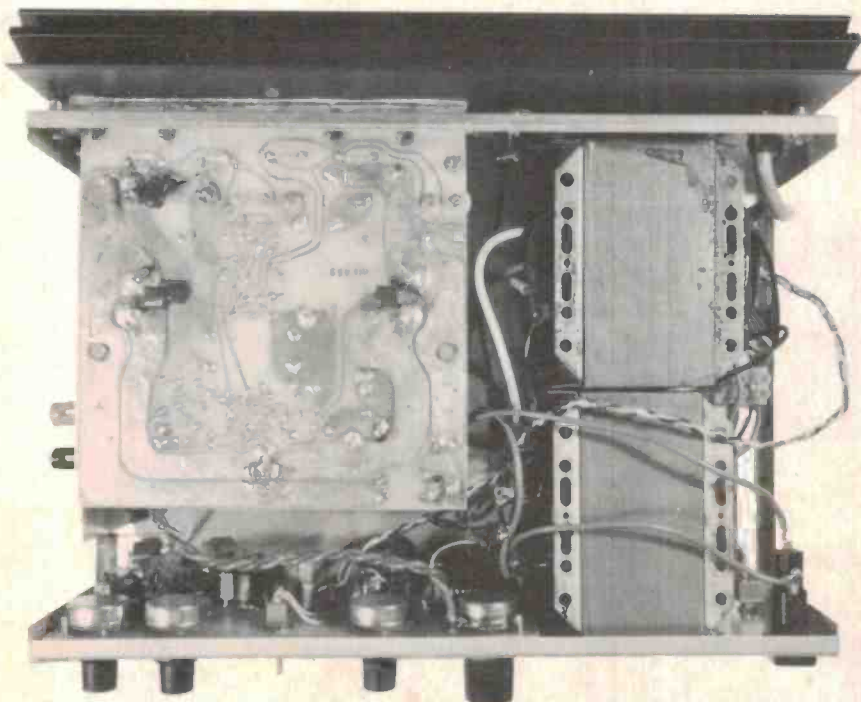

General view inside the case showing location of components. Mount the mains transformer with the 15-0-15 V winding tags uppermost for easiest access.

be easily terminated in the terminal block.

Now install the mains on/off switch on the front panel and wire it up to the terminal block *exactly as shown*. Sleeve all exposed mains connections on the rear of the switch.

Connect the two 35 V windings on the PF4361/1 power transformer to the ETI-499 module (which I presume is ready assembled and waiting). Make sure they're correctly phased. Bolt the transformer in position using 4 BA x 6 mm bolts and lock washers under the nuts. Solder its primary leads to the power on/off switch (sleeve exposed connections, as before).

Install the line output terminals next. I used a spring terminal pair mounted on a strip. These are common speaker connectors, mounted on an angle bracket at the left hand side of the case (when viewed from the front). If you have to fabricate the bracket yourself, do this now. We'll leave the exact details to you as you may have different terminals from the ones I used. The angle bracket is mounted to the bottom of the case with a couple of 8 BA x 6 mm screws. Make sure the bracket clears the filter capacitors on the ETI-499 module. This module mounts upside down from the heatsink and the capacitors come close to the line output bracket. The terminal



Rear view of the amplifier. Note the access hole for the Lo-Z output socket in the heatsink, just left of centre, and the line output terminals protruding from the right hand side of the case.

## THE '100 V LINE'

The 100 V line voltage system is widely used for public address loudspeaker reticulation because it simplifies the interconnection of a number of loudspeakers to a single amplifier. It is analogous to the 240 Vac mains voltage system, which allows appliances of vastly different power consumption to be operated from a single supply. For example, a toaster designed to consume 1 kW is made with an impedance of  $(240)^2/1000$ , or 58 ohms. An electric clock can be run from the same supply, but it only draws 3/5 of 5/8 of 30% of half of . . . and probably has an impedance of 10 000 ohms or more. The ac mains supply can drive many different loads to their designed power rating because it can maintain the voltage supply substantially constant. This is another way of saying the supply has a low source impedance.

Now, public address set-ups often require many loudspeakers of varying power ratings. In order to drive every loudspeaker to its maximum rating at the same time, a constant line voltage is assumed (for a given amplifier power output) and individual step-down transformers (usually with tapings for different power/impedance ratings) are used at each loudspeaker. The most common line voltage employed is 100 V. This means that each loudspeaker will deliver its rated power when fed with a 100 V signal.

For example, a loudspeaker with an 8 ohm voice coil impedance and a 30 W maximum rating will require a drive voltage of  $\sqrt{(8 \times 30)} = 15.5$  V to achieve full output. Thus it will require a step-down transformer having a turns ratio of 100:15.5. With tapings at greater ratios, less power will be delivered to the speaker; i.e. at a tapping providing a ratio of 100:11, 15 W will be delivered to the speaker; at a ratio of 100:9, 10 W will be delivered, and so on.

Any other loudspeaker power/impedance combination with a suitable transformer ratio can be connected to the same 100 V line and driven to the power rating selected, provided that the total loudspeaker power requirement can be supplied by the amplifier driving the line. That is, if ten 10 W-rated loudspeakers are connected to the line, the amplifier must be rated to deliver 100 W. Alternatively, a 100 W amplifier may be employed to drive four 10 W-rated loudspeakers and two 30 W-rated loudspeakers, all connected to the same line.

In practice, horn loudspeakers — which are commonly employed in PA applications — are usually operated at about 1/4 to 1/2 of their maximum rated power, so that a 150 W amplifier with a 100 V line output (such as the one described in this article) will happily drive 15 or 20 horns with maximum ratings of 20 to 30 watts.

Note that a 70 V line system is sometimes employed, but this is less common than 100 V line systems. It works in the same way.

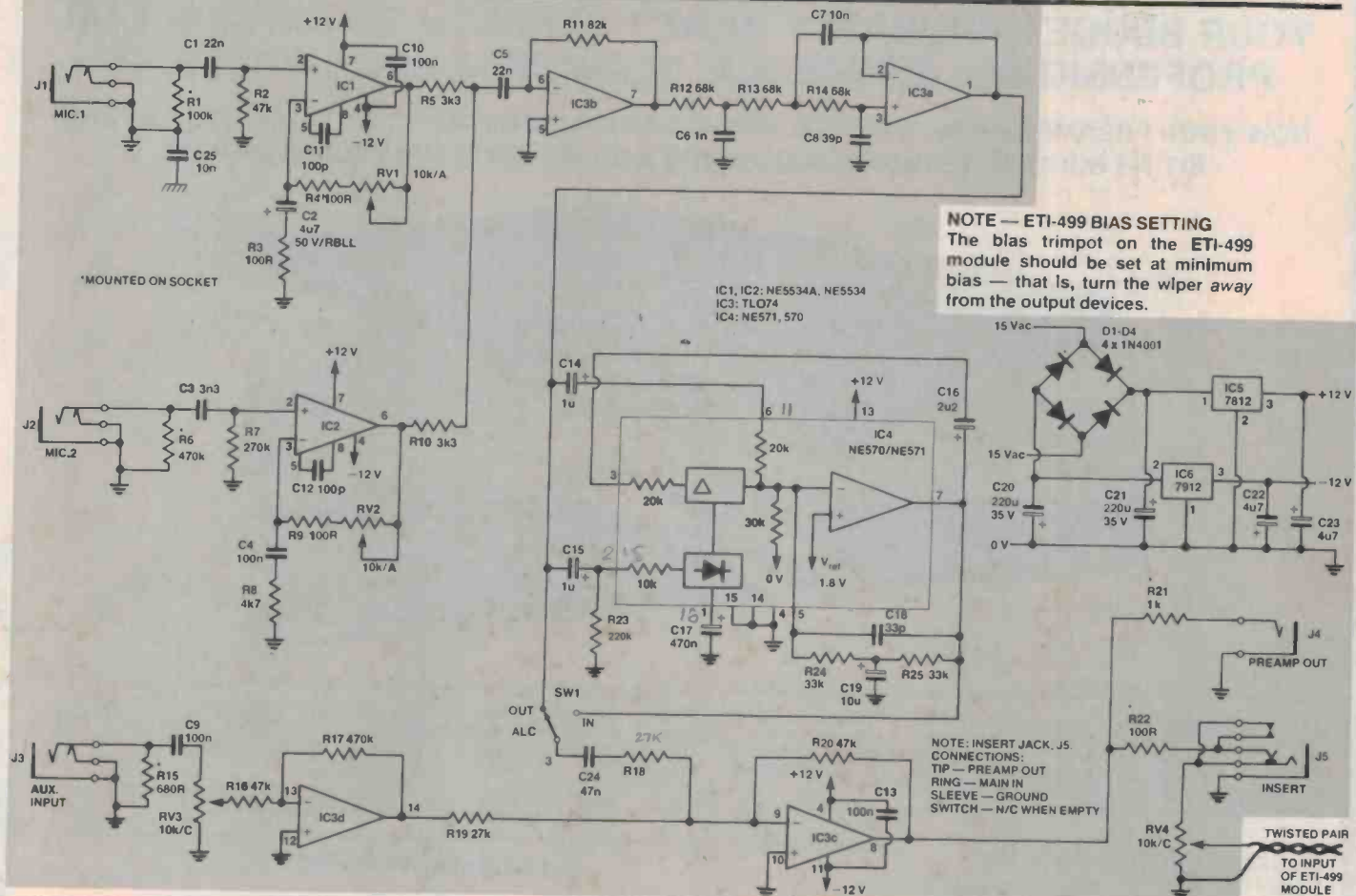

## HOW IT WORKS — ETI 498

The overall circuit arrangement and design features are explained in the general text, so this explanation will be confined to specific circuit description.

### MIC INPUTS

We have designated MIC 1 as a low-impedance input and MIC 2 as a high-impedance input. Signals from the MIC 1 Input are amplified by IC1. The gain of this stage can be varied by varying RV1, a potentiometer connected in the feedback loop of IC1. The gain can be varied between about 2 and 102. Signals from the MIC 2 input are amplified by IC2, the gain of which can be varied in the same way as IC1. RV2 here can vary the gain between 1 (unity gain) and 3. Resistors R1 and R6 provide dc return for each input capacitor, preventing 'clicks' or 'pops' when inserting or unplugging a mic.

An RC network on each of the MIC 1 and MIC 2 inputs forms single-pole high-pass filters with a breakpoint set at about 150 Hz to reduce low frequency output (the reason for this is explained in the main text). C1-R2 are the relevant components on the MIC 1 input, C3-R7 on the MIC 2 input. A further single-pole high-pass filter is introduced in the feedback network of each mic amp stage: C2-R3 for IC1 and C4-R8 for IC2. The breakpoint is set at 340 Hz and is the lower roll-off point for the speech filtering.

### MIC SUMMING

The amplified microphone signals are summed at the outputs of IC1 and IC2, at the junctions of R5 and R10. Another high-pass pole is introduced by these two resistors, in conjunction with C5. This too, is part of the speech filtering. IC3b buffers the summed mic signals and provides a further amount of gain. The output

of this stage, pin 7, drives a low-pass filter stage comprising R12, 13 and 14, capacitors C6, 7 and 8 and IC3a. This filter has a breakpoint set at 3 kHz, providing a sharp roll-off above this frequency.

The net effect of the high and low-pass filters up to this stage provides filtering of the voice frequency spectrum to improve 'intelligibility' where listeners to the PA have to contend with a variety of interfering noises from numerous sources at open-air events.

### ALC

The 'automatic level control' (ALC) circuit centres on IC4, an NE570 or 571 'compressor' IC. This circuitry attempts to maintain a near-constant output, provided the input from the microphone stages exceeds a threshold level determined by the value of R23. Decreasing R23 increases the threshold, reducing the effect of the ALC. The ALC prevents 'soft' sounds from being lost in external noise while helping prevent clipping from plosive sounds ('p' and 't' for example) in speech.

The 'attack' time of the ALC is determined by C17. Decreasing the value of this capacitor improves the transient response of the stage (helping it cope with plosives) but has the drawback of increasing the distortion. We chose the value shown as a compromise between these two parameters and it seems to work well in practice.

The input to the ALC circuit (from pin 1, IC3a) and the output (from pin 7, IC4) go to SW1, a SPDT switch, which selects ALC IN or ALC OUT.

### AUX INPUT

The auxiliary input is meant for low impedance, 'line level' signals, such as from the output of a tape recorder. Input impedance is determined

largely by R15 and is around 600 ohms or so. IC3d provides amplification, having a gain of 10. The input level may be attenuated by RV3. This, in conjunction with C9, provides a single-pole high-pass filter.

### INPUT MIXING

The MIC and AUX inputs are summed at the input of IC3c (pin 9). C24 and R18 provide a further high-pass filter for the MIC-ALC stages with a breakpoint at 125 Hz, further increasing the attenuation below this region.

### OUTPUTS

The output of IC3c (pin 8) passes to the input of the ETI-499 power amp module via the INSERT jack (J5) and the volume control, RV4. A PREAMP OUTPUT is provided too, at J4.

The INSERT jack is a stereo/switched type and provides a point where a graphic equaliser or howl-round stabiliser can be introduced (see the ETI-485 Graphic Equaliser and the ETI-486 Howl-Round Stabiliser in our publication '30 Audio Projects').

Resistors R21 and R22 provide isolation between the outputs and short-circuit protection for the output of IC3c.

### POWER SUPPLY

The on-board power supply derives its input from the two 15 Vac windings on the PF4361/1 power transformer used to supply the ETI-499 module. These two windings are connected to provide a centre-tapped 30 Vac supply (15-0-15). Two full-wave capacitor input rectifiers, comprising D1 to D4 and C20-C21, then provide about  $\pm 20$  Vdc input to a pair of three-terminal regulators: a 7812 which provides a +12 V rail, and a 7912 which provides a -12 V rail.

To page 65

ALTRONICS ... ALTRONICS ... ALTRONICS ... ALTRONICS ... ALTRONICS ... ALTRONICS ... ALTRONICS ... ALTRONICS ... ALTRONICS ... ALTRONICS ...

ALTRONICS ... ALTRONICS ... ALTRONICS ... ALTRONICS ... ALTRONICS ... ALTRONICS ... ALTRONICS ... ALTRONICS ... ALTRONICS ... ALTRONICS ...

**WILL**  
**YOUR BUDGET PROBABLY WON'T STRETCH TO AFFORD OUR PROFESSIONAL SERIES ALL ALUMINIUM RACK CABINETS**

NOW YOUR PREAMPS, AMPS, CONTROL MODULES MONITOR PANELS ETC. CAN LOOK EVERY BIT AS GOOD AS TECHNICS, NAKAMICHI AND OTHER TOP MANUFACTURERS

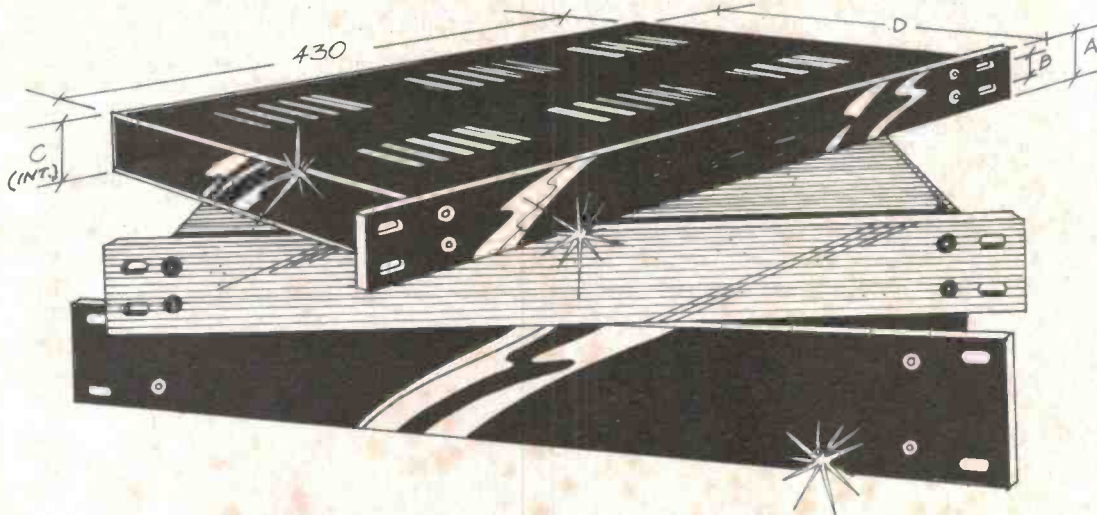

**THREE YEARS AGO** or so we were selling nicely finished racking cabinets for around \$60-\$70 but, alas the maker kept increasing the prices until we would have had to sell them for a price way beyond the reach of the average constructor - so, sadly we discontinued the range.

\* These beautifully crafted rack cabinet boxes will give your equipment a real 1st class appearance. \* All aluminium construction. \* REMOVABLE TOP AND BOTTOM PANELS. \* All dimensioning conforms to the International standard. \* Natural or Black finish. \* Ventilated lid. \* Deluxe brushed

finish anodised front panel. \* Individually cartoned. \* Supplied in Flat Pack Form - Easily assembled in minutes.

Side Elevation:  
 D = 254mm C (Internal Chassis Height)  
 B (Mounting Bolt Centres)

**MASS PRODUCTION TOOL UP SLASHES COSTS** Well, of course, the demand for our rack cabinets continued, so to meet the challenge of high labour and handling costs we have toolled up with all the necessary dies etc. to mass produce high quality precision finish rack cabinets to International Dimension Standards with remarkable cost savings.

**SIX NATURAL AND BLACK FINISH MODELS** The Black or Natural finish cabinets are each available in 44mm, 88mm or 132mm high models. Mounting hole centres conform exactly to International racking specifications both vertically and horizontally.

INTRODUCTORY PRICES						
Cat. No.	Finish	A	B	C	PRICE	5 or More
H 0401	Natural	44	34	38	\$39.50	\$38.00
H 0402	Natural	88	57	82	45.00	42.50
H 0403	Natural	132	89	126	49.50	45.00
H 0411	Black	44	34	38	39.50	38.00
H 0412	Black	88	57	82	45.00	42.50
H 0413	Black	132	89	126	49.50	45.00

Beware of other rack boxes that do not conform to international rack sizing.

**INCREDIBLE SAVINGS ON SCREWS AND SPACERS**

Yes we are now producing huge quantities of hardware overseas - all to exacting quality standards - all quality plated and all at a fraction of the price your used to paying

**1/8th inch WHITWORTH STEEL NUTS AND BOLTS ROUND HEAD ZINC PLATED**

Length	Pack Qty.	Price
H 1000 9mm	25	.65
H 1002 9mm	500	4.25
H 1005 12mm	25	.65
H 1007 12mm	500	4.75
H 1009 25mm	25	.75
H 1011 25mm	500	6.50
H 1020 Hex Nut	30	.65
H 1022 Hex Nut	500	5.00
H 1030 S/Proof Washer	50	.80
H 1032 S/Proof Washer	500	6.20
H 1040 Flat Washer	50	.65
H 1042 Flat Washer	500	5.00

Huge Savings with Trade Packs (Contents: 500)

**BA NUTS AND BOLTS Bolts Plated Round Head Steel, Nuts Brass**

	Pack	Price
H 1050 4BA x 12mm	25	.75
H 1052 4BA x 12mm	500	5.70
H 1060 6BA x 12mm	25	.75
H 1062 6BA x 12mm	500	6.25
H 1070 Nut Hex 4BA	25	.75
H 1072 Nut Hex 4BA	500	12.50
H 1080 Nut Hex 6BA	25	.75
H 1082 Nut Hex 6BA	500	7.50
H 1090 4BA S/Proof Washer	50	.75
H 1092 4BA S/Proof Washer	500	5.95
H 1095 4BA Flat Washer	50	.75
H 1097 4BA Flat Washer	500	5.95

**SELF TAPPING SCREWS Cadmium Plated Steel**

	Pack	Price
H 1100 No. 4 x 6mm	25	.65
H 1102 No. 4 x 6mm	500	3.95
H 1110 No. 4 x 12mm	25	.70
H 1112 No. 4 x 12mm	500	4.95
H 1120 No. 8 x 12mm	25	.75
H 1122 No. 8 x 12mm	500	6.50

From less than 1c each

**SPACERS (STANDOFFS) SUPERB NICKEL PLATED BRASS**

UNTAPPED 4 BA or 1/8" CLEARANCE

TAPPED 4 BA

Cat.	Length.	Pack Qty.	Price	Cat.	Length.	Pack Qty.	Price
H 1305	6mm	8	.95	H 1379	9mm	8	1.00
H 1359	6mm	100	8.50	H 1380	9mm	100	9.50
H 1372	12mm	6	.95	H 1383	12mm	8	1.20
H 1373	12mm	100	11.00	H 1384	12mm	100	12.50
H 1375	25mm	4	.95	H 1387	25mm	4	1.00
H 1376	25mm	100	15.00	H 1388	25mm	100	16.00

# AT DOUBLE THE PRICE OUR DAINICHI HIGH FIDELITY SPEAKERS WOULD STILL REPRESENT OUTSTANDING VALUE

Altronics have teamed up with one of Japan's most respected speaker designer/manufacturers (Dainichi manufacture OEM speakers for Pioneer) The result, an outstanding range of pure fidelity speakers available to you at IMPORT PRICES for which we will no doubt incur the wroth of our competitors.

<p><b>CONE TWEETER 50 WATT</b> 50 watt max. power 8 OHM Z.</p>  <p>Amazing performance budget price. Frequency response 2 KHZ-18 KHZ. 110mm Diam. Hole centres 79 mm. Australia's best value at this price.</p> <p>C 3020 ..... \$7.50 4 or more ..... \$7.00</p>	<p><b>DOM TWEETER 60 WATT</b> 60 watt max. power.</p>  <p>Silky smooth frequency response. 1.5 KHZ to 20 KHZ. Wide Angle dispersion. Massive power handling capacity. Diam. 94 mm. High spectrum. Purity. Incredible low price!</p> <p>C 3010 ..... \$14.50 4 or more ..... \$13.50</p>	<p><b>MIDRANGE 50 WATT</b> Midrange clarity that has to be heard to be appreciated!</p>  <p>Absolutely 1st class reproduction of mid-range - piano, vocal, guitar, violin etc. Huge 50 watts max. input. 8 OHM. Frequency response 700 - 5 KHZ. Value Plus!</p> <p>C 3030 ..... \$17.50 4 or more ..... \$16.90</p>	<p><b>WOOFER 307 mm (12 in.)</b> 40 watts max. power 8 OHM.</p>  <p>Roll edge cone suspension. Resonant to 30 HZ. Frequency range 30-2 KHZ. Smooth, faithful bass speaker. Ideal Hi-Fi replacement. 48 mm voice coil.</p> <p>C 3040 ..... \$29.50 4 or more ..... \$27.50</p>
--	--	---	--

**OUR MAX POWER RATINGS** are conservative RMS ratings NOT music power or peak power ratings that some manufacturers quote.

**MAKE UP A LOW COST STEREO SYSTEM** The combination of C3010/C3030/C3040 will enable you to make up a simply superb speaker system for less than \$150 (less cabinets) - send stamped addressed envelope for enclosure and crossover designs.

## GREAT NEW MOSFET PA AMPLIFIER KIT FROM ETI.

See June '82 **150 watts power output.**



**UNCONDITIONALLY STABLE - SOUND STUDIO SPECIFICATIONS**

**OUTPUT IMPEDANCE** Selectable to low Z voice coil or 100V or 70V line out.

**INPUTS** 2 mic inputs HI or low Z with speech filter.  
1 Aux input.

- Low noise 5534 op amps used
- Noble W/wound power resistors used in output stage for guaranteed stability.

K5030 complete kit as illustrated \$239.00

OR  
want a Deluxe studio format finish?

The above kit is also available housed in the superb H0413 racking cabinet.

K5035 ..... \$269.00

## ETI 469B PERCUSSION SEQUENCER KIT

Use with the ETI 469 percussion synthesiser. Programmes 8 beats per sequence. Fully synchronised and variable tempo.



K1042 ..... \$19.50

## GUITAR PREAMP KIT

SEE EA JUNE '82

NOW YOU CAN OPERATE YOUR GUITAR DIRECT INTO ANY HIFI AMP.



K 1080 ..... \$14.50

## GO ANYWHERE 240V PWR. KITS

See EA May and June 82. These great new inverter kits enable you to power 240V appliances for your car, caravan or boat.

### 30 WATT

Suits small appliances i.e. turntable, tape deck, shaver etc.



K6700 ..... \$55.00

### 300 WATT

Use to power HIFI, TV set, mains lighting etc. Fully regulated and overload protected.



Low age rate xstal used. All sockets provided for IC's.  
K6750 ..... \$185.00

## THEREMIN KIT

SEE EA JUNE '82

SUPERFUN WEIRD AND WONDERFUL MUSIC AND SCIENCE FICTION SOUND GENERATOR - WORKS ON HAND CAPACITY.

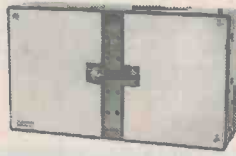

K1200 ..... \$29.50

## SUPERB PEN WATCH

**\$12.50 VALUE, ABSOLUTELY FREE WITH EVERY ORDER OF \$100 or MORE!**

Offer expires 31/7/82  
Uses standard Parker refills  
Includes gift box and instructions



CAT X1000 ..... \$12.50 if purchased sep.

## NEW 24 HOUR 7 DAYS P/WEEK PHONE ORDER SERVICE FOR BANKCARD HOLDERS

Take advantage of "off peak" low STD phone rates and phone your order to our new recorded 24 hour order service. Give your name, address with postcode, phone number, bankcard number and expiry date then your order - and presto your order will be processed and back to you in a flash - Please nominate Jetservice if you want overnight delivery.

**\$2 Delivery Australia Wide:** We process your order the day received and despatch via Australia Post. Allow approx. 7 days from day you post order to when you receive goods. Weight limited 10kgs.

**\$4 Delivery Australia Wide:** We process your order day received and despatch via Jetservice for delivery next day.

Bankcard Holders can phone order up to 8pm (EST) for next day delivery - Sounds incredible doesn't it? Alright you cynics just try us! Weight limit 3.3kgs. Jetservice cannot deliver to P.O. box numbers (Australia Post would have a fit!)

**ALTRONICS**  
105 Stirling St. PERTH  
(09) 328 1599  
for instant service

**ALL MAIL ORDERS:**  
BOX 8280 PERTH  
Stirling St. WA 6000

# Take everything—but not my Babani Books!!!

## REACTANCE/FREQUENCY CHART FOR AUDIO AND RF.

Enables the reactance of any capacitor or resistor to be read off immediately — from 10 Hz to 100 MHz. Resonant frequencies of LC networks ditto.

196 75¢

## PRACTICAL TRANSISTORISED NOVELTIES FOR HI-FI

Circuits for audio power meter, stereo phone adaptor, multi-channel mixers, gain control, contour network etc. etc.

201 \$1.30

## HI-FI LOUDSPEAKER ENCLOSURES

Data for building corner reflex, bass reflex, exponential horn, folded horn, tuned port, Klipschorn labyrinth, tuned column, loaded port and multi speaker panoramics. Clear dimensioned diagrams included.

205 \$3.50

## DIODE CHARACTERISTICS, EQUIVALENTS & SUBSTITUTES

Includes signal, zener, rectifier diodes etc. Full interchangeability data and characteristics of thousands of diodes of all types with every possible alternative. Includes UK, USA, European, Russian, and Far Eastern devices.

211 \$4.60

## AUDIO ENTHUSIASTS' HANDBOOK

Discusses audio and hi-fi topics including record/playback curves, stylus compliance, disc recordings — then and now, evaluating loudness, equipment compatibility, acoustic feedback, equipment performance figures and standards etc. etc.

214 \$4.05

## BUILD YOUR OWN ELECTRONIC EXPERIMENTERS' LAB USING ICs.

Includes many circuits and designs for constructing test and measuring instruments mostly using modern ICs. Includes AF osc, TTL pulse detector, hi-impedance Vm, square-wave osc/pulse gen, logic probe, lo-range ohmmeter, bridge, signal tracer etc.

218 \$3.10

## SOLID STATE NOVELTY PROJECTS

A number of novelty projects using modern ICs and transistors. Includes 'Optomin' — a musical instrument played by reflecting a light beam with your hand, water warbler for pot plants, music tone generator, LEDs and ladders game, touch switch, electronic roulette wheel etc.

219 \$3.10

## BUILD YOUR OWN HI-FI & AUDIO ACCESSORIES

Essential for keen hi-fi and audio enthusiasts. Projects include stereo decoder, three-channel mixer, FET preamp for ceramic pick-ups, mic preamp with adj. bass, stereo dynamic noise limiter, loudspeaker projector, voice-operated relay, etc.

220 \$3.10

## 28 TESTED TRANSISTOR PROJECTS

Some circuits are new, others are familiar designs. Projects can be split and/or combined for specialised needs.

221 \$4.60

## SOLID STATE SHORT WAVE RECEIVERS FOR BEGINNERS

Design and construction of several solid-state short-wave receivers giving high level of performance yet utilising relatively few inexpensive components. See also 226.

222 \$4.60

## 50 PROJECTS USING CA 3130 ICs.

The CA3130 is an advanced operational amplifier capable of higher performance than many others: circuits often need fewer ancillary components. Interesting and useful projects in five groups. Audio projects. RF projects. Test equipment. Household projects. Misc. projects.

223 \$4.60

## 50 CMOS PROJECTS

Many interesting and useful projects — multivibrators, amplifiers and oscillators; trigger devices; special devices.

224 \$4.60

## PRACTICAL INTRO TO DIGITAL ICs

Introduction to digital ICs (mainly TTL 7400). Besides simple projects, includes logic test set to identify and test digital ICs. Also includes digital counter-timer.

225 \$4.60

## HOW TO BUILD ADVANCED SHORT WAVE RECEIVERS

Full practical constructional details of receivers with performance equal to commercial units. Also 'add-on' circuits of Q meter, S meter, noise limiter etc.

226 \$4.60

## BEGINNERS' GUIDE TO BUILDING ELECTRONIC PROJECTS

Enables total beginners to tackle electronic projects. Includes component identification, tools, soldering, building methods, cases, legends etc. etc. Practical basic projects are included.

227 \$4.60

## HANDBOOK OF RADIO, TV, INDUSTRIAL & TRANSMITTING TUBE & VALVE EQUIVALENTS

Equivalents book for amateurs and servicemen. More than 18 000 old and new valves from UK, USA, Europe, Japan et al. CV (military) listings with commercial equivalents included.

BP2 \$2.25

## FIRST BOOK OF PRACTICAL ELECTRONIC PROJECTS

Full constructional data, circuits, components lists for many practical projects including audio distortion meter, super FET receiver, guitar amp, metronome, etc.

BP23 \$2.55

## GIANT CHART — RADIO, ELECTRONICS, SEMI-CONDUCTOR & LOGIC SYMBOLS

Identify those symbols at a glance. A must for beginners and advanced enthusiasts alike. Professionals can always hide it in their desks! A steal at only...

BP27 \$2.20

## 50 FET PROJECTS

Projects include amplifiers and converters, test equipment, tuners, receivers and receiver aids, mixers and tone controls etc etc. The FET used is not critical. This book is of interest and value to SW listeners, radio amateurs, hi-fi enthusiasts and general experimenters.

BP39 \$6.10

## IC555 PROJECTS

One wonders how life went on before the 555! Included are basic and general circuits, motor car and model railway circuits, alarms and noise makers plus section on subsequent 556, 558 and 559s.

BP44 \$6.45

## MOBILE DISCO HANDBOOK

Most people who start mobile discos know little about equipment or what to buy. This book assumes no preliminary knowledge and gives enough info to enable you to have a reasonable understanding of disco gear.

BP47 \$4.60

## ELECTRONIC PROJECTS FOR BEGINNERS

This book gives the newcomer to electronics a wide range of easily built projects. Actual components and wiring layouts aid the beginner. Some of the projects may be built without using soldering techniques.

BP48 \$4.60

## LM 3900 IC PROJECTS

Unlike conventional op-amps, the LM 3900 can be used for all the usual applications as well as many new ones. It's one of the most versatile, freely obtainable and inexpensive devices around. This book provides the groundwork for simple and advanced uses — It's much more than a collection of projects. Very thoroughly recommended.

BP50 \$4.95

## LONG DISTANCE TV RECEPTION (TV-DX)

Written by UK authority, the book includes many units and devices made by active enthusiasts. A practical and authoritative intro to this unusual aspect of electronics.

BP52 \$6.60

## PRACTICAL ELECTRONIC CALCULATIONS & FORMULAE

For the practical person's workbench. Bridges gap between technical theory and cut-and-dried methods which work but leave the experimenter unfulfilled. There's a strong practical bias. Tedious and higher maths avoided where possible. Many tables included. This one's a beauty!

BP53 \$8.25

## HOW TO BUILD YOUR OWN SOLID-STATE OSCILLOSCOPE

Project divided into sections for builder individually to construct and test — then assemble into complete instrument. Includes short section on scope usage.

BP57 \$5.50

## SECOND BOOK OF CMOS IC PROJECTS

Leading on from book number 224 '50 CMOS IC PROJECTS', this second book provides a further selection of useful circuits mainly of a fairly simple nature. Contents have been selected to ensure minimum overlap between the two books.

BP59 \$5.10

## BEGINNER'S GUIDE TO DIGITAL ELECTRONICS

Covers all essential areas including number systems, codes, constructional and sequential logic, analog/digital/analog conversion.

BP61 \$3.50

## ELEMENTS OF ELECTRONICS

This series provides an inexpensive intro to modern electronics. Although written for readers with no more than basic arithmetic skills, maths is not avoided — all the maths is taught as the reader progresses.

The course concentrates on the understanding of concepts central to electronics, rather than continually digressing over the whole field. Once the fundamentals are learned the workings of most other things are soon revealed. The author anticipates where difficulties lie and guides the reader through them.

**BOOK 1 (BP62):** All fundamental theory necessary to full understanding of simple electronic circuits and components.

**BOOK 2 (BP63):** Alternating current theory.

**BOOK 3 (BP64):** Semiconductor technology leading to transistors and ICs.

**BOOK 4 (BP77):** Microprocessing systems and circuits.

**BOOK 5 (BP89):** Communications.

This series constitutes a complete inexpensive electronics course of inestimable value in hobby or career.

**Books 1/2/3 \$8.25 (each)**

**Book 4 \$10.80**

**Book 5 \$9.95**

## SINGLE IC PROJECTS

Simple to build projects based on a single IC. A few projects use one or two transistors as well. A strip board layout is given for each project plus special constructional and setting up info. Contents include low level audio circuits, audio power amps, timers, op-amps and miscellaneous circuits.

BP65 \$5.10

## BEGINNER'S GUIDE TO MICROPROCESSORS & COMPUTING

Introduction to basic theory and concepts of binary arithmetic, microprocessor operation and machine language programming. Only prior knowledge assumed is very basic arithmetic and an understanding of indices.

BP66 \$6.40

## COUNTER DRIVER AND NUMERAL DISPLAY PROJECTS

Well-known author F.G. Rayer features applications and projects using various types of numeral displays, popular counter and driver ICs, etc.

BP67 \$6.40



### ELECTRONIC PROJECTS USING SOLAR CELLS

Well-known author Owen Bishop has designed a number of projects that benefit from solar power and obviate the problems encountered with batteries, such as weight and bulk, frequency of replacement, and failure when batteries are exhausted.

**BP82** \$7.15

### VMOS PROJECTS

A book to suit the dyed-in-the-wool experimenter. Though primarily concerned with VMOS power FETs and their applications, power MOSFETs are dealt with, too, in a chapter on audio circuits. A number of varied and interesting projects is covered under the headings: Audio Circuits, Sound Generator Circuits, DC Control Circuits and Signal Circuits. Learn while you build.

**BP83** \$7.20

### DIGITAL IC PROJECTS

Companion to No. 225 Practical Introduction to Digital ICs and BP61 Beginner's Guide to Digital Electronics. The projects included in this book range from simple to more advanced projects — some board layouts and wiring diagrams are included. The more ambitious projects have been designed to be built and tested section by section to help the constructor avoid or correct any faults that may occur.

**BP84** \$7.20

### INTERNATIONAL TRANSISTOR EQUIVALENTS GUIDE

Companion to BP1 and BP14 equivalents books, but contains a huge amount of information on modern transistors produced by over 100 manufacturers. Wherever possible, equivalents are subdivided into European, American and Japanese types. Also shown are the material type, polarity, manufacturer and indication of use or application.

**BP85** \$10.85

### AN INTRO TO BASIC PROGRAMMING TECHNIQUES

Ideal for beginners seeking to understand and program in BASIC. Book includes program library for biorhythms, graphing Y against X, standard deviations, regressions, generating musical note sequences, and a card game.

**BP86** \$6.60

### SIMPLE LED CIRCUITS — BOOK 2

Sequel to BP42. Further light-emitting diode circuits. If you liked BP42 you'll love this one. If you don't know either it's well worth buying both!

**BP87** \$5.05

### ELECTRONIC CIRCUITS FOR MODEL RAILWAYS

Constructional details of a simple model train controller, a controller with simulated inertia, a high-power controller, an electronic steam whistle and a 'chuff generator'. Signal systems and train lighting and RF suppression also covered.

**BP95 (was 213)** \$6.60

### CHOOSING AND USING YOUR HI-FI

Provides fundamental info invaluable when buying hi-fi. Explains tech. specs, advice on minimum acceptable standards and specs for adequate sound. Also invaluable advice on how to buy and install and maximise your equipment's potential. Includes glossary of terms.

**BP68** \$6.10

### ELECTRONIC GAMES

How to build many interesting electronic games using modern ICs. Covers both simple and complex circuits for beginner and advanced builder alike. Good one!

**BP69** \$6.40

### ELECTRONIC HOUSEHOLD PROJECTS

Most useful and popular projects for use around the home. Includes two-tone buzzer, intercom, smoke and gas detectors, baby alarm, freezer alarm etc. etc.

**BP71** \$6.10

### A MICROPROCESSOR PRIMER

This small book takes the mystery out of microprocessors. It starts with a design for a simple computer described in language easy to learn and follow. The shortcomings of this basic machine are then discussed and the reader is shown how these are overcome by changes to the instruction set. Relative addressing, index registers follow as logical progressions. An interesting and unusual approach.

**BP72** \$6.40

### REMOTE CONTROL PROJECTS

Covers radio, Infra-red, visible light, ultrasonic controls. Full explanations are provided so that the reader can adapt the projects for domestic and industrial as well as model use.

**BP73** \$7.15

### ELECTRONIC MUSIC PROJECTS

Provides constructors with practical circuits for the less complex music equipment including fuzz box, waa-waa pedal, sustain unit, reverb and phaser, tremolo generator etc. Text covers guitar effects, general effects, sound generators, accessories.

**BP74** \$6.40

### ELECTRONIC TEST EQUIPMENT CONSTRUCTION

Describes construction of wide range of test gear including FET amplified voltmeter, resistance bridge, field strength indicator, heterodyne frequency meter etc.

**BP75** \$6.40

### POWER SUPPLY PROJECTS

Designs for many power supplies including simple un-stabilised, fixed and variable voltage regulators — particularly for electronics workshops. Also included are cassette power supply, Ni-Cad charger, voltage step-up circuit, and simple inverter, plus info on designing your own supply. All designs are low voltage types for semiconductor circuits.

**BP76** \$6.50

### PRACTICAL COMPUTER EXPERIMENTS

How to build typical computer circuits using discrete logic. This book is useful intro to devices such as adders and storers as well as a general source book of logic circuits.

**BP78** \$6.50

### RADIO CONTROL FOR BEGINNERS

How complete systems work with constructional details of solid state transmitters and receivers. Also included — antennas, field strength meter, crystal controlled superhet, electro-mechanical controls. Ideal for beginners. Section dealing with licensing etc. not applicable to Australia.

**BP79** \$6.40

### POPULAR ELECTRONIC CIRCUITS — BOOK 1

Yet more circuits from Mr Penfold! Includes audio, radio, test gear, music projects, household projects and many more. An extremely useful book for all hobbyists, offering remarkable value for the designs it contains.

**BP80** \$7.15

### ELECTRONIC SYNTHESISER PROJECTS

For the electronic music enthusiast, an invaluable reference. This book is full of circuits and information on how to build analogue delay lines, sequencers, VCOs, envelope shapers, etc. etc. The author takes a clear and logical approach to the subject that should enable the average enthusiast to understand and build up what appears to be a quite complex instrument.

**BP81** \$6.45

## ORDER FORM

Send to ETI Book Sales, 4th Floor, 15 Boundary St, Rushcutters Bay NSW 2011.  
Please allow 4-5 weeks for delivery. Trade enquiries welcomed.

Please forward:		Post & Handling:		1 — 4 books:	\$1.35	11 — 20 books:	\$3.50
Book	Qty.			5 — 10 books:	\$2.70	Over 20 books:	\$5.00
196	..... 224	BP50	.....	BP67	.....	BP79	.....
201	..... 225	BP52	.....	BP68	.....	BP80	.....
205	..... 226	BP53	.....	BP69	.....	BP81	.....
211	..... 227	BP57	.....	BP71	.....	BP82	.....
214	..... BP2	BP59	.....	BP72	.....	BP83	.....
218	..... BP23	BP61	.....	BP73	.....	BP84	.....
219	..... BP27	BP62	.....	BP74	.....	BP85	.....
220	..... BP39	BP63	.....	BP75	.....	BP86	.....
221	..... BP44	BP64	.....	BP76	.....	BP87	.....
222	..... BP47	BP65	.....	BP77	.....	BP89	.....
223	..... BP48	BP66	.....	BP78	.....	BP95 (was 213)	.....

I enclose \$ ..... (inc. p & h.)

Name .....

Address .....

Postcode .....

# ROD IRVING ELECTRONICS

425 HIGH STREET, NORTHCOTE 3070, MELBOURNE. (03) 489-8131.

## THIS MONTH'S KIT



### ETI-469B SEQUENCER FOR THE PERCUSSION SYNTHESISER

Turn your ETI-469 Percussion Synthesiser into an auto-rhythm generator! This inexpensive add-on unit will permit a maximum 8-step sequence to be programmed, and both channels of the synthesiser can be driven. Tempo can be varied by a potentiometer. P.O.A.



## ETI-498 P.A. AMP

All the features you could wish to want!  
 \* Automatic Level Control \* Two mic Inputs  
 \* Auxiliary input \* Preamp output \* Insert Input  
 for graphic equaliser or howl-round stabiliser  
 \* Speech filtering for improved intelligibility  
 \* 150 W power output \* Drives 2, 4, 8, 16, 50 (70 V) or 100 (100 V) ohm loads.  
 P.O.A.

PCB PRICE	DESCRIPTION	DATE	PRICE	DESCRIPTION	DATE	PRICE	DESCRIPTION	DATE	PRICE
ET 014	4.50 Dual Voltage Power Supply	Dec 71		ET 547	3.50 Telephone Bell Extension	Jne 77	80LS12	3.50 SELECTALOTT	Dec 81
ET 043	2.00 Head or Tails	Oct 76	\$3.50	ET 549A	2.90 Metal Detector	May 77	80LBR12	2.90 Light Beam Relay	Nov 80
ET 044	1.90 Two Tone Doorbell	Oct 76	\$4.50	ET 560	1.90 240V Mains Locator	May 80	80MA4	2.50	Apr 80
ET 047	1.90 Morse Practice Set	Dec 76	\$3.00	ET 561	2.90 Metal Detector	Mar 80	80PCA	2.90 Power Heat Controller	Apr 80
ET 048	1.90 Buzz Board	Dec 76	\$3.00	ET 562	3.90 Geiger Counter	Apr 80	80HHS6	2.50 How Haul Siren	Jun 80
ET 062	2.50 Simple Audio Amp	Oct 76	\$5.00	ET 563	3.50 Nicad Fast Charger	Jly 80	80FB12	2.90 Guitar Fuzz Box	Jul 80
ET 063	2.50 Electronic Bongos	Mar 77	\$6.00	ET 566A	2.90 Pipe & Cable Locator	Apr 80	80G6	5.90 Musical Tone Generator	Feb 81
ET 065	2.20 Electronic Siren	Nov 79	\$8.00	ET 568	3.90 Pipe & Cable Locator	Apr 80	80GPS3	2.90 Voltage Regulator Multi	Jun 80
ET 066	1.90 Temp Alarm	Dec 79	\$3.00	ET 567	3.50 Core Balance Relay	Apr 80	80AD12	3.00 Autodim Light Dimmer	Mar 80
ET 068	2.20 Lad Dice	Dec 79	\$4.00	ET 568	2.90 Photo Flash Trigger	Oct 80	80AU3	3.50 Hi Fi Auto Turn Off	Dec 80
ET 071	2.50 Tape Noise Limiter	Oct 76	\$5.00	ET 570A	4.90 Infrared 'Trip' Relay TX	Jan 82	80AW4	4.50 Receiver All Wave	Apr 80
ET 072	1.90 Two Octave Organ	Jne 79	\$8.00	ET 570b	4.90 Infrared 'Trip' Relay RX	Jan 82	80TMB8	5.90 Digital Engine Analyser	Apr 80
ET 083	1.90 Train Controller	Dec 79	\$4.00	ET 572	4.90 Digital PH Meter	Dec 80	80TMB8	2.50 Digital Engine Analyser	Aug 80
ET 084	2.50 Car Alarm	Oct 77	\$12.00	ET 573	3.50 Universal Timer	Oct 79	80PP7A	6.50 Eprom Programmer	Jul 80
ET 085	1.90 Car over Rev Alarm	Jne 79	\$8.00	ET 576	5.90 Electrogram	TPV 6	80PP7B	2.50 Eprom Programmer	Jul 80
ET 130	1.90 Temp/Volts Converter	Feb 76	\$3.00	ET 577	3.50 General Purpose Power Supply	TPV 6	80RF5	2.90 Rumble Filter	May 80
ET 132	2.90 Experimentor Power Supply	Feb 77	\$3.00	ET 578	2.90 Simple Nicad Charger	Jne 80	80RM12	2.90 Cylon Voice Simulator	Dec 80
ET 134	2.90 R.M.S. Voltmeter	Aug 77	\$3.00	ET 581	2.50 15V Dual Power Supply	Jne 76	80SA3	4.90 Playmaster Stereo Amp.	Mar 80
ET 135	2.50 Digital Panel Meter	Oct 77	\$3.00	ET 583	2.90 Marine Gas Alarm	Aug 77	80CH7	6.50 240 V.A.C. Light Chaster	Jul 80
ET 136	2.50 Linear Scale Cap. Meter	Mar 78	\$3.00	ET 585R	1.90 Ultrasonic Receiver	TPV 6	80RAM12	3.90 Ram Expansion for Dream	Dec 80
ET 137A	3.90 Frequency Meter Lod	May 78	\$3.00	ET 585T	1.90 Ultrasonic Transmitter	TPV 6	80PA6	7.50 Playmaster 300W amp. Module	Jun 80
ET 137B	3.90 Audio Oscillator	May 78	\$3.00	ET 585	3.90	80CL4	3.50 Time Controller	Apr 80	
ET 139	1.90 Power Meter	May 78	\$3.00	ET 591A	3.90 Up/Down Digit Counter	Jly 78	80TRS11	2.90 TRS 80 Printer Serial In.	Nov 80
ET 147	3.50 Electronic Dummy Load	Oct 80	\$34.00	ET 591B	3.90 Up/Down Digit Counter	Jly 78	81DC2	2.20 La Gong Doorbell	Feb 80
ET 149	3.50 2 Tone Generator	Feb 80	\$34.00	ET 598	2.90 White Noise Generator	Nov 81	81DC5	3.00 Dream Tape Controller	May 81
ET 152	2.90 Capacitance Meter	Feb 80	\$34.00	ET 598	2.90 Touch Switch	Feb 81	81G3	11.50 Colour Graphic Analyser	Mar 81
ET 157	4.50 Crystal Marker	Oct 81	\$23.00	ET 598B	2.50 Touch Switch	Feb 81	81UCB	4.50 Universal Timer and Stopwatch	Aug 81
ET 158	3.50 Low Ohms Meter	Nov 81	\$23.00	ET 599A	2.50 Infra Red Remote Control TX	May 80	81MP6	2.90 Microprocessor Power Sup.	Jun 81
ET 159	2.90 10-15V Exp. Scale Voltmeter	Dec 81	\$23.00	ET 599B	2.50 Infra Red Remote Control	May 80	81RA4	4.50 Infra-Red Relay	Apr 81
ET 245	2.90 White Line Follower	Nov 77	\$3.00	ET 599C	2.90 Infra Red Remote Control	May 80	81RA8	2.90 Infra-Red Relay	Apr 81
ET 250	3.50 House Alarm (262)	Aug 80	\$3.00	ET 603	4.90 Mucsic Synthesizer Sequencer	Aug 77	81SP1	2.90 RS232 TRS80 System 80 In.	Jan 81
ET 255	2.90 Thermometer	Nov 80	\$3.00	ET 604	6.04 Metronome	Spt 77	81S13	7.90 TRS80/System 80 Serial In.	Mar 81
ET 256	2.90 Humidity Meter	Nov 80	\$16.50	ET 606	3.90 Electronic Tuning Fork	Nov 79	81SW1	3.90 Moving Coil Preamp	Jul 81
ET 257	2.50 Universal Relay Board	May 81	\$12.00	ET 607A	2.90 Sound Effects Generator	Aug 81	81MC7	2.90 Moving Coil Preamp	Feb 81
ET 258	2.50 Mini Drill Speed Controller	Jan 82	\$16.00	ET 607B	2.90 Sound Effects Generator	Aug 81	81RM2	2.50	Mar 81
ET 259A	2.50 Versatile 'Incremental' Timer	Jan 82	\$36.00	ET 607C	2.90 Sound Effects Generator	Aug 81	81DC3A	9.50 Digital/Analog Store. Cro.	Mar 81
ET 260	2.60 Photo Lamp Flasher	Dec 79	\$3.00	ET 631-2	7.50 Keyboard Encoder	Apr 77	81WS10	2.90 Wind Speed Indicator	Oct 81
ET 261	2.90 Fog Horn	Dec 79	\$3.00	ET 635	3.90 Train Steam Whistle	Apr 81	81P6	2.90 Pool/Lotto Selector	Jun 81
ET 262	2.90 Intercom	Dec 79	\$3.00	ET 636	16.90 7 Slot S100 Mother Board	May 80	81A010	3.50 Audio Test Unit Cass.Deck	Oct 81
ET 263	2.90 Simple Egg Timer	Dec 79	\$3.00	ET 637	4.90 Epron Programmer	Jan 78	81A010	3.50 Audio Test Unit Cass.Deck	Oct 81
ET 264	2.90 Simple Siren	Mar 80	\$3.00	ET 638A	65.00 Memory Mapped VDU	Jly 78	81MC8	9.50 Musicolour IV	Aug 81
ET 316	3.50 Transistor Assisted Ignition	May 77	\$3.00	ET 640	4.50 Stac Timer	Nov 78	81SG9	4.20 Led Sandglass	Sep 81
ET 317	3.50 Car Rev Monitor	Jul 77	\$3.00	ET 650B	4.50 Stac Timer	Nov 78	81P9	3.90 Digital Clock Thermometer	Sep 81
ET 324	2.50 Lad Tacho	Aug 80	\$3.00	ET 650C	4.50 Stac Timer	Nov 78	81S11	4.90 Slide Cross Fader	Nov 81
ET 325	2.50 Car Auto Electric Probe	Spt 80	\$12.00	ET 650D	4.50 Stac Timer	Nov 78	81G49	3.90 Photon Torpedo Game	Sep 81
ET 326	2.90 Exp. Scale Lad Voltmeter	Oct 80	\$22.00	ET 650E	4.50 Stac Timer	Nov 78	81UCB	4.90 Universal Timer and Stopwatch	Aug 81
ET 327	2.90 Turn/Hazard Indicator	Oct 80	\$22.00	ET 660	19.00 Learners Microcomputer	Oct 81	81MC7	9.50 Moving Coil Preamp	Jul 81
ET 328	2.90 Lad Oil Temp Meter	Jan 81	\$18.00	Key Set (18) To Suit ET660			81SW7	2.90 Train Steam Whistle	Jul 81
ET 329	2.50 Exp. Scale Vehicle Ammeter	Feb 81	\$27.00	Colour Option Kit to Suit 660			81SM7	2.90 Bagatelle	Jul 81
ET 330	3.90 Car Alarm	Jul 81	\$34.00	ET 682	69.00 Versatile Epron Card	Mar 81	81VM2	2.90 High Impedance DC Voltmtr	Feb 81
ET 332	2.90 Electronic Stethoscope	Aug 81	\$34.00	ET 708	2.90 Aerial Amp	Mar 76	81HB4	7.50 Heart Rate Monitor	Apr 81
ET 333	2.90 Reversing Alarm	Jan 82	\$18.00	ET 713	4.90 FM Tuner add on	Spt 77	81HB8	2.90 Heart Rate Monitor	Apr 81
ET 363	3.50 Overload Indicator	Aug 73	\$11.95	ET 717	4.50 Cross Hatch Generator	Mar 78	81RC4A	3.50 Infra Red Remote Control	Apr 81
ET 417	2.90 Led Level Meter	Aug 73	\$11.95	ET 729	3.90 UHF TV Masthead amp	Feb 80	81RC4B	2.50 Infra Red Remote Control	Apr 81
ET 435	8.50 25 Watt Stereo AMP	Mar 75	\$8.00	ET 730	4.50 UHF TV Converter	May 81	81RC4C	2.75 Infra Red Remote Control	Apr 81
ET 440	2.20 General Purpose Preamp	Jy 76	\$3.00	ET 731	4.50 Teletype Modulator	Oct 79	81SP5	2.50 Sound Pressure Meter	May 81
ET 446	3.50 Stereo Limiter	Jy 76	\$3.00	ET 735	3.90 UHF to VHF Converter	May 81	81OR7	9.50 Electronic Organ	Jy 81
ET 449	2.90 Mike Amplifier	May 77	\$3.00	ET 760	2.50 UHF to VHF Converter	May 81	81CH12	3.50 Christmas Decoration	Dec 81
ET 450A	3.50 Bucket Brigade	Dec 77	\$3.00	ET 824	2.90 Slot Car Power Supply	Dec 81	81M10a	4.90 500MHz Digital Freq.Mtr.	Dec 81
ET 450B	3.50 Bucket Brigade	Dec 77	\$3.00	ET 825	5.90 Slot Car Controller	Dec 81	81M10b	4.90 500MHz Digital Freq.Mtr.	Dec 81
ET 452	2.90 Guitar Practice Amplifier	Jan 80	\$3.00	ET 1501A	2.50 Without Cass	Apr 81	81M10c	3.50 500MHz Digital Freq.Mtr.	Dec 81
ET 453	2.90 AMP Class B. Gen Purpose	Apr 80	\$3.00	ET 1501B	2.50 Negative Ion Generator	Apr 81	81M10d	3.90 Led Bar Graph Display	Dec 81
ET 454	3.50 Fuzz Box	Apr 80	\$3.00	ET 1501C	1.50 Negative Ion Generator	Apr 81	82ep1	7.90 Easy to use Epron Programmer With Plugpack	Jan 82
ET 455	3.90 Loud Speaker Protector	Mar 80	\$25.00	ET 1503	3.90 Battery Charger	Aug 81	82ep2	7.90 Easy to use Epron Programmer With Plugpack	Jan 82
ET 457	2.90 Scratch & Rumble Filter	Spt 80	\$27.00	Dream 6800 12.50			81mill	2.50 Metronome (Low Current)	Jan 82
ET 458	4.90 Lad Level Meter	Jne 81	\$27.00	Dream 6802 12.50			81wd12a	2.50 Wind Direction Indicator	Jan 82
ET 459A	3.50		\$27.00	Power Supply to Suit DREAM MICRO KIT			81wd12b	2.50 Wind Direction Indicator	Jan 82
ET 466	7.50 300W AMP Module	Feb 80	\$63.00	HEX Keypad 19 keys					
ET 467	6.90 4 Input Mike Preamp	Jy 80	\$27.00	75CD7	3.50				
ET 470	2.90 60 Watt Amp Module Series 4000	TPV 6	\$28.00	75L11	2.50				
ET 471	9.90 Audio Preamp Series 4000	TPV 6	\$48.00	76E04	1.00				
ET 472	2.90 Power Supply For Series 4000	TPV 6	\$24.00	76PC9	5.50				
ET 473	5.90 Moving Coil Preamp Series 4000	TPV 6	\$34.00	78M8	2.90				
ET 474	2.90 Interface 60W Amp	Jan 80	\$3.00	78C5	4.90				
ET 475	4.90 AM Tuner	Spt 80	\$8.00	78A06	3.90				
ET 476	6.90 Series 3000 AMP 25W Stereo	Nov 80	\$64.00	78N6	3.50				
ET 477	4.90		\$64.00	78T3	4.50				
ET 478MB	15.00 Series 5000 Preamp Main Board	Oct 81	\$24.50	78NG4	2.90 Photo Timer	Mar 78			
ET 478MC	3.90 Moving Coil Preamp (5000)	Sot 81	\$18.00	78UT4	4.50 Pink/White Noise Gen.	Apr 78			
ET 478MM	3.90 Moving Magnet Preamp (5000)	Sot 81	\$18.00	78UP10	9.50 Low Cost VDU Keyboard	Apr 78			
ET 478SA	2.50 Series 3000 Preamp Switch Bnd	Oct 81	\$3.00	79SB10	3.90 2650 Extra Ram	Oct 78			
ET 478SB	1.90 Series 3000 Preamp Switch Bnd	Oct 81	\$3.00	79SE11	2.50 Bass Filter	Oct 79			
ET 478SC	1.90 Series 3000 Preamp Switch Bnd	Oct 81	\$3.00	79PC9	3.90 Photo Flash Exposure MTR.	Nov 79			
ET 478SD	1.90 Series 3000 Preamp Switch Bnd	Oct 81	\$3.00	79SE3	3.90 Pulse Generator	Sep 79			
ET 478SE	1.90 Series 3000 Preamp Switch Bnd	Oct 81	\$3.00	79TH11	2.90 Train Model Sound	Mar 79			
ET 478SF	1.90 Series 3000 Preamp Switch Bnd	Oct 81	\$3.00	79PS11	2.90 Transistor Assisted Ign.	Nov 79			
ET 478SG	1.90 Series 3000 Preamp Switch Bnd	Oct 81	\$3.00	79PC12	2.90 Experimentors Power Sup.	Nov 79			
ET 478SH	1.90 Series 3000 Preamp Switch Bnd	Oct 81	\$3.00	79SF10	2.90 Fan Speed Control	Dec 79			
ET 478SI	1.90 Series 3000 Preamp Switch Bnd	Oct 81	\$3.00	79SPF	2.90 Photo Slave Flash	Dec 79			
ET 478SJ	1.90 Series 3000 Preamp Switch Bnd	Oct 81	\$3.00	79URP6	2.50 Photo Sound Trigger	Sep 79			
ET 478SK	1.90 Series 3000 Preamp Switch Bnd	Oct 81	\$3.00	80ST10A	2.50 Universal Power Supply	Jun 79			
ET 478SL	1.90 Series 3000 Preamp Switch Bnd	Oct 81	\$3.00	80ST10B	3.50 Stylus Timer	Oct 80			
ET 478SM	1.90 Series 3000 Preamp Switch Bnd	Oct 81	\$3.00	80TC12	2.90 Bipolar Train Controller	Dec 80			
ET 478SN	1.90 Series 3000 Preamp Switch Bnd	Oct 81	\$3.00	80CM5A	4.50 Digital Capacitance MTR	Mar 80			
ET 478SO	1.90 Series 3000 Preamp Switch Bnd	Oct 81	\$3.00	80CM3B	2.50 Digital Capacitance MTR	Mar 80			
ET 478SP	1.90 Series 3000 Preamp Switch Bnd	Oct 81	\$3.00	80G6	6.50 T.V. Pattern Generator	Jun 80			
ET 478SQ	1.90 Series 3000 Preamp Switch Bnd	Oct 81	\$3.00	80TV8	3.90 T.V. Cro Adapter	Aug 80			
ET 478SR	1.90 Series 3000 Preamp Switch Bnd	Oct 81	\$3.00	80F3	3.20 Audio Prescaler	Mar 80			
ET 478SS	1.90 Series 3000 Preamp Switch Bnd	Oct 81	\$3.00	80PP3	2.50	Mar 80			
ET 478ST	1.90 Series 3000 Preamp Switch Bnd	Oct 81	\$3.00	80LL7	2.90 Leds & Ladders	Jul 80			



# public address amp

strip should be mounted to the bracket with countersunk 8 BA x 6 mm screws — secure them well so that the screw heads are flush. A cutout is necessary in the case lid to clear these terminals.

Mounting of the OP590 output transformer comes next. First, solder three lengths of heavy gauge hookup wire to the appropriate lugs on the transformer. Use 24 x 0.2 mm insulated hookup wire, at least. Bolt the OP590 in place using 4 BA x 6 mm bolts and lock washers under the nuts. Wire the output of the ETI-499 module to the fuseholder. Then wire up the OP590, the low-Z output socket and line output terminals.

The ETI-499 power amp module can now be mounted. First, however, wire up the twisted-pair input from the preamp. Apply thermal compound to the heatsink bracket on the power amp module and then bolt the module to the heatsink using 2 BA x 12 mm screws and lock washers under the nuts.

Now do a double check of all your interwiring. Using an ohmmeter, ensure there is no dc path between the preamp-power amp signal earth and the case. If all seems well, install a three-pin on the mains cable and you're ready to power up for a test run.

## Testing it

Set all level controls to the minimum position (fully anti-clockwise). Connect a loudspeaker to the appropriate output (either low-Z or line output). Turn the ALC off. Insert a microphone in the appropriate jack — according to what mic you have and how you've configured the inputs. Hold your breath . . . and turn on. Advance the mic level control and the volume control and talk into the mic. The sound should be clear and undistorted. If you have any problems, switch off and trace the fault before continuing.

Assuming all is well at this stage, obtain a cassette deck or tape recorder and plug it into the auxiliary input. Play a pre-recorded tape and see that the sound is clear and that the gain controls have plenty of 'room to move'. Next, try recording on tape, taking the recorder input from the preamp output jack while speaking into the mic.

Try out the effect of the ALC. There should be a dramatic difference in the dynamic range when speaking, without noticeable distortion.

Note that the speech filtering in the mic circuits reduces the bass and 'softens' plosive sounds like 'p' and 't'. The steep roll-off above 3 kHz contributes to making the voice sound less 'natural', but dramatically improves intelligibility when extraneous noise is

present. There is no filtering on the auxiliary input and the bandwidth is only limited by the output transformer.

## Conclusion

In use, the ALC needs to be employed with care — it is not necessary on all occasions. It is generally most effective when other sources of extraneous noise are present in the area.

The heatsink proved more than adequate for the job, from experience, barely getting warm to the touch.

I think you'll find the ETI-488/499 PA very effective — may it 'cut through the mush' for you every time!

ARTWORK: Full-size reproductions of the pc board and front panel artwork are available from ETI by sending an A4 stamped, self-addressed envelope to ETI-498/499 Artwork, 15 Boundary St, Rushcutters Bay NSW 2011.

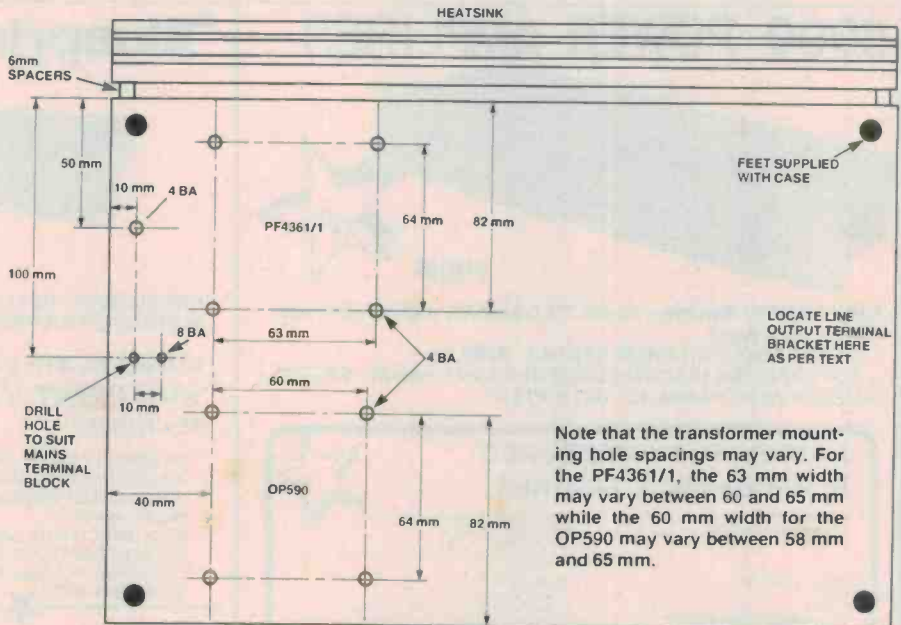

Note that the transformer mounting hole spacings may vary. For the PF4361/1, the 63 mm width may vary between 60 and 65 mm while the 60 mm width for the OP590 may vary between 58 mm and 65 mm.

DRILLING DETAILS — BOTTOM OF CASE

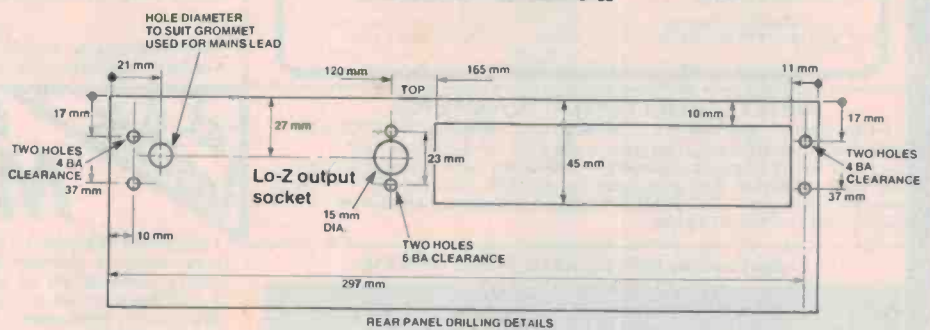

REAR PANEL DRILLING DETAILS

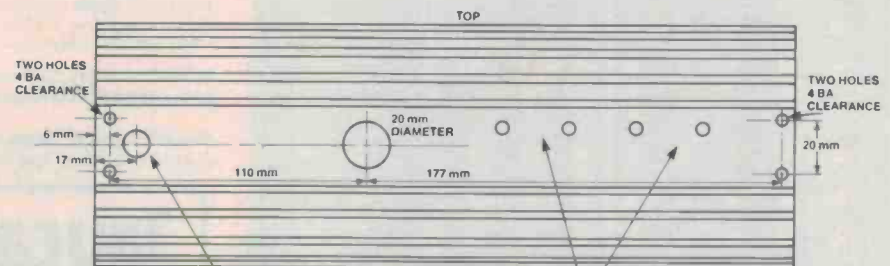

HEATSINK DRILLING DETAILS

NOTE: The front panel is best marked out and drilled using the preamp pc board as a template. The output fuseholder and mains power switch are located at the extreme right of the front panel, at top and bottom, respectively. The front panel artwork or Scotchcal panel may be used to locate hole centres for these, and they mount directly on the panel. Drill clearance holes for the preamp controls and input jacks, 2 — 3 mm oversized.

# 5000 AMPS FURTHER REFINEMENT

**5000 POWERAMP** — Much has been said about the brilliant 5000 Mosfet PA by David Tillbrook. Justifiably so in our opinion. If you wish to know more send us a SAE for a descriptive leaflet. If you are well versed with the 5000 PA you may like to know that we now supply Beryllium Oxide (high thermal conductivity) TO-3 ceramic washers in place of the poor conductivity — and flimsy — mica washers, STANDARD in our kit. You may have also noticed a number of suppliers offering 'versions' of the 5000 PA and Preamp which to some could be interpreted as the same as the quality Jaycar kit. Whilst we could be smug and say that imitation is the sincerest form of flattery, we would be kidding ourselves. We still firmly believe that the Jaycar 5000 kits are the best for many reasons: Among which are: — Only the finest components go in e.g. 1% Metal film resistors. — Continuing refinement. e.g. Beryllium washers, superior export packing. — superior cosmetic appeal.

**PREAMP REFINEMENTS** — For quite some time now we have been using the LM194CH ultra-matched transistor array in the M.C. section of the preamp. We felt that this expensive military grade component was justified. We also used the Mil-spec MAT-01GH by Precision Monolithics Inc. of the USA, National Semiconductor now has a device called the LM394H which we now intend to use exclusively in our "Blueprint" series preamps. The H version is EVEN QUIETER than the CH versions in the past. While this component is considerably more expensive than the standard LM394 we feel that the extra investment on our part is justified. Yet another example of "Further Refinement".

## 5000 POWER AMPLIFIER

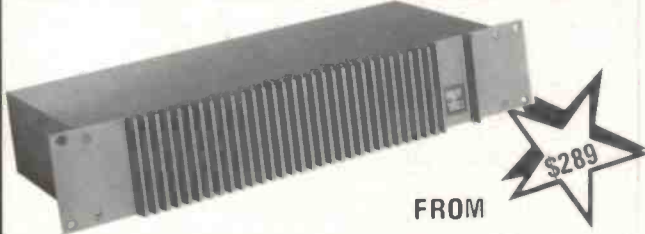

FROM

\$289

**EXCLUSIVE!!** Beryllium Oxide TO-3 heatsink washers now used. (Safety pink type).

- STANDARD (ETI) FRONT PANEL \$289.00
- SUPERFINISH (RECOMMENDED) FRONT PANEL \$299.00 (SUPERFINISH PANEL ILLUSTRATED)

### LABORATORY MEASURED PERFORMANCE FIGURES:

POWER OUTPUT  
FREQUENCY RESPONSE

100W RMS into 8 ohms (both channels driven)  
8Hz to 20kHz, -0 -0.4dB  
2.8Hz to 65kHz, +0 -3dB  
Note: These figures are determined solely by passive filters

INPUT SENSITIVITY  
HUM  
NOISE

1V RMS for 100W output  
-100dB below full output (flat)  
-116dB below full output (flat, 20kHz bandwidth)

2nd HARMONIC DISTORTION

<0.001% at 1kHz (0.0007% on prototypes) at 100W output using a 756V supply rated at 4A continuous  
<0.003% at 10kHz and 100W

3rd HARMONIC DISTORTION

<0.0003% for all frequencies less than 10kHz and all powers below clipping

TOTAL HARMONIC DISTORTION  
INTERMODULATION DISTORTION  
STABILITY

Determined by 2nd harmonic distortion (see above)  
<0.003% at 100V (50Hz and 9kHz mixed 4:1)  
Unconditional

## "Blueprint" 5000 preamp



FROM

\$245

**EXCLUSIVE!!** NEW LM394H EXTRA LOW NOISE ULTRA-MATCHED TRANSISTOR PAIR USED IN M.C. PREAMP.

STANDARD (STILL GOOD) VERSION ONLY \$245.00

### "BLUEPRINT VERSION"

FEATURES:

- EXTREMELY CLOSE TRACKING TO RIAA PHONO EQUALISATION
- GOLD PLATED CONNECTORS ON PHONO INPUTS
- ENGLISH "LORLIN" LOW NOISE SELECTOR SWITCHES USED
- LOW NOISE 1% 50ppm METAL FILM RESISTORS USED
- TINNED FIBREGLASS PCB'S
- LOW CAPACITANCE SCREENED CABLE USED THROUGHOUT
- QUALITY I.C. SOCKETS PROVIDED
- SPECIAL REAR PANEL
- MULTICOLOURED LED DISPLAY

### SPECIAL OFFER

If you have the good taste to purchase both the 5000 PA and Preamp during June, we will give you our exclusive

JAYCAR

— SOUND ENGINEERING —

T-shirt absolutely FREE. Tell us how big you are or it may not fit!  
Available separately for only \$6.50 each.

### BERYLLIUM OXIDE WASHERS

If you wish to upgrade the quality of your existing 5000 PA with Beryllium washers you can have a set of 8 for \$15 plus P&P — High thermal shock capacity — Perfectly safe if not EATEN!! — Ceramic material that conducts better than Aluminium — High dielectric strength — As used in Military Aerospace equipment — Precision cut for TO-3 profile.

Freight outside NSW only \$15. Within NSW \$10



## the new 8 channel MIXER KIT

† Balanced (600 ohm) mic inputs/line inputs † Balanced output † Input attenuators † Cannon connectors included in the price † Bass, mid & treble equalization on each input † "Effects" (i.e. echo etc) capability † Foldback on all 8 inputs † Stereo pan on all 8 inputs † 60mm slide faders used throughout † 19" rack mount capability (or console mount) † Professional black front panel with format borders and multicoloured knobs to assist function identification † Designed for quick easy service † VU metering † Only high quality components used † 5534A OP amp used for low noise and very low distortion.

**BASIC MIXER KIT** with all features. Includes 19" rack panel all knobs and electronic components AND 10 CANNON connectors \$495

Console mount chassis in steel, plated and pre-punched. Includes power supply for mixer and wooden end pieces. \$98

# Jaycar

125 YORK ST SYDNEY 2000

Ph. 2646688 Telex 72293

Mail Orders To:

Box K-39 Haymarket 2000

Post and Packing charges



SHOP HOURS

Mon-Fri 9 to 5.30

Sat 9 to 2

Thurs night to 8pm

\$5-\$9.99 (\$1.20) \$10-\$24.99 (\$2.40)

\$25-\$49.99 (\$3.50) \$50-\$99.99 (\$4.60)

\$100 up (\$6.20)

SEND SAE FOR FULL DATA ON 5000 SERIES AND THE NEW STEREO MIXER KIT

# Add-on sequencer for our percussion synthesiser

Design: Ray Marston    Development: Geoff Nicholls

This sequencer enables you to 'program' a rhythm sequence of up to eight steps on the percussion synthesiser for automatic accompaniment.

THIS IS the sequencer unit promised in our Percussion Synthesiser project published in the April issue. It is a straightforward add-on unit that can provide a variety of 'programmed' rhythms, employing one or both channels of the synthesiser, with up to eight steps in the sequence. In addition, a variable control allows you to set the tempo of the rhythm sequence set-up. Two dual-in-line-package (DIP) switches, with eight switches each, are employed to choose the rhythm pattern, one DIP switch package for each channel output.

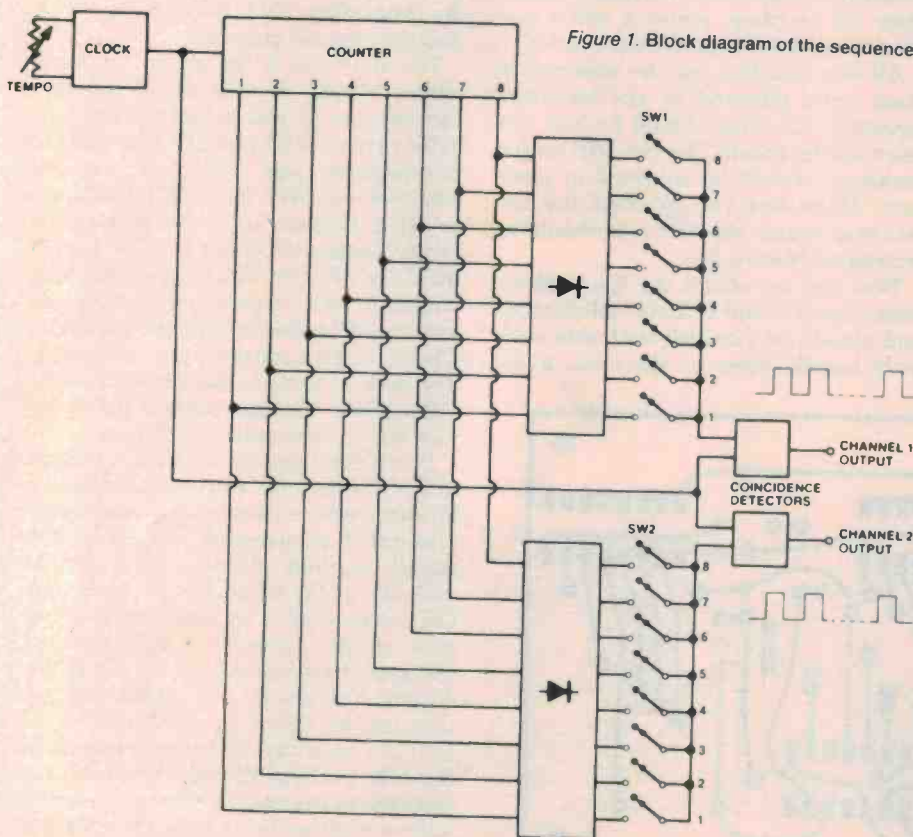

Figure 1. Block diagram of the sequencer.

## Design

Figure 1 shows the overall arrangement of the sequencer unit. A clock oscillator drives an 'octal' counter. One of the eight outputs goes high with each clock cycle, each output going high in turn — 1, 2, 3, 4 . . . 8. Each output of the counter is connected to one switch in each of two switch banks — SW1 and SW2 — via a diode, which provides isolation between the switches in each bank. If switch 1 of SW1 is selected, the first output of the counter ('1') will be passed to the input of a 'coincidence detector'. This pulse is gated with the clock pulse in the coincidence detector as the counter outputs are one clock cycle wide and the coincidence detector effectively 'shortens' the output pulse to the same width as the clock pulse (5 ms). The output of the coincidence detector connects to the 'SEQ. IN' line of the relevant channel on the Percussion Synthesiser. The same goes for any of the switches.

Closing switches on SW1 and SW2, while leaving others open, provides a pulse train that generates the required rhythm. For example, closing switches 1, 3 and 4 will generate a waltz rhythm.

The clock 'rate' or repetition frequency can be varied by means of a potent-

# Project 469B

## PARTS LIST ETI-469B

Resistors		all 1/2W, 5% unless noted
R1	.....	2k2
R2	.....	3k3
R3	.....	22k
R4, R5	.....	27k
R6	.....	100k
R7	.....	1k
RV1	.....	250k/A pot.

Capacitors	
C1	..... 2u2/20 V tant.
C2	..... 470u/16 V axial electro.

Semiconductors	
D1-D18	..... 1N914, 1N4148
IC1	..... 555
IC2	..... 4022
IC3	..... 4011

Miscellaneous	
SW1, SW2	..... 8-pole DIP switches
SW3	..... DPDT toggle switch

ETI-469B pc board; four 6 mm spacers; four 25 mm 4 BA countersunk head bolts; four 4 BA nuts and washers; hookup wire.

**Price estimate**  
\$18 — \$20

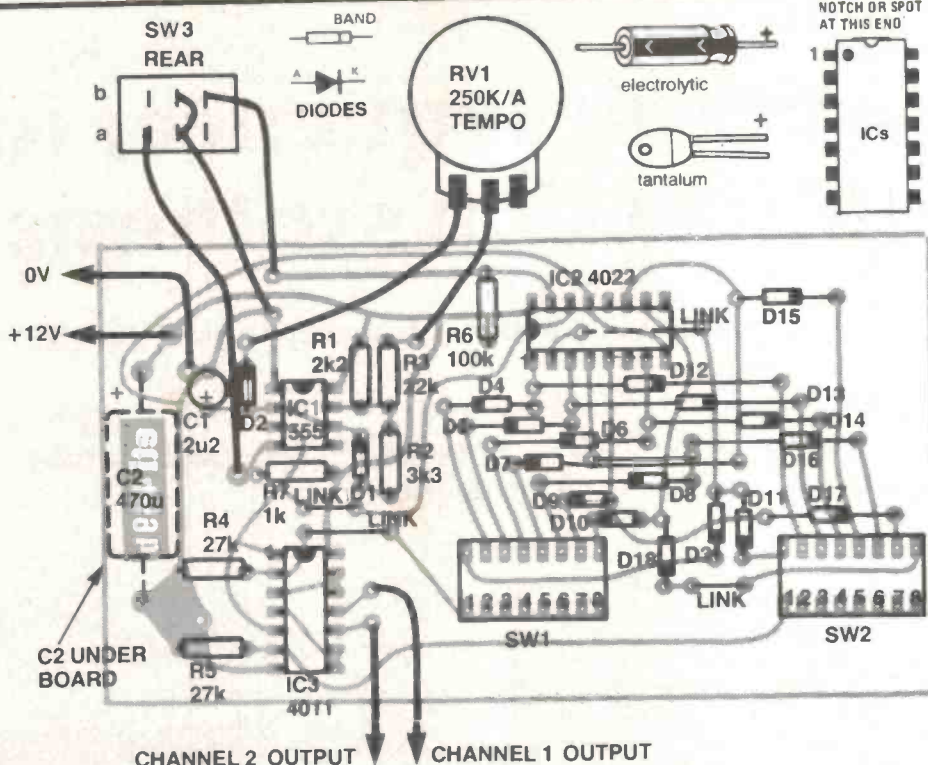

imeter to vary the tempo of the output rhythm pulses.

## Construction

This is quite a straightforward project to build. Contrary to popular assumption, however, all the components *do not* mount on the non-copper side of the pc board! If you peruse the component overlay diagram you will note that C2 is mounted on the track side of the board. This is to provide clearance when mounting the project in the case housing the Percussion Synthesiser.

There are five links on the board and these should be inserted first — one of them is partly under IC2. Note that one link is located between the positions of D6 and D7 and is not identified on the overlay with the word 'LINK'. Use 22 or

26 gauge tinned copper wire for the links. You could use insulated hookup wire but tinned copper wire is generally more convenient.

Tackle all the diodes next. There are 18 of them and you need to take care with their orientation. Having soldered them all in place, pause a while and check each one for correct orientation.

All the resistors can be soldered in place next, followed by the tantalum capacitor, C2. This should be laid flat down on the board. The two DIP switch packages should be soldered in place next. Make sure you get them the correct way round: the 'ON' side should be orientated toward IC2.

Now you can solder the ICs in place. Note that IC2 and IC3 are CMOS types and should be handled with due care. Only handle them by the ends; avoid

handling the pins. When you insert them solder pins 8 and 16 of IC2 first; with IC3, solder pins 7 and 14 first. Having soldered these (the supply and 0 V pins), solder all the other pins.

Finally, solder C2 in place on the copper side of the board and attach leads for connecting RV1, SW3, 0 V, +12 V and the channel outputs.

The unit can be tested very simply before wiring it into the Percussion Synthesiser, if you so desire. Temporarily wire up RV1 and SW3. Set RV1 to mid-position and SW3 off. Set all switches on SW1 and SW2 to the on position. Connect a crystal earpiece on either output. Connect a 12 V supply and turn SW3 on. You should get a loud clicking in the earpiece if all is well, and varying RV1 should vary the click rate. Check that the other output is working. Try setting some of the switches of the DIP switch for that channel off to see how the rhythm pattern changes.

If you don't get the anticipated result at first, switch off and check the board for dry joints, missed joints, incorrectly orientated components, etc. With the supply applied, check supply pins of each IC, *at the IC pins*. If it checks out OK, switch SW3 on again and, using your crystal earpiece (handy piece of test gear, that!), check pin 3 of IC1 for an output. You should get a loud clicking that can be varied by varying RV1. If not, you may have IC1 inserted back to front or perhaps diodes D1 or D2 are incorrectly orientated. Check the latter with a multimeter. Check that SW3 is correctly wired.

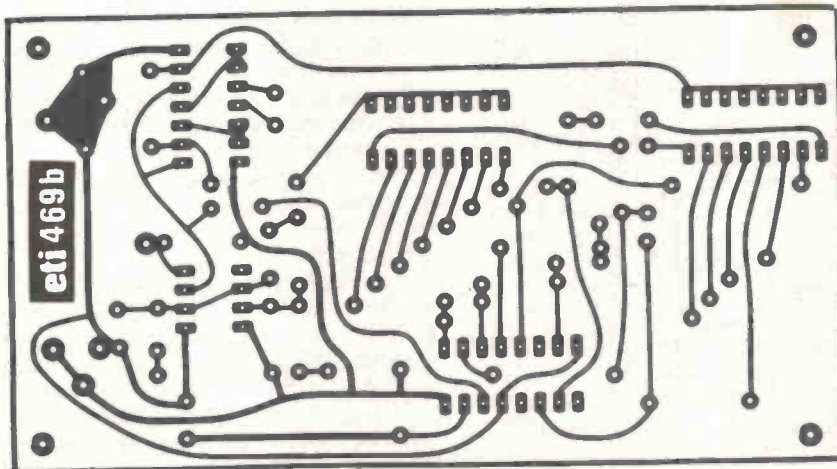

# sequencer

## HOW IT WORKS — ETI 469B

General operation of the sequencer is explained in the main text. The 'clock' here is provided by a 555 timer, IC1, the octal counter is IC2 and the two 'coincidence' detectors are formed by gates IC3a and IC3c.

The 555 is arranged as an astable oscillator generating a non-symmetrical output of 5 ms-wide pulses, the inter-pulse period being variable over a considerable range by means of RV1, the 'tempo' control. (See also 'Lab Notes', May 1981, page 66). The charge and discharge paths of the timing capacitor, C2, are separated by means of D1 and D2 respectively, and thus the charge and discharge time constants can be controlled independently. R1-R2 largely determine the charge time constant by setting the pulse width here, while RV1-R3 determine the discharge time constant. Varying RV1 will vary the pulse repetition rate.

The output of the clock, IC1, drives the input of the 4022 counter, IC2. This is an 'octal' (i.e. 'one-of-eight') counter chip having eight decoded outputs. Each output goes high in turn for each complete clock input cycle. So the '0' output goes high first, then the '1' output, then the '2' output and so on until the '7' output goes high when the whole sequence repeats. Each output can be selected by a switch from the DIP switch packages, SW1 and SW2, coupled to the switch via a diode so that pulses are not coupled from switch to switch. Any output selected by a switch goes to one input of a NAND gate — pin 2 of IC3a for channel 1, pin 6 of IC3c for channel 2. The other input of each of these gates (pins 1 and 5 respectively) are driven by the clock pulses. Looking at IC3a, pins 1 and 2 will be high only for the duration of a clock pulse and thus the gate output, pin 3, will be low for 5 ms during the time whichever counter output selected occurs. IC3b is simply an inverting buffer and pin 11 goes high for 5 ms whenever the selected counter output goes high. Similarly for IC3c and d.

The sequencer is powered from the synthesiser board. To turn the sequencer off when not required, SW3a shorts the RESET pin (pin 4) of the 555 (IC1) to 0 V, preventing it operating and causing the output (pin 3) to go low. At the same time, SW3b allows the RESET pin of IC2 (pin 15) to be pulled high, via R6. This sets outputs '1' to '7' low and output '0' high, as can be seen from the timing diagram at left. If pole 1 of SW1 or SW2 happens to be closed, no output will result as the clock output (pin 3 of IC1) is low. Thus the DIP switches, SW1 and SW2, may be left 'programmed' and not affect the operation of the synthesiser, as the channel 1 and channel 2 outputs will be low while the sequencer is turned off. In addition, when SW3 is switched to the ON position, the sequencer will commence automatic operation at the start of the programmed sequence and not at some random beat.

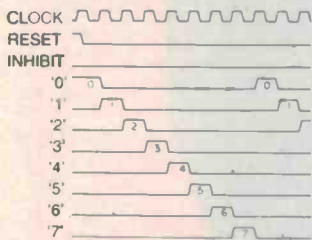
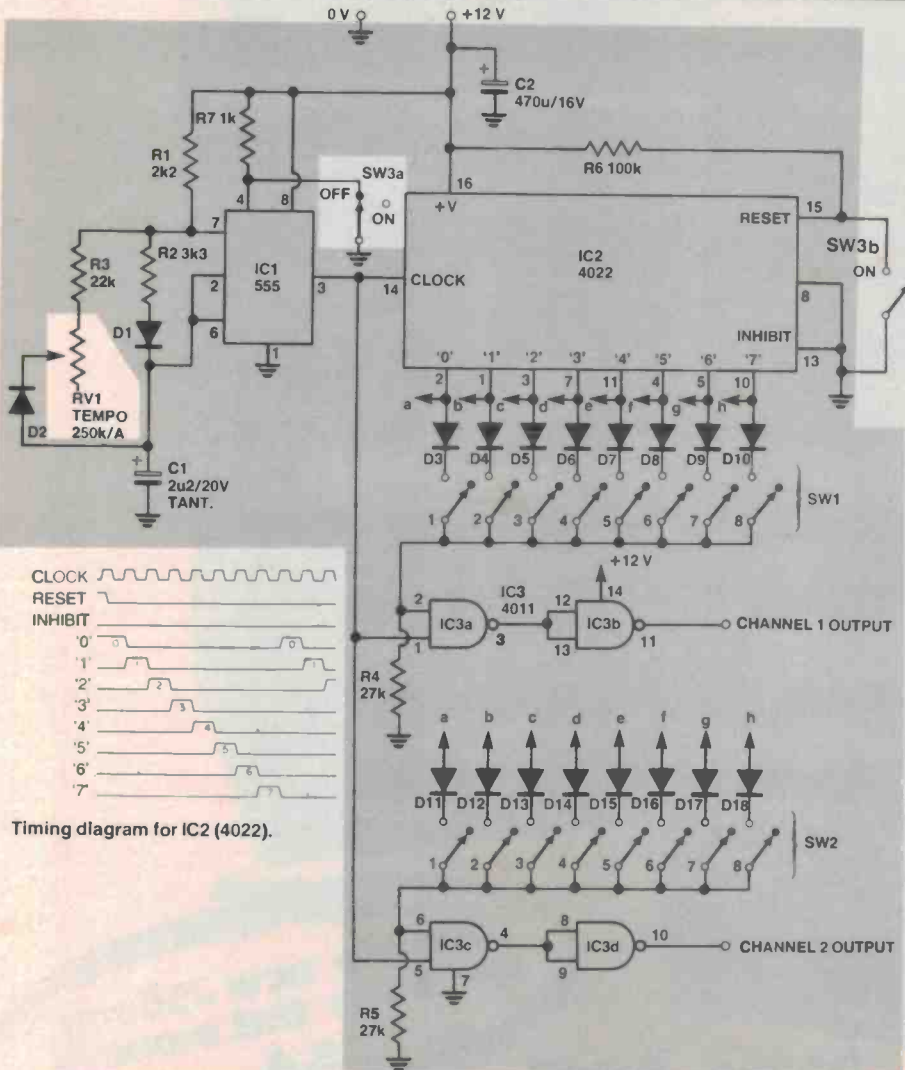

Timing diagram for IC2 (4022).

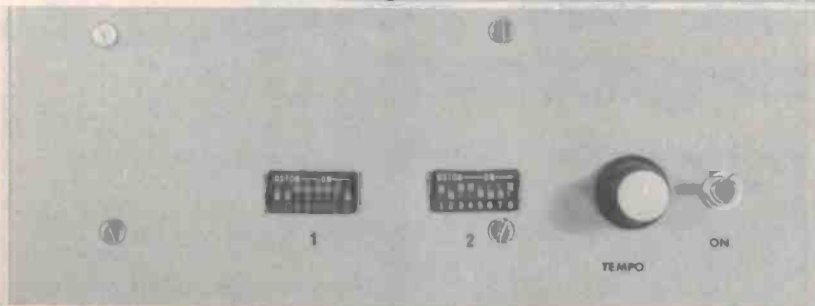

View looking down on the lid of the synthesiser showing the sequencer installed.

If the 555 output is OK check each output pin of IC2. You should get a regular clicking at  $\frac{1}{8}$  the clock rate. Again, varying RV1 should vary the click rate. With a multimeter, and while the sequencer unit is disconnected from the power supply, check that pins 8 and 13 of IC2 are connected to the 0 V line and ▶

### VARIATIONS

If you find the tempo control covers too wide a range for your tastes, then use a 100k/A potentiometer instead. You can set the maximum tempo by changing the value of R3. You'll probably find it too fast anyway when RV1 is at minimum resistance, so its value should be increased. Try 100k, for starters.

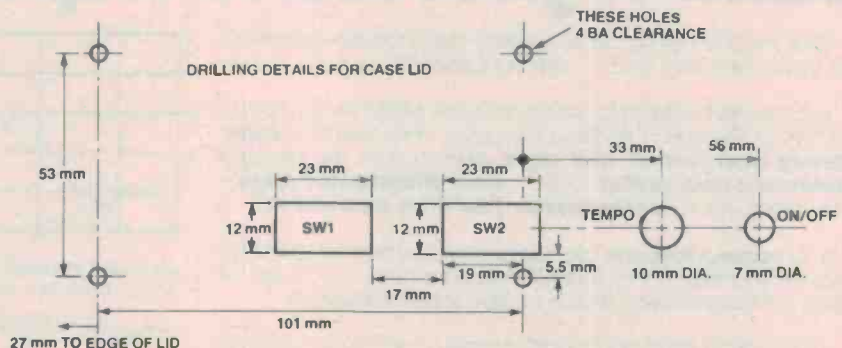



See the new 250mm system in this month's E.A.

Now two new magnificent



# build-it-yourself hi fi speaker systems

Dick Smith brings you these superbly styled speaker systems to suit your room, your decor ... and your pocket!

Acoustically designed by Neville Williams, MIREE (Aust.), Editor-In-Chief of Electronics Australia magazine, they feature a **completely new format and style**, starting with the strikingly **handsome new grilles** with the **new 'Playmaster' logo** and ending with a **performance you'd be amazed at!**

You'll **save a fortune** over comparable commercial speakers - because you build them yourself. And all it takes is a couple of hours construction time, a tube of glue and a screwdriver.

They look so good, and sound so great, your friends will never believe you built them!

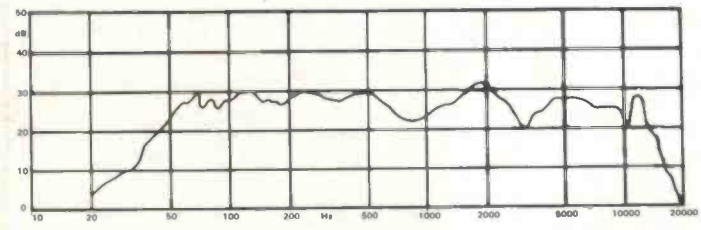

Measured response of Playmaster 300mm speaker system. Compare this performance with speaker systems you'd pay 3 or 4 times as much for.

(Measurements performed by Dick Smith Electronics technical staff)



The boxes simply fold together - no wood-working knowledge needed. All panels are pre-cut, pre-rebated and pre-drilled. We've even heard of schoolchildren building their own Playmasters: they're that simple!



**What the experts say:**

"... the end result represents outstanding value for money. Whether you buy it in kit form or fully assembled, we are sure you will be pleased with sound quality."

"... the new Playmaster 3-70L has generous power handling capacity so that it can give a good account of itself on virtually any type of music."

Neville Williams & Leo Simpson  
(EA, March 1982)

All you need is a tube of glue and a screwdriver - everything else is supplied for you. The wiring loom for the speakers is pre-assembled - the connectors just push on. And the speakers drop into position in the holes provided. If you can read simple instructions, you can build your own commercial quality speakers.



**Look at these new features:**

- ★ All new design in simulated woodgrain finish to complement decor
  - ★ Separate level control for high and mid ranges\* - tailor the sound to suit your listening environment
  - ★ Special speaker sealant material supplied to ensure absolute air tightness
  - ★ New design ribbed woofer with massive 30cm cone for accurate bass reproduction
  - ★ Built-in plinth to raise speaker off floor level for minimum audio colouration
  - ★ Manufactured to the exacting standards of the original design published in Electronics Australia magazine
  - ★ Acoustically transparent silk-like grille cloth heat welded to support frame.
- \*300mm system only

And now you're finished. Settle back with a drink, play your favourite record or tape. The sound quality will make you more than happy and your friends will never believe you built them!

300mm SYSTEM	250mm SYSTEM *
<b>Speaker kit, crossovers &amp; faders</b> This kit includes 300mm woofers, high and mid range faders, and 3 way crossover with high power handling capacity. Cat C-2042 ..... <b>\$175.00</b>	<b>Speaker kit, and crossovers</b> This kit includes 250mm woofers and 3 way crossover with medium power handling capacity. Cat C-2044 ..... <b>\$149.00</b>
<b>Enclosure kits</b> A pair of large 70 litre cabinets for the ultimate in sound reproduction. Cat C-2632 ..... <b>\$159.10</b>	<b>Enclosure kits</b> A pair of large 53 litre cabinets to give great sound reproduction. Cat C-2634 ..... <b>\$143.10</b>
<b>Deluxe speaker grilles</b> Handsome new design featuring the new 'Playmaster' logo. Cat C-2612 ..... <b>\$39.90</b>	<b>Deluxe speaker grilles</b> Handsome new design to fit 53 litre cabinets, featuring the new 'Playmaster' logo. Cat C-2610 ..... <b>\$35.90</b>
<small>Note. All prices are per pair.</small>	
<b>TOTAL SYSTEM ONLY</b>	<b>TOTAL SYSTEM ONLY</b>
<b>\$374 per pair!</b>	<b>\$328 per pair!</b>

\*250mm System available early July. Phone your nearest store for full details of availability.



# DICK SMITH Electronics



SEE PAGE 34 FOR ADDRESS DETAILS



DSE/A285/PALLM

**NEW RELEASE!!**  
**GW TEST & MEASURING**  
**EQUIPMENT '82**



**Vertical Deflection**  
 — L & R Channels  
**Sensitivity**  
 — 10mV/Div  
**Bandwidth**  
 — DC:DC-5MHz (-3dB)  
 — AC:2Hz-5MHz (-3dB)  
**Horizontal Deflection**  
**Sensitivity**  
 — 250mV/Div  
**Bandwidth**  
 — DC-500KHz (-3dB)  
**Sweep Frequency**  
 — 10Hz-100KHz in 4 ranges and fine control

**STEREO SCOPE**  
 GOS-1522  
**\$325 + S.T.**



**FUNCTION GENERATOR WITH DIGITAL COUNTER**  
 GFG-8015D  
**\$322 + S.T.**

**SWEEP FUNCTION GENERATOR**  
 GFG-8015S  
**\$312 + S.T.**



**GFG-8015D:** Sine, Triangle, Square, Pulse and Ramp. (Duty Variable) 0.2Hz~2MHz 7 Range. VCF (Voltage Control Frequency) DC Offset Variable. 20V p-p open circuit.  
**GFG-8015S:** Spec same as GFG-8015 with sweep mode in lin/log operation.



**GAG-808D:** Sine wave characteristics: 7V rms or more (when no load) Frequency Characteristics: 10Hz to 1 MHz ± 0.5dB Square wave characteristics: Output voltage: More than 10V p-p (when no load) Sag: 5% or less (at 50Hz) Rise and Fall Times: Less than 200 nS

**AUDIO GENERATOR WITH DIGITAL COUNTER**  
 GAG-808D  
**\$279 + S.T.**

**CURVE TRACER**  
 GCT-1212  
**\$149 + S.T.**



Curve tracing on a scope is made easy with this Instrument. Characteristics curves of all types of semiconductors can be accurately displayed (TR, FET, SCR, UJT, ZENER, DIODE)



Sole Australian Agent:  
**EMONA ENTERPRISES**  
**PTY. LTD.**

CBC Bank Bldg, 661 George Street, Haymarket, Sydney.  
 (02) 212 4815

Available from:  
 NSW: Radio Despatch Service 211 0191, Emtronics 211 0531, David Reid Electronics 29 6601, Pre Pack Electronics 569 9797, Martin de Launay (Wollongong) 28 6020 (Newcastle) 24 7511, VIC: Radio Parts 329 7888, SA: Int. Communication Systems P/L 47 3688, WA: Latco Trading Co. 387 4966, ACT: Electronic Components P/L 80 4654, TAS: D & I Agencies 23 2842.

**JIL SX-200,**  
**A BETTER SCANNING**  
**MONITOR RECEIVER.**

Covers 26-88 MHz & 108-180 MHz & 380-514 MHz



Monitors over 33,000 frequencies from 26 to 88 MHz, 108 to 180 MHz and 380 to 514 MHz. Bands included within this range are HF and UHF CB, 27 and 155 MHz MARINE, Australian LOW BAND, AIRCRAFT band, VHF SATELLITE band, 10 Mx, 6 Mx, 2 Mx and 70CMx AMATEUR BANDS, VHF High BAND as well as UHF two-way band.

Mechanically rugged the SX-200 uses high quality double-side Epoxy-Glass printed circuit boards throughout. Some of its other outstanding features include 3 MODE SQUELCH circuitry which allows the lockout of spurious and carrier only signals, extremely low spurious count, AM and FM detection on all bands, FINE TUNING control for off channel stations, 240 VAC on 12 Volt DC operation, Accurate QUARTZ CLOCK, Squelch operated OUTPUT for switching a tape recorder etc, 16 Memory channels, MEMORY BACKUP which lasts up to two years, high SENSITIVITY and SIGNAL-TO-NOISE ratio on all bands, CRYSTAL FILTER for excellent SELECTIVITY and easy servicability due to component layout as well as a 90 day warranty.

Its high quality and performance is testified by the fact that it is in use by a large number of State government and Federal bodies including most state and federal police departments.

Contact GFS, the Australian Distributors, or our interstate outlets for full technical specifications.

We also market a range of pocket scanning receivers and transceivers. Contact us for full details.

PRICE \$512 INCL S.T.+ \$8 P&P  
 SERVICE MANUAL \$10+\$1 P&P  
 SCAN-X BASE ANTENNA \$48+\$8 P&P

Interstate Dealers:  
 WA: (09) 387 4966  
 NSW: (02) 211 0531  
 QLD: (07) 397 0808  
 SA: (08) 269 4744

**GFS Electronic Imports**

15 McKeon Road  
 Mitcham, 3132 Vic  
 TLX 38053 GFS  
 (03) 873 3939

From page 69

that pin 15 is shorted to 0 V when SW3 is turned to the on position. If there are any problems, sort them out before continuing.

If IC2 checks out OK, see that the output pulses are getting to pins 2 and 6 of IC3. Just close one switch in each DIP switch package for this test. If signals are present here, check pins 3 and 4 of IC3 (the outputs of IC3a and IC3c, respectively). Note that these outputs are normally high (at +12 V) and go low (0 V) on the receipt of coincident pulses at the gate inputs.

**Mounting**

We mounted our sequencer unit in the lid of the box of our Percussion Synthesiser, as shown in the accompanying photographs. The 'tempo' potentiometer and on/off switch are mounted adjacent, as detailed in the accompanying drilling/cutout diagram on page 69.

The best way to go about mounting the sequencer unit is to first drill holes for the on/off switch and tempo pot, as shown. Measure up and mark out the positions with a soft pencil (HB is fine) and centre-punch the hole positions. Drill from the top side of the lid to avoid burrs or blemishes appearing on the outside surface. Next mark out the cutouts for the DIP switches — not the pc board mounting holes, they're last. The DIP switch cutouts are best cut using a small jigsaw (the MiniTool model 000.62.108 is ideal for the job — see the April issue), but the 'traditional' hobbyist's technique of drilling around the inside of the marked cutout, removing the material and then filing the edges is effective, though care needs to be exercised with the file to get a neat appearance. Less filing is necessary, and it's easier, when a jigsaw is used.

With the DIP switch cutouts completed, fit the board from the underside of the lid, pushing it hard up against the lid. Carefully mark the pc board hole positions, using the board as a template. Remove the board, centre punch the holes and drill them to clear 4 BA bolts. Countersink the holes on the top side of the lid.

Now the pc board can be mounted on the lid. It is spaced away from the under surface by four 6 mm spacers. These allow the DIP switches to project through the top surface of the lid while not jamming the components on the board against the lid. With that done, mount and wire up SW3 and RV1. Wire the sequencer unit to the synthesiser board and give it all a test run. If/when all is OK, complete the case assembly and your Percussion Synthesiser with Sequencer is ready to rock! (or waltz, or foxtrot . . .).



# 3M BRAND

Photosensitive  
● Products ●

SELF ADHESIVE  
ALUMINIUM  
OR  
PLASTIC FILM

\* BLACK, BLUE OR RED  
"ON ALUMINIUM"

† BLUE, BLACK, GREEN, RED  
"ON WHITE FILM"  
"ON CLEAR FILM"

**3M BRAND**  
"I.N.T."

"Image 'n Transfer"

**BLACK OR WHITE**

Graphic  
**TRANSFER**  
Material  
for

\* Architects, Draftsmen,  
Map Makers, Illustrators,  
Key Liners

† A.V. Producers,  
Layout Artists

**WE STOCK IN DEPTH**  
MAJOR SUPPLIERS  
INDUSTRY, SCHOOLS.

**INTRODUCTORY  
KIT SPECIAL**  
\$56.80 + S.T.

Telex, Phone Toll Free  
or Write

**PROMPT DELIVERY**  
Maximum Charge \$3.00

**KALEX**

101 Burgundy St.  
Heidelberg 3084  
(03) 458 2976  
Telex AA 37678  
MELTON  
(03) 743 1011

**ELECTRONIC COMPONENTS &  
ACCESSORIES SPECIALIST  
SCHOOL SUPPLIERS**

**I M A R K**

for **JAPANESE ICs  
& TRANSISTORS**

OEM Quantity prices available

**NEC**



**SANKEN**



**OKI**

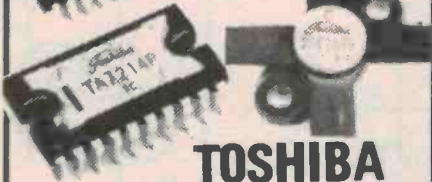

**TOSHIBA**



**HITACHI**



**SANYO**



**MITSUBISHI**



**MATSUSHITA**

**FWJITSU**

Send for price list

**I M A R K**

PTY. LTD.

167 Roden St., West Melbourne,  
Victoria 3003

Phone: (03) 329 5433 Telex AA37753

**Bill Edge's  
ELECTRONIC AGENCIES**

115 Parramatta Rd., Concord 2137  
(Chr. Lloyd George Ave.) Ph. 745 3077  
123 York Street, Sydney 2000  
(Next door to Dick Smith) Ph. 29 2098

**MAIL ORDERS**

P.O. Box 185 Concord 2137

**NEW TRADING HOURS BOTH STORES**

MON.—FRI. 9am—5.30pm  
THURS. till 8pm

**MAIL CHARGES**

\$5—\$9.99 .....\$2.00  
\$10—\$24.99 .....\$3.00  
\$25—49.99 .....\$4.00  
\$50—\$99.99 .....\$5.00  
\$100 or more ....\$6.50

Airmail add \$4.50. Registered mail \$3.00  
extra. Certified mail 75c extra.

ALL HEAVY OR BULKY ITEMS (OVER  
20KG) SENT COMET ROAD FREIGHT  
\$10.00 ANYWHERE IN AUSTRALIA.

BANKCARD WELCOME BY PHONE, MAIL  
OR OVER THE COUNTER.

## JUNE SPECIALS

HE2429 HEATSINK FAN TYPE 225mm .....	8.00
NORMALLY \$9.75 SAVE \$1.75	
PE0030 PLUG 3.5mm Red .....	20c
SAVE 15c	
PE0032 PLUG 3.5mm Black .....	20c
SAVE 20c	
PE0058 PLUG 6.5mm Phone .....	38c
SAVE 22c	
PE0159 JACK SOCKET 6.5mm Panel .....	40c
SAVE 20c	
PE0318 PLUG RCA RED .....	20c
SAVE 15c	
PE0320 PLUG RCA BLACK .....	20c
SAVE 15c	
PE0448 PLUG 5 PIN DIN LINE 180° .....	45c
SAVE 35c	
KE1500 Musicolour MK3(EA9/76) Kit .....	\$45
SAVE \$14.95	
KE1525 Lightchaser Kit (EA8/80) .....	\$45
SAVE \$20.00	
KE3000 Electronic Organ Kit (EA7/81) .....	\$54
SAVE \$14	
KE4120 Infra Red Remote Control (ET1599) .....	\$43
SAVE \$26	

## NEW KITS

SEQUENCER FOR DRUM MACHINE ETI496B Cat. KE1076 .....	\$20
PREAMP FOR 150W PA AMP ETI498 Cat. KE3041 .....	P.O.A.
ASC11 KEYBOARD KIT ETI670 (SUIT ETI660 & ETI675 COMPUTER) Cat. KE6606 .....	\$130
150 WATT GUITAR AMP ETI499 Cat. KE3040 .....	\$99
PROPELLER EFFECTS ETI607F Cat. KE0250 .....	\$11.95
DRUM MACHINE ETI469 Cat. KE1075 .....	\$89.00
VOICE OPERATED RELAY EA4/82 Cat. KE1130 .....	\$15
VOICE CANCELLER EA4/82 Cat. KE1155 .....	\$20
LCD DIGITAL CAPACITANCE METER EA3/82 Cat. KE4075 .....	\$59.90
DUAL POWER SUPPLY EA 3/82 Cat. KE4080 .....	\$89.50
FUNCTION GENERATOR EA4/82 Cat. KE4095 .....	\$85

# Ideas for Experimenters

These pages are intended primarily as a source of ideas. As far as reasonably possible all material has been checked for feasibility, component availability etc, but the circuits have not necessarily been built and tested in our laboratory. Because of the nature of the information in this section we cannot enter into any correspondence about any of the circuits, nor can we produce constructional details.

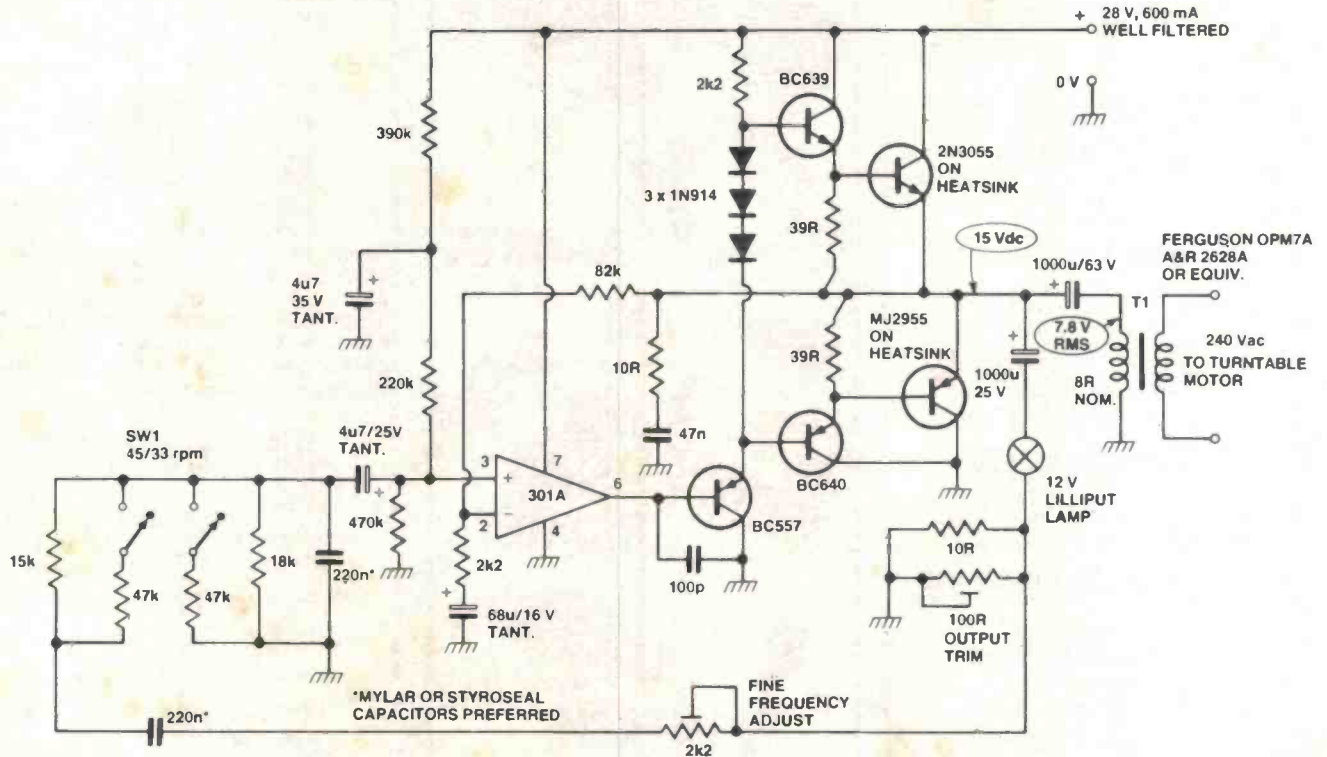

## Turntable speed controller

Philip Allison of Summer Hill NSW submitted this useful idea.

This device was designed to vary the supply frequency to the motor of a synchronous turntable, enabling correction of the 3-5% excess speed found with the unit. In addition, provision has been made for 45 rpm drive without the tedium of belt changing — a feature useful to owners of expensive single-speed turntables like the Linn Sondek. Other advantages of this circuit include a steady voltage output and low distortion compared to the mains. Note that one can also slow down those pop recordings that appear to be recorded at slightly high speed, producing a more 'natural' sound (maybe the apparent fast speed is deliberate? — Ed.)

The circuit is based around the ETI-452 Guitar Practice Amp power output stage (this appeared in the January 1980 edition but the ETI-453 General Purpose Amp Module, April '80,

uses the same circuit — Ed.) I have made some modifications and additions, as shown in the circuit diagram, converting it to a power Wien Bridge oscillator using a 12 V lilliput lamp as the stabilising element. I used a 2N3055 and MJ2955 combination for the output stage (though this is unnecessary — Ed.). The output transformer came from a discarded valve hi-fi amp, but others with a 30:1 ratio and at least a 12 W rating should be fine. A power transformer is not recommended here as I found they had poor efficiency.

The 100 ohm trimpot is adjusted to give 240 Vac with the turntable connected. A strobe disc allows setting the correct speed (using the 2k trimpot). Component tolerances may necessitate small adjustments to be made to the Wien Bridge capacitors or resistors to give the desired frequency range. Extra resistors are switched in circuit to

increase the frequency for 45 rpm operation.

## Any ideas?

Have you had a bright idea lately, or discovered an interesting circuit modification? We are always looking for items for these pages so naturally, we'd like to hear from you.

We pay between \$5 and \$10 per item — depending on how much work we have to do on it before we publish it.

The sort of items we are seeking, and the ones which other readers would like to see, are novel applications of existing devices, new ways of tackling old problems, hints and tips.

# RADIO DESPATCH SERVICE

869 George Street,  
Sydney, 2000.  
(Near Harris Street)  
Telephone:  
(02) 211 0191 (02) 211 0816

Open Monday-Friday 8.15 am  
till 5.30 pm (Thursday 8.30  
pm). Saturday 8 am till 11.45  
am Sharp.

MODEL AT-4



MODEL AT-T



## THE RECIPE FOR SUCCESSFUL EXPERIMENTS

*First take your breadboard . . .*

Model	E. & O.E.	Tax Exempt	Tax Paid
AT-DN	Bus strip with 100 tie points	1.94	2.28
AT-TN	Breadboard with 640 tie points	7.40	8.70
AT-2N-1	One breadboard with one bus strip	9.45	11.10
AT-2N	One breadboard with two bus strips	10.98	12.90
AT-2NA*	As above but with screw terminals and bass plate	15.66	18.40
AT-4N-3*	As above but with two breadboards one bus strip	19.17	22.52
AT-4N-1*	As above but with two breadboards three bus strips	23.00	27.03
AT-4N*	As above but with two breadboards four bus strips	24.49	28.78
AT-6N*	As above but with three breadboards five bus strips	34.83	40.93

ASTERISK DENOTES THAT THIS ITEM COMES COMPLETE WITH  
MOUNT BASE AND TERMINALS

**THE BEST QUALITY AT COMPETITIVE PRICES**

**MAIL ORDERS TO:** MAIL ORDER DEPT. E.T.  
Radio Despatch Services  
869 George St., Sydney 2000 Ph (02) 211 0191, 211 0816.

## The ultimate in frequency counting

Philips' compact, microcomputer-based frequency counters offer outstanding accuracy over a 10 Hz to 1500 MHz measuring range, plus many powerful new performance features.

Choose from the 120 MHz PM 6673, 550 MHz PM 6674, directly-gated 600 MHz PM 6675 or 1500 MHz 6676.

Microcomputer-controlled reciprocal counting eliminates the traditional  $\pm 1$  cycle error, ensuring maximum accuracy at low frequencies. So now you get at least 7-digit resolution per second of measuring time. And automatic switchover to conventional counting at 10 MHz guarantees peak performance at higher frequencies.

Advanced front-end circuitry provides error-free triggering, with excellent noise immunity over a wide dynamic range. In addition, there's a choice of five timebase crystal oscillators — with even the most stable version ( $5 \times 10^{-10}/24$  h) battery-operable for field use.

Interface options including the IEC 625/IEEE 488 bus also put programming capability at your disposal for production and quality assurance testing.

Maximum input sensitivity is a high 10 mV, and facilities are included for burst and multiple burst frequency average measurements.



From Philips, of course

For more detailed information phone  
Philips Scientific and Industrial  
Equipment:  
Sydney — Graham Adams or  
Mike Meechan 888 8222  
Melbourne — Ralph Brown 690 6366

Brisbane — Eleanor Futter 44 0191  
Adelaide — Duncan Glenn 223 4022  
Perth — Lois Woodcock 277 4199  
NEW ZEALAND  
Wellington — Steve Morris 859 859



Test & Measuring  
Instruments

**PHILIPS**

AHEARNSI 51

# ELECTRONIC GAMES AT DIRECT IMPORT PRICES

**ALL NEW POCKET COM II MINI TWO WAY**

A full 2-way transmission and a size that fits secretly into your pocket. A great gift for any child. Buy a few and start a 'spy ring'! No licence required.

**ONLY \$995**

Cat D-1101



**SAVE \$200 ON THIS PEN/WATCH**

A superbly styled silver ball-point pen complete with an LCD digital clock inside the pen. Shows day date and seconds.

**NORMALLY \$995 THIS \$795 NOW**

Cat Y-1030



**SHOP BY PHONE**

 (02) 888 3200

QUOTE YOUR BANKCARD NUMBER

**NOW A DIGITAL WATCH AT A DICK SMITH PRICE**

This watch features a digital readout, stop watch, countdown timer, hourly chime, plus visual and audio alarm warnings with attractive liquid crystal display.

**ONLY \$4450**

Cat Y-1045



**SPEAK & SPELL**

Helps develop skills in spelling, pronunciation and reading. It pronounces the word and can tell you whether your answer is correct.

**ONLY \$8300**

Cat Y-1300

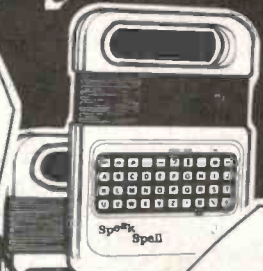

**SPEAK & READ**

The Speak and Read™ helps beginning reading skills. It introduces more than 250 of the most basic English words.

**ONLY \$9900**

Cat Y-1313



**SPEAK & MATH**

This amazing unit can generate over 100,000 math problems. It will also talk to you telling you what the problem is and whether you are right or wrong.

**ONLY \$8900**

Cat Y-1310



**SEE & HEAR SONIC INVADERS**

Looks like something out of Star Wars! It has a multicoloured display with realistic sound effects.

**AMAZING \$4900 VALUE**

Cat Y-1153



**NEW NEW! WORLD WATCH**

Now you can tell the time anywhere in the world! In 20 different time zones.

**VALUE \$6495**

Cat Y-1051



**ENHANCE YOUR DECOR CUTIE PHONE**

The very latest in modern phones. When not in use the mouth piece sits conveniently folded. It has attractive push button keys, with a memory re-dial for engaged calls.

**WAS \$7200 NOW \$5500**

SAVE \$1700

NOTE: Not Telecom permitted

Cat Y-1179



**ECONOMY TV GAME**

Turn your old black and white TV into a games centre with this unit. Four great games ideal for the whole family.

**WHY PAY MORE \$1995**

Cat Y-1170



**WHY PAY MORE LCD CALCULATOR**

This ultra-slim handy calculator is great for school, home, office in fact anywhere. Supplied complete with batteries and instructions.

**WAS \$2950 NOW ONLY \$995**

Cat Q-3022



**COMPARE WITH UNITS COSTING A \$1000 OR MORE**

**COMPUTER CHESS**

Become a chess grandmaster with six graduated levels of learning to increase your skills. It even plays against itself.

**\$275**

Cat Y-1260



**DICK SMITH Electronics**

SEE PAGE 34 FOR ADDRESS DETAILS



DSE/A235/SB

# Ideas for Experimenters

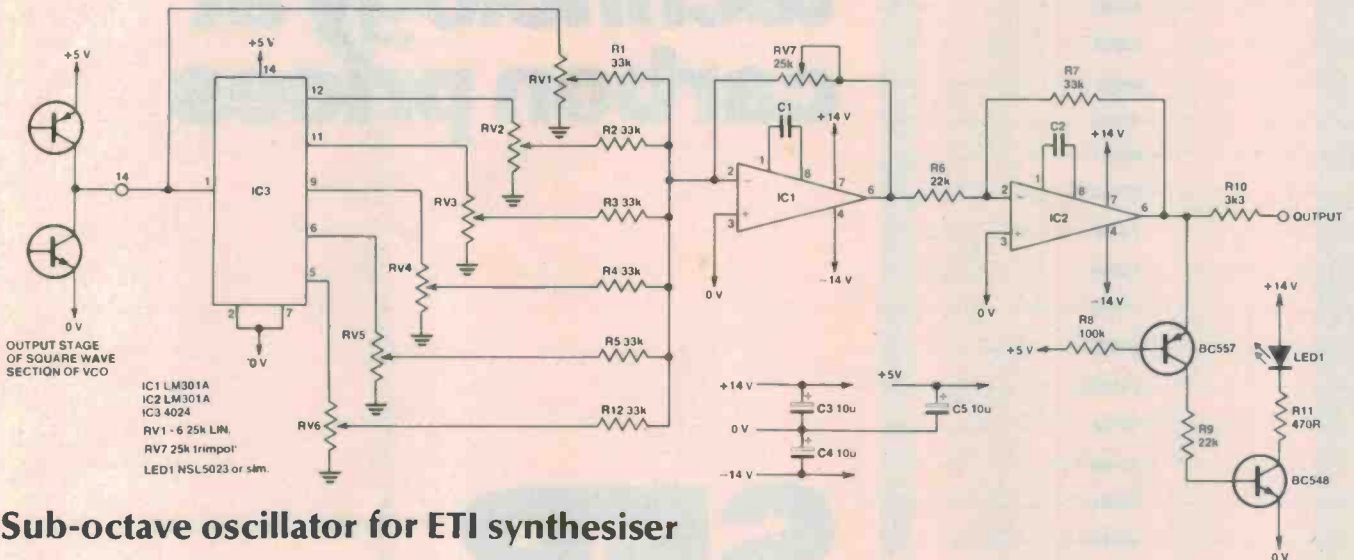

## Sub-octave oscillator for ETI synthesiser

Ken Stone, of Cheltenham in Victoria, devised this sub-octave oscillator for his ETI synthesiser and passes it on for other ETI synth owners.

Each sub-octave is created in the 4024 (IC3) by the division of the original frequency. Five sub-octaves are created and mixed together, along with the orig-

inal square wave, in a mixer which is based on the synthesiser's mixer (board 601b). No level control is put on the front panel; level can be adjusted by RV7. This is because the unit is installed between one VCO's square wave out position on the waveform selection switch of the VCO, allowing the volume

to be controlled by the existing mixer.

When using the unit, switch the VCO 'range' control to one of the higher frequencies.

The sub-octave unit could be mounted in a utility box bolted to the top of the synthesiser. It can be used to create 'warm' and deep 'feelable' sounds.

## Pick the winner!

This idea, from J. Gallant of Tasmania, is useful in competition situations to provide an impartial method of determining which competitor pressed a button first.

The circuit operates as follows. IC1a and b operate as a square wave oscillator with a frequency of about 1 kHz. This clocks the 4017, causing it to scan the switches. If one is closed, the high from the 4017 output will be fed through that switch to the 4017 CE input, which then keeps that output high. At the same time, the appropriate LED is turned on, and the speaker emits a 1 kHz tone.

Now, IC1d and e form a monostable with the input to IC1d normally kept low by IC1e, which has its input pulled high by the 180k resistor on its input. Thus the output of IC1d is normally high, so C1 is discharged. When the input to IC1d is pulled high by the closed switch, its output goes low, pulling down the input to IC1e through C1. C1 now starts to charge up through the 180k resistor. When the voltage across

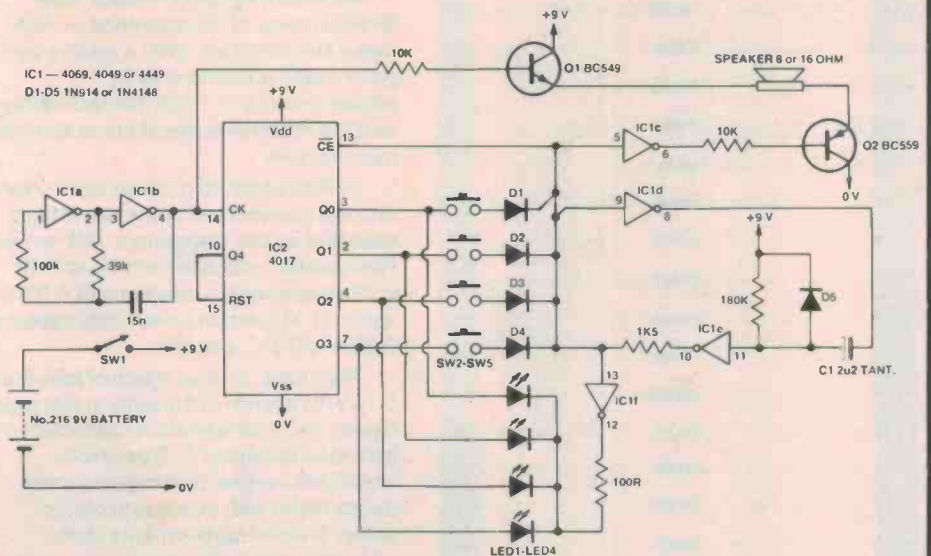

it reaches the inverter input threshold, the monostable reverts to its original state and C1 discharges through D1. The LEDs and speaker are then turned off; the monostable period is about two seconds.

Current drain is fairly low in the

quiescent state and a 216 type 9 V battery will power this circuit for a fairly long time, as it is normally only used intermittently. None of the components are critical, and the oscillator frequency and monostable period could be changed if desired.

# Metal Film technology at carbon prices

# SFR

## Standard Film Resistors

# PHILIPS

At last. A range of metal film resistors with improved performance over carbon film types, at the low prices you'd expect to pay for carbon film resistors!

We're talking about Philips' new SFR25 range of 5% tolerance — ¼W metal film resistors. With a quality and price made possible only by advancements in metal film technology and the massive scale of our automated manufacture.

SFR25's feature a 'clean lead' finish and are constructed to the same high standard as the Company's 'MR' series. Resistance coverage from 1Ω to 1MΩ (E24 values) with a tolerance of ±5% is assured. Maximum power dissipation is 0.33W at 70°C ambient.

They have a noise figure of less than 0.1 μV/V (a tenth of the carbon film noise figure) and a temperature coefficient of less than 250ppm/°C. Even more important, neither parameter shows degradation with increasing ohmic value. These improvements stem primarily from the homogeneity and stability of the resistive deposition.

So there you have it. Another quality product, ahead of its time, from Philips.

For further information phone:

**Philips Electronic Components and Materials,**  
P.O. Box 50, Lane Cove, 2066. Phone: Sydney 427 0888,  
Melbourne 544 2444, Adelaide 45 0211, Brisbane 44 0191 Perth 277 4199.



**Electronic  
Components  
and Materials**

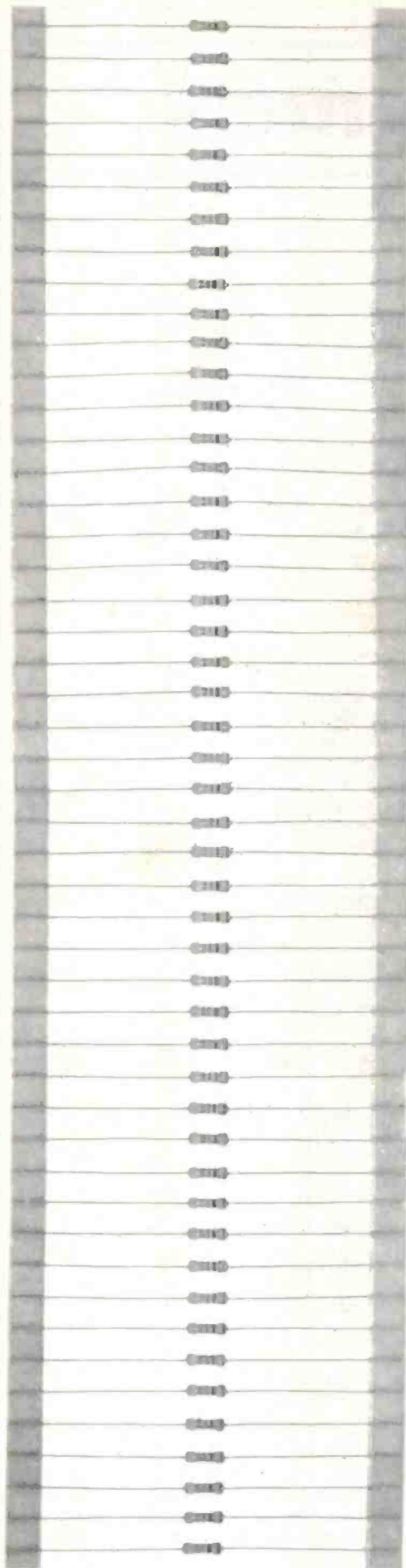

# Ideas for Experimenters

## Temperature probe for a DMM IDEA OF THE MONTH

The circuit diagram below is for an adaptor unit which converts a digital multimeter, which has a 200 mV range, into a digital thermometer. The temperature can be read directly, as 1 mV corresponds to 1°C.

As shown, the circuit can be regarded as two sections. Section A is a regulated battery power supply. This is based on a circuit in ETI, Feb. '82 (p. 21). As configured, the output voltage is 7.4 V. Section B is the actual temperature transducer. The LM334 is a temperature controlled current regulator. Its current,  $I_t$ , is given by the equation:

$$I_t = F \cdot T_k$$

where  $T_k$  is the temperature in °K, and F is the current-to-temperature ratio. The value of F is set by adjusting RV3. In this circuit F is set to 1  $\mu\text{A}/^\circ\text{K}$ .

Now, RV2 is set to 1k so the potential drop across it,  $E_t$ , is given by:

$$E_t = I_t \cdot 1000$$

Therefore, substituting for  $I_t$ , using the first equation and the given value of F, we find:

$$E_t = 10^{-6} \cdot T_k \cdot 10^3$$

and so,

$$E_t = T_k / 1000$$

Hence the potential drop across RV2 (in millivolts) corresponds *directly* to the temperature of the LM334, in °K.

However, we want the temperature to

Ian Hogan, Linden Park SA

be in °C, and we know that:

$$T_k = T_c + 273.2$$

where  $T_c$  is the temperature in °C. So the 47k resistor and RV1 are set up as a voltage divider, to provide an offset voltage of 273.2 mV. So the voltage across the multimeter plugs, in millivolts, corresponds directly to the temperature of the LM334, in °C, as desired.

The device was built on a small piece of Veroboard, and housed in a very small zippy box. The banana plugs for the multimeter were screwed directly onto the back of the box, so the unit sits on top of the multimeter. The LM334

was put into a probe on the end of a short piece of cable. The leads were soldered onto the cable, and each covered with heat-shrink tubing to prevent shorts. The probe body was formed from a larger piece of heat-shrink tubing. The top half of the LM334 was allowed to protrude, to provide good thermal contact with the body being measured.

Before the leads to the probe are connected, adjust RV2 to 1k as accurately as possible. Then adjust RV1 to give 273.2 mV potential drop. Finally, with the probe connected and immersed in ice water, adjust RV3 so that there is no potential drop across the multimeter plugs. The probe should be wrapped in plastic to protect it from direct contact with the ice water.

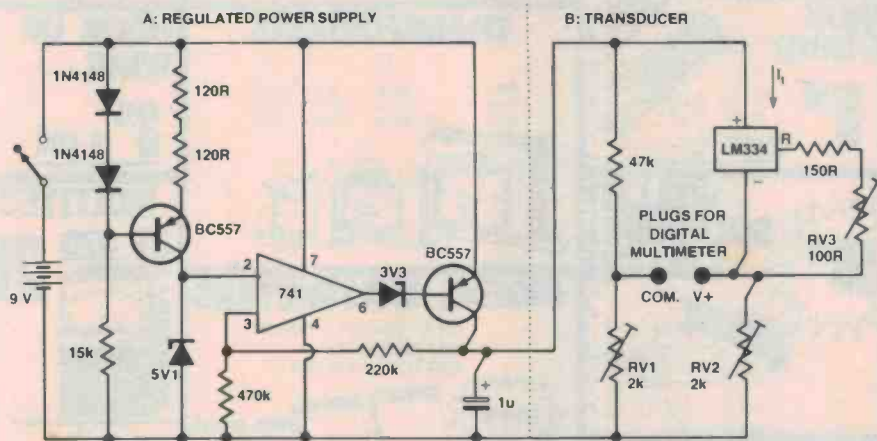

## ★ 'IDEA OF THE MONTH' CONTEST ★

Scope Laboratories, who manufacture and distribute soldering irons and accessory tools, have offered to sponsor a contest with a prize to be given away every month for the best item submitted for publication in the 'Ideas for Experimenters' column — one of the most consistently popular features in ETI. Each month we will be giving away a Scope Panavise pc board holder, model 333 — as described in News Digest, p.8, October '81 issue. Selections will be made at the sole discretion of the editorial staff of ETI Magazine. Apart from the prize, worth about \$70, each winner will be paid \$10 for the item published. You must submit original Ideas of circuits which have not previously been published. You may send as many entries as you wish.

### RULES

This contest is open to all persons normally resident in Australia with the exception of members of the staff of Scope Laboratories, Murray Publishing, Offset Alpine, Australian Consolidated Press and/or associated companies.

Closing date for each issue is the last day of the month. Entries received within seven days of that date will be accepted if postmarked prior to and including the date of the last day of the month.

The winning entry will be judged by the Editor of ETI, whose decision will be final. No correspondence can be entered into regarding the decision.



Winner will be advised by telegram the same day the result is declared. The name of the winner, together with the winning idea, will be published in the next possible issue of ETI.

Contestants must enter their names and address where indicated on each entry form. Photostats or clearly written copies will be accepted but if sending copies you must cut out and include with each entry the month and page number from the bottom of the page of the contest. In other words you can send in multiple entries but you will need extra copies of the magazine so that you send an original page number with each entry.

This contest is invalid in states where local laws prohibit entries.

Entrants must sign the declaration on the coupon that they have read the above rules and agree to abide by their conditions.

### COUPON

"I agree to the above terms and grant Electronics Today International all rights to publish my Idea in ETI Magazine or other publications produced by them. I declare that the attached idea is my own original material, that it has not previously been published and that its publication does not violate any other copyright".

\* Breach of copyright is now a criminal offence.

Title of idea .....  
 Signature .....  
 Name .....  
 Date .....  
 Address .....  
 Postcode .....

Cut out and send to: Scope/ETI 'Idea of the Month' Contest, ETI Magazine, 15 Boundary St, Rushcutters Bay NSW 2011.

# ROD IRVING ELECTRONICS

425 HIGH STREET, NORTHCOTE 3070, MELB, VIC PH (03)4898131 TELEX 38897

## RACK MOUNTING BOXES

19 X 5 1/2 X 12"	\$45.00
19 X 6 X 10"	\$39.95
19 X 5 1/2 X 12"	\$55.00
19 X 7 1/2 X 12"	\$79.00
19 X 10 X 12"	\$89.00
SERIES 5000	\$55.00

## CABINET OF 16 DRAWERS

PUT ALL YOUR BITS & PIECES AWAY IN THESE INCREDIBLY CHEAP CABINET OF DRAWERS.



**12<sup>00</sup>**

## JIFFY BOXES

UB1 - 150 X 90 X 50	\$1.80
UB2 - 196 X 113 X 60	\$2.75
UB3 - 130 X 68 X 41	\$1.50
UB5 - 83 X 54 X 28	\$ .90



## ROD CUTS PRICES ON CANNON CONNECTORS

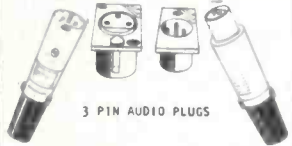

3 PIN AUDIO PLUGS

	1-9	10 UP
LINE SOCKET -	\$2.70	\$2.60
PANEL PLUG -	\$1.70	\$1.60
LINE PLUG -	\$1.60	\$1.50
PANEL SOCKET -	\$2.90	\$2.80
XLR - LNE - 11C -	\$4.20	\$3.90
XLR - LNE - 32 -	\$2.90	\$2.50

ALSO AC POWER CONNECTORS AVAILABLE

## HORN SPEAKERS

**NOW ONLY 6<sup>75</sup>**

## PANELMETERS

PM65	0-10V	\$10.00	\$9.00
PM65	0-20V	\$10.00	\$9.00
PM65	0-100uA	\$10.00	\$9.00
PM65	0-10A	\$10.00	\$9.00
PM65	0-50uA	\$8.50	\$7.50
PM65	0-100uA	\$8.50	\$7.50
PM65	0-50uA	\$6.50	\$5.50
PM65	0-10A	\$6.50	\$5.50
PM65	0-10A	\$6.50	\$5.50
PM65	0-10A	\$6.50	\$5.50

## CONNECTORS DB 25

DB25P - PLUG -	1-9	10 +
DB25S - SOCKET -	\$3.90	\$3.50
DB25C - COVER -	\$4.90	\$4.50
	\$2.20	\$1.80

**SAVE**

## ALIGNMENT TOOL SET

**2<sup>95</sup> This month only 1<sup>95</sup>**

## SOLDERING IRON STAND

**5<sup>50</sup>**

## TRANSFORMERS

	1-9	10-19	20+
2851	\$2.90	\$2.50	\$1.90
2155	\$4.50	\$3.90	\$3.30
6672	\$5.50	\$5.40	\$5.10

## HOOK UP WIRE

**3<sup>75</sup> a roll**

## UNIVERSAL TEST LEAD KITS

**4<sup>95</sup> This month only 3<sup>95</sup>**

## WELLER SOLDERING STATION

**58<sup>50</sup>**

## DIGITAL MULTIMETERS

GREAT NEW AUTO RANGING MULTIMETERS AS ADVERTISED RECENTLY

**\$49.95 ME-533**

**\$59.95 ME-532**

## MULTITESTERS

**YF 370 28<sup>00</sup>**

**17<sup>50</sup>**

**YF 303 34<sup>00</sup>**

**21<sup>50</sup>**

**YF 10 2KU/V 9<sup>58</sup> VALUE**

## COMPUTER COOLING FANS

**16<sup>90</sup>**

115V 240V 4%

## COMPONENT SPECIALS

BF469	\$ .90
BF470	\$ .90
2114	\$1.95
4116	\$1.95
2708	\$4.50
2716	\$5.50
2732	\$9.50
TMP50	\$1.10

BATTERY SNAPS A STEAL AT 10c EACH

3AG FUSE HOLDER	50c
2AG FUSE HOLDER	50c

	1-9	10-99	100-999	1000
IN4148	.06c	.05c	.04c	.03c
IN4001	.06c	.05c	.05c	.05c
IN4002	.06c	.05c	.05c	.05c
IN4003	.06c	.05c	.05c	.05c
IN4004	.07c	.06c	.05c	.04c
IN4005	.09c	.08c	.07c	.06c
IN4006	.10c	.09c	.08c	.06c
IN4007	.12c	.09c	.08c	.07c

2.2 MF POLY	
400V CAPS	.90c
555	.25c
10 For	\$ 2.20
74C926	\$ 5.00
BC547	100 For \$ 9.00
BC558	100 For \$10.00
BC559	100 For \$10.00
BC548	100 For \$ 9.00

## CAPACITORS

	CAPACITY (uF)	VOLTAGE (DCV)	PRICE
33000	16V	\$21.70	2900 40V \$ 5.90
68000	16V	\$19.50	6800 16V \$ 5.75
100000	10V	\$19.50	10000 25V \$ 9.00
			10000 40V \$11.50
			15000 25V \$10.30
			22000 25V \$12.00
			22000 40V \$20.50
			27000 35V \$21.70

**HIGH QUALITY**

## COMPUTERS OF THE DECADE Sorcerer Mk II - Dick Smith System 80

**? Ask Rod for a price ?**

## RELAYS

6 AMP CONTACTS PCB MOUNTING

12V SP	\$4.50
12V DP	\$5.50
24V SP	\$4.90
24V DP	\$5.90

We have the cheapest price on Philips speakers

Please debit my Bankcard

Bankcard No. \_\_\_\_\_

Expiry Date \_\_\_\_\_

Name \_\_\_\_\_

Signature \_\_\_\_\_

MAIL ORDERS: P.O. BOX 235 NORTHCOTE, VIC. 3070  
Min. P&P \$2.00. Mail Order Enquiries (03) 481 1436.



# Shoparound

THIS PAGE is to assist readers in the continual search for components, kits and printed circuit boards for ETI projects. If you are looking for a particular component or project — check with our advertisers if it is not mentioned here.

## ETI-645 Turtle Robot

As notified last month, a complete kit of parts for this project is being offered at a special introductory price by Flexible Systems, and ETI is acting as a clearing house for orders and despatching kits; see page 47 for further details. You can call into our Sydney or Melbourne offices during business hours to see a Tasman Turtle and purchase kits. In Sydney, you'll find us at:

4th Floor, 15 Boundary St,  
Rushcutters Bay.

In Melbourne, at:

22nd Floor, 150 Lonsdale St,  
Melbourne.

Note that 'Tasman Turtle' is a registered trademark of Flexible Systems.

## ETI-498 PA Amp

This project will be widely available, most kit suppliers having indicated they will be stocking it in one form or another. The ETI-499 MOSFET power amp module used in the PA amp is readily available in kit form, too.

For those not constructing this kit in the case described in our article, components, pc boards, transformers, etc, should be readily available from kit and component suppliers. Suitable cases are legion! For those looking for something rugged, you should ogle a new range of rack-standard cases from Altronics in Perth. They're obtainable in standard rack heights with natural aluminium or black anodised finish. A standard 87 mm high box costs around \$45, has tons of room and should last a lifetime. Altronics are located at 105 Stirling St, Perth, (09)328-1599, or on the other side of P.O. Box 8280, Perth 6000 WA.

The Ferguson OP590 output transformers are the only ones we've been able to find for the job, but constructors should have few difficulties obtaining them. They aren't cheap, but they're way ahead of whatever's in second place!

## ETI-469B Sequencer

The ETI-469 Percussion Synthesiser featured in the April issue made mention of an add-on sequencer for

auto-rhythm accompaniment. This issue describes the promised sequencer and all suppliers carrying the percussion synthesiser kit have indicated they'll be stocking the sequencer. The only 'non-stock' component is the 250k/A tempo potentiometer, but, as one was required in the synthesiser, constructors should have little trouble obtaining one — for those assembling the unit for themselves. In any case, a 100k/A pot may be substituted, as explained in the text.

## PC Boards, panels etc.

Almost every pc board ever published by ETI may be obtained from the following firms:

RCS Radio  
651 Forest Rd  
Bexley NSW 2207

All Electronic Components  
118 Lonsdale St  
Melbourne Vic. 3000

In addition, many of our boards are stocked by Radio Despatch Service or, if they haven't got your requirements in stock, can have them made to order for you. Here they are:

Radio Despatch Service  
869 George St  
Sydney NSW 2000

The same three firms can provide front panels for our projects, too.

For the projects we've done over the past three or four years, many (if not most) pc boards and panels may be obtained through the following firms:

Mini Tech  
P.O. Box 9194  
Auckland N.Z.

James Phototronics  
522 Grange Rd  
Fulham Gardens S.A. 5024

Sunbury Printed Circuits  
10 Counihan St  
Sunbury Vic. 3429

Jemal Products  
P.O. Box 168  
Victoria Park W.A. 6100

Rod Irving Electronics  
425 High St  
Northcote Vic. 3070

## Solderless Breadboarding Sockets

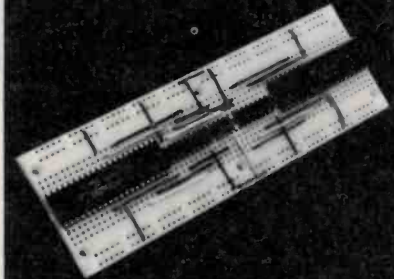

enable you to insert your electronic components directly — without soldering irons or adapters.

*Go from conception to working circuit in minutes.*

The highest quality socket in the industry now carries a lifetime guarantee. Should the SK 10 ever break, be damaged or fail to perform as described, return it for a free replacement. No questions asked.

We can offer such a guarantee because the SK 10 is a top quality socket built tough for years of use. Integrated circuits and discrete components insert directly without adapters. No patch cords needed. And of course, no soldering.



**ELECTRONIC  
DEVELOPMENT SALES  
PTY LIMITED**

92 CHANDOS STREET, ST. LEONARDS  
P.O. BOX 217 ST. LEONARDS, N.S.W. 2065  
AUSTRALIA  
TELEPHONE: 438 2500 438 2412  
TELEX AA 25963

### DISTRIBUTORS

N.S.W.: DGE SYSTEMS  
103 Broadmeadow Road, Broadmeadow  
Phone: (049) 69 1625

### MACELEC ELECTRONIC

99 Kenny Street, Wollongong 2500  
Phone: (042) 29 1455

### A.C.T.: ORTEX PTY LTD

5B Cumberland Court, Wollongong Street, Fyshwick 2609  
Phone: (062) 82 4995

VIC: STEWART ELECTRONIC COMPONENTS PTY LTD  
44 Stafford Street, Huntingdale 3166  
Phone: (03) 543 3733

S.A.: GRAPHIC ELECTRONIC INDUSTRIES PTY LTD  
41A Rundle Street, Kent Town, 5067  
Phone: (08) 42 6655

### W.A.: RESERVE ELECTRONICS

5 Bookham Street, Morley 6062  
Phone: (09) 275 2377

QLD: FRED HOE & SONS PTY LTD  
246 Evans Road, Salisbury North 4107  
Phone: (07) 277 4311

# TURN YOUR OLYMPIA ES100 TYPEWRITER INTO A WP PRINTER AND COMPUTER TERMINAL FOR

# \$245

(Exc. tax)

In 20 minutes your typewriter can also become an RS232 compatible hard-copy terminal and a Word Process quality printer. Do-it-yourself, or for a small extra charge, we will do the conversion for you.

Buy from the sole manufacturer and Save.

DEALER INQUIRIES WELCOME

**SME**  
SYSTEMS

PEN 194 B

22 Queen Street, Mitcham, 3132. Phone (03) 874 3666. Telex: AA37213.



MARC NR82FI \$315

## ULTRA SENSITIVE 12 BAND COMMUNICATIONS RECEIVER

OFFERING TRUE WORLD-WIDE  
LISTENING COVERAGE!

### NEW-MARK NR82FI

**FEATURES**

- 12 BANDS LW/MW/4-SW/5-VHF/UHF WITH DIGITAL FREQUENCY COUNTER
- FREQUENCY COVERAGE 145 KHZ TO 479 MHZ
- 3 WAY POWER AC/BATTERY/CAR BATTERY
- .8 MICROVOLT SENSITIVITY ON VHF BANDS
- CONTROLS FOR SQUELCH, RF GAIN, BFO
- ANTENNA ADJUSTMENT NARROW/WIDE SENSITIVITY, BASS, TREBLE & DIRECT TAPING FACILITY THROUGH DIN SOCKET. DIMENSIONS 452 x 288 x 130 (WHD) mm.

APG



RADIO PARTS  
GROUP

MELBOURNE AUSTRALIA  
562 Spencer St., West Melb. 3003  
(03) 329 7888  
1103 Dandenong Rd., E. Melvem  
(03) 211 8122

Manual Temperature Controlled  
5 Second Heat.

‘BEST VALUE FOR MONEY’

## MINI SCOPE



Model MS

- \* FAST 5 SECOND HEAT UP
- \* FINGER TIP TEMPERATURE CONTROL
- \* FINGER TIP WATTAGE CONTROL
- \* FAST COOL DOWN
- \* COOLER BARREL AND HANDLE

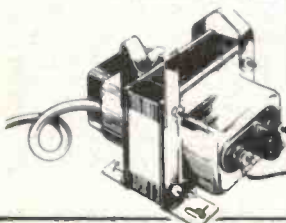

**SCOPE**  
3.3 VOLT SAFETY  
TRANSFORMER  
CODE: TF

\* Comment made by Ian Truscott

## IAN J. TRUSCOTT ELECTRONICS

Cnr Eastfield & Bayswater Roads,  
South Croydon, Victoria  
Telephone 723 3860

WE CARRY A COMPREHENSIVE RANGE  
OF ELECTRONIC COMPONENTS  
AT VERY KEEN PRICES

as well as

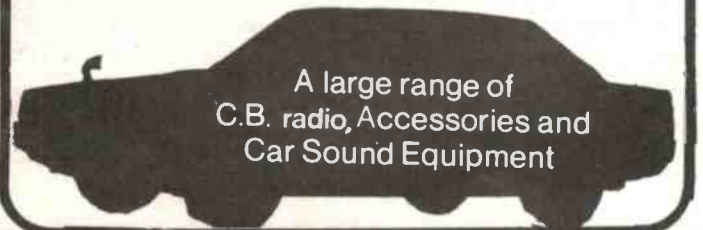

A large range of  
C.B. radio, Accessories and  
Car Sound Equipment

# COMMUNICATIONS

## VK2ETI on the air!

The Electronics & Communications Club of Murray Publishers, publishers of ETI and 21 other specialist titles, has been granted the callsign of VK2ETI following representations to the D.O.C. when renewing this year's licence.

The club, formerly known as the Modern Magazines Electronics & Communications Club, recently changed its name as the publishers had a name change. The club had held the callsign VK2DTE since October 1980.

VK2ETI does not have a 'fixed' set-up as yet, but plans are afoot. The club station has been activated on two metres recently. If you hear us on the bands, give us a call!

### Shuttle comms

Like a boy scout — be prepared for the next Shuttle flight. You can receive Shuttle downlink frequencies if you have the right equipment, some being in the SHF 'S' band, others being on VHF.

In the 'S' band, the astronaut voice downlink frequencies are centred on 2287.5 MHz primary and 2217.5 MHz secondary. You may also find FM data transmissions and TV signals around 2205 and 2250 MHz.

Back-up communications may

be found on 243.0 MHz, 259.7 MHz and 296.8 MHz, predominantly on voice. You're going to have to be resourceful with your receiving system as very little commercially available gear covers those bands. But it could be interesting...



### Spurious sidebands

Phase IIIB OSCAR launch has been delayed until this month owing to a problem with a recently launched European Space Agency satellite yet to be solved. Apparently, a plasma ring formed around the satellite causing corona discharge problems, and a 'freeze' on future Arienne launches has been implemented until it's solved. (Westlink Report).

**BY1PK, Peking, China** is on the air. Reported operational since March 25, when the Communist Chinese government authorised limited 'club station CW-only operation on 15 and 20 metres'. 21 030 kHz is reported to be the best frequency, 0200-0600 Z daily. (Westlink Report).

**Six metres hot** with activity levels and dx reported as 'better than last year'. Long haul VK5 to W5 (South Australia — Texas) contacts have been noted amongst some good openings to the Pacific and Asian regions. Their sunspots have a lot more life in them yet! (Thanks to Graeme, VK2ZZV).



### 'Pro' scanner from Tandy

Tandy's PRO-2002 scanning receiver covers the range from around 70 MHz to 500 MHz in four bands and can be run from 240 Vac mains or 12 Vdc supply.

The receiver, manufactured under the Realistic label, covers 68-88 MHz, 108-136 MHz, 144-174 MHz and 410-512 MHz, and features a comprehensive digital display that can show channel number, time and frequency with ease.

The PRO-2002 can handle both AM and FM transmissions at the push of a button and is promoted as their 'Rolls Royce' scanning receiver. It sells for \$495.95 retail, catalogue No. 20-9116. Enquire at your nearest Tandy outlet.

### New Vicom releases

Vicom International recently released a new range of VHF/UHF power amplifiers, SWR meters and antennas.

Seven new Tono VHF/UHF amplifiers were released, five for 2 m with outputs ranging up to 210 W. One model, designed for the handheld owner, delivers 45 W from 3 W input. Most feature an in-built preamp giving up to 13 dB gain. Two 70 cm band models were also released with outputs of 45 W and 65 W, the latter also featuring a preamp.

Three new Daiwa meters have been added to Vicom's extensive range, all featuring the unique 'cross needle' principle. The CN630 N is designed for the serious VHF/UHF enthusiast, being identical with the popular CN630 but having N connectors fitted. Specified frequency range is 140-450 MHz, and power ranges are 20 and 200 W fsd. In addition, the new CN510 is a compact unit covering 1.8-60 MHz and power ranges of 20 and 200 W. The model CN540 is also new to the range, being identical with the CN150 but covering 50-150 MHz.

Three new antennas have been added to Vicom's collection: the GPV5, a 2 m collinear comprising two 3/4 waves in phase plus decoupling radials with a height of 1.7 m



and a claimed gain of 6.8 dB; the GPV7, a 70 cm collinear comprising three 3/4 waves in phase plus decoupling radials with a height of 1.7 m and claimed gain of 6.8 dB; and for the dual band enthusiast, there's the GPV720, designed for operation on both 2 m and 70 cm. Again a collinear, it has a height of 1.1 m and a claimed 2 m gain of 2.8 dB and 70 cm gain of 5.7 dB.

For further information on these products contact Vicom International, 57 City Rd, South Melbourne, Vic. (03)62-6931, or 339 Pacific Highway, Crows Nest, NSW, (02)436-2766.

# THE DICK SMITH SYSTEM 80 — TRS 80 SOFTWARE CATALOGUE

DICK SMITH'S Program Catalogue for 1982

## System 80

& also suitable TRS-80 with Level II BASIC

**Educational Software**  
A great way to introduce your kids to the world of computers. Our wide range of games and educational software will keep your children entertained and learning at the same time.

**Business Software**  
The business software in this catalogue is specially designed to help your business become more efficient and profitable.

**GAMES**  
There are over 100 exciting games in this catalogue. They range from simple puzzles to complex strategy games. All are designed to give you hours of fun in the comfort of your own home.

**NEW - BETA BLITZ**  
A new and exciting game that will keep you on the edge of your seat. Be the first to reach the top of the mountain.

**NEW - TYPING TUTOR**  
Large stacks of data to speed up your typing.

**NEW - DAT FILE**  
A new and exciting game that will keep you on the edge of your seat. Be the first to reach the top of the mountain.

**FREE**

Dick Smith brings you this superb catalogue choc-a-bloc full of software for your System 80 (and TRS 80 with Level II BASIC).

Inside are details of:

1) Educational Software, a great way to introduce your children to the growing world of computers.

2) Business Software, specially designed to help make your business more efficient and profitable.

3) Games, with plenty of excitement to give endless hours of fun in the comfort of your own home

**AVAILABLE IN ALL STORES!**

Why not call in to your nearest Dick Smith retailer and pick one up, or send the coupon below.

**SEND TO:  
INTERNATIONAL MAIL ORDERS  
DICK SMITH ELECTRONICS  
PO BOX 321, NORTH RYDE  
NSW 2113**

Please send me a copy of the Dick Smith Software Catalogue.

NAME .....

ADDRESS .....

DSE/A227M/PAI

## short circuits

# Centre zero LED bar/dot meter

D.H. Dawes  
Granville NSW

THIS CIRCUIT drives twenty LEDs with a single bar/dot driver. Ten LEDs (green) are for a positive input signal and ten LEDs (red) for a negative input signal. A yellow LED, which is lit permanently, gives the centre zero indication. The LEDs would, for best effect, be mounted on a panel as shown below:

CENTRE ZERO BAR/DOT METER

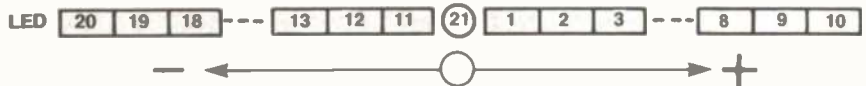

When used in the bar mode, the bar of light elongates to the left for an increasing negative signal and to the right for an increasing positive signal.

The circuit runs from a single 12 Vdc supply. A 5 V regulator is included, which serves both to power the LEDs and to provide a reference line for the positive and negative input signals.

IC1 is connected as a simple (but effective) 'absolute value' amplifier. This drives the LM3914, which will only accept positive input signals. IC2 is connected as a comparator, and serves as a polarity indicator. When the input is positive the output of the comparator is high, which drives Q3 via ZD1 and Q2, enabling LEDs 1-10.

When the input is negative, the output of the comparator swings low,

switching off Q3 and switching on Q1, which enables LEDs 11-20. As there is no gain in the absolute value amplifier, the full-scale reading is equal to that set by the internal reference of IC3. This means that the full-scale value of this circuit is about  $\pm 1.2$  V. This value can be altered by conditioning the required

input signal. The LM3915 may be substituted for the LM3914 if a logarithmic, rather than a linear, scale is desired.

This circuit can, apart from its obvious applications as a general centre zero meter, be used to display the difference between two voltage levels, e.g: a reference level and an unknown level. In this application the position on the circuit marked 'A' would be separated from the +5 V line and would be connected to the reference voltage. The unknown voltage to be compared would be connected to the input terminal. Both the reference and the unknown would be referred to 0 V. The only limitation is that the reference voltage should be between 4 and 8 volts above 0 V when using a 12 V supply.

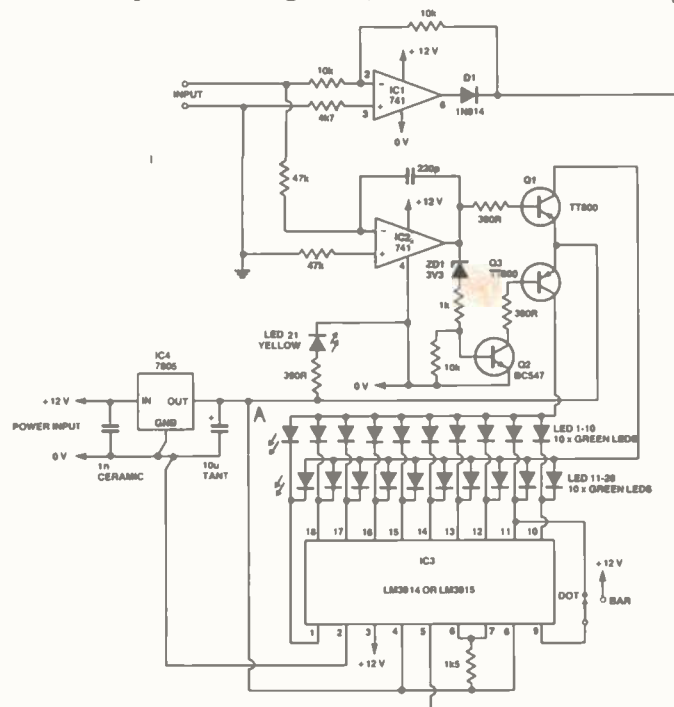

# COMPUTER REFERENCE GUIDE'S

# SOFTWARE HANDBOOK.

## Contents

### PART I INTRODUCTORY INFORMATION

*Chapter 1. Introduction*

*Chapter 2. How To Use This Handbook*

### PART II MAJOR VENDOR SOFTWARE & HARDWARE DESCRIPTIONS

*Chapter 3. Minicomputers and Medium Scale Computers.* This chapter describes all software products from major minicomputer and medium scale computer manufacturers categorized by application type. Software products described include Operating Systems, Application Packages and Utilities. The different high-level languages applicable to the various models are listed. Just as importantly it also provides details on hardware systems and configurations allowing software products to be matched to hardware capabilities. 22 different company reports are included.

*Chapter 4. Microcomputers.* Covers identical features as for Chapter 3 except now for microcomputers. At least 60 different company reports are included.

*Chapter 5. Industry Standard Microcomputer Software Packages.* Includes descriptions on major industry standard operating systems, languages, utilities and application packages for microcomputer systems.

### PART III INDEPENDENT SOFTWARE PACKAGES

*Chapter 6. Software Packages From Independent Vendors.* This chapter covers software supplied by independent systems and software companies. This software is categorized by application type and includes over 70 different categories. Within each category, all suppliers are listed alphabetically. Each package listed and described includes the computer system type or types on which it runs.

### PART IV CROSS REFERENCE INDEXING & ADDRESSES

*Chapter 7. Cross Reference Indexing by Computer Type (Minicomputers & Medium Scale Computers).* This Chapter provides a detailed cross reference listing for software products by minicomputer and medium scale computer manufacturer. Each manufacturer is listed alphabetically and each software supplier is, in turn listed alphabetically, under each manufacturer. The various application category types of software are listed with each software supplier.

*Chapter 8. Cross Reference Indexing by Computer Type (Microcomputers).* This format is identical to Chapter 7 but contains microcomputer manufacturers.

*Chapter 9. Name and Address Listing.* This Chapter lists all hardware and software suppliers alphabetically with name, address, telephone number, and where possible Managing Director/General Manager, Sales Manager and Technical Manager.

The Australian Software handbook, released by Computer Reference Guide in March, has been designed to provide information and advice for prospective computer users and present computer users on software products available for most of the major micro, mini, and medium-scale computers sold on the Australian market. An important feature of this handbook is that it allows software packages to be indexed by two major criteria: Application and Machine type — providing easy reference according to need.

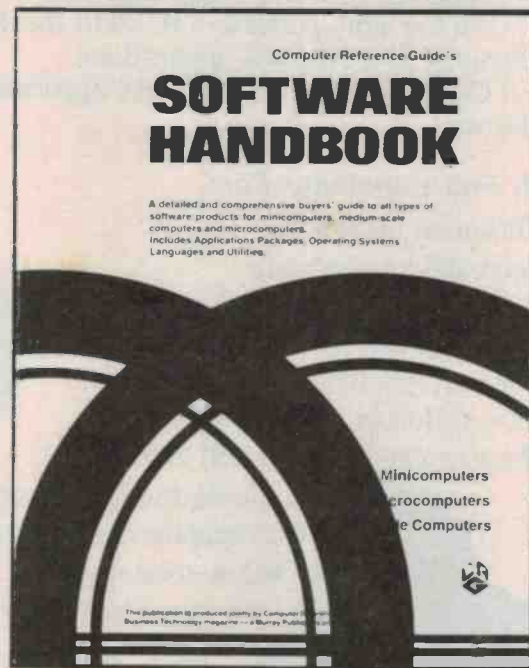

**For further information:**

COMPUTER REFERENCE GUIDE  
Suite 204, 284 Victoria Avenue  
Chatswood NSW 2067 Phone: (02) 419 3277

I would like to order: Computer Reference Guide's  
Software handbook.

Name: .....

Address: .....

Postcode: .....

Telephone: .....

I enclose my cheque for \$ .....

payable to Computer Reference Guide

or charge my Credit Card .....

Card No. .... Expiry date .....

Signature .....

**EACH COPY \$25.50**

**Postage and handling \$2.50.**

# “Why buy just a video game when you can get a full colour computer for this price.”

A computer like this would have been science fiction a few years ago. Now it's a reality. It's the Commodore VIC-20, a full-fledged, expandable colour computer that costs little more than video games.

Everybody loves video games and the VIC-20 has some of the best. But the Commodore VIC-20 can also help the kids with their homework and mum with her budgeting. Dad can even take the light, portable VIC-20 to the office for financial and business applications.

And Commodore has many more applications on the way.

## With Full Capability For:

- Education programs
- Recreational programs
- Personal computing
- Includes Microsoft, PET BASIC
- Full-size typewriter-style keyboard
- Easy to follow instruction manual
- Memory expansion to 32K RAM
- Connects to any TV set
- 66 graphic characters
- 25K total memory
- 4 sound generators
- 16 colours



## The computer for everyone.

The VIC-20 is the friendliest way we know to learn computing. It has a full computer keyboard even a small child can operate.

It plays music, has exciting graphics and lets you create pictures. It even tells you when you've made a mistake and how to correct it. The VIC-20 can take your children from pre-school through post-graduate studies.

Why get just another game that could end up in the closet? Get an honest-to-goodness computer for just \$399. Get the Commodore VIC-20.

Learn more about Commodore, the micro-computer you can depend on. Call or write for the name and location of your Commodore dealer nearest you.

**The Commodore Information Centre.**  
3 Campbell St., Artarmon NSW 2064. Phone: 437 6296.

 **commodore**  
COMPUTER

# COMPUTING TODAY

## Batchelor girl wins System 80!

### — December issue contest results

It was with a distinct feeling of *deja vu* that we selected the winner of the 1981 Dick Smith System 80 Contest — Ms Kay Pitman of Batchelor in the Northern Territory.

**Why the *deja vu* feeling? — both winners of the 1980 System 80 Contest (Sept. issue) were women! On top of that, entries for the 1981 contest far outstripped those for the 1980 contest — which was one of the most successful contests we'd ever run!**



It has taken us an enormous length of time to wade through the thousands of entries. Heavens, what a job! We were literally staggered at the response. Choosing a winner proved extremely difficult. There were many imaginative and clever entries, not forgetting quite a few who had innovative ideas as to how they would use a System 80.

Apart from a large number of entrants who said they'd use a System 80 for applications like schoolwork and games playing, we had entries ranging from an industrial chaplain who wanted to use it as a sort of 'computer ambassador' to

reduce computer fear, to a resident of King Island (where computers 'don't exist') who wanted to introduce islanders to the world of computers. There were entries from doctors who wanted to use the System 80 in statistical research into cancer, from teachers of the handicapped to aid in their work and from researchers and social workers who wanted to use the System 80 in their work with the unemployed. The variety of applications suggested are just too many to list here, but that's a representative sample.

What did the winner have to say? Here it is: "Can the heartbeat of the 'chip' decade serve those whose heartbeat has been in this land for 50 000 years? If I had a System 80 I know it could help span the years. I train traditional aboriginals as

teachers. The System 80 would be invaluable for vital research and curriculum development."

Congratulations, Kaye, you should be well advanced with your scheme for the System 80 by the time this appears in print. We wish you all success.

By the way, it might interest people to know that the Editor had to do a lot of persuading before he could get away with the 'Batchelor girl' crack in the heading of this article. He wants it firmly stated that he's neither sexist nor a bad speller — he just can't resist a good pun!

Finally, thanks to all those readers who entered and made the contest such a success.

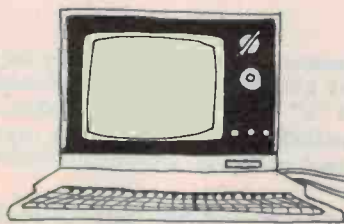
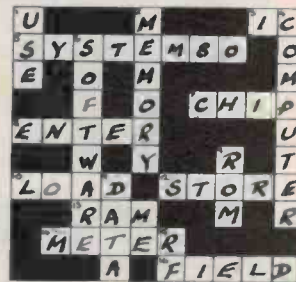

### Chromasette

Many readers know of CLOAD, the monthly cassette of seven programs from the US for TRS-80 Models I and III. There are far more buyers than subscribers, as most buy back issues through larger computer stores, avoiding the hassle of bank drafts.

You may not have heard of Chromasette monthly from the same stable. It contains six to eight programs for the TRS-80 Colour Computer, or '80C'.

It got off to a good start in July 1981, with entirely fresh programs. In honesty, Chromasette have tossed in the odd Model I/III program recharged for 80C, but rarely. They have a huge user-base to draw on for programs. Often these have

been so lengthy that they have had trouble squeezing them onto the tape, even though the 80C loads at 1500 baud (three times the Model I speed)!

Greg Wilson (P.O. Box 9, Potts Point NSW 2011) acts as their agent here.

For \$55 in our money you get a cassette airmailed from the US every month for a year. Back issues are not as cheap, at \$6 each.

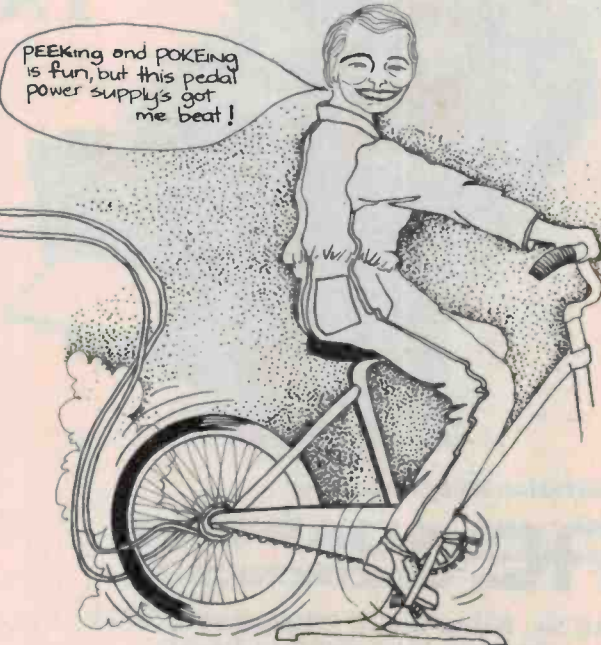

**NOW!**

# NEW PRODUCTS!

**NOW AVAILABLE**

**WAVE MATE INC.**

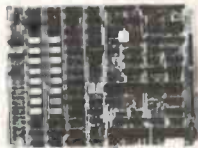

## THE BULLET-(SBC)" IS THE STATE-OF-THE-ART SBC

Standard features include:

- 4 MHz Z-80A CPU
- 128 K byte RAM
- Single/Double density floppy disk controller for both 5 1/4 and 8 inch drives.
- DMA to/from all I/O devices
- 2 serial ports
- Centronics printer port
- Hard disk interface
- Vectored interrupts
- Real time clock
- 5 volts only
- Enhanced C-BIOS

**\$995.00 + Sales Tax**

Dealer enquiries invited



**abacus**

## DELTA-SBC

- 4 MHz Z-80A CPU
- 64 K byte RAM
- Double density 5 1/4 and 8 Inch drives
- DMA
- 2 serial ports
- 2x parallel

**A & T ..... \$795 + Sales Tax**

**KIT..... \$595 + Sales Tax**

**BOARD.. \$175 + Sales Tax**

## CRT CONTROLLER

This intelligent CRT Controller is completely contained on a 6x6 1/2" printed circuit board. The design is based on an 8085A Microprocessor and an 8275 integrated CRT Controller. It features the following:

- 25 Lines, 80 characters/line
- 5x7 Dot Matrix
- 8085 CPU
- Two 8185s
- Two 2716s (1 for software, 1 for user programmable character generator)
- Serial interface RS232 and TTL
- Baud rates of 110, 150, 300, 600, 1200, 2400, 4800 & 9600.
- Keyboard Scanning System
- Uses +5V power supply and ±12V power supply.

**Bare Board \$89.95 + Sales Tax**

**512 Bridge Road, Richmond,  
Vic. 3121  
Telephone (03) 429 5844**

## Orange Micro

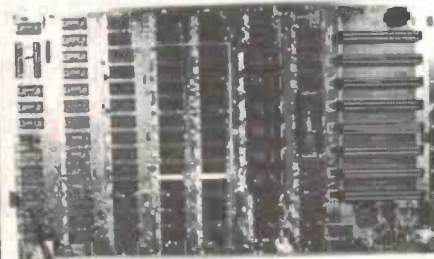

**(Price \$275.00 + Sales Tax)**

Features:

- runs Apple™ software.
- PAL is on main board, saves buying a PAL add on card.
- will take all add on cards as it has same type BUSS.
- board is fully socketed and has all passive components and crystal. Just add IC's, ROM's, keyboard, power supply and case.
- plug straight into your home colour TV via RF modulator and save on buying a monitor.

TM Reg trade mark of Apple Computers Inc.

# If you're still looking for the best 5 1/4" floppy — YOU HAVEN'T FOUND US YET!! TANDON TM100—S.



**Tandon's TM-100 family of mini-floppies offer the absolute highest storage capabilities of any 5 1/4" high-speed, random access disk drive available in two single head and two double head models, single and double density.**

**Unsurpassed Storage Capacity** - Up to an incredible 1000K bytes information on 160 tracks. Recording density is 5877 BPI.

**Advanced Dual-Head Design** - Tandon Magnetics has for years been the leading designer and supplier of read/write heads to most major disk drive manufacturers.

**Increased Throughput** - Tandon's TM-100 have a track-to-track access time of only 5 milliseconds (an incredible 3 milliseconds double track density.)

**Proven Reliability** - Designed for total reliability, as demonstrated by more than 50,000 production models in operation.

Australian Representative

**AE ADAPTIVE  
ELECTRONICS P/L**

**418 St. Kilda Road, Melbourne, 3004.  
Ph: (03) 267 6800 (4 lines).  
Telex: AA32565**

**MICROBASE (09) 328-9308  
CISA (02) 29-1599  
COMPAK (03) 592-6285  
TOOWOOMBA (076) 32-7542**



# Printout

## Four million pixels on hi-res CRT

The Philips M38-200, just released, is a new, very high resolution CRT which is capable of displaying four million (1728 x 2288) picture elements, say Philips.

It resolves the equivalent of 3000 TV lines in a nominal 15-inch (380 mm) diagonal format. This very high resolution permits the tube to give excellent quality graphic displays — or a minimum of 8000 complicated (including non-Roman or subscripted) characters in full detail, using for example an 18 x 32 dot matrix cell.

The M38-200 is said to be suitable for such applications as high-resolution facsimile systems, phototypesetting, CAD graphics, and full-page document displays in word processing.

The unrivalled resolution of the M38-200 is achieved by a specially designed electron gun in combination with the matching deflection coil, type AT1991. Distortion, deflection, defocusing and raster pin-cushion effects in the tube/coil combination are said to be negligible.

The same combination of tube and deflection unit can be used in both vertical (portrait) and horizontal (landscape) screen formats.

The M38-200 has a wide neck and a 70° deflection angle. Several phosphors are available, including W, WA and GH types, to match all applications.

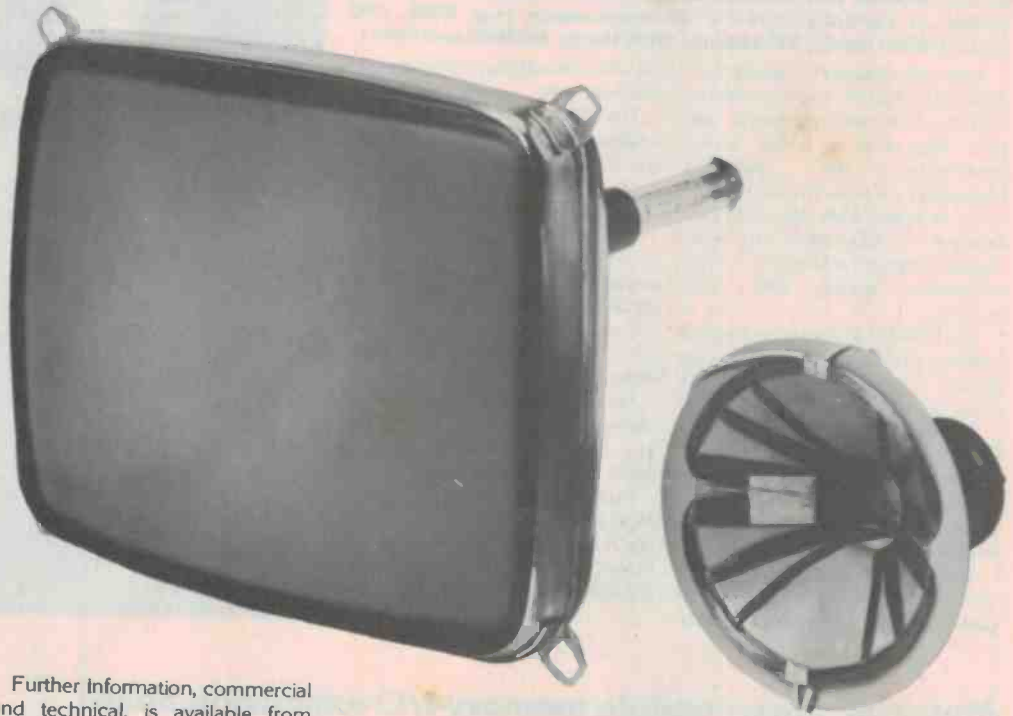

Further information, commercial and technical, is available from Philips Components, 67 Mars Road, Lane Cove NSW 2066. (02)427-0888

## ITOH 8510 dot-matrix printer

Software Source have released a new printer manufactured by C-ITOH Electronics, the 8510.

Priced at under \$900 including tax, the 8510 comes standard with friction and tractor feed, dot-programmable graphics, 100 character-per-second logic-seeking head with nine print-wires, giving remarkable clarity of print and full ascender/descenders on the upper and lower case character set.

A unique feature of the 8510 is that the pin-feed is behind the print platen, allowing printing on the top line of the first form of a box of paper, avoiding the usual wastage.

The 8510 is capable of printing with full incremental proportional spacing, and has an internal proportional mode which may be software-selected.

Also standard is a complete pre-programmed graphics character set giving square and round-cornered borders, angles, symbols,

and various block graphics, as well as a complete set of Greek and mathematical symbols, a comprehensive set of general algebraic and trigonometric symbols, properly formed  $\frac{1}{2}$  and  $\frac{1}{4}$ , as well as a superscript and subscript character set.

Linefeeds may be software-selected in any number of one-hundred-and-forty-fourths of an inch and may be printed in either forward or reverse direction. All characters may be printed boldfaced or underlined, and characters per line may be selected from 40 to 136.

A serial version allowing a multitude of protocols up to 9600 Baud is available at an additional cost. Full details from Software Source, 89 Oxford St, Bondi Junction NSW.

## Club Call

MICOM (the Microcomputer Club of Melbourne) has changed its meeting place to Burwood State College on Burwood Highway. Meetings are held on the third Saturday of each month from 2 pm to 5 pm, and cater for varying interests, such as beginners' problems in choosing a home or business computer and comparisons by experienced programmers of the relative merits of various program languages. MICOM also currently has one user group for CP/M users, which also meets monthly. For further information contact MICOM, P.O. Box 60, Canterbury Vic. 3126.

## Friction feed for Epson printers!

Melbourne-based deForest Software recently announced the availability of a friction feed kit for the Epson MX70, MX80 and MX100 printers.

This kit installs in minutes and allows the printer to accept friction feed paper. This was the only drawback of the Epson printers, say deForest.

The unit sells for \$55 and is available from deForest Software, 26 Station Street, Nunawading Vic. 3131. (03)878-9276.

# Print-out

## 'Universal' Philips development system

The Philips PM4421 is a complete tool for development of microcomputer and microprocessor-based products based on a variety of currently available microprocessors (e.g: 8085, Z80, 2650, R6500 family, 8400 family, 6800 family, M68000 and more).

It has the capacity to handle both 8-bit and 16-bit microprocessors as well as multi-microprocessor setups. Aids such as a text editor, assemblers and high-level languages are provided for the software designer, while the hardware designer is supported with techniques including real time in-circuit emulation, tracing and state analysis.

The PM4421 is housed in a single cabinet together with a video display, two mini-floppy disk drives and a detachable keyboard.

At the heart of the system is a Philips P851 mini-micro central processing unit. Other features are a 64K system memory and control units for the VDU, keyboard and floppy disks.

System memory is completely isolated from emulation memory to give full memory protection, essential when debugging systems under development.

The PM4421 has a multibus-multiprocessor architecture so that real-time microcomputer emulation is as accurate and complete as possible.

This means that system functions (including buss and memory) and emulation functions are totally separate. In particular, the emulating microprocessor is not slowed down by any system management task or constraint.

No restriction whatsoever is placed on memory space addressing, I/O addressing or interrupt levels that can be accepted.

Further information on Philips' MDS is available from Philips Scientific & Industrial Equipment, 25 Paul Street, North Ryde NSW 2113. (02)888-8222.

Further information on Philips' MDS is available from Philips Scientific & Industrial Equipment, 25 Paul Street, North Ryde NSW 2113. (02)888-8222.

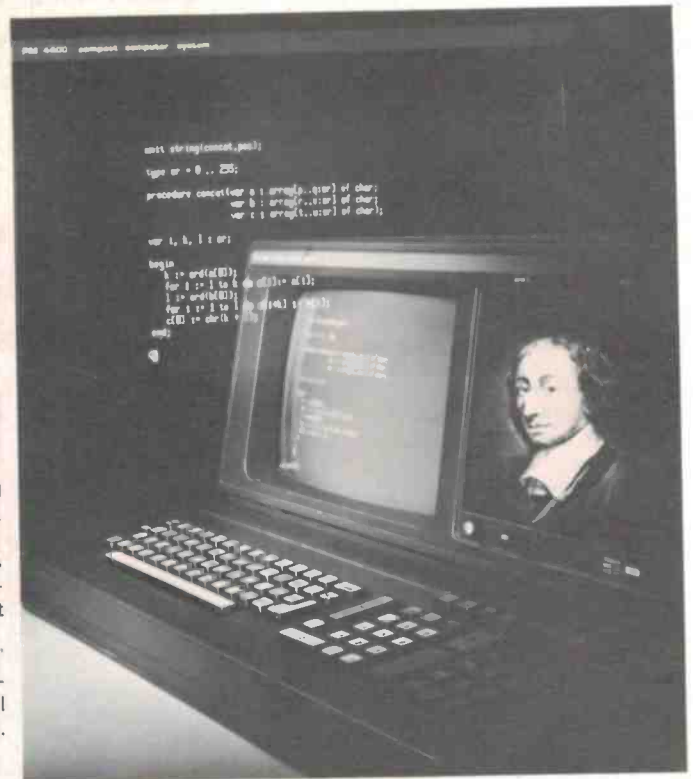

## Motorola micromodule memory-I/O expansion board

Motorola has introduced 'Micromodule 16', which provides RAM, ROM, I/O and timer expansion for the Motorola Micromodule series of 8-bit monoboard microcomputers.

Micromodule 16 incorporates 2K of static RAM, which can be backed up with an external battery and power-fail detect circuit, and mounts an additional four 24-pin sockets in which the user may install his choice of 1K, 2K, 4K or 8K EPROMs, MOS or bipolar PROMs,

mask ROMs or pin-compatible RAMs for up to 32K of additional memory.

Both parallel and serial input/output are provided. The parallel I/O is shipped as a standard Centronics-type interface, but can be configured by the user as a

buffered PIA port. The serial I/O is shipped as an MC6850 ACIA with user option for Baud rates from 50 to 19.2K and for RS-232C, RS-422 or RS-423 interface applications. The user can replace the ACIA with an MC6852 SSDA (Synchronous Serial Data Adaptor) if the system requires synchronous serial communications. An MC6840 triple, programmable, 16-bit

counter/timer is included.

Other features of Micromodule 16 include 1 MHz or 2 MHz operation and on-board address, data and control buss buffers.

Micromodule 16 may be ordered in any of three versions. Immediate availability is through the factory and selected authorised Motorola Systems distributors.

# We've got 1500 semi lines waiting at the end of your phone!!

## So get on the AT Hotline now!!

**(02)487 3798**

MAIL ORDER HOTLINE NUMBER

Mail orders to:

PO Box 355, Hornsby NSW 2077

# AT APPLIED TECHNOLOGY

Showroom/Office at 1a Pattison Ave. Waitara 2077

Hours 9-5 Monday to Saturday.

Phone (02) 487 2711 Telex APPTec AA72767

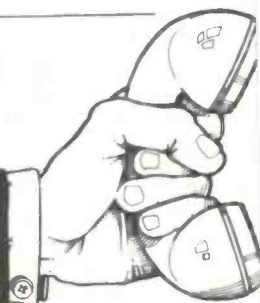

## 16-Bit #1

In the past, 8-bit technology was all that was available in microcomputer chips. 16-bit technology was on the horizon, and the prospects were very exciting.

16-bit microchip technology is now a reality as operating systems and end user industrial and business applications software packages are now available.

By far the most exciting way of entering the field of 16-bit computing is via the 8085/88 S100 card, according to AED. It can completely support current 8-bit CP/M and other software as well as the new CP/M-86 and other 16-bit software. The card allows 8-bit software to run under the 16-bit disk operating

system and 16-bit software to run under the 8-bit DOS.

If you wish, one program can contain both 8-bit and 16-bit code. The card runs the 8-bit 8085 and the 16-bit 8088 at 5 MHz. However, 8 and 10 MHz 16-bit chips are under development and these will both run on this card.

The card is imported into Australia by AED Microcomputer Products, 130 Military Rd, Guildford NSW. (02)681-4966.

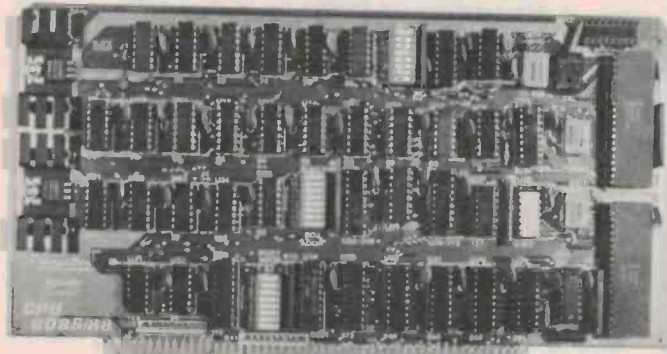

## 16-Bit #2

Cromemco dealer Informative Systems announced in February a 16-bit dual processing unit (DPU) carrying a 68000 and a Z80A featuring error checking and correction (ECC) RAM, said to be available in Australia by July.

"The new upgrade path opened by Cromemco will maintain compatibility with existing 8-bit software while opening up the full 16 Mega-byte address space of the 68000," Mr Norman Rosenbaum, Informative's National Sales Manager, said.

The 16-bit enhancement relies on hardware rather than software, and is less cumbersome and more efficient than translation programs.

"With the extra address space the DPU can handle up to twelve remote users, doubling the existing multi-user capacity of the Cromemco."

New programs written for the 68000 under the (also new) 16-bit Unix-like Cromix operating system, which contains the 8-bit Cromix as a hybrid program, are given a 16-bit input/output command as a header.

The memory boards in the DPU will come in 256K and 512K byte increments, using 150 ns 64K RAMS.

"The DPU board will be available to all existing Cromemco users from July as a single board, and to new users in packaged systems," added Mr Rosenbaum.

A basic System One with DPU, dual floppies, 256K of EEC RAM will cost \$5825. The same system with 5Mb of Winchester hard disk storage will cost \$8995.

"The cost of a single board for existing systems will be well under \$2000."

For further information contact Norman Rosenbaum, Informative Systems Pty Ltd, 337 Moray St, South Melbourne Vic. 3205. (03)690-2284.

## 16-Bit #3

Digital Equipment claim to have introduced the computer industry's smallest 16-bit single-board computer (SBC) in Australia and New Zealand.

The compact size of their Falcon SBC-11/21 makes it ideally suited for build-in applications by original equipment manufacturers (OEMs) where space is at a premium, they say.

The new low-end member of Digital's microcomputer family is priced at just under \$600 in Australia in quantities of 100 (just under NZ\$800)

According to Werner Faets, Microcomputer Business Manager for the South Pacific Region, the Falcon SBC-11/21 provides designers with the power and flexibility of 16-bit microcomputers, yet is priced competitively with 8-bit SBCs.

"We are targeting the new board toward the market space traditionally held by 8-bit boards. Falcon brings full 16-bit computer power to

application areas where cost and size — what we call form factor — previously made it impractical to use the longer word-length microcomputers."

The new Falcon SBC-11/21 is aimed at dedicated ROM-based applications in such areas as laboratory instrumentation, manufacturing monitoring and control, process control, robotics, and medical devices.

Dimensions are 132 x 228 mm, enabling integration into instruments and control machinery where space is critical.

For further information contact Marion Rhydderch, Digital Equipment Australia Pty Ltd, Chatswood Plaza (Northern Tower), Railway Street, Chatswood NSW 2067. (02)412-5252

The Applied Technology Semiconductor Hotline. Just a phone call away are just about all the semis you'll ever need. No minimum order, no minimum quantity — no wasted time. Just phone in your order & give your Bankcard number. We'll check stocks, confirm prices and your goods are on their way. Another unique feature of Applied Technology — for data on any of our semiconductors all you have to do is add 20¢ to your order for each device you need data on, and it's yours.

As well as our enormous range of semis, we've got a comprehensive range of resistors, capacitors IC sockets and computer connectors.

What about our range? How about 193 different 74LS, or 180 7400, 140 4000 series CMOS — over 1500 different semiconductors in stock. Because we manufacture computers, we're constantly aware of the latest developments in semiconductors — and we stock all the latest ICs for our customers. Our full range is listed on our exclusive Semiconductor Wall Chart — yours for the asking.

What about our prices? Just as a sample — 7400s for 25¢, 4001s for 30¢, BC547s for 15¢ and Z80 CPUs for \$8.75 — and these are one-off, tax inclusive prices! Why not give us a try? All it takes is a phone call to our Semiconductor Hotline.



# Printout

## THE CHIP-8 COLUMN

What with the RCA COSMAC VP-111, the ETI-660 and several other small, low-cost computer systems running CHIP-8 language interpreters, we've had a big demand for programs. We've been publishing plenty of '660 software, but little for the RCA COSMAC. Our new column is intended to redress the balance.

Contributions for this column are welcome. We'd like to see programming hints and tips as well as your own programs. Commented listings are preferred and **MUST BE TYPED**; you must prove them by loading the program from your typed submission. All contributions will be paid for.

This first contribution comes from J.L. Elkhorne of Chigwell in Tasmania. It is a game, called 'COSMAC Asteroids'. You have a ship which you can move around the screen and fire missiles at huge asteroids which come flying across the screen. If your missile hits an asteroid, you score. If the asteroid hits you, points are deducted from your score. Your score is displayed at the end of the game and a reset brings a new asteroid on screen.

After the CHIP-8 interpreter is loaded, key in the following program. A spaceship appears which can be controlled by the following keys:

- 4 — left
- 6 — right
- 2 — up
- 8 — down
- 5 — fire

### COSMAC ASTEROIDS—J.L. Elkhorne, Tas.

0200	A300	6A1F	6B10	DAB3	0260	2276	D561	77FE	4F01	02C0	8244	D126	3F01	00EE
0208	6900	6D14	6C00	A304	0268	2280	D561	7503	3700	02C8	6E0A	FE18	7DFF	00EE
0210	6100	6200	D126	6718	0270	00EE	6718	00EE	85A0	02D0	3D00	1218	A313	F933
0218	A300	6306	E3A1	2242	0278	8680	7601	7DFF	00EE	02D8	F265	00E0	6A18	680A
0220	6304	E3A1	2248	6302	0280	6C06	6E02	FE18	6E03	02E0	F029	DA85	7A06	F129
0228	E3A1	224E	6308	E3A1	0288	FE15	FE07	3E00	128A	02E8	DA85	7A06	F229	DAB5
0230	2254	6305	E3A1	225C	0290	7CFF	3C00	1282	7902	02F0	A30C	F565	A304	F555
0238	22B6	4718	12D0	1236	0298	6718	A504	D126	C305	02F8	12F8	0000	0000	0000
0240	1242	DAB3	7A02	1258	02A0	8934	F31E	F065	C3EE					
0248	DAB3	7AFE	1258	DAB3	02A8	8032	F055	7108	A304	0300	C0E0	C010	3C7E	FFFF
0250	7BFE	1258	DAB3	7B02	02B0	D126	A303	00EE	A304	0308	7E3C	0000	3C7E	FFFF
0258	DAB3	00EE	A303	4718	02B8	C302	C401	D126	8134	0310	7E3C			

Notes on the game: The writer works with an expanded 4K VP-111. A modular concept is used in development, with an area assigned to each subroutine; this makes it easy to add features or otherwise modify the scheme. After the program is tested, it's put into linear form for ease of keying in. The documented original is kept on file, along with a copy of the final version. (If a reader is really keen, he can tear the listing apart, as I've done in the past. Presenting all the documentation and comments seems unnecessary.) However, some additional information is supplied:

Variables Used	Function
A, B	Ship co-ordinates
1, 2	Asteroid co-ordinates
5, 6	Missile co-ordinates
E	Tone, timer
D	Missiles/energy
9	Score
7	Missile range
C	Miscellaneous

Module	Address
Mainline	0200 — 023F
Move ship	0242 — 025B
Missile	025C — 027D
Hit asteroid	0280 — 02B5
Move asteroid	02B6 — 02CF
Scoring	02D0 — 02F9
Patterns	0300 — 0312

HAPPY

36th  
ANNIVERSARY

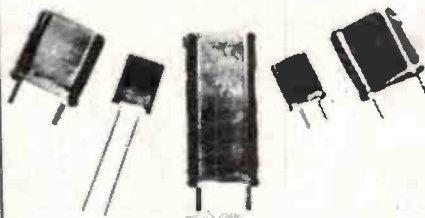

Quantity Orders of Quartz Crystals  
100 off or more available at very  
competitive prices.

Ring 546 5076 for quotes.

**Bright Star Crystals** Pty. Ltd.

PO Box 42, Springvale. Ph (03) 546-5076 Telex AA36004

# Schools need 'Sendata' Acoustic Couplers.



If your school is using recommended micro-computers fitted with RS232 interfaces, then communication with major data bases is just an acoustic coupler away!

## The 700 Series.

Meeting the communications demands of the '80s, Electromed Pty. Ltd. have designed a series of low cost couplers that are easily operated by students and offer unsurpassed performance, even when two microcomputers are connected together via the telephone system.

**SENDATA**

700 Series Coupler & Apple Computer.

ELECTRO-MEDICAL ENGINEERING PTY. LTD.

VICTORIA:  
69 SUTHERLAND ROAD.  
ARMADALE VIC. 3143.  
(03) 509 5844. TELEX: AA34008

N.S.W.  
133 ALEXANDER STREET.  
CROWS NEST, 2065.  
(02) 439 5488 • 439 4964



# National

## A NEW WAVE IS ON THE HORIZON

Available in four models these low cost oscilloscopes feature:

- 15-20-30 MHZ.
- 1mV/Div sensitivity
- Stable automatic trigger 'AUTO FIX'
- Full range of triggering mode
- Bright and sharp CRT with Auto Fix
- TV(V) and TV(H) sync separator circuit
- Rectangular tube, illuminated internal graticule (VP-5220A and VP-5231A)
- Built-in delay line for observation of pulse transient (VP-5231A only)
- High reliability - MTBF 15,000 hours

National have a wide range of scopes - to 300 MHz.  
Please call or write for further information

**..FROM \$389 - 00** (NOT INC. S.T.)

Probes supplied as standard accessory



SCIENTIFIC DEVICES AUSTRALIA PTY. LTD.

2 JACKS ROAD, SOUTH OAKLEIGH, VICTORIA, 3167 TELEPHONE: 579 3622  
P.O. BOX 63, SOUTH OAKLEIGH, VIC. 3167 TELEX: AA32742  
CABLES: DEVICES MELBOURNE

**bankcard**  
welcome here

nagmedia magmedia magmedia

# Try new Verbatim Datalife™ disks for the performance of a lifetime



## CLEANING DISKS

The Verbatim Datalife™ Head Cleaning Disk is a convenient, reliable, safe means of removing up to 90 percent of debris contaminating magnetic recording heads used in computer and word processing systems.

The Verbatim Datalife™ Head Cleaning Kit consists of a durable, reusable, Lexan® jacket and presaturated, disposable cleaning disks.

The Verbatim approach is superior to and less expensive than other cleaning disks presently available.

The kit, available in 8" and 5¼" sizes, differs from those already available in the marketplace in the following ways:

- The Verbatim cleaning disks are disposable. This approach allows a fresh clean disk to be used each time. No accumulated debris from previous cleanings comes in contact with the heads.
- Each cleaning disk is presaturated with a precise amount of cleaning solution. Presaturation eliminates the inconvenience associated with splashing solvents onto a disk.

Sole Australian distributor



# magmedia

Magmedia service puts the customer first

SYDNEY  
(02) 428 1100

CANBERRA  
(062) 48 6751

BRISBANE  
(07) 229 1941

MELBOURNE  
(03) 699 9688

ADELAIDE  
(08) 223 6261

HOBART  
(002) 24 4522

PERTH  
(09) 328 3311

YC 9

magmedia magmedia magmedia

# Print-out



## Stag programmer

Digitec Australia Pty Ltd have been appointed as sole Australian agents for Stag Electronic Designs Ltd of the UK.

Stag are a well-known manufacturer of universal PROM programmers. Their personality modules available for the PPX programmer cover bipolar PROMs, EPROMs, CMOS PROMs and EEPROMs.

Other modules are available for Signetics IFL, BRAL and PAL.

For further information contact Digitec Australia Pty Ltd, 1155 Toorak Road, Hartwell Vic. 3124. (03)299-2088

## Book Review

**Computer Reference Guide's Software Handbook (produced jointly with Murray Publishers). Tony Webster. \$25.50. Available from Computer Reference Guide, Suite 204, 284 Victoria Avenue, Chatswood NSW 2067. (Include \$2.50 for postage and handling.)**

The cost of this book is sure to be a deduction on the tax forms of every person wanting to keep up with the Australian computing industry. Previously the only means of gathering reliable software information was the old ring, run around and wait method, which was, in one word, tedious. Tony Webster with his software handbook has provided a much-needed service for the supplier, user and potential purchaser of all kinds of computer equipment.

The handbook is broken down into easy to read sections comprising micros, minis, mainframes and industry category applications. In the latter section listings range alphabetically from access control through dry cleaners to word processing.

If you already own or use a system and wish to review other software

product offerings, there is also a section indexed by machine type. Effective cross-referencing connects the various sections.

An annoyance and frustration often encountered with handbooks of this type is the lack of contact addresses and telephone numbers for the products, etc. reviewed. To save the cat, desk or telephone from being kicked, Tony Webster has provided not only phone numbers and addresses, but also wherever possible the Managing Director's name.

Now that Tony has produced the Microcomputer Handbook and the monumental Software Handbook we're waiting breathlessly for his next mammoth production — the Who's Who of Computing in Australia, or maybe The Whole Computer Catalogue?

## TRS-80C software update

Since writing the article for the March issue (p. 101), Greg Wilson (P.O. Box 9, Potts Point NSW 2011 or (02) 358 6491) has been granted licences to reproduce 80C software under licence. The growth in suppliers parallels the spectacular sales being achieved by the 80C in USA. It took ten months to take off there. How long here?

Aardvark-80, 23352 S.Commerce, Walled Lake, MI 48068  
 Abrams Clayton, 2758 Comstock Ave, San Jose, CA 95124  
 Adventure International, PO Box 3435, Longwood, FL 32707  
 Alford & Associates, PO Box 6743, Richmond, VA 23230  
 Algorix Inc, California (Greg licence)  
 Allen Gelder Sftwr, California (Greg licence)  
 American Business Computers, 1185 Mill St, Pryor, OK 74361  
 Armadillo Sftwr, Austin (Greg licence)  
 Artwork Sftwr Co, 150 North Main St, Fairport, NY 14450  
 Avalon Hill Game Co, 4517 Harford Rd, Baltimore, MD 21234  
 Bank Sftwr, 37 Balmoral Dr, Spring Valley, NY 10977  
 The Berg Works, Box 742H, Janesville, WI 53545  
 Cer-Comp, Nevada (Greg licence)  
 Cognitec, 704 Nob Av, Del Mar, CA 92014  
 Color Sftwr Services, Texas (Greg licence)  
 Computer Information Exchange, Box 159, San Luis Rey, CA 92066  
 Computer Island, New York (Greg licence)  
 Computer Simulations Co, 305 Hammes Ave, Joliet, IL 60436  
 Computerware, Dept CPO Box 666, Encinitas, CA 92024  
 Connection-80, 73-15 86 Drive, Woodhaven, NY 11421  
 Coolidge & Associates, 2050 S.Lamar #10 Austin, TX 78704  
 Datasoft Inc, 19519 Business Center Drive, Northridge, CA 91324  
 DSL Cmpt Products, Michigan (Greg licence)  
 Digibyte Systems Corp, 31 East 31 St, New York, NY 10016  
 Dorset Educational Systems, PO Box 1226, Norman, OK 73070  
 Eigen Systems, PO Box 10234, Austin, TX 78766  
 Erickson, PO Box 11097, Chicago, IL 60611  
 Edward L. Gittelsohn, 577 Wildwood Rd, West Hempstead, NY 11552  
 Graphic Source, Rt 2 Box 44, Canton, KS 67426  
 Great XPT, Michigan (Greg licence)  
 Harmonics, Utah (Greg licence)  
 Frank Hogg Lab Inc, 130 Middletown Plaza, Syracuse, NY 13210  
 HW Electronics, 19511 Business Center Dr, Northridge, CA 91324  
 Hoyt Stearns Electronics, 4131 E.Cannon Dr, Phoenix, AZ 85026  
 Huntington Computing, PO Box 787, Concoran, CA 93212  
 Illustrated Memory Banks, Massachusetts (Greg licence)  
 Jarb, California (Greg licence)  
 Land Systems, Ohio (Greg licence)  
 Lyman Frank, 12 Reservoir St, Cambridge, MA 20138  
 Gary Magnusen, Indiana (Greg licence)  
 Mark Data Products, California (Greg licence)  
 Martin Consulting, Canada (Greg licence)  
 MG Products, PO Box 7544, Tulsa, OK 74105  
 Micro Learningware, PO Box 2134, N.Mankato, MN 56001  
 Micro Procr Systems, 37060 Garfield, Mt Clemens, MI 48043  
 Micro Works, PO Box 1110, Del Mar, CA 92014  
 Micro-Labs Inc, 902 Pinecrest, Richardson, TX 75080  
 Mint Sftwr, Louisiana (Greg licence)  
 Tom Mix Sftwr, Michigan (Greg licence)  
 Britt Monk, Ohio (Greg licence)  
 Moses Engineering Co, South Carolina (Greg licence)

## Computer graphics seminar

The Frost & Sullivan show is on again, folks! Now in its seventh year worldwide, Frost & Sullivan's 'Understanding and Using Computer Graphics' seminar returns to Australia for the second time in July.

To be held in the Southern Cross Hotel, Melbourne, over 7 — 9 July, and the Menzies Hotel, Sydney, over 14 — 16 July, the show is still led by Carl Machover, the internationally recognised authority on computer graphics.

The seminar aims to make the full usage and benefits of computer graphics known to both potential and current users.

With the introduction of new versatile low-cost hardware and software, the role of computer graphics is changing, becoming a workaday time and money saving tool. With graphics you can show a variety of charts, graphs, pictures and animated processes to communicate ideas and information

easily and effectively.

For people who are now using or who are making decisions about using computer graphics within their organisations, this three-day seminar will describe computer graphics; show how installing computer graphics can be justified; explain what hardware, software and systems are available; give costs and performance comparisons; show how to get started; show how computer graphics is being used in various applications.

For information please contact Jill Morris, Sales Department, Frost & Sullivan Ltd, 104-112 Marylebone Lane, London, W1M 5FU, United Kingdom. Intelix: 261671 FANDS G.

Andrew Nucci, 73 Maitland Place, Garfield, NJ 07026  
 Warren Napier, Pennsylvania (Greg licence)  
 Neff Systems & Sftwr, 4340 Solano Way, Union City, CA 94567  
 Nelson Sftwr Systems Inc, PO Box 19096, MPLS, MN 55419  
 Peacock Ent, Pheasant Run Box 474 RD#3, Canastota, NY 13032  
 Prickly-Pear Sftwr, 3518 S.Randi Place, Arizona, AZ 85730  
 Program Store, 4200 Wisconsin Ave, Washington, DC 20016  
 Programmer's Institute, Nth Carolina (Greg licence)  
 Rainbow Connection Sftwr, Minnesota (Greg licence)  
 Sandhill Color, 1524 Toluca, Alliance, NE 68301  
 Seebrees Computing, 456 Granite Ave, Nonrovia, CA 91016  
 Charles M. Smith, 92748 N.Macauther, Oklahoma City, OK 73132  
 Snake Mtn Sftwr, Nth Carolina (Greg licence)  
 Soft Sector Marketing Inc, Michigan (Greg licence)  
 Spectral Associates, Washington (Greg licence)  
 Strawberry Sftwr Inc, Box 743, Vashon Island, WA 98070  
 Sugar Sftwr, Ohio (Greg licence)  
 Superior Graphic Sftwr, 406 Little Mountain Rd, Waynesville, NC 28786  
 Talbot Microsystems, 5030 Kensington Way, Riverside, CA 92507  
 Tallgrass Technlgs Corp, 9009 W.95th St, Overland Park, KS 66212  
 Tandy Electronics, 210 Victoria Rd, Rydalmere  
 Transformation, Illinois (Greg licence)  
 TRC, Nth Carolina (Greg licence)  
 VEICO International, 3870 West 143rd St, Cleveland, OH 44111  
 Wizard Sftwr, 3410 Leigh Rd, Pompano Beach, FL 33062

## 68PDC04

### Processor and Disc Controller Card

- Accepts Motorola 6802 and 6809 micro-processors
- 1k scratchpad RAM
- Extended addressing range
- Full RS232 with handshaking
- Parallel port with control lines
- Single/Double density, 5 1/8 Inch, single/Double sided Floppy Disc Controller interface

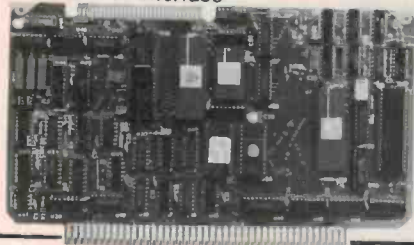

## 68GPB03

### The ultimate in microprocessor I/O.

- 16 channel ADC (with 12 bit resolution).
- 2 channel DAC (with 8 bit resolution).
- 32 bit programmable I/O (2 x MC6821).
- 6 programmable timers (2 x MC6840).
- 2 serial synchronous/asynchronous interfaces
- Hardware and software programmed baud rate generation.

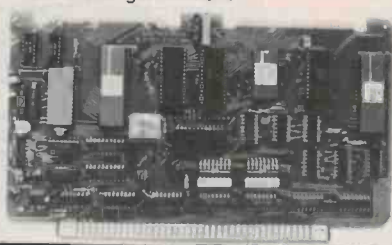

## 68MB05

### 48/96 K, RAM/EPROM CARD

- 2K Devices (2716, 6116, etc.)
- 4K Devices (2732, etc.)
- Three 16K/32K blocks individually selectable
- Extended addressing (4 pages)
- \*All cards are Motorola Exorcliser Bus compatible

## MICRO GEAR

3 Coora Place, Churchill, VIC. 3842

Phone (051) 34-7836  
 A.H. (051) 22-1157

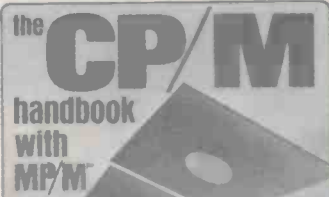

# CP/M finally explained!

Rodney Zaks

Anyone interested in computers will have heard the expression CP/M, but many may still be unclear as to what it is and what it does. Rodney Zaks' book *The CP/M Handbook with MP/M* will answer any questions you may have about using a computer equipped with CP/M.

CP/M stands for Control Program for Microprocessors, and is the industry standard in operating systems for small computers. It is available on nearly all computers using the 8080, 8085 or Z80 microprocessors, as well as some using the 6502 microprocessor.

The *CP/M Handbook* is a simple, clear and practical introduction to the use of CP/M-equipped computers, and a reference text. For beginners this book offers step-by-step instructions for using CP/M without fear — turning the system on, inserting a diskette, correct user discipline, remedial action for a problem situation — and everything is explained in a clear, concise and easy-to-read format.

For experienced programmers the book includes a comprehensive description of all CP/M facilities and resources, plus a complete discussion of all versions of CP/M, up to and including 2.2, MP/M and CDOS. Fifteen appendices feature complete summaries of all commands and facilities.

#### Contents include:

- An Introduction to CP/M
- CP/M and MP/M facilities
- Handling files with PIP
- Using the editor
- Inside CP/M and MP/M
- Reference guide to CP/M and MP/M commands and programs
- Practical hints
- The future

The *CP/M Handbook with MP/M* is available from ETI Book Sales, 4th Floor, 15 Boundary St, Rushcutters Bay NSW 2011 for \$16.95 plus \$2 postage and packing.

Please send me . . . copies of *The CP/M Handbook with MP/M* at \$16.95 + \$2 p&p per copy

Total .....

Name .....

Address .....

Postcode .....

Signature .....

# MINI-MART

## Where readers can advertise — For Sale/Wanted/Swap/Join.

● We'll publish up to 24 words (maximum) totally free of charge for you, your club or your association. Copy must be with us by the 1st of the month preceding the month of issue. Please — please — print or type adverts clearly, otherwise it may not turn out as you intended! Every effort will be made to publish all adverts received; however, no responsibility for so doing is accepted or implied. Private adverts only will be accepted. We reserve the right to refuse adverts considered unsuitable.

● Conditions: Name and address plus phone number (if required) must be included within the 24 words. Reasonable abbreviations, such as 25 W RMS or 240 Vac, count as one word. Adverts must relate to electronics, audio, communications, computing etc — general adverts cannot be accepted.

Send your advert to:

ETI Mini-Mart,  
4th Floor, 15 Boundary St,  
Rushcutters Bay NSW 2011.

### AUDIO

**FOR SALE:** Playmaster 136 amplifier, superb performance for the price, \$80. Bh (03)489-9255, ah (03)723-1532.

**STAX UA7** carbon fibre tonearm with extra aluminium segment. Never used, half price, \$225 ono. Ian, 1/23 Mulwarree Ave, Randwick NSW 2031. (02)398-1189.

**FOR SALE:** National colour video cassette recorder. Search, dubbing, auto repeat, etc. \$450 ono. Bh (03)489-9255, ah (03)723-1532.

**VALVE AMPLIFIER,** Pioneer 24 W RMS, Shure cartridge, Byer professional studio turntable and arm, large speaker enclosures, superb system, sacrifice \$300 ono. (02)46-5451.

### MISCELLANEOUS

**FOR SALE:** Large screen oscilloscope, BWD 1722D, as new condition with manuals, \$350. (068)47-2491.

**FREE to genuine schoolboy,** ETI and EA etc, approx 100. Ring (02)807-1374, ask for Peter, between 6 and 7 pm.

**2 kVA 240 Vac to 110 Vac autotransformer,** \$35; old HP frequency counter and modulation meter, both valves, \$20 each. (02)337-5241 ah.

**WANTED:** Dec, Feb, Mar, Apr 1978 ETI mags in reasonable condition. Contact Andrew Hartwich, 11 Laby St, Ararat Vic. 3377.

**MAGAZINES for sale:** ETI, EA, Creative Computing etc. Inquiries: ring ah (03)80-4221. Address: A. Pam, 43 Mont Victor Rd, Kew 3101, Melbourne.

**WANTED:** Back issues of ETI and EA or R & H prior to 1973. Novice AOCIP requirement. Bob Simpson, P.O. Box 150, Brighton 3186. (03)67-8871.

**COPYRIGHT:** The contents of Electronics Today International and associated publications is fully protected by the Commonwealth Copyright Act (1968).

Copyright extends to all written material, photographs, drawings, circuit diagrams and printed circuit boards. Although any form of reproduction is a breach of copyright, we are not concerned about individuals constructing projects for their own private use, nor by pop groups (for example) constructing one or more items for use in connection with their performances.

Commercial organisations should note that no project or part project described in Electronics Today International or associated publications may be offered for sale, or sold, in substantially or fully assembled form, unless a licence has been specifically obtained so to do from the publishers, Murray Publishers Pty Ltd, or from the copyright holders.

**LIABILITY:** Comments and test results on equipment reviewed refer to the particular item submitted for review and may not necessarily pertain to other units of the same make or model number. Whilst every effort has been made to ensure that all constructional projects referred to in this edition will operate as indicated efficiently and properly and that all necessary components to manufacture the same will be available no responsibility whatsoever is accepted in respect of the failure for any reason at all of the project to operate effectively or at all whether due to any fault in design or otherwise and no responsibility is accepted for the failure to obtain any components parts in respect of any such project. Further, no responsibility is accepted in respect of any injury or damage caused by any fault in the design of any such project as aforesaid. The Publisher accepts no responsibility for unsolicited manuscripts, illustrations or photographic material.

### COMMUNICATIONS

**KENWOOD R300** communications receiver. 0.1 MHz to 30 MHz, AM and SSB. Mint condition, accessories, VHF converters, \$270 ono. Five range marker gen, \$25 (051)22-1395 ah.

**SWLs:** The Southern Cross DX Club covers all bands in 'DX Post'. For a sample magazine and details write to PO Box 64, Campbelltown SA 5074.

**COLLINS R390/391/390A** rear-mounted tools, valve pullers and coverplates required. Some modules for sale. Bruce, 3 Shadwell St, Cheltenham Vic. 3192. (03)583-1638.

### COMPUTERS

**SELL:** TRS-80 level II, 16K RAM. Near new, has lower case and numeric keypad, with power supply, manuals. Jeff, 2 Nodding Ave, Frankston Vic. (03)783-5179 (Mon-Thur.).

**FOR SALE:** Technical manual for the Sorcerer MK II, very little use, excellent condition, \$11. (03)690-5486, ask for John.

**SELL:** 1200 baud cassette interface, suit 6800-based system, with software and data, \$60. Book: 33 games for TRS80/Apple/PET, \$7. W. Geary, #3 Second Ave, Rossmoyne 6155. (09)457-8809.

**MICROACE:** 4K ROM, 16K RAM plus adaptor, leads, manual and book of programs, \$250. (02)639-3115 ah.

**SELL:** ZX80, 16K RAM, 8K ROM, power supply, programming manual, some programs, \$240. Phone Mick or leave message, (062)41-5140.

**SELL:** ZX81 16K RAM, as new with \$100 of software (understanding your ROM, games, four newsletters). Suit beginner. Price \$375 ono. Phone (058)83-9427.



# COMPUTER CITY

AS PART OF THE

# COMPUTER COUNTRY GROUP

Refers its clients to Computer Country Advertisements throughout this magazine for details of products.

In Queensland & N.T. please contact direct to

## COMPUTER CITY

600 OLD CLEVELAND RD.,  
CAMP HILL 4152 BRISBANE  
TELEPHONE: (07) 398 6759  
(07) 398 6571

## HI RES GRAPHICS 320 x 200 FOR AIM 65 — SYM-1

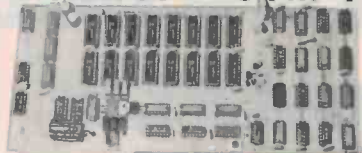

Micro Technology Unlimited K 1008  
8K Dual Ported. RAM Adds Hi Res  
Graphics to AIM 65 and SYM-1 with  
320 x 200 bit-mapped pixel display.  
\$249 A&T

### SPECIALS

K1008-21A for AIM with Printer  
Graphics and Basic Interface Soft-  
ware. Normally \$326. NOW ONLY  
\$239 A&T. K1008-20S for SYM with  
Graphics Interface Software. Nor-  
mally \$264. NOW ONLY \$209 A&T.  
K1002-21S Music Synthesiser with  
Instrument Software. Normally \$75.  
NOW ONLY \$55 A&T.



P.O. BOX 6502  
GOODNA 4300  
Phone  
(07) 288-2757

BANKCARD available for Austra-  
lian & N.Z. customers. Same P & P  
for N.Z. & Australia. Prices subject  
to change without notice. Plus sales  
tax if applicable.

## COLOR COMPUTER TITLES FROM

# POWERCHIP SOFTWARE

(With minor modifications, all programs will run on  
TRS-80 Model I, II, II, Apple, Pet, Atari, IBM, or any  
BASIC microcomputer system.)

### COLOR COMPUTER GRAPHICS

Included are many complete programs, each of which  
causes the computer to display vivid, exciting  
imagery. This is the only book specifically designed  
to aid the TRS-80 Color Computer owner. \$10.95

### 55 MORE COLOR COMPUTER PROGRAMS FOR THE HOME, SCHOOL & OFFICE

An all-new and different collection of tested,  
ready-to-run software for businessmen, teachers,  
students and hobbyists. \$10.95

### MY BUTTONS ARE BLUE AND OTHER LOVE POEMS FROM THE DIGITAL HEART OF AN ELECTRONIC COMPUTER

Love's sweet valentine, a rare classic of the new age  
of high technology. 66 poems written by a TRS-80  
Color Computer. \$10.95

### 101 COLOR COMPUTING PROGRAMMING TIPS & TRICKS

You'll learn what to do, how to do it, when to make  
changes and when not to, all in this extensive color  
programmer's compendium of tricks. \$10.95

### 55 COLOR COMPUTER PROGRAMS FOR THE HOME, SCHOOL & OFFICE

For the business office, classroom, home, a  
brand-new volume of tested ready-to-run software  
designed for the TRS-80 Color Computer. \$10.95

### THE COLOR COMPUTER SONGBOOK

40 of the world's best-known songs, scored for the  
TRS-80 Color Computer. Here's high technology at  
its best. \$10.95

### 33 NEW APPLE COMPUTER PROGRAMS FOR HOME, SCHOOL & OFFICE

A handy collection of ready-to-run Applesoft  
programs for businessmen, teachers, students and  
hobbyists. \$10.95

### 101 APPLE COMPUTER PROGRAMMING TIPS & TRICKS

A mammoth collection of practical, useful efficient  
techniques and operating shortcuts to handle routine  
programming chores quickly. \$10.95

### 50 PROGRAMS IN BASIC FOR THE HOME, SCHOOL & OFFICE—2ND EDITION

\$10.50

### 50 MORE PROGRAMS IN BASIC FOR THE HOME, SCHOOL & OFFICE

\$10.50

### MURDER IN THE MANSION AND OTHER COMPUTER ADVENTURES—2ND EDITION

\$10.50

### 101 POCKET COMPUTER PROGRAMMING TIPS & TRICKS

\$10.50

### POCKET COMPUTER PROGRAMMING MADE EASY

\$10.50

### AND NOW FOR THE CASIO FX-702P 35 PRACTICAL PROGRAMS FOR THE CASIO POCKET COMPUTER

\$10.95

ORDER NOW, send cheque/postal order, include \$1  
postage per book, max. \$3, or send for a FREE catalogue  
to:  
POWERCHIP SOFTWARE, P.O. Box 32, South Caulfield,  
3162. Tel: (03) 529 2884

TITLE/S.....

NAME.....

ADDRESS.....

POSTCODE.....

TELEPHONE.....

Enclosed is Cheque/Postal Order for \$.....

# Australians are dying younger from heart disease.



National Heart Foundation.

## CHEAP COMPUTERS

Cheap 48K Hong Kong look-a-like,  
looks like major fruit brand. Runs all  
apples softwares, and add on cards.

Discounted to \$999 complete with  
case, keyboard and power supply,  
or \$1400 with disk drive and  
controller and sales tax paid.



Also cheap switching power supply  
at below local manufacturing cost.  
Features: +5V, 5A; -5V, 1A;  
±12V, 1A. \$110 tax paid.

Call **DICK CHAN** on  
**(03) 329 9404** for an  
appointment and running test.  
Agents and Dealers Welcome  
(STD reverse charge)

# An alternative pocket computer printer

**Tom Moffat**

39 Pillinger Drive,  
Fern Tree, Tasmania.

For the thin-of-pocket or frugal-minded, here's how to employ a cheap 'surplus' teleprinter as a printer for your Sharp or Tandy pocket computer.

THIS IS ONE of those stories about doing things on the cheap; in this case, getting a printer for a pocket computer, or any computer for that matter, without paying a lot of money for it. A couple of things have to be assumed . . . first, your pocket computer is your second computer — you've got a bigger system as well (and for many people this seems to be the case). Second, you've got a teleprinter, or you think you may have a use for one. Suggestions in my earlier series of articles, "Get Going on Radioteletype" (ETI, Aug. — Sept. '79), may whet the appetite.

Of course, it's possible to buy a printer for the Sharp or Tandy pocket computers; they've been advertised lately for around \$180 and are quite good value . . . but they've only got one use: pocket computers. (Maybe it's a bit early to say that, it might be worth looking into . . . hmmm!) For that \$180 you can buy one very fine pre-owned teleprinter, the electronics to get it going (ETI-730 converter kit), many rolls of paper and ribbons, and still have money left over! The only real problem is that an old Baudot teleprinter isn't really designed for communicating with modern computers, and some of the important ASCII characters are missing. But it's quite possible to make do, as you'll soon see.

You'll find the old teleprinter slow and noisy, compared to modern printers, but pocket computers aren't renowned for their speed either. But why worry, you can sit back and contemplate the excellence of the program you've just written as it's slowly pounded out on the teleprinter.

## The method

The computer used to drive the teleprinter in this instance is a small one with a Motorola 6800 processor, 1K of RAM, and a PIA (peripheral interface adaptor) to communicate with the outside world.

The operating program is written in pure 6800 machine code, and can be located in any part of the computer's memory. There are also three tables and a code store, which can also be located as desired. Two of the tables contain teletype codes and the third is a small one involved in code conversion. Their addresses must be specified in the main program as follows:

Input code store address at 0214 and 0236 (loc. C1B0)

One-byte character table at 02EA (0090)

Four-byte character table at 02D0 (00C0)

Code conversion table at 02BE (01A0)

Information must be entered at these addresses to show the locations of the various tables in your system. The information in brackets are the locations in my system. A four-byte software shift register and some other storage bytes are located at 0030. These are best left where they are; it would be messy to move them. The PIA is located at 8012/8013.

The same general programming technique should work with just about any system, using say Z80 or a 6502, providing you have something resembling a PIA for interfacing. You must be able to

program it so that some bits are inputs while others are outputs. In this case we use bit 3 as an input to feed data from the pocket computer into the main system, and bit 4 as an output to tell the pocket computer when the teleprinter is busy printing. Bit 0 is an output through which the serial data is fed to the teleprinter. Bits 1 and 2 must also be outputs. The other bits in the PIA can be set to whatever your system requires.

A small modification is necessary to the pocket computer's cassette interface to make some connections to the plug that mates with the socket in the side of the pocket computer. This involves opening the cassette interface and installing a 4009 IC to invert and buffer the pocket computer signals so they can be used in the main system. The IC is installed in the flat part of the interface, with the pins cut off short so it will fit in. The leads and resistors are simply soldered to what's left of the pins (see Figure 2 for details). The 10k and 33k resistors are for safety; the 33ks prevent damage if the PIA is accidentally programmed into the output mode where it should be an input, causing two outputs to fight against each other. Many PIAs have been blown up this way. The 10ks are there because the designers of the pocket computer saw fit to isolate all the other input/outputs with 10ks — better safe than sorry.

Counting from the end where the cassette cable leaves the interface, pin 1 carries data out of the pocket computer, pin 2 tells it 'printer busy', and pin 3 is an input that is held low by another 10k to tell the pocket computer a printer is connected. Four of the six inverters in

the 4009 are wasted, but it's still the easiest way to achieve the desired result. This scheme results in a voltage difference of 4.5 volts between the cases of the pocket computer and the main system, but in practice it hasn't caused any problems. Just don't touch them together or you will flatten the batteries in the cassette interface.

The interface at the teleprinter end need be nothing more than the transistor loop switch section of the ETI-730 RTTY receiving converter (Aug '79). Perhaps the easiest way to arrange this would be to buy the ETI-730 circuit board and only install the parts necessary to get the loop switch going (the rest of the parts can be added later if desired). The loop switch section was designed to accept TTL-compatible signals straight in, if the jumper from the rest of the circuit is deleted. Of course you'll need something to supply the loop current as well. See the original article.

### Data format

The pocket computer stores each character and basic keyword as a single eight-bit binary number (which henceforth will be expressed as hexadecimal). When you type in 'RETURN' what actually gets stored is hex 'DE'. The letter A is '51', figure 1 is '41', and so on. The entire code set is detailed in Table 1. When the pocket computer is told to LIST or PRINT, it first sends out 8D or 8E, depending on the command, followed by a string of data. Every line ends in '00'.

Each byte is sent out four bits at a time in serial format, with four data bits preceded by a start pulse. The start pulse and each data pulse are 2 ms long, and there is a 9 ms pause between each half-byte. See Figure 1.

Before the data comes in, the 6800 system is sitting in a loop, looking for a start pulse. When it's detected, a subroutine loads the following four bits into an accumulator. It then looks for a start pulse again and when it comes it fills the rest of the accumulator with the following four bits. The completed byte is then stored away and the procedure is started again for the next byte. A store 80 bytes long is provided, enough to hold the longest program or print line available from the pocket computer.

After each byte is stored it is inspected to see if it's a '00'. If it is, the 6800 system sets bit 4 of the PIA low to tell the pocket computer to hold off sending while the teleprinter prints what it's already got. But there's a lot to do before a character is printed.

The first job is to determine whether the data resulted from a PRINT or a LIST command by checking the first

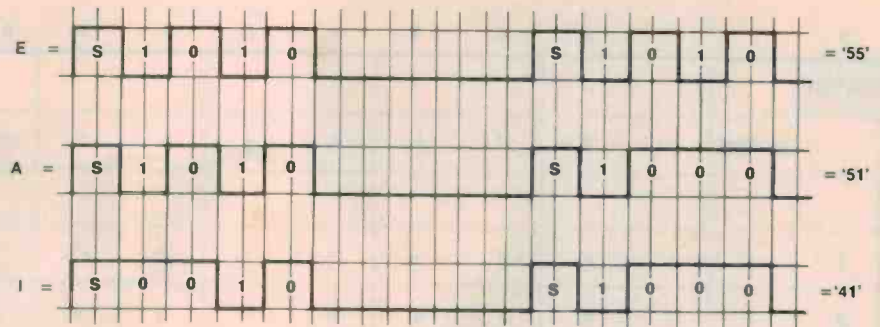

Figure 1. Pocket computer serial data format (1 ms per division).

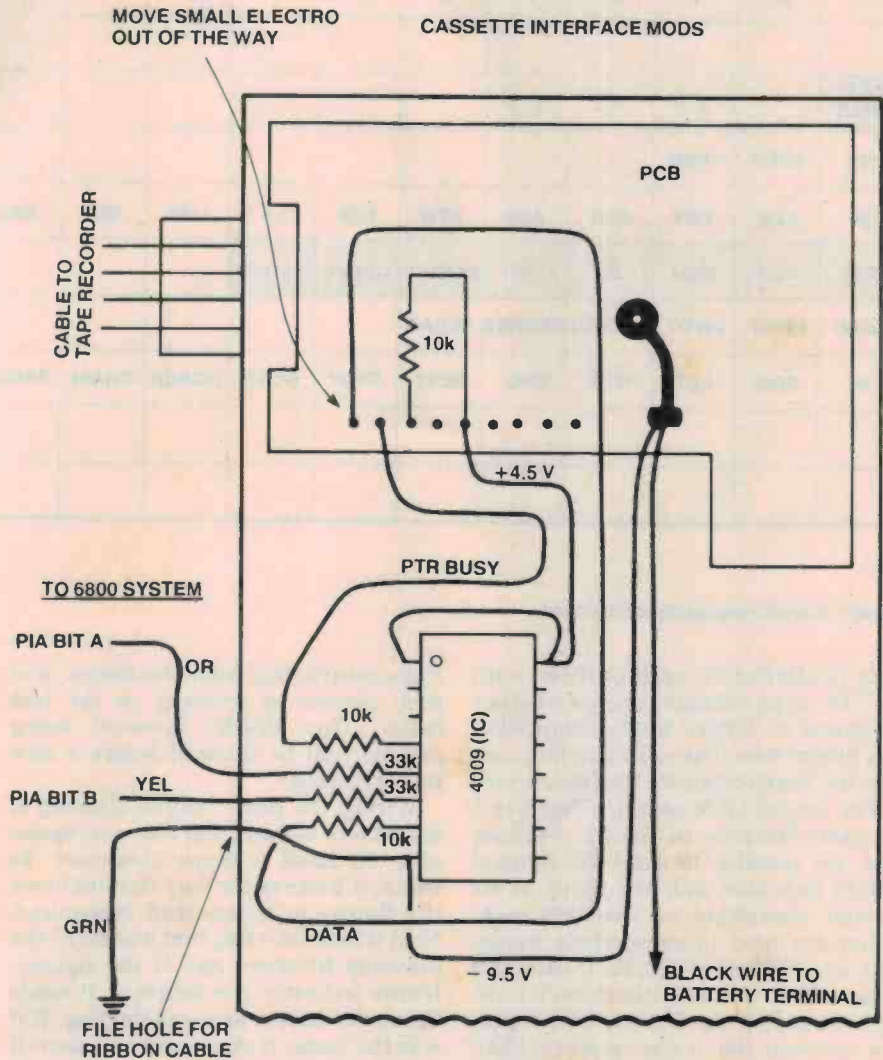

Figure 2. Pocket computer cassette interface modifications. Pinout of the 4009 IC shows the view looking down on top of the package.

byte for 8D or 8E. If LIST, a line number is required, and the computer counts the number of digits in the line number, inserts leading spaces, and prints a '.' between the line number and the program statements that follow. If PRINT, it skips over the line number routine and just prints everything out as is.

An inspection of the pocket computer code table will reveal that it's full of holes and that several codes are present

which are direct commands and will never appear as part of a stored program (they are the shaded ones). The table in its original form would be very wasteful of memory, so the 6800 system packs it down, eliminating the empty holes and direct commands. The result is two tables, one of which contains most of the functions that can be represented by one character, such as the figures, the letters, and some punctuations. One ▶

	0	1	2	3	4	5	6	7	8	9	A	B	C	D	E	F
0	ENTER															
1	SPACE	..	?	!	#	%	¥	\$	π	√	.	:	:			
2																
3	(	)	>	<	=	+	-	·	/	^						
4	Ø	1	2	3	4	5	6	7	8	9	∞					
5		A	B	C	D	E	F	G	H	I	J	K	L	M	N	O
6	P	Q	R	S	T	U	V	W	X	Y	Z					
7																
8	FILE IDENT		>=	<=	<>									LIST LINE IDENT	PRINT LINE IDENT	DATA BLOCK IDENT
9	TO	STEP	THEN													
A	SIN	COS	TAN	ASN	ACS	ATN	EXP	LN	LOG	INT	ABS	SGN	DEG	DMS		
B	RUN	NEW	MEM	LIST	CONT	DEBUG	CSAVE	CLOAD								
C	GRAD	PRINT	INPUT	RADIAN	DEGREE	CLEAR										
D	IF	FOR	LET	REM	END	NEXT	STOP	GOTO	GOSUB	CHAIN	PAUSE	BEEP	AREAD	USING	RETURN	
E																
F																

Table 1. Pocket computer function codes.

byte is allowed for each of these, with bit 7 being an indicator to show whether a 'figures' or 'letters' shift is required in the teleprinter. The next five bits contain the Baudot code for that character.

The second table contains four bytes for each function. In the 32 resulting bits, it's possible to store the figures/letters indicator, followed by up to six Baudot characters at five bits each. These are used to store whole words, such as GOTO, GOSUB, RETURN, and some of the symbols that don't have equivalents on the Baudot teleprinter. For instance, the <= sign becomes 'LEQ' and \* for multiply becomes 'space-dot-space'. For ';' we use ':', and π becomes 'PI'. It ain't pretty, but it works.

Once the 6800 system figures out where to look in which table, it transfers the contents down into a software shift register and then goes into the print routine. When it encounters a '00' it knows that line is finished and it goes back to the start of the program, telling the pocket computer to load another line into the store. Each character printed is counted, and if the characters in a line exceed 60 the computer inserts a car-

riage return, line feed, five spaces, and then carries on printing on the line below. Any BASIC keyword being printed will be finished before a new line is started.

Within the print routine a string of stored bits is converted into a recognizable 50 baud teletype character. To begin, it looks at the very first bit to see if a figures or letters shift is required. Next it looks at a flag that was set by the previous function, and if the figures/letters indicator was different, it sends figures or letters and sets the flag. If it was the same, it skips over this part. It then generates a 20 ms start pulse, and then goes to the software shift register where the character or function is waiting to be printed. The figures/letters routine has already dumped the first bit out of the shift register, so what's left are valid teletype bits. The program shifts five of these along and sends them, with a delay of 20 ms between each. It then sends a stop pulse of 30 ms before going to the next five data bits. The result of all these gyrations comes out bit 0 of the PIA as a string of TTL-compatible highs and lows that are

serial Baudot teletype signals.

Back in the shift register, each bit shifted out is replaced by a '0' going in the other end, and the bits that don't represent characters already contain 0s. When the computer sees nothing but 0s it knows the shift register is empty, and goes back to the input store for the next data byte put there by the pocket computer. Although this seems complicated it happens in the twinkling of an eye and the result is a nice string of teletype print running at what the experts call 'machine speed', ticking along with no gaps or pauses. There is a short pause between each line as the pocket computer loads in its next line of data, the length of the pause depending on the length of the line to be printed.

To summarise, consider the handling of a program line, such as '80:GOSUB 200'. This comes out of the pocket computer as '8D-48-40-D8-42-40-40-00'. 8D says it's a LIST line, so the line number routine is required. The line number routine then counts the digits in the line number, (actually every code starting with a 4), until it comes to something else. In this case there are

two digits, so it tells the teleprinter to print one space, then the digits 8 and 0, and a '.' (the '.' wasn't supplied by the pocket computer). It then gets the next code, D8, finds it means 'GOSUB', and prints that. The next code, 42, produces '2', and then come two 40s, each producing a '0'. Finally comes 00, meaning end of the line. The computer prints a carriage return, a line feed, resets the character counter, and then tells the pocket computer to load the next line into the store. An example of a complete pocket computer program, formatted for the teleprinter, is LISTed and RUN in Figure 3. As you can see, having a full page width to work with makes life much easier.

Now, if you happen to be the proud owner of a 'proper' ASCII printer, this same technique could be used to hook it to the pocket computer, with the routines generating 7-bit ASCII characters instead of 5-bit Baudot. The figures/letters determination would be unnecessary. Or going after it in the other direction, most of the routines could be used to translate ASCII output from the main computer into Baudot, allowing the use of an 'el cheapo' teleprinter with a 'big' computer system. ●

LIST:

```

10: INPUT 'WHAT DEGREE INCREMENT? ':,A
20: PRINT 'X (DEGREES)      SIN (X)      COS (X)      TAN
      (X) '
30: PRINT '-----'
40: PRINT ''
50: FOR X=A TO 360 STEP A
60: B= SIN X:C= COS X:D= TAN (X+E-9)
70: PRINT ' ',,USING 'XXX':,X:', ' ',,USING 'XX.XX
      XXX':,B:', ' ',,C:', ' ',,USING '.XXXXX PWR ':,D
80: NEXT X
90: USING
100: END

```

SAMPLE RUN:

X (DEGREES)	SIN (X)	COS (X)	TAN (X)
30	0.50000	0.86602	5.77350E-01
60	0.86602	0.50000	1.73205E 00
90	1.00000	0.00000	-5.72957E 10
120	0.86602	-0.50000	-1.73205E 00
150	0.50000	-0.86602	-5.77350E-01
180	0.00000	-1.00000	1.74532E-11
210	-0.50000	-0.86602	5.77350E-01
240	-0.86602	-0.50000	1.73205E 00
270	-1.00000	0.00000	-5.72957E 10
300	-0.86602	0.50000	-1.73205E 00
330	-0.50000	0.86602	-5.77350E-01
360	0.00000	1.00000	1.74532E-11

POCKET COMPUTER TO TELETYPE: 6800 MACHINE CODE

1-BYTE CHARACTER TABLE:

```

0090 B4 F4 E4 C0 A8 84 74 F0 B0 8C 9C 40 60 4C 38 48
00A0 40 58 2C 14 30 68 73 24 1C 18 0C 34 74 28 50 04
00B0 70 3C 64 5C 54 44 10 D0 CC 9C 5C D8 54 AC 00 00

```

4-BYTE CHARACTER TABLE:

```

00C0 11 AC 20 00 12 9D 51 00 98 00 00 00 B8 C0 00 00
00D0 B8 00 00 00 F8 00 00 00 A4 00 00 00 11 61 20 00
00E0 11 21 20 00 BC 00 00 00 C4 00 00 00 E0 00 00 00
00F0 90 E4 00 00 DC 00 00 00 11 B9 51 00 11 70 E9 00
0100 11 30 E9 00 10 D0 E9 00 10 23 20 00 12 81 83 48
0110 10 25 81 98 12 8C 31 00 11 C3 A1 00 10 38 31 00
0120 13 14 31 00 13 0E A1 00 13 01 31 00 12 17 69 00
0130 11 26 20 00 11 23 59 00 11 86 09 00 13 13 A1 00
0140 12 8B 31 00 12 50 59 00 12 47 A1 00 2D 58 90 00
0150 35 4C 30 48 30 CD E0 48 2B 12 66 0C 4A 0F 54 20
0160 39 30 C2 80 32 C4 00 00 58 6A 20 00 11 30 09 00
0170 2A 07 20 00 40 D2 00 00 1A 17 09 00 50 23 68 00
0180 2C 61 19 00 2C 74 E4 C8 38 B8 61 88 37 1C A4 08
0190 4E 10 69 00 61 50 C4 88 72 8C 32 C8 2A 01 E2 8C

```

CONVERSION TABLE:

```

01A0 00 15 00 03 C0 BB BB 00 BB B0 A3 00 91 87 00 00
INPUT STORE: 01B0-01FF

```

MAIN PROGRAM:

```

0200 CE 80 12 C6 3B E7 01 C6 77 E7 00 C6 36 E7 01 DF
0210 34 8D 7B CE 01 B0 DF 36 DE 34 86 1F A7 00 8D 53
0220 16 8D 50 58 58 58 58 1B DE 36 A7 00 08 4D 26 E6
0230 86 0F B7 80 12 CE 01 B0 A6 00 08 DF 36 81 8E 27
0240 1E C6 FF 8D 24 03 8D 21 37 CB 03 27 02 8D 50 33
0250 37 8D 57 33 9C 26 F9 86 1D 8D 62 C6 01 8D 40 DE
0260 36 6D 00 27 AC 8D 43 20 F6 A6 01 84 F0 81 40 26
0270 01 5A 39 86 03 A5 00 26 FC 8D 0B 8D 07 44 8A 08
0280 A4 00 24 F7 8D 00 37 C6 A1 5A 26 FD 33 39 86 10
0290 8D 46 8D 44 86 40 8D 40 86 3C 97 3B 39 C6 05 86
02A0 20 8D 35 7A 00 3B 5A 26 F8 39 DE 36 A6 00 8D 0D
02B0 7D 00 3B 2A 04 8D D7 8D E4 7C 00 37 39 CE 01 A0
02C0 16 54 54 54 54 08 5A 26 FC AB 00 81 2E 2B 1A CE
02D0 00 C0 80 2E 48 48 20 15 36 37 8D 63 33 32 39 8D
02E0 00 C6 05 8D 9F 5A 26 FA 39 CE 00 90 5C DF 38 9B
02F0 39 97 39 86 00 99 38 97 38 DE 38 86 80 A4 00 91
0300 3A 27 0D 97 3A 4D 26 04 86 F8 20 02 86 D8 8D C8
0310 DE 38 5D 26 0C A6 03 97 33 A6 02 97 32 A6 01 97
0320 31 A6 00 97 30 8D 0B 8D 18 7A 00 3B 7D 00 30 26
0330 F6 39 78 00 33 79 00 32 79 00 31 79 00 30 39 97
0340 30 DE 34 86 0E A7 00 8D 96 C6 05 37 86 07 8D E2
0350 49 A7 00 8D BA 33 5A 26 F2 86 0F A7 00 8D 80 8D
0360 80 39

```

LET THE

# AUSTRALIAN BEGINNING

BRING MAINFRAME POWER INTO YOUR HOME OR OFFICE



## THE AUSTRALIAN BEGINNING PTY. LTD.

The Australian Beginning Pty. Ltd. is an Australian company, with Australian based computer facilities, using the Australian Telecommunications network to offer Australian clients Australian information services and software.

## WE ARE PROUD TO ANNOUNCE THE LAUNCHING OF AUSTRALIA'S FIRST MICROCOMPUTER INFORMATION UTILITY

**The AUSTRALIAN BEGINNING** is Australia's first microcomputer information utility, aimed at giving the average microcomputer user access to the computer data banks and also massive storage space previously only available to large Mainframe installations. The era of home computers has now officially begun in Australia, now that the AUSTRALIAN BEGINNING is here; as now, any small businessman or student can have on his desk for an extremely small cost, a system that has the level of storage power and access to data banks for which only a few years ago, government departments and large private users were paying millions of dollars.

The AUSTRALIAN BEGINNING can be accessed through a number of "approved" personal computers, and terminals, by use of an acoustic coupler or modem.

Users will receive a number of benefits which will include:

### INFORMATION SERVICES

Members will have access to a number of information sources which will include the latest news, sports results, financial reports, and farm information.

### NATIONWIDE COMMUNICATION

Members will be able, also, to communicate nationwide with other AUSTRALIAN BEGINNING members through our system.

THE AUSTRALIAN BEGINNING  
RECOMMENDS 3M DISKETTES

### SOFTWARE BANK

Users will have access to a myriad of computer programs that will include entertainment, educational aids, programming and diagnostic tools, and financial applications.

### MAINFRAME POWER

Users will have the capability to make use of the Mainframe's huge storage capacity by using any of our large programs, or storing your large programs on our system.

### SHOP AT HOME

You can take advantage of our "shopping by computer" system to get the best prices on a number of popular consumer items.

### EXTREMELY EASY TO USE

You do not have to be a computer programmer to make use of the AUSTRALIAN BEGINNING. All of the instructions are in everyday English, so that even the younger members of your family will be able to operate the system.

### LOW COST

While services like these used to cost tens of thousands of dollars to the government departments and large corporations who used them, they are now available to you for less than the cost of a packet of cigarettes a day for the "average" user.

You can join the AUSTRALIAN BEGINNING by paying a one-time joining fee of \$100, and a small hourly user charge of \$10 an hour 6 p.m.-8 a.m. WEEKDAYS and ALL DAY Weekends

TO JOIN THE AUSTRALIAN BEGINNING FAMILY, AND TAKE ADVANTAGE OF THE EXCITING SERVICES WE WILL BE OFFERING, PLEASE COMPLETE THE COUPON BELOW:

<b>MEMBERSHIP REQUEST</b>	
<p>Yes, I think the idea of the AUSTRALIAN BEGINNING is great! I enclose \$100 so please send me my user manual and password.</p>	
<input type="checkbox"/>	I have a computer, Brand.....
Model.....	
<input type="checkbox"/>	Please send me information on low cost equipment packages I can use to take advantage of the AUSTRALIAN BEGINNING'S services.
NAME: .....	
ADDRESS:.....	
CITY:.....	
STATE:.....	POSTCODE.....
PHONE.....	
THE AUSTRALIAN BEGINNING (SALES) PTY.LTD., 364 LaTrobe Street, Melbourne, Victoria, 3000. Tel: (03)329.7998	
<input type="checkbox"/>	I am interested, but I need more information.

DEALER INQUIRIES INVITED

# Apple graphics guide

The Apple II, despite its relative age, has much to offer. Apart from colour, which should be cliché by now, the Apple features three display modes, including hi-res and lo-res graphics. Here's a beginners' guide.

**Mike James**

THE APPLE was perhaps the first personal computer to offer graphics capabilities. I remember finding the early glossy colour advertising for the system unbelievable because it was so far in advance of its competitors in terms of presentation and performance. Now we have colour boards for the S100 buss and machines such as the Atari 800 and the Peach all offering high resolution and easy-to-use graphics, but the Apple still has a lot to offer.

If you have an Apple, this article will help you understand its graphics capabilities and make the most of them. If you are thinking of buying a micro, graphics is an important factor to bear in mind, so read on to see what the Apple has to offer.

## Apple's graphic features

The system has three distinct display modes: Text, Low-Resolution Graphics and High-Resolution Graphics. When first switched on, the Apple starts out in Text mode displaying just 24 lines of 40 characters. This, to me, is one of the most disappointing features of the Apple. Not only are you restricted to 40 characters per line, but there is no lower case! You can't win 'em all!

In low-res graphics mode you can display any number of blocks from an array of 40 blocks wide and 48 blocks high. A block can be any of sixteen different colours, so you need a colour TV to see them. Low-res graphics are easy to use, fast and ideal for simple games programs such as tennis, squash, arcade games, etc. Their obvious disadvantage is that it is not possible to draw precise shapes.

If you enter high-res graphics mode you can plot any of an array of 280 dots wide by 192 dots high. Dots can be any one of six colours but not every dot can be any colour. There is a limitation to the colour TV which means that not every colour is available at every position, and displaying two points in different colours side-by-side results in white! Because of these considerations,

colour in high-res graphics is difficult to use reliably and we will concentrate on black and white graphics.

High-res graphics are very good for drawing graphs and line diagrams, but anything complicated can be a little slow and shading in areas of continuous tone is painfully slow.

Although high-res graphics is the most difficult of the Apple's graphics modes, it is also the most exciting and rewarding to work with. Adjacent blocks have no space between them so continuous areas of colour can be constructed.

## Mixed modes

As well as the three 'pure' modes, the Apple can work in a mixed graphics and text mode rather than the pure graphics. If you want either pure low-res graphics or pure high-res graphics from Applesoft then you have to use a PEEK (see the Apple manual for details; Table 1 gives a summary).

Another feature of the display modes is that each has two pages. This means that you can write information to one page while displaying the other and then suddenly flip pages, thus making the new information appear. This can be useful for animation and generally speeding up display presentation. Under Applesoft, page two of low-res graphics can only be reached via a POKE, but page 2 of high-res can be invoked via an HGR 2 statement. Unlike HGR, HGR 2 gives a pure graphics mode, i.e. the four lines of text do not appear at the bottom of the screen.

## Graphics in general

Now that we know the sort of thing the Apple can do, let's pause a moment and consider the way other micros tackle the graphics problem. Some micros (such as the Commodore PET) have adopted a very different approach to graphics. Instead of allowing the user to plot small points or blocks and then build up

shapes, the PET supplies a set of graphics characters. This reduces the amount of memory used to store any display. It also allows a free mixing of graphics and alphanumeric characters anywhere on the screen. The disadvantage of this method is that you depend on the machine's designer to supply you with all the shapes that you need — i.e. battleships, rockets, etc, and you have the problem of fitting them together to make bigger shapes. For example, I remember trying to draw a square on the screen of a PET and spending hours trying to find the correct graphics character to complete a corner without leaving a gap. It is true that I found the beast after a rest and a coffee, but it brought home how much I was at the mercy of the available character set!

Not so on the Apple, however. A basic low-res character is simply a solid rectangular block — no hunting for shapes, you can either plot a block or leave it off. This is easy to use but the shapes that you can display are limited. To deal with shapes such as diamonds, hearts, spades and clubs you really have to go to high-res graphics. Although the range of shapes you can make in high-res mode is unlimited, drawing a common but complicated shape such as a heart is not easy and there have been times when it would have been nice to have a PET-style graphics set built in.

There is one innovation that was introduced by the Apple which provides a link between the two graphics methods: the shape table — but more of that later.

## Co-ordinates

Using either of Apple's graphics modes depends on an understanding of co-ordinates. Among the questions most often asked by someone new to Apple graphics are, "How do I plot a diagonal line in low-res?", and "How do I plot a circle in high-res graphics?" The answer to both of these questions lies in the use of co-ordinates and co-ordinate geometry. If the introduction of the ►

word 'geometry' has you remembering school and hence about to turn to another article, take courage and read on. Co-ordinate geometry is not about theorems and proofs but is about how to generate or draw geometric figures such as circles, ellipses, etc.

The best way to understand co-ordinates is to imagine a chessboard. Starting from the top left-hand corner, count off each column starting at 0 and then count off each row starting at 0. Now if you are asked to label any square you should have no trouble. This is all there is to the idea of a co-ordinate. By tradition, the first co-ordinate you give is the column number and the second the row number — so 3,6 means column 3, row 6. Also by tradition, the column number is called the x co-ordinate and the row number is called the y co-ordinate. Two important things to notice are that all the squares in the same column have the same x co-ordinate and all the squares in the same row have the same y co-ordinate. Moving horizontally across the board changes x and leaves y fixed and moving vertically changes y but leaves x fixed.

The Apple uses two co-ordinate systems. In low-res graphics the screen is divided into an array of 40 columns by 48 rows. As with the chessboard example, the numbering starts in the top left-hand corner of the screen with 0,0, making the block in the lower right-hand corner 39,47. If four rows of text are used at the bottom of the screen then the maximum y co-ordinate is reduced to 39.

In high-res graphics the screen is divided into an array of dots 280 by 192, once again with 0,0 in the top left-hand corner. The maximum co-ordinate (i.e: the bottom right-hand corner) is therefore 279,191. If four lines of text are included, then the maximum y value is reduced to 159. Details of the memory maps can be seen in Table 2.

## Low-resolution graphics

After some theory it's time to look at how Apple handles low-res graphics. First we will go over the standard low-res commands and explain how they are used. In the next section a program will provide a practical demonstration of how the instructions can be used together to produce the sort of games so often seen on the Apple.

The first low-res graphics command we need is GR. This switches the Apple to mixed text and low-res graphics mode and clears the screen. Once in low-res the colour of the next and subsequent plotted points is set by:

```
COLOR=arithmetic expression
      (note American spelling)
```

The arithmetic expression must evaluate to a number in the range 0 to 15. The range of colours can be seen in Table 3, but the most often used are 0 for black and 15 for white. To plot a point in the currently selected colour, use:

```
PLOT arithmetic expression 1,
      arithmetic expression 2
```

The first arithmetic expression is the x co-ordinate of the point and the second is the y co-ordinate. The following program illustrates the use of these three commands:

```
10 GR
20 INPUT X,Y,C
30 COLOR=C
40 PLOT X,Y
50 GOTO 20
```

This program will let you enter the x and y co-ordinate and colour of a point to be plotted. Try using it to explore the screen and see what happens if you try to plot in the text area or outside the screen altogether. It is important to realise that you can alter the colour of a point only by replotting it. (Some machines have an UNPLOT command instead). For example, if you want to make a point flash on and off:

```
10 GR
20 COLOR=15
30 PLOT 30,30
40 COLOR=0
50 PLOT 30,30
60 GOTO 20
```

To make the point flash slower put a FOR...NEXT loop in between lines 30 and 40 and lines 50 and 60. (Why do you need two delays?)

It is obvious that plotting horizontal or vertical straight lines is something that we need to know how to do in low-res graphics. Although it is possible to plot lines using only the PLOT command, Applesoft provides two special commands, VLIN and HLIN, which plot vertical and horizontal lines in the selected colour much faster than the equivalent set of PLOTS. To specify a vertical line you have to say which y co-ordinate it starts and finishes at (i.e: its length) and which position on the screen it is at (i.e: its x co-ordinate). The form of the VLIN command is thus:

```
VLIN starting y co-ordinate,
      finishing y co-ordinate AT
      x co-ordinate
```

It should come as no surprise that the form of the HLIN command is:

```
HLIN starting x co-ordinate,
      finishing x co-ordinate AT
      y co-ordinate
```

For example, to draw a square:

```
10 REM**PLOT A SQUARE WITH
30 REM**CORNERS AT 10,10 AND 20,20
30 GR
40 COLOR=15
50 HLIN 10,20 AT 10
60 HLIN 10,20 AT 20
70 VLIN 10,20 AT 10
80 VLIN 10,20 AT 20
```

A command that deserves more attention than it usually receives is SCRIN. The command:

```
C=SCRIN (x co-ordinate,
        y co-ordinate)
```

returns the colour of a specified point on the screen. As we will see in the next section it can be used for some very interesting dynamic graphics.

As an example of low-res graphics the following program plots a sort of pinball board and then bounces a 'ball' around the screen. It is not a complete game but provides the starting material for a number of different games which the reader may care to develop himself.

```
10 GR
20 GOSUB 1000
30 X=35
40 Y=RND(1)*39
50 HV=1
60 VV=1
70 GOSUB 2000
80 GOTO 70
90 END
1000 COLOR=15
1010 HLIN 0,39 AT 0
1020 HLIN 0,39 AT 39
1030 VLIN 0,39 AT 0
1040 VLIN 0,39 AT 39
1050 VLIN 8,12 AT 5
1060 VLIN 18,22 AT 5
1070 VLIN 28,32 AT 5
1080 PLOT 10,15
1090 PLOT 10,16
1100 PLOT 10,25
1110 PLOT 10,26
1120 PLOT 15,20
1130 PLOT 15,21
1140 PLOT 20,20
1150 PLOT 21,20
1160 PLOT 20,10
1170 PLOT 20,30
1180 VLIN 0,11 AT 30
1190 VLIN 39,28 AT 30
1200 RETURN
2000 COLOR=0
2010 PLOT X,Y
2020 COLOR=15
2030 X=X-HV
2040 Y=Y-VV
2050 IF SCRIN(X,Y)=0 THEN PLOT X,Y:
      HFLIP=0:RETURN
      IF HFLIP=0 THEN HFLIP=1:
      X=X+HV:Y=Y+VV:HV=-HV:
      GOTO 2030
2070 VV=-VV
2080 HV=-HV
2090 X=X-HV
2100 Y=Y-VV
2110 HFLIP=0
2120 GOTO 2030
```

The main part of the program (lines 10 to 90) simply sets up starting values and calls subroutines. The first subroutine draws the pinball board using a list of HLIN, VLIN and PLOT commands. The method used is straightforward and the reader should be able to alter the board layout without any trouble.

The starting co-ordinates for the 'ball' are set up in lines 40 and 50, the x co-



ordinate being random between 0 and 39. Lines 50 and 60 set the horizontal and vertical velocities (VV, VH) to 1. The values of VV and VH govern the distance and direction that the 'ball' will move at each step. Lines 70 and 80 call the 'move ball' subroutine repeatedly. If the ball moves too fast for your game, then slow it down with a FOR...NEXT loop at line 75. The move ball subroutine is the heart of the program. It moves the ball from X,Y to X-VH,Y-VV by first unplotting the existing ball position (line 2010) and then plotting the new ball position. Before the new position is plotted, it is checked to see if it is free, i.e. is black (line 2050), using the SCRN function. If it isn't free then it is part of the border or an obstacle and the ball cannot move into that position.

When the ball hits an area of white its direction changes. Either the vertical velocity is reversed (VV=-VV) or its horizontal velocity is reversed (VH=-VH) but not both.

The way this program achieves this 'bouncing' effect is a little unusual. At line 2080 the horizontal velocity is reversed and HFLIP is set to 1 to record this fact. The ball's position is now returned to its old value and a GOTO 2030 causes the program to try to plot the ball's new position. If this is yet again blocked by a white square then the horizontal velocity and the ball's position are returned to their previous values and the vertical velocity is reversed in another attempt to find a free location.

All this might seem very complicated, but it does mean that the ball will bounce its way around a screen full of whatever objects you care to plot in subroutine 1000.

The program can be extended to cope with different sorts of collision by plotting obstacles in different colours and using SCRN to test what should happen when the ball tries to move into an occupied location. (For example, you could increase the velocities when the ball strikes a red obstacle.)

## High-resolution graphics

As mentioned earlier, high-res graphics is difficult to use but the effects it can achieve are well worth the trouble. To enter a mixed high-res and text mode the command HGR should be used. If you want a pure high-res screen then the command HGR 2 should be used instead, but notice that graphics page 2 is used. Either HGR command clears the screen before allowing you to plot using the colour selected by the HCOLOR = instruction. As discussed earlier, the use of colour in high-res graphics is a tricky subject and needs an article all to itself,

so we will assume that all graphics will be in black and white. The high-res equivalent of PLOT is:

```
H PLOT x co-ordinate, y co-ordinate
```

although it is not used as much as PLOT because a single high-resolution point is very small indeed. The work-horse instruction for high-res is the extended H PLOT command:

```
H PLOT start x co-ordinate,
        start y co-ordinate TO
        finish x co-ordinate,
        finish y co-ordinate
```

This will plot a line from the starting co-ordinates to the finishing co-ordinates. Horizontal and vertical lines are now special cases of the general line drawing. For example to draw a line from 40,10 to 100,90 use:

```
H PLOT 40,10 TO 100,90
```

When drawing diagonal lines it is sometimes disappointing to see the rough and ragged result looking more like a bolt of lightning rather than a straight line! There is nothing that can be done about this except to buy a computer with still higher resolution graphics. If you can put up with lines that aren't solid then I find it is better to plot only the points that lie exactly on the line and leave the eye to fill in the gaps. This is often the best way to plot graphs and curves to look smooth. For example, consider the two lines plotted by the program given below:

```
1 HGR2
2 HCOLOR=3
10 X1=0
20 Y1=50
30 X2=259
40 Y2=73
50 ACC=.1
60 H PLOT X1,Y1 TO X2,Y2
70 M=(Y2-Y1)/(X2-X1)
80 FOR I=X1 TO X2
90 Y=M*I+80
100 D=Y-INT(Y)
110 IF D<ACC THEN H PLOT I,Y
120 NEXT I
```

The first line is plotted as a solid line using the H PLOT command and the second line only plots those points that are within a distance ACC of the true line. I leave you to choose which is better for your application.

The H PLOT command has two more ways in which it can be used. First, if you only give a pair of finish co-ordinates, then the last plotted dot is taken to be the start of the line, for example:

```
10 H PLOT 10,10
20 H PLOT TO 100,90
```

is the same as:

```
10 H PLOT 10,10 TO 100,90
```

Second, you can carry on an H PLOT command with as many TO final co-ordinate pairs as you can type. Each time a TO is encountered a line is drawn from the last pair of co-ordinates to the pair following the TO. An example might help to make this clear.

```
10 H PLOT 10,10 TO 100,90 TO 50,50
```

is the same as:

```
10 H PLOT 10,10 TO 100,90
20 H PLOT 100,90 TO 50,50
```

## Some useful shapes

There are two ways of using high-res graphics — you can list and plot every point you're interested in (in which case you'd do well to invest in a light pen or a graphics tablet) or you can generate the shapes that you need by the use of formulae. To illustrate the point, consider the problem of plotting a circle. You could store the co-ordinates of every point on the circle in an array and then plot every point, or you could use the equation that defines a circle to generate each point in turn. If you need to draw a very complicated shape then you have little choice but to buy a light pen! Most graphics applications require nothing more than straight lines, circles and ellipses, so it's worth knowing how to draw them.

Drawing straight lines in Applesoft is easy; all you have to do is use the H PLOT command. But how do you draw a curve? The answer is to draw a number of straight lines that lie as close to the curve as possible. For example, if we consider the circle drawing problem, co-ordinate geometry tells us that any point on the circle is given by an x co-ordinate of  $r \cos(\theta) + x$  and a y co-ordinate of  $r \sin(\theta) + y$ , where r is the radius of the circle centred at x,y. As theta goes from 0 to  $2\pi$  every point on the circle is generated, and we could use this fact to plot a sufficiently large number of points to give the impression of a continuous curve. This is what the following program does:

```
1 HGR2
2 HCOLOR=3
10 PI=3.14159
20 X=100
30 Y=100
40 R=60
50 INC=.09
100 FOR THETA=0 TO 2*PI STEP INC
110 H PLOT R*COS(THETA)+X,
        R*SIN(THETA)+Y
120 NEXT THETA
```

You can vary the size and position of the circle by varying R, X and Y. Or, you can plot from point to point by making the following changes to the program: ▶

```

42 X2 = X + R
43 Y2 = Y
100 FOR THETA = 0 TO 2*PI + INC
STEP INC
105 X1 = R*COS(THETA)+X
106 Y1 = R*SIN(THETA)+Y
110 HPLOT X2,Y2 TO X1,Y1
115 X2 = X1
116 Y2 = Y1

```

If you want to draw an ellipse, then you can do it by simply modifying the original dot-drawn circle program as follows:

```

35 R1 = 60
40 R2 = 20
110 HPLOT R1*COS(THETA)+X,
R2*SIN(THETA)+Y

```

If you want to produce a line-drawn ellipse, then modify your line-drawn circle program as follows:

```

40 R1 = 60
42 X2 = X+R1
45 R2 = 20
105 X1 = R1*COS(THETA)+X
106 Y1 = R2*SIN(THETA)+Y

```

The two variables R1 and R2 are the axes of the ellipse. You can vary these to make a 'thinner' or 'fatter' ellipse. You can move the ellipse around on screen by varying X and Y. Drawing a cylinder is relatively easy; simply add the following lines to the line-drawn ellipse program:

```

51 GOSUB 100
52 X = 100
53 Y = 30
54 GOSUB 100
55 HPLOT R1+100,100 TO R1 + 100,30
56 HPLOT 100-R1,100 TO 100-R1,30
57 END

```

```
130 RETURN
```

Line 51 gets the lower ellipse drawn. Lines 52 to 54 then draw another ellipse of the same size above the first and lines 55, 56 draw the lines between the two.

For a bit of fun, take your line-drawn circle program and modify it thus:

```

44 N = 4
45 A = 3
50 INC = 2*PI/A
100 FOR THETA = 0 TO N*PI + INC
STEP INC

```

Voila! — a triangle. Now, in turn, try A = 2.5, 4 and 5. Interesting? Then set N = 8 and try, in turn, A = 2.25, 4.5, 6.75 and 9. Try exploring other relations.

## Shape tables

It was mentioned earlier that one of the problems of using Apple graphics is that

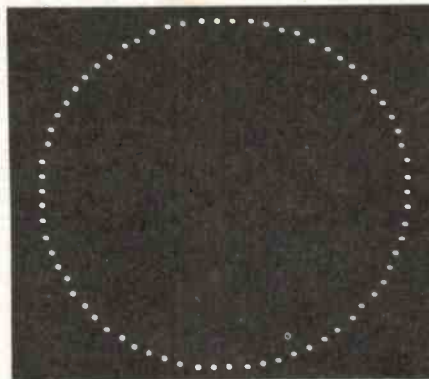

A circle composed of dots

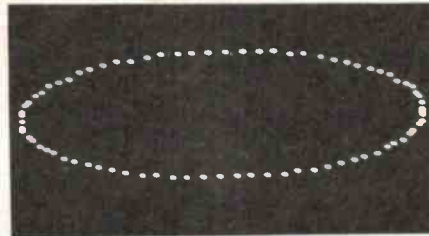

An ellipse composed of dots

standard shapes are not available from the keyboard. This can be overcome by use of a very clever idea — the shape table. Put simply, the shape table is a way of recording the outline of a shape and then plotting it at any point on the screen, any size and in any orientation. So, via a set of shape tables you could make often-used shapes as freely available in high-res graphics as if they were symbols on the keyboard. The only trouble is that shape tables are fairly difficult to use (it would take yet another article to explain them, for example) and my advice to anyone considering using them is to buy a shape table compiler.

A shape table compiler is usually a BASIC program that will allow you to draw your fundamental shape on the screen, accepts any corrections and then produces a shape table for it — this makes life very much easier. Shape tables are often used to provide a set of standard characters (e.g. A-Z and 0-9) so that text can be placed *anywhere* on a graphics screen.

## Conclusions

In this fairly rapid look at Apple graphics I have tried to show the sort of things an Apple can do and how they can be done. I have obviously had to treat some topics very briefly, but I hope I have given the reader sufficient understanding to go on and discover how more advanced graphics are achieved. I say 'discover', for although you can go out and read books on graphics in general, the Apple is an ideal machine for learning about graphics by experiment — and it's fun!

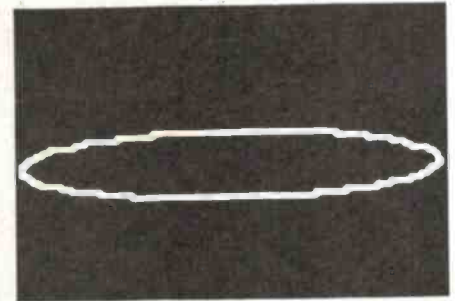

A 'continuous' ellipse — it's better done with dots.

Location	Function
49232 (C050)	Display GRAPHICS
49233 (C051)	Display TEXT
49233 (C052)	Display all TEXT or GRAPHICS
49235 (C053)	Mix TEXT and GRAPHICS *
49236 (C054)	Display Page 1
49237 (C055)	Display Page 2
49238 (C056)	Display Low-Res *
49239 (C057)	Display High-Res *

Table 1. The various display modes and the soft switches which control them. The items marked with an \* only function in the graphics mode.

Mode	Page 1	Page 2
Text	1024-2047 (0400-07FF)	2048-3071 (0800-0BFF)
Low-Res	As Text	As Text
High-Res	8192-16383 (2000-3FFF)	16384-24575 (4000-5FFF)

Table 2. The three 'pure' modes and their corresponding screen addressing.

## Dec Hex Colour

0	0	Black
1	1	Magenta
2	2	Dark Blue
3	3	Purple
4	4	Dark Green
5	5	Grey 1
6	6	Medium Blue
7	7	Light Blue
8	8	Brown
9	9	Orange
10	A	Grey 2
11	B	Pink
12	C	Light Green
13	D	Yellow
14	E	Aquamarine
15	F	White

Table 3. The available colours and their codes for low-res graphics.

CODE	SYM-BOL	CODE	SYM-BOL	CODE	SYM-BOL	CODE	SYM-BOL	CODE	SYM-BOL	CODE	SYM-BOL	CODE	SYM-BOL	CODE	SYM-BOL
0	@	32	!	64		96		128	@	160	!	192		224	
1	A	33	"	65		97		129	A	161	"	193		225	
2	B	34	#	66		98		130	B	162	#	194		226	
3	C	35	\$	67		99		131	C	163	\$	195		227	
4	D	36	%	68		100		132	D	164	%	196		228	
5	E	37	&	69		101		133	E	165	&	197		229	
6	F	38	'	70		102		134	F	166	'	198		230	
7	G	39	(	71		103		135	G	167	(	199		231	
8	H	40	)	72		104		136	H	168	)	200		232	
9	I	41	*	73		105		137	I	169	*	201		233	
10	J	42	+	74		106		138	J	170	+	202		234	
11	K	43	,	75		107		139	K	171	,	203		235	
12	L	44	-	76		108		140	L	172	-	204		236	
13	M	45	.	77		109		141	M	173	.	205		237	
14	N	46	/	78		110		142	N	174	/	206		238	
15	O	47	0	79		111		143	O	175	0	207		239	
16	P	48	1	80		112		144	P	176	1	208		240	
17	Q	49	2	81		113		145	Q	177	2	209		241	
18	R	50	3	82		114		146	R	178	3	210		242	
19	S	51	4	83		115		147	S	179	4	211		243	
20	T	52	5	84		116		148	T	180	5	212		244	
21	U	53	6	85		117		149	U	181	6	213		245	
22	V	54	7	86		118		150	V	182	7	214		246	
23	W	55	8	87		119		151	W	183	8	215		247	
24	X	56	9	88		120		152	X	184	9	216		248	
25	Y	57	:	89		121		153	Y	185	:	217		249	
26	Z	58	;	90		122		154	Z	186	;	218		250	
27	[	59	<	91		123		155	[	187	<	219		251	
28	\	60	=	92		124		156	\	188	=	220		252	
29	]	61	>	93		125		157	]	189	>	221		253	
30	^	62	?	94		126		158	^	190	?	222		254	
31	_	63		95		127		159	_	191		223		255	

AS COLUMN 1 BUT FLASHING

AS COLUMN 2 BUT FLASHING

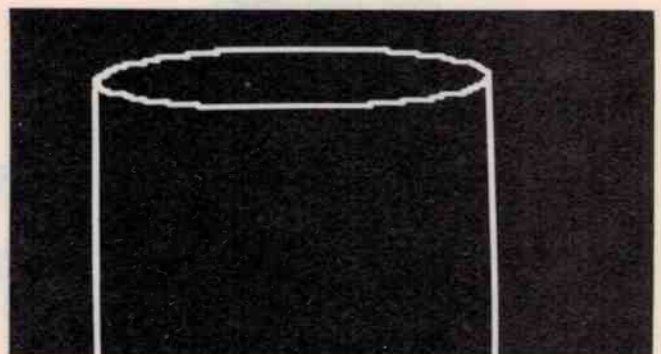
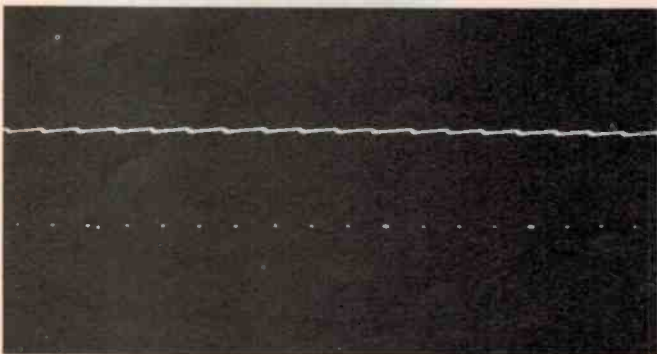

# THE COMPUTER COUNTRY GROUP

The Apple Professionals



WE ARE VICTORIA'S OLDEST APPLE DEALER

EXCELLENT PRICES!  
EXCELLENT SERVICE!  
EXCELLENT BACKUP!  
WHY GO ELSEWHERE?



WE HAVE PROBABLY ONE OF THE BIGGEST RANGES OF  
APPLE PRODUCTS IN AUSTRALIA

**COMPUTER COUNTRY (VICTORIA) PTY LTD**  
338 QUEEN STREET,  
MELBOURNE, VIC. 3000.  
(03) 329-7533

**IN QUEENSLAND**  
CALL COMPUTER CITY  
600 OLD CLEVELAND ROAD,  
CAMP HILL, QLD. 4152.  
(07) 398-6759

**IN SOUTH AUSTRALIA**  
CALL KEY COMPUTER  
1055 SOUTH ROAD,  
EDWARDSTOWN, SA 5039.  
(08) 277-8936



**SOON TO BE OPENING IN PERTH.**  
**FOR FURTHER INFORMATION Call Computer Choice**  
(09) 332 5651

64K SS50 STATIC NOW AVAILABLE \$399 + TAX  
 64K S100 STATIC NOW AVAILABLE \$399 + TAX  
 DON'T FORGET TO CHECK WITH US BEFORE YOU BUY A COMPUTER OR OTHER PRODUCTS

# ROD IRVING ELECTRONICS

425 HIGH STREET, NORTHCOTE 3070, MELBOURNE, VICTORIA

MASSIVE PRICE CUTS ON BIG BOARD COMPUTER

64K SINGLE BOARD COMPUTER KIT NOW ONLY \$499 + TAX.

## 16K EPROM CARD-S 100 BUSS



\$89.50  
KIT

BLANK PC BOARD \$49  
USES 2708's at

Thousands of personal and business systems around the world use this board with complete satisfaction. Puts 16K of software on line at ALL TIMES! Kit features a top quality soldermasked and silk-screened PC board and first run parts and sockets. Any number of EPROM locations may be disabled to avoid any memory conflicts. Fully buffered and has WAIT STATE capabilities.

OUR 450 NS 2708'S ARE \$5.90EA. WITH PURCHASE OF KIT

ASSEMBLED AND FULLY TESTED ADD \$36

## S100 COMPUTER PRODUCTS

### 32K S-100 EPROM CARD

NEW!



\$99.95  
KIT

USES 2716's  
Blank PC Board - \$59  
ASSEMBLED & TESTED ADD \$30

SPECIAL: 2716 EPROM's (450 NS) Are \$5.90 EA. With Above Kit.

- KIT FEATURES
- 1 Uses +5V only 2716 (2Kx8) EPROM's
  - 2 Allows up to 32K of software on line!
  - 3 IEEE S-100 Compatible
  - 4 Addressable as two independent 16K blocks
  - 5 Cromemco extended or Norbitalk bank select
  - 6 On board wait state circuitry if needed
  - 7 Any of all EPROM locations can be disabled
  - 8 Double sided PC board solder-masked, silk-screened
  - 9 Gold plated contact fingers
  - 10 Unselected EPROM's automatically powered down for low power.
  - 11 Fully buffered and bypassed
  - 12 Easy and quick to assemble

\*\*\* AVAILABLE AGAIN \*\*\*



- 16K Dynamic Ram Board
- Fully Expandable to 64K
- Assembled, tested and guaranteed
- S100 Compatible
- 16K Dynamic RAM Board assembled and tested Special \$265 plus tax (4mhz) \$299 plus tax (4mhz) This must be the best offer available on quality tested dynamic RAM boards.

32K Assembled and tested \$289 plus tax (4mhz)

48K Assembled and tested \$309 plus tax (4mhz)

64K Assembled and tested \$329 plus tax (4mhz)

## 16K STATIC RAM KIT-S 100 BUSS

KIT \$179  
A&T \$199



KIT FEATURES

- 1 Addressable as four separate 4K blocks
- 2 ON BOARD BANK SELECT circuitry (Cromemco Standard) Allows up to 512K on line
- 3 Uses 2714 (60NS) 4K Static Ram's
- 4 ON BOARD SELECTABLE WAIT STATES
- 5 Double sided PC Board with solder mask and silk screened layout. Gold plated contact fingers
- 6 All address and data lines fully buffered
- 7 Kit includes ALL parts and sockets
- 8 PROMS are soldered to Pk 67
- 9 LOW POWER! Under 1.5 amps TYPICAL from the +5 Volt Bus
- 10 Blank PC Board can be populated as any multiple of 4K.

BLANK PC BOARD w DATA \$55  
LOW PROFILE SOCKET SET \$22  
SUPPORT IC'S & CAPS \$29  
ASSEMBLED & TESTED ADD \$30

OUR #1 SELLING RAM BOARD!

## 16K STATIC RAM SS-50 BUSS

PRICE CUT!

\$199 KIT  
A&T \$219

FULLY STATIC AT DYNAMIC PRICES



32K STATIC ALSO AVAILABLE

- KIT FEATURES
- 1 Addressable on 16K Boundaries
  - 2 Uses 2714 Static Ram
  - 3 Runs at Full Speed
  - 4 Double sided PC Board Solder mask and silk screened layout Gold fingers
  - 5 All Parts and Sockets included
  - 6 Low Power Under 1.5 Amps Typical

FOR SWTPC 6800 BUSS!

BLANK PC BOARD - \$49 COMPLETE SOCKET SET - \$22 SUPPORT IC'S AND CAPS - \$45

## ETI 660 THE \$99 COMPUTER!

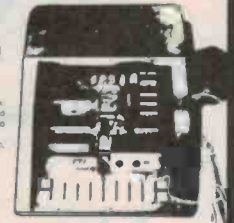

FEATURES INCLUDE

- Colour capability operates from optional 9 V plugpack
- 1K memory expandable to 3K (on-board, single board construction), cassette interface, audio output, simple to program (uses Chip-8)
- Expansion projects coming up include ASCII keyboard, light pen, camera software, etc.
- Starter Kit (1K RAM, B&W Video) \$99.00
- 9 V, 1 amp plug pack to suit \$12.50
- Colour video option \$13.50
- RAM Expansion (add to PCB) \$18.00

### ETI636 7 SLOT MOTHERBOARD WITH ACTIVE TERMINATION

Kit of Parts \$89.00. Assembled and tested \$115.00, inc tax.  
RITRON COMPUTER GRADE POWER SUPPLY, +5V Reg. 10A.  
± 16V Unreg Kit of parts \$89.90 inc tax A&T \$109.00 inc tax  
Write for list of other power supplies. Tax free prices also available.

# SINGLE BOARD COMPUTER KIT NOW ONLY \$499 + TAX (17½%)

Also available: Blank PCB's with Roms \$275 + Tax.  
Assembled & Tested \$599 + Tax.

THE FERGUSON PROJECT: Three years in the works, and maybe too good to be true. A tribute to hard headed, no compromise, high performance, American engineering! The Big Board gives you all the most needed computing features on one board at a very reasonable cost! The Big Board was designed from scratch to run the latest version of CP/M\*. Just imagine all the off-the-shelf software that can be run on the Big Board without any modifications needed! Take a Big Board, add a couple of 8 inch disc drives, power supply, and an enclosure, and you have a total Business System for about 1/3 the cost you might expect to pay.

FEATURES: (Remember, all this on one board!)

### 64K RAM

Uses industry standard 4116 RAM'S. All 64K is available to the user, our VIDEO and EPROM sections do not make holes in system RAM. Also, very special care was taken in the RAM array PC layout to eliminate potential noise and glitches.

### Z-80 CPU

Running at 2.5 MHZ. Handles all 4116 RAM refresh and supports Mode 2 INTERRUPTS. Fully buffered and runs 8080 software

### SERIAL I/O (OPTIONAL)

Full 2 channels using the Z80 SIO and the SMC 8116 Baud Rate Generator. FULL RS232! For synchronous or asynchronous communication. In synchronous mode, the clocks can be transmitted or received by a modem. Both channels can be set up for either data-communication or data-terminals. Supports mode 2 Int. Price for all parts and connectors: \$65

### BASIC I/O

Consists of a separate parallel port (Z80 PIO) for use with an ASCII encoded keyboard for input. Output would be on the 80 x 24 Video Display.

### REAL TIME CLOCK (OPTIONAL)

Uses Z-80 CTC. Can be configured as a Counter on Real Time Clock. Set of all parts: \$19

### 24 x 80 CHARACTER VIDEO

With a crisp, flicker-free display that looks extremely sharp even on small monitors. Hardware scroll and full cursor control. Composite video or split video and sync. Character set is supplied on a 2716 style ROM, making customized fonts easy. Sync pulses can be any desired length or polarity. Video may be inverted or true.

### FLOPPY DISC CONTROLLER

Uses WD1771 controller chip with a TTL Data Separator for enhanced reliability. IBM 3740 compatible. Supports up to four 8 inch disc drives. Directly compatible with standard Shugart drives such as the SA800 or SA801. Drives can be configured for remote AC off-on. Runs CP/M\* 2.2.

### FOUR PORT PARALLEL I/O (OPTIONAL)

Uses Z-80 PIO. Full 16 bits, fully buffered, bi-directional. User selectable hand shake polarity. Set of all parts and connectors for parallel I/O: \$29

### PFM 3.0 2K SYSTEM MONITOR

The real power of the Big Board lies in its PFM 3.0 on board monitor. PFM commands include: Dump Memory, Boot CP/M\*, Copy, Examine, Fill Memory, Test Memory, Go To, Read and Write I/O Ports, Disc Read (Drive, Track, Sector), and Search. PFM occupies one of the four 2716 EPROM locations provided. It does not occupy any of the 64K of system RAM!

Bankcard Mail Orders Welcome

Please debit my Bankcard.  
 Bankcard No. \_\_\_\_\_  
 Expiry Date \_\_\_\_\_  
 Name \_\_\_\_\_  
 Signature \_\_\_\_\_

General enquiries (03) 489-8131. Mail order enquiries (03) 481-1436. Ritronics Wholesale (03) 489-7099. (Tax Exempt Enquiries)

Prices subject to change without notice. Send 60¢ and SAE for free Price lists. MAIL ORDERS PO BOX 235, NORTHCOTE, Vic. 3070. Minimum pack and post \$5.00. Telex AA38897. PLEASE WRITE OR RING FOR THE BEST POSSIBLE PRICES ON DISC DRIVES, PRINTERS AND OTHER COMPUTER COMPONENTS. 6/82-4

# SPACE DOGFIGHT



Luke Skywalker rides again! Shoot the evil X-wing fighter and see it disintegrate before your very eyes. But watch it! The X-wing fighter will sneak up behind and clobber you — unless you duck out of its way!

In this game, you control a Y-wing fighter that first appears in the middle of the screen, immediately you run the program. LOOK OUT! The huge X-wing fighter appears over your port rear quadrant — press key 9 to drop out of its way and, as it cruises past, hit key 5 to fire your missile before the X-wing craft disappears off the screen to the right.

- To move your Y-wing fighter UP — press key 1.
- To move it DOWN — press key 9.
- To move LEFT — press key 6.
- To move RIGHT — press key 7.
- To FIRE — press key 5.

A one-second tone is heard whenever the X-wing craft runs into the Y-wing craft — and you lose points from your score. When you score a hit, you'll hear a 'pip-pip-pip-pip-pip', 'bits' will disappear from the X-wing craft and it will change shape — making it much harder to hit, especially as you score more hits.

The game lasts about 80 seconds and your

score appears on screen at the end. Press 'RESET 8' to get a new game. We'll let all you keen CHIP-8 hackers have fun annotating the listing to find out how it works on this one.

This program has been modified and rewritten for the '660 from an original program submitted by J.L. Elkhorne of Chigwell, Tasmania, called 'COSMAC Asteroids', written for a 4K VP-111 reproduced elsewhere in this issue).

## PROGRAM NOTES

There are eight basic 'modules' in this program:

- 0600 — 0607 PLACE Y-WING MID SCREEN
- 0608 — 0641 CALL AND EXECUTE ROUTINES
- 0642 — 065B MOVE Y-WING FIGHTER
- 065C — 067F MISSILE DYNAMICS
- 0680 — 06B5 HIT X-WING FIGHTER
- 06B6 — 06CE MOVE X-WING FIGHTER
- 06D0 — 06F8 SCORING
- 0700 — 0711 FIGHTER & MISSILE PATTERNS

Scanning of the keyboard and executing the commands entered is done within the second module, from 061A to 0635. The Y-wing fighter pattern resides at 0700-0702, the missile at 0703. The

X-wing pattern is entered in two places (as it is called twice) at 0704-0709 and 070C-0711.

For left-handers, the keyboard positions can be exchanged by changing 061A to 63 02, 0620 to 63 01, 0626 to 63 07, 062C to 63 0F and 0632 to 63 03.

If you want to put the SHOOT key between the MOVE LEFT and MOVE RIGHT keys, change the original (right-handed) program by altering 0620 to 63 05 and 0632 to 63 06. Left-handers change 061A to 63 03 and 0632 to 63 02.

You can also muck about with the fighter patterns (completely changing the 'look' of the game, without altering its operation). You can change the Y-wing fighter to a miniature X-wing craft by altering addresses 0700-0702 to 28 18 28; or a 'reverse' of that by entering 10 28 10 instead. Note that your missile is at address 0703. You can make the larger craft harder to hit by changing address 0704-0709 to 00 66 18 18 66 00; do likewise at addresses 070C-0711. Or you could try something like 00 D8 20 D8 00 in those addresses. The 'reverse' of that pattern is 00 20 D8 20 00. You can really decrease the size of your Y-wing craft by entering 20 10 20 at addresses 0700-0702. Have fun!

X-WING	DOG FIGHT	0632	63	05	0666	4F	01	069A	A7	04	06CE	00	EE	0702	C0	10	
0600	A7	00	0634	E3	A1	0668	26	80	069C	D1	26	06D0	3D	00	0704	C3	66
0602	6A	1F	0636	26	5C	066A	D5	61	069E	C3	05	06D2	16	18	0706	18	18
0604	6B	10	0638	26	B6	066C	75	03	06A0	89	34	06D4	A7	13	0708	66	C3
0606	DA	B3	063A	47	18	066E	37	00	06A2	F3	1E	06D6	F9	33	070A	00	00
0608	69	00	063C	16	D0	0670	00	EE	06A4	FO	65	06D8	F2	65	070C	C3	66
060A	6D	14	063E	16	36	0672	67	18	06A6	C3	EE	06DA	00	E0	070E	18	18
060C	6C	00	0640	16	42	0674	00	EE	06A8	80	32	06DC	6A	18	0710	66	C3
060E	A7	04	0642	DA	B3	0676	85	A0	06AA	FO	55	06DE	6B	0A	<b>ERRATA</b>		
0610	61	00	0644	7A	02	0678	86	B0	06AC	71	08	06E0	FO	29	<b>VIDEO DRAWING</b>		
0612	62	00	0646	16	58	067A	76	01	06AE	A7	04	06E2	DA	B5	May issue p.117		
0614	D1	26	0648	DA	B3	067C	7D	FF	06B0	D1	26	06E4	7A	06	This program has the last four lines missing! Following 06A4 (00 EE), enter:		
0616	67	18	064A	7A	FE	067E	00	EE	06B2	A7	03	06E6	F1	29	81 04		
0618	A7	00	064C	16	58	0680	6C	06	06B4	00	EE	06E8	DA	B5	82 74		
061A	63	07	064E	DA	B3	0682	6E	02	06B6	A7	04	06EA	7A	06	16 32		
061C	E3	A1	0650	7B	FE	0684	FE	18	06B8	C3	02	06EC	F2	29	00 00		
061E	26	42	0652	16	58	0686	6E	03	06BA	C4	01	06EE	DA	B5	In addition, addresses 0664 to 0672 contain a data file and do not call subroutines, as the disassembled listing indicates.		
0620	63	06	0654	DA	B3	0688	FE	15	06BC	D1	26	06F0	A7	0C			
0622	E3	A1	0656	7B	02	068A	FE	07	06BE	81	34	06F2	F5	65			
0624	26	48	0658	DA	B3	068C	3E	00	06C0	82	44	06F4	A7	04			
0626	63	01	065A	00	EE	068E	16	8A	06C2	D1	26	06F6	F5	55			
0628	E3	A1	065C	A7	03	0690	7C	FF	06C4	3F	01	06F8	16	F8			
062A	26	4E	065E	47	18	0692	3C	00	06C6	00	EE	06FA	00	00			
062C	63	09	0660	26	76	0694	16	82	06C8	6E	0A	06FC	00	00			
062E	E3	A1	0662	D5	61	0696	79	02	06CA	FE	18	06FE	00	00			
0630	26	54	0664	77	FE	0698	67	18	06CB	7D	FF	0700	C0	20			

# SuperCalc™

THE ULTIMATE BUSINESS TOOL

NOW AVAILABLE FOR ANY CP/M MICRO  
 THE APPLICATIONS ARE ENDLESS  
 BALANCE SHEETS, DEPRECIATION SCHEDULES,  
 BREAKEVEN ANALYSES, COSTING, PROFIT ANALYSES,  
 STOCK CONTROL, SCIENTIFIC CALCULATIONS, PRICE  
 LISTS, STATISTICS, PROJECTIONS—THE LIST GOES  
 ON AND ON. CALL OR WRITE FOR MORE INFORMATION. **\$295.00**  
 DEALER ENQUIRIES INVITED.

*Software Source*

89 OXFORD STREET, BONDI JUNCTION. (02) 389 6388. P.O. BOX 364, EDGECLIFF. 2027

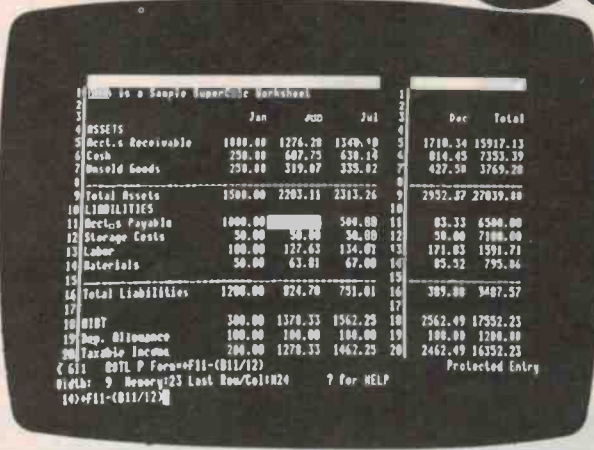

## HIGH RESOLUTION, HIGH VISIBILITY GRAPHICS

MicroBee brings you unsurpassed graphics facilities under easy to learn BASIC control. In low resolution mode (128x48 units) you can generate 'chunky' graphics and run Tandy programmes. For finer control a couple of keystrokes, switch you to high resolution graphics (512x256 units) and still let you combine them with text. Doing all this is easy for MicroBee. It shares the same intelligent VDU controller IC with IBM's new personal computer. So, like the IBM, MicroBee has a fully programmable screen display. MicroBee's standard 16 line by 64 character upper/lower case format can be updated to the professional 80x24 format to run CP/M programs. No need for expensive add ons. Simple, easy to use BASIC commands make using your MicroBee easy, even if you're just getting into computers.

## UNIQUE CONTINUOUS MEMORY AND BUILT IN SOUND

Only MicroBee brings you this great facility. You can hold programs and data in continuous memory when you switch off, or move to a new location. There's no longer any need to store on cassette or floppy discs at the end of the day. A power failure doesn't mean the loss of valuable programs or data. An inbuilt battery holds everything in memory until power is restored or you switch on again. MicroBee, your portable terminal. MicroBee's built in sound facilities bring you two octaves of music to tune up your programming skills. Again under simple to use BASIC control. Add sound to your game programs. Or maybe write your own music. The speaker is inbuilt. And it's so easy to learn. MicroBee brings you unique facilities and opens up new programming opportunities. MicroBee, the personal computer that never forgets.

## SERIAL AND PARALLEL PORTS READY.

Your MicroBee is fully equipped to interface and communicate with the outside world. The programmable RS232 standard port means connecting a serial printer, modem or another computer is as simple as plugging it in. MicroBee's built in software means you're ready to run at 300 or 1200 baud. When you're ready to go further, use MicroBee's parallel port and connect up joysticks, Centronics type printers or any other peripherals needing a parallel port. Even the cassette interface has something special. It will store and load programmes at 300 or 1200 baud in either BASIC or Z80 code as well as letting you merge lines into an already existing BASIC program. MicroBee works happily with your ordinary audio cassette recorder, and gives you a good load and save every time, even at the higher (1200 baud) rate. It's as simple as plugging it in with MicroBee.

# *microbee does*





## EXPANSION POWER

If you're not sure how you'll be using your MicroBee in the future, we've thought of that too. MicroBee is designed for inexpensive future expansion. The basic MicroBee with 16K of user RAM easily converts to 32K with a changeover board. Adding ROM (Read Only Memory) up to 28K is as easy as plugging it in to the memory board. Want S100 expansion? MicroBee goes one better. Its unique Z80 expansion bus lets your MicroBee interface with S100 as well as all the other expansion busses.

And if you're thinking of using disc drives and want to be able to run world standard CP/M Software, MicroBee's still with you. The soon to be released memory board and factory mod convert your MicroBee to 48K RAM, running CP/M with the ability to take disc drives. So you can run the same programs as IBM, DEC, Xerox and HP do on their Micros. MicroBee, ready when you are.

## POWERFUL 16K MICROWORLD BASIC

Programming has never been simpler. Novice or experienced programmer, you'll find MicroBee's 16K BASIC in ROM a delight to use. MicroWorld gives you everything you get with other BASICs plus extra help. Like special error reporting and editing. And support of the built in sound and graphics facilities. So MicroBee's powers aren't hard to use. The BASIC also controls printers and modems. Writing programs is simpler because of the BASIC's search and replace ability. When you want to go further, MicroWorld Editor/Assembler helps you use Z80 code and write USR subroutines. It's in ROM for instant access. Or get going right away with **Cassette Programs**. From only \$6.95 each. Chose from games like Chase, Target, ZTrek, Solitaire, Wumpus, Biorythm, Calender Maker or utilities like Typing Drill, Diagnostic, Textmaster.

## SOFTWARE SUPPORT

As a MicroBee owner, you'll become a member of the MicroWorld Users' group, and receive our newsletter and updates. Your kit comes on 14 day satisfaction guarantee. And there's a \$50 complete cover service coupon if you have trouble.

You can phone order MicroBee on (02) 487 3798. Use your Bankcard. Or to Mail Order your MicroBee just write to:- MicroBee, Box 311, Hornsby NSW 2077

Due to enormous demand, MicroBee deliveries have been delayed.

### Complete kit

Includes 16K RAM,  
16K ROM BASIC,  
all manuals.

# \$399

### Software includes:

Editor/Assembler (ROMs, Manual) \$49.50  
Cassette software (each) \$6.95

### APPLIED TECHNOLOGY

Showroom/Office 1 A Pattison Ave., Waitara  
Hours 9-5 Monday to Saturday.  
Phone (02) 487 2711 Telex APPTTEC 72767

## microbee



# more, simply



Glover & Assoc. AT/24



**S-100**  
**SPECIALISTS**

283 CLARENCE ST  
SYDNEY NSW 2000  
TEL: 79-2482  
622-1709

# ARE YOU STILL WAITING

FOR YOUR  
MICROCOMPUTER ORDER?

While others are promising we are delivering EX STOCK. And we still have the best prices. Just take a look at these:

## RAM + 16

Features: S-100, 16K x 8 bit static RAM • 2 or 4 MHz • Uses 2114 1K x 4 static RAM chip • 4K step addressable • 1K increment memory protection, from bottom board address up or top down • Deactivates up to 6 1K board segments to create "holes" for other devices • DIP switch selectable wait states • Phantom line DIP switch • Eight bank select lines expandable to 1/2 million byte system • Data, address and control lines all input buffered • Ignores I/O commands at board address.

Bare Board .....	\$ 35.00
4Mhz kit .....	\$174.00
4Mhz A&T .....	\$199.00
Kit no RAM .....	\$120.00

## DYNAMIC RAM

T.I. 4116-3 ..... 16K for \$16.00  
Upgrade Super 80, TRS 80, and others  
Expandable + 64K.  
Dynamic RAM Board A&T..... \$425.00  
Guaranteed to work at 4Mhz or your money back

## QT SILENCE-MOTHERBOARDS

The Silence + has become one of the most tried and proven motherboards on the market. Using a unique grounding matrix, each line is completely surrounded with ground shielding which eliminates necessity for termination and gives the unit a very high cross talk rejection. One of the OEM customers has used the Silence + as high as 14Mhz without terminations.

### FEATURES:

- LED power indicator
  - Eliminates necessity for termination
  - Fits most industry standard mainframes
  - Available in 6, 8, 12 and 18 slot configurations
- |                                 |          |
|---------------------------------|----------|
| QTCMB6BB 6 Slot Bare Board      | \$ 31.00 |
| QTCMB6A 6 Slot A&T              | \$ 81.00 |
| QTCMB8BB 8 Slot Bare Board      | \$ 33.00 |
| QTCMB8A 8 Slot A&T              | \$104.00 |
| QTCMB12BB 12 Slot Bare Board    | \$ 39.00 |
| QTCMB12A 12 Slot A&B            | \$138.00 |
| QTCMB18BB 18 Slot Bare Board    | \$ 61.00 |
| QTCMB18A 18 Slot A&T            | \$178.00 |
| S100 Sockets Solder Tail (Gold) | \$ 630   |

## SYSTEM + II (2MB +)

Computer system with 8" Dual Sided Drives (uses Y-E DATA YD174 Disk Drives) Terminal not included.  
A&T (6 Slot) ..... \$4270.00  
A&T (8 slot) ..... \$4370.00

QT Systems are designed for both businessmen and engineers in accordance with the latest IEEE standards. Among other functions, they can be used for accounting and word processing as well as a variety of scientific applications. The systems are available with MP/M or QT DOS operating systems to allow multi-user, multi-tasking operations. QT also offers a full line of business and applications software, ranging from a business package to word processing.

Technical specifications: 4 MHz Z-80 CPU • Dbl-sided, dbl-den 5 1/4" or 8" floppy disk controller (handles both drives simultaneously) • CP/M 2.2 included • 64K RAM, expandable per your requirements • Comes complete in single mainframe • RS232C serial port • Parallel port • Hard disk compatible • Monitor program & disk routines included on EPROM • Power-on/reset jump to monitor program • Documentation included • Extensive software available.

## SOFTWARE +

Word processing • System utilities and diagnostics • Games • CP/M users group diskettes \$10.00 each, catalogue \$4.50 • Pascal, Fort, Tarbell Basic, Fortran and most other compilers and utilities are available • Complete range of business software • Custom programming can be arranged on a fixed price or hourly basis.

## SBC2/4 Z80 S100 SINGLE BOARD COMPUTER

The QT Computer SBC2/4 Processor Board is a versatile and powerful Z80 based design which is compatible with the proposed IEEE S-100 bus standard. Although the SBC2/4 may be used as the host CPU of a large system, it has all the necessary features to be used as a stand-alone computer system.

Unlike old designs it will work reliably with dynamic RAM boards and more importantly with soft sectored disk controllers, and hence standard versions of CP/M. This will give you access to the largest software base for microcomputers.

- Z80A 8 bit CPU
- 2 or 4 Mhz Switch selectable
- 1K RAM (which can be located at any 1K boundary)
- Full 64K use of RAM allowed in shadow mode
- DMA compatibility allows MWRT signal generation on CPU board or elsewhere in system under DMA logic or front panel control
- TWO programmable timers available for use by programs run with the SBC+2/4 (timer output and controls available for use on CPU board).

Shipping weight: 2lbs.

QTCB24B Bare Board	\$ 66.00
QTCB24K Kit	\$199.00
QTCB24A Assembled and Tested	\$269.00

The MD+MD Mainframe offers the same quality as the MF+. It accepts two 5 1/4" disk drives with remaining space for either a 6, 8, or 12 slot Silence Plus Motherboard..

QTCMFMD without Motherboard	\$400.00
QTCMFMD6 with 6 Slot Motherboard	\$480.00
QTCMFMD8 with 8 Slot Motherboard	\$500.00
QTCMFMD12 with 12 Slot Motherboard	\$540.00
QTCMFMDB bare metal work	\$195.00

## DISK CONTROLLER

CCS2422A features ROM bootstrap loader and monitor • CP/M 2.2 with documentation included • Accepts 5 1/4" and 8" disk drives • Double sided/single sided select • Read, write IBM 3740 or system 34 single or double density • Fast seek available for voice coil operation • Automatic disk density determination • ROM bootstrap phantom.

CCS2422A A & T Incl. CP/M 2.2 .....	\$399.95
JADE DD Bare Board .....	\$ 85.00
QTFDC II A&T Incl. QT DOS .....	\$379.00
Disk Drive cables made to order.....	P.O.A.

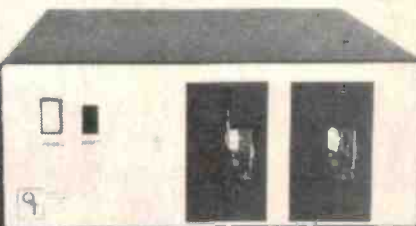

Also available without cutouts on front panel

## MINI-SYSTEM + (1/2MB +)

Computer System with 5 1/4" Single Sided Drives (uses TEAC FD-50A Disk Drives) Terminal not included.  
A&T (6 slot)..... \$2745.00  
A&T (8 slot)..... \$2845.00

## MAINFRAMES

S-100 MAINFRAME  
FOR DUAL 8" DISK DRIVES



AT LAST! A desk top enclosure that will accommodate a S-100 bus system and two 8" disk drives. The MF+MD mainframe is the most versatile dual 8" mainframe on the market. It will accommodate 6, 8, or 12 slot card cages using the Silence + motherboards. Just add a CPU, memory board, disk controller and terminal and you have an inexpensive, high quality computer system.

### FEATURES:

- Accommodates and 8" standard disk drive (801R, DT-8, etc.)
  - IEEE S-100 Silence + 6, 8 or 12 slot motherboard available. (See motherboard description at left.)
  - Keyed power switch.
  - Reset switch on front panel.
  - Anodized 6, 8, or 12 slot cages.
  - Quiet fan provides cool system operation featuring filtered positive air pressure. User may add two additional fans for the 12 slot if required.
  - Detachable line chord plugs directly into EMI filter for electrical noise suppression.
  - 16 DB25 cut out
  - 2 50 pin plug connector cut outs.
  - 2 DD55 cut outs.
  - Dimensions 9 5/8" x 17" x 21" (HxWxD)
  - Power supply +8V@25A/+16V @ 5A/ +5@2.5A/ 5@5A/+24V@3A
  - Input Voltage 110-113VAC/220-240VAC 50-60 Hz 48 lbs.
- |                                    |          |
|------------------------------------|----------|
| QTCMFDD without Motherboard        | \$575.00 |
| QTCMFDD6 with 6 Slot Motherboard   | \$625.00 |
| QTCMFDD8 with 8 Slot Motherboard   | \$650.00 |
| QTCMFDD12 with 12 slot Motherboard | \$700.00 |
| QTCB Bare Metalwork                | \$175.00 |

## PERIPHERALS +

We have fantastic specials on printers, terminals, plotters and disk drives. Call or write for details and pricing. Here are some examples:

YD-174 8" DS/DD Drives.....	@ \$625.00
2 for.....	\$1200.00
VIEWPOINT Terminal 80x24 detachable keyboard.....	\$995.00
Hazeltine Esprit 80 x 24 Green Screen. Emulates other terminals. Optional Graphics. Best value.....	\$975.00
WATANABE 6 colour plotter.....	\$1295.00
TEAC and MPI mini drives, 40 or 80 track. Single or double sided. Our prices are too low to advertise!! We carry a complete range of cabinets and power supplies for 5 1/4" and 8" drives for single and dual drives.	
TOH DAISYWHEEL 25 cps (parallel).....	\$1500.00
Serial or 40 cps optional.	
TOH M8510 Graphics Printer Parallel version (serial optional).....	\$ 795.00

**LIMITED STOCKS LIMITED STOCKS!!**  
64K static RAM • Full IEEE 696  
Intermix RAM • Assembled and tested, with 64K  
and EPROM • 200 nano. Very or 256K  
low power. CR256-64 ..... \$795.00  
64K A&T \$495. CR256-256..... \$995.00

PLACE YOUR BANKARD ORDERS BY PHONE!! WE DELIVER OVERNIGHT ANYWHERE IN AUSTRALIA. FOR \$3.50 up to 4kg. Or \$10 up to 10kg.

WE HAVE A COMPLETE RANGE OF S100 BOARDS AND MICROCOMPUTER PRODUCTS IF THE PRODUCT YOU REQUIRE IS NOT ADVERTISED DUE TO LACK OF SPACE PLEASE CALL OR WRITE.

OUR 1982 CATALOGUE IS NOW AVAILABLE. SEND S.A.E. FOR FREE COPY!!

PRICES DO NOT INCLUDE SALES TAX OR DELIVERY. AND ARE SUBJECT TO CHANGE WITHOUT NOTICE.



COMPUTER SALE — COMPUTER SALE — COMPUTER SALE — COMPUTER SALE — COMPUTER SALE —

# INCREDIBLE SEMI-CONDUCTOR PRICES

	1-9	10-25	25 plus		1-9	10-25	25 plus
2114	1.70	1.60	1.30	4164	10.00	9.00	8.00
4116	1.70	1.50	1.30	8725	9.00	8.00	7.00
2708	3.90	3.80	3.50	6116	9.00	8.00	7.00
2716	4.00	3.90	3.60	BU480	3.00	2.80	2.50
2732	7.50	6.90	6.00	BU126	1.80	1.50	1.25

Plus Sales Tax.

## ITOH PRINTERS

- ITOH 8300 PARALLEL ..... \$660 + Tax
- ITOH 8300 SERIAL ..... \$730 + Tax
- ITOH 1500 PARALLEL ..... \$1515 + Tax  
(Daisy Wheel)
- ITOH 1500 SERIAL ..... \$1555 + Tax  
(Daisy Wheel)
- ITOH 8510 PARALLEL ..... \$910 + Tax
- ITOH 8510 SERIAL ..... \$1010 + Tax  
(Graphics Etc.)

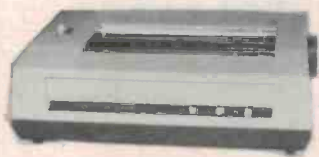

## DISC DRIVES

- MPI 51 ..... \$275.00 + 17.5% S.T.
- MPI 52 ..... \$385.00 + 17.5% S.T.
- MPI 91 ..... \$415.00 + 17.5% S.T.
- MPI 92 ..... \$515.00 + 17.5% S.T.

## TANDON

- TM100-1 ..... \$295.00 + 17.5% S.T.
- TM100-2 ..... \$385.00 + 17.5% S.T.
- TM100-3 ..... \$415.00 + 17.5% S.T.
- TM100-4 ..... \$515.00 + 17.5% S.T.

## Y-E-DATA

8" Double Sided Double density \$625.00 + S.T.  
 Please Note: We have many different types of connectors available for computers.

## VERBATIM DISCS

- 8" Soft Sector ..... 10 for \$43.00
- 5" Soft Sector ..... 10 for \$41.00

NOW AVAILABLE

## CPM SOFTWARE-WORDSTAR \$495.00 COMPLETE CPM 2.2 SYSTEMS

System available with ★ Debtors Software ★ 1.2 MHz Formatted ★ 18 MHz Green Phosphor Monitor  
 ★ Parallel, Serial Interfaces

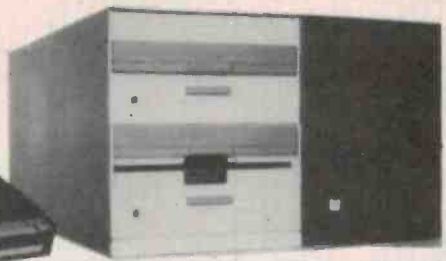

**FROM ONLY \$2950  
+ Tax**

Remember this is assembled and tested.  
 It has a 90 day warranty so why not buy a  
**REAL SYSTEM**

## TRIO OSCILLOSCOPES



Model	Screen Size	Bandwidth	Sensitivity	Sweep Time	Trace	ALL PRICES Plus 17 1/2% Sales Tax
CO-1303D	75mm	DC- 5MHz	10MV/DIV	—	Single	\$ 219.00
CO-1303G	75mm	DC- 5MHz	10MV/DIV	—	Single	\$ 264.00
CS-1559A	130mm	DC-10MHz	10MV/DIV	1uS/DIV .5S/DIV	Single	\$ 448.00
CS-156AMKII	130mm	DC-15MHz	10MV/DIV	5uS/DIV .5S/DIV	Dual	\$ 498.00
CS-1562A	130mm	DC-10MHz	10MV-DIV	1uS/Div .5uS/Div	Dual	\$ 528.00
CS-1566	130mm	DC-20MHz	5MV/DIV	.5uS/DIV .5uS/DIV	Dual	\$ 645.00
CS-1572	130mm	DC-30MHz	5MV/DIV	.2uS/DIV .5S/DIV	Dual	\$ 929.00
CS-1575	130mm	DC- 5MHz	1MV/DIV	.5uS/DIV 2MS/DIV	Dual	\$ 537.00
CS-1577	130mm	DC-35MHz	2MV/DIV	1uS/DIV .5S/DIV	Dual	\$ 983.00
CS-1830	130mm	DC-35MHz	2MV/DIV	.2uS/DIV .5S/DIV	Dual	\$ 1163.00

MINIMUM PURCHASE \$10.00

MINIMUM P&P \$2.00

Bankcard Mail Orders Welcome  
 Please debit my Bankcard

# RITRONICS WHOLESAL

425 HIGH STREET, NORTHCOTE, VIC. 3070  
 (03) 481 1923, (03) 489 7099. P.O. BOX 235

Bankcard No. ....  
 Expiry Date .....  
 Name .....  
 Signature .....

SALE — COMPUTER SALE — COMPUTER SALE — COMPUTER SALE — COMPUTER SALE — COMPUTER SALE —

COMPUTER SALE — COMPUTER SALE — COMPUTER SALE — COMPUTER SALE — COMPUTER SALE —



6/82-3

## A giant 'Detail' for UK101 and Superboard II owners, revealing their system's subtleties.

AMONG THE more popular single-board machines equipped with graphics are the Superboard II and its UK competitor, the UK101. The two systems are basically very similar but they do have differences, both in their graphics sets and the layout of the screen memory.

This Graphic Detail is intended to reveal these differences and make program conversion between them simpler. It should also be of use to those converting to or from totally different systems.

### Controlling Codes

There are a number of monitors around for the two computers and Table 1 is intended to show the various cursor and other 'non-printing' functions. The numbers shown are those associated with the CHR\$( ) function.

FUNCTION	MON 01	MON 02	CEGMON
Carriage Return	13	13	13
Cursor Left	—	08	—
Cursor Right	—	09	11
Cursor Up	—	11	—
Cursor Down	10	10	10
Home	—	—	12
Clear Screen	—	12	26
Clear Window	—	—	30

Table 1. The 'non-printing' functions for the various monitors.

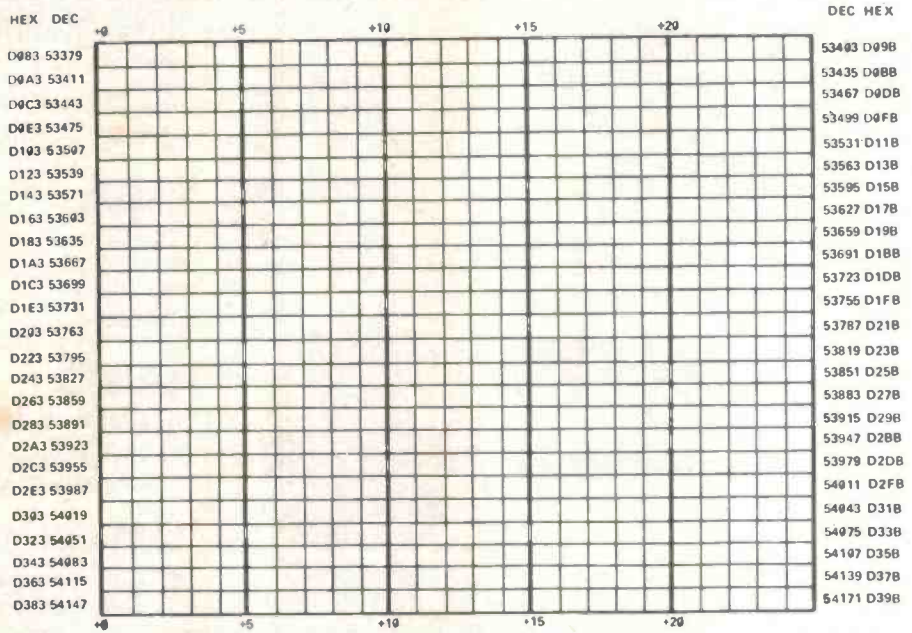

The Superboard II's screen memory map.

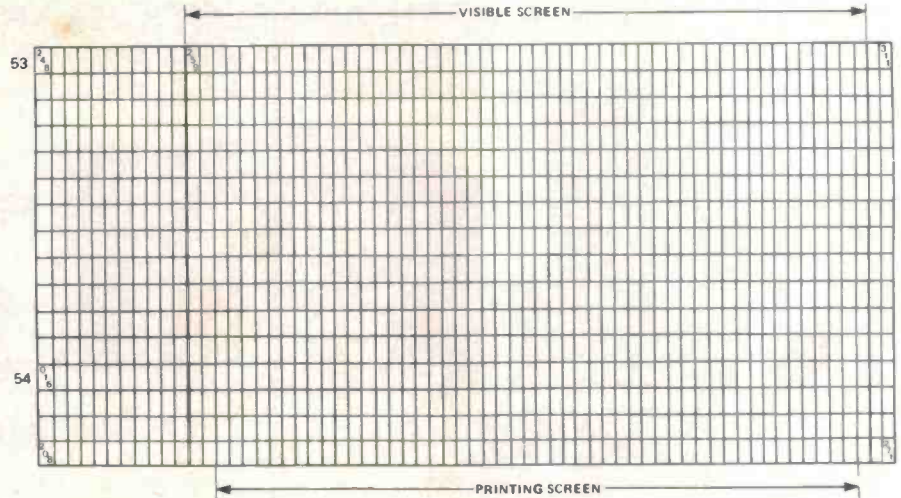

The UK101 has a slightly more convoluted arrangement as can be seen from its screen map.

The following 36 characters are from the Superboard II and should be inserted in the table when using that system.

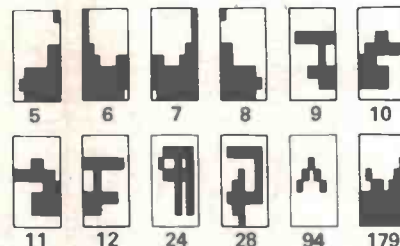

# GRAPHIC DETAILS

CODE	SYM-BOL	CODE	SYM-BOL	CODE	SYM-BOL	CODE	SYM-BOL	CODE	SYM-BOL	CODE	SYM-BOL	CODE	SYM-BOL	CODE	SYM-BOL
0		32		64		96		128		160		192		224	
1		33		65		97		129		161		193		225	
2		34		66		98		130		162		194		226	
3		35		67		99		131		163		195		227	
4		36		68		100		132		164		196		228	
5		37		69		101		133		165		197		229	
6		38		70		102		134		166		198		230	
7		39		71		103		135		167		199		231	
8		40		72		104		136		168		200		232	
9		41		73		105		137		169		201		233	
10		42		74		106		138		170		202		234	
11		43		75		107		139		171		203		235	
12		44		76		108		140		172		204		236	
13		45		77		109		141		173		205		237	
14		46		78		110		142		174		206		238	
15		47		79		111		143		175		207		239	
16		48		80		112		144		176		208		240	
17		49		81		113		145		177		209		241	
18		50		82		114		146		178		210		242	
19		51		83		115		147		179		211		243	
20		52		84		116		148		180		212		244	
21		53		85		117		149		181		213		245	
22		54		86		118		150		182		214		246	
23		55		87		119		151		183		215		247	
24		56		88		120		152		184		216		248	
25		57		89		121		153		185		217		249	
26		58		90		122		154		186		218		250	
27		59		91		123		155		187		219		251	
28		60		92		124		156		188		220		252	
29		61		93		125		157		189		221		253	
30		62		94		126		158		190		222		254	
31		63		95		127		159		191		223		255	

All these characters make up the UK101's graphic repertoire.



# DICK SMITH KITS



## EASY TO BUILD

We supply everything you will need to assemble the kits, right down to the last nut and bolt. We even include full instructions rewritten by our technical specialists to make construction easy.

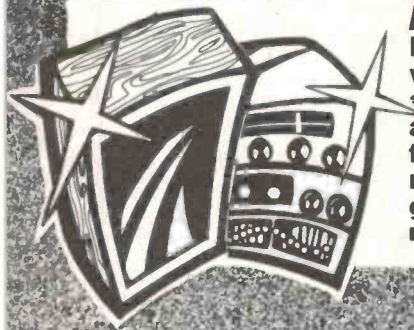

## LOOK SO GOOD

Imagine how proud you will be when you are able to show a fully assembled kit to your friends and say 'I built it myself!' They look so good your friends will never believe you.

## QUALITY COMPONENTS

We only use brand new, prime spec components in our kits. If we do have to make parts substitutions we check these out with the designer of the project first before we make the change.



**NEW**

## FUNCTION GENERATOR

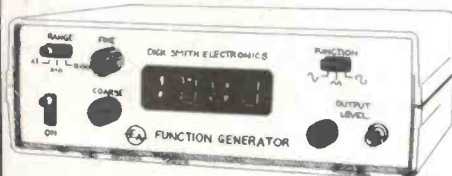

This kit produces sine/triangle and square waves over a frequency range from below 20Hz to over 160KHz! it has four digit LED readout enabling accurate frequency setting. This kit makes an ideal companion for our frequency counter kit (Cat K-3439). The case shown above is optional at extra cost (Cat H-2505 \$19.95).  
Cat K-3520

SEE EA APRIL 82

**\$59<sup>50</sup>**

**SAVE A FORTUNE ON THESE QUALITY SPEAKER KITS!**

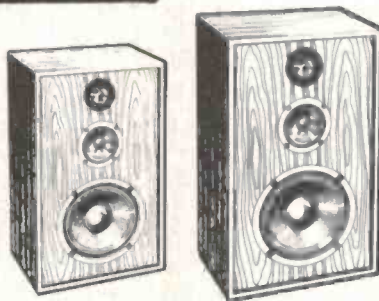

*Famous Playmaster*

Now Dick Smith offers you these superb speaker kits just right for your needs. All are manufactured to exacting standards of E.A. specifications. All kits include 3 magnificent speakers (woofer, mid-range and tweeter), superbly re-designed cabinets to suit any decor, full instructions, wiring harness with clip on connections (no soldering required). All kit prices are per pair.

**8" 3 WAY SYSTEM**  
200mm SPEAKER KIT

Cat C-2046 \$89.50

BOX KIT Cat C-2626 \$82.00

**ONLY \$ 171<sup>50</sup>**

**10" 3 WAY SYSTEM**  
250mm SPEAKER KIT

Cat C-2044 \$149.00

BOX KIT Cat C-2624 \$99.00

**ONLY \$ 248**

**\$100's less than equivalent pre-built units!**

**STOCKS LIMITED AT THIS PRICE - SO HURRY!!**

## SOUND LEVEL METER



This unit will measure noise in its many forms. Measures levels of less than 20dB to levels greater than 120dB with fast or slow response times. A large VU meter gives easy readings and the meter range is selectable in 9 steps. The kit is mounted in a zippy box and is battery powered.  
Cat K-3476

**ONLY \$ 35<sup>50</sup>**

**NEW**



### PERCUSSION SYNTHESIZER

Now we've got rhythm with this percussion synthesizer. Produces the sounds of drums, cymbals, snares and bongos. You can play manually or by total electronic control. By the simple connection of a sequencer you can have automatic rhythm, just right for learning the basics of timing in music.  
Cat K-3517

**ONLY \$47<sup>50</sup>**

**NEW**

FOR FAMILY FUN  
REDISCOVER THE CRYSTAL  
SET WITH THE

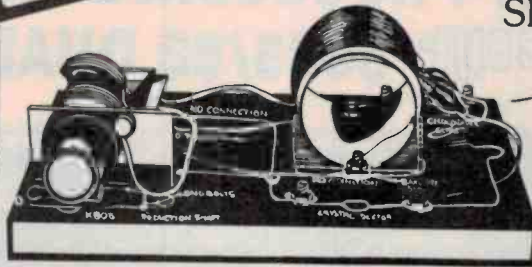

### DICK SMITH CRYSTAL SET

- ★ No batteries
- ★ Surprisingly good sound
- ★ Foolproof circuits

A most satisfying project that will give you lots of satisfaction. It can pull in a surprising number of broadcast stations and produce good sound when connected to a stereo system. AND it even works during a blackout!

Cat K-2650

**ONLY \$6<sup>90</sup>**

SEE EA APRIL 82

**NEW**

Cat K-3518

### PERCUSSION SEQUENCER

Look at this great new kit! Single PCB kit enables percussion synthesizer (Cat K-3517 above) to be controlled externally by this rhythm generator, and it does it automatically! You could start your own band! Also useful for taping and dubbing.

**ONLY \$12<sup>50</sup>**

**BUILD IT YOURSELF FOR UNDER \$100!**

### The Dick Smith Professional Frequency Counter

\*500MHz, 7 digit resolution \*with optional pre scaler  
A completely new frequency & period counter using the latest IC technology. The low component count makes it a very reliable and easy to build unit. It will measure frequency to 500MHz (with optional pre scaler) and period both with a 7 digit resolution.

Features include ★Professional design and finish - use high quality instrument case ★Easy to build with virtually all wiring on PCB's ★High accuracy ★All switches are integral to the display board and front panel. Based on E.A. design Dec. 81 issue.  
Cat K-3439

**\$99<sup>50</sup>**

#### PRE SCALER

Convert your Cat K-3439 Frequency Counter to 10-500 MHz with this optional pre-scaler. It's a must for just

**\$29.95**



### 150 WATT MOSFET PUBLIC ADDRESS/GUITAR AMPLIFIER

Cat K-3525

Guitar and public address amplifier utilizing ETI's 499 Mosfet 150 watt power amplifier module as published in ETI March, 1982.

Comes complete with pre-amp PCB and special Hitachi mosfets 2SJ49 and 2SK134. Also includes on board power supply, just add transformer (PF4361/1 Cat. M-0153).

Short Form Kit — case and transformer not supplied

**ONLY**

**\$119**

Transformer to suit **\$52<sup>50</sup>**  
Cat. M-0153



### HOT CANARY

This great gimmick kit will keep any child, or adult, amused for hours. An electronic bird noise maker that sounds just like a real bird! Cat K-3395

**ONLY**

**\$15<sup>50</sup>**

### PROTECT YOUR LIFE & EQUIPMENT CORE BALANCE RELAY



This could save your life and protect your equipment. The Core Balance Relay electronically detects fault currents and trips a relay which cuts the power. The relay cannot be reset until the fault has been corrected. Portable unit moulded into a tough plastic case and runs off 240V.  
Cat K-3315

**\$52**

### Multi-function Timer Stopwatch

Use as a stopwatch, countdown timer or event timer! Selectable timing rates between 0.01 and 1.0 seconds make this ideal for sporting events, darkrooms etc. Wiring for the unit for any of seven different functions is possible.  
Cat K-3435



**ONLY \$39<sup>50</sup>**

YOU COULD WIN A MILLION!

### LOTTO/POOLS SELECTOR

Push button, with large LED display makes it easy. Supplied with an attractive front label. Good luck!  
Cat K-3392



**\$19<sup>95</sup>**

### LEDS AND LADDERS

Based on the old 'Snakes and Ladders' game, we've replaced snakes with LEDS! This kit has been updated with new circuitry and simplified controls so the whole family can enjoy playing. Complete kit includes front panel sticker and zippy box.  
Cat K-3390



**ONLY \$16<sup>50</sup>**

# DICK SMITH Electronics

SEE PAGE 34 FOR ADDRESS DETAILS



DSE/A283/LM

# 16 AND 8 BIT PROCESSING ON THE ONE CARD THE GODBOUNT 8085/88 DUAL PROCESSOR

\* SWITCH  
SELECT 2 OR 5  
MH OPERATION

\* SOFTWARE  
SWAPPING OF  
CONTROLS

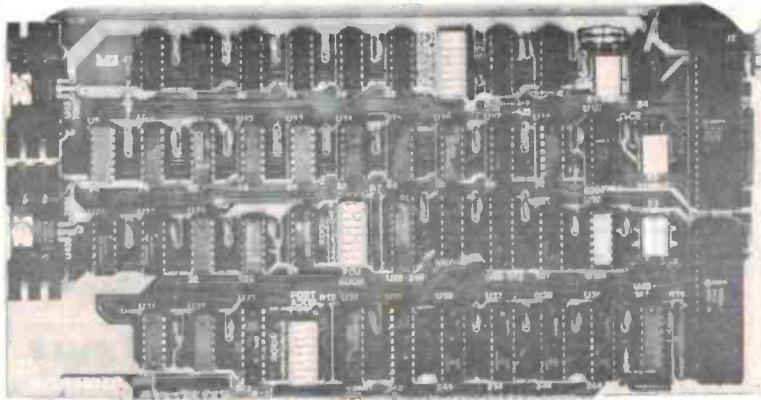

— 8088 CPU  
FOR 16 BIT  
OPERATION ON  
THE 8 BIT  
DATABUS  
— CP/M86  
AVAILABLE

— 8085 CPU FOR  
8 BIT OPERATION  
— CP/M 80  
AVAILABLE

— IEE S100  
STANDARD  
INTERFACE

**THE CPU CARD FOR NEXT YEARS COMPUTER  
AVAILABLE TODAY FROM AUSTRALIA'S LARGEST S100 SUPPLIER**



## MICROCOMPUTER PRODUCTS

130 MILITARY ROAD, GUILDFORD 2161. NSW.

TEL: (02) 681-4966 TLX: AA70664. OPEN 9-6 MON TO SAT.

you may have guessed it  
over  
**6 Megabyte on a**  
**IMS 5000**

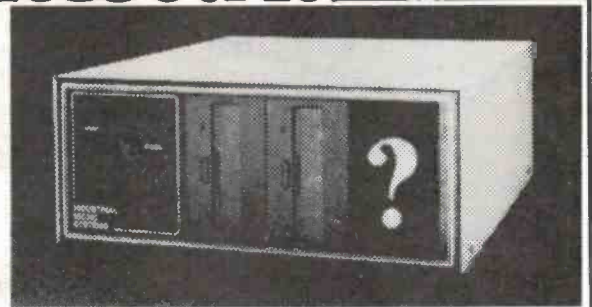

### But it's the speed & reliability that counts

The IMS5000 with hard disk was benchmarked against all the other hard disk systems at the NCC Chicago USA '81 exhibition. On average 5.25 inch hard disk operates 15% faster than 8 inch Winchester, and up to 5 times faster than other 5 inch Winchester, and it will not cost a fortune.

The demonstration system at the NCC was dropped and punctured in transit by a forklift, and it still came up first time without an error! This is the sort of rugged reliability users have come to expect from IMS International Computers.

Isn't this what you NEED? — A machine so reliable, its manufacturers warrant it for TWO years.  
— A machine so versatile, it operates under CP/M, MP/M, MVT-EFAMOS, USCD-PASCAL, MARC, MICROBOL;

— Yet a machine which is inexpensive and powerful. What system are you looking at purchasing? IMS I hope is at least on your short list. If not, Contact SI Micro and discuss your requirements with them. (The face is becoming familiar).

**SERIES  
8000  
SERIES  
5000**

**IMS**  
INTERNATIONAL  
COMPUTERS

## S.I. MICROCOMPUTER PRODUCTS PTY LTD

**NEW  
ADDRESS**

3rd Floor, 107 Walker St., North Sydney, 2060  
Phone (02) 922 3977 • Melbourne (03) 26 5522





# Hard copy from your Sinclair

Peter Freeby

Sooner or later, every computer owner wants hard copy from his or her machine. If you have a low-cost machine, printout need not be high-cost — thought Clive Sinclair. So he produced the ZX printer, and at a price to suit the ZX owner.

THE ZX PRINTER, while announced some time ago, has only recently been released in Australia, at a retail price of \$190. As befits the machine it is designed to team with, the ZX printer is compact, functional and simple to operate. It plugs directly into the ZX81 or the ZX80 with 8K BASIC ROM. It provides metallised paper, obtainable from the suppliers at \$25 for a five-roll pack. You can print nine lines to the vertical inch (25.4 mm) at a speed quoted as 50 characters per second. The 20 m roll allows you to print over 250 screens-worth of text (about 6500 lines)!

## Putting it to use

The ZX printer is extremely simple and quick to put into operation. It takes longer to put a mains plug on the power supply lead than it takes to plug in the printer and learn the use of the one control available — the paper feed. The plug on the printer lead has an integral socket to accept the add-on 16K RAM pack. The 17-page instruction book gives a clear description of how to load a fresh roll of paper, use the feed button,

tear the paper neatly off the roll (!), clean the printer and, of course, the general principle of operation. There is also a selection of programs aimed at giving you the pleasure of seeing your new acquisition work, while at the same time showing the use of those BASIC statements associated with the ZX printer. Strange as it may seem, these BASIC statements are neither explained nor described in the text; instead we are directed to read chapter 20 of the ZX81 instruction book.

It would amuse me to report that the ZX81 instruction book then referred you to the ZX printer instructions; however, although it does tell you that the printer will have instructions with it, it has a short chapter to quite clearly explain the function of the three relevant BASIC statements. These are LLIST, LPRINT and COPY. The first two are just like LIST and PRINT except that they direct the display to the printer instead of to the television screen or monitor. The third statement, COPY, enables you to print out a copy of whatever is displayed on the screen at the time.

## General theory of operation

Normally when reviewing equipment or books it is not the 'done thing' to quote more than a sentence or two from any supplied text, but in this instance the ZX printer instruction book gives us a very simple and concise description of the basic workings of the printer:

'the printer functions in rather the same way as a TV picture, i.e. by scanning from left to right. A conductive stylus is pulled across the paper at high speed, and where a black dot is wanted a pulse of current is passed through the stylus. This evaporates the aluminium coating on the paper, and allows the black backing to show through. To avoid the need to return the stylus quickly to the left-hand edge of the paper, there are in fact two styli, mounted on a moving belt, which follow each other in quick succession. The belt and the paper feed roller are both driven continuously whilst printing, so that when the next stylus comes round, the paper has been moved up ready for the next line.'

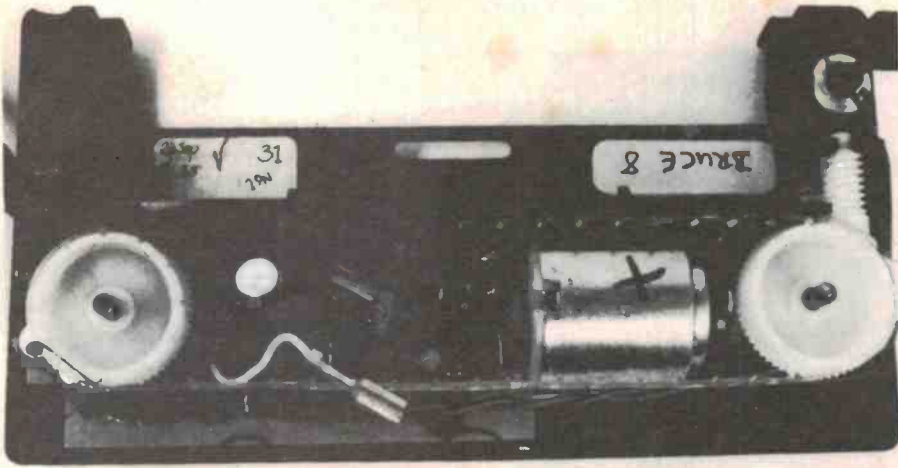

The internal workings of the printer. The belt carrying the two styli runs between the two white pulleys. Some examples of the printout are shown on this page.

Having only three major print statements to consider, the ZX printer is very easy to use. Formatting the display to the printer can be carried out using the TAB and AT (@) statements, albeit when using the AT statement line commands are ignored and only column commands in the range  $\pm 21$  are actioned. Although unlikely to cause much confusion, it must be remembered that the output from LPRINT is not printed immediately but stored in a buffer one line long. The computer will only print:

- 1) when the buffer is full
- 2) after an LPRINT statement that does not end in a comma or semicolon
- 3) when a comma or TAB item requires a new line
- 4) at the end of a program if there is anything left unprinted.

### In conclusion

The printout presented by the ZX printer was clear and readable with no disturbing fuzziness which occasionally has been seen with other systems. Graphic symbols can 'join up' from line to line, giving a clear, continuous picture. Keeping the printer clean is probably very important, and although the review model has been tested to some extent, long term reliability cannot be commented upon. As with the ZX81 and the ZX80 before it, the ZX printer offers something that, for the initial outlay, is quite remarkable, and can only add to the effectiveness of your ZX system. ●

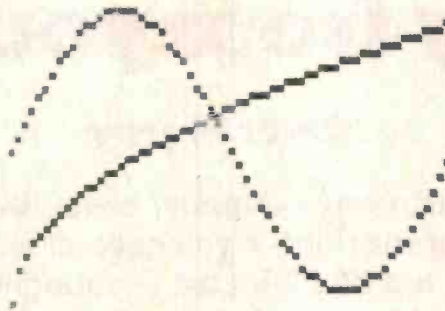
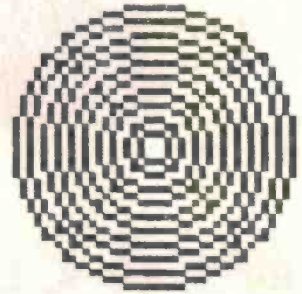

ZX80  
ZX81

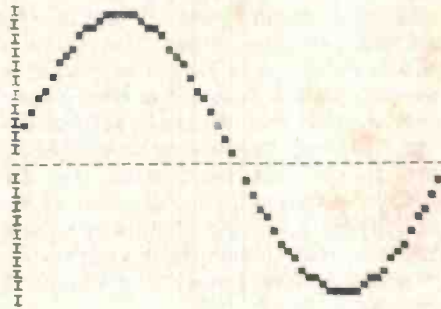

WHAT  
NEXT

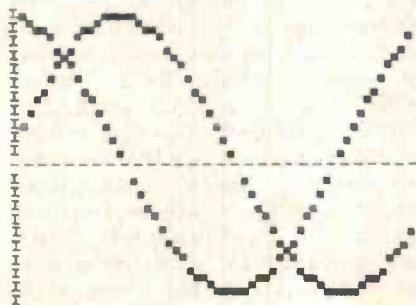

```
ZX81 ZX81 ZX81
PRINT "AND FINALLY, THE PRI
FOR N=1 TO 100
NEXT N
LPRINT "ZX81 ZX81 ZX81
LPRINT
LPRINT
LPRINT
NEXT N=0 TO 50
PRINT "AND LIST PROGRAMS"
FOR N=0 TO 40
NEXT N
LPRINT 5530
LPRINT
LPRINT
LPRINT
PRINT "FOR ANOTHER CYCLE"
GOTO 1142
```

# VIC 20

## COLOUR COMPUTER

from **DICK SMITH ELECTRONICS**

for only

# \$399

*DON'T PAY \$599!*

Digital cassette recorder connects here: for loading or saving programs.

Exciting range of games cartridges simply plug in!

Obtain access to data banks and other computers with a Modem: it just plugs in!

Your colour (or B&W) TV set connects here: no need to buy an expensive colour monitor.

Add 'joystick' controls here for even more games fun.



look at these features

look what it can do!

- ★ Colour graphics in up to eight colours – directly addressable from the keyboard!
- ★ Memory expandable up to 32K with plug-in modules.
- ★ Typewriter-style keyboard, with programmable function keys: you're really in control!
- ★ An inbuilt tone generator for music and sound effects!
- ★ It's ready to use immediately you turn it on – and it's expandable as your experience and budget require.

Yes, the VIC 20 is a truly remarkable breakthrough in computer technology – and it represents outstanding value for money. And it is fully backed with Dick Smith's own satisfaction guarantee.

Try it for yourself: if you're not completely happy you can return it within 7 days for a full refund! You can't lose!

- ★ Play a wide variety of full colour games – like space invaders, chess, etc. All you do is plug in a games cartridge!
- ★ Or write your own computer programs: with full colour display and an incredible range of graphics to choose from. Your imagination is the only limit!
- ★ Create computer music and sound effects to go with your programs! It's so easy with the VIC 20.
- ★ Give your family an introduction to the exciting world of computers: using the most exciting computer available in the world today!

come in to one of our stores and see for yourself!

# DICK SMITH Electronics



See our other ads in this issue for store addresses

WIN A DATSUN STANZA  
Details in all stores

DS1A142

# minitool

**MADE IN W. GERMANY**



**WORKSHOP KIT 000-62-90 X** - Carry case, Power supply, Pistol drill, Drill stand, Orbital sander, Jig saw, flexible Shaft unit, spare Blades, Table clamp, Platform table. R.R.P. ~~\$250~~ \$187.50

**WORKSHOP KIT 000-62-90 Y** - Same as above but not including flexible Shaft unit. R.R.P. ~~\$199~~ \$149.50

**SPECIAL PRICES!!**

**BULK SHIPMENTS**

**MAIL ORDER OR CALL IN**  
all items ex-stock



## ORBITAL SANDER

000-62-206  
5000 strokes/min.

**\$37.00**



## POWER SUPPLY

240v Plug-pak.  
12v output, 1 amp.

**\$15.00**

+ 17 1/2% TAX



**\$37.00**

## JIG SAW

000-62-108  
5000 strokes/min.  
Platform table incl.  
in kit. Extra as individual item.

**PERFORMANCE TOOLS - NOT TOYS!!**

## PISTOL DRILL

000-62-402  
7000 R.P.M.  
Drill capacity  
·08 - 6mm

**\$37.00**

ESSENTIAL FOR -  
electronics  
jewellery  
arts & crafts  
model building  
restricted access  
engineering

## ANGLE GRINDER

000-63-605  
7000 R.P.M.

**\$45.00**

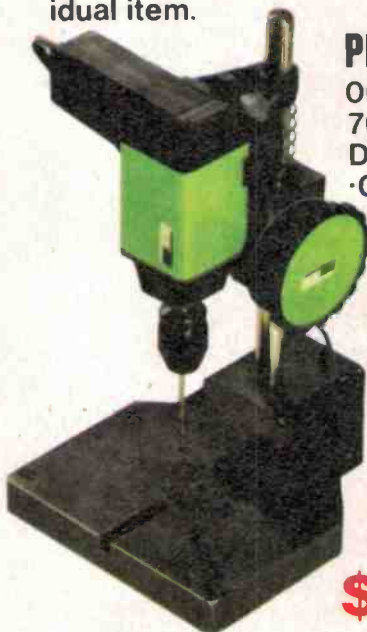

## DRILL STAND

000-62-493  
Accepts Pistol Drill  
& Angle Grinder.  
(Use saw blades for  
cutting.)

**\$37.00**

All units warranty 6 months

**\$45.00**



## FLEXIBLE SHAFT & GRINDSTICK

000-62-804  
7000 R.P.M.

*Ideal for miniature & electronic engineering. A 'must' for the modelmaker.*

SEND S.A.E. FOR  
FULL PRICE LIST

**MINITool AUSTRALIA PTY. LTD.**

ACCESSORY RANGE ♦

**134A AYR ST. DONCASTER VIC. 3108 PH. 850 9887**

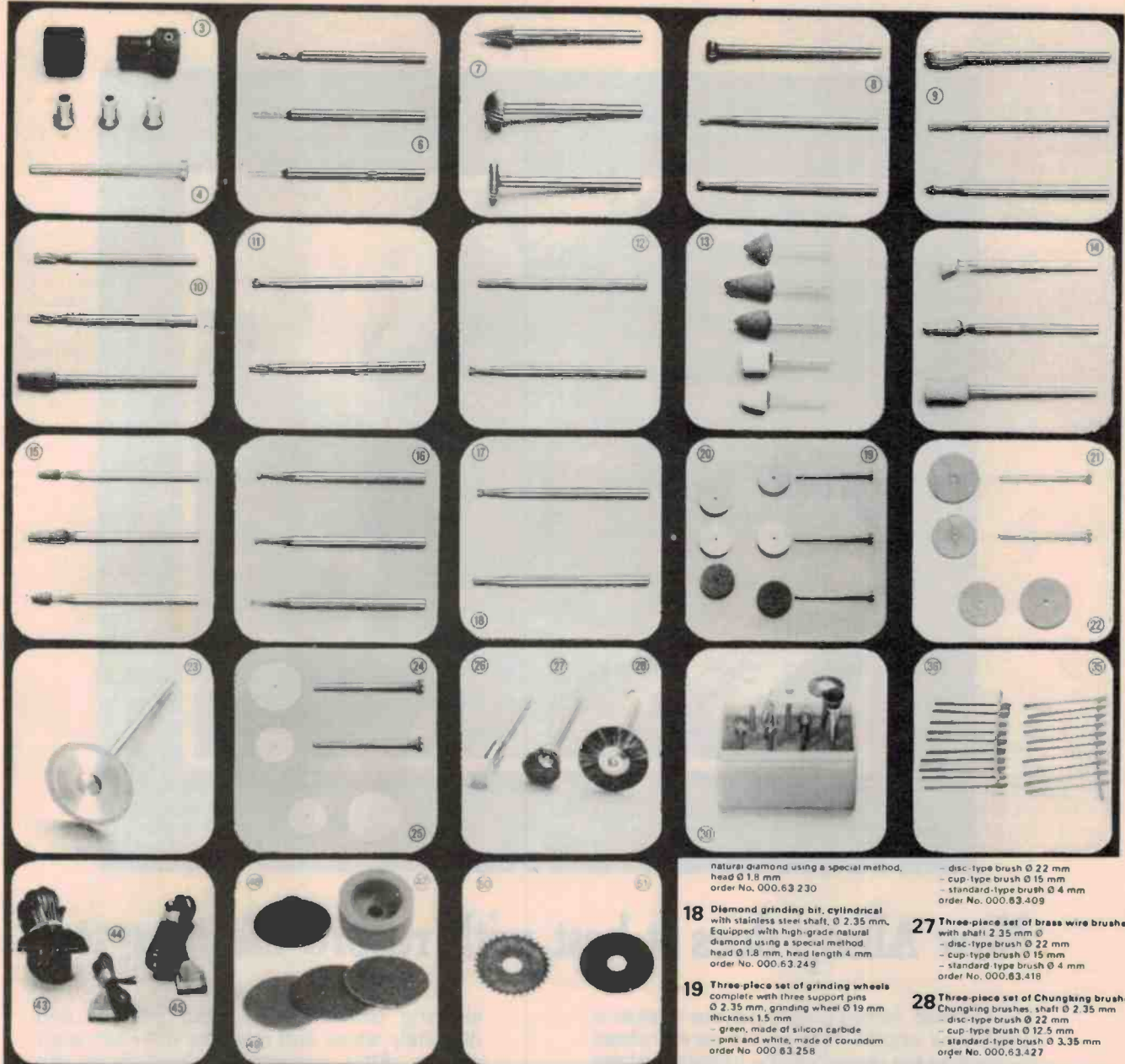

- 3** Three-piece chuck set with brass insert for 1/2, 4/ and 3 mm Ø order No. 000.62.886
- 4** Support piece suitable for the above interchangeable equipment. Shaft made of stainless steel Ø 2.35 mm order No. 000.63.507
- 6** "Mitro" three-piece set of twist drill bits made of high-grade special steel, shaft Ø 2.35 mm, bit Ø 0.5/0.7/0.8 mm order No. 000.63.007
- 7** Three-piece milling set shaft Ø 3 mm - conical with sharp tip, coarse-toothed head Ø 5.8 mm, head length 10.8 mm - semi-circular, coarse-toothed head Ø 9.9 mm, head length 4.9 mm - pinon-type, coarse-toothed head Ø 9.9 mm, head length 2.3 mm order No. 000.62.457
- 8** Three-piece milling set made of high-grade special steel, shaft Ø 2.35 mm - circular, coarse-toothed, head Ø 2.3 mm - conical, coarse-toothed, head Ø 2.3 mm, head length 2 mm - oval, coarse-toothed, head Ø 4 mm, head length 2.1 mm order No. 000.63.105
- 9** Three-piece milling set made of high-grade special steel, shaft Ø 2.35 mm - oval, coarse-toothed head Ø 0.5 mm, head length 9.8 mm - pointed, coarse-toothed head Ø 2.3 mm, head length 3.1 mm
- 10** Three-piece milling set made of high-grade special steel, shaft Ø 2.35 mm - cylindrical, coarse-toothed head Ø 2.3 mm, head length 6.1 mm - conical, coarse-toothed head Ø 2.3 mm, head length 6.4 mm - bud shaped, coarse-toothed head Ø 5 mm, head length 10 mm order No. 000.63.123
- 11** Two-piece carbide drilling set made of high-performance carbide, shaft Ø 2.35 mm - circular, coarse-toothed head Ø 2.3 mm - conical, coarse-toothed head Ø 1.8 mm, head length 5 mm order No. 000.63.132 Illustration at next page.
- 12** Two piece carbide drilling set made of high-performance carbide, shaft Ø 2.35 mm - cylindrical, coarse-toothed head Ø 1.8 mm, head length 5 mm - conical, coarse-toothed head Ø 1.8 mm, head length 1.6 mm order No. 000.63.141
- 13** Five-piece set of grinding bits head made of corundum, shaft Ø 3 mm head with attachments head Ø 14.9 mm, head length 15.8 mm - conical head Ø 13.6 mm, head length 18.1 mm
- 14** Three-piece set of grinding bits head made of corundum, shaft made of steel, nickel-plated, stainless, shaft Ø 2.35 mm - trapezoidal, head Ø 7.5 mm, head length 5.2 mm - conical head Ø 4 mm, head length 10.7 mm - head Ø 6.4 mm, head length 12.1 mm order No. 000.63.203
- 15** Three-piece glass grinding set for surface grinding of glass. Head made of silicon carbide, shaft made of steel, nickel-plated, stainless, Ø 2.35 mm - conical, short head Ø 2.6 mm, head length 6.1 mm - conical, long head Ø 3.7 mm, head length 10.8 mm - bud-shaped, pointed head Ø 3.1 mm, head length 5.8 mm order No. 000.63.212
- 16** Three-piece glass cutting set for cutting contours on glass. Head with natural diamond, shaft made of stainless steel Ø 2.35 mm, head Ø 1/1, 1/4/1.6 mm order No. 000.63.221
- 17** Diamond grinding bit, circular with high-grade steel shaft, stainless Ø 2.35 mm. Equipped with high-grade natural diamond using a special method, head Ø 1.8 mm order No. 000.63.230
- 18** Diamond grinding bit, cylindrical with stainless steel shaft, Ø 2.35 mm. Equipped with high-grade natural diamond using a special method, head Ø 1.8 mm, head length 4 mm order No. 000.63.249
- 19** Three-piece set of grinding wheels complete with three support pins Ø 2.35 mm, grinding wheel Ø 19 mm thickness 1.5 mm - green, made of silicon carbide - pink and white, made of corundum order No. 000.63.258
- 20** Three-piece set of spare grinding wheels, without support pin, grinding wheel Ø 19 mm, thickness 1.5 mm - green, made of silicon carbide - pink and white, made of corundum order No. 000.63.267
- 21** Two-piece set of friction discs complete with two support pins Ø 2.35 mm, friction discs made of corundum - Ø 22 mm, 0.6 mm in thickness - Ø 25 mm, 1.0 mm in thickness order No. 000.63.276
- 22** Two-piece set of spare friction discs without support pins, friction discs made of corundum - Ø 22 mm, 0.6 mm in thickness - Ø 25 mm, 1.0 mm in thickness order No. 000.63.285
- 23** Diamond friction disc with support pin made of stainless steel Ø 2.35 mm. Equipped with high-grade natural diamond using a special process Ø 18 mm, 0.7 mm in thickness order No. 000.63.294
- 24** Two-piece set of circular saw blades complete with two support pins made of special stainless steel Ø 2.35 mm, saw blade Ø 16/22 mm order No. 000.63.301
- 25** Two-piece set of spare circular saw blades, without support pins, made of special stainless steel, saw blade Ø 16/22 mm order No. 000.63.310
- 26** Three-piece set of steel wire brushes with shaft Ø 2.35 mm
- 27** Three-piece set of brass wire brushes with shaft 2.35 mm Ø - disc-type brush Ø 22 mm - cup-type brush Ø 15 mm - standard-type brush Ø 4 mm order No. 000.63.418
- 28** Three-piece set of Chungking brushes Chungking brushes, shaft Ø 2.35 mm - disc-type brush Ø 22 mm - cup-type brush Ø 12.5 mm - standard-type brush Ø 3.35 mm order No. 000.63.427
- 29** Three-piece set of Chungking brushes Chungking brushes, shaft Ø 2.35 mm - disc-type brush Ø 22 mm - cup-type brush Ø 12.5 mm - standard-type brush Ø 3.35 mm order No. 000.63.427
- 30** Ten-piece metal building tool set all with shaft Ø 2.35 mm - Three corundum grinding bits - Three milling bits - Two brushes, plastic - One felt disc on support pin - One circular saw on support pin order No. 000.62.439
- 35** Saw blades for jigsaw, set of ten, coarse order No. 000.62.117
- 36** Saw blades for jigsaw, set of ten, fine order No. 000.62.144
- 43** 3 m extension lead order No. 000.62.091 - without illustration
- 44** Transformer adapter order No. 000.62.064 - without illustration
- 45** Car adapter 12 volt order No. 000.62.073 - without illustration
- 47** Cup grinding wheel made of corundum Ø 32 mm, complete with mount order No. 000.63.623
- 48** Grinding disc, set of three, Ø 40 mm order No. 000.63.632
- 49** Sandpaper, self-adhesive, circular, set of ten. Assorted fine, medium and coarse Ø 40 mm order No. 000.63.641
- 50** Saw blade for wood Ø 32 mm, complete with mount order No. 000.63.569
- 51** Saw blade for metal Ø 32 mm, complete with mount order No. 000.63.678



## Now Allsop does it best with record cleaning too!

The **Orbitrac** record cleaning system takes a totally new approach to record care. Instead of cleaning the record on the turntable where it may be detrimental to the turntable's delicate drive components, the system is designed to clean the record whilst on the supplied antistatic mat. More importantly, unlike the various common handheld devices, the **Orbitrac** anchors in the record centre so that the ultra-soft cleaning fibres are automatically aligned with record grooves as the dual action

cleaning disc makes perfect contact and delicately wipes and removes dirt from each groove. After one or two revolutions the record should be free of impurities and have no static charge because of the **Orbitrac** specially formulated cleaning solution. This system comes complete with **Orbitrac** cleaner, solution and sprayer, wipe off brush, special record cleaner anti-static mat, attractive case and complete instructions.



Dealer inquiries invited

**Communications Power Inc (Aust) Pty Ltd**

P.O. Box 246 Double Bay N.S.W. 2028. Phone (02) 357 2022. Telex: 23381 "COMPOW"

**ALLSOP** **3**

# SIGHT & SOUND

## Stereo TV sound proposed by US and Japan

The US Electronic Industries Association (EIA) has spent the past three years or so discussing future television sound standards for use in that country, and it is expected to recommend a multi-channel television sound standard to the FCC very soon.

**Not only will the new standard provide for stereo sound, but it will also involve a secondary audio programme system which can be used for the transmission of sound in a second language.**

In addition, two proprietary signals for broadcasting station use are proposed for inclusion in the transmitted signal at a lower level.

One of these low-level signals will be used for electronic news gathering (ENG) purposes so that reporters in the field can carry receivers which will monitor this narrow band, over which programme directors in broadcasting studios can issue instructions.

sibility of the second sound channel will require the purchase of a suitable decoder, additional audio amplifier and a second loudspeaker.

In order that users shall be able to upgrade their systems when they so wish, the new stereo television system must employ some multiplexing scheme similar to that employed in FM stereo broadcasts.

Thus there will be a (left + right) signal channel and a (left - right) channel covering the full 5 kHz audio bandwidth, the left - right signal being modulated onto a suitable subcarrier. The secondary audio programme for other languages will probably offer a 10 kHz to 12 kHz

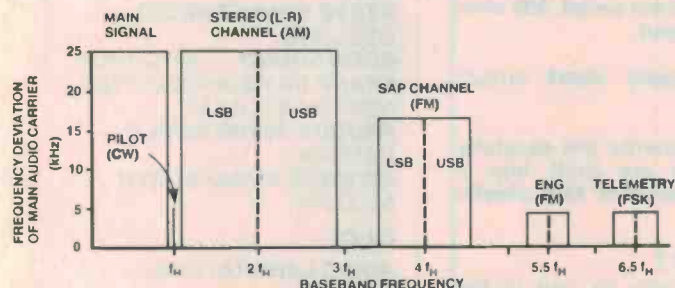

Figure 1. The Zenith multichannel system.

The second low-level sub-channel will carry an FSK signal which can be remotely monitored so that unmanned broadcasting stations can satisfy FCC requirements.

Current Japanese proposals for stereo television sound standards do not include any proposals for the inclusion of the ENG or remote signal monitoring channels.

The American proposals take into account the fact that compatibility with existing television receivers is to be regarded as essential. The additional audio transmissions must not be allowed to degrade the picture or sound quality of the huge numbers of receivers now in use, although the reception of stereo sound and pos-

sible audio bandwidth and will be modulated onto a subcarrier of higher frequency.

The two proprietary channels will be modulated onto still higher frequency subcarriers, but their bandwidth can be quite low — probably about 3.5 kHz. Thus the audio spectrum of the transmitted signal may be like that proposed by the Zenith Company (Figure 1) or by the Telesonic Company (Figure 2).

A constraint imposed by the US National Television System Committee (NTSC — often humourously remembered as 'Never Twice the Same Colour') is that the 6 MHz interchannel frequency spacing is unalterable and therefore the total

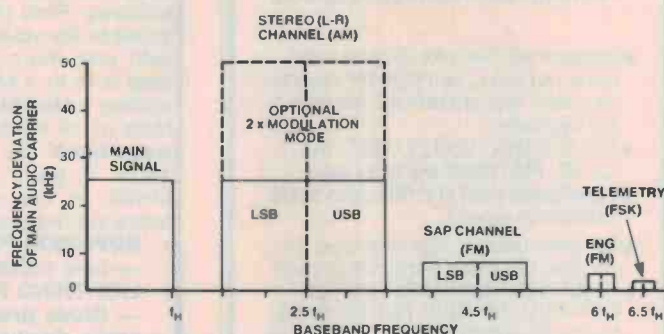

Figure 2. The Telesonic system.

bandwidth required by the improved radio transmissions cannot exceed that of the conventional transmissions.

When one remembers that the television signal already has a chroma subcarrier, the number of subcarriers required becomes quite large. As the frequency of the ultrasonic subcarrier is increased, the signal-to-noise ratio in that channel becomes smaller. Thus a decoded stereo signal will have a signal-to-noise ratio some 16 to 20 dB lower than that of the monaural left-plus-right signal, whereas the secondary audio signal, where the highest possible fidelity is not so vital, will contribute perhaps 10 dB more noise than the stereo signals. The least critical ENG and telemetry signals will operate at still higher noise levels, but this is acceptable.

The US systems prefer to employ AM for the stereo subcarrier, since this technique appears to provide less distortion than in systems using FM for both the main signal and for

the subcarrier. The two systems (Figures 1 and 2) employ different subcarrier frequencies, each claiming specific reasons for the choice of these frequencies.

The Japanese-proposed system for stereo television sound has an audio spectrum similar to that of Figure 3. The control tone at  $3.5 f_H$  indicates whether the subcarrier contains stereo difference signals or whether it contains a second language soundtrack. If desired, the left-minus-right signal could be transmitted on the  $2 f_H$  subcarrier and a further channel could be added on a subcarrier of  $5 f_H$  (for example, for a second language).

Although these systems are, at the moment, only proposals, it seems likely that it will be only a matter of time before television sound becomes available at least in stereo, if not also in multilingual sound, especially with satellite television covering areas such as Europe.

Brian Dance

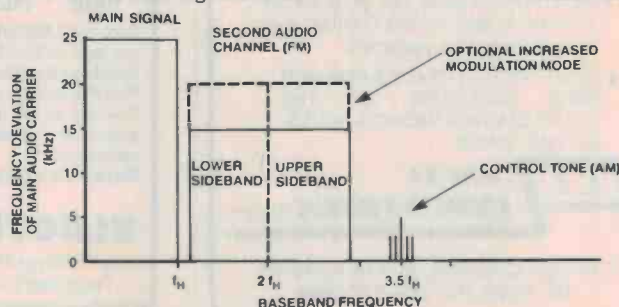

Figure 3. The Japanese system.



# NORTRONICS

## AUDIO & DIGITAL TAPE HEADS



for long life extended response

- Replacement heads for cassette decks, reel to reel decks, cartridges and cassette recorders. Also professional recorders and duplicators.
- Will fit AMPEX, SCULLY, TEAC, ATC, GATES, PENTAGON and many more.
- Specification sheet of all Nortronics heads available on request.
- Complete range of Alignment tapes for cassette, reel to reel and cartridge decks.
- REGULAR MAINTENANCE ENSURES CONTINUED OPTIMUM PERFORMANCE. Nortronics manufacturers a full range of audio care products.

TAPE  
HEAD  
CLEANER



ALIGNMENT  
TAPES



SPLICING  
BLOCKS



SPLICING TABS



### ZENITH/HEIGHT GAUGES

- NORTRONICS audio care products are designed to care for and maintain your valuable recording equipment.
- SEND TWO 27c STAMPS FOR OUR FREE BROCHURE ON THE COMPLETE NORTRONICS ACCESSORIES RANGE.

**E.I.**

**EMAC  
INDUSTRIES** Pty. Ltd.

2 Bengal Crescent, Mount Waverley,  
Vic. 3149. Ph: (03) 277-9989.

## Sweep away the Snow



Clean up your snowy or ghosting TV pictures. First check your aerial, is it suitable for your area? If not, replace with one more suitable; the second step is to fit a Masthead Amplifier. By adding a Masthead say of 20dB with a ratio of 10 times, you can increase a weak signal say of 100uf to 1000uf or 1m/V. A good Masthead such as a MH20, at the cost of \$85, has the following features:

- \* **SUPERIOR PERFORMANCE**  
— Low noise planar transistors.
- \* **LIGHTNING PROTECTION**  
— Diode protection from electrostatic discharge.
- \* **CORROSION FREE**  
— AC voltage to amplifier prevents electrolysis action.
- \* **EASY TO INSTALL**  
— Screw terminals. Power supply includes 2 way splitter so that amplifier can provide a signal for one or two TV receivers.
- \* **ECONOMICAL**  
— No balun required, 300 ohm or 75 ohm input from aerial. 300 ohm or 75 ohm output.
- \* **SAFE**  
— Power supply short circuit protected.
- \* **LONG LIFE**  
— The components are carefully selected, and are built into a strong, weatherproof ABS plastic housing.

### MH20WN \$91

Designed specifically for use in the Newcastle & Wollongong areas. The strong local channels 3 & 5A are attenuated, allowing amplification of distant Sydney channels 2, 7, 9 & 10 without cross modulation problems. Three versions are available with -10dB, -20dB, -30dB attenuation.

Contact **ELECTROCRAFT** we will be able to give you good verbal advice on ...

Updating your antenna.  
Providing an extra outlet & splitter for that second set.  
Providing an FM, stereo antenna outlet. Installing an antenna for that new channel or UHF translator which started recently.

We have the largest selection of TV antenna's in N.S.W.

**ELECTROCRAFT** PTY  
LTD  
68 Whiting Street, Artarmon N.S.W.  
Telephone 438-4308 or 438-3266

## Bring your music into focus here . . .

### NSW

**LEISURE SOUND** — SYDNEY —  
**ARTARMON** — PARRAMATTA  
**RUSSIN ELECTRONICS** —  
ASHFIELD  
**RIVERINA HI FI** — BROOKVALE  
**DAVE RYALL ELECTRONICS** —  
DEE WHY  
**CAMPBELLTOWN HI FI** —  
CAMPBELLTOWN  
**CARINGBAH HI FI** — CARINGBAH  
**THE HI FI SHOP** — HURSTVILLE  
**DUTY FREE TRAVELLERS  
SUPPLIES** — SYDNEY

### NSW COUNTRY

**LISMORE HI FI** — LISMORE  
**HUNTER VALLEY ELECTRONICS**  
— MAITLAND  
**NEWCASTLE HI FI** —  
NEWCASTLE  
**SINGLETON HI FI** — SINGLETON  
**UPPER HUNTER ELECTRONICS**  
— MUSWELLBROOK  
**SPRINGWOOD HI FI** —  
SPRINGWOOD  
**PITMANS RADIO & TV SERVICE** —  
WAGGA WAGGA  
**WOLLONGONG HI FI** —  
WOLLONGONG

### ACT

**DURATONE HI FI** — PHILLIP  
**KINGSTON HI FI** — KINGSTON

### VIC

**NATSOUND** — MELBOURNE  
**TIVOLI HI FI** — HAWTHORN

### VIC COUNTRY

**STEVE BENNET AUDIO** —  
GEELONG  
**BOON SOUND** — WODONGA  
**FRANK DAY & ASSOCIATES** —  
NORTH BALLARAT  
**PROUDS AUDIO WORLD** —  
BENDIGO  
**MILDURA AUDIO WORLD** —  
MILDURA

### QLD

**AUDIO LABORATORIES** —  
MILTON  
**STEREO SUPPLIES** — BRISBANE

### QLD COUNTRY

**DISCO STEREO SUPPLIES** —  
TOWNSVILLE  
**NOOSA HI FI** — NOOSA HEADS  
**MARLIN CITY HI FI** — CAIRNS

### SA

**THE SOUND CRAFTSMEN** —  
HAWTHORN

### WA

**THE AUDIO CENTRE** — WEST  
PERTH

### WA COUNTRY

**NORTH WEST AUDIO** —  
KARRATHA

### TAS

**BEL CANTO** — HOBART



Bring your music into focus . . .

with the  
B&W  
DM22

*Like a photograph that is out of focus, a loudspeaker that presents a hazy, clouded image will never make music sound real.*

*In a camera, exact optical focus, is achieved by the combination of advanced design and exacting constructional standards. B&W Loudspeakers achieve musical focus by adhering to the same strict standards. Their advanced technology includes crossover designs optimized by computer and cone inspection performed by laser interferometry. B&W's flawless construction is evidenced throughout — from massive cast-alloy frames to exquisite wood veneer finishes.*

*B&W Loudspeakers reproduce much more than just the notes and overtones of a performance. By revealing the subtlest details of the music, they add a sense of depth and clarity that brings one much closer to the experience of listening to a live performance. Serious music listeners use a variety of terms to describe this elusive quality. We at B&W call it focus.*

DISTRIBUTED IN AUSTRALIA BY:  
CONVOY INTERNATIONAL,  
4 DOWLING STREET, WOOLLOOMOOLOO, SYDNEY,  
NSW 2011. TELEPHONE : (02) 358 2088

**B&W**

B&W DM is a registered trade mark of B&W Loudspeakers Ltd.

**DM22**

The DM22 benefits from B&W's most important technological innovations, including the use of polymer driver materials and laser interferometry design procedures. Yet the DM22 is not a 'utility' model but rather is a handsomely crafted wood veneer, high performance loudspeaker. The DM22 achieves a new level of value and is truly the least expensive loudspeaker worthy of the B&W name.





# Marantz Gold. Life couldn't sound more beautiful. —

A day is made perfect by its ending. Sunset, anticipation for the evening to come.

Soothing, sounds of your favourite music. The day's problems disappear.

The moment is Marantz. Unmatched in its eloquence, unmatched for its purity of sound reproduction.

Elegant, indulgent.

The Marantz Gold Renaissance 1000.

Top-of-the-line in a range of superbly crafted hi-fi systems from Marantz.

Six separate components of unsurpassed technical excellence. Highly sophisticated Pre-amplifier and Power Amplifier, 14-station

preset AM/FM Stereo Tuner, Cassette Deck, Equalizer and fully automatic Turntable — subtly burnished gold tone.

And finally, the magnificent system speakers — matched in quality and luxury of design to rosewood finish furniture pieces.

Marantz Gold Renaissance Series.

Life couldn't sound better.

**Marantz Gold.**  
**The New Audio Standard.**

**marantz.**

*Now you're listening.*

Distributed by: MARANTZ (Australia) Pty. Limited, 19 Chard Road, Brookvale, NSW, 2100.  
Telephone (02) 939 1900 Telex AA24121. Melbourne (03) 544 2011. Brisbane (07) 44 6477.  
Adelaide (08) 223 2699, Perth (09) 276 3706, Townsville (077) 72 2011

Design and specifications subject to change without notice.

## New shape for Ortofon

**Ortofon's new moving-coil cartridge, the MC200, breaks with in-house tradition with new styling, a new transducer technique and attractive pricing!**

The MC200 features a new 'selective', wide range damping system, a boron cantilever and an asymmetric nude diamond stylus held in a 'fork' at the end of the cantilever.

The transducer employs a newly developed ring magnet (toroid) of samarium cobalt. All this has allowed Ortofon to fit a high performance cartridge in a very slim headshell with a total weight of only 16.5 grams. A design feature is the ability to plug the MC200 into standard tonearm sockets! The MC200 incorporates overhang and vertical adjustment facilities.

Recommended retail price is \$320. Enquiries to Harmon Australia, LMB 12, North Ryde NSW 2113. (02)887-3233.



## 16 pounds, and what do you get?

**Bob Carver, designer of the 'magnetic field' amplifier, has come up with a 600 W/channel amp that weighs only 16 lb (7.25 kg) and is said to give a super-high headroom for life-like dynamic range.**

Dubbed the M1.5, Carver Corporation's blurb claims the new amp employs "...dramatically new Demand Responsive Magnetic Field circuitry...". It also features a "...unique acceleration stress monitoring and protection circuit which constantly evaluates stress, thermal input and other vital factors

to render the loudspeakers immune from amplifier damage."

The Carver M1.5 went on sale in America in March for around US\$800. Convoy International, who have the Carver agency here, will have them in Australia in due course.

## Sony's new top tapes

**Following a move spearheaded by BASF late last year, Sony have introduced a 'Type II' CrO<sub>2</sub> cassette, dubbed UCX-S, and said to take hi-fi musical recording "a step closer to perfection".**

Available in C60 and C90 tapes for \$5 and \$6.70 respectively, the new UCX-S tapes came on sale recently. Sony say they have improved retentivity and the tapes deliver a 3 dB increase in MOL and sensitivity over their previous Type II tapes, at the high frequency end. In addition, Sony say they have

improved sensitivity by 1 dB at the low frequency end and MOL by 1.5 dB at that end of the spectrum.

The UCX-S tapes feature cleaning tape leaders and the tapes' 'Super Performance' (SP) mechanism, said to prevent uneven winding of the tape.

# JUST TO KEEP THE RECORD CLEAN

THE audio-technica

# SONIC BROOM

From the Scientific Lab of the designers of the revolutionary new \*DUAL-MAGNET High-Fidelity Record Cartridges comes this outstanding record-cleaner combination.

The curved and ribbed configuration of The Sonic Broom is carefully designed to present wave after wave of soft, multi-cleaning-action fibres to the rotating surface of your most cared for record, be it Direct-Cut, Digital or straight out LP.



Conventional Constant Density Pad

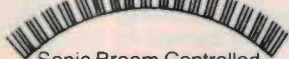

Sonic Broom Controlled Density Pad

The multi-grooves between the rows of ultra-soft cleaning fibres collect the microscopic dust particles and sludge swept out by the fibres, allowing successive bands of clean fibres to sweep the record surface time after time.

This unique cleaning action in combination with Audio Technica's scientifically designed Anti-Static Cleaning Fluid erases every last vestige of noise-producing dust and fingerprint sludge and gives you clean sound from your most often played records.



## JUST TO KEEP THE RECORD CLEAN

buy audio-technica's SONIC BROOM today.  
Rec. Retail \$17.90 at all leading Hi-Fi Stores.

For your nearest Stockist phone

**THE MAURICE CHAPMAN GROUP P/L**

NSW (02) 438 3111 Vic. (03) 818 1730 S.A. (08) 272 8011  
WA. (09) 446 5679 Qld. (07) 261 1513



Another High-Fidelity concept from

# audio-technica

INNOVATION ■ PRECISION ■ INTEGRITY

# Not Just Speaker Wire



Conventional speaker wire limits the performance of your sound system by decreasing power output, restricting dynamic range, and reducing clarity and definition. You can significantly improve the performance of your audio system by switching from your present speaker wire to Monster Cable.

Constructed of over 500 strands of high purity copper in a unique configuration, Monster Cable is specifically engineered for low resistance, low capacitance, and low inductance. The Results?

- Deeper, tighter bass.
- Maximum power transfer.
- Increased clarity and definition.
- Wider dynamic range.

Even low-powered systems show a remarkable improvement. Recommended by leading audio manufacturers, Monster Cable is safe to use with all amplifiers and receivers, regardless of design. Don't be deceived by imitations. If it doesn't say Monster Cable you're not getting all the performance you paid for.

## MONSTER CABLE

DISTRIBUTED BY CONVOY SYDNEY (02) 358 2088

Available from: NSW—AUTO ACOUSTICS Sydney \* ABSOLUTE SOUND Sene Soud \* BING LEE DISCOUNTS Fairfield \* CAMPBELL TOWN HI FI Campbelltown \* DUTY FREE TRAVELLERS SUPPLIES Sydney \* FUTURE AUDIO North Sydney \* THE HI FI SHOP Hurstville \* LEISURE SOUND Sydney, Artarmon, Parramatta \* LEN WALLIS AUDIO Lane Cove \* MIRANDA HI FI Miranda, Parramatta, Rosebark, Bondi Junction \* PARK HI FI Summer Hill, Sydney \* RUSSIN HI FI Ashfield \* WARRINGAH HI FI Mona Vale \* WOOLLAHRA ELECTRONICS Woollahra \* CLASSIC CAR SOUND Adamstown \* EASTERN HI FI Newcastle West \* HUNTER VALLEY ELECTRONICS Maitland \* NEWCASTLE HI FI Newcastle \* PITMAN'S RADIO & TV SERVICE Wagga Wagga \* SOUND COMPONENTS Tarragon \* WARDLELLS SIGHT-4-SOUND Broadmeadows \* WOLONGONG HI FI Wollongong A.C.T. \* DURATONE PHILIP VICTORIA—TRUDI HI FI Hawthorn \* NATSOUND Melbourne \* EAST COAST AUDIO Albert Park \* SOUND BUFF \* STEVEN BENNETT AUDIO Geelong \* PROUD S AUDIO WORLD Bundoora \* SHEPPARTON HI FI Shepparton QLD.—STEREO SUPPLIES Brisbane \* REG MILLS STEREO Buranda \* HANNO S HI FI Toowoomba \* DOWNTOWN HI FI Brisbane \* LIVING SOUND CENTRE Ashgrove \* QLD ENTERTAINMENT COMPANY Eight Mile Plains \* GOLD COAST HI FI & STEREO SOUND Southport \* HIGHWAY SOUND CENTRE Mt Isa \* STEREO WORLD Cairns \* GEOFF BRADFORD HI FI Toowoomba \* DISCO STEREO SUPPLIES Townsville \* CUSTOM SOUND CENTRE Nambour BTH, AUST.—BLACKWOOD SOUND Blackwood \* THE SOUND CRAFTSMEN Hawthorn \* TRACK HI FI Adelaide \* GREENFELL PLAZA HI FI Adelaide \* ASLIN HI FI Mount Gambier \* WHYALLA TV & RADIO Whyalla W.A.—AUDIO DISTRIBUTORS Mosman Park \* THE AUDIO CENTRE West Perth \* JAPAN HI FI Victoria Park \* ALBERT S TV & HI FI CENTRE Perth \* ESPERANCE ELECTRONICS Esperance \* NORTH WEST AUDIO Karratha TAB.—UNITED ELECTRONICS Launceston \* BEL CANTO Hobart \* QUANTUM SOUND CENTRE Hobart

# SIGHT &

## Noise reduction developments

All recording enthusiasts are familiar with the well-known Dolby B noise reduction technique, which currently dominates the audio tape cassette market — although it will be replaced by the Dolby C system for an improved performance.

However, these Dolby systems are used only for tape recording and, to a very limited extent, for FM broadcasting, whereas noise improvement is also highly desirable in many other fields.

The Dolby system can be employed only when the signal is processed before the recording or transmission and again during the replaying or reception.

National Semiconductor has developed a Dynamic Noise Reduction (DNR) system using a single chip which, it is claimed, does not require the signal to be processed before recording or transmission and which can be used with all the types of signal shown in Table 1. Natsemi claim it is complementary to the Dolby systems and can actually be employed together with a Dolby system to enhance the noise reduction obtained by the Dolby circuit.

National Semiconductor's DNR system is based on the LM1894 device and is claimed to be the most universal and cost-effective noise reduction technique available. In addition to its use in the domestic market, it will be employed in certain radio receivers designed for incorporation in General Motors' cars.

Many other companies will also be using the DNR system in audio-visual products to be introduced early in 1982.

Market research studies by National Semiconductor indicated that only some 20% of the available audio material had been encoded for special processing, so they consider the demand for the DNR system will be high.

Recently the Columbia Broadcasting System (CBS) has developed an audio compression system for use with disc recordings. This CX noise reduction technique can be used in addition to the DNR and Dolby systems and applies a 2:1 compression to the audio being recorded on discs. Warner, RCA and DiscoVision have agreed with CBS that they will produce disc recordings encoded in this way.

National Semiconductor's LM13700 operational transconductance amplifier is used as the basis of the decoder used with CX recordings, and it is claimed that this system enables an effective signal-to-noise ratio of 80 dB to be obtained on playback.

A substantial growth is expected in the supply of CX encoded discs, but there will be a delay of something like six months to a year before CX compatible equipment becomes readily available in the USA.

National Semiconductor consider that by 1985 the Dolby, DNR and CX will have approximately equal shares of the noise reduction market and that combinations of these systems will develop to cover the wide variety of encoded and non-encoded material that has been in production and which is already present in most libraries.

A single type of noise reduction system will not meet all requirements and with trends towards 'home entertainment centres' combining video and audio, the ability to reproduce a wide variety of material becomes highly desirable. Will everything eventually be replaced by digital systems?

Brian Dance

	Dolby Systems	DNR System	CX System
Audio tape recording	Yes	Yes	No
FM broadcasts	Limited Use	Yes	No
AM broadcasts	No	Yes	No
Video cassette recorders	No	Yes	No
Television (high market)	No	Yes	No
Videodisc	No	Yes	Yes
Disc recording	No	Limited Use	Yes

Table 1. Primary current noise reduction systems

# SOUND



## Super-compact stereo microcassette recorder

Joining Sanyo's range of 'personal audio' products is a new sophisticated microcassette recorder, model M-X55.

Features include full stereo record and playback facilities, a two-speed (12 and 24 mm/sec) recording system for extended record and playback use and a built-in one-point stereo condenser microphone.

A control is provided for balance, a switch for 'dictation' or 'conference' in the record mode, and a high/low tone control for playback mode.

Input sockets are also conveniently located for external microphone and auxiliary. A set of lightweight stereo headphones is also included.

The unit is powered from two AA batteries and sells at a recommended retail price of \$209. For further information contact Mr. W. Fabiszewski, Sanyo Australia Pty Ltd, 225 Miller Street, North Sydney NSW 2060. (02)436-1122

## Pioneer tunes in to car sound

Pioneer has emerged as the world's leading manufacturer of car stereo products, according to worldwide sales figures recently released in Tokyo.

The statistics clearly show that Pioneer has steadily drawn away from its nearest competitor over the last two years. Pioneer sold some \$A294 million worth of car stereo units in the period from October 1979 to September 1980, nearly \$A60 million ahead of its competitor, Clarion.

Pioneer's 23% lead in the first year had increased to 46.3% in the sec-

ond year, based on a 30.6% increase in growth between the two years under comparison.

The Japanese-based company is confident it will further increase its lead during the current financial year and is predicting rapid growth in sales of car stereo (both regular and components), speakers and accessories.

## The audio experts are raving about the Magnetic Field Amplifier



M-400 Magnetic Field Amplifier

"Its distortion and noise levels are entirely negligible . . . it's hardly conceivable that a small, inexpensive lightweight cube such as this could deliver as much clean power as any but a few of the largest conventional amplifiers on the market."

That's what Julian Hirsch reported in Stereo Review about the Carver M-400—the unique magnetic field power amplifier. It's a cube that weighs around 4 kgs and delivers 200 watts per channel. And costs a lot less than you think.

Equally startling, the M-400 can safely drive speaker-load impedance as low as 2 ohms. And in mono it can deliver more than 500 watts into an 8-ohm load, with peaks to 900 watts! (Bring on digital audio!)

To hear for yourself why all the audio experts have flipped over Carver, ask for a demonstration and descriptive literature. It will be a totally new experience for you.

**CARVER**  
CORPORATION

DISTRIBUTED BY CONVOY SYDNEY (02) 358 2088

### Available from:

N.S.W.: LEISURE SOUND City • Parramatta • Artarmon 29 1364  
VIC.: TIVOLI HI FI Hawthorn 8 18 2872  
QLD.: STEREO SUPPLIES Brisbane 221 3623  
S.A.: SOUNDCRAFTSMEN Hawthorn 272 0341  
W.A.: JAPAN HI FI; AUDIO DISTRIBUTORS



# The dbx dynamic range expansion system: challenge to digital?

Live musical performance can have a dynamic range as great as 90 dB, though 80 dB is probably a more 'usual' figure. The very best discs achieve about 65 to 70 dB, as do the best open reel tape decks, whilst top cassette decks get only 55 dB or so. Hence signal compression is used on recording, followed by expansion on playback. The dbx system of compansion claims to be able to achieve 90 dB, a figure being claimed by digital recorder makers — and without compansion. Brian Dance explains.

**Brian Dance**

PERHAPS the most difficult of all the problems one meets in both disc and tape recording systems is that of preventing unwanted noise from appearing in the output. Such noise is, for example, generated by microscopic non-homogeneities in the groove of a disc, while tape hiss arises as each particle of the magnetic material on a tape passes across the replay head gap. The best known noise reduction technique is the Dolby system, but the more recently developed dbx system discussed here operates on different principles. Both have their own advantages.

## The dbx system

In equipment using the dbx system, all the incoming signals are compressed by

a 2:1 ratio (as measured in dB). For example, if the difference between the loudest and quietest passages to be recorded is 60 dB, the dbx recording circuitry will compress the dynamic range so that there is only 30 dB between the maximum and minimum signal levels.

When the recording is replayed, the circuitry 'restores' the signal to the original 60 dB dynamic range by providing greater amplification for the higher-level signals than for the lower-level signals. Any tape noise will, hopefully, be at a level below that of the smallest signal and will thus be amplified very little. This is illustrated in Figure 1.

In the case of disc recordings, the disc must have been recorded using a dbx

compression circuit, in which case it can be replayed with no appreciable playback hiss. Ordinary recorded discs cannot benefit from dbx.

Unlike the Dolby system, the dbx system operates at all frequencies with a compression and subsequent expansion dependent only on the signal level. (Obviously this is a simplification, since there will be certain 'attack' and 'decay' times during which the gain change takes place.)

## Dynamic range

A good human ear can perceive sound levels from the threshold of audibility (0 dB) up to a level of the order of 120 dB, which produces severe discomfort or even pain. Occasional transient peak

levels of 120 dB occur during live musical performances. However, the background noise level due to movements of the audience, etc, can reach levels of 30 dB (Figure 2) or even more. Thus the dynamic range which a perfect system should be able to handle should not be less than some 80 dB, although some experts regard 90 dB as being a more desirable figure.

When one is recording music on either a magnetic tape or on a disc, the signal must be suitably compressed so that the loudest passages do not overload the equipment and thus cause distortion, yet the quiet passages must be well above the level of the tape hiss or record noise. The maximum dynamic range which can be accommodated on a vinyl recording disc is normally about 55 dB, although 65 dB to 70 dB is said to be obtainable from the very best pressings. Clearly this is well below the desirable dynamic range.

Similarly, the dynamic ranges of professional studio tape recorders are limited to around 60 dB to 70 dB or so for the open reel models, while that of a good cassette recorder may be only about 55 dB (weighted, sans noise reduction figures).

If circuitry is not employed to increase the dynamic range of the recorded signal where necessary, the music as reproduced from the disc or tape sounds uninterestingly flat, and the contrast between the loud and quiet instruments is considerably blurred. Thus the excitement and realism of the performance is largely lost.

The dbx system can compress the signal for the recording process and expand it again so that a dynamic range of the order of 90 dB can be obtained. The noise from the dbx system is claimed to be appreciably below the ambient room noise, as shown in Figure 3.

### Comparison with Dolby

One of the advantages of the dbx system over the various Dolby systems is that

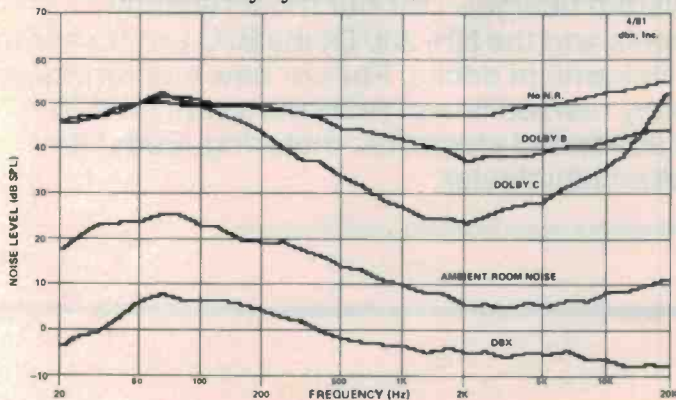

Noise from biased chromium dioxide cassette tape compared with typical ambient room noise. One-third octave analysis. Tape noise level referred to 200 nWb/m = 110 dB SPL.

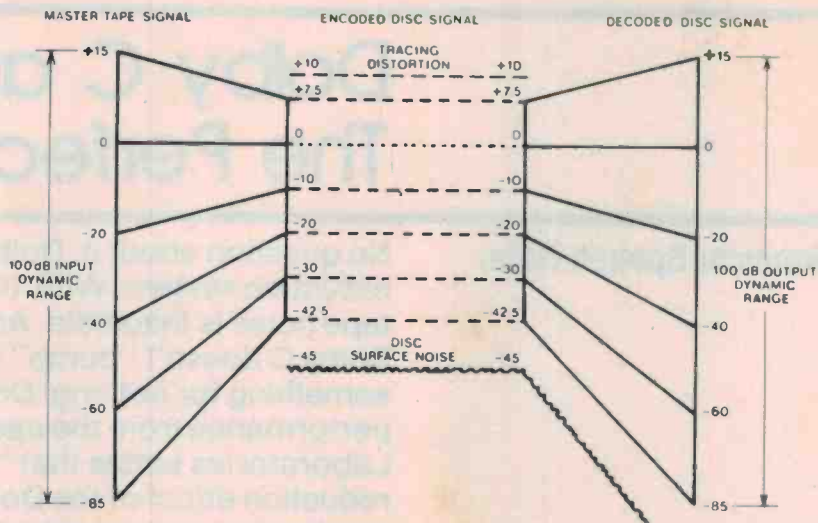

Signal compression and expansion during the encoding and decoding stages for dbx discs.

the expansion is provided uniformly over the whole frequency range and therefore one does not need to carry out the adjustment procedures which are required for setting up a Dolby circuit. A badly adjusted Dolby circuit can produce an appreciably inferior performance.

Although Dolby does its work well at high frequencies, where the hiss is generally the most obtrusive noise, the dbx equipment will also reduce any low frequency noise such as mains hum or turntable rumble that may be added to the signal by the circuitry.

Figure 3 indicates that the noise reduction obtainable using the dbx tape system is, at least in theory, somewhat better than that provided by a Dolby system. In practice the dynamic range obtainable is greater than that with Dolby B, but it may not be quite so high as the values suggested in the graphs of Figure 3 owing to the need to prevent any possible tape or disc overloading in certain frequency regions.

Any tape recorded for playback through dbx equipment will sound quite peculiar if replayed through a recorder without dbx circuitry; so will any dbx

disc. On the other hand a dbx-encoded tape replayed through a Dolby B circuit will provide a reasonable signal if one reduces the treble response somewhat.

Although the number of dbx discs is greatly increasing at the present time, it may be some time before the selection is considered reasonably adequate by most potential users. At present the number of pre-recorded Dolby tapes available is much greater, giving Dolby an advantage there.

### Performance

It is quite uncanny to place the tonearm over a dbx disc and start playing it, since one hears virtually nothing until the first notes of the music are reached! 'Digital' dbx discs provide even quieter backgrounds, since the hiss from the master tape, together with its saturation distortion, wow and flutter, are claimed to be eliminated. However, any digital tape equipment likely to be available in the foreseeable future may be quite expensive, whilst the usual problem of lack of standards in digital equipment is likely to cause considerable difficulties, perhaps for some years to come. Nevertheless, the 90 dB ▶

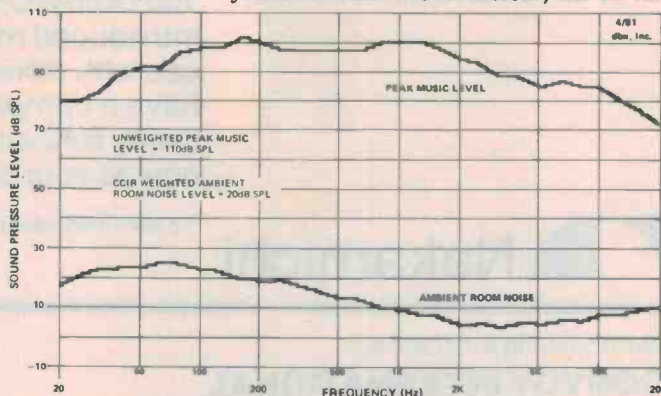

Peak music and ambient noise levels measured in typical living room environments. One-third octave analysis.

---

# Dolby C and Nakamichi The Perfect Combination

---

## Nakamichi Spoken Here.

No question about it. Dolby C is a remarkable noise-reduction system. With 10-dB greater quieting than Dolby B, tape noise is inaudible. And, unlike straight companders, Dolby C doesn't "pump" or "breathe". But you don't get something for nothing! Dolby C demands exceptional performance from the cassette recorder. Even Dolby Laboratories states that "taking full advantage of the noise reduction effect of the Dolby C system requires high mechanical and electrical performance from the recorder incorporating it, including very low noise in the circuitry which surrounds the noise reduction processor".

To achieve its superior quieting, Dolby C uses more compression during recording and more expansion in playback. If recorder response and tracking are excellent, the compensation is perfect. But every frequency-response error in the recorder is magnified more by Dolby C than by Dolby B. The result? Audible coloration! Mistracking error alters tonal balance and upsets the delicate relationship between fundamental and harmonics. The result? A change in timbre!

While many cassette decks will feature Dolby C, Nakamichi recorders are renowned for the superior headroom and inherently smooth, wideband, 20-20,000 Hz response needed to recreate the total sound experience — a response free from low-frequency contour effect, mid-frequency sag and high-frequency rolloff — the response demanded by Dolby C to achieve its full potential without audible coloration.

New for Nakamichi? Hardly! We have always demanded such perfection from our recorders — perfection that defies obsolescence. So, with utmost confidence, we offer the NR-100 Dolby-C system designed for our most recently introduced models and the NR-200 Dolby B/C processor for use with other Nakamichi decks. For our new customers, we have a completely revised line of recorders with built-in Dolby B/C and advanced electronic metering. See them now at your Nakamichi dealer.

To learn more about Nakamichi's unique technology, write directly to:

 **Nakamichi**

---

Distributed in Australia by:

**CONVOY INTERNATIONAL**

4 Dowling St., Woolloomooloo, Sydney, NSW 2011. Tel: (02) 358 2088

Dolby NR under license from Dolby Laboratories, Inc. The word "DOLBY" and the Double-D symbol are trademarks of Dolby Laboratories, Inc.



approximate dynamic range of the current dbx discs enables them to achieve a very impressive performance.

## Equipment

For home recording, the series II equipment manufactured by dbx Inc, Chapel St, Newton, Massachusetts 02195, USA, includes a Model 224 (with monitoring facility) and a Model 222 (without a monitoring facility). When used as an addition to one's existing equipment, they claim to provide an 85 dB range on open reel recorders and an 80 dB range even with cassette recorders. This includes a noise reduction of some 30 dB across the entire audio range together with an extra 10 dB 'headroom' at the upper level of the dynamic response.

The peak signal to the weighted background noise ratio is quoted as some 110 dB. The frequency response is quoted flat to within  $\pm 0.5$  dB over the range 40 Hz to 20 kHz and about -1 dB at 30 Hz. Total harmonic distortion is quoted as being less than 0.5% from 30 Hz to 100 Hz and less than 0.1% from 100 Hz to 20 kHz, while intermodulation distortion is less than 0.2%.

The Model 222 and 224 units incorporate circuitry for the recording and the replaying of tapes and for playback of discs. However, a smaller Model 21 unit is available for the playback of dbx discs and of dbx-encoded pre-recorded tapes when the latter become available. The performance of this Model 21 unit, which cannot be used for recording tapes, is fairly similar to that of the 222 and 224 equipment, but the frequency response is quoted as being matched to the decoding curve to within  $\pm 0.5$  dB between 30 Hz and 15 kHz, and the total harmonic distortion is given as being less than 0.2% at 1 kHz at up to 4 V RMS output.

The units mentioned are the domestic Series II units, but a Type I series is available for professional use where tape speeds are generally higher; it is not compatible with the Series II units, owing to minor signal processing differences.

When using dbx equipment, one often tends to turn up the volume before the start of the programme simply because one expects to hear some background hiss or noise and may even wonder if the system is working! However, this problem is soon overcome after the equipment has been used for some time. The dbx system can be very demanding on programme material; for example, wideband noise in the presence of high-level programme signals will be considerably amplified, but the programme material will usually mask the noise.



The dbx Model 21 decoder shown with a range of the currently available dbx-encoded discs.

## Expanders

The dbx company also produces a range of volume expanding equipment. Most records, tapes and radio programmes have their dynamic range compressed somewhat, and the expanders have been designed with the object of restoring the original wider dynamic range. They can be set to provide any dynamic range expansion from 1:1 (no expansion) up to 1:1.5 measured on the dB scale; the latter is usually far too great and 1:1.2 to 1:1.3 is normally as much as is needed for any programme material.

There are currently three of these expanders available. The simplest is the 1BX, which treats the whole of the audio frequency band together. The next unit in the range is the 2BX, in which the bass and treble are treated separately by splitting the audio frequency band into two parts. The most expensive unit is the 3BX, in which the audio frequencies are divided into three parts, each of which is separately processed. The advantage of splitting the frequencies for separate processing is that a high-level signal in one part of the frequency band will not cause a lower-level signal in another part of the band to be affected. (See also our review of the 3BX, Sept. '80 ETI.)

By making loud passages louder relative to quiet passages, it is claimed that these expanders restore much of the realism of recorded or broadcast music and make it more like what one hears in a live performance. In each unit the frequency response is claimed to be flat to within  $\pm 0.5$  dB from 20 Hz to 20 kHz at the 1:1 setting, total harmonic distortion typically 0.1% under the

same conditions and intermodulation distortion 0.15% typical.

A further unit, the dbx 118, provides continuously variable expansion from 1:1 to 1:2 and continuously variable compression from 1:1 to infinity. The compression mode is said to be useful when making tapes for playback in moving vehicles, where the ambient noise may be too high for the quieter passages to be heard without volume compression. A peak limiter is also incorporated in the unit.

## Equaliser

The dbx 20/20 unit combines a microprocessor-controlled ten-band graphic equaliser, real-time analyser, pink noise generator, sound pressure level meter, and includes a calibrated microphone; it is designed to automatically adjust for the effects of furniture, drapings and other factors which alter the acoustics of the listening room. When the microphone is placed in the desired position for listening, the precise equalisation characteristic is computed within 15 seconds. This characteristic can then be stored for later use at the touch of a memory button. The best average characteristic can also be computed for a number of listening positions.

Bargraph LED readouts are provided on all ten bands in this instrument.

## Conclusion

The dbx equipment can certainly provide some rather amazing dynamic range expansion and noise reducing effects, but like all such equipment, it must be used intelligently. ●

# We pay our engineers while they



The day you join the Air Force you start receiving a salary. Even though you're a full time student either at the RMIT (Royal Melbourne Institute of Technology) or the WAIT (Western Australian Institute of Technology).

At the WAIT you can study communications or electronics. At the RMIT you can study mechanical, aeronautical, communications or electronics engineering.

All of them lead to a degree.

When you graduate as an officer you will be posted to one of several RAAF bases.

There you will undertake design projects, supervise maintenance and have the management of maintenance resources for some of the most sophisticated equipment in the country.

## ONCE YOU KNOW WHERE YOU'RE GOING YOU CAN REALLY FLY.

As a graduate officer you have more than merely an engineering degree. Because in the RAAF you are also given training in management and administration.

So by the time you're about 22, you will be much further advanced than your civilian counterparts. Not only because of your technical expertise, but also your capacity to accept responsibility. After all, by then you could be in charge of a hangar full of aeroplanes and anything up to 30 men.

To enter the Engineer Cadet Scheme you must be an Australian citizen under 20 on January 1st of your year of entry and meet our selection requirements.

# Are you still studying to be engineers.

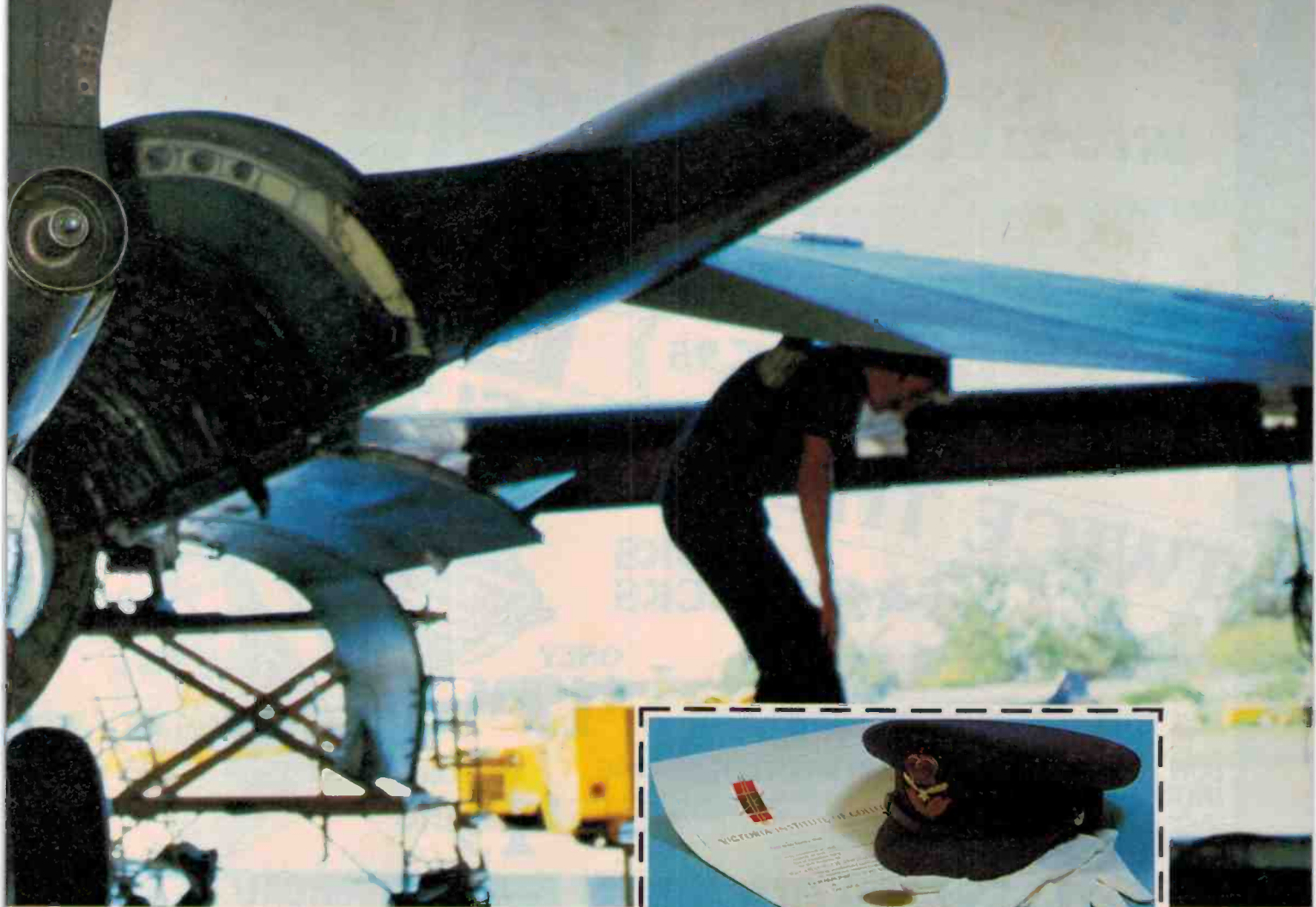

You must also be matriculated or be doing your matriculation this year.

*If you're not doing your matriculation until next year you may be eligible for a RAAF scholarship to help you through.*

Either way, ring any RAAF Careers Adviser or fill out the coupon and we'll send you more information.

MELBOURNE	(03) 61 3731
SYDNEY	(02) 212 1011
CANBERRA	(062) 82 2333
PERTH	(09) 325 6222
ADELAIDE	(08) 212 1455
HOBART	(002) 34 7077
BRISBANE	(07) 226 2626

Once you know you want to be an engineer, join the Air Force and get off to a flying start.



Application forms are available now.  
Mail to: RAAF Careers Office, GPO Box  
XYZ, in your State Capital

I would like more information on:

- The RAAF Engineer Cadet Scheme
- RAAF ECS Scholarship

Name .....

Address .....

..... Postcode .....

Birthdate .....

## Air Force Officer.

Engineer Cadet Scheme

Authorised by the Director General of Recruiting, Department of Defence

AFE9 DPS 111

# TWICE THE FUN!

## WITH DICK SMITH FUN WAY INTO ELECTRONICS

**Vol 1** For the absolute beginner, this book is a must. 20 exciting projects - all built without the need to solder. The unique "breadboard" method of construction enables you to follow the circuit via the wires, and because every project is battery powered, they are perfectly safe! Learn electronics the FUN WAY! Cat. B-2600

**Vol 2** We now have this superb book in stock again. Packed with 20 exciting projects to build (see Kit list below) this book provides fun AND education! From printed circuit boards to using a multimeter, it's all there - and it's fun. Cat. B-2605

**\$4<sup>95</sup>**

**\$6<sup>95</sup>**

POST AND PACKAGE  
\$1 PER BOOK

# TWICE THE VALUE!

## BOOKS & KIT PACKS

### FUN WAY VOL. 1 VALUE PACK

An easy to follow system of learning basic electronics. 20 exciting projects for you to build ranging from a beer powered radio to an electronic siren. Completely safe, no need to solder, suitable for all ages. Hours of fun building educational projects. Find out what electronics is all about - the easy way! Cat. K-2615

ONLY  
**\$17<sup>95</sup>**

### FUN WAY VOL. 2 GIFT PACK WITH SOLDERING IRON

Fantastic savings! Over \$25 value! Everything you need to build an actual working project, including a hobbyist soldering iron and pack of solder, a 9 volt battery, a copy of 'Fun Way Vol. 2' and a Wireless Microphone Kit. The 'Fun Way Vol. 2 Gift Pack' makes electronics fun, easy, and now, economical. Cat K-2620

ALL FOR  
**\$19<sup>95</sup>**

## FUN WAY TWO KITS: EASY, SAFE & ECONOMICAL!

### MULTI-PURPOSE LED FLASHER . . . . \$2.95

A really simple kit that can be used as a warning device, electronic jewellery, etc. Cat K-2621

### DING DONG DOORBELL \$4.50

Welcome visitors to your home with this integrated circuit doorbell! Cat K-2622

### MORSE CODE TRAINER \$4.50

This simple oscillator circuit lets you learn Morse code the easy way! Cat K-2623.

### UNIVERSAL TIMER . . . \$5.50

Use it as an egg timer, a dark-room timer, etc: in fact, it's got a lot of applications! Cat K-2624

### ELECTRONIC DICE . . . . \$4.95

Throwing a dice is old hat: do it electronically! Simple circuit has other uses too. Cat K-2625

### MONOPHONIC ORGAN \$7.95

Easy to build, and easy to play! And it even has 'vibrato' - just like the big ones! Cat K-2626

### POCKET TRANSISTOR RADIO . . . . \$7.95

Simple to build, and it's nice and small. Listening is so much more fun! Cat K-2627

### TOUCH SWITCH . . . . \$5.50

One touch on, next touch off - or 'on while touched'. Dozens of uses in the home. Cat K-2628.

### MOSQUITO REPELLER \$4.95

Don't get eaten by mozzies: scare them away electronically. Take it anywhere. Cat K-2629

### SIMPLE AMPLIFIER \$6.50

A useful little amplifier for all those projects needing audio amplification. Cat K-2630

### WIRELESS MIC. . . . \$6.50

A tiny transmitter that can be received on any FM receiver. A great little kit! Cat K-2631

### LIGHT ACTIVATED SWITCH . . . . \$5.50

Highly useful for alarms, night light switches, etc etc. Sensitive and reliable. Cat K-2632

### METAL/PIPE LOCATOR \$6.50

A simple BFO circuit you can use to find metals, pipes, wiring, etc - maybe gold! Cat K-2633

### SOUND ACTIVATED SWITCH \$6.95

Picks up sound waves and trips a relay. Use as a telephone bell extender, too. Cat K-2634

### HOME/CAR BURGLAR ALARM \$6.50

Learn how burglar alarms work when you install your own! For home or car. Cat K-2635

### ELECTRONIC SIREN \$4.95

Great for alarm use - or where any warning is required. Good for kids toys, too! Cat K-2636

### LED LEVEL DISPLAY \$8.95

This fascinating project shows you the audio level of any amplifier. Cat K-2637

### INTERCOM UNIT . . . . \$8.95

Communicate! Build this intercom and talk between rooms, etc. Cat K-2638

### LED COUNTER MODULE . . . . \$7.95

Learn how digital circuits work by building a counter. Count slot car laps, etc. Cat K-2639

### SHORTWAVE RECEIVER \$6.95

Listen in to the exciting world of shortwave radio: amateurs, foreign countries! Cat K-2640

**SCHOOLS, RE-SELLERS, ETC.:**  
We'll negotiate a special price for bulk quantities on either books or kits, or both!

# DICK SMITH ELECTRONICS

SEE PAGE 34 FOR ADDRESS DETAILS



DSE  
A170M  
LM



# Hitachi Promise You Quality and Reliability

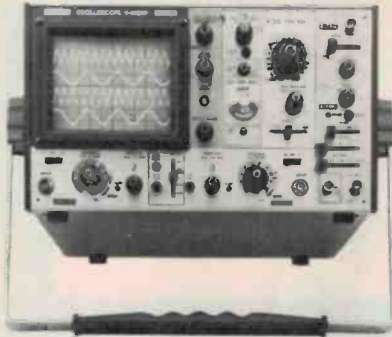

Hitachi Oscilloscope  
V-1050F/100MHz

1. Large Bright 8 X 10cm screen.
2. Quad trace operation.  
(CH1, CH2, A trigger and B trigger)
3. High sensitivity 500 $\mu$ V/div (5MHz)
4. High accuracy  $\pm 2\%$  (+10 to 35°C)
5. Alternate time base operation.
6. 20 MHz bandwidth limiter.
7. Full TV triggering.

Hitachi Portable Oscilloscopes

V-650F	DC~65MHz DUAL-TRACE DELAYED SWEEP
V-353F	DC~35MHz DUAL-TRACE DELAYED SWEEP
V-203F	DC~20MHz DUAL-TRACE DELAYED SWEEP
V-352F	DC~35MHz DUAL-TRACE
V-302F	DC~30MHz DUAL-TRACE
V-202F	DC~20MHz DUAL-TRACE
V-152F	DC~15MHz DUAL-TRACE
V-151F	DC~15MHz SINGLE-TRACE

Hitachi Mini Portable Oscilloscopes

V-509	DC~50MHz DUAL-TRACE DELAYED SWEEP 215(W) X 110(H) X 350(D)mm 5kg
V-209	DC~20MHz DUAL-TRACE 215(W) X 110(H) X 350(D)mm 4.5kg



**STANDARD COMPONENTS PTY. LTD.**

10 Hill St., Leichhardt N.S.W. 2040  
PH. (02)660.6066 (13 lines)



**AWA New Zealand Limited**

Wi-neera Drive, Porirua, N.Z. P.O. Box 50-248  
Telephone: PRO 75-069

## Complete Disco System



for only \$2950

including

- LENTIK PDM 1000 MIXER
- TWO TECHNICS SLB 202 TURNTABLES
- LENTIK 150W RMS POWER AMP
- TWO LENTIK 112 HT 3 WAY ENCLOSURES (rated at 150W RMS EA.)
- MICROPHONE HEADPHONES AND ALL NECESSARY LEADS
- MUSICOLOR IV
- FOUR PAR 38 LIGHT BOXES (four globes in box)
- ONE YEAR PARTS AND LABOUR WARRANTY



**LENTIK PA 4200**

- 150W RMS
- 4 CHANNEL
- BUILT IN REVERB
- BASS AND TREBLE CONTROL ON EACH CHANNEL
- MASTER VOLUME AND MASTER REVERB

\$565

Without carpeted box

\$515



**LENTIK SLAVE AMPS**

- 75W MONO \$299
- 75 + 75 STEREO \$390
- 150W MONO \$350
- 150 + 150W STEREO \$495
- 350W MONO \$450

## UNITED SOUND SYSTEMS QLD. AGENT FOR ETONE

Models available ex stock

611	12"	300 mm	30W RMS	\$34.90
616	12"	300 mm	Twin Cone	\$42.60
511	12"	300 mm	40W RMS	\$45.10
516	12"	300 mm	Twin Cone	\$60.20
231	12"	300 mm	60W RMS	\$66.20
236	12"	300 mm	Twin Cone	\$79.20
241	12"	300 mm	80W RMS	\$82.95
246	12"	300 mm	Twin Cone	\$88.20
451	12"	380 mm	100W RMS	\$140.50
484	12"	380 mm	200W RMS	\$220.40
801	15"	380 mm	200W RMS	\$242.20
805	15"	380 mm	250W RMS	\$247.30



BACKGROUND MUSIC TOO EXPENSIVE  
NOT WITH A LENTIK AM/FM AUTO REV

### CASSETTE RADIO

- AM/FM Radio
- Auto Reverse
- Cassette Deck
- Built in 20 watt Amplifier
- line out socket

Only requires speakers

**\$399**

All prices include freight to Qld. Coastal Cities.

Trade inquiries welcomed.

MANUFACTURED IN QUEENSLAND BY:

## UNITED SOUND SYSTEMS

Corner Ann and Warner Streets, Fortitude Valley 4006. Phone 52 2899, 52 7538  
SERVING QUEENSLAND AND NORTHERN NEW SOUTH WALES

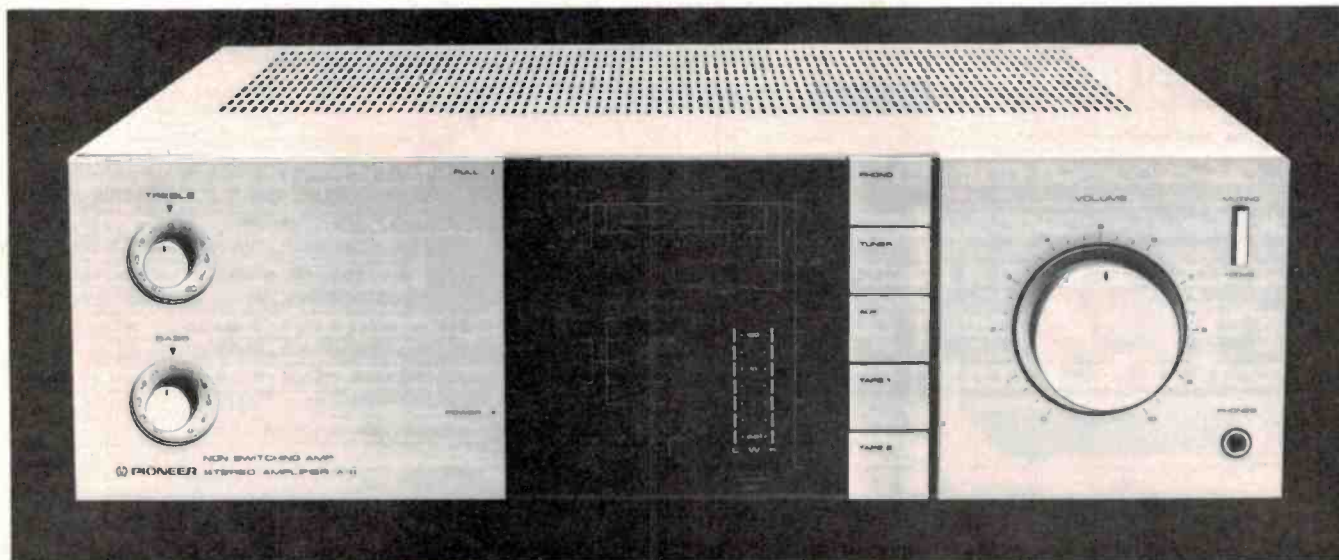

## Pioneer A-8 amplifier

Words like 'superlative... exemplary' don't come often from Louis Challis, but after reviewing the Pioneer A-8 amp he was using them quite a few times. Can't be bad!

**Louis Challis**

IT IS A LITTLE more than 25 years ago that two of my friends purchased their first Japanese receiver and main amplifier. Both were manufactured by Pioneer and were purchased because of the reputation they had already earned for both price and performance. In the intervening period I have purchased Pioneer equipment and at least one Pioneer amplifier is still providing sterling service in my office. Pioneer have recently acquired a number of other firms, like Phase Linear in America, and have released a number of new and unquestionably exciting pieces of equipment.

The A-8 amplifier and its bigger brother the A-9 (which is not reviewed here) are the new top-of-the-line amplifiers from Pioneer. They provide a radical departure in both appearance and ergonomic design from their predecessors, and the A-8 amplifier also incorporates a number of technical features which come unheralded in this country. The most important of these features is the development of the 'non-switching amplifier' which is a new form of dynamic bias to minimise crossover distortion. Crossover distortion in transistorised amplifiers has constituted the major source of com-

plaints that transistorised amplifiers "will never sound as good as the best valve amplifiers did, or could."

The A-8 amplifier competes with an extremely large number of other amps, all of which also claim to have a wide array of new features. The difference is that this amplifier 'delivers the goods'.

### Features

The visual impact of the front panel is bold and striking. The right hand third of the panel contains a very large volume control, which is centrally

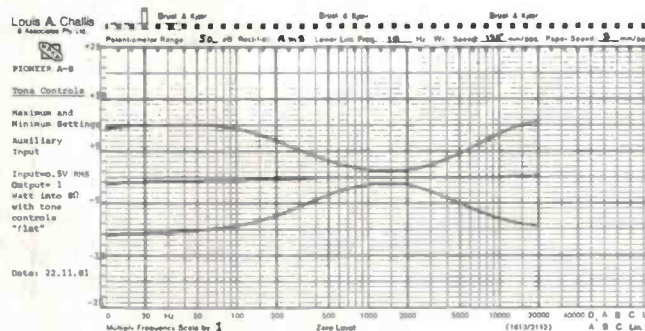
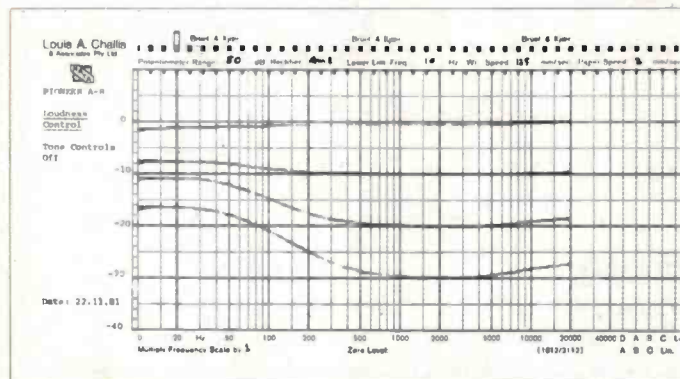

positioned. The only other controls on that section of panel are a 20 dB muting switch, located above and to the right and a headphone socket immediately to the right and below. To the left and separating this panel from the middle panel are a vertical array of rectangular push-buttons for the selection of phono, tuner, auxiliary, tape 1 or tape 2, in the primary input signal path.

The central panel incorporates a series of rear-illuminated block schematics of the sections connected or switched on, called by Pioneer a 'pictograph'. These are really miniature mimic diagrams with yellow, green and red illumination which tell you which speaker system has been chosen, whether the tone controls are switched in or out, if the loudness or subsonic filter have been activated as well as which of the five possible input signals is being fed to either of your two possible tape recorders. The lights also provide warning as to whether your muting or protection circuits are operating. The power circuit protection indicator conveniently changes from the normal green to red on the operation of the protection circuitry, when either an overload or short circuit is applied to the output speaker leads.

This panel also incorporates a small LED peak power display, with settings ranging between one milliwatt and 100 watts to indicate the power of each channel output into 8 ohms. With only seven LEDs in a vertical array these can only provide indication in rather large 10 dB steps. The step from one milliwatt to 0.3 watts may be regarded as rather big, but this should not really be a problem when you are listening to real music.

Whilst at first sight the left hand end of the panel consists of just two controls for treble and bass recessed into a panel, on closer examination the panel is found to hinge down. Behind it, like the proverbial Pandora's Box, are a whole host of other controls. These include the channel controls for balance, and a selector for copying from tape 1 to tape 2 or tape 2 to tape 1, as well as from other possible sources.

The switches include a tone control defeat button, described as a 'straight line', a selector for moving magnet or moving coil cartridges, two switches for adjusting the loading on the moving coil to provide impedances of 100 ohms and 33 ohms respectively, and two capacitor loadings for the moving magnet of 200 pF or 400 pF. This last switch takes into account the expected 100 to 200 pF capacitance of the record player leads. Other switches include a stereo/mono switch, a loudness switch, a subsonic filter switch and two small buttons for selecting A and/or B speaker systems. The treble and bass controls each have detents with five positive and negative steps, which provide a total  $\pm 10$  dB of boost or cut at 50 Hz and 20 kHz.

The amplifier's top cover is fabricated from steel and incorporates a very large area of perforated slots to ensure adequate ventilation, whilst the bottom is also very well perforated. The back of the cabinet features only one pair of sockets for phono, as well as the normal tuner, auxiliary, and four sockets for each of the tape recorders. Eight unusual but very effective colour-coded universal terminals are provided for speaker connection. A large decal, however, warns that with either A or B system in use the impedance should be

6 ohms to 16 ohms per speaker, while with A plus B systems each speaker should have 12-32 ohms impedance. You therefore cannot use 2 x 8 ohms speaker systems. The terminals are better designed than the normal 'universal' terminals intended to take banana leads, for they also incorporate a sensible shrouded base so that the bare wires will not be likely to short to the metal chassis immediately adjacent.

## Inside

The inside of the amplifier will be more impressive to engineers and the technically minded than it will be to the average hi-fi buff, and typifies the extent to which consumer electronics has developed, displaying innovation in both design and construction. The highlight of this innovation is not visible with the naked eye as it is embodied in the variable bias system developed by Pioneer. This is a high-speed feedback circuit which continuously monitors the amplitude of the incoming signals and automatically elevates or lowers the bias current fed to the output transistors.

The transistors are never allowed to be completely cut off, so in theory there is no switching distortion, which plagues other amplifiers almost irrespective of type. The output power transistors used in this circuit are very large rectangular monolithic modules, each of which is mounted below one of the newly developed multi-finned heatsinks. The efficiency and heat dissipation of these cleverly designed units is obviously an order of magnitude better than previous types of heatsink, with which we have all been familiar. Each of the heatsinks also incorporates a thermal feedback

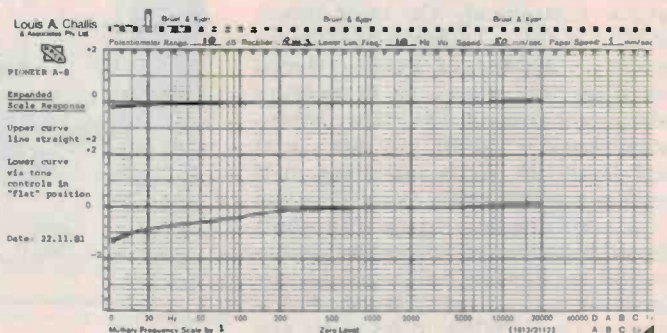
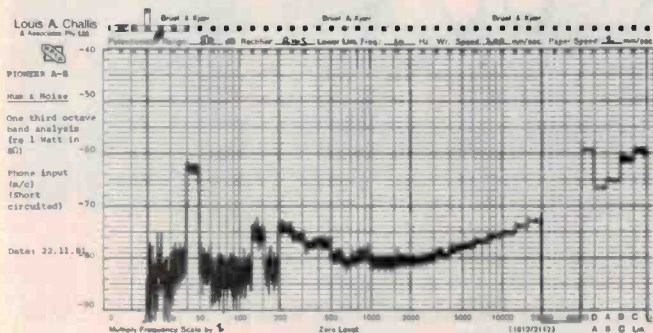

# SOUND review

element screwed in at the top to detect overload or runaway conditions.

The layout is conventional yet very sensible. On one side of the rear is a very large, exceedingly well-shielded power transformer, which is fully encapsulated and features a copper shorting strap to reduce the stray leakage flux. Behind this is the power supply module, with protection fuses and both high and low-level voltage regulators. On the right hand side connected to the rear panel are the preamplifier circuits, which are directly connected by very short leads to the input terminals for each of the inputs. These circuits are then connected by means of ribbon cable to the adjacent card, which is similarly connected to tape recorder inputs and outputs. This card and its board-mounted changeover switches are controlled by means of a Bowden cable from the front panel.

The switching circuit and the amplifier's protection circuit are located at the rear. In the front the power amplifier printed circuit is mounted on its side. Behind the front panels are the similarly mounted vertical printed circuits for the tone control feedback assembly, the volume control assembly, and the moving coil and moving magnet equaliser assemblies. The display module printed circuits are connected to a motherboard with plug-in sockets, whilst the switching and logic card incorporates unusual printed circuit-mounted slide switches.

Apart from the obvious use of consumer electronic components, this amplifier looks more like a professional piece of test equipment than a piece of consumer electronics.

## Measurement

Four times during the last six years, in advance of the impending release of amplifiers with what have been described as 'state of the art' improvements, we have been forced to select new equipment to allow us to measure distortion. Fortunately the most recent time was at the end of last year when we decided to design and build a special new filter that allows us to measure individual harmonic distortion components down to  $-120$  dB, (i.e. down to at least  $0.0001\%$ ). As it turns out, that decision was fortunate, as we have had at least two amplifiers since then which warranted this improvement in capability, and the Pioneer A-8 is one of them. Pioneer only claim that the distortion is no more than  $0.005\%$  at 98 watts and

that the continuous power rating for two channels driven is 90 watts.

We performed our distortion measurements at 90 watts and found that the Pioneer publicity personnel are rather modest. At 100 Hz we measured  $0.0038\%$ , at 1 kHz  $0.0018\%$  and at 6.3 kHz  $0.0013\%$ . At the 1 W level these figures were only slightly higher, being  $0.008\%$  at 100 Hz,  $0.0036\%$  at 1 kHz and  $0.006\%$  at 6.3 kHz. Any improvements in performance beyond this point would be, in my opinion, of purely academic interest. The transient intermodulation distortion is also extremely low, being way below  $0.1\%$ .

The sensitivity of the phono inputs for one watt output are 300 microvolts for moving magnet and 41 microvolts for moving coil, which are excellent figures. Equally important, the overload characteristics of these two inputs are 220 millivolts for the moving magnet and 35 millivolts for the moving coil input. This means that you have a very wide margin left in hand before you approach the overload limits on either type of cartridge. *Both of these sets of figures are significantly better than claimed in the handbook.* The output impedance of each of the two main

amplifiers is 75 milliohms, which is a particularly low figure and obviously would benefit greatly from very low impedance cables to follow.

The dynamic headroom of the amplifier is 1.3 dB relative to the 90 watts power rating, so the manufacturer's rating is realistic and not overstated. The signal-to-noise ratios with the volume set for one watt output are  $-73$  dB unweighted and  $-79$  dB A-weighted for the auxiliary,  $-79$  dB(A) for the moving magnet input and  $-66.5$  dB(A) for the moving coil input. Some of these figures are slightly lower than quoted by the manufacturer, but overall are still good.

The transient overload recovery test performed in accordance with IHF-A-202 shows that the amplifier has *impeccable* recovery performance. It recovers within the first quarter cycle from an overload without any trace of jitter or instability. The excellent linearity of the frequency response shows up particularly well in the expanded scale response (level recording 8). There is no real droop in the 10 Hz to 20 kHz range and it can be seen to be impeccably flat, within 0.2 dB at 10 Hz and within 0.1 dB at 20 kHz with the tone controls defeated. It is still

To page 149

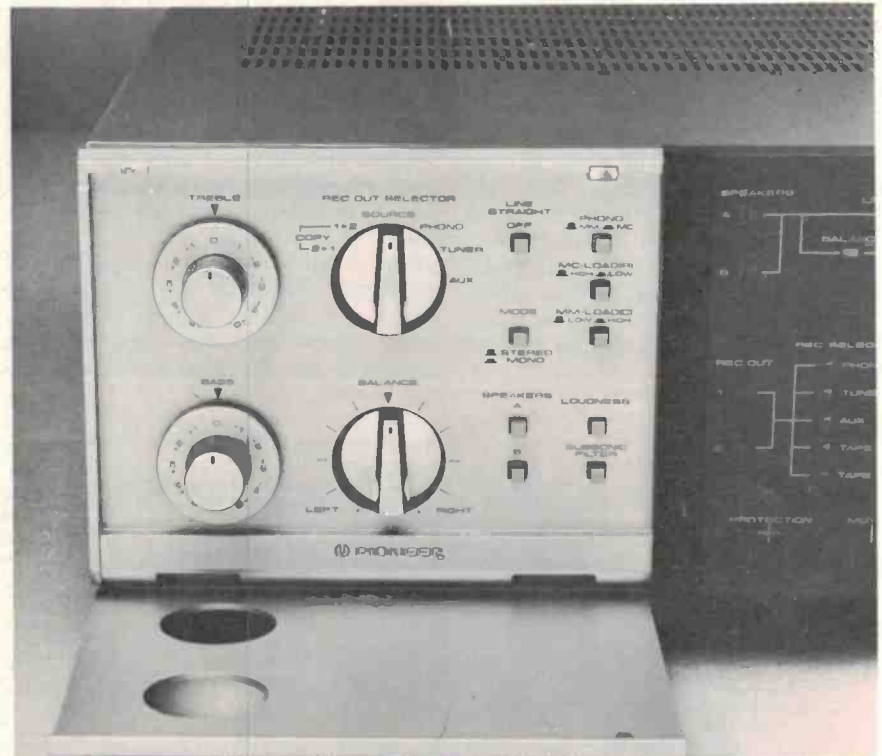

Behind a hinge-down escutcheon at the left of the front panel one finds all the 'set and forget' controls. Only the treble and bass are accessible through holes in this escutcheon.



# MODEL PETERSON SIX STUDIO MONITOR



## GENERAL DESCRIPTION:

The model six 'Studio Monitor' is probably one of the best 'value for money' monitors available in Australia today. In comparing other speakers to this unit subjectively, not only did we have to use imports at twice the price to compare but, surprisingly, found in many instances it out-performed units three times the price.

## CABINET MATCHING:

790 (79) de luxe or standard.  
 SOUND PRESSURE LEVEL: 1 watt, 1 meter.  
 95 db  
 SHIPPING: 1 speaker per carton.  
 (Matched pairs.)

WEIGHT	IN CARTON	OUT OF CARTON
	29.5 kg	28.00 kg
DIMENSIONS:		
Height	860mm	790mm
Width	465mm	395mm
Depth	480mm	430mm

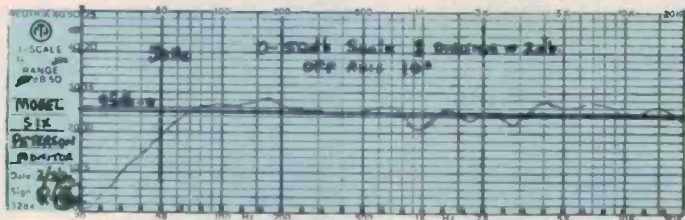

FREQUENCY GRAPH: CALIBRATED. 0-50 db Scale

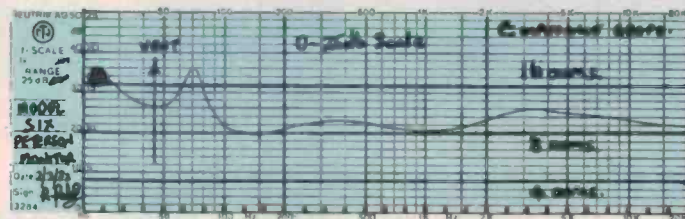

IMPEDANCE GRAPH (Z) CALIBRATED. 0-25 db Scale

## SPECIFICATIONS:

TYPE: Tuned reflex dual ports  
 SYSTEM: 30cm (12") 3 way (8 ohm)  
 MAXIMUM RATING: 120 watts R.M.S.  
 MINIMUM PREF. DRIVE: 15 watts R.M.S.  
 DRIVER SIZE: 30cm (12")  
 CAPACITY: 76 litre  
 BAFFLE: 19mm braced  
 COLOURS AVAIL.: Royal Grove Walnut  
 ATTENUATION: Dual variable  $\pm 6$  db  
 CROSSOVER TYPE: 3rd generation  
 CROSSOVER frequ: 400 Hz and 5kHz  
 MIDRANGE ROLLOFF: 6db  
 MIDRANGE ROLLOFF: 6db  
 DRIVER ROLLOFF: 6db  
 TWEETER ROLLOFF: 18db  
 TWEETER ROLLOFF: N/A  
 FREQUENCY RANGE: 20 Hz to 20 kHz  
 EFFECTIVE RANGE: 40 Hz to 20 kHz

All graphs are live environmental.  
 All S.P.L. levels are calculated from a pink noise source. 1 watt, 1 meter.  
 (This is, we feel, a more accurate indication of musical listening levels, than random spot frequency methods.)



## PETERSON SPEAKER LABORATORIES P/L

VICTORIA: Clive Peters, all stores; Frankston Sound; Brash's, all stores; Reliance Hi-Fi, Footscray; Mildura Audio, Mildura; Gleeson and Tonta, Dandenong; Maryvale Electronics, Morwell; John Thomas, Ballarat; Roy Vincents Audio, Echuca; Denman Audio, St. Kilda; Sounds Alive, Shepparton. NEW SOUTH WALES: Orange Audio, Orange, Car Radio & Hi-Fi, Wagga Wagga; The Record Centre, Griffith; Brian Bambach, Newcastle; Kent Hi-Fi, Canberra; Nitronics, Coffs Harbour. WESTERN AUSTRALIA: High-Fidelity Stereo, Perth. QUEENSLAND: Queensland Entertainment Co. P/L, Eight Mile Plains; Downtown Hi-Fi, 64 Charlotte St., Brisbane. SOUTH AUSTRALIA: Track Hi-Fi, City; Ern Smith, Norwood; Astra Hi-Fi, Woodville South; O'Connells, Country.

your kind of  
music...

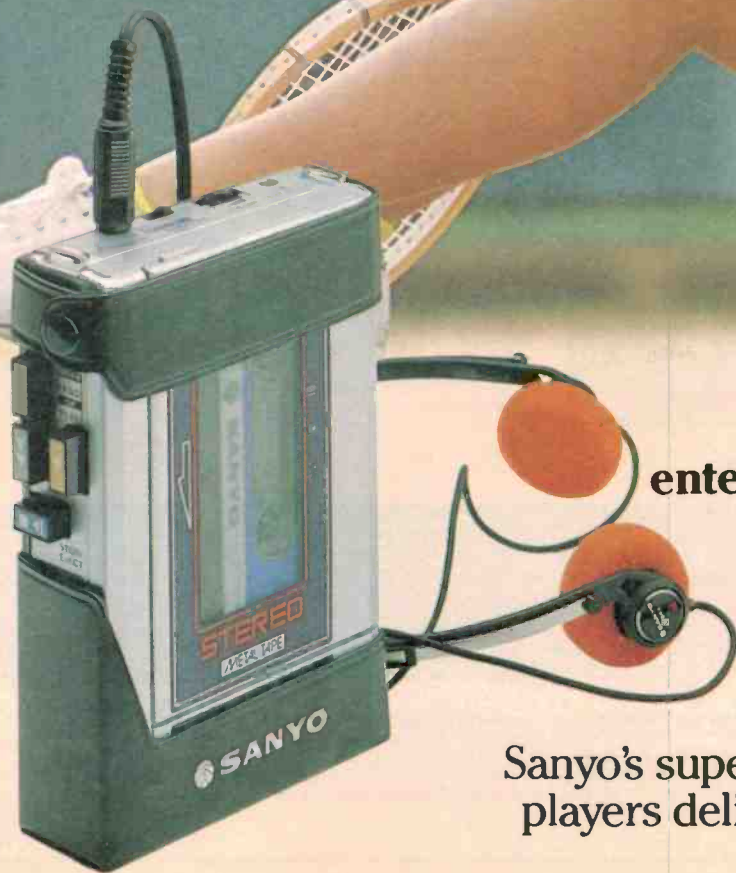

**Put some high powered  
entertainment into your day with  
these swingers from Sanyo.**

Whether you're having fun,  
playing your favourite  
sport, or simply relaxing  
with your kind of music,

**Sanyo's super-compact personal radio/tape  
players deliver high powered performance  
wherever you go.**

**M-G10 Compact Personal Tape Player** -  normal and metal tape facility  Hi-Lo tone switch  lightweight headphones  
 convenient thumbwheel volume control  Auto-Stop tape system  cue and review  carry case with shoulder strap.



whenever you  
want it!

Clean, compact styling and every feature  
you need for your listening pleasure -  
All this, plus the rugged reliability  
you expect from Sanyo -  
one of the world's most respected  
brands in audio equipment.

 **SANYO**  
*That'sLife!*

M-G30 Combination AM/FM Radio and Tape player -  headphones  metal tape facility  tone switch  
 metal/normal tape selector  FM stereo/mono mode selector  cue and review  Auto-Stop tape mechanism  carry case.

# PEERLESS SPEAKERS

The name behind the big names in hi-fi!

Chosen for their high quality by the world's leading speaker makers!

Peerless is a world authority on loudspeaker design. In fact, many of the world's top hi-fi manufacturers select Peerless speaker components for inclusion in their own Brand Speaker Systems. Made in Denmark, Peerless speakers are incomparable for their high-power handling, smooth frequency response, low distortion and colouration.

Peerless speakers can be purchased three ways:—

1. Fully-assembled in timber cabinets — from bookshelf to floor-standing models.
2. Speaker Kits — build-it-yourself and save up to 40% on assembled speaker prices.
3. Individual speaker components to suit your exact hi-fi needs.

Peerless makes speakers to suit amplifiers from 20-100 watts. For true-to-life sound, Peerless is the name behind the biggest names in hi-fi. Hear Peerless speakers at one of the authorised dealers below — or contact the sole importer for full technical details.



**Peerless**

Sole Australian Importer: G.R.D. GROUP PTY. LTD.  
698 Burke Road, Camberwell, Vic. 3124. Trade Enquiries welcome.

## N.S.W.

**Bondi Junction**  
Danish Hi-Fi (Aust.) Pty. Ltd. Ph: (02) 387 5878

**Concord**  
Electronic Agencies Ph: (02) 745 3077

**Crows Nest**  
Deeva Hi-Fi Ph: (02) 439 3999

**Dee Why**  
David Ryall Electronics Ph: (02) 982 7500

**Wagga Wagga**  
Car Radio & Hi-Fi Centre Ph: (069) 21 4618

## VIC.

**Ballarat**  
Turner Audio Ph: (053) 32 2042

**Camberwell**  
Danish Hi-Fi (Aust.) Pty. Ltd. Ph: (03) 82 7348

**Cheltenham**  
Beland Electronics Ph: (03) 550 2279

**Geelong**  
Steve Bennett Audio Ph: (052) 21 6011

**Hawthorn**  
Tivoli Hi-Fi Ph: (03) 818 8637

**Warrnambool**  
Bruce Henderson Audio World Ph: (055) 62 5147

## S.A.

**Adelaide**  
Hi-Fi Acoustics Ph: (08) 223 6774

**Adelaide**  
Danish Hi-Fi (Aust.) Pty. Ltd. Ph: (08) 51 2124

**Goodwood**  
The Acoustic Foundry Ph: (08) 271 0276

**Hawthorn**  
Sound Craftsmen Ph: (08) 272 0341

**St. Peters**  
Milltronix Ph: (08) 42 3781

## W.A.

**Claremont**  
Danish Hi-Fi (Aust.) Pty. Ltd. Ph: (09) 384 2852

**Kalamunda**  
Beale Charter Pty. Ltd. Ph: (09) 293 1512

## QLD.

**Brisbane**  
Brisbane Agencies Ph: (07) 221 9944

**Brisbane Centre**  
Audio Centre Ph: (07) 284 2495

**Redcliff**  
Hi-Fi Sales Ph: (07) 284 2495

CONCORD/P5792



## THE S-100 BUS MULTI USER EXPERT

430 LITTLE COLLINS STREET, MELBOURNE, 3000  
(03) 602 3946, (053) 67 1066.

### CT-200 MICROCOMPUTER

Consists of an attractive 10 slot S100 mainframe with Z80A Single Board Computer operating at 4MHz, serial & parallel I/O, 2K Computailor Monitor PROM, Z80A-CTC, and a dynamic RAM board with 64K of 200ns RAMs, mains filter, cooling fan and a heavy duty power supply.

\$1750

### CT-82 DUAL 8" FLOPPY DISK UNIT:

Consists of an attractive aluminium box, two double-sided, double-density floppy disk drives, mains filter and a power supply with the +5V DC rail overvoltage protected, an air filter and cooling fan.

\$1845

### Z80A CPU BOARD:

As described in CT-200

\$490

### 64K DYNAMIC MEMORY BOARD:

As described in CT-200

\$580

### FLOPPY DISK CONTROLLER BOARD:

Handles up to four drives in any combination of 8"/5.25", single/double density, single/double sided.

\$465

### CP/M 2.2 CUSTOMIZED TO CT-200

### MP/M 2.0 CUSTOMIZED TO CT-200

\$210

\$560

A wide variety of software, terminals and printers are also available.

Prices given here do not include sales tax. Ask for our short form catalogue.



# SOUND review

From page 144

within 1.4 dB at 10 Hz and within 0.15 dB at 20 kHz with the tone controls switched on and centred. This amplifier achieves its frequency linearity primarily as a result of the lack of coupling capacitors between the various stages from front end to output. The result is an amplifier with superlative transient performance, which is enhanced by particularly low distortion characteristics.

The subsonic filter features the same lazy roll-off that we have complained about recently with other amplifiers. It is a shame Pioneer have not made that attenuation steeper, providing a sharp roll-off either at or below 10 Hz to control wow from records and low frequency transients that can so easily destroy your speakers.

The crosstalk characteristics drop from a figure of 55 dB at 1 kHz to 31 dB at 20 kHz. This drooping characteristic is not perfect but is quite acceptable. The tone control circuits provide modest but acceptable characteristics in terms of cut and boost, whilst the loudness control provides an excellent approximation of the Fletcher-Munson curve over the mid-band to low frequency region. The RIAA linearity lies within

0.3 dB right across the range, and the majority of the manufacturer's important performance figures were confirmed or found to be very close to the stated figures.

## At home

I kept the amplifier at home for a little longer than I normally do, because it offered so many useful features. The one I liked best was the 'pictograph system' or what I would prefer to call a 'mimic diagram'. This makes it easy to see what you are doing, and more directly than the majority of other indication systems currently being offered to the consumer.

Ignoring the frills, however, the A-8 has one major virtue — the *quality of the sound it can produce*. Its lack of non-linear harmonic distortion and its complete lack of colouration make it an attractive option when selecting an amplifier with 80-120 watt-plus capability. In use, driving either a set of B&W 801s or a set of Fisher ST 550 speakers, it is quite happy pushing out 100 watts of peak signal almost continuously. Moreover, its performance is equally good at very low signal levels, where the quality is exemplary. In use with a set of Pioneer electrostatic

headphones *the quality of sound at low levels is superlative*, and so this is an amplifier 'for all seasons'. At a recommended retail price of \$769 this is one amplifier whose technical performance would be very hard to beat. ●

## PIONEER A-8 STEREO AMPLIFIER

Dimensions: Width: 420 mm; height: 132 mm; depth: 423 mm.

Weight: 13.8 kg

Price: \$769

Manufactured: In Japan by Pioneer Electronics Corporation

Distributor: Pioneer Electronics Australia, 178 Boundary Rd, Braeside Vic. 3195.

Absolute copyright in this review and accompanying measurements is owned by Electronics Today International. Under no circumstances may any review or part thereof be reprinted or incorporated in any reprint or used in any advertising or promotion without the express written agreement of the Managing Editor.

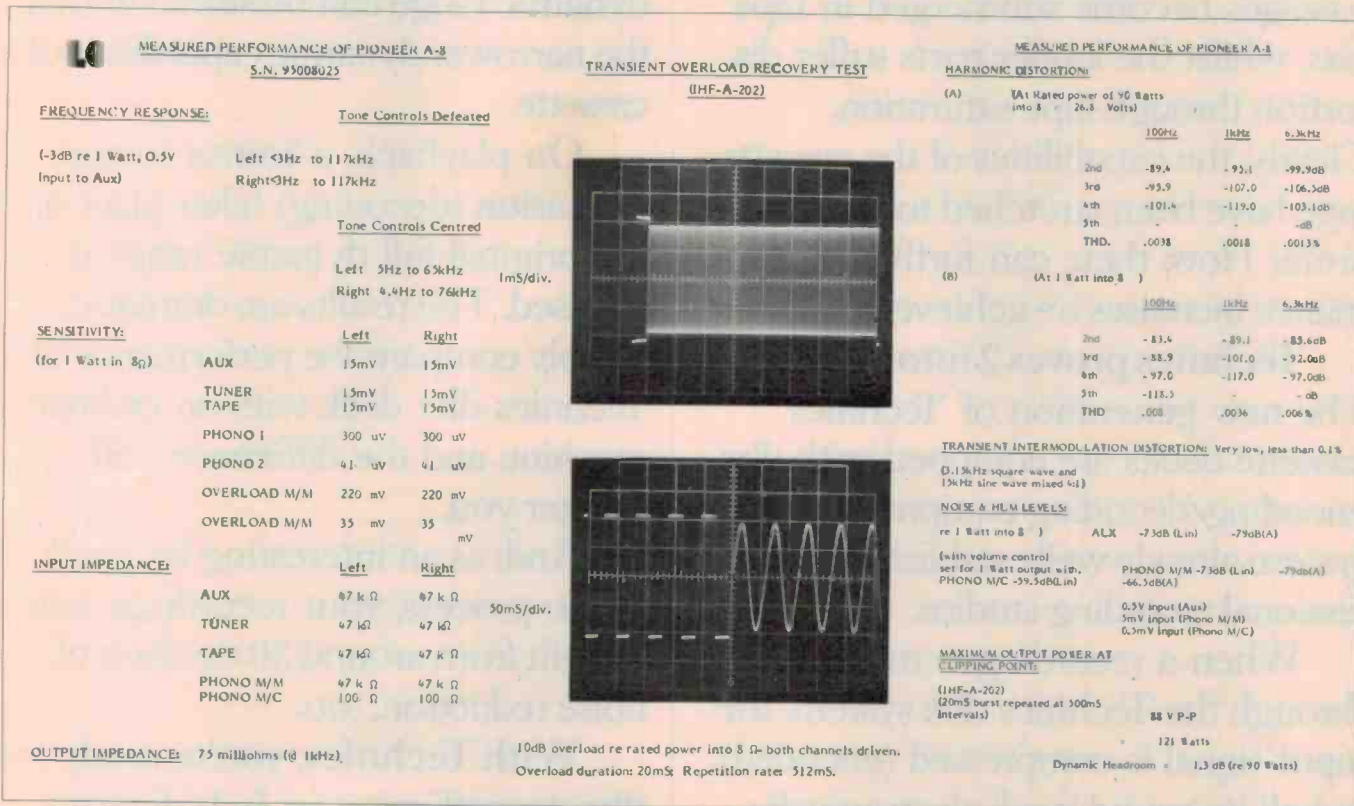

# Why Technics their dbx

You can't fit a quart in a pint pot. Dynamic range is what brings music truly 'alive'. It's the difference in sound level between the proverbial 'drop of a pin' and the cannons' roar in a digital recording of the 1812. This difference represents more than 100 decibels of dynamic range – a figure regularly exceeded by a full orchestra or live rock band in full flight.

However, even with modern tape formulations, this full dynamic range cannot be captured on a cassette recording due to the inherent limitations of the tape itself. The quietest passages become submerged in tape hiss, whilst the louder parts suffer distortion through tape saturation. Clearly, the capabilities of the cassette tape have been stretched to their limits. How, then, can further performance increases be achieved?

**Technics proves 2 into 1 does go!** The new generation of Technics cassette decks are equipped with dbx encoding/decoding equipment – a system already well established in professional recording studios.

When a recording is made through the Technics dbx system, the input signal is compressed (encoded) to half its 'sound level', electronically,



so a performance with a wide dynamic range can be stored within the narrower dynamic capabilities of a cassette.

On playback, a 'mirror image' expansion (decoding) takes place and the original full dynamic range is released. The results are dramatic. Simply compare the performance of a Technics dbx deck with an ordinary machine and the difference will stagger you.

And, as an interesting by-product of the process, your recordings will benefit from around 30 decibels of noise reduction, too.

**With Technics, you're ready for dbx recordings, too.** In hi-fi terms,

# have developed cassette decks.

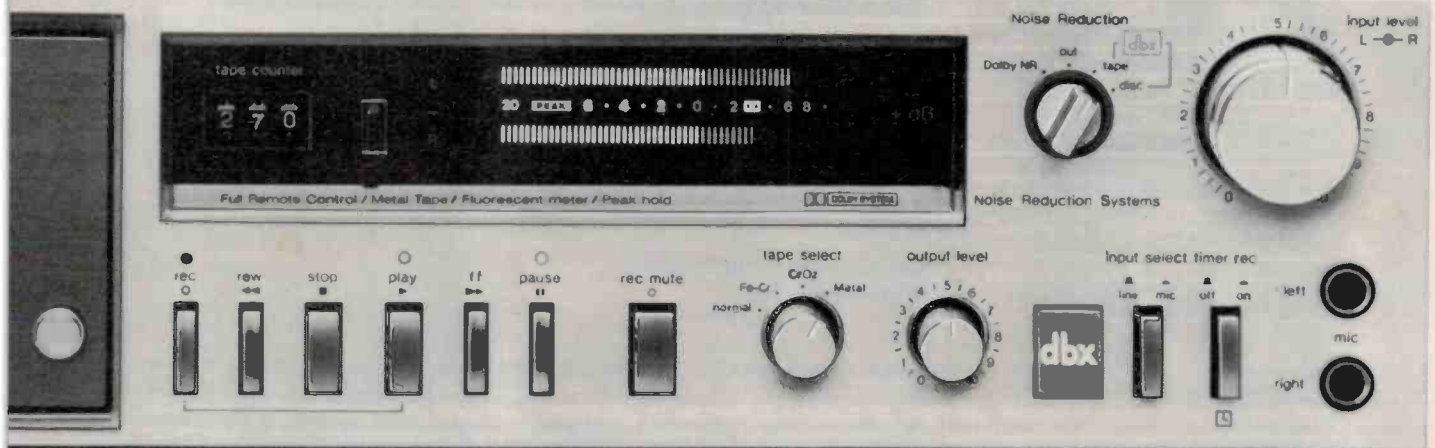

the quality of pre-recorded cassettes has left much to be desired. But when dbx recorded material is released in Australia, you'll notice a big difference. Play a pre-recorded dbx tape through your Technics dbx cassette deck and you may well think you're listening to a good quality disc.

And whilst on the subject of discs, there are dbx albums being made, too. Naturally, Technics have taken this into consideration. And you'll find a DISC position on the dbx selector, so you can play dbx-encoded albums through your existing system.

Technics RS-M270X dbx cassette deck. A typically advanced Technics component that combines

stable, reliable tape transport with highly sophisticated electronics. Direct drive motors for both capstan and reel drive; IC logic solenoid controls; 2-colour, peak-hold FL meters; 20-20,000 hz frequency response with metal tape; 110 dbx dynamic range.

Let Technics expand your music experience to new horizons.

Listen to a Technics dbx cassette deck and hear the amazing difference for yourself.

Of course, all Technics components carry a two-year warranty.

**Technics**  
Expanding the music experience.



Electronics Today International is published by Murray Publishers Pty Ltd, 15 Boundary St, Rushcutters Bay NSW 2011. It is printed (In 1982) by Offset Alpine, cnr. Wetherill and Derby Sts, Silverwater NSW, and distributed by Australian Consolidated Press.

**Editor**  
**Roger Harrison VK2ZTB**  
**Technical Editor**  
**David Tilbrook VK2YMI**  
**Production Editor**  
**Jane Clarke B.A. (Hons)**  
**Advertising Production**  
**John Gerrie**  
**Editorial Staff**  
**William Fisher B.Sc. (Hons)**  
**J.B. Scott B.Sc./B.E. (Hons)**  
**VK2YBN**  
**Jan Vernon B.A.**  
**David Currie**  
**Geoff Nicholls B.Sc./B.E.**

**Layout**  
**Bill Crump**  
**Githa Pilbrow**  
**Typesetting**  
**Julie Hewlett**

**Reader Services**  
**Paula Maloney**  
**Managing Editor**  
**Collyn Rivers**  
**Acoustical Consultants**  
**Louis Challis & Associates**

**Mail enquiries:** There is no charge for replies, but a foolscap-sized, stamped, addressed envelope must be enclosed. Queries relating to projects can only be answered if related to the item as published. We cannot advise on modifications to projects, other than errata or addenda, nor if a project has been modified or if components are other than specified. We try to answer letters as soon as possible. Difficult questions may take time to answer.

**Phone enquiries:** We can only answer readers' technical enquiries by telephone after 4.30 pm. The number to ring is: **(02)33-5669**. In enquiring by telephone about back issues or photostats, please ring **(02)268-9015**.

**Editorial and Sales Office:**  
**4th Floor, 15 Boundary St, Rushcutters Bay NSW 2011. Ph: (02)268-9811;**  
**Tlx: 27243**

**Sales Manager: John Whalen**  
**(address as above)**

**Melbourne:** Virginia Salmon, 150 Lonsdale St, Melbourne Vic 3000. Ph: 662-1222; Tlx AA34340

**Adelaide:** Admedia Group, 24 Kensington Rd, Rose Park SA 5067. Ph: 332-8144; Tlx AA82182.

**Brisbane:** Geoff Horne Agencies, 16 Bellbowrie Centre, Bellbowrie Qld 4070. Ph: 202-6813.

**Perth:** C. Thomas, Adrep Advertising Representatives, 62 Wickham St, East Perth WA 6000.

**New Zealand:** Frank Hargreaves, Circulation Marketing Manager, c/- ACP, 4th Floor, Sun Alliance House, 42-44 Shortland St, Auckland. Ph: (9)30311.

**United Kingdom:** Australian Consolidated Press, Ludgate House, 107 Fleet St, London EC4A 2AL. Ph: 353-1040; Tlx: 267163.

**Japan:** Genzo Uchida, Bancho Media Services, 15 Sanyei-cho, Shinjuku-Ku, Tokyo 160. Ph: 359-8866; Cable: Elbanchorito; Tlx: BMSINC J25472 Tokyo.

**USA:** Australian Consolidated Press, 21 East 40th Street (Floor 23), New York NY 10016. Phone: (212) 685-9570.

The publisher accepts no responsibility for unsolicited manuscripts, illustrations or photographic material.

## ORDER FORM

I enclose \$ ..... for (tick appropriate box/es). All prices include postage.  
 Send orders to: ETI, 4th Floor, 15 Boundary St, Rushcutters Bay NSW 2011. Phone: (02)33-4282.

<input type="checkbox"/>	<b>Subscriptions</b>	\$23.30 per year within Australia \$36.60 overseas (surface mail) Airmail rates on application	\$ .....	<b>NAME (Please print)</b>	.....
<input type="checkbox"/>	<b>Back issues</b>	\$2.50, available from November 1978	\$ .....	<b>ADDRESS</b>	.....
<input type="checkbox"/>	<b>or photocopies</b>	\$2.50 per article per issue			.....
	Project No. ....	Month .....	Year .....	\$ .....	.....
	Project No. ....	Month .....	Year .....	\$ .....	.....
	Project No. ....	Month .....	Year .....	\$ .....	.....
	Project No. ....	Month .....	Year .....	\$ .....	.....
	Please attach a list if more than four required.				
<input type="checkbox"/>	<b>Binders</b>	No. .... @ \$6.10 in NSW No. .... @ \$7.50 in other states	\$ .....	<b>POSTCODE</b>	.....



Few palates could  
tell that McWilliam's Chablis  
didn't come from this small  
French village.



This little village in Burgundy has been making an attractive dry white wine for quite a while now. The wine has long been called after the name of the village... Chablis.

They make it primarily from the Chardonnay grape, so do we. Their soil is ideal for Chardonnay, so is ours. Their wine has a delicate bouquet, pleasing fruit on the palate with a clean, crisp, dry finish, and so has ours.

Their prices are astonishingly high, McWilliam's prices are astonishingly affordable...vive la Australie! **McWILLIAM'S**



'URBAN LEGENDS' are the stuff from which many jokes originate. You know — like the one about the cuckolded husband who drove a truck for a certain cement crowd who filled his wife's lover's expensive Mercedes sports car with cement!

Well, Dregs is about to create (or is it resurrect?) another urban legend — albeit an electronic one (after all, this is ETI, isn't it?)

Barry Wilkinson, who was ETI's famed project engineer in 'the early days', now owns Nebula Electronics, which specialises in one-off design and small production runs of electronic equipment. Barry's work lately has become more and more involved with microcomputers — even micro-microcomputers (i.e.: small enough to fit in your pocket!). Yes folks, he's right into the micro revolution — no more rack cabinets, or even big boxes — if it doesn't fit in your hand or your pocket, he's not interested. So successful has this new line of work been for Barry that he's seriously considering moving into smaller premises!

### Toots, mon!

True or not, the Scots are universally renowned for their pennypin... er, thriftiness, so what better place to pilot a new electronic 'debit card' scheme than Scotland?

To be launched in Aberdeen, the scheme will allow motorists to buy petrol and have the cost debited directly from their account at the point of sale. All they need do is proffer a card, similar to the 'Handybank' or 'Autobank' cards, instead of cash or a credit card — no waiting for change, vouchers, etc. (Save time, not money?) BP Oil and the Clydesdale Bank have teamed up to pilot the scheme, no doubt thinking that if they can get it working on the world's 'toughest' customers, the rest of the world will be a pushover!

Guid luck tae ye, laddies!



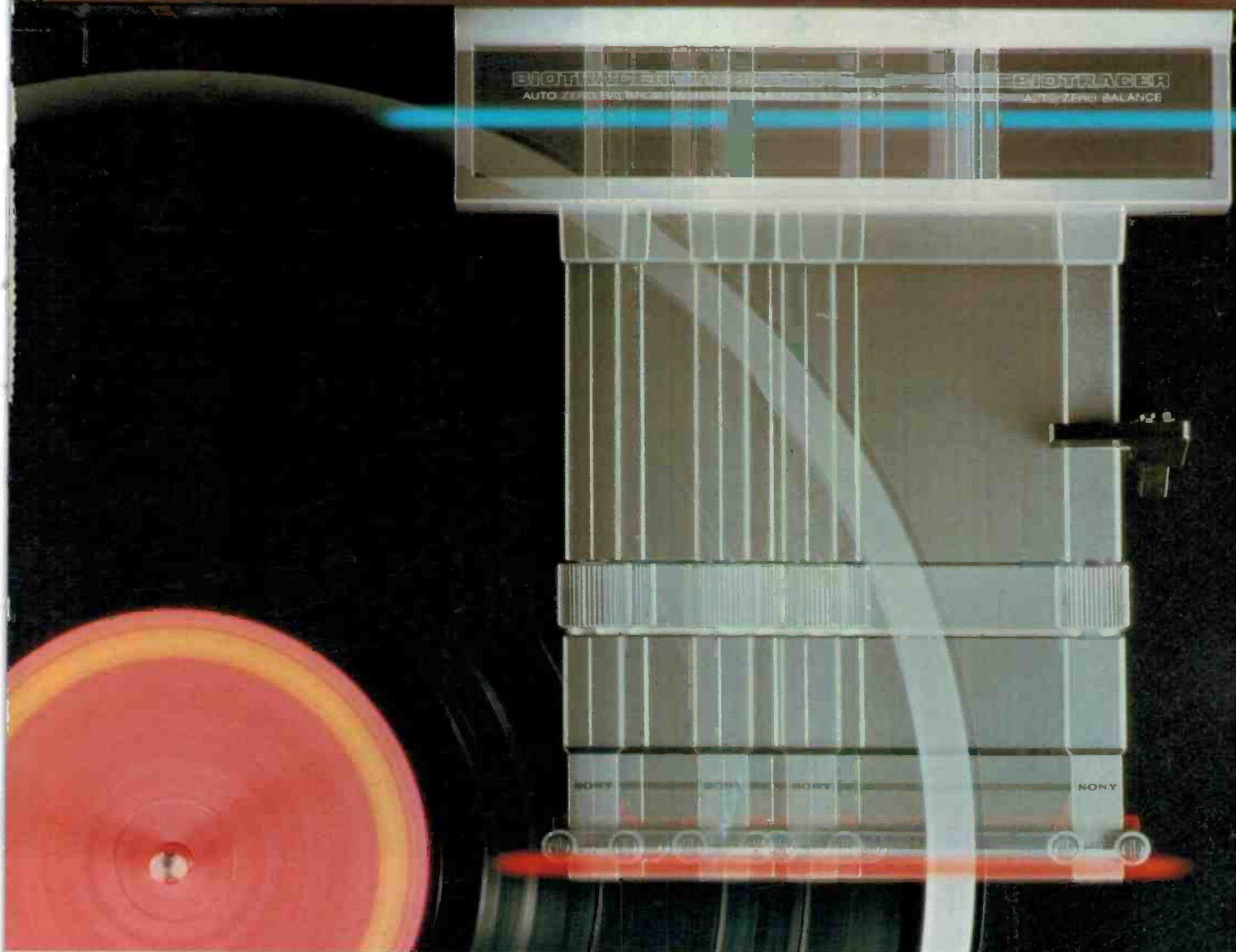

## Off on a tangent with Sony.

We didn't jump into tangential tracking turntables right off the bat. And Sony hopes you didn't either. Because while most lateral tonearms don't exactly shift gears as they travel down their path, they do run into some rough spots. A hang-up called "cogging" that inhibits totally free flowing movement, and hampers left and right stereo separation.

Sony has alleviated cogging and out of phase problems with an invention called Tangential Tracking Biotracer.

Controlled by two microcomputers and four sensors, the motion of the Biotracer tonearm is continuously fluid for precise phase alignment of the stylus.

To the average person these differences may sound slight. But if your standards are as high as Sony's, you'll understand the angle we're driving at.



**SONY**  
THE ONE AND ONLY

SON 0116

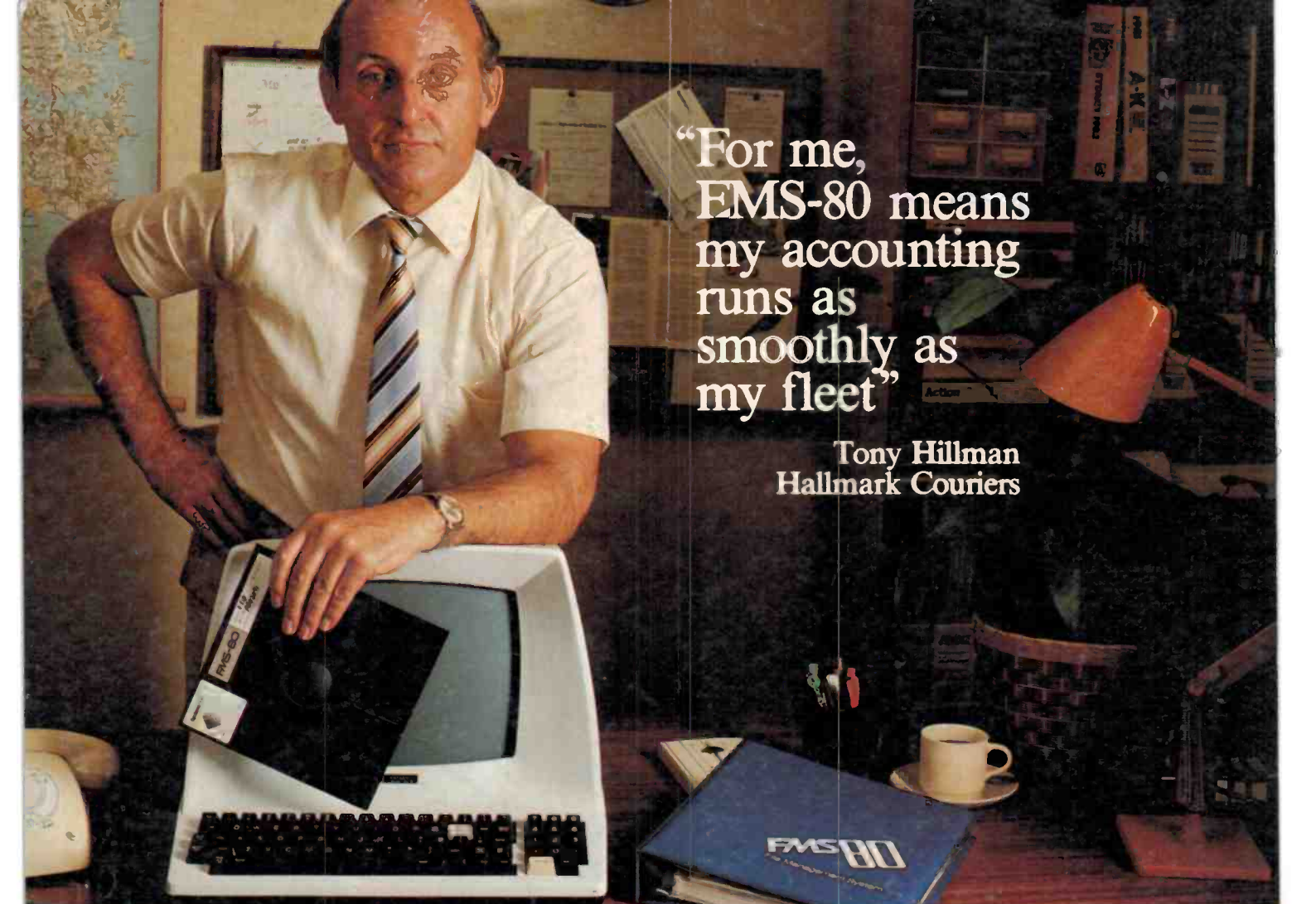

“For me,  
EMS-80 means  
my accounting  
runs as  
smoothly as  
my fleet”

Tony Hillman  
Hallmark Couriers

your filing system  
wastes time and money.  
Here's the solution...

## FMS-80

By early last August, Tony Hillman had problems. Tony heads the fastest growing courier service in Sydney. In just over 2 years his turnover had grown over 700%. Servicing the advertising industry, he knew speed, service and efficiency were crucial. He knew time meant money and he knew he was wasting it. A manual job record and accounting system was holding the company back; he and all the staff worked back until 1am to get out the month's invoices. And because he had to pay his drivers fortnightly, his cash flow situation was getting difficult. He had to invoice fortnightly. Tony needed a solution. One which could cope with 387 clients and over 15,000 transactions per month and run his invoicing and accounts. And have flexibility for future growth.

FMS80 was the answer for Tony. The FMS80 data management system gives him total integration of his day to day

transactions and his accounts. With no costly tracking down of errors. FMS80 finds possible errors before they cost him time and money. FMS80's advanced report generator helps Tony look ahead. If there's going to be a cash flow problem in two weeks time, he knows now. Expandability and flexibility are the keys to FMS80's power. For Tony this has meant that when he needs an individual driver's report, his FMS80 can provide it. Now he's looking at incorporating trial balance and creditor's reports.

**But what can FMS80 do for my business?** For you, FMS80's power and flexibility might mean being able to carry out a stock valuation in only two minutes. Or being able to add crucial supplier codes you forgot the first time. Or maybe tailoring reports to have just the information you want. Or it might be FMS80's ability to work in with WordStar™, to produce text and chart reports.

**If you already have an accounting program** FMS80 will very likely tap straight into your existing files. This means flexible financial forecasting with complete control of future variables. Answer all those 'what if' questions straight off your existing files. Can you see FMS-80 working for you? Then contact us right away for further information. Or give us the real challenge; let us show you just how FMS-80 can work in your application.

**FMS80 Data Management System including new Shell 80 interface \$1100**

**MINIMICRO  
SUPERMART**  
Pty Limited

Showroom:  
33-35 Auchison Street,  
St Leonards NSW 2065  
Phone: (02) 439 1628

Dealer enquiries to:  
**John F. Rose Computer Services Pty Ltd**  
33-35 Auchison Street, St Leonards, NSW 2065  
Phone (02) 439 1220 Telex AA27901

Glover & Assoc JFR/3