



**ELECTRONICS
TODAY
INTERNATIONAL**

**LED LEVEL
DISPLAY**

60 dB range, 'twin dot' display
shows peak and average

STATIC
nemesis of
electronic systems

Advanced BASIC
Learners' computer
Death of the turntable?

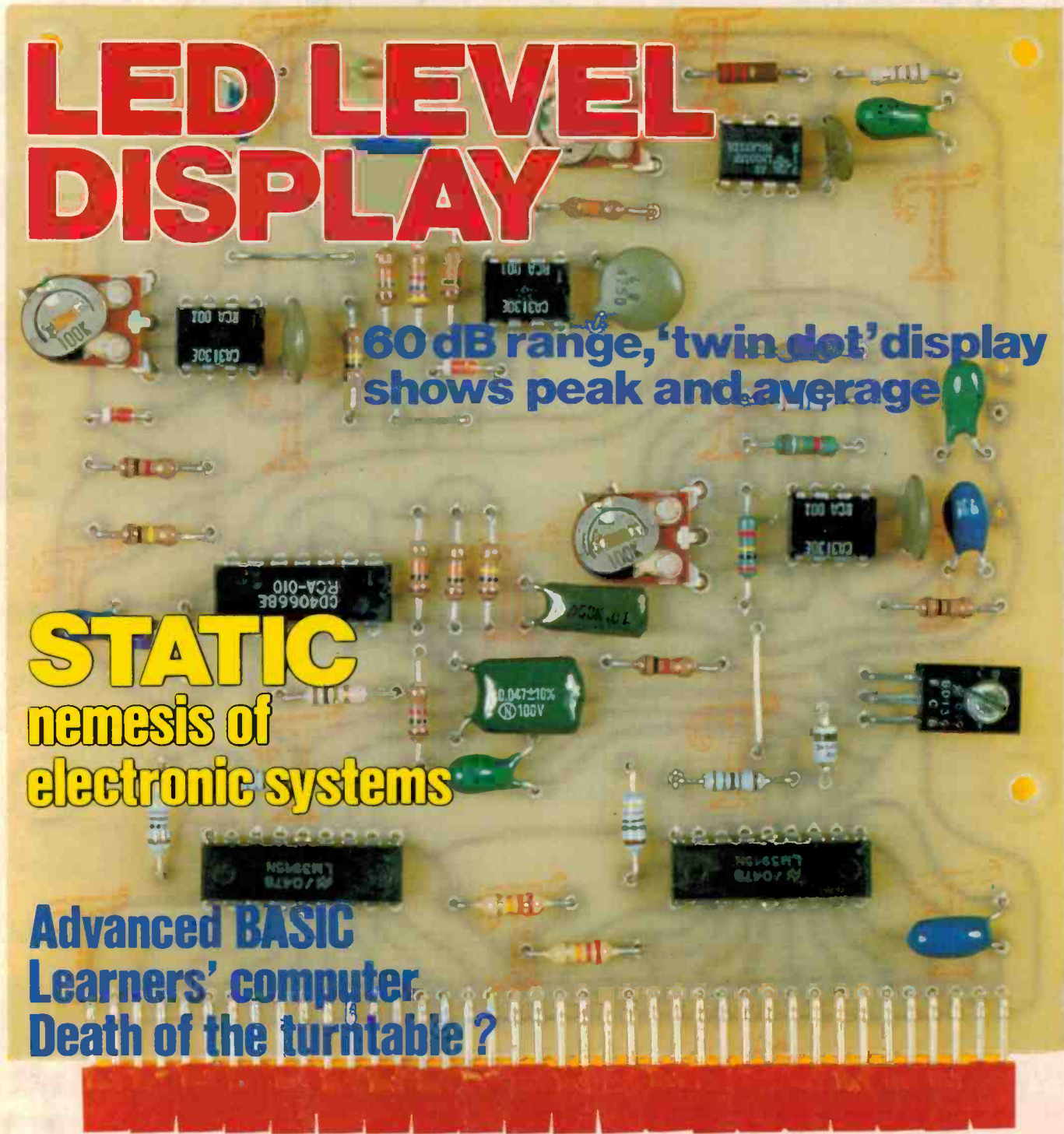

AFTER 500 PLAYS OUR HIGH FIDELITY TAPE STILL DELIVERS HIGH FIDELITY.

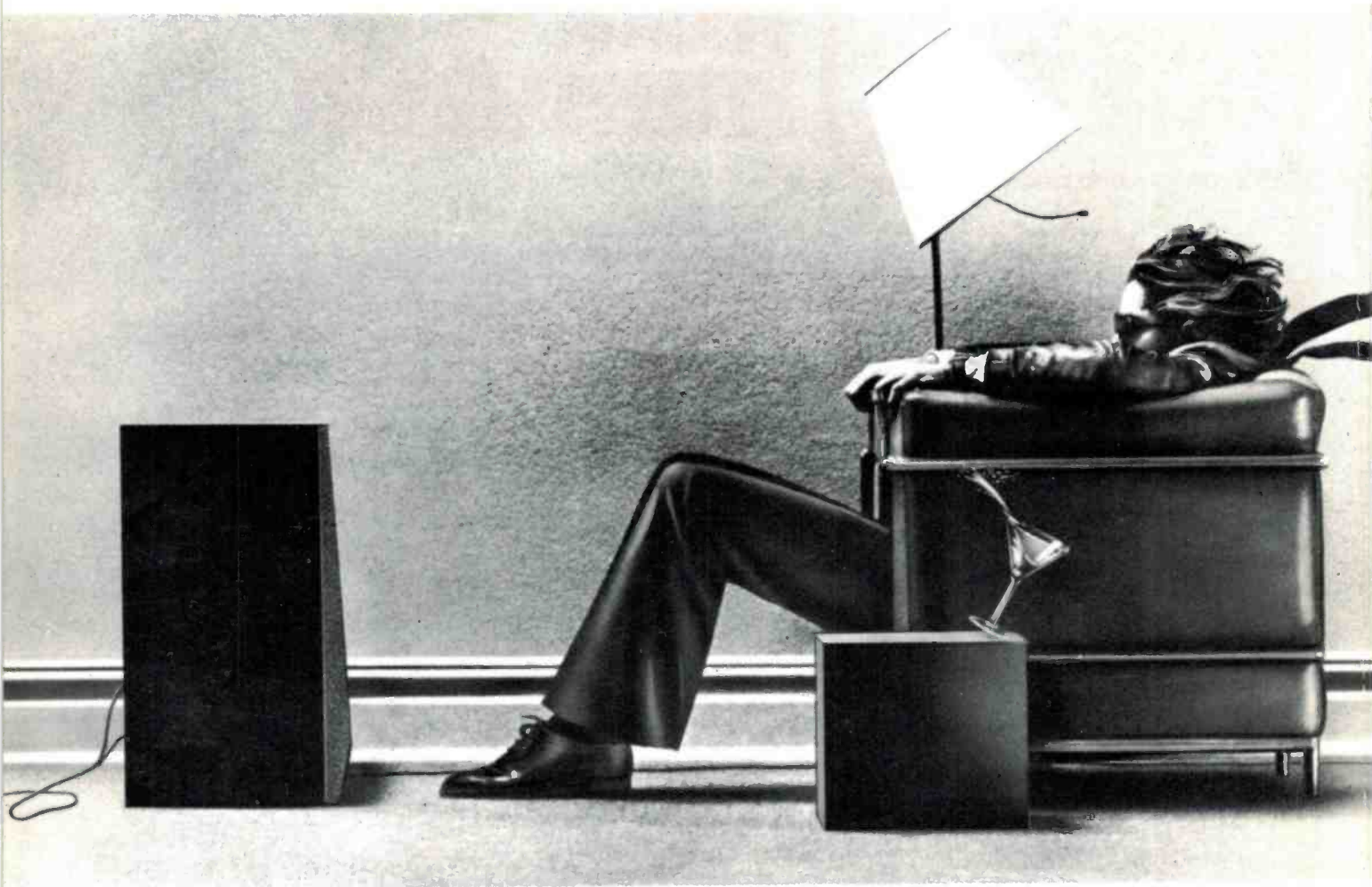

If your old favourites don't sound as good as they used to, the problem could be your recording tape.

Some tapes show their age more than others. And when a tape ages prematurely, the music on it does too.

What can happen is, the oxide particles that are bound onto tape loosen and fall off, taking some of your music with them.

At Maxell, we've developed a binding process that helps to prevent this. When oxide particles are bound onto our tape, they stay put. And so does your music.

So even after a Maxell recording is 500 plays old, you'll swear it's not a play over five.

Distributed by
HAGEMEYER

For further information on Maxell Tapes
write to Maxell Advisory Service,
P.O. Box 307, North Ryde, N.S.W. 2113



maxell[®]
simply excellent

WT191/80



ELECTRONICS TODAY INTERNATIONAL

Registered for posting as a publication —
Category B
ISSN No. 0013-5216

POLICE RADAR — POLICE TRAPPED?

THE NSW POLICE announced that they would be introducing the KR-11 radar speed trap into their Highway Patrol operations just as we went to press this month. In the March issue, our feature article by Jon Brereton examined the operation of the Digidar 1 units then in use and the KR-11, which the NSW Police were then trialling. That article examined the technical operation of both types of radar speed trap and detailed the possible modes of failure of each.

We think the introduction of the KR-11 is a step in the right direction, but not far enough. There is still a problem with the use of the unit in that it can record a 'violating' signal where the vehicle producing it is out of sight of the radar's operator. The KR-11 does a crude spectrum analysis of the returned signals. Jon Brereton says, "Since it searches down in frequency, it will always pick the fastest target whose return is strong enough to satisfy the sensitivity conditions. The long and the short of it all is that the KR-11 picks not the strongest ('nearest') return but that corresponding to the fastest vehicle... it has 'thrown away' some information, but the hope is that it has retained a more useful piece of information."

While that seems fairly straightforward, it's not foolproof. In the March feature article, we published a list of the measured radar cross-sections of some 15 vehicles, ranging from a Honda motorbike to a Kenworth truck. The tables showed that there is an enormous variation, even between vehicles of a similar size. Jon Brereton commented:

"For reliable operation the onus is on the policeman to pick out which car is the fastest, which may present difficulties when it is recalled that the difference in distance between vehicles returning signals just strong enough to activate the device may be a factor of around ten."

This may lead the radar operator to think that the vehicle he sees 100 metres away is speeding, when the radar is actually measuring the return from a speeding vehicle 1 km away!

That's the most drastic situation, admittedly, but it's by no means a remote possibility. Let's look more closely at the police's method of operation with the KR-11. We understand they propose to use KR-11s in the 'mobile operation' mode to measure the speed of vehicles approaching the patrol car on the opposite side of the road. In this mode the KR-11 uses a ground return signal to determine the patrol car's speed and then subtracts this from the target's apparent speed. The clear danger in this method of operation is that, as we have explained, the radar operator has to choose which car in his sight is the speeding vehicle, with the distinct possibility that he may not be able to see the vehicle actually causing the reading on the KR-11. Take the situation where a Peugeot 505, the only car in sight, travelling at 100 km/h — within the highway speed limit — is seen by the patrol car approaching at a distance of 300 metres. An Inter Acco truck around 600 metres away travelling at 120 km/h would cause the KR-11 to indicate a speed violation, as the ratio of the approaching radar cross-sections of the two vehicles is 10 (March issue, p.16), giving equal radar returns where the larger vehicle is twice as far away as the smaller. At a distance of 600 m the Inter Acco truck may be easily missed and the patrol car would mistakenly pursue and book the Peugeot 505. The NSW Police do not say how they intend to prevent such problems or avoid such situations.

Clearly, it is unfair to the motorist, but we must also point out that the NSW Police Department are being unfair to their members who operate the units — the fallibility of the KR-11 falls back on the police operator.

While the motorist who does not speed, yet is caught by circumstances similar to that described, is the prime loser, so are the police — especially if a number of motorists mount challenges in the courts, successful or not. Such litigation has already reduced public confidence in police radar operations. The KR-11, whilst a step in the right direction, does not remove the onus of proof from the operator when, with appropriately modified electronics, we are certain that it can. We feel that the innocent on both sides of the radar trap need not be trapped by the trap itself.

Roger Harrison
Editor



QUICK INDEX

FEATURES

- 8 Flat TV Tube, 19 mm Deep
- 14 Electrostatic Discharge Hazards
- 26 Seeking the Gluon
- 35 Liquid Crystal Displays
- 162 Dregs

PROJECTS & TECHNICAL

- 30 156: 100 MHz Instrument Probe
- 43 458: LED Level Display
- 53 155: Audio Dummy Loads
- 103 660: Learners' Microcomputer Pt.2
- 61 Lab Notes: Safety With CMOS
- 41 Short Circuits: CMOS Logic Probe
- 72 Ideas For Experimenters
- 79 Shoparound
- 159 Printed Circuit Board Artwork

COMPUTING TODAY

- 87 Experimental Dynamic RAM
- 90 Printout — News and Views
- 98 For Sorcerer Apprentices
- 103 A Learners' Microcomputer Pt.2
- 112 Talking Computers
- 119 Advanced BASIC
- 129 Fast Plotter for the TRS80

SIGHT & SOUND

- 137 Film and TV School Places
- 142 Optical Disc Recorders
- 148 Sanyo Plus 75 Receiver Review
- 154 Marantz' SM1000 Amp Reviewed

GENERAL

- 8 News Digest
- 77 Letters
- 82 Communications News
- 138 Sight & Sound News
- 160 Mini Mart — Readers' Adverts
- 161 ETI Services
- 68 Babani Books — Mail Order

advertisers

Altronics	65
A&R Sonar	66
Alfatron	96
Archive Computers	100
Applied Technology	102
Australian Govt.	25, 128
All Electronic Components	47
Audio Telex	117
AED	127
Anderson Digital	133
Arena	144
Acoustic Foundry	153
Ball & Howell	23
Best Vision	55
Bright Star	117
Bose	140
Cletronics	58
Commodore Aust.	86
Comp-Soft	89
City Personal	95
Convoy	109, 116, 139, 153, 157
C&K Electronics	27
Chadwick	56
Consolidated Mktg	134, 135
David Reid	67
Dave Ryall	70
Dick Smith	6, 24, 28, 29, 58, 60, 78, 83, 88, 93, 99, 110, 122, 132, 146
Danish Hi-Fi	56
Direct Computer Retail	111
deForest Software	123
Electromark	64
Energy Control	84
Elmeasco	7
Electro Med	34
Electronic Agencies	39
Elitronics	46
Elsama	58
Electrocraft	118
Electronic Calc. Discounts	125
Emona	64
G.F.S.	58
Hagemeyer	2, 163
Hitachi	150, 151
Jensen	74
Jaycar	13
Kit Parts	109
Looky Video	38
Lothlorien Farming	116
Logic Shop	123
M.J. Pratt	84
Micro 80	92
Meneta	106
MicroPro Design	23
Maurice Chapman	40
Microtrix	111
Magnetic Media Services	118
Microgear	130
Marantz	136
Nissim	70
North Point HI-Fi	34
Pre-Pak	71
P.A. Australia	52
Q.T. Computers	121
Royston	63
Radio Despatch	64
Radofin	164
Rod Irving	50, 51, 59, 73, 115
Radio Parts	118
S.I. Microcomputers	96
Software Source	58
Sony	141
Stanton	147
T.C.G.	85
T.C.T. Micro Design	106
Tandy	158
VSI	76, 81
Warburton Franki	101



**ELECTRONICS
TODAY
INTERNATIONAL**



COVER

The ETI-458 LED level meter up close! Photography and cover design by Ivy Hansen.

*Recommended retail price only.

features



ELECTROSTATIC DISCHARGE — NEMESIS OF ELECTRONIC SYSTEMS 14

Electrostatic hazards are present during manufacture, assembly and use of electronic equipment, and can cause permanent and drastic damage to components. This article reviews the nature of ESD and how to avoid it.

SEEKING THE GLUON 26

Are gluons the fundamental particles that hold everything together?



LIQUID CRYSTAL DISPLAYS 35

LCDs are widely used in such things as watches, digital instruments, computer displays, even pocket TVs. This article explains how they work.

news

NEWS DIGEST 8

'Picture-frame' TV with flat tube?; Discount on 465B oscilloscopes; 200 watt high power bass/P.A. bin kit; Another ETI contest to come; etc.

PRINTOUT 90

Vector Graphics' VIP reviewed; Club call; Local micro support products at US prices; Uncovering more of the Z80; etc.

COMMUNICATIONS NEWS 82

Updated Comni VHF receiver; The missing link; New FM transmitter from QEI; and more.

computing

COMPUTING TODAY 87

IBM makes experimental dynamic RAM circuits using simple polycide technology; Computerland to sell Commodore business machines.

TALKING COMPUTERS — NEW HOPE FOR THE BLIND 112

A voice generator recently developed by the USA's National Institute of Health should soon be opening up job opportunities for the blind in the computer and allied fields.

ADVANCED BASIC — PART 1 124

If you followed the previous series 'Back Door into BASIC', or picked up the rudiments of BASIC programming elsewhere, you're probably asking yourself: "Where do I go from here?" Phil Cohen's new series of articles on advanced BASIC will tell you.

projects



156: HI-Z INSTRUMENT PROBE 30

This probe will allow you to make CRO or frequency meter/timer measurements on high impedance circuits with waveforms having rise times as fast as three or four nanoseconds — and the cost is well below commercial equivalents.



458: LED LEVEL METER 43

This project is in fact the first part of the construction for the Series 5000 Control Preamp. However, the LED level meter described here is ideal for any application requiring a wide dynamic range level display. Naturally, two are required for stereo applications.

155: AUDIO DUMMY LOADS 53

Apart from a multimeter and perhaps an oscilloscope, a resistive dummy load of 4, 8 or 16 ohms impedance capable of dissipating up to 100 watts is just about the most useful item of test equipment the audio enthusiast could have. Here are several ways to build one.

660: LEARNERS' MICROCOMPUTER 103

This month we go into the 'architecture' of the micro-processor, an RCA CDP1802, detailing the functions of the various portions to gain an understanding of how our computer works.

sight & sound

SIGHT & SOUND NEWS 137

Film and TV School applications now invited; First trade audio exhibition; Selectavision under way, stereo TV to come, says RCA; etc.

OPTICAL DISC RECORDERS 142

The new technology of the digital disc 'played' by a laser pick-up must signal the eventual demise of the conventional record and turntable. Alan Concannon reviews the various applications and advantages of this revolutionary technology.

SANYO PLUS 75 RECEIVER REVIEW 148

Sanyo's new Plus 75 AM/FM stereo receiver is aimed at the higher end of the market, and according to Louis Challis its biggest 'plus' is that you can play it as loudly as if the rock band were in the room with you!



MARANTZ 'ESOTEC' SM1000 STEREO AMP REVIEW 154

Marantz' Esotec range has been designed to be the ultimate in hi-fi quality. The SM1000 amplifier lives up to that high standard, but you have to pay for such excellence!

general

SHORT CIRCUITS 41

CMOS logic probe

LAB NOTES 61

Safety with CMOS

ELECTRONICS BOOKS FROM ETI 68

Beginners' books, data books, circuit books, etc.

IDEAS FOR EXPERIMENTERS 72

'Broadcast booster' for AM band DXers; Meter for the ETI-560 mains cable seeker; Modification to ETI-640 VDU cures 'Interlace jitter'; etc.

LETTERS 77

SHOPAROUND 79

PCBs 159

MINI-MART 160

ETI SERVICES 161

DREGS 162

next month



TECHNICS' SB10 LOUDSPEAKERS

We first introduced readers to Technics' revolutionary 'Honeycomb Disc' drivers, and the SB range of speakers, back in the May '80 Issue and we have been hankering for some time to review the SB10s. What surprises will Louis Challis' spectral decay analysis have in store?

'CURRENT TRIP' CAR ALARM

Featuring entry/exit delay, this alarm uses the battery earth strap as a 'trip' sensor! It's easy to build and install, uses commonly available components, and does not suffer from false triggering problems.

LOGIC PULSER PROBE

Featuring five modes of operation — single pulse plus pulse trains of 1, 10, 100 and 1000 Hz — this versatile little test instrument can be fitted in a ball pen and may be used with CMOS or TTL circuitry. Mode selection is made by an ingenious touch switch and a seven-segment display indicates which mode you're in.

SERIES 5000 PREAMP — PART 1

To properly take advantage of the superlative performance of our widely acclaimed Series 5000 MOSFET Power Amplifier, David Tilbrook has designed a preamp/control unit to match. This article explains the philosophy and circuit techniques behind this top-line project. Features include a moving-coil cartridge preamp, two moving-magnet cartridge preamps, accurate RIAA compensation, a versatile tape monitor scheme, and the ETI-458 LED level meter for each channel.

Although these articles are in an advanced state of preparation, circumstances may affect the final content. However, we will make every attempt to include all features mentioned here.

FANTASTIC

MICROCOMPUTER KIT

MicroAce Build-it-yourself

- *Software compatible with the very popular ZX80
- *An ideal introduction to computer technology.
- *The world's lowest price computer.

Unique component parts

The MicroAce is not just another personal computer. Quite apart from its exceptionally low price, the MicroAce has two uniquely advanced components: the powerful BASIC Interpreter, and the simple teach yourself BASIC manual.

The unique versatile BASIC Interpreter offers remarkable programming advantages:

- **UNIQUE 'ONE-TOUCH' KEY WORD ENTRY:** the MicroAce eliminates a great deal of tiresome typing. Key words (RUN, PRINT, LIST, etc.) have their own single-key entry.
- **UNIQUE SYNTAX CHECK.** Only lines with correct syntax are accepted into programs. A cursor identifies errors immediately. This prevents entry of long and complicated programs with faults only discovered when you try to run them.



- **EXCELLENT STRING-HANDLING CAPABILITY**—takes up to 26 string variables of any length. All strings can undergo all relational tests (e.g. comparison). The MicroAce also has string input—to request a line of text when necessary. Strings do not need to be dimensioned.
- Up to 26 single dimension arrays.
- FOR/NEXT loops nested up to 26.
- Variable names of any length.
- BASIC language also handles full Boolean arithmetic, conditional expressions, etc.
- Exceptionally powerful edit facilities, allows modification of existing program lines.

Excellent value

For just \$199.00 you get everything you need to build a personal computer at home... PCB, with IC sockets for all ICs; case; leads for direct connection to a cassette recorder and television (black and white or colour); everything!

Yet the MicroAce really is a complete, powerful, full-facility computer, matching or surpassing other personal computers at several times the price.

The MicroAce is programmed in BASIC, and you can use it to do quite literally anything, from playing chess to managing a business.

The MicroAce is pleasantly straightforward to assemble, using a fine-tipped soldering iron. It immediately proves what a good job you've done: connect it to your TV... plug in a mains adaptor... and you're ready to go.

Fewer chips, compact design

The MicroAce owes its remarkable low price to its remarkable design: the whole system is packed on to fewer, newer, more powerful and advanced LSI chips. A single SUPER ROM, for instance, contains the BASIC interpreter, the character set, operating system, and monitor. And the MicroAce 1K byte RAM (EXPANDABLE TO 2K ON BOARD) is roughly equivalent to 4K bytes in a conventional computer—typically storing 100 lines of BASIC. (Key words occupy only a single byte.)

ACCESSORIES TO MAKE YOUR MICROACE EVEN MORE VERSATILE.

Video Modulator to use your MICROACE on TVs with VHF tuner
Cat: K 6040 **\$4.95**

Dick Smith Plug Pack.
9V 600mA Cat: M 9560 **\$12.95**

Cassette recorder 'National' brand to load and save programs Cat: A 4095 **\$79.95**

Expansion kit to 2K of RAM
Cat: K 6501 **\$9.95**

YES! THE MICROACE CAN BE EXPANDED TO 2K—ON BOARD!!



INCLUDES

- P.C. Board with IC Sockets for all ICs.
- All components supplied.
- New, wipe clean, touch sensitive keyboard.
- Stylish moulded case.
- Leads and Plugs. (For cassette and TV connection)
- Free BASIC programming book-course.
- Coaxial TV antenna connection switch.

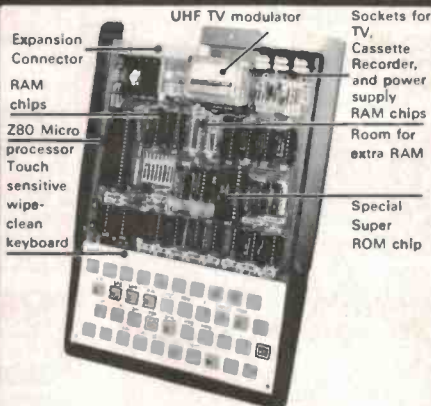

Teach yourself

If the features of the BASIC interpreter mean little to you—don't worry. They're all explained in the specially written book *free* with every kit! The book makes learning easy, exciting and enjoyable, and represents a complete course in BASIC programming—from first principles to complex programs.

A hardware manual is also included with every kit.



EXCLUSIVE TO DICK SMITH STORES

SEE OUR OTHER ADVERTS FOR STORE ADDRESSES.
Available by mail order
(P. & P. \$5.50 from P.O. Box 321, North Ryde)



EXCLUSIVE
'Sorry Dick it doesn't work'
return coupon: even if you
can't get it going, we will
correct your problems
for a service fee.

Facts from Fluke on low-cost digital multimeters.

The 8020A Analyst.

People who know electronic test and measurement equipment throughout the world recognize Fluke as a leader in the design and manufacture of precision instrumentation — products that speak for themselves in accuracy, reliability and engineering excellence.

Now users of handheld 3½-digit multimeters are also getting to know us because of the wide acceptance of the 8020A Analyst, the world's best-selling handheld DMM, and the 8022A Troubleshooter, our basic-performance multimeter.

With the addition of the 8024A Investigator to the Fluke low-cost DMM line, we now offer three choices with three distinct levels of performance:

basic voltage/current/resistance functions; the added convenience of conductance for high resistance measurements to 10,000 Megohms; or all these functions plus K-type thermocouple compatibility, peak hold and a logic level/continuity detector.

As a product family, the Troubleshooter, Analyst and Investigator offer a unique combination of electrical performance, mechanical ruggedness and environmental endurance to users who want the convenience



Model 8020A:
The Analyst

- Seven functions
dc voltage
ac voltage
dc current
ac current
resistance
diode test
conductance (1/R)
- 3½-digit resolution
- 0.1% basic dc accuracy
- LCD display
- Overload protection
- Safety-designed test leads

of a handheld DMM without sacrificing the accuracy and performance of a benchtop instrument.

Simple, straightforward and easy on the eyes.

We've always thought a handheld DMM should actually *work* like one — that is, the size and shape and placement of controls should allow true one-hand operation.

Fluke handheld DMM's are strikingly simple in design with uncluttered front panels

where function and range combinations are clearly defined by color coding. A single row of eight trouble-free push-buttons replaces the awkward rotary switches still offered on other multimeters.

The crisp, razor-sharp 3½-digit LCD readout in these three instruments features a wide viewing angle that you can see in bright sunshine or low ambient light.

Graduated with honors from the school of hard knocks.

All Fluke handheld DMM's feature tough, lightweight cases that stand up to the abuses of life in the field. Sturdy internal construction surrounded by a high-impact, flame-retardant shell make these units virtually indestructible. And all meet severe shock/vibration tests.

The shocking truth about overloading.

Like all Fluke Multimeters, our handheld DMM's are equipped with extensive internal protection against overloads and operator errors. Don't worry if you accidentally plug the test leads of

your Fluke DMM into a wall outlet while the instrument is in the resistance function. The same test could destroy a multimeter with lesser defenses. But a Fluke DMM comes through with flying colors. A simple case of survival of the fittest.

Our DMM's can stand up to this kind of punishment because a substantial portion of their components are devoted exclusively to reliability. The 8020A, 8022A and 8024A can withstand 500V on resistance ranges, and 1000V dc and 750 rms ac on all voltage ranges.

In addition, the instrument is protected against transients to 6 kV.



FLUKE®

The 8022A Trouble shooter.

Model 8022A:
The Troubleshooter

- Six functions
dc voltage
ac voltage
dc current
ac current
resistance
diode test
- 3½-digit resolution
- 0.25% basic dc accuracy
- LCD display
- Overload protection
- Safety-designed test leads



The 8024A Investigator.

Model 8024A:
The Investigator

- Nine functions
dc voltage
ac voltage
dc current
ac current
resistance
diode test
conductance (1/R)
logic level and continuity detect
temperature (K-type thermocouple)
- Peak hold on voltage and current functions
- Selectable audible indicator for continuity or level detection
- 3½-digit resolution
- 0.1% basic dc accuracy
- LCD display
- Overload protection
- Safety-designed test leads



ELMEASCO
Instruments Pty. Ltd.

P.O. Box 30, Concord, NSW, 2137
13-15 McDonald St., Mortlake, NSW, 2137
Phone: (02) 736-2888, Telex: 25887

P.O. Box 107, Mt. Waverley, Vic. 3149
21-23 Anthony Drive, Mt. Waverley, Vic. 3149
Phone: (03) 233-4044, Telex: 36206

Adelaide: (08) 271-1839
Brisbane: (07) 229-3161
Perth: (09) 398-3362

Flat tube is key to "hanging picture" TV

The long-awaited flat tube television which will eventually hang on the wall like a picture is to go into production next year.



Clive Sinclair has finally produced his long-time 'dream', a tiny, portable, go-anywhere-in-the-world TV receiver. It is built around his flat screen cathode ray tube — which has much wider application if development continues.

AWA and Hughes in joint bid

Amalgamated Wireless (Australasia) Ltd and Hughes Aircraft of the USA recently announced that they are completing negotiations to form a team that will submit proposals to the Australian Government for the supply of satellite ground terminals.

AWA, with its Australian resources, would apply Hughes' technology to provide local Australian manufacturer support and engineering services.

Hughes' successful satellite system activity world-wide must place it in a strong position to bid competitively for an Australian system, and AWA, who established commercial beam wireless communications between Australia and Europe in 1927, are now aspiring to a major role in the new satellite system.

Sinclair Research Ltd (SRL), of Cambridge in eastern England, has announced the successful completion of a five-year research and development programme on a flat TV tube that is just 19 mm deep.

First use of the revolutionary tube will be in a new pocket TV and FM radio that will sell for around \$100 when it is introduced next year. The 'Microvision' set will be produced in a highly automated plant at the Dundee, Scotland, factory of the Timex watch corporation.

The first phase of a \$10 million four-year capital investment programme will cover the establishment of an advanced manufacturing facility at Dundee that will employ 250 people next year and be able to produce a million flat tubes a year.

By 1985, 1000 people will be working at an expanded plant that will have a capacity to make several million tubes.

Although the final design of the actual set has not been agreed it will measure just 152 x 101 x 25 mm. It will thus be about the size of a typical paperback book and easy to carry in the pocket.

The set, with its 76 mm diameter screen and total weight of little more than 100 grammes, will be able to operate to the transmission standards of most parts of the world. (The exception at present is the French standard).

Mr Clive Sinclair, founder of Sinclair Research, says a number of technical advances have been achieved in the development of flat screen TV tubes. These include perfection of a new method of vacuum forming glassware, a volume

reduction of two and a half times over the size of a conventional tube, while the tube is brighter than normal and needs less power to operate it. The TV set will run on transistor radio batteries.

Sinclair Research chose to have the new tube and sets made alongside each other in Scotland after an international search for a manufacturing base. One other location seriously considered was Hong Kong.

Mr Sinclair says all the development work on the tube, set and automated machines needed to produce them has now been completed and if the target production rates to be introduced in a year's time are met, the number of minutes needed to produce a set will be the fastest yet achieved anywhere. A pilot plant in Cambridge has already been producing flat screen tubes for the past 18 months at the rate of up to 50 a day.

The Microvision pocket set, however, is just an example of things to come, predicts the Sinclair chief. He says the basic flat tube can easily be modified for projection TV systems and he foresees the day when three small tubes will be used in a giant 1.27 metre diagonal screen full-colour projection TV that will hang on the wall.

The optics and electronics for it would fit into a shoebox-size unit that would be mounted above the screen to project the pictures onto it.

The flat tube might also be linked up to the Sinclair personal computer to give it a new visual dimension and together they could be used as a personal mobile teletext unit.



CSIRO help the handicapped

The CSIRO Division of Manufacturing Technology in Adelaide has developed an automated microfiche reader which allows severely immobilised people or those with impaired manual skills to read books by using simple touch controls.

The device is to be launched on the commercial market by R.W. Bowman Manufacturing Pty Ltd.

Some people, because of physical handicaps, cannot use conventional microfiche readers as they require some manual skill to move cards in and out and select a particular page. The automated reader incorporates a microprocessor electronic control and allows such people to use a conventional machine through simple touch controls.

LCD work wins award

UK Professor Cyril Hilsum has received the American 1981 David Sarnoff Award of the US Institute of Electrical and Electronics Engineers for his work in the development of a range of superior liquid crystals for use in digital watches and calculators.

Prof. Hilsum has co-ordinated the UK research as LCDs, and he expects further programme on flat panel electronic displays, which has given that country a leading position in liquid crystal applications as flat-screen materials.

Prof. Hilsum has a back-

ground in infrared and semiconductor research as well as research and development to produce new types giving even higher performance for such applications as flat-screen displays that will be needed for both defence and civil purposes.

Silicon still has it over GaAs . . .

That's the consensus of proponents of both who gathered at the first High Speed Digital Technologies Conference in San Diego, California, in January.

Although advances in GaAs technology are coming quickly, advances in silicon technology will continue to keep it ahead, delegates agreed.

Although Bell Laboratories and TRW, among others, are developing GaAs technology, both reported work on silicon integrated circuits. There were, of course, advances reported in GaAs technology from, for example, Fujitsu and Rockwell International.

Designers of communications systems may look longingly at gallium arsenide, but they're settling for silicon. Reliability, ease of manufacturing and better integration levels give it the edge over faster but difficult GaAs as the mainstay material for high-speed digital circuitry for the foreseeable future.

The reliability of silicon was a major factor in Bell Labs' choice of bipolar technology for a signal regenerator for a trans-oceanic fibre-optic cable to be installed in 1988.

"No one knows anything about gallium arsenide's reliability level for what we need," says David Ross, an engineer at

the undersea light-wave systems development department.

Researchers are giving considerable attention to improving the densities of GaAs ICs, and Rockwell International Corp's Electronics Research Centre in Thousand Oaks, California, reported on its 8-by-8-bit multiplier that puts more than a thousand gates on a chip.

Meanwhile the hottest news at March's International Electron Devices Meeting in Washington, USA, may well be that silicon can compete very effectively with gallium arsenide in the processing of high-speed integrated circuits.

Researchers at American Telephone & Telegraph Corp's Bell Laboratories in Murray Hill, New Jersey, have succeeded in producing a MOS ring oscillator with one micrometre line widths that will operate at 40 picoseconds!

They have also devised a 2.5 GHz divide-by-eight counter.

Plans are to take this technology into the large-scale and very large-scale integration arenas for memories and logic as soon as possible.

. . . But GaAs device price to drop?

Scientists at the Massachusetts Institute of Technology's Lincoln Laboratory in Lexington, Mass., have developed a technique that may greatly reduce the cost of gallium arsenide semiconductor material.

It might also make possible new sorts of integrated circuits substrate, creating a thin slab of high-quality crystal.

With thin, single-crystal films on insulating substrates, or in multiple layers, according to its developers.

Called Cleft (cleavage of lateral epitaxial films for transfer), the approach uses — and reuses — a GaAs substrate that is bonded to glass. Single-crystal GaAs is grown on this substrate through vapour-phase epitaxy and then cleaved parallel to the plane of the

The same substrate is used repeatedly to grow slabs 5 to 10 μm thick and comparable in their electrical characteristics with melt-grown GaAs.

With Cleft, the usual GaAs substrate, typically 250 to 400 μm thick, is unnecessary, saving all but a few per cent of the GaAs normally needed for a solar cell or IC and therefore drastically cutting cost.



Another great contest coming!

Thousands of readers so enjoyed the contests we have run over the past year that we have received many requests for more and next issue your wishes will be granted!

Radofin Electronics (Aust.) have offered one of their Adam 180 Teletext adaptors, which we ran a news item about on these pages in the April issue, as a contest prize.

To refresh your memory, the Adam 180 adaptor is an add-on unit that can be used with any colour or B&W TV set and features both VHF and UHF input, Teletext at the touch of a button, Teletext superimposed over normal TV reception, double height characters, clock and controller, subtitle and newsflash capability, handheld remote control unit and 12 months' warranty.



Teletext broadcasts contain information on weather, traffic, TAB results, share prices, currency rates, food prices, theatre, travel etc. The retail value of the Adam 180 is \$575. It's going to be a great contest, and remember — you've got to be in it to win it! Don't miss the July issue of ETI.

Lightweight 50 MHz oscilloscope

The Iwatsu SS3510 Service Oscilloscope has recently become available from Tech-Rentals Pty Ltd.

The SS3510 is a compact, lightweight, full specification 50 MHz oscilloscope with dual trace and delayed sweep. It is suitable for use with advanced electronic equipment, yet its size and portability are said to make it ideal for situations such as field service and commissioning, where a large oscilloscope would not be practicable.

The Iwatsu SS3510 is priced at \$1795 plus tax and comes complete with probes, viewing hood, leatherette cover and a full operating and service manual. It is also available for rental or on a rental/purchase plan.

Tech-Rentals also recently re-

leased their 1981 rental catalogue, which lists over 300 different types of equipment plus specifications from the world's leading manufacturers. This equipment is available for short- or long-term rental with purchase option. Equipment listed includes oscilloscopes, logic analysers, digital multimeters, spectrum analysers, chart recorders, data loggers, signal generators, sound level meters and computer terminals.

Tech-Rentals Pty Ltd can be contacted at 83-87 Wellington St, Windsor Vic. 3181, (03) 51-1303, and at 68 Alexander St, Crows Nest NSW 2065.

Static protection — questions and answers

The Charleswater organisation, which specialises in static protection of electronic devices, has prepared a four page publication on the subject, in question and answer form, available from their Australian distributor, Royston Electronics.

What is static protection all about? And why has it become of such great interest in the last two years?

Static Protection refers to protection of discrete devices, such as CMOS and MOS integrated circuits, from burn out or degradation due to static electricity — see the feature article in this issue.

Static protection has become of great interest because of the increasing need for higher circuit densities in microelectronic components, and the use of MOS technology. While the use of MOS technology results in a device which has greater circuit density and lower costs per unit, the penalty is increased sensitivity to electrostatic discharge.

Even with the addition of MOS devices the output is left unprotected and therefore is

sensitive to static discharge damage.

The great interest generated in recent years is due to the rapidly expanding use of such devices, growing at the rate of fifty to sixty per cent per year.

An example from the wide range of Charleswater static protection products, marketed under the brand name STATFREE, is the CP302 conductive nylon bag. This is designed for packaging static sensitive materials such as CMOS, MOS and printed circuit boards.

Information on this and other static protection products, and copies of the publication, are available from Royston Electronics, 27 Normanby Road, Notting Hill, Vic 3149, (03)543-5122; and 15/59 Moxon Road, Punchbowl, NSW 2196. (02) 709-5293.

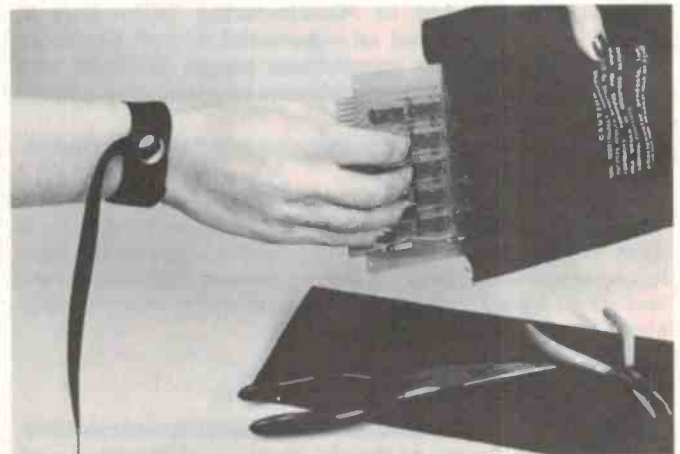

New shapes in LEDs

Four new shapes of Philips' LEDs are now available: plus, minus, triangle and square.

Each shape can be obtained in three colours — 'super-red', green and yellow, designated CQX55-58 (super-red), CQX65-68 (green) and CQX75-78 (yellow). Luminosity is 1 mcd at 10 mA, and the LEDs

have a body diameter of 5 mm and incorporate a lens.

For further details contact Philips Electronic Components and Materials, 67 Mars Rd, Lane Cove NSW 2066. (02) 427-0888.

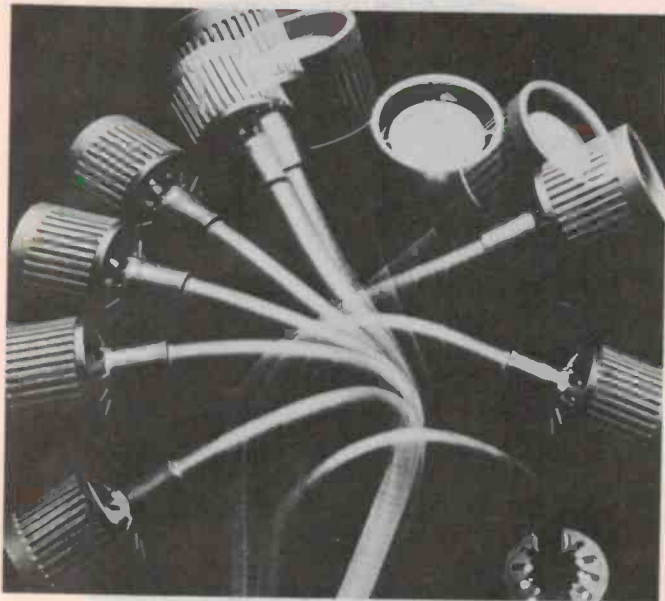

Low-voltage work lamp

The halogen bulb of this 12 V lamp only draws 20 W, yet has an output of 4400 lux at 40 cm, compared to only 850 lux from a standard 80 W bulb at that distance, making it ideal for work which requires intense light.

The rubber-sleeved flexible arm can be adjusted through 360° vertically or horizontally, and the lamp housing is small so as not to obstruct the work area. The lamp base has a switch and can be supplied in various mounting forms: screw on, C-clamp, magnetic, table base.

Contact Consolidated Ultrasonics (A'asia) Pty Ltd, 77 Allen St, Leichhardt NSW 2040, (02) 569-5022, for catalogue and further information.



Headhunting among the kit managers



Mr. Denis Fanna has been appointed manager of Bill Edge's Electronic Agencies' newly-formed kit department.

Denis has diplomas in Radio and TV servicing and comes to Electronic Agencies from the Dick Smith stable where he spent two years in the kit section.

Bill Edge boasts, "With the expertise of Denis and some great ideas we have, our kits will soon be the best in Australia."

Electronics Today Limited

It has been brought to our attention that a company in Britain has been trading under the title 'Electronics Today Limited'.

'Electronics Today Limited' has not now, nor has ever had, any connection of any sort with this magazine, nor with any other edition of Electronics Today International. If any Australian readers or companies have had dealings with Electronics Today Limited they may find it to their advantage to telephone ETI's Managing Editor (Collyn Rivers) on (02)33-4282.

New displays now available

Following the recent association between C & K of Australia and The Staver Co. Inc. of America, a range of numeric/alphanumeric displays is available under the American trade name "Signalex".

The displays, predominantly seven-segment numeric, range in size from 40 mm (1½") high to a giant 610 mm (24") high. They offer bistable electromagnetic operation and draw no power except when changing.

Seven display sizes form the range, offering white vanes on matt black background as standard with some "Dayglow" colours as optional. Operating voltage of 12 volts dc is standard, although other voltages can be made to order.

These devices find application in time and temperature signs, price signs, scoreboards,

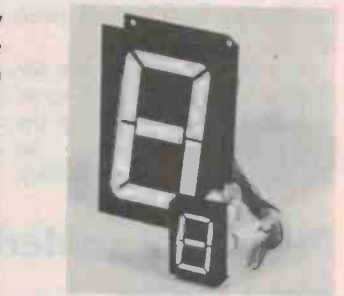

electronic scales, petrol pumps, traffic controls, clocks, etc.

For further information please contact C & K Electronics (Aust.) Pty Ltd, P.O. Box 101, Merrylands NSW 2160. (02)682-3144.

C & K switch catalogue

C & K of America have just released a new, greatly expanded switch catalogue, outlining the total range of electro-mechanical switching devices they manufacture.

The range of more than 1 000 000 switches has been even further expanded, and C & K factories are now operating in Hong Kong and England in order to maintain the same level of service throughout the world. The catalogue contains 71 pages and is available free of charge from C & K Electronics (Aust.) Pty Ltd, P.O. Box 101, Merrylands NSW 2160. (02) 682-3144.

Discount on 465B oscilloscopes

Tektronix recently announced a major discount on the range of 465B, 100 MHz oscilloscopes, claimed to be one of the most popular 100 MHz scopes in Australia with close to 1000 units currently in use.

The discount is due to overstocking, and Tektronix want to clear their supply before the end of the financial year.

The selling price has been reduced by \$400 to \$3150 plus sales tax, until current stocks are cleared.

Features of the 465B are:

- 100 MHz at 5 mV/div.
- 2 ns/div. sweep rate with x10 sweep magnifier
- Trigger view
- Versatile trigger selection
- Alternate sweep

For further information contact your local Tektronix sales office.

200 watt 'bin' kit

In response to a strong demand, Jaycar has produced a high power bass/P.A. bin suitable for pop groups, discos and other applications requiring high power sound systems.

The bass-reflex enclosure measuring 590 mm wide x 390 mm deep x 730 mm high, features a massive 18" (457 mm) diameter bass driver conservatively rated at 200 watts RMS. This unit is made in England by the well-known Celestion organisation. The top end of the system is handled by two Motorola piezo horns.

To keep the cost down the system is available in kit form. The kit, (shown built-up in the illustration) includes all speakers, pre-cut cabinetry,

Canon connector, corner pieces, heavy duty feet, grille, screws etc. The handles and carpet covering are available if necessary at a small extra cost.

The cost of the kit is \$495 including tax. This price represents a considerable saving on commercial built-up units. The illustration shows black mesh grille removed for clarity.

For further information contact Gary Johnston or Lyndsay Clout at Jaycar, 380 Sussex St, Sydney 2000 NSW. (02) 264-6688.



Miniature soldering station from Weller

The WMCP-EC miniature soldering station was recently released by the Cooper Tool Group under the Weller brand of soldering equipment.

Eight miniature soldering tips are available, and the station is said to be ideally suited to microcircuit technicians, watch-makers and other users requiring precise micro-soldering.

The WMCP-EC features a completely new concept in temperature control. A sensor acting as a transducer transmits the actual tip temperature

to an evaluator. The working temperature is continuously variable between 40° and 450°, with the set temperature automatically maintained within a tolerance range of $\pm 2^\circ\text{C}$.

For further information contact a Weller distributor or the Albury Sales Office of the Cooper Tool Group, P.O. Box 366, Albury NSW 2640. (060) 21-6766.

Bang, bang, you're soldered?

No, it's not the new silmline western six-shooter and holster — Scope Laboratories of Melbourne recently released a new version of their 60 W rechargeable portable soldering iron.

A green LED indicator at the rear of the tool warns when the unit needs recharging, and internal circuitry changes have reversed polarity for greater safety when recharging from dc in a vehicle.

The standard leather holster has also been upgraded to provide greater protection from residual heat and the relatively sharp profile of some tips.

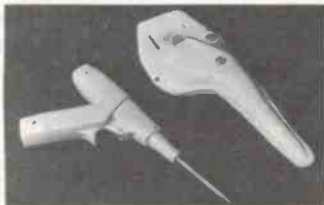

Further information can be obtained from Scope Laboratories, P.O. Box 63, Niddrie Vic. 3042. (03)338-1566.

New NiCad battery charger

The PS519 Universal Nickel-Cadmium Battery Charger from A & R Electronics, marketed under the Arlec brand, incorporates a number of novel features.

It will accept a total of five batteries of varying sizes, and above each battery position is a LED which lights during charging, providing an instant check that the battery is correctly connected. There is also a battery testing facility. Charging

power is from 240 V 50 Hz ac mains through an Arlec plug pack ac adaptor. Further details are available from A & R Electronics Pty Ltd, 30 Lexton Rd, Box Hill Vic. 3128. (03)89-0661.

High-voltage electrolytics

Philips has developed several new series of electrolytics for use in high-voltage circuits such as in televisions, monitors, etc.

041/042/043 are complementary series, the 041 being general purpose types with a capacitance range from 1 uF (385 V) to 22 uF (160 V), and the 042 and 043 being long-life types ranging from 10 uF (385 V) to 100 uF (160 V).

The 052 series is an extension of the 050 series and includes long-life types ranging from 47 uF (385 V) to 1000 uF (250 V).

For more information contact Philips Electronic Components and Materials, 67 Mars Rd, Lane Cove NSW 2066. (02) 427-0888.

Short-form catalogue from Swann

Swann Electronics' detailed short-form catalogue has recently been released to assist all manufacturers with their switch and neon indicator design and applications.

Swann manufacture the largest range of appliance and lighting switches in the Southern Hemisphere. If you would like a copy of this catalogue, contact Swann Electronics Pty Ltd, P.O. Box 350, Mt Waverley Vic. 3148.

JAYCAR — YOUR No. 1 SOURCE FOR KITS

Audio enthusiasts — you have not been forgotten. We now have a fantastic range of audio kits for most applications.

Here is a selection of the fine range of kits available from us:—

Amplifiers:

ETI 480/100 (See ETI Dec. 1976)

Complete 100W RMS Amp including deluxe anodised cabinet, handles, connectors, etc. Built for heavy road use. Very popular as slave or main amp. \$130.00

ETI 480/100 Preamp

All componentry to build unit for 2 x Guitar or mic. inputs. Has separate level controls, Bass, Treble and Master Vol. Control. Can be built into ETI 480/100 case above. \$30.00

Both of the above make one of the most popular road amps in use today.

ETI 480/50 watt module \$23.00

ETI 480/100 watt module \$27.00

(Please do not compare these modules with other inferior modules) Ours have special heavy gauge pre-punched heatsink brackets — essential for high power use.)

ETI 466 300W AMP MODULE (ETI Feb. 1980)

Rugged 300W RMS Amplifier module which has become the "Industry Standard". The Jaycar module has been especially reconfigured so that it will fit vertically into a standard 5 1/4" rack box. Don't be misled by others, theirs is too wide for vertical insertion into a standard rack box. The Jaycar module has not been altered electrically in any way from the original design. \$70.00

JAYCAR 3002 (2 x 300 watt RMS Amp).

This magnificent kit features 2 x 466 modules in a specially built 19" rack case, Dual power supplies and Philips 65D heatsinks (the best). The number of 3002's now built & giving reliable service on the road is growing daily. Around half the price of built-up commercial units. \$489.00 Complete down to the last nut and bolt.

\$489.00 plus \$20.00 freight.

KEYBOARD INSTRUMENTS

Jaycar 88-note touch sensitive Piano. Complete kit including professional 7 1/4 octave keyboard, built-up cabinet, etc., only \$589.00 plus \$25.00 sent anywhere in Australia.

Jaycar String Synthesiser, four octave C to C (49 note) split keyboard, transposable pitches. C-B-Bb-Eb. Complete Kit contains all cabinetry, components, etc. \$445.00 plus \$20.00 freight.

Keyboard Special! Kimber-Allen

61-note keyboards. Can be used in the E.A. 760 Electronic Organ (Ref. E.A. June '76). Professional English made keyboards at a crazy price, only \$99.00 each, plus \$15.00

Ideal for organs, synthesisers, or any electronic keyboard experimental work.

E. A. Graphic Analyser Kit (E. A. March '81)

Complete kit of parts including transformer, modulator, Xtal front panel, etc. \$89.00
Colour Option \$20.00
Horwood Box to suit \$14.50

E.T.I. 477 Mosfet Amp Module (E.T.I. Jan-March '81)

Complete kit including high voltage Hitachi Mosfets, fibreglass P.C.B., pre wound coil, etc. \$59.00
Cast front panel \$39.50
Power Transformer \$34.50
Other components for 5000 amp available.

"Le Gong" Kit (Refer E. A. March '81) \$13.95

"P. C. Birdies" Kit (Refer E. A. May '81) only \$14.95
Contains all parts, including Jiffy Box, I.C., P.C.B. etc.

2 Channel Infrared Remote Control Kit (Refer E. A. May '81) Complete kit of parts \$65.00

Sound Level Meter Kit (Refer E. A. May '81) Complete kit of parts for this project including high quality electret mic insert. \$39.50

P.C.B.'s for many other current projects available.

UHF Masthead Amp Kit (Refer E.T.I. April '81) Complete kit of parts including fibreglass boards, OM350, power supply, etc. only \$35.00

P&P CHARGES:

ORDER VALUE	CHARGES
\$ 5 - \$9.99	\$1.00
\$ 10 - \$24.99	\$2.00
\$ 25 - \$49.99	\$3.00
\$ 50 - \$99.99	\$4.00
\$100 or more	\$5.00

Jaycar

Shop Hours:

Mon - Sun -
9AM - 5.30PM



380 Sussex St Sydney 2000. Ph 264 6688

Electrostatic discharge — nemesis of electronic systems

D.E. Frank

Electrostatic hazards to electronic equipment are known to be present at manufacturing facilities during the assembly and testing of electronic systems as well as during shipment and handling at the user's facilities. In order to protect these systems, it is necessary to understand the nature of electrostatic discharge (ESD), how it is generated, and how it is transmitted to electrostatic discharge sensitive (ESDS) components. Additionally, it is necessary to understand which parts are ESDS, how they are damaged, and the subsequent effect on the respective system.

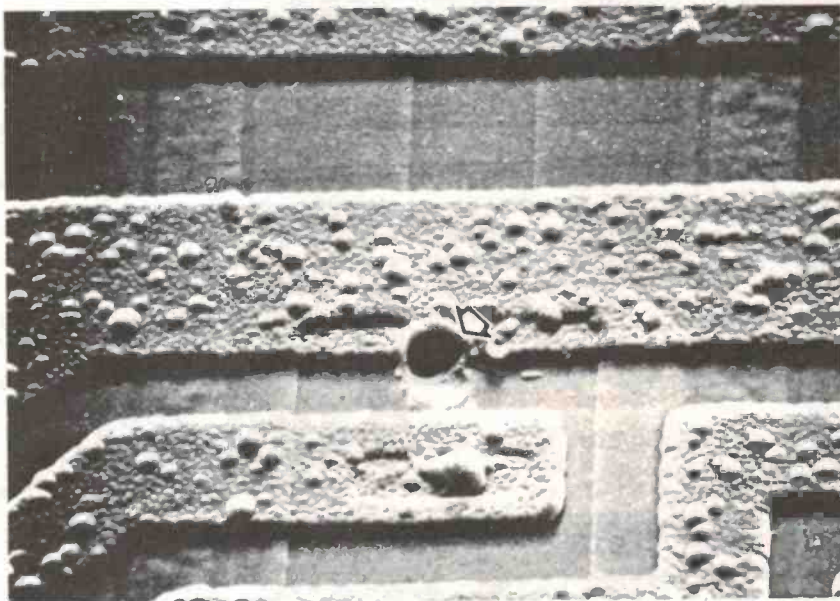

Close up view (x1000) of electrostatic damage in an op-amp. (See the series of pictures on pages 16-17).

What is ESD?

OUR MOST common conception of electrostatic discharge is the miniature lightning bolt or shock we receive in periods of low humidity when we walk across a carpet or slide across vinyl seatcovers and then discharge to a door knob or door handle. In essence, however, most static electricity is subliminal or occurs at values well below our perception level of 1500 to 2000 volts.

Static electricity is generated whenever two substances are rubbed together, separated, or flow relative to one another (such as a gas or liquid over a solid). This static electricity (electrical charge at rest) is stored on non-conductive materials and tends to remain in the localized area of contact

This article is reprinted with permission from Douglas Service magazine, Volume XXXVII, July/August 1980.

awaiting the opportunity to discharge to the first available ground source. In the case of conductive materials, the charge is rapidly distributed over the entire surface and the surface of other conductors which come in contact.

The Triboelectric Series (Table 1) shows the charge relationships of many materials. Note that cotton is identified as a reference material, being at mid-point of Table 1. It tends to absorb moisture, thereby rendering it somewhat conductive. However, when cotton is rubbed against another material, it has the ability to produce a static charge.

Materials listed above cotton tend to assume a positive charge by giving off electrons in a friction separation situation, while those listed below cotton become negatively charged by acquiring electrons. When any two materials experience separation or rubbing, the

material listed highest on the table will become positively charged, and the material listed lower will accept the negative charge.

For the sake of simplicity, let us define the cause of common static as the flow of materials and people within an environment. Materials include all components, packaging, and other raw materials which make up our finished product. People carry and generate charges, and it all takes place within a defined environment made up of facilities and equipment. The environment is not limited to a plant, but can be defined as a package, or many plants as in a transport situation.

Static, as it manifests itself in our environment, is actually a symptom. If we can impose control on the elements which create static as an end result, we can control the generation of a myriad of problems caused by static.

It is the author's intent to present an understanding of ESD, to explain how various materials and situations generate ESD, and to discuss ESD sensitive devices in depth. In the discussion of ESD sensitive devices, an effort has been made to present a thorough "physics of failure" analysis to provide insight into the design and structure of ESD sensitive devices as well as the failure modes and effects. Those individuals not desiring an in-depth technical treatise may review Tables 2 and 3, and also the discussion in paragraphs entitled "Detecting ESD Damage" and "Protecting Your Equipment".

ESDS devices

Typical ESD voltages are shown in Table 2, and the ranges of susceptibility of ESDS devices are shown in Table 3. Parts of devices can be destroyed (hard failures) or simply degraded or made intermittent (soft or upset failures) due to exposure to electrostatic discharge. Parts are susceptible to damage when an ESD occurs across their terminals. ESDS parts can be destroyed by an ESD where one pin is connected to a high voltage source and other pins are ungrounded. In other words, a hard ground connection is not required to destroy an ESDS part.

MOS large scale integration devices in hermetic packages with non-conductive lids could be damaged by

MATERIALS		
AIR	↑ Increasingly Positive	
HUMAN HANDS		
ASBESTOS		
RABBIT FUR		
GLASS		
MICA		
HUMAN HAIR		
NYLON		
WOOL		
FUR		
LEAD		
SILK		
ALUMINUM		
PAPER		
COTTON		
STEEL		↓ Increasingly Negative
WOOD		
AMBER		
SEALING WAX		
HARD RUBBER		
NICKEL COPPER		
BRASS SILVER		
GOLD PLATINUM		
SULFUR		
ACETATE RAYON		
POLYESTER		
CELLULOID		
ORLON		
SARAN		
POLYURETHANE		
POLYETHYLENE		
POLYPROPYLENE		
PVC (vinyl)		
KEL-F (CTFE)		
SILICON		
TEFLON		

Table 1. Triboelectric series

Means of Static Generation	Electrostatic Voltages	
	10 to 20%	65 to 90%
	Relative Humidity	Relative Humidity
Walking across carpet	35 000	1 500
Walking over vinyl floor	12 000	250
Worker at bench	6 000	100
Vinyl envelopes for work instructions	7 000	600
Common poly bag picked up from bench	20 000	1 200
Work chair padded with polyurethane foam	18 000	1 500

Ref. U.S. Department of Defense DOD-HDBK-263 (tables III and IV) 2 May, 1980.

Table 2. Typical electrostatic voltages

spraying the lids with canned coolant, despite there being no ground path connected to the part.

ESDS parts installed in assemblies normally have their leads connected to a sufficient mass of conductive material, such as printed circuit board (pcb) runs and wiring, which may provide the required ground to result in damage from an ESD. In such cases, however, the voltages required are normally higher than those needed when one or more pins or the part case is grounded.

Assemblies and equipment containing ESDS parts are often as sensitive as the most sensitive ESDS part which they contain. Incorporation of protective circuitry in these assemblies and equipment can provide varying degrees of protection from ESD applied to their terminals. Such assemblies and equipment, however, can still be vulnerable from induced ESD caused by strong electrostatic fields or by contact of pcb electrical connections or paths with a charged object.

Intermittent or upset failures can occur on certain types of parts, such as LSI memories and chips, either prior to or after lidding and sealing. Such failures can also occur when equipment is in operation, characterised by a loss of information or temporary distortion of its functions. No apparent hardware damage occurs and proper operation resumes automatically after the ESD exposure or, in the case of some digital equipment, after re-entry of the information by resequencing the equipment.

Upset can also be the result of an ESD spark in the vicinity of the equipment. The electromagnetic pulse generated by the spark causes erroneous signals to be picked up by the equipment circuitry. Upset can also occur by the capacitive or inductive coupling of an ESD pulse or by the direct discharge of an ESD through a signal path providing an erroneous signal.

While upset failures occur when the equipment is operating, catastrophic failures can occur any time. Cata-

strophic ESD failures can be the result of electrical overstress of electronic parts caused by an ESD, such as: a discharge from a person or object, an electrostatic field, or a high voltage spark discharge (see Figure 1).

Some catastrophic failures may not occur until some time after exposure to an ESD, as in the case of marginally damaged ESDS parts, which require operating stress and time to cause further degradation and ultimate catastrophic failure. Only certain part types seem to be susceptible to this latent failure process.

There are some types of catastrophic ESD failures which could be mistaken for upset failures. For example, an ESD could result in aluminium shorting through a SiO₂ dielectric layer. Subsequent high currents flowing through the short, however, could vaporise the aluminium and open the short. This failure may be confused with upset failure if it occurs during equipment operation, but the damage due to the ESD would cause a latent defect that will probably reduce the operating life of the part.

Parts that are very susceptible to ESD upset are any within logic families that require small energies to switch states or small changes of voltage in high impedance lines. Examples of families that are sensitive would be NMOS, PMOS, CMOS, and low power TTL. Linear circuits with high impedance and high gain inputs would also be highly susceptible, along with RF amplifiers and other RF parts at the equipment level; however, design for RFI immunity can protect these parts from damage due to ESD high voltage spark discharge.

To protect parts sensitive to ESD high spark discharge at the equipment level requires: good radio frequency interference (RFI)/electromagnetic compatibility (EMC) design, buffering of busses, proper termination of busses, shielding of buss conductors, and the avoidance of penetrations of the equipment enclosure that lead to sensitive parts.

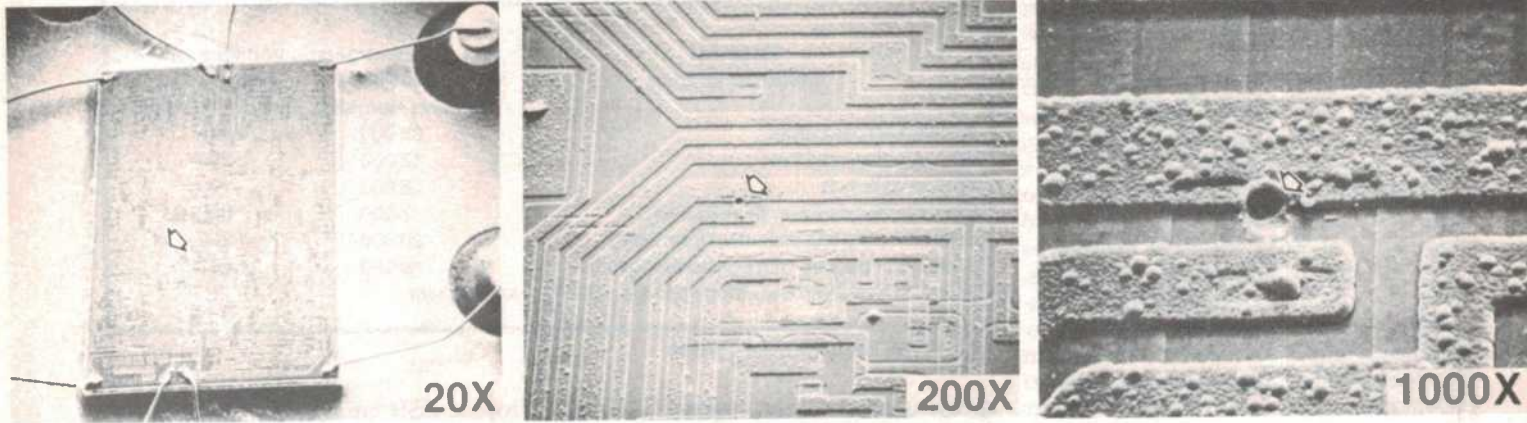

Figure 1. Static discharge damage in an op-amp integrated circuit (arrows show location of damage).

Failure mechanisms

Typical ESD failure mechanisms are divided into the two following categories. Those in the first category, thermal secondary breakdown, metallisation melt and bulk breakdown, are power dependent. Those in the second category, dielectric breakdown, gaseous arc discharge, and surface breakdown, are all voltage dependent. All of the above are applicable to microelectronic and semiconductor devices. Metallisation melt and gaseous arc discharge are evident in film resistors, and bulk breakdown is typical of piezoelectric crystals.

Besides these catastrophic failure mechanisms, un-encapsulated chips and LSI MOS integrated circuits have exhibited temporary failure due to gaseous arc discharge from positive charges deposited on the chip as a by-product of gaseous arc discharges within the package between the lid and the substrate.

Thermal secondary breakdown is also known as avalanche degradation. Since thermal time constraints of semiconductor materials are generally large compared with transient times associated with ESD pulse, there is little diffusion of heat from the areas of power dissipation, and large temperature gradients can form in the parts. Localised junction temperatures can approach material melt temperatures, usually resulting in development of hot spots and subsequent junction shorts due to melting.

For junction melting to occur in bipolar (P-N) junctions, sufficient power must be dissipated in the junction. In the reverse bias condition, most of the applied power is absorbed in the immediate junction area with minimal power loss in the body of the part. In the forward bias condition, the junction in-

CLASS 1: SENSITIVITY RANGE 0 TO <1000 VOLTS
Metal Oxide Semiconductor (MOS) devices including C (Complementary), D (Double-Diffused), N (N-Channel), P (P-Channel), V (V-Groove) and other MOS technology without protective circuitry, or protective circuitry having Class 1 sensitivity
Surface Acoustic Wave (SAW) devices
Operational Amplifiers (OP AMP) with unprotected MOS capacitors
Junction Field Effect Transistors (JFETs) (Ref.: Similarity to MIL-STD-701: Junction field effect transistors and junction field effect transistors, dual unitized)
Silicon Controlled Rectifiers (SCRs) with $I_o < 0.175$ amperes at 100° Celsius (°C) ambient temperature (Ref.: Similarity to MIL-STD-701: Thyristors [silicon controlled rectifiers])
Precision Voltage Regulator Microcircuits: Line or Load Voltage Regulation <0.5 percent
Microwave and Ultra-High Frequency Semiconductors and Microcircuits: Frequency >1 gigahertz
Thin Film Resistors (Type RN) with tolerance of <0.1 percent; power >0.05 watt
Thin Film Resistors (Type RN) with tolerance of >0.1 percent; power ≤ 0.05 watt
Large Scale Integrated (LSI) Microcircuits including microprocessors and memories without protective circuitry, or protective circuitry having Class 1 sensitivity (Note: LSI devices usually have two to three layers of circuitry with metallization crossovers and small geometry active elements.)
Hybrids utilizing Class 1 parts
CLASS 2: SENSITIVITY RANGE >1000 TO ≤ 4000 VOLTS
MOS devices or devices containing MOS constituents including C, D, N, P, V, or other MOS technology with protective circuitry having Class 2 sensitivity
Schottky diodes (Ref.: Similarity to MIL-STD-701: Silicon switching diodes [listed in order of increasing trr])
Precision Resistor Networks (Type R2)
High Speed Emitter Coupled Logic (ECL) Microcircuits with propagation delay ≤ 1 nanosecond
Transistor-Transistor Logic (TTL) Microcircuits (Schottky, low power, high speed, and standard)
OP AMPs with MOS capacitors with protective circuitry having Class 2 sensitivity
LSI with input protection having Class 2 sensitivity
Hybrids utilizing Class 2 parts
CLASS 3: SENSITIVITY RANGE >4000 TO $\leq 15,000$ VOLTS
Lower Power Chopper Resistors (Ref.: Similarity to MIL-STD-701 Silicon Low Power Chopper Transistors)
Resistor Chips
Small Signal Diodes with power ≤ 1 watt excluding Zeners (Ref. Similarity to MIL-STD-701 Silicon Switching Diodes [listed in order of increasing trr])
General Purpose Silicon Rectifier Diodes and Fast Recovery Diodes (Ref. Similarity to MIL-STD-701 Silicon Axial Lead Power Rectifiers, Silicon Power Diodes [listed in order of maximum DC output current], Fast Recovery Diodes [listed in order of trr])
Low Power Silicon Transistors with power ≤ 5 watts at 25°C (Ref. Similarity to MIL-STD-701 Silicon Switching Diodes [listed in order of increasing trr], Thyristors [bi-directional triodes], Silicon PNP Low-Power Transistors ($P_c \leq 5$ watts @ $T_A = 25^\circ\text{C}$), Silicon RF Transistors)
All other Microcircuits not included in Class 1 or Class 2
Piezoelectric Crystals
Hybrids utilizing Class 3 parts

Table 3. List of ESDS devices by part type

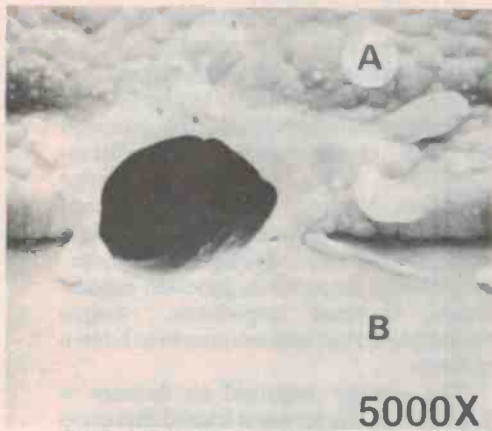

5000X
Detailed view of the 6-micron (0.0002") diameter hole created in aluminium metallisation (A) and silicon dioxide substrate (B) by static discharge.

hibits lower resistance. Even though a greater current flows, a greater percentage of the power is dissipated in the body of the part. Thus, more power is generally required for junction failure in the forward bias condition.

For most transistors, the emitter-base junction degrades with lower current values than the collector-base junction. This is because the emitter-base junction normally has smaller dimensions than any of the other junctions in the circuit. For reversed polarity signals, only a very small microampere current flows until the voltage exceeds the breakdown voltage of the junction. At breakdown, the current increases and results in junction heating, due to the nucleation of hot spots and current concentrations. At the point of second breakdown, the current increases rapidly due to a decrease in resistivity and a melt channel forms that destroys the junction. This junction failure mode is a power-dependent process.

Metallisation melt failures can occur when ESD transients increase part temperature sufficiently to melt metal or fuse-bond wires. Theoretical models exist which allow computation of currents that can cause failure for various materials as a function of area and current duration. Such models are based on the assumption of uniform area of the interconnection material. In practice, it is difficult to maintain a uniform area, and the resultant non-uniform area can result in localised current crowding and subsequent hot spots in the metallisation. This type of failure could occur where the metal strips have reduced cross-sections as they cross oxide steps. Normally due to shunting of the currents by the junction, this failure requires a larger power level at higher frequencies than is required for junction damage at lower frequencies. Below 200 to 500 MHz, the

junction capacitance still presents a high impedance to currents, thereby shunting them around the junction.

Bulk breakdown results from changes in junction parameters due to high local temperatures within the junction area. Such high temperatures result in metallisation alloying or impurity diffusion, resulting in drastic changes in junction parameters. The usual result is the formation of a resistance path across the junction. This effect is usually preceded by thermal secondary breakdown.

Dielectric breakdown occurs when a potential difference is applied across a dielectric region in excess of the region's inherent breakdown characteristics, and a puncture of the dielectric occurs. This form of failure is due to voltage rather than power and could result in either total or limited degradation of the part, depending on the pulse energy. For example, the part may heal from a voltage puncture if the energy in the pulse is insufficient to cause fusing of the electrode material in the puncture. It will, however, usually exhibit lower breakdown voltage or increased leakage current after such an event, but it will not exhibit catastrophic part failure.

This type of failure could result in a latent defect resulting in catastrophic failure with continued use. The breakdown voltage of an insulating layer is a function of the pulse rise time, since time is required for avalanching of the insulating material.

Gaseous arc discharge occurs in parts with closely spaced, unpassivated, thin electrodes. Gaseous arc discharge can cause degraded performance. The arc discharge condition causes vaporisation and metal movement, which is generally away from the space between the electrodes. The melting and fusing do not move the thin metal into the interelectrode regions. In melting and fusing, the metal flows together and flows or opens along the electrode lines. There can be fine metal globules in the gap region, but not in sufficient numbers to cause bridging. Shorting is not considered a major problem with passivated thin metal electrodes.

On a SAW band pass filter device with thin metal of approximately 0.4 micron and 3.0 microns (1 micron = 1×10^{-6} metres) electrode spacing, operational degradation was experienced from ESD. When employing thicker metallisation such as 1.35 microns, this gaseous arc discharge in an arc gap at typically 50 microns can be used for protection to dissipate incoming high voltage spikes.

For LSI and memory ICs with passivation/active junction interfaces

susceptible to inversion, gaseous arc discharge from inside the package can cause positive ions to be deposited on the chip and cause failure from surface inversion. This has been reported to occur especially on parts with nonconducting lids. A special case of this is UV-EPROMs with quartz lids, where failures can be annealed by neutralising the positive charge with ultraviolet light through the quartz lid.

Surface breakdown occurs at perpendicular junctions, and is explained as a localised avalanche multiplication process caused by narrowing of the junction space charge layer at the surface. Since surface breakdown depends on numerous variables, such as geometry, doping level, lattice discontinuities, and unclean gradients, the transient power which can be dissipated during surface breakdown is generally unpredictable.

The destruction mechanism of surface breakdown results in a high leakage path around the junction, thus nullifying the junction action. This effect, as well as most voltage sensitive effects like dielectric breakdown, is dependent upon the rise time of the pulse and usually occurs when the voltage threshold for surface breakdown is exceeded before thermal failure can occur.

Another mode of surface failure is the occurrence of an arc around the insulating material. This failure is similar to metallisation gaseous discharge except that discharge is between metallisation and semiconductor.

Specific effects on circuits

Now, having identified the causes of ESD and the major types of failure mechanisms, it is important to assess how these failures manifest themselves in systems. Typical devices and their degradation thresholds are summarised in Table 4. A more detailed analysis of the physical mechanisms follows.

MOS structures are a conductor and semiconductor substrate separated by a thin dielectric. This family includes MOS field effect transistors (FETs), MOS ICs, bipolar, hybrid, linear and digital ICs and MOS capacitors. Or more basically, the family includes any dual dielectric system or semiconductor with metallisation crossovers. The newer devices in this area — the VMOS (vertical groove MOS), the HMOS (high density MOS), the HEX MOS, and some of the prototype GaAs MESFETS (gallium arsenide metal semiconductor field effect transistor) — approach 1 micron or less compared with today's chip geometries of 4 to 5 microns (see Figure 2). Needless to say, as these

DEVICE	TEST RESULTS	
	THRESH. OLD. ¹ VOLTS	DEGRADATION CRITERIA ²
Diodes 1N459 1N916 TI551 1N4151	> 3000 3000 450 > 3000	50% drop in V_R at $I_R = 5 \mu A$
Zener Diodes LVA356	> 3000	50% drop in V_R at $I_R = 5 \mu A$
Transistors 2N2222 2N2369A 2N2432A 2N2540 2N2907 2N3117 2N3570 2N4251 2N4872 2N5154	1000 460 620 1450 1200 1000 380 460 1200 > 3000	50% drop in $V_{BR(CBO)}$ at $I_B = 5 \mu A$
Junction Field-Effect Transistors 2N2608 2N3112 2N3971 2N4118A	320 530 160 140	50% drop in $V_{BR(GSS)}$ at $I_G = 5 \mu A$
Metal-Oxide Semiconductor Transistors GI MEM 520c (chip)	58	$I_G > 5 \mu A$ at $V_{GS} = 22 V$
Complementary Metal-Oxide Semiconductor Integrated Circuits RCA CD4001	250	> 0.5 μA Input at 10 V or > 10% decrease in output voltage across 100-K Ω load
Silicon-Controlled Rectifiers 2N886A 2N3030	680 1000	50% increase in I_{CGO}

NOTES:

- Reverse-breakdown polarity.
- Where V_R is the reverse voltage, I_R the reverse current, $V_{BR(CBO)}$ the collector/base breakdown voltage, I_B the base current, $V_{BR(GSS)}$ the gate/source breakdown, I_G the gate current, V_{GS} the gate/source voltage, and I_{CGO} the gate leakage current.

Table 4. Typical device degradation threshold

smaller geometries blend with higher purity processing, the device susceptibilities will rise and ESD transients of 20 volts will become lethal.

Differences in susceptibilities of these MOS technologies are dependent upon the gate dielectric strength and the oxide thickness. In the past, gate dielectric thickness has typically been around 0.11 micron with dielectric strengths ranging around 1×10^6 to 1×10^7 V/cm, with breakdown between 80 and 120 volts. Researchers today, however, are creating functional devices with dielectric thicknesses in the 0.06 to 0.08 micron range and breakdowns at 20 and 25 volts.

Many monolithic ICs have metallisation runs which cross over active semiconductor regions with field oxide between them serving as the insulator. These are called parasitic MOS transistors. Normally, these break down around 100 volts due to field intensification at the corners of the metallisation and weak dielectric strength of the oxide barrier. Breakdown of the oxide insulator is permanent, as opposed to breakdown of a semiconductor, which is reversible.

If very short-term overvoltages occur, a subsequent breakdown or avalanche occurs at a lower value than normal. As the punch-through short occurs, the metallisation will flow through the dielectric to create a low resistance short. However, in some instances where there is a particularly thin metallisation, such as 0.4 micron, or there is sufficient energy passed through the short, the metal will be vaporised and the short will clear but leave a cratered hole in the dielectric. Degraded performance may result but

not a catastrophic failure. There is conjecture that the short in some circumstances might reappear or performance might continue to degrade.

Semiconductor junctions included in this classification are positive-negative (PN) junctions, P-type intrinsic N-type (PIN) junctions, and Schottky barrier junctions. Their sensitivity to ESD depends on geometry, size, resistivity, impurities, junction capacitance, thermal impedance, reverse leakage current and reverse breakdown voltage.

The energy required to damage a junction in the forward biased direction is generally ten times that required in the reverse biased direction. Emitter-base junctions in bipolar transistors, whether integrated circuit or a discrete transistor, are usually more susceptible to ESD damage than collector-base or collector-emitter junctions. This is primarily due to size and geometry, where the emitter-side wall experiences large energy-densities during reverse biased ESD. Because of larger areas, the collector-base and collector-emitter do not experience the same energy densities, although with the collector-base and collector-emitter it is possible to laterally forward bias the base-emitter. In this case, a current crowding at the emitter side will occur.

Junction field-effect transistors which have high impedance gates are particularly sensitive to ESD. They have extremely low gate-to-drain and gate-to-source leakage in the order of less than 1 nanoampere, and relatively high breakdown voltage of greater than 50 volts. Therefore, the gate-to-drain and gate-to-source are usually the most sensitive ESD paths. Figure 3 is a

TYPICAL CELL GEOMETRIES

MC68000 Series
HMOS

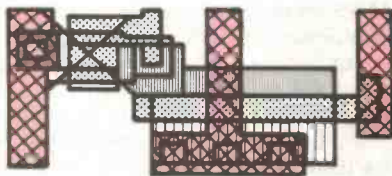

MC6800 Series
NMOS

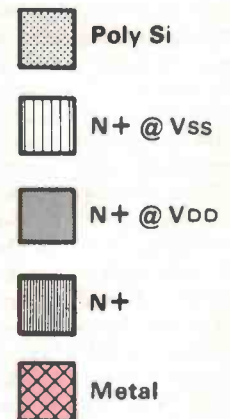
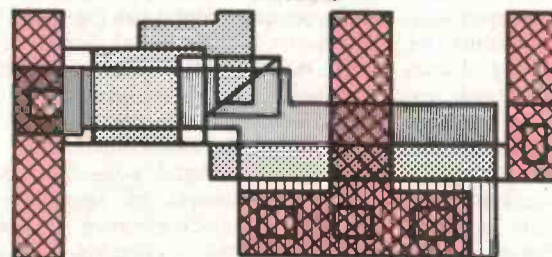

HMOS ADVANTAGES

Circuit densities twice standard NMOS

$$NMOS = 4128 \mu^2 \text{ Per Cell}$$

$$HMOS = 1852.5 \mu^2 \text{ Per cell}$$

Speed-power product four times better than standard NMOS

$$NMOS \cong 4 \text{ PICOJOULES}$$

$$HMOS \cong 1 \text{ PICOJOULE}$$

Figure 2. Comparison of HMOS and NMOS technologies.

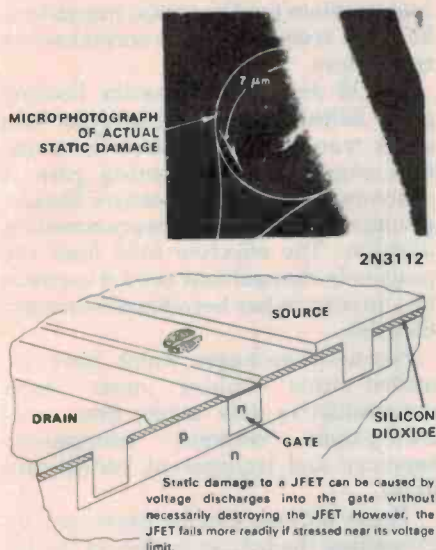

Figure 3. Example of nondestructive ESD damage to a JFET device.

classic example of non-destructive ESD damage to a JFET device. The device shown continued to function normally in the circuit. However, it experienced a dramatic decrease in its reverse breakdown voltage.

Schottky barrier junctions, such as the 1N57111 diode and TTL Schottky integrated circuits, are particularly sensitive to ESD because they have very thin junctions and the presence of metal increases the probability of ESD being carried through the junction.

Semiconductor junctions as sensitive ESD constituents are found not only in diodes, transistors, and bipolar integrated circuits, but also in MOS as parasitic diodes and input protection clamps. Although the input port junctions are meant to provide protection from ESD damage, the size of the protective junctions is limited due to cost and performance tradeoffs. Thus, ESD pulses of sufficient energy can damage the input protection junctions.

The temperature coefficient of extrinsic semiconductors is positive. That is, the higher the temperature, the higher the resistance. This feature prevents current crowding and hot spots from forming at low temperatures. However, in the reverse biased mode all the energy is being dissipated by the relatively large voltage drop across the relatively narrow depletion width of the junction. Due to geometrical effects, local resistance variations, and crystal defects, perfectly uniform current distribution does not occur across the junction. As an ESD occurs across the junction, the temperature at the depletion region increases quickly, and the extrinsic semiconducting material becomes an intrinsic semiconducting material, causing a sharp decrease in resistance which results in thermal

secondary breakdown. The more rapid the discharge, the more uniform is the increase in temperature and therefore the current across the junction. This means that for short duration discharges of less than 10 nanoseconds, the resultant filament short is wide compared to longer duration discharges.

It is possible for spots to develop but not grow completely across the junction such that at low bias voltages they do not cause a failure condition. However, during operation at certain bias conditions, locally high current densities may exist with a corresponding highly localized large increase in temperature at the previously formed hot spot locations, such that continued growth of a filament short may occur or silicon and metallisation may diffuse through the junction via the electromigration process at temperatures greater than 200°C. Low-leakage, high-breakdown JFET and Schottky barrier junctions seem to be particularly susceptible to this failure process.

It is this same failure process that requires the breakdown test of JFETs be performed as a leakage test rather than putting the junction into breakdown. With low-leakage junctions, highly localised currents can occur during junction reverse breakdown.

With the Schottky barrier junction, metallisation is immediately available to migrate through the junction at localised hot spots. As the current filament develops across a semiconductor junction, it is analogous to putting a parallel resistor across the junction of the same value as the short. However, in some marginally formed hot spots, it may be similar to putting a zener diode and a resistor in parallel with the junction. Failure indication of filament short from a high resistance short is high leakage.

Film Resistors: Resistor material adhering to an insulating substrate comes under the ESDS constituent classification of film resistor. The degree of sensitivity will depend on the ingredients and formulation of the resistor material and size-power considerations.

Hybrid microcircuits frequently contain either thin film resistors or thick film resistors. Hybrid designs which cannot tolerate large changes in resistance, such as precision voltage regulators, are sensitive to ESD.

Thick film resistors consist of a conductive metal oxide as the resistive element, a metal additive to improve electrical performance, and a glass frit to provide a support matrix, adhesion to the substrate, and resistivity control. Such parts are particularly sensitive to

ESD. Since the charge is almost always negative for thick films, electrical discharge has been considered as a possible trimming method when conventional trimming overshoots the desired resistance tolerance. It has also been found that the thick film resistance changes are heavily dependent on voltage rather than energy.

Thin film resistors, on the other hand, are more energy dependent and do not have changes greater than 5% in resistance until the energy of discharge is sufficient to cause film rupture.

In addition to hybrid microcircuits, some monolithic integrated circuits may also contain encapsulated thin film resistors, such as polysilicon resistors, as part of an input protection circuit. Discrete encapsulated resistors which contain the film resistor structure are also sensitive to ESD.

Carbon film, metal oxide, and metal film resistors are somewhat sensitive to ESD, especially at low tolerance and low wattage ratings. A frequently recurring ESD problem with resistors is with the 0.05 W metal film, part RNC50, specified at 0.1% tolerance. Putting these parts in a polyethylene bag and rubbing them on another bag is sufficient to shift the tolerance of these resistors.

ESD failure mechanisms of film resistors are not well defined. This is partly the result of not knowing the ingredients and formulations of the resistor material, which are often held proprietary by the manufacturer.

For thick film resistors, the failure mechanism has been modelled as the creation of new shunt paths in a matrix of series-parallel resistors and infinitesimal capacitors isolating metallic islands. With the application of high electric fields, the dielectric breakdown of the glass frit or other isolating dielectric material is exceeded and the ensuing rupture welds metallic particles together in a conducting path known as metallisation melt. Since this model involves a dielectric breakdown process, it is mostly voltage dependent. ▶

WATCH THAT SOLDER SUCKER

Removing integrated circuits soldered directly to a printed circuit board usually requires sucking away the solder from a reheated pad or plated through hole. That is fine for bipolar circuitry, but it can be extremely dangerous for MOS devices. Dan Anderson, president of Anderson Effects, points out that standard plastic solder suckers have been found to produce a static surge of 5000 to 10 000 V at the tip. This tip is invariably in direct contact with a device's lead when the surge occurs, resulting in a damaged or destroyed device. Anderson Effects and other firms now offer static-free metalised plastic models that produce no static charge. For more information, contact Anderson Effects Inc., P.O. Box 657, Mentone, California 92359 USA.

It appears that the ESD behaviour of resistive materials is very much a function of the number of parallel current paths or the number of capacitive couplings between parallel paths in the film structure. The nature of the glass used in the material also appears to be quite important, both because it influences the distribution of the resistive elements and because it can act as a resistive element itself. Thus, the behaviour of different thick film resistor paths to ESD can vary greatly. ESD sensitivity testing, therefore, should be specified for critical tolerance thick film resistors.

For thin film resistors and encapsulated metal film, metal oxide, and carbon film resistors, the failure mechanism is primarily a thermal, energy-dependent process modelled as the destruction of minute shunt paths. This mechanism is associated with an increasing resistance shift on the thin film and metal film type resistor which appears to be voltage dependent. This negative shift is usually not more than 5% and is typically less than 1% before changing to positive shifts as ESD voltage increases.

Some thin film resistors, such as deposited tantalum nitride on SiO₂ substrates, may be so small and power-limited that ESD voltages greater than 5000 volts from a person can melt the resistor open. For most cases, however, a shift in resistance will be the failure indicator.

Thus, for circuit designs tolerant of large resistance changes, the failure may not be critical. Generally, after exposure to an ESD, the stability of the resistor is reduced and the degree of instability is directly related to the level of ESD. Temperature coefficient changes have been known to result from such ESD exposure.

For thick film resistors, the resistance shift is negative. The resistance change can easily exceed 50% with some thick film pastes. Some exceptions to this may occur, especially at low resistance values. For thin film, metal film, metal oxide and carbon film at lower ESD levels, small negative resistance shifts of less than 5% can be experienced. At higher ESD levels, large positive shifts greater than 10% can be experienced, depending on the power rating.

Metallisation Strips. Relatively narrow, thin metallisation strips on a substrate such as SiO₂, which carry current between terminals without any other energy-absorbing element in the path, are susceptible to ESD. These metallisations may consist primarily of aluminium or gold, but can also be multi-layered. The failure mechanism

is burnout from joule heating. This type of constituent is often used in monolithic integrated circuits, hybrid microcircuits and multiple finger overlay transistor construction found in switching and high frequency transistors.

Joule heating is most likely to occur when: (1) the ESD source has very low contact resistance, resulting in high currents over short time constants, and (2) a low resistance large area diode is connected by the metallisation path between the two terminals, resulting in large currents due to the low voltage drop in the diode forward biased direction.

Increasing the width or thickness of the strip will decrease ESD sensitivity. The use of glassivation and thinner SiO₂ between the strip and the silicon also reduces ESDs. The failure indicator from this failure mode is open.

Passivated field-effect structures with nonconductive lids. Various NMOS and PMOS integrated circuit designs have been found to fail from very localised high concentrations of positively charged ions on the outer passivated surface of the die.

NMOS designs fail from excessive leakage currents as a result of field inversion between N+ junctions, such as thick field parasitic transistors,

intermediate field parasitic transistors, EPROM transistors, and normal select transistors.

PMOS designs, such as the floating gate, EPROM or depletion type field effect transistors, fail when the negative charge on the floating gate is overcompensated by a positive charge, giving an erroneous unprogrammed indication. The effective field from the positively charged ions needed to create this inversion has been found to exceed 85 volts.

Hermetic packages which have recorded this failure mode have nonconductive lids made from non-transparent ceramic, transparent sapphire and transparent borosilicate glass.

These failures can be prevented by grounding the bottom surface of the lid over the die or by initiating preventive measures to avoid electrostatic charging of the nonconductive lid. This failure mechanism is most common with NMOS and PMOS UV-EPROMS having transparent lids. NMOS static random access memory (RAMs) in a ceramic package, however, have also been reported to fail from the ESD failure mechanism. Unless testing shows otherwise, any LSI integrated circuit with nonconductive lids could conceivably have field effect structures which are susceptible to failure from

CONDUCTIVE WRIST STRAP PROTECTS MICROCIRCUITS.

Royston Electronics has recently introduced a conductive wrist strap that meets the latest military specifications for quick release and resistance to line voltages from accidental contact.

Military users have specified these new requirements for wrist straps to prevent static electricity damage to microcircuits while radar, avionics, computer and other equipment is undergoing repair, maintenance or inspection in base stations or the field.

The CP401A grounding strap has a wrist attachment of "Velcro" hook-and-loop tape that separates with a slight pull for safety and to prevent a worker from breaking the grounding wire by inadvertently leaving the work area while still wearing the strap.

The wrist strap is made of conductive polyester ribbon for permanent conductivity, but with built-in resistance to protect the wearer against possible line voltages.

An alligator clip at the other end of the four-foot long grounding wire can be attached to any convenient ground, draining static electricity before it can build up to levels that are harmful to microcircuits.

The wrist strap and ground wire are joined by a standard snap fastener. An extra snap fastener provides a convenient connection for grounding electric tools, bench covers or other items in the work

area that must be grounded to prevent static electricity build-up.

Information on this, and the comprehensive range of other anti-static devices, is available from Royston Electronics, Melbourne (03)543-5122 or Sydney (02)709-5293.

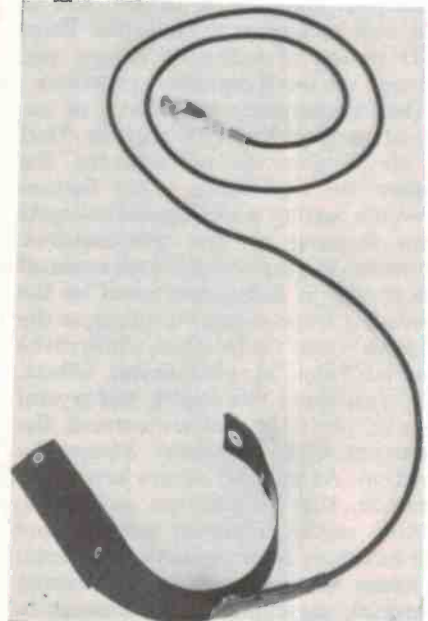

undesirable field inversion or gate threshold voltage shifting.

Failure mechanism involves positive-charged ion clusters deposited on the die as a result of air breakdown in the air gap between the die surface and the bottom of the package lid. Charging of the bottom of the lid can be induced by several means, one of which is by freeze spraying the package with canned coolant. The positive charging rate of the freeze spray impinging on the top of the lid depends on the flow rate of the coolant from the can. At low flow rates, the charging is negative and does not induce failure; at high flow rates, sufficient positive charging can occur and induce failure. The localised air breakdown in the air gap of the package causes ionised streamers to form from the die to the lid. The positive charge on the bottom of the lid drives the positive charge in the streamer toward the die surface and attracts the negative charge toward the lid. This results in very localised clusters of positive ions on the die surface. Because of the nature of the air breakdown for certain package ambients, this charge is probably identical in type to the very large ions that can be experimentally created by positive corona discharge in the air.

These localised positive charges also cause the formation of inversion layer leakage paths between N+ diffusions and shift the gate threshold voltage on PMOS depletion type transistors. The formation of leakage paths and the gate

threshold shifts give rise to isolated circuit failures. This failure mechanism is recoverable by neutralising the positive charge on the outer surface of the die.

On UV-EPROMs with transparent lids, recovery is nondestructive when 2737\AA (2.737×10^{-7} metres) ultraviolet light with a minimum photon energy of 4.3 eV is applied to the chip for as short as three to five seconds.

Failure indicators for this failure mode come under the general classification of operational degradation. Operational degradation will take the form of a functional failure. In the case of NMOS UV-EPROMs, certain programmed bits appear unprogrammed and certain unprogrammed bits appear programmed. In one group of failure indicators, bit failures have been organised in columns where programmed bits appear unprogrammed. In another group of failure indicators, bit failures were organised on rows where unprogrammed bits appeared programmed.

The failure indicators for PMOS UV-EPROMs are random single-bit failures throughout the memory which would read as programmed but appear as unprogrammed. Failure indicators for NMOS static RAM have been reported as random hits stuck in "1" or "0" logic state and the adjacent cell also stuck but in the opposite logic state.

Piezoelectric crystal devices, such as quartz crystal oscillators and SAW

devices, can fail from ESD, resulting in operational degradation. Electrical parameters of piezoelectric crystals contained within these parts are damaged by excessive driving current. Also, the piezoelectric effect from high voltages causes mechanical stress and movement to be generated in the crystal plate. When the voltage is too great, mechanical forces cause motion in excess of the elastic limits of the crystal and crystal fracture occurs. Fracture may occur as a lifted platelet, as has been experienced in lithium niobate SAW delay lines. Such fractures, when occurring in sufficient number, will cause enough change in the operating electrical characteristics to cause failure.

Closely spaced electrodes. When employing thick metallisation, such as 1.35 microns, gaseous arc discharge in an arc gap 50 microns wide can be used as a protection device to dissipate incoming high voltage spikes. In devices with closely spaced, unpassivated, thin electrodes, however, gaseous arc discharge can cause degraded performance.

Devices that employ thin, closely spaced electrodes include SAW devices. Other parts, such as high-frequency, multiple-finger transistors, and new technology, such as very large scale integration (VLSI) and very high speed integration (VHSI), could also be degraded to failure from arc discharge between metallisation runs. Arc discharge causes vaporisation and metal movement generally away from the space between the electrodes. Melting and fusing do not move the thin metal into the interelectrode regions, but the metal pulls together and flows or opens along the electrode lines. There can be fine metal globules in the gap region, but not in sufficient numbers to cause bridging. Shorting is not considered a major problem with unpassivated thin metal electrodes.

ESD failures have been experienced on SAW band pass filters with thin metal of 0.4 micron and electrode spacing of 3.0 microns.

Detecting ESD damage

By this time, hopefully, the reader has developed an acute sensitivity to the nature of ESD and the insidious nature of ESD damage to the function of an electronic device or a black box. Although there are many thousands of users worldwide, very few have the capability — that is, trained people and facilities — to perform the failure analysis that would lead to the recognition of ESD as the culprit in numerous equipment failures. ▶

NEW MATERIAL WILL OVERCOME SPACECRAFT LOSSES

A new composite material just successfully tested in Britain will overcome a problem in space that has led to the loss of at least two satellites.

Orbiting spacecraft are bombarded by high-energy electrons that cause electrostatic charges of up to 20 000 volts to build up on the surface of the craft. As a result a spontaneous electrical discharge can occur through the outer thermal protective material.

As well as damaging the covering of the satellite, the discharge can cause false electronic signals to disrupt the operation of the craft. If this should happen while it is being manoeuvred in space, the satellite could be lost.

British Aerospace says that these dangers will be eliminated by encasing the satellite in a new composite sandwich material which dissipates the surface charge the moment it hits the spacecraft. The material, which has been patented, also eliminates electrostatic-induced interference, minimises contamination and will prolong the operational life of satellites by maintaining the thermo-optical protection.

In tests, samples of the multi-layer thermal-insulating material have successfully withstood electron energy levels of

30 000 volts at intensities up to 30 times greater than those anticipated in space.

The material has shown that the electrostatic surface potential cannot build up to operationally dangerous levels even at temperatures as low as minus 170° Celsius, where the probability of a discharge is much greater.

British Aerospace says the new material is made up of one of two types of material already used for thermal insulation. However, in this new material it is arranged in composite sandwich form along with two conductive layers of aluminium or carbon, which are earthed to the satellite's main structure.

Electrons penetrating the outer skin are captured by the first conducting layer, while the second aluminium layer on the inner side of the material captures the more highly charged particles that may have penetrated further into the surface of the spacecraft. The inner conductive layer can also act as a radio frequency shield.

The multilayer technique may find further use in protecting spacecraft equipment such as thermal control mirrors, solar arrays and the back of antenna dishes, and British Aerospace say there may be other applications on the ground.

Even with trained people and the proper tools, identifying ESD damage can be difficult. Phil Kohlhaas of 3M Static Control Systems reported at a recent seminar (hosted by Warren Yates of Electronic Products magazine) that 3M sent 100 deliberately static-damaged devices to a testing laboratory. The lab performed a 100% failure analysis — SEM (scanning electron microscope), glass removal, metal removal, the works — and in 60% of the cases, could not identify ESD-related damage that had occurred.

ESD-induced failures are often mistaken for other types of failures. This is particularly true, according to Roy Walker of IITRI/RAC, when it comes to steady-state electrical over-stress failures. Agreeing with Walker, Hewlett-Packard's Kim Gray said he encountered a latch-problem in a CMOS device that appeared to result from steady-state-overstress failure; it turned out to be an ESD failure.

A lack of ESD awareness causes many people to limit ESD protection to only the most widely used susceptible devices — FETs without protection, and CMOS with double diode protection. But don't be lulled into a false sense of security if you're using bipolar devices. It's just more difficult to discern the ESD mechanism in a bipolar device than in a MOS device. Walker and others contend that there are many more ESD related problems in bipolar devices than we actually know about

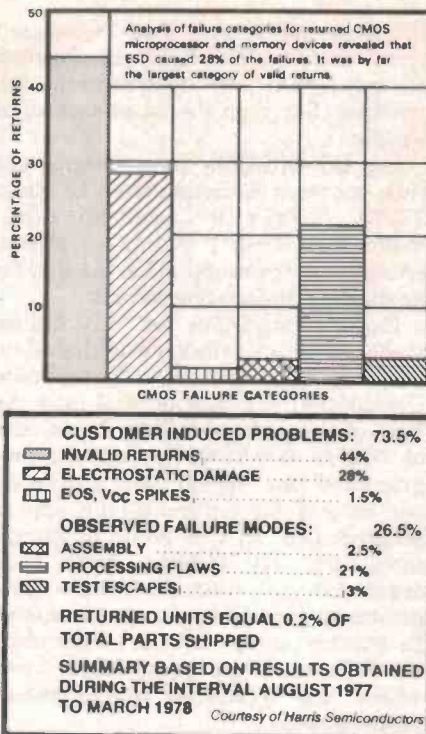

Figure 4. Typical device degradation threshold.

because of limitations of ESD failure analysis.

The ESD problem is big — make no mistake about that — even though it's really not possible to put a precise handle on just how big. For example, Gene Freeman presented some failure analysis data compiled by Harris Semiconductor on devices returned to them

(see Figure 4). Note that ESD comprises the largest single failure mode.

Steve Halperin of Analytical Chemical Labs reported on his company's observations of equipment manufacturers. Where large boards of critical design are involved, he has seen up to a third of all boards started during a day enter a "repair and refurbish" function at some period during handling in the manufacturing facility. Cost of manufacturing failures can be prohibitive, but at least these types of problems are caught at the factory. But what about devices that are degraded by ESD but don't fail until later, out in the field? Halperin quoted figures from some computer manufacturers indicating that 70% of their field service calls were static related.

Degraded devices can become much more than just an expensive field service problem. We cannot ignore the possible substantial costs of product liability, as a failure in a critical end item system might mean substantial property losses or loss of life.

An effective plan to combat ESD requires a strong static awareness on the part of all concerned — factory assembly and test personnel, engineering, maintenance, and field service. But most of all, it requires a strong commitment on the part of top management.

Protecting your equipment

Once it is recognised that static discharge can degrade equipment per-

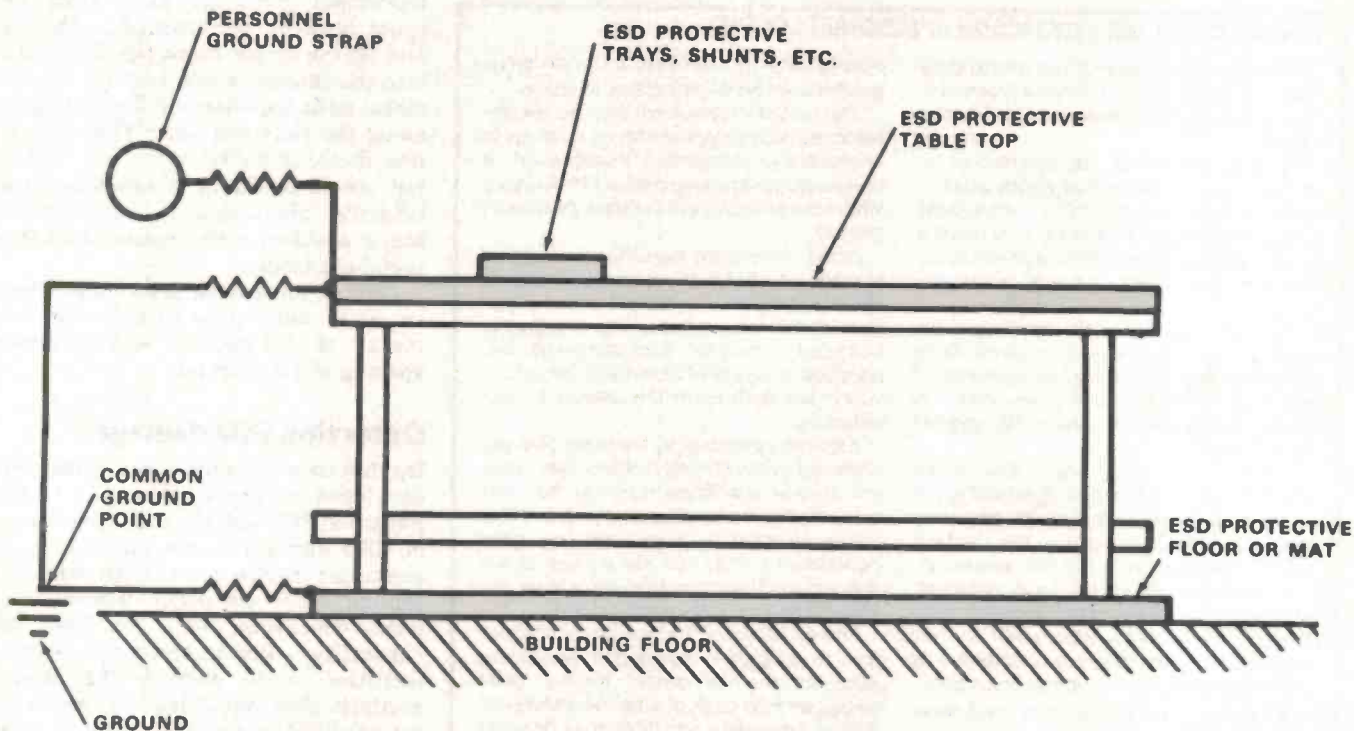

Figure 5. Typical ESD grounded work bench.

formance, and that in reality only the 'tip of the iceberg' can be identified as ESD, it is evident that ESD can be combatted only through protective measures. The first and most obvious key, as just stated, is top management's absolute commitment toward a total ESD program.

If management is astute enough to make this commitment, a total awareness and educational programme reaching to all individuals interfacing with the equipment is essential. After awareness is implementation, preparation of specifications and requirements to control work environments, identification and labelling of ESDS hardware, acquisition of antistatic handling equipment and work stations, and coordination of ESD programmes with both suppliers and users. ●

YOUR CHECK-LIST

1. Identify static-sensitive parts. Manufacturers should be required to clearly mark all parts that are suspected to be sensitive to static charge. Markings should read "static-sensitive devices".
2. Provide procedural guidelines to all personnel involved in handling, packaging, testing, assembling, and reworking "static-sensitive devices".
3. Maintain good grounding techniques by keeping equipment and personnel at the same potential. Use conductive countertops, floor matting, wrist straps, or arm sleeves, and make proper connections to a grounding source. (See Figure 5.)
4. Use conductive carriers for transporting, storing, and shipping static-sensitive parts.
5. Use neutralisers to neutralise charge on personnel, handling tools, and work surfaces.
6. Use a noncontacting static voltmeter to regularly monitor static charge in assembly area and on working personnel. This offers control and also keeps personnel static-conscious.
7. Failed parts should be treated with the same precautions; otherwise, the cause of the original failure may never be determined.
8. Keep all LRU assemblies stored away from high energy sources at all times (e.g. radar, laser, X-ray).
9. Keep connector caps on LRUs at all times whenever they are not installed. (Conductive caps are preferred.)
10. Never open an LRU on or remove an SRU unless at a properly equipped work station.

GRAFIX PLUS!

ANADEX DP9500/9501 HIGH RESOLUTION MATRIX PRINTERS

- HIGH DENSITY GRAPHICS STD
- 100 PERCENT DUTY CYCLE
- FULL COMMUNICATIONS CONTROL INCLUDING DEC PROTOCOL



- 132-220 COLUMNS
- RS232-C, CURRENT LOOP AND PARALLEL INTERFACE ALL STANDARD
- COMPLETE FORMS CONTROL
- EX-STOCK!



BELL & HOWELL AUSTRALIA PTY. LTD.
Phone (02) 660-5366. Telex 21914.

Electronics and Instrumentation Division
55 Murray Street, Pyrmont, NSW 2009.

SWITCHING POWER SUPPLIES

The California DC range of switching regulated power supplies is now available in Australia. The LR Series of open frame supplies provide size and weight savings over linear, series regulated supplies. Conservatively rated for long life, the LR Series was designed for use in computers, computer peripherals and industrial controls. They provide power for floppies, tape drives, memories and microprocessors. The range includes versions with up to four independent output voltages.

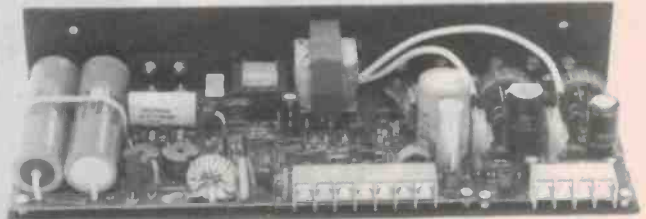

Standard features include:

- Plus/Minus 20 percent line tolerance
- Inrush limiting on turn-on
- Individual output regulation of 1 percent
- Individual output current limiting with foldback
- Thermal protection
- 50 millivolt P-P output ripple and noise
- 0-40 degrees C convection cooling without derating
- 70 percent minimum efficiency at full load

The power supplies range in price from \$170 to \$330.

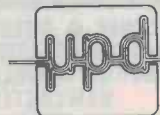

MicroPro Design Pty. Ltd.

PO Box 153, North Sydney, NSW 2060. Phone (02) 438-1220.

Our stores are well "stacked!"

New Newcastle store

Due to the evergrowing number of Mail Order customers in the Newcastle area, we saw the need of a retail outlet in the district. Now we are pleased to announce a new store will open about June 1st.

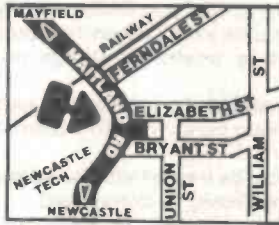

New Cannington store

Perth is a growing city. As it grows, so do we. We are pleased to announce a second store has opened in Cannington. The west will never be the same.

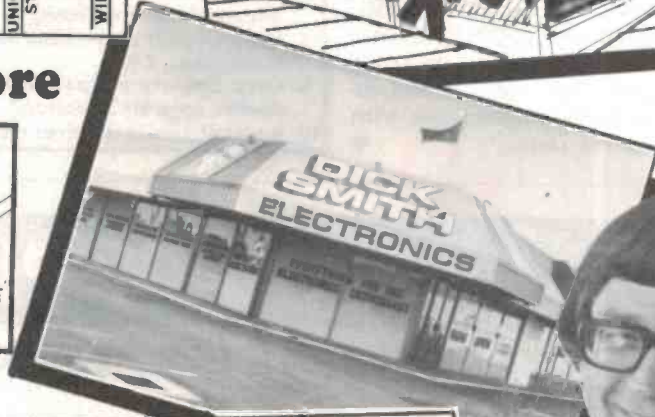

New Springvale store

Springvale is the third addition to the Victorian connection. Due to customer demand, 2 stores just couldn't cope.



New Auburn store

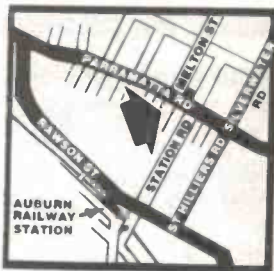

Auburn is No. 8 for Sydney, and we now provide a service that is within reach of just about everyone. Why not call in and take advantage of the many bargains and direct import prices.



DICK SMITH Electronics



SYDNEY ● MELBOURNE
BRISBANE ● ADELAIDE ● PERTH
CANBERRA ● WOLLONGONG
NEWCASTLE
MAIL ORDER CENTRE:
P.O. Box 321, North Ryde, NSW 211
Ph. (02) 888 3200

Join the people who have made the Air Force their life



"I've seen a lot of Australia. Now I'm looking forward to being posted overseas."



"I enjoy being a member of the team that keeps our F111's fully operational."



"You're trained to work on some of the most advanced equipment in the world."



"The opportunities for promotion with more pay and responsibility are there."



"You don't mind working hard if it's for a specific purpose like the country's security."



"At 23 I found myself promoted to Section Head. That kept me on my toes."



"It isn't all work I have time to relax and play my favourite sport."



"The training has set me up with a career for life — it's really professional."

The satisfaction and rewards are immense.

A new lifestyle. New friends. New interests. New qualifications. New places visited.

And you start on full adult pay too! After training we'll pay you even more! Then there's four weeks annual leave and the opportunity to continue studying for higher qualifications. So if you want to reach a higher rank, it's up to you.

It's not an easy life.

Success demands application. A disciplined approach to your work. What's more, you'll be part of a special team that's proud to wear the Air Force uniform.

Normally you'll work a five day week. But at times we expect you to do extra duties.

You must be prepared to join us for a minimum of six years and be prepared to live and work on any one of our bases.

Your future.

Is it in Flight Systems, Propulsion Systems, Air Frames, Telecommunications, Engineering, Administration, Weaponry, Supply or Motor Transport?

The choice is vast. The scope unrivalled.

So if you're aged between 17 and 34 years (17 and 43 years if no trade training is required), an Australian citizen or meet our nationality requirements, we would like to meet you. (People with civilian qualifications and experience are most welcome to apply.) Enquiries are also invited for Apprenticeships.

Today, walk into the Air Force Recruiting Office nearest you and have a chat with a Careers Adviser. The address is in the phone book. It could be your first important step to an exciting new career.

Alternatively send the coupon or phone for the facts:

Brisbane: 226 2626	Townsville: 71 3191	Sydney: 212 1011
Wollongong: 28 6294	Parramatta: 635 1511	Canberra: 82 2333
Hobart: 34 7077	Adelaide: 212 1455	Perth: 325 6222
Melbourne: 61 3731	Newcastle: 2 5476	



To:
**RAAF CAREERS
 ADVISER, G.P.O. Box XYZ**
 in the capital city nearest you
 Yes! I am interested in an RAAF
 career. Please send me full details.

Name _____
 Mr/Miss _____
 Address _____
 State _____ Postcode _____
 Date of Birth: _____/_____/_____

RG.417.FP.11ET

You're somebody in Today's Air Force

Authorised by Director-General Recruiting Dept. Defence

Seeking the gluon

Brian Dance

Are gluons the fundamental particles that hold everything together?

IT'S A LONG TIME since Thomson discovered the electron (from which the name of our hobby is derived), but modern electronic equipment has been used to search for more and more particles, the latest being the 'gluon'. The name gluon obviously comes from the fact that this particle is postulated as acting as a glue which holds something together, but the story is a little more involved than this.

In the 1960s the hypothesis that all nuclear particles consist of still smaller particles known as 'quarks' was tentatively proposed and this idea has grown in importance with time so that it is now widely accepted. Evidence has been accumulated for the existence of five different quarks and physicists are now seeking a sixth type which is believed to exist for reasons of symmetry. According to the current theory, quarks combine in groups of three to form protons and neutrons which are held together by the 'strong' nuclear force. The latter is one of the four fundamental forces of nature, the others — in order of diminishing strength — being the electromagnetic force which controls all chemical change, the 'weak' force responsible for certain radioactive changes (beta radioactivity) and the gravitational force.

Each of these forces is associated with an intermediary particle, at least in theory. The best known of these intermediary particles is the photon, which gives rise to the electromagnetic forces which manifest themselves as electrostatic forces between electrical charges, the magnetic forces in electric motors, etc. The intermediary particle connected with the strong force is the gluon, which is said to travel very rapidly between the quarks which it is holding together.

Experimenters have thought there would be little hope of detecting the gluon to confirm the theoretical work, since it is associated with the strongest of the four forces known to exist in nature. However, recent work has

provided quite strong evidence that this particle exists. Nobel prize winner Professor Abdus Salam predicted in his concluding talk at the Geneva high energy physics conference in 1979 that the gluon is likely to be discovered before the long-awaited intermediary particle of the weak interaction, the intermediate vector boson which has been sought in neutrino experiments, and it certainly appears that his forecast will be correct.

A team of people working with the PETRA accelerator (near Hamburg, West Germany) announced details of the evidence they had obtained for the existence of gluons at an international conference held at the Fermi National Accelerator Laboratory in Batavia, Illinois, USA, and astonished the particle physicists working in this field.

The PETRA work employed beams of high energy electrons and of positrons. (The positron is the antiparticle of the electron and is similar to it, except that it has a positive charge.) At moderate energies the colliding beams of particles and their antiparticles result in the disintegration of the components into pairs of quarks and anti-quarks which move off very rapidly in opposite directions before they are transformed into the types of particle with which we are much more familiar.

The PETRA workers employed particle energies of about 30 GeV (30 000 million electron volts). They found that, instead of two particles moving in opposite directions from the point of collision, three jets of particles were formed. Two of these jets were narrow, but the third was broad and it

was this latter beam that contained the evidence for the existence of gluons.

Theoretical particle physicists have been gradually formulating a theory of quantum chromodynamics (QCD) to describe the forces that operate deep inside protons, neutrons and similar particles. Gluons are postulated as the carriers of the 'colour' force acting between quarks and are thus ultimately responsible for all of the strong force phenomena. Somewhat delicate effects found in neutrino experiments have given considerable support to the QCD theory, but these effects can easily be masked and are difficult to measure. The work at the PETRA accelerator has provided a new and very effective way of testing the QCD theory.

Under the high energy conditions, one particle of each quark-antiquark pair is believed to have produced a high speed gluon. This process, when continuously repeated, knocked the main beam of particles slightly to one side and thus created a stream of gluons which quickly transformed into quarks and then into other particles. The gluons and the quarks have such a short lifetime that their existence has to be inferred from their effects in the same way that the existence of an animal is often inferred from its foot-prints. The detection of the three beams by the PETRA workers provided very strong evidence of the existence of gluons. The hard gluon emission has been called 'Glühstrahlung' (German for 'glue radiation') by some workers.

This new work at PETRA may well be of great importance for the future in our understanding of the relationship of the

FORCE	APPROXIMATE RELATIVE STRENGTH
Nuclear or strong	1
Electro-magnetic	10^{-2}
Weak	10^{-12}
Gravitational	10^{-39}

Table 1. The forces of nature.

four forces of nature — which are of vital importance in modern physics. The director of the FermiLab, Leo Lederman, has said that physicists are absolutely delighted with the new results and that the discovery of the gluon is of vital importance for our understanding of the theory of the strong force. Physicists are already convinced that the electro-magnetic and weak forces are basically different views of the same thing and it seems likely that the QCD theory will bring the strong nuclear force into the same general system.

We have known about the photon since early this century. If the existence of the gluon is confirmed, it will be only the second intermediary particle to be found. These particles are vital to our understanding of the basic particle interactions and such a discovery should encourage work on further searches for the intermediate vector boson; if the latter has a relatively high mass, a more powerful and more expensive accelerator may be required before it can be produced. The fourth intermediary, the graviton, has also been proposed, but owing to the very weak nature of the gravitation force, it may be a very long time before it is discovered — assuming it can exist. ●

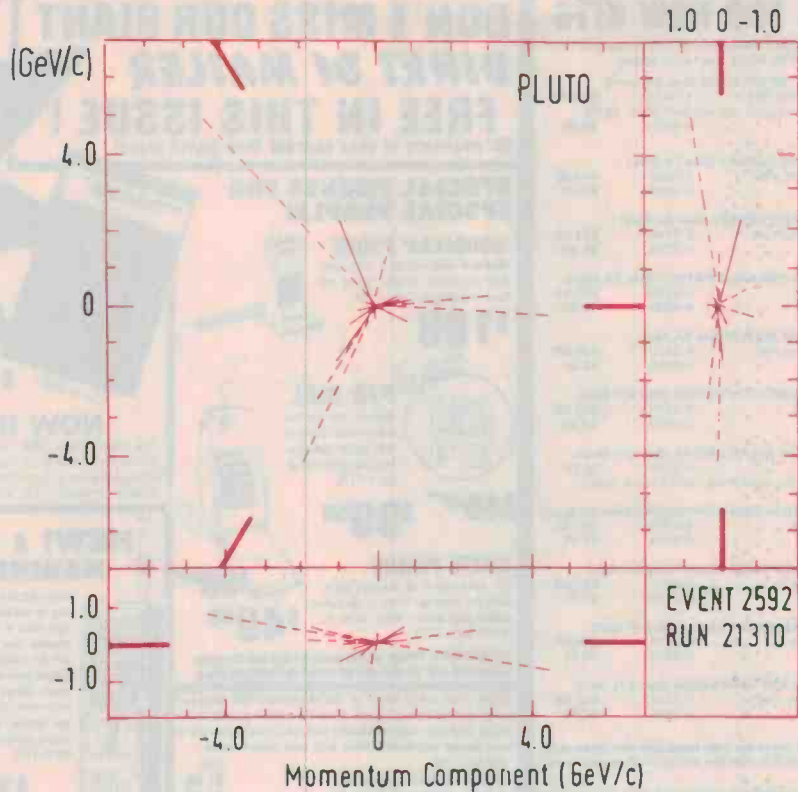
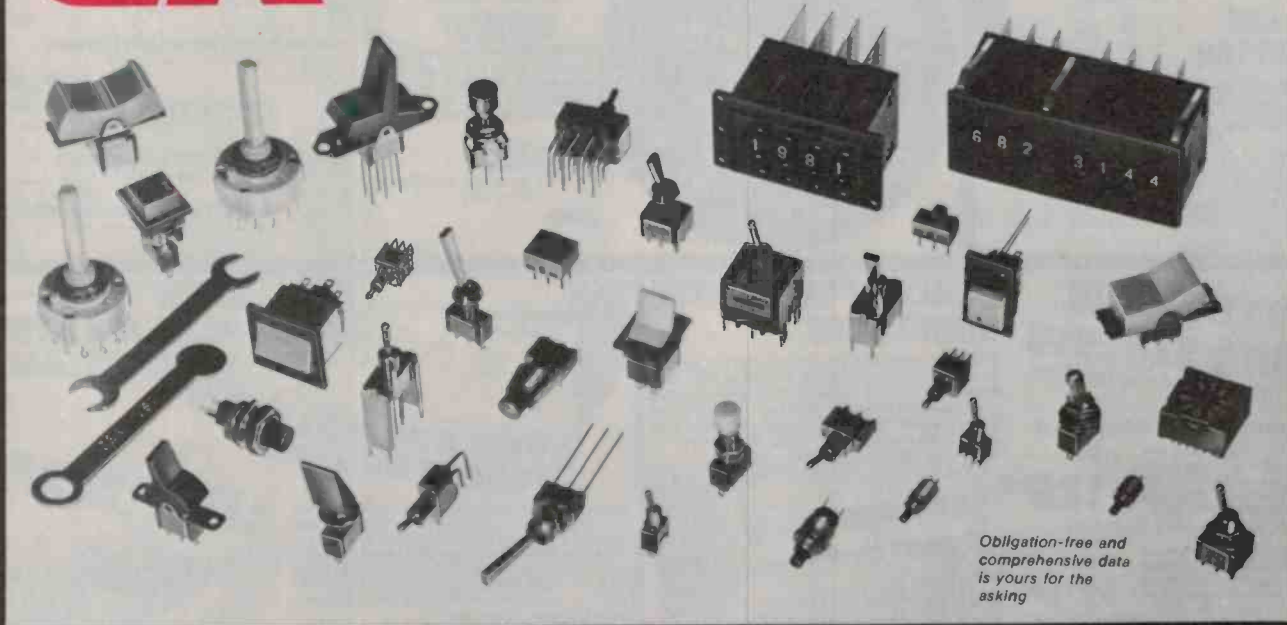

Figure 1. Moments of particles produced at 31.6 GeV at PETRA. Solid and dotted lines correspond to charged and neutral particles respectively. The thick bands show the directions of the jet axis. The three drawings cover the three dimensions. (CERN COURIER.)

C&K

The Primary Source Worldwide...

Subminiature toggle, rocker, illuminated rocker and lever handle, subminiature and microminiature momentary push button, slide, thumbwheel, sealed rocker dip, rotary, pushbutton, if you want it ... we've got it ... the world's finest switch range ... C & K.



Obligation-free and comprehensive data is yours for the asking

C & K Electronics (Aust.) Pty Limited
Office 2/6 McFarlane Street Merrylands N.S.W. 2160
PO Box 101 Merrylands 2160 Tel. (02) 682 3144 Telex AA23404

Agents: Melb. 598 2333/Adel. 269 2544/Bris. 36 1277/Perth 458 7111

PARTS FOR NEW KITS

See also our advert elsewhere in this magazine with new kits since our last catalog.

BENCHMARK (See EA June)
Complete kit, inc inst. K-3478 \$45.00
*Ext. speaker required: use our A-2451 @ \$9.50
PCB only H-8400 \$3.95

HOT CANARY (See EA May)
Complete kit, inc inst. K-3245 \$14.95
PCB only H-8396 \$2.25

SPEED SENTRY (See EA May)
Complete kit, inc. inst. K-3245 \$11.75
PCB only H-8399 \$1.95

INFRA RED REMOTE CONTROL (See EA May)
Full kit, inc inst. K-3380 \$63.95
PCB only H-8397 \$6.95

dB METER (See EA May)
Complete kit, inc inst. K-3476 \$34.80
PCB only H-8398 \$2.35

UHF TV DOWNCONVERTER (See ETI May)
Full kit, inc inst. K-3235 \$32.50
PCB only H-8637 \$2.95

UNIVERSAL RELAY DRIVER (See ETI May)
PCB only H-8638 \$2.25
(All parts for this kit are normal stock items)

SYSTEM 80/TRS 80 SERIAL INTERFACE (See EA April)
Full kit, inc. inst. K-3608 \$67.50
PCB only H-8394 \$7.95

INFRA RED BEAM RELAY (See EA April)
Full kit, inc. inst. K-3375 \$37.50
PCB only H-8395 \$3.95

CORE BALANCE RELAY (See ETI April)
Full kit, inc. inst. K-3315 \$49.50
PCB only H-8635 \$4.50

NEGATIVE ION GENERATOR (See ETI April)
Complete kit, inc. inst. K-3335 \$41.95
PCB only H-8634 \$3.95

(Above prices & dates are from magazine estimates only. We cannot guarantee that the articles will appear when specified.)

BUILD A KIT:

It's simple and it's FUN. Quality Dick Smith kits, complete with instructions to make electronics really enjoyable!

TRANSISTORS TESTER



This one tests bipolar transistors, diodes, FETs and even SCR's & PUT's. It's a low cost and practical instrument simple enough for a beginner to build. Ideal also for the serviceman. A valuable piece of test equipment you can't afford to miss!
Cat. K-3052

\$19.75

TV CRO ADAPTOR

PUT YOUR OLD B&W TV TO WORK!



\$29.95

If you're typical of many people, you never could bring yourself to throwing out the old B&W tv. Lucky you! EA have come up with a kit which enables you to use that old tv set as an audio CRO! You've always wanted a CRO, but could never justify buying one, right? Now you can have your own CRO for next to nothing; and the screen's big too! Cat. K-3080

DON'T MISS OUR GIANT DINKI DI MAILER FREE IN THIS ISSUE!

(Or available at your nearest Dick Smith store)

SPECIAL PHONES FOR SPECIAL PEOPLE!

'CORDLESS' PHONE

Receive or make calls up to 100m away from your phone. Includes 'phone' and base unit/charger. Cat Y-1178

\$199



P/B DIAL

Replaces any standard dial to convert phone to push button operation. Easy (no solder) install. Cat Y-1175

\$49.95

\$39.50

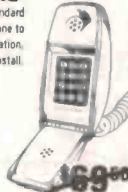

CUTIE PHONE

The name says it all! It's cute and it folds flat when not in use. Push button dialling with last no. recall, simple to install. Cat Y-1179

\$49.50

PLEASE NOTE: These 'phone devices are not Telecom approved and should not be used on Telecom lines.

We're often asked which of the electronics and computer magazines we have available. All of the following are normally stock; however some (especially overseas) magazines are in very limited quantities. Check with your nearest store.

Cat No.	Title	Price
8-5010	Electronics Australia	\$1.80
8-5015	Electronics Today Int	\$1.75
8-5030	Everyday Electronics (UK)	\$1.00
8-5032	Practical Electronics (UK)	\$1.10
8-5040	Wireless World (UK)	\$2.40
8-5044	Amateur Radio Action (Aust)	\$1.30
8-5050	QST (USA)	\$2.80
8-5059	Australian Personal Computer	\$1.85
8-5061	Byte (USA)	\$2.85
8-5062	Micro 80 (Aust)	\$2.50
8-5064	80 Microcomputing (USA)	\$2.50
8-5065	Kilobaud (USA)	\$2.85
8-5066	Creative Computing (USA)	\$2.85
8-5071	Popular Electronics (USA)	\$1.25
8-5074	Radio Electronics (USA)	\$1.75
8-5090	Elektron (UK/Europe)	\$1.70

PLEASE NOTE: Above magazines are not available from our Mail Order Centre.

WATCH THIS SPOT
To see what you missed out on!
Did you miss out on our BELOW COST SPECIAL?
LAST MONTH:
200g roll solder
for only \$2.40 (normally \$4.95)
SAVING YOU \$2.55
NEXT MONTH:
????

HUGE SAVING ON 4116 RAMS!

Top quality, prime spec (yes, the fast 250ns type) at an incredible price reduction. Check this out:

16k KIT (8 IC'S)
(Ware over \$200 18 months ago: Some people still charge that!)
NOW ONLY:
\$29.95 Cat X-1188

INDIVIDUAL IC'S:
Again, the prime spec variety: Cat Z-9310
WERE \$9.95
\$3.95



Cat B-2081 \$17.95

NOW IN STOCK!

The brand new 1981 edition of the World Radio TV Handbook: the international 'bible' of broadcasting. Get right up to date! Includes details of WARC '79. A must for SWL's.

NEW! 6 CHANNEL MARINE 2-WAY

How's this one! Fully approved hand-held two way for boatmen, fishermen, etc. Maximum legal power of 5 watts, capable of 6 channel operation (one channel comes already fitted with the emergency channel of 27.88MHz). External jacks allow you to connect to boat power, antenna, etc. for greater range. 3-way meter shows battery strength, transmit power and received signal strength. A must for anyone concerned with their own safety. Cat D-1123

\$120.00

TIME IT! CLOCK IT!

This superb liquid crystal stopwatch/clock is just the go for today's modern sportsman: whether taking part or watching from the sidelines! Huge, easy to read digits, giving time to 1/100th second, also does lap times, etc. And it's also a highly accurate clock. Incredible value: we've seen similar models for \$100 and more! Cat Y-1041



\$39.50

3.5MM STEREO PLUG & SOCKET!!!

These new plugs & sockets are much sought after by project builders and experimenters. Both plug and socket are extremely versatile where space is a problem. The plug suits our micro-sized cassette recorder headphones (see catalogue).
PLUG. P-1140 75c. SOCKET. P-1240 95c.

COAX ALTERNATOR SUPPRESSOR

Gets rid of that whine. Heavy duty.
Cat. A-7928 \$4.95

DELUXE DISTRIBUTOR SUPPRESSOR

Connects in distributor coil lead. Easy to mount.
Cat. A-7904 50c

GENERATOR NOISE SUPPRESSOR

Heavy duty. Easy mounting with only a screwdriver.
Cat. A-7902 65c

ALTERNATOR NOISE SUPPRESSOR

Has 3 leads. Greatly reduces alternator whine.
Cat. A-7924 \$2.50

DELUXE ALTERNATOR SUPPRESSOR

High density ferrite core. Excellent results.
Cat. A-7926 \$9.50

SPARK PLUG SUPPRESSOR

Fit into spark plug lead. Self-threaded for easy fitting.
Cat. A-7908 65c

VEHICLE NOISE?

Kill annoying whines, cracks & clicks with our range of automotive electrical noise suppressors. Easy to fit - and your ears will thank you!

NEW PLAYMASTER MOSFET AMP KIT

OVER 500 SOLD IN THREE MONTHS!

EXCLUSIVE FEATURES ONLY IN THE DICK SMITH KIT!

Timber sleeve shown is optional: Cat H-3113 @ \$8.50

\$159.00

Timber sleeve shown is optional: Cat H-3113 @ \$8.50

Timber sleeve shown is optional: Cat H-3113 @ \$8.50

Timber sleeve shown is optional: Cat H-3113 @ \$8.50

Timber sleeve shown is optional: Cat H-3113 @ \$8.50

Timber sleeve shown is optional: Cat H-3113 @ \$8.50

Timber sleeve shown is optional: Cat H-3113 @ \$8.50

Timber sleeve shown is optional: Cat H-3113 @ \$8.50

Timber sleeve shown is optional: Cat H-3113 @ \$8.50

Timber sleeve shown is optional: Cat H-3113 @ \$8.50

Timber sleeve shown is optional: Cat H-3113 @ \$8.50

Timber sleeve shown is optional: Cat H-3113 @ \$8.50

Timber sleeve shown is optional: Cat H-3113 @ \$8.50

Timber sleeve shown is optional: Cat H-3113 @ \$8.50

Timber sleeve shown is optional: Cat H-3113 @ \$8.50

Timber sleeve shown is optional: Cat H-3113 @ \$8.50

UPDATE YOUR AUDIO SYSTEM!

AND SAVE WHILE THEY'RE REDUCED!!

Playmaster AM/FM Tuner/Clock

Superb quality AM and FM stereo tuner which also doubles as a highly accurate digital clock. Easy to build: all the hard work is done for you as the tuner section is pre-built and tested. Superb! Cat K-3484

\$159.95
\$129.50

Playmaster Graphic Equaliser

Your listening room probably does horrible things to your sound! You can correct these errors with a graphic equaliser - and make your music exactly as the original! Step-by-step instructions included. Cat K-3500

\$99.95
\$75.00

Playmaster Graphic Analyser

Want to REALLY get the best from your system? The Playmaster Graphic Analyser tells you where the problem areas are: you can set your graphic equaliser up perfectly. And it also doubles as a brilliant LED audio level meter the rest of the time! Cat K-3510

\$89.95
\$75.00

QUALITY PLAYMASTER AUDIO KITS

Want real value and real quality in hi fi? You can't go past the famous Playmaster kit range from Dick Smith Electronics. Designed by Electronics Australia magazine, each of these kits will add a new dimension to your system. Easy to build (each kit comes with our exclusive step-by-step instruction manual).

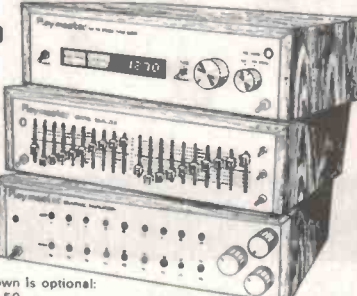

OVER 500 SOLD IN THREE MONTHS!

Electronics Australia's brilliant new design, featuring the very latest in solid state technology: power mosfets. A stunning sound, with a huge 50 watts per channel output! This new Playmaster features loudness and muting controls, plus full range bass & treble controls. Input selection is shown by LEDs, and speakers can be switched from the front panel (two sets of speakers can be used).
Over 500 customers cannot be wrong: the new Playmaster Mosfet Stereo Amplifier is a worthy update for any hi fi system; and because you build it yourself, you save a fortune over comparable commercial amplifiers!
Each kit includes comprehensive step-by-step instruction manual, complete with our exclusive 'Sorry, Dick - it doesn't work' coupon: if you run into trouble, we'll fix your problems for a small fee!

NEW PLAYMASTER MOSFET AMP KIT

EXCLUSIVE FEATURES ONLY IN THE DICK SMITH KIT!

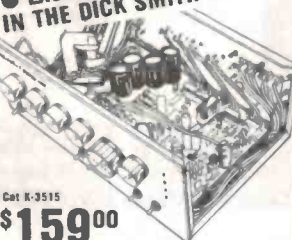

Cat K-3515
\$159.00

B-R-R-R-R!

Control your winter warmth!
A Kambrook Time Switch on your heaters, electric blankets, etc etc will make the cold much more bearable! Imagine getting into a bed already warmed for you: the Kambrook can turn your electric blanket on whenever you like. Or the bathroom can be heated for your morning shower BEFORE you get up! Controls up to 10A, 240V.
(Use for swimming pool filters in summer, too!) Cat Y-1120

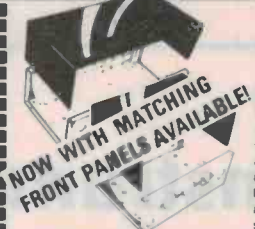

A GOOD CASE FOR BUILDING PROJECTS

Since we made these cases available for general project building, the response has been fantastic. But there has been a very common request: "How about a blank front panel to suit the cases?" Well here they are: front panels to suit our 'Playmaster' and 'Musicolor' size cases, but without any holes or markings. They're finished in the same way our normal front panels are - but you decide where you want the holes and what markings you want (use rub-on letters such as 'Lettaset') Now there's no excuse for putting off that special project: build it with a project case from Dick Smith!

NEW PROGRAMS

For the System 80 Computer (will also run on TRS-80 I/II)
Flight Simulator:
Accurate flight characteristics and fast animation really put you in the pilot's seat! For non-pilots, learn the basics of flight. For experienced pilots, explore an aircraft's capabilities without risking a plane! The makers say that no flight simulator under \$100,000 can match the realism! Cat X-3684 \$34.90

MAINS WIRING?

These useful mains wiring aids from Dick Smith make the job that much easier...

- WALL MOUNTING BOX**
Accepts standard switch plates, power outlets, TV outlets, etc. Proud of wall, enough room for wiring & outlet, etc. within box. Cat P-5531 \$1.25
- WALLBOARD CLIP**
Great for fibrous plaster, fibre, masonite, ply, etc. Lugs clip over wall board, power outlet screws on so it is flush with wall. Ideal for new installations in old buildings. Cat P-5530 45c
- Junction Box**
For mains cable connections, complete with connectors. As used by electricians, etc. Cat P-5625 \$1.70
- DOUBLE POWER OUTLET:** For new jobs or for converting singles. Takes same space as single. Cat P-5560 \$6.00
- POWER OUTLET SAFETY CHECKER**
Check outlets easily and safely. 3 lights give instant good/bad reading. Cat P-5300 \$4.95

LARGE CASE (Ideal for amps, etc)
Size 270 x 250 x 80mm. Cat H-3110 \$7.95

SMALL CASE (Incredibly versatile)
Size 250 x 200 x 80mm. Cat H-3160 \$6.50

Panel to suit: Cat H-3111 @ \$4.90

Panel to suit: Cat H-3161 @ \$4.50

NO OZONE: JUST GOOD IONS!

Medical authorities tell us how good negative ions are for us: the effect is just like being near a mountain waterfall. But beware: some generators produce dangerous ozone too! Not this one: checked by the University of New South Wales; it produces safe and beneficial negative ions ONLY! 240V operated, uses virtually no power! Cat Y-9000 \$85.00!

NICAD PRICES TUMBLE!

Since we announced our large-size NiCad batteries we've been swamped. So we've made another huge purchase: only this time we bought bulk packs. There are two batteries packed on a card: because you buy in bulk too, you save!
'C' Cells Cat S-3302 Were \$4.25 each, NOW \$7.50 pack 2!
'D' Cells Cat S-3304 Were \$4.50 each, NOW \$7.95 pack 2!
'AA' (panlight) Cells Cat S-3300 (Still available singly); Reduced for June & July ONLY: Were \$2.05 ea, NOW 1.95 ea.



CHARGING NICADS:

Use our M-9517 NiCad battery charger and your choice of our battery holders to suit the size & number of cells. See our 1981 catalog, page 97, for more details.

MUSICAL COMPUTER:
Learn music - even without knowing a note. This program will teach you! It's an alternative to conventional music education: or it's a great assistance to it. Covers all the basics of music recognition. Cat X-3640 \$39.95

AT LAST! 'SPACE INVADERS GAME'
Here it is: a superb version of the most popular arcade game in the world. The major difference is that you don't have to keep pumping two bob bits down your computer's throat! All the fun - without the expense. And just look at the price of this program!! Cat X-3699 \$8.95

AND MORE GAMES:
Enter a world where fantasy is at your fingertips! These games are not only fun, they're challenging and mentally stimulating. These are all from the 'EPIX' series by one of the world leaders in computer games. Automated Simulations of the USA.
TEMPLE OF APHA! (Cat X-3641) \$39.95
HELLFIRE WARRIOR (Cat X-3642) \$39.95
STAR WARRIOR (Cat X-3643) \$39.95

Ask at your nearest Dick Smith store for a full listing of currently available computer programs

AND NOW OPEN IN NEWCASTLE

We've finally found a great store location in Newcastle: handy to everywhere, and with parking available! You'll find us in Tighes Hill, almost opposite Newcastle Tech. Why not call in and say hello!

173 MAITLAND ROAD, TIGHES HILL

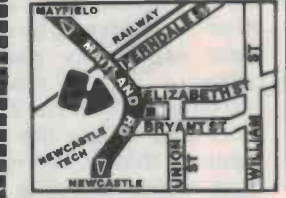

NEW SEMICONDUCTORS

We're always bringing our semiconductor range up to date. Here are the latest additions. These are NOT included in the 1981 Dick Smith catalog. If a device YOU want is not here, why not ask for it anyway? We may stock it already, and if we don't, we'll certainly consider stocking it if there is sufficient demand.

- | | | |
|---|--------|---------|
| 4046 Phase-locked-loop | Z-5646 | \$1.95 |
| 74LS367 Hex bus driver | Z-5292 | 75c |
| 74LS174 6 bit D flip flop | Z-5290 | \$1.00 |
| 74LS139 Multiplexer | Z-5285 | 90c |
| 74157 Multiplexer | Z-5267 | 85c |
| 2516/2716 16K EPROM | Z-9207 | \$11.95 |
| LM311 Voltage comparator | Z-6048 | 70c |
| 74LS373 Dual D flip flop | Z-5295 | \$1.95 |
| 74LS165 Par. load 8 bit shift register | Z-5288 | \$1.65 |
| 74LS86 Quad 2 input OR gate | Z-4986 | 45c |
| 74LS27 triple 3 input NOR gate | Z-4927 | 40c |
| 74LS05 Hex inverter | Z-4905 | 35c |
| 74109 Dual J-K triggered flip-flop | Z-5252 | 50c |
| LM339N Quad Comparator | Z-6039 | 70c |
| 81LS95/97 Tri State Carry Driver | Z-5300 | \$1.80 |
| CD4040 14 st. ripple carry bin. counter | Z-5640 | \$1.70 |
| CD4069 Inverter | Z-5669 | 45c |
| CD4526 4 bit prog. down counter | Z-5744 | \$1.65 |
| 74LS132 Quad 2 input Schmitt trigger | Z-5283 | \$1.70 |

NEW! 3.5 DIGIT LCD

A MUST FOR THE SERVICE TECH, SERIOUS HOBBYIST ETC!

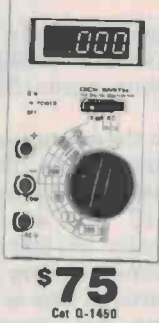

Amazing value for such a versatile and accurate instrument. Features 20 ranges up to 600V DC, 1kV AC and 200mA DC, at an accuracy of 0.8%! Operates from a single 9 volt battery (supplied) and it measures only 90 x 170 x 25mm. An investment that will pay for itself over and over. Cat Q-1450 \$75



NEW! \$179.00
TEAC QUALITY METAL DECK
We've been searching for a deck like this for some time - and here it is. A superbly made unit, featuring the latest in technology: metal capability (of course). Dolby noise reduction (of course); separate bias & equalisation switching, peak reading LEDs as well as large vu meters... the features go on and on. Call into a Dick Smith store and check this superb deck out - but soon. You might miss out! Cat A-3501

Noticed the price of Dick Smith cassette tape in the mailer? You should; it's half price! Yes, quality Dick Smith cassettes for half their normal price. See them in the mailer in this magazine!

DICK SMITH ELECTRONICS

- NSW**
- AUBURN: 145 Parramatta Rd. 648 0558.
 - BLAKEHURST: 613 Princes Hwy. 546 7744.
 - BROADWAY: 818 George Street. 211 3777.
 - BROOKVALE: 531 Pittwater Rd. 93 0441.
 - CHULLORA: 147 Hume Hwy. 642 8922.
 - GORE HILL: 162 Pacific Hwy. 439 5311.
 - PARRAMATTA: 30 Grose Street. 683 1133.
 - SYDNEY: 125 York Street. 290 3377.
 - WOLLONGONG: 263 Kiera Street. 28 3800.
 - TIGHES HILL: (Newcastle) 173 Maitland Rd

- ACT** ● Fyshwick: 96 Gladstone Street. 80 4944.
QLD ● BURANDA: 166 Logan Rd. 391 6233.
● CHERMSIDE: 842 Gympie Rd. 59 6255.
SA ● ADELAIDE: 60 Wright Street. 212 1962.
VIC ● MELBOURNE: 399 Lonsdale Street. 67 9834.
● RICHMOND: 656 Bridge Rd. 428 1614.
● SPRINGVALE: Dandenong & S'vale Rds. 547 0522.
WA ● PERTH: 414 William Street. 328 6944.
● CANNINGTON: Wharf St & Albany Hwy. 451 8666

BUYING BY MAIL?

ORDER VALUE:	P&P
\$6 (min) to \$9.99	\$1.00
\$10.00 to \$24.99	\$2.00
\$25.00 to \$49.99	\$3.00
\$50.00 to \$99.99	\$4.00
\$100 or more	\$5.50

NOTE: These charges apply to goods sent by post in Australia only. Large and bulky items cannot be sent by post. If you prefer, we will dispatch your order by Comet Road Freight to anywhere in Australia for only \$7.00 - that's below what it costs us! Large and bulky items are normally sent by Comet unless you specify differently. (eg by rail or air - you pay freight on delivery).

DICK SMITH MAIL ORDER CENTRE:
SERVICE CENTRE: LANE COVE & WATERLOO RDS, NORTH RYDE NSW 2113. PHONE (02) 888 3200. 9AM TO 5PM, MONDAY TO FRIDAY ONLY.

PO Box 321, North Ryde, N. S. W. 2113. Ph: (02) 888 3200.
SHOP HOURS: 9AM - 5.30PM Mon - Fri. 9AM - NOON Sat. (Brisbane 1/2 hr earlier). Some stores open for late night shopping; please phone store before making special trip in!

COMPUTER HOTLINE

Want to know more about our computers? Or maybe you're having problems and need advice. For friendly, helpful information on System 80 or Sorcerer computers, or on any of our peripherals, phone our Computer Hotline: Monday - Friday, 9 - 5.30 **888 2002** on Sydney (02)

Dear Customers,

Quite often the products we advertise are so popular they run out within a few days. Or unforeseen circumstances might hold up goods so that advertised lines are not in the stores by the time the advert appears. Please don't blame the store manager of staff that cannot solve a stock drake on the other side of the world, or even locate a shipment that has gone astray.

What we are trying to say is that if you are about to drive across town to pick up a particular line at a Dick Smith store, why not give the store a ring first (addresses and phone numbers opposite) just in case! Thanks
Dick Smith and Staff

MAJOR DICK SMITH RE-SELLERS:

- ATHERTON, QLD:** Tableland Radio Service 2 Jack Street. Phone 912 017
BENIOGO, Vic: Sumner Electronics 95 Mitchell Street. Phone 431 977
BLACKHEATH, NSW: Goodwin Electronics 123 Station Street. Phone 878 379
BROKEN HILL, NSW: Crystal TV Rentals 66 Crystal Street. Phone 8897
CAIRNS, QLD: Thompson Instrument Services 75-81 McLeod Street. Phone 512 404
COFFS HARBOUR, NSW: Coffs Harbour Electronics 3 Coffs Harbour Place, Park Ave. Phone 525 684
DARWIN, NT: Kent Electronics 42 Stuart Highway. Phone 814 749
UUBOO, NSW: Seleka Sound. 31 Talbragar Street. 826 939
EAST MAITLAND, NSW: East Maitland Electronics. Cnr Laws & High Streets. 337 327
FAIRY MEADOW, NSW: Trilogy Wholesale Elect. 40 Princes Hwy. Phone 831 219
GERALDTON, WA: KB Electronics & Marine 261 Main Terrace. Phone 212 176
GOSFORD, NSW: Tomorrow's Electronics & Hi Fi 68 William Street. Phone 747 246

Listed below are re-sellers who stock a large proportion of our range. However we cannot guarantee that they will have any or all of the items, or at the same prices, as those shown here.

- HOBART, TAS:** Aero Electronics 123a Bathurst Street. Phone 348 232
KINGSTON, TAS: Kingston Electronics & Records Channel Court. Phone 296 802
LAUNCESTON, TAS: Advanced Electronics 5a The Quadrant. Phone 317 075
LISMORE, NSW: Decro Electric Alaghton St & Bruner Hwy. Phone 214 137
MACKAY, Qld: Stevens Electronics 42 Victoria Street. Phone 511 723
MARYBOROUGH, Qld: Keller Electronics 218 Adelaide Street. Phone 214 559
MORUYA, NSW: Coastal Electronics 43 Vulcan Street. Phone 742 545
MT GAMBIER, SA: Hutchesson's Communications 5 Elizabeth Street. Phone 256 404
MUSWELLBROOK, NSW: Silicon Chip Electronics Suite 3, 98 Bridge Street. Phone 43 1096
NAMBOUR, Qld: Nambour Electronic Shop Shop 4, Lowan House. Ann St. Phone 411 605
NEWCASTLE, NSW: Elektron 2000 181 Wharf Road. Phone 262 644
ORANGE, NSW: M&W Electronics 48 McNamara Street. Phone 626 491
ROCKHAMPTON, Qld: Purely Electronics 15 East Street. Phone 21 058
SOUTHPORT, Qld: Amateur's Paradise 121 Nerang Street. Phone 322 684
TAMWORTH, NSW: Sound Components 28 Brisbane Street. Phone 661 263
TOWOOMBA, Qld: Hunts Electronics 18 Neil Street. Phone 326 944
TOWNSVILLE, Qld: Tropical TV 43 Fulham Rd. Vincent Village. Phone 791 421
TRARALGON, Vic: Power N' Sound 147 Argyle Street. Phone 743 638
WAGGA, NSW: Wagga Wholesale Electronics 82 Fosyth Street.
WINDSOR, NSW: Hawkesbury Electronic Centre 111 George Street. Phone 773 411
WOONGA, VIC: A & M Electronics 78a High Street. Phone 244 588
WHYALLA NORRIE, SA: Mellor Enterprises Shop 2, Forsyth Street. Phone 454 764

There's a re-seller near YOU!

High impedance instrument probe features 100 MHz bandwidth

This probe will allow you to make CRO or frequency meter/timer measurements on high impedance circuits with waveforms having rise times as fast as three or four nanoseconds. Cost is well below commercial equivalents.

Jonathan Scott

MOST READERS would be aware that, when taking a measurement on electronic circuitry, the input impedance of the measuring instrument must be much greater than the impedance of the circuit to which it is attached, otherwise the accuracy of the measurement suffers. The input impedance of the majority of oscilloscopes is generally 1M with a parallel capacitance of between 20 pF and 40 pF. For a wide variety of applications this is perfectly adequate and will suffice for measurements of frequencies up to 5 MHz or so. The input impedance of the CRO falls with increasing frequency owing to the falling reactance of the input capacitance. For example, a capacitance of 30 pF — which may be made up of direct input capacitance plus cable capacitance — has a reactance of only 500 ohms at 10 MHz. The input capacitance also affects the rise time of the input — that is, the speed at which a 'step' input will rise from the 10% amplitude value to the 90% amplitude value.

The input impedance of an oscilloscope can be effectively raised, and the capacitance decreased, by using a 'step-down' probe. For example, a 'x10' probe will generally have an input impedance of 10M and a parallel capacitance of between 5 pF and 15 pF. While this improves the input impedance there are two trade-offs. Firstly, unless elaborate (and expensive) compensation is employed, the rise time is degraded, and secondly, maximum sensitivity is decreased by a factor of ten. As Murphy's law would have it, your CRO will run out of grunt just when you need it most.

Taking the situation with digital counter/timers, we find similar problems. Those that operate beyond 30 MHz or 50 MHz generally employ a prescaler with an input impedance of 50 ohms — which is perfectly all right if you're working on low impedance circuits and/or with high signal levels. But there are those occasions when you need



a high impedance input and a fast (high frequency) rise time. As with the CRO, this is where your counter/timer runs out of grunt.

It's times like these you need . . . the ETI-156 instrument probe. This project is a x1 active instrument probe using a special buffer IC with an input impedance of typically 100 000 megohms! — that's 10^{11} ohms — a very low input capacitance of around four to five picofarads, a fast rise time (around three nanoseconds) and a bandwidth of 100 MHz. Output impedance is around 50 ohms and the device is capable of driving capacitive loads up to several thousand picofarads. Thus it is eminently suited for use with high speed, wide bandwidth oscilloscopes and digital frequency meter/timers at frequencies up to 100 MHz. Output impedance is close to 50 ohms and it is thus suited to drive both high impedance instrument inputs and low impedance inputs (which are generally 50 ohms).

Design

It's all done inside a special IC — an LH0033CG from National Semiconductors. This is described as a 'fast buffer amplifier'. (It has a companion designated LH0063, described as a 'damn fast buffer amplifier!'). The LH0033 is a direct-coupled FET-input voltage follower/buffer (gain ≈ 1) designed to provide high current drive at frequencies from dc to over 100 MHz. It will provide ± 10 mA into 1k loads (± 100 mA peak) at slew rates up to 1500 V/ μ s, and the chip exhibits excellent phase linearity up to 20 MHz. No offset voltage adjustment is required as the unit is constructed using specially selected FETs and is laser-trimmed during construction. Input is directly to the gate of a junction FET, operated as a source follower, driving a complementary output pair of bipolar transistors.

Regulated plus and minus supplies of 15 V each provide power to the IC. Low-power three-terminal regulators are

SPECIFICATIONS ETI-156 HIGH IMPEDANCE INSTRUMENT PROBE

Input impedance	10^9 to 10^{11} ohms (depends on construction)
Input capacitance	about 5 pF (depends on construction)
Maximum permissible input voltage	
*Hi-z load	± 15 V
*50 Ω load	± 10 V
Output impedance	50 to 55 Ω
Bandwidth	100 MHz
Rise time	better than 3.5 ns
Gain	
*Hi-z load	0.98
*50 Ω load	0.49

hi-z instrument probe

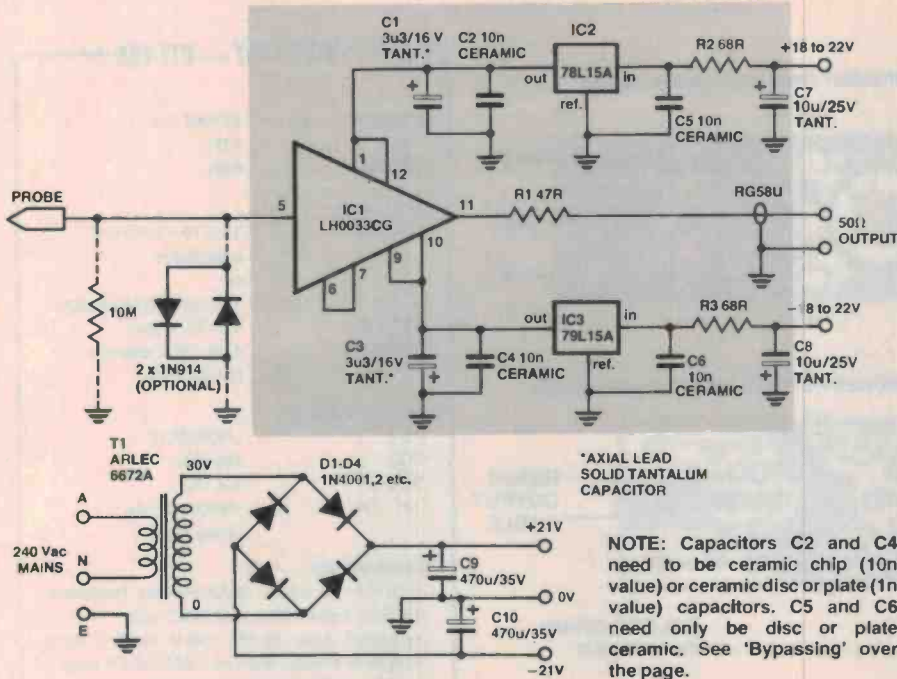

*AXIAL LEAD SOLID TANTALUM CAPACITOR

NOTE: Capacitors C2 and C4 need to be ceramic chip (10n value) or ceramic disc or plate (1n value) capacitors. C5 and C6 need only be disc or plate ceramic. See 'Bypassing' over the page.

used to keep the unit compact. An external unregulated supply of between 18 and 22 volts at around 50 mA is required to power the probe.

The supply pins on the IC need to be well bypassed over a wide frequency range so that the IC can maintain its characteristics, and the construction has been specially arranged to achieve

this. Axial lead solid tantalum capacitors are used to bypass the IC's supply pins at the lower frequencies, while low inductance ceramic capacitors are employed as bypasses for the higher frequencies. A double-sided fibreglass pc board is used to preserve the high frequency response and the high input impedance, and the layout is arranged

SPECIFICATIONS LH0033

Absolute maximum ratings

Supply voltage	±40 V
Max. power dissipation	1.5 W
Input voltage	same as supplies
Continuous output current	±100 mA
Peak output current	±250 mA

dc characteristics (LH0033C/LH0033CG) — typical

Output offset voltage	12 mV
Voltage gain	0.98
Input impedance	10 ¹¹ ohms
Output impedance	6 ohms
Output voltage swing (V _s = ±5 V)	(6 V p-p)
Supply current (V _s = ±15 V)	21 mA
Power consumption (V _s = ±15 V)	630 mW

ac characteristics (LH0033C/LH0033CG) — typical

Slew rate (V _{in} = ±10 V)	1400 V/μs
Bandwidth (V _{in} = 1 V _{rms})	100 MHz
Phase non-linearity (1 - 20 MHz)	2°
Rise time (ΔV _{in} = 0.5 V)	3.2 ns
Propagation delay (ΔV _{in} = 0.5 V)	1.5 ns
Harmonic distortion (f = 1 kHz)	<0.1%

NOTE: Unless otherwise specified, these figures apply for +15 V applied to pins 1 and 12, -15 V to pins 9 and 10, and pin 6 shorted to pin 7. Specifications apply over temperature range between -25°C and +85°C; typical values shown are for a temperature of 25°C.

LH0033 Output Voltage vs Supply Voltage

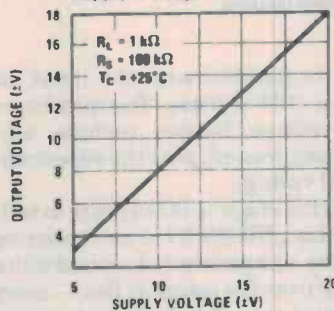

LH0033 Frequency Response

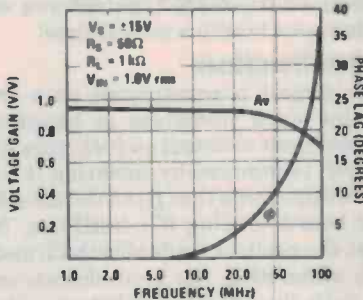

HOW IT WORKS ETI-156

This instrument probe employs a wideband hybrid voltage follower/buffer IC, the LH0033, with very close to unity gain, that features a very high input impedance and a low output impedance. It requires regulated, well-bypassed supply rails. Two three-terminal low power regulators provide plus-and-minus 15 V supplies from an unregulated input.

The internal circuit of the LH0033 is shown below. Basically, it consists of a FET input stage (Q1), operated as a source follower. The other FET, Q4, provides a constant current source for the source bias of Q1, while Q2 and Q3 are connected as diodes and provide bias for the bases of Q5 and Q6. Resistors R1 and R2 are laser trimmed in manufacture so that the IC meets the offset voltage specification. As Q1 has a constant current source load, the input impedance at the gate of Q1 is very high indeed and the distortion of the stage is very low. The output of the source follower drives a complementary pair output stage, Q5-Q6. Thus the IC will have a very high input impedance, a very low output impedance and a gain very close to unity. With appropriate construction employed for the internal devices, the bandwidth over which the device will operate can be made very wide indeed. The -3 dB point for the LH0033 is 100 MHz.

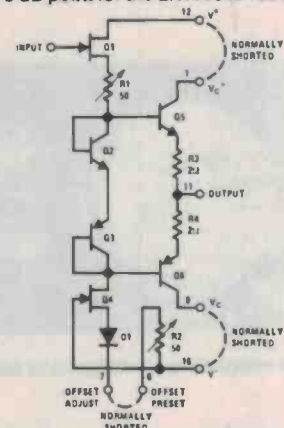

As the device is direct-coupled, dc levels will be maintained between input and output.

Bypassing requirements for the IC's supply leads are explained elsewhere in the article.

To provide regulated plus-and-minus 15 V rails for the IC, two three-terminal regulators are employed, a 78L15A for the positive rail and a 79L15A for the negative rail. These can supply up to 100 mA and have a very low output impedance up to several hundred kilohertz, which is exploited for low frequency bypassing. Each supply rail requires an unregulated input of between 18 V and 22 V. Decoupling of the supply leads is provided by R2/C7 on the positive rail and R3/C8 on the negative rail. The input terminal of each regulator is bypassed to prevent instability.

As the input voltage is limited to a maximum equal to the supply rails (high impedance load), input protection may be added in applications where only low level signals are being examined. As shown in the main circuit, this protection consists of two 1N914 diodes connected back-to-back in parallel with a 10M resistor across the input. Signals above 1 V peak-to-peak will be clipped, preventing any damage to the IC. If very fast rise time signals are to be examined then better protection for the IC can be obtained by using hot-carrier diodes such as the HP 5082-2800 instead of the 1N914s.

Project 156

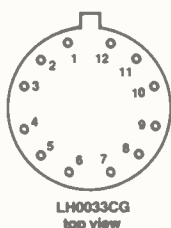

LH0033CG
top view



TANTALUM
CAPS.

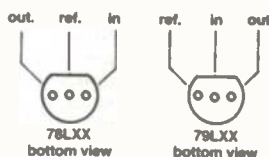

IC2, IC3 PINOUTS

COMPONENT OVERLAY, TOP OF BOARD

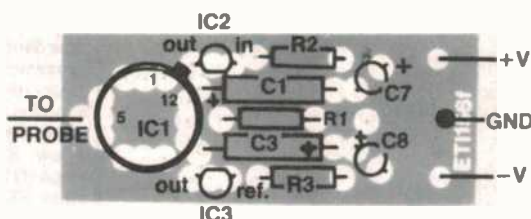

COMPONENT OVERLAY, BOTTOM OF BOARD

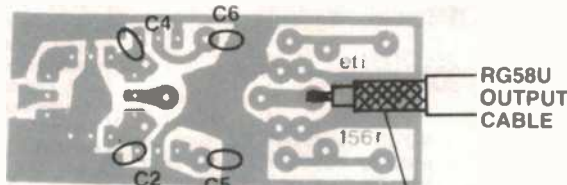

SOLDER BRAID
TO COPPER

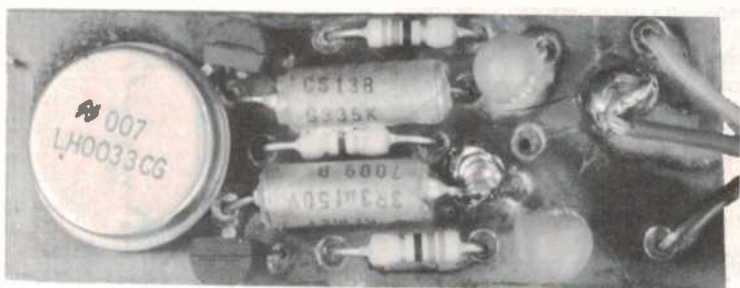

The completed pc board, prior to assembly in the probe housing.

PARTS LIST — ETI 156

Resistors all 1/2W, 5%
R1 47R
R2, R3 68R

Capacitors
C1, C3 3u3/16 V solid tant.
axial leads,
or
C2, 4, 5, 6 10n ceramic block caps.
C7, C8 10u/25 V tant.
C9, C10 470u/35 V electrolytics
(if required)

Semiconductors
IC1 LH0033CG
IC2 78L15A
IC3 79L15A
D1 - D4 1N4001, 2, etc.
(if required)

Miscellaneous

ETI-156 pc board (double-sided fiberglass);
RG58U coax cable and BNC plug; T1 — (if
required) Arlec 6672A 240 V to 30 V trans-
former or similar; optional 10M/1/2W 5% resistor
and 2 x 1N914 diodes; wire; probe housing —
Jabel type PH3T or similar.

Price estimate

We estimate the cost of purchasing all the com-
ponents for this project will be in the range:

\$48 - \$55

Note that this is an estimate only and not a
recommended price. A variety of factors may
affect the price of a project, such as — quality of
components purchased, type of pc board (fibre-
glass or phenolic base), type of front panel
supplied (if used), etc — whether bought as
separate components or made up as a kit.

to permit direct connection to the probe tip and provide low input capacitance.

However, the presence of the pc board substrate will degrade the input impedance, surprisingly enough, and you can drill out the area of board immediately beneath pin 5 of the IC and solder the pin directly to the probe tip. For those who wish to go 'all the way' (as Frank Sinatra sings), the plastic insulation of the probe tip can be replaced with a similar piece of Teflon — if you can afford it and have access to a lathe.

The maximum input voltage permissible, when driving a high impedance load, is plus or minus 15 volts. When driving a 50 ohm load, maximum input voltage permissible is only plus or minus 10 volts (limited by maximum output current). No input protection has been included. However, if you are only working with circuits where voltages are no greater than about 1 V peak-to-peak, protection can be added by putting two diodes back-to-

back in parallel with the input, along with a 10M resistor. The maximum input voltage figures include any dc voltages present, *plus* the superimposed signal voltage.

At this stage it is only fair to tell you that the LH0033CG is an expensive device (by comparison) at around \$30 or so apiece over the counter. But — compare the total cost of this probe to a similar commercially-made type and you won't catch your breath a second time!

Construction

The project is constructed on a small double-sided fiberglass pc board *with components mounted on both sides of the board*. Commence by soldering in place the components that go on the top side of the board, leaving IC1 until last. Note that the positive leads of both C3 and C8 are soldered to the groundplane areas on both the top and the bottom sides of the board. Take care with the orientation of the tantalum capacitors, as well as IC2 and IC3. Having done that,

solder C2, C4, C5 and C6 to the bottom side of the board. Now you can install IC1. Watch the orientation — the tag on the can points toward the 'out' pin of IC2. You will have to juggle the legs a little. Push the can as far down on the board as you're able; its base should sit no more than 3 mm from the board.

Now that you have everything in place, *check it all*. It seems pretty simple, but Murphy's law will ensure that the simplest things have the highest stuff-up rates!

All's well? — now you attach the output coax cable to the underside of the board, plus the dc input and ground (0 V) wires. *But* — before you do, slip the output end piece of the probe case over the cable and supply wires, push it down about 150 mm or so and then slip the case of the probe case down the wires. This saves slipping them over the other end of the whole business and sliding them all the way to the probe.

The probe tip can be attached and

hi-z instrument probe

soldered in place last of all. Now you can screw it all together and attach the appropriate plugs to the other end of the cable and supply wires.

With the construction completed, you can power up and try it out. Note that the transformer suggested in our power supply is but one of many suitable types. Any transformer that will deliver at least 26 Vac at a load of about 50 mA

will suffice. Alternatively, any dual-polarity dc supply having an output between 18 and 22 volts at 250 mA will power the probe.

Notes

When using the probe to drive a 50 ohm load, the pulse response can be improved if you wish by a simple modification. Apply a fast rise time

square wave to the input and observe the output on a wideband (50 MHz to 100 MHz) CRO. The rise time can be optimized by paralleling small-value ceramic capacitors across R1 — tack them in place on the underside of the board.

Always take care that you don't exceed the input voltage limitation; LH0033s are expensive.

BYPASSING

SUPPLY LEAD BYPASSING is important in order that the LH0033 can operate correctly over the full bandwidth from dc to 100 MHz. To ensure this, the bypassing has been specially arranged and the techniques employed are probably unfamiliar to many readers.

The output circuit signal return path for the IC is via the ground and the two supply rails. Any significant impedance in series with this path (or paths) will subtract signal from the output load. Thus, the supply rail bypassing has to present an impedance which is a *fraction* (like one-tenth or better) that of the minimum output load impedance. Here, the minimum output load is about 100 ohms (R1 + 50 ohms Instrument input impedance) and the supply bypassing impedance should ideally be less than 10 ohms across the frequency range.

The bypassing on each supply rail to the IC leads here takes advantage of the characteristics of three separate components to cover three sections of the frequency range.

From dc to around 100 kHz, each three-terminal regulator (IC2, IC3) has an output impedance well below one ohm, rising to four or five ohms at 1 MHz, as shown in Figure 1. The two tantalum capacitors, C1 and C3, then take over.

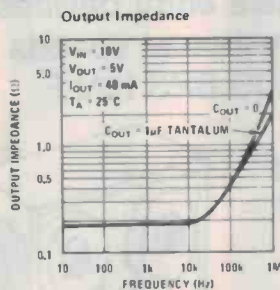

Figure 1. Output impedance characteristic of a three-terminal regulator.

Solid tantalum capacitors have a characteristic impedance that falls with frequency according to its value, which then 'flattens out' in the region around 500 kHz — 1 MHz, rising to a few ohms around 10 MHz, as can be seen in Figure 2. Thus, C1 and C3 serve as effective bypasses across the range from around 100 kHz to around 10 MHz. Axial lead tantalum capacitors were chosen as their construction exhibits the slowest impedance rise following the minimum impedance value.

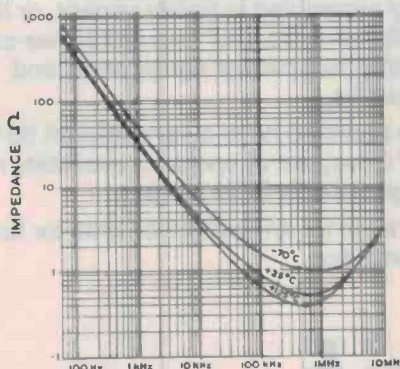

Figure 2. Impedance characteristic of axial lead solid tantalum capacitors.

To provide bypassing over the decade from 10 MHz to 100 MHz, capacitors C2

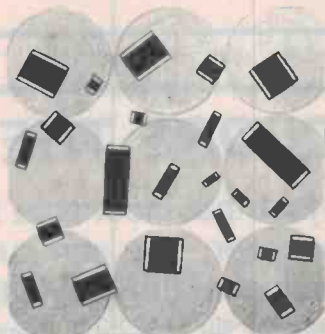

Figure 3. Ceramic chip capacitors — shown about actual size. They have no leads, just plated end pads for connections.

and C4 have been specially chosen and positioned on the pc board. For the prototype, 'chip' ceramic capacitors were used. These tiny, 'naked' chips of ceramic with a capacitor embedded in them are probably the most effective bypass capacitors made. The leads and physical construction of all capacitors form an inductance which is effectively in series with the capacitance of the component. The combined effect forms a series resonant circuit, the frequency of which (that is, the self-resonant frequency of the component) is mainly dependent on the length of the connecting leads, the particular construction of the capacitor and the way in which it is mounted. Ceramic chip capacitors, being a tiny block with connecting pads or surfaces on each end, have extremely low values of series inductance and thus very high self-resonant frequencies — see Figure 4. Now, any value of chip capacitor between 1n and 10n can be used for C2 and C4. The self-resonant frequency

of a 1n chip capacitor is somewhat above 100 MHz (as per Figure 4), but that of a 10n chip is between 40 MHz and 50 MHz. Now, this isn't a problem, for the chip's impedance falls with frequency as usual until near the self-resonant frequency where it falls rapidly, reaching a minimum at the self-resonant frequency. Above that frequency its impedance rises again, but is still low enough for effective bypassing.

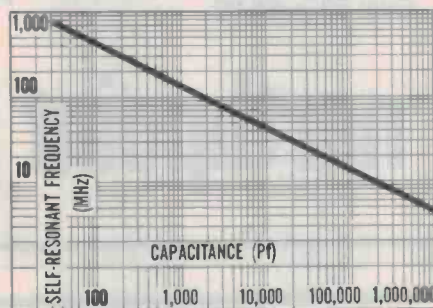

Figure 4. The self-resonant frequency versus capacitance of a typical ceramic chip capacitor.

Ordinary ceramic disc and plate capacitors behave in much the same way. The self-resonant frequency of a typical 5 mm diameter disc or 5 mm square plate capacitor depends on the lead length, as shown in Figure 5. Thus, you could use 470 pF or 1000 pF (1n) capacitors of this type for C2 and C4, provided you installed them on the underside of the board with *absolute minimum lead length*. More information on this subject can be obtained from "Self Resonance in Capacitors" by Roger Harrison, ETI March 1978, page 80.

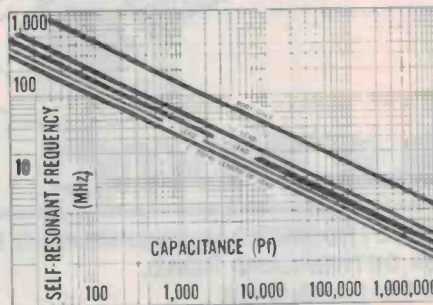

Figure 5. The self-resonant frequency versus capacitance of a typical 5 mm disc or plate ceramic capacitor with differing lead lengths (from lower curve, up — 25 mm lead length, 22 mm, 13 mm, 6 mm and none).

**CASSETTE
SPECIALS**

PHILIPS LOUDSPEAKERS

	Price per Box of 10
OPUS UDC90	\$19.00
AMPEX 20/20 C90	\$19.00
AMPEX GMI C90	\$33.00
AMPEX PROF C45	\$7.50
AMPEX PROF C90	\$14.90

Mail order charges:

Up to 20 — \$2.75

20 to 50 — \$3.50

Over 50 — \$5.00

PROFESSIONALLY DESIGNED SPEAKER KITS

See us at Northpoint Hi-Fi for the new range of Philips Loudspeakers. We have the ETI-designed Series 4000 on display. Both the 4000/1 and 4000/2 can now be supplied fully assembled in timber veneer, or if you prefer to make your own boxes, we can supply the speaker components and networks.

We now also have a very efficient 50 watts 12" 3-way set of speakers available, ready to go, for only \$249 per pair.

Come in for an audition or write for further information.



northpoint hi-fi

100 Miller St, North Sydney.
Phone 922-7780.

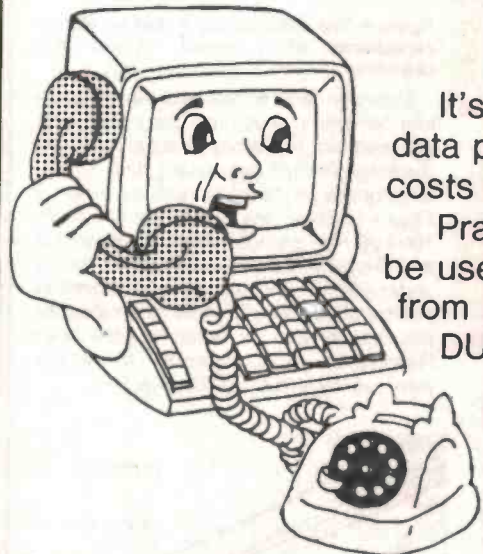

CLOSE THE GAP

It's a fact that most data terminals are remote from the data processor. You can cut data entry delays, errors and costs by closing the gap with Sendata acoustic modems.

Practically all RS232 compatible data entry devices can be used via the standard telephone system at speeds from 300 BPS FULL DUPLEX to 1200 BPS HALF DUPLEX with Sendata modems.

**Call us for further details and
the number of your nearest
Sendata stockist.**

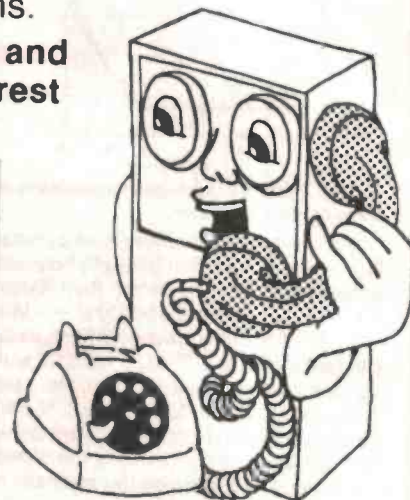

ELECTRO-MED

ELECTRO-MEDICAL ENGINEERING P/L.
69 SUTHERLAND ROAD,
ARMADALE, 3143.
VICTORIA, AUSTRALIA.
TELEPHONE: (03) 509 5844
TELEX: A34008

Liquid crystal displays

Liquid crystal displays, often referred to as LCDs, are widely used in such things as watches, digital instruments, computer displays — and even pocket TV sets, these days! Here's how they work.

Robin C.H. Moorshead B.Sc.

JUST AS DAY follows night, there are certain patterns of change in the physical world which we hold to be always true. Perhaps one of the earliest that we learn is that matter exists in three states, solid (crystalline), liquid or gas. The particular state a substance exists in depends on temperature. At low temperatures substances tend to be solid, at higher temperatures liquid, and yet higher, gaseous. Furthermore, the transition between the states is clear and precise; for example, ice changes to water at 0°C — there is no gradual transition.

This pattern of change is explained by the 'kinetic theory'. This theory is based on several assumptions: that matter consists of minute, more or less spherical particles which are held together by 'cohesive forces' which are spread evenly over their surface. In the solid (crystalline) state the particles are tightly bound by the cohesive forces and are perfectly ordered like bricks in a wall. As the temperature increases, the particles begin to vibrate and the cohesive forces weaken so the particles can move about but are still attached to one another (see Figure 1).



Figure 1.

At higher temperatures the cohesive forces are vanishingly small and the (gas) particles fly about at random (see Figure 2).



Figure 2.

Simple materials which fit into this description have another property, that their physical characteristics are the same from whichever direction they are approached. This is termed 'isotropic'. Examples of isotropic materials are glass, steel or water. Their electrical resistance, refractive index and strength are the same from whichever direction we measure them.

Against the grain

However, by no means all materials are isotropic; wood for example is much stronger across the grain than with the grain, graphite has a higher electrical resistance when measured through its 'plate' structure than when it is measured along the plates. Such materials as these are termed 'anisotropic' (see Figure 3).

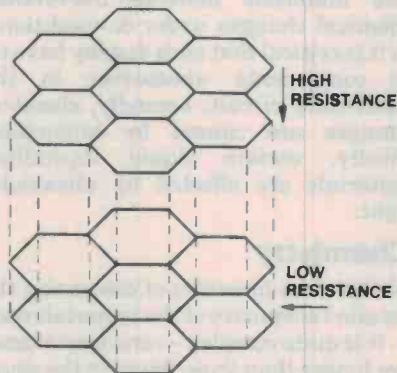

Figure 3. The resistance of graphite along and through its plates.

It would be surprising if wood and graphite were isotropic, since they are constructed of rods (cellulose fibres) and plates (the graphite). In the same way we would not expect roof slates to fall into a box in a random arrangement; they will have a strong tendency to fall flat and so order themselves into an anisotropic arrangement.

Rods and plates

Many of the large molecules found in organic chemistry have exactly the same kind of rod- or plate-like shapes and have anisotropic crystal structures. The tendency towards ordered arrangements in these substances is so great that when they melt they retain a

degree of order until the temperature is considerably increased. As a result the liquid has anisotropic properties, some flowing in a gliding stepwise fashion or interfering with the passage of light. When this happens the substance is said to possess a liquid crystalline phase (sometimes termed a mesomorphic or paracrystalline state).

So we have:

For an isotropic material: solid \blacklozenge liquid \blacklozenge gas

For an anisotropic material: solid \blacklozenge crystal \blacklozenge liquid \blacklozenge gas

It is of interest to note that this property has been well known since 1890, and some 0.6% (15 000-20 000) of organic chemicals show this behaviour.

Nematic and smectic

Liquid crystals fall into two main categories: nematic (from the Greek for thread) and smectic (from the Greek for soap).

Smectic liquid crystals have many interesting properties but have found little practical application, so this article will not discuss them further.

The nematic liquid crystals have many applications and form the substance of this article. There are several types of nematic materials. The differences between these types is shown in Figure 4.

Some nematic liquid crystals possess properties which cause them to interfere with the passage of light in an applied electric field, or with changing temperature. They are of great interest in modern electronic displays for several reasons: \blacktriangleright



This 32-character liquid crystal display can produce numbers and letters on a 5 x 7 dot matrix in any of the 32 individual character cells. The device is made by General Electric and is model 95E from their GE-LXD product line.

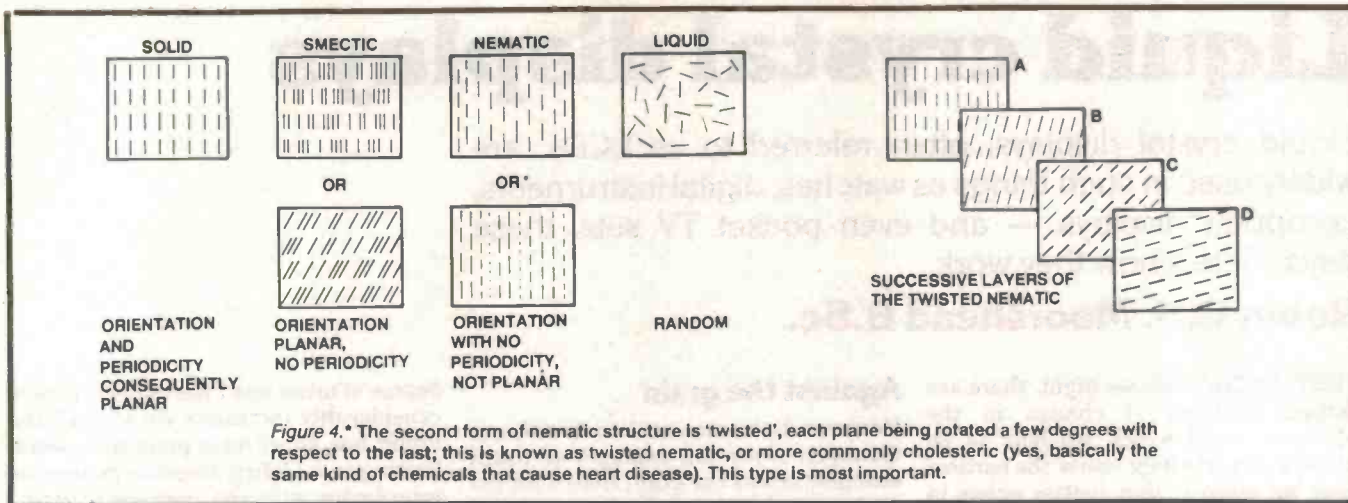

1. The power consumption of such displays is extremely small, between $2 \mu\text{A}$ and $0.2 \mu\text{A}$ per segment of a seven-segment display, about $10 \mu\text{W}$ per cm^2 of display, whereas a similar LED display consumes 500 mW.

2. They are made of the commonest elements (carbon, hydrogen, oxygen, nitrogen), rather than the more expensive elements such as gallium, germanium, etc.

3. Since they do not emit light themselves, but interfere with the passage of incident light, they cannot be 'washed out' by strong incident light.

4. They are compatible with PMOS circuits.

There are, needless to say, disadvantages as well:

1. Since they are passive, i.e. they do not emit light, they cannot be read in the dark; however, this can be overcome by providing background illumination. This increases power consumption; the power consumed does not however have to pass through the addressing circuit, as it does in LED displays.

2. Since they are operating in a phase between solid and liquid their temperature range is limited, at a maximum between -20°C and 100°C , but more typically 0°C to 60°C .

Below this temperature the display freezes; above the maximum the liquid is isotropic and no display is visible. Furthermore, the response time near the freezing point is rather slow, in the order of 0.2-second rise time and 0.6-second fall time. Freezing or liquefying the display does no permanent damage, but temperatures in excess of 150°C may cause irreversible damage. There is no doubt that future development will broaden this temperature range considerably.

3. The lifetime is still limited, but provided conditions are ideal it is now well in excess of 40 000 hours. Future development of materials with higher

purity and chemical stability will improve this a great deal.

Stability may be affected by several factors. Firstly, certain liquid crystalline materials undergo irreversible chemical changes under dc conditions, so it is critical that such display have no dc components whatsoever in the addressing circuit; secondly, chemical changes are caused by impurities; thirdly, certain liquid crystalline materials are effected by ultraviolet light.

Chemistry

We have no intention of discussing the detailed chemistry of the materials used — it is quite complex — and most names are longer than those found in the small print on toothpaste tubes. However, an outline of the structure of a typical nematic and a typical cholesteric material are included for comparison (see Figures 5 and 6).

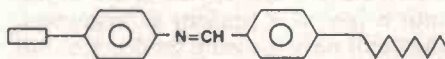

Figure 5. A 'Shifts' base. This has a fairly straight structure about seven times as long as it is broad.

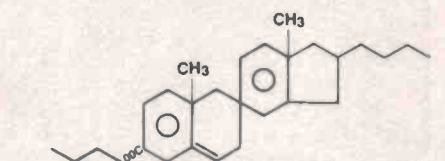
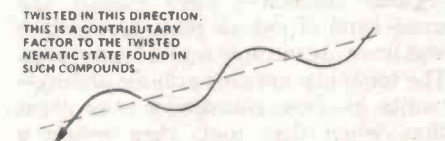

Figure 6. A cholesterol ester. The molecule is about eight to ten times longer than it is broad.

The actual material used in a display is not usually pure; it is more frequently a mixture of two or more nematics. This has the advantage of increasing the liquid range by the creation of a 'eutectic' mixture (see Figure 7).

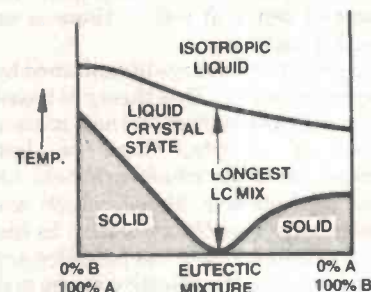

Figure 7.

The anisotropic properties that materials suitable for display purposes must include are:

1. The refractive index is different as the material is viewed from different aspects, i.e. the light is bent more as it passes through the material in one direction than another.

2. The molecule must possess a dipole. This is an uneven distribution of charge on the molecule, which causes it to align in an electric field (see Figure 8).

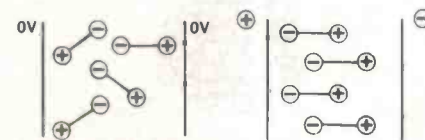

Figure 8.

A large proportion of organic molecules possess such dipoles. The dipole on the materials used in liquid crystalline displays have two components, one along the long axis (ϵ_{\parallel}) and one perpendicular (ϵ_{\perp}) to it.

If the dipole along the long axis A is

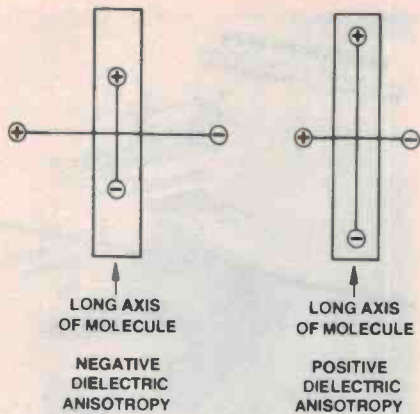

Figure 9.

greater than the dipole perpendicular to it, it is said to possess positive dielectric anisotropy. If the dipole is greater on the perpendicular axis it is said to possess negative dielectric anisotropy (see Figure 9).

3. The material must also possess anisotropic conductivity (as graphite does). The conductivity in nematic liquid crystals is greater along the long axis than perpendicular to it.

4. The material should have a resistivity of the order of $10^9 \Omega \text{ cm}$.

Display construction

The displays work in two different ways, but the construction of the cells is similar; the differences are mainly in the filters on the back and faces of the display and in the type of background.

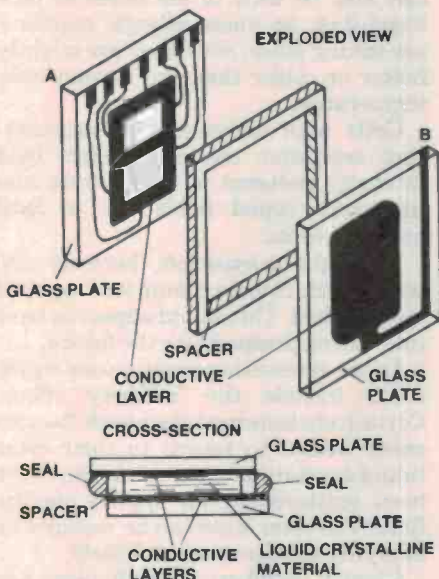

Figure 10.

The cell consists of a very thin layer (about $12 \mu\text{m}$) of the liquid crystalline material between two sheets of glass, which have a conductive coating on their inside (see Figure 10). One glass plate (A) has the actual seven-segment display etched on it. The other plate (B) has a common electrode etched on it.

The conductive coating is either tin oxide or a mixture of tin and indium oxides. This provides an electrode with about 90% transmission of light.

This conductive coat is further treated so that the molecules align themselves with the surface while an electric field is not applied.

This provides a more or less translucent display. When an electric field is applied, the molecules move so as to align their dipoles with the electric field. This causes changes in the optical properties of the liquid crystal material which appears as the display.

There are two principle techniques used here, dynamic scattering and polarisation modes.

Dynamic scattering

In this mode the liquid crystalline material is chosen such that it has negative dielectric anisotropy, with the greater electrical conductivity along its long axis. The molecules are normally perpendicular to the surface, and when an ac field is applied the molecules, in clusters, move to re-align their dipoles with the field. The re-alignment of the dipole is in opposition to the conductivity and the liquid becomes turbulent. This turbulence is seen as milkiness in the display (see Figure 11).

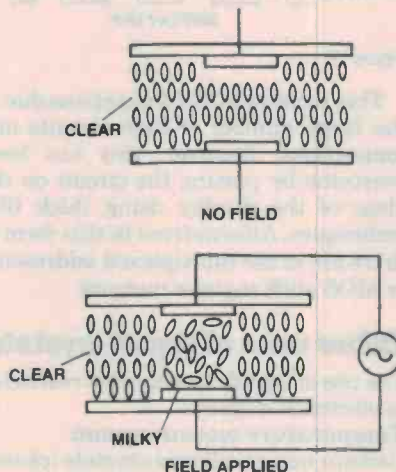

Figure 11.

Since there is no light emitted the display must be used to modify the passage of incident light. This may be done either by passing light through the display, or more usually by reflecting light from a mirror behind the display (see Figures 12 and 13).

The transmissive cell will appear to glow and the reflective cell will appear misty where the segments are switched on. These displays have the shortcoming of a rather low 'contrast ratio'. That is, the apparent difference between the switched on and switched off display is not very great.

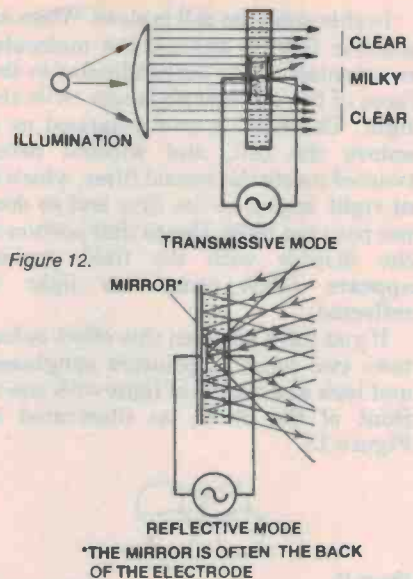

Figure 12.

Figure 13.

Polarisation modes

The display is constructed in basically the same way as the dynamic scattering cell. The difference lies in the type of liquid crystalline material. The material used is one which assumes a twisted nematic structure and has positive dielectric anisotropy (the major component of its dipole along its long axis).

In this case the inside faces of the cell are coated so that the molecules are parallel to them and aligned in a particular direction when no electric field is applied.

The cell thickness is designed so that there is a complete 90° turn of molecules between the top and bottom faces. The twisted nematic has the property that it twists light that passes through it. Polaroid filters are fitted above and below the cell so that light is polarised as it enters, and is twisted through 90° , exiting through a filter opposed at 90° to the first. The light is then reflected off a mirror and returns via the same pathway (see Figure 14).

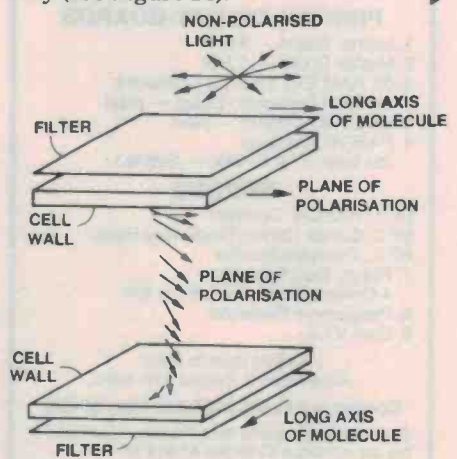

Figure 14.

In this state the cell is clear. When an electric field is applied the molecules re-orientate to lie perpendicular to the faces of the cell and no longer twist the light. The light is now polarised as it enters the cell, and without being twisted meets the second filter, which is at right angles to the first and so does not pass the light. Hence that portion of the display with the field applied appears black (since no light is reflected).

If you have not seen this effect before take two pairs of polaroid sunglasses and look at a source of light with one in front of the other, as illustrated in Figure 15.



Figure 15.

Held in this way light, although polarised, is free to pass through the second filter, since the plane of polarisation is the same for both lenses. If one

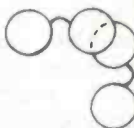

Figure 16.

lens is now rotated through 90°, as in Figure 16, no light passes, since the light polarised by the first lens will not pass through the second.

The effect of having the 'crossed polaroids' in the cell causes almost total extinction of reflected light and consequently a high contrast ratio, an almost completely black and white display. This is many times better than the dynamic scattering cells.

Addressing technique

The cells are normally operated under ac conditions (although some cholesteric cells may operate under dc).

The technique commonly used is to have dc pulses of identical amplitude, one applied to the back, the other to the display segment via an exclusive OR gate. In the off state the two signals are in phase, in the on state they are out of phase (see Figure 17).

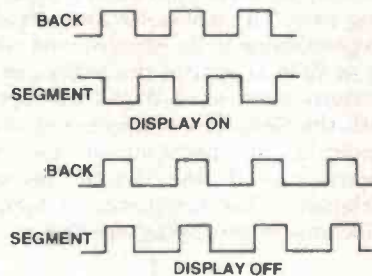

Figure 17.

This technique has limitations due to the large number of both circuits and connections; however, this has been overcome by putting the circuit on the glass of the display using thick film techniques. Alternatives to this form of drive are to use multiplexed addressing or MOS shift register memory.

Other uses of liquid crystals

The use of liquid crystal is not restricted to electrical displays.

Temperature measurement:

Certain nematic liquid crystals (cholesteric) change colour over the whole range of the spectrum (red to violet) as their temperature changes. Furthermore, the colour change is over a very narrow temperature range, usually 2 or 3°C. The temperature at which this happens, and the range over which the change takes place, can be adjusted by use of mixtures of different cholesterics.

A set of ten to twelve of such cells in a row, the following one starting to show colour at 2°C higher temperature than the previous one, forms a useful thermometer working over a fairly restricted range. It has found application as living room and refrigerator thermometers.



Beckman of the US produced an 'LCD Designers Kit, model 750-1' a few years back that was enormously successful. This has been superseded by their model 750-2 designers kit, which includes a 6 mm, four-digit LCD display (the 741-4), plus polariser, connectors, board and instruction manual. Beckman products are distributed in Australia by Warburton Frankl.

Perhaps a more important application is using liquid crystals which have a very narrow range over which they change colour (0.5°C). They have found application in medicine, since they can resolve differences of 0.05°C.

Assuming the liquid crystal is set to show colour at normal skin temperature, any local deviation from the correct temperature will show as a different colour. This has applications in detecting cancers, since they tend to be hotter than normal body heat. They can also be used to see areas of poor blood-flow, or where allergic reactions are taking place, since they are slightly hotter or colder than the normal body temperature.

Cells with extremely low temperature resolution can even detect field intensity patterns of microwaves and ultrasonic sound fields due to local heating effects.

As might be expected, there are also cells which change colour with applied electric field. This would appear to have interesting prospects for the future.

Other interesting possibilities which occur include the 'memory effect'. Certain cholesterics take hours, in some cases weeks, to return to their clear liquid crystalline state after they have been scattered by an applied electric field. The clear state can be restored by applying a different electric field.

Clearly liquid crystal technology has an enormous amount to offer a wide variety of fields — electronics, medicine and others. We are likely to see further interesting developments in the next few years as this technology takes over and improves on existing display techniques. How about an alphanumeric display with independently variable colour segments? ●

LY VIDEO

Shop: 418 Bridge Road, Richmond, Vic.
Mail: PO Box 347, Richmond, 3121, Vic.

BREAKTHROUGH IN TECHNOLOGY FOR OSI (OHIO) SII/C1P

PRINTED CIRCUIT BOARDS

1. Mother Board — 8 Slot
2. Mother Board — 5 Slot
3. 8K RAM Exp. Board & Connector
4. 8K RAM Expansion Board — plain
5. 8K EPROM Board — plain
6. PASCAL Compiler
(on tape, 5" & 8" Disc — Soft/w.)

EPROMS

- EP.1. PASCAL Compiler
- EP.2. Cursor Control/Single Key Basic
- EP.3. Extended Monitor
7. Floppy Disc Controller
- 4 Drives, Single sided, 8" or 5¼"
8. Programme Generator
9. Dual V.I.A.

Drilled Boards extra.
Assembled & Tested \$15 extra.

Component Packs available from \$6-\$50.

See previous adverts for over 100 items of software or buy our catalogue \$3.50 plus \$1.00 P&P.

BIG-WIDE WONDERFUL

audio-technica range

Below is only a small part of the ninety-two precision-built items of sound reproducing equipment from Audio Technica — the largest range of its kind in the world.

AT1100 TONEARM



AT-1100 is a new low-mass tonearm with a plug-in, integrated arm. Precision fabricated, main features include extremely low-mass, immunity to resonance, and damping to reduce IM distortion and enable high trackability. Distinctive in profile, the AT-1100 uses the dynamic Tracing System to place the tonearm pivot at the same level as the stylus for stable tracing even at high amplitudes.

\$416.76

AT32 DUAL MOVING COIL PHONO CARTRIDGE



Designed to bring the state-of-the-art to moving-coil cartridge performance, the AT32 incorporates independent left and right coils oriented at 45 degree/45 degree angles to the walls of the record groove. Because only audio-technica can boast of this unique mirror-image of the actual path of the record cutter head, this model is capable of extremely wide separation imagery, and its high trackability also ensures accuracy at any record cutting level.

\$229.32

AT11E DUAL MAGNET PHONO CARTRIDGE

Our lowest cost elliptical stylus cartridge yet built to high Audio-Technica standards.

\$36.12



ATMS UNIVERSAL HEADSHELL



This highly rigid, resonance-free head shell is made of carefully selected materials and shaped precisely to give the very best sound quality.

\$36.37

AT650 STEP-UP TRANSFORMER

This stylish, matt-black transformer helps get full performance and sound quality from the Dual Moving Coil cartridge. It has bypass capabilities and an impedance adjustment switch so that the proper impedance gets to the moving coil. The AT650 for true quality sound.

\$318.05



AT 15XE DUAL MAGNET PHONO CARTRIDGE



The AT-15XE is much like the AT-15SS in terms of taking maximum advantage of the micro-mass moving element. It gives the same lifelike sound reproduction with smooth response even into the high frequency ranges. This cartridge is designed for the finest tonearms and deluxe automatic turntables.

\$142.48

ATH8 STEREOPHONE



The excellent transient response delivered by this stereophone is the result of its low-mass 2-micron diaphragm and 2-pole electret system. Bass is faithfully reproduced as low as 10 Hz, mid-range remains natural, and highs reach a solid 32,000 Hz. The open-back design eliminates false resonances.

\$346.79

AT609



\$8.69

The AT609 is a lead wire consisting of 14 twisted strands. Each strand is 99.99 percent pure silver and 0.12mm in thickness and insulated with polyurethane. The whole is then covered with Teflon. Transmission loss is minimised by avoiding coloration, which, if used, impairs the properties of the insulators. The gold-plated tips at both ends of the AT609 are attached to the lead wire with high quality silver contained solder.

AT618 DISC STABILIZER

The AT618 is a precision stabilizer developed to damp any vibration of the disc record and turntable thus improving rotation stability. The machined brass block is entirely covered with a natural rubber protector. Weight: 600 grams.

\$39.92



AT6012 RECORD CLEANING KIT

The AT6012 has a velvet cloth especially woven to special Audio-Technica specifications wherein the velvet pile is interweaved in rows that have directional sweeping action. This is an efficient record cleaner with sufficient width to cover the groove area of a 30cm LP record. If the cleaner fluid supplied with AT6012 is used, the AT6012 will become a moist type, which can easily remove not only dust particles from the bottom of the record groove but also oily dirt such as finger prints from the record surface.

\$17.65



available at all quality hi-fi dealers

However, if you have a supply problem you can order by mail. Simply enclose your cheque or money order and details of requirements to PO Box 328, Artarmon NSW 2064. We will then arrange for the dealer nearest your address to forward your purchase at once by registered mail.

THE MAURICE CHAPMAN GROUP PTY. LIMITED

44 Dickson Ave, Artarmon, NSW 2064. Phone (02) 438-3111 • 150 Burwood Rd, Hawthorn, Vic 3122. Phone (03) 818-1730
• Perth (09) 446-5679 • Brisbane (07) 261-1513 • Adelaide (08) 272-8011

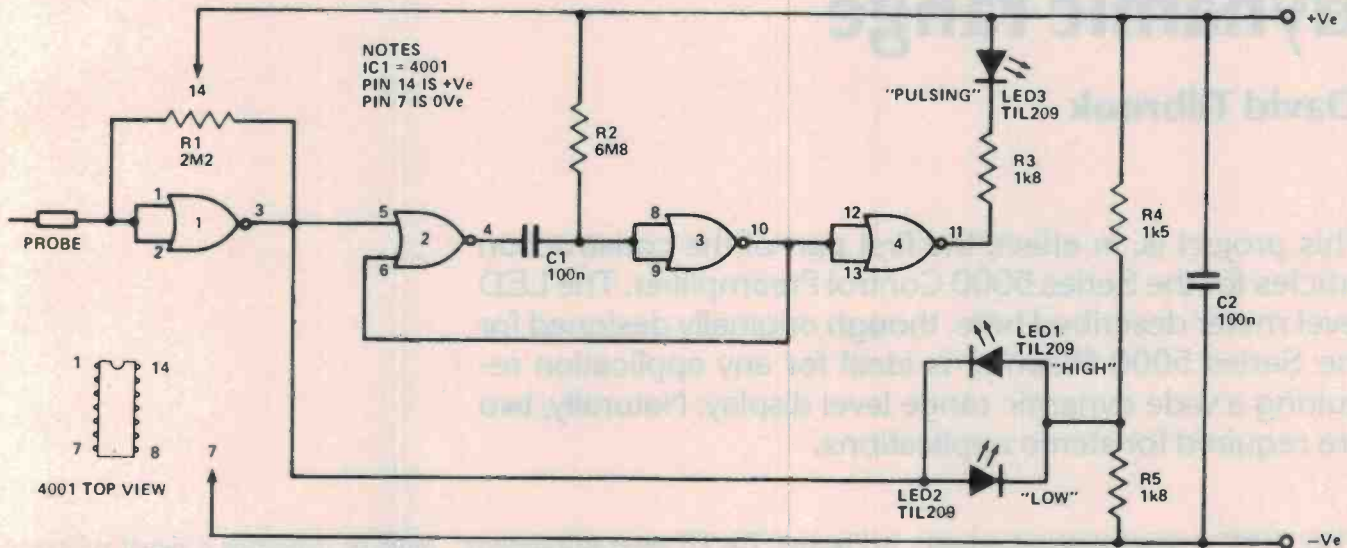

CMOS logic probe

A LOGIC PROBE is a device which is used when testing digital circuits, and it shows the logic state at the selected test point. In common with most designs, this one can indicate four input states, as follows:

1. Input high (logic 1).
2. Input low (logic 0).
3. Input pulsing.
4. Input floating.

The circuit uses the four two-input NOR gates contained within the 4001 CMOS device and is primarily intended for testing CMOS circuits. The probe derives its power from the supply of the circuit being tested. The first gate has its inputs tied together so that it operates as an inverter, and it is biased by R1 so that roughly half the supply potential appears at its output. A similar voltage appears at the junction of R4 and R5, and so no significant voltage

will be developed across D1 and D2, which are connected between this junction and gate 1 output. Thus under quiescent conditions, or if the probe is connected to a floating test point, neither D1a or D2 will light up. If the input is taken to a high logic point, gate 1 output will go low and switch on D1, giving a 'high' indication. If the input is taken to a low test point, gate 1 output will go high and D2 will be switched on to indicate the 'low' input state.

A pulsed input will contain both logic states, causing both D1 and D2 to switch on alternately. However, if the mark to space ratio of the input signal is very high, this may result in one indicator lighting up very brightly while the other does not visibly glow at all. In order to give a more reliable indication of a pulsed input, gates 2 to 4 are connected as a buffered output monostable multivibrator. The purpose of

this circuit is to produce an output pulse of predetermined length (about half a second in this case) whenever it receives a positive-going input pulse.

The length of the input pulse has no significant effect on the output pulse. D3 is connected at the output of the monostable, and is switched on for about half a second whenever the monostable is triggered, regardless of how brief the triggering input pulse happens to be. Therefore a pulsing input will be clearly indicated by D3 switching on.

The various outputs will be:

Floating input — all LEDs off.

Logic 0 input — D2 switched on (D3 will briefly flash on).

Logic 1 input — D1 switched on.

Pulsing input — D3 switched on, or pulsing in the case of a low frequency input signal (one or both of the other indicators will switch on, showing if one input state predominates). ●

LED level meter features simultaneous peak & average display plus 60 dB dynamic range

David Tilbrook

This project is, in effect, the first part of the construction articles for the Series 5000 Control Preamplifier. The LED level meter described here, though originally designed for the Series 5000 Preamp, is ideal for any application requiring a wide dynamic range level display. Naturally, two are required for stereo applications.

THE MOST common instrument used to measure audio signal level is the VU meter (VU stands for volume unit). Before the introduction of the VU standard however, ordinary meter movements were used. A full-wave rectifier converted the applied audio signal to dc suitable for driving a voltmeter, usually fitted with a dB scale. Although this is completely suitable for steady sinewave measurement it is entirely unsatisfactory for measurement of constantly changing voltages such as audio signal level. The biggest problem is overshoot of the meter movement. If a 1 kHz sine-wave, for example, is applied to this type of meter, the movement can overshoot the correct reading by nearly 80%, indicating a transient that is in fact not present. The VU standard was introduced to overcome these problems. It does this by defining the 'ballistics' of any meter movement to be used in audio signal level measurement. A comparison of VU and ordinary meter movement ballistics is shown in Figure 1. The amount of overshoot of the VU meter is specifically defined by the standard to be not less than 1% and not greater than 1.5%. This characteristic is achieved by carefully modifying the shape of the meter pole pieces and counterweighting the pointer. These techniques ensure that the movement stabilises in the shortest possible time, around 0.3 s (300 ms) for the case shown

in Figure 1. The VU meter still displays dB (i.e: 1 VU = 1 dB), but its reaction to transient signals is significantly better than the ordinary meter movement.

could be indicating a signal voltage of say -15 dB when the peaks of the signal are actually overloading an amplifier. Another disadvantage of most VU

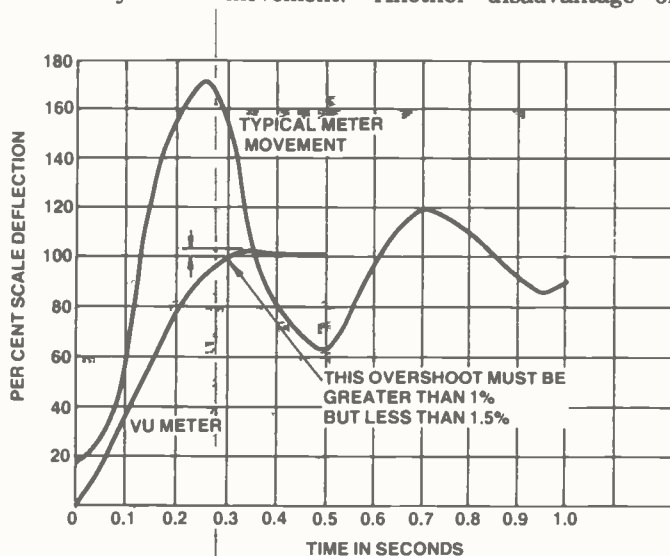

Figure 1. 'Ballistics' of a VU meter compared to conventional moving-coil meter.

Nevertheless, the VU meter is still very slow. It indicates something between the average and the real peak of the signal voltage depending on the complexity and transient nature of the particular input signal. The 0.3 s rise time of the meter will hide all but the most repetitive peaks, so a VU meter

meters is their limited dynamic range. Usually they display only the 'top' 23 dB of the total range (i.e: -20 to +3 dB) and with the ever increasing dynamic range of modern recording techniques this is not sufficient.

The ETI-458 overcomes these problems by replacing the meter movement

pk/av LED level meter

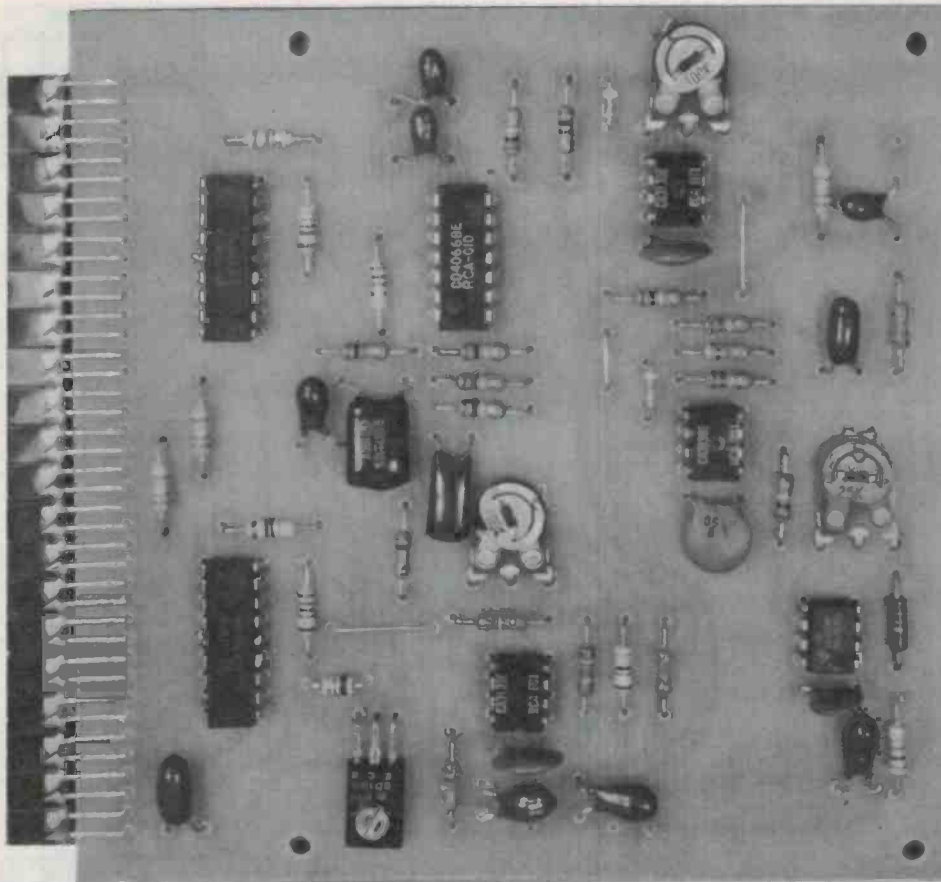

Full-size reproduction of the completed project. Note the components are laid flat to permit close stacking of two boards for a stereo display.

PEAK FACTOR 10-15 dB GREATER THAN SINE WAVE

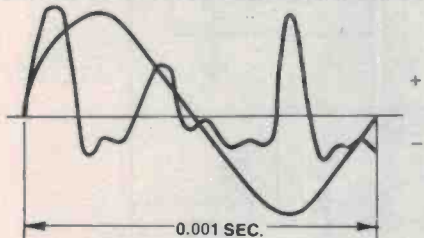

A typical 'music' signal may have a completely different peak-to-average ratio compared to a sine wave, and the peaks are often not symmetrical in amplitude about the zero axis. The duration of peaks may be as short as 50 microseconds.

with a row of light emitting diodes driven by a pair of dB LED display drivers. Twenty LEDs are used, with 3 dB between each LED, so the total dynamic range displayed is 60 dB. The circuit monitors both the true peak and the average signal level and displays both simultaneously. The difference between the peak and the average signal level is around 3 dB, so with a sine wave applied consecutive LEDs will light. With music applied however, the difference between the two LEDs will be substantially greater, depending on the transient nature of the signal applied.

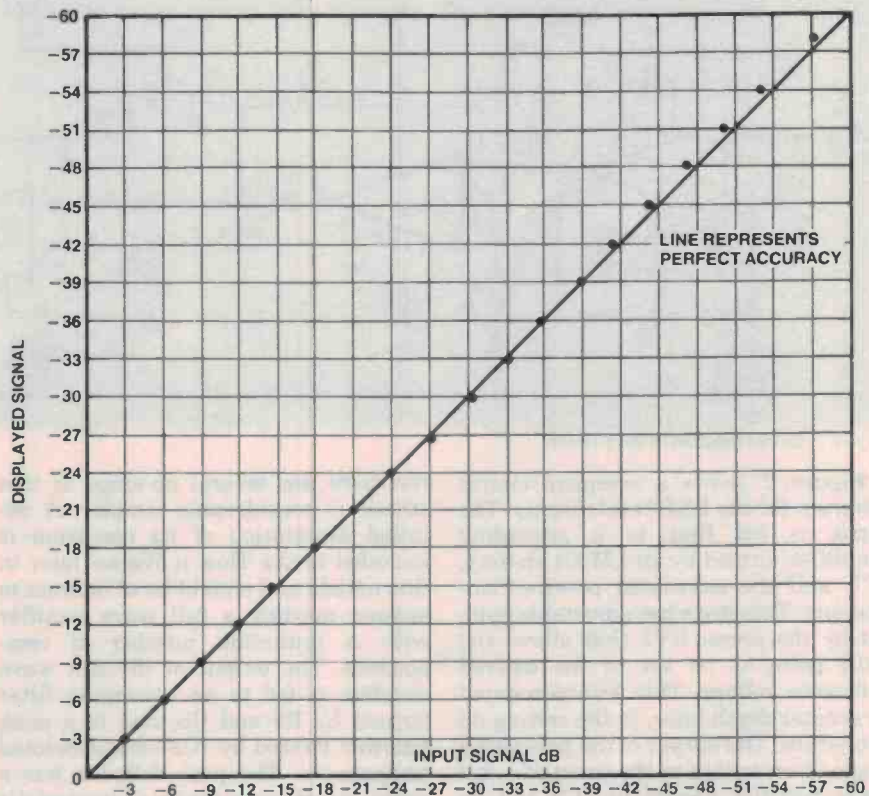

Figure 4. Accuracy of the ETI-458 LED level meter display (dots) compared to 'perfect accuracy' (line).

Project 458

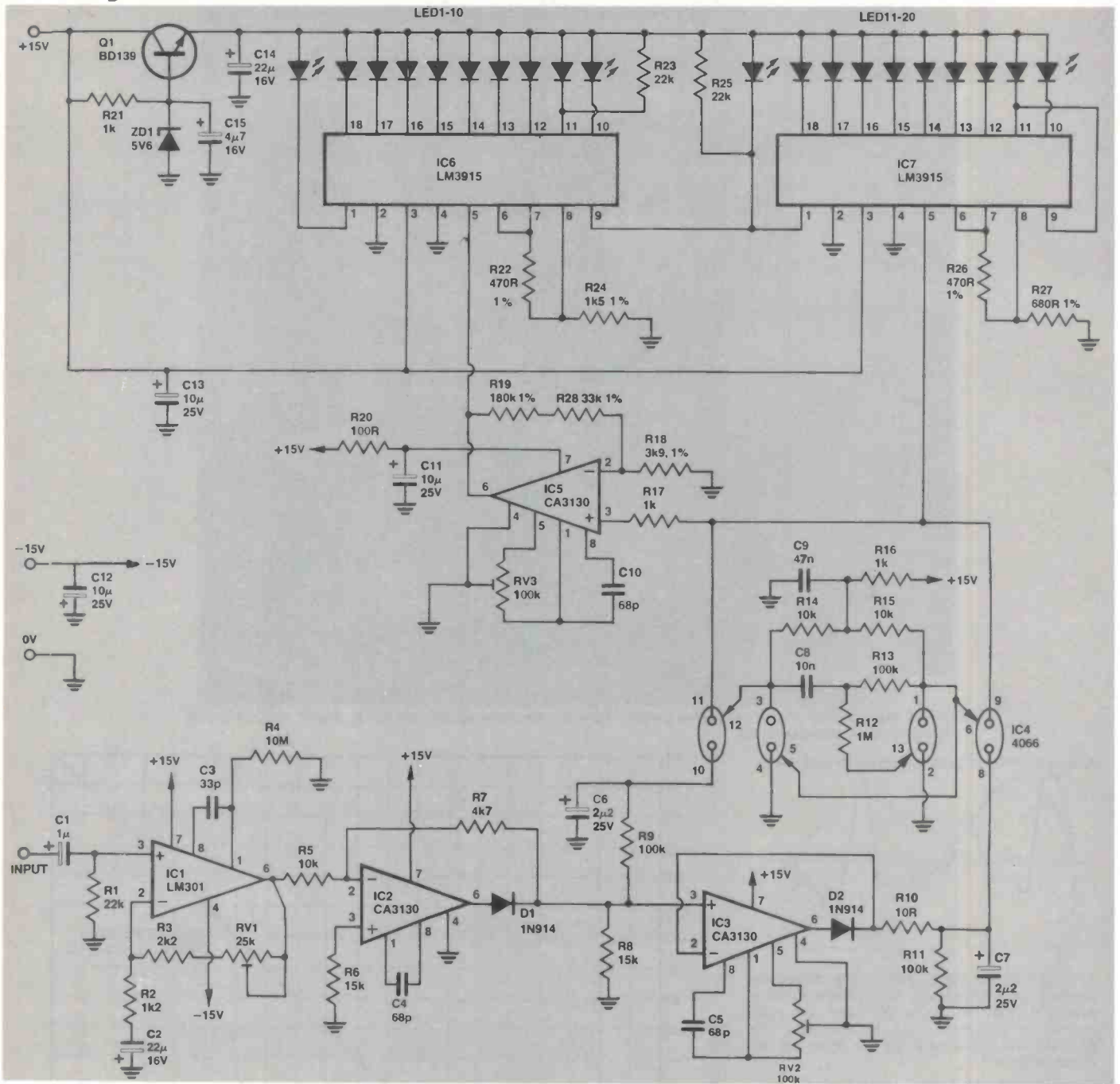

Figure 2. Circuit diagram of the ETI-458.

Figure 2 shows a complete circuit diagram for the LED level display. The input is fed first to a *prescaling* amplifier formed by an LM301 op-amp, IC1, and the associated passive components. This stage has adjustable gain, set by the preset RV1 that allows the 0 dB point to be set to the desired reference voltage. This will be covered in greater depth later, in the setting up procedure. The output of the prescaling stage is connected to the input of a full wave rectifier formed by IC2 and its associated components. Most full wave

rectifiers use several op-amps so this circuit is considerably simpler. A detailed description of its operation is included in the 'How it Works' later in this article and should be of interest to anyone needing a full wave rectifier with a minimum number of components. The output of the full wave rectifier is fed to an averaging filter formed by R9 and C6, and to a peak follower formed by IC3 and associated components. The peak follower has a rapid attack/slow decay characteristic so that it responds quickly to any

transients but decays slowly so the transient can be seen easily on the display. The outputs from the peak follower and the averaging filter are connected to the inputs of two CMOS analogue switches. The outputs of these switches are connected together and go to the input of the LED display. Two more CMOS switches are used to form a square wave oscillator. This oscillator has out of phase outputs used to drive the signal-carrying analogue switches alternately off and on at a relatively high frequency. When the switch

pk/av LED level meter

connected to the output of the averaging filter is on, the average signal voltage is connected to the input of the LED display. This switch is subsequently turned off by the oscillator and the other analogue switch turned on, connecting the output of the peak follower to the LED display. So, only one of the two LEDs is on at any instant, but the rapid switching speed between them and the persistence of vision make them both appear to be on.

Input signals to the LED display portion of the circuit are fed simul-

taneously to the LM3915 driving the upper 30 dB display and via a voltage amplifier to the lower 30 dB display. The biggest problem in the design of an audio level meter with a 60 dB dynamic range arises from the fact that 60 dB below typical 0 dB input voltages could be around 2 mV. This is well below the dc offset voltage of most op-amps so special precautions have been taken in the design to ensure that dc offset errors can be reduced to negligible levels. This is the purpose of the presets RV2 and RV3. These are dc offset controls. Ad-

justment of these is covered in the setting up procedure. The sensitivity of the LM3915 can be adjusted by changing the voltage between pins 6/7 and ground. The IC maintains a voltage of 1.25 V across R22. The current through R22 will be $1.25/470$ or approximately 2.67 mA. A further 75 μ A is supplied from pin 8 of the device, so the total current through resistor R24 to ground will be 2.67 mA + 75 μ A or approximately 2.73 mA. The voltage drop across R24 will therefore be around 2.73 mA x 1.5k or 4.1 V. Adding the 1.25 volts across R22 gives a total of 5.35 V between pins 6/7 and ground.

This means that the topmost LED driven by IC6 will light when the input voltage to the device is 5.35 V. Now, 30 dB below this is:

$$\frac{-30}{20} = \log \frac{x}{5.35}$$

or 1.17 V, which is well above the voltage expected on the output of IC5 due to the dc offset. The reference voltage used was chosen specifically to ensure that this would be the case. Now the easiest way to cascade two LM3915s would be to simply set the reference voltage of the second LM3915 the same as that of the first and precede the first one by a 30 dB gain amplifier. However, with the recommended supply voltage of +/- 15 V the maximum peak signal voltage that can be delivered by IC1 will be around 6 V. The operation of the absolute value generator (full wave rectifier, IC2) further divides this by two, so the maximum peak signal voltage available will be around 3 V and the top several LEDs would never be lit. To overcome this problem the reference voltage of IC7 is decreased so that the top LED will be lit by a 3 V input signal, and the gain of the amplifier formed by IC5 is changed accordingly.

The resistors R26 and R27 set the reference voltage of IC7 at 3.1 V and 30 dB below this voltage is

$$\frac{-30}{20} = \log \frac{x}{3.1}, \text{ or } 98 \text{ mV.}$$

Now, the top LED driven by IC6 must correspond to this voltage, so the required gain around IC5 is $5.34/98 \text{ mV}$ or 54.6. The values of the resistors R19 and R18 set this gain at $(180+33+3.9)/3.9$ or around 56 which is a good enough approximation, amounting to an error of less than 0.5 dB. ▶

HOW IT WORKS — ETI 458

The input stage consists of a variable gain amplifier formed by IC1 and its associated components. This is a conventional IC amplifier circuit in which the gain is determined by the values of the components RV1, R3 and R2. Specifically:

$$A_v = \frac{R2 + R3 + RV1}{R2}$$

So the bigger the value set on RV1, the greater the gain. Capacitor C2 has the effect of decreasing this gain for very low frequencies, or dc, decreasing the dc offset on the output.

The second stage is the full wave rectifier or 'absolute value generator'. As mentioned in the text, most full wave rectifiers require more than a single op-amp, so this stage will be of use in any application requiring a full wave rectifier with minimum component count. For negative-going signals the stage functions as an inverting amplifier with a gain of 0.5. This is determined by the values of R5 and R7. When the input signal goes positive the output is driven hard against its negative supply voltage, which in this case is 0 V. So the output stage is turned off, and has a relatively high output impedance. In this state the resistors R5, R7 and R8 form a potential divider and connect the input signal to the output directly. Again, the output voltage is one half of the input voltage. In order for this circuit to work, the output stage in the op-amp must be CMOS so that the output can go completely to 0 V and have an output impedance high enough not to short out the signal voltage from the potential divider. This is the reason the CA3130 is used. Furthermore, this is a relatively fast device which ensures that the full wave rectifier will have a frequency response that covers the entire audio spectrum. The one disadvantage of the circuit is that it requires a high load impedance since the output signal for positive-going input signals is obtained from the potential divider and not from the op-amp itself. In this application the load is around 100k (R9) which causes negligible error.

The output of the full wave rectifier is fed simultaneously to an average filter formed by R9 and C6, and to the peak hold circuit formed by IC3 and its associated components. The peak hold circuit is really nothing more than a 'precision diode' that charges a capacitor to the peak voltage. The precision diode is formed by including a conventional signal diode in the feedback loop of a fast op-amp. If an input signal is applied which is less than the forward voltage drop of the diode, the stage is

effectively in open loop gain (around 320 000 for the CA3130). The output voltage will rise very quickly, turning the diode on. Since the output of the diode is connected to the inverting input of the op-amp, the stage functions with unity gain once the diode has been turned on. Capacitor C5 ensures stability of the stage while preset RV2 allows adjustment of dc offsets due to this stage. The output of the peak hold circuit charges capacitor C7 through resistor R10. The combination of R10 and C7 defines the attack rate of the peak detector.

As shown, the value of R10 is 10 ohms and this is small in comparison to the output impedance of the CA3130, but is included in case some applications require the peak detector to have a slower attack rate. With the values shown, the LED level meter will display single 50 μ s pulses accurately and this is entirely adequate for any audio application.

Resistor R11 discharges the capacitor and its value of 100k dictates a decay rate of around one second. This gives the level meter its rapid attack, slow decay characteristic and enables even short transients to be spotted.

As explained in the text, both the average and the peak levels of the signal are displayed simultaneously. This is accomplished by multiplexing the outputs of the peak and average detectors. This is done by switching between the output of these two circuits at a relatively high frequency (say a few hundred Hertz). In the circuit, this is done with CMOS transmission gates. The 4066 was chosen mainly because its on resistance is a little lower than the older 4016 and this enables the remaining two gates in the package to be used as the driving oscillator. The oscillator is formed by resistors R12 to R15 and capacitor C8, with the associated two transmission gates. The frequency of the oscillator is determined by the values of R13 and C8 at around 150 Hz.

IC5 functions as an amplifier stage as discussed in the text. Once again dc offset adjustment is provided, this time by RV3. Capacitor C10 provides the necessary compensation to ensure stability. Details of the two LED drivers and the amplifier formed by IC5 are in the main text.

The transistor Q1 and the associated components R21, C15 and ZD1 form a simple 5V regulator to power the LM3915s. Capacitor C16 is essential for stability of the LED drivers and must be mounted close to the LEDs.

Save **25%**
JUST RELEASED!

ELISTRONICS

289 LATROBE ST., MELBOURNE 3000
 (03) 602-3282, 602-3836 Telex AA37758 LSTRON

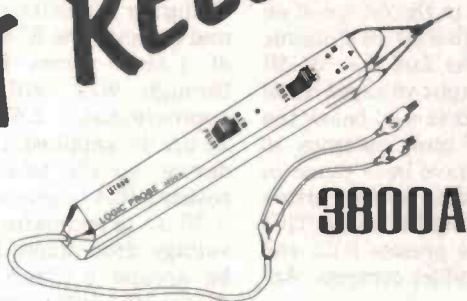

3800A

\$22⁰⁰

\$25³⁰ inc tax

Max Input 10MHz
 Memory/Pulse Sw.
 TTL/CMOS Sw.
 Input Impedance 300k
 Smart black plastic case
 53cm leads

**2
 NEW
 PROBES**



\$14⁰⁰

\$16¹⁰ inc tax

DLP-1

Max Input 1.5MHz
 Strong Aluminium case
 LEDs: HI - LOW - PULSE
 80cm leads
 KEY to LEDs on back of probe
 Input Impedance 300k

WB-DN 100 Holes
\$1⁹⁸ **\$2²⁸** INC



WB-TN 640 Holes
\$7⁵⁷ **\$8⁷⁰** INC



WB-2N-1 100 + 640 Holes
\$9⁶⁵ **\$11¹⁰** INC



WB-2N 200 + 640 Holes
\$11²¹ **\$12⁹⁰** INC

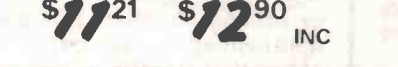

NEW! BREAD BOARDS

Now DIRECTLY imported at
 1/2 cost of other breadboards!

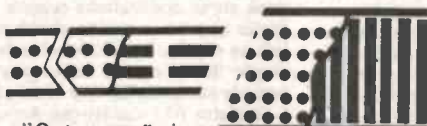

"Cut-away" view



WB-4N 400+1280 Holes
\$25⁰³ **\$28⁷⁸** INC

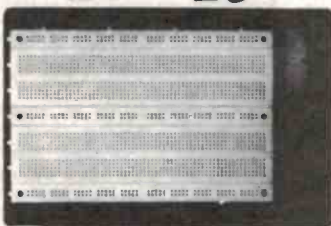

WB-4N-1 300+1280 Holes
\$23⁵⁰ **\$27⁰³** INC

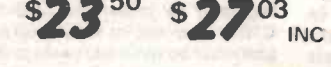

WB-4N-3 100+1280 Holes
\$19⁵⁹ **\$22⁵³** INC

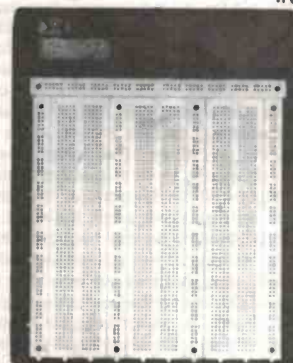

WB-6N 500+1920 Holes
\$35⁵⁸ **\$40⁹²** INC



ALL ELECTRONIC COMPONENTS

That's our name . . . that's our game!!!

MAJOR STOCKISTS OF ALL GENERAL RADIO AND ELECTRONIC COMPONENTS

Only "recognised brands" and top-quality components stocked. Resistors (Incl. large industrial types) capacitors, semi-conductor devices, switches, meters, valves, metalwork, front panels, plugs, sockets, cable connectors, transformers, speakers, etc. Prompt and efficient attention through our mail order department. Major stocklist of all ETI & EA kits — you name it — we will quote.

ETI AND EA KITSET SPECIALISTS (LARGEST RANGE IN AUSTRALIA) — TOP QUALITY, LOW PRICES

LEARN WHILE YOU BUILD

STEREO UNITS

- S1 ETI 484 Compressor Expander
- S2 ETI 482 50 watt per channel Amplifier
- S3 ETI 482A Preamp Board
- S4 ETI 482B Tone Control Board
- S5 ETI 485 Graphic Equalizer
- S6 ETI 480 50 watt Amplifier less H/S & bracket
- S7 ETI 480 100 watt Amplifier less H/S & bracket
- S8 ETI 480 Power Supply for above
- S9 ETI 443 Expander Compressor
- S10 ETI 444 Five watt stereo
- S11 ETI 422B Booster Amplifier including metalwork
- S12 ETI 438 Audio Level Meter
- S13 ETI 440 25 watt Stereo Amplifier including metalwork
- S17 ETI 422 50 watt per channel Amplifier*
- S18 ETI 426 Rumble Filter
- S19 ETI 429 Simple Stereo Amplifier
- S21 ETI 417 Over LED Distortion Monitor
- S24 ETI 427 Graphic Equalizer*
- S28 E.A. Playmaster 136 13 watt
- S30 E.A. Playmaster 143 12.5 watt
- S32 E.A. Musicolour II 1000 w/ch
- S33 E.A. Musicolour III 1000 w/ch
- S34 E.A. Stereo Dynamic Noise Filter
- S35 ETI 470 60 watt audio amplifier module
- S36 ETI 4000 Series 60 watt stereo amplifier
- S37 ETI 451 Hum Filter for Hi-Fi systems
- S38 E.A. Stereo Infrared Remote Switch
- S39 ETI 455 Stereo Loudspeaker Protector
- S40 E.A. Super-Bass Filter Less Power Pack
- S42 E.A. Stylus Timer
- S43 ETI Series 3000 Amplifier 25w/ch
- S44 ETI 477 Mosfet power amp module inc. brackets
- S45 ETI 457 Scratch/Rumble Filter

PRE-AMPLIFIERS AND MIXERS

- P1 ETI 445 Stereo Pre-Amplifier
- P2 ETI 449 Balance Mic Pre-Amplifier
- P5 ETI 414 Master Mixer 8 channel
- P6 ETI 419 Mixer Pre-amplifier — 4 ch. Mixer Pre-amplifier — 2 ch.
- P7 ETI 401 F.E.T. 4 Input Mixer
- P10 E.A. Playmaster 145 Mixer
- P11 ETI 446 Audio Limiter
- P12 ETI 471 High Performance Stereo Pre-amplifier
- P13 ETI 477 Moving Coll Cartridge Pre-Amp
- P14 ETI 474 High to low Impedance Interface
- P15 ETI 467 4 Input Guitar/Mic. Pre-amp Suits ETI 466

TUNERS

- T1 ETI 062 A.M. Tuner
 - T2 ETI 740 F.M. Tuner*
 - *Wooden cabinet not included
- ## GUITAR UNITS
- G1 ETI 447 Audio Phaser
 - G2 ETI 413 2 x 100 watt Bridge Amplifier
 - G5 ETI 413 100 watt Guitar Amplifier
 - G6 ETI 410 A.D.U. for your Guitar
 - G8 E.A. PM 134 21 watt Guitar Amplifier
 - G9 E.A. PM 138 20 watt Guitar Amplifier
 - G14 ETI 452 Guitar Practice Amplifier
 - G15 ETI 466 300 watt Amp module — less H/S & Transformer
 - G16 ETI 454 Fuzz-Sustain less foot switch

AUDIO TEST UNITS

- AT1 ETI 441 Audio Noise Generator
- AT2 ETI 128 Audio Millivolt Meter
- AT4 ETI 102 Audio Signal Generator
- AT5 E.A. A.F. Tone Burst Generator
- AT7 ETI 137 Audio Oscillator
- AT8 ETI 138 Audio Power Meter

POWER SUPPLIES

- PS1 ETI 132 Experimenters Power Supply
- PS2 ETI 581 Dual Power Supply (High Powered Version)
- PS3 ETI 712 CB Power Supply
- PS4 ETI 131 Power Supply
- PS6 ETI 105 Laboratory Power Supply
- PS7 ETI 111 I/C Power Supply
- PS9 E.A. 1976 Regulated Power Supply
- PS10 E.A. Dual 30-2 0-30V at 2A or 0-60V at 2A or Dual Pos and Neg 30V at 2A
- PS11 E.A. C.B. Power Supply
- PS12 ETI 142 Power Supply 0-30 V 0-15 A (fully protected)
- PS13 ETI 472 Power Supply
- PS14 E.A. Power Supply for Dream 6800
- PS15 ETI 577 Dual 12V supply
- PS16 E.A. Power Saver

COMPUTER AND DIGITAL UNITS

- C1 ETI 633 Video Synch Board*
- C2 ETI 632M Part 1 Memory Board V.D.U.*
- C3 ETI 632P Part 1 Power Supply V.D.U.*
- C4 ETI 632A Part 2 Control Logic V.D.U.*
- C5 ETI 632B Part 2 Control Logic V.D.U.*
- C6 ETI 632C Part 2 Character Generator V.D.U.*
- C8 ETI 632 U.A.R.T. Board*
- C9 ETI 631-2 Keyboard Encoder*
- C10 ETI 631 A/Sch. Keyboard (less keyboard)*
- C12 E.A. Educ-8 Computer
- C13 E.A. Cassette-Tape Interface
- C14 ETI 638 Eprom Programmer
- C15 ETI 637 Cuts Cassette Interface
- C16 ETI 651 Binary to Hex Number Converter
- C17 ETI 730 Getting Going On Radio Tele Type
- C18 E.A. Dream 6800 Computer for Beginners less keyboard and cover
- C19 ETI 731 R.T.Y. Modulator
- C20 ETI 450A Bucket Brigade
- C21 ETI 450B Mixer for above

TEST EQUIPMENT

- Kir T2 ETI 133 Phase Meter
- TE3 ETI 533C Digital Display
- TE4 ETI 129 R.F. Signal Generator
- TE5 ETI 130 Temperature Meter
- TE6 ETI 706 Marker Generator
- TE8 ETI 122 Logic Tester
- TE9 ETI 124 Tone Burst Generator
- TE10 ETI 123 C Mos Tester
- TE11 ETI 116 Impedance Meter
- TE12 ETI 533 Digital Display
- TE13 ETI 117 Digital Voltmeter 1975 Display
- TE14 ETI 117 Digital Voltmeter 1976 Display
- TE15 ETI 704 Cross Hatch Dot Generator
- TE16 ETI 120 Logic Probe
- TE17 ETI 121 Logic Pulser
- TE18 ETI 118 Digital Frequency Meter 1975 Display
- TE19 ETI 118 Digital Frequency Meter 1976 Display
- TE33 E.A. Simple Function Generator
- TE34 ETI 487 Real Time Audio Analyser
- TE35 ETI 483 Sound Level Meter
- TE36 ETI 489 Real Time Audio Analyser
- TE37 ETI 717 Cross Hatch Generator
- TE38 E.A. 3 Mhz Frequency Counter
- TE41 E.A. Function Generator
- TE42 E.A. Transistor Tester incl. BiPolar & F.E.T.S.
- TE43 ETI 591 Up Down Pre-settable Counter
- TE44 ETI 550 Digital Dial (less case) includes ETI 591
- TE45 ETI 144 Expanded Scale R.M.S. Voltmeter
- TE46 ETI 148 Versatile Logic Probe
- TE47 ETI 724 Microwave Oven Leak Detector
- TE48 ETI 150 Simple Analog Frequency Meter
- TE49 ETI 151 Linear Scale Ohm Meter

- TE50 ETI 152 Linear Scale Capacitance Meter
- TE51 E.A. Digital Capacitance Meter
- TE52 ETI 589 Digital Temp. Meter
- TE53 E.A. T.V. C.R.O. Adaptor less Power Pack
- TE54 E.A. XTAL Locked Pattern Generator
- TE55 E.A. Decade Resistance Sub Box
- TE56 E.A. Capacitance Sub Box
- TE57 E.A. Decade Capacitance Sub Box
- TE58 E.A. Tantulum Capacitance Sub Box
- TE59 ETI 140 1 GHZ Frequency Meter/Timer
- TE60 ETI 572 PH Meter
- TE61 ETI 135 Panel Meter

WARNING SYSTEMS

- WS1 ETI 583 Gas Alarm
- WS3 ETI 528 Home Burglar Alarm
- WS4 ETI 702 Radar Intruder Alarm
- WS7 ETI 313 Car Alarm
- WS12 ETI 582 House Alarm
- WS14 E.A. 1976 Car Alarm
- WS15 E.A. 10 Ghz Radar Alarm
- WS16 E.A. Light Beam Relay
- WS17 ETI 247 Soil Moisture Indicator

MODEL TRAIN UNITS

- MT1 ETI 541 Model Train Control
- MT2 E.A. 1974 Model Train Control
- MT6 E.A. 1978 Train Control

AUTOMOTIVE UNITS

- A1 ETI 317 Rev. Monitor
- A2 ETI 081 Tachometer
- A3 ETI 316 Transistor Assisted Ignition
- A4 ETI 240 High Power Emergency Flasher
- A6 ETI 312 Electronic Ignition System
- A7 ETI 301 Vari-Wiper
- A14 E.A. Dwell Meter
- A15 E.A. Variwiper
- A16 E.A. Tacho for Tune-ups
- A17 E.A. Ignition Analyser and Tachometer
- A18 E.A. Strobe Adaptor for Ignition Analyser
- A19 E.A. 1975 C.D. 1. Capacitor Discharge Ignition
- A22 ETI 318 Digital Car Tachometer (less Metalwork)
- A23 ETI 319A Variwiper Mk. 2 (no dynamic braking)
- A24 ETI 319B Variwiper Mk. 2 (for dynamic braking)
- A25 ETI 555 Light Activated Tacho
- A26 ETI 320 Battery Condition Indicator
- A27 E.A. Transistor Assisted Ignition
- A28 ETI 324 Twin Range Tacho less case
- A29 ETI 328 LED Oil Temp. Meter less V.D.O. probe

PHOTOGRAPHIC

- PH1 ETI 586 Shutter Speed Timer
- PH3 ETI 514B Sound Light Flash Trigger
- PH4 ETI 532 Photo Timer
- PH7 ETI 513 Tape Slide Synchronizer
- PH10 ETI 540 Universal Timer
- PH12 E.A. Sync-a-Slide
- PH14 ETI 558 Mast Head Strobe
- PH15 ETI 553 Tape Slide Synchronizer
- PH16 E.A. Digital Photo Timer
- PH17 ETI 594 Development Timer
- PH18 ETI 568 Sound or light operated Flash Trigger inc. optional parts

RECEIVERS/TRANSMITTERS

- R1 ETI 711 Remote Control Transmitter Switch
- R2 ETI 711R Remote Control Receiver
- R3 ETI 7110 Remote Control Decoder
- R4 ETI 711B Single Control
- R5 ETI 711C Double Control
- R6 ETI 711P Power Supply
- R7 ETI 707A 144 Mhz Converter
- R8 ETI 707B 52 Mhz Converter
- R9 ETI 708 Active Antenna

- R11 ETI 780 Novice Transmitter
- R12 ETI 703 Antenna Matching Unit
- R15 E.A. 110 Communications Receiver
- R17 E.A. 130 Communications Receiver
- R18 E.A. All Wave I/C 2
- R20 E.A. Fremodyne 4 Complete Kit
- R21 E.A. Fremodyne 4 RF Section
- R29 E.A. Short Wave Converter for 27 Mhz
- R31 E.A. 27 Mhz Pre-amp
- R32 E.A. 10-30 Mhz Pre-amp
- R33 ETI 718 Shortwave Radio
- R34 ETI 490 Audio Compressor
- R35 ETI 721 Aircraft Band Converter (less XTALS)

- R36 ETI 726 6 or 10 metre Power Amp
- R37 ETI 475 Wide Band A.M. Tuner
- R38 ETI 585 Ultrasonic Switch

VOLTAGE/CURRENT CONTROLS

- V1 ETI 481 12 volt to -40V D.C. 100 watt Inverter
- V2 ETI 525 Drill Speed Controller
- V3 E.A. S.C.R. Speed Controller
- V6 E.A. 1976 Speed Control
- V7 ETI 592 Light Show Controller (3 ch.) (1000 w/ch)
- V8 E.A. Inverter 12V D/C input 230V 50hz 300VA output
- V9 ETI 593 Colour Sequencer (for use with ETI 592)

MISCELLANEOUS KITS

- M1 ETI 604 Accentuated Beat Metronome
- M2 ETI 546 G.S.R. Monitor (less probes)
- M3 ETI 549 Induction Balance Metal Detector includes wire for search head
- M4 ETI 547 Telephone Bell Extender
- M5 ETI 602 Mini Organ (less case)
- M6 ETI 544 Heart Rate Monitor
- M7 ETI 044 Two Tone Doorbell
- M8 ETI 043 Heads and Tails
- M9 ETI 068 L.E.D. Dice Circuit
- M10 ETI 539 Touch Switch
- M14 ETI 701 Masthead Amplifier
- M23 E.A. Electronic Roulette Wheel
- M25 E.A. Digital Metronome
- M26 E.A. Voice Operated Relay
- M29 E.A. Sound Effects Generator
- M30 ETI 551 Light Chaser 3 channel 1000 watt/ch
- M32 E.A. Remote TV Headphone
- M34 ETI 650 STAC Timer
- M36 ETI 557 Reaction Timer
- M37 ETI 249 Combination lock (less lock)
- M38 ETI 814 Dinky Die
- M39 E.A. Electronic Combination lock (including lock)
- M40 E.A. Mast Head Amplifier
- M41 ETI 576 Electromyogram
- M42 E.A. Prospector Metal Locator including headphone
- M43 ETI 561 Metal Locator less dowel and tubing potplant stand
- M44 E.A. Musical Tone Generator
- M45 E.A. Light Chaser 3 channel
- M46 E.A. Power saver for induction motors
- M47 E.A. Twin Tremolo for Organs/Stage Amps
- M48 E.A. Lissajous Pattern Generator
- M49 E.A. Selectalott
- M50 ETI 1500 Discriminating Metal Locator
- M51 E.A. Light Chaser
- M52 E.A. Cylon Voice

E. D. & E. (SALES) PTY. LTD., NOW

ALL ELECTRONIC COMPONENTS

118 LONSDALE STREET, MELBOURNE, VIC. 3000. TEL: 662-3506.

Project 458

Internally, the LM3915 consists of a string of comparators; each one compares the input signal to a reference voltage it derives from a ten-way potential divider (see Figure 3). The accuracy of the LM3915 is determined by these internal resistors and is therefore very good. To ensure the display is accurate over the entire 60 dB range it is only necessary to ensure that the changeover from one LM3915 to the other is accurate. Resistors R18, R19, R22, R24, R26, and R27 have been specified as 1% tolerance types for this reason. This is probably unnecessary for most applications. I have built the unit using 5% types and the error was only around 1.5 dB which is effectively hidden by the 3 dB increments between LEDs. Figure 4 shows the accuracy of one of the prototype units built with 1% resistors in the places specified. If the accuracy were perfect, all the dots would lie on the straight line. The deviation from the line is only small, so the unit is very accurate over the entire 60 dB dynamic range.

Transistor Q1 forms a simple voltage regulator delivering 5 V to the LEDs. This decreases the power dissipation in the LM3915s. The current consumption from the positive rail is around 100 mA while the negative rail needs only several milliamps. If the display is to be used from an existing power supply in a preamplifier for example, care should be taken to ensure that the relatively high positive rail current does not upset the preamplifier performance. In the Series 5000 preamp a separate positive rail is used for the display to decrease any possibility of interaction between the display and the audio signal voltages in the preamp.

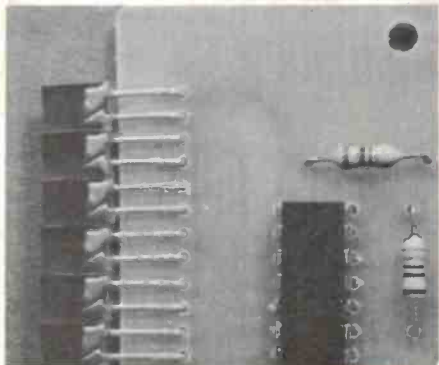

Close-up of the pc board showing orientation of the LEDs. IC7 at lower right.

Construction

The pc board is virtually essential for this project, particularly if you are constructing it as part of the Series 5000 Control Preamp.

Start construction by mounting the

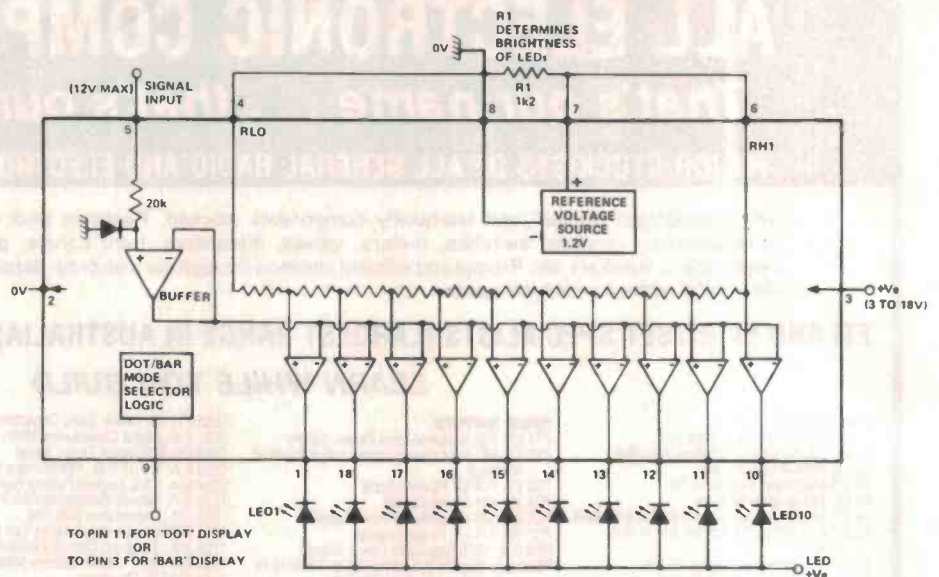

Figure 3. Internal block diagram of the LM3915.

LEDs. This is by far the most difficult part of the project. The LEDs must be inserted evenly and with equal heights, and this is *not* easy. Furthermore, the LEDs must be inserted the right way around. The longer of the leads represents the anode of the LED. Check the orientation of each LED against the overlay, before soldering. The best way I found to mount the LEDs is to start by inserting the first LED on one end of the display. Bend this LED flush against the edge of the pc board. Now solder the leads and bend the LED upright again. Insert the next LED and ensure that its height on the board is identical to the first. Now solder the second LED into position. Continue like this for the remaining eighteen LEDs, checking the orientation of each one as you go. After all the LEDs are soldered into position check that the heights are all even and make any adjustments needed now by reheating the appropriate solder joints. Be careful when soldering the LEDs that you do not overheat the leads; this will damage the device and is very easily done. Once all the LEDs are even bend the whole line down against the circuit board as shown in the photographs.

Now all the other components can be mounted. The order of mounting is not really important although it is good general practice to solder the passive components first (resistors and capacitors). And then solder the ICs and transistors. In the Series 5000 Preamp the LED level displays are mounted directly above one another, so all components should be mounted as close as possible to the pc board. The presets are mounted against the circuit board and this is best done by bending their leads at right angles first, and then

soldering. Similarly, many of the larger capacitors, such as the greencaps and ceramics, may have to be folded against the board. Leave sufficient lead on the components so that this can be done. Alternatively, bend the component over before soldering. Be careful with the orientation of all polarised components, such as transistor Q1 and the electrolytic and tantalum capacitors. Tantalum capacitors, for example, are very intolerant of reverse biasing.

Setting up procedure

Once all the components have been mounted on the pc board and checked, the unit can be switched on. Ensure that the power supply you are using has sufficient current capability for the positive rail and that it is correctly connected to the supply points on the circuit board. If the input is touched with a finger two LEDs should light and move up the display. If all is well the dc offsets can now be adjusted. The preset RV2 adjusts the dc offset of the peak follower. This will be adjusted to equal the dc level of the average filter, i.e. that from the output of the full wave rectifier. The overall dc offset can be nulled by RV3.

First connect the input of the LED level meter to earth on the board. This ensures that no signal voltage will be present when the adjustments are made. Now turn both RV2 and RV3 fully clockwise; both LEDs should run off the bottom of the display. Turn RV3 slowly anticlockwise until the second LED from the bottom has just turned on. If RV2 is now turned anticlockwise also, a second LED will light on the display. This is the peak level LED. Adjust RV2 to superimpose this LED

pk/av LED level meter

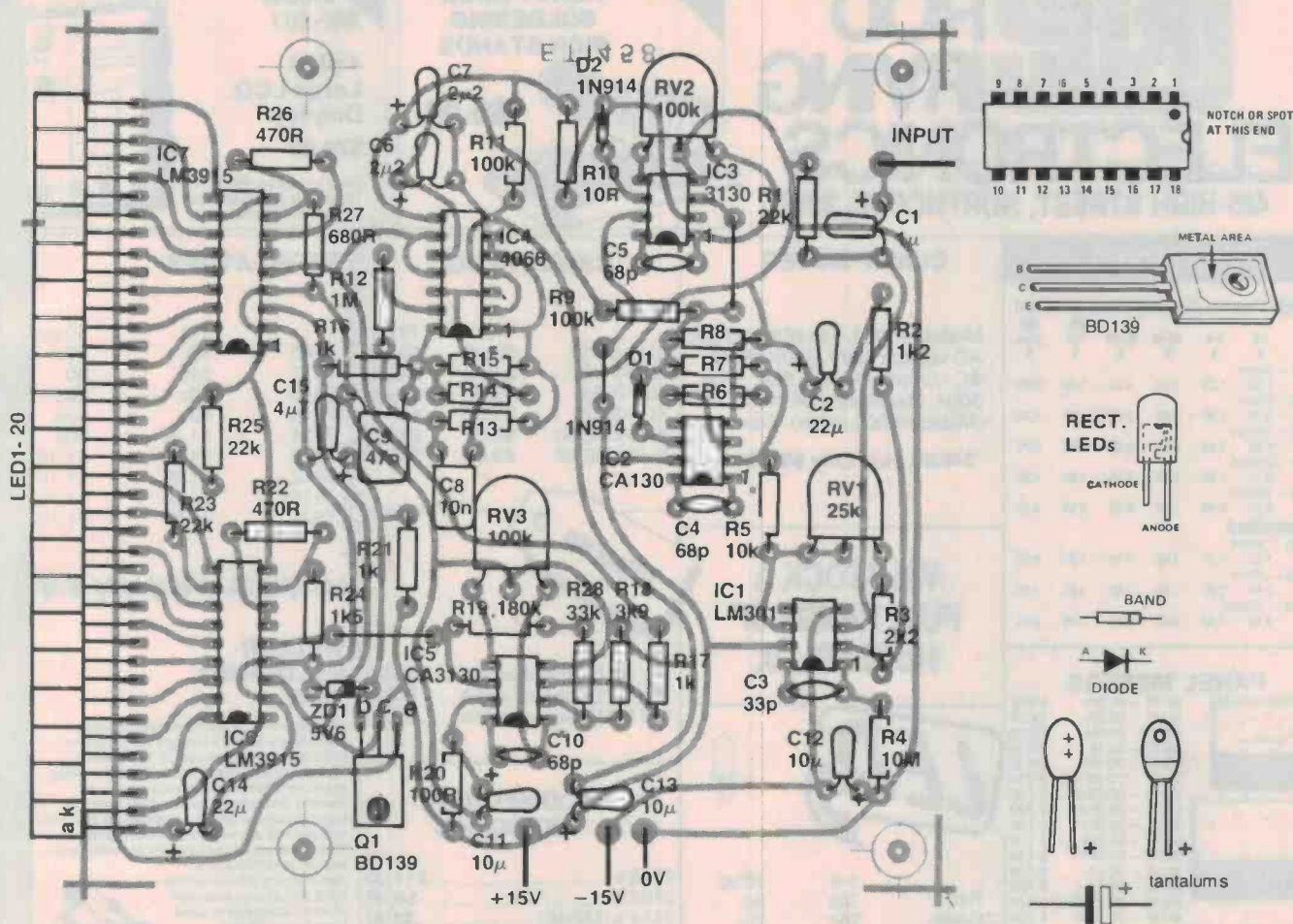

onto the second bottom LED. Now adjust RV3, turning it clockwise again until the LED has just run off the bottom of the display.

The final stage in the setting up procedure is to align the meter for the appropriate 0 dB level. Preset RV1 varies the gain of the prescaling amplifier stage formed by IC1. Adjustment of this preset will vary the input voltage required to light the top LED between 260 mV and 2.5 V. If your application requires 0 dB to be a higher voltage than 2.2 V, use a potential divider at the input to decrease the input signal voltage. If more gain is required increasing the value of the preset from 25k to 100k will decrease the necessary input voltage to around 70 mV, which should be sufficient for most applications.

In the Series 5000 amplifier the top LED is designated +9 dB, so the fourth LED from the top is 0 dB. Calibration of the 0 dB reference is best left until the preamp is finished and the procedure will be described in the Series 5000 Preamp construction article, coming soon.

PARTS LIST — ETI 458

Resistors	all 1/2 W, 5% unless marked otherwise	C9	47n greencap
R1, 23, 25	22k	C11, 12, 13	10u/25 V tant.
R2	1k2	C15	4μ7/16 V tant.
R3	2k2	Semiconductors	
R4	10M	IC1	LM301, 8-pin DIL
R5, 14, 15	10k	IC2, 3, 5	CA3130, 8-pin DIL
R6, R8	15k	IC4	4066
R7	4k7	IC6, IC7	LM3915
R9, 11, 13	100k	D1, D2	1N914 or sim.
R10	10R	ZD1	5V6 zener diode
R12	1M	Q1	BD139
R16, 17, 21	1k	LED1-20	Siemens LD80-2 or sim.
R18	3k9 1%	Miscellaneous	
R19	180k 1%	ETI-458 pc board (double-sided); one 6 BA bolt and nut.	
R20	100R	Price estimate	
R22, R26	470R 1%	We estimate the cost of purchasing all the components for this project will be in the range:	
R24	1k5 1%		\$38 — \$44
R27	680R 1%	Note that this is an estimate only and not a recommended price. A variety of factors may affect the price of a project, such as — quality of components purchased, type of pc board (fibre-glass or phenolic base), type of front panel supplied (if used) etc — whether bought as separate components or made up as a kit.	
R28	33k 1%		
RV1	25k min. trimpot		
RV2, RV3	100k min. trimpot		
Capacitors			
C1	1μ/6V tant.		
C2, C14	22u/16 V tant.		
C3	33p ceramic		
C4, 5, 10	68p ceramic		
C6, C7	2u2/25 V tant.		
C8	10n greencap		

RIT ROD IRVING ELECTRONICS

425 HIGH STREET, NORTHCOTE, 3070

New **LOOK AT THIS!**
HEAVY BASE SOLDERING IRON STANDS



\$5.90

SOAR
Model ME-501

4 digit Large LCD Display

\$79.00

Send for specs. \$69 plus 15 percent sales tax. Add \$3 P&P and Certified Mail.

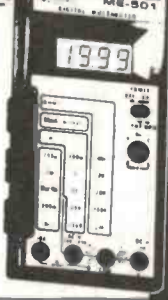

HEATSINKS

High Thermal Capacity Black Anodised

	1-4	5-9	10-49	50-99	100-499	500 plus
	\$	\$	\$	\$	\$	\$
HS1 - 38mm	1.85	1.75	1.50	1.35	1.00	0.90
HS2 - 75mm	3.00	2.90	2.50	2.00	1.50	1.40
HS3 - 150mm	5.80	5.40	4.90	3.80	2.90	2.70
HS4 - 225mm	8.10	7.60	7.10	5.90	4.50	4.30
HS5 - 300mm	8.90	8.40	7.90	6.50	4.90	4.60
Unanodised						
HS11 - 38mm	1.40	1.20	1.00	0.90	0.80	0.70
HS12 - 75mm	2.50	2.20	1.90	1.60	1.25	1.20
HS13 - 150mm	4.90	4.50	4.00	3.20	2.45	2.40

CLAMP METER

Model YF-700. Top of the range. AC voltage 150V, 300V, 600V. AC current 6A, 15A, 60A, 150A, 300A. Resistance 5K ohms (Midscale 200 ohms). Was **\$49.99. Now Only \$43.55**

CANON PLUGS

	1-9	10 up
XLR-3-11c	\$2.90	\$2.80
XLR-3-12c	\$1.90	\$1.70
XLR-3-31	\$3.50	\$3.30
XLR-3-32	\$1.50	\$1.40
XLR-LNE-31	\$2.50	\$2.30
XLR-LNE-32	\$3.90	\$3.75

REGULATORS

	1-9	10 up
7805	90c	80c
7812	90c	80c
7815	90c	80c
7818	90c	80c
7824	\$1.00	90c
7905	\$1.20	\$1.10
7912	\$1.20	\$1.10
7915	\$1.20	\$1.10
7924	\$1.20	\$1.10

WE STOCK A FULL RANGE OF HOBBYBLOX



PANEL METERS



MU 65 - DC 30V	\$10.00
MU 65 - DC 20V	\$10.00
MU 65 - DC 10A	\$10.00
MU 65 - DC 1A	\$10.00
MU 65 - DC 1mA	\$10.00
MU 65 - DC 100 UA	\$10.50
MU 45 - DC 300 V	\$ 7.50
MU 45 - DC 50 V	\$ 7.00
MU 45 - DC 20 V	\$ 7.00
MS 45 - DC 15 V	\$ 7.00
MU 45 - DC 10 A	\$ 7.00
MU 45 - DC 5 A	\$ 7.00
MU 45 - DC 1 A	\$ 7.00
MU 45 - DC ± 50 UA	\$ 7.00
MU 45 - DC 1 mA	\$ 7.00
MU 45 - DC ± 100 UA	\$ 7.50
MU 45 - DC 50 UA	\$ 7.00
MU 45 - VU	\$ 7.00
MU 65 - E VU	\$12.00



	1-9	10 up
Red	10c	9c
Green	25c	22c
Yellow	25c	22c

COMPONENT SPECIALS

12V Sp Changeover 6A	\$4.90
12V DP Changeover 6A	\$5.50
12V DP Changeover 1A	\$1.20
2716's	\$11.00
2708's	\$6.90
2114's (450nS)	\$2.90
4116's (200nS)	\$2.90

WELLER SOLDERING IRON

A transformer powered soldering station, complete with a low voltage temperature controlled soldering pencil. The special Weller "closed loop" method of controlling maximum tip temperature is employed thereby protecting temperature sensitive components while the grounded tip protects voltage and current sensitive components. The soldering pencil features stainless steel heater construction, a non-burning silicon rubber cord and a large selection of iron plated tips in sizes from 8mm to 6mm diameter with a choice of tip temperature of 600 degrees F/315 degrees C and 800 degrees F/430 degrees C.



\$56.90

TWIN CONE SPEAKERS

10 watt speakers with great response.

\$7.50 each



HORN SPEAKERS

Ideal for alarm

5 watt \$6.90
 10 watt \$17.50

SPECIAL



SWITCHES

- C&K 7101, 1 to 9 90c; 10 up to 85c; SPDT.
- C&K 7201, 1 to 9 \$1.30; 10 up \$1.20; DPDT.
- El-Cheapo SPDT, 1 to 9 75c; 10 up 70c.
- El-Cheapo DPDT, 1 to 9 \$1.20; 10 up \$1.10.
- Single pole momentary push-button El-Cheapo, 1 to 9 25c; 10 to 25 23c; 25 up 22c.

TOP QUALITY NI-CAD BATTERIES

D-Cell size \$6.90. C-Cell size \$6.25. P&P add 30c per cell. Also available in protected pack form for specific voltage and current applications. Prices and information on request.



19 INCH RACK MOUNTING BOXES

	1-5	5 up
Black	\$37.50	\$34.50
Standard	\$36.50	\$34.50

TRANSFORMERS

2851 6.3-0-6.3 150mA \$2.90.
 2155 0-15V 1A \$4.50
 6672 15-30V 1A \$5.90
 R1810 8V at 10A 2x15V \$24.50
 R1820 8V at 20A 2x15V \$34.50

IC SOCKETS

Low Profile

	10-25	25 up
8 pin	15c	14c
14 pin	17c	16c
16 pin	18c	17c
18 pin 20c	19c	
20 pin 22c	21c	
22 pin 24c	23c	
24 pin 29c	28c	
28 pin 32c	31c	
40 pin 40c	38c	

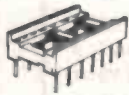

COMPUTER COOLING FANS

Special
 4" \$19.50



SPECIAL ULTRA-SONIC TRANSDUCERS

\$11.00 a pair
 40Hz Tx & Rx.



SCOTCHCAL RANGE

8016	Blue on White Plastic	\$5.50
8018	Green on White Plastic	\$5.50
8011	Red on White Plastic	\$5.50
8012	Black on transparent Plastic	\$5.50
8013	Black on Yellow Plastic	\$5.50
8015	Black on White Plastic	\$5.50
8009	Light blue on aluminium	\$5.50
8001	Red on aluminium	\$5.50
8005	Black on aluminium	\$5.50
8007	Reversing film	\$3.90

NOTE: ALL ABOVE SHEETS 10 x 12

- 8500 Photosensitive Developer \$9.40
- 3900 Clear Coating (Glossy Finish) \$9.30
- 3930 Clear Coating (Matte Finish) \$9.30
- ML-3 Applicator block \$3.90
- ML-4 Developer pads \$8.90 (per 100)
- 8002KA Evaluation Kit



Bankcard Mail Orders Welcome
 Please debit my Bankcard

Bankcard No
 Expiry Date.....
 Name.....
 Signature ET16/81

TO ORDER: Heavy items sent Comet freight-on. Mail Order phone 481-1436. Wholesale customers phone RITRONICS WHOLESALE 489-7099 or 489-1923. Mail orders to PO Box 235, Northcote 3070. Minimum mail order \$2. Add extra for heavy items, registration and certified mail. Prices & specs subject to change without notice.

ROD IRVING ELECTRONICS

425 HIGH STREET, NORTHCOE 3070, MELBOURNE. (03) 489-8131.

ELECTRONIC COMPONENT SUPPLIERS, DESIGNERS & MANUFACTURERS.
RITRONICS WHOLESALE (03) 489-7099. MAIL ORDERS (03) 481-1436.

For heavier items add additional postage. Extra heavy items sent Comet freight on. Prices subject to change without notice. Send 60c and SAE for free catalogues. Minimum pack and post \$1.00. Bankcard Mail Orders welcome.

DISCOUNT COMPONENTS — SUPER SPECIALS

2114	2.90	10 2708 at	\$59.00
2716	\$11.00	100 2114 at	\$285.00
2708	\$6.90	100 4116 at	\$250.00
4116	\$2.90	100 BC548 at	\$9.00
		100 Red Leds at	\$9.00

CMOS	74C04	.40	LF356-AN	1.10	UA4558TC	1.40	7494	.90	74LS40	.50	81LS97	2.10	2N5874	1.40	TIP32C	1.00	8295	25.00
4000	74C08	.40	LF357	1.10	MMS837	2.50	7495	.45	74LS42	.75	TRANSISTORS		2N5961	.30	TIP33A	1.10	DM8578	3.50
4001A	74C10	.40	LM358	.70	LM7555	1.80	7496	.80	74LS47	.85	2N301	2.20	2N5963	1.10	TIP34A	1.20	Ay-5-2376	19.50
4001B	74C14	.90	LM373	4.10	Mc10116L	.95	7497	2.50	74LS48	1.00	2N657	.60	2N6027	.60	TIP24B	1.50	MM5104N	10.00
4002	74C20	.40	LM374	5.40	LF13741	.60	74107	.80	74LS49	1.00	2N930	.60	3N201	.90	TIP42B	1.10	MM55106N	10.00
4006	74C30	.40	LM376	.70	LF1374-1M	.70	74109	.60	74LS51	.40	2N1613	1.10	AC127	.70	TIP110	1.30	MM57160	7.50
4007	74C32	.40	LM377	2.90	DS75452	.60	74116	2.20	74LS54	.55	2N1711	.50	AC128	.70	TIP120	1.30	8748A	99.00
4008	74C42	1.10	LM379	5.70	76477	4.90	74121	.45	74LS55	.55	2N1893	1.00	AC187	.70	TIP2955	1.20	8755A	99.00
4009	74C48	1.55	LM308 8PIN	1.30	75451	.60	74122	.65	74LS58	.65	2N2219A	.60	AC188	.70	TIP3055	1.20	MCT2	3.00
4010	74C73	.75	LM380	.75	75491	1.40	74123	.60	74LS59	.55	PN2222	.20	AD149	2.50	VN88AF	2.50	MCT6	3.30
4011	74C74	.70	14PIN	1.50	75492	1.40	74125	.55	74LS73	.55	PN2222	.20	AD161	1.70	MICRO CHIPS		MCT275	1.50
4012	74C76	.75	LM318A-N	2.40	TTL (s)		74126	.60	74LS74	.60	PN2222	.20	AD162	1.70	ADCO 800	12.00	MCC671	3.00
4013	74C83	1.40	LM318N	1.80	74S00	.80	74132	.80	74LS75	.50	2N2463	.35	BC318	.30	DACO 080	2.00	4N28	.85
4014	74C85	1.20	LM382N	2.00	74S02	.80	74141	1.10	74LS76	.50	2N2484	.65	BC319	.18	2012 200 NS2	.00	4N33	1.20
4015	74C86	.80	LM383	2.70	74S04	.80	74145	.85	74LS78	.50	2N2646	.70	BC327	.15	2102 350 NS2	.00	4N26	.85
4016	74C90	.80	LM384	2.40	74S10	.75	74147	2.00	74LS83	.00	2N2647	1.10	BC328	.30	2102 450 NS1	4.40	MM80C95	.90
4017	74C93	1.40	LM386	1.00	74S11	.75	74148	1.40	74LS85	.00	2N2894	.80	BC337	.30	2102 650 NS1	4.40	80C96	.90
4018	74C95	.95	LM387	1.30	74S32	.75	74150	1.20	74LS86	.50	2N2905	.40	BC338	.30	2111	8.60	MM80C97	.90
4019	74C107	.70	LM391	1.80	75S51	.75	74151	.60	74LS87	.55	PN2205	.40	BC347	.15	2114 150	NS	8098	.90
4020	74C150	3.40	LM393	.80	74S74	1.20	74152	4.90	74LS90	.50	2N3053	.60	BC548	15	NS	11.15	OPTOCOUPERS	
4021	74C151	1.00	LF398	5.00	74S86	1.40	74153	1.20	74LS92	.90	2N3054	.90	BC549	15	2114 300 NS3	3.50	MCT2	1.00
4022	74C160	.90	8038	6.00	74S112	1.20	74154	1.20	74LS93	.80	2N3055	.90	BC558	16	321	3.10	MCT6	3.00
4023	74C192	.90	NE530	1.10	74S135	2.20	74155	.90	74LS94	.80	2N3059	.60	BC559	18	8-31	3.00	MCT275	1.50
4024	74C164	1.10	OM350	9.90	74S138	3.20	8T28	1.60	74LS95	.55	2N3301	4.00	BC559	18	2513	14.50	MCC671	3.00
4025	74C173	1.00	555	.40	74S157	2.95	9310	.65	74LS100	.50	2N3340	4.00	BC637	25	2516	55.00	4N28	1.00
4026	74C174	.80	556	1.10	74S158	2.95	9311	1.00	74LS102	.50	2N3503	.70	BC638	36	2532	69.00	4N33	3.20
4027	74C175	1.00	LM565	1.30	74S182	3.30	9312	1.35	74LS103	.50	2N3503	.70	BC639	40	2650	23.00	4N26	1.00
4028	74C192	1.20	LM565CH	2.00	7400 SERIES		74156	1.50	74LS104	.50	2N3564	.30	BC640	40	2708	8.50	VOLTAGE REGULATORS	
4029	74C195	1.00	NE566	2.50	7401	.40	74157	.60	74LS106	.60	2N3564	.30	BCY70	85	2716	12.00	78L05	.40
4030	74C221	1.90	LM567	1.50	7401	.40	74161	1.00	74LS107	.60	2N3565	.30	BCY71	85	4116	5.50	LM341P-5	.80
4031	74C373	1.80	NE571	6.50	7402	.40	74162	1.00	74LS109	.60	2N3566	.30	BD135	70	5101	9.00	7805	1.00
4034	74C374	2.00	LM709 14PIN	7.00	7403	.40	74163	.85	74LS110	.60	2N3567	.30	BD136	70	MM5204	12.50	7905	1.70
4035	74C901	.90	UA710CA	.60	7404	.40	74164	.60	74LS112	.60	2N3568	.30	BD137	70	MM5220	7.20	LM309K	1.20
4039	74C902	.90	LM710-10C	.90	7405	.50	74165	.60	74LS113	.65	2N3569	.30	BD138	70	MM5307	18.00	7805K	2.10
4040	74C905	11.20	711	.80	7406	.50	74174	.50	74LS114	.50	2N3641	.30	BD139	70	MM5309	6.50	LM323-K	6.90
4041	74C906	.90	UA711-H	.85	7407	.50	74175	.90	74LS115	.75	2N3642	.30	BD140	70	MM5312	9.00	7805SK	8.50
4042	74C907	.80	UA716HC	6.25	7408	.40	74176	1.10	74LS116	.65	2N3643	.30	BD141	70	MM5369	2.60	LM341P-8	.80
4043	74C915	1.50	723	.50	7409	.40	74177	1.10	74LS117	.75	2N3644	.30	BD142	70	5387	8.50	78L12CP	.40
4044	74C922	3.80	LM723CH	1.10	7410	.40	74180	.90	74LS118	.80	2N3645	.30	BD234	50	5387	8.50	79L12C	.65
4046	74C923	5.00	LM725	3.90	7411	.40	74181	2.30	74LS119	.60	2N3646	.30	BD262	1.20	6508	5.50	7812	1.00
4047	74C925	5.50	LM733	1.20	7412	.40	74182	.90	74LS120	.60	2N3647	.30	BD301	75	6520	5.50	7912	1.90
4048	74C926	5.90	UA739	2.00	7413	.50	74184	1.20	74LS121	.65	2N3648	.30	BD302	75	6522	10.00	7812KC	2.15
4049	74C927	5.90	741	.25	7414	.70	74185	1.20	74LS122	.50	2N3692	.35	BD303	75	6523	17.00	7912KC	2.60
4050	74C932	5.90	LM741-H	1.20	7416	.50	74190	1.00	74LS123	.75	2N3693	.35	BD304	75	6524	17.00	7912KC	2.60
4051	80C SERIES		UA747	1.00	7417	.60	74191	1.50	74LS124	.75	2N3702	.30	BD305	75	6525	17.00	7912KC	2.60
4052	MM80C95	.90	UA747HC	2.20	7420	.60	74192	1.70	74LS125	.50	2N3703	.30	BD306	75	6526	17.00	7912KC	2.60
4053	80C96	.90	UA748	.50	7421	.40	74193	.80	74LS126	.70	2N3704	.30	BD307	75	6527	17.00	7912KC	2.60
4060	MM80C97	.90	UA748HC	1.25	7423	.50	74194	1.10	74LS127	.50	2N3705	.30	BD308	75	6528	17.00	7912KC	2.60
4066	80C98	.90	UA753	1.80	7425	.45	74195	.65	74LS128	.50	2N3706	.30	BD309	75	6529	17.00	7912KC	2.60
4068	LINEAR		UA760HC	4.10	7426	.40	74196	.85	74LS129	.50	2N3707	.30	BD310	75	6530	17.00	7912KC	2.60
4069	LH0002	9.50	UA777	2.40	7427	.40	74197	1.10	74LS130	.50	2N3708	.30	BD311	75	6531	17.00	7912KC	2.60
4070	LH0022C	16.60	UA777HC	2.65	7430	.40	74198	1.10	74LS131	.50	2N3709	.30	BD312	75	6532	17.00	7912KC	2.60
4071	LH0042CH	8.60	9334	1.70	7432	.40	74199	1.30	74LS132	.50	2N3710	.30	BD313	75	6533	17.00	7912KC	2.60
4072	LH0070	12.70	UA743	1.80	7437	.40	74221	.90	74LS133	.50	2N3711	.30	BD314	75	6534	17.00	7912KC	2.60
4073	LM0071	12.70	UA760HC	4.10	7438	.50	74290	.90	74LS134	.50	2N3712	.30	BD315	75	6535	17.00	7912KC	2.60
4075	TL071	1.00	UA796HC	1.70	7440	.50	73293	.90	74LS135	.50	2N3713	.30	BD316	75	6536	17.00	7912KC	2.60
4076	TL072	1.50	LM802	1.10	7441	1.00	74365	.80	74LS136	.50	2N3714	.30	BD317	75	6537	17.00	7912KC	2.60
4077	TL073	1.50	LM131DM	2.40	7442	.50	74366	.80	74LS137	.50	2N3715	.30	BD318	75	6538	17.00	7912KC	2.60
4078	SAK140	2.20	1408	4.90	7443	1.40	74367	1.00	74LS138	.50	2N3716	.30	BD319	75	6539	17.00	7912KC	2.60
4081	UAA170	3.50	LM1458	.60	7444	1.20	74368	1.00	74LS139	.50	2N3717	.30	BD320	75	6540	17.00		

HELP FIGHT THE SILENT KILLER

Kidney disease is the silent killer in Australia today. It may be present without apparent symptoms — & hundreds of Australians die of it every year.

But because people can't see their kidneys and don't know much about their functions, they miss the vital early warning signs.

Our kidneys are, in fact, miraculous miniature laboratories containing one to two million filters that help control blood pressure & the important balance of salt & water in our bodies. Yet over 300,000 people consult their doctors each year with kidney complaints.

The Australian Kidney Foundation is the only voluntary gift-supported community health organisation solely concerned with fighting kidney disease, the silent killer. The Foundation provides research & education programmes to both the general public and the medical profession. As well as life-giving aid to thousands of ordinary Australians.

We need urgent financial support to continue our work — and we need kidney donors.

For more information, ring the number below. Any donation of \$2 or over is tax deductible and bequests, endowments and legacies are exempt from State & Federal Estate duties.

Remember, as someone has so rightly pointed out — the life you could help to save could be your own.

**The Australian Kidney Foundation,
1 York St., Sydney. Phone 27 1436**



N.T. Department of Transport & Works

PLANT WORKSHOP MANAGER Neg. to \$26,500

MECHANICAL ENGINEER Neg. to \$23,000

The Services Division of the N.T. Department of Transport & Works is responsible for the management and maintenance of the Department's extensive and wide-spread plant and vehicle fleet. The fleet has a replacement value exceeding \$30 million and comprises heavy earthmoving plant and vehicles, drilling and other specialised water investigation equipment, fire tenders, light vehicles and minor construction and maintenance equipment.

These are two new positions designed to strengthen the plant management team —

- The WORKSHOP MANAGER will be responsible to the Plant Manager for the effective and efficient performance of the mechanical workshops in Darwin, Katherine, Tennant Creek and Alice Springs, employing around 120 people.

Applicants must be experienced leaders who can get results from supervisors, tradesmen and clerical staff to maximise plant availability at minimum cost. At least five years' experience in a similar capacity is essential; overseas or remote area experience would be highly regarded; tertiary engineering qualifications are desirable; the preferred age range is 35 to 45.

- An energetic and capable young MECHANICAL ENGINEER is to be recruited for the position of Project Engineer, responsible to the Plant Manager for special studies and projects involving plant management or maintenance. Such projects may concern computerisation of plant performance data, cost reduction studies, design of specialised equipment or systems review.

A good working knowledge of workshop practices, plant reporting and technical purchasing requirements is desirable. The position will ideally suit a qualified mechanical engineer in the 25 to 30 age group, who wishes to develop technical and personal skills in this unique plant organisation. In particular, the position is regarded as a source of future senior line managers.

In addition to the excellent salaries indicated, conditions of employment for both positions include 6 weeks annual leave, superannuation, subsidised housing and return air fares for the family to a southern capital every two years. Both positions are located in Darwin.



REPLIES AND CONFIDENTIALITY

No details disclosed nor enquiries made without your permission. Initial enquiries can be made by telephoning Darwin (089) 81 8750. Applications quoting Reference Number 870132 should be addressed to:

John Bastian
Manager for the Northern Territory

PA AUSTRALIA



21 Temira Crescent
Larrakeyah, N.T. 5790

See Situations Vacant columns for advertisement for PLANT PURCHASING OFFICER and SENIOR SPARE PARTS CONTROLLER, also for Transport & Works' plant organisation.

High power 'dummy loads' for audio amplifier testing

Apart from a multimeter and perhaps an oscilloscope, a resistive dummy load of 4, 8 or 16 ohms impedance capable of dissipating up to 100 watts is just about the most useful item of test equipment the audio enthusiast could have. Here are several ways to build one.

Andrew Kay
Roger Harrison

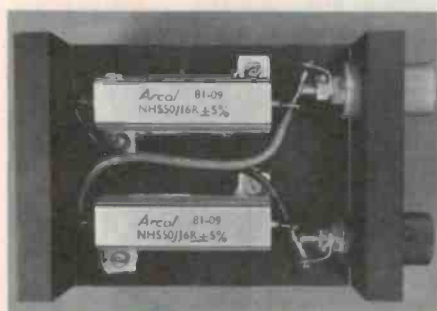

ETI-155b 8 ohm, 100 W dummy load using non-inductive resistors.

WHEN IT COMES to designing electronic equipment — from the very simple to the very complex — if one asked several designers how they would go about a certain design problem undoubtedly you'd get a different answer from each. Here again, we see a fine example illustrating that old saying — "... there's more than one way to skin a cat."*

The project staff at ETI have spent some considerable time over the past two years developing a variety of amplifiers. The fruits of these labours have been duly published and enjoyed by many readers. However, we've always lacked a *decent* dummy load for such work and have sort of *made do* with such contraptions as a string of one ohm 5W resistors dangled in a tub (plastic!) of water, lengths of electric jug element, etc, etc. Whilst jury-rigging such things is in the finest traditions of electronic design and development, the (more than) occasional mishap is not just a

* For cat lovers we'll modify that to "... skin a rockmelon", or something similar!

frustrating interruption but often a decided nuisance giving rise to dark mutterings, steam from the ears and shouts of "we'll have to get a *decent* dummy load?!"

As no doubt many of our more intrepid readers, and/or do-it-yourself audio fanatics, have discovered, such things are hard/difficult/impossible (... delete whichever not applicable) to come by.

Then, Everest Electronics came to the rescue. Eagle-eyed readers will have seen the item we ran in News Digest in the March 1981 issue concerning the *Arcol* range of metal-clad power resistors carried by Everest. When the information arrived, quick as a flash we organised some non-inductive types for a dummy load. Several weeks later two 16 ohm 50 W non-inductive Arcol resistors arrived on the Editor's desk. An hour later we had a working dummy load! Naturally, everybody thought it would make a good project ...

In the meantime, a freelance associate of ours, Andrew Kay, had desired exactly the same thing. Andrew, however, went about solving the problem a different way. He purchased a batch of one watt 1% resistors and made a 50 W dummy load. But, he figured, why not have a little more versatility and make two the same, allowing parallel and series connection to obtain a 4 ohm, 100 W dummy load or a 16 ohm 50 W dummy load as well as a twin 8 ohm 50 W dummy load enabling testing of both channels of a stereo amplifier at the same time! Frankly, we

don't know why we didn't think of it earlier ourselves.

So — here follows the description of several ways to skin a cat/rockmelon/whatever, or build some high power audio dummy loads.

Multi-resistor method (ETI-155a)

By parallelling resistors of an appropriate value, one can obtain an effective resistance of the wanted value and ▶



ETI-155a 4, 8 or 16 ohm dummy load (50 or 100 W) using 98 390 ohm 1 W resistors.

Project 155

wattage rating. Now, the cheapest, most common power rating for carbon film resistors is one watt (1 W). To obtain a 50 watt resistor, 50 would need to be paralleled. To obtain an effective resistance of eight ohms, each 1 W resistor would have to have a value of 400 ohms. The nearest preferred value is 390 ohms. Fifty in parallel would give an effective resistance of 7.8 ohms which is about 2½% lower than the ideal eight ohms. However, 49 in parallel gives an effective resistance of 7.959 ohms — less than ½% out. If you require the tolerance of your load to be within 1% or better, then you'll have to use 1%, 1 W resistors. If you only require a tolerance of +/−5%, then the common 5%, 1 W variety will do the job. Either way, you're better off using 49 resistors so that the effective resistance of the load comes closer to the ideal eight ohms.

The dummy load described here consists of two eight ohm loads, which enables the testing of both channels of a stereo amplifier.

The idea itself is not at all new or original, having been used by radio amateurs for years to obtain resistive dummy loads for terminating radio transmitters while they are on test. The advantages of a dummy load for any kind of power source are:

- the power source (in this case an AF power amplifier) is presented with an ideal resistive load of the correct value,
- the chances of damaging expensive loudspeakers during experimental phases of construction are eliminated, and
- completely silent "full power" testing is made possible even for extended periods of time; which is great for public relations and your ears.

Essentially each dummy load consists of 49 high stability 1% metal film resistors connected in parallel to give a terminal resistance of 8 ohms. The author used cheap, readily available Beyschlag type MBE 0414 1 W series. Since the tolerance rating of the resistors is 1%, the upper tolerance limit for the combination is 8.04 ohms and the lower limit is 7.88 ohms. The number of resistors to be bought was a compromise between the desire for a result of exactly 8 ohms and the need to keep the cost to a minimum. Obviously, larger numbers of resistors could be used (say 70 x 560 ohms in parallel) and the reader can easily vary the circuit to suit the pocket and availability of the resistors. The resistors used in this project can be obtained from

Crusader Electronic Components at 81 Princes Highway, St. Peters NSW, for about 6¢ each. This price is for quantities of 100 up, but since the dual circuit uses 98 resistors there is no difficulty here.

Separate terminal posts are provided for each load so that two separate 50 W sources can be terminated in 8 ohms each or the two halves may be connected in series to give a single 16 ohm 50 W load; and last but not least parallel connection of the two halves will result in a 4 ohm 100 W load. Because metal film resistors are used there are no inductive effects to worry about such as could occur if wirewound units were employed. The stray capacitances present are so low as to be insignificant.

Construction is simple, if somewhat tedious. Lots of soldering is involved! The author used two ordinary household tin cans; one can has a lid (e.g. a coffee tin) the other is a smaller one of the throw-away type (baked beans etc!). The top and bottom of the smaller can were used as soldering planes for terminating the ends of the resistors while the larger can was used to house the project with the lid carrying the terminal posts. Since the coffee tin is virtually leak proof you could fill it with some kind of insulating fluid such as transformer oil and thereby increase the dissipation capability of the dummy loads.

Tin-plated steel is very easy to solder but the sharp edges are dangerous to careless fingers. Blank copper clad printed circuit board could be used instead but does not withstand heat as well as the plain metal sheet.

The arrangement of tin cans may not seem very glamorous but it is highly effective and very cheap — the whole cost of the project comprises about \$7 for the resistors and about \$2 for the terminal posts. The tin can housing can be spray-painted and the terminal posts labelled and marked to suit individual needs.

Before starting choose a medium sized coffee tin with a resealable lid for the case and select a tin can of smaller diameter which will fit easily into the coffee tin. About eight or nine centimetres in diameter should be fine for the smaller tin can. Using a can opener remove the top and bottom of the smaller can and discard the contents (maybe you should eat the contents — but that's really outside the scope of ETI!). Also, discard the remaining cylindrical portion of the can! Mark up one of the tin-plated discs so obtained

with a grid of ten by ten lines as shown in Figure 1 to give 100 intersections.

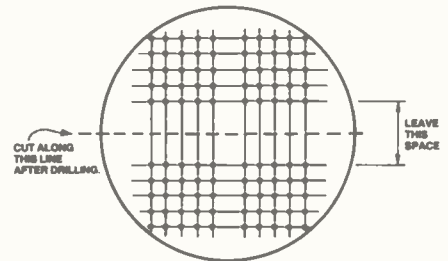

Figure 1. Drilling and cutting details for the tin-plated discs obtained from a small can.

Allow a space of about 10 mm along one diameter as shown. This will allow the discs to be cut in half later. Clamp both discs together onto a drill bench or a block of wood, ensuring that they are exactly superimposed. Drill a hole on each intersection of the previously marked lines. Make the holes slightly larger than twice the diameter of the resistor leads; this will assist assembly later on. Take care that your hands are kept clear during drilling since if the drill bit grabs, the two tin discs will whirl around very much like a meat slicer, and almost as sharp! Only 98 holes are needed so don't get carried away.

When the holes are drilled, cut the two discs along the middle space left along one diameter so that you end up with four half discs each with 49 holes. Tin the area around each hole with solder and proceed with assembly.

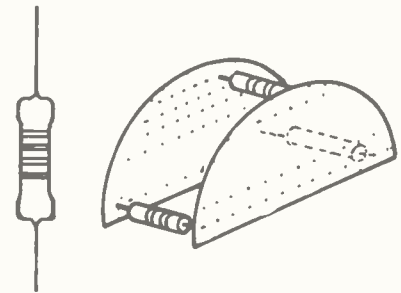

Figure 2. Cut the resistor leads as shown at left and then solder three resistors to two half-discs as shown to make a rigid assembly.

Trim all the resistor leads as shown in Figure 2 so that one lead is longer than the other on each component. Take two matching half-discs and using three resistors assemble a rigid structure as shown in Figure 2. Insert the resistors, one row at a time, in between the two tin plates with the leads poking through the holes. If you insert the longer lead of each resistor into its hole first, the other end should be short enough to allow manoeuvring into the hole in the second plate. After one row of resistors is in place solder all the leads of that row on

audio dummy loads

both plates, then proceed with the next row.

Repeat the assembly for the second half of the unit then trim all excess leads flush with the surface of the tin plate. Using a stiff brush (e.g. an old toothbrush) scrub the soldered surface with methylated spirits to remove deposits of flux.

Connect an ohmmeter between the plates of each load — the reading, believe it or not, should be pretty close to 8 ohms. Inspect all solder joints and re-solder if the reading is not correct. Install the four terminals in the lid of the coffee tin using one red and one black terminal for each half of the unit. Lay the two assembled resistor pads side by side as shown in Figure 3. Using fairly stiff copper wire connect the upper plates to one terminal each. Use

the same colour terminal for both plates as this will be important later if the loads are to be connected in series or parallel. Using the same sort of wire, but insulated, connect the lower sides of the resistor assemblies to the other two terminals. You should finish up with an assembly which will be supported under the lid of the coffee tin and which is so positioned as to allow it to be inserted into the container and for the lid to be

sealed.

To prevent the two halves of the load from shorting together, install an insulating spacer between them using a scrap piece of copper-clad board or matrix board. If using the pcb material, ensure that enough copper is removed to insulate the two halves from each other. If using the matrix board, you will have to drill a couple of additional holes and use small screws to attach the spacer to

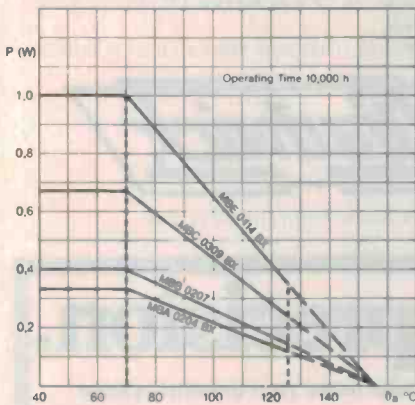

The upper curve in this graph shows the typical dissipation characteristics of the Beyschlag resistors used in the ETI-155a dummy load. Power dissipation is derated at operating temperatures above 70°C.

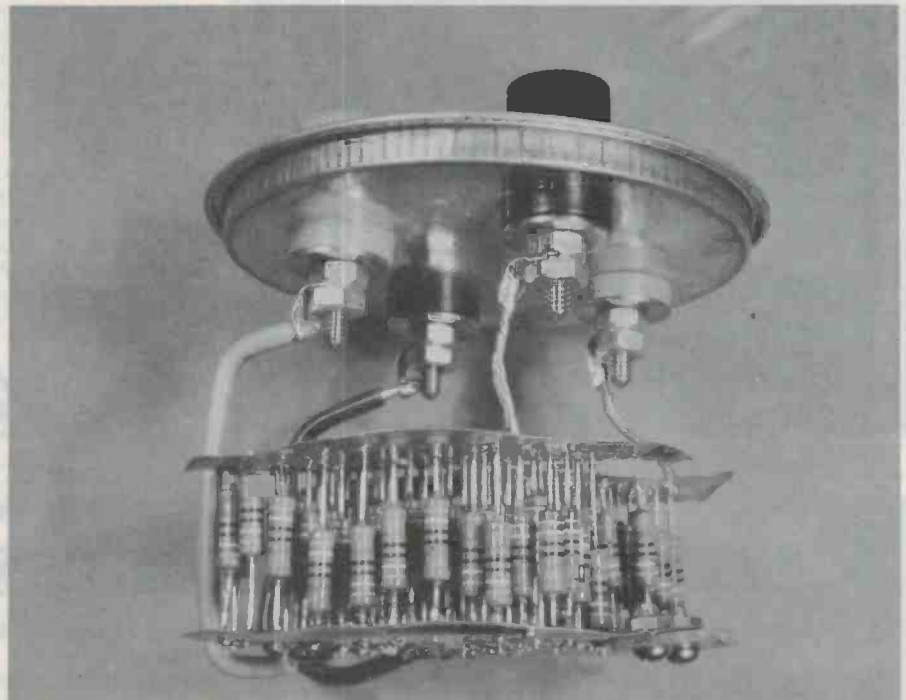
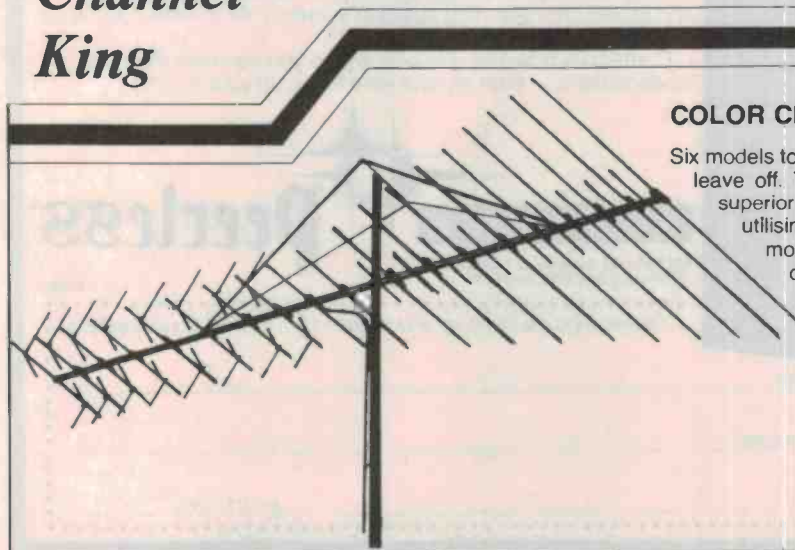

Figure 3. The two half-disc pairs are assembled side-by-side and heavy gauge wire soldered between the discs and the terminals. An insulating spacer of matrix or pc board holds the two assemblies apart.

Channel King



COLOR CROSSFIRES — MODELS CX9 to CX28

Six models to choose from. The aërials take over where the colorays leave off. The famous Color Crossfire series set a standard for superior broadband performance. Of logical periodical design, utilising the Channel Master Energy Absorption principle to put more elements to work for flatter response, higher gain and directivity across the VHF TV/FM spectrum.

Also available from Channel King is an extensive range of hardware Cables, Amplifiers and M-A-T-V Distribution Equipment which can be seen at our showroom.

1117 Burwood Highway,
Ferntree Gully, Victoria 3156
Telephone (03) 758-9111

HOW MANY TIMES DID IAN DURY HIT YOU WITH HIS RHYTHM STICK?



With today's digitally recorded music it is even more imperative that you take full advantage of the "state of the art" recordings with the "state of the art" speakers.

Don't be let down by speakers that distort and fuse your music into a coalised jumble of sounds: Chadwick's "Executive" range of speaker systems will perform brilliantly (a five year warranty makes sure the brilliance will last).

For our top of the range speaker, we began with two terrific Etone 245 300mm bass drivers (which we made even better with a unique modification). Then we added two Audax 160mm full range Bextrene cone drivers, which we loaded in a transmission line enclosure, vented at the rear. Next we added two Audax 25mm domes and two 50mm aluminium cone super tweeters. And finally we linked them all together with a crossover especially designed for this configuration.

And being the perfectionists that we are, we didn't stop there, next we added mirror baffles for very tight stereo imaging.

While our top of the range "Executive Monitor" (\$1195) may not suit everyone, the "Executive 12" (\$595) or the "Executive 10" (\$495) will.

So when Ian hits you, make sure you can hear it: contact Chadwick today on (02) 647 1103 for the name of your nearest retailer.



Chadwick Audio Furnishings Pty. Ltd.

G.M + ASSOC. 76/81

Danish design. Peerless precision.



Loudspeakers from Peerless make your present system sound like new.

Not only will the new precision-built Peerless PAS series improve the sound from your present system, but the beautiful Danish designed natural wood-veneer cabinets complement any interior.

Now you can enjoy tight clean bass responses, with accurate mid-range and crisply defined treble notes.

The new mini Peerless models PAS 20 and 30 are designed for shelf use (upright or horizontally) while models PAS 40, 50 and 80 are floor standing speaker systems. All models handle up to 100 watts RMS inputs.

Contact us now and discover where you can hear Peerless loudspeakers — then let your ears make up your mind.

G.R.D. GROUP Pty. Ltd.

698 Burke Rd. Camberwell, Victoria 3124
Telephone: (03)82 1256 Telex 31712



P1380

Please send me literature and dealer list on the PAS Loudspeakers.

NAME _____

ADDRESS _____

POSTCODE _____

audio dummy loads

the resistor assemblies.

Before inserting the assembled unit into the coffee container, mark the lid to indicate which terminals are connected by the resistive pads.

To test the unit, connect each load across a known working amplifier or if this is not convenient, use a car battery (not more than 12 V) as the driving source. If using an amplifier, connect an ac voltmeter across the load under test. If you can use a sine wave generator to drive the amplifier, all the better. Adjust the amplifier volume control to give about 10 to 15 volts across the loads. Check by feeling the resistors with your hand that they are in fact warming up. Increase the output of the amplifier until the voltage across the loads is about 20 volts. This should result in the resistors getting quite hot after a couple of minutes.

If using a car battery, connect the two loads in parallel and connect the battery across them. Check the current drawn; it should be approximately 3 A with a 12 volt battery.

When testing is satisfactorily completed, install the whole assembly into the coffee container and press down the lid. If you plan to use the loads continuously, fill the container with insulating oil before assembling.

Metal-clad resistor method (ETI-155b)

This has to be just about the world's quickest project! Two 50 W, 16 ohm Arcol resistors connected in parallel were used as a single 8 ohm, 10 W resistor is more expensive. The Arcol resistors have two diametrically

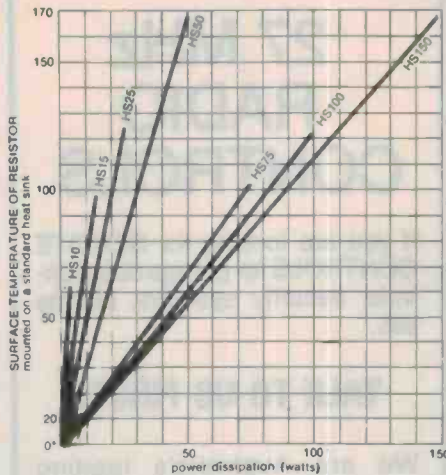

Temperature-dissipation characteristics of the Arcol metal-clad resistors. The curve marked 'HS50' applies to the types specified for the ETI-155b dummy load. (Temperatures shown are surface temperatures at reduced dissipation).

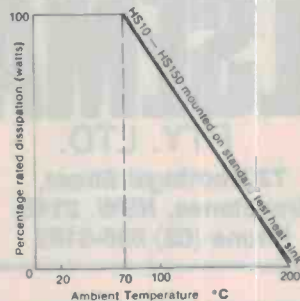

Power derating graph for the Arcol resistors.

opposed mounting tags drilled to take 6 BA bolts. We mounted them on a short (71 mm) length of heatsink obtained from Autotron Australia, of P.O. Box 202, Glen Waverley, 3150 Victoria. We understand a number of component suppliers keep stocks of this product.

We chose it because its shape is very convenient for this application but almost any suitable heatsink on which the Arcol resistors can be comfortably mounted will suit.

The two resistors are mounted in the 'well' beneath the fins, positioned such that the securing bolt holes do not foul any of the fins. The photograph makes this clear. Two large terminal posts are mounted on one side to provide convenient connections and the resistors are wired in parallel in the manner shown in the photograph.

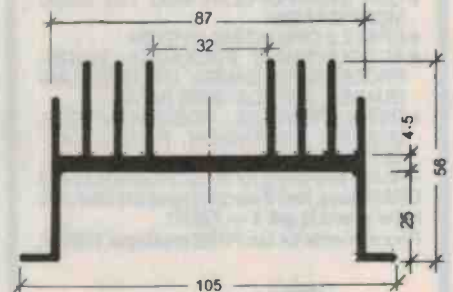

Cross-sectional profile of the Autotron type XA heatsink used for the ETI-155b dummy load. This style of heatsink is obtainable in a variety of lengths.

With the heatsink used, at a dissipation of 100 watts, the heatsink temperature rapidly rises and will reach 150°C after some minutes! Fan cooling keeps it within bounds, but if you expect to use the dummy load for lengthy periods then a larger section of the Autotron heatsink or whatever you wish to use is recommended. To keep the resistors at 70°C or below, (their maximum temperature at full dissipation before derating) we suggest either a single 500 mm length (standard size, natural finish) or two 200 mm lengths (standard size, black anodised).

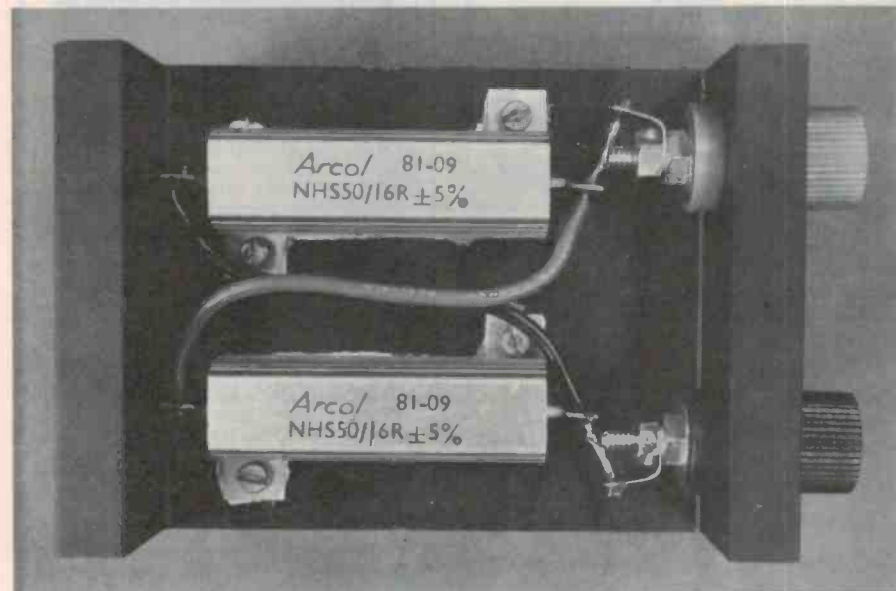

The ETI-155b assembled — the world's quickest project!

PARTS LIST — ETI 155

- ETI-155a**
98 x 390R, 1 W, 1% or 5% carbon resistors.
4 x large binding posts, two black, two red.
Tin cans to suit — see text; high current wire (see text and pics).
- ETI-155b**
2 x Arcol 16R, 50 W, 5% non-inductive resistors, type NHS50.
2 x large binding posts, one black, one red.
Heatsink (see text); high current wire (see text and pics).

Price estimate

ETI-155a	\$7 - \$9
ETI-155b	\$18 - \$22

Note that these are estimated prices only and not recommended prices. A variety of factors may affect the price — cost price movements, whether you use 1% or 5% resistors, type of heatsink employed, etc, etc.

Have an
ADVENTURE
on your
SORCERER

Now there are NINE adventures available:
● Adventureland ● Pirate Adventure ● Mission Impossible ● Voodoo Castle ● The Count ● Strange Odyssey ● Mystery Fun House ● Pyramid of Doom ● Ghost Town.

Try just one for \$14.95, and you won't be able to put your computer away! But be warned — they're addictive. For the month of June we're offering a special price for the complete set of 9 — just \$120.00 — SAVE OVER \$14.00!

We have a COMPLETE range of DISK and TAPE-based SOFTWARE and PERIPHERALS for the SORCERER including:

- OUR EVER-POPULAR MOD 1.01 BASIC MODIFICATION.
- CPM 2.2 OPERATING SYSTEM.
- ACCOUNTANCY PACKAGES, WORD-PROCESSORS, GAMES, UTILITIES, LANGUAGES, APPLICATIONS PACKS.
- DISKS, PRINTERS, VIDEO MONITORS, MEMORY EXPANSION, PAPER, CASSETTE TAPES etc, etc.

— In fact everything for the SORCERER (or any CPM/Micro). And if we don't have it in stock, we know where to get it — FAST!

Phone or write for our FREE catalogue TODAY.

*Software
Source*

PO BOX 364, EDGECLIFF, NSW 2027
PHONE (02) 33-4536

27 MHz
**RADIO
CONTROLS**

If you are looking for REMOTE CONTROLS for garage door controls, security systems, alarms etc.,

TALK TO US FIRST!

We are Australia's leading maker. Our range covers most of your requirements.

ELSEMA
PTY. LTD.

73 Kootingal Street,
Greystanes, NSW. 2145.
Phone (02) 636-3162

**DICK SMITH
ELECTRONICS**



NOW OPEN

**7
DAYS***

On Parramatta Rd

Yes! Dick Smith Electronics, your one-stop electronics supermarket, has a branch open 7 days per week! Now you won't be caught short looking for a .001uF greencap to finish a project on Sunday afternoon. Just call into Dick Smith Electronics — Auburn!

*Open 9AM — 5.30PM Mon-Fri, 8.30 — 12 noon Sat & 10AM — 2PM Sunday

**145 Parramatta Rd,
Auburn Ph 648 0558**

**Australians
are dying
younger
from heart
disease.**



National Heart Foundation.

**TRY THIS EXCITING
HOBBY!**

Build your own Organ, at
half the cost of a
ready-built Organ.

**WITH WERSI ORGAN
KITS**

Wide range of models:
COMBO to large CHURCH ORGANS



*Also
available
ready-built.*

- STRING ORCHESTRA
- BASS SYNTHESIZER
- ELECTRIC PIANO
- and the famous WERSIVOICE ROTATION SOUND

Catalogue 104 pages in colour — \$3.00 (incl. postage).
Klaus Wunderlich Demonstration Record, music only with jacket notes — \$7.00 (incl. postage).

CLEFTRONICS PTY. LTD.
9 Florence St., Burwood, Vic. 3125
Phone: (03) 288-7899

**SX-200 VHF
UHF / HF
RECEIVER**

26-88,
108-180
AND
380-514
MHz
\$499
Plus \$8 p&p

AM and FM



**Breakthrough in
Scanning Receiver Technology.**

The new SX-200 represents the latest STATE-OF-THE-ART technology in the development of Scanning Monitor Receivers. It has many features that previous have not been available on receivers of its type.

For example the tremendous frequency coverage, which encompass all of the following bands — HF & UHF CB, 27 & 155MHz MARINE, Australian LOW BAND, AIRCRAFT band, VHF SATELLITE band, 10Mx, 6Mx, 2Mx and 70Mx AMATEUR, VHF HIGH BAND and UHF TWO-WAY band. Other features include Automatic detection of am or fm on all bands, Squelch Circuitry that can be used to LOCK OUT carrier only and spurious signals, Fine Tuning control for off channel stations, 240 VAC plus 12VDC operation, Squelch Operated Output that may be used to trigger a tape recorder or channel occupancy counter and accurate Quartz Clock.

Write for a brochure or drop in for a demonstration of this remarkable receiver.

G.F.S. ELECTRONIC IMPORTS
15 McKEON ROAD, MITCHAM, 3132.
(03) 873 3939

ROD IRVING ELECTRONICS

425 HIGH STREET, NORTHCOE 3070. MELBOURNE. PH (03) 489-8131

KITS

THIS MONTH'S KITS

ETI-458 LED LEVEL METER

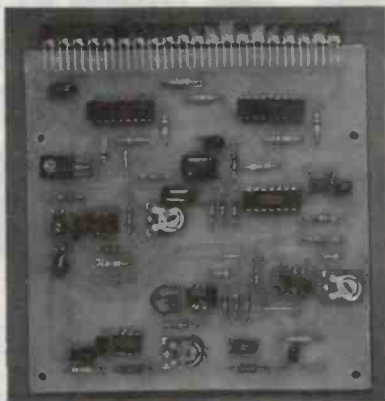

Unique LED level meter features 'twin dot' true display showing peak and average levels of audio signal. **60 dB dynamic range**. Stand-alone project, to be part of Series 5000 Stereo Preamp Control Unit.

P.O.A.

ETI-156 INSTRUMENT PROBE



Very high input impedance, 50 ohm output impedance, 100 MHz bandwidth, dc coupled, gain x1. Just the thing for CROs and digital counter/timers when you want to measure high speed signals in high impedance/low level circuits.

P.O.A.

\$100 Prom Board



ETI 682
KITS \$115.00
PCB \$65.00

ETI 572 Digital PH Meter



\$97.50

ETI 568 Light & Sound Flash Kit



\$25.00

ETI 476 Series 3000

\$84.00

ETI 475 AM Tuner



\$89.00

ETI 329 Expanded Scale Vehicle Ammeter



\$17.00

ETI 567 Core-Balance Relay



\$48.00

KITS

Playmaster Graphic Analyser kit.....\$99.50
EA 79SF9 Sound Flash Trigger.....\$15.00
ETI 585R Ultra Sonic RX.....\$15.95
ETI 585T Ultra Sonic TX.....\$8.95
ETI 576 Electromyogram kit.....\$89.00



Series 5000 Mosfet \$275.00



ETI 477 Series 5000 Mosfet Power Amp
All parts individually available
\$58.00

ETI 599 Infra-Red Remote Control



\$76.00

ETI 147 Oct '80 Electronic Load kit parts.....\$75.00
ETI 327 Turn Hazard Unit kit parts.....\$22.00



ETI 729 UHF TV Masthead

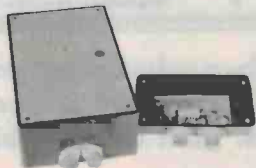

\$34.00

ETI1501 Negative Ion Generator



\$42.00

EA Digital Engine Analyser Oct 80 80TM8a 10
Kit parts inc. front panel.....\$44.95



EA Car Battery Voltage Monitor Oct EA kit parts.....\$6.50
EA Bipolar Train Controller Nov 80 kit parts.....\$26.00
EA Digital Storage CRO Adaptor Nov 80 kit parts \$78.00
EA Light Beam Relay Nov 80 kit of parts.....\$13.00
EA RS232 Printer Interface Nov 80 kit parts.....\$15.00

ROD IRVING ELECTRONICS

425 HIGH STREET, NORTHCOE 3070. MELBOURNE. PH (03) 489-8131

ROD IRVING ELECTRONICS

425 HIGH STREET, NORTHCOE 3070. MELBOURNE. PH (03) 489-8131

For heavier items add additional postage. Extra heavy items sent Comet freight on. Prices subject to change without notice. Send 60c and SAE for free catalogues. Minimum pack and post \$1.00. Bankcard Mail Orders welcome.

LOOK AT THESE GREAT KITS NEW



ALL DICK SMITH KITS FEATURE:

- Quality components
- Full, easy-to-follow instructions
- Competitive price

WHY SETTLE FOR LESS?

NEW FOR JUNE:

NEW EA BENCHMARK
 The hobbyist's answer: a nifty little kit featuring a project power supply and amplifier in one case. Think of all the trouble-shooting applications! Requires external speaker (use our A-2451 remote speaker @ \$9.50)

CORE BALANCE RELAY

Save a fortune on commercial units!

Includes pre-wound coil
 This one should be in every hobbyists workshop - it could save your life! Senses any leakage to earth from a mains appliance (e.g. through your body) and shuts off power before it has a chance to electrocute you.

SEE ETI APRIL
\$49⁵⁰
 Cat. K-3315



\$45
 K-3478

UHF TV Downconverter
 UHF TV is here: but only a small percentage of TV's are fitted with UHF tuners. Use any standard VHF TV set with this converter: use for a single channel or make it tuneable.

Cat. K-3235
 SEE ETI MAY
\$32⁵⁰

INFRA RED BEAM RELAY

Ideal burglar alarm, door minder, etc. Sounds alarm if beam is cut. Also fantastic for wildlife photography.

SEE EA APRIL

Cat. K-3375
\$37⁵⁰

HOT CANARY (short form)
 SEE EA MAY

A gimmick that will keep any child amused for hours! An electronic bird whistle that sounds just like the real thing.

Cat. **\$14⁹⁵**
 K-3395

INFRA RED REMOTE CONTROL

Control any mains operated (or other) device from across the room. Now you can turn the TV off from your chair - or turn the stereo on.

Cat. K-3380 **\$63⁹⁵**
 SEE EA MAY

Improve your health
NEGATIVE ION GENERATOR

Completely safe - battery or plug-pack operated. With an incredibly well researched article showing how beneficial negative ions can be!

\$41⁹⁵ Cat. K-3335
 SEE ETI APRIL

SERIAL INTERFACE (For System 80)

Enables your System 80 or TRS-80 computer be used with many of the serial-type devices: teleprinters, etc. A must for the hobbyist buff gives you the chance to use ex-disposals gear.

Cat. K-3608 **\$57⁵⁰**
 SEE EA APRIL

SPEED SENTRY (short form)
 SEE EA MAY

For safer driving. An alarm sounds if you go over a pre-set speed. You set the speed.

Cat. **\$11⁷⁵**
 K-3245

dB METER

Troubled by noise? Worried about exceeding noise pollution laws? Build this simple dB meter and find out. Easy to build, save \$\$\$ on commercial units.

Easy to build.
 Cat. K-3476 **\$34⁵⁰**
 SEE EA MAY

DICK SMITH ELECTRONICS



See our other advertisements in this publication for addresses, phone numbers, post and packing etc.

Lab Notes

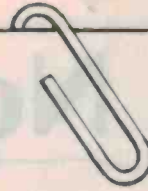

Safety with CMOS

Certain elementary safety precautions must be taken when handling CMOS ICs or designing CMOS circuits. Ray Marston explains all in this month's Lab Notes.

EARLY CMOS ICs earned a reputation for being easily damaged by static electricity, either when being handled or when being soldered into circuit boards, etc. Subsequently, manufacturers tried to overcome this 'fragility' problem by providing the ICs with extensive built-in input and output protection on each gate in each package. These protection networks do a fairly satisfactory job, but provide the designer with a few extra problems when employing CMOS circuits.

CMOS protection networks

CMOS ICs are, by definition, metal-oxide semiconductor devices, in which the input signal is applied to the near-infinite impedance (about 10^{12} ohms) of the metal-oxide gate. Typically, the gate oxide has a breakdown voltage of about 80 V; if a gate oxide breakdown does occur, the resultant damage to the device is catastrophic and irreversible. To protect the CMOS against excessive input voltages (particularly arising from static energy), all modern CMOS

ICs are provided with extensive built-in protection on all inputs and outputs.

Figure 1 shows the standard protection network that is used on the vast majority of B-series CMOS devices. Here, all diodes marked as 'D1' are used to prevent the input or output from swinging more than 600 mV below the V_{SS} (0 V) rail, and all diodes marked as 'D2' are used to prevent the input or output from swinging more than 600 mV above the V_{DD} (supply positive) rail. D3 is intended to prevent the V_{DD} terminal from swinging negative to the V_{SS} pin (electrostatically) when the device is being handled.

There are a couple of minor exceptions to the standard version of the protection network. One of these is the type used on the 4049B and 4050B series of hex buffer/converters which, as shown in Figure 2, have their inputs free to swing well above the V_{DD} rail. These particular ICs are specifically intended for use in logic-level conversion applications, in which (for example) the input may come from a 12 V CMOS net-

work but the output and the IC supply rail are matched to a 5 V TTL network.

Another exception is the 4066B type of transmission gate or bilateral switch, and its equivalents. These devices comprise a bilateral electronic switch and a switch-control network. In these circuits, all switch-control networks have the type of input protection shown in Figure 1, but the switches themselves have the simple protection network shown in Figure 3.

Note in Figures 1-3 that all diodes marked with asterisks are 'parasitic' devices, which just happen to occur fortuitously as an inherent part of the CMOS manufacturing process, while all other diodes are specifically designed into the circuits. Also note that the networks are intended only to give protection against 'normal' electrostatic discharge voltages. When the networks are subjected to ordinary dc signals, the diodes are liable to burn out if their forward currents exceed 10 mA or so, thereby causing possible catastrophic damage to the IC substrate. ▶

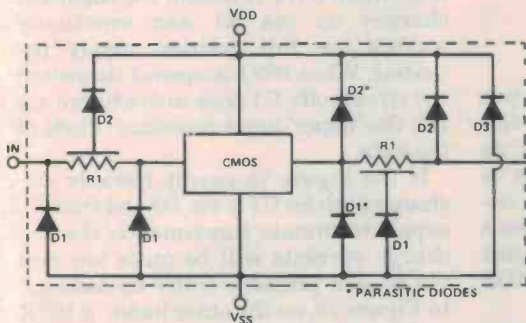

Figure 1. These are the standard electrostatic discharge protection networks used on most B-series CMOS ICs. The two diodes associated with the resistors are distributed across the entire resistance, as shown.

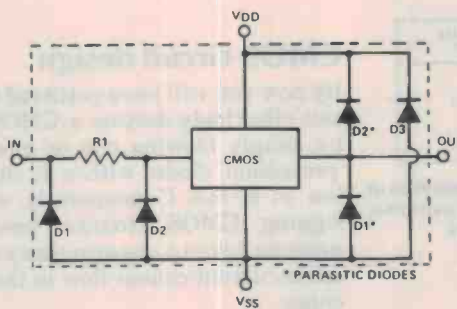

Figure 2. This protection network is used on the 4049B and 4050B hex buffers. Note that the input is free to swing above the positive supply (V_{DD}) rail.

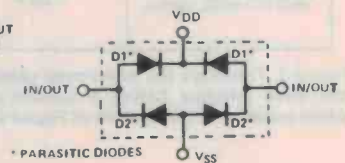

Figure 3. The 4066B quad bilateral switch has standard B-series protection on its gate control input terminals, but has this simplified form of protection on its 'switch' elements.

Lab Notes

Major CMOS manufacturers such as RCA reckon that an electrostatically charged human body can be approximated by the circuit of Figure 4, in which the 'body' has an effective capacitance of 100 pF and a source resistance of 560R. The manufacturers have carried out extensive tests with this model by charging the 'body' to various

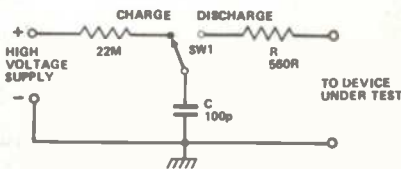

Figure 4. Manufacturers use this equivalent-body discharge network when evaluating the capabilities of their CMOS protection networks.

voltages and then discharging it (via the 560R series resistor) into different terminal combinations (input, output, VSS, VDD) of CMOS devices to establish worst-case capability figures for the three types of electrostatic-discharge protection networks. It should be noted in these tests that the 560R series resistor acts as a current-limiting voltage dropper, so the voltage actually reaching the CMOS device is far lower than the initial electrostatic voltage.

The results of the manufacturer's protection capability tests are shown in Figure 5. As you can see, the standard protection network can withstand a 4 kV electrostatic discharge. A quick calculation shows, however, that this represents a peak protection-diode current of several amps, yet we've already seen that these diodes can withstand dc currents of only 10 mA or so. Puzzled?

PROTECTION NETWORK	WORST-CASE CAPABILITY
STANDARD B-SERIES 4048S AND 4068S 4068S BILATERAL SWITCH	4 kV 1 kV TO 2 kV < 800 V

Figure 5. These are the worst-case capabilities of the three different CMOS protection networks, when tested with the network of Figure 4.

Up the junction

Just about the only way of destroying a diode is to literally vaporise its junction, and this can only be done by applying an

adequate amount of power for sufficient time for the melting process to take place. Since a junction must inevitably be formed on a substrate, which has a finite mass, all junctions inevitably have a certain amount of thermal inertia and are, in fact, destroyed by energy overloads (power-time product), rather than by simple power overloads.

Consequently, it is quite normal to find that a diode rated at 1 A (for example) can, in fact, withstand brief current surges up to several hundred amps. Similarly, CMOS protection diodes, which have very low dc current ratings (10 mA), can withstand very high levels of surge current (several amps), provided that the surge current

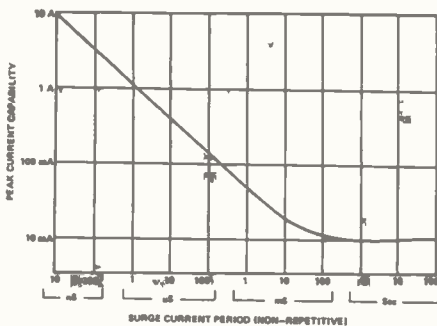

Figure 6. Typical surge-current capabilities of CMOS protection diodes.

duration is very brief. Figure 6 shows the typical surge current capabilities of these protection diodes. Remembering that the 100p—560R 'human body' equivalent circuit has a time constant of a mere 56 nS, it no longer comes as a surprise to note that these diodes can withstand several amps of peak current from a 4 kV discharge!

CMOS circuit design

By now you will have gathered that you can effectively destroy a CMOS device by simply blowing one or more of its 'protection' diodes with a dc current as low as 10 mA. Consequently, when designing CMOS circuits, precautions must be taken to ensure that excessive diode current cannot flow in the CMOS chips.

CMOS ICs can be 'blown' by excessive signals applied to either the input or the output terminals. If several CMOS stages are cascaded, empirical ex-

perience shows that a front-end 'blow' will usually destroy only a single device (because low energy levels are normally involved), but a rear-end (output) 'blow' will often have a ripple effect (because high energy levels are involved) and cause the destruction of all ICs in the chain.

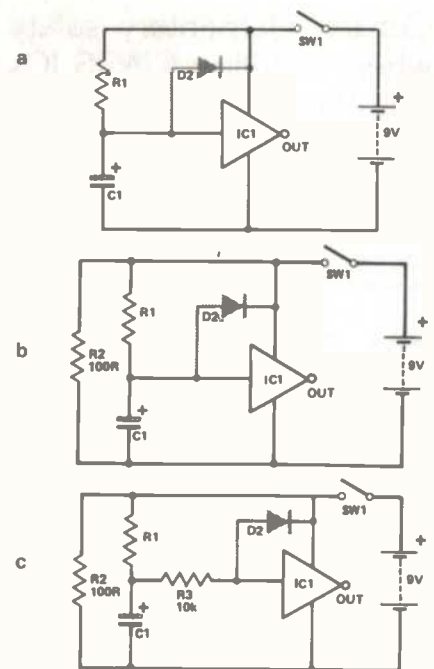

Figure 7. Circuits (a) and (c) are safe, but circuit (b) will almost certainly cause front-end 'blow'. See text for explanation.

The most common cause of front-end 'blow', and its cure, are illustrated in Figure 7. Here, a capacitor is connected directly between the IC gate and the 0 V line; when SW1 is closed, the capacitor charges up via R1 and eventually attains the full positive supply potential. When SW1 is opened (to switch the circuit off), C1 tries to discharge via D2, the 'upper' input protection diode of the gate.

In the Figure 7a circuit, the only discharge path for C1 is via D2 and the IC's supply terminals; consequently the discharge currents will be quite low and the IC will probably suffer no damage. In Figure 7b, on the other hand, a 100R resistor is connected across the supply terminals, so C1 will try to discharge to ground via D2 and R2, and the resulting 90 mA peak current will almost certain-

ly result in the destruction of the chip. In practice, R2 may well take the form of various resistors and semiconductor devices distributed throughout the total circuit.

Figure 7c shows the cure for the Figure 7b design problem, a 10k resistor wired in series with the gate to limit the C1 discharge currents to a safe value. Whenever you design CMOS circuits and have to connect a capacitor between a gate and the 0 V rail, always make sure that the capacitor discharge current is limited to a safe value, either by a series gate resistor or by some other factor.

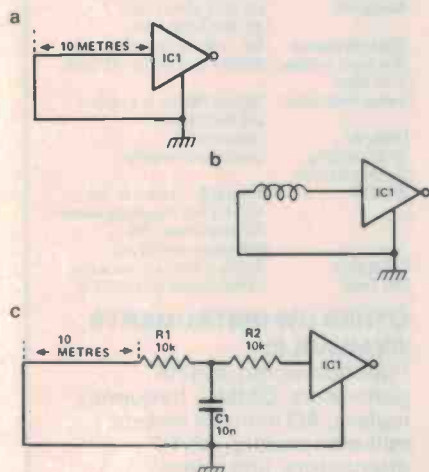

Figure 8. Long input cables, as in (a), can be equivalent to an inductor (b), and present another front-end blowing hazard. The cure is simple (c).

Figure 8 illustrates another possible cause of front-end 'blowing', and its cure. In Figure 8a, it seems that the IC's input is safely grounded by the 10 m of input cable (in practice, this cable may go to a low impedance sensor, etc), but in actual fact (Figure 8b) this cable will inevitably be inductive and can easily pick up unwanted radiation and possibly feed destructive signals to the IC input. Figure 8c shows that the circuit can be rendered safe with a simple filter (R1-C1) and a series gate resistor (R2).

Back-end blowing

The most common cause of back-end blowing is unexpected back-EMFs (from inductive loads) reaching the CMOS output by breaking through

from power-driving circuitry.

Inductive loads, such as relays, can generate surprisingly large back EMFs as their fields collapse at switch-off, as can be proved by connecting a relay in the 'buzzer' mode shown in Figure 9. Typically, a 12 V relay will generate a back-EMF of about 300 V! If you ever use CMOS to switch a relay or other highly inductive load using a transistor driver, always protect the transistor with a pair of 1N4001 diodes connected as shown in Figure 10a. If you want to be really safe, you can use another pair of similarly connected diodes to directly protect the output of the CMOS stage, as shown in Figure 10b.

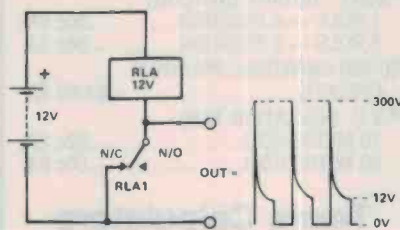

Figure 9. This 'buzzer' circuit can be used to check the magnitude of the back-EMF from a relay. 300 V is typical!

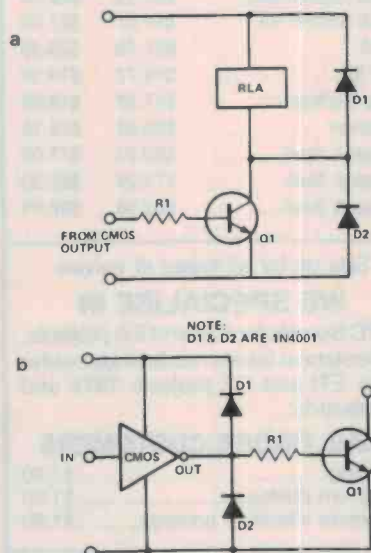

Figure 10(a). A transistor relay-driver can be protected with a pair of diodes. (b) The output of a CMOS stage can be given added protection with a similar arrangement.

HERE AT LAST!

A book on computing that takes you from 'what-is-all-this-fuss-about-computers' through a thorough 'beginners'-buying-guide' right up to 'building-your-own-computer' from projects previously published in ETI.

When faced with the awesome task of choosing or assembling a computer system — whether you want a "learning aid" or a "working tool", a "ready-rolled machine" or a "project kit", you'll find very few places to go. This book rolls it all into one. Assembled from articles published in ETI over the past few years, with additional material to aid the newcomer, it's an invaluable reference work. Running to 156 pages, this book contains 16 articles on various aspects of computing and 10 construction projects.

Copies available for \$4.95, plus 85 cents post and handling, from:

ETI Subscriptions Dept.
3rd Floor, 15 Boundary St
Rushcutters Bay NSW 2011

Name

Address

..... Postcode

I enclose cheque , Money Order for total of \$ for copies of "Computers and Computing — 1980 Yearbook".

ELECTROMARK PTY. LTD.

Australian Suppliers of

**Toroidal
Transformers**



Using advanced winding technology, ILP Toroidal Transformers have only half the weight and height of their laminated equivalents and are appreciably more efficient. Induced hum is reduced by a factor of ten. Supplied with rigid mounting kit with centre bolt, steel and neoprene washers.

30 VA	\$18.49	\$2.08 S.T.
50 VA	\$23.27	\$2.62 S.T.
80 VA	\$25.04	\$2.82 S.T.
120 VA	\$29.39	\$3.31 S.T.
160 VA	\$40.00	\$4.50 S.T.
225 VA	\$47.99	\$5.40 S.T.
300 VA	\$55.89	\$6.29 S.T.
500 VA	\$77.36	\$8.70 S.T.

Send stamped, addressed envelope for a list of secondary windings available.

ELECTROMARK PTY. LTD.

40 Barry Avenue, Mortdale, NSW 2223
SA: Sonics Sound, Holden Hill, SA 5088

RADIO DESPATCH SERVICE

869 George Street,
Sydney, NSW. 2000.
(Near Harrls Street)
Phone 211-0816, 211-0191.

JUNE SPECIALS

"KAMBROOK" KD30 LIGHT AND CORD REEL UNIT	\$20.00
"ARLEC" PS519 UNIVERSAL NI-CAD BATTERY CHARGER	\$13.85
"LANSON" RETRACTABLE 10 METRE CORD PACK	\$7.90
"TRANSWEST" 13.8V/5AMP D.C. REGULATED P/SUPPLY	\$49.92
"JABEL" ROTARY SWITCHES	
1 POLE — 6 POSITION	50c EA.
3 POLE — 2 POSITION	50c EA.
CC-250 UNIVERSAL POLARITY CHECKER	\$4.00 EA.
P.V.C. INSULATION TAPE	
10 METRE ROLL	22c EA.
20 METRE ROLL	50c EA.

Texas Calculators

	Excluding sales tax	Including sales tax
TI 58c	\$141.11	\$156.00
PC100c Printer	\$216.28	\$239.00
TI 55	\$54.27	\$60.00
TI 30 Student pack	\$20.13	\$22.50
TI 35 Student Kit	\$24.57	\$27.00
TI 25	\$21.70	\$23.95
TI1750	\$16.72	\$18.50
Little Professor	\$17.20	\$19.00
Dataman	\$23.63	\$26.15
Speak & Spell	\$69.53	\$77.00
Speak & Math	\$74.29	\$82.30
Speak & Read	\$83.09	\$92.00

See us for all types of valves.

WE SPECIALISE IN

- PC Boards for ETI and EA projects.
- Scotchcal labels made under order for ETI and EA projects 1979 and onwards.

MAIL ORDER CUSTOMERS

Packing	\$1.00
Minimum postage	\$1.00
Minimum interstate postage	\$1.50

OPEN: Mon-Fri 8 am to 5.30 pm.
Thursday night late shopping until
8.30 pm. Saturday 8 am to
11.45 am.

GW

GODD WILL

ELECTRONIC TEST INSTRUMENTS

Best Oscilloscope Value in '81!

A 6.5MHz bandwidth laboratory oscilloscope but with 130 mm 5" calibrated CRT for only \$225 (plus sales tax).

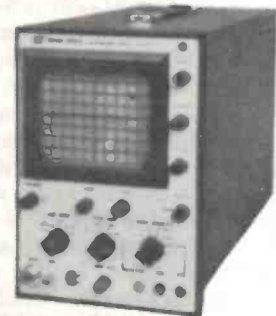

SPECIFICATIONS

Vertical Deflection	
Sensitivity:	10mV/DIV
Attenuator:	1/1, 1/10, 1/100, and GND
Bandwidth:	DC: DC-6.5MHz(-3dB) AC: 2Hz-6.5MHz(-3dB)
Input Impedance	1M + 5% Within 35PF
Max Input Voltage:	600VP-P or 300V(DC+AC peak)
Time Base	
Sweep Frequency:	10Hz to 100KHz in 4 ranges and fine control
Linearity:	Less than 5%
Synchronizing:	Internal and external
Synchronization	
INT, EXT	Internal & +; external; line 0-140° for line frequency sweep
Calibration	50mVp-p 1KHz square wave
CRT Type	130mm Round screen C.R.T.

OTHER GW INSTRUMENTS AVAILABLE:

Function/audio and RF generators, DMM's, frequency meters, AC millivolt meters, milliohm meters, AF/RF attenuators, line filters, capacitance/leakage meters, puncture/insulation testers, regulated power supplies and PA amplifiers.

SOLE AUSTRALIAN AGENT: EMONA ENTERPRISES PTY. LTD.

661 George Street,
Sydney, NSW 2000.
Phone (02) 212-4815

AVAILABLE FROM:

NSW: Emtronics (02) 211-0531.
Radio Despatch Services (02) 211-0191. David Reid Electronics P/L (02) 29-6601. Martin de Launay Newcastle (049) 24-741. Wollongong (042) 28-6020. Pre-Pack (02) 569-9797. VIC: Radio Parts Group (03) 329-7888. SA: International Communication Systems P/L (08) 47-3688. WA: Letco Trading Co. (09) 387-4966. TAS: D & I Agencies (002) 232 842

SUPERB TONE
with this

FAMOUS UNISEF
AM/FM/FM-MPX
RADIO CASSETTE
2x6W
IN DASH MODEL

SAVE \$20



OUR NATIONAL MAIL ORDER PRICE

mere **\$69.95**

JAPANESE QUALITY

COMBINE IT WITH ONE OF THESE **ULTRA FABULOUS**

GRAPHIC EQUALISERS

"Arrow" 5 Band Model
60Hz-10000Hz frequency control
40 watts



AT **\$89.50**

OR A SUPERB **7 BAND**

'PROLINE' **\$99.50**
MASSIVE 50 WATT

Here THE ULTIMATE.....
'LANKAR' SPEAKERS

1 Piece (Grille-Sprk)
145x52.5mm



\$24.50 PR.

GP 660 6" TRI-AXIAL
10oz Magnet 4 Ohm 40 watts **\$57.50** PR.

Deluxe Mesh Grille
Gp 440 4" TWIN
4 Ohm 20 watts **\$29.95** PR.



6P 751 5"x7" Co AXIAL
10 oz magnet
4 Ohm 25 watts **\$42.95** PR.

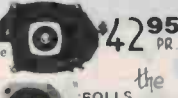

the "ROLLS ROYCE"
3 Way Separates
4 Ohm 40 watts
GPX 650

super deluxe grille **\$75.00**

GP 580 CONVERTABLE CO AXIALS **\$39.50**

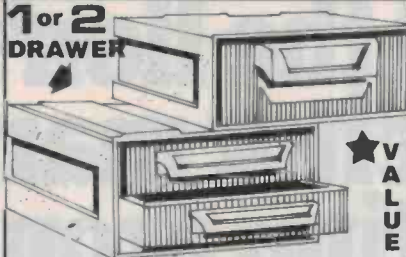
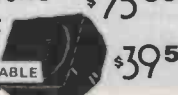

1 or 2 DRAWER

★ **VALUE**

STRONG & STURDY !!!
INTERLOCKING STACKING TOP, SIDES & BOTTOM.

STACK TO SUIT YOUR SPACE. **Yes!**
THIS IS STUPID ... \$2.00 EACH
THIS PRICE MAY NEVER BE REPEATED **\$2 each**

TRANSISTOR ASSISTED IGNITION SYSTEM **35**



save fuel & money too!

NEW KIT!
DIGITAL CAPACITANCE METER
EASY TO BUILD
4 DIGITS
L.E.D. DISPLAY - BIG & BRIGHT
MEASURES 1pF - 99.99 uF - 3 Ranges
INEXPENSIVE TOO!

SEE EA APRIL '80
order NOW only **\$59.95**
GREAT VALUE! in kit form

HEY I DEALERS IN W.A. COUNTRY AREAS IF YOU ARE DYNAMIC & PROGRESSIVE & WANT TO RESELL OUR PRODUCTS AT OUR PRICES WITH SUBSTANTIAL MARGINS RING JACK ON (09) 381 7233 NOW

WANT A REAL ORTOMATIKANTEN- A?
THIS IS IT
SWITCH YOUR CAR RADIO ON UP SHE GOES!
SWITCH YOUR RADIO OFF DOWN SHE GOES!
SIMPLE TO MOUNT
5 SECTION x 1M
FULLY AUTO 12v ANTENNA
AND COP THE PRICE **\$24**
READY TO INSTAL



TO-5 HEATSINKS

\$15.00 per 100
or **25c** ea



all orders **AUST. WIDE**
P&P \$2
ALTRONICS one stop ELECTRONICS SHOP

TRULY MAGNIFICENT!

\$59.95

MOSFET AMP MODULE KIT

all parts as specified by ETI



HI-POWER mosfets

Yes. We have stocks of these for the MOSFET AMP!

BC550	1-9	10 up
BF469	35c	32c
BF470		
2SK 134 (Hi-Power)		\$1-30 \$1-15
2SJ 49 (Hi-Power)		

Heatsink extra!
NOTE THIS PRICE

AND LOOK AT THIS BARGAIN!!
These are **HITACHI HI-VOLTAGE** versions as specified in E.T.I. Note: Neither Altronics nor E.T.I. recommend the compromise low-power types....THEY MAY BE UNSUITABLE!

MOS. TRANSFORMER
BUILT TO FULL 'E.T.I.' SPECS.
flux shorting copper band
prim. 240v
sec. (36v a 2-5Ax2) **\$39.95**
(15v a -5Ax2)

FM INTERCOM
2 channel
NO WIRES!!
simply plug-in to the MAINS
without doubt, this is the best QUALITY UNIT yet!!



OUR **\$55** PR. PRICE

elsewhere for **\$69**

VARIABLE POWER SUPPLY KIT 'USEFUL' PROJECT
\$39.95
(ETI 132)
0-15V @ 1.2 Amps
Many uses - Complete with Scale Meter.
smart **looker too!!!**
SIMPLE ASSEMBLY!!!



YOU MAY SEND CHEQUES, MONEY ORDERS OR USE YOUR BANKCARD (FULL NO & EXPIRY DATE) NO C.O.D. SORRY

SCHOOLS' GOVT. & LOCAL GOVT. DEPARTMENTS. FOR YOUR CONVENIENCE. ALL GOODS INVOICED FOR 14 DAY PAYMENT IF OVER \$100.

NO... WE WILL NOT OFFER FREE P&P JUST TO GET YOUR BUSINESS

A FLAT \$2 PLUS OUR LOW PRICES IS THE BEST GENUINE DEAL

ALTRONICS 105 Stirling St. PERTH (09) **328 1599** for instant service

All MAIL ORDERS: BOX 8280 PERTH Stirling St. WA 6000

Rush in your order NOW, we will rush it back

We didn't get the lion's share of the capacitor market by pussyfooting around.

EX STOCK ALL STATES

We got it by holding inventories of components running into millions of dollars and having stock available on tap in every State. — We wouldn't attempt to supply the nation with minimal stock from one central store.

QUALITY

We got it by setting the highest standards in quality and reliability. Our original RB's, RT's and 'Greencaps' are now the industry standard against which other capacitors are judged.

BUYING OFFICES

We got it by establishing buying offices in the heart of the offshore manufacturing areas to ensure low costs and continuity of supply. We have offices in Tokyo and Hong Kong and are the sole agents for Elna, Samhwa, Nissei and Taiyo, the acknowledged world leaders in capacitor production.

AUSTRALIAN OWNED

We are a stable Australian owned Company with the background and people to know and understand our customers' requirements.

FULL DATA AVAILABLE
ON REQUEST

SOANAR

Soanar Electronics Pty Ltd

A member of the A & R Soanar Electronics Group
30 Lexton Road, Box Hill, Vic., 3128. Australia

VICTORIA: 89 0661
N.S.W. 789 6733
Sth. AUST: 51 6981

QUEENSLAND: 52 1131
WEST. AUST. 381 9522
TASMANIA: 31 6533

Babani Books —

1ST BOOK OF TRANSISTOR EQUIVALENTS & SUBSTITUTES

Complete transistor equivalents. Plus 25 000 transistors with alternatives and equivalents. Covers devices from UK, USA, Germany, France, Europe, Hong Kong etc. See also 211 and BP14.

BP1 \$2.25

2ND BOOK OF TRANSISTOR EQUIVALENTS & SUBSTITUTES

Data on devices not included in BP1. This book supplements BP1, i.e. no data is duplicated.

BP14 \$4.05

FIRST BOOK OF PRACTICAL ELECTRONIC PROJECTS

Full constructional data, circuits, components lists for many practical projects including audio distortion meter, super FET receiver, guitar amp, metronome, etc. etc.

BP23 \$2.75

52 PROJECTS USING IC 741

A must for those interested in any way in this inexpensive and versatile IC. European best seller!

BP24 \$3.50

GIANT CHART — RADIO, ELECTRONICS, SEMI-CONDUCTOR & LOGIC SYMBOLS

Identify those symbols at a glance. A must for beginners and advanced enthusiasts alike. Professionals can always hide it in their desks! A steal at only

BP27 \$2.20

50 PROJECTS USING RELAYS, SCRs & TRIACS

Relays, SCRs and Triacs are used in motor speed control, dimming, heating, timers, light sensitive devices, warning circuits, light modulators, priority indicators, circuit breakers etc. Book gives tried and proven circuits allowing easy modification to suit special needs.

BP37 \$4.60

FUN AND GAMES WITH YOUR CALCULATOR

Amazing collection of 101 jokes and riddles, several quite mind-boggling games for two or more players and a dictionary of numbers which are words if the calc. is read upside down.

BP38 \$2.75

HOW TO MAKE WALKIE-TALKIES

Practical circuitry and construction of transmitters, receivers and antennas. A book of great interest to the licenced operator especially. This book was written with the UK licencing regulations in mind. Some parts may not accord with local regulations.

BP43 \$5.50

IC555 PROJECTS

One wonders how life went on before the 555! Included are basic and general circuits, motor car and model railway circuits, alarms and noise makers plus section on subsequent 556, 558 and 559s.

BP44 \$6.45

PROJECTS IN OPTO-ELECTRONICS

Included are simple circuits using LEDs as well as sophisticated designs such as infra-red transmitters & receivers, modulated light transmission and photo projects.

BP45 \$4.95

LM 3900 IC PROJECTS

Unlike conventional op-amps, the LM 3900 can be used for all the usual applications as well as many new ones. It's one of the most versatile, freely obtainable and inexpensive devices around. This book provides the groundwork for simple and advanced uses — it's much more than a collection of projects. Very thoroughly recommended.

BP50 \$4.95

ELECTRONIC MUSIC & TAPE RECORDING

Shows how electronic music can be made at home with simple and inexpensive equipment. Describes how sounds are created and recorded to build up final compositions. Includes how to build a small studio including mixer and effects units

BP51 \$4.60

LONG DISTANCE TV RECEPTION (TV-DX).

Written by UK authority, the book includes many units and devices made by active enthusiasts. A practical and authoritative intro to this unusual aspect of electronics.

BP52 \$4.60

PRACTICAL ELECTRONIC CALCULATIONS & FORMULAE

For the practical person's workbench. Bridges gap between technical theory and cut-and-dried methods which work but leave the experimenter unfulfilled. There's a strong practical bias. Tedious and higher maths avoided where possible. Many tables included. This one's a beauty!

BP53 \$8.25

RADIO STATIONS GUIDE

Eight sections covering: European LW/AM; European, Near East and N. African MW/AM; World-wide SW/AM; European FM/VHF; Broadcast band USA; Broadcast band Canada; Local UK; Wavelength/frequency conversion. Book shows station site, country, frequency, wavelength, effective radiated power and, in some cases, call sign.

BP55 \$6.45

ELECTRONIC SECURITY DEVICES

Simple and also sophisticated alarms using light, infra-red and sonics; also gas and smoke detectors, flood alarms, doorphone and baby alarms etc.

BP56 \$5.35

HOW TO BUILD YOUR OWN SOLID-STATE OSCILLOSCOPE

Project divided into sections for builder individually to construct and test — then assemble into complete instrument. Includes short section on 'scope usage.

BP57 \$5.50

COUNTER DRIVER AND NUMERAL DISPLAY PROJECTS

Well-known author F.G. Rayer features applications and projects using various types of numerical displays, popular counter and driver ICs, etc.

BP67 \$6.10

ELECTRONIC GAMES

How to build many interesting electronic games using modern ICs. Covers both simple and complex circuits for beginner and advanced builder alike. Good one!

BP69 \$6.40

TRANSISTOR RADIO FAULT-FINDING CHART

How to trace most common faults quickly. Top of chart indicates faults — users then follow arrows indicating checks in correct sequence until fault is cleared. Clever one!

BP70 \$1.85

A MICROPROCESSOR PRIMER

This small book takes the mystery out of microprocessors. It starts with a design for a simple computer described in language easy to learn and follow. The shortcomings of this basic machine are then discussed and the reader is shown how these are overcome by changes to the instruction set. Relative addressing, index registers follow as logical progressions.

An interesting and unusual approach.
BP72 \$6.40

REMOTE CONTROL PROJECTS

Covers radio, infra-red, visible light, ultrasonic controls. Full explanations are provided so that the reader can adapt the projects for domestic and industrial as well as model use.

BP73 \$7.15

direct from ETI

POWER SUPPLY PROJECTS

Designs for many power supplies including simple unregulated, fixed and variable voltage regulators — particularly for electronics workshops. Also included are cassette power supply, Ni-Cad charger, voltage step-up circuit, and simple inverter, plus info on designing your own supply. All designs are low voltage types for semiconductor circuits.

BP76 \$6.40

PRACTICAL COMPUTER EXPERIMENTS

How to build typical computer circuits using discrete logic. This book is a useful intro to devices such as adders and storers as well as a general source book of logic circuits.

BP78 \$3.50

RADIO CONTROL FOR BEGINNERS

How complete systems work with constructional details of solid state transmitters and receivers. Also included — antennas, field strength meter, crystal controlled superhet, electro-mechanical controls. Ideal for beginners. Section dealing with licencing etc not applicable to Australia.

BP79 \$6.40

HI-FI LOUDSPEAKER ENCLOSURES

Data for building corner reflex, bass reflex, exponential horn, folded horn, tuned port, Klipschorn labyrinth, tuned column, loaded port and multi speaker panoramics. Clear dimensioned diagrams Included.

205 \$3.50

PRACTICAL ELECTRONIC SCIENCE PROJECTS

Unusual projects including laser, electronic gas detector, ultra high voltage generator, digital clock, reaction timer, geiger monitor, ultrasonic receiver and transmitter, electroscopes etc.

207 \$2.75

DIODE CHARACTERISTICS, EQUIVALENTS & SUBSTITUTES

Includes signal, zener, rectifier diodes etc. Full interchangeability data and characteristics of thousands of diodes of all types with every possible alternative. Includes UK, USA, European, Russian, and Far Eastern devices.

211 \$4.60

ELECTRONIC CIRCUITS FOR MODEL RAILWAYS

Constructional details of a simple model train controller; a controller with simulated inertia, a high-power controller, an electronic steam whistle and a 'chuff generator'. Signal systems and train lighting and RF suppression also covered.

213 \$3.65

BUILD YOUR OWN ELECTRONIC EXPERIMENTER'S LAB USING ICs.

Includes many circuits and designs for constructing test and measuring instruments mostly using modern ICs. Includes AF osc, TTL pulse detector, hi-impedance Vm, square-wave osc/pulse gen, logic probe, lo-range ohmmeter, bridge, signal tracer etc.

218 \$3.10

BUILD YOUR OWN HI-FI & AUDIO ACCESSORIES

Essential for keen hi-fi & audio enthusiasts. Projects include stereo decoder, three channel mixer, FET pre-amp for ceramic p.u.s, mic pre-amp with adj. bass, stereo dynamic noise limiter, loudspeaker protector, voice operated relay etc.

220 \$3.10

50 PROJECTS USING CA 3130 ICs.

The CA 3130 is an advanced operational amplifier capable of higher performance than many others: circuits often need fewer ancillary components. Interesting and useful projects in five groups. Audio projects. RF projects. Test equipment. Household projects. Misc. projects

223 \$4.60

50 CMOS IC PROJECTS

Many interesting and useful projects — multivibrators; amplifiers and oscillators; trigger devices; special devices.

224 \$4.60

BEGINNERS' GUIDE TO BUILDING ELECTRONIC PROJECTS

Enables total beginners to tackle electronic projects. Includes component identification, tools, soldering, building methods, cases, legends etc etc. Practical basic projects are included.

227 \$4.60

ORDER FORM

Please forward

Book	Qty	224	...	BP43	...	BP57	...
		227	...	BP44	...	BP67	...
205	...	BP1	...	BP45	...	BP69	...
207	...	BP14	...	BP50	...	BP70	...
211	...	BP23	...	BP51	...	BP72	...
213	...	BP24	...	BP52	...	BP73	...
218	...	BP27	...	BP53	...	BP76	...
220	...	BP37	...	BP55	...	BP78	...
223	...	BP38	...	BP56	...	BP79	...

PLEASE NOTE: Following titles being reprinted.
Delivery expected within six weeks ... 160, 202, BP39.

Trade enquiries welcomed

Send to: ETI 'Book Sales', 4th Floor,
15 Boundary St, Rushcutters Bay NSW 2011.
Please allow 4 - 5 weeks for delivery.

Post & handling:

1 - 4 books: \$1.35 11 - 20 books: \$3.50
5 - 10 books: \$2.70 over 20 books: \$5.00

I enclose \$ (inc. p & h.)

Name

Address

.....

..... postcode

Attention all colour TV technicians

At last we are proud to announce a new pocket size PAL TV COLOUR PATTERN GENERATOR.

GENERAL INFORMATION

The TV COLOUR PATTERN GENERATOR, PAL MC-11 B, was intended to be used for control services, installations and repairing of TV sets C.C.I.R. in PAL colour and in the black and white, B and G systems (or I system). In order to control and adjust the various parameters of the colour TV sets, the MC-11 B has eight adjustment patterns for screen observations. The technician always has access to the services of this instrument in both the laboratory and in the clients home.

The MC-11 B is a small size pocket generator which one can always have on hand, and thanks to its autonomic feeding by the nickel cadmium battery, it is always ready for use. An adaptor/recharger is supplied with the generator plus a connecting cable and a Ni-Cad battery.

SPECIFICATIONS

- Output impedance: 75 ohms.
- Signal Pattern:
 1. Colour bars. Grey scale in B/W position.
 2. Red raster. Grey in B/W position.
 3. Crosshatch.
 4. Dots.
 5. Central single cross.
 6. Central dot.
 7. White raster.
 8. Vertical lines at 2,217 Mhz without sound (half subcarrier frequency).



NISSIM PTY. LTD.

249-251 Carlisle Street, Balaclava,
VIC. 3183. Phone (03) 527-7146.

PRE-STOCKTAKE SALE

next thing you know
RESISTORS
ALL 1/2 & 1/4 watt
2c
ALL 1 watt
4c
we'll be giving them away

TTL and CMOS at Supa Low Prices

7401	23c	4001	23c
7405	23c	4002	25c
7410	23c	4006	1.16
7413	43c	4007	31c
7420	23c	4012	14c
7430	23c	4014	96c
7440	23c	4018	98c
7441	98c	4022	1.08
7445	52c	4025	23c
7446	93c	4027	45c
7460	23c	4028	93c
7470	37c	4029	1.33
7472	52c	4049	37c
7475	36c	4050	53c
7480	92c	4071	23c
7482	1.37	4081	23c
7483	1.37	4416	48c
7491	68c	4449	23c
7492	53c	4513	1.93
7496	72c	4518	1.89
74121	34c	4520	1.08
74141	107	74C02	26c

supa special!
All values of SINGLE GANG
ROTARY POTS Just 40c.
ALL DOUBLE GANG 80c.

supa value
BC 548 TRANSISTORS
ONLY 8c!
top quality

SUPA LOW PRICES ON ELECTRO'S

1,000uf 35v.R.T.	60c
1,000uf 50v.R.T.	93c
2,500uf 16v.R.T.	56c
2,500uf 25v.R.T.	64c
3,300uf 16v.R.T.	90c

DAVE RYALL ELECTRONICS

657 PITWATER ROAD, DEE WHY, NSW. PH (02) 982-7500.

Mail Order PO Box 176, Dee Why, NSW 2099.

END OF YEAR CLEARANCE SALE!

"It's our end of financial year. We need the sales, you get the savings!"

STEREO COMMANDER

Ultrasonic remote control for home, car or boat, Hi-Fi system, connects to tape in/out sockets, 12V operation, hand-held remote unit, limited quantity!

Only \$59

HEAVY-DUTY SQUIRREL-CAGE BLOWERS

220V 300mm long x 100mm diam

• RUGGED, QUIET
• POWERPULL AIR FLOW
• SAFETY CUTOFF SWITCH
• FULLY TESTED AND G'TEED - EX COMPUTER

\$24

FM wireless mikes.

NEW MODEL 88-108MHz OMNI-DIRECTIONAL ELECTRET CONDENSOR MIKE. Ideal for stage, church, school, home-parties etc. Tune in on your FM radio. Save \$5 on our regular \$28.50 price.

\$23.50

ECONOMY FM MIKE 88-108MHz

Transmits to 50m range, condenser microphone. Normally \$16

\$10

3 POSITION STEREO SPEAKER SELECTOR

3 de-luxe toggle switches select any combination of 3 sets of remote speakers. Easy instal, wall mounting, for 8-16 ohm speakers, with instructions.

FILL YOUR HOME WITH SOUND!

\$9.99

UNIVERSAL BALUNS

A special purchase of 75-300ohm TV baluns, usually \$1.95 ea. LIMITED QTY.

\$1.20

75 OHM WALL SOCKET

SINGLE \$1.25
TWIN \$2.15

TV & FM SPLITTER

2 WAY 300 OHM SPLITTER \$2.25
2 WAY 75 OHM SPLITTER \$2.50
4 WAY 75 OHM SPLITTER \$4.25

6.5MHz CRO

130mm 5" TUBE

\$259 DELIVERED FREE! ANYWHERE IN AUSTR.

WITH INTERNAL CALIBRATION & SHIELDED CO-AXIAL INPUT & FOCUS, INTENSITY AND HORIZONTAL GAIN CONTROLS - ALL SOLID STATE OPER.

TOP TRADE-INS TOO

Much better... 75mm than similar... see for models - see for your self!

NOW AVAILABLE EX STOCK

14 DAY TEST AND PROVE TRIAL or your money refunded in full!

stock sellout!

50% OFF Resistors 1/2, 1, 5, 10W
20% OFF Potentiometers
50% OFF Inductors

CLEARANCE

20% OFF Transformers
20% OFF Semiconductors
25% OFF Metal Boxes etc
50% OFF Poly. Cer Caps
25% OFF Plugs, Sockets

20% OFF Speakers
25% OFF Cables etc.
50% OFF Electrocs.
20% OFF CB Equip.
20% OFF Car Stereo.
20% OFF Accessories

SACRIFICE SALE GENUINE REDUCTIONS TO CLEAR STOCK

KEEP KOOL FANS

EX-Computer - G'TEED High quality, very quiet.

3" \$15
5" \$18
6" \$17
7" \$19

ROUND 165mm diam/100mm 115mm diam x 50mm

SUPER-SLIM 4" 92x92x25mm 220V Just 1" thick! ONLY \$21

DC MOTORS

EACH \$13

A new range of ELECTRONICALLY CONTROLLED DC motors, variable speed by triostat adjustment, for replacement in most cassette recorders, tape decks, players, etc. High quality with lower wow/flutter, less vibration, longer life.

Model	Rated voltag V	Working speed rpm	Rated load current mA	Direction of rotation
EG-10ED-6F	6.0	4.2-7.5	2400	128 CW
EG-10ED-9F	9.0	6.0-11.0	2000	92 CW
EG-10ED-9F	12.0	8.4-15.0	2400	69 CW
EG-10ED-2H	12.0	8.4-15.0	2400	69 CCW

- ## SPECIALS
- 200 1/2 watt assorted resistors.....\$1.95
 - 250 mixed-up resistors.....\$1.95
 - 25 various 8F, video, peaking chokes.....\$1.95
 - 12 various triaser caps, range 3-120pF.....\$1.95
 - 25 sized triaser pots, range 100-2Mg.....\$1.95
 - 20 various new pots, sgle.gang,switched,etc.....\$1.95
 - 15 inst. knobs,precision,black,for mt.plate.....\$1.95
 - 45 assorted valve sockets, 7,9 pin etc.....\$1.95
 - 10 sized switches, rotary,toggle,slider,DPDT.....\$1.95
 - 1 centre desoldering wick in dispenser.....\$1.95
 - 20 assorted zener diodes, 40mV,1W,5W,etc.....\$1.95
 - 4 3055 power transistors, 10-3 60V 115W.....\$1.95
 - 48 electrical terminal connectors,blocks of 12.....\$1.95
 - 2 DPDT mini toggle switches.....\$1.95
 - 1 1.7V ni-cad pencil batteries 50mAh,steed.....\$1.95
 - 6 metres grey 3 core mains lead.....\$1.95
 - 25 silicon diodes 1N814 and 1N4148.....\$1.95
 - 25 2MA1 silicon rectifiers 100 PIV 1 AMP.....\$1.95
 - 15 assorted types, colours, LEDs 100K steed.....\$1.95
 - 3 2 core mains power leads with 3 pin plug.....\$1.95
 - 1 5 pin din to 5 pin din audio lead.....\$1.95
 - 20 sized 3AG fuses, in range JA to 20A.....\$1.95
 - 30 asst. types 3AG fuseholders, chassis,1line.....\$1.95
 - 30 metres hook-up wire, 5 asst cols.....\$1.95
 - 1 Ignition Filter kit for CB, car stereo,etc.....\$1.95
 - 1 universal cable connector kit,for car hi-fi.....\$1.95
 - 12 1000uF 50V pig-tail electra capacitors.....\$1.95
 - 1 grey foam speaker grille.....\$1.95
 - 14 Bourne 75ohm 1W 50 ohm precision pots.....\$1.95
 - 14 alligator clips, ass. sizes, red & black.....\$1.95
 - 4 asst relays, various voltages, types.....\$1.95
 - 10 ign noise suppressor resistors for HiFi cables.....\$1.95
 - 1 24V DC 430 plug-in relay, 3 pole 10A CO.....\$1.95
 - 4 50ohm 2W 5W pots with knobs,tweeter con.....\$1.95
 - 3 thermal cut-out switches, approx. 70°C over.....\$1.95
 - 1 PCB etic resist Dulo pen for making PCB's.....\$1.95
 - 1 set CB radio crystals, trans/rac,asst chan.....\$1.95
 - 1 40/700pF, MSP 2 gang tuning cap.....\$1.95
 - 4 2uf non-polar polyester 50V 100V caps.....\$1.95

\$1.95 *SAVE \$\$\$

EA. PACK LOOK!

TRANSFORMERS

MAINS 120V PRIM.
12-0-12 VOLT
500mA Secondary
MAIL \$1 extra P/P
ORDERS \$1

Series primaries for 240v use! 2 for \$3.95

CAR STEREO SPECIALIST

Turn up the volume

It's NEW, quality, modular HI-FI for your car - comprises AM/FM Stereo Tuner, auto-stop cassette deck with Cr02 switch, 5 band graphic equalizer and rack. 30W PER CHANNEL OUTPUT. Specs similar to home hi-fi, send SAE for a copy! R.R.P. \$299

\$249

BATTERY ELIMINATOR POWER SUPPLIES

6-9-12V DC
240V INPUT 300mA \$7.99
500mA \$11.50

30cm BLACK & WHITE TV - AC/DC UNIVERSAL VIDEO MONITOR

12" Black and white TV can be changed at the flick of a switch to a high resolution VIDEO MONITOR for use with most computers. Operates on 12V DC/240V AC for portable use. Usually \$149 NOW SAVE \$20 AT THIS SPECIAL PRICE!

\$129

NEW CLIP-IN BUTTON PHONE DIALLERS

Instal in mins! Only 3 wires to connect!

\$29.99 NOW SAVE \$10

Specially designed to replace Aust. rotary dial. Not approved by Telecom under current reg.

Tape heads

High quality, low cost REC/PLAY tape heads for replacement in most cassette recorders. Suits Vortec mechanisms, etc.

MONO HEADS \$2.99 EA \$10

* Power Transformers

Bulk purchase of new, best quality mains transformers used in M and K chassis AWA-Thorn colour TV sets.

240V AC INPUT \$9

H Primary: 0,120V,175V, plus 0,120V,125V for 240V, 250V operation.
H Secondary: 0,120V 1 Amp plus 6V 1 Amp.
K Primary: 0,240V,250V
K Secondary: 0,105V 1.3 Amp plus 6V 0.9 Amp plus 12V 0.25 Amp.

PRE-PAK electronics

P.O. Box 43, CROYDON 2132
1a West St, Lewisham, N.S.W.
Ph: 569-9797 P/POST 10% VALUE

Phone or MAIL ORDER by bankcard

LEDs

3mm RED round.....15¢
3mm GREEN round.....12¢
5mm GREEN round.....25¢
5mm YELLOW round.....30¢
5mm ORANGE round.....30¢

RECTANGULAR LEDs 12¢
Red or Green 5x2mm

6 Watt STEREO AMP

3w+3w Amplifier with wood-grain base suit BSR or Garrard turntable, Volume, Bass, Treble controls, 1/4" phone 3 din sockets, 8-15A spkr's. All parts and instructions supplied, easy to install.

\$15

220v AC RELAYS

4% Plug-in 10 Amp Contacts SOCKET \$1 ea \$2.65

HEAVY DUTY MINI RELAYS

24V 700mA EA. 5A% contacts DPDT \$1.49

MINI PCB RELAY

8V-15V 250mA SPOT 2A cont. 10+ \$1.50

YOKES FOR AWA COLOUR TVs

MANUFACTURERS EXCESS STOCK! Brand new picture tube deflection yokes for AWA 63cm H chassis and 53 in K chassis TV sets.

at \$8 EA

Ideas for Experimenters

These pages are intended primarily as a source of ideas. As far as reasonably possible all material has been checked for feasibility, component availability etc, but the circuits have not necessarily been built and tested in our laboratory. Because of the nature of the information in this section we cannot enter into any correspondence about any of the circuits, nor can we produce constructional details.

'Broadcast Booster' for AM band DXers

Here is an inexpensive method of providing some receiver front end selectivity and signal boosting for transistor AM receivers, an idea passed on by Paul Spresser of Ipswich, Queensland.

The unit is comprised of a ferrite rod (like those generally used for transistor radio antenna coils) with a coil-cum-antenna wound on it, tuned by a dual-gang 'broadcast' capacitor. The ferrite rod and coil acts as an inductive 'link' to the transistor radio's loopstick antenna. Construction is fairly non-critical. Using a ferrite rod around 150 mm or so long by 9.5 mm diameter, wind 50 to 60 turns of 20 gauge insulated wire (exact gauge is unimportant, but nothing thinner than, say, 26 gauge) onto the ferrite rod — not too near one end. Secure the coil with insulating tape. This can be mounted in a plastic zippy box as shown in the drawings, along with the dual-gang capacitor. This capacitor should have a maximum capacitance of around 400 pF.

For best reception, connect up a good 'ground' and a long wire antenna, at least six metres long. Place the trans-

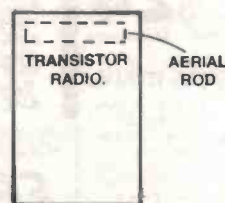
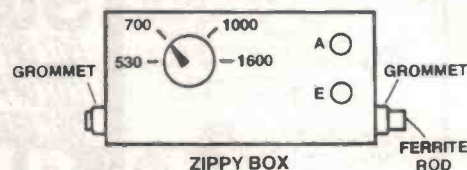
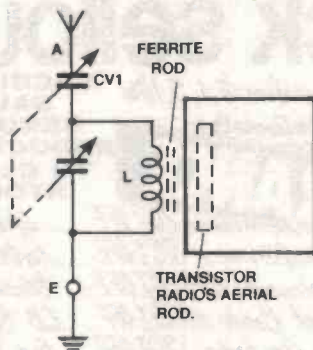

istor broadcast radio with its loopstick antenna aligned parallel to the ferrite rod and reasonably close to it (about 30 mm), tune in a station and tune the dual-gang capacitor for best reception. Further improvement can be made by increasing or decreasing the coupling between the booster and the transistor radio.

If the station tuning on the booster is crowded toward the minimum capacitance end of the dial, take a few turns off

the ferrite rod coil. If the station tuning is crowded toward the other end, add a few turns.

This booster improves front end selectivity and image rejection quite noticeably. Adjacent stations can generally be adequately separated, although both will be heard.

If you mount the booster in a zippy box having a metal lid, connect the lid to the circuit earth. Banana sockets make good aerial and earth connectors.

Simplest triac light dimmer

Triac control circuits are legion in the electronics literature, but try as he might, B.J. Pfeiffer of Lower Mitcham in South Australia could not find a really simple triac light dimmer.

The circuit here has about the minimum possible component count and can handle a lamp load up to 1 kW with a variation from full off to full on.

The circuit is straightforward, the only 'problem' component being RFC1, an item which is not generally commercially available. However, a suitable RF choke is easily made. Mr Pfeiffer suggests winding a layer or two of plastic insulation tape on a 50 mm length of 9.5 mm diameter ferrite rod. Close-wind a layer of 22 B&S enamelled copper wire over the insulation tape, then wind tape tightly over the rod in a

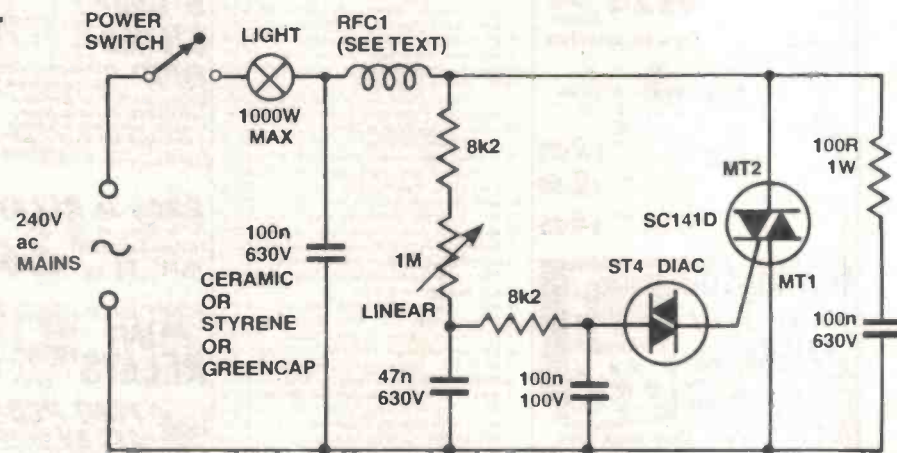

couple of layers. Bind the winding ends firmly.

Construction is non-critical except for taking the usual precautions with

mains-type assembly. Watch the ratings of the capacitors and see that the power switch is properly rated (5 A, at least).

JENSEN ELECTRONICS

75 PROSPECT ROAD, PROSPECT, SA 5082

PHONE (08) 269-4744

SUPER SPECIAL TA7205P AUDIO-1C's. Normally \$4.55 THIS MONTH ONLY WHILE THEY LAST \$2.00

SPECIALS

ELECTROLYTIC CAPACITORS

1500 uf	25v	25c
1000 uf	40v	25c
1000 uf	16v	20c
1000	10v	20c
680 uf	40v	20c
220 uf	63v	15c
220 uf	6.3v	6c
68 uf	6.3v	4c
47 uf	250v	30c
47 uf	25v	6c
22 uf	25v	6c
10 uf	63v	6c
10 uf	25v	6c
2.2 uf	63v	6c
0.47 uf	63v	6c

POLY CAPS

.018 uf	100v	10c
.047 uf	630v	10c
.1 uf	100v	5c
.12 uf	100v	5c
.33 uf	100v	5c
18 nf	250v	5c
33 nf	250v	5c
68 nf	100v	5c
220 nf	250v	5c
.47 uf	100v	8c
1.2 uf	100v	10c

CERAMIC CAPS

6.8 pf	50v	2c
100 pf	50v	2c
820 pf	50v	2c
1000 pf	50v	2c

CARB FILM 1/2-WATT 5% RESISTORS

2c each

PHILIPS TV SLIDE POTS

1K, 22K, 220K
10c each

5mm RED LEDS

10c each

2SD 350 \$4.50
0.5 uf 250v 10c each

NOISE SUPP. CAPS

REED SWITCHES

10c each

IDEAL FOR MODEL TRAINS.
ALL COMPONENTS ARE
PRIME SPEC. NO REJECTS.

TRANSISTORS

2 SA 489	4.30	380	.65	839	.60	1449	2.75	525	2.90	1306 W	5.40	7061	2.75
495	.65	387	1.45	900	.70	1569	5.45	2SK 19GR	1.45	1322	6.20	7063	2.10
496	1.60	403	1.20	930	.55	1674	.70	23 A		1339	7.30	7069	4.45
545	1.90	454	.50	945	.70	1675	.70	30		1342	5.45	7120	1.80
561	.75	460	.55	1014	1.65	1678	2.35	33 F	1.40	1366 W	7.50	7204	4.85
562	.75	495	1.60	1018	3.18	1685	.75	34 E	1.25	LA 3301	6.95	7222	6.25
564	1.40	496	1.90	1047	.75	1687	.95	40		4031	7.05	7310	3.15
628	.65	509	1.30	1061	1.60	1760	3.20	49		M5 1202	3.10	TBA 810	6.80
634	1.95	536	.50	1096	1.40	1846	1.40	55	1.05	8476	29.95	TCA 220	5.99
673	.70	538	1.50	1124	2.20	1893	.68		1.00	NDC 40013	15.95		
683	1.15	605	2.35	1162	1.15	1957	1.35	3SK 41	4.95	NIS 7261	9.30		
706	4.20	710	.70	1172	14.50	1969	6.25	45	2.35	PLL02 AG	11.95		
719	.90	711	.55	1215	.70	1973	1.85	48	4.95	UHIC 001-7	29.95		
844	.75	732	.65	1226	1.25	1974	2.75			UPC 20	6.95		
1015	.85	733	.65	1239	9.70	2029	5.20			575	4.95		
2SB 187	1.00	735	.80	1247	2.20	2075	4.95			577	1.60		
474	2.15	763	.80	1306	3.15	2166	3.65			592	1.55		
525	1.45	776	9.40	1312	.90	2SD 187	1.35			1020	11.50		
536	3.85	781	6.50	1318 R	.90	200	6.30	AN 214	5.25	1156	4.85		
544	1.10	784	.90	1327	.70	235	2.25	315	7.95	UPD 858	10.95		
555	15.00	785	.85	1345	1.65	261	.95	612	5.10	861	19.75		
681	9.80	799	6.25	1359	.90	288	2.00	BA 301	4.95	SL 1626	11.50		
2SC 103	2.10	815	.90	1383	1.30	313	1.80	511	9.25	1640	8.80		
372	.70	828	.90	1384	1.05	325	1.60	521	9.25	TA 7045	5.75		
373	.60	829	.75	1398	1.90	359	1.80	HA 1156 W	4.05	7060	2.20		

Many more available.
Send SAE for free list.

WE ALSO STOCK

HF and UHF transceivers, multimeters, instrument cases, plugs, sockets, switches, Zippy boxes, soldering irons, solder, fuses, test equipment, microphones, speakers, crystals, books, antennas, power supplies and cables.

FAST MAIL ORDER SERVICE

ENQUIRIES: PHONE (08) 269-4744. 2 LINES

PRICES SUBJECT TO CHANGE WITHOUT NOTICE

MINIMUM PACK AND POSTAGE \$1.00

TRADE ENQUIRIES WELCOME



MAIL ORDERS WELCOME

Please debit my Bankcard

B'card No.

Expiry Date

Name.....

Signature.....

Ideas for Experimenters

Meter for the ETI-560 Mains Cable Seeker

Adding a meter to provide a visual indication to your Mains Cable Seeker (May 1980 issue) is a simple job, according to **K. Howell of Renmark, S.A.**

The meter is connected between the junction of diodes D1 and D2 (meter negative) and the junction of resistors R3 and R4 (meter positive). Meter sensitivity is relatively unimportant, anything from, say, 100 microamps to 1 mA would suffice.

With both a visual indication and an audible indication, you can't help finding that hidden mains wiring!

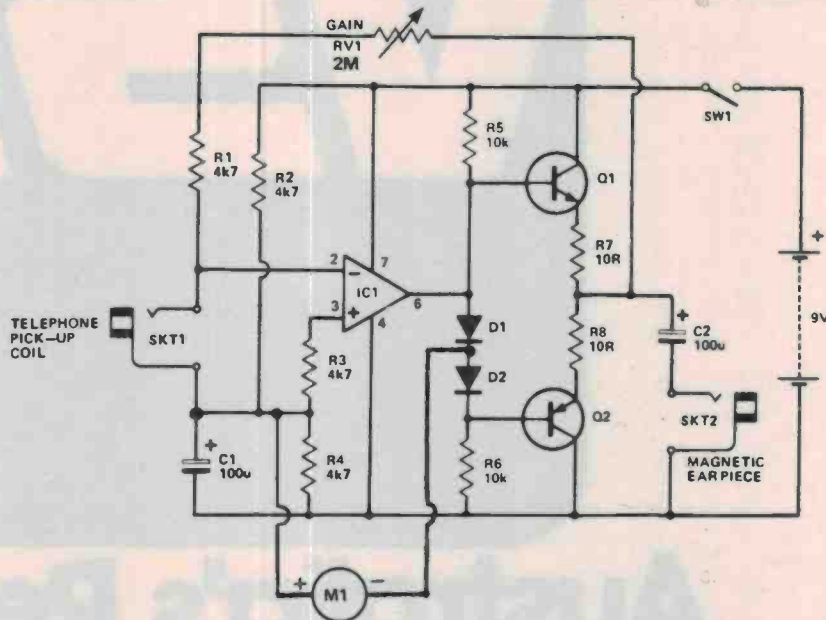

Any ideas?

Have you had a bright idea lately, or discovered an interesting circuit modification? We are always looking for items for these pages so naturally, we'd like to hear from you.

We pay between \$5 and \$10 per item — depending on how much work we have to do on it before we publish it.

The sort of items we are seeking, and the ones which other readers would like to see, are novel applications of existing devices, new ways of tackling old problems, hints and tips.

ETI-640 VDU mod. cures "interlace jitter"

J.J. Wilson of Modbury in South Australia writes that the following small modification to the very popular ETI-640 S100 VDU cured a case of cyclic jitter of one TV sweep line — which he dubbed 'interlace jitter' — on his VDU.

The cure is very simple:

- 1) Remove the diode from pin 2 of IC38.
- 2) Add a 6k8½W 5% resistor between pin 4 of IC38 and the wiper of RV1.

This should result in a display that is perfectly stable.

Visual beat for ETI-604 metronome

Mr A. Partridge of Launceston, Tasmania, constructed our Accentuated Beat Metronome (ETI-604, September '77) and found it very useful. However, he felt the lack of visual indication of the beat was a drawback. Connecting a LED and limiting resistor from pin 3 of IC3 and 0 V in the project was unsuccessful as the flashes were too brief to be of use.

The solution he found was to add another 555, wired as a monostable as shown in the circuit here. This 'stretches' the beat pulse and has the additional advantage that, with the 555's 200 mA sourcing capability, it can drive a small incandescent lamp direct-

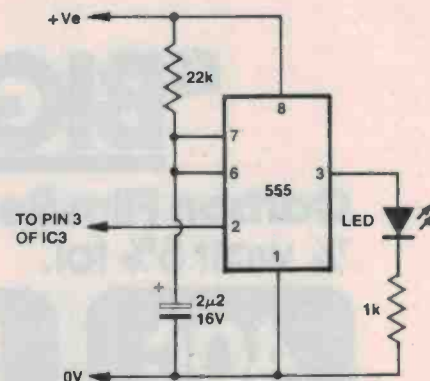

ly, although a LED is shown here. Any suitable LED may be used, such as the common TIL220 — either red, green or yellow, to suit your taste.

Quick & easy front panels

Laminex (or similar material) offcuts are readily available at hardware and builders' suppliers. Front panels of this laminated plastic material are attractive and inexpensive.

It may be cut to size with tin snips or hacksaw, drilled, scribed, filed, etc. As it is so easily worked and the end result is cheap and useful, try it on your next

experimental project.

An excellent idea — from **J.L. Elkhorne of Chigwell, Tasmania**.

ERRATA

A rather obvious, but potentially dangerous error occurred in the circuit on the top left of page 60 ('Power Monitor') in the March issue. It shows the mains active input connected to the earth at the output. The mains active input should instead go to the fuse. Correct your copy now. Correction slips were inserted in the majority of copies distributed.



Australia's Resistor House

"BIG SAVINGS!"

Carbon Film Resistors
1/4 watt 5% tol.

40¢

100
in 1000 lots*

50¢

100
in 100 lots*

Metal Film Resistors
1/4 watt 1% tol. 50 P.P.M.

\$2

100 in lots of
1000*

\$2.50

100 in
lots of 100*

*Plus sales tax if applicable.



**VSI
ELECTRONICS
(AUSTRALIA)
PTY LTD**

VSI, the distributor offering something unique – Service.

Adelaide 51 6483; Brisbane 52 4261; Melbourne 877 5311; Perth 328 8091; Sydney 439 8622

LETTERS

Dear Sir,

I recently purchased Permostat due to the high recommendation in your magazine. Like yourselves, I do not like liquid cleaners, but after the terrific write-up and test I decided to give it a try. (ETI, Jan 1981). I have a pretty good stereo system valued at \$11 000 of which great care is taken. It is only used at home.

I purchased the 1812 Overture 'test' record; due to the many frequencies in the one record it cost me \$21. I played it twice and then used Permostat on it. The amount of rubbish the needle picked up from the record was tremendous, in fact I consider it too much for such a new record, especially as the needle had just been replaced at a cost of \$300. Before a single track from one side was finished I had to clean the rubbish from the needle — a considerable amount.

I now have a problem, as a residue has remained on the needle which is impossible to remove. Also the record concerned has lost some of its dynamic sound and appears to be slightly muffled in sound.

Permostat was used strictly to instructions and we feel it has either damaged our needle and/or our record as there are not the same precise, sharp notes as before.

The only thing I can think of is that the humidity, which is high here, has somehow affected this product. We purchased a kit plus refill as we have over 300 records and were going to eventually get them all done, but after the 1812 Overture and its consequences we will not be doing them.

Could you please advise as to what can be done to combat our now murky sound and dirty needle. I have a Denon turntable with moving coil and a DL303 cartridge. I am also wondering if there is any way possible that our needle could be damaged as it's very expensive and only two weeks old and should last us two years.

Hoping you can offer a helpful reply as we are very dissatisfied with this product. If not could you please let us know who we can contact to get the information we need.

**Greig Tucker
Wulagi N.T.**

We thought that the best way to answer your letter, Mr Tucker, was to show it to the Australian importer of Permostat,

Derek Pugh of Concept Audio. Fortunately, Derek called into our office, bringing with him David Milty of Milty Products, the UK manufacturer of Permostat, who happened to be visiting Australia at the time. Both gentlemen read your letter and discussed with us the problems you experienced and a solution. Here is their reply.

(Roger Harrison)

We are sorry to read of the problems you have encountered with Permostat but can assure you that absolutely no damage has been done to your stylus, or indeed to your record.

To fully understand what has occurred, we must go into some depth when looking at a PVC recording. Firstly, it is incorrect to assume that a record straight out of the packet is indeed clean. This is not the case as factory dust and debris is often in the groove to a considerable degree — held there of course by a strong static discharge.

It is important therefore when taking a brand new record from its sleeve that it be thoroughly cleaned in an effort to remove as much of the debris as possible. There are many reputable cleaners on the market that will do this, but most are of the brush or pad variety that find it very hard to dig the dust out of the groove in defiance of the static charge.

By far the most effective cleaning device in this respect is the Pixall Roller, a new version of which is due on the market very shortly. This comprises a specially formulated adhesive tape that is rolled across the record. The elasticity in the adhesive surface allows deep penetration into the grooves and removal of not only surface dust but dust in the groove as well.

Having therefore attempted to clean the record as best you can, Permostat should be applied according to the instructions. It is common practise to put too much Permostat on a record. This should not be done. Also, buffing should take place for at least 30-40 seconds on both sides of the record of course and the buffing should be very, very firm.

The record that you have mentioned in your letter would, I am afraid, have been very, very dirty from the onset and the dust and debris in the groove has been rising up your stylus and collecting around the shank. In time of course your stylus will

thoroughly clean the record but you do have the slight inconvenience in the meantime of the build-up on your stylus. This, we must emphasise, is a dry build up and can be easily removed with a reputable stylus cleaner.

As I am sure you can see, there is a very logical explanation as to what has been happening and again we hasten to assure you that your stylus in no way has been damaged and your record in no way impaired.

Regarding your specific record of the "1812 Overture", it may be best to seek out a Keith Monks Record Cleaning Machine and use it to thoroughly clean your record before once again applying the Permostat. Permostat is soluble in water so removal would be no problem. Certainly a thorough cleaning of this nature of your record, together with a thorough cleaning of your stylus and the correct re-application of Permostat should ensure that you will not encounter similar problems again.

We would appreciate greatly hearing from you when our recommendations have been carried out and we do hope that as a result your confidence in Permostat will grow.

**Derek Pugh
Concept Audio Pty Ltd**

Dear Sir,

It is not often I get to see your wonderful magazine as I understand you are not permitted to sell it in Britain and I only get the occasional copy when Zel, mummy's Aust. rep., remembers to put in a copy with the bundles of AWWs, Aust. Polo News etc.

I considered myself lucky to be able to pick up a copy of your Tenth Birthday issue (congratulations, chaps) when I visited Australia just recently and was fascinated by the array of interesting articles. I found the report on Negative Ion Generators and the report on Voyager I's encounter with Saturn particularly fascinating. Being a music and audio enthusiast from way back (having your own band instils a certain *musicality* into one's outlook) I was particularly interested in your Sound Reviews — especially the Marantz Tt1000 turntable. While I appreciate Mr Challis' gracious suggestion that your country send one as a wedding present, I think something peculiarly *Australian* would be more appropriate. Nonetheless I think we shall obtain one to go with the Linn-Sondek, as it's always handy to have a spare, don't you think?

I look forward to seeing more of your splendid publication over the next decade.

Charles

BARGAINS FOR PEOPLE WHO CAN READ!

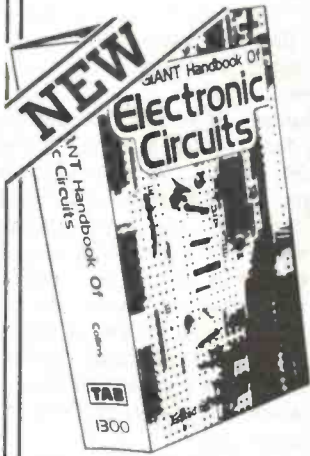

GIANT HANDBOOK OF ELECTRONIC CIRCUITS

Contains nearly 900 pages of unlimited information on electronic circuits for just about every application. Contains over 1,100 clear concise illustrations! A must for any hobbyist, enthusiast, amateur radio buffs etc. Cat. B-1780 P&P \$2.00

\$18⁹⁵



A BIT OF BASIC

A thorough introduction to computer programming in BASIC & extended BASIC. 183 pages of software, hardware, programming information etc. A must for micro-computer owners! B-2329 P&P \$1

\$6⁵⁰



SO YOU ARE THINKING ABOUT A SMALL BUSINESS COMPUTER

100 pages of useful information giving you facts and education on a computer ideal to run your business! Contains many useful guidelines to ensure limited costly mistakes. Cat. B-2355 P&P \$2.00

\$12⁵⁰

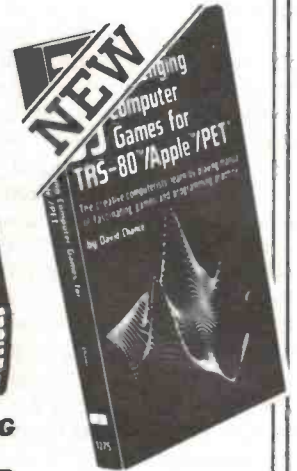

33 GAMES FOR TRS-80 APPLE PET

256 pages — 8 chapters of games with sample run and full listing of the program. Educational as well as fun! Cat. B-1870 P&P \$2.00

\$8⁹⁵

TEST GEAR FOR RADIO HAMs

2nd edition, hardbound book. 134 pages of reference data, power supplies, signal source etc. Cat. B-2041 P&P \$2.00

\$13⁷⁵

We stock the latest electronics magazines from Aust. & O'ceas.

MICROSOFT BASIC DECODED AND OTHER MYSTERIES

Explains System 80 & TRS-80 ROM's! Cat. B-2356 P&P \$3

\$29⁹⁵

INTRODUCTION TO MICROCOMPUTERS

Vol. 1. Deals with basic concepts of microcomputers. Explains what they are, systems language & programming. B-2340 P&P \$2.00

\$12⁵⁰

TTL COOKBOOK

328 pages containing a complete guide to understanding and use of transistor logic! B-1246 P&P \$2.00

\$12⁷⁵

DICK SMITH'S FUNWAY INTO ELECTRONICS

Introduces 20 exciting projects. Completely safe: no soldering! Fully illustrated. B-2600 P&P \$1

\$4⁹⁵

DIGITAL ELECTRONICS

288 pages of Basic theory, construction projects and experiments. B-1688 P&P \$1.00

\$7⁵⁰

101 TV TROUBLES

An all inclusive guide to the cause and cure of over 101 TV problems. 224 pages. Cat. B-1648 P&P \$1.00

\$8⁵⁰

ARRL ANTENNA HANDBOOK

5 chapters of theory plus chapters on various amateur designs. B-2204 P&P \$1

\$8⁷⁵

TOWERS INTERNATIONAL TRANSISTOR SELECTOR

B-1828 P&P \$1.00

128 pages containing over 10,000 transistors with substitutes, diagrams specifications etc.

\$8⁵⁰

RADIO AMATEUR HANDBOOK

640 pages covering every aspect, including circuit boards. B-2218 P&P \$2

\$15⁹⁵

DICK SMITH'S AUSTRALIAN CB HANDBOOK

Everything you want to know about CB's in 128 jam packed pages! B-2325 P&P \$1

\$3⁹⁵

BASIC HANDBOOK

The Encyclopedia of the BASIC Language! 360 pages. B-2335 P&P \$2

\$15⁹⁵

SOME COMMON BASIC PROGRAMS

193 pages — 76 programs. This book will make your computer work for you!

B-2345 P&P \$2.00

\$12⁵⁰

ZILOG SHORTFORM DATABOOK

This book is a great aid in helping you understand your computer! B-2360 P&P \$1

\$6⁰⁰

COMPUTER & COMPUTING YEARBOOK

All you want to know about computers but were afraid to ask! Cat. B-5095 P&P \$1

\$4⁹⁵

TICK APPROPRIATE BOXES FOR BOOKS REQUIRED

Send this page + cheque for correct amount to our Mail Order Department.



DICK SMITH Electronics



Mail Order Centre:
P.O. Box 321 Nth Ryde,
NSW. Ph. (02) 888 3200
SYDNEY MELBOURNE
BRISBANE ADELAIDE
PERTH WOLLONGONG
CANBERRA NEWCASTLE

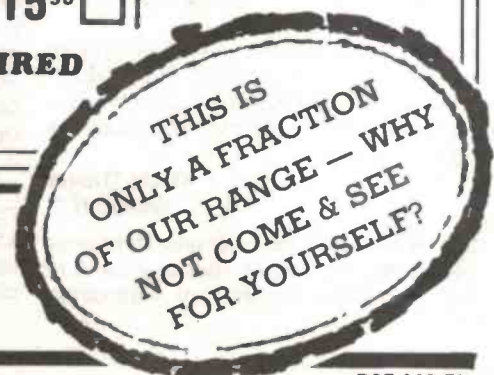

Shoparound

THIS PAGE is to assist readers in the continual search for components, kits and printed circuit boards for ETI projects. If you are looking for a particular component or project — check with our advertisers if it is not mentioned here.

ETI-156 instrument probe

This project hinges around the high-speed hybrid buffer from National Semiconductor, the LH0033CG. It's not cheap, but way ahead of whatever's in second place! This IC will set you back around \$30 odd, we understand, and Radio Despatch Service in Sydney and Radio Parts in Melbourne have indicated they are stocking this item. In addition, the following firms have indicated they have the device on order and may well have stocks by the time this issue goes on sale: Magraths, Rod Irving Electronics and Polykits (317 Swanston St, Melbourne). We understand the LH0033 may also be available through Dick Smith stores — but phone first, or try their mail order service.

The Jabel type PH3T plastic probe housing we obtained from Radio Despatch Service. Jabel products are distributed by Watkin Wynne, 32 Falcon St, Crows Nest NSW 2065. (02)43-2107.

If you elect to use chip ceramic capacitors for bypassing, they may be obtained quite inexpensively from Vitramon, 289 Bay St, Brighton-le-Sands NSW 2216. (02)599-2325.

Constructors should have little difficulty in obtaining the other components, although it may require a little shopping around to locate axial lead solid tantalum capacitors for C1 and C3.

ETI-458 LED level meter

The LM3915 dB LED display drivers have only recently become readily available here and we don't have complete information on who will have stocks when this issue goes on sale. However, Sydney readers might try Jaycar, Electronic Agencies and Radio Despatch Service. Melbourne readers should try All Electronic Components, Ellistronics, Polykits, Magraths, Rod Irving Electronics and Tasman Electronics. Dick Smith Electronics may be stocking this item but, as this was not confirmed as we went to press, phone first or enquire from their mail order department.

As for the LEDs, any rectangular LEDs that will mount together with a 2.5 mm spacing will suit this project. Check that first.

The CMOS switch IC, the CD4066, was chosen for its low on-resistance and should not be substituted. You may have to shop around for this one but suppliers who keep a wide range of IC types generally stock the 4066. The CA3130 should not be a scarce item, likewise the 301 op-amp.

One per cent tolerance resistors are, thankfully, relatively common these days. Note that 5% resistors may be used in lieu of 1% types, with some degradation in accuracy.

We understand this project will be widely stocked as a project.

ETI-155 dummy loads

For the ETI-155a dummy load, 1% resistors should not be difficult to obtain

as many suppliers stock the standard E12 range these days. However, Andrew Kay purchased the Beyschlag types from Crusader Electronic Components, 81 Princes Highway, St Peters NSW. Note that 1 W rated resistors are required.

The Arcol NHS50 resistors used in the ETI-155b dummy load are distributed in Australia by Everest Electronics, 61 Compass Drive, Seaford S.A. 5169. The NHS50s will set you back around \$7 each.

The Autotron type XA heatsink extrusion we used in the ETI-155b is manufactured and distributed by Autotron Australia, P.O. Box 202, Glen Waverley Vic. 3150. We understand a number of component suppliers are stocking this item. We used the XA-007, which is 71 mm long and only useful for short-term operation of the dummy load. A 500 mm length, type XA-05, would be better for longer term usage. Any heatsink having a thermal rating around 1°C per watt or better should suffice. We chose the Autotron type as the 'well' incorporated provides a convenient, protected mounting for the resistors and a chassis or other enclosure is not required.

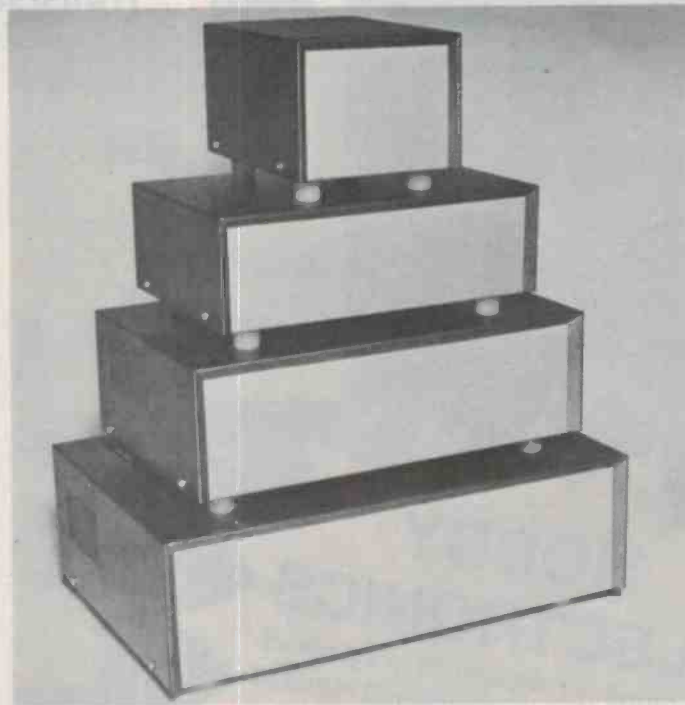

Instrument cases always present problems to the constructor. Rarely does he have the facilities to construct a 'professional-looking' case or cabinet, let alone the patience or skill! Putting a project in a case is part of the 'tidying up' process for most constructors and is therefore generally considered last. Then, cost becomes an important factor — and that's where the biggest compromise comes on many a project.

Ballarat Electronic Supplies manufacture and distribute a range of attractive metal cases at very competitive prices. Their 'C' series instrument cases, illustrated here, are constructed with an aluminium 'U' base and steel cover. The aluminium base has a satin finish, the steel cover being finished in hammertone paint, and the front wrap-around is formed so as to recess the front panel. There are six in the range, designated (in size order) C642, C453, C853, C1063, C1066 and C1284. The C642, for example, is 150 mm wide by 55 mm high by 100 mm deep overall and has dimples in the base to serve as feet. The C1284 is 305 mm wide by 105 mm high by 200 mm deep. The larger cases are supplied with bolt-on plastic feet and have slots in the rear of the top cover for ventilation. Known as 'K&W' cases, many component suppliers stock them.

Further details from Ballarat Electronic Supplies, 5 Ripon St, Ballarat Vic. 3350. (053)31-1947.

Hobby Electronics

AN ETI PUBLICATION

HE 105
Bench Amplifier
Irradiates for testing all your audio projects. This amplifier is a well-proven design with low distortion and high reliability.

HE 103
Transistor Tester
This ingeniously simple piece of test gear not only tests you & your transistors also working properly, it even shows you how much gain they have.

HE 104
AM Tuner
This compact design selects only a single strong station and is a handful of parts components. Expected to build a guaranteed, daily good result.

HE 106
Radio Microphone
Not just for secret agencies! There are all kinds of uses for this amazing little microphone transmitter. It can be built in half an hour, using only readily available parts.

**HOBBY
ELECTRONICS**
the monthly magazine that's packed
with fascinating projects and features.
On sale now at all newsagents
Only 95¢!



Australia's Transistor House

TO 92 PACKAGE TRANSISTORS
FROM THE INDUSTRY LEADERS

**BC 547, 548, 549, 557, 558, 559,
5 cents each in lots of 100**

(plus sales tax if applicable)

**NOW
5¢
EACH**



**VSI
ELECTRONICS
(AUSTRALIA)
PTY LTD**

The Distributor Offering Something Unique - Service

Adelaide 51 6483 • Brisbane 52 4261 • Melbourne 877 5311 • Perth 328 8091 • Sydney 439 8622



Updated Comni VHF receiver

GFS Electronic Imports of Melbourne recently announced the Comni R01010, an updated version of a synthesised airband AM receiver which can be used in a wide variety of applications including airlines, flying clubs and the Department of Transport.

The receiver is designed for operation on both 240 Vac and 12 Vdc, and a phase-locked loop frequency synthesiser gives full frequency coverage with 25 kHz channel spacing from 108-136.975 MHz — the entire VHF navigation and communication aeronautical band. Highly effective impulse noise reduction is claimed to be achieved by using multistage active IF noise blanker circuitry, and a sensitivity of less than 1 microvolt for 20 dB signal to noise ratio is achieved by a double conversion superhet receiving system.

Easy selection of the 1120

channels is achieved by use of a coaxial-type channel selector switch, with a front-panel-mounted LED giving a received signal indication. Frequency readout is also provided by a red LED five-digit display.

The unit weighs 3 kg and measures 160 mm wide by 56 mm high by 250 mm deep. It is supplied with all mounting hardware, plus a detachable telescopic antenna for desk-top operation.

For further information contact GFS Electronic Imports, 15 McKeon Rd, Mitcham Vic. 3132. (03)873-3939.

New FM transmitter from QEI

Rank Electronics recently announced the release of the QEI Model 675T150, a 150 watt FM transmitter.

Claimed to be a 'state-of-the-art' 100% solid state transmitter, the 675T150 features adjustable power output from 100 to 150 watts with VSWR protection.

The transmitter exciter uses a programmable phase-locked loop frequency synthesiser, and is designed for use with the QEI 722 stereo generator and 811SCA generator.

The 675T150 uses a conservatively rated power transistor in the output stage, and a driver transistor allows an exciter of 10 W output to drive the final stage to 150 W. The unit is convection cooled for

maximum reliability, and the power supply is current-limited to prevent the output stage from drawing excessive current during severe mismatch conditions. In addition, a VSWR protection circuit is incorporated to reduce the input to the final stage under mismatch conditions.

For further details contact: Sydney — Kevin Sylvester (02) 449-5666; Melbourne — Paul Brooker (03)541-8444; Brisbane — David Power (07)44-0251; Adelaide — John Sullivan (08)295-0211; Perth — Pat Cahill (09)443-1811.

The missing link

Good news for 2m operators!

As many operators may have noticed, there is at present a dead spot for 2m communication along the Hume Highway for a considerable distance north of Seymour.

Plans are at last afoot to fill this gap. The Shepparton and District Radio Club is well advanced in a project that will result in the installation of a repeater, hopefully on Mt. Wombat. Tests carried out from Mt. Wombat have proved that the position has great potential for coverage, and the dead spot on the

Hume would be well covered. In fact, coverage could extend as far south as Melbourne and beyond Albury to the north.

The heart of the repeater will be a Philips 828 transceiver and a polar 254 antenna system.

Since all 2m operators within the repeater's coverage will be greatly benefitted by it, SADARC would welcome inquiries from anyone who would like to take part in this project, as well of course as any financial assistance anyone might be able to offer. Contact SADARC, P.O. Box 692, Shepparton Vic. 3630, or their publicity officer, VK3DFA.



Digital storage RF spectrum analyser

Bringing digital storage capabilities to the most widely used frequency ranges in the RF spectrum, Tektronix recently introduced the 7L14 Spectrum Analyser.

The 7L14 will be of special importance to operators using the HF, VHF and UHF bands, and has been designed to meet the needs of user groups such as broadcast stations (AM, FM and TV), military communications, CATV companies, and utility companies (specifically firms and agencies that use two-way radio).

The 7L14 is claimed to have a longer lifetime and lower operating costs, resulting from the use of a standard P31 Phosphor CRT in place of the storage CRT.

The 7L14 provides frequency

coverage from 10 kHz to 1800 MHz. Other features include a built-in limiter to protect the first mixer; 70 dB on-screen dynamic range, spurious free; minus 130 dBm sensitivity, with 30 Hz resolution; CRT readout of control settings; four-to-one shape factor resolution filters; tracking generator and counter options; and a display mainframe compatible with more than 25 different 7000 Series plug-ins.

More information can be obtained from Tektronix Australia Pty Ltd, 80 Waterloo Rd, North Ryde NSW 2113. (02) 888-7066.

CBers — watch your whips!

The SEC has renewed its call to CB mobile operators to take care with aeriels, following the deaths of two men in Gippsland, Victoria.

The men died while erecting a CB aerial on Mount Tassie in a bid to improve the range of their radio's reception. The aerial touched high voltage overhead power lines and both men were electrocuted.

SEC Chief Electrical Inspector, Mr Len Francis, says accidents with CB radio antennae mounted on vehicles contacting power lines are not uncommon.

"A typical incident occurred when an antenna of a mobile radio unit contacted a 22 000 volt line some time ago. An SEC crew investigating the supply interruption found that although the vehicle had left the

scene, the antenna was still welded to the line. That particular operator should consider himself very lucky in avoiding serious injury or death," Mr Francis said.

The SEC urges all CB enthusiasts to look up and observe the position of power lines before erecting an antenna. If the antenna is mounted on a vehicle, check travel routes for power lines, as special care must be taken when the combined height of the vehicle and the antenna is more than four metres.

For further information, contact Peter Strachan on (03)615-2881.



**HAS THE TASTE STOPPED
GETTING THROUGH?**

If your present tobacco just doesn't deliver the satisfaction you want, then roll a Cannon.
A rich new blend of medium dark cigarette tobacco that's just a little bit stronger.
Cannon, for the taste you're missing out on now.

CANNON.
SLIGHTLY STRONGER.



Sooner or later you'll need a Gregory's.



Gregory's

Street Directories, Guides and Maps.

What comes down depends on what you put up!

NEWCASTLE STORE OPENS
LATE MAY/EARLY JUNE
173 Maitland Rd. Tighes Hill
Watch local press for details



V5JR 5 band vertical

If you're limited on space this is the antenna for you!

- Covers 10-80 metres.
- 6.7m high, weight only 2.3 kg.
- Rated at 1kW PEP.
- Fits up to 32mm dia. support pipe.

The V5JR uses pre-tuned trap coil assemblies, enabling the one antenna and feedline to automatically operate on any chosen bands between 80-10 metres.

\$99⁰⁰

P&P \$4.00
D-4305

3 BAND YAGI HYGAIN TH3JR

Gain-Average 8dB, Front to Back ratio 25 dB, SWR (at resonance) less than 1.5:1, Impedance 50 ohms, Power rating 600 watts PEP.
Longest element 24.2', Boom length 12', Turning radius 14.3', Wind load at 80 MPH 87 lbs, Net weight 21 lbs, Mast diameter accepted 1 1/4", Surface area 3.35 sq. ft.

\$265⁰⁰ D-4304 P&P \$5.50

Antenna Rotator

With fully approved supply

Consists of

- ruggedly made rotator with massive disk brakes.
- Control box-indicates direction of beam.
- One set of mast clamps
- Approved power supply.

for only **\$152⁵⁰** D-5000
D-5002 P&P \$5.50

Separate parts if required:
Rotator & Control box (D-5000). \$133.00
Approved Power Supply (D-5002). \$19.50.
Additional Mast Clamps (D-5001). \$18.95

CABLE TO SUIT:
(W-2042). \$1.60/m.

FRG 7700SW

Ask for a copy of our brochure showing you what the FRG-7700 can do for you!

\$495

INC. BONUS 12V CONVERSION KIT

There's not much we need to say about this outstanding receiver: let the features speak for themselves

- 2MHz-30MHz continuous
- All mode-including FM
- Superbly easy to operate
- Timer for turning receiver ON/OFF plus control of external equipment (eg. tape recorder).
- Optional memory unit gives 12 memory channels.



D-2841
P&P \$5.50

RAK BL-50A BALUN

Suits the TH3JR

P&P \$3.00
\$27⁵⁰
D-5310

ANTENNA BALUN KIT

Freq: 3-30 MHz
Input pwr: 2 kW PEP.

\$99⁰⁰ P&P \$1.00
D-5350

YOU CAN AFFORD THE ULTIMATE!



FT107M **\$1278** ONLY

Yaesu's newest & finest transceiver. Packed with heaps of features and more. All mode. 240W pep output.

INC. DMS & PS.
D-2871 P&P \$5.50

CREDIT TERMS TO APPROVED BUYERS.

DICK SMITH Electronics

MAIL ORDER CENTRE:
PO. BOX 321 Nth. Ryde. 2113 (02) 888 3200



- | | | |
|--------------------------|----------------------------|-------------------------|
| NSW: AUBURN Ph: 648 0558 | WOLLONGONG Ph: 28 3800 | SPRINGVALE Ph: 547 0522 |
| BLAKENURST Ph: 546 7744 | NEWCASTLE (Opening soon) | WA: PERTH Ph: 328 6944 |
| BROADWAY Ph: 211 3777 | ACT: Fyshwick Ph: 80 4944 | CANNINGTON Ph: 451 8666 |
| BROOKVALE Ph: 93 0441 | QLD: BURANDA Ph: 391 6233 | |
| CHULLORA Ph: 642 8922 | CHERMSIDE Ph: 59 6255 | |
| GDRE HILL Ph: 439 5311 | SA: ADELAIDE Ph: 212 1962 | |
| PARRAMATTA Ph: 683 1133 | VIC: MELBOURNE Ph: 67 9834 | |
| SYDNEY Ph: 290 3377 | RICHMOND Ph: 428 1614 | |



AFFORDABLE INSTRUMENTATION

AIM-65 and SYM-1
HDE Mini Disc System

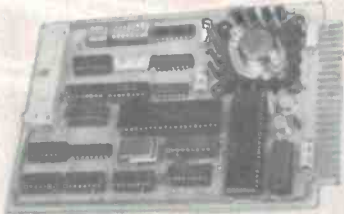

Includes controller card cables, FODS s/w power supply TEAC FD50A. SD,SS drive

Single System \$799
Dual System \$1089

TEAC FD50A

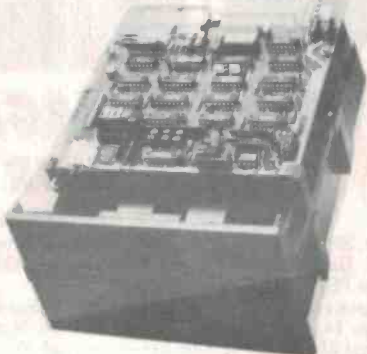

71K bytes head load solenoid brushless drive motor for high reliability.



AIM-65 enclosure with integral PS. 5V at 4A plus/minus 12 at 0.4A, plus 24V at 0.7A. Space and power for an additional board such as:—

PROTO PLUS A&T	\$149
AIM-65 1K	\$429
AIM-65 4K assembler and BASIC	\$649
PROTO PLUS address decoder and buffered	\$64
SYM-1 1K	\$199
DRAM PLUS 32K RAM	\$369
16K Eprom space. Programmer 40 I/O. 4 X 2532	\$63.50

energy CONTROL

P.O. BOX 6502, GOODNA 4300
PHONE (07) 288-2757

SAE for Catalogue

Plus sales tax if applicable
Prices subject to change without notice.

SME SYSTEMS

STOCK CLEARANCE SALE

16K STATIC RAM



2114 low power RAM chips, 4K addressable boundary, standard bank select (40H), 4MHz operation with no wait state required when using our chips, wait state generator for above 4MHz, plated thru holes, solder resist, optional 300nS RAMS available.

KIT \$250 A&T \$290
BARE PCB \$45

2708 16K EPROM



Switch selectable as 8 or 16K card, 8K address boundary, wait state generator, suits industry standard, 2708's standard S100, plated thru holes, solder resist.

KIT \$85 A&T \$98
BARE PCB \$45

1A Z80 CPU CARD

KIT \$150 A&T \$180

SD MPB-100 Z80 CPU

KIT \$250 A&T \$280

DUAL SERIAL I/O CARD

KIT \$165 A&T \$195

THESE PRICES VALID UNTIL
CURRENT STOCK RUNS OUT

22 Queens Street, Mitcham, Vic. 3132.
PO Box 19, Doncaster East, 3109. Telex AA37213.
DEALER: Adelaide — 223-6539, Sydney — 661-9237.

Send 66c in stamps for COMPUTER PRINTOUT CATALOGUE for more details.

ALL PRODUCTS AUSTRALIAN MADE AND EX STOCK (ALMOST)
DEALER ENQUIRIES WELCOME
Prices and specs subject to change without notice.

All prices tax free, for retail prices add 15 percent.

No car is complete without one



Gregory's S.P. car service and repair manuals and Gregory's new 1980/81 street directories



G2

will get you there.

The Superboard

Ready to go, ready for more

Cassette interface, 300 Baud Kansas City standard, so you can swap programs, ask your dealer how to double the speed!

Printer port and sound generation.

All you need is a 5v power supply.

RF Modulator Connection.

24 x 24 or 12 x 48 Display

4MHz crystal

Character generators giving a full 256 characters from Alpha-numerics to planes, guns and spaceships.

Monitor ROM, allowing you to enter machine code.

8K BASIC available on power up with floating point, trig functions, multi-dimensional array, and full string facilities.

Joystick interface. It gives a 'natural' feel to game manoeuvres like driving a tank, firing a rocket.

4K of RAM on-board space for a further 4K ready socketed. Just plug in the chips.

6502 processor or chip as in four out of five of the top selling personal computers.

Your connection to the expansion facilities, up to 32K or RAM, dual disks and the outside world.

Full 53 keyboard with upper case, lower case and graphic elements. Drive it in polled mode and you can detect up to eight keys pressed simultaneously — how's that for real-time games?

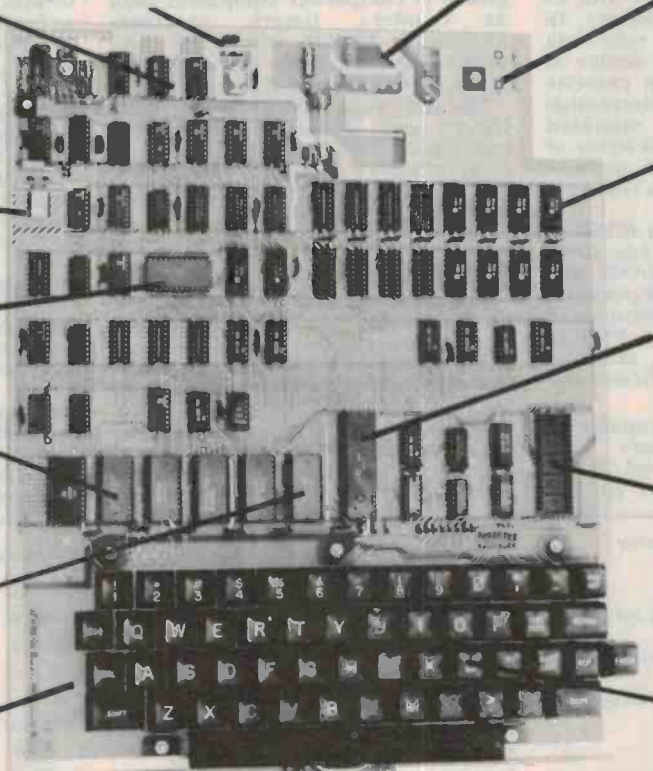

Our Superboard lets you suit yourself, offering a ready to go configuration that you can add to as needed. The Superboard is the first complete personal computer system contained entirely on a single board.

This is a major electronic breakthrough and we at Ohio Scientific accomplished it by using custom state-of-the-art LSI micro circuits. The Superboard offers you more features than many of the more expensive alternatives.

We designed the Superboard specifically with versatility and economy in mind. It is suitable not only for the serious computer user, but also for first time users, the student or the hobbyist. The Superboard gets you off to the right start, and you can add to it later — saving money all along the line. If you're just starting, get the ready-to-go CI model, then all you'll need is your cassette and television set and you're into the world of computers in a really serious and flexible way.

EXPANSION CAPABILITIES:

- UP TO 32K MEMORY
- DUAL MINI-FLOPPY DRIVES
- FULL COLOUR VIDEO
- PROTOTYPING BOARDS
- A/D AND D/A CONVERSION

OHIO SCIENTIFIC
TOMORROWS TECHNOLOGY TODAY

OHIO SCIENTIFIC



In the world of personal computers there is just one that is known as the best: the PET

**NOW
16K RAM
AT 8K PRICE
\$999**

The Commodore PET has become the standard for the Personal Computer Industry.

The Pet is completely integrated, with the processor, memory, keyboard and visual display unit contained within a robust housing, allowing easy transportation with no interconnecting cables necessary. In order to retrieve and save your data and programs, a storage device is used which operates like a cassette recorder, with your information recorded reliably on standard cassettes. The PET has 16k bytes of RAM. Optional equipment permits expansion to 32k. Also, it has 14k bytes of ROM.

The Pet communicates in BASIC—the easiest computer language. Easy to learn and easy to use, BASIC has now become the standard for personal computers, with literally thousands of programmes available. The PET is also programmable in machine language, allowing more efficient use of the system.

The full-size keyboard is capable of producing letters, numbers and graphic symbols. Upper and lower case is standard. Characters appear

on the screen in a pleasant green colour designed to reduce eye fatigue and may be displayed in normal or reverse print.

PET's IEEE-488 Bus—just like H.P.'s mini and full size computers—permits direct connection to over 200 pieces of compatible equipment such as counters, timers, spectrum analysers, digital voltmeters and printer plotters from H.P., Philips, Fluke, Textronix and others.

The full range of Commodore Disk Drives and Printers are plug-compatible with the PET and a comprehensive range of cassette and disk based programmes are available through the extensive network of Commodore Dealers.

APPLICATIONS

The Commodore PET is a creature of many faces. Its applications are limited only by the user's imagination.

The future of the PET is virtually unlimited; its present capabilities are already many and impressive. As a personal computer, the PET can teach languages and mathematics; play games; create graphic designs; store meal recipes and change

number of portions; maintain budgets, personal records and checkbooks; operate appliances and temperature controls.

As a management tool, it delivers the information the executive needs, in the form he can use, and available to him alone. Trend analyses charts and graphs can be almost instantly available.

The professional may use the PET for maintaining appointment schedules, recording income and expenditures and filing all the specialized information and forms he may need to make his work more efficient—from medical records for a doctor to income tax computations for an accountant.

The engineer, mathematician, physicist, has a tool far superior to the very best programmable calculators yet developed... at a cost that is comparable...and with almost infinitely greater versatility.

And the businessman has a computer that can maintain inventories, keep payroll records, operate accounts payable and receivables, issue cheques and handle correspondence.

Commodore PET 4016 Computer Technical Specifications.

Computer/Memory

Read/Write Memory (RAM) 16K bytes available to the user.

Read Only Memory (ROM) 14K bytes in total, divided into:

8K BASIC interpreter available immediately you turn on your PET.

5K Operating System

1K Test Routine

The 6502 micro-processor chip makes the PET one of the fastest and most flexible BASIC systems. Significant features of Commodore BASIC are:

- 960 simple variables
- 960 integers
- 960 string variables
- 960 multi-dimensional array fields for the above 3 types of variables
- Up to 80 characters per program line with several statements per line
- Upper/Lower case characters and graphics capability
- Built in clock
- 9-digit floating point binary arithmetic
- True random number generator
- Supports multiple languages; machine language accessibility

Keyboard

74-Key professional keyboard.
Separate calculator/numeric pad.

Upper-case alphabetical characters with shift key to give 64 graphics characters.

Can be set for lower case and shifted upper case characters.

Screen

40 characters wide by 25 lines (1000 characters in 8 × 8 dot matrix).

23 cm screen phosphor screen.

Brightness control.

64 ASCII plus 64 graphics characters.

Blinking cursor with full cursor control, including programmable control.

Screen editing capabilities

Full cursor control (up, down, left, right).

Character insert and delete.

Reverse character field.

Overstriking.

Return key sends the entire line to the CPU regardless of cursor position.

Input/Output

8 bit parallel input/output port.

IEEE-488 Bus (HP-IB and IEC Bus) allows up to 12 other peripherals to be connected.

Two cassette ports.

Video signals for additional displays.

Serial output port.

Technical Data

Dimensions: Height 355 mm (14"). Width 419 mm (16.5"). Depth 185 mm (18.5"). Shipping Weight 20.9 kg (46 lbs).

Power requirements 240V ± 10%, Frequency 50 Hz. Power 100 Watts.

Commodore BASIC

APPEND	GOSUB..RETURN	STOP	SPC
BACKUP	IF..THEN	SYS	LEFT\$
CLOSE	INPUT	VERIFY	RIGHT\$
CLR	INPUT *	WAIT	MID\$
CMD	LET		CHR\$
COLLECT	LIST	SGN	ASC
CONCAT	LOAD	INT	LEN
CONT	NEW	ABS	VAL
COPY	ON..GOSUB	SQR	STR\$
DATA	OPEN	SIN	TI
	POKE	COS	TI\$
DEF/FN	PRWT	TAN	ST
DIM	READ	ATN	DS
DIRECTORY RECORD		LOG	DS\$
DLOAD	REM	EXP	+
DOPEN	RENAME	AND	-
DSAVE	RESTORE	OR	*
END	RUN	NOT	/
FOR/NEXT	SAVE	TAB	↑
GET	SCRATCH	POS	π

Commodore

microcomputers

COMPUTING TODAY

Experimental dynamic RAM made with simple polycide technology

IBM researchers have fabricated experimental one-micrometre dynamic RAM circuits with far simpler process technology than has previously been used, while retaining density and performance.

The simplification is based on a materials improvement, with polycide (tungsten silicide on polycrystalline silicon) replacing polysilicon.

The RAM can be constructed with one layer of polycide rather than the two layers of polysilicon commonly used. By using an unconventional layout for the RAM, the researchers achieved the same circuit density with one layer of polycide as with two layers of polysilicon.

Memory cross sections, fabricated by electron-beam direct writing with one-micrometre ground rules, have cells 34 square micrometres in area, believed to be the smallest ever made.

Dynamic RAMs have been made with one layer of polysilicon, but performance is far better with polycide. Because the sheet resistance of polycide is only one-fourteenth that of polysilicon the risetime for the polycide wordlines in such cells is only one-tenth that of polysilicon wordlines.

Further, contact resistance for metal-to-polycide is only one-eighteenth that for metal-to-silicon.

These improvements are significant for VLSI circuits made by electron-beam methods because of the large number of interconnections and contact holes used.

The use of polycide in field-effect transistors was first proposed in 1977 by IBM researchers Billy L. Crowder and Stanley Zirinsky, as a better way to deal with the increases in resistance that occur as the dimensions of devices and circuits are scaled down.

These increases can be dealt with by using multilevel schemes, but making the many contacts and interconnections needed for VLSI structures is itself a problem.

Silicides for electronics applications are practical outgrowths of a space-age materials development. They were originally intended to be used as cladding for re-entry vehicles.

In addition to having low resistance, they can withstand corrosive environments and high temperatures, and they can be patterned into fine-line structures.

The work described here was performed by Hu H. Chao,

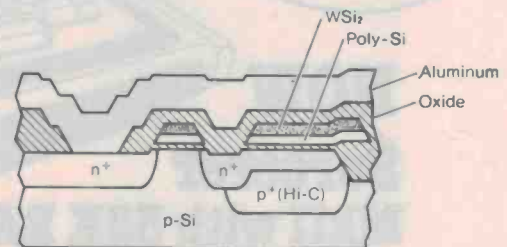
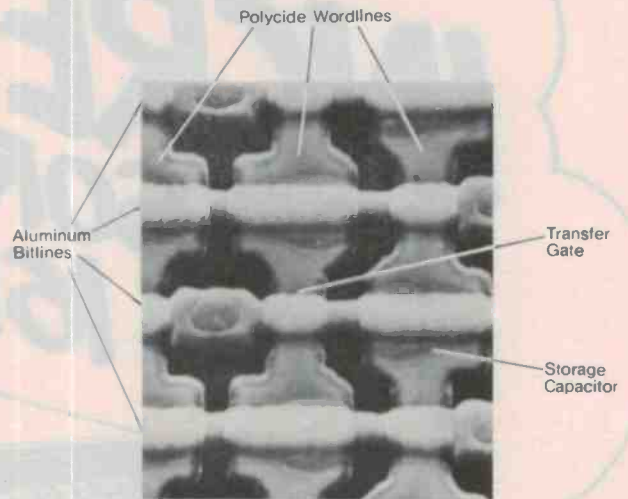

IBM researchers have fabricated experimental one-micrometre dynamic RAM (random-access memory) circuits with far simpler process technology than has previously been used, while retaining density and performance. The scanning electron micrograph shows part of a memory array fabricated with polycide (tungsten silicide on polycrystalline silicon) wordlines and aluminum bitlines. The drawing shows a cross section of a memory cell.

Robert H. Dennard, Mon Yen Conference, held recently in Tsai, Matthew R. Wordeman, New York City, and Alice Cramer, and was announced at the 1981 International Solid State Circuits Conference by IBM.

Computerland to sell Commodore business machines

Computerland and Commodore Australia Pty Ltd have announced that the two companies have come to an

Included in the package are Commodore's full hardware and software lines, including their soon-to-be-released V.I.C. computer.

V.I.C. is an abbreviation for Video Interface Computer, which will sell for less than \$400.

Nigel Shepherd, Managing Director of Commodore, said

that he was looking forward to the Computerland relationship. He also said, "Our PET, CBM, and V.I.C. computer lines will continue to be available through our own network of dealers too."

"I believe that the Commodore dealers and Computerland stores can successfully co-exist since they essentially market in

agreement in which Computerland will sell the American computer company's much-celebrated equipment.

different ways." Computerland's Richard Graham agreed, "It has always been our intent to continue to expand our product offering as the public's awareness of small computers increases."

"In our view, the Australian public is on the verge of accepting computers in a big way, and

this line extension is one of our ways to be ready."

These new products will be phased into participating Computerland Stores between late March and 30 June. They will have "off the shelf" software including Visicalc, and be compatible with THE SOURCE database.

**INCREDIBLE:
32K SORCERER
FOR A 16K PRICE!**



**NOW
Sorcerer
MkII with 32K RAM
at no extra cost!**

Yes! With every 16K Sorcerer computer, we now include at no extra charge, an additional 16K of RAM! Here's your chance to buy the superb Sorcerer, and save money at the same time.

Plus these other winning features:

- Unbelievable graphics capabilities.
- Expandable to 48K on board.
- Interchangeable ROMPACS™ for incredible versatility.
- Built-in 4K ROM resident monitor.
- Built-in serial and parallel ports - standard!
- 2 cassette control ports - both with motor control!
- Economic disk storage now available (optional) with Exidy's new FDS - floppy disk subsystem (does not need expansion interface).*

**ROMPACS™
makes Sorcerer
uniquely versatile**

Plug-in ROMPACS™ change the Sorcerer into a dedicated processor with instant change back again! ROMPACS™ available include Word Processor Pac, Development Pac, EPROM Pac. Ask for details at your nearest store.

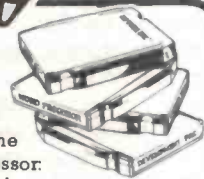

**all this \$1395
for only 1395**

X-3002

and including 32K
memory and standard
BASIC ROMPAC™.

*See page 140
for this exciting system.

**DICK SMITH
Electronics**



**SEE OUR OTHER ADS FOR
FULL ADDRESS DETAILS**

COMPSOFT Microcomputer Services lets you add computer power — a board at a time...

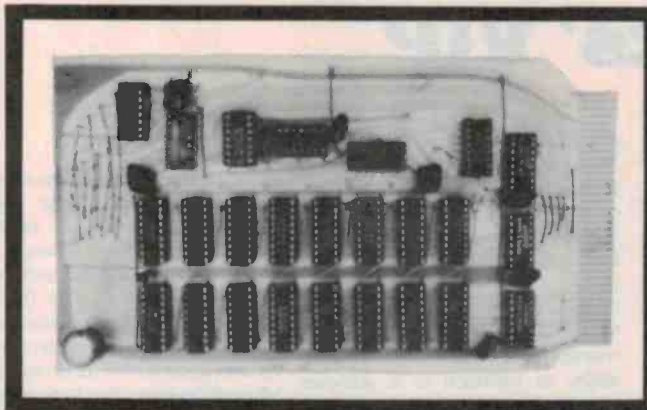

...with these
new, easy
to buy
options

— versatile, simple but powerful
to suit all OHIO SCIENTIFIC, SYM, KIM & AIM USERS

You can now expand your system at an incredible low price and add new boards as you need them. The heart of our system is the 8 SLOT MOTHERBOARD

(shown above). It will allow you to add all the boards mentioned below and many new ones currently under development.

NOW YOU CAN HAVE A 48K RAM/ROM DUAL 5 1/4" or 8" DISK SYSTEM FOR AN INCREDIBLY LOW PRICE

- 8 SLOT MOTHERBOARD
 - Full address and data bus buffering.
 - 8 free slots & on-board regulator
 - 8k RAM BOARD with connector
 - This board can be fully interfaced to any system without requiring a motherboard
 - (For 8k RAM board without connector, less \$4)
 - 8k EPROM BOARD
 - (Does not include EPROMS)
 - VIA/PIA I/O BOARD
 - Provides 32 lines of parallel I/O
 - FLOPPY CONTROLLER
 - CONNECTOR CABLE
 - FLOPPY CABLE
 - 2114's LOW POWER STATIC RAM
 - BASF FLOPPY DISKS, 5 1/4"
 - BASF FLOPPY DISKS, 5 1/4"
 - BASF FLOPPY DISKS, 8"
 - BASF FLOPPY DISKS, 8"
- | | |
|--------------------|----------|
| Blank PC board | \$ 26 |
| Kit | \$ 62 |
| Assembled & tested | \$ 80 |
| Blank PC board | \$ 20 |
| Kit | \$ 90 |
| Assembled & tested | \$112 |
| Blank PC Board | \$16 |
| Kit | \$ 28 |
| Assembled & tested | \$ 42 |
| Blank PC Board | \$ 17 |
| Kit | \$ 47 |
| Assembled & tested | \$ 63 |
| Blank PC board | \$ 20 |
| Kit | \$ 56 |
| Assembled & tested | \$ 76 |
| | \$ 15 |
| | \$ 12 |
| ea | \$ 2.95 |
| ea | \$ 4.40 |
| Box of 10 | \$ 40.00 |
| ea | \$ 4.80 |
| Box of 10 | \$ 44.00 |

- | | |
|--|----------|
| SUPERBOARD CASES | \$ 35.00 |
| POWER SUPPLY | \$ 50.00 |
| SUPERBOARD SERVICING MANUAL | \$ 12.00 |
| C4P SERVICING MANUAL | \$ 22.00 |
| B/W T.V. MONITORS | \$135.00 |
| M.P.I. B51 5 1/4" DISK DRIVES | \$295.00 |
| DABUG III — on screen editing — single key basic, etc. | |
| PASCELF — the world's smallest Pascal type compiler, only 4k long. | |

All prices are ex-tax and subject to change without notice.

MICROLINE 80 PRINTER \$730

SUPERBOARD II's \$395

ex stock

COMPSOFT MICROCOMPUTER SERVICES

235 Swan Street, Richmond, Victoria, 3121. Telephone 428 5269.

Print-out

Vector Graphics' VIP

From small beginnings the Vector Graphics organisation has become a sizeable force in the microcomputer industry — all brought about by the drive and administration of Lore Harp, one of the few women in the microcomputer business.

Lore arrived in the US in the early days of the micro industry. Coming from a small town near Dusseldorf in Germany, Lore has become one of the great American success stories, building Vector Graphics from a small backyard company producing computer boards up to a multi-million dollar corporation.

The show really got on the road when Lore realised the potential of marketing a memory board that her husband, Dr. Bob Harp, had designed on the side while working for a PhD in electronics at Stanford University in California. By August 1976 Lore had joined forces with a friend and formed a company to market boards to the growing number of hobbyists, all wanting to get into the micro world. The Vector '8K Baby' was born, and Vector was on the way to becoming the multinational company we know today.

Vector has always stuck to very rigid policies; these include comprehensive quality control, shipping on time, production of documented products, good manuals, and trouble-shooting over the telephone.

The Australian agents for Vector Graphics are Dicker Data Projects at Carringbah in Sydney, with agents in most Australian states. It comes as no surprise to see a woman, Fiona Dicker, carrying on the Company's image and traditions.

ETI was most impressed when the Vector VIP, the smallest in the Vector range, arrived on our desk to be put through its paces.

The Vector VIP exposed

The Vector VIP is a general purpose microcomputer system designed for stand-alone use in a number of applications. Hardware features include: (a) 56K of user available random access memory; (b) six slot, fully shielded and terminated S100 motherboard; (c) 4 MHz single board computer; (d) 64K dynamic RAM on board.

It arrived on our desk exactly as it would have been shipped to a customer — that is, assembled and fully tested, including both hardware and operating system software.

The VIP is a compact single unit housing the VDU and keyboard, with an attached single-sided 'Unistor' mini-floppy disk drive unit. The system was obviously designed to sit neatly on a desk, and took up little space. This is a big plus when aiming at the small business market where a system has to fit in as best it can. The VIP is well designed and housed in a rugged metal box that obviously spelt business. It could be used sitting on a factory floor controlling factory records or in a swish advertising agency keeping track of expense accounts and space bookings.

The video console housed a non-detachable typewriter style keyboard and a separate 10-key numeric pad. The keyboard was well graded and very sensitive to touch, a feature great for the typists of the world but for those who rely on two fingers and lots of luck this takes some getting used to. The screen displayed the standard 24 lines x 80 characters in an ASCII 8 x 10 dot matrix format. The green phosphor screen is very easy to see during both day and night use and there was none of the annoying flickering sometimes found on VDUs. Reverse video and screen intensity are operator adjustable. The disk drive unit is not removable from the console and did provide a bit of a hassle when trying to move them around the office. Having spoken to Fiona about this I am informed this has been remedied and the whole unit is now completely detachable and plug compatible.

The quad density micropolis 5¼" diskette drive provides a storage capacity of 315K bytes.

Peripherals

Printer systems — The VIP series is capable of interfacing to one

printer at a time, either one of Vector's system printers or one of the many standard printers available on the market, through the RS232C interface. We used an Anadex from Bell and Howell (watch ETI for a review) and gained very good results, quickly and without fuss.

Communications — The communications capability includes the ability to interface to a standard asynchronous modem or acoustic coupler, and standard software with the system enables 30 characters per second — that is 300 bits per second, data transmission rate. It also provides emulation of a 'dumb' serial terminal, making the VIP series suitable for use as intelligent terminals handshaking with larger mini or mainframe systems for distributed data processing in offices or remote processing in environments such as universities or colleges.

Operating system

The operating system is the industry standard CP/M2 from Digital Research, allowing use of most CP/M-compatible software. The documentation with the system was truly amazing and by far the best seen to date. Documentation completely covered every aspect of the operating system in great detail and left nothing remaining to mystify and confuse. The explanations covering the use of the disk drives and loading of the operating system were excellent.

Software

In providing the VIP with a CP/M operating system, Vector has virtually opened a 'Pandora's box' with all sorts of available goodies to meet almost every conceivable requirement. Application packages can be obtained from a number of

VECTOR VIP SPECIFICATIONS

	Height (mm)	Depth (mm)	Width (mm)	Weight (kg)
Console	324	457	533	10
Disk drive	82	211	145	7.9

Video terminal

Screen	305mm monochromatic
Characters	ASCII, 8 x 10 dot matrix
Contrast	Dark on light or light on dark selected by software (normally light on dark) Operator adjustable
Display area	24 lines x 80 characters
Radiation	Complies with US Federal Regulation for Radiation Control, as required by the Radiation Control for Health and Safety Act of 1968, implemented by Title 21, Subchapter J, Code of Federal Regulation

Diskette drive

Diskette used	16 sector, hard sectored, 133 mm
Capacity	480K unformatted
Transfer rate	250K bits/second
Average rotational latency time	100 milliseconds
Access time track-to-track	30 milliseconds
Settling time	10 milliseconds
Head load time	75 milliseconds
Drive motor start time	1 second
Rotational speed	300 RPM
Recording density	5248 bits per inch (BPI)
Track density	100 tracks per inch (TPI)
Surfaces used on diskette	1

Communications

Interface	RS-232C
Asynchronous baud rates	110, 150, 300, 600, 1200, 2400, 4800, 9600

Reliability

MTBF	8000 hrs.
MTTR	0.5 hrs.
Media life	3 x 10 ⁶ passes on single track
Head life	104 hrs.
Soft error rate	1 in 10 ⁹
Hard error rate	1 in 10 ¹²
Seek error rate	1 in 10 ⁶

sources including the US Lifeboat Associates Company, and Davidson Software in Melbourne. A number of high level languages can be supported, including Microsoft BASIC 80, one of the fastest and most powerful general purpose languages available. The Vector Execuplan Package is totally brilliant for the executive wishing to obtain fast and accurate forecasting and planning.

Development tools — including SCOPE — an advanced, screen-oriented program editor; RAID — a full-screen simulator-debugger for assembly language programs; ZSM Assembler using the 8080 subset mnemonics; and the extended systems monitor on PROM, allowing direct manipulation of memory and input/output, can be used for enhanced programming and program manipulation.

Optional hardware and software available include: (1) The system can support up to three additional mini floppy drives by adding additional Unistor modules. (2) Letter quality or high speed dot matrix printing facilities. (3) Graphics capabilities including Vector's high resolution graphics display board, Vector's video digitiser board, a graphics monitor, a TV camera to go with the digitiser, and associated software.

Conclusion

The Vector VIP is an impressive, fast and very reliable desk-top micro suitable for a vast number of business, industrial and educational applications. It is easy to use and should provide the first-time user with a valuable means of entering the computer age.

Elaine Ray



Dot-matrix printer breaks \$500 price barrier

Dick Smith Electronics has just announced the release in Australia of a compact 80-column, tractor-feed impact printer which offers a variety of features for \$495 including sales tax.

The new printer features 30 characters per second printing, with 5 x 7 dot-matrix characters and the capacity to print the full upper and lower case ASCII character set. It is also capable of high-resolution graphics printing, software selectable. It accepts fan-fold sprocketed paper up to 204 mm wide, and is fitted with a standard Centronics-type parallel interface. This makes it compatible with most micro-computers like the System-80, Exidy Sorcerer, Tandy TRS-80,

Northstar Horizon etc.

The new printer measures a compact 328 x 127 mm and weighs just 2.5 kg. It is manufactured for Dick Smith Electronics in Japan, and uses a single hammer print head. This considerably reduces the number of moving parts in the head, and is claimed to give improved reliability.

The new printer has DSE catalogue number X-3252. Check your local Dick Smith store or dealer for availability.

Nelcon '81 in Dunedin

Nelcon '81 (New Zealand National Electronics Conference), the eighteenth in a series of yearly conferences held with the aim of providing a forum for the New Zealand electronics community, will be held at Otago University in Dunedin from August 25-27.

Around 20 papers will be presented on the themes of education, application, and economics of electrical technology within the New Zealand context. Papers to be

presented range from the application of electronics in industry to the use of microprocessor systems as an aid in the learning process.

First, disposable nappies — now, disposable print heads!

Just like the baby's nappy, the print head in EPSON's new MX-80 Matrix printer is disposable.

Rated at a full 50 to 100 million characters, service is as simple as changing a ribbon cartridge. "In fact", says a spokesman for Warburton Franki, the Epson Australian distributor, "you just snap the head out, throw it away and snap in a new one. It is as easy as that. The only tool you need is at the end of your arm. Anyone in your office can do it and the replacement head costs less than \$50.00."

This feature is considered by Epson to be a real breakthrough, bringing excellent service reliability and dependability in whatever application the printer is employed.

The MX-80 provides the choice of 40, 80, 66 or 132 columns of printing in as many as four distinct printing density modes, a total of 12 different combinations which can accommodate nearly any printing requirement. More than half of

these utilise multi-strike and/or multi-pass techniques to generate 'correspondence quality' printing.

Ideal for manuscripts, mailing labels, proposals and nearly any other function where attractive, clean, clear, well-formed characters are required. "So long as you are not trying to fool someone into thinking that you actually typed a document or letter," says Warburton Franki, "the MX-80 can handle nearly all of your text processing requirements".

Other attractive features of the MX-80 are bi-directional printing — logical seeking of shortest lines — 80 cps — 64 graphics characters — forms handling etc. At \$900 (discounts on quantity available) Warburton Franki regard the MX-80 as a fully loaded printer at a 'bare bones' price.

For further details contact your local Warburton Franki office.

In conjunction with the conference a trade display and social events will be held.

Further information and registra-

tion forms are available from Nelcon '81, c/- Extension Department, Otago University, P.O. Box 56, Dunedin, New Zealand.

CAN YOU AFFORD NOT TO SUBSCRIBE TO MICRO-80?

MICRO-80 is a monthly magazine dedicated to users of SYSTEM 80 and TRS-80 microcomputers. Owned and produced entirely in Australia, each issue of MICRO-80 contains at least six programs, articles, useful hints and answers to readers' problems; all designed to help YOU get the most out of your SYSTEM 80 or TRS-80. Since MICRO-80's first issue in December 1979, we have published over 80 major pieces of software and 10 hardware projects. Most of the programs and articles are written by our readers to whom we pay publication fees thus enabling them to make their hobby pay. MICRO-80 readers can save money by buying Tandy products at 10% discount from an authorised dealer - for details see any issue of MICRO-80. Our sister business, MICRO-80 PRODUCTS, sells Australian designed and produced software and high quality, imported goods at low, sensible prices. We repeat, if you own a SYSTEM 80 or TRS-80,

CAN YOU AFFORD NOT TO SUBSCRIBE TO MICRO-80? 12 month subscription delivered to your door, only \$25.00

CASSETTE EDITION only \$60.00 for 12 months

If you do not have enough time at the keyboard to type in the program listings which are published in MICRO-80 each month, then you need a cassette subscription. As well as MICRO-80 magazine, you receive a cassette each month containing all the programs listed in the magazine.

SPECIAL OFFER TO ALL NEW SUBSCRIBERS TO MICRO-80

A FREE cassette containing 6 programs (3 Level I + 3 Level II), together with complete documentation, will be sent to every new subscriber to MICRO-80.

Suspicious of mail order? Then send \$2.50 for a single copy of MICRO-80 and see for yourself that this is the magazine for you!

Daisy Wheel Typewriter/Printer

MICRO-80 has converted the new OLIVETTI ET-121 DAISY WHEEL typewriter to work with the TRS-80 and SYSTEM 80 or any other microcomputer with a Centronics parallel port (RS 232 serial interface available shortly). The ET-121 typewriter is renowned for its high quality, fast speed (17 c.p.s.), quietness and reliability. MICRO-80 is renowned for its knowledge of the TRS-80/SYSTEM 80 and its sensible pricing policy. Together, we have produced a dual-purpose machine: an attractive, modern, correcting typewriter which doubles as a correspondence quality Daisy-wheel printer when used with your micro-computer.

How good is it? - This part of our advertisement was typeset using an ET-121 driven by a TRS-80. Write and ask for full details.



MPI DISK DRIVES

MPI is the second biggest manufacturer of mini floppy disk drives in the world. They produce a family of high quality 5 1/4" drives with super-fast track-to-track access times (5ms!)

- 40 TRACK SINGLE HEAD \$339
- 40 TRACK DUAL HEAD \$449
- 80 TRACK SINGLE HEAD \$499
- 80 TRACK DUAL HEAD \$599

Dual head drives use both sides of the disk and occupy two drive positions - it is like having two drives for little more than the price of one!

Prices quoted are for bare drives. Add \$10 per drive for a cabinet and \$30 per drive for a power supply.

DISKETTES FOR TRS-80

- NASHUA 40 track single side . . . \$4.50 ea
- VERBATIM 40 track double side, . \$5.90 ea
- VERBATIM 77 track single side . . \$5.90 ea*

THE FABULOUS NEWDOS 80 IN STOCK NOW!

ND-80 \$149

The disk operating system that gives:

- New basic commands that support variable record lengths up to 4095 bytes long.
- Mix or match disk drives - supports any number of tracks from 18 to 80. Use 35, 40 or 77 track 5 1/4" mini disk drives or 8" disk drives, or any combination.
- A security boot-up for basic or machine code programs. User never sees "Dos-ready" or "Ready" and cannot "break" clear screen or issue any direct basic statement including "List" and much, much more

77 TRACK DISK DRIVES DOUBLE YOUR CAPACITY

DD-7S \$775

Micropolis Floppy Disk, 77 Track, 100% larger capacity than most mini-floppy drives, complete with cable, power supply, chassis, and includes NEWDOS '80.

SYSPAND 80 FOR THE SYSTEM 80 \$119.00

SYSPAND 80 is a self-contained module which connects to the expansion port on your SYSTEM 80 and gives you a CENTRONICS parallel port to drive a printer PLUS the TRS-80 40 line bus. SYSPAND 80 allows you to connect all Tandy peripheral, including the expansion interface, disk drives, MICROTEK MT-32 memory expansion unit and the fabulous EXATRON STRINGY FLOPPY.

TRS-80 MEMORY EXPANSION UNIT MT-32 ... \$149.00

The MT-32 is manufactured by MICROTEK Inc., USA. It provides a CENTRONICS printer port and sockets for up to 32K of dynamic RAM. It comes complete, ready to plug into the expansion port of your Level II 16K machine. (Will also work with your SYSTEM 80 via SYSPAND 80).

- MT-32A without RAM \$149.00
- MT-32B with 16K RAM \$179.00
- MT-32C with 32K RAM \$209.00

16K MEMORY EXPANSION KIT

ONLY \$30 incl. p&p

These are prime, branded, 200 ns (yes, 200 ns!) chips. You will pay much more elsewhere for slow, 350 ns chips. Ours are guaranteed for 12 months. A pair of DIP shunts is also required to upgrade the CPU memory - these cost an additional \$4.00. All kits come complete with full, step-by-step instructions, no soldering is required. You don't have to be an electronic type to instal them.

DISK DRIVE HEAD CLEANING DISKETTES

\$29.00 plus \$1.20 p & p

Disk drives are expensive and so are diskettes. As with any magnetic recording device, a disk drive works better and lasts longer if the head is cleaned regularly. In the past, the problem has been, how do you clean the head without pulling the mechanism apart and running the risk of damaging delicate parts. 3M's have come to our rescue with SCOTCH BRAND, non-abrasive, head cleaning diskettes which thoroughly clean the head in seconds. The cleaning action is less abrasive than an ordinary diskette and no residue is left behind.

ONLY \$1995 INC. S.T.

To: MICRO-80
P.O. Box 213, Goodwood, S.A. 5034

Please rush me the items checked below:

- 12 month subscription to MICRO-80 and my free software cassette \$24.00
- 12 month subscription to MICRO-80 and the cassette edition, plus my free software cassette \$60.00
- The latest issue of MICRO-80 \$2.50

PLUS THE ITEMS LISTED BELOW

DESCRIPTION	PRICE
TOTAL ENCLOSED	

Name

Address

Post Code

bankcard No.
welcome here

Please debit my Bankcard \$

Expiry date

Signature

ETI

MICRO 80 PRODUCTS

(08) 272 0966

433 MORPHETT STREET,

ADELAIDE S.A. 5000

AUSTRALIAN SOFTWARE

We have a wide range of Australian software available. Send for a free catalogue

TRS 80 and SYSTEM 80 OWNERS TRS 80 and SYSTEM 80 OWNERS

How many of these kids are equipped for the electronic world of tomorrow?



This century has seen remarkable advances in electronics. Advances which are now a part of every day living. As this continues into the next century, there will be the need for more education in electronics. A good basic knowledge of electronics is essential for those children who are to become our future technicians, programmers and so on. Without this knowledge, your child could be left in the dark, perhaps without a future career.

You can give your kids a head start in electronics; knowledge which is essential to the future of your children.

DICK SMITH'S FUN WAY INTO ELECTRONICS

can provide that essential knowledge- & what's more it's FUN!

Give your child a start for \$4.95

DICK SMITH'S Funway Vol 1.

Contains useful & educational projects.
Cat. B-2600

DICK SMITH'S Funway Vol 2.

Increase your knowledge. Fun & educational.
Cat. B-2610



Great kits from FUNWAY VOL 1.

Has all you need to make any of the projects described in Volume 1.

Projects 1-10 \$6.90

Cat. K-2600

Projects 11-20 \$7.50

Cat. K-2610

FUNWAY VOL 2 kits

from only **\$2.75**

Build many fascinating & worthwhile projects. There are many to choose from!

Drop in today & pick up your FREE kit catalogue for more details!

DICK SMITH Electronics



SEE OUR OTHER ADS FOR FULL ADDRESS DETAILS

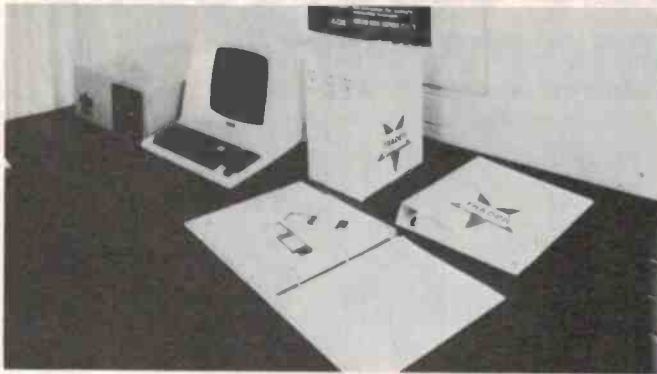

TRADER for traders

Anderson Digital Equipment recently released a new software product called 'TRADER', which stands for Total Real-time Accounting from A.D.E.

The product is a fully integrated suite of computer programs designed and written in Australia for use with the North Star micro-computer. The product comes with a set of manuals that A.D.E. claim are simple and easy to follow.

TRADER incorporates invoicing, stock control, debtors ledger, creditors ledger and general ledger. With each set of TRADER software, you receive a diskette with sample data on file which permits the user to teach himself without fear of damaging his own vital data.

In addition, monthly training courses are available for a nominal fee. Each dealer is trained in the concepts and use of TRADER and can professionally advise how the system will benefit the prospective user. To assist with program problems A.D.E. has developed a program problem reporting procedure where a user can detail his

problem on a set form and mail it to A.D.E.'s software support department for attention.

TRADER features a unique control routine that looks at each transaction and decides what should be done with it. For example, if an invoice is created TRADER updates the debtors ledger, reduces stock and updates the general ledger file. This is done automatically with no action by the operator other than creating the invoice.

TRADER uses a data-base concept where, for example, each debtor's transaction is linked to the respective debtor; the system does not need to sort. Therefore the user can quickly and easily obtain reports, according to A.D.E.

For further information contact Anderson Digital Equipment Pty Ltd, P.O. Box 322, Mount Waverley, 3149 Vic. (03)543-2077.

Local support at US prices

A new computer centre opening in Sydney this month will offer its own microcomputer products on the basis of standard US retail pricing.

Q.T. Computer Systems (Aust), opening at 283 Clarence Street, opposite Sydney Town Hall, is associated with Q.T. Computer Systems Inc., USA, one of the largest stateside microcomputer manufacturers.

Q.T. Computer Systems (Aust) will specialise in both hardware and software, offering a complete service to the microcomputer user.

The centre will cater particularly for microcomputer users, providing a wide range of IEEE-compatible S100 boards, all available either as bare boards or assembled and tested.

There will also be a full range of complete systems, customised to suit all commercial and industrial applications. Other supplies stocked will include diskettes, ribbons, print wheels and some hard to obtain components — and if they don't have a particular item in stock, they'll get it, according to Q.T.'s press release.

Q.T. Computer Systems say they will provide a fully equipped repair centre, staffed by a qualified engineer, and will commission and test all products before delivery.

All standard warranties will be fully backed and local software

Exorciser buss boards

Two multipurpose microcomputer cards, the 68MB02 16K RAM/16K EPROM memory card and the 68GPB03 general purpose card are available from Micro Gear and would be of interest to Motorola micro enthusiasts or users.

Combination and versatility together with a small number of support chips make these cards attractive to the amateur as well as the advanced user. Both are designed and manufactured in Australia by Micro Gear. They are compatible and the 68GPB03 is

Two digital to analogue converters with an output voltage range of 10 volts and a resolution of eight bits, together with a reset on power up circuit are also included. The board occupies 32 consecutive locations and can be positioned in any 32 bit block in the 64K address space. All signals are available on two double-sided gold-plated edge connectors.

The 68MB02 is capable of occupying up to 32K of memory, 16K in RAM and 16K in EPROM. 2114s are used for RAM while the EPROMs are 2716 using single supply 5V types. EPROM can be expanded in 2K increments whilst RAM can be expanded in 1K increments. The board is configured as four independent 8K blocks, two of RAM and two of EPROM, which can be allocated to any 8K boundary in the 64K address space. This card is available as a bare circuit board for \$75 plus 15% sales tax, if applicable.

The 68GPB03 contains two serial communication interfaces, each of which can be synchronous or asynchronous. Baud rates can be generated in both hardware and software. Thirty-two programmable input/output lines are provided as well as two 6840 timers, which in

This card comes fully assembled and tested on the digital side but without 2 x 6820, 2 x 6840, 2 x 6850/6852 and hardware baud rate generation. Price is \$160 plus 15% sales tax. It can be obtained with all analogue circuitry and assembled and tested for an additional \$180 plus tax.

Contact Micro Gear, 3 Coora Place, Churchill 3842 Vic. (051) 67-1498 or (051)22-1157 after hours. Contact hours are provided as well as two 6840 timers, which in

Club call

A CompuColor II Intecolor microcomputer users group (CUWEST) has been formed in Western Australia.

CUWEST meets every month and has a software library available to members. Anyone interested in joining the group can contact J.D. Newman at 8 Hillcrest Drive, Darlington W.A. 6070. Phone 299-6153.

The Northern and Western Suburbs Computer Users' Group of Melbourne held its inaugural meeting on Thursday night, February 5th.

The Group, comprising 12 users of "TRS-80" computers and a correspondent member in Brisbane, represents considerable expertise in computer programming, especially in BASIC and assembly languages, as well as hardware adaptation. Operators of microcomputers and others interested are welcome to join the group to participate in exchange of knowledge and mutual help in improving computing technique.

Meetings will be held at 142 Pascoe Vale Rd, Moonee Ponds, each second Thursday at 7 pm. Those interested in joining the group may telephone David Coupe (03)370-9590 or Clive Budd (03) 370-2917.

support will be provided for all microcomputer products, particularly for CP/M based systems, TRS-80 and Apple. The centre will be managed by Mr. Leon Mor, and it is suggested you contact him for further details. (02)929-8655.



**apple
computer
systems**

Our Apple II prices are among the most competitive in Australia. Beware of the "apparent" discounts offered by some unauthorised outlets. We are **AUTHORISED APPLE DEALERS** and as such can offer the full range of quality **APPLE** products, with full warranty and backup. Now compare our prices and give us a call.

	Tax Free	Tax Inclusive
Apple II Plus 48K	\$1,495.00	\$1,634.00
Apple II Plus 32K	\$1,372.75	\$1,577.00
Apple II Plus 16K	\$1,325.25	\$1,524.00
Disk II with controller	\$ 684.00	\$ 786.00
Disk II Add-on	\$ 515.80	\$ 594.32
Pascal Language System	\$ 470.25	\$ 540.80
Pal Colour Card	\$ 166.25	\$ 191.20
Integer Basic Card	\$ 190.00	\$ 218.50
80 Column Card	\$ 400.00	\$ 460.00
CCS Parallel Interface	\$ 220.00	\$ 253.00
RF Modulator	\$ 35.00	\$ 39.95
Sanyo Green Screen Monitor	\$ 312.00	\$ 345.00

NEW — Zenith Education Systems.

A complete computer aided instruction package designed to allow you to construct your own tutorials in any subject. Questions can be linked to graphics for diagrams. Incorrect answers can lead student on a chain of further questions to illustrate the reason for mistake. Marvellous teaching aid. **\$250.00**



COMMODORE

LIMITED OFFER — for a limited period only we can offer 16K PET 4016 computers for just \$999.00. This is what you get:

- 16K Commodore Computer
- Full Size Keyboard
- Green Phosphor Video Screen
- PET/CBM Guide
- BASIC 4 manual
- Full warranty and backup

— all for just **\$999.00**

The Commodore C2N cassette is available for this system at \$128.00.

The normal list price for a 16K PET is over \$1600! This offer is for a limited period only so make sure of yours today.

PET SOFTWARE

Visicalc	\$295.00
3D Startrek	\$ 22.00
Car Race	\$ 22.00
Night Drive	\$ 22.00

TREASURE TROVE SERIES — four games per tape — send for full details.

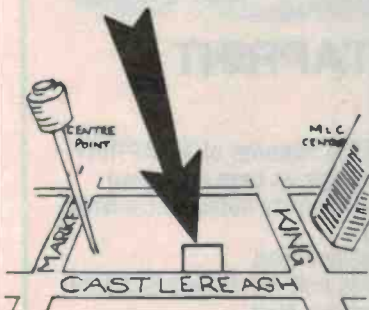

SOFTWARE

NEW — EPYX Software, available on Apple, TRS-80 or PET on cassette or disk:

Star Warrior	\$39.95
Temple of Apschal	\$39.95
Hellfire Warrior	\$39.95
Rescue at Rigel	\$29.95
Starfleet Orion	\$24.95
Invasion Orion	\$24.95
Datestones of Ryn	\$19.95
Morloc's Tower	\$19.95

OTHERS:

ZORK (Apple or TRS Disk)	\$39.95
Microchess (Apple, TRS, PET, Atari)	\$24.95
Galaxy Invasion (TRS cass.)	\$19.50
Cosmic Fighter (TRS cass.)	\$19.50
Attack Force (TRS cass.)	\$19.50
Super Nova (TRS cass.)	\$19.50
Microsoft Editor/Assembler	\$39.95
Microsoft Basic Level III	\$69.95
Microsoft Adventure (Apple Disk)	\$35.95
Sands of Mars (Apple, TRS, Atari disk)	\$39.95
Lasar Wars (Apple, TRS disk)	\$29.95
Galactic Ovest (Apple, TRS disk)	\$29.95
House of Usher (Apple, TRS disk)	\$24.95
World War III (Apple, TRS disk)	\$29.95

**sinclair
ZX80**



PRICE BREAKTHROUGH

SINCLAIR ZX80 COMPUTER	
Includes ZX80 BASIC manual	\$195.00
MAINS ADAPTOR	\$ 16.00
THE ZX80 COMPANION BOOK	\$ 16.00
30 PROGRAMS FOR THE SINCLAIR	\$ 12.50

City Personal Computers

75 CASTLEREAGH STREET,
BOX 1498 G.P.O. SYDNEY 2001
Phone: (02) 233 8992



**SORCERER
STOP PRESS**

Now you can have disks on your Sorcerer **WITHOUT THE S-100 EXPANSION UNIT!** That saves you nearly \$600 straight away.

These are the respected VISTA disks which come as a complete system, with built-in controller ready to plug straight into your Sorcerer. Three different configurations are available — 200K, 400K and 800K — so you can select exactly the disk capacity you need.

Here are some of the key features:

- Completely packaged system, tested and ready to plug into SORCERER.
- Two, or three 40 track drives, case controller and power supply.
- CP/M Disk Operating System with complete documentation.
- BASIC-E or CBASIC compiler option.

The VISTA disk system is supplied with complete documentation including full CP/M information, system guide, interface guide, Assembler users guide and more.

Here are three options available:

- V200E-10 200K single drive, in a dual drive case to allow for expansion, ready to plug into the Sorcerer with CP/M, BASIC E, full documentation and a box of disks. **\$990.00**
- V200E-20 400K dual drive, complete and ready to plug into Sorcerer, with CP/M, BASIC E, documentation and disks. **\$1450.00**
- V200E-22 800K dual double-sided disks, ready to plug into the Sorcerer, with CP/M, BASIC E, documentation and disks. **\$1850.00**

No other system offers such value for money. Already the major software houses are arranging to supply software on Vista format disks, and the CP/M operating system opens the door to even more. Write or phone today for our free factsheet and price list on the VISTA V-200 Disk System.



sinclair

SORCERER SOFTWARE

AUDIOTREK — startrek with sound unit which plugs into motor control jack	\$24.95
BASEBALL — real time graphics	\$15.95
CRIBBAGE — good graphics, requires 16K	\$19.95
FASTGAMMON — excellent popular program	\$21.95
PUNT — racing with graphics and sound	\$15.95
OUBIC — 4x4 Tic Tac Toe!	\$12.95
GALAXIANS — dive bombing space invaders	\$19.95
SORCERER INVADERS — one of best 'invaders'	\$19.95
STARBASE HYPERION — strategy game	\$19.95
MACHINE CODE TUTORIAL PACKAGE	\$24.95
BASIC TUTORIAL PACKAGE	\$24.95

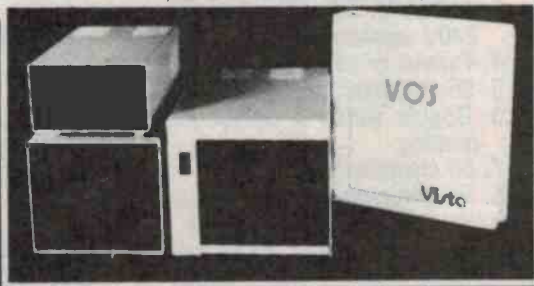

INDUSTRIAL MICRO SYSTEMS

The face is (becoming) familiar

No surprise...it stands out in the crowd. The quality and reliability that Industrial Micro Systems' customers have grown accustomed to is now available in our complete system. A system that will grow with your needs.

You can start with a minimum 16K, single disk system. The system shown above can be expanded to 608K-Bytes of fast RAM with three double-sided, double-density drives. And more to come.

The microcomputer industry standard CP/M™ operating system is delivered with the system. PASCAL is available. Industrial Micro Systems systems users are developing an impressive array of application software.

The system is offered in rack mount and table top versions and also in our own desk enclosure.

In addition to gaining in familiarity, the Industrial Micro Systems picture for total system products should be coming into focus for everyone. Advanced, reliable electronics...industry standard software...and functional high quality enclosures.

Industrial Micro Systems, your source for complete systems. And the prices are right.

Ask your dealer to see the full Industrial Micro Systems line of products and be watching for exciting new additions soon to come from Industrial Micro Systems.

SERIES 5000 SERIES 8000

S.I. MICROCOMPUTER PRODUCTS PTY LTD

Formerly Sigma International Pty. Ltd.

GPO BOX 72 SYDNEY 2001 92 PITT ST SYDNEY (02) 231 4091 232 6804
Melbourne (03) 26-5522. Brisbane (07) 52-8455. Hobart (002) 28-6288.

ALFATRON proudly presents two new PRINTERS at prices you can afford.

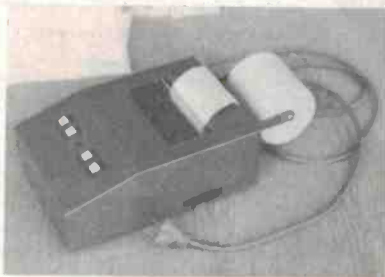

ALFAPRINT

1. 21 column dot matrix printer
2. Uses ordinary paper
3. Choice of 12V DC, 24V DC or 240V versions
4. Parallel or serial interface
5. 96 character set (ASCII)
6. Double width & upside down printing
7. 50 characters per second
8. Fully microprocessor controlled
9. Hammertone case available
10. Basic unit without case \$239.99
11. 40 column dot matrix printer

Alfatron has made it possible for you to own a printer at long last. Now you can have a 40 column printer for under \$300 even if you have to pay sales tax. Loaded with software options these little beauties will find a place in your micro-processor project without putting too large a dint in the pocket.

Check out the features then contact us for more information or better still send your order. Both units available in a basic version which requires a DC power source and has a parallel interface. They can also be supplied in a green Hammertone case for 240 volt AC operation. Case and cradle mountings available separately if required.

DEALERSHIP ENQUIRIES WELCOME

Prices do not include sales tax if applicable.

For Melbourne and Interstate contact:
ALFATRON PTY. LIMITED
1761 Ferntree Gully Road, Ferntree Gully, 3156, Vic.
Telephone: (03) 758-9551

For Sydney contact:
MEASURING AND CONTROL EQUIPMENT
2A Chester Street, (P.O. Box 78) Epping, 2121,
N.S.W. Telephone: 86-4060



BETAPRINT

12. All the features of ALFAPRINT
13. Available in case as shown
14. Print density software controllable
15. Fast line feed
16. Basic unit (W/O case \$259.99)
17. Fast line feed
18. Basic unit (W/O case \$259.99)

Print-out

"Mark II" System 80 for business

Dick Smith Electronics has announced the release of a new System 80 Mark II Business Computer, specifically designed for small to medium business computing applications.

The new machine is a development from the existing model I System 80 computer. It provides virtually all of the features which have made the basic machine so widely used by schools, colleges and private individuals, together with many additional features designed to make it more suitable for serious business use.

These features include full video display of lower-case letters (essential for serious word processing), and a separate numerical keypad for fast and easy entry of numbers. The machine also features a built-in "communications terminal" program, making it ideal for accessing data base services.

The additional features of the Business Computer make it virtually three machines in one: a computer, a word processor (with suitable software), and a data communications terminal.

Like the original System 80, the Mark II Business Computer provides the industry-standard Microsoft "Level II" 12K BASIC as standard. This means that it can run just about all of the enormous range of software that has been written in this version of BASIC.

As well as providing display of the full upper and lower case character set on its video screen, the new Business Computer provides lower case letters having "true descenders" for maximum clarity.

It also provides a choice of two different keyboard modes: "typewriter" mode (lower case letters normal, with the SHIFT key used for capitals) and "computer" mode (upper case letters normal). This makes it ideal for both word processing and normal computing.

In addition to the normal typewriter-format keyboard, a separate 15-key numeric keypad is provided which lets you key in long strings of numbers rapidly with one hand and a minimum of effort.

The numeric pad is complete with BACKSPACE/ERASE, decimal point, comma and duplicate ENTER keys, quite separate from the main keyboard. In addition it provides four special "user-defined" keys which may be used to input special control codes or to call up certain functions.

Other features of the System 80 Business Computer include an optional automatic flashing cursor, which may be used or disabled as



desired, and improved "anti-bounce" protection on the keyboard scanning, for greater reliability.

Using a matching Expansion Unit, add-on memory card and various peripheral units such as printers, floppy disk drives and a modem, the machine can be expanded into a very powerful small business system. It can have up to 48K of user RAM memory, up to four floppy disk drives with a total capacity of more than 400 000 characters, and a choice of either a higher speed matrix printer or a word processor-type daisywheel printer. An Australian-designed and manufactured acoustic coupling

modem is also available, for data communications. The System 80 Mark II will be supported with a range of Australian-developed software. Among the software currently available is a Stock Control and Pricing System, a General Ledger System, an Accounts Receivable System and a low cost mini word processor for casual word processing.

Listed as catalogue number X-4100, the new Dick Smith System 80 Mark II Business Computer is priced at \$1495.00. The new machine will be available from Dick Smith branches and resellers in each state.

New address for Christchurch group

The Christchurch Microcomputer Users' Group have asked us to publish their new address.

To contact the group write c/- Jay Mann, 330 Centaurus Rd, Christchurch 2, New Zealand, or pm in the Christchurch Polytech phone Christchurch 32-5652. The group meets on the second Wednesday of each month at 7.30 pm in the Christchurch Polytech Lecture Hall.

Uncovering more of the Z80!

Holmes and Watson would have turned in their graves if they had read the article on uncovering the Z80 in April ETI, says reader Stephen Dennis of Dundas, NSW.

"It is evident that Dr Moriarty distracted the otherwise thorough investigation that was made, because several other undocumented instructions can be found.

"If one looks at the numerical order listing of Z80 op-codes in the back of the Zilog Assembly Language Programming Manual, a strange omission occurs between CB 2F and CB 38. After looking at the operations that occur, the following rotate instruction can be deduced (elementary, my dear Watson):

```
reg ← 2 x reg + 1
```

i.e: shift left once and add one, hence the new mnemonic:

```
RLO reg machine code: CB 30 to 37
```

where reg is any of A, B, C, D, E, H, L, (HL) (the machine code corresponds to the standard Intel/Zilog convention for register values, i.e: B=0 C=1 ... (HL)=6 A=7).

"If one looks even harder at the other unused Z80 op-codes (those with ED as a prefix), it is possible for one to find even more op-codes. However, to date most of these are duplicates of other Z80 codes or have as yet unknown effects on the CPU (i.e: not so elementary, Watson).

"The best way to check these instructions is to try using them, because after all that is what the spirit of hobbyist computing is about (even if the manufacturers and advertisers tell you differently).

Switchmode supplies feature tiny size, low price, top specs.

Switchmode power supplies, in great demand in the micro market, have not been widely available here, but that should change according to Autotron, who recently gained the Power General agency.

Perhaps the best example of US manufacturer Power General's product prowess is their recently released 1050 series of 50 W switchmode supplies.

Each power supply has overall dimensions of 120 x 120 x 44 mm, weighs 560 g and costs \$139. The available dc outputs (5 V at 10 A, 12 V at 4 A, 15 V at 3.4 A, and 24 V at 2 A) are floating, so either side may be grounded.

True off-the-line switchers in the series achieve 80% efficiency in power conversion, according to Power General. Output ripple and noise are quoted as 50 mV peak-to-peak or 15 mV RMS. Supply inputs are pin-strappable — either 85 to 130 Vac or 170 to 260 Vac at 47 to 470 Hz.

The line regulation is given as $\pm 0.1\%$, the load regulation $\pm 0.2\%$ and the temperature coefficient $\pm 0.02\%/^{\circ}\text{C}$. The transient response

is quoted as 300 μs to 1% of the final value; the input-to-output isolation 2500 Vac; and the holdup time 16 ms after the loss of ac power.

Full-rated output is provided over an ambient temperature range of 0 to 45 $^{\circ}\text{C}$ and operating temperature is specified from 0 to 70 $^{\circ}\text{C}$. Current limiting, fusing, inrush-current limiting, soft start, and remote sensing are all standard features.

Every series 1050 unit uses Schottky rectifiers to minimise the diode voltage drop across its rectifiers.

A single-sided MIL-SPEC FR4-grade printed-circuit board enhances the reliability of the power supply assembly. The price of \$139 is for 1-9 units with delivery ex stock. A catalogue is available on request from Autotron Australia, P.O. Box 202, Glen Waverley 3150 Vic.

For Sorcerer Apprentices

Well, what can I say except "here we are again"? Over the past few months I have been incredibly busy, including extended trips abroad; time to write this article was simply not available to me. Without wasting any more space, let's go to the letters to the editor, still from last year.

Dear Editor,

Thanks for including some SORCERER programming ideas and facts in ETI. At last. When I go to buy an electronic mag, I always check for any useful information contained therein that I can use on my Sorcerer computer. So I bought the ETI magazine and will continue to do so if such articles continue to appear. To close I include a simple method of clearing a section of memory.

In Exidy Monitor e.g.:

```

>EN 0 <CR>
>000: 0 <CR>
0001: / <CR>
>MO 0 1 S100 <CR>
    
```

In a flash, location 0 to 100 inclusive are loaded with '0's. To test this simply use the Monitor [DU 0 100 <CR>] command and examine the display.

Greg Fergus.

Thanks Greg. I can only hope that you'll see this page when scanning through ETI at your newsagent and apologise for what surely appears to you to be an inexcusable delay. Since I have no further travels on my diary for the rest of this year I suggest that you make a point of getting ETI regularly in the future. Your method of clearing memory is very nice and fast. Another approach to this for those who are not too familiar with hexadecimal calculations goes like this: (again in Exidy Monitor):

```

>EN F080: <CR>
>F080: 21 / <CR>
    
```

(You will now see an exclamation mark in the top corner of your screen)

```

>MO F080 F345 F081 <CR>
    
```

You'll see that there are 709 (2C5hex) exclamation marks on the screen. 2C5 hex is the difference between F345 hex and F080 hex, but there was no need to know this figure. This works of course in any location of memory, I used the screen addresses so you can see what's going on.

Over the last few months an ever increasing number of second-hand computers became available through publications like "Trading Post" or the daily papers. I rang several sellers to find out the reason for their decisions to sell. Two major reasons clearly stood out: upgrading to a bigger system (mainly small businesses) or lack of understanding of the computer. The second reason is a cause for concern, since the acquiring of a computer system is a rather expensive exercise. I for one was lucky to have a computer background; however, I found the first few days with my very own computer to be a most frustrating experience. No one could provide any answers to the seemingly insurmountable number of problems that suddenly awaited me during every spare minute of my life.

Today there are several companies and user groups who are quite capable of providing some answers to most problems. As far as I am aware, classes are available at some institutions for Apple computers but I have not heard of any classes for Sorcerer users. Sorcerer Mark II owners have the benefit of a much improved manual in comparison to the first publication. Here are a few of these improvements:

*** WAIT:

This instruction, although explained in the first manual, has been understood and utilised by very few. The revised edition of the BASIC user manual has the following to say about the WAIT instruction:

WAIT <I,M>[<T>]. I, M and T must all be integers from 0 to 255, I is the number of the I/O port, M specifies which bits are to be tested, and T specifies a condition the tested bit must satisfy.

A bit is a single digit, either a zero (0) if the bit is off or a one (1) if the bit

is on (8 bits equal 1 byte), and a port is similar to a memory address (the Sorcerer has 256 such ports and uses ports 252 through 255), which can be scanned, written to or tested. The command "PEEK" is similar to "INP", "POKE" is similar to "OUT" while "WAIT" could be compared with an "IF...THEN" loop.

One application listed in the manual is WAIT 254, 16 which waits for the horizontal sync pulse to ensure that direct poke-ing to the screen RAM does not "drop out".

I am interested to hear from any person who has used WAIT in other applications so we can pass on that information. By the way, WAIT uses ANDs and XORs, as most of you probably know by now. But what do ANDING, ORing, exclusive ORing mean in understandable terms?

*** ONE-STROKE INSTRUCTIONS:

There are seven more of these instructions situated on the numeric keys 1 through 7 on top of the alpha keyboard. Use them by pressing <GRAPHIC> and <SHIFT>. They are:

```

<GRAPHIC> & <SHIFT> 1 = STR$
<GRAPHIC> & <SHIFT> 2 = VAL
<GRAPHIC> & <SHIFT> 3 = ASC
<GRAPHIC> & <SHIFT> 4 = CHR$
<GRAPHIC> & <SHIFT> 5 = LEFT$
<GRAPHIC> & <SHIFT> 6 = RIGHT$
<GRAPHIC> & <SHIFT> 7 = MID$
    
```

*** AND: is used to zero a bit position in a byte. Examine the following truth table:

```

0 AND 0 = 0
0 AND 1 = 0
1 AND 0 = 0
1 AND 1 = 1
    
```

*** OR: (logical) is used to set a bit position in a byte:

```

0 OR 0 = 0
0 OR 1 = 1
1 OR 0 = 1
1 OR 1 = 1
    
```

*** XOR: (exclusive OR) is used to compare two bits or to complement a bit:

```

0 XOR 0 = 0
1 XOR 0 = 1
1 XOR 1 = 0
    
```

In other words:

- >>> AND: if either bit is zero (0), the result is always zero (0).
- >>> OR: if either bit is one (1), the result is always one (1).
- >>> XOR: if one, AND ONLY ONE operand is one (1), the result is zero (0). An obvious application for this is: When you XOR any bit with 1 (one), it will be the opposite of what it was before.

"So far so good" was my reaction when first introduced to this, but in what situations do I use all this newly acquired knowledge? There was no obvious need for all that stuff. Then I wrote a program which was to allow me to enter data without worrying about lower or upper case. I used to write this in the following fashion:

```
IF A$ = "Y" OR A$ = "y" THEN .....
```

Nowadays I simply AND the character with 95 decimal. Here's why: 95 decimal equals 05F hexadecimal or 01011111 binary. Now, looking at our truth tables above, we will see that any figure between 96 dec (60 hex) and 127 dec (7F hex) will be converted to a number minus 32 (20 hex), but if it happens to be between 40 hex and 5F hex, no change will take place. Of course, I still must ensure that the character to be ANDed is not below 40 hex (less than an "A"). Should we decide that all letters have to be in lower case, we simply OR the figure with 96 dec (60 hex). In Exidy BASIC this would look like this:

```

100 A$ = "X": REM no need for "LET A$ = "X" !"
200 A$ = CHR$(ASC(A$) OR 96): REM A$ = "x"
300 A$ = CHR$(ASC(A$) AND 95): REM A$ = "X"
400 B$ = "Hello": A$ = ""
500 FOR X = 1 TO LEN(B$)
600 A$ = A$ + CHR$(ASC(MID$(B$,X,1)) AND 95)
700 NEXT X: REM A$ is now "HELLO"; B$ REMAINS "HELLO"
    
```

Bye for now,
A.P.F. Fry

And you thought your System 80 was just for playing games...

THESE PROGRAMS WILL ALSO RUN ON A 16K TRS-80 MODEL II

Most people think the same way. Personal computers – ho hum. Great for playing 'Space Invaders' . . . but what else can you do with them?

How would you like to do your 1981 Income Tax return by computer?

AUSTRALIAN INCOME TAX, 1981

YES! You can now use your personal computer to accurately and properly complete your personal income tax return! 'Austax 81' goes through each vital step of the tax form, making sure you don't miss anything! Calculations are done for you – automatically – and you can add, delete or change any entry at any time: the program automatically adjusts all the figures to suit! As far as we know, this is the ONLY program available for the 1981 income tax form, written specifically for a personal computer!

Program suitable for form 'S' available June; program for 'A' form available July. 'AUSTAX 81' Cat X-3762 \$29.95

TYPING TUTOR

With our new 'Typing Tutor' program, you can learn to touch type in less than 8 hours! The computer is your teacher: it will tell you if you are making errors; even concentrate on the keys that are giving you problems! And it's so much cheaper than doing a typing course! 'TYPING TUTOR' Cat X-3682 \$19.95

UNIVERSAL DATA FILE

Catalogue your stamp collection. Or your butterflies. Or recipes. Or even keep your club's membership records in order!

Dick's brand new 'Datfile' is an all-purpose data storage and processing program. You can store virtually anything you can write down in 'Datfile' – and then add to it. Delete it. Modify it. Sort it. Process it. Extract it or portions of it. In fact, you can use 'Datfile' to process information in just about any way you can imagine. Disk based. 'DATFILE' Cat X-3760 \$99.00

SPEED READING COURSE

Time is always pretty short these days: why waste it by taking longer than necessary to read? Read everything faster, and with greater comprehension, with this unique program. 'SPEED READING' Cat X-3692 \$19.95

MUSICAL COMPUTER

You've always regretted stopping those piano lessons! Now here's your opportunity to learn to read music – even though you can't play a note! It will teach you all the basics – from note recognition through to tempo. 'MUSICAL COMPUTER' Cat X-3640 \$34.95

76 USEFUL PROGRAMS

Loan repayments, interest, mortgages – through to geometry, algebra, calculus, trigonometry . . . all those things you learnt at school but have long since forgotten. When you need to work something out, let your computer do it for you. 'COMMON PROGRAMS' Cat X-3665 \$19.50

AND FOR THE KIDS . . .

A set of three programs designed to help them learn. They learn faster because learning becomes FUN! Take your choice of maths oriented, spelling or word usage programs. They've all been written exclusively for Dick Smith

'SCURVE INVADERS' (Basic Maths Drill) Cat X-3694 \$9.95 EACH
'HANGMAN/CONCENTRATION' (Spelling/words) Cat X-3696
'ALPHABET COUNTDOWN/RHYME TIME' (Manipulating words) Cat X-3698

AND YES . . . you can still use your computer to play games – including 'Space Invaders Game'.

FOR MORE DETAILED INFORMATION: Ask for a free data sheet at any Dick Smith store, re-seller or the Mail Order Centre.



AUSTRALIA'S FASTEST SELLING PERSONAL COMPUTER . . .

THE DICK SMITH SYSTEM 80

OVER 2000 COMPUTERS SOLD IN SIX MONTHS!

FROM ONLY

\$695

(4K RAM)
Cat X-4003

16K RAM

\$750

Cat X-4005

It's not hard to see why! Compare the System 80:

It is over \$250 cheaper than a similar TRS-80 – and offers more features!

Features like a built-in cassette deck & power supply. 2 cassette controls instead of 1. S-100 bus compatibility. Built-in video modulator (use with any standard TV set!)

Want to know more about the amazing System 80? Ask for free comparison & information data: available at your nearest Dick Smith store, Mail Order Centre or authorised re-seller.

DICK SMITH ELECTRONICS

See our main advert in this issue for our store locations and authorised re-sellers

BANKCARD/TERMS AVAILABLE TO APPROVED CUSTOMERS

PETER ILIFFE

PH. (07)2622615

archive
COMPUTER SERVICES
PO Box 13 Clayfield, 4011, Queensland, Australia.



THE
BOSS

Friday, 13 May, 1982

Good Evening,

We sell a wide range of computer products at very competitive prices with full support and give honest opinions and advice on software and hardware. If a product we don't sell would suit your application better, we'll obtain it for you or tell you where to go!

Our catalogue, 88 pages at last count, is free for the asking and contains a veritable wealth of information, new and used specials as well as some useless trivia. Send for it before you buy anything from anyone.

We ship many items ex stock within 1 day. If a delay is involved, we blame someone else and offer a refund (sometimes). Phone or write to check availability of any particular item.

Apple: CCS Plug-in Boards
Systems: CCS, Archives Business Computer, WD Microengine
Floppys: CCS, Morrow, Nashua, YE-Data, MPI, Qume
Software: All CP/M software, CP/M User's Group, UCSD
Printers: Anadex, Itoh, Nec Spinwriters, NDK, Malibu
Terminals: Televideo, Ampex, SSM Video Boards, Keytronics
S-100 Bus: California Computer Systems, Morrow/ThinkerToys
Hard Disks: Corvus Disks, Constellation and Mirrors, Morrow

For a complete list of products, send for our FREE catalogue.

We are not infallible, but we try to be and we do care about our business and our customers. Tax free prices are available and dealer enquiries are invited.

Dynamically Refreshingly Yours,

Peter J. Iliffe

V.P. in charge of Soliciting

P.S. Our catalogue now has a tutorial on "Bringing Up CP/M"

What's so hard about building a Heathkit product?

nothing!



JUST PICK A KIT... ANY KIT
Whether you're a beginner or an experienced kit builder, you'll find it's easier than you'd dreamed!

STEP-BY-STEP, CHECKING AS YOU GO — you can't go wrong when you do one step at a time and check your work!

GET STARTED



ALL THE PARTS ARE INCLUDED — even solder — so all you need are a soldering iron, wire cutter, pliers and a screwdriver!

THE EASY-TO-FOLLOW INSTRUCTIONS even show you how to solder perfect connections!

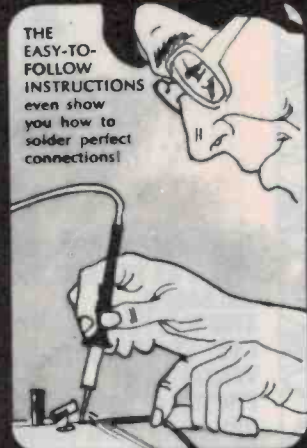

ALL FINISHED



ONE LAST CHECK that all the connections are made right, and you're ready to turn it on...

IT WORKS

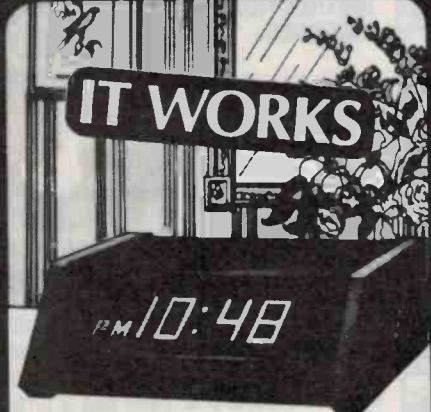

AND TO THINK YOU BUILT IT YOURSELF! It's a great feeling. You saved money — you enjoyed it — and you ended up with a great, hand-crafted product!

You can start right now...fill in the coupon and mail it today!

Every Heathkit product in our '81 catalog is designed to be built by people with little or no prior knowledge or kit-building experience. For more than a quarter of a century, people from every walk of life have been building them — successfully — and so can you.

Heathkit products offer outstanding performance with kit-form savings and provide the satisfaction that comes from creating something of value with your own hands.

Each kit includes a comprehensive, easy-to-understand assembly manual that reduces even the most complex operation to a simple step-by-step procedure. Every step is fully explained and illustrated. The possibility of error is practically eliminated because you check your work as you go.

Find out how you can enjoy the savings, value and personal satisfaction of building your own Heathkit products, by sending for the 1981 Heathkit catalog today!

FREE



Send to
Warburton Franki Heathkit Centre
220 Park Street, South Melbourne, Vic. 3205. Phone: 699 4999

Name

Address

State Postcode

Tired of waiting?

**NOW AVAILABLE: AUSTRALIA'S MOST POPULAR KIT COMPUTER
... THE SUPER INSTRUCTOR 80 Z80/S100 microcomputer...**

**THE IDEAL STARTING POINT...
LEARN AS YOU BUILD...
Z80 BASED...
S100 BUS FOR
EASY EXPANSION...
VERSATILE...
PROVEN DESIGN...
PROGRAMMING COURSE
AND FULL
INSTRUCTIONS
INCLUDED.**

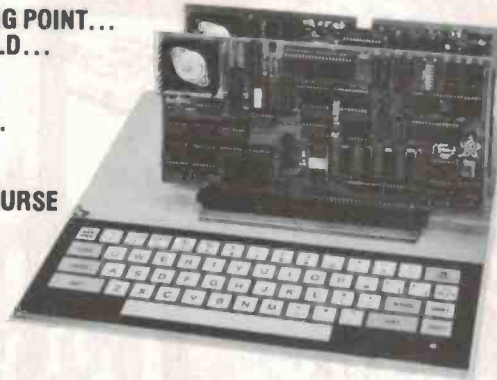

Based on the DGZ80 single board Z80/S100 computer published in ETI, November 1979, the INSTRUCTOR 80 is a complete computer that enables you to learn as you build and once you have mastered the basic concepts, you can readily expand your computer as your needs and budget allow. INSTRUCTOR 80 is not just a cheap "throw away toy" but is a no compromise, professional quality package that will form the basis of your soundest computer investment for years to come. Your INSTRUCTOR 80 is supplied with our unique programming course and already has a large library of supporting software. With suitable system configurations you can use your INSTRUCTOR 80 to play games such as SPACE INVADERS, CHESS or program in MICROWORLD 12K Level II BASIC. Add disk drives and you can run CP/M 2.2 and have access to virtually all business software or program in PASCAL, COBOL, RPG or FORTH.

SPECIFICATIONS:

CPU Z80 2MHZ (4MHZ Option)
I/O 8 BIT INPUT PORT, 2 Programmable I/O PORTS
4 Channel Counter/Timer all interrupt driven
On board provision for cassette and printer interface
VDU 64 characters/line, 16 lines/screen, 128 upper/lower case characters with graphics.
MEMORY On board 2K ROM/2K RAM expandable to 64K with low cost/reliable STATIC S100 Ram boards.
KEYBOARD Full ASCII (upper/lower case) with audible tactile feedback... preassembled/tested.
EXPANSION S100 bus. Motherboard has 4 slots, options to 10 slots.

BUILD IT YOURSELF & SAVE A BUNDLE!

By adding optional S100 cards you can build a system to match virtually any "ready made" such as TRS80, SYSTEM 80, SORCERER, APPLE or PET at a fraction of the cost!!! The INSTRUCTOR 80 is also available Assembled/tested for \$449.00.

BEWARE OF CHEAP IMITATIONS

Instructor 80 uses the Z80 at full speed (2MHz). VDU produces 64 characters/line UPPER/LOWER CASE and GRAPHICS. INSTRUCTOR 80 uses only proven STATIC MEMORY-expandable to 64K. Full software support including BASIC, ASSEMBLER and GAMES now available.

REMEMBER:

Applied Technology is 9 years old and we have been microcomputer specialists for over 5 years. All our products are proven and our exclusive technical support/warranty service applies.

All items expected to be available and prices correct at time of going to press. Please phone for confirmation of price and availability.

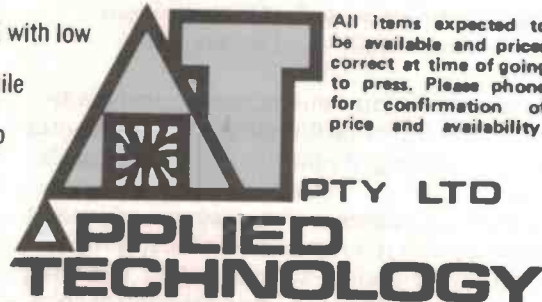

PTY LTD

APPLIED TECHNOLOGY



bankcard

AND NOW AT GOSFORD -

1 Debenham Road, West Gosford (behind the Pizza Hut) 043 24 2711.

OFFICE/SHOWROOM
1a Pattison Avenue,
Weitara 2077.
Hours: 9-5 Monday to
Saturday. Ph. 487 2711

MAIL ORDERS TO:
PO Box 311, Hornsby,
2077.
Please add \$2.00 per
order towards cost of
post and packaging.

A learners' microcomputer Part 2

How to get into microcomputing without boiling your brain cells or breaking the bank

This month we go into the 'architecture' of the micro-processor, an RCA CDP1802, detailing the functions of the various portions necessary for an understanding of how our computer works.

Design: Hugh Anderson
Development: Graeme Teesdale

THE OBJECTIVE of this project is to teach the beginner something about microprocessors while attempting the practical aspect of it. The following text in general will relate to devices used in this project; however, some comparisons with other device groups will be done.

Architecture

A block diagram of the 1802 is illustrated here.

The principal feature of this micro-processor is the sixteen 16-bit register arrays, labelled (R). The 16-bit register gives an addressing capability of 2^{16} , i.e. 65 536 bytes, normally known as a memory system of 64K bytes. Because the 1802 is only an 8-bit microprocessor it is necessary to handle the 'R' register in two 8-bit bytes, designated as $R(x).1$ for high order bytes and $R(x).0$ for low order bytes, where $R(x).1$ indicates the selected 'R' register D to F, i.e. 0-15, and registers over decimal 9 are indicated in a hexadecimal code using letters A to F. The array can also be used as a 32 by 8-bit array if necessary.

Individual registers in the array (R) are selected by one of three 4-bit binary code registers: N, P, X — these in turn are converted to a 16-bit address to the R registers by the 4-to-16 line decoder. Each of the three registers has a particular use. For example: the X designator selects one of the 16 registers $R(x)$ to 'point' to the memory for an operand (or data) in certain ALU (Arithmetic Logic Unit) or I/O (input-output) operations.

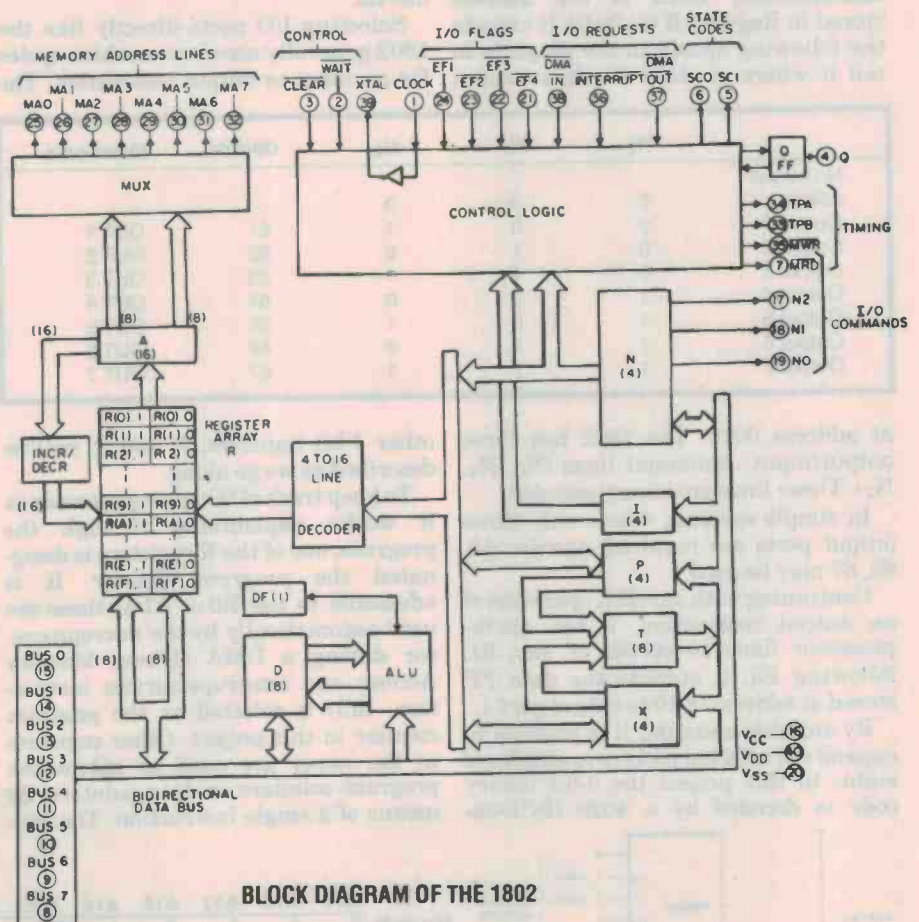
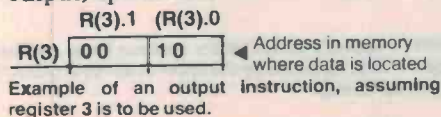

The memory system can be considered as a number of pigeon holes (up to 64K) starting at address 0000 and going to FFFF, each having eight individual storage compartments. I.e. an 8-bit data word (or byte) can be stored in two hexadecimal numbers, and hence

the data at memory location 0010 could be, for example, FF.

An output instruction will take the data FF stored in location 0010 and place it at an output port connected to the outside world.

Project 660

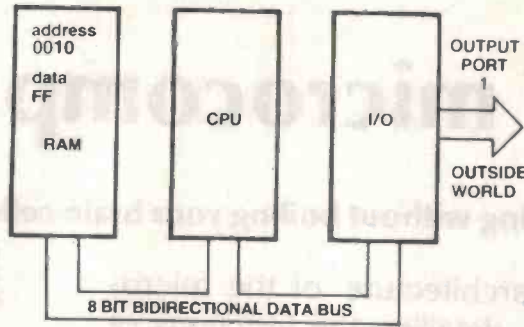

How the microprocessor (CPU), random access memory (RAM) and input/output (I/O) sections of the computer are interconnected.

In this case the data is stored in RAM, memory which can be written to or read from.

The control instruction for the 'x' register is SET X (mnemonic SEX!) and opcode of EN where N is the selected 'R' register. Getting confused yet?! As we have selected Register 3, opcode is E3. When the microprocessor reads the opcode E3 in the program it automatically looks to the address stored in Register R (3) 0010. It expects the following opcode in the program to tell it where to place the data located

decimal decoder) to enable selection of RAM, a colour encoder IC and I/O IC plus additional expansion ports.

Not all microprocessors use this system; some consider designated memory locations as an I/O port. An example is the Motorola 6800 microprocessor. The popular Motorola 6800 D2 kit considers I/O ports at addresses 8004, 8006. Both methods have their merits.

Selecting I/O ports directly like the 1802 generally uses less machine cycles for an input or output instruction. The

	N ₂	N ₁	N ₀	Opcode	Mnemonic
No output select	0	0	0	-	-
Output 1	0	0	1	61	OUT 1
Output 2	0	1	0	62	OUT 2
Output 3	0	1	1	63	OUT 3
Output 4	1	0	0	64	OUT 4
Output 5	1	0	1	65	OUT 5
Output 6	1	1	0	66	OUT 6
Output 7	1	1	1	67	OUT 7

at address 0010. The 1802 has three output/input communal lines (N₀, N₁, N₂). These lines are binary encoded.

In simple systems, where only three output ports are required, opcodes 61, 62, 67 may be used.

Continuing with our SEX operation of an output instruction, if the microprocessor finds an opcode of, say, 61, following E3, it outputs the data FF stored at address 0010 to output port 1.

By suitable encoding it is possible to expand the selected ports in multiples of eight. In this project the 3-bit binary code is decoded by a 4028 (BCD-to-

other 4-bit registers, N and P, will be described as we go along.

To keep track of the microprocessor as it works sequentially through the program, one of the R registers is designated the *program counter*. It is advisable to use R0 or R1 as these are used automatically by the microprocessor during a DMA (Direct Memory Access) and interrupt service instruction. R(3) is selected as the program counter in this project. Other registers in the array are used as subroutine program counters or data pointers, by means of a single instruction. The con-

tents of the P register can be used to call any R registers. The control instruction is SET P (mnemonic SEP), opcode DN, where once again N is the designated 'R' register.

To enable the microprocessor to select any address location from 0000 to FFFF a 16-bit address buss must be used. To reduce the pinout count on the 1802 microprocessor chip, RCA have a bit-multiplexed address line labelled MA0 to MA7.

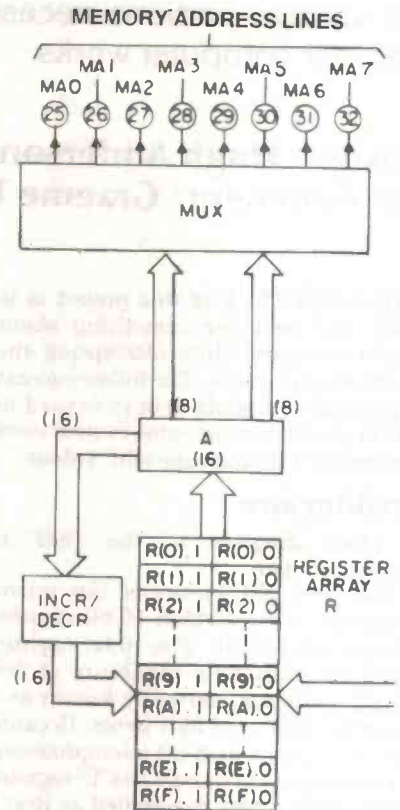

In each cycle, the high order byte, A8 — A15, appears on the memory address lines MA0-7 first. Those bits required by the memory address are latched by a timing pulse, TPA. The low-order byte of the 16-bit address appears on the address lines after the termination of TPA. Latching of all eight higher-order address bits would permit a memory system of 64K bytes.

Taking address 0FFF as an example:

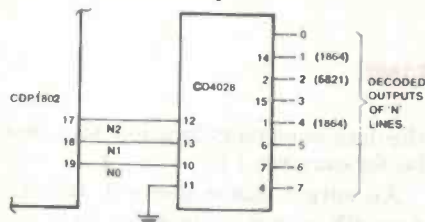

The 4028 BCD-to-decimal decoder decodes the CPU's 3-bit I/O commands and selects a colour encoder IC (1864), an I/O IC (6821) or RAM.

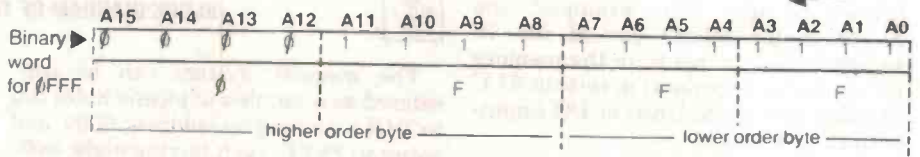

How the binary word represented by the hex number 0FFF appears on the 1802's address lines. As there are only eight lines, the higher order byte (A8-A15) appears first, followed by the lower order byte (A0-A7). In the 1802, the order of the lines is inverted (A8 is where A0 is, etc).

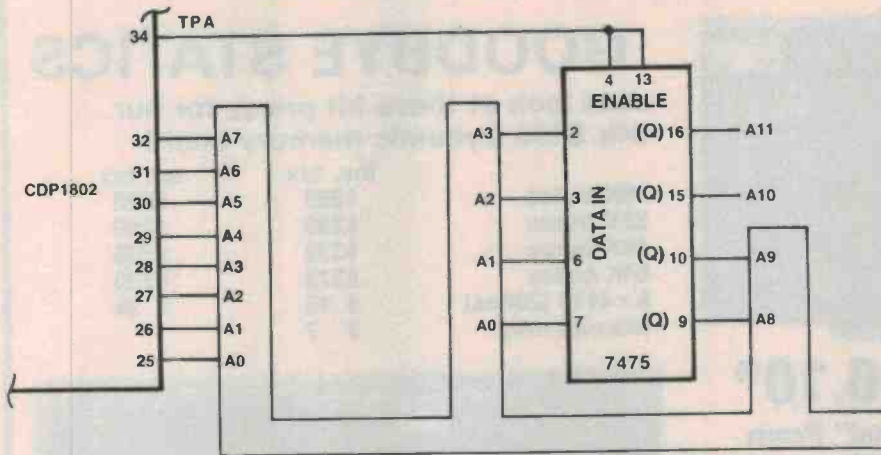

Part of the latch circuit used to temporarily store the lower four bits of the higher order address byte. When the TPA pulse from the 1802 goes low, the 7475 puts the data that was present on the data inputs, at the time TPA was present, onto address lines A8-11 while the 1802 switches the lower order address byte onto the data buss lines A0 to A7.

It can be observed from the table at lower left that it is necessary to decode only the lower four bits of the higher order byte plus all of the lower order bytes for the microprocessor to address memory location 0FFF. It is important to remember that with the 1802 multi-

plexed address lines A8 becomes A0 and so on, up to A15 (i.e. they're inverted). The 7475 is a 4-bit bistable latch and is used as temporary storage for the lower 4-bits of the high byte. When the ENABLE pins (4 and 13) go low, the information that was present at the data

input at time of transition is returned at the Q outputs. The latching pulse (TPA) is obtained from the 1802 at pin 34. Just using this one 4-bit latch it is possible to decode the necessary address lines.

Some microprocessors have all sixteen address lines available: ▶

EXPANDED BLOCK DIAGRAM OF 6800

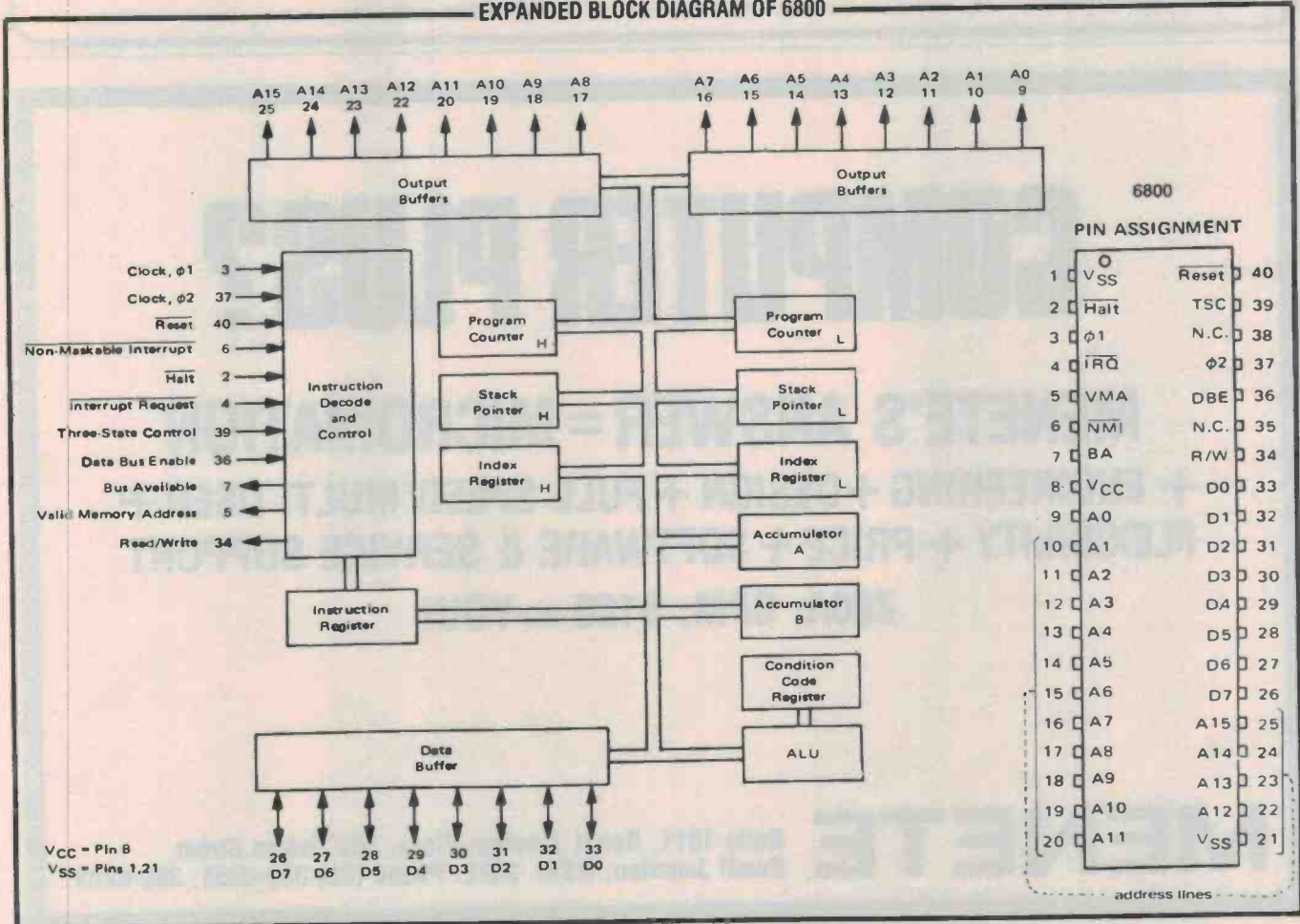

48k RAM FOR \$295*

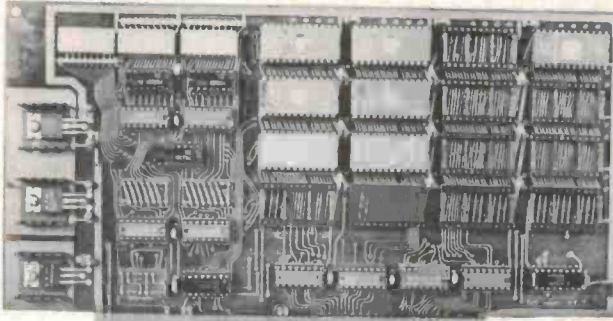

GOODBYE STATICS

Just look at these kit prices for our 64k S100 Dynamic memory board.

	inc. tax	ex. tax
16K bytes	\$259	\$225
32K bytes	\$299	\$260
48K bytes	\$339	\$295
64K bytes	\$379	\$330
8x4116 (200ns)	\$ 40	\$ 35
Manual only	\$ 7	

2716 (+5V) \$6.10*

Yes! We sell the TCT "Universal" Prom board (ETI-682.) Take a look at these prices!

	inc. tax	ex. tax
Complete kit	\$115	\$100
Board only	\$ 69	\$ 60
2716 (+5V,450ns)	\$ 7	\$ 6.10
Manual only	\$ 7	

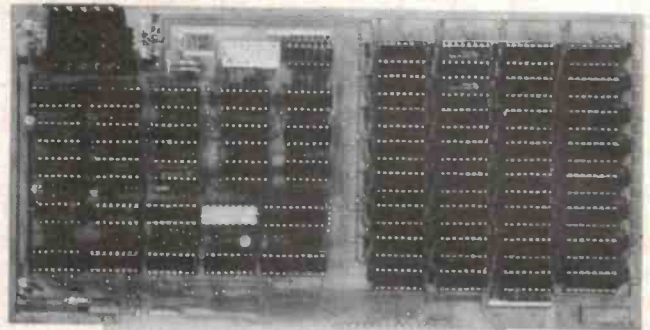

TCT Micro Design Pty. Ltd.

P.O. Box 263 Wahroonga, 2076, N.S.W.

Phone: (02) 48-5388

Please add \$3 for post and packing.

* Plus sales tax.

COMPUTER PLUS?

MENETE'S ANSWER = MICROMATION
+ ENGINEERING + DESIGN + FULL SPEED MULTI USER +
FLEXIBILITY + PRICE + SOFTWARE & SERVICE SUPPORT
Z80A: CPM: S100 = YOU!

MENETE

Suite 1811, Bondi Junction Plaza, 500 Oxford Street,
 Bondi Junction, NSW. 2022. Phone (02) 389-8255, 389-8283.

The 8085 microprocessor has the lower order address bytes multiplexed on the data buss lines.

NOTE: Owing to a last-minute problem with supply of some critical components, we have had to hold over the description of the construction of the ETI-660 computer,

which should now commence in the July issue, assuming no further intervention of problems beyond our control, fairies at the bottom of the darkroom, etc.

8085 BLOCK DIAGRAM

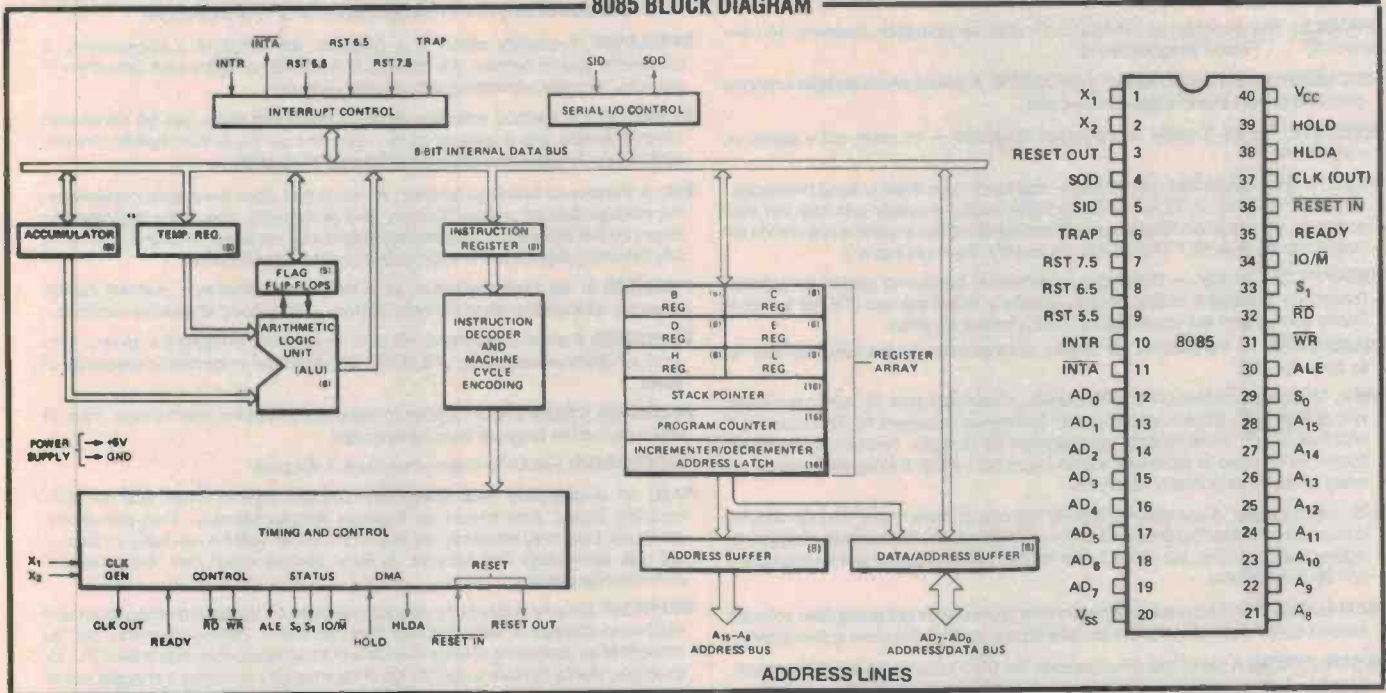

☆☆☆ GLOSSARY OF TERMS ☆☆☆

ALU: Arithmetic Logic Unit. That portion of the microprocessor which performs calculations according to a set of instructions.

ADDRESS: A label or name (usually a binary or hexadecimal number) specifying a particular memory location.

ALPHANUMERIC: Letters and numbers.

ARRAY: A group of related variables or constants — generally given a name or a label. Arrays are often located in consecutive memory locations.

ASSEMBLER: A program which takes a series of mnemonics and puts out a corresponding binary code.

ASYNCHRONOUS: Refers to a circuit in which the various elements are not arranged to change state in synchronism, or in synchronism with another signal.

BCD: Binary-coded decimal. A binary code to represent decimal numbers; for example, a 4-bit binary code can represent the numbers 0 to 15.

BASIC: The most widely used high-level computing language in the hobbyist field. Allows you to communicate with a computer in a fair approximation of pidgin English.

BAUD: A measure of the speed or rate of data transmission. A baud is the transmission of one bit per second.

BINARY: The 'base two' number system in which everything is represented in 'ones' and 'zeros'.

BIT: A single binary digit, representing either a 'one' or a 'zero'.

BOOTSTRAP: This refers to the process of inserting instructions or entire routines directly onto the data and address busses of a computer.

BRANCH: A certain instruction included in a program which makes the processor perform a step out of the usual sequence, usually if a certain specified condition is satisfied. A branch instruction will skip or jump following instructions.

BUSS: Generally, a system of interwiring in which each line has a designated task or carries only specific signals. A buss permits communication between devices making up a computer and can be one-way (unidirectional) or two-way (bidirectional).

BYTE: A binary number, usually of eight bits. It can represent a number from 0 to 255 (8-bit byte) as there are 256 possible combinations of ones and zeros eight bits long.

CPU: Literally, 'Central Processing Unit'. Generally a shorthand term referring to the microprocessor in a microcomputer. One of those terms used more out of tradition than for the sake of clear writing.

CLOCK: An oscillator that provides timing signals which synchronise the operations carried out by the microcomputer.

DMA: Direct Memory Access (or Direct Memory Address) — means what it says. The term refers to the practice of fetching data directly from memory by an external (or peripheral) device without the need for intervention by the microprocessor. A good technique for speeding data transfer.

DEBUG: A BUG is a mistake or similar problem that has crept into a program. The act of debugging removes it. The terms were said to be introduced when a small insect crawled into an early computer and stuffed up its operation. The 'bug' was ceremoniously taped to a page of the report which explained the fault. No, we don't quite believe it either, but it's a good story anyway and its inclusion is a long-standing tradition.

DECODER: A device which changes one code to another. For example, a 4-bit binary code may be changed to a 1-of-16 code. Certain ICs are made to perform such a function, generally called 4-to-16 line decoders. A 4-bit to 1-of-10 decoder is called a BCD to decimal decoder — for each 4-bit code in, the decoder will activate the appropriate one of its ten output lines.

DISABLE: The opposite to ENABLE. To halt an operation — to turn something off (if only temporarily). Also, look it up in your Funk & Wagnell.

Project 660

- DUMP:** If you have a wheelbarrow full of dirt and tip it out, that's dumping the dirt. If you have your computer memory full of data and you transfer it to tape, that is called dumping. Note you can dump from memory to tape and from tape to memory. Pity you can't do it with wheelbarrows sometimes.
- EPROM:** Erasable Programmable Read Only Memory. First, look up ROM. It says, basically, that ROM is a memory you can't muck around with. An EPROM is thus a ROM you can rewrite — Erasable (the ability to rub out) and Programmable (the ability to program).
- ENABLE:** The opposite to DISABLE. To start an operation (promise her/him anything . . .). Funk & Wagnell refers.
- ENCODER:** Aha! The opposite of a DECODER. A device which accepts uncoded data and turns it into the appropriate code.
- EXECUTE:** To kill a cutey. In computer language — to carry out a series of instructions.
- FLAG:** A linen object that one salutes — but sailors use them to send messages. So do computers. A FLAG is an indicator signal (usually just one bit) that generally signals a condition to a peripheral device. (If an answer is required to an instruction such as SET THE FLAG, it's usually "Aye, aye cap'n").
- GRAPHICS:** Literally — drawings; a method of producing graphs or pictorial figures on a suitable output device, usually a video monitor (TV set for most hobby computers) but sometimes a chart recorder or printer.
- HARDWARE:** All the circuitry, pc boards, etc that make up the computer and/or its peripherals.
- HEX:** Shortened version of HEXADECEMAL, meaning '6 plus 10', which is a funny way of saying 16. It refers to the number system with a base of 16. This uses 0 to 9 and then A to F of the alphabet to represent its 16 digits. Two hex digits can be conveniently used to represent a byte (eight bits). Funk & Wagnell reckon it's a nasty curse — so do many hobbyists.
- I/O:** Input/Output. A computer generally has one or more 'ports' through which it communicates with 'the outside world' — peripheral devices such as a keyboard, video display, printer, etc. An I/O port may be just an input or just an output or it can be bidirectional.
- INITIALISATION:** The process by which the processor is got going after you turn the power on. In some systems you have to do it, in others it's done automatically.
- INSTRUCTION:** A set of bits which causes the CPU to carry out a particular task. Usually a basic or fundamental command understood by the microprocessor.
- INSTRUCTION SET:** That set of fundamental instructions which controls a microprocessor's or computer's basic set of possible operations. In general, the larger the instruction set the more powerful the microprocessor.
- INTERFACE:** A device or circuit which effects the transfer of data (in the appropriate form) from one system to another or one part of a system to another part. In homo sapien terms, this is represented by the FIST — as in, "ya wanna punch in ter face?"
- INTERPRETER:** A program which permits the computer to operate with a high-level language. It literally interprets what you've written in the high-level language into a code (bloody great strings of 1s and 0s) which the microprocessor 'understands' (i.e: acts on).
- INTERRUPT:** What happened to Mt St. Helens. In a computer, an interrupt suspends (hence, interrupts) normal program execution while something else happens (usually urgent and involving a peripheral).
- LANGUAGE:** A repertory of instructions — symbols, expressions, etc, used to 'call up' the instructions or procedures a processor can execute. Higher-level languages are easily understood by mere humans and computers of all sorts designed to work with such languages (BASIC, for example) use an INTERPRETER to change this into the MACHINE CODE under which the processor operates.
- LOAD:** The opposite to DUMP. Generally it means 'to store' binary data, usually into some form of memory.
- MACHINE CODE:** The binary form of instructions which a processor actually 'understands'.
- MEMORY:** Sort of 'electronic pigeon holes' in which binary data is stored. There are many forms of memory, generally in two classes: volatile and non-volatile. Volatile memory 'loses' what's stored in it when you turn the power off. Memory ICs (RAM chips) are an example. Non-volatile memory permanently stores data. Cassette tape is an example.
- MEMORY-MAPPED:** An organisation of the hardware and software of a computer to enable data to be transferred directly from memory to an output port without involvement of the microprocessor.
- MNEMONIC:** Not related to manic, but you'll become that if you try and remember too many mnemonics. A mnemonic is a nickname for a particular instruction and is thus made easy for us humans to remember (we have quasi-volatile memories, generally affected by lack of sleep, drink and self-abuse). The 1802 microprocessor, for example, has one mnemonic called 'SEX' — see how easy mnemonics are to remember!
- MODULATOR:** A device, included in every good hobby computer, which takes the computer's output and converts it to an RF signal on a suitable TV channel, giving you a cheap, convenient visual display — even if you don't understand what's on the screen.
- MULTIPLEX:** The principle of arranging or communicating information from a number of sources by selecting each source sequentially.
- OPCODE:** Hexadecimal or binary numbers used for the instructions communicated directly to the microprocessor or CPU of a computer.
- OPERAND:** A quantity which is a constant, the result of a computation, a parameter you've defined, the address of a quantity or of the next instruction to execute. Virtually 'something with which to operate'.
- PARALLEL:** A method whereby data, so many bits wide, can be transferred simultaneously over a group of wires — one wire per bit. An 8-bit system requires eight wires. In effect, the bits are transferred 'in parallel'.
- PIA:** A Peripheral Interface Adaptor. A device that does the interfacing between the microprocessor and/or memory and peripherals, converting the outgoing binary coded signals to the appropriate signals for the peripherals and converting any incoming signals to the appropriate code for the computer.
- POINTER:** In the microprocessor, or in memory external to it, pointers can be registers allocated to listing memory address — they 'point' to memory locations.
- PROGRAM:** A set of instructions, either in mnemonics, in digital (i.e: binary) form or in a high-level language, which tells the computer to perform a sequence of tasks.
- PROGRAM COUNTER:** A register in the microprocessor which keeps track of which part of the program is being executed.
- PROCESSOR:** See CPU. Failing that, Funk & Wagnell.
- RAM:** An uncastrated male sheep; the zodiacal sign of Aries, and the verb meaning batter. Also known as Random Access Memory. That part of the computer's memory which can be read in any order. RAM is inevitably volatile — but new technology has brought us RAM devices which can retain data for considerable periods.
- REFRESH:** Usually refers to the process required by dynamic memory to ensure continued storage of data that has been sent to it. Dynamic memory can be thought of as consisting of large numbers of small capacitors. When the CPU, for example, wants to store a specific bit of information in memory it charges one of these small capacitors. The capacitor will slowly discharge itself, however, so additional hardware is used to look periodically at all of the capacitors and refresh the charge on each one.
- RESET:** Simply — go back to the start, do not pass GO, do not collect 200 bytes.
- REGISTER:** A general-purpose memory, or set of memory locations, built into the microprocessor itself. Sometimes, particular registers may be designated for a specific purpose.
- ROM:** Read-Only Memory — the opposite to Write-Only Memory (the latter being fairly rare and thus unconscionably expensive for the hobbyist, apart from being totally useless). Read-Only Memory is memory which cannot be altered or otherwise mucked about with. In humans it is that part of the brain which stores forever shameful, embarrassing or otherwise traumatic events.
- ROUTINE:** A whole program or part of a program designed to perform a single function or action.
- SCRATCHPAD:** A piece of wood on which cats are supposed to sharpen their claws in lieu of the furniture. In a microprocessor, a scratchpad is an area of memory used to store data temporarily or for making quick data transfers. It is probably the most frequently used area of memory.
- SERIAL:** The sequential transfer of data — one bit after another. Usually only one wire is needed for serial data transfer.
- SOFTWARE:** Programs, routines, instructions, mnemonics — all that stuff the electronics works on.
- STACK:** A colloquial expression for a vehicle accident. Here, we're talking about a sequence of registers or memory locations. Usually, the last bit of data put in is the first fetched out.
- STACK POINTER:** An address that specifies the location of the last entry in the STACK.
- STROBE:** To rapidly read registers or memory locations in sequence.
- SUBROUTINE:** A part of a program which performs a specific task and which is available for use elsewhere in a program or routine, as often as you like.
- VDU:** Visual Display Unit. Usually a TV set in hobby computers, but may be a video monitor which accepts the digital output direct from the computer.
- VARIABLE:** A specified location in memory (usually RAM) which is allocated a specific meaning in a program or routine. It may contain a fixed data value or changing data during program execution.
- £@%*!:** Term used by extremely frustrated or provoked computer hobbyist when his program refuses to be debugged or his computer won't boot up. ●

Introducing
**THE HUG 1802
 MICROPROCESSOR**

Developed by our parent company in New Zealand to allow the hobbist to get into microprocessors at minimal cost.

This simple single board microcomputer has already become the top selling micro kit in New Zealand — thoroughly tested and proven over the last 8 months.

And for those wishing to expand, there are many add-ons already under development.

CLUB

We have established a club for 1802 users to swap software and interesting applications. Club members are eligible for discount on software and peripherals purchased through us.

Club members will be given first (and possibly the only) opportunity to purchase anticipated new innovations as we develop them.

Membership is free ONLY to those who purchase the original HUG 1802 kit from Kit Parts (Aust.) Pty. Ltd.

Write now for **FREE** details to:

**KIT PARTS (AUSTRALIA)
 PTY. LTD.,**

**PRIVATE BAG, NOOSA HEADS,
 QLD. 4567.**

New Zealand customers please write to:

**Kit Parts Ltd.,
 PO Box 6544,
 216 Cuba Street,
 Wellington.**

**The audio experts
 are raving about
 Sonic Holography**



C-4000 Control Console

"When the lights were turned out we could almost have sworn that we were in the presence of a real live orchestra."

Hal Rodger, Popular Electronics

"Had I not experienced it, I probably would not believe it . . . the 'miracle' is that it uses only the two normal front speakers."

Julian Hirsch, Hirsch-Houck Labs

Sonic Holography is only the most spectacular achievement of the C-4000. The others are merely extraordinary.

Consider what you actually have in the C-4000

- A full function stereo preamplifier
- A time-delay system with controllable reverberation mix
- A built-in 40 watt (total) power amplifier for time delay speakers
- The Autocorrelator system that reduces noise up to 8 dB with any source material
- A peak unlimiter-downward expander that nearly doubles dynamic range
- And the Sonic Hologram system that aroused the quotes above.

To hear for yourself why all the audio experts have flipped over Carver, ask us for a demonstration and descriptive literature. It will be a totally new experience for you.

CARVER
 CORPORATION

DISTRIBUTED BY CONVOY SYDNEY (02) 358 2088

Available from:

N.S.W.: LEISURE SOUND City • Parramatta • Artarmon 29 1364
 VIC: TIVOLI HI-FI Hawthorn 818 2872
 QLD: STEREO SUPPLIES Brisbane 221 3623
 S.A.: SOUNDCRAFTSMEN Hawthorn 272 0341
 W.A.: THE SOUNDCRAFTSMAN Subiaco 381 5114

PRINTER SURPRISE:

Fan form paper • 80/40/132 columns • 9 x 7 dot matrix bi-directional impact printer.

Unbelievable Performance

125 characters/second or 64 lines per minute • continuous printing • many functions such as vertical format unit and more.

Unbelievable Quality

Full 96 characters, upper and lower case • adjustable sprocket feed, 115 to 240mm wide • 7-bit parallel interface - Centronics type.

Unbelievable Price

Available NOW at a substantial saving on our normal price • use cash, Bankcard, or Credit Terms (available to approved personal shoppers only).

\$895

**C.Itoh
Model 8300P
Cat. X-3255**

**NORMAL
PRICE
\$970**

**SAVE
\$75!!!**



**DICK SMITH
ELECTRONICS**



See our other advertisements for store addresses.

Direct Computer Sales

MAIL ORDER TO AUSTRALIA

32 Lloyd Avenue, Cremorne, Sydney 2090.
(02) 908-2235. Tlx AA20149.

BUSINESS Hours: Our office is open between 9 and 5 weekdays and also 7 to 10pm Monday through Thursday so that our Australia wide clients can use STD when it's cheap (after 9pm save 60% on your call).

SERVICE: We provide full service, equal to any in the business, on all our lines. We support fully the manufacturer's warranty and provide complete after warranty service.

PAYMENTS:

1. Bank cheque.
2. Local Letter of Credit — ask your bank.
3. Personal cheque — allow time to clear.
4. For organisations who must receive delivery before payment we are strictly 7 days with a surcharge of 3% of the total invoice value applying for 30 days.

A receipt will be issued immediately for all monies received.

If you desire the protection of a written contract between us we can issue you with a Proforma Invoice (or quote).

DELIVERY: (door to door).

1. Customer pick-up (by arrangement) from our premises.
2. To capital cities — everything except big printers, colour monitors and peripheral cards — \$15.00 each article.
To all other places — NSW \$20; Vic, Qld, SA \$27; WA \$38; Tas \$30, each article.
3. Peripheral cards — \$4.00 each by certified mail.

These prices include full insurance and also apply each way for goods returned for service.

APPLE DISCOUNTED

Still the same theme after 6 months of trading; and we are keeping it. For the rest of the year we will improve our service by:

- extending our range even further to include more of the little things you need,
- improving our product knowledge,
- developing more effective ways of passing this knowledge on to you, particularly if you are a non capital city resident,
- and doing things quicker (the earlier shortage of Apple products really slowed us up).

For capital city people Australia is only \$15 wide (unfortunately we couldn't hold this price for everyone — pity).

Our free April soft and hardware catalogue contains helpful information and all our prices. Here's some;

THIS MONTH'S SPECIAL (Order this month Deliver next)	DOS 3.3 UPGRADE KIT \$53 Tax Free. \$61 Tax Paid
--	--

	\$		
16K Apple II Plus	1220	Disk + Controller	630
16K Apple II Plus + 32K	1340	Disk add-on	476
Sanyo green screen	297	General Colour	455
Trendcom 200	630	Microline 80	765
Paper Tiger 445G	1145	Graphics Tablet	744
Z80 Softcard	333	M.H. A-D/D-A	399
M.H. Clock Card	172	CCS Serial Interface	157
M.H. Music System	458	Sendata 700	350

For tax paid prices add 15%

Prices subject to change and exclude delivery.

PLEDGE: Any order that cannot be supplied ex-stock we will specify a despatch date on our receipt. Failure to despatch by this date will require us to immediately issue a full refund, unless otherwise instructed by the customer.

DIRECT COMPUTER SALES

32 Lloyd Avenue, Cremorne, Sydney 2090.

Phone (02) 908-2235 Telex 20149

INTRODUCING

\$100 MULTIUSER SYSTEMS

Microtrix continues to present state-of-the-art microcomputer products. Our extremely popular single-user system can now be easily expanded to cater for two, or up to five, users.

This has been made possible by a new intelligent multiuser input/output board. Known as the MPC-4, it provides four serial I/O channels with individual baud rate selection, and an input and output buffer for each port. Data transfers are efficiently handled by interrupt driven techniques.

An on-board Z-80 Microprocessor controls the functions of the MPC-4, freeing the main CPU to complete other tasks. This creates a more efficient and higher performance system.

But that's not all! The hardware is backed up by a sophisticated multiuser operating system: COSMOS. CP/M compatibility is maintained, but file protection is greatly enhanced. Both global and local files are supported. An editor, Z-80 assembler, linker, loader, CBASIC 2, and a full set of utility programs are provided. These, together with a time-of-day clock, make the system appear like more expensive minicomputers. And COSMOS will also support a hard disc when required.

The MPC-4 and COSMOS are available separately, or complete systems can be configured to suit your requirements. So, for the latest in microcomputer technology, contact us now.

DEALERS REQUIRED AUSTRALIA-WIDE

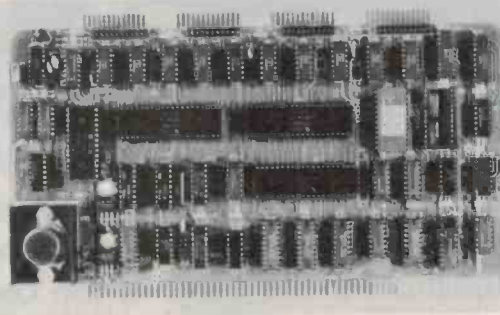

SYSTEM PRODUCTS

SBC 200 Single Board Computer	\$400 kit	\$470 A/T
Versafloppy 2 Double density controller	\$425 kit	\$485 A/T
Expandoram 2 Dynamic RAM 16K	\$360 kit	\$420 A/T
Expandoram 2 Dynamic RAM 64K	\$600 kit	\$660 A/T
VDB8024 Video card with Z-80	\$450 kit	\$520 A/T
PROM 100 PROM programmer	\$245 kit	\$295 A/T

microtrix



MICROTRIX

PO Box 158, Hurstbridge, Victoria 3099
Phone (03) 718-2581

A complete catalogue of all our products is available for the asking. Please add 15 percent sales tax to the above figures if applicable. Postage on any single board is \$3.



Talking computers — new hope for the blind



A voice generator recently developed by the National Institute of Health (USA) will soon be opening up job opportunities for the blind in the computer and allied fields.

Alan Concannon.

AS MICROCOMPUTERS start to produce synthetic speech, technology will open up job possibilities for the blind in programming, word processing, information storage and retrieval, telephone access reservations and other similar areas where a computer can instruct the operator by means of synthesised voice production.

At the Federal Administration in America, a blind computer programmer has been using a prototype micro-computer-controlled voice generator for over a year. With this particular appli-

cation the host computer communicates by synthesised voice with the programmer, who inputs to the computer by a conventional keyboard.

A programmer with sight can of course see the printed read-outs or the data on a VDU. The blind operator has two systems available that will allow him to receive the same communication through other senses: tactile devices using his fingers, or listening to a voice generator.

Audible output, or listening to a voice generator, is by far the more popular,

mainly because it is a more natural method. This system is also more efficient because blind people use their sense of hearing all the time for communication, and have it developed to an excellent degree.

Tactile devices include braille line printers and an optical-to-tactile converter called **Optacon**. This allows the user to scan the printed text or a display screen with a hand-held camera, and the tactile image of each symbol is presented to the finger of the other hand.

Voice generator

Two basic operations are involved in the generation of the 'voice'. First the printed words and punctuation are converted to commands, which in turn are converted into a suitable form to drive a voice synthesiser. Then the synthesiser converts these commands into an audible output. The most common method for this today uses a phoneme synthesiser with a speech-by-rule program under microcomputer control.

The generator used by the NIH (National Institute of Health, USA) for their experiment used a phoneme synthesiser that produces 64 different phonetic sounds, the program determining which are required for each word. Whenever a word has been completely vocalised, the microcomputer initiates transfer of pending phonemes for the next word. This transfer takes place in microseconds, so that speech output is continuous.

Speech synthesisers are also fairly versatile units in that they can control not only speed of delivery but also pitch and accent, and may be placed in either the manual or programmable mode.

The synthesiser unit is interfaced

with the computer, many miles away, via a telephone line. Data from the blind operator's keyboard is received and transmitted along the telephone line to the host computer. Data from the host computer is also transferred to the speech synthesiser over the telephone line for the blind programmer to hear.

The microcomputer used by the NIH included a CPU, 4K of RAM, 4K of PROM, a serial interface for the keyboard and a display screen. A display screen was used so that should garbled or complicated outputs come through the synthesiser and not be understood, the Optacon method can verify the material. The synthesiser can, however, spell out each word of the text for clarification, so a display screen may be dispensed with if desired.

Fewer than 5% of common English words are mispronounced. Of these proper nouns, technical terms and foreign words produce the most mispronunciations. The text-to-phoneme conversion rules allow, where possible, one-syllable words only to be used.

Words are assembled from sequences of alphabetic characters and are pronounced upon the appearance of any

nonalphabetic or punctuation character, such as space. Numbers may be pronounced on a digit-by-digit basis or a units-tens-hundreds basis. Therefore "27" could be pronounced "two seven" or "twenty seven". The digit-by-digit convention was selected for the NIH prototype because of clarity and correct vocalisation of lists of numbers separated only by commas, eg. 400, 700, 1000, etc.

Punctuation marks are verbalised, since special meanings may be assigned to them in various programming languages. Whenever the machine produces phrases or larger units of text, programmed pauses are generated for end-of-phrase symbol, eg. full stops, question marks, colons, etc. An unvarying designation is given to symbols that share the same representation; eg. hyphens and minus signs are both pronounced as minus signs.

How the voice generator works

As the unit goes through the text, it is analysed and separated into words and symbols. Each word is then searched for in an exception dictionary. If the word is ▶

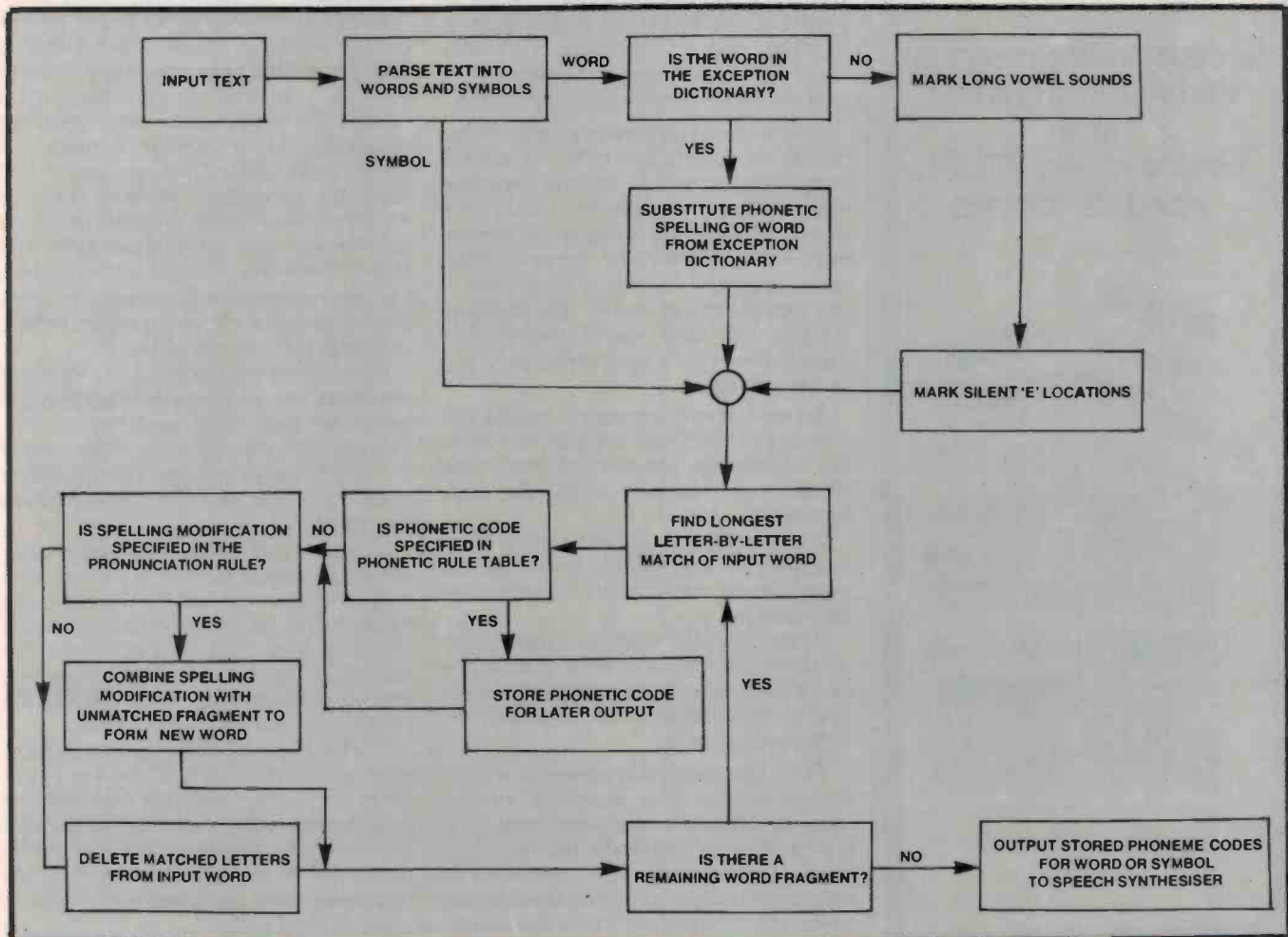

No car
is complete
without one



Gregory's S.P. car service
and repair manuals
and
Gregory's new 1980/81
street directories



G2

will get you there.

found the phonetic codes corresponding to that particular word are sent directly to the speech synthesiser. If the word is not found in the exception dictionary, the program scans for long vowel sounds, silent 'e' locations and other usual patterns which will be vital in determining pronunciation.

Various other pronunciation rules are then applied to determine which possible phonetic sound will be produced for the letter or letter sequence of a word. For example, 'cy' as used in the word 'cycle' would be given an 's' and not a 'k' sound.

The program then repeatedly applies word fragment rules of pronunciation to convert the remaining letters of words into phonetic codes. These are stored until all the codes for a word have been generated. Then all the symbols in a text string are matched and the program finally determines the appropriate complete verbalisation and pause duration.

Controlling the generator

The blind programmer can select three different modes of output: full words, i.e. continuous speaking; spelling out of words, i.e. should the pronunciation be poor then spelling it out makes comprehension easier; repeating of words, should for any reason the programmer wish to hear a word or sentence again.

Spell-out sometimes is necessary because the pronunciation is not always very clear, especially for mis-spellings, abbreviations, composite words, obscure computer programming symbol names like SQ. RT. for "square root", and any complex words not included in the exception dictionary. The spelling method can also clarify words that sound alike but are spelt differently, e.g. to, too and two.

Several speech response options are also available. These include slow rates for clarifying obscure phrases and words, and higher rates for text browsing.

To eliminate outside interference headphones are usually worn by the programmer, rather than using general speakers.

Voice generators can be controlled by a number of methods, such as switches and knobs, codes from a typewriter keyboard, or a combination of panel and keyboard controls.

The voice generator operates with a host computer in a 'translate' output mode or with the microcomputer in a speech 'review' mode. In the translate mode, text from the host computer is converted to phonetic codes, then passed to the speech synthesiser. In the review

mode, the last few hundred words of the text transmitted from the host computer are automatically stored in the microcomputer and are available for review and repetition.

A host computer usually transmits text or character data to the voice output generator faster than the speech synthesiser can operate. Unless the host output is constrained, the storage in the microcomputer may overflow, causing loss of data. Also, should the speech review mode be used, further data transfer from the host computer must be suspended to prevent an overflow of stored text.

Usually, an output suspension control code is sent to the host computer to halt delivery of further data. After the speech synthesiser 'catches up', an output resumption control code is transmitted to restart the text translate mode.

Conclusions

After its trial period the NIH system has drawn the following conclusions from its operating staff.

Higher quality speech is recommended for applications with vocabularies that include technical terms, and fewer user-defined symbols. Although speech output seems to be the most efficient way for a blind programmer to interact with a computer, hard-copy output needs to be used in situations requiring interpretation of unusual formats and error conditions. Optacon scans are used on occasions, working from a display screen, which may clarify words or phrases not intelligible from the Voice Generator. However, the need for Optacon scans should slowly diminish when improved speech and voice output terminal logic is available.

Specialised pronunciation rules and punctuation are sometimes needed for computer and other applications. For example, should voice output be needed for medical applications, pronunciation rules for Greek and Latin may have to be included.

Voice output generators and stand-alone terminals for the blind are now commercially available in the USA, the price being subject primarily to the voice quality and sophistication required. It is possible to buy a unit similar to the one used by the NIH in the USA for approximately US\$500.

A whole new job horizon is starting to open up for the blind. If the concept of synthetic voice generation were applied imaginatively in many as yet untried job areas, the blind would no longer be restricted from entering many fields requiring the processing of visual material and data.

NEW!

"THE BIG BOARD" OEM - INDUSTRIAL - BUSINESS - SCIENTIFIC SINGLE BOARD COMPUTER KIT! Z-80 CPU! 64K RAM!

NEW!

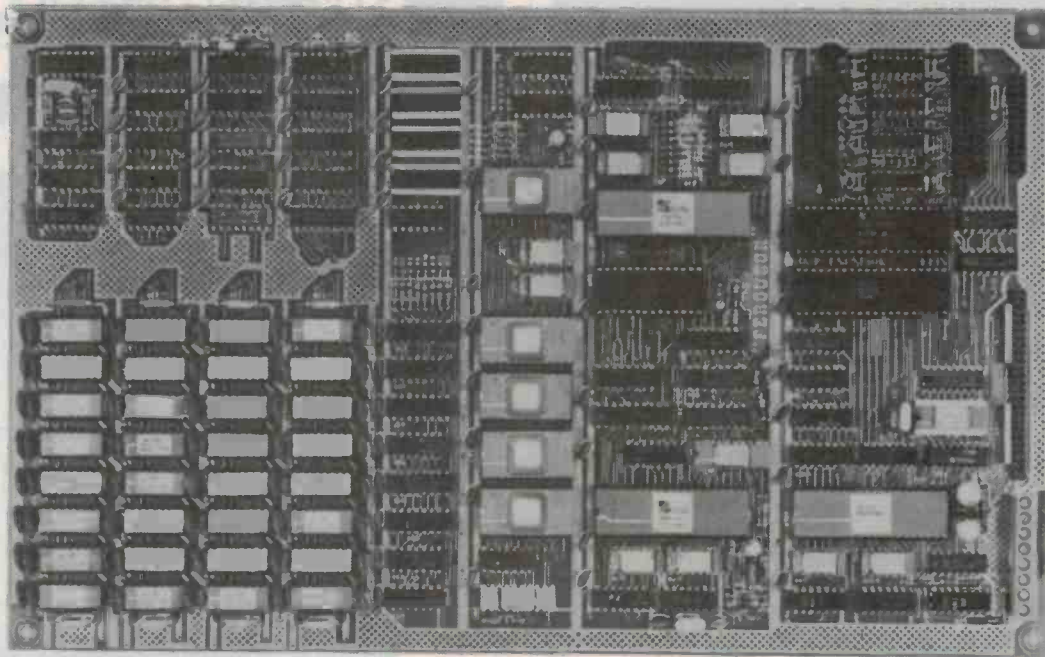

THE FERGUSON PROJECT: Three years in the works, and maybe too good to be true. A tribute to hard headed, no compromise, high performance, American engineering! The Big Board gives you all the most needed computing features on one board at a very reasonable cost. The Big Board was designed from scratch to run the latest version of CP/M*. Just imagine all the off-the-shelf software that can be run on the Big Board without any modifications needed! Take a Big Board, add a couple of 8 inch disc drives, power supply, and an enclosure; and you have a total Business System for about 1/3 the cost you might expect to pay.

\$695.00 (64K KIT BASIC I/O)

SIZE: 8 1/2 x 13 1/2 IN.
SAME AS AN 8 IN. DRIVE.
REQUIRES: 5V @ 3 AMPS
12V @ .5 AMPS.

FEATURES: (Remember, all this on one board!)

64K RAM

Uses industry standard 4116 RAM'S. All 64K is available to the user, our VIDEO and EPROM sections do not make holes in system RAM. Also, very special care was taken in the RAM array PC layout to eliminate potential noise and glitches.

Z-80 CPU

Running at 2.5 MHZ. Handles all 4116 RAM refresh and supports Mode 2 INTERRUPTS. Fully buffered and runs 8080 software.

SERIAL I/O (OPTIONAL)

Full 2 channels using the Z80 SIO and the SMC 8116 Baud Rate Generator. FULL RS232! For synchronous or asynchronous communication. In synchronous mode, the clocks can be transmitted or received by a modem. Both channels can be set up for either data-communication or data-terminals. Supports mode 2 Inl. Price for all parts and connectors: **\$95**

BASIC I/O

Consists of a separate parallel port (Z80 PIO) for use with an ASCII encoded keyboard for input. Output would be on the 80 x 24 Video Display.

24 x 80 CHARACTER VIDEO

With a crisp, flicker-free display that looks extremely sharp even on small monitors. Hardware scroll and full cursor control. Composite video or split video and sync. Character set is supplied on a 2716 style ROM, making customized fonts easy. Sync pulses can be any desired length or polarity. Video may be inverted or true.

FLOPPY DISC CONTROLLER

Uses WD1771 controller chip with a TTL Data Separator for enhanced reliability. IBM 3740 compatible. Supports up to four 8 inch disc drives. Directly compatible with standard Shugart drives such as the SA800 or SA801. Drives can be configured for remote AC off-on. Runs CP/M* 2.2.

FOUR PORT PARALLEL I/O (OPTIONAL)

Uses Z-80 PIO. Full 16 bits, fully buffered, bi-directional. User selectable hand shake polarity. Set of all parts and connectors for parallel I/O **\$45**

REAL TIME CLOCK (OPTIONAL)

Uses Z-80 CTC. Can be configured as a Counter on Real Time Clock. Set of all parts: **\$25**

PFM 3.0 2K SYSTEM MONITOR

The real power of the Big Board lies in its PFM 3.0 on board monitor. PFM commands include: Dump Memory, Boot CP/M*, Copy, Examine, Fill Memory, Test Memory, Go To, Read and Write I/O Ports, Disc Read (Drive, Track, Sector), and Search. PFM occupies one of the four 2716 EPROM locations provided. It does not occupy any of the 64K of system RAM!

CP/M* 2.2 FOR BIG BOARD

The popular CP/M* D.O.S. modified by MICRONIX SYSTEMS to run on Big Board is available for \$150.00.

TERMS CASH CHEQUE OR BANKCARD (MIN \$100 DEP)

ALL PRICES PLUS TAX IF APP

REGISTERED PACK & POST \$5.00



RITRONICS WHOLESALE
425 HIGH ST., NORTHCOTE VIC
481 1923 489 7099 PO BOX 235

Copy of manual and assembly instructions \$15. Refundable on purchase of board. Photocopy exchanged for original. Delivery ex stock.

Bankcard Mail Orders Welcome

Please debit my Bankcard

Bankcard No

Expiry Date

Name

Signature

Lothlorien Farming

Cultivating new concepts

Proudly announce
the release of

THE CAVERNS OF MORDIA

Truly the most sophisticated
computer game of adventure
and strategy yet devised!



For the Apple II, II plus Computer
(48k & disk drive req'd.)

Dungeons	Dragons	Dagger	Tremors
Drop-offs	Orcs	Sword	Spider Web
Dwarf Trade	Balrogs	Mithril Armour	Holes
Passages	Serpents	Flares	Evil Spirits
Ascent Shafts	Vampire Bats	Dragon Net	Demon Curse
Tunnels	Goblins	Charm Ring	Gold
Maps	Giant Spiders	Dragon Occular	Vitality Exchange
Caving Reports	Demons	Orb of Power	Chests
Teleportation	Traps... and More!		

- * Different kind of combat with different monsters
- * Game can be interrupted & saved on disk for continuation later
- * Complex combat/retreat with variety of equipment & situations
- * Game never repetitious
- * New maps generated on re-start

Comprehensive, illustrated, 60 page Manual
Membership in the Caverns of Mordia Club
Disk, Manual & Club Membership \$59

(Postage & handling incl'd.)

(Aust.)



Name _____
Address _____
Card No.
Expiry Date _____ Signature _____

send to

Lothlorien Farming, Box 1033,
GPO Sydney 2001, Australia

The audio experts are raving about the Magnetic Field Amplifier



M-400 Magnetic Field Amplifier

"Its distortion and noise levels are entirely negligible . . . it's hardly conceivable that a small, inexpensive lightweight cube such as this could deliver as much clean power as any but a few of the largest conventional amplifiers on the market."

That's what Julian Hirsch reported in Stereo Review about the Carver M-400—the unique magnetic field power amplifier. It's a cube that weighs around 4 kgs and delivers 200 watts per channel. And costs a lot less than you think.

Equally startling, the M-400 can safely drive speaker-load impedance as low as 2 ohms. And in mono it can deliver more than 500 watts into an 8-ohm load, with peaks to 900 watts! (Bring on digital audio!)

To hear for yourself why all the audio experts have flipped over Carver, ask for a demonstration and descriptive literature. It will be a totally new experience for you.

CARVER
CORPORATION

DISTRIBUTED BY CONVOY SYDNEY (02) 358 2088

Available from:
N.S.W.: LEISURE SOUND City • Parramatta • Artarmon 29 1364
VIC: TIVOLI HI-FI Hawthorn 818 2872
QLD: STEREO SUPPLIES Brisbane 221 3623
S.A.: SOUNDCRAFTSMEN Hawthorn 272 0341
W.A.: THE SOUNDCRAFTSMAN Subiaco 381 5114

35 years young

and
still on
top

NEW CRYSTAL MARKER OSCILLATOR

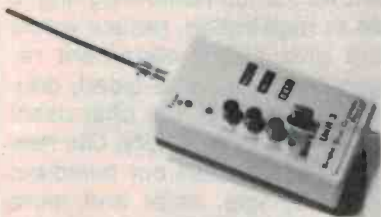

Marker frequency from 2MHz to 20MH

Manufacturers of

PIEZO ELECTRIC CRYSTALS
Contractors to Federal and State
Government Departments.

REPRESENTATIVES:

NSW: J. E. Waters,
11 Salisbury St, Botany. 2019.
Ph 666-8144.

SA: R.W. Electronics,
51 Wood Ave, Riddleyton. 5008.
Ph 46-4571.

QLD: Fred Hoe & Sons P/L,
246 Evans Rd, Salisbury North.
Brisbane. Ph 277-4311.

WA: Westest Electronics,
71 Jean St, Hamilton Hill. 6161.
(Mail only) Ph (09) 337-6393.

TAS: Dilmond Instruments,
PO Box 219, Bellerive. Hobart.
Ph 479-47-9077.

Send SAE for new catalogue or quote for
your requirements.

Bright Star Crystals

Pty.
Ltd.

PO Box 42, Springvale.
Ph (03) 546-5076 Telex AA36004

SWITCHCRAFT

CONNECTORS & ELECTRONIC
COMPONENTS

Superb quality and reliability
from one of the oldest and most
experienced manufacturers in
the U.S.A.

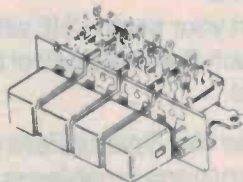
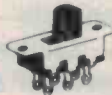
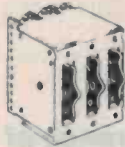
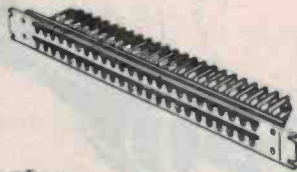

AUSTRALIAN DISTRIBUTORS
AUDIO TELEX COMMUNICATIONS
PTY. LTD.

SYDNEY MELBOURNE
1 Little Street, 7 Essex Road,
Parramatta, 2150 Mt Waverley, 3149
Tel: 633 4344 Tel: 277 5311

BRISBANE
394 Montague Road,
West End, 4101
Tel: 44 6328

HERE AT LAST!

A book on computing that takes you from 'what-is-all-this-fuss-about-computers' through a thorough 'beginners'-buying-guide' right up to 'building-your-own-computer' from projects previously published in ETI.

When faced with the awesome task of choosing or assembling a computer system — whether you want a "learning aid" or a "working tool", a "ready-rolled machine" or a "project kit", you'll find very few places to go. This book rolls it all into one. Assembled from articles published in ETI over the past few years, with additional material to aid the newcomer, it's an invaluable reference work. Running to 156 pages, this book contains 16 articles on various aspects of computing and 10 construction projects.

Copies available for \$4.95, plus 85 cents post and handling, from:

ETI Subscriptions Dept.
3rd Floor, 15 Boundary St
Rushcutters Bay NSW 2011

✂ —————

Name

Address

..... Postcode

I enclose cheque , Money Order for
total of \$ for copies
of "Computers and Computing — 1980
Yearbook".



GOOD WILL INSTRUMENTS TEST EQUIPMENT

NEW FOR 1981

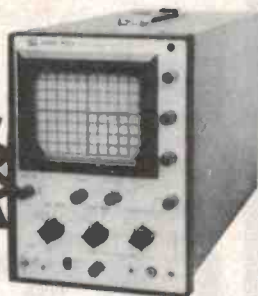

INTRODUCTORY OFFER

SPECIAL
\$275.00
(NORMALLY \$295.00)

5 INCH 6.5MHZ
OSCILLOSCOPE
G.W. — GOS-955A

SPECIFICATIONS

GOS-955A

Vertical Deflection: 10mV/DIV, 1/1, 1/10, 1/100, and GND, DC: DC-6.5MHz (-3dB), AC: 2Hz-6.5MHz (-3dB), 1MΩ ± 5 percent within 35PF, 600VP-P or 300V(DC plus AC peak); 250mV/DIV or better, DC-500KHz (-3dB), 1MΩ ± 10 percent within 35PF.
Time Base: 10Hz to 100KHz in 4 ranges and fine control. Less than 5 percent Internal and External.
Synchronization: Internal - & +; external; line 0-140° for line frequency sweep.
INT: more than 1 DIV. EXT: more than 2V p-p
Calibration: 50mV p-p 1KHz square wave
CRT Type: 130mm Round screen C.R.T.
Blanking: G1

Function Generator

GFG-8015

(Sine/Square/Trip/100
0.2-2MHz. Triangle
pulse, ramp wave).

\$185



Digital Multimeter
GDM-8035
(3½-digit AC/DC VA ohm).
\$265

GPS-3020
D.L. Regulated
Power Supplies
From \$100



Audio Signal Generator
GAG-808A
(10Hz-1MHz)
(Sine/Square wave)
\$189



Digital
Frequency
Counters
From \$358



RADIO PARTS GROUP

562 Spencer Street, West Melbourne
Phone (03) 329-7888
1105 Dandenong Road, East Malvern
Phone (03) 211-8122

ELECTROCRAFT

will put you in the picture

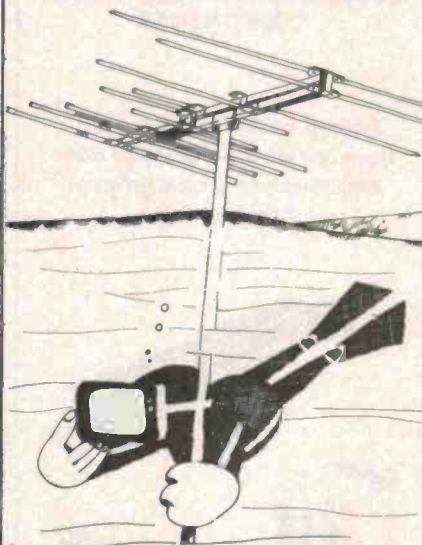

with the largest range of
Antenna accessories in
Australia.

Antenna's — FM — VHF —
UHF — MARINE — CB.

Amplifiers — over 30 types in
stock.

Mast head — Distribution etc:
Cables — plugs — sockets —
baluns — rotators — Splitters
2 to 8 way. — diplexers VHF &
UHF. — Wide band UHF set
top convertors. Single Channel
for VCR's.

Convert your set to UHF with
the Touch Remote control by
General.

*Phone the Specialists for
your antenna problems, we
will help you to receive
good pictures or good
sound.*

ELECTROCRAFT PTY LTD

68 Whiting Street, Artarmon N.S.W.
Telephone 438-4308 (ext. 6)
or 438-3266 (ext. 6)

WE ARE SPECIALISTS
30 years in the antenna business.
Hours: 8am to 5pm.

Prices subject to alteration without notice.

Verbatim®



MINIDISKS

Verbatim, the world's leading producer of minidisks, makes the widest range of minidisks available for word processing and data processing applications. Intent on maintaining this position of leadership, we constantly strive to make our minidisks even better.

Each Verbatim minidisk is equipped with a hub reinforcing ring to aid in registration, reduce errors and give better alignment repeatability. Our dual-sided, double density minidisks offer users higher storage capacity. Our new plastic box makes our minidisks easier to use, safer and more convenient to store. Our testing standards go beyond the industry standard because we insist on Verbatim being the industry standard of excellence.

Try new Verbatim disks
for the performance
of a lifetime.

"We play it back,
Verbatim"

Magnetic Media Services Pty.Ltd.

SYDNEY: 5 Apollo Place, Lane Cove, NSW. 2066. Phone (02) 428-1100. Telex AA22703.

MELBOURNE: 320 Toorak Road, South Yarra, VIC. 3141. Phone (03) 240-8288. Telex AA32127.

BRISBANE: 146 Leichhardt Street, Brisbane, QLD. 4000. Phone (07) 229-1941. Telex AA42367.

CANBERRA: 25 Lonsdale Street, Bradon, ACT. 2601. Phone (062) 48-6751. Telex AA22703.

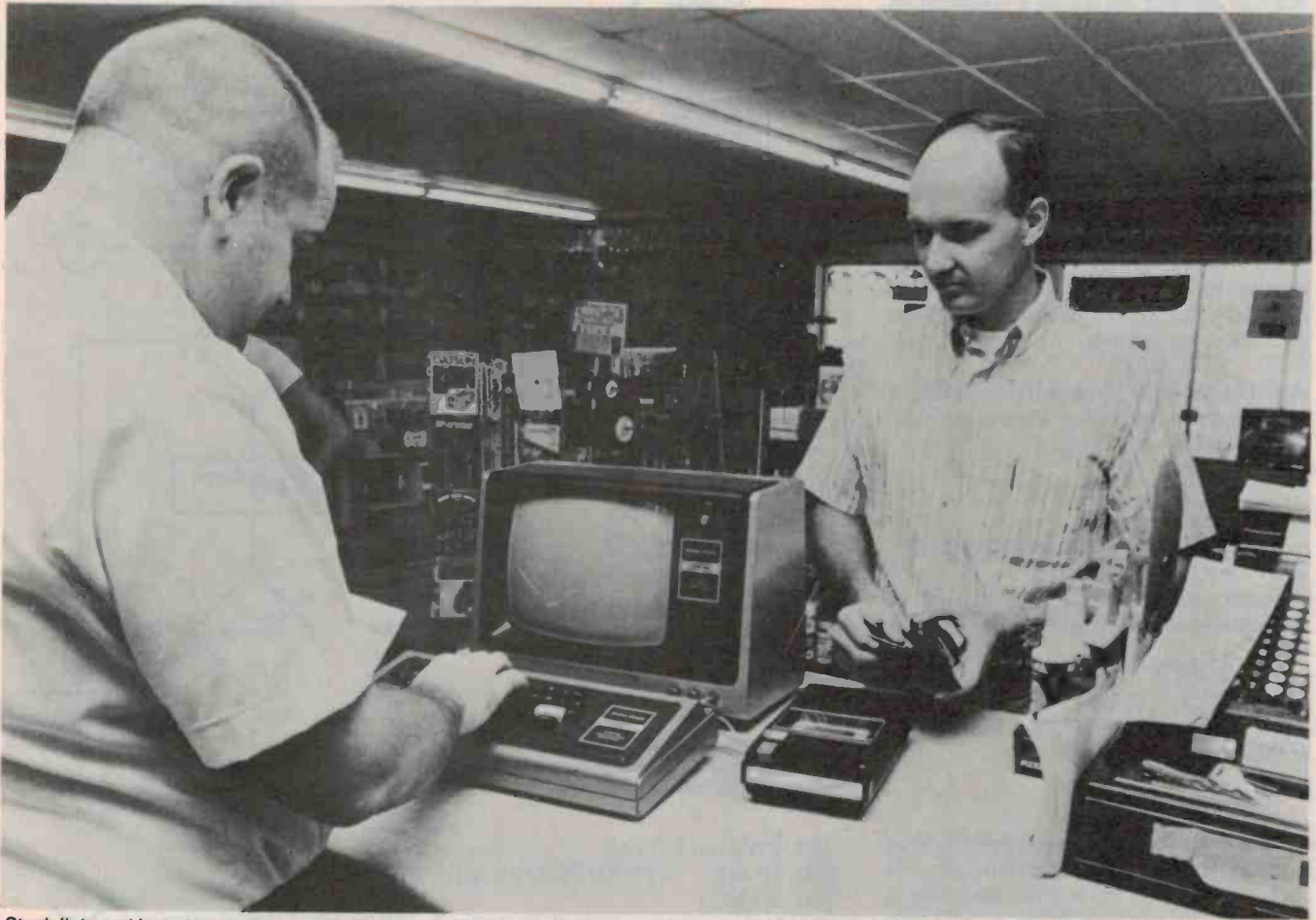

Stock lists and inventory control require the sort of programming techniques that are explained in this article.

Advanced BASIC

Phil Cohen

If you have followed the previous series on Back Door Into BASIC, or picked up the rudiments of BASIC programming elsewhere, you're probably asking yourself "where do I go from here?"

THE EASY ANSWER to that question in the introduction is — programming experience will reveal all to the initiate. But really, that just isn't true. There's a lot to be learned about programming which most people (myself included) could never develop from scratch — novel concepts and systems, applied mathematical methods et cetera.

These Advanced BASIC articles, which will appear in ETI from time to time, are intended to provide food for thought and to stimulate those who have exhausted their interest in computer games.

The language used is an 8K Microsoft BASIC, and minor alteration will allow

the included examples to run on almost any medium-sized personal computer system.

Although the various parts of this series have been written to cover a particular concept or field of study, these are not covered exclusively — each part introduces other facets which add together to provide a useful program or major program segment in each part of the series.

Sorting

A very common problem in computing is sorting of one type or another. This can be anything from simple alphabetic sorting to sorting of time-dependent

data from different sources to give an overall picture. There have been *books* written on different sorting algorithms — but we're not going into it quite as deeply as that!

This article covers three types of sorting: 1) pigeon-hole, 2) push-down and 3) ripple.

Pigeon-hole sorting

This is the fastest and most wasteful in memory space of the three types. It can only be used in some instances where the minimum difference between successive sorted data is fixed and known, and where the range of input values is also known. Essentially, it ►

entails having set aside a location in memory for each possible input and putting the incoming data into its reserved location as it comes in.

This type of sort is useful for applications such as the handling of monthly sales figures — it has the additional advantage of reserving space for interpolated data.

As an example of the use of this type of algorithm, the following program will take in up to 52 weekly figures (weekly sales, for example) and then interpolate the unknown figures.

```
10 DIM A(52)
```

A holds the data. A negative value in A will mark an 'unknown' figure, so:

```
20 FOR I = 1 TO 52
```

```
30 A(I) = -1
```

```
40 NEXT I
```

Now input the data:

```
50 INPUT "WEEK NUMBER"; N
```

```
60 IF N < 0 THEN 105
```

A negative number will end the input of data and cause the results to be printed out.

```
70 INPUT "SALES"; S
```

```
80 IF S < 0 THEN 70
```

This stops locations being marked as unknown by mistake.

```
90 A(N) = S
```

```
100 GOTO 50
```

Now for the interpolation routine. This uses a linear approximation between two values to fill in the unknown values which occur between them. It will only do so between the earliest and latest known data.

```
105 J = 1
```

```
110 J = J + 1
```

```
120 IF J > 51 THEN 250
```

```
130 IF A(J) > - .5 THEN 110
```

The above will find an 'unknown' week. If there are none left, it will jump to 250, which prints the results. Now find the nearest known figures before and after point J (the unknown week which we found above):

```
150 FOR AF = J + 1 TO 52
```

```
160 IF A(AF) > - .5 THEN 190
```

```
170 NEXT AF
```

```
180 GOTO 110
```

```
190 FOR BF = J - 1 TO 1 STEP - 1
```

```
200 IF A(BF) > - .5 THEN 230
```

```
210 NEXT BF
```

```
220 GOTO 110
```

BF and AF now contain the nearest 'known' weeks before and after J, respectively. Now interpolate:

```
230 A(J) = (A(BF)*(AF-J) +
A(AF)*(J-BF)) / (AF-BF)
```

(This is a standard linear interpolation equation, which can be derived with a bit of geometry). Find the next unknown:

```
240 GOTO 110
```

Now print the results when finished:

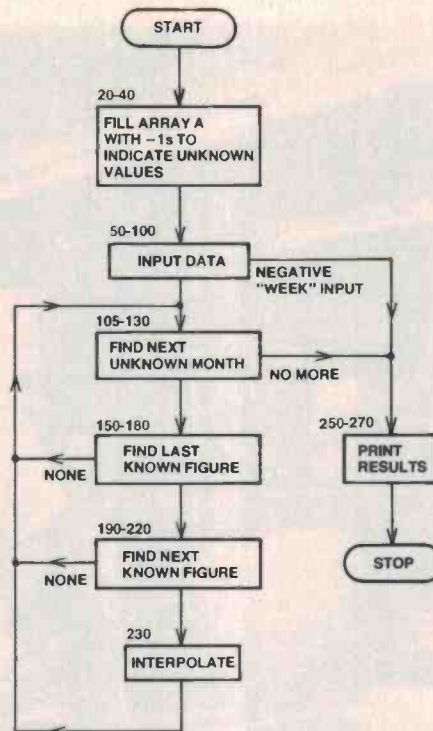

Figure 1. A 'pigeon-hole' sorting routine with interpolation. This can be used to provide an educated guess at missing sales figures.

```
250 FOR I = 1 TO 52
```

```
260 IF A(I) > - .5 THEN PRINT I, A(I)
```

```
270 NEXT I
```

A flowchart for the above program is given in Figure 1.

Push-down sorting

In applications where a variable number of data points is to be sorted and stored in order, push-down order is often the best course, being fairly simple to implement. The idea is that a list of the items in order is kept in a 'stack' structure. This is simply an array larger than the largest number of data to be held. The data is stored in the array elements with subscripts *below* a certain value. This value increases as more data is added.

The value of the subscript at the 'top' of the stack is held in the 'stack pointer'. This is incremented as data is added to the stack.

The addition of an item of data *in the middle of the stack* means that the rest of the data has to be 'pushed down' to accommodate it.

The following example will sort numbers into ascending order using a push-down algorithm (see Figure 2 for flowchart).

```
10 DIM S(50)
```

S is the stack — up to 50 items can be stored.

```
20 SP = 0
```

SP, the stack pointer, points to the

PART 1

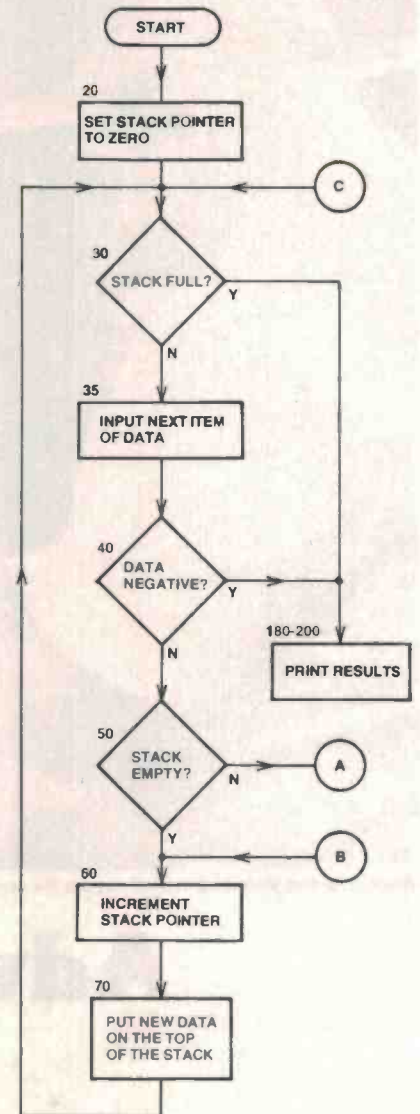

Figure 2. Push-down sorting — full explanation in the text.

highest location which is in use. Setting it to 0 indicates that the stack is empty.

```
30 IF SP = 50 THEN PRINT
"NO ROOM": GOTO 180
```

```
35 INPUT "DATA"; D
```

```
40 IF D < 0 THEN 180
```

inputs the data (which is assumed to be above zero). A number below 0 is taken as an instruction to print the results. Line 30 checks to see if the stack is full up. First, find out where to put D — check to see if it's the *only* data:

```
50 IF SP > 0 THEN 90
```

```
60 SP = SP + 1
```

```
70 S(SP) = D
```

```
80 GOTO 30
```

If it's not the *only* data, find out where it should be in the stack:

PART 2

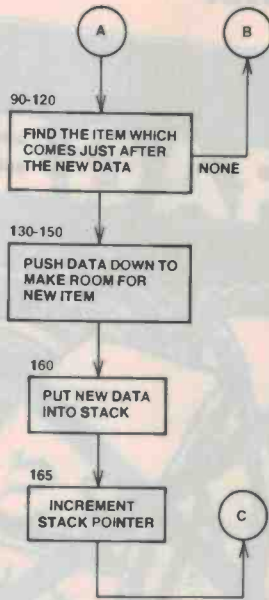

```

90 FOR I = 1 TO SP
100 IF S(I) > D THEN 130
110 NEXT I
  
```

If D reaches this point then it must be the largest item, so
 120 GOTO 60
 puts it on the 'top' of the stack. If line 100 sends it to line 130, it must come just before item I. Push the data down just before item I:

```

130 FOR J = SP TO I STEP -1
140 S(J+1) = S(J)
150 NEXT J
  
```

and then insert D:
 160 S(I) = D
 165 SP = SP + 1
 170 GOTO 30

Now print the results:
 180 FOR I = 1 TO SP
 190 PRINT S(I)
 200 NEXT I

Ripple sort

This is probably the best-known sorting algorithm. It is also known as bubble sort or even, on occasion, travelling-wave sort.

The way it works is this: the data is put into a fixed-length array (or, as in the case of the example to follow, a stack). Starting at one end, the program compares successive pairs of items and swaps their positions in the list if they appear in the wrong order. It repeats this, starting at the same end each time, until it hasn't made any changes in the latest pass. Thus a 'bubble' of change sweeps up through the data array. ▶



Microcomputers?

MACROSERVICE

283 Clarence Street
 Sydney NSW 2000
 Telephone 29 2402-922 1709
 Associated with QT Inc. - USA.

SBC+2/4 SINGLE BOARD COMPUTER

Features: 1K RAM (which can be located at any 1K boundary) plus one each Parallel and Serial I/O parts on board • Power on jump to on-board EPROM (2708 or 2716) • EPROM addressable on any 1K or 2K boundary • Full 64K use of RAM allowed in shadow mode • Programmable Baud rate selection, 110-9600 • 2 or 4MHz switch selectable • DMA capability allows MWRT signal generation on CPU board or elsewhere in system under DMA logic or front panel control • Two programmable timers available for use by programs run with the SBC+2/4 (timer output and controls available at parallel I/O connector, parallel input and output ports available for use on CPU board).
 Bare Board \$ 60.00
 A&T \$295.00

RAM+ 65

• S-100, 16K x 8 bit static RAM • 2 or 4MHz • Uses 2114L (300NS) CHIP • Addressable in 4K steps • Memory protection in 1K increments, from bottom board address up or top down • May deactivate up to six 1K segments of board to create 'holes' for other devices • DIP switch selectable wait states • Phantom line DIP switch • Features bank selection by I/O instruction using any one of 256 DIP switch-selectable codes - allows up to 256 software-controlled memory banks.
 Bare Board \$ 35.00
 4MHz A&T \$250.00

SILENCE+ MOTHERBOARDS

These motherboards are among the quietest on the market. A unique grounding matrix - with each line completely surrounded by ground shielding - eliminates need for termination and gives high crosstalk rejection • They're customer-proven, without crosstalk sometimes operating at 14MHz • A LED power indicator helps eliminate zapped circuits • IEEE S-100 std. compatible, available with 6, 8, 12, 18 or 22 slots • (The 22 slot board fits Imsai chassis and has slot for front panel.)

6 Slot		12 Slot	
Bare Board	\$25.00	Bare Board	\$ 30.00
A&T	\$50.00	A&T	\$ 90.00
8 Slot		18 Slot	
Bare Board	\$27.00	Bare Board	\$ 50.00
A&T	\$70.00	A&T	\$140.00

MAINFRAME+ DISK DRIVE

5 1/4" Disk Mainframe with 25A Pwr Sup	
MF + MD12 (12 slot M/B)	\$500.00
MF + MD8 (8 slot M/B)	\$475.00
MF + MD6 (6 slot M/B)	\$450.00
8" Disk Mainframe with 25A Pwr Sup	
MF + DD6 (6 slot M/B)	\$625.00
MF + DD8 (8 slot M/B)	\$650.00
MF + DD12 (12 slot M/B)	\$675.00

EXPANDABLE+ REV II DYNAMIC MEMORY BOARD

Features: Runs at 4MHz • 3242 refresh controller with delay line • Four layer PC board insures quiet operation • Supports 16K, 32K, 48K or 64K of memory • 24 IEEE-specified address lines • Optional M1 wait state allows error free operation with faster processors • Optional Phantom disable • Uses Z-80 or on-board refresh signal • Bank on/off signal selected by industry standard I/O port 40 (Hex) • Convenient DIP switch selection of data bus bits determines bank in use • 3 watts low power consumption • Convenient LED indication of bank in use.

Definitely works with Cromemco and North Star

Bare Board	\$ 75.00
A & T	
16K	\$350.00
32K	\$450.00
48K	\$575.00
64K	\$675.00

I/O+ INDUSTRIAL GRADE I/O BD

Has two serial Sync/Async ports (RS-232, current loop or TTL) with individual Xtal controlled programmable baudrate generators • Four 8-bit Parallel ports; one latched input port and other three can be programmed in combinations of Input, output or bidirectional • Also, has three 16-bit Programmable Timers and an 8-level Programmable Interrupt Controller w/Auto restart (8080/Z80) • Other features include; on-board clock divisor for timers, completely socketed, wire wrap posts for easy port configuration plus more.

Bare Board	\$ 70.00
A&T	\$375.00

CLOCK/CALENDAR+ FOR APPLE II, S-100 OR TRS-80

Features: Date/Month/Year • Day of week • 24 hour time or 12 hour (a.m./p.m.) selectable • Leap year (perpetual calendar) • 4 interval interrupt timer; 1024Hz (approx. 1 mllsec), 1 sec., 1 min., 1 hr. • On-board battery backup • Simple time and date setting • Simple software interface • Time advance protection while reading.

S-100 or Apple		TRS-80	
A&T	\$150.00	A&T Only	\$150.00
Bare Bd	\$ 60.00		

SYSTEMS

Computer System with 8" Single Sided Drives without Terminal	
A&T (6 slot)	\$3595.00
A&T (8 slot)	\$3695.00
A&T (12 slot)	\$3795.00
Computer System with 5 1/4" Single Sided Drives No Terminal	
A&T (6 slot)	\$2495.00
A&T (8 slot)	\$2595.00
A&T (12 slot)	\$2695.00

System 80, TRS-80, Sorcerer & other computer owners. . . .

THIS DISK DRIVE HAS
TWICE THE STORAGE OF A TANDY DRIVE!

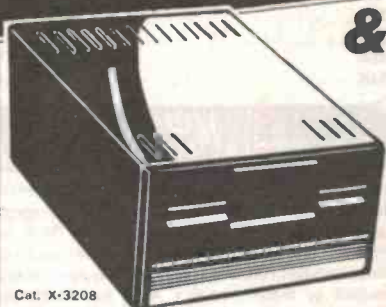

Cat. X-3208

Micropolis™ quality for use with your System 80, TRS-80 etc. Just connect to your system expansion unit via a daisy chain cable.

& it costs less!

look at these figures
THE TANDY DISK DRIVE

The Tandy disk drive with 35 tracks gives 87.5K of storage and costs \$699. If you want approximately the same storage as the Dick Smith Micropolis™ then you will need to spend:

THE DICK SMITH/MICROPOLIS™

The Dick Smith Micropolis™ has 77 tracks with 2.5K per track giving a grand total of 192.5K of storage on one disk drive. That is more than TWICE the storage capacity for a lower price!

TANDY TOTAL \$1378

DICK'S TOTAL \$649

OR TWICE AS MUCH STORAGE AGAIN IF YOU GO TO DOUBLE DENSITY!

Requires either NEWDOS/80 or MICRO-DOS for 77 track operation.

SORCERER OWNERS

SAVE \$700

ON DISK STORAGE

NEW EXIDY QUAD DENSITY DRIVE DOESN'T NEED AN EXPANSION UNIT YET COSTS ONLY \$1190⁰⁰

Soft Sector Quad Density (308K bytes/disk) formatted
 ● Provision for add-on drive ● Complete with system software/utilities including DOS (worth around \$150!).

Cat. X-3220



USER MANUAL SUPPLIED WITH DRIVE

DICK SMITH ELECTRONICS



SEE OUR OTHER ADVERTISEMENTS IN THIS MAGAZINE FOR STORE ADDRESSES, PHONE NUMBERS, POSTAGE ETC.

80 CPS FOR \$820

INCLUDING TAX

MICROLINE 80 MATRIX PRINTER

- 80 CHARACTERS PER SECOND WITH A 200,000,000 CHARACTER HEAD WARRANTY
- CONNECTS DIRECTLY TO TRS-80™ APPLE® AND OTHER COMPUTERS
- UPPER AND LOWER CASE, FULL 96 CHARACTER ASCII SET. ALSO BLOCK GRAPHICS FOR GRAPHS AND DIAGRAMS
- RUGGED CONSTRUCTION WITH A METAL CHASSIS AND TWO MOTORS

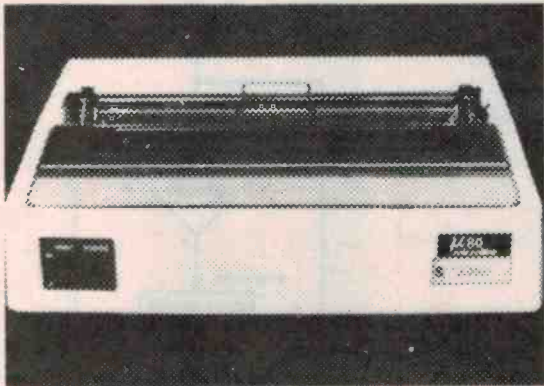

BUY NOW FROM

THE **LOGIC** SHOP PTY. LTD.

212 HIGH STREET, PRAHRAN, VIC, 3181
TEL: (03) 51-1950

91 REGENT STREET, CHIPPENDALE, N.S.W. 2008
TEL: (02) 699-4910

SHOP 16, CIVIC ARCADE, ADELAIDE ST, BRISBANE,
QLD. 4000. TEL: (07) 31-2330

454 WILLIAM STREET, PERTH, W.A. 6000
TEL: (09) 328-7345

CREDIT CARDS WELCOME
FREIGHT VARIATION AS APPLICABLE

TRS-80 is a registered trademark of Tandy Electronics.

LS1-09

To celebrate the opening of our
SYSTEMS STORE
at 894 CANNING HIGHWAY, APPECROSS
PERTH, W.A. — (09) 364 7389
We are making the following special offer

Why Wait?



Limited
Quantities

THE NEW MODEL 111

deForest Software have purchased the functional Model 3 Computer and fitted 48K of memory, a disk-controller that really works — plus 2 reliable MT1 disk drives giving 175,000 bytes of storage per disk.

The Model 3 can fill a wide range of needs. Most of the Model 1 software can be used, giving a selection of applications. Each model 3 includes a 65 key keyboard with 12 key data pad, top-mounted recessed "reset" switch, hidden side-mounted AC switch and monitor controls, 12" built in high resolution monitor and printer connector.

Sale Price **\$2999**

FREE ROAD FREIGHT ANYWHERE IN AUSTRALIA

MOD 3 DOS & MANUAL	\$29.95
16K RAM ½ price	\$28.00
DISKMASTER TRS-80* Disk Indexing Programme	\$15.00
Model 2 Business Systems	30% off all software

SPECIAL OFFERS AVAILABLE AT

deForest Software (W.A.) Pty. Ltd.

894 Canning Hwy, Applecross, Perth WA. (09) 364-7384.

deForest Software

26 Station Street, Nunawading, Melbourne, VIC. (03) 877-6946.

*TRS-80 is a registered Trade Mark of the Tandy Corporation

The following program allows named data items with several parameters to be stored or deleted one at a time. They can also be sorted according to any one of the parameters. A full flowchart is given in Figures 3 to 6.

```

100 REM MAIN PROGRAM
110 INPUT "HOW MANY ITEMS
(MAXIMUM)"; NI
120 INPUT "HOW MANY
VARIABLES PER ITEM"; NV
130 DIM A(NI, NV), A$(NI), N$(NV)
A holds the parameters associated with
each item, A$ holds the item names and
N$ holds the parameter type names.
140 FOR I = 1 TO NV
150 PRINT "WHAT IS
VARIABLE "; I; " CALLED ";
160 INPUT N$(I)
165 NEXT I
170 SP = 0
SP is the stack pointer.
180 INPUT "COMMAND"; C$
190 IF C$ = "I" THEN GOSUB 1000
200 IF C$ = "S" THEN GOSUB 2000
210 IF C$ = "R" THEN GOSUB 3000
220 IF C$ = "E" THEN STOP
230 GOTO 180

```

inputs the command and takes the appropriate action. I = input, S = sort, R = remove and E = end.

```

1000 REM INPUT
1020 IF SP >= NI THEN PRINT
"NO ROOM": RETURN
checks for stack overflow.
1030 SP = SP + 1
1040 INPUT "ITEM NAME"; A$(SP)
1050 FOR I = 1 TO NV
1060 PRINT "WHAT IS THE ";
N$(I); " OF ITEM "; A$(SP)
1070 INPUT A(SP, I)
1080 NEXT I
1090 RETURN

```

The above section of code inputs the new item and its parameters and puts them on to the end of the stack, incrementing the stack pointer.

```

2000 REM SORT
2005 IF SP < 2 THEN PRINT "NOT
ENOUGH ITEMS": RETURN
Stops the user trying to sort one item!
Trying to sort one item will upset the
algorithm used.

```

```

2010 INPUT "SORT ACCORDING
TO WHAT"; S$
2020 FOR I = 1 TO NV
2030 IF N$(I) = S$ THEN 2060
2040 NEXT I
2050 PRINT
"NOT FOUND": RETURN

```

finds out which parameter to use in the sort.

```

2060 S = I
stores the result of the above so that we
can use I for the next loop (it's tradi-
tional to use the letter I for this
because in FORTRAN it represents the
first integer variable).
2070 F = 0

```

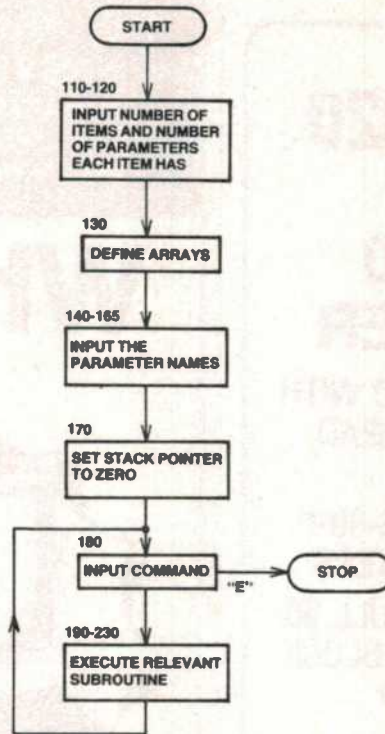

Figure 3. The main program. This calls all the sub-routines and initialises everything.

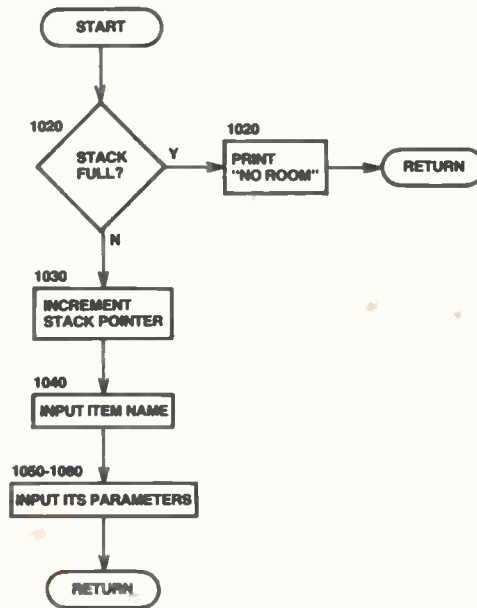

Figure 4. Adding an item.

F is a flag which indicates (if it is set to 1) that a swap has been made on the latest pass.

```

2080 FOR I = 2 TO SP
2090 IF A(I, S) > A(I - 1, S) THEN
2190

```

If the two items don't need to be swapped, line 2090 skips the next bit.

```

2100 T$ = A$(I)
2110 A$(I) = A$(I - 1)
2120 A$(I - 1) = T$
2130 FOR J = 1 TO NV
2140 T = A(I, J)

```

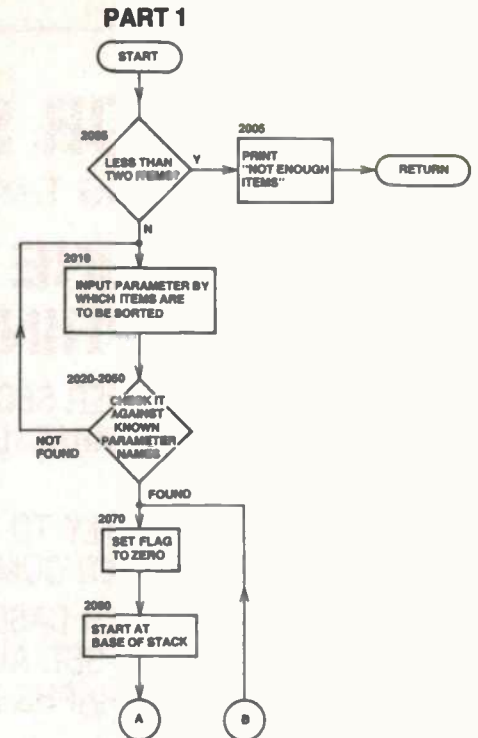
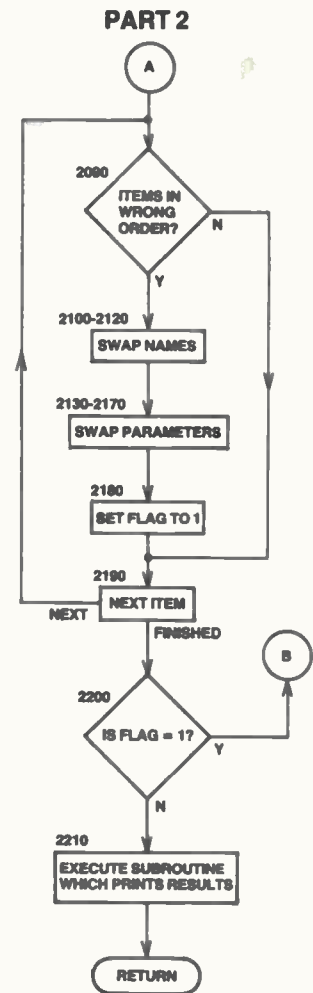

Figure 5. The sorting routine itself.



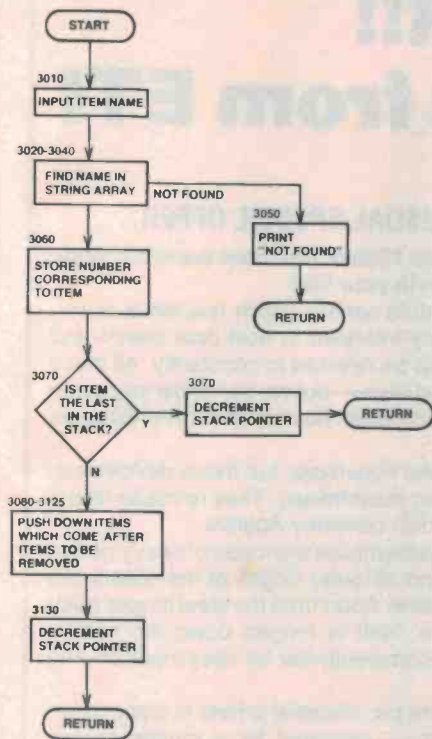

Figure 6. Removing an item. This is fairly similar to Figure 2 in parts.

```

2150 A(I, J) = A(I - 1, J)
2160 A(I - 1, J) = T
2170 NEXT J
2180 F = 1

```

swaps the two items (including their parameters). T\$ and T are temporary stores. F is set to 1 to show that a change has been made in the current pass.

```

2190 NEXT I

```

tests the next pair.

```

2200 IF F = 1 THEN 2070

```

repeats the whole thing if there have been any swaps. Hopefully, after enough 'ripples', the program will do one pass without finding any items in the wrong order.

```

2210 GOSUB 4000

```

prints the results.

```

2220 RETURN
3000 REM REMOVE
3010 INPUT "WHICH ITEM "; S$
3020 FOR I = 1 TO SP
3030 IF A$(I) = S$ THEN 3060
3040 NEXT I
3050 PRINT

```

"NOT FOUND" : RETURN

finds out which item is to be removed.

Store I (as in line 2060):

```

3060 S = I

```

Check to see if the item is at the end of the stack:

```

3070 IF S = SP THEN
    SP = SP - 1 : RETURN

```

deals with this case.

The next section is essentially a push-down sort in reverse, the only complication being the moving of the parameter values. It might be instructive to look at the differences between Figures 2 and 6.

```

3080 FOR I = S TO SP
3090 A$(I) = A$(I + 1)
3100 FOR J = 1 TO NV
3110 A(I, J) = A(I + 1, J)
3120 NEXT J
3125 NEXT I
3130 SP = SP - 1
3140 RETURN

```

The next routine prints out the list. All the string variables are limited to eight characters for format reasons. This routine is only entered via the sort routine.

```

4000 REM PRINT
4020 PRINT
4030 PRINT "NAME",
4040 FOR I = 1 TO NV
4050 PRINT LEFT$(N$(I), 8),
4060 NEXT I
4070 PRINT
4080 FOR I = 1 TO SP
4090 PRINT LEFT$(A$(I), 8),
4095 FOR J = 1 TO NV
4100 PRINT A(I, J),
4110 NEXT J
4120 PRINT
4130 NEXT I
4140 RETURN

```

COMPUTER CONSULTANTS

Specialising in comprehensive proven packages with top quality hardware - Installed with stationery, training, full back-up and maintenance.



SORD 203 III



SORD 223 III



DIABLO 3000



DIABLO 3200



INTERTEC SUPERBRAIN

WHOLESALEERS
RETAILERS
MANUFACTURERS
GENERAL BUSINESS
REAL ESTATE
PRINTERS
COSTING

GLASS CUTTING
WORD PROCESSING
MOTOR DEALERS
FURNITURE MANUFACTURERS
BUS OPERATORS
INSURANCE BROKERS
SPARE PARTS

TEXTILE INDUSTRY

Calculator & Computer
DISTRIBUTORS

3 ROWLEY STREET,
SEVEN HILLS,
NSW. 2147

PHONE 8.30 am to 3.30 pm
(02) 624-8400 or 624-8849

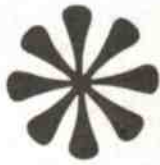

SPECIAL OFFER!! — direct from ETI

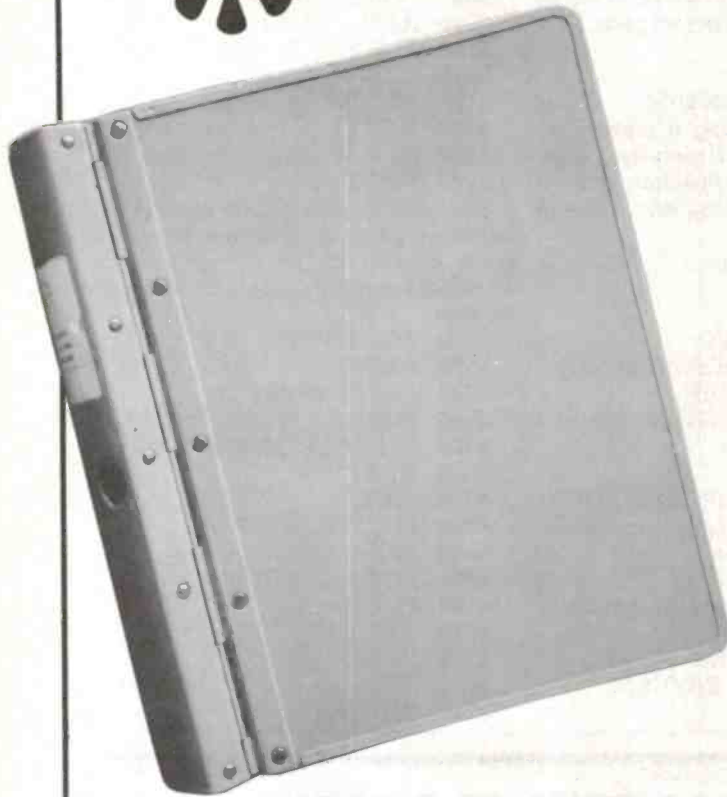

HERE IS A MOST UNUSUAL SPECIAL OFFER.

Our company has for sale 1500 of the most superbly made binders you've ever seen in your life!

We bought them for a data service which has since closed down. They are specifically intended to hold data sheets and similar material which must be referred to constantly. All those for sale are brand spanking new — but we can show you some old ones that have been in constant hourly use for over 20 years and they are still as new!

We know this sounds like hyperbole, but these devices can only be described by using superlatives. They're made (like a Rolls-Royce!) by the Swedish company Aggripa.

For example, the hinge assemblies are made of heavy-gauge plated steel. The spine and all outer edges of the covers are heavy-gauge enamelled steel. Apart from the steel hinges holding the covers, the spine itself is hinged down the centre, enabling the binder to lie completely flat for easy insertion and removal of material.

As may be seen from the pix, material is held in place by an eight-hole pin mechanism — actuated by a remote control trigger at the bottom of the spine.

These binders are ideal for housing valued reference material, data sheets, etc, etc.

These binders are not normally obtainable in small numbers — if they were the retail price would be at least \$25 each.

We are offering them exclusively to ETI readers for the absolute bargain price of \$10 each (plus \$2.00 post and packing). See also inset table for quantity prices.

These binders may be inspected at our Sydney and Melbourne offices during normal working hours.

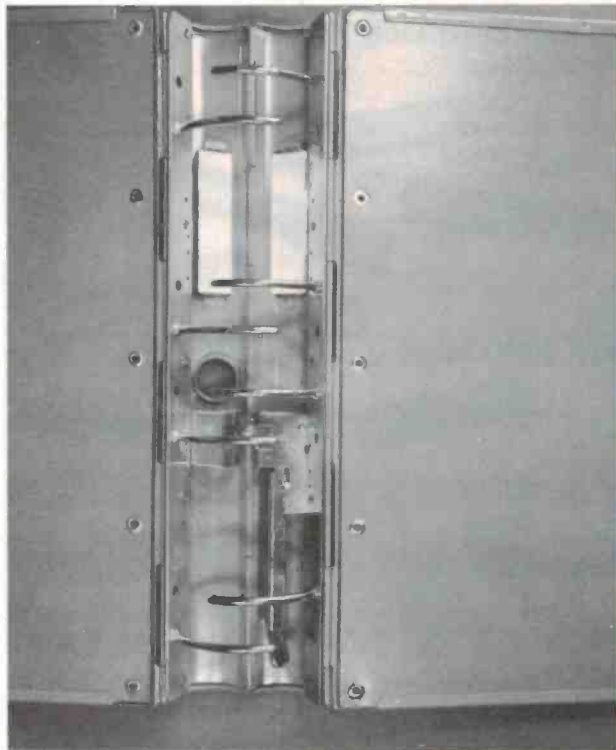

UNCONDITIONAL MONEY-BACK GUARANTEE.

ETI guarantees to return the purchase price in full and without query to any reader/s not totally satisfied with their purchase, providing the goods are undamaged and returned within seven days of receipt.

PLEASE FORWARD (QTY) OF BINDERS.

I ENCLOSE CHEQUE/POSTAL NOTE FOR

Name

Address

..... Postcode

Please make out cheques to ETI and forward together with order to BINDER OFFER, Electronics Today International, 15 Boundary St, Rushcutters Bay NSW 2011.

PRICES

1 - 5	\$10 each	plus \$2.00 each p & p.
6 - 24	\$9.00 each	free
25 plus	\$8.00 each	free

AED SUPER COMPUTERS

AED BUILD STANDARD OR SPECIAL COMPUTERS USING CALIFORNIA'S SUPER S100 CARDS PLUS OUR NEW SYSTEM SOFTWARE AND INTERFACING.

WHAT IS IT MAKES AN AED COMPUTER STAND ALONE?

IEEE 696 S100 — The only international standard 4MHz Z80 CPU, or 8085/88 if your application requires it, super reliable high speed static memory (and you won't faint at the price either).

CPM 2.2 the only industry standard disk operating system and running on industry standard 8" disks with up to 1.2MB capacity each, plus 26MB or more hard disk if required. Super fast memory mapped video display that can be reconfigured to behave like any common serial terminal with a single command, or flex its full complement of features.

Plus software for almost all applications, including word processing — For accounting: Australian written packages now used by companies such as AWA, Greyhound, Hoescht, Mobil Distributors, and the Victorian Racing Club. Includes: Debtors, Creditors, Stock Control, Payroll and General Ledger, etc.

If you need to write your own programs, we have the languages: Basic, Cobol, Pascal, C, etc., as well as all the machine code utility packages.

The simplest of AED computers are easily upgraded to the most complex, should the need arise.

HOBBYIST — ENQUIRE ABOUT THE AED "STARTER" SYSTEM

See our previous Ads in ETI, EA & APC.



MICROCOMPUTER PRODUCTS

SOFTWARE OF EVERY DESCRIPTION AND APPLICATION FOR CP/M
AUSTRALIA'S LARGEST RANGE OF S100 CARDS
10 TO 26MB HARD DISK, SINGLE SIDED FLOPPIES, DOUBLE SIDED FLOPPIES
VIDEO MONITORS, DOT MATRIX PRINTERS, DAISY WHEEL PRINTERS
VERY SIMPLE COMPUTERS, VERY COMPLEX COMPUTERS, VERY SPECIAL COMPUTERS
VERY STANDARD COMPUTERS, HOME COMPUTERS, HOBBY COMPUTERS
EDUCATIONAL COMPUTERS, ENGINEERING COMPUTERS, BUSINESS COMPUTERS
BOOKS — DATA — ADVICE
PROTOTYPING, PARTS, CABLES, ICs, IC SOCKET CONNECTORS

COMPLETE COMPUTERS FOR YOUR APPLICATION, OR EXTRAS FOR YOUR EXISTING MACHINE.

See previous Ads in ETI & EA.

AED ARE THE ONLY PEOPLE WHO CAN HELP
BUSINESSMEN AND ENGINEERS AND HOBBYIST.

130 MILITARY ROAD, GUILDFORD, NSW 2161

Phone (02) 681-4966 (3 lines). Telex AA70664.

OPEN 9-6 MONDAY TO SATURDAY

Our new Systems Technician Apprenticeship scheme is more than just an Apprenticeship.

Applications close 3 July, 1981



Opportunity to work in electronics.

Tomorrow's aircraft and ground electronic systems will be highly complex, to say the least.

That's why we're looking for young, alert people interested in electronics and aircraft to be trained as Systems Technicians.

It's a highly specialised field that not only requires an analytical approach to problem solving but the potential to move into a management position very early in your career.

Areas of involvement include flight, propulsion, environmental, navigation, weaponry, electronic warfare, radar and computers.

Opportunity to receive a higher than normal standard of training.

After completing your certificate of Technology/Trade Training course, you'll spend four to five years gaining practical field experience as Tradesman. Then, if selected, you'll undertake a specially designed six months RAAF Systems Technicians programme that includes developing your management and communication skills plus further specialised systems instruction. On graduation you will be a fully qualified Senior Non Commissioned Officer

Systems Technician in either the Aircraft, Avionics or Ground Electronics fields.

Opportunity for promotion.

Imagine, you could be a Commissioned Officer in your early 30's with great future prospects in the Engineer Branch of Today's space-age Air Force.

Opportunity to get valuable work experience.

These days, successfully completing an Apprenticeship doesn't automatically guarantee you a secure, well-paid job. We do!

Opportunity to travel and make more friends.

Initially, you'll go to Laverton (Vic.) or Wagga (NSW) depending on your specialised field.

Then you could find yourself working at any one of our many bases.

Wherever you are, there'll be excellent sports and social facilities at your disposal.

Opportunity to do something for yourself now!

If you're aged between 16-21 years, have Year 11 (Year 12 preferred) education with

passes in Mathematics, Physics and English, are an Australian citizen and can meet our other entry requirements, talk to an Air Force Careers Adviser now! Alternatively, send the coupon and we'll send you the facts.

Adelaide:	212 1455	Parramatta:	635 1511
Brisbane:	226 2626	Perth:	325 6222
Canberra:	82 2333	Sydney:	212 1011
Hobart:	34 7077	Townsville:	71 3191
Melbourne:	61 3731	Wollongong:	28 6492
Newcastle:	2 5476		

To: RAAF CAREERS ADVISER, G.P.O. Box XYZ in the capital city nearest you. Yes! I am interested in a RAAF career. Please send me full details.

Name: _____

Address: _____

State: _____ Postcode: _____

Date of Birth: ____/____/____

RCOT.455.FP.31.ET

You're somebody in Today's Air Force

Authorised by Director-General Recruiting Dept. Defence RCOT.455.FP.31.ET

Fast plotter

Let your TRS80 take the strain for plotting all those complex functions with this superbly documented program.

A. Lacy

IN THE DIM and distant past I remember gazing at microcomputer advertisements showing (apparently) all manner of graphs and mathematical symbols flowing across the screen. When I finally got my hands on a machine I soon found out the sad truth. The TRS80 certainly has graphics capability in the form of SET and RESET functions, but ever so slow!

POKE and PEEK also give access to the display but the speed is not much better, the fastest method of all in BASIC being to PRINT a string containing graphics characters. This method is very successful when small areas of the display are to move, but I still want to see those sine waves rippling across the screen!

The method shown here is a machine code program which sometimes needs to be slowed down to give a viewable display. I shall firstly describe the machine code program itself then show you how to interface such a program to a BASIC language program.

The machine code

This is for your information only; don't worry, you don't have to type in any assembly code to use the graph plotter. All of the references to line numbers in this section are for the assembly code listing. Lines 10-120 are the equivalent of REM statements in BASIC. I include these in my 'library' of source programs because I find assembly code very 'opaque'; that is, the program itself does not suggest how it works. This is also the reason for all the comments down the right hand side of the listing.

The CALL on line 170 is used to get information from the BASIC program. After this call has been made the HL register pair contains a value corresponding to the value V in the BASIC statement: $10 X = USR(V)$

Lines 200-260 are mainly concerned with setting up loop parameters, the equivalent of the FOR...NEXT state-

ment. As in any program the input variables need to be tested and the appropriate action taken if they are out of the desired range. This is done on lines 230-240; if the variable is greater than 40 then the loop contents will be skipped and the next variable will be processed. I chose a value of 40 because the screen is 48 graphics characters high and space might be needed for axis and other information. The values in the program will give one free line at the top and three at the bottom. Similarly 'XAXIS' defines the display width as numbers of graphics characters. The maximum is 128, and I chose 120, giving some free space at the screen edges.

If the check on line 240 is not made then values could be input which caused memory locations other than screen memory to be loaded, possibly in the areas of RAM used by the TRS80's housekeeping routines. Most likely you would have to reset the machine to get any more sense out of it!

At this point you need to know how TRS80 graphics are accessed from machine language. In the TRS80 there are two graphics chips, one containing all the information required for the ASCII character set (and more if you know how to get it out), the other really a bit of TTL which switches on graphics blocks at the right instant of time during the screen scan. If bit 7 in the screen memory location being accessed is set at logic "1", then the graphics generator will turn on, otherwise the ASCII generator will be enabled. So we know that we must turn on bit 7 at the required location.

But what is that location? Well, a bit of arithmetic is needed to calculate it and this calculation is what comprises the bulk of the program. Each graphics block corresponds to a byte of memory and is three graphics characters high and two wide. The characters themselves correspond to bits in the memory

byte as shown in Table 1.

GRAPHIC CHARACTER DISPLAYED	BIT POSITION	EQUIVALENT VALUE (HEX)
A	0	1
B	1	2
C	2	4
D	3	8
E	4	10
F	5	20
NOT USED ALWAYS 1 FOR GRAPHICS	6	40
	7	80

A	B
C	D
E	F

Table 1. This shows the relationship between display memory bytes and the character displayed on the screen.

We must determine the bit to be set as well as the correct location; the procedure used is listed:

- 1) Divide the variable by three. 260-290
- 2) Save the remainder. 300
- 3) Multiply quotient by 64. 350-360
- 4) Subtract it from baseline. 410
- 5) Get the horizontal position. 420
- 6) If odd then add 1 to remainder. 450-460
- 7) Subtract position from origin. 500
- 8) Convert remainder to a bit position. 520-580
- 9) Is it already a graphics location? 590
- 10) If not then set bit 7 610
- 11) And reset bit 5 620
- 12) Put the information on the screen. 640
- 13) Check to see if finished. 690
- 14) Get the next variable 200
- 15) And carry on!

Most of the other operations in the program are concerned with setting up registers prior to the above or with loop counting. In the TRS80, if a machine code routine has been called from BASIC then a RET instruction will return control to the next BASIC statement.

The information for the graph plot is ▶

68GPB03

The ultimate in
microprocessor I/O.

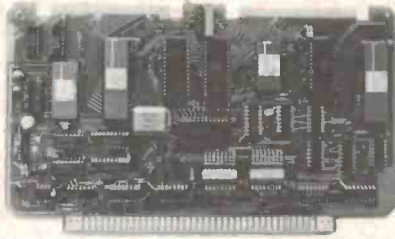

- 16 channel ADC (with 12 bit resolution).
- 2 channel DAC (with 8 bit resolution).
- 32 bit programmable I/O (2 x MC6821).
- 6 programmable timers (2 x MC6840).
- 2 serial synchronous/asynchronous interfaces.
- Hardware and software programmed baud rate generation.
- High quality double-sided PCB.
- Motorola Exorciser Bus and outline compatible.
- Occupies only 32 consecutive bytes.

Basic circuit card including buffers, address decoding and sockets is available assembled and tested for \$199. All analog I/O assembled and tested for additional \$219.

68MBO2

Two boards in one

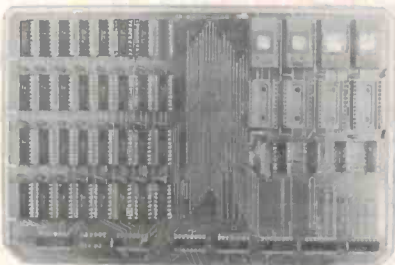

- 16K RAM (2114) expandable in 1K increments.
- 16K EPROM (2716, plus 5V) expandable in 2K increments.
- Two 8K RAM blocks selectable in 8K increments.
- Two 8K EPROM blocks selectable in 8K increments.
- High quality double-sided PCB.
- Motorola Exorciser Bus compatible.

PCB and instructions \$75.

All prices add 15 percent sales tax if applicable. P&P \$2.

Subject to change without notice.

MICRO GEAR

3 Coora Place,
Churchill, VIC. 3842
Phone (051) 67-1498
A.H. (051) 22-1157

stored in an integer array as a set of values between 0 and 40. This is rather wasteful of space since each element of the array is contained in two bytes and only the least significant byte is being used. It does make life easier, though, when filling such an array in BASIC.

The code shown is relocatable; that is, it doesn't mind where it is loaded in memory. This is achieved by avoiding references to absolute addresses within the program; in other words, any jumps or branches are specified as forwards or backwards relative to the current position in the program.

The BASIC program

I will describe the program line by line, so treat this section as a set of extended REM statements.

40 GG%(N) is an array where I decided to store the machine code subroutine; it could just as well be put in reserved memory by POKEing the DATA statements. DD%(n,m) is the 'target' array. The program treats this as a list of m arrays, each of single dimensions, and displays them in quick succession, giving the impression of movement.

50-100 These DATA values represent the subroutine.

110 It sometimes happens that there are several groups of DATA statements in my programs. I always start them with a 255 and end them with a series of 0s. This avoids having to be too precise about numbers of READs. Just laziness really and not necessary here. The first number in line 50, then, is a dummy number; take it out if you are not going to use line 110.

140-160 A way of getting the right bytes in place in the integer array. If you are POKEing the subroutine then you don't need this.

190 Lets you know something is happening; see line 220. The following lines are included as a simple example to get you started. You will, of course, wish to be more adventurous.

200-230 Now go and have a cup of coffee. "What!", I hear you say. "This was supposed to be a fast graph plotter!" Well, the plotting is fast, but the values to be plotted are still computed in poor old BASIC, so it will take some time to fill the array DD% with 1200 values, especially if complicated functions are used. Line 240 causes the program to wait for you to get back from coffee!

260 This is it! The first statement on this line is a DISC BASIC feature and it tells the computer where to go to start the machine code subroutine. I have put it just before the USR call because when machine code is stored in array variables it can get shuffled around as the

BASIC program executes, so the entry point needs to be updated before each USR call. The variable used on this line (X9) must have been previously allocated for a similar reason. These problems do not arise when the code is stored in reserved memory, and the DEFUSR statement could go just after the DATA read section to be executed once only. The next statement on this line, USR, passes the location of the start of the array, not the plotting subroutine, so that it knows where to go to get the element values. The USR statement also passes control to the subroutine.

In Level II BASIC the entry point definition is more cumbersome; you will have to POKE values corresponding to the entry point into location 16526D and 16527D.

300 Loops back round to give a continuously moving display.

Using the program

Type in the BASIC listing and RUN it! This will give you an idea of the speed of plotting; each frame seems to appear instantly. Now try various functions on line 220. Remember, you have two independent variables to play with, I2 and I1. Line 260 can appear anywhere in your own program as many times as you wish, so there is plenty of scope for experiment.

For example, a program could be written to alter a few of the target array elements while it is running, maybe under keyboard control. This could give a moving display which also changes over a longer time period.

This diagram shows how the byte position is calculated in the plotter subroutine (line numbers refer to the assembly listing). In this example graphic characters B and C are shown turned on, which means that bits 1, 2 and 7 are logic '1' in that location. The byte will look like this:

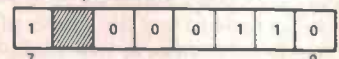

This represents a Hex value of 86H (or 134D).

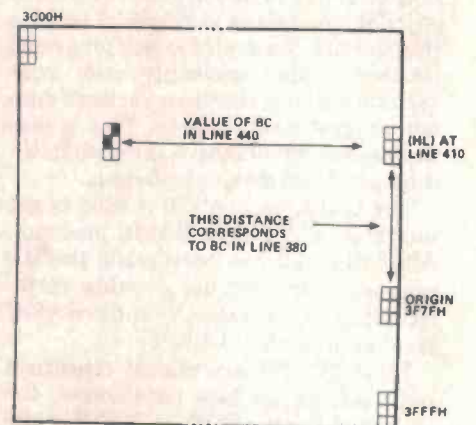

Program Listing

```

40 DIMGG%(41),DD%(120,10)
50 DATA255,205,127,10,6,120,14,0,126,229,197,254,40,48,60,6,255
60 DATA4,214,3,254,40,56,249,47,104,38,0,203,39,6
70 DATA6,41,16,253,229,193,33,127,63,183,237,66,193,197,203,56
80 DATA56,1,60,72,6,0,183,237,66,71,4,175,55,23
90 DATA16,253,71,126,203,127,32,4,203,255,203,175,176,119,193
100 DATA225,35,35,16,183,201,0,0,0,0,0
110 READ G9:IF G9<>255 THEN 110
120 FOR X9=0 TO 41
130 READ Y9:READ Z9
140 X8=256*Z9+Y9
150 IF X8>32768 THEN X8=X8-65536
160 GG%(X9)=X8

```

```

170 NEXT X9
180 **REM END OF DATA READ
190 CLS:PRINT@512,"DATA READ COMPLETE, FILLING ARRAY
200 FOR I1=0 TO 10
210 FOR I2=0 TO 120
220 DD%(I2,I1)=SIN(I2/20+I1/1.57)*19+20
230 NEXT I2,I1
240 CLS:INPUT"PRESS ENTER FOR DISPLAY";D
250 FOR I2=1 TO 10
260 DEF USR3=VARPTR(GG%(0)):X9=USR3(VARPTR(DD%(0,
I2)))
270 FOR X=1 TO 50:NEXT:REM**IF YOU WANT TO SLOW IT
DOWN!
280 CLS
290 NEXT I2
300 GOTO 250

```

Machine Code

```

010 ;*****GRAFIC 1.4
020 ;GRAPH PLOTTER
030 ;THIS PROG INTENDED FOR USE AS A
RELOCATABLE
040 ;USR CALL FOM BASIC. IT WILL RESPOND
TO
050 ;0<=A<40, VALUES OUTSIDE THIS RANGE
WILL
060 ;NOT CAUSE A CRASH BUT WILL BE
IGNORED
070 ;HL MUST POINT TO THE FIRST ELEMENT OF
080 ;A 120 ELEMENT INTEGER ARRAY
090 ;Y=0 CHR POSITION 4
100 ;Y=119 CHR POS. 63
110 ;X=0 IS ON LINE 13
120 ;X=39 IS ON LINE 2
BF00 130 ORG 0BF00H ;SOMEWHERE TO
ASSEMBLE IT
0A7F 140 GETHL EQU 0A7FH ;GET USR ARG INTO
HL
0078 150 XAXIS EQU 120 ;NO. HORIZONTAL
POSITIONS
3F7F 160 ORIGIN EQU 3F7FH ;BYTE
DISPLACEMENTS
CALCULATED FROM
HERE
161 ;HL POINTS TO
ARRAY(0)
BF00 CD7F 0A 170 START CALL GETHL
BF03 06 78 180 LD B,XAXIS
BF05 0E 00 190 LD C,0 ;FOR SBC LATER
BF07 7E 200 LOOP0 LD A,(HL) ;GET ARRAY BYTE
INTO A
BF08 E5 210 PUSH HL ;SAVE FOR NEXT TIME
BF09 C5 220 PUSH BC ;SAVE IT FOR LOOP
COUNT
BF0A FE 28 230 CP 40 ;ARG>40 OUT OF
RANGE?
BF0C 30 3C 240 JR NC,LOOP4 ;YES SO SKIP THIS
ONE
BF0E 06 FF 250 LD B,OFFH ;-1 INTO B
BF10 04 260 LOOP1 INC B
BF11 D6 03 270 SUB 3 ;SUCCESIVE
SUBTRACT
BF13 FE 28 280 CP 40 ;DIV BY 3 ROUTINE
BF15 38 F9 290 JR C,LOOP1 ;ON EXIT
B=QUOTIENT
BF17 2F 300 CPL ;TO MAKE 2>=A>=0
'A CONTAINS
'REMAINDER'
BF18 68 310 LD L,B ;SET UP FOR LOOP2
BF19 26 00 320 LD H,0 ;PREPARE FOR *64
BF1B CB 27 330 SLA A
BF1D 06 06 340 LD B,6 ;FOR LOOP 2

```

```

BF1F 29 350 LOOP2 ADD HL,HL ;MULT. BY REPEATED
BF20 10 FD 360 DJNZ LOOP2 ;ADDITION
BF22 E5 370 PUSH HL ;2 *HL
BF23 C1 380 POP BC ;HL INTO BC
BF24 21 7F 3F 390 LDHL,ORIGIN ;CALCLATE SCREEN
ADDRESS
BF27 B7 400 OR A ;CLEAR CARRY FLAG
BF28 ED 42 410 SBC HL,BC ;GET VERT POS.
BF2A C1 420 POP BC ;GET AXIS COUNT
BF2B C5 430 PUSH BC ;SAVE BC FOR DJNZ
LATER
BF2C CB 38 440 SRL B ;B/2 FOR X-AXIS POS
BF2E 38 01 450 JR C,LOOP3 ;ODD OR EVEN?
BF30 3C 460 INC A ;PIXEL ALIGN
BF31 48 470 LOOP3 LD C,B ;FOR 16 BIT SBC
BF32 06 00 480 LD B,0 ;GET IT RIGHT WAY
ROUND
BF34 B7 490 OR A ;CLEAR CARRY FLAG
BF35 ED 42 500 SBC HL,BC ;FOR HORIZ. POSITION
BF37 47 510 LD B,A ;FOR LOOP5
BF38 04 520 INC B ;BECAUSE DJNZ DECS
B EACH
521 ;PASS IN LOOP5
BF39 AF 530 XOR A ;XOR WILL ZERO A
BF3A 37 540 SCF ;PUT 1 IN CARRY TO
SHIFT
541 ;INTO A AT LOOP5
BF3B 17 550 LOOP5 RLA ;MOVE THE BITS TO
THE
551 ;CORRECT PIXEL
POSITIONS
BF3C 10 FD 560 DJNZ LOOP5 ;THIS MANY SHIFTS
NEEDED
BF3E 47 570 LD B,A ;PUT RESULT IN B
BF3F 7E 580 LD A,(HL) ;GET DISPLAYED BYTE
BF40 CB 7F 590 BIT 7,A ;IS IT GRAPHICS?
BF42 20 04 600 JR NZ,SET ;IF SO SET IT
BF44 CB FF 610 SET 7,A ;IF NOT MAKE IT
GRAPHICS
BF46 CB AF 620 RES 5,A ;NON-GRAPHICS
SPACE=20H
BF48 B0 630 SET OR B ;PUT THE EXTRA BITS
IN
BF49 77 640 LD (HL),A ;DISPLAY THEM
BF4A C1 650 LOOP4 POP BC ;RESTORE AXIS
COUNTER
BF4B E1 660 POP HL ;FOR ARRAY COUNT
BF4C 23 670 INC HL ;TWICE BECAUSE 1
INTEGER
BF4D 23 680 INC HL ;ARRAY
ELEMENT=2BYTES
BF4E 10 B7 690 DJNZ LOOP0 ;MORE X-AXIS?
BF50 C9 700 RET ;BACK TO BASIC

```

Imagine a business computer . . .

If you have a small business, you've probably realised already that a computer would make your business much more efficient.

Imagine. It could keep the books (probably far better than you're doing it now!). It could keep incredibly tight control of your stock. It could help you with your business correspondence (e.g. word processing). And it could keep your staff records, data, mailing lists, etc - all within easy reach and so very easy to use, analyse, update, etc.

Imagine such a computer in your business!



STOP! You're probably imagining the wrong computer!

Today's business computer is different: no longer do you need a special room, special power arrangements and a staff of specialist PhD's to run it for you!

All you need is a desk top, a power point and you're away!

Introducing the Dick Smith System 80 Mk II: THE Computer especially for AUSTRALIAN small businesses . . .

FAR MORE THAN JUST A COMPUTER: IT'S A WHOLE SYSTEM!

The System 80 MKII Business System has been designed specifically to suit Australian small business. Every System 80 Business System comes with the full back-up of Dick Smith Electronics: Australia's leader in small computers.

And the System 80 Business System includes an exclusive range of business programs especially written for Dick Smith to suit Australian business conditions: they're not copies or adaptations of some useless overseas programs which most other small business systems offer!

Here are just some of the programs currently available: and these are just the start!

- Full business accounting package (inc. a/c payable, a/c receivable & general ledger)
 - Stock Control & Pricing System (modelled on Dick's own incredibly successful system)
 - Data File: store ANY information that can be stored in a card index system - and use it much more easily & quickly!
 - Word processors (two types to choose from - mini or full size word processing system)
- MORE PROGRAMS CURRENTLY UNDER PREPARATION!**

FULL SYSTEM FROM ONLY \$3406!!



INTERESTED?

Call in to any of our stores and talk to our computer experts. Or give us a ring: any Dick Smith store or our 'Computer Hotline' on Sydney (02) 888 2002.

NO REPRESENTATIVES WILL CALL: we don't have any!

DICK SMITH Electronics



SEE OUR OTHER ADS FOR FULL ADDRESS DETAILS

It's a winning combination

ADE

NorthStar



The famous North Star Micro Computer is now sold, serviced and supported by
ANDERSON DIGITAL EQUIPMENT PTY LTD.

In excess of 15,000 North Star Horizon Micro Computers are in operation throughout the world in business offices, schools and universities, research laboratories, and industrial plants. The Horizon's uses range from word processing to highly complex industrial monitoring.

SPECIAL FEATURES INCLUDE:

- Z80 processor
- 64KB RAM memory
- Two quad density minidisks (360KB each)
- The motherboard has 12 S-100 circuit board slots
- Realtime clock
- Two serial, one parallel input/output interfaces

Join the winners — RING NOW! Dealer enquiries welcome

ADE

Anderson Digital Equipment Pty Ltd

— THE VIABLE ALTERNATIVE —

P.O. Box 322, MT WAVERLEY, VIC AUST 3149 Phone (03) 543 2077. P.O. Box 341, PENNANT HILLS, N.S.W. AUST 2120 Phone (02) 848 8533. Adelaide: 79 9211. Perth: 325 5722. Hobart: 34 4522. Brisbane: 350 2611. Darwin: 81 5760. Canberra: 58 1811. Newcastle: 69 1625. Albury/Wodonga: (060) 2671. Barnawartha 129. N.Z. Wellington: 69 3008. Auckland: 66 3833. Christchurch: 79 6210. New Guinea Lae: 42 3924.

**YOUR NEAREST
sinclair
ZX80**

DEALER IS

NEW SOUTH WALES
City Personal Computer,
75 Castlereagh Street,
Sydney, NSW, 2000.
Phone 233-8992.

Emona Enterprises Pty. Ltd.,
Suite 206/611 George Street,
Sydney, NSW, 2000.
Phone 212-4815.

Electron 2000,
181 Wharf Road,
Newcastle, NSW, 2300.
Phone (049) 26-2918.

David Reid Electronics Pty. Ltd.,
127 York Street,
Sydney, NSW, 2000.
Phone 29-6601.

A.C.T.
Computer World,
Shop G71,
Gallery Level,
Woden Plaza, A.C.T., 2606.
Phone 81-1368.

ALBURY
Minit Computer Service,
530 Kiewa Street,
Albury, NSW, 2640.
Phone 21-5933.

SOUTH AUSTRALIA
Acuis Trading,
185 Pirie Street,
Adelaide, S.A., 5000.
Phone 223-1900.

VICTORIA
Minit Computer Service,
119 McCrae Street,
Bendigo, Vic., 3550.
Phone 43-2589.
David Reid Electronics Pty. Ltd.,
356 Lonsdale Street,
Melbourne, Vic., 3000.
Phone 602-4673.

Radlo Parts Group,
562 Spencer Street,
West Melbourne, Vic., 3003.
Phone 329-7888.
Rod Irving Electronics,
425 High Street,
Northcote, Vic., 3070.
Phone 489-8131.

QUEENSLAND
Datacom,
101 F.E. Walker Street,
Bundaberg, Qld., 4670.
Phone (071) 71-4740.
Software 80,
200 Moggill Road,
Taringa, Qld., 4068.
Phone (07) 371-6996.

WESTERN AUSTRALIA
Micro-Base,
127 Fitzgerald Street,
Perth, W.A., 6005.
Phone 328-9308.

expand your

**sinclair
ZX80**

8K ROM \$75
16K RAM \$150
available now!

**The perfect way to upgrade
your sinclair
ZX80** inexpensively.

**CASSETTES, BOOKS... and FLICKER FREE,
REAL TIME MOVING GRAPHICS**

- BREAKOUT • LUNA LANDER • SPACE BATTLE • PING PONG •
- GRAPHICS • MUSIC • HEXADECIMAL • ACTIVE DISPLAY • MOVIES •

No modifications to hardware whatsoever. All software is thoroughly tested and claimed to be the most advanced developed so-far. Games are written in machine code to make maximum use of memory and provide continuous live action without loss of TV synchronisation. All programs run in 1K memory unless otherwise stated.

ORDER FORM: SINCLAIR EQUIPMENT (AUSTRALASIA) PTY. LTD.
86-88 Nicholson Street, Abbotsford, Victoria, 3067. Telephone 419 3033.

Quantity	Item	Item Price	Total
	Ready-assembled Sinclair ZX80 Personal Computer(s) Price incl. ZX80 BASIC manual, excl. mains adaptor	\$199.00	
	Mains Adaptor(s) (600 Ma at 9V DC Nominal unregulated).	\$ 16.00	
	8K ROM	\$ 75.00	
	16K RAM	\$150.00	

I enclose cheque/Bankcard/Diners Club/Amex

Name

Address Postcode

SPECIAL

sinclair

down to amazing
new low price

was
\$295

NOW

\$199

Remember

— all prices shown include sales tax, postage and packing. N.B. Your Sinclair ZX80 may qualify as a business expense.



Until now, building your own computer cost you around \$600 — and still leave you with only a bare board for your trouble. The Sinclair ZX80 changes all that. For just \$199 you get everything you need including leads for direct connection to your own cassette recorder and television. The ZX80 really is a complete, powerful full-facility computer matching or surpassing other personal computers costing much more. The ZX80 is programmed in BASIC and you could use it for anything from chess to running a power station.

Two unique and valuable components of the Sinclair ZX80: the Sinclair BASIC interpreter and the Sinclair teach-yourself BASIC manual. The unique Sinclair BASIC interpreter: offers remarkable programming advantages — unique 'one touch' key word entry. The ZX80 eliminates a great deal of tiresome typing. Key words (RUN, PRINT, LIST etc) have their own

single key entry. Unique syntax check. Only lines with correct syntax are accepted into programs. A cursor identifies errors immediately, preventing entry of long and complicated programs with faults only to discover them when you run.

Excellent string handling capability — takes up to 26 string variables of any length. All strings can undergo all rational tests (e.g. comparison). The ZX80 also has string input to request a line of text; strings do not need to be dimensioned. Up to 26 single dimension arrays. FOR/NEXT loops nested up to 26. Variable names of any length. BASIC language also handles full Boolean arithmetic, conditional expressions, etc.

Exceptionally powerful edit facilities, allows modification of existing program lines. Randomise function, useful for games and secret codes. Timer under program control. PEEK and

POKE enable entry of machine code instructions. USR causes jump to a user's machine language sub-routine. High resolution graphics with 22 standard graphic symbols. The Sinclair teach-yourself-BASIC manual 96 page book free with every kit.

Fewer chips, compact design, volume production means MORE POWER FOR YOUR DOLLAR! The ZX80 owes its low price to its remarkable design; the whole system is packed onto fewer, newer more powerful and advanced LSI chips. A single SUPER ROM, for instance, contains the BASIC interpreter, the character set, operating system and monitor. And the ZX80's 1K byte RAM is roughly equivalent to 4K bytes in a conventional computer because the ZX80's brilliant design packs the RAM so much more tightly. (Key words occupy just a single byte). You can add to the memory via the expansion port, giving a maximum potential of 16K.

ZX80 8K BASIC ROM

THE CHIP

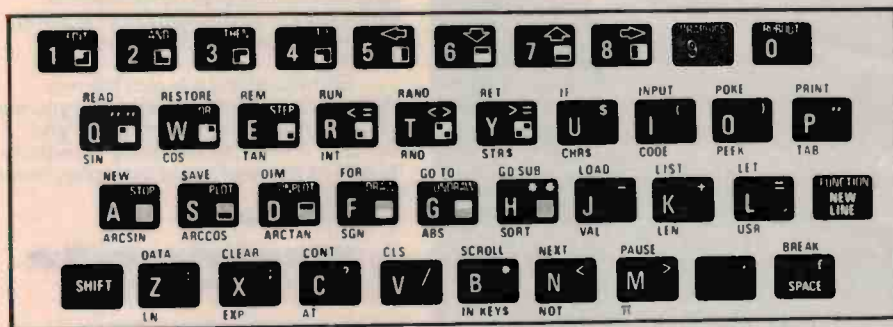

A drop-in replacement for the existing 4K BASIC ROM, comes with a new keyboard template and a supplementary operating manual. Designed for high-level, full facility computing.

Available NOW from:

SINCLAIR EQUIPMENT (AUSTRALASIA) PTY. LTD., 86 Nicholson St., Abbotsford, Vic., 3067. Tel. 419 3033.

RARE ADDITIONS FROM MARANTZ. SLIMLINE COMPONENTS.



Rare: very valuable.

Additions: the things added.

Ma'rantz: a range of ultra-high performance Slimline Components which blend state-of-the-art engineering with operational versatility.

MARANTZ ST450 AM/FM STEREO TUNER

Electronic Gyro-Touch tuning and digital display enable precise and speedy station selection which can be servo-locked for drift-free operation.

MARANTZ EQ20 STEREO GRAPHIC EQUALIZER

Beautifully styled, the EQ20 provides highly personalised tone control flexibility with its ten detented slide controls per channel – the perfect finishing touch to any high quality audio system.

MARANTZ SC500 STEREO PREAMPLIFIER

Traditional Marantz performance in the all important first stage of amplification. Moving coil cartridge head-amp and different cartridge load inputs are just two of the comprehensive number of facilities.

MARANTZ SM500 DC POWER AMPLIFIER

Perfectly complements the SC500 and delivers 50 watts RMS per channel. Output is displayed on two large, peak responding power level meters.

MARANTZ PM350 INTEGRATED AMPLIFIER

Bass, mid and treble controls and LED power level meters, combined with an output of 30 watts RMS per channel, make this the ideal amplifier for normal listening levels.

MARANTZ SR1100 AM/FM STEREO RECEIVER

Slim, stylish and component width, the 30 watt RMS per channel SR1100 provides a new concept in compact audio sophistication.

MARANTZ SD5010 STEREO CASSETTE DECK

Forerunner to a new generation of superior cassette decks, the SD5010 has soft-touch controls, LED meters, metal tape facility, fine bias control and an electronically controlled linear skating mechanism operating the cassette drawer.

Shown are but a few of the new Marantz Slimline Components. If you see your hi-fi as an investment and, if you demand critical performance standards as well as the best value for money, listen to the future.

Listen to Marantz.

marantz
Now you're listening.

Distributed by MARANTZ (AUST) PTY. LTD.
P.O. Box 604, Brookvale, N.S.W. 2100
Telephone: (02) 939 1900 Telex AA24121
Melbourne (03) 329 7655 Brisbane (07) 446 478
Adelaide (08) 223 2699 Perth (09) 276 2944

SIGHT & SOUND

Apply now for Film and TV School places

Applications for places in the Australian Film and Television School's full-time training courses for 1982 will close on July 1 this year.

Although the AFTS receives enquiries from many hopeful would-be students, it emphasises that the majority of these enquiries come from people who are not suitable for the AFTS Full-time Program. Many are too young and inexperienced; there is no upper or lower age limit, but the preferred age range for entrants is 20-28, with average age being 23, and some broader social and cultural knowledge as well as evidence of interest and examples of work in the chosen field are required.

The AFTS runs two full-time courses: a three-year diploma course in all aspects of production, direction, production management, camera, sound, editing and scriptwriting/research for film and television; and a screenwriting course offering terms of up to 12 months to reasonably well-established writers. Successful applicants to this course generally come from an older age group.

The diploma course seeks mature, creative, 'ideas' people, dedicated to careers in the visual media, with defined ideas of the area in which they wish to work, and able to submit relevant examples of their work in support of their applications. While prospective students must state their preferred area of specialisation when applying, the course provides opportunities to work in all craft areas and students are trained in both film and television.

Examples of former work certainly need not be professional, and the amount of previous experience or courses taken has no definitive bearing on the final selection; quality rather than quantity is sought. There are no

educational pre-requisites and entry does not depend on matriculation aggregates or subjects. The AFTS is not a tertiary institution under the auspices of the State or Federal Departments of Education, but rather a training school, with largely practical courses, set up by an act of Federal Parliament in 1973 and funded directly by the Federal Government, to serve the needs of the Australian film and television industry and education.

Up to 25 people, from all walks of life, are selected annually for the diploma course.

The screenwriting course gives an opportunity to writers with some experience to work as writers in-residence in the AFTS Writing Workshop. They receive intensive guidance in developing screenwriting techniques and ideas, and undertake an



Third-year student Annie Cocksedge recording location film sound.

introductory course in the other craft areas of film and television. They write scripts with and for students on the diploma course, as well as developing their own ideas. Examples of written work, published or unpublished, performed or unperformed, are required with applications. Four to seven writers are offered places each year.

Application forms and course information brochures are available from the Recruitment Office, Full-time Program, Australian Film and Television School, P.O. box 126, North Ryde NSW 2113, (02) 887-1666, and from the AFTS Melbourne office, P.O. Box 373, North Melbourne Vic. 3051, (03)328-2683.



Third-year student Peter Hammond, who is majoring in sound, at the 24-channel AWA sound mixing console of the School's television studio, Studio One.



Sansui claims to end distortion

Sansui's two new integrated amplifiers, the AU-D11 and the AU-D9, are claimed to have as good as eliminated the problem of all kinds of distortion due to the new 'Super Feedforward' system.

The feedforward technique actually predates the conventional negative feedback technique, and was developed by the same person, H.S. Black of Bell Laboratories, but until now it has not been successfully used in commercially available amplifiers because of inherent problems.

Sansui engineers are claimed to have solved these problems by combining feedforward technique with negative feedback, thus eliminating both steady-state distortion (harmonic distortion, switching and crossover distortion and intermodulation) and transient distortion

(including transient intermodulation distortion — TIM).

The amps feature a built-in preamp for moving coil cartridges, and a simple construction (only a phono equaliser and the power amp) that avoids sound-muddling capacitors between equaliser output and speaker systems. The equaliser is of the high-gain dc-servo construction which prevents quasi-dc components from causing instability. The new DD/DC (Diamond Differential dc) construction in the AU-D11's equaliser amp is also said to minimise distortion.

Selectavision under way, stereo TV to come, says RCA

RCA began shipping its Selectavision videodisc players to US distributors early in March and say that they're developing a second-generation system that will deliver stereo sound.

Among its efforts in developing a videodisc system with stereo capabilities is the production of a television receiver that can pick up and play stereo signals, according to Jack Sauter, group vice-president in charge of consumer electronics.

Referring to the videodisc customer, he noted, "Stereo will build in popularity. Our task is to build a television set that will do something with it.

"Nobody has a stereo television set. We're going to build television sets that will have that capability in '82," he said.

Mr. Sauter said the company has not set a price on the stereo videodisc system, and has not set a formal introduction date for it, other

than "12 to 18 months" after the introduction of the initial system.

The monaural system, marketed beginning March 22 at a suggested retail price of US\$499.95, will not be upgradeable into a stereo system, he noted. RCA is planning to produce and sell 200 000 units by the end of this year.

Industry sources said the company is testing the market with the monaural system, and plans to make a larger splash with a stereo system in the event of market acceptance of the videodisc player.

The Phillips-type laser disc player, currently sold by Pioneer and Magnavox, offers an audio hookup into a stereo system and retails for US\$750.

First trade audio exhibition

The first trade audio exhibition, arranged by the Australian section of the Association of Sound and Communications Engineers, was held recently at the Lantern Restaurant, Sydney, and proved to be a great success.

The first of its kind for members of the public address industry, it featured current and new products from four major sound companies in Sydney:

- Audio Engineers Pty Ltd — showed a wide range of Shure products including microphones, mixers, amplifiers and speaker enclosures.

- Audio Telex Communications Pty Ltd — comprehensive display included public address control racks, the new range of DI amplifiers, Atlas horns and speakers, Turner and Asiatic microphones, headsets and sound column reproducers.

- Amalgamated Wireless (Aust.) Ltd — had the largest exhibit, which included AWA amplifiers, Toa

amplifiers, microphones and horn speakers, AKG microphones, Toa radio microphones and loudhailers.

- Freedman Electronics Pty Ltd — had a large display of auditorium sound reinforcement equipment including Freedman speaker enclosures, Carlsboro 16-channel mixers, power amplifiers, graphic equalisers, echo and reverberation units plus a wide range of stage microphones and stands.

The Association of Sound and Communications Engineers is a world-wide organisation catering for members of the audio industry. Further information may be obtained from the Australian representative, Mr. E.C. Moore, 62 Tasman St, Kumell NSW 2231. (02)668-9889.

Sanyo takes no chances with videodisc

Sanyo recently announced that it would manufacture all three formats of videodisc equipment — VHD, RCA and Philips VLP — "due to the company's strong orientation towards export markets".

The VHD format is generally favoured in Japan, so Sanyo will manufacture in this format for the home market. Production is planned to commence between June and August of this year.

Sanyo Japan will also start production of RCA format disc players for the US market around March or April of this month, and plans are also under way to extend manufacturing operations for RCA disc

players to Sanyo's TV factory in Arkansas, USA, at a later stage.

A production date for Philips optical laser players, primarily intended for the European market, will be postponed until the most popular European disc format becomes more clearly defined.

For further information contact Mr. Bruce Johnson, Sanyo Australia Pty Ltd, 225 Miller St, North Sydney NSW 2060. (02)436-1122.

New Sanyo dictaphone

The Sanyo M1001 dictaphone features 600 mW output, one-touch recording, quick recording and review, a conveniently located pause control, a sensitive inbuilt microphone, a LED indicator that monitors recording input, and uses standard compact cassettes.

It measures only 100 mm x 157 mm x 41 mm and weighs 600 g. Other facilities include a remote microphone input, earphone socket and an external power supply. It comes with a handy carry strap, and normal power is provided by four AA-size batteries. Recommended retail price is \$65.

For further information contact Mr. R. Hopwood, Sanyo Australia Pty Ltd, 225 Miller St, North Sydney NSW 2060. (02) 436-1122.



B&W DM12

THE UNOBTRUSIVE REVOLUTIONARY

We could have built something smaller, but we were determined to build a miniature speaker that rises way above the limitations hitherto imposed by a small enclosure. In particular, we wanted to achieve wider response and more realistic sound levels in the low frequency range. We also wanted safe power-handling capacity. Thanks to our unique resources in computer and laser technology and the sheer creativity of our design team, DM12 achieves all this and more.



B&W LOUDSPEAKERS



It's certainly small.
Just 355mm (14 in) high x 220mm (8 3/4 in) wide x 270mm (10 1/2 in) deep.
106dB.

That's the surprising peak sound pressure level DM12 produces from its 12 litre enclosure.

Monitor standard.
Frequency linearity + 2 dB 85 Hz to 20kHz.

APOC-protected.
B & W's exclusive audio-powered overload circuit protects against accidental damage or overload.

For further information see your B & W dealer or contact
Convoy International Pty Ltd
4 Dowling Street Woolloomooloo NSW 2011
Telephone (02) 358 2088

Ooh, Mac — what a Monster!

Said the actress to the Bishop as he flashed his hi-fi system — she'd spotted his Monster speaker cable of course!

Monster Cable (TM) is a specially-constructed speaker connecting cable claimed to improve the sound of a system and provide more power drive to the loudspeakers.

Constructed using many strands of fine copper wire, the cable is plastic encapsulated in a figure-8 format designed to have good flexibility, very low dc resistance (given as 3 milliohms per foot, that's 9.8 milliohms per metre), very low capacitance (69 pF per metre claimed) and low series inductance (0.75 uH per metre claimed). The terminations are colour coded so that you get correct phasing when installing the cable.

The manufacturers claim that Monster Cable reduces power loss compared to conventional speaker cables, improving damping factor, and their brochure shows a sine-square pulse test to illustrate the comparison, showing a 14% improvement (about 0.6 dB).

In addition, the manufacturers claim improved amplifier performance can be obtained in some circumstances where the high

capacitance factor of other cables causes instability in some amplifiers. The Monster Cable brochure is also illustrated with a high frequency pulse test showing what happens in such cases.

Monster Cable is claimed to add "... depth and clarity to mid/high frequencies ..." due to its construction, as well as giving "... tighter, cleaner bass ...".

Monster Cable is obtainable in pre-cut lengths or can be cut to length. A variety of terminations are available, such as spade, big banana tips, gold banana tips and gold pin tips. The cable is distributed here by Convoy International Pty Ltd, 4 Dowling St, Woolloomooloo NSW 2011. (02)358-2088.

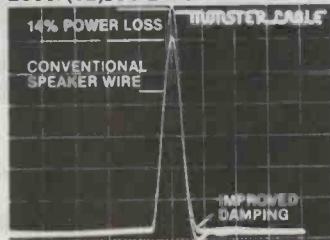

Video recorder and TV in one

An interesting variation on the video cassette theme is now being marketed by Sharp in Japan.

They have released an 18-inch television with a built-in video cassette, the unique console system being made possible with the Sharp front-loading cassette system. The television has a slot in the front cabinet into which you pop your video cassette when you want to play or record.

Combining the TV and the video recorder reduces the cost by about

30%, say Sharp, but don't expect to see the unit flood on to the market over here; Sharp say they are merely trying it out in Japan to gauge reaction and that it may be a year or more before they look at the export market, and then America would be first off the rank.

However, the concept is interesting and worth keeping an eye on.

Dennis Lingane

N.V. Dale Electronics announce imports

Janszen electrostatic speakers, Cizek speakers and Cart Align, a cartridge alignment tool, will soon be available in Australia from N.V. Dale Electronics.

N.V. Dale Electronics have also been appointed sole distributors for Victoria, South Australia and Tasmania for the following brands: Bozak speakers, Stanton cartridges, styli and record care products, Soundguard, Vortec and GLI and Systems 80 furniture modules.

N.V. Dale Electronics also handle Telarc and Delos audiophile

records, Proprius, American Gramophone, Opus and Trend records, Infinity speakers, QED audio accessories, Audio Pro speakers and subwoofers, L & D Speakers, Audionics, Berkshire audio products, and J.E. Sugden of the UK products.

You can find N.V. Dale Electronics at 274 Victoria St, Brunswick Vic. 3056. (03)387-6170.

Now the Bose® 901® IV Direct/Reflecting® speaker. The evolution of the revolution.

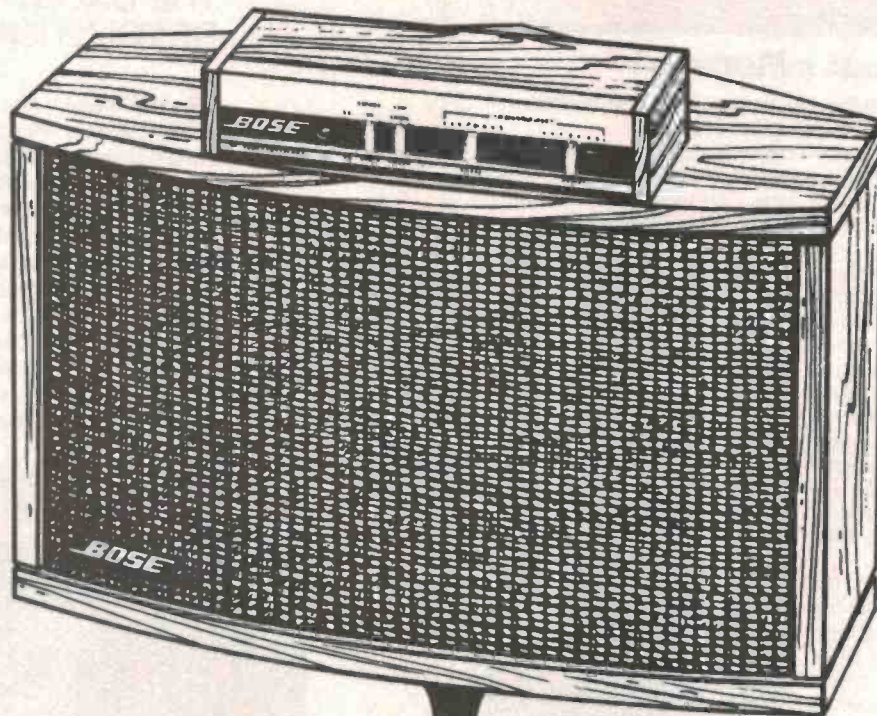

When Bose introduced the original 901® speaker, it was hailed by critics as a revolution. Now the 901® speaker has evolved to its finest form. The new Bose 901® Series IV.

New equalizer controls allow you to adjust this speaker for individual room acoustics and speaker placement. And a new driver

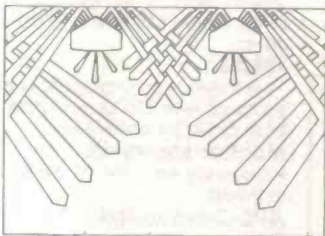

is so advanced in materials and design that Bose has removed the power limitations for home use.

The new Bose 901® IV is durable enough to handle any amplifier, yet can be driven with as little as 10 watts per channel.

You can put together a system with the life-like, spacious sound of the Bose 901® Series IV

Direct/Reflecting® speaker for a fraction of what it would cost to get the same kind of sound with any other speaker.

BOSE®

BOSE AUSTRALIA INC., 11 MURIEL AVENUE, RYDALMERE, NSW 2116.
TELEPHONE (02) 684-1022, 684-1255.

Sony's inseparable separates.

Sony's new ST-J55 tuner and TA-F55 amplifier come in elegant matching designs. Separately, they're

straight signal processing circuit construction, revolutionary Heat Pipe, and Pulse Power Supply, providing

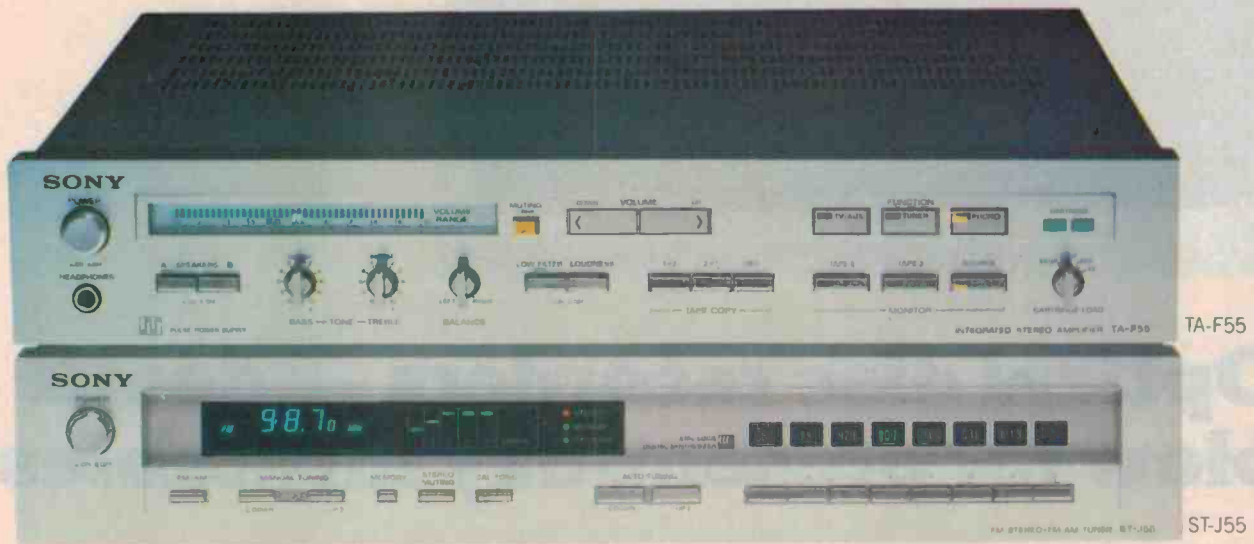

outstanding. Together, they're out on their own, both in appearance and performance.

The J-55's tuner is frequency synthesized and quartz locked. A neat line of feather-touch switches gives a choice of Memory, Auto, or manual tuning.

The J55's incredible electronic MNOS memory tuning lets you preset your 8 favourite AM/FM stations - including reception adjustments like muting or mode pre-set.

The other half of the team, the 65W F55 Amplifier, features an electronic motor driven volume control,

extremely clean and noise-free sound quality.

The F55 operates with almost any type of MC and MM cartridge; has gold-plated phono jacks, oxygen-free copper wiring, metallized film resistors and polypropylene capacitors.

You won't find better engineering than these. Not even from Sony.

SONY®

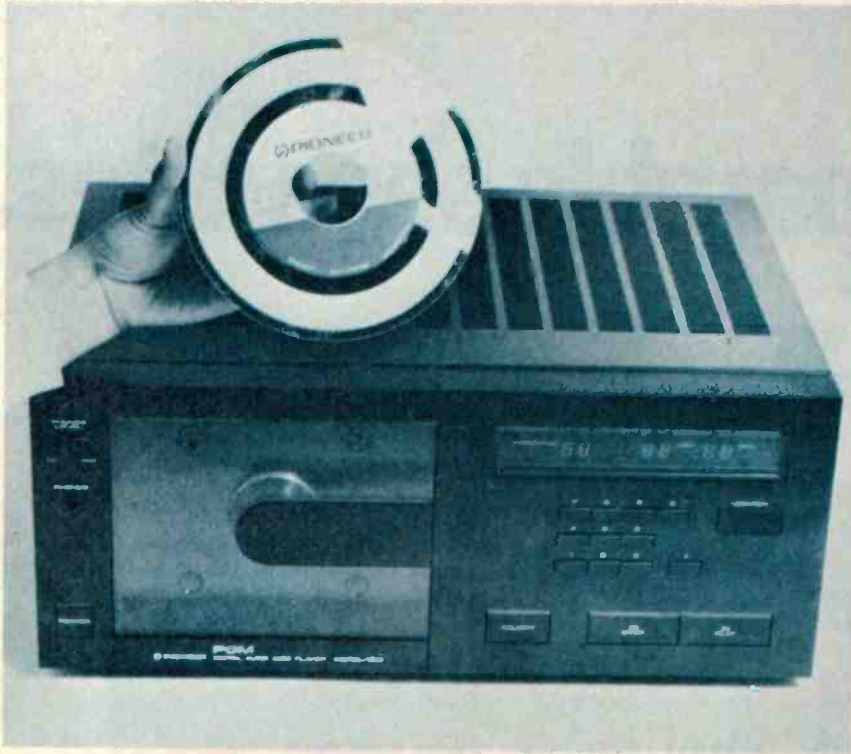

Optical disc recorders — death blow for present-day turntables?

The new technology of the digital disc 'played' by a laser pick-up with no direct surface contact at all must signal the eventual demise of the conventional record and turntable system. Alan Concannon (Mem. IEEE T.Eng(CEI) MITE MNZEI) reviews the various applications and advantages of this revolutionary technology.

Alan Concannon

GRANDFATHER most probably used a freshly sharpened sliver of bamboo each time he played his record on the gramophone. Then progress introduced the scratchy stainless steel needles, the ones which were supposed to be thrown away after each playing of the old 78s. With the fifties came the plastic record with the microgroove and the sapphire stylus, then finally came the diamond stylus. But the eighties, due to research carried out by Philips Industries and other manufacturers, will see the introduction of the laser beam stylus, which for numerous reasons will quickly cate-

gorise all its predecessors as museum pieces.

Existing hi-fi records and turntables are adversely affected by worn sapphires and diamonds, dust, scratches and many other surface defects. Also, to combat the bogey of scratch, audio engineers had to devise equalisation circuits which allowed treble notes to be recorded over normal strength and played back at reduced volume. This makes the surface noise, which is in the same tenal range, more difficult to hear. But with static, dust and other pollutants gathering around

the stylus, the battle to keep the sound pure is one of constant vigilance.

The new consumer record player

The only really new technology in the future turntable system will be the records, which will become digital compact discs, and the stylus or means of taking the recording from the disc to the amplifier. The new laser pick-up stylus, at least for consumer-standard record players, will work with existing amplifiers and speakers, so initially the

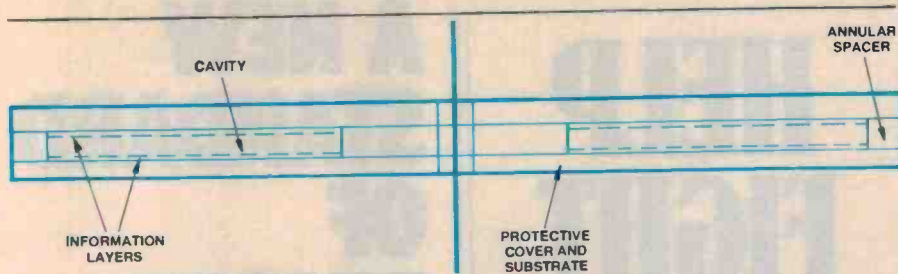

Figure 1. The Philips Air Sandwich or a disc protective system. (Not to scale.)

turntable will be the only hi-fi component to be replaced.

On consumer-standard record players the Philips compact disc (just 115 mm diameter with 60 minutes' playing time) spins on a turntable, but there the similarity ends. Sound reproduction is vastly superior due to the sound information being stored on the disc digitally and read out optically.

Playing the disc is based on the principle of light diffraction, which means that pre-recorded information can be extracted without mechanical contact. The information is stored on the disc in the form of a helical track or microscopic pits, the pick-up head being an optical device using a miniature aluminium gallium arsenide laser. The light reflected back from the metallic layer on the disc contains all the signal information in digital form to reproduce the original recording.

The laser in the pick-up produced today is estimated to last 2000 hours. The proposed units, which Philips originally expected to be on the market during 1980, are no bigger than today's cassette players. The units will provide an output signal for playback through any standard stereo amplifier.

The disc is recorded on one side only and is covered by a metallic layer beneath a transparent protective coating. It is both light in weight and durable, and because the information is not stored on the surface of the disc it is secure against dust, dirt, scratches and general wear. With the disc only 115 mm in diameter, storage creates no problem. Operating the player is de-

scribed as simplicity itself; you select the play, stop, automatic or search mode, and it responds to your requests.

The larger 300 mm commercial optical disc

The new optical disc recorder was based on the technology used in the video disc system for home entertainment, but Philips' designers had a few problems to overcome. They had to develop an inexpensive disc recorder of digital information, which had to have direct read-after-write capability and be able to record in any ordinary enclosure — i.e.: not the usual dust-free protected room.

They concluded that an optical disc recording by laser was the answer, and produced a disc that can record as much digital data as 25 magnetic tapes operating at 6250 bits per inch. Due to its protective cover, no processing of the disc is required and its shelf life of ten years is assured with a tellurium-based film.

The system is also error-free, the optical system being designed to check the recorded data instantly and to re-record at once any part of the disc where irregularities appear. This process was developed experimentally for the Philips DRAW (Direct Read After Write) information system. The DRAW system records information on a 300 mm disc with 40 000 tracks per side or 1.0×10^{10} bits per side.

The optical disc

A variety of materials was considered

for the disc substrate and its protection. After taking into account thickness uniformity, strength, optical properties and cost, polymethyl-methacrylate (PMMA, or Plexiglass) was selected as the primary disc material.

A tellurium-based film was chosen for the recording medium, consideration being given to reproducibility, storage, resolution and sensitivity. The sensitivity of tellurium is sufficient to allow at least 10 M bit/second recording with less than 8 mW incident at the film surface. Accelerated aging tests on the tellurium-based film indicated a shelf life of ten years at normal room temperatures.

Protection from scratches, dust, and sticky fingers, etc, is provided by a transparent cover over the disc, this system being known as the Philips Air Sandwich (see Figure 1). The sandwich consists of two discs, each coated with a tellurium layer and separated by ring spacers at the inner and outer radii. The tellurium is placed on to the disc during the assembly process in a clean, dust-free room prior to the protective cover being applied.

The optical system

In the optical system (see Figure 2) the light output from the laser is split into two beams: 90% for recording and 10% for reading or reproducing what is on the record.

The recording beam is encoded with the information signal by a light modulator. The read beam passes two mirrors and a beam splitter, so arranged that the record and read beams are re-combined at the objective. The objective focuses the beams on to the information layer inside the disc, the focused power available for recording at the disc's surface being 12 mW.

Since the read beam is slightly off centre to the optical recording axis, the playback spot trails the recording spot by a few microns. This means that the recorded pit is read shortly after writing, making immediate correction



The Sony/Philips laser-read disc system, launched in Japan last October.

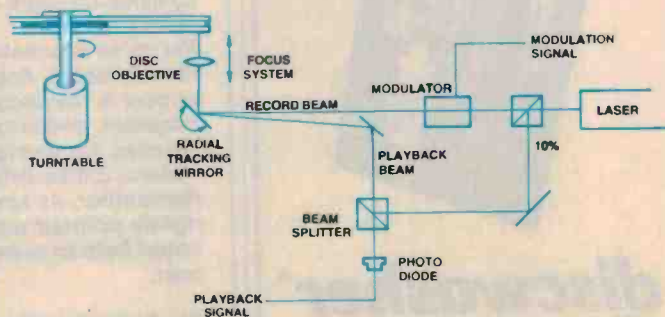
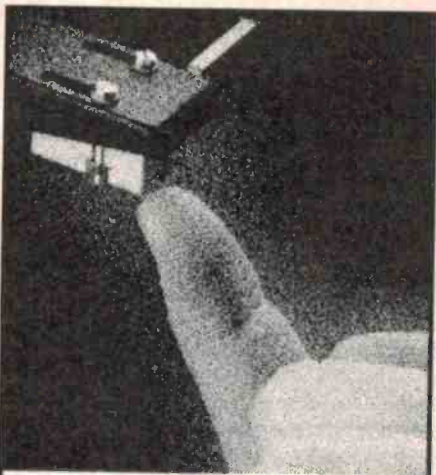

Figure 2. Optical system for the commercial-standard disc recorder.



SC-2 gives your cartridge more than The Finger!

The famous SC-1 stylus brush (standard of the record and hifi industries) now has a synergistic fluid called SC-2.

SC-2 Fluid enhances and speeds cleaning and yet protects diamond adhesives, cartridge mounting polymers and fine-metal cantilevers against the corrosive effects of many other "cleaners."

The Discwasher SC-2 System. Stylus care you can finger as clearly superior.



discwasher[®]
PRODUCTS TO CARE FOR YOUR MUSIC
AVAILABLE AT LEADING
HI-FI DEALERS AND RECORD STORES.

HELP FIGHT THE SILENT KILLER

Kidney disease is the silent killer in Australia today. It may be present without apparent symptoms — & hundreds of Australians die of it every year.

But because people can't see their kidneys and don't know much about their functions, they miss the vital early warning signs.

Our kidneys are, in fact, miraculous miniature laboratories containing one to two million filters that help control blood pressure & the important balance of salt & water in our bodies. Yet over 300,000 people consult their doctors each year with kidney complaints.

The Australian Kidney Foundation is the only voluntary gift-supported community health organisation solely concerned with fighting kidney disease, the silent killer. The Foundation provides research & education programmes to both the general public and the medical profession. As well as life-giving aid to thousands of ordinary Australians.

We need urgent financial support to continue our work — and we need kidney donors.

For more information, ring the number below. Any donation of \$2 or over is tax deductible and bequests, endowments and legacies are exempt from State & Federal Estate duties.

Remember, as someone has so rightly pointed out — the life you could help to save could be your own.

The Australian Kidney Foundation,
1 York St., Sydney. Phone 27 1436

A NEW STANDARD OF RECORD CARE

DISCWASHER D4 SYSTEM

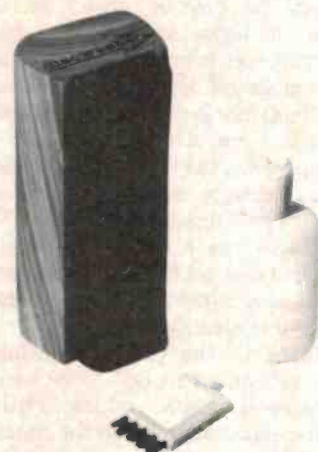

NEW D4 FLUID

Inherently more active against record contamination. Inherently safe for record vinyl. Preferentially absorptive formula carries all contamination off the record.

NEW D4 FABRIC

Unique directional fibers preferentially remove fluid and contamination. D4 fabric results in clearly better cleaning, better drying and ultimately residue-free surfaces.

UNMATCHED VALUE

The Discwasher D4 System is enhanced by the durability and aesthetics of the hand-finished walnut handle. Included in the D4 System are the DC-1 Pad Cleaner and new instructions.

discwasher[®]
PRODUCTS TO CARE FOR YOUR MUSIC
AVAILABLE AT LEADING
HI-FI DEALERS AND RECORD STORES.

of errors possible; should any difference occur between the record and read signals they are detected and re-recorded.

Warping of the disc can cause vertical excursion of the information surface by as much as 1 mm. Any misfocus is sensed optically, and the error is minimised by a servo-mechanism focusing system.

A radial tracking mirror is used to follow the recording tracks during playback. The read spot must follow the tracks to within 0.1×10^{-6} m. Since disc eccentricity on remounting can be as large as 50×10^{-6} m, the radial mirror must be controlled to reduce this error to within the $0.1 \mu\text{m}$ limits. Mistracking is sensed optically, and the signal controls the radial mirror to reduce the error.

Comparison with magnetic tapes

When a comparison is made between the best commercially available magnetic storage devices and the optical disc system the results are interesting (see Table 1). Using the optical disc, the cost per bit of information stored is considerably cheaper, storage life is greater, access time is reduced, and the hardware cost for information stored lowered. Magnetic tape's main advantage is that it can be erased and re-recorded — the laser optical disc system is permanent and would not be suitable for this type of application.

Briefly, then, the laser optical disc's main advantages are low cost, efficient storage and improved archival properties. The volumetric storage efficiency of the optical disc is also better — approximately one hundred times better than that of magnetic tape's 6250 bits per inch.

The packing density of magnetic re-

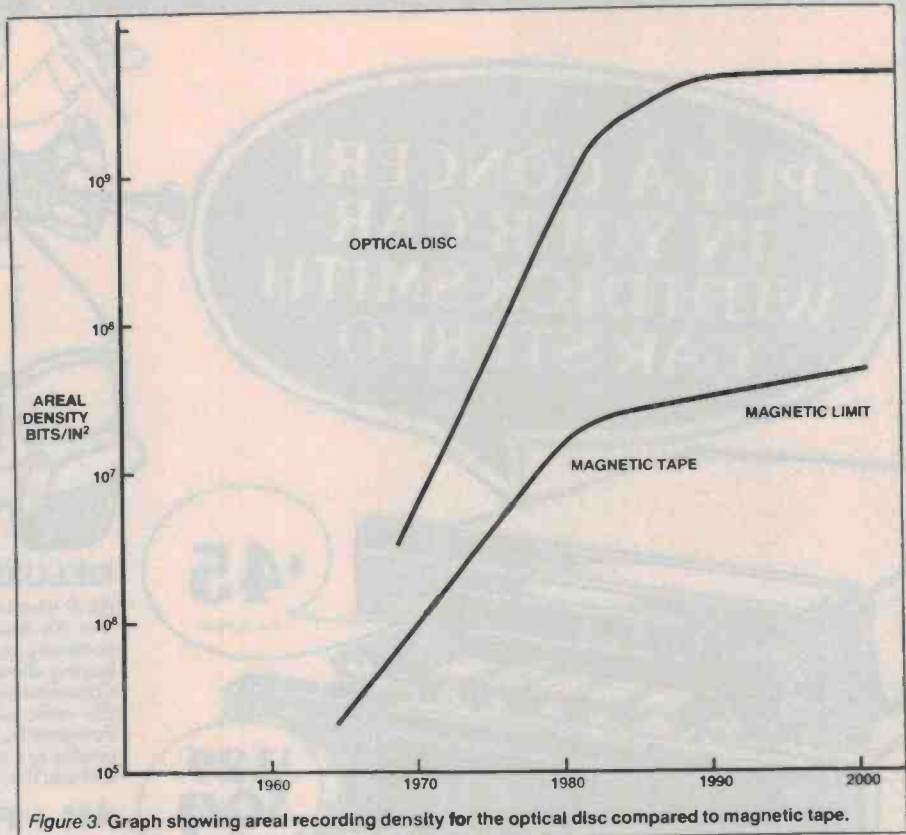

Figure 3. Graph showing areal recording density for the optical disc compared to magnetic tape.

coding (see Figure 3) has an ultimate limit somewhere below 10^8 bits per in^2 , whereas optical recording on metal films has now progressed to this level, and densities above 10^9 bits per in^2 are expected as a result of current research.

The consumer video disc system maps roughly six bits of information on each pit on the disc. The recording format chosen for the digital disc conservatively assigns only one bit to a recorded pit. The present research and development is aimed at increasing the storage capacity of the disc to about 10^{11} bits. Endeavours will be made to produce

smaller pits, smaller track spacing, more efficient data encoding and an increase in the number of encoded bits per recorded pit.

Amplifiers and speakers have reached a stage where it is difficult to improve on them in any great degree. But for any class of consumer, in the home or in the radio studio, the record and turntable system has until now been a major weakness. With the advent of the laser optical system, tomorrow should bring a near-perfect and highly durable system to satisfy even the most fastidious music lover. ■

Table 1. Characteristics of magnetic tape and optical discs.

Commercial units only

Device	Media cost per bit in cents	Archival life in years	Access time in ms	User capacity Mbytes	Hardware cost in US dollars
6250 bits/in tape IBM 3420-8	2.2×10^{-6}	1-2	45 000	91	\$28 440
IBM 3850 System	5×10^{-5}	1-2	16 000	462 500	\$2 400 000
Philips Optical Disc	5×10^{-8}	Up to ten years	100-500	2500	\$10 000
Philips Juke Box	5×10^{-9}	Up to ten years	3000	25×10^6	\$200 000
Philips Optical Disc Pack	1.5×10^{-8}	Up to ten years	50-100	125 000	\$200 000

**PUT A CONCERT
IN YOUR CAR
WITH DICK SMITH
CAR STEREO**



\$45

Cat. A-5940

**\$129
\$99**

Cat. A-6480

**\$99
\$89**

Cat. A-6486

DELUXE AM RADIO

An 8 transistor radio with push button tuning for only \$45? Yes it's true. A similar radio to this one was sold by this company in 1976 for a massive \$79 — our direct import buying allows us to beat inflation! Complete with all bits and pieces, including a large speaker, this radio will fit most cars in the standard cut-out aperture. Powered by your battery (12V DC negative earth) this radio produces a massive 5 watts output. All you need is an antenna and you'll be listening to your favourite stations in no time at all.

AM + FM STEREO + CASSETTE

The FET front end plus its small size are only two of the outstanding features of this AM/FM cassette stereo. Measuring only 120(d)x180(w)x44(h)mm it will fit into most fascia cutouts, the small size has been accomplished by placing the tuner dial in the cassette flap! Indicator lights tell you when you have FM stereo and when you have a tape playing. Ideal for any 12V DC negative earth vehicle. Use with any of the speakers shown below.

AUTO REVERSE STEREO

No more troubles with turning the tape over at end of play — this unit automatically plays the other side. If you wish to fast forward or reverse the tape then it is easy — the controls lock down and then pop out at the end of the tape. Ideal for under dash installation the unit works from 12V DC negative earth. The 4 IC and 2 diode construction boasts a healthy 8 watts maximum output — enough power for even the most avid audiophile. Can be used with any of the speakers shown below.

Dual Cone Speakers



Cat. A-7080

A massive 280 gram magnet, plus 4 ohm impedance and a rating of 20 watts — ideal for those high power systems. Excellent bass and treble response.

\$29⁹⁰

For top quality sound from the in-built tweeter and bass unit. Handles 20 watts into 4 ohms and comes complete with superb grille.

\$39⁵⁰

Cat. A-7000

ALL NEW EQUALISER/AMPLIFIER

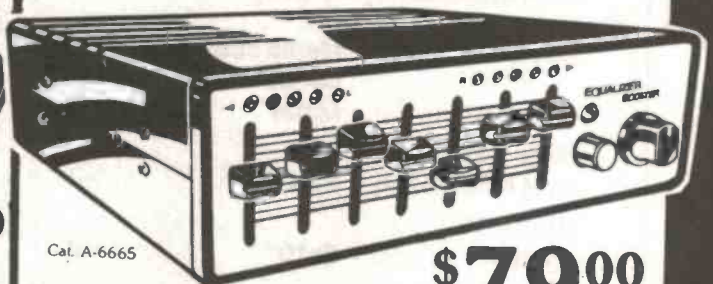

Cat. A-6665

\$79⁰⁰

Boost up your power to 25 watts per channel and at the same time be able to control 7 different frequencies! The slider controls will enable you to set-up the sound that you like thereby compensating for any deficiencies in the cars acoustics. One pair or two pairs of speakers may be used and if using two pairs there is a fader between the front and rear speakers. Use with 12V DC negative earth.

Rear Shelf Speakers



Cat. A-6980

Rated at 4 ohms impedance and 8 watts power. Mount on your rear shelf or can be removed from box for flush mounting.

\$16

Flush Mount Speakers



Cat. A-6985

130mm diameter speakers with a rating of 4 ohms and 10 watts maximum power. Soft padded speaker grille for that touch of luxury. Mount on rear shelf or in doors.

\$18 \$15

All speakers are sold and priced as pairs

SEE THE OTHER DICK SMITH ADS IN THIS MAGAZINE FOR STORE ADDRESSES & PHONE NUMBERS



The moving coil replacement from Stanton Magnetics... the revolutionary 980LZS!



Now from the company to whom the professionals look for setting standards in audio equipment comes a spectacular new cartridge concept. A low impedance pickup that offers all the advantages of a moving magnet cartridge without the disadvantages of the moving coil pickup. At the same time it offers exceedingly fast rise time—less than 10 micro seconds—resulting in dramatic new crispness in sound reproduction—a new “openness” surpassing that of even the best of moving coil designs. The 980LZS incorporates very low dynamic tip mass (0.2 mg.) with extremely high compliance for superb tracking. It tracks the most demanding of the new so called “test” digitally mastered and direct cut recordings with ease and smoothness at 1 gram $^{+1/2}$ $^{-1/4}$.

The 980LZS features the famous Stereohedron™ stylus and a lightweight samarium cobalt super magnet. The output can be connected either into the moving coil input of a modern receiver's preamps or can be used with a preamp, whose output is fed into the conventional phono input.

For “moving coil” audiophiles the 980LZS offers a new standard of consistency and reliability while maintaining all the sound characteristics even the most critical moving coil advocates demand. For moving magnet advocates the 980LZS provides one more level of sound experience while maintaining all

the great sound characteristics of cleanliness and frequency response long associated with fine moving magnet assemblies.

From Stanton... The Choice of The Professionals.

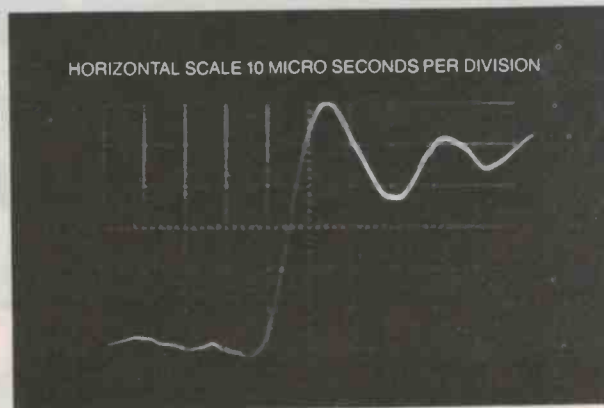

Actual unretouched oscilloscope photograph showing rise time of 980LZS using CBS STR112 record.



STANTON

THE CHOICE OF THE PROFESSIONALS™

IMPORTERS AND EXPORTERS OF AUDIO EQUIPMENT



SOUNDEX PTY LTD

WA Head Office: 156 Railway Parade, Leaderville, 6007. Phone (09) 381-2930.
NSW Office: 7 Jordan Road, Wahroonga, 2076. Phone (02) 487-2543.

Sanyo Plus 75 receiver — high-powered sound!

Sanyo's new Plus 75 AM/FM stereo receiver is aimed at the higher end of the market, and according to Louis Challis its biggest 'plus' is that you can play it as loud as if the rock band were in the room with you.

Louis A. Challis

Sanyo have changed their Australian image in the last two years from one of medium to bottom-of-the-line products to a new image of total capability. The Plus series of products has been designed to fill the gap at the top end of the spectrum with a range of quality products designed to compete effectively

and commercially with the other best known Japanese brands.

Features

The Plus 75 AM/FM Stereo Receiver is an excellent example of a well-designed receiver offering the frills, gimmicks and performance that the well-heeled

audio faddist has been looking for.

The receiver is in keeping with the basic styling that Sanyo have been using for the last four years, with the brushed satin aluminium escutcheon divided into two halves; the top half features a perspex insert escutcheon behind which is a long slide rule-type dial. The top section of this features FM and AM frequency designations whilst the centre section features a blue digital display indicating AM or FM.

The lower section of the upper escutcheon features two seven-segment green LEDs to indicate power output, whilst more LEDs separately indicate the selection of AM, FM, phono, auxiliary, FM stereo and FM quartz-locked tuning. A five-segment array of red LEDs displays the incoming signal sensitivity.

The bottom half of the escutcheon is arranged with two levels of controls — of which there are so many that they tend to be a little crowded. A 'busy' appearance is presented, and the whole effect is a little overpowering. The main controls are in the lowest row and consist of push buttons for speakers A and/or B; bass, mid-range and treble controls; a volume control with mechanical indents; a balance control; push buttons for loudness; 20 dB muting; stereo/mono; FM muting and

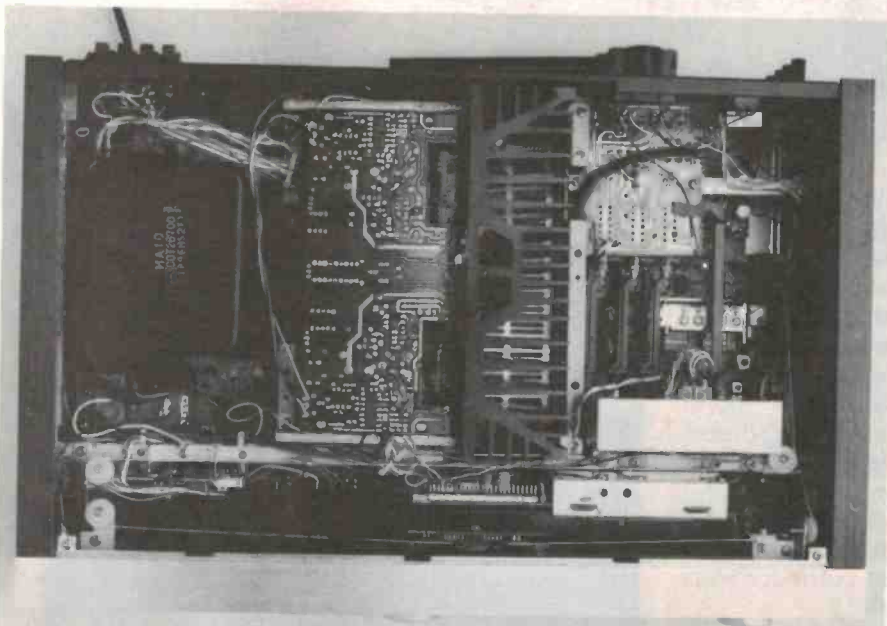

Internal view of the receiver. Note the fully encapsulated power transformer at the left and the heatsink dividing the chassis.

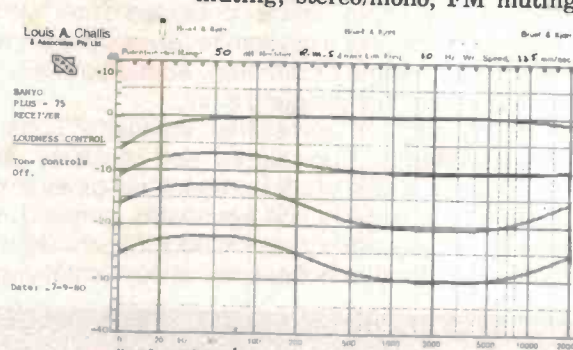
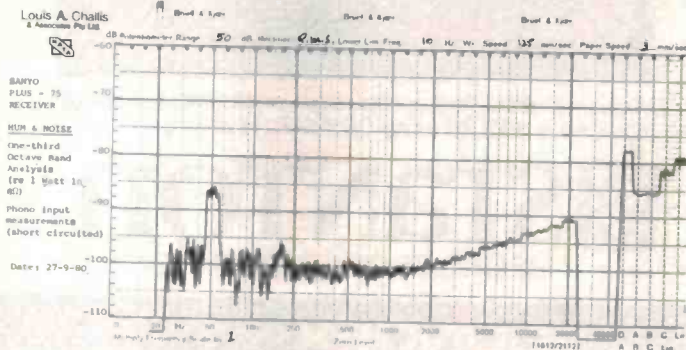



AM/FM phono or auxiliary. The last control on the right-hand side is the tuning control, which is smooth and well counterbalanced.

The minor controls are located logically above the respective major controls. At the left-hand side is a power display range switch which allows the power display to be increased in sensitivity by ten to one so that the maximum setting is 15 watts instead of 150 watts. This would be the position in which most people would be expected to use the receiver. Above the bass control are three push buttons for corner frequencies of 100 Hz, 200 Hz and 400 Hz for the bass boost or cut. Above the mid-range control is a tone control defeat button, whilst above the treble control are switches for selecting corner frequencies of 2.5 kHz, 5 kHz and 10 kHz for the treble boost and cut. Above the loudness control are subsonic and high frequency filters. Above the muting mode and FM muting switches are monitor switches for selecting source or tape for recorders 1 and 2 and dubbing on and off, respectively. Above the mode switch is a quartz-locked frequency tuning selector and a moving magnet or moving coil cartridge input selector switch.

At the rear of the receiver are four terminals for connecting AM and FM external aerials, and a 50 μ s and 75 μ s de-emphasis switch to suit Australian and American conditions. Inputs are provided for one cartridge, one

auxiliary, and two tape recorders. Linked inputs and outputs are provided between the preamplifier out and the main amplifier in, whilst connection of the speakers is achieved through four pairs of well-designed, silver-plated, spring-loaded terminals. The AM antenna is a clever ball and socket jointed fixture providing 60° arc movement in the horizontal plane.

The inside of the amplifier is well-designed, the most significant features being the subdivision of the circuitry with a main power supply stage on the left including a fully encapsulated power transformer. Two well-designed power amplifier output stages are located adjacent to it, flanked in the centre by a very large and unusual heatsink. This incorporates a thermal cutout circuit which in the event of excessive temperatures switches off the output stage. To the right of this is the AM/FM tuner stage incorporating a tuned RF stage for FM and separate shielded cans for the digital tuning stage and for the SQ quartz-locked tuning stage. The digital display which traverses the slide rule dial at the front of the unit incorporates a flat ribbon cable to carry the signals through to the dial, which, whilst unusual, is nonetheless very practical. Four additional printed circuits are located behind the power level, signal level and pre-amplifier tuning stages at the front of the receiver.

The unit features a strong steel

chassis and simulated veneer plywood sides in what is a relatively complex but well-designed system. The power supply fuses are located inside the unit, and although the manufacturer does not specifically state "no user serviceable parts inside", those words could well have been presented on the rear panel.

On test

The test performance of the receiver stage provided very good results. With the tone controls defeated the frequency response is 10 Hz to 100 kHz; with the tone controls centred this extends from 9 Hz to 54 kHz. The moving magnet cartridge sensitivity is 620 μ V.

At rated power of 75 watts into both channels the distortions are typically .014% at 100 Hz, .008% at 1 kHz and .023% at 6.3 kHz. At 1 watt level these figures are still excellent at .02%, .007% and .009%. The transient intermodulation distortion is less than 0.1%.

Hum and noise levels are particularly good, being -86 dB(A) for the auxiliary input, -86 dB(A) for the moving magnet phono input and -76 dB(A) for the moving coil input. The dynamic head room at rated output is 1.5 dB, whilst the performance on the transient overload recovery test is excellent.

The most unusual feature of this amplifier is the provision of variable corner frequencies in the tone control circuits, which is one feature I consider well worthwhile and a positive bonus. The addition of the mid-range control is advantageous and in general terms

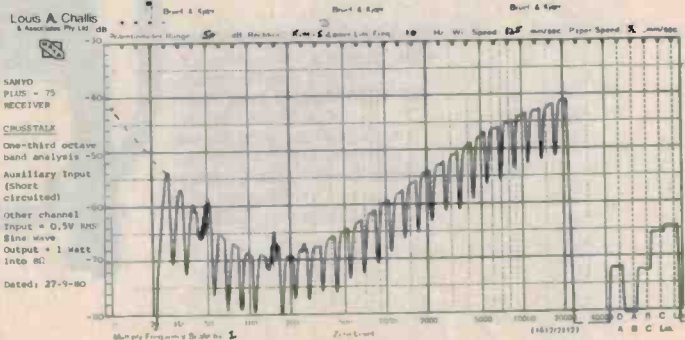
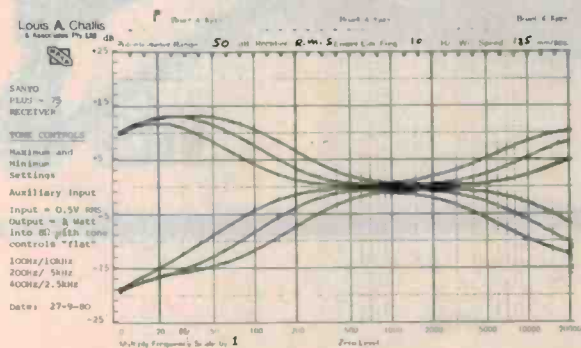

HITACHI VIDEO SYSTEM

HITACHI VERS

You buy a video system to put more fun in your life. To expand your viewing possibilities. To turn your TV into a multi-use entertainment center. For optimum enjoyment, you need two things: versatility and creativity. The Hitachi VT-7000 Portable Video System gives you an abundance of versatility. The creativity, you've already got.



VT-7000 Portable Video Recorder

- Still picture & frame advance
- Full remote control

VT-TU70 Video Tuner/Timer

- Soft-touch tuning
- 10 day/1 program preset with daily repeat recording

VK-C770 Portable Color Video Camera

- 6X zoom lens
- Electronic viewfinder

VHS

UTILITY & YOUR CREATIVITY

FORMULA FOR FUN:

You'll be able to enjoy a wide variety of prerecorded tapes: old and new movies, cultural events, educational materials, and a fast growing list of rock concerts.

The VT-7000 Recorder and A-V70 Adaptor are all you need for full playback convenience. And thanks to Hitachi's advanced technology, the picture (and sound!) quality are excellent.



Have you ever had the feeling you could put together a better show than some of the ones on TV? With the VT-7000 Recorder and VK-C770 Camera, you can indulge your fantasy. You'll also appreciate their light weight and small size when taping family outings, sports events, and so on.



The VT-7000 Portable Video System is a totally versatile, total

enjoyment system. Not only are the units lightweight and compact for take-along convenience, but their elegant, matching design makes them look great in any home. And their performance and reliability are outstanding, thanks to Hitachi's world-leading integrated technology. No matter what type of application appeals to you, you'll find that the VT-7000 System makes it easier and more enjoyable.



With the addition of the VT-TU70 Tuner/Timer, you're assured of never missing another must-see show. If an appointment or a trip takes you away from home, just set the VT-TU70 to record it, then watch it later at your leisure. You can preset to record a program up to 10 days ahead, or for daily repeat recording. In addition, you can tape one show while watching another.



What's missing from this great video system? Just one thing: you. Your creativity is all that's needed to let it reach its full potential. And the more creative you are, the more fun you'll have with it. The VT-7000 Portable Video System. Let your nearest Hitachi dealer show you the fun.

 **HITACHI**

adds to the flexibility of the unit. Overall, the audio section of this receiver provides impeccable performance.

The FM performance on mono features a 21 dBf sensitivity for 26 dB signal-to-noise ratio, but surprisingly features a 26 dBf stereo sensitivity for 46 dB signal-to-noise ratio. The measured ultimate signal-to-noise ratio is 75 dB on mono and 70 dB on stereo. The frequency response in the FM mode is particularly flat, extending from 17 Hz to 17 kHz at -3 dB. The total harmonic distortion on stereo at 1 kHz is +.3%, whilst the spurious response rejection and image rejection ratios are both better than 70 dB.

Although of generally conventional design, the FM stage offers exceptionally good reception with either a simple folded dipole antenna or with a commercial external stacked Yagi array, correctly aligned to receive the incoming signals. The incorporation of the RF stage certainly provided very good performance, bettered by very few receivers.

By contrast the AM response at -6 dB bandwidth is 40 Hz to 1.8 kHz. This must rate as one of the narrowest selectivities I have seen and is very open to criticism because of the good and

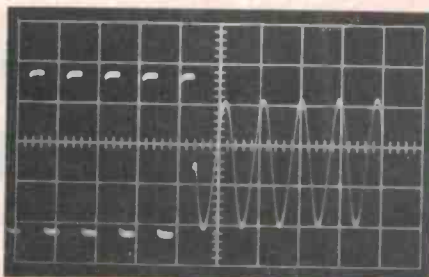

Transient overload recovery test (IHF-A-202)
1 ms/div.
10 dB overload re-rated power into 8 ohms — both channels driven. Overload duration: 20 ms; repetition rate: 512 ms.

useful AM broadcast quality in this country. The AM sensitivity is 300 μ V/m and ranks as only a moderate performance, suitable for local reception only, not for long-range reception.

In practical use in my home, with two sets of loudspeakers connected (a set of Fisher monitor speakers in parallel with a set of Quads and subwoofer), the system was able to reproduce rock music with healthy outputs in excess of 110 dB peak with no sign of significant distortion but with plenty of movement of the windows and doors. The Plus 75 is readily capable of producing music powers of up to 75 watts on a continuous basis without thermal distress and

without significant distortion. This is a kind of power level which ten years ago might have been considered unnecessarily excessive, but perhaps the general acceptance of rock music and rock music power levels has changed our style of music and consequent needs in equipment.

The Sanyo Plus 75 is a receiver which can form the basis of a home music centre, background music system for a restaurant or school, monitor system for a radio station, or even meet the requirements of people who like to listen to their music at 'realistic' sound levels.

SANYO PLUS 75 RECEIVER

Dimensions: 480 mm wide x 355 mm deep x 135 mm high
Weight: 14 kg
Manufactured by: Sanyo Electric Co Ltd in Osaka, Japan
Price: \$490
Distributed by: Sanyo Australia

Absolute copyright in this review and accompanying measurements is owned by Electronics Today International. Under no circumstances may any review or part thereof be reprinted or incorporated in any reprint or used in any advertising or promotion without the express written agreement of the Managing Editor.

MEASURED PERFORMANCE OF SANYO PLUS 75 RECEIVER

FREQUENCY RESPONSE:

(-3dB re 1 Watt, 0.5V Input to Aux)

Left 10Hz to 53kHz
Right 10Hz to 52kHz

Tone Controls Centred

Left 9.0Hz to 54kHz
Left 8.5Hz to 56kHz
Right 8.0Hz to 55kHz
Right 8.0Hz to 56kHz

Tone Controls Defeated

Turnover Frequencies

100Hz/10kHz
400Hz/25kHz
1000Hz/10kHz
4000Hz/2.5kHz

SENSITIVITY:

(for 1 Watt in 8 Ω)

	Left	Right
AUX	13.5mV	14.0 mV
TUNER	4mV	4mV
TAPE	14.5mV	13mV
PHONO M/M	620 μ V	600 μ V
PHONO V/C	58 μ V	58 μ V
OVERLOAD M/M	180mV	180mV
OVERLOAD M/M	20mV	19mV

INPUT IMPEDANCE:

	Left	Right
AUX	47 k Ω	48 k Ω
TUNER		
TAPE	47k Ω	48k Ω
PHONO M/M	47k Ω	47k Ω
PHONO V/C	100k Ω	100k Ω

OUTPUT IMPEDANCE: 690 milliohms (@ 1kHz)

S.N. 771 40018

HARMONIC DISTORTION:

(A) (At Rated power of 75 Watts into 8 Ω = 26.5 Volts)

	100Hz	1kHz	6.3kHz
2nd	-78.5	-83.6	-78.9dB
3rd	-83.7	-86.4	-82.4dB
4th	-90.2	-96.7	-76.7dB
5th	-97.5	-99.3	-dB
THD	0.014%	0.008%	0.023%

(B) (At 1 Watt into 8 Ω)

	100Hz	1kHz	6.3kHz
2nd	-76.2	-83.2	-83.2dB
3rd	-78.8	-	-90.1dB
4th	-88.1	-	-86.4dB
5th	-87.3	-	-dB
THD	0.02	0.007	0.009%

TRANSIENT INTERMODULATION DISTORTION: 0.1%

(3.15kHz square wave and 15kHz sine wave mixed 4:1)

NOISE & HUM LEVELS:

re 1 Watt into 8 Ω)

	AUX	PHONO M/M	PHONO V/C
(with volume control set for 1 Watt output with,	-83 dB (Lin)	-79dB (Lin)	-63dB (Lin)
	-86 dB(A)	-86 dB(A)	-76dB(A)

0.5V input (Aux)
5mV input (Phono M/M)
0.5mV input (Phono V/C)

MAXIMUM OUTPUT POWER AT CLIPPING POINT:

(IHF-A-202)
(20ms burst repeated at 500ms intervals)

82 V P-P
105 Watts
Dynamic Headroom = 1.5 dB (re 75 watts)

Not Just Speaker Wire



Conventional speaker wire limits the performance of your sound system by decreasing power output, restricting dynamic range, and reducing clarity and definition. You can significantly improve the performance of your audio system by switching from your present speaker wire to Monster Cable.

Constructed of over 500 strands of high purity copper in a unique configuration, Monster Cable is specifically engineered for low resistance, low capacitance, and low inductance. The Results?

- Deeper, tighter bass.
- Maximum power transfer.
- Increased clarity and definition.
- Wider dynamic range.

Even low-powered systems show a remarkable improvement. Recommended by leading audio manufacturers, Monster Cable is safe to use with all amplifiers and receivers, regardless of design.

Don't be deceived by imitations. If it doesn't say Monster Cable you're not getting all the performance you paid for.

MONSTER CABLE

DISTRIBUTED BY CONVOY SYDNEY (02) 358 2088

Available from: N.S.W. LEISURE SOUND City • Parramatta • Artarmon 29 1364
 • RUSSIN ELECTRONICS Ashfield 799 2421 • WOOLLAHRA ELECTRONICS Bondi Junction 389 9625 • WOLLONGONG HI-FI Wollongong 28 3773 • PITTMANS Wagga Wagga 25 2155. ACT: DURATONE HI-FI Phillip 82 1388 • KINGSTON HI-FI Kingston 95 7895. VIC: TIVOLI HI-FI Hawthorn 818 2872 • BLACKWOOD SOUND Blackwood 278 1281. QLD: STEREO SUPPLIES Brisbane 221 3623 • DISCO & STEREO SUPPLIES Townsville 72 4226. S.A.: SOUNDCRAFTSMEN Hawthorn 272 0341. W.A.: ALBERTS Perth 361 5422 • THE AUDIO CENTRE Perth 322 5177 • JAPAN HI-FI Victoria Park 362 1466 • LESLIE LEONARD HI-FI Perth 325 2699 • THE SOUNDCRAFTSMAN Subiaco 381 5114. N.T.: RADIO PARTS Darwin 81 8508.

Forging new
frontiers in speaker
performance

Richard Allan

top quality
English speakers
now available

- *New Release:—
- CG 12L HI-FI Bass driver
lightweight cone for better
transient and frequency
response.

Also available HP 12B Super, HP 8B, CG 12 Super.
New stocks of Richard Allan speakers
soon to arrive.

Professional advice on all facets of speaker
design and construction available.
Come and inspect our unique
experimental speaker design
facility.

The ACOUSTIC FOUNDRY Hi Fi



56 King William Road, Goodwood 5034
(08) 2710276.

Please forward me further details
on Richard Allan speakers.
(Trade enquiries also welcome).

NAME

ADDRESS

POSTCODE

Marantz' 'Esotec' SM1000 stereo amp

Marantz have recently been marketing a range of amplifiers, record players, cassette decks and receivers which have been designed to be the ultimate in their class. The majority of these units have "mind blowing" characteristics including massive weights, unbelievable output powers and gimmicks calculated to attract the well heeled audiophile for whom money is no object.

Louis Challis

WITH THE RELEASE of their "Esotec Series" of products Marantz have finally put their act together and offered a series of quasi-compatible components whose general technical features, and most particularly their individual costs, truly justify the title "esoteric".

Of all of the components listed in their latest brochure, the SM1000 Power Amplifier is the biggest. This amplifier is also the heaviest that we have ever reviewed and at 43 kg is one of the heaviest components that we have ever handled in the laboratory.

Perfection?

Marantz claim that in developing their Esotec Series of products they have striven to achieve the ideal power amplifier and naturally claim that they have been successful.

They examined the characteristics of even and odd order harmonics in terms of the total harmonic distortion and make the claim that:-

1. Even order harmonic distortion is produced by a system whose transfer mechanisms are asymmetric in nature.
2. Odd-order harmonic distortion is produced by a system whose transfer mechanism is symmetric in nature.
3. Symmetric transfer functions generate intermodulation products

ducts that *lie above* the two or more frequencies that are intermodulating.

4. Asymmetric transfer functions generate intermodulation products that *lie below* the two or more frequencies that are intermodulating.

Since intermodulation products are *non-harmonic* they are far more offensive to the ear than simple harmonic distortion. Herein lies the rub. Should the designer reduce the odd order harmonic distortion and favour the *even order, steady state distortion*? Were the mechanisms of high frequency THD adequately investigated? These are the kind of questions we had in mind when we reviewed the amp.

Features

The SM1000 Amplifier is a particularly attractive piece of hardware. The front escutcheon is constructed from golden-hued brushed satin aluminium with two very large illuminated VU type meters set in the front panel. These are calibrated in "power into 8 ohms" over the range .01 to 400 watts and from +3 to -50 dB re 400 watts into 8 ohms. The bottom of the front panel features a hinged, drop down cover behind which are two pushbutton switches for selecting speaker group 1 or 2, two individual

gain controls for the left and right speaker group 1 or 2, two individual gain controls for the left and right channels, and interlocked pushbutton switches for selecting ac or dc input coupling.

The rear of the amplifier features three, rather than the normal two, sets of universal output speaker terminals. The first set is direct-connected whilst the second and third sets are switch controllable from the front panel. The primary input connections are by means of either a pair of gold plated coaxial sockets or a pair of XLR recessed locking sockets to accept professional "Canon type" plugs.

The side panels, front panel and chassis construction is built "like the proverbial battle ship" and the top panel is slotted for improved ventilation. On the two sides of the unit there are expanded mesh grilles for an air intake and discharge respectively for a cooling fan system which forms part of the power output stage. The top panel features a small separate removable cover to provide access to an internal mesh pre-filter assembly.

The inside of the amplifier is, as the manufacturers claim, built to exacting professional standards and features the electronic circuitry constructed in a series of compartmentalised enclosures that stretch from the front panel to the rear, utilising all the available space.

In the foremost compartment are the preamplifier stages and the meter amplifier circuitry, which provides each meter with a direct reading 53 dB range. The meters are sensibly



The controls hidden behind the drop-down front cover.

calibrated in 1-2-5 steps from .01 watts to 200 watts and then provide two additional steps of 300 and 400 watts into 8 ohms. Immediately behind the metering circuitry and preamplifier stage are two large individual power transformers on opposite sides of the chassis. These flank four very large power supply capacitors of 23 000 μ F each. Straddling the centre of the amplifier is additional circuitry incorporating the protection controls for the output stage. These control modules simultaneously act as an electrostatic screen between the power transformer stage and the output stage.

At the rear of the amplifier is the power output stage incorporated within what Marantz call their "heat dissipation tunnel". This makes use of a technique developed by NASA for transistor cooling. This technique uses a series of transistors each fitted with its own heat sink for improved thermal dissipation. Each transistor has a "heat dissipator" with twelve long finger-like



projections to operate at nearly the same temperature as the case. This controls the maximum temperature variations from case to fins at less than 8°C compared with up to 35°C measurable on more conventional heat-sink assemblies. The fan speed is sensibly thermostatically controlled so that it draws less air at low thermal outputs and more air with increasing load. By utilising an outer rotor type motor, the fan noise is effectively minimised (but only at low speeds). The internal circuitry is laid out on large, well-cooled printed circuit cards, the majority of which incorporate plug and socket connections to ease factory construction, and where spare cards or extender boards are available, general servicing as well.

The internal wiring is conventional heavy duty, and laced to MIL type specs. In the fully assembled form, although designed for rack mounting, it should be noted that a residential type racking system would never support the weight, unless placed at the bottom of the rack with additional end support.

On the bench

The objective testing of the unit supported the claims of the manufacturer as the frequency response was flat to within 0.1 dB from 10 Hz to 20 kHz. In the dc mode the frequency response extends from dc to beyond 150 kHz. The power output claims are modest for the unit is readily capable of producing 625 watts into an 8 ohm load with both channels driven and with a 4 ohm load in excess of 700 watts into each channel. At the rated 400 watt level into 8 ohms the total harmonic distortion characteristics are relatively low, being only .01% at 100 Hz, .02% at 1 kHz, and .02% at 6.3 kHz.

At the 1 watt level, and at virtually all powers below 50 watts, the distortions are particularly low, being only 0.008% at 100 Hz, 0.05% at 1 kHz and 0.009% at 6.3 kHz. Because of the claims made in some of Marantz' literature we measured the intermodulation distortion in strict accordance with the C.C.I.R. Two-Tone Test Method.

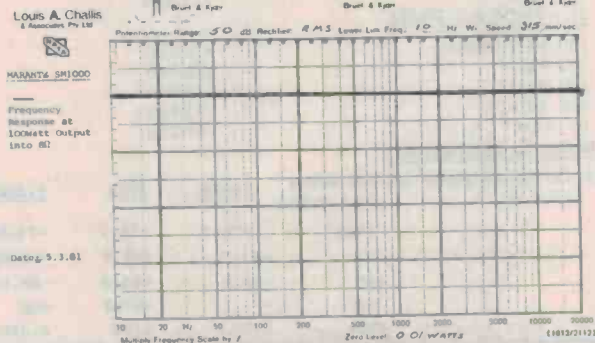
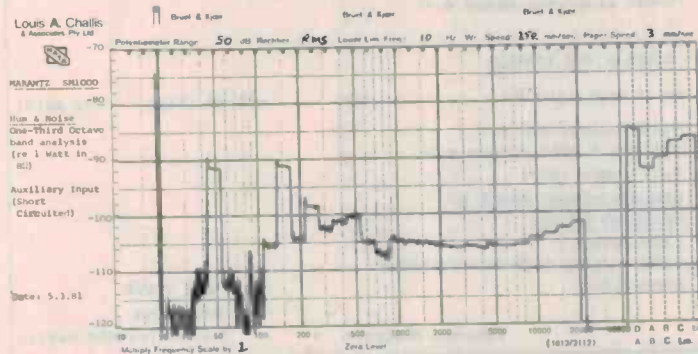
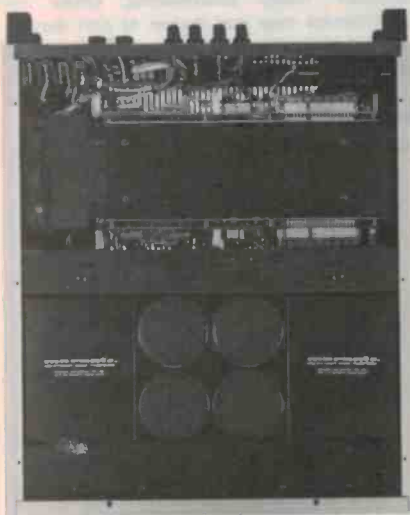

These distortions were also related to power working level and at the 100 watt level the difference frequency component (f_1-f_2) was -82.5 dB, at 200 watts -74.6 dB, at 300 watts -73.5 dB and at 400 watts -73.3 dB. This performance is also exemplary and more than good enough for either the well-off audiophile or a professional. The signal to noise ratio is -87 dB unweighted and -92 dB(A), which is good but not the best we have seen.

In practical use, after *manhandling* into the appointed location, the amplifier proved to be very easy to use. The unit incorporates a six second time delay so that power is not applied to the output circuitry in such a way to cause clicks and pops, nor result in inadvertent damage to expensive speakers. With direct reading of power output on the meters one knows exactly what the amplifier is doing and what dynamic headroom one has before approaching the clipping point of 625 watts output into 8 ohms.

Connected to various sets of high powered speakers like the JBL L110s, Fisher Monitor Speakers, or National Technics SB 10s, or all three systems in parallel to handle the power output, one soon finds what this amplifier is all about. This amplifier is able to handle such loads without complaint like a professional trouper. We made effective

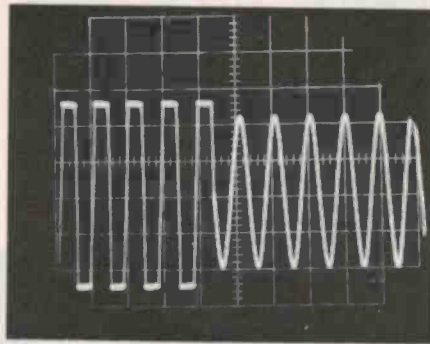

10 dB overload re rated power into 8 ohms — both channels driven. Overload duration: 20 ms; repetition rate: 512 ms. 1 ms/div.

use of the amplifier in a laboratory study to test a series of six loudspeakers, literally to destruction, to determine their power output ratings. It performed admirably in a situation which would have distressed lesser units.

To the ear

In subjective testing we coupled the amplifier to the Esotec Tt1000 Series Turntable, a Carver C4000 Control and an AIWA AD6900 Cassette Deck. With this set-up it provided *superlative performance and at power levels which were truly awe inspiring*. Sound pressure levels in excess of 110 decibels fall easily within its scope even in rooms with volumes exceeding 500 cubic

metres.

Listening to records like Telarc's 'Peer Gynt Suite' (TEL10048) and Stravinsky's 'Rite of Spring' (TEL10054) provided me with the opportunity to hear what "high fidelity" is really all about, without detracting from source material or adding any audible colouration.

Well?

The Marantz SM1000 amplifier has the capability to provide superlative performance at home, in a laboratory, in a studio or in a rock band with the ease and true panache of a professional. At a selling price of \$4999.00 it is to be expected that many readers will lose interest — but not all — for cost, like quality, is one form of beauty that is seen in the eyes of the beholder. ●

MARANTZ MODEL SM1000 AMPLIFIER

Dimensions: 483 mm wide by 178 mm high by 550 mm deep.
 Weight: 43 kg Price: \$4999
 Manufactured in Japan for Marantz, California U.S.A.
 Distributed by: Marantz (Aust.) Pty Ltd,
 P.O. Box 604, Brookvale NSW 2100.

Absolute copyright in this review and accompanying measurements is owned by Electronics Today International. Under no circumstances may any review or part thereof be reprinted or incorporated in any reprint or used in any advertising or promotion without the express written agreement of the Managing Editor.

MEASURED PERFORMANCE OF MARANTZ MODEL SM1000 S.N. 09 P010003							
FREQUENCY RESPONSE:							
(-3dB re 1 Watt, 0.5V Input to Aux)	DC	150kHz	(B)	(At 1 Watt into 8Ω)	100Hz	1kHz	6.3kHz
				2nd	-83.2	-88.5	-85.6dB
				3rd	-88.7	-90.0	-83.9dB
				4th	-96.2	-	-90.8dB
				5th	-	-	-dB
				THD	0.008	0.005	0.009%
SENSITIVITY:							
(for 1 Watt in 8 Ω)	AUX	Left	Right				
		148mV	148mV				
INPUT IMPEDANCE:							
	AUX	Left	Right				
		27k	27k				
OUTPUT IMPEDANCE:							
	AUX	20 milliohms (@ 1kHz)					
C.C.I.R. F1/F2 TEST							
	$f_1 = 16$ kHz	$f_2 = 15$ kHz	$f_1 - f_2$				
100 Watt Output			-82.5dB				
200 Watt "			-74.6dB				
300 Watt "			-73.5dB				
400 Watt "			-73.3dB				
	$f_1 = 21$ kHz	$f_2 = 20$ kHz					
100 Watt Output			-73.4dB				
200 Watt "			-75.3dB				
300 Watt "			-73.3dB				
400 Watt "			-73.6dB				
10 Watt "			-85.2dB				
HARMONIC DISTORTION:							
(A) (At Rated power of 400 Watts into 8Ω = 56.6 Volts)	100Hz	1kHz	6.3kHz				
	2nd	-79.3	-73.2	-71.5dB			
	3rd	-81.7	-86.9	-88.6dB			
	4th	-93.3	-84.3	-80.8dB			
	5th	-	-97.3	-dB			
	THD	0.01	0.02	0.028%			
TRANSIENT INTERMODULATION DISTORTION: Very low less than 0.1%							
(3.15kHz square wave and 15kHz sine wave mixed 4:1)							
NOISE & HUM LEVELS:							
	re 1 Watt into 8Ω	AUX	-87 dB (Lin)	-92 dB(A)			
(with volume control set for 1 Watt output with, 0.5V input (Aux))							
MAXIMUM OUTPUT POWER AT CLIPPING POINT:							
(1HF-A-202)							
(20ms burst repeated at 500ms intervals)							
						200 V P-P	
						625 Watts	
						Dynamic Headroom =	1.9 dB (re 400 Watts)

High-Com II

NOISE REDUCTION SYSTEM



Obviously a noise reduction system that carries the Nakamichi logo has to offer some *real* benefits over existing systems.

Features like:—

- Professional two-band design affords 20 dB noise reduction throughout the *entire* audio band — necessary if side effects such as breathing, pumping and sonic coloration are to be eliminated.
- Ultra-fast attack and release times in each band assures accurate transient reproduction and minimal distortion — necessary for *faithful* reproduction of music.
- Optimum compander ratio for each band provides an additional 5 dB headroom affording a dynamic range improvement of 25 dB!
- 50 dB range peak responding meters assure correct record level monitoring.
- Subsonic and MPX filters eliminate externally induced errors.
- Suitable for any cassette or reel-to-reel recorder.

High-Com II follows Nakamichi's commitment to excellence in the fine art of recording.

SPECIFICATIONS:

Noise reduction system	2 bands, level encoding and decoding
Compression ratio	Encoding 1:2, Decoding 2:1
Noise reduction	20 to 25 dB
Frequency response	20 to 20 kHz \pm 1 dB
Distortion	less than 0.1%
Dimensions	482(w) x 82(h) x 270(d)mm (fitted for 19" rack mount)

High-Com is the trademark of AEG-TELEFUNKEN

For complete information on Nakamichi's High-Com II, see your nearest dealer or write to Convoy International Pty Ltd, 4 Dowling Street, Woolloomooloo 2011.

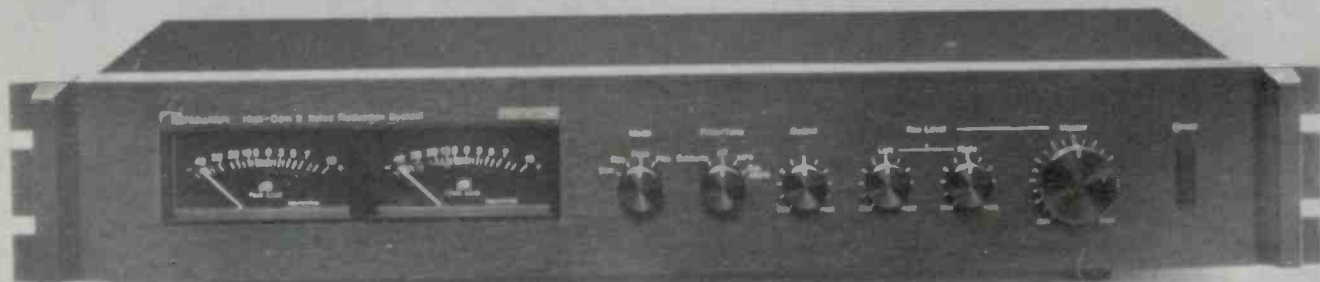

WHY?

In recent years over
500,000 music lovers
chose a Realistic[®]
receiver over Pioneer[®]
Kenwood[®] and
Technics[®] . . .

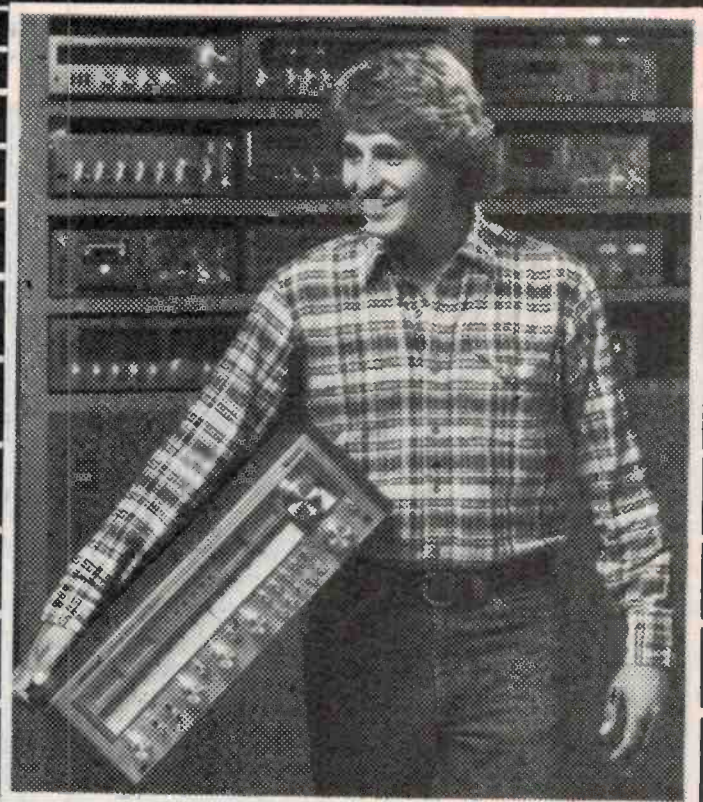

We make it easy for you. Tandy is a retailer as well as a manufacturer. When the store is also the factory, you're apt to get less fiction and more fact. Also, Tandy has more company-owned and operated service stations than almost anyone we know of in the audio business.

We've stood the test of time. Could it be we sell so much Realistic because we've been around since 1921—long before those other brands were even a twinkle in daddy's eye? Although hi-fi is typically a younger person's product, maybe the kids prefer to bet their hard-earned bucks on the outfit with the greyest hair.

We have the edge on technology. Then there's this to consider: The same company that puts Realistic out front also builds and markets the world's most popular personal computer, the TRS-80.™ It seems to us that a company smart enough to design equipment as innovative and complex as a

computer is a logical one to choose to build your stereo receiver!

We're close to you. Need another good reason to buy Realistic? Let's take availability. Instead of tens or hundreds of places to find it, we offer over 7,300—wherever you go in Australia, USA, Canada, Belgium, England, France, Germany, Holland, and Japan as well as 31 other countries. Being more available doesn't necessarily make us more lovable. But it goes a long way towards assuring you of being able to get in touch with us when you need advice on adding a tape deck or replacing a lost instruction manual.

We've challenged the rest and won your trust. Incidentally, we're not picking on Kenwood, Pioneer and Technics. The same half-million-plus folks who chose Realistic also probably had a crack at buying Sansui, Marantz, Fisher. The important thing is . . . they didn't!

TANDY
ELECTRONICS

Mail Order Department P.O. Box 229, Rydalmere, N.S.W. 2116.

Using ETI PCB Artwork

This method can be used to make negatives of ETI artwork from October 1977 on, provided the reverse of the page is printed in blue. The film used is Scotchcal 8007, which is UV sensitive and can be used under normal subdued light.

Cut a piece of film a little larger than the pc board and expose it to UV light through the magazine page. The non-emulsion side should be in contact with the page. This surface can be detected by picking the film up by one corner — it will curl towards the emulsion side. Exposures of about 20 minutes are normally necessary.

The film can now be developed by placing it emulsion side up on a table, pouring some Scotchcal 8500 developer on the surface and rubbing it with a clean tissue.

Further information on Scotchcal and pcb manufacture can be found in the September and December 1977 issues of ETI.

Please note that occasionally lack of space may prohibit the printing of blue type behind all pcbs. In this case the reader must resort to more conventional photographic techniques for pcb manufacture.

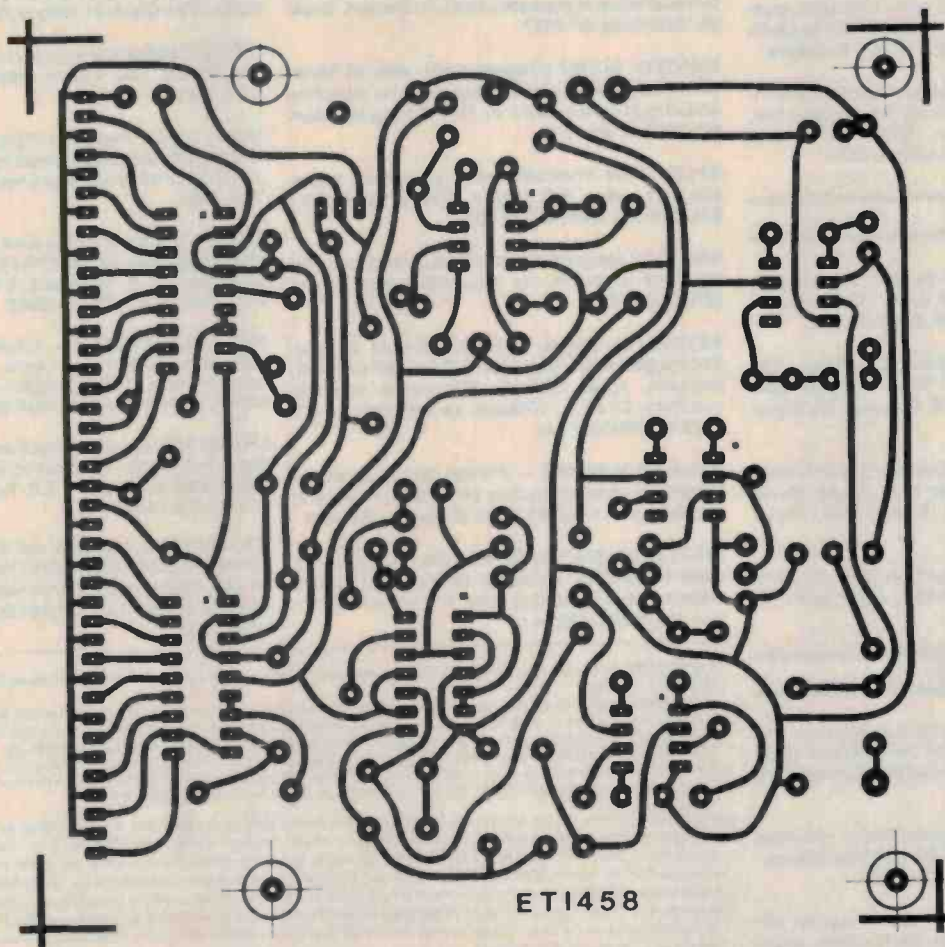
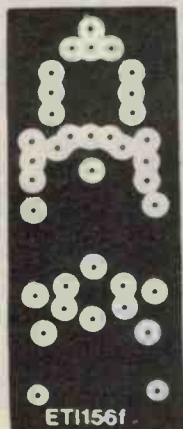

MINI-MART

Where readers can advertise —
For Sale/Wanted/Swap/Join.

• We'll publish up to 24 words (maximum) totally free of charge for you, your club or your association. Copy must be with us by the 1st of the month preceding the month of issue. Please — please — print or type adverts clearly, otherwise it may not turn out as you intended! Every effort will be made to publish all adverts received however, no responsibility for so doing is accepted or implied. Private adverts only will be accepted. We reserve the right to refuse adverts considered unsuitable.

• Conditions: Name and address plus phone number (if required) must be included within the 24 words. Reasonable abbreviations, such as 25 W RMS or 240 Vac, count as one word. Adverts must relate to electronics, audio, communications, computing etc — general adverts cannot be accepted. Send your advert to:

ETI Mini-Mart, Modern Magazines
15 Boundary St,
Rushcutters Bay NSW 2011

AUDIO

FOR SALE: 80 watt amplifier, \$179. Stereo graphic equaliser, 10 knobs per channel, \$169. Both new. (02)30-1839.

HAFLEER DH 200 power amp, \$580; DH101 preamp, \$295; both as new cond. P. Prava, 4 Bandera Ave, Wagga NSW 2650. Ph (069) 31-1253.

BOOMERANG TAPE RECORDING CLUB: A club of tape recorder enthusiasts from all over Australia. Write to us for details: BTRC, P.O. Box 155, Carlingford 2118.

FOR SALE: JH manual belt drive turntable, complete with tonearm, mag. cartridge, stylus plinth and perspex cover. Ph. (049) 61-4854. Best offer.

JOIN the Australian Tape Makers Society, the international tapespondence club. Tapespondence, printed magazine, other benefits. Details, Secretary, P.O. Box 77, Umina NSW 2257.

MISCELLANEOUS

SELL: 11 Mini speakers, \$1.50 each; 28 electronic mags — ETI, EA, EE, \$2.00 each. Price includes p&p. K. Howell, P.O. Box 405, Renmark S.A.

COMPUTER DATING: Absolutely free! The ultimate in compatibility! Send stamped self-addressed envelope to 24A Simpson St, Bondi 2026. (Sydney only).

FOR SALE: Electronics magazines, project books, mainly Australian. 125+ for only \$50.00. David Crittle, 31 Bellevue Parade, Wagga 2650. Phone (069) 22-6240.

FOR SALE: Quantity of older TV tuners and parts for tuner repairs, mainly Philips, Astor and Pye. Phone (02) 456-1211.

COMMUNICATIONS

VINTAGE VALVES — Going back a long time, \$10 ea. Can't guarantee ac types but filament types tested for continuity. R. Lockerbie, Cameron St, Merimbula 2548.

DR48 NATIONAL communications receiver, 0.5-30 MHz, AM-SSB, FM108-88, LED freq. display, 3-way power, \$250 ono. (02)522-8949.

FERRIS SSB 5000 CB radio, power supply, RF signaliser, base power-mike, SWR meter, coax, etc, \$260 ono. Phone (02) 522-5270.

STATISTICAL PROGRAMS and custom software, all types, for TI and HP (including 41C) calculators, \$10-\$200. D. Green, Running Creek Rd, Rathdowney, Qld 4287.

WANTED TO BUY: Sorcerer 16K or System 80 16K, used but in good working order. Mario Tito, 207 Lauren St, Urangan Qld 4658. Phone (071)28-9527 a.h., (071)28-9133 b.h.

ZX80, including 55 programs on tape, improved patch cords, home-made power supply, cost \$350 — sell \$250 ono. Phone (071)71-5939.

FOR SALE: Superboard II, 8K RAM, power supply, and many programs included, \$330. Tim Turner, 41 Glebe St, Glebe NSW 2037. (02) 692-0889.

TELETYPE ASR33, mint condition, complete with RS232 and 20 mA interfaces, plus full set of maintenance manuals, \$550. I.E. data entry terminals complete with self-contained 12-inch VDU and detachable full keyboard with auxiliary hex pad and cursor control keys. Manuals and circuit diagrams available, \$150 ea. Memorex 8" floppy disk drive with control electronics and 240 volt power supply, all mounted in 19-inch rack-mounting case with exhaust fan and provisions for second drive. Controller card for PDP8 — system included. Manuals also included, \$250 ono. Phone 487-2972.

S100 8K STATIC RAM, 2102, base 2, inc. 450 ns, fully socketed, 4K selectable, documentation — works! \$110. Ring Joe (02)30-1990 a.h. 11/51 Birriga Rd, Bellevue Hill NSW 2023.

SELL: COMPUCOLOR II, 32K, extended keyboard. Software FORTRAN; utilities: editor, assembler, debug, etc, \$2750. M. Donaldson, 47 Birdwood Rd, Holland Pk Qld 4121. Phone (07)397-5667.

DREAM 6800 power supply (1A version), fully built and tested, \$30. Phone (062)47-8548, Canberra ACT 2601.

SELL: Digital Research Corp. S100 static RAM board, fully stocked, burned in, runs 4 MHz, \$230. VK7FM, 23 McGuinness Crescent, Lenah Valley Tas. 7008.

MOTOROLA 6802 DZ kit plus EME-1 VDU board, power supplies, full ASCII keyboard and manuals \$220. Contact N. Bradicica, 8 Elaine St, Regents Park NSW 2143. (02)644-8949.

PRINTER/TERMINAL — Olivetti TE 318, RS232, 150 Baud, upper/lower case, with stand. See working with TRS-80, \$350. Also U/S unit as above, good i/face, \$75. Stan (02)88-4453 a.h.

DREAM 6800 Chip 8 instructions manual and software. For further information send stamped self-addressed envelope to T.S. Huett, P.O. Box 520, Woodridge Qld 4114.

S100 CPU: Bought \$330, sell \$250, excellent condition. SD-SBC 100 2.5 MHz, 2K mon, 1K RAM, up to 8K PROM, parallel I/O, serial I/O, and more. Andrew Heard, 18 Elsworth Dv, Banksia Pk. (05) 264-1055.

SPECTRUM ANALYSER for sale, Tektronix portable, 1-500 MHz range, \$2200. Ph. (08) 381-7419 a.h.

COMPUTERS

S100, 16K static RAM board, ETI-642, 450 nS, see running, \$225. Alan Peek, phone (02) 89-1450.

SORCERER 32K Mk 11. Light pen, TRS80 emulator, debug, assembler, disassembler. \$1370 o.n.o. Phone (02)427-5143 (ah).

COLOUR VTR Shibaden SV700, Xenon converted. New heads, power supply and colour boards. Unused since purchased, \$300. R. Stewart, Grant St, Goornong Vic 3557.

WANTED: SC/MP Evaluation Kit, with all literature. Need not be working but must be complete and circuit board intact. N. Guy, 7 King St, Boort Vic 3537. Phone 215.

SALE: ZX80 computer with programs, power adapter, video VHF output. Rarely used. Only \$260. Phone Tom (02)799-4091.

OSI-C2-4P complete with 8K RAM, printer port and loads of software. As new \$600 ono. Phone (07)286-2665.

KEYBOARD, HP-35, 106-key, numeric keypad, 32-function (LIST etc.), \$50. NS-SC/MP kit, built, manuals, spare SC/MP, \$80. 4-digit solenoid counters, \$4 ea. L. Williams, 6a Emerson Gr, SA 5073. (08)31-0467 a.h.

DREAM SOFTWARE — Listing and instructions for 6800 Invaders (requires 2K system) — \$5, and Car Rally (1K) — \$3. 50 Janie St, Aspley Qld 4034.

EXCELLENT SOFTWARE for sale. Programs for most computers. Extra-low prices. Best quality diskettes and cassettes only. For more information ring (03)80-4221 a.h.

COPYRIGHT: The contents of Electronics Today International and associated publications is fully protected by the Commonwealth Copyright Act (1968).

Copyright extends to all written material, photographs, drawings, circuit diagrams and printed circuit boards. Although any form of reproduction is a breach of copyright, we are not concerned about individuals constructing projects for their own private use, nor by pop groups (for example) constructing one or more items for use in connection with their performances.

Commercial organisations should note that no project or part project described in Electronics Today International or associated publications may be offered for sale, or sold, in substantially or fully assembled form, unless a licence has been specifically obtained so to do from the publishers, Modern Magazines (Holdings) Ltd or from the copyright holders.

LIABILITY: Comments and test results on equipment reviewed refer to the particular item submitted for review and may not necessarily pertain to other units of the same make or model number. Whilst every effort has been made to ensure that all constructional projects referred to in this edition will operate as indicated efficiently and properly and that all necessary components to manufacture the same will be available no responsibility whatsoever is accepted in respect of the failure for any reason at all of the project to operate effectively or at all whether due to any fault in design or otherwise and no responsibility is accepted for the failure to obtain any components parts in respect of any such project. Further, no responsibility is accepted in respect of any injury or damage caused by any fault in the design of any such project as aforesaid. The Publisher accepts no responsibility for unsolicited manuscripts, illustrations or photographic material.



Electronics Today International is published by Modern Magazines (Holdings) Ltd, 15 Boundary St, Rushcutters Bay NSW 2011. It is printed (in 1981) by Offset Alpine, cnr. Wetherill and Derby Sts, Silverwater NSW, and distributed by Gordon and Gotch.

Editor
Roger Harrison VK2ZTB
 Technical Editor
David Tilbrook VK2YMI
 Production Editor
Jane Clarke B.A. (Hons)
 Editorial Staff
William Fisher B.Sc. (Hons)
J.B. Scott B.Sc./B.E. (Hons)
 VK2YBN
Graeme Teesdale
Jan Vernon B.A.
Phil Wait VK2DKN
 Art Direction and
 Technical Photography
Ivy Hansen
 Layout
Bill Crump
 Typesetting
Lin Booth
 Reader Services
Jan Collins
 Managing Editor
Collyn Rivers
 Acoustical Consultants
Louis Challis & Associates

Mail enquiries: There is no charge for replies, but a foolscap-sized, stamped, addressed envelope must be enclosed. Queries relating to projects can only be answered if related to the item as published. We cannot advise on modifications to projects, other than errata or addenda, nor if a project has been modified or if components are other than specified. We try to answer letters as soon as possible. Difficult questions may take time to answer.

Phone enquiries: We can only answer readers' technical enquiries by telephone after 4.30 pm. In enquiring by telephone about back issues or photostats, please ask for the Subscriptions Department.

(02)33-4282

Editorial and Sales Office:
 4th Floor, 15 Boundary St, Rushcutters Bay NSW 2011. Ph. 33-4282;
 Tlx: 27243

Sales Manager: **Bob Taylor**
 Sales Admin: **Jan Collins**
 (address as above)

Melbourne: Virginia Salmon, 150 Lonsdale St, Melbourne Vic 3000. Ph: 662-1222; Tlx AA34543.

New Zealand: Geoff Collins, P.O. Box 39163, Auckland NZ. Ph: (9)760-150.

Adelaide: Admedia Group, 24 Kensington Rd, Rose Park SA 5067. Ph: 332-8144; Tlx AA82182.

United Kingdom: Australian Consolidated Press, Ludgate House, 107 Fleet St, London EC4A 2AL. Ph: 353-1040; Tlx: 267163.

Brisbane: Geoff Horne Agencies, 16 Bellbowrie Centre, Bellbowrie Qld 4070. Ph: 202-6813.

Japan: Genzo Uchida, Bancho Media Services, 15 Sanyocho, Shinjuku-Ku, Tokyo 160. Ph: 359-8866; Cable: Elbanchorito; Tlx: BMSINC J25472 Tokyo.

Perth: Aubrey Barker, 133 St Georges Terrace, Perth WA 6000. Ph: 322-3184; Tlx: AA93810

USA: Peter Samuel, Australian Consolidated Press, 444 Madison Avenue, New York NY 10022. Ph: 751-3383; Tlx: 620892.

ORDER FORM

I enclose \$ for (tick appropriate box/es). All prices include postage.
 Send orders to: ETI, 4th Floor, 15 Boundary St, Rushcutters Bay NSW 2011. Phone: (02)33-4282.

<input type="checkbox"/>	Subscriptions	\$23.30 per year within Australia	\$	NAME (Please print)
		\$28.80 overseas (surface mail)	\$	
		Airmail rates on application		
<input type="checkbox"/>	Back Issues	\$2.50 from April 1977 on (October 1978 unavailable)		ADDRESS
<input type="checkbox"/>	or photocopies	\$2.50 per article per issue		
	Project No.	Month Year	\$	
	Project No.	Month Year	\$	
	Project No.	Month Year	\$	
	Please attach a list if more than four required.			
<input type="checkbox"/>	Binders	No. @ \$6.10 in NSW	\$	POSTCODE
		No. @ \$7.50 in other states	\$	

ETI

ONE OF THE HACKS who writes for Dregs was driving along one of Sydney's main thoroughfares the other week when he spied a billboard graffiti team at work. Traffic noticeably slowed, some drivers blew their horns, others shouted encouragement and generally, those going past took notice.

It seems billboard graffiti is no longer the spasmodic expression of consumer frustration or political activism. It's now a highly organised attack against specific targets. The best-known team involved is 'Billboard Utilising Graffitiists Against Unhealthy Promotions' and they sign their work B.U.G.A. U.P. an acronym which, to the billboard lessees, seems more than appropriate! The incident of seeing the team at work set this writer thinking — what will they do next? Tossing the question amongst the lunchtime communal salad gave rise to the thought that B.U.G.A. U.P. were not optimising their efforts. The audience they reached via billboard graffiti was inevitably limited. About the most powerful advertising media available were undoubtedly TV and radio. With a slight change in name, technology and tactics, B.U.G.A. U.P. would become 'Broadcast Utilising Graffitiists Against Unhealthy Promotions'.

Speculation on the activities of this hypothetical group produces some interesting (if not amusing) possibilities: radio and TV ads suddenly blotted out and replaced by a typical B.U.G.A. U.P. anti message, advertising jingles suddenly re-arranged mid-tune etc, etc.

The problem arises, however, of how B.U.G.A. U.P. could go about such a campaign. Well, it seems there are two possibilities: infiltration and direct assault. A B.U.G.A. U.P. member (or members) could infiltrate certain advertising agencies and secretly 'doctor' radio station tapes and TV video tapes. Hmmm — bound to be

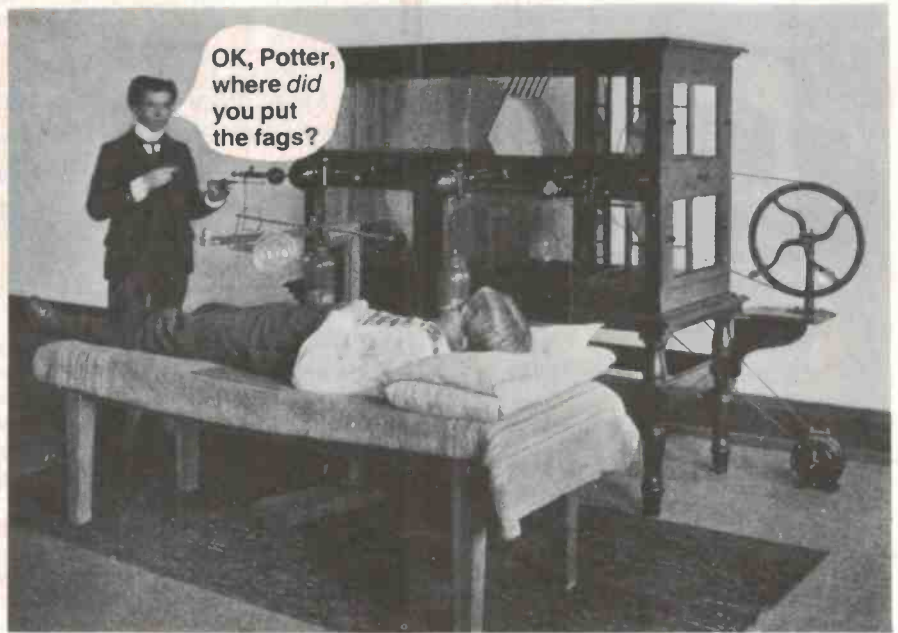

discovered as the infiltrator's profile is a little high. Same problem in infiltrating radio or TV stations. A more subtle method would be to infiltrate Telecom (maybe there's no need? ...) and 'patch' B.U.G.A. U.P. messages into the appropriate audio/video lines between studios and transmitters. This one isn't new and dates back to WWII, we're told.

So much for infiltration. Piracy is the second avenue and is as old as broadcasting itself. The idea is to have a rival, but mobile, transmitter and to broadcast B.U.G.A. U.P. messages virtually 'over the top' of transmissions during the time an advert is running. Tch, tch. One can imagine scenes of the B.U.G.A. U.P. broadcast van charging down the back streets of Blacktown hotly pursued by a Department of Communications van, police etc — a scenario straight out of the Keystone Cops!

No doubt B.U.G.A. U.P. has entertained such aspirations, but are stumped by the sheer scale of the technology and organisation, let alone the cost. But ... pocket computers were 'pie in the sky' a scant few years ago. Perhaps technological sophistication will reach the 'urban guerillas' yet.

WE'RE STILL getting feedback from the 'What's in a name?' article we published a few months ago in Dregs. This month B.W. Hopkins of Puckapunyal, Victoria, tells us of the Officer Commanding the Army School of Catering in 1980, whose name was Major Tucker. He also once knew a

Sergeant whose surname was Major, who (you guessed it) became promoted to Sergeant-Major Major. Not content with this, his brother was Major Major!

And one that we recently came across in the office here ... how about an ethnologist called Dr. Coon (nasty, nasty ...).

Pun pulchritudes

At last! — some non-computing puns. Well, we do get the occasional one, but this time around we received a whole spate. Anyway, the computer puns were generally dismal — like John Macklin's entry: "On a clear disk you can seek forever". Trevor Bartlett's winning entry published in the February issue brought out a few puns in the (resistors, resistance) same vein, but not of the same quality, including another from Trevor himself.

Amongst the best of the non-computing puns was one from Michael Clarke of Browns Plains in Qld: "Who's a cute little blonde capacitor with a set of electrodes enough to polarise a man's electrolyte — Farad Fawcett-Majors!" We have too many ladies on staff to let that one through, so this month's prize goes to Ian Steele of Ringwood in Victoria with: "What do you get if you cross a positive air ion with a negative air ion — an air heir!" Clearly inspired by our April issue lead article.

Penultimate puns to appear in the July issue — stay tuned!

UNTIL WE DEVELOPED THE STEREO GROOVE, HI-FI WAS PRETTY HO-HUM!



The world of hi-fi owes a lot to the original and continuing innovation of JVC. Few companies, if any, have done as much to help turn records and record-players into the virtual musical instruments they are today... or to lead the way in developing so many *firsts* in the more recent concepts of sound amplifiers, cassette decks and computer-designed speaker

systems. Hi-fi, as we know it today, had its beginnings in 1956, with JVC's development of the 45°/45° groove for stereo records. The fact that this system still remains as the world standard is, in itself, outstanding testimony to the technology of JVC. The development revolutionised not only the record-making industry, in which we've been involved since 1930; it also paved the way for enormous advancement in the design and engineering of record-playing equipment. Now, hi-fi has expanded to



R-S77. Super-A FM/AM Stereo receiver

embrace a wealth of highly-sophisticated electronic equipment; and it's not surprising that JVC has continued to play a leading role in so much of its development.



HR-3660 EA. VHS Colour Video Cassette recorder

THAT WASN'T OUR ONLY FIRST, EITHER.

We also pioneered Japan's television industry, introducing their first TV receiver just over 40 years ago. A more recent innovation is VHS, the home video recording system now gaining world-wide acceptance as *the* system for such equipment. In the course of staying ahead, we've introduced a number of world *firsts* of radical importance: the Quartz Lock turntable is one of them.

THE QUARTZ LOCK TURNTABLE. MANY TIMES MORE ACCURATE.

It stands to reason that if your equipment is at the top end of the range, then your turntable must be capable of comparable performance. Only Quartz Lock ensures this, tying the speed of the turntable to the unvarying pulse of the atom, and providing a level of accuracy far in excess of conventional turntables.



MORE MILESTONES IN HI-FI.

To match the superb quality of Quartz Lock, we produced the S.E.A. graphic equalizer system. Then we refined it to such a degree it even compensates for the effect your furniture has on sound when it leaves the speakers! To expand the capabilities of tape, we designed ANRS and



SEA-80. Stereo Graphic Equalizer

Super ANRS — automatic noise reduction systems which not only reduce distortion and 'hiss' but actually extend the dynamic range of the tape. Similarly, with speakers: at JVC we employ computers in their design to help provide the ultimate in sound reproduction.

AND NOW, SUPER-A.

In its own way, as significant a hi-fi development as the stereo groove. Imagine an amplifier which combines the *best* features of the two recognised amplifier classes (A and B)... an amp which combines the *efficiency* of one with the *low distortion* of the other. Some engineers said it couldn't be done; but not those at JVC. Enter the Super-A amplifier... the *latest JVC first!*

Distributed and Serviced by...
HAGEMEYER



the right choice

THE FUTURE.

It's already with us. For instance, we were so far ahead in the new metal tape technology that our cassette decks were metal-compatible before the tapes were generally available. And now there's the JVC Electro-Dynamic Servo Tonearm, damping tonearm resonance by means of a purely electronic system and two 'thinking' linear motors. Who was it who dubbed JVC, 'the innovators'?



TELETEXT

The Information Computer
you access on your own Television



- **STOCK BROKERS—SHARE MARKET ENTHUSIASTS**—Get the latest Stock Exchange and Futures market reports.
- **PUNTERS**—Get the latest odds on a race and the earliest actual results and dividends.
- Who won the cricket, football, league, tennis—get all the important results.
- What were the lotto, lottery, pool numbers—how much did it pay?
DID YOU WIN? The results are on Teletext.
- **MUM**—How much should you be paying for fruit and veggies, meat and poultry.
- **DAD**—Read the news at your leisure.
- **KIDS**—Enjoy mastermind, jokes, graphics and puzzles.
- What will the weather be like tomorrow in Brisbane, Sydney, Perth, New York, Athens, London—**IT'S ALL ON TELETEXT.**

GET ALL THIS INFORMATION and much more from the **FREE** electronic newspaper of the 80's—**YOUR OWN** television set with an **ADAM 180 TELETEXT ADAPTOR** by **RADOFIN ELECTRONICS (AUST).**

THE ADAM 180 TELETEXT ADAPTOR

by
RADOFIN ELECTRONICS (AUST)

5 Curlewis Street, Bondi, NSW 2026, AUSTRALIA

Telephones: (02) 309 1957 or (02) 309 1904